

Contents

A-Z

Owner's Manual for
Vehicle



The Ultimate Driving
Machine



THE BMW 3 SERIES SEDAN.

OWNER'S MANUAL.

BMW EfficientDynamics
Less emissions. More driving pleasure.

3 series **Owner's Manual for Vehicle**

Thank you for choosing a BMW.

The more familiar you are with your vehicle, the better control you will have on the road. We therefore strongly suggest:

Read this Owner's Manual before starting off in your new BMW. Also use the Integrated Owner's Manual in your vehicle. It contains important information on vehicle operation that will help you make full use of the technical features available in your BMW. The manual also contains information designed to enhance operating reliability and road safety, and to contribute to maintaining the value of your BMW.

Any updates made after the editorial deadline for the printed or integrated Owner's Manual are located in the appendix of the printed quick reference for the vehicle.

Supplementary information can be found in the additional brochures in the onboard literature.

We wish you a safe and enjoyable drive.

BMW AG

© 2012 Bayerische Motoren Werke
Aktiengesellschaft
Munich, Germany
Reprinting, including excerpts, only with the written
consent of BMW AG, Munich.
US English VI/12, 07 12 490
Printed on environmentally friendly paper, bleached
without chlorine, suitable for recycling.

Contents

The fastest way to find information on a particular topic or item is by using the index, refer to page [232](#).

[6](#) Notes

At a glance

[12](#) Cockpit
[16](#) iDrive
[23](#) Voice activation system
[26](#) Integrated Owner's Manual in the vehicle

Controls

[30](#) Opening and closing
[45](#) Adjusting
[55](#) Transporting children safely
[59](#) Driving
[70](#) Displays
[87](#) Lamps
[92](#) Safety
[111](#) Driving stability control systems
[116](#) Driving comfort
[138](#) Climate control
[145](#) Interior equipment
[153](#) Storage compartments

Driving tips

[160](#) Things to remember when driving
[163](#) Loading
[166](#) Saving fuel

Mobility

[172](#) Refueling
[174](#) Fuel
[175](#) Wheels and tires
[187](#) Engine compartment
[189](#) Engine oil
[192](#) Coolant
[193](#) Maintenance
[196](#) Replacing components
[207](#) Breakdown assistance
[213](#) Care

Reference

[220](#) Technical data
[224](#) Short commands of the voice act. system
[232](#) Everything from A to Z

Notes

Using this Owner's Manual

The fastest way to find information on a particular topic is by using the index.

An initial overview of the vehicle is provided in the first chapter.

Updates made after the editorial deadline

Any updates made after the editorial deadline for the Owner's Manuals are located in the appendix of the printed quick reference for the vehicle.

User's manual for Navigation, Entertainment, Communication

The topics of Navigation, Entertainment and Communication are described in a separate user's manual, which is also included with the on-board literature.

Additional sources of information

Should you have any questions, your service center will be glad to advise you at any time.

Information on BMW, e.g., on technology, is available on the Internet: bmwusa.com.

Symbols

 Indicates precautions that must be followed precisely in order to avoid the possibility of personal injury and serious damage to the vehicle.

◄ Marks the end of a specific item of information.

"..." Identifies Control Display texts used to select individual functions.

»...◄ Verbal instructions to use with the voice activation system.

»...◄◄ Identifies the answers generated by the voice activation system.

 Refers to measures that can be taken to help protect the environment.

Symbols on vehicle components

 Indicates that you should consult the relevant section of this Owner's Manual for information on a particular part or assembly.

Vehicle equipment

This Owner's Manual describes all models and all standard, country-specific and optional equipment that is offered in the model series. Therefore, in this Owner's Manual, equipment is also described and illustrated that is not available in your vehicle, e.g. because of the selected optional equipment or the country-specific variants.

This also applies for safety-related functions and systems.

For options and equipment not described in this Owner's Manual, please refer to the Supplementary Owner's Manuals.

On right-hand drive vehicles, some controls are arranged differently than shown in the illustrations.

Status of the Owner's Manual

The manufacturer of your vehicle pursues a policy of constant development that is conceived to ensure that our vehicles continue to embody the highest quality and safety standards. In rare cases, therefore, the features described in this Owner's Manual may differ from those in your vehicle.

Updates made after the editorial deadline

Any updates made after the editorial deadline for the Owner's Manuals are located in the appendix of the printed quick reference for the vehicle.

For your own safety

Maintenance and repairs

Advanced technology, e.g., the use of modern materials and high-performance electronics, requires suitable maintenance and repair methods.

Therefore, have this work performed only by a BMW center or a workshop that works according to BMW repair procedures with appropriately trained personnel.

If this work is not carried out properly, there is the danger of subsequent damage and related safety hazards.

Parts and Accessories

For your own safety, use genuine parts and accessories approved by BMW. When you purchase accessories tested and approved by BMW and Genuine BMW Parts, you simultaneously acquire the assurance that they have been thoroughly tested by BMW to ensure optimum performance when installed on your vehicle. BMW warrants these parts to be free from defects in material and workmanship. BMW will not accept any liability for damage resulting from installation of parts and accessories not approved by BMW. BMW cannot test every product made by other manufacturers to verify if it can be used on a BMW safely and without risk to either the vehicle, its operation, or its occupants. Genuine BMW Parts, BMW Accessories and other products approved by BMW, together with professional advice on using these items, are available from all BMW centers. Installation and operation of non-BMW approved accessories such as alarms, radios, amplifiers, radar detectors, wheels, suspension components, brake dust

shields, telephones, including operation of any mobile phone from within the vehicle without using an externally mounted antenna, or transceiver equipment, for instance, CBs, walkie-talkies, ham radios or similar accessories, may cause extensive damage to the vehicle, compromise its safety, interfere with the vehicle's electrical system or affect the validity of the BMW Limited Warranty. See your BMW center for additional information. Maintenance, replacement, or repair of the emission control devices and systems may be performed by any automotive repair establishment or individual using any certified automotive part.

California Proposition 65 Warning

California laws require us to state the following warning:

Engine exhaust and a wide variety of automobile components and parts, including components found in the interior furnishings in a vehicle, contain or emit chemicals known to the State of California to cause cancer and birth defects and reproductive harm. In addition, certain fluids contained in vehicles and certain products of component wear contain or emit chemicals known to the State of California to cause cancer and birth defects or other reproductive harm. Battery posts, terminals and related accessories contain lead and lead compounds. Wash your hands after handling. Used engine oil contains chemicals that have caused cancer in laboratory animals. Always protect your skin by washing thoroughly with soap and water.

Service and warranty

We recommend that you read this publication thoroughly. Your vehicle is covered by the following warranties:

- ▷ New Vehicle Limited Warranty.
- ▷ Rust Perforation Limited Warranty.
- ▷ Federal Emissions System Defect Warranty.
- ▷ Federal Emissions Performance Warranty.

- ▶ California Emission Control System Limited Warranty.

Detailed information about these warranties is listed in the Service and Warranty Information Booklet for US models or in the Warranty and Service Guide Booklet for Canadian models.

Your vehicle has been specifically adapted and designed to meet the particular operating conditions and homologation requirements in your country and continental region in order to deliver the full driving pleasure while the vehicle is operated under those conditions. If you wish to operate your vehicle in another country or region, you may be required to adapt your vehicle to meet different prevailing operating conditions and homologation requirements. You should also be aware of any applicable warranty limitations or exclusions for such country or region. In such case, please contact Customer Relations for further information.

Maintenance

Maintain the vehicle regularly to sustain the road safety, operational reliability and the New Vehicle Limited Warranty.

Specifications for required maintenance measures:

- ▶ BMW Maintenance system
- ▶ Service and Warranty Information Booklet for US models
- ▶ Warranty and Service Guide Booklet for Canadian models

If the vehicle is not maintained according to these specifications, this could result in serious damage to the vehicle. Such damage is not covered by the BMW New Vehicle Limited Warranty.

Reporting safety defects

For US customers

The following only applies to vehicles owned and operated in the US.

If you believe that your vehicle has a defect which could cause a crash or could cause injury or death, you should immediately inform the National Highway Traffic Safety Administration NHTSA, in addition to notifying BMW of North America, LLC, P.O. Box 1227, Westwood, New Jersey 07675-1227, Telephone 1-800-831-1117.

If NHTSA receives similar complaints, it may open an investigation, and if it finds that a safety defect exists in a group of vehicles, it may order a recall and remedy campaign.

However, NHTSA cannot become involved in individual problems between you, your dealer, or BMW of North America, LLC.

To contact NHTSA, you may call the Vehicle Safety Hotline toll-free at 1-888-327-4236 (TTY: 1-800-424-9153); go to <http://www.safercar.gov>; or write to: Administrator, NHTSA, 400 Seventh Street, SW., Washington, DC 20590. You can also obtain other information about motor vehicle safety from <http://www.safercar.gov>

For Canadian customers

Canadian customers who wish to report a safety-related defect to Transport Canada, Defect Investigations and Recalls, may telephone the toll-free hotline 1-800-333-0510. You can also obtain other information about motor vehicle safety from <http://www.tc.gc.ca/roadsafety>.



At a glance

These overviews of buttons, switches and displays are intended to familiarize you with your vehicle. You will also become quickly acquainted with the available control concepts and options.

Cockpit

Vehicle equipment

All standard, country-specific and optional equipment that is offered in the model series is described in this chapter. Therefore, equipment

is also described that is not available in a vehicle, e. g., because of the selected optional equipment or country variant. This also applies for safety-related functions and systems.

All around the steering wheel

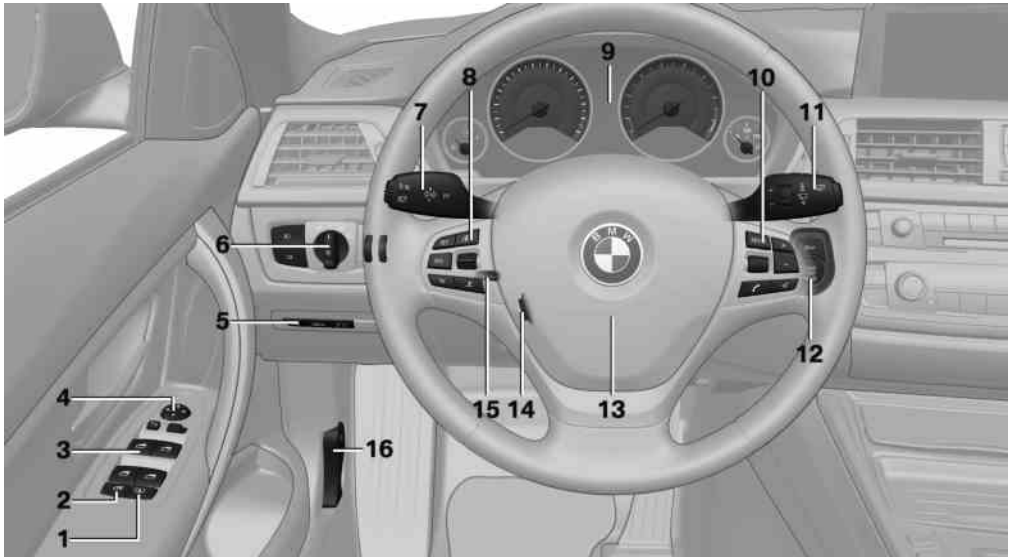

- 1 Roller sunblinds [43](#)
 - 2 Rear window safety switch [42](#)
 - 3 Power windows [41](#)
 - 4 Exterior mirror operation [52](#)
 - 5 Glove compartment on the driver's side [153](#)
- Driver assistance systems



Active Blind Spot Detection [106](#)































Collision warning [102](#)

Collision warning with braking function [100](#)







Lane departure warning [104](#)

- 6 Lamps

-  Front fog lamps 90
-  Parking lamps 87
-  Low beams 87
-  Automatic headlamp control 88
-  Daytime running lights 88
-  Adaptive light control 89
-  High-beam Assistant 89
-  Instrument lighting 90
- 7** Steering column stalk, left
-  Turn signal 63
-  High beams, headlamp flasher 63
-  High-beam Assistant 89
-  Roadside parking lamps 88
-  Computer 81
- 8** Steering wheel buttons, left
-  Store speed 122
-  Resume speed 124
-  Cruise control on/off, interrupting 122
-  Active Cruise Control on/off, interrupting 116
-  Increase distance 118
-  Reduce distance 118
- Cruise control rocker switch 123, 117
- 9** Instrument cluster 70
- 10** Steering wheel buttons, right
-  Entertainment source
-  Volume
-  Voice activation 23
-  Phone, see user's manual for Navigation, Entertainment and Communication.
- Thumbwheel for selection lists 81
- 11** Steering column stalk, right
-  Windshield wipers 64
-  Rain sensor 65
-  Clean the windshields and headlamps 65
- 12**  Start/stop the engine and switch the ignition on/off 60
-  Auto Start/Stop function 61
- 13** Horn
- 14**  Steering wheel heating 54
- 15** Adjust steering wheel 54
- 16** Unlock hood 188





All around the center console



- | | | | | | |
|---|--|-----|----|---|-------|
| 1 | Headliner | 15 | 8 | Controller with buttons | 16 |
| 2 | Control Display | 16 | 9 | Parking brake | 63 |
| 3 | Ventilation | 143 | 10 |  PDC Park Distance Control | 124 |
| 4 |  Hazard warning system | 207 | | Backup camera | 126 |
| |  Central locking system | 33 | | Parking assistant | 133 |
| | | | | Surround View | 126 |
| 5 | Glove compartment | 153 | 11 |  Driving Experience Switch | 113 |
| 6 | Radio/CD/Multimedia, see user's manual for Navigation, Entertainment and Communication. | | |  DSC Dynamic Stability Control | 111 |
| 7 | Climate control | 138 | 12 | Transmission selector lever | 67 67 |

All around the headliner



- | | | | | | |
|---|---|---|---|---|-----------------------------------|
| 1 |  | Emergency Request 207 | 4 |  | Reading lamps 91 |
| 2 |  | Glass sunroof, powered 43 | 5 |  | Interior lamps 91 |
| 3 |  | Indicator lamp, front passenger airbag 94 | | | |

iDrive

Vehicle equipment

All standard, country-specific and optional equipment that is offered in the model series is described in this chapter. Therefore, equipment is also described that is not available in a vehicle, e. g., because of the selected optional equipment or country variant. This also applies for safety-related functions and systems.

The concept

The iDrive combines the functions of a multitude of switches. Thus, these functions can be operated from a central location.

 Using the iDrive during a trip

To avoid becoming distracted and posing an unnecessary hazard to your vehicle's occupants and to other road users, never attempt to use the controls or enter information unless traffic and road conditions allow this. ◀

Controls at a glance

Controls



- 1 Control Display
- 2 Controller with buttons

The buttons can be used to open the menus directly. The controller can be used to select menu items and create the settings.

Control Display

Notes

- ▶ To clean the Control Display, follow the care instructions.
- ▶ Do not place objects close to the Control Display; otherwise, the Control Display can be damaged.

Switching off

1.  Press the button.
2. "Switch off control display"

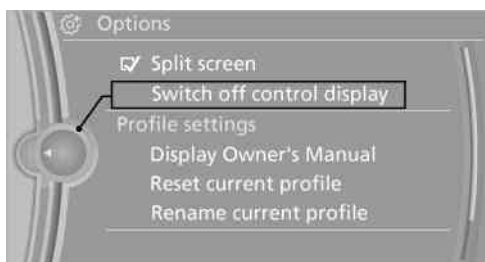

Switching on

Press the controller again to switch the screen back on.

Controller with navigation system

Select menu items and create settings.

1. Turn.

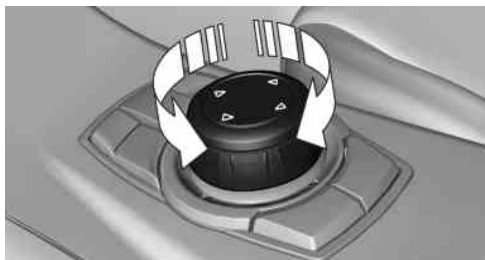

2. Press.



3. Move in four directions.

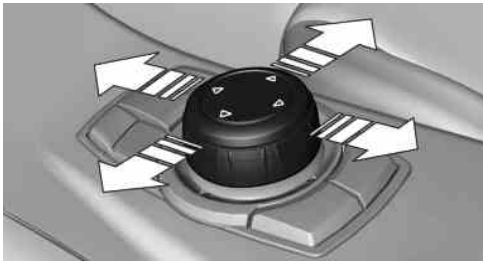

Buttons on controller

Press the button	Function
MENU	Open the main menu.
RADIO	Opens the Radio menu.
MEDIA	Opens the CD/Multimedia menu.
NAV	Opens the Navigation menu.
TEL	Opens the Telephone menu.
BACK	Displays the previous panel.
OPTION	Opens the Options menu.

Controller without navigation system

Select menu items and create settings.

1. Turn.

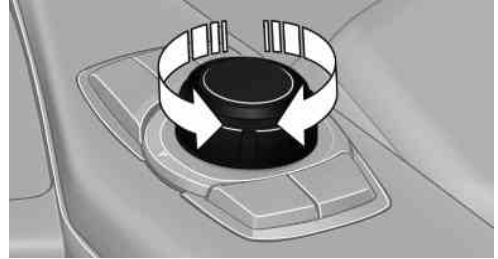

2. Press.

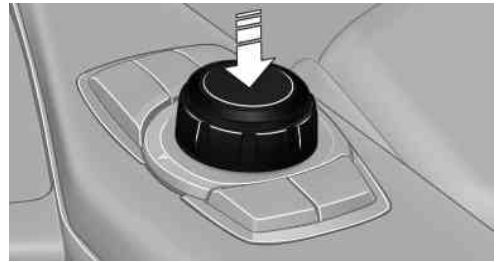

3. Move in two directions.

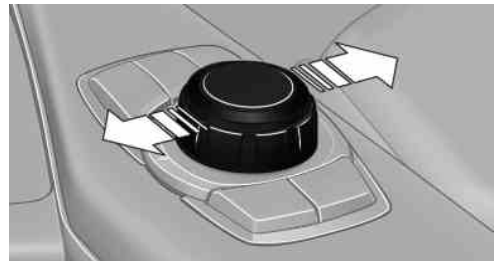

Buttons on controller

Press the button	Function
MENU	Open the main menu.
Audio	Open audio menu last listened to, switch between audio menus.
TEL	Opens the Telephone menu.

Press the button	Function
BACK	Open previous panel.
OPTION	Opens the Options menu.

Operating concept

Opening the main menu



Press the button.

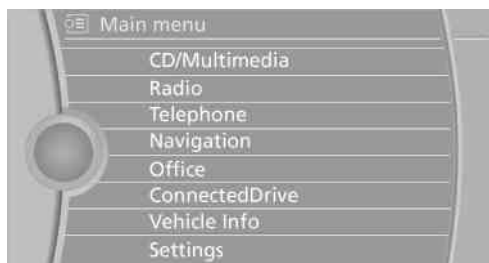

The main menu is displayed.

All iDrive functions can be called up via the main menu.

Selecting menu items

Menu items shown in white can be selected.

1. Turn the controller until the desired menu item is highlighted.

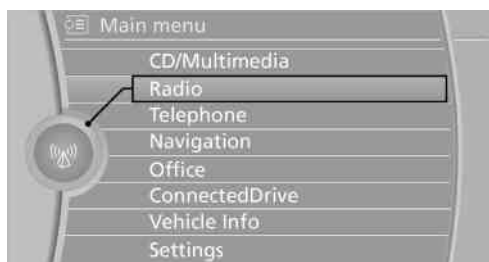

2. Press the controller.

Menu items in the Owner's Manual

In the Owner's Manual, menu items that can be selected are set in quotation marks, e.g., "Settings".

Changing between panels

After a menu item is selected, e.g., "Radio", a new panel is displayed. Panels can overlap.

- ▷ Move the controller to the left.

The current panel is closed and the previous panel is displayed.

The previous panel is opened again by pressing the BACK button. In this case, the current panel is not closed.
- ▷ Move the controller to the right.

A new panel is opened on top of the previous display.

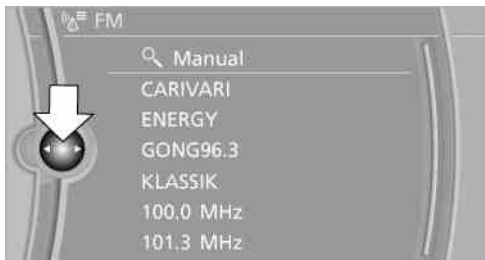

White arrows pointing to the left or right indicate that additional panels can be opened.

View of an opened menu

When a menu is opened, it generally opens with the panel that was last selected in that menu. To display the first panel of a menu:

- ▷ Move the controller to the left repeatedly until the first panel is displayed.
- ▷ Press the menu button on the controller twice.

Opening the Options menu



Press the button.

The "Options" menu is displayed.

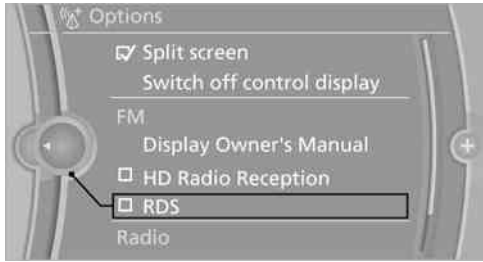

Additional options: move the controller to the right repeatedly until the "Options" menu is displayed.

Options menu

The "Options" menu consists of various areas:

- ▶ Screen settings, e.g., "Split screen".
This area remains unchanged.
- ▶ Control options for the selected main menu, e.g., for "Radio".
- ▶ If applicable, further operating options for the selected menu, e.g., "Store station".

Changing settings

1. Select a field.
2. Turn the controller until the desired setting is displayed.

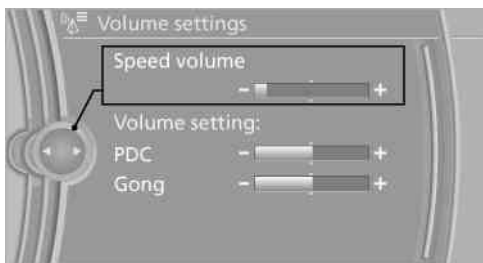

3. Press the controller.

Activating/deactivating the functions

Several menu items are preceded by a checkbox. It indicates whether the function is activated or deactivated. Selecting the menu item activates or deactivates the function.

- The function is activated.

- The function is deactivated.

Example: setting the clock

Setting the clock

1.  Press the button. The main menu is displayed.
2. Turn the controller until "Settings" is highlighted, and then press the controller.

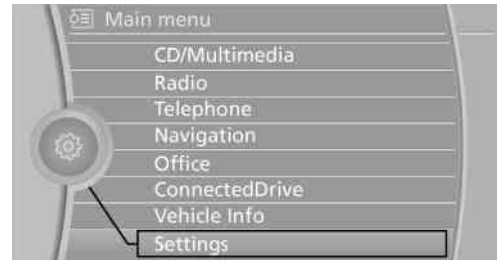

3. If necessary, move the controller to the left to display "Time/Date".
4. Turn the controller until "Time/Date" is highlighted, and then press the controller.



- Turn the controller until "Time:" is highlighted, and then press the controller.

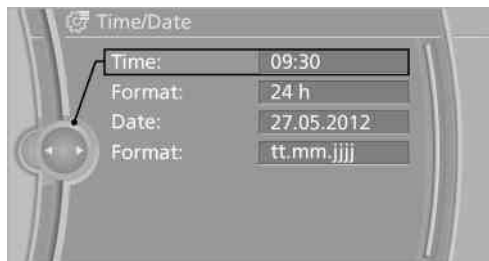

- Turn the controller to set the hours and press the controller.
- Turn the controller to set the minutes and press the controller.

Status information

Status field

The following information is displayed in the status field at the top right:

- ▷ Time.
- ▷ Current entertainment source.
- ▷ Sound output, on/off.
- ▷ Wireless network reception strength.
- ▷ Telephone status.
- ▷ Traffic bulletin reception.











Status field symbols

The symbols are grouped as follows.







Radio symbols

Symbol	Meaning
	Satellite radio is switched on.

Telephone symbols

Symbol	Meaning
	Incoming or outgoing call.
	Missed call.
	Wireless network reception strength. Symbol flashes: network search.
	Wireless network is not available.
	Bluetooth is switched on.
	Roaming is active.
	Text message was received.
	Check the SIM card.
	SIM card is blocked.
	SIM card is missing.
	Enter the PIN.

Entertainment symbols

Symbol	Meaning
	CD/DVD player.
	Music collection.
	Gracenote® database.
	AUX-IN port.
	USB audio interface/mobile phone audio interface.
	USB audio interface.
	Mobile phone audio interface.

Additional symbols

Symbol	Meaning
	Spoken instructions are switched off.

Split screen

General information

Additional information can be displayed on the right side of the split screen, e.g., information from the onboard computer.

In the divided screen view, the so-called split screen, this information remains visible even when you change to another menu.

Switching the split screen on and off

1.  Press the button.
2. "Split screen"

Selecting the display

1.  Press the button.
2. "Split screen"
3. Move the controller until the split screen is selected.
4. Press the controller or select "Split screen content".
5. Select the desired menu item.

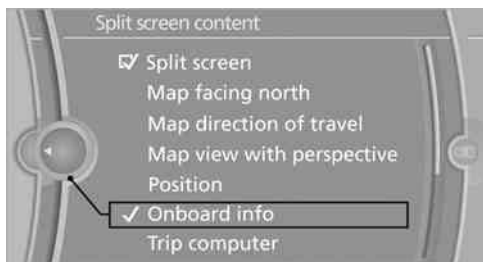

Programmable memory buttons

General information

The iDrive functions can be stored on the programmable memory buttons and called up directly, e.g., radio stations, navigation destina-

tions, phone numbers and entry points into the menu.

The settings are stored for the remote control currently in use.

Without navigation system and telephone

Only radio stations can be stored on the buttons, refer to user's manual for Navigation, Entertainment and Communication.

Saving a function

1. Highlight the function via the iDrive.
2.  Press the desired button for more than 2 seconds.

Running a function

1.  Press the button.
- The function will run immediately. This means, for example, that the number is dialed when a phone number is selected.

Displaying the button assignment

Use a finger to touch the buttons. Do not wear gloves or use objects.

The key assignment is displayed at the top edge of the screen.

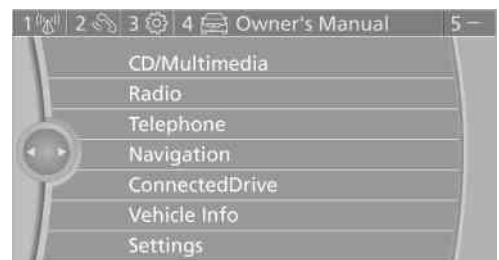

- ▷ To display short information: touch the button.
- ▷ To display detailed information: touch the button for an extended period.



Deleting the button assignments

1. Press buttons 1 and 8 simultaneously for approx. five seconds.
2. "OK"

Entering letters and numbers

General information

1. Turn the controller: select letters or numbers.
2. Select additional letters or numbers if needed.
3. "OK": confirm the entry.

Symbol	Function
	Press the controller: delete the letter or number.
	Press the controller for an extended period: delete all letters or numbers.
	Enter a blank space.

Switching between cases, letters and numbers

Depending on the menu, you can switch between entering upper and lower case, letters and numbers:

Symbol	Function
A^Bc	Enter the letters.
1@+	Enter the numbers.
abc or ABC	Move the controller up.

Without navigation system

@^A A^a a[@] Select the symbol.

Entry comparison

Entry of names and addresses: the selection is narrowed down every time a letter is entered and letters may be added automatically.

The entries are continuously compared to the data stored in the vehicle.

- ▶ Only those letters are offered during the entry for which data is available.
- ▶ Destination search: town/city names can be entered using the spelling of language available on the Control Display.

Voice activation system

Vehicle equipment

All standard, country-specific and optional equipment that is offered in the model series is described in this chapter. Therefore, equipment is also described that is not available in a vehicle, e. g., because of the selected optional equipment or country variant. This also applies for safety-related functions and systems.

The concept

- ▶ Most functions that are displayed on the Control Display can be operated by spoken commands via the voice activation system. The system prompts you to make your entries.
- ▶ Functions that can only be used when the vehicle is stationary cannot be operated using the voice activation system.
- ▶ The system uses a special microphone on the driver's side.
- ▶ ›...‹ Verbal instructions in the Owner's Manual to use with the voice activation system.

Requirements

Via the Control Display, set a language that is also supported by the voice activation system so that the spoken commands can be identified. Set the language, refer to page 85.

Using voice activation

Activating the voice activation system

1.  Press the button on the steering wheel.

2. Wait for the signal.

3. Say the command.

The command is displayed in the instrument cluster.

 This symbol in the instrument cluster indicates that the voice activation system is active.

If no other commands are available, operate the function in this case via iDrive.

Terminating the voice activation system



Briefly press the button on the steering wheel or ›Cancel‹.

Possible commands

Most menu items on the Control Display can be voiced as commands.

The available commands depend on which menu is currently displayed on the Control Display.

There are short commands for functions of the main menu.

Some list entries, e.g. Phone book entries, can also be selected via the voice activation system. Speak these list entries exactly as they are displayed in the respective list.

Having possible commands read aloud

You can have the available commands read out loud for you: ›Voice commands‹

For example, if the "Settings" menu is displayed, the commands for the settings are read out loud.

Executing functions using short commands

Functions on the main menu can be performed directly by means of short commands, nearly ir-

respective of which menu item is currently selected, e.g., ›Vehicle status‹.

List of short commands of the voice activation system, refer to page 224.

Help dialog for the voice activation system

Calling up help dialog: ›Help‹

Additional commands for the help dialog:

- ▷ ›Help with examples‹: information about the current operating options and the most important commands for them are announced.
- ▷ ›Help with voice activation‹: information about the principle of operation for the voice activation system is announced.

Example: playing back a CD

1. Switch on the Entertainment sound output if necessary.
2.  Press the button on the steering wheel.
3. ›CD and multimedia‹
The medium last played is played back.
4. ›CD track ...‹ e.g., CD track 4.

Setting the voice dialog

You can set whether the system should use the standard dialog or a shorter version.

In the shorter variant of the voice dialog, the announcements from the system are issued in an abbreviated form.

On the Control Display:

1. "Settings"
2. "Language/Units"

3. "Speech mode:"
4. Select the setting.

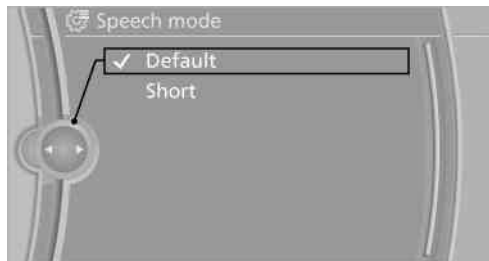

Adjusting the volume

Turn the volume button while giving an instruction until the desired volume is set.

- ▷ The volume remains constant even if the volume of other audio sources is changed.
- ▷ The volume is stored for the remote control currently in use.

Notes on Emergency Requests

Do not use the voice activation system to initiate an Emergency Request. In stressful situations, the voice and vocal pitch can change. This can unnecessarily delay the establishment of a telephone connection.

Instead, use the SOS button, refer to page 207, in the vicinity of the interior mirror.

Environmental conditions

- ▷ Say the commands, numbers, and letters smoothly and with normal volume, emphasis, and speed.
- ▷ Always say commands in the language of the voice activation system.
- ▷ When selecting a radio station, use the common pronunciation of the station name:

- ›Station ...« e. g. Classic Radio station
- ▶ Keep the doors, windows, and glass sunroof closed to prevent noise interference.
- ▶ Avoid making other noise in the vehicle while speaking.

Integrated Owner's Manual in the vehicle

Vehicle equipment

All standard, country-specific and optional equipment that is offered in the model series is described in this chapter. Therefore, equipment is also described that is not available in a vehicle, e. g., because of the selected optional equipment or country variant. This also applies for safety-related functions and systems.

Integrated Owner's Manual in the vehicle

The integrated Owner's Manual can be displayed on the Control Display. The equipment and functions that are in the vehicle are described therein.

Components of the integrated Owner's Manual

The integrated Owner's Manual consists of three parts, which offer various levels of information or access possibilities.

Quick Reference Guide

Located in the Quick Reference is important information for the operation of the vehicle, the operation of basic vehicle functions or for what to do in the event of a flat tire. This information can also be displayed during driving.

Search by pictures

Information and descriptions based on illustrations can be searched via search by pictures. This is helpful, for example, if the description of an outfitting package that cannot be named is needed.

Owner's Manual

Information and descriptions can be searched by direct entry of a search term via the index.

Select components

1.  Press the button.
2. Turn the controller: open "Vehicle Info".
3. Press the controller.
4. Selecting desired range:
 - ▷ "Quick reference"
 - ▷ "Search by pictures"
 - ▷ "Owner's Manual"

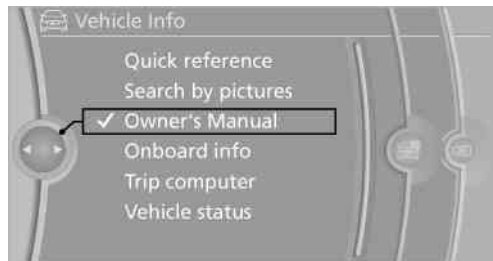

Leafing through the Owner's Manual

Page by page with link access

Turn the controller until the next or previous page is displayed.

Page by page without link access

Leaf through the pages directly while skipping the links.

Highlight the symbol once. Now simply press the controller to leaf from page to page.



Leaf back.



Leaf forward.

Context help - Owner's Manual to the temporarily selected function

The relevant information can be opened directly.

Opening via the iDrive

To move directly from the application on the Control Display to the options menu:

1.  Press the button or move the controller to the right repeatedly until the "Options" menu is displayed.
2. "Display Owner's Manual"



Opening when a Check Control message is displayed

Directly from the Check Control message on the Control Display:

"Display Owner's Manual"

Changing between a function and the Owner's Manual

To change from a function, e.g., radio, to the Owner's Manual on the Control Display and to switch between the two displays:

1.  Press the button or move the controller to the right repeatedly until the "Options" menu is displayed.
2. "Display Owner's Manual"
3. Select the desired page in the Owner's Manual.
4.  Press the button again to return to the function displayed last.
5.  Press the button to return to the page of the Owner's Manual displayed last.

To switch back and forth repeatedly between the function displayed last and the page of the Owner's Manual displayed last, repeat steps 4 and 5. This opens a new panel every time.

Programmable memory buttons

General information

The Owner's Manual can be stored on the programmable memory buttons and called up directly.

Storing

1. "Owner's Manual" Select via the iDrive.
2.  Press the desired button for more than 2 seconds.

Executing

1.  Press the button.
The Owner's Manual is displayed immediately.



Controls

This chapter is intended to provide you with information that will give you complete control of your vehicle. All features and accessories that are useful for driving and your safety, comfort and convenience are described here.

Opening and closing

Vehicle equipment

All standard, country-specific and optional equipment that is offered in the model series is described in this chapter. Therefore, equipment is also described that is not available in a vehicle, e. g., because of the selected optional equipment or country variant. This also applies for safety-related functions and systems.

Remote control/key

Buttons on the remote control

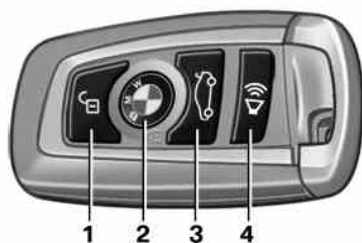

- 1 Unlocking
- 2 Locking
- 3 Opening the trunk lid
- 4 Panic mode in alarm system

General information

The vehicle is supplied with two remote controls with keys.

Every remote control contains a replaceable battery.

The settings called up and implemented when the vehicle is unlocked depend on which remote control is used to unlock the vehicle, Personal Profile, refer to page 31.

In addition, information about service requirements is stored in the remote control, Service data in the remote control, refer to page 193.

Integrated key

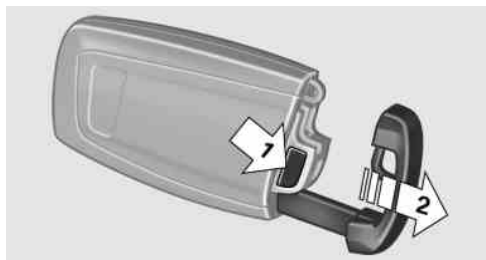

Press the button on the back of the remote control, arrow 1, and pull out the key, arrow 2.

The integrated key fits the following locks:

- ▷ Driver's door.
- ▷ Glove compartment on the front passenger side.

The front passenger glove compartment contains a switch for separately securing the trunk lid, refer to page 38.

Replacing the battery

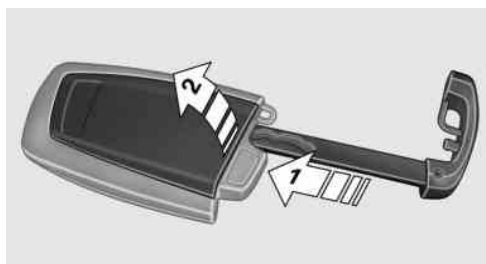

1. Take the integrated key out of the remote control.
2. Push in the catch with the key, arrow 1.
3. Remove the cover of the battery compartment; see arrow 2.
4. Insert a battery of the same type with the positive side facing upwards.
5. Press the cover closed.



Take the used battery to a recycling center or to your service center.

New remote controls

You can obtain new remote controls from your service center.

Loss of the remote controls

Lost remote controls can be blocked by your service center.

Emergency detection of remote control

It is possible to switch on the ignition or start the engine in situations such as the following:

- ▷ Interference of radio transmission to remote control by external sources.
- ▷ Discharged battery in the remote control.
- ▷ Interference of radio transmission by mobile devices in close proximity to the remote control.
- ▷ Interference of radio transmission by charger while charging items such as mobile devices in the vehicle.

A Check Control message is displayed if an attempt is made to switch on the ignition or start the engine.

Starting the engine in case of emergency detection of remote control



Automatic transmission: if a corresponding Check Control message appears, hold the remote control, as shown, against the marked area on the steering column and press the Start/Stop

button within 10 seconds while pressing the brake.

Manual transmission: if a corresponding Check Control message appears, hold the remote control, as shown, against the marked area on the steering column and press the Start/Stop button within 10 seconds while pressing the clutch pedal.

Personal Profile

The concept

You can set several of your vehicle's functions to suit your personal needs and preferences.

- ▷ The settings are automatically saved in the profile currently activated.
- ▷ The remote control used is detected when the vehicle is unlocked and the stored profile is called up.
- ▷ Your personal settings will be recognized and called up again even if the vehicle has been used in the meantime by someone else with another remote control.

The individual settings are stored for three Personal Profiles and one guest profile.

Transmitting the settings

Your personal settings can be taken with you to another vehicle equipped with the Personal Profile function. For more information, contact your service center.

The settings are transmitted as follows:

- ▷ The USB interface in the center armrest onto a USB device.

Profile management

Opening the profiles

A different profile can be called up than the one associated with the remote control currently in use.

1. "Settings"
2. "Profiles"

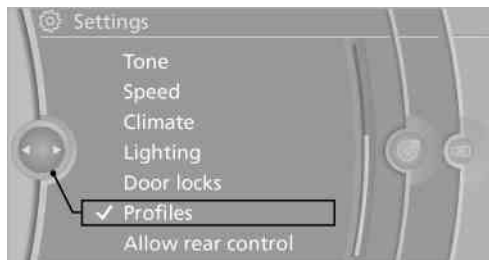

3. Select a profile.

The profile that is opened is assigned to the remote control currently in use.

Renaming profiles

1. "Settings"
2. "Profiles"

The current profile is selected.

3. Open "Options".
4. "Rename current profile"

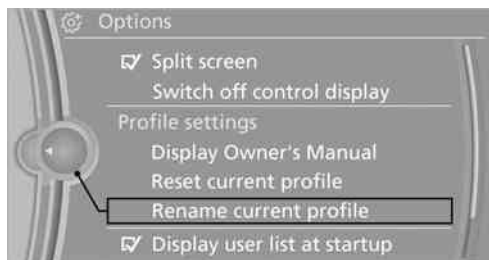

Resetting profiles

The settings of the active profile are reset to their default values.

1. Switch on the ignition.
2. "Settings"
3. "Profiles"
 - The current profile is selected.
4. Open "Options".
5. "Reset current profile"

Importing profiles

Existing settings and contacts are overwritten with the imported profile.

1. "Settings"
2. "Profiles"
3. "Import profile"

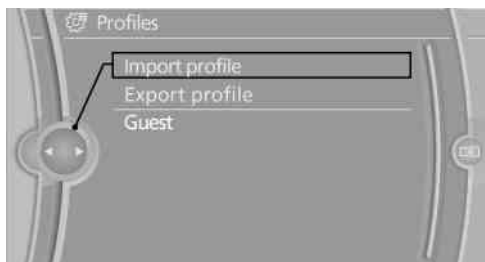

4. USB interface: "USB device"

Exporting profiles

Most settings of the active profile and the saved contacts can be exported.

This can be useful for storing and opening personal settings, e.g. if settings are accidentally changed or deleted.

1. "Settings"
2. "Profiles"
3. "Export profile"
4. USB interface: "USB device"

Using the guest profile

The guest profile can be used to make individual settings without affecting the three Personal Profiles.

This can be useful for drivers who are using the vehicle temporarily and do not have their own profile.

1. "Settings"
2. "Profiles"
3. The current profile is selected.
4. Open "Guest".
5. Adjust the settings.

Note: the guest profile cannot be renamed.

Display profile list during start

The profile list can be displayed during each start for selecting the desired profile.

1. "Settings"
2. "Profiles"
3. Open "Options".
4. "Display user list at startup"

Personal Profile settings

The following functions and settings can be stored in a profile.

More information on the settings can be found under:

- ▷ Collision warning: warning time, last setting on/off.
- ▷ Exterior mirror position.
- ▷ CD/Multimedia: audio source listened to last.
- ▷ Driving Experience Switch: sport program
- ▷ Driver's seat position: automatically retrieved after unlocking.
- ▷ Programmable memory buttons: assignment.
- ▷ Head-up Display: selection, brightness, position and rotation of the display.

- ▷ Headlamp courtesy delay feature: time setting.
- ▷ Tone: tone settings.
- ▷ Automatic climate control/Automatic climate control with enhanced features: settings.
- ▷ Navigation: map views, route criteria, voice output on/off.
- ▷ Park Distance Control PDC: adjusting the signal tone volume.
- ▷ Radio: stored stations, station listened to last, special settings.
- ▷ Backup camera: selection of functions and type of display.
- ▷ Side View: selection of the display type.
- ▷ Language on the Control Display.
- ▷ Lane departure warning: last setting, on/off.
- ▷ Active Blind Spot Detection: last setting, on/off.
- ▷ Daytime running lights: current setting.
- ▷ Triple turn signal activation.
- ▷ Locking the vehicle: after a brief period or after starting to drive.

Central locking system

The concept

The central locking system becomes active when the driver's door is closed.

The system simultaneously engages and releases the locks on the following:

- ▷ Doors.
- ▷ Trunk lid.
- ▷ Fuel filler flap.

Operating from the outside

- ▷ Via the remote control.
- ▷ Via the door handles of the driver's and front passenger doors.

The following takes place simultaneously when locking/unlocking the vehicle via the remote control:

- ▷ Depending on how the vehicle is equipped, the theft protection is activated/deactivated. Theft protection prevents the doors from being unlocked using the lock buttons or the door opener.
- ▷ The welcome lamps, interior lamps and courtesy lamps are switched on and off.
- ▷ The alarm system, refer to page 40, is armed or disarmed.

Operating from the inside



Via the button for the central locking system.

If the vehicle has been locked from inside, the fuel filler flap remains unlocked.

If an accident of a certain severity occurs, the central locking system unlocks automatically.

The hazard warning system and interior lamps come on.

Opening and closing: from the outside

Using the remote control

General information



Take the remote control with you. People or animals left unattended in a parked vehicle can lock the doors from the inside. Always take the remote control with you

when leaving the vehicle so that the vehicle can then be opened from the outside. ◀

Unlocking



Press the button on the remote control.

The vehicle is unlocked.

Welcome lamps, interior lamp and courtesy lamps are switched on.

You can set how the vehicle is to be unlocked.

The setting is stored for the remote control currently in use.

1. "Settings"
2. "Door locks"
3. With professional navigation system:
"Unlock button:"

Without professional navigation system:  Select a symbol.

4. Select the desired function:

- ▷ "Driver's door only"

Only the driver's door and the fuel filler flap are unlocked. Pressing again unlocks the entire vehicle.

- ▷ "All doors"

The entire vehicle is unlocked.

Depending on how the vehicle is equipped or the country-specific variant, you can set whether the doors are also unlocked with the  button on the remote control.

Convenient opening

The remote control can be used to simultaneously open the windows and the glass sunroof.



Press and hold the button on the remote control.

The windows and the glass sunroof open.

Releasing the button stops the motion.

Locking



Press the button on the remote control.



Locking from the outside

Do not lock the vehicle from the outside if there are people in it, as the vehicle cannot be unlocked from inside without special knowledge. ◀

Switching on interior lamps and courtesy lamps



Press the button on the remote control with the vehicle locked.

Panic mode

You can trigger the alarm system if you find yourself in a dangerous situation.



Press the button on the remote control for at least 3 seconds.

To switch off the alarm: press any button.

Opening the trunk lid



Press the button on the remote control for approx. 1 second.

The trunk lid opens, regardless of whether it was previously locked or unlocked.

During opening, the trunk lid pivots back and up. Ensure that adequate clearance is available before opening.

In some vehicle equipment variants, the trunk lid can only be opened using the remote control if the vehicle was unlocked first.

To avoid locking yourself out of the vehicle, do not place the remote control into the cargo area. The trunk lid is locked again as soon as it is pushed closed.

Confirmation signals from the vehicle

1. "Settings"
2. "Door locks"

3. Deactivate or activate the desired confirmation signals.

- ▶ "Acoustic sig. lock/unlock"
- ▶ "Flash when lock/unlock"

Retrieving the seat and mirror settings

The driver's seat and exterior mirror positions used last are stored for the remote control currently in use.

When the vehicle is unlocked, these positions are automatically retrieved if this function was activated.



Pinch hazard when moving back the seat

If this function is used, first make sure that the footwell behind the driver's seat is empty. Otherwise, people can be injured or objects damaged when the seat is moved back. ◀

The adjustment procedure is interrupted:

- ▶ When a seat position switch is pressed.
- ▶ When a button of the seat and mirror memory is pressed.

Activating the setting

1. "Settings"
2. "Door locks"
3. "Last seat position auto."

Malfunction

If the vehicle can no longer be locked or unlocked with the remote control, the battery may be discharged or there may be interference from external sources such as mobile phones, metal objects, overhead power lines, transmission towers, etc.

If this occurs, unlock or lock the vehicle at the door lock using the integrated key.

For US owners only

The transmitter and receiver units comply with part 15 of the FCC/Federal Communication Commission regulations. Operation is governed by the following:

FCC ID:

- ▷ LX8766S.
- ▷ LX8766E.
- ▷ LX8CAS.
- ▷ LX8CAS2.
- ▷ MYTCAS4.

Compliance statement:

This device complies with part 15 of the FCC Rules. Operation is subject to the following two conditions:

- ▷ This device may not cause harmful interference, and
- ▷ this device must accept any interference received, including interference that may cause undesired operation.

Any unauthorized modifications or changes to these devices could void the user's authority to operate this equipment.

Using the door lock

General information

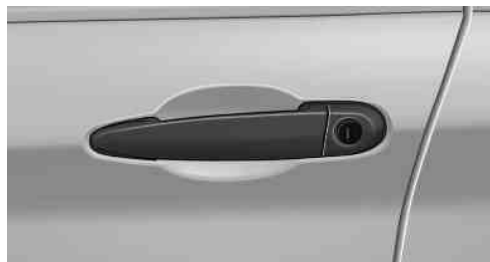

Locking from the outside

Do not lock the vehicle from the outside if there are people in it, as the vehicle cannot be unlocked from inside without special knowledge. ◀

The alarm system is triggered when the door is opened, if the vehicle is unlocked via the door lock.

In order to terminate this alarm, unlock vehicle with the remote control, or switch on the igni-

tion, if necessary, by emergency detection of the remote control.

Only the driver's door is unlocked or locked via the door lock.

Locking the doors and trunk lid together

To lock all doors and the trunk lid at once:

1. With the doors closed, lock the vehicle using the button for the central locking system in the interior.
2. Unlock and open the driver's or front passenger door.
3. Lock the vehicle.
 - ▷ Lock the driver's door using the integrated key in the door lock, or
 - ▷ Press down the lock button of the front passenger door and close the door from the outside.

The fuel filler flap can only be locked using the remote control.

Manual operation

If an electrical malfunction occurs, lock or unlock the vehicle using the integrated key via the door lock on the driver's door.

Opening and closing: from the inside

Locking and unlocking

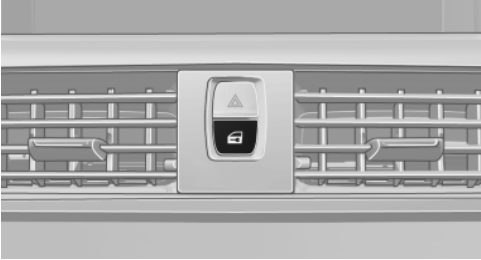

Pressing the buttons locks and unlocks the doors and the trunk lid when the front doors are closed, but they are not secured against theft.

The fuel filler flap remains unlocked.

Unlocking and opening

- ▷ Either unlock the doors together using the button for the central locking system and then pull the door handle above the armrest or
- ▷ Pull the door opener twice individually on each door: the first time unlocks the door, the second time opens it.

Automatic locking

The setting is stored for the remote control currently in use.

1. "Settings"
2. "Door locks"
3. Select the desired function:
 - ▷ "Lock if no door is opened"
The vehicle locks automatically after a short period of time if a door is not opened.
 - ▷ "Lock after start. to drive"
The vehicle locks automatically after you drive away.

Trunk lid

Opening

During opening, the trunk lid pivots back and up. Ensure that adequate clearance is available before opening.

Opening from the outside

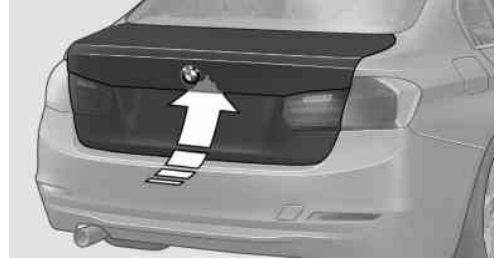

- ▷ Press the button on the trunk lid.
- ▷  Press the button on the remote control for approx. 1 second.
- ▷ With Comfort Access the trunk lid opens with no-touch activation, refer to page 39.

Opening from the inside



Push the button in the driver's footwell.

If the vehicle is stationary, the trunk lid opens if it is not locked.

Closing



Recessed grips in the interior trim of the trunk lid make it easier to pull down the lid.

 Keep the closing path clear
Make sure that the closing path of the trunk lid is clear; otherwise, injuries may result. ◀

 Do not place the remote control in the cargo area

Take the remote control with you and do not leave it in the cargo area; otherwise, the remote control is locked inside the vehicle when the trunk lid is closed. ◀

Locking separately

The trunk lid can be locked separately with the switch in the front passenger glove compartment.

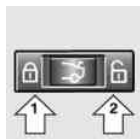

- ▷ Trunk lid secured, arrow 1.
- ▷ Trunk lid not secured, arrow 2.

Slide the switch into the arrow 1 position. This secures the trunk lid and disconnects it from the central locking system.

When the front passenger glove compartment is locked, the trunk lid cannot be opened.

This is beneficial when the vehicle is parked using valet service. The infrared remote control can be handed out without the key.

Emergency unlocking



Pull the handle inside the cargo area.

The trunk lid unlocks.

Comfort Access

The concept

The vehicle can be accessed without activating the remote control.

All you need to do is to have the remote control with you, e.g., in your jacket pocket.

The vehicle automatically detects the remote control when it is nearby or in the passenger compartment.

Comfort Access supports the following functions:

- ▷ Unlocking/locking of the vehicle.
- ▷ Unlocking of the trunk lid separately.
- ▷ Open trunk lid with no-touch activation.
- ▷ Starting the engine.

Functional requirements

- ▷ There are no external sources of interference nearby.
- ▷ To lock the vehicle, the remote control must be located outside of the vehicle.
- ▷ The next unlocking and locking cycle is not possible until after approx. 2 seconds.
- ▷ The engine can only be started if the remote control is inside the vehicle.

Comparison with ordinary remote control

The functions can be controlled by pressing the buttons of the remote control or Comfort Access.

Unlocking

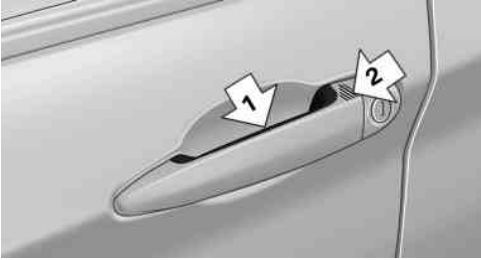

Grasp the door handle on the driver's or front passenger door completely, arrow 1. This corresponds to pressing the  button on the remote control.

Locking

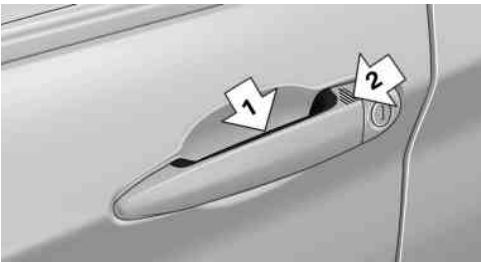

Press the area on the door handle, arrow 2, with your finger for approx. 1 second.

This corresponds to pressing the  button on the remote control.

To save battery power, ensure that the ignition and all electronic systems and/or power consumers are switched off before locking the vehicle.

Convenient closing

Press the area on the door handle, arrow 2, with the finger and hold it down.

In addition to locking, the windows and the glass sunroof are closed.

 Monitor the closing process
Monitor the closing process to ensure that no one becomes trapped. ◀

Unlocking the trunk lid separately

Press the button on the exterior of the trunk lid. This corresponds to pressing the  button on the remote control.

 Do not place the remote control in the cargo area

Take the remote control with you and do not leave it in the cargo area; otherwise, the remote control is locked inside the vehicle when the trunk lid is closed. ◀

Open trunk lid with no-touch activation

With Comfort Access, the trunk lid can be opened with no-touch activation using the remote control you are carrying.

A sensor detects a directed foot motion in the center of the area at the rear of the car and the trunk lid opens.

During opening, the trunk lid pivots back and up. Ensure that adequate clearance is available before opening.

 Do not touch vehicle

With the foot motion, make sure there is steady stance and do not touch the vehicle; otherwise, there is a danger of injury, e. g. from hot exhaust system parts. ◀

1. Position in the center behind the vehicle.
2. Move foot in the direction of travel underneath the bumper and immediately back.
The hazard warning system flashes three times.

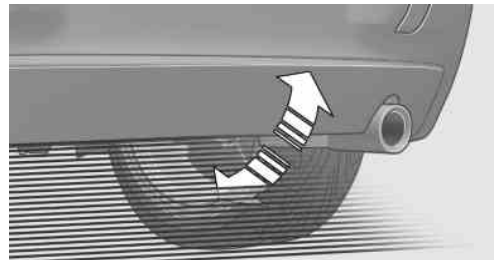

The trunk lid opens, regardless of whether it was previously locked or unlocked.



Preventing inadvertent opening

In situations where the trunk lid should not be opened with no-touch activation, ensure that the remote control is located beyond the range of the sensor, at least 5 ft/1.50 m from the rear of the car.

Otherwise, the trunk lid may be opened inadvertently, for example by an unintentional or misinterpreted movement of the foot. ◀

Malfunction

Comfort Access may not function properly if it experiences interference from external sources such as mobile phones, metal objects, overhead power lines, transmission towers, etc.

In this case, open or close the vehicle using the buttons on the remote control or use the integrated key in the door lock.

If there is a malfunction, open the trunk lid with the remote control button or with the button on the trunk lid.

Alarm system

The concept

The vehicle alarm system responds to:

- ▷ Opening of a door, the hood or the trunk lid.
- ▷ Movements in the vehicle.
- ▷ Changes in the vehicle tilt, e.g., during attempts to steal a wheel or when towing the car.
- ▷ Interruptions in battery voltage.

The alarm system briefly indicates tampering:

- ▷ By sounding an acoustic alarm.
- ▷ By switching on the hazard warning system.
- ▷ By flashing the daytime running lights.

Arming and disarming the alarm system

General information

When you lock or unlock the vehicle, either with the remote control or at the door lock, the alarm system is armed or disarmed at the same time.

Door lock and armed alarm system

The alarm system is triggered when the door is opened, if the vehicle is unlocked via the door lock.

In order to terminate this alarm, unlock vehicle with the remote control or switch on the ignition, if necessary, by emergency detection of the remote control.

Trunk lid and armed alarm system

The trunk lid can be opened using the remote control, even if the alarm system is armed.



Press the button on the remote control for approx. 1 second.

After the trunk lid is closed, it is locked and monitored again by the alarm system. The hazard warning system flashes once.

In some vehicle equipment variants, the trunk lid can only be opened using the remote control if the vehicle was unlocked first.

Panic mode



Press the button on the remote control for at least 3 seconds.

Switching off the alarm

- ▷ Unlock the vehicle using the remote control.
- ▷ With Comfort Access: if you are carrying the remote control with you, pull on the door handle.

Indicator lamp on the interior rearview mirror

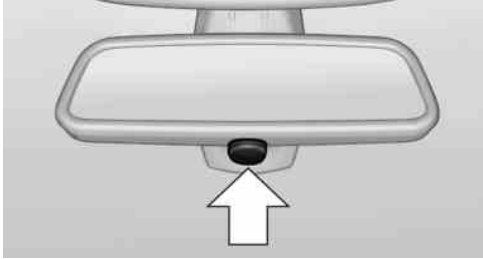

- ▷ The indicator lamp flashes briefly every 2 seconds:
The system is armed.
- ▷ The indicator lamp flashes after locking:
The doors, hood or trunk lid is not closed properly, but the rest of the vehicle is secured.
After 10 seconds, the indicator lamp flashes continuously. Interior motion sensor and tilt alarm sensor are not active.
- ▷ The indicator lamp goes out after unlocking:
The vehicle has not been tampered with.
- ▷ The indicator lamp flashes after unlocking until the engine is started, but no longer than approx. 5 minutes:
An alarm has been triggered.

Tilt alarm sensor

The tilt of the vehicle is monitored.

The alarm system responds in situations such as attempts to steal a wheel or when the car is towed.

Interior motion sensor

The windows and glass sunroof must be closed for the system to function properly.

Avoiding unintentional alarms

The tilt alarm sensor and interior motion sensor can be switched off together, such as in the following situations:

- ▷ In automatic car washes.
- ▷ In duplex garages.
- ▷ During transport on car-carrying trains, at sea or on a trailer.
- ▷ When animals are to remain in the vehicle.

Switching off the tilt alarm sensor and interior motion sensor



Press the remote control button again within 10 seconds as soon as the vehicle is locked.

The indicator lamp lights up for approx. 2 seconds and then continues to flash.

The tilt alarm sensor and interior motion sensor are switched off until the vehicle is locked again.

Power windows

General information





Take the remote control with you

Take the remote control with you when leaving the vehicle so that children, for example, cannot operate the power windows and injure themselves. ◀



Opening

- ▷  Press the switch to the resistance point.
The window opens while the switch is held.

- ▷  Press the switch beyond the resistance point.

The window opens automatically.

Pressing again stops the motion.

Convenient opening, refer to page 34, via the remote control.

Closing

-  **Keep the closing path clear**
Monitor the closing process and make sure that the closing path of the window is clear; otherwise, injuries may result. ◀

- ▷  Pull the switch to the resistance point.
The window closes while the switch is held.

- ▷  Pull the switch beyond the resistance point.

The window closes automatically.

Pressing the switch stops the motion.

Convenient operation, refer to page 34, via the remote control.

Convenient closing, refer to page 39, with Comfort Access.

Pinch protection system

If the closing force exceeds a specific value as a window closes, the closing action is interrupted. The window reopens slightly.

-  **Danger of pinching even with pinch protection**

Even with the pinch protection system, check that the window's closing path is clear; otherwise, the closing action may not stop in certain situations, e.g., if thin objects are present. ◀

-  **No window accessories**
Do not install any accessories in the range of movement of the windows; otherwise, the pinch protection system will be impaired. ◀

Closing without the pinch protection system

-  **Keep the closing path clear**
Monitor the closing process and make sure that the closing path of the window is clear; otherwise, injuries may result. ◀

For example, if there is an external danger or if ice on the windows prevents a window from closing normally, proceed as follows:

1. Pull the switch past the resistance point and hold it there.
Pinch protection is limited and the window reopens slightly if the closing force exceeds a certain value.
2. Pull the switch past the resistance point again within approx. 4 seconds and hold it there.
The window closes without pinch protection.

Safety switch

The safety switch in the driver's door can be used to prevent children, for example, from opening and closing the rear windows using the switches in the rear.

Switching on and off

-  Press the button.
The LED lights up if the safety function is switched on.

-  **Safety switch for rear operation**
Press the safety switch when transporting children in the rear; otherwise, injury may result if the windows are closed without supervision. ◀

Roller sunblinds

Roller sunblind for rear window

General information

If you are no longer able to move the roller sunblind for the rear window after having activated it a number of times in a row, the system is blocked for a limited time to prevent overheating. Let the system cool.

The roller sunblind for the rear window cannot be moved at low interior temperatures.

Extending or retracting roller blind for rear window



Press the button.

Roller sunblinds for the rear side windows

Pull out the roller sunblind at the loop and hook it onto the bracket.



Do not open the window while the roller sunblind is raised.

Do not open the window while the roller sunblind is raised; otherwise, there is a risk of damage at high speeds that may result in personal injury. ◀

Glass sunroof, powered

General information

The glass sunroof is operational when the ignition is switched on.



Keep the closing path clear

Monitor the closing process and make sure that the closing path of the glass sunroof is clear; otherwise, injuries may result. ◀



Take the remote control with you

Take the remote control with you when leaving the vehicle so that children, for example, cannot operate the roof and injure themselves. ◀



Tilting the glass sunroof

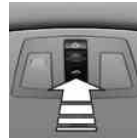

Push switch upward briefly.

- ▷ Closed roof is tilted open.
- ▷ The opened roof closes until it is in its tilted position. The sliding visor stays completely open.

Opening/closing the glass sunroof and sliding visor together

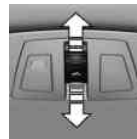

- ▷ Slide switch back to the resistance point and hold. Glass sunroof and sliding visor open together as long as the switch is held down.

- ▷ Press switch back past the resistance point. The glass sunroof and sliding visor open automatically. Pressing the switch again stops the opening motion.

Analogously, the glass sunroof is closed by sliding the switch forward.

The sliding visor remains open and can be closed by hand.

Convenient operation, refer to page 34, via the remote control.

Convenient closing, refer to page 39, with Comfort Access.

Comfort position

Stops the roof in the comfort position if the roof is not fully open. This reduces wind noise in the passenger compartment.

If desired, continue the movement by pressing the switch.

Pinch protection system

If the closing force when closing the glass sunroof exceeds a certain value, the closing movement is stopped, beginning at approximately the middle of the opening in the roof, or from the tilted position during closing.

The glass sunroof opens again slightly.

 Danger of pinching even with pinch protection

Despite the pinch protection system, check that the roof's closing path is clear; otherwise, the closing action may not be interrupted in certain extreme situations, such as when thin objects are present. ◀

Closing from the open position without pinch protection

For example, if there is an external danger, proceed as follows:

1. Press the switch forward beyond the resistance point and hold.
Pinch protection is limited and the roof re-opens slightly if the closing force exceeds a certain value.
2. Press the switch forward again beyond the resistance point and hold until the roof closes without pinch protection.

Closing from the raised position without pinch protection

If there is an external danger, push the switch forward past the resistance point and hold it.

The roof closes without pinch protection.

Initializing after a power failure

After a power failure during the opening or closing process, the roof can only be operated to a limited extent.

Initializing the system

The system can be initialized when the vehicle is stationary and the engine is running.

During the initialization, the roof closes without pinch protection.



Keep the closing path clear

Monitor the closing process and make sure that the closing path of the glass sunroof is clear; otherwise, injuries may result. ◀

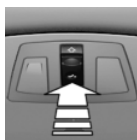

Press the switch up and hold it until the initialization is complete:

- ▶ Initialization begins within 15 seconds and is completed when the sunroof is completely closed.
- ▶ The roof closes without pinch protection.

Adjusting

Vehicle equipment

All standard, country-specific and optional equipment that is offered in the model series is described in this chapter. Therefore, equipment is also described that is not available in a vehicle, e. g., because of the selected optional equipment or country variant. This also applies for safety-related functions and systems.

Sitting safely

The ideal seating position can make a vital contribution to relaxed, fatigue-free driving.

The seating position plays an important role in an accident in combination with:

- Safety belts, refer to page 48.
- Head restraints, refer to page 49.
- Airbags, refer to page 92.

Seats

General information

 Do not adjust the seat while driving
Do not adjust the driver's seat while driving, or the seat could respond with unexpected movement and the ensuing loss of vehicle control could lead to an accident. ◀

 Do not incline the backrest too far to the rear

Also on the front passenger side, do not incline the backrest on the front passenger side too far to the rear during driving, or there is a risk of slipping under the safety belt in the event of an accident. This would eliminate the protection normally provided by the belt. ◀

Manually adjustable seats

At a glance

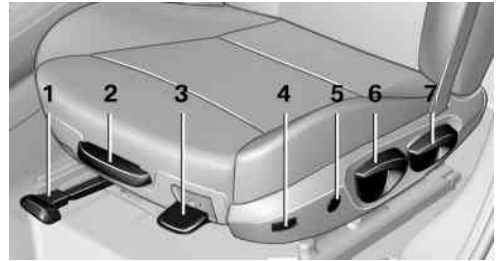

- 1 Forward/backward
- 2 Thigh support
- 3 Seat tilt
- 4 Backrest width
- 5 Lumbar support
- 6 Height
- 7 Backrest tilt

Forward/backward



Pull the lever and slide the seat in the desired direction.

After releasing the lever, move the seat forward or back slightly to make sure it engages properly.

Height

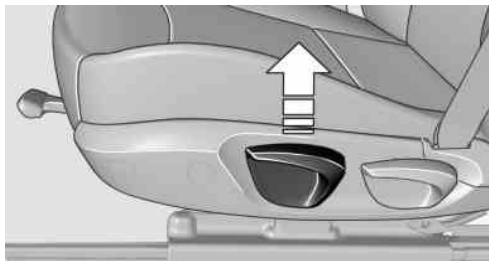

Pull the lever and apply your weight to the seat or lift it off, as necessary.

Backrest tilt



Pull the lever and apply your weight to the backrest or lift it off, as necessary.

Seat tilt

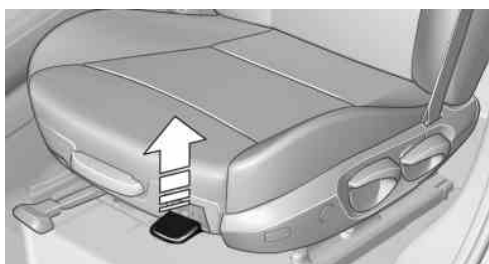

Pull the lever and move the seat to the desired tilt. After releasing the lever, apply your weight to the seat or lift it off to make sure the seat engages properly.

Electrically adjustable seats

At a glance

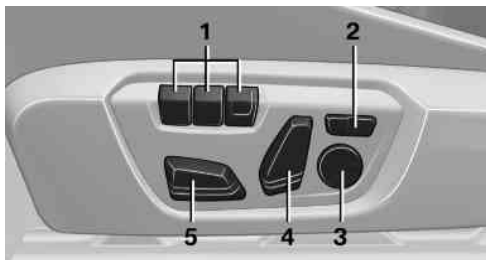

- 1 Seat and mirror memory
- 2 Backrest width
- 3 Lumbar support
- 4 Backrest tilt
- 5 Forward/backward, height, seat tilt

Note

The seat setting for the driver's seat is stored for the remote control currently in use. When the vehicle is unlocked via the remote control, the position is automatically retrieved if the function, refer to page 35, is activated for this purpose.

Adjustments in detail

1. Forward/back.

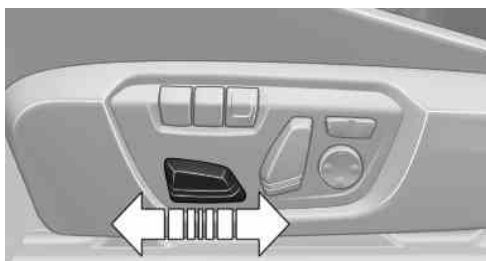

2. Height.

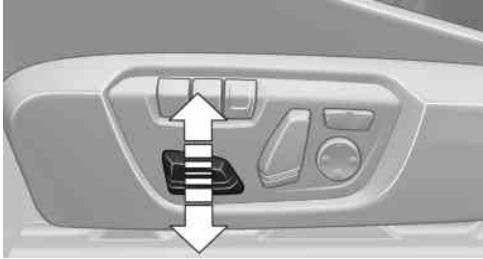

3. Seat tilt.

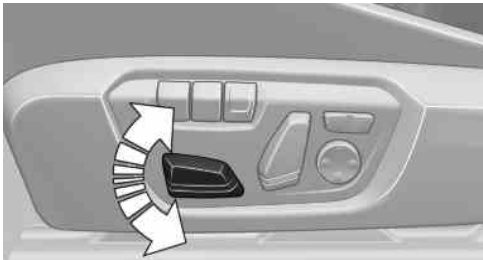

4. Backrest tilt.

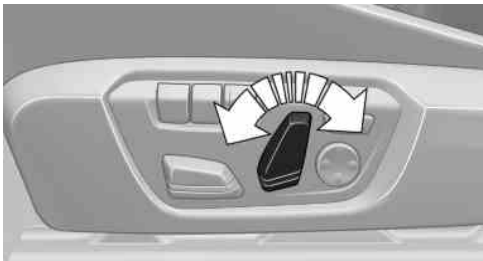

Thigh support

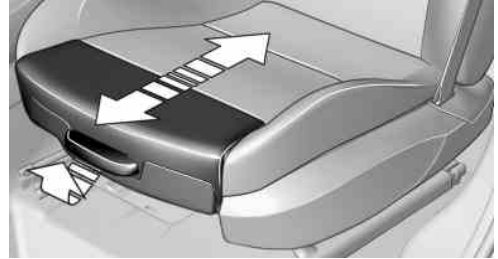

Pull the lever at the front of the seat and adjust the thigh support.

Lumbar support

The curvature of the seat backrest can be adjusted in such a way that it supports the lumbar region of the spine. The lower back and the spine are supported for upright posture.



- ▶ Press the front/rear section of the switch.
The curvature is increased/decreased.
- ▶ Press the upper/lower section of the switch.
The curvature is shifted up/down.

Backrest width



Change the width of the backrest using the side wings to adjust the lateral support.

Front seat heating



Switching on



Press the button once for each temperature level.

The maximum temperature is reached when three LEDs are lit.

If the drive is continued within approx. 15 minutes, the seat heating is activated automatically with the temperature selected last.

When ECO PRO, refer to page 167, is activated, the heater output is reduced.

Switching off



Press the button longer.

The LEDs go out.

Rear seat heating



Switching on



Press the button once for each temperature level.

The maximum temperature is reached when three LEDs are lit.

If the drive is continued within approx. 15 minutes, the seat heating is activated automatically with the temperature selected last.

When ECO PRO, refer to page 167, is activated, the heater output is reduced.

Switching off



Press the button longer.

The LEDs go out.

Safety belts

Seats with safety belt

The vehicle has five seats, each of which is equipped with a safety belt.

Number of safety belts

Your vehicle has been fitted with five safety belts for the safety of you and your passengers. However, they can only offer protection when adjusted correctly.

Notes

Always make sure that safety belts are being worn by all occupants before driving away.

Although airbags enhance safety by providing added protection, they are not a substitute for safety belts.

- ▷ The shoulder strap's anchorage point will be correct for adult seat occupants of every build if the seat is correctly adjusted.
- ▷ The two outer safety belt buckles, integrated into the rear seat, are for passengers sitting on the left and right.
- ▷ The center rear seat belt buckle is solely intended for the center passenger.



One person per safety belt

Never allow more than one person to wear a single safety belt. Never allow infants or small children to ride on a passenger's lap. ◀

**Putting on the belt**

Lay the belt, without twisting, snugly across the lap and shoulders, as close to the body as possible. Make sure that the belt lies low around the hips in the lap area and does not press on the abdomen. Otherwise, the belt can slip over the hips in the lap area in a frontal impact and injure the abdomen.

The safety belt must not lie across the neck, rub on sharp edges, be routed over solid or breakable objects, or be pinched. ◀

**Reduction of restraining effect**

Avoid wearing clothing that prevents the belt from fitting properly, and pull the shoulder belt periodically to readjust the tension across your lap; otherwise, the retention effect of the safety belt may be reduced. ◀

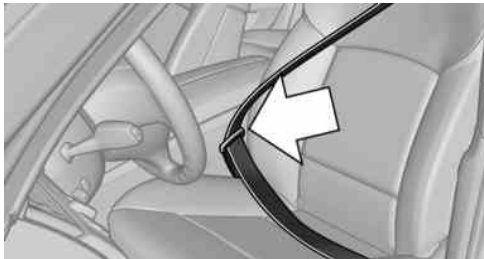
Buckling the belt

Make sure you hear the latch plate engage in the belt buckle.

Unbuckling the belt

1. Hold the belt firmly.
2. Press the red button in the belt buckle.
3. Guide the belt back into its reel.

Safety belt reminder for driver's seat and front passenger seat

The indicator lamp flashes or lights up and a signal sounds. Make sure that the safety belts are positioned correctly.

The safety belt reminder is active at speeds

above approx. 5 mph/8 km/h. It can also be activated if objects are placed on the front passenger seat.

Damage to safety belts

In the case of strain caused by accidents or damage:

Have the safety belts, including the safety belt tensioners, replaced and have the belt anchors checked.

**Checking and replacing safety belts**

Have the work performed only by your service center; otherwise, it cannot be ensured that this safety feature will function properly. ◀

Front head restraints**Correctly adjusted head restraint**

A correctly adjusted head restraint reduces the risk of injury to cervical vertebrae in the event of an accident.

**Adjusting the head restraint**

Correctly adjust the head restraints of all occupied seats; otherwise, there is an increased risk of injury in an accident. ◀

Height

Adjust the head restraint so that its center is approximately at ear level.

Distance

Adjust the distance so that the head restraint is as close as possible to the back of the head.

If necessary, adjust the distance by adjusting the tilt of the backrest.

Adjusting the height

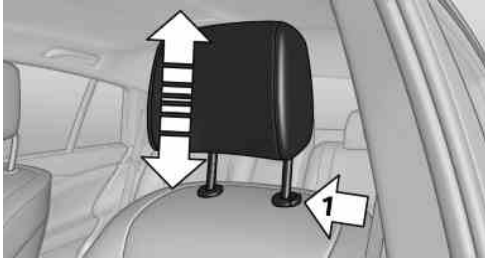

- ▷ To raise: pull.
- ▷ To lower: press the button, arrow 1, and push the head restraint down.

Tilt

Three different tilt positions are available.

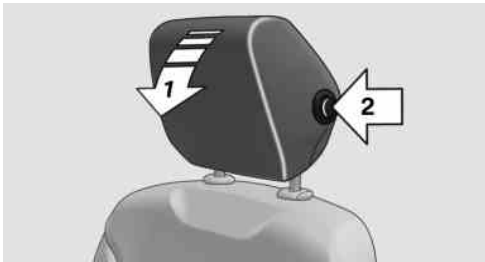

- ▷ Forward: pull the top edge of the head restraint forward, arrow 1.
- ▷ Back: press the button, arrow 2. The head restraint folds as far back as possible.

Removing

Only remove the head restraint if no one will be sitting in the seat in question.

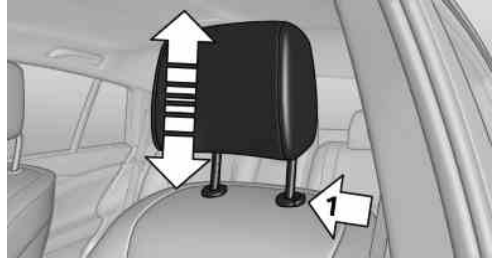

1. Pull the head restraint upward as far as possible.
2. Press the button, arrow 1, and pull the head restraint out completely.



Before transporting passengers

Reinstall the head restraint before transporting anyone in the seat; otherwise, the protective function of the head restraint is unavailable. ◀

Rear head restraints

Correctly adjusted head restraint

A correctly adjusted head restraint reduces the risk of injury to cervical vertebrae in the event of an accident.



Adjusting the head restraint

Correctly adjust the head restraints of all occupied seats; otherwise, there is an increased risk of injury in an accident. ◀

Height

Adjust the head restraint so that its center is approximately at ear level.

Adjusting the height

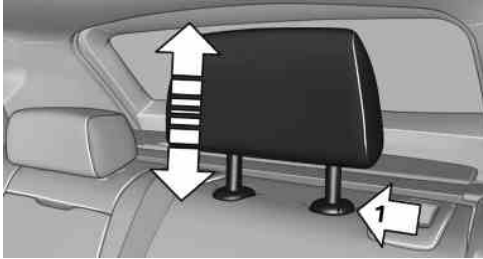

- ▷ To raise: pull.
- ▷ To lower: press the button, arrow 1, and push the head restraint down.

The center head restraint cannot be adjusted in elevation.

Folding down head restraints

 Extending/retracting head restraint

Only fold down head restraint if no passengers are in the rear. Fold out retracted headrests again if passengers are being carried in the rear; otherwise, there is increased risk of injury in the event of an accident. ◀

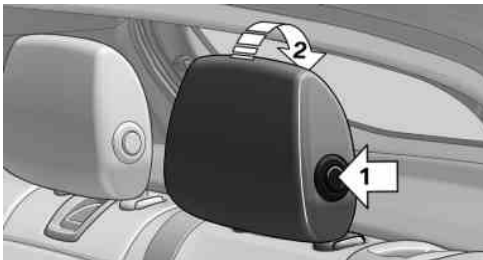

- ▷ To lower flaps: press the button, arrow 1, and press down the head restraint.
- ▷ Fold back up: pull up head restraints.

Removing

Only remove the head restraint if no one will be sitting in the seat in question.

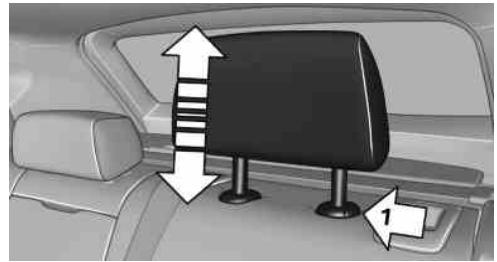

1. Pull the head restraint upward as far as possible.
2. Press the button, arrow 1, and pull the head restraint out completely.

 Before transporting passengers Reinstall the head restraint before transporting anyone in the seat; otherwise, the protective function of the head restraint is unavailable. ◀

Seat and mirror memory

General information



Two different driver's seat and exterior mirror positions can be stored and retrieved for each remote control. Settings for the backrest width and lumbar support are not stored in memory.

Storing

1. Switch on the ignition.
2. Set the desired position.

3.  Press the button. The LED in the button lights up.
4. Press the desired button 1 or 2. The LED goes out.

If the M button is pressed accidentally:

-  Press the button again.
The LED goes out.

Calling up settings

-  Do not retrieve the memory while driving
Do not retrieve the memory setting while driving, as an unexpected movement of the seat or steering wheel could result in an accident. ◀

Comfort function

1. Open the driver's door.
2. Switch off the ignition.
3. Briefly press the desired button 1 or 2.

The corresponding seat position is performed automatically.

The procedure stops when a switch for adjusting the seat or one of the buttons is pressed.

Safety mode

1. Close the driver's door or switch on the ignition.
2. Press and hold the desired button 1 or 2 until the adjustment procedure is completed.

Calling up of a seat position deactivated

After a brief period, the calling up of stored seat positions is deactivated to save battery power.

To reactivate calling up of a seat position:

- ▷ Open and close the door or trunk lid.
- ▷ Press a button on the remote control.
- ▷ Press the Start/Stop button.

Mirrors

Exterior mirrors

At a glance



- 1 Adjusting
- 2 Left/right, Automatic Curb Monitor
- 3 Fold in and out

General information

The mirror on the passenger side is more curved than the driver's side mirror.

-  Estimating distances correctly
Objects reflected in the mirror are closer than they appear. Do not estimate the distance to the traffic behind you based on what you see in the mirror, as this will increase your risk of an accident. ◀

Depending on how the vehicle is equipped, the mirror setting is stored for the remote control in use. When the vehicle is unlocked via the remote control, the position is automatically retrieved if the setting for this function is active.

Selecting a mirror



- To change over to the other mirror:
Slide the mirror changeover switch.

Adjusting electrically



- The setting corresponds to the direction in which the button is pressed.

Saving positions

Seat and mirror memory, refer to page 51

Adjusting manually

If an electrical malfunction occurs, for example, press the edges of the mirror glass.

Automatic Curb Monitor

When the reverse gear is engaged, the mirror glass tilts downward slightly on the front passenger side. This improves your view of the curb and other low-lying obstacles when parking, for example.

Activating

-  Slide the mirror changeover switch to the driver's side mirror position.
- Engage transmission position R.

Deactivating

Slide the mirror changeover switch to the passenger's side mirror position.

Fold in and out

 Press the button.

Possible up to approx. 15 mph/20 km/h.

For example, this is advantageous

- ▶ In car washes.
- ▶ In narrow streets.
- ▶ For folding back mirrors that were folded away manually.

Mirrors that were folded in are folded out automatically at a speed of approx. 25 mph/40 km/h.

-  **Warning:** Fold in the mirror in a car wash. Before entering an automatic car wash, fold in the exterior mirrors by hand or with the button; otherwise, they could be damaged, depending on the width of the vehicle. ◀

Automatic heating

Both exterior mirrors are automatically heated whenever the engine is running.

Automatic dimming feature

Both exterior mirrors are automatically dimmed. Photocells are used for control in the Interior rear view mirror, refer to page 53.

Interior rearview mirror

Reducing the blinding effect

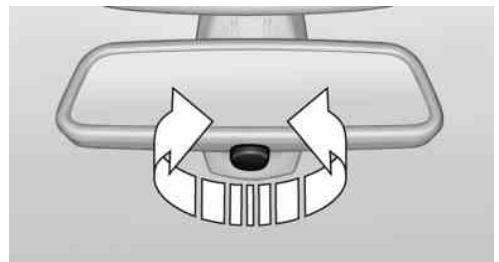

From behind when driving at night: turn the knob.

Interior rearview mirror, automatic dimming feature

The concept

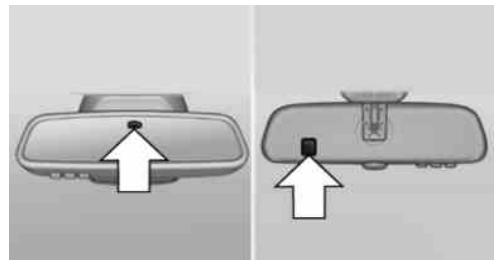

Photocells are used for control:

- ▶ In the mirror glass.
- ▶ On the back of the mirror.

Functional requirement

For proper operation:

- ▷ Keep the photocells clean.
- ▷ Do not cover the area between the inside rearview mirror and the windshield.

Switching on/off



Press the button.

- ▷ On: the LED lights up.
- ▷ Off: the LED goes out.

Steering wheel

General information



Do not adjust while driving

Do not adjust the steering wheel while driving; otherwise, an unexpected movement could result in an accident. ◀

Adjusting

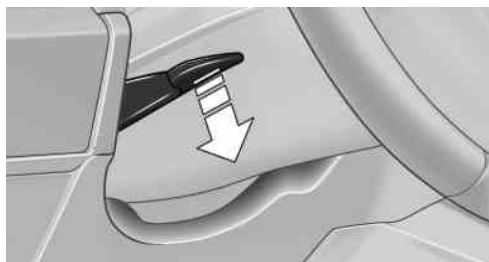

1. Fold the lever down.
2. Move the steering wheel to the preferred height and angle to suit your seating position.
3. Fold the lever back.

Steering wheel heating



Transporting children safely

Vehicle equipment

All standard, country-specific and optional equipment that is offered in the model series is described in this chapter. Therefore, equipment is also described that is not available in a vehicle, e. g., because of the selected optional equipment or country variant. This also applies for safety-related functions and systems.

The right place for children

Note



Children in the vehicle

Do not leave children unattended in the vehicle; otherwise, they could endanger themselves and other persons, e.g., by opening the doors. ◀

Children should always be in the rear

Accident research shows that the safest place for children is in the back seat.



Transporting children in the rear

Only transport children younger than 13 years of age or shorter than 5 ft/150 cm in the rear in child restraint fixing systems provided in accordance with the age, weight and size of the child; otherwise, there is an increased risk of injury in an accident.

Children 13 years of age or older must wear a safety belt as soon as a suitable child restraint fixing system can no longer be used, due to their age, weight and size. ◀

Children on the front passenger seat

Should it ever be necessary to use a child restraint fixing system in the front passenger seat, make sure that the front, knee and side airbags on the front passenger side are deactivated. Au-

tomatic deactivation of front passenger airbags, refer to page 94.



Deactivating the front passenger airbags

If a child restraint fixing system is used in the front passenger seat, the front passenger airbags must be deactivated; otherwise, there is an increased risk of injury to the child when the airbags are triggered, even with a child restraint fixing system. ◀

Installing child restraint fixing systems

Before mounting

Before mounting child restraint fixing systems, ensure that the rear seat backrests are locked.

Notes



Manufacturer's information for child restraint fixing systems

To select, mount and use child restraint fixing systems, observe the information provided by the system manufacturer; otherwise, the protective effect can be impaired. ◀

On the front passenger seat

Deactivating airbags

After installing a child restraint fixing system in the front passenger seat, make sure that the front, knee and side airbags on the front passenger side are deactivated.

Deactivate the front passenger airbags automatically, refer to page 94



Deactivating the front passenger airbags

If a child restraint fixing system is used in the front passenger seat, the front passenger airbags must be deactivated; otherwise, there is

an increased risk of injury to the child when the airbags are triggered, even with a child restraint fixing system. ◀

Seat position and height

Before installing a child restraint fixing system, move the front passenger seat as far back as possible and adjust its height to the highest position to obtain the best possible position for the belt and to offer optimal protection in the event of an accident.

Do not change the seat position and height after this.

Backrest width

Adjustable backrest width: before installing a child restraint fixing system in the front passenger seat, open the backrest width completely. Do not change the backrest width again and do not call up a memory position.



Backrest width for the child seat

Before installing a child restraint fixing system in the front passenger seat, the backrest width must be opened completely. Do not change the adjustment after this; otherwise, the stability of the child seat will be reduced. ◀

Child seat security



The rear safety belts and the front passenger safety belt can be locked against pulling out for mounting the child restraint fixing systems.

Locking the safety belt

1. Pull out the belt webbing completely.
2. Secure the child restraint fixing system with the belt.
3. Allow the belt webbing to be pulled in and pull it taut against the child restraint fixing system. The safety belt is locked.

Unlocking the safety belt

1. Unbuckle the belt buckle.
2. Remove the child restraint fixing system.
3. Allow the belt webbing to be pulled in completely.

LATCH child restraint fixing system

LATCH: Lower Anchors and Tether for Children.

Note



Manufacturer's information for LATCH child restraint fixing systems

To mount and use the LATCH child restraint fixing systems, observe the operating and safety information from the system manufacturer; otherwise, the level of protection may be reduced. ◀

Mounts for the lower LATCH anchors



Correctly engage the lower LATCH anchors

Make sure that the lower LATCH anchors have properly engaged and that the child restraint fixing system is resting snugly against the backrest; otherwise, the degree of protection offered may be reduced. ◀

Before mounting the LATCH child restraint fixing system, pull the belt away from the child restraint fixing system.

Without a through-loading system: Position

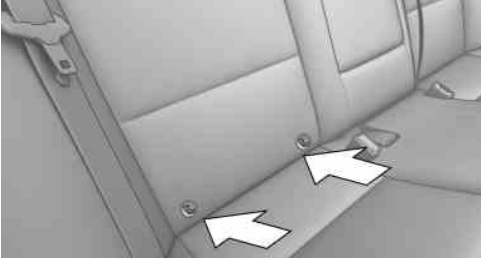

Mounts for the lower LATCH anchors are located in the gap between the seat and backrest.

With a through-loading system: Position

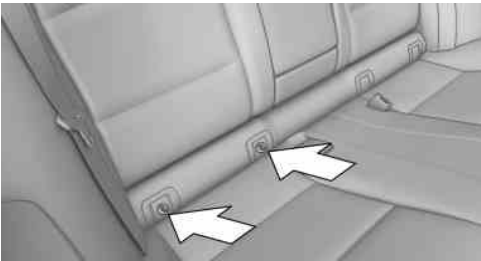

Mounts for the lower LATCH anchors are located behind the indicated covers.

Mounting LATCH child restraint fixing systems

1. Mount the child restraint fixing system; refer to the operating instructions of the system.
2. Ensure that both LATCH anchors are properly connected.

Child restraint fixing system with a tether strap

Note



LATCH mounting eyes

Only use the mounting eyes for the upper LATCH retaining strap to secure child restraint fixing systems; otherwise, the mounting eyes could be damaged. ◀

Mounting points

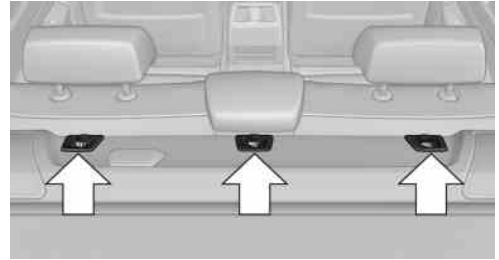

Depending on the vehicle equipment, there are two outer or three mounting points for child restraint fixing systems with a tether strap.

Retaining strap guide



Retaining strap

Make sure that the upper retaining strap is not routed over the head restraints or sharp edges and is free of twisting on its way to the upper mounting point; otherwise, the belt cannot properly secure the child restraint fixing system in an accident. ◀

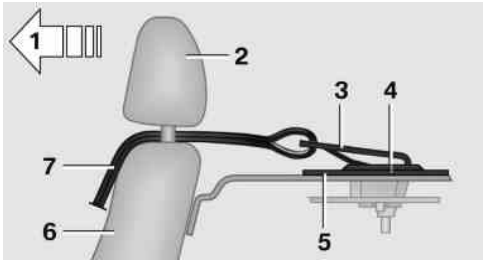

- 1 Direction of travel
- 2 Head restraint.
- 3 Hook for upper retaining strap
- 4 Mounting point/eye
- 5 Rear window shelf
- 6 Seat backrest
- 7 Upper retaining strap

Attaching the upper retaining strap to the mounting point

1. Remove the mounting point cover.
2. Raise or remove head restraints.
3. Guide the upper retaining strap between the supports of the head restraint.
4. Attach the hook of the retaining strap to the mounting eye.
5. Tighten the retaining strap by pulling it down.
6. Lower and lock head restraints as needed.

Locking the doors and windows

Rear doors

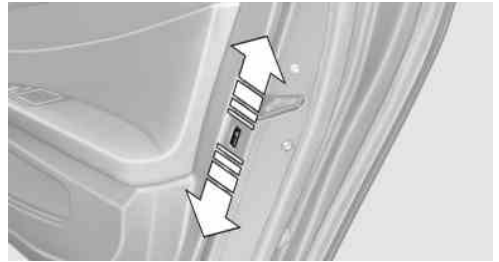

Push the locking lever on the rear doors down. The door can now be opened from the outside only.

Safety switch for the rear



Press the button on the driver's door if children are being transported in the rear.

This locks various functions so that they cannot be operated from the rear: safety switch, refer to page 42.

Driving

Vehicle equipment

All standard, country-specific and optional equipment that is offered in the model series is described in this chapter. Therefore, equipment is also described that is not available in a vehicle, e. g., because of the selected optional equipment or country variant. This also applies for safety-related functions and systems.

Start/Stop button

The concept



Pressing the Start/Stop button switches the ignition on or off and starts the engine.

Automatic transmission: The engine starts if the brake is depressed while pressing the Start/Stop button.

Manual transmission: the engine starts if the clutch pedal is depressed when the Start/Stop button is pressed.

Ignition on

Automatic transmission: Press the Start/Stop button but do not depress the brake.

Manual-shift transmission: press the Start/Stop button, and do not press on the clutch pedal at the same time.

All vehicle systems are ready for operation.

Most of the indicator and warning lamps in the instrument cluster light up for varying lengths of time.

To save battery power when the engine is off, switch off the ignition and any unnecessary electronic systems/power consumers.

The ignition switches off automatically:

- ▶ When the vehicle is locked, if the low beams are switched on.

- ▶ Shortly before the battery is discharged completely, so that the engine can still be started.
- ▶ If the engine is switched off and the ignition is switched on, the system automatically switches to the radio ready state when the door is opened if the lights are switched off or the daytime running lights are switched on.

If the engine is switched off and the ignition is switched on, the system automatically switches to the radio ready state when the door is opened if the lights are switched off.

Ignition off

Automatic transmission: Press the Start/Stop button again, but do not depress the brake.

Manual-shift transmission: press the Start/Stop button again, and do not press on the clutch pedal at the same time.

All indicator lamps in the instrument cluster go out.

To save battery power when the engine is off, switch off the ignition and any unnecessary electronic systems/power consumers.



Transmission position P with the ignition off

When the ignition is switched off, position P is engaged automatically. When in an automatic car wash, for example, ensure that the ignition is not switched off accidentally. ◀

Ignition automatically cuts off while the vehicle is stationary and the engine is stopped:

- ▶ During locking, also with the low beams activated.
- ▶ Shortly before the battery is discharged completely, so that the engine can still be started. This function is only available when the low beams are switched off.

- ▷ When opening and closing the driver door, if the driver's seat belt is unbuckled and the low beams are switched off.
- ▷ While the driver's seat belt is unbuckled, if the driver's door is open and the low beams are switched off.

When the ignition is switched off, by opening or closing the driver's door or unbuckling the driver's seat belt, the radio ready state remains active.

Radio ready state

Activate radio ready state:

- ▷ When the ignition is switched off: press ON/OFF button on the radio.
- ▷ When the engine is running: press the Start/Stop button.

Some electronic systems/power consumers remain ready for operation.

Radio ready state switches off automatically:

- ▷ After approx. 8 minutes.
- ▷ When the vehicle is locked using the central locking system.
- ▷ Shortly before the battery is discharged completely, so that the engine can still be started.

Starting the engine

General information



Enclosed areas

Do not let the engine run in enclosed areas; otherwise, breathing of exhaust fumes may lead to loss of consciousness and death. The exhaust gases contain carbon monoxide, an odorless and colorless but highly toxic gas. ◀



Unattended vehicle

Do not leave the vehicle unattended with the engine running; doing so poses a risk of danger.

Before leaving the vehicle with the engine running, set the parking brake and place the transmission in position P or neutral to prevent the vehicle from moving. ◀



Repeated starting in quick succession

Avoid repeated unsuccessful attempts to start the vehicle or starting the vehicle several times in quick succession. Otherwise, the fuel is not burned or is inadequately burned, posing a risk of overheating and damage to the catalytic converter. ◀

Do not wait for the engine to warm up while the vehicle remains stationary. Start driving at moderate engine speeds.

Manual transmission

Starting the engine

1. Depress the brake pedal.
2. Press on the clutch and shift to neutral.
3. Press the Start/Stop button.

The ignition is activated automatically for a certain time and is stopped as soon as the engine starts.

Automatic transmission

Starting the engine

1. Depress the brake pedal.
2. Press the Start/Stop button.

The ignition is activated automatically for a certain time and is stopped as soon as the engine starts.

Engine stop

General information



Take the remote control with you

Take the remote control with you when leaving the vehicle so that children, for example, cannot start the engine. ◀

 Set the parking brake and further secure the vehicle as required

Set the parking brake firmly when parking; otherwise, the vehicle could roll. On steep upward and downward inclines, further secure the vehicle, for example, by turning the steering wheel in the direction of the curb. ◀

Before driving into a car wash

In order for the vehicle to be able to roll into a car wash, heed the information regarding Washing in automatic car washes, refer to page 213.

Manual transmission

Switching off the engine

1. With the vehicle at a standstill, press the Start/Stop button.
2. Shift into first gear or reverse.
3. Set the parking brake.

Automatic transmission

Switching off the engine

1. Engage transmission position P with the vehicle stopped.
2. Press the Start/Stop button.
The engine is switched off.
The radio ready state is switched on.
3. Set the parking brake.

Auto Start/Stop function

The concept

The Auto Start/Stop function helps save fuel. The system switches off the engine during a stop, e.g., in a traffic congestion or at traffic lights. The ignition remains switched on. The engine starts again automatically for driving off. Certain vehicle components may experience additional wear as a result of this system.

Automatic mode

The Auto Start/Stop function is operational after each engine start.

This function is activated at speeds faster than about 3 mph, approx. 5 km/h.

Engine stop

The engine is switched off automatically during a stop under the following conditions:

Manual transmission:

- ▷ Neutral is engaged and the clutch pedal is not pressed.
- ▷ The driver's safety belt is buckled or the driver's door is closed.

Automatic transmission:

- ▷ The selector lever is in transmission position D.
- ▷ Brake pedal remains depressed while the vehicle is stopped.
- ▷ The driver's safety belt is buckled or the driver's door is closed.

The air flow of the air conditioner is reduced when the engine is switched off.

Displays in the instrument cluster



The READY display in the tachometer signals that the Auto Start/Stop function is ready to start the engine automatically.



The display indicates that the conditions for an automatic engine stop have not been satisfied.

Note

The engine is not switched off automatically in the following situations:

- ▷ External temperature below approx. +37 °F/+3 °C.

- ▷ The external temperature is high and automatic climate control is running.
- ▷ The passenger compartment has not yet been heated or cooled to the required level.
- ▷ The engine is not yet at operating temperature.
- ▷ The wheels are at a sharp angle or the steering wheel is being turned.
- ▷ After driving in reverse.
- ▷ Fogging of the windows when the automatic climate control is switched on.
- ▷ The vehicle battery charge is very low.
- ▷ The engine compartment lid is unlocked.
- ▷ The parking assistant is activated.
- ▷ Stop-and-go traffic.
- ▷ The transmission selector lever is in position N or S/M.

Starting the engine

The engine starts automatically under the following conditions:

- ▷ Manual transmission:
The clutch pedal is pressed.
- ▷ Automatic transmission:
By releasing the brake pedal.

After the engine starts, accelerate as usual.

Safety mode

After the engine switches off automatically, it will not start again automatically if any one of the following conditions are met.

- ▷ The driver's safety belt is unbuckled and the driver's door is open.
- ▷ The hood was unlocked.

Some indicator lamps light up for varying lengths of time.

The engine can only be started via the Start/Stop button.

Note

Even if driving away was not intended, the deactivated engine starts up automatically in the following situations:

- ▷ Excessive warming of the passenger compartment when the cooling function is switched on.
- ▷ The steering wheel is turned.
- ▷ Automatic transmission: the transmission position is changed from D to N, R, or M/S.
- ▷ Automatic transmission: the transmission position is changed from P to N, D, R, or M/S.
- ▷ The vehicle begins rolling.
- ▷ Fogging of the windows when the automatic climate control is switched on.
- ▷ The vehicle battery charge is very low.
- ▷ Excessive cooling of the passenger compartment when the heating is switched on.
- ▷ Low brake vacuum pressure; this can occur, for example, if the brake pedal is depressed a number of times in succession.

Activating/deactivating the system manually

Using the button



Press the button.

- ▷ LED comes on: Auto Start Stop function is deactivated.
The engine is started during an automatic engine stop.

The engine can only be stopped or started via the Start/Stop button.

- ▶ LED goes out: Auto Start Stop function is activated.

Switching off the vehicle during an automatic engine stop

During an automatic engine stop, the vehicle can be switched off permanently, e.g., when leaving it.

1. Press the Start/Stop button. The ignition is switched off. The Auto Start/Stop function is deactivated.

Automatic transmission: the transmission position P is engaged automatically.

2. Set the parking brake.

Engine start as usual via Start/Stop button.

Automatic deactivation

In certain situations, the Auto Start/Stop function is deactivated automatically for safety reasons, such as when the driver is detected to be absent.

Malfunction

The Auto Start/Stop function no longer switches of the engine automatically. A Check Control message is displayed. It is possible to continue driving. Have the system checked.

Parking brake

Applying

The lever automatically engages after being pulled up.

 The indicator lamp lights up red. The parking brake is set.

 Lower lamp: indicator lamp in Canadian models

Releasing

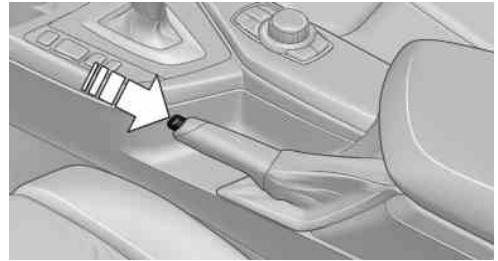

Raise lever slightly, press the button and guide the lever down.

Notes



Use while driving

If on a rare occasion it is necessary to use the parking brake while driving, do not use excessive force when applying it. When using it, keep the button on the lever depressed.

Otherwise, using excessive force when applying the parking brake may cause the rear wheels to lock, resulting in fishtailing. ◀

To prevent corrosion and braking control on one side only, lightly apply the parking brake periodically while coasting, if traffic conditions permit.

The brake lamps will not light up if the parking brake is engaged.

Turn signal, high beams, headlamp flasher

Turn signal



Do not fold in the exterior mirrors

During driving and during the operation of the turn signals/warning flashers, do not fold in the exterior mirror, or else the additional flasher lights in the exterior mirror do not have the prescribed position and can only be poorly detected. ◀

Using turn signals

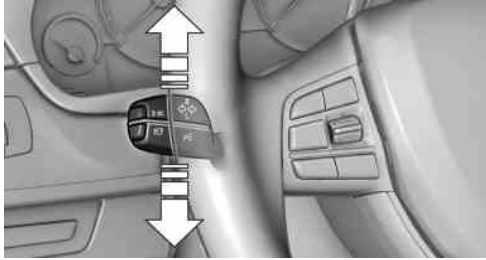

Press the lever beyond the resistance point.

To switch off manually, press the lever to the resistance point.

Unusually rapid flashing of the indicator lamp indicates that a turn signal bulb has failed.

Triple turn signal activation

Press the lever to the resistance point.

The turn signal flashes three times.

The function can be activated or deactivated:

1. "Settings"
2. "Lighting"
3. "Triple turn signal"

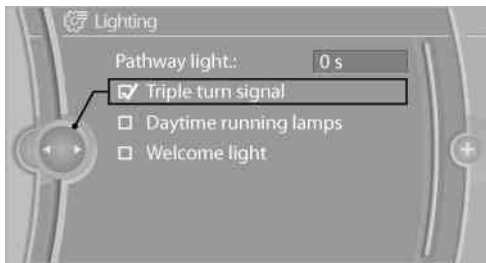

Signaling briefly

Press the lever to the resistance point and hold it there for as long as you want the turn signal to flash.

High beams, headlamp flasher

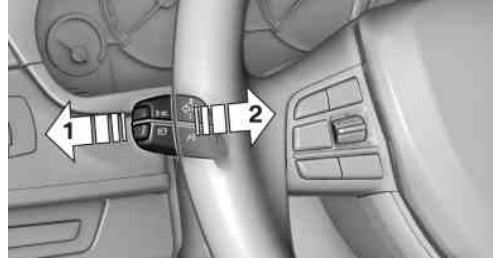

- ▷ High beams, arrow 1.
- ▷ Headlamp flasher, arrow 2.

Washer/wiper system

Switching the wipers on/off and brief wipe

⚠ Do not switch on the wipers if frozen
Do not switch on the wipers if they are frozen onto the windshield; otherwise, the wiper blades and the windshield wiper motor may be damaged. ◀

⚠ No wiper operation on dry windshield
Do not use the windshield wipers if the windshield is dry, as this may damage the wiper blades or cause them to become worn more quickly. ◀

Switching on

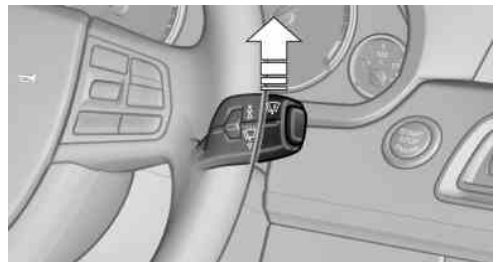

Press the wiper levers up.

The lever automatically returns to its initial position when released.

- ▶ Normal wiping speed: press up once.
The wipers switch to intermittent operation when the vehicle is stationary.
- ▶ Fast wiping speed: press up twice or press once beyond the resistance point.
The wipers switch to normal speed when the vehicle is stationary.

Switching off and brief wipe

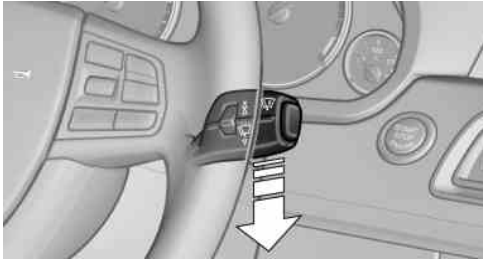

Press the wiper levers down.

The lever automatically returns to its initial position when released.

- ▶ Brief wipe: press down once.
- ▶ To switch off normal wipe: press down once.
- ▶ To switch off fast wipe: press down twice.

Intermittent operation or rain sensor

The concept

The rain sensor automatically controls the time between wipes depending on the intensity of the rainfall. The sensor is located on the windshield, directly behind the interior rearview mirror.

Activating/deactivating

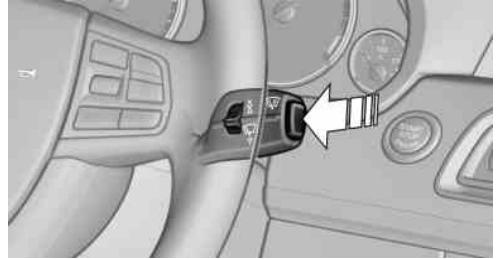

Press the button on the wiper lever.

The LED in the steering column stalk lights up.



Deactivate the rain sensor in car washes

Deactivate the rain sensor when passing through an automatic car wash; otherwise, damage could be caused by undesired wiper activation. ◀

Setting the frequency or sensitivity of the rain sensor

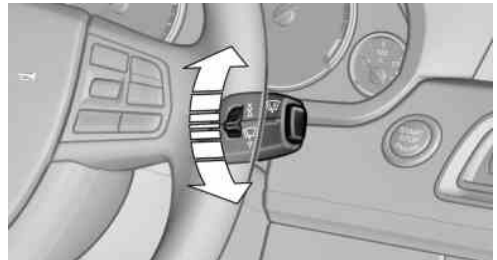

Turn the thumbwheel.

Clean the windshield, headlamps

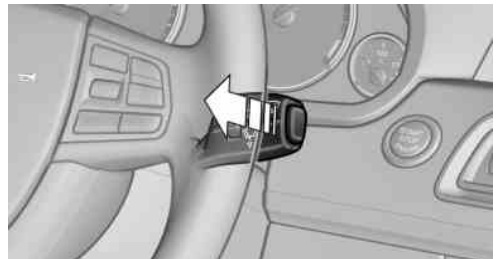

Pull the lever.

The system sprays washer fluid on the windshield and activates the wipers briefly.

In addition, the headlamps are cleaned at regular intervals when the vehicle lights are switched on.

 Do not use the washer system at freezing temperatures

Do not use the washers if there is any danger that the fluid will freeze on the windshield; otherwise, your vision could be obscured. For this reason, use antifreeze.

Avoid using the washer when the reservoir is empty; otherwise, you could damage the pump. ◀

Windshield washer nozzles

The windshield washer nozzles are automatically heated while the ignition is switched on.

Fold-out position of the wipers

Required when changing the wiper blades or under frosty conditions, for example.

1. Switch off the ignition.
2. Under frosty conditions, ensure that the wiper blades are not frozen onto the windshield.
3. Press the wiper lever up beyond the point of resistance and hold it for approx. 3 seconds, until the wiper remains in a nearly vertical position.

After the wipers are folded back down, the wiper system must be reactivated.

 Fold the wipers back down

Before switching the ignition on, fold the wipers back down to the windshield; otherwise, the wipers may become damaged when they are switched on. ◀

1. Switch on the ignition.
2. Press the wiper levers down. The wipers move to their resting position and are ready for operation.

Washer fluid

General information

 Antifreeze for washer fluid

Antifreeze is flammable. Therefore, keep it away from sources of ignition.

Only keep it in the closed original container and inaccessible to children.

Follow the instructions on the container. ◀

Washer fluid reservoir

 Adding washer fluid

Only add washer fluid when the engine is cool, and then close the cover completely to avoid contact between the washer fluid and hot engine parts.

Otherwise, there is the danger of fire and a risk to personal safety if the fluid is spilled. ◀



All washer nozzles are supplied from one reservoir.

Fill with water and – if required – with a washer antifreeze, according to the manufacturer's recommendations.

Mix the washer fluid before adding to maintain the correct mixing ratio.

For the capacity, refer to technical data.

Manual transmission

Shifting



Shifting into 5th or 6th gear

When shifting into 5th or 6th gear, push the gearshift lever to the right; otherwise inadvertent shifting into the 3rd or 4th gear could lead to engine damage. ◀

Reverse gear

Select only when the vehicle is stationary. When the gearshift lever is pressed to the left, a slight resistance needs to be overcome.

Automatic transmission with Steptronic

Transmission positions

D Drive, automatic position

Position for normal vehicle operation. All forward gears are available.

R is Reverse

Select only when the vehicle is stationary.

N is Neutral

Use in automatic car washes, for example. The vehicle can roll.

When the ignition is switched off, refer to page 59, position P is engaged automatically.

P Park

Select only when the vehicle is stationary. The drive wheels are blocked.

P is engaged automatically:

- ▶ After the engine is switched off when the vehicle is in radio ready state, refer to page 60, or when the ignition is switched off, refer to page 59, and when position R or D is engaged.

- ▶ With the ignition is off, if position N is engaged.
- ▶ If the safety belt is unbuckled, the driver's door is opened, and the brake pedal is not pressed while the vehicle is stationary and transmission position R or D is engaged.

Before exiting the vehicle, make sure that position P of the automatic transmission is engaged. Otherwise, the vehicle may begin to roll.

Kickdown

Kickdown is used to achieve maximum driving performance. Press on the gas pedal beyond the resistance point at the full throttle position.

Engaging the transmission position

- ▶ Transmission position P can only be disengaged if the engine is running and the brake pedal is pressed.
- ▶ With the vehicle stationary, press on the brake pedal before shifting out of P or N; otherwise, the shift command will not be executed: shift lock.



Depress the brake until you start driving

To prevent the vehicle from creeping after you select a driving position, maintain pressure on the brake pedal until you are ready to start. ◀

Engaging D, R and N



Briefly push the selector lever in the desired direction, beyond a resistance point if necessary.

After releasing the selector lever, it returns to its center position.



Press unlock button, in order to:

- ▷ Engage R.
- ▷ Shift out of P.

Engaging P



Press button P.

Sport program DS and manual mode M/S

Activating the sport program



Push the selector lever to the left out of transmission position D.

DS is displayed in the instrument cluster.

The sport program of the transmission is activated.

Activating the M/S manual mode

1. Push the selector lever to the left out of transmission position D.
2. Push the selector lever forward or backward. Manual mode becomes active and the gear is changed.

The engaged gear is displayed in the instrument cluster, e.g., M1.

Once maximum engine speed is attained, M/S manual mode is automatically upshifted as needed.

Switching to manual mode

- ▷ To shift down: press the selector lever forward.
- ▷ To shift up: pull the selector lever rearwards.

Gears will only be shifted at appropriate engine and road speeds, e.g., downshifting is not possible if the engine speed is too high.

The selected gear is briefly displayed in the instrument cluster, followed by the current gear.

Sport automatic transmission: prevent automatic upshifting in M/S manual mode

For vehicles with Sport automatic transmissions, automatic shift operations are not performed, at maximum engine speed for example, if one of the following conditions is met:

- ▷ DSC deactivated.
- ▷ TRACTION activated.
- ▷ SPORT+ activated.

In addition, the kickdown is deactivated.

Ending the sport program/manual mode

Push the selector lever to the right.

D is displayed in the instrument cluster.

Shift paddles for Sport automatic transmission

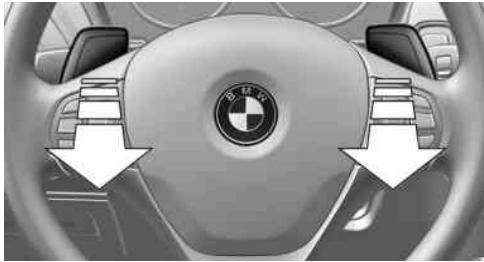

The shift paddles on the steering wheel allow you to shift gears quickly while keeping both hands on the steering wheel.

If the shift paddles on the steering wheel are used to shift gears in automatic mode, the transmission temporarily switches to manual mode.

If the shift paddles are not used and the vehicle is not accelerated for a certain time, the system switches back into automatic mode if the selector lever is in transmission position D.

- ▶ Shift up: pull right shift paddle.
- ▶ Shift down: pull left shift paddle.

The vehicle only shifts up or down at appropriate engine and road speeds, e.g., it does not shift down if the engine speed is too high.

The selected gear is briefly displayed in the instrument cluster, followed by the current gear.

Displays in the instrument cluster



The transmission position is displayed, e.g.: P.

Displays

Vehicle equipment

All standard, country-specific and optional equipment that is offered in the model series is described in this chapter. Therefore, equipment

is also described that is not available in a vehicle, e. g., because of the selected optional equipment or country variant. This also applies for safety-related functions and systems.

Instrument cluster

Overview, instrument cluster

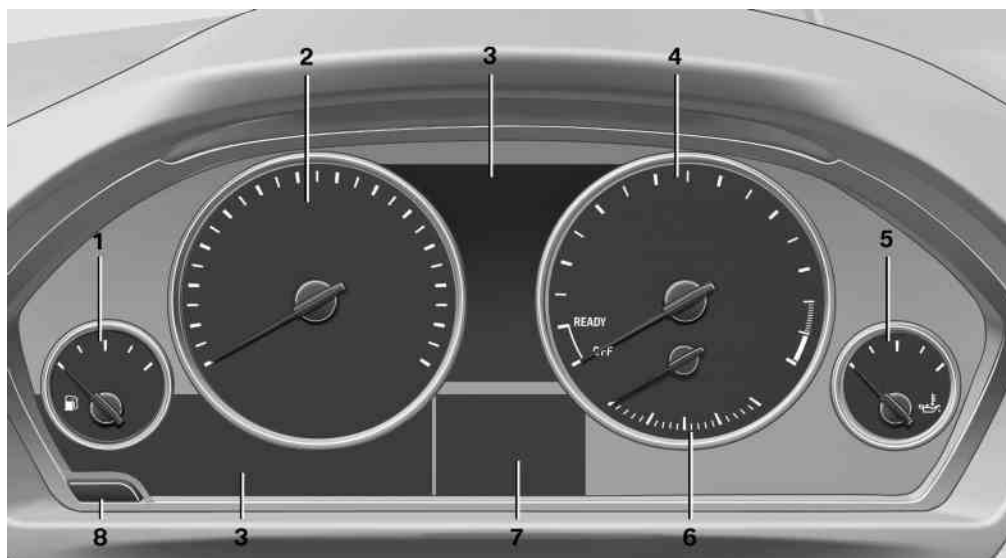

- | | |
|------------------------------|-------------------------------|
| 1 Fuel gauge 76 | 5 Engine oil temperature 76 |
| 2 Speedometer | 6 Current fuel consumption 77 |
| 3 Indicator/warning lamps 74 | 7 Electronic displays 72 |
| 4 Tachometer 76 | 8 Display/reset miles 76 |

Overview, instrument cluster with enhanced features

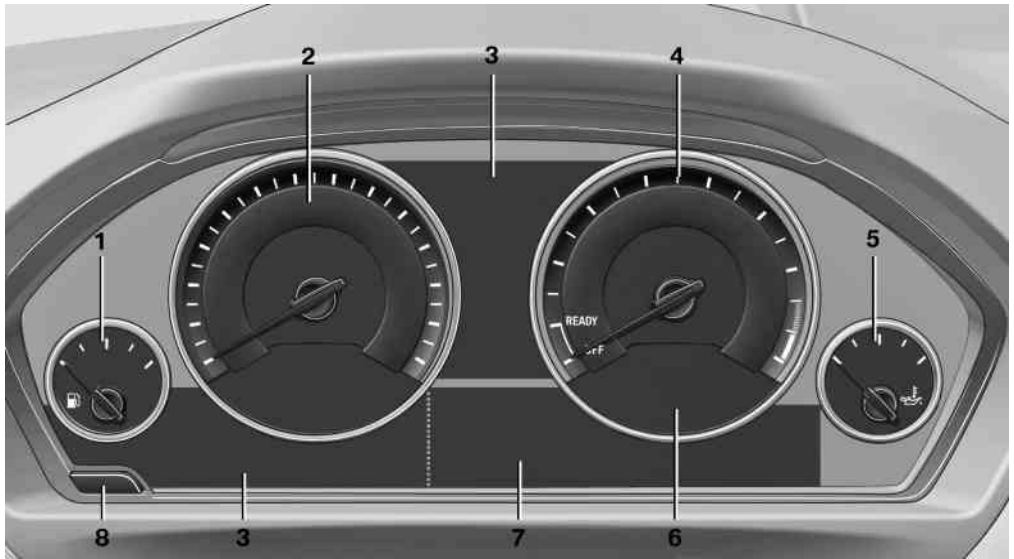

- | | |
|--|---|
| 1 Fuel gauge 76 | 5 Engine oil temperature 76 |
| 2 Speedometer | 6 Current fuel consumption 77 |
| 3 Indicator/warning lamps 74 | 7 Electronic displays 72 |
| 4 Tachometer 76 | 8 Display/reset miles 76 |

Electronic displays

Overview, instrument cluster

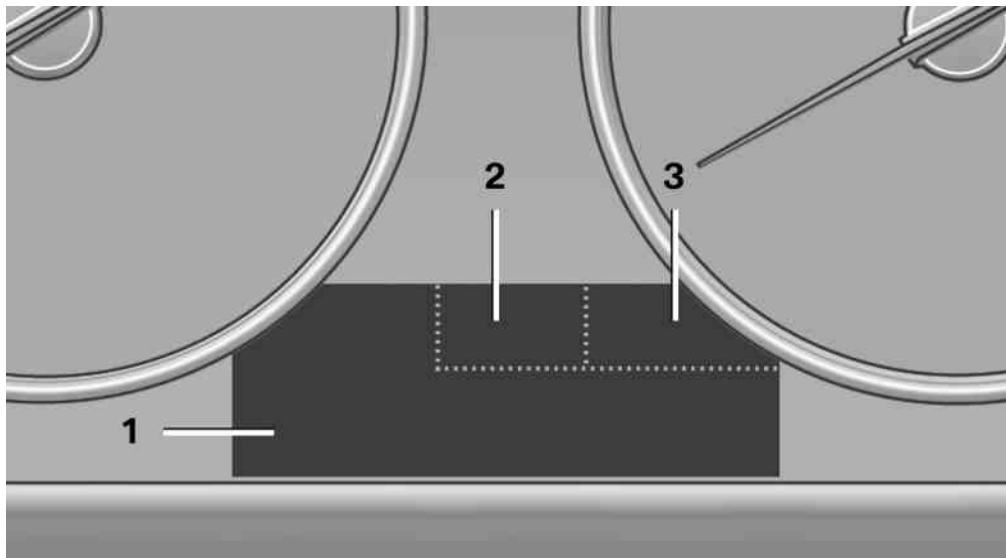

- 1** Messages, e.g. Check Control [73](#)
 - Time [76](#)
 - Date [76](#)
 - External temperature [76](#)
 - Selection lists [81](#)
 - Service requirements [77](#)

- Miles/trip miles [76](#)
- Computer [81](#)
- 2** Transmission display [69](#)
 - Gear shift indicator [79](#)
- 3** Status, Driving Experience Switch [113](#)

Overview, instrument cluster with enhanced features

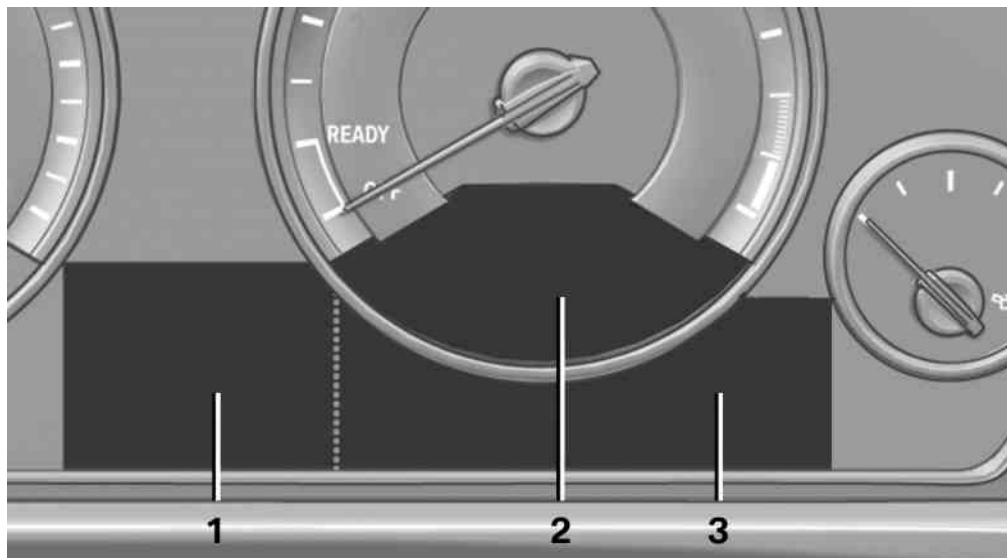

- | | |
|---|--|
| <p>1 Time 76
 External temperature 76
 Date 76
 Selection list, such as for the radio 81
 Speed limit detection 79
 Computer 81
 Miles/trip miles 76</p> | <p>Navigation display, see user's manual for Navigation, Entertainment and Communication.</p> <p>2 Energy recovery 77
 Transmission display 69
 Current fuel consumption 77
 ECO PRO 167</p> <p>3 Messages, e.g. Check Control 73
 Service requirements 77</p> |
|---|--|

Check Control

The concept

The Check Control system monitors functions in the vehicle and notifies you of malfunctions in the monitored systems.

A Check Control message is displayed as a combination of indicator or warning lamps and text messages in the instrument cluster and in the Head-up Display.

In addition, an acoustic signal may be output and a text message may appear on the Control Display.

Indicator/warning lamps

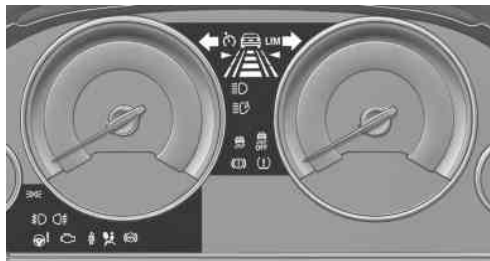



The indicator and warning lamps can light up in a variety of combinations and colors.

Several of the lamps are checked for proper functioning and light up temporarily when the engine is started or the ignition is switched on.

Overview: indicator/warning lamps

Symbol	Function or system
	Turn signal
	Front fog lamps
	Rear fog lamp
	High beams
	High-beam Assistant
	Parking lamps, headlamp control
	Active Cruise Control
	Vehicle detection, Active Cruise Control

Symbol	Function or system
	Collision warning
	Adjustable speed limit
	Cruise control
	Lane departure warning
	DSC Dynamic Stability Control
	DSC Dynamic Stability Control is deactivated or DTC Dynamic Traction Control is activated
	Tire Pressure Monitor Flat Tire Monitor
	Safety belts
	Airbag system
	Steering system
	Emissions
	Parking brake Brake system
	In Canadian models Parking brake Brake system
	ABS Antilock Brake System

Symbol	Function or system
	ABS Antilock Brake System in Canadian models
	At least one Check Control message is displayed or is stored (symbol in display)



ABS Antilock Brake System in Canadian models



At least one Check Control message is displayed or is stored (symbol in display)

Text messages

Text messages in combination with a symbol in the instrument cluster explain a Check Control message and the meaning of the indicator and warning lamps.



Supplementary text messages

Addition information, such as on the cause of a fault or the required action, can be called up via Check Control.

The supplementary text of urgent messages is displayed on the Control Display automatically.

Symbols

Depending on the Check Control message, the following functions can be selected.

- ▷  "Owner's Manual"
Display additional information about the Check Control message in the integrated owner's manual.
- ▷  "Service request"
Contact the service partner.
- ▷  "Roadside Assistance"
Contact Roadside Assistance.

Hiding Check Control messages

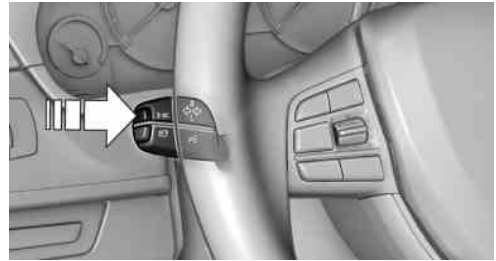

Press the computer button on the turn signal lever.

- ▷ Some Check Control messages are displayed continuously and are not cleared until the malfunction is eliminated. If several malfunctions occur at once, the messages are displayed consecutively.
These messages can be hidden for approx. 8 seconds. After this time, they are displayed again automatically.
- ▷ Other Check Control messages are hidden automatically after approx. 20 seconds. They are stored and can be displayed again later.

Displaying stored Check Control messages

1. "Vehicle Info"
2. "Vehicle status"
3.  "Check Control"
4. Select the text message.

Messages after trip completion

Special messages that are displayed during driving are displayed again after the ignition is switched off.

Fuel gauge



The vehicle inclination may cause the display to vary.

Notes on refueling, refer to page [172](#).

Tachometer

Always avoid engine speeds in the red warning field. In this range, the fuel supply is interrupted to protect the engine.

Engine oil temperature



▶ Cold engine: the pointer is at the low temperature end. Drive at moderate engine and vehicle speeds.

▶ Normal operating temperature: the pointer is in the middle or in the left half of the temperature display.

▶ Hot engine: the pointer is at the high temperature end. A Check Control message is displayed in addition.

Coolant temperature

If the coolant along with the engine becomes too hot, a Check Control message is displayed.

Check the coolant level, refer to page [192](#).

Odometer and trip odometer



▶ Odometer, arrow 1.

▶ Trip odometer, arrow 2.

Display/reset miles



Press the knob.

▶ When the ignition is switched off, the time, external temperature and odometer are displayed.

▶ When the ignition is switched on, the trip odometer is reset.

External temperature

External temperature warning

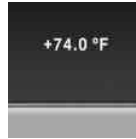

If the indicator drops to +37 °F/+3 °C, a signal sounds.

A Check Control message is displayed.

There is an increased risk of ice on roads.



Ice on roads

Even at temperatures above +37 °F/+3 °C, there can be a risk of ice on roads.

Therefore, drive carefully on bridges and shaded roads, for example, to avoid the increased risk of an accident. ◀

Time

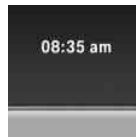

The time is displayed at the bottom of the instrument cluster.

Setting the time and time format, refer to page [84](#).

Date

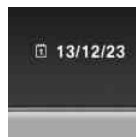

The date is displayed in the instrument cluster.

Setting the date and date format, refer to page [84](#).

Range

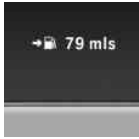

After the reserve range is reached:

- ▶ A Check Control message is displayed briefly.
 - ▶ The remaining range is shown on the onboard computer.
- ▶ When a dynamic driving style is used, such as when cornering quickly, operation of the engine is not always ensured.

The Check Control message appears continuously below a range of approx. 30 miles/50 km.



Refuel promptly

Refuel no later than at a range of 30 miles/50 km, or operation of the engine is not ensured and damage may occur. ◀

Displaying the cruising range

1. "Settings"
2. "Info display"
3. "Additional indicators"

The range is displayed in the instrument cluster.

Current fuel consumption

Instrument cluster



Displays the current fuel consumption. You can check whether you are currently driving in an efficient and environmentally-friendly manner.

Instrument cluster with enhanced features



Displays the current fuel consumption. You can check whether you are currently driving

in an efficient and environmentally-friendly manner.

Displaying the current fuel consumption

1. "Settings"
2. "Info display"
3. "Additional indicators"

The bar display for the current fuel consumption is displayed in the instrument cluster.

Energy recovery



The kinetic energy of the vehicle is converted to electrical energy while coasting. The vehicle battery is partially charged and fuel consumption can be reduced.

Service requirements

The concept

The driving distance or the time to the next service is displayed briefly after the ignition is switched on.

The current service requirements can be read out from the remote control by the service specialist.

Display

Data regarding the service status or legally mandated inspections of the vehicle are automatically transmitted to your service center before a service due date.

Instrument cluster



Display in the instrument cluster.

Instrument cluster with enhanced features

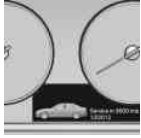



Display in the instrument cluster with expanded scope.

Detailed information on service requirements

More information on the scope of service required can be displayed on the Control Display.

1. "Vehicle Info"
2. "Vehicle status"
3.  "Service required"
Required maintenance procedures and legally mandated inspections are displayed.
4. Select an entry to call up detailed information.

Symbols

Symbols	Description
	No service is currently required.
	The deadline for service or a legally mandated inspection is approaching.
	The service deadline has already passed.

Entering appointment dates

Enter the dates for the required inspections. Ensure that the vehicle date and time are set correctly.

1. "Vehicle Info"
2. "Vehicle status"
3.  "Service required"
4. "§ Vehicle inspection"

5. "Date:"
6. Adjust the settings.
7. Confirm.
The entered date is stored.

Automatic Service Request

Data regarding the service status or legally mandated inspections of the vehicle are automatically transmitted to your service center before a service due date.



You can check when your service center was notified.

1. "Vehicle Info"
2. "Vehicle status"
3. Open "Options".
4. "Last Service Request"



Service history

Perform maintenance work at the service center and have them recorded in the vehicle data. The entries are like a service booklet of the documentation of regular maintenance.

The entered maintenance work can be displayed on the Control Display. Function is available as soon as a maintenance operation has been entered in the vehicle data.

1. "Vehicle Info"
2. "Vehicle status"
3.  "Service required"
4.  "Service history"
Performed maintenance operations are displayed.
5. Select an entry to call up detailed information.

Symbols

Symbols	Description
	Green: maintenance was performed on schedule.
	Yellow: maintenance was performed late.
	Maintenance was not performed.





Gear shift indicator

The concept

The system recommends the most fuel efficient gear in the current driving situation.

Displays

Indicators to shift up or down are displayed in the instrument cluster.

Symbols	Description
	Fuel efficient gear is engaged.
	Shift up to fuel efficient gear.
	Shift down to fuel efficient gear.
	Shift into neutral.

Speed limit detection with No Passing Information

The concept

Speed limit detection

Speed limit detection uses a symbol in the shape of a traffic sign to display the currently detected speed limit. The camera at the base of the interior rearview mirror detects traffic signs at the edge of the road as well as variable overhead sign posts. Traffic signs with extra symbols for wet road conditions, etc. are also detected and compared with vehicle interior data, such as for the rain sensor, and are displayed depending on the situation. The system takes into account the information stored in the navigation system and also displays speed limits present on routes without signs.

No Passing Information

No Passing Information displays in the instrument cluster the beginnings and ends of no passing zones detected by the camera. The system accounts for only the beginnings and ends of No Passing zones marked by signs.

No display is shown:

- ▷ In countries where No Passing zones are primarily identified with road markings.
- ▷ On routes without signage.
- ▷ Where there are railroad crossings, highway markings or other situations where no signage is present, but passing would not be permitted.

Notes



Personal judgment

The system cannot serve as a substitute for the driver's personal judgment of the traffic situation.

The system assists the driver and does not replace the human eye. ◀

At a glance

Camera

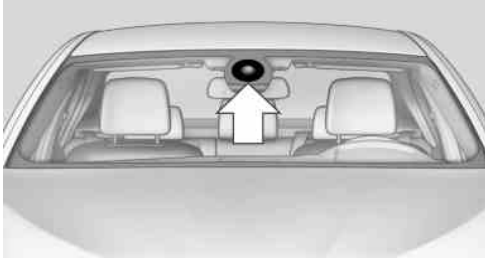

The camera is located near the base of the mirror.

Keep the windshield in the area behind the interior rear view mirror clean and clear.

Switching on/off

1. "Settings"
2. "Info display"
3. "Speed limit information"

If speed limit detection is switched on, it can be displayed on the info display in the instrument cluster via the onboard computer. No Passing Information is displayed together with activated speed limit information.

Display

The following is displayed in the instrument cluster.

Speed limit detection

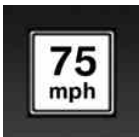

Current speed limit.



Speed limit detection is not available.

Speed limit detection can also be displayed in the Head-up Display.

No Passing Information



- ▷ Start of No Passing zone.
- ▷ End of No Passing zone.
- ▷ No Passing Information not available.

No Passing Information can also be displayed in the Head-up Display.

System limits

The system may not be fully functional and may provide incorrect information in the following situations:

- ▷ In heavy fog, rain or snowfall.
- ▷ When signs are concealed by objects.
- ▷ When driving very close to the vehicle in front of you.
- ▷ When driving toward bright lights.
- ▷ When the windshield behind the interior rearview mirror is fogged over, dirty or covered by a sticker, etc.
- ▷ In the event of incorrect detection by the camera.
- ▷ If the speed limits stored in the navigation system are incorrect.
- ▷ In areas not covered by the navigation system.
- ▷ When roads differ from the navigation, such as due to changes in the road network.
- ▷ When passing buses or trucks with a speed sticker.
- ▷ If the traffic signs are non-conforming.
- ▷ During calibration of the camera immediately after vehicle shipment.

Selection lists in the instrument cluster

The concept

The following can be displayed or operated using the buttons and the thumbwheel on the steering wheel and the display in the instrument cluster:

- ▶ Current audio source.
- ▶ Redial on telephone.
- ▶ Activation of the voice activation system.

In addition, programs of the Driving Experience Switch are displayed.

Display

Instrument cluster



Instrument cluster with enhanced features



Activating a list and adjusting the setting

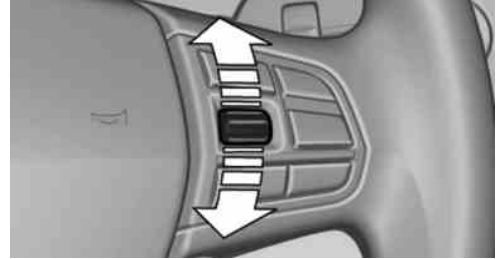

On the right side of the steering wheel, turn the thumbwheel to activate the corresponding list.

Using the thumbwheel, select the desired setting and confirm it by pressing the thumbwheel.

Computer

Indication in the info display

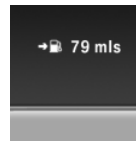

The information from the on-board computer is shown in the info display in the instrument cluster.

Calling up information on the info display

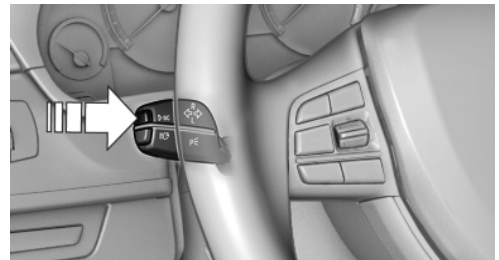

Press the onboard computer button on the turn signal lever.

Information is displayed on the info display of the instrument cluster.

Information at a glance

Repeatedly pressing the button on the turn signal lever calls up the following information on the info display:

- ▷ Range.
- ▷ Average fuel consumption.
- ▷ Current fuel consumption.
- ▷ Average speed.
- ▷ Date.
- ▷ Speed limit detection.
- ▷ Time of arrival.

When destination guidance is activated in the navigation system.
- ▷ Distance to destination.

When destination guidance is activated in the navigation system.
- ▷ Arrow view of navigation system.

When destination guidance is activated in the navigation system.

When the arrow view in the Head-up Display is inactive.
- ▷ ECO PRO bonus range.

Adjusting the info display

You can select what information from the on-board computer is to be displayed on the info display of the instrument cluster.

1. "Settings"
2. "Info display"
3. Select the desired displays.

Information in detail

Range

Displays the estimated cruising range available with the remaining fuel.

It is calculated based on your driving style over the last 20 miles/30 km.

If there is only enough fuel left for less than 45 miles/80 km, the color of the display changes.

Average fuel consumption

This is calculated for the period during which the engine is running.

The average fuel consumption is calculated on the basis of various distances.

Average speed

Periods in which the vehicle is parked with the engine manually stopped do not enter into the calculation of the average speed.

Resetting average values

Press and hold the computer button on the turn signal lever.

Distance to destination

The distance remaining to the destination is displayed if a destination is entered in the navigation system before the trip is started.

The distance to the destination is adopted automatically.

Time of arrival

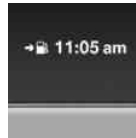

The estimated time of arrival is displayed if a destination is entered in the navigation system before the trip is started.

The time must be correctly set.

Speed limit detection

Description of the speed limit detection, refer to page 79, function.

Speed limit

Display of a speed limit which, when reached, should cause a warning to be issued.

The warning is repeated if the vehicle speed drops below the set speed limit once by at least 3 mph/5 km/h.

Displaying, setting or changing the limit

1. "Settings"
2. "Speed"
3. "Warning at:"

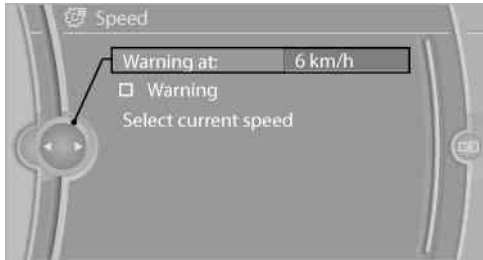

4. Turn the controller until the desired limit is displayed.
5. Press the controller.
The speed limit is stored.

Activating/deactivating the limit

1. "Settings"
2. "Speed"
3. "Warning"
4. Press the controller.

Setting your current speed as the limit

1. "Settings"
2. "Speed"
3. "Select current speed"
4. Press the controller.
The current vehicle speed is stored as the limit.

Trip computer

The vehicle features two types of computer.

- "Onboard info": the values can be reset as often as necessary.
- "Trip computer": the values provide an overview of the current trip.

Resetting the trip computer

1. "Vehicle Info"
2. "Trip computer"
3. "Reset": all values are reset.

"Automatically reset": all values are reset approx. 4 hours after the vehicle comes to a standstill.



Display on the Control Display

Display the onboard computer or trip computer on the Control Display.

1. "Vehicle Info"
2. "Onboard info" or "Trip computer"

Resetting the fuel consumption or speed

1. "Vehicle Info"
2. "Onboard info"
3. "Cons." or "Speed"

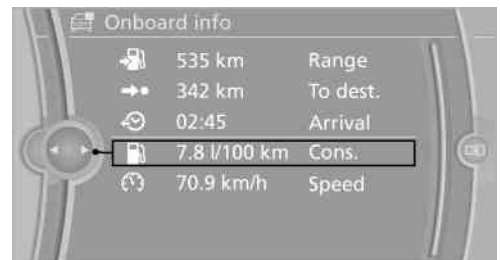

4. "Yes"

Sport displays

In the Control Display, the current values for power and torque can be displayed.

Displaying sport displays in the Control Display

1. "Vehicle Info"
2. "Sport displays"

Settings on the Control Display

Time

Setting the time zone

1. "Settings"
2. "Time/Date"
3. "Time zone"
4. Select the desired time zone.

The time zone is stored.

Setting the time

1. "Settings"
2. "Time/Date"
3. "Time:"

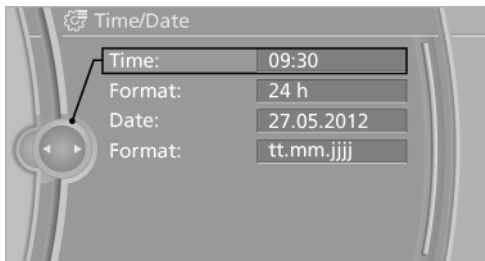

4. Turn the controller until the desired hours are displayed.
5. Press the controller.
6. Turn the controller until the desired minutes are displayed.
7. Press the controller.

The time is stored.

Setting the time format

1. "Settings"
2. "Time/Date"
3. "Format:"
4. Select the desired format.

The time format is stored.

Date

Setting the date

1. "Settings"
2. "Time/Date"
3. "Date:"
4. Turn the controller until the desired day is displayed.
5. Press the controller.
6. Make the necessary settings for the month and year.

The date is stored.

Setting the date format

1. "Settings"
2. "Time/Date"
3. "Format:"
4. Select the desired format.



The date format is stored.

Language

Setting the language

To set the language on the Control Display:

1. "Settings"
2. "Language/Units"
3. "Language:"



4. Select the desired language.

The setting is stored for the remote control currently in use.

Units of measure

Setting the units of measure

To set the units for fuel consumption, route/distance and temperature:

1. "Settings"
2. "Language/Units"
3. Select the desired menu item.

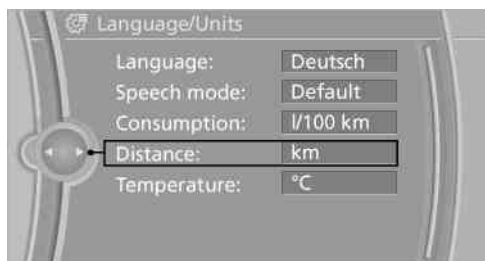

4. Select the desired unit.

The setting is stored for the remote control currently in use.

Brightness

Setting the brightness

To set the brightness of the Control Display:

1. "Settings"
2. "Control display"
3. "Brightness"



4. Turn the controller until the desired brightness is set.
5. Press the controller.

The setting is stored for the remote control currently in use.

Depending on the light conditions, the brightness control may not be clearly visible.

Assist system information

Display on the Control Display

Information on the Assist system can be displayed by activating Assist on the Control Display.

1. "Settings"
2. "Control display"

3. "Driver assistance info"

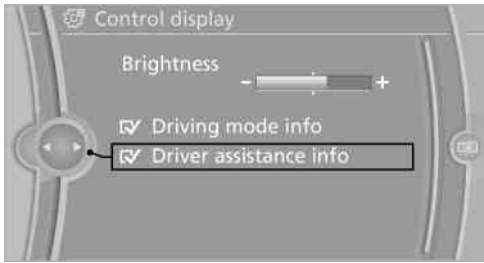

Lamps

Vehicle equipment

All standard, country-specific and optional equipment that is offered in the model series is described in this chapter. Therefore, equipment is also described that is not available in a vehicle, e. g., because of the selected optional equipment or country variant. This also applies for safety-related functions and systems.

At a glance

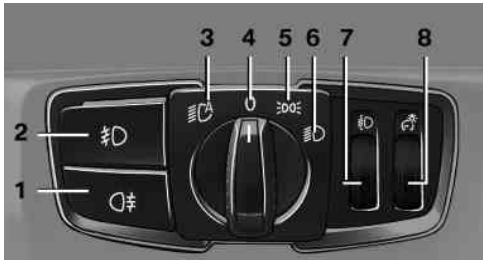

- 1 Rear fog lamps
- 2 Front fog lamps
- 3 Automatic headlamp control / Adaptive Light Control / High-beam Assistant / welcome lamps / daytime running lights
- 4 Lamps off/daytime running lights
- 5 Parking lamps/daytime running lights
- 6 Low beams/welcome lamps / High-beam Assistant
- 7 Headlamp range control
- 8 Instrument lighting

Parking lamps/low beams, headlamp control

General information

Switch position: 0, ,

If the driver door is opened with the ignition switched off, the exterior lighting is automatically switched off at these switch settings.

Parking lamps

Switch position : the vehicle lamps light up on all sides, e.g., for parking.

Do not use the parking lamps for extended periods; otherwise, the battery may become discharged and it would then be impossible to start the engine.

When parking, it is preferable to switch on the one-sided roadside parking lamps, refer to page 88.

Low beams

Switch position with the ignition switched on: the low beams light up.

Welcome lamps

When parking the vehicle, leave the switch in position or : the parking and interior lamps light up briefly when the vehicle is unlocked.

Activating/deactivating

1. "Settings"
2. "Lighting"
3. "Welcome light"

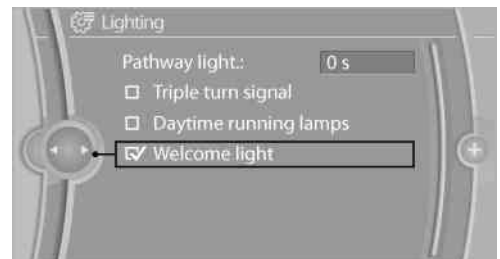

The setting is stored for the remote control currently in use.

Headlamp courtesy delay feature

The low beams stay lit for a short while if the headlamp flasher is switched on after the ignition is switched off.

Setting the duration

1. "Settings"
2. "Lighting"
3. "Pathway light.: s"



4. Set the duration.

The setting is stored for the remote control currently in use.

Automatic headlamp control

Switch position : the low beams are switched on and off automatically, e.g., in tunnels, in twilight or if there is precipitation. The indicator lamp in the instrument cluster lights up.

A blue sky with the sun low on the horizon can cause the lights to be switched on.

The low beams always stay on when the fog lamps are switched on.





Personal responsibility

The automatic headlamp control cannot serve as a substitute for your personal judgment in determining when the lamps should be switched on in response to ambient lighting conditions.

For example, the sensors are unable to detect fog or hazy weather. To avoid safety risks, you should always switch on the lamps manually under these conditions. ◀

Daytime running lights

With the ignition switched on, the daytime running lights light up in position 0,  or . After the ignition is switched off, the parking lamps light up in position .

Activating/deactivating

1. "Settings"
2. "Lighting"
3. "Daytime running lamps"



The setting is stored for the remote control currently in use.

Roadside parking lamps

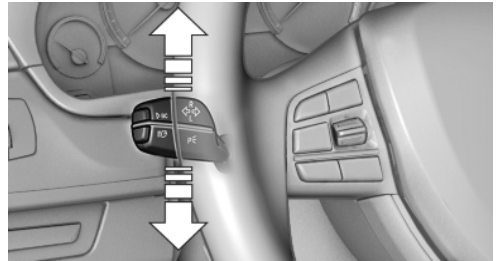

The vehicle can be illuminated on one side.

Switching on

With the ignition switched off, press the lever either up or down past the resistance point for approx. 2 seconds.

Switching off

Briefly press the lever to the resistance point in the opposite direction.

Adaptive light control

The concept

Adaptive light control is a variable headlamp control system that enables dynamic illumination of the road surface.

Depending on the steering angle and other parameters, the light from the headlamp follows the course of the road.

In tight curves, e.g., on mountainous roads or when turning, one of the two front fog lamps is switched on as a turning lamp. As a result the inside of the curve is better lighted.

Activating

Switch position  with the ignition switched on.

The turning lamps are automatically switched on depending on the steering angle or the use of turn signals.

To avoid blinding oncoming traffic, the Adaptive Light Control does not swivel to the driver's side when the vehicle is at a standstill.

When driving in reverse, only the turning lamp is active.

Malfunction

A Check Control message is displayed.

Adaptive light control is malfunctioning or has failed. Have the system checked as soon as possible.

High-beam Assistant

The concept



When the low beams are switched on, this system automatically switches the high beams on and off or suppresses the light in the areas that blind oncoming traffic. The procedure is controlled by a sensor on the front of the interior rearview mirror. The assistant ensures that the high beams are switched on whenever the traffic

situation allows. The driver can intervene at any time and switch the high beams on and off as usual.

Activating



The High-beam Assistant can be activated when the low beams are switched on.

1. Turn the light switch to  or .
2. Press the button on the turn signal lever, arrow.



The indicator lamp in the instrument cluster lights up.

When the low beams are on, the lights are automatically brightened or dimmed.

The system responds to light from oncoming traffic and traffic driving ahead of you, and to adequate illumination, e.g., in towns and cities.



The blue indicator lamp in the instrument cluster lights up when the system switches on the high beams. Depending on the version of the system in the vehicle, the high beams may not switch off for oncoming vehicles, but may only be dimmed in the areas that blind oncoming traffic. In this case, the blue indicator light will stay on.

Switching the high beams on and off manually

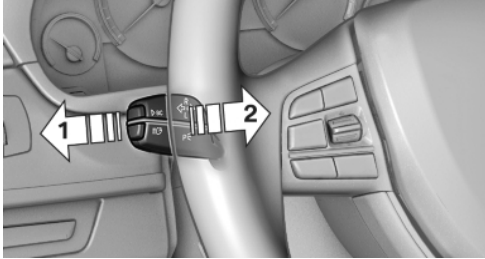

- ▷ High beams on, arrow 1.
- ▷ High beams off/headlamp flasher, arrow 2.

The High-beam Assistant can be switched off when manually adjusting the light. To reactivate the High-beam Assistant, press the button on the turn signal lever.

System limits

Personal responsibility

The high-beam assistant cannot serve as a substitute for the driver's personal judgment of when to use the high beams. Therefore, manually switch off the high beams in situations where this is required to avoid a safety risk. ◀

The system is not fully functional in situations such as the following, and driver intervention may be necessary:

- ▷ In very unfavorable weather conditions, such as fog or heavy precipitation.
- ▷ In detecting poorly-lit road users, such as pedestrians, cyclists, horseback riders and wagons; when driving close to train or ship traffic; and at animal crossings.
- ▷ In tight curves, on hilltops or in depressions, in cross traffic or half-observed oncoming traffic on freeways.
- ▷ In poorly-lit towns and cities and in the presence of highly reflective signs.
- ▷ At low speeds.

- ▷ When the windshield in front of the interior rearview mirror is fogged over, dirty or covered with stickers, etc.

Camera

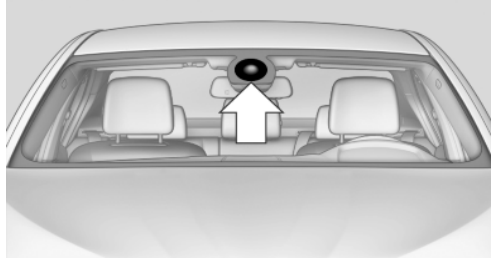

The camera is located near the base of the mirror.

Keep the windshield in the area behind the interior rear view mirror clean and clear.

Fog lamps

Front fog lamps

The parking lamps or low beams must be switched on.



Press the button. The green indicator lamp lights up.

If the automatic headlamp control, refer to page 88, is activated, the low beams will come on automatically when you switch on the front fog lamps.

Instrument lighting

Adjusting



The parking lamps or low beams must be switched on to adjust the brightness.

Adjust the brightness using the thumbwheel.

Interior lamps

General information

The interior lamps, footwell lamps, entry lamps and courtesy lamps are controlled automatically.

The brightness of some of these lamps is influenced by the thumbwheel for the instrument lighting.



- 1 Interior lamps
- 2 Reading lamp

Switching the interior lamps on and off



Press the button.

To switch off permanently: press the button for approx. 3 seconds.

Switch back on: press button.

Reading lamps



Press the button.

Reading lamps are located at the front and rear next to the interior lamps.

When the interior lamps are switched off permanently, the reading lamps cannot be switched on.

Ambient light

Depending on the equipment, the lighting can be individually adjusted in the interior for some lights.

Selecting color scheme

1. "Settings"
2. "Lighting"
3. "Ambient:"

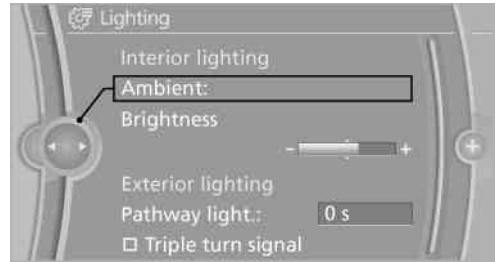

4. Select the desired setting.

If the color scheme of the line is selected and the welcome lamps are activated, the welcome lamps are displayed in color when unlocking the vehicle.

Setting the brightness

The brightness of the ambient light can be adjusted via the thumbwheel for the instrument lighting but also independently of it.

1. "Settings"
2. "Lighting"
3. "Brightness:"
4. Adjust the brightness.

Safety

Vehicle equipment

All standard, country-specific and optional equipment that is offered in the model series is described in this chapter. Therefore, equipment

is also described that is not available in a vehicle, e. g., because of the selected optional equipment or country variant. This also applies for safety-related functions and systems.

Airbags

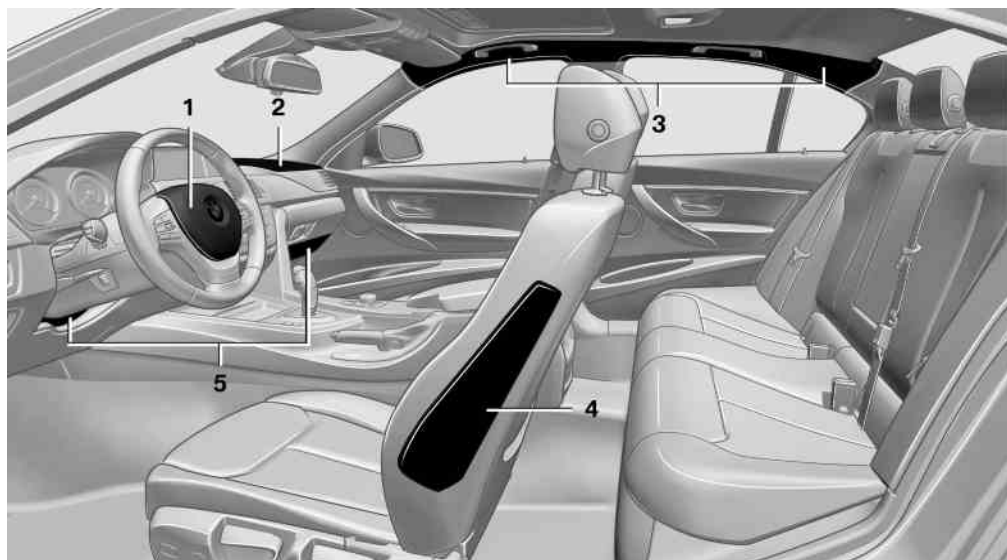

- | | | | |
|---|-------------------------------|---|--------------|
| 1 | Front airbag, driver | 4 | Side airbag |
| 2 | Front airbag, front passenger | 5 | Knee airbags |
| 3 | Head airbag | | |

Front airbags

Front airbags help protect the driver and front passenger by responding to frontal impacts in which safety belts alone cannot provide adequate restraint.

Side airbags

In a lateral impact, the side airbag supports the side of the body in the chest and lap area.

Head airbags

In a lateral impact, the head airbag supports the head.

In the event of a rollover accident, the head airbag can help to prevent the person from being thrown out of the vehicle.

Knee airbag

The knee airbag supports the legs in a frontal impact.

Protective action

Airbags are not triggered in every impact situation, e.g., in less severe accidents or rear-end collisions.



Information on how to ensure the optimal protective effect of the airbags

- ▷ Keep at a distance from the airbags.
- ▷ Always grasp the steering wheel on the steering wheel rim, holding your hands at the 3 o'clock and 9 o'clock positions, to keep the danger of injury to your hands or arms as low as possible if the airbag is triggered.
- ▷ There should be no people, animals, or objects between an airbag and a person.
- ▷ Do not use the cover of the front airbag on the front passenger side as a storage area.
- ▷ Keep the dashboard and window on the front passenger side clear, i.e., do not cover with adhesive labels or coverings, and do not attach holders such as for navigation instruments and mobile phones.
- ▷ Make sure that the front passenger is sitting correctly, i.e., keeps his or her feet and legs in the footwell; otherwise, leg injuries can occur if the front airbag is triggered.
- ▷ Do not place slip covers, seat cushions or other objects on the front passenger seat that are not approved specifically for seats with integrated side airbags.
- ▷ Do not hang pieces of clothing, such as jackets, over the backrests.
- ▷ Make sure that occupants keep their heads away from the side airbag and do not rest against the head airbag; otherwise, injuries can occur if the airbags are triggered.
- ▷ Do not remove the airbag restraint system.
- ▷ Do not remove the steering wheel.

- ▷ Do not apply adhesive materials to the airbag cover panels, cover them or modify them in any way.
- ▷ Never modify either the individual components or the wiring in the airbag system. This also applies to steering wheel covers, the dashboard, the seats, the roof pillars and the sides of the headliner. ◀

Even when all instructions are followed closely, injury from contact with the airbags cannot be ruled out in certain situations.

The ignition and inflation noise may lead to short-term and, in most cases, temporary hearing impairment in sensitive individuals.



In the case of a malfunction, deactivation and after triggering of the airbags

Do not touch the individual components immediately after the system has been triggered; otherwise, there is the danger of burns.

Only have the airbags checked, repaired or dismantled and the airbag generator scrapped by your service center or a workshop that has the necessary authorization for handling explosives.

Non-professional attempts to service the system could lead to failure in an emergency or undesired triggering of the airbag, either of which could result in injury. ◀

Warnings and information on the airbags are also found on the sun visors.

Functional readiness of the airbag system



When the ignition is switched on, the warning lamp in the instrument cluster lights up briefly and thereby indicates the operational readiness of the entire airbag system and the belt tensioner.

Airbag system malfunctioning

- ▷ Warning lamp does not come on when the ignition is turned on.
- ▷ The warning lamp lights up continuously.

 When there is a malfunction, have the airbag system checked immediately

When there is a malfunction, have the airbag system checked immediately; otherwise, there is a risk that the system does not function as expected in the event of an accident despite corresponding severity of the accident. ◀

Automatic deactivation of the front passenger airbags

The system determines whether the front passenger seat is occupied by measuring the resistance of the human body.

The front, knee, and side airbag on the front passenger side are activated or deactivated accordingly.

 Leave feet in the footwell

Make sure that the front passenger keeps his or her feet in the footwell; otherwise, the front passenger airbags may not function properly. ◀

 Child restraint fixing system in the front passenger seat

Before transporting a child on the front passenger seat, see the safety notes and instructions under Children on the front passenger seat. ◀

Malfunction of the automatic deactivation system

When transporting older children and adults, the front passenger airbags may be deactivated in certain sitting positions. In this case, the indicator lamp for the front passenger airbags lights up.

In this case, change the sitting position so that the front passenger airbags are activated and the indicator lamp goes out.

If it is not possible to activate the airbags, have the person sit in the rear.

To make sure that the occupied seat cushion can be evaluated correctly

▷ Do not attach covers, cushions, ball mats or other items to the front passenger seat un-

less they are specifically recommended by the manufacturer of your vehicle.

- ▷ Do not place any electronic devices on the passenger seat if a child restraint system is to be installed on it.
- ▷ Do not place objects under the seat that could press against the seat from below.

Indicator lamp for the front passenger airbags

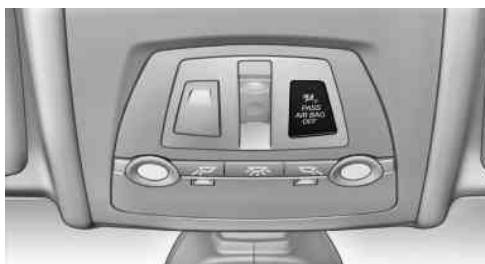

The indicator lamp for the front passenger airbags indicates the operating state of the front passenger airbags.

The lamp indicates whether the airbags are activated or deactivated.



- ▷ The indicator lamp lights up when a child who is properly seated in a child restraint fixing system intended for that purpose is detected on the seat or the seat is empty. The airbags on the front passenger side are not activated.
- ▷ The indicator lamp does not light up when, for example, a correctly seated person of sufficient size is detected on the seat. The airbags on the front passenger side are activated.

Detected child seats

The system generally detects children seated in a child seat, especially in the child seats that were required by NHTSA when the vehicle was manufactured. After installing a child seat, make

sure that the indicator lamp for the front passenger airbags lights up. This indicates that the child seat has been detected and the front passenger airbags are not activated.

Strength of the driver's and front passenger airbag

The strength with which the driver's and front passenger airbags are triggered depends on the position of the driver's and front passenger seats.

To maintain the accuracy of this function over the long-term, calibrate the front seats when a corresponding message appears on the Control Display.

Calibrating the front seats

A corresponding message appears on the Control Display.

1. Move the respective seat forward all the way.
2. Move the respective seat forward again. It moves forward briefly.
3. Readjust the seat to the desired position.

The calibration procedure is completed when the message on the Control Display disappears. If the message continues to be displayed, repeat the calibration.

If the message does not disappear after a repeat calibration, have the system checked as soon as possible.



Unobstructed area of movement

Ensure that the area of movement of the seats is unobstructed to avoid personal injury or damage to objects. ◀

Tire Pressure Monitor TPM

The concept

The tire inflation pressure is measured in the four mounted tires. The system notifies you if

there is a significant loss of pressure in one or more tires.

Functional requirements

The system must have been reset when the inflation pressure was correct; otherwise, reliable signaling of a flat tire is not ensured. Always use wheels with TPM electronics to ensure that the system will operate properly. Reset the system after each correction of the tire inflation pressure and after every tire or wheel change.

System limits



Sudden tire damage

Sudden serious tire damage caused by external influences cannot be indicated in advance. ◀

The system does not operate correctly if it has not been reset. For example, a flat tire may be indicated despite correct tire inflation pressures.

The system is inactive and cannot indicate a flat tire:

- ▶ For a mounted wheel without TPM electronics.
- ▶ When the TPM is disturbed by other systems or devices with the same radio frequency.

Status display

The current status of the Tire Pressure Monitor TPM can be displayed on the Control Display, e.g., whether or not the TPM is active.

1. "Vehicle Info"
2. "Vehicle status"
3. (⚠) "Tire Pressure Monitor - TPM"

The status is displayed.

Status display

The tire and system status is indicated by the color of the tires.

A change in the tire inflation pressure during driving is taken into account.

A correction is only necessary if this is indicated by the TPM

Wheels, green

The tire inflation pressure is equal to the target state.

One wheel is yellow

A flat tire or major drop in inflation pressure in the indicated tire.

All wheels are yellow

- ▷ A flat tire or major drop in inflation pressure in several tires.
- ▷ The system was not reset after a wheel change and thus warns based on the inflation pressures initialized last.
- ▷ A flat tire in one or more tires while the system is being reset.

Wheels, gray

The system cannot detect a flat tire. Reasons for this may be:

- ▷ TPM is being reset.
- ▷ Disturbance by systems or devices with the same radio frequency.
- ▷ Malfunction.

Resetting the system

Reset the system after each correction of the tire inflation pressure and after every tire or wheel change.

1. "Vehicle Info"
2. "Vehicle status"
3.  "Reset"
4. Start the engine - do not drive away.
5. Reset the tire pressure using "Reset".
6. Drive away.

The tires are shown in gray and "Resetting TPM..." is displayed.

After driving for a few minutes, the set tire inflation pressures are applied as set values. The resetting process is completed automatically during driving. The tires are shown in green and "TPM active" is shown on the Control Display.

The trip can be interrupted at any time. If you drive away again, the process resumes automatically.

If a flat tire is detected during a reset, all tires are displayed in yellow.

Low tire pressure message



The yellow warning lamp lights up. A Check Control message is displayed.

- ▷ There is a flat tire or a major loss in tire inflation pressure.
 - ▷ The system was not reset after a wheel change and thus warns based on the inflation pressures initialized last.
1. Reduce your speed and stop cautiously. Avoid sudden braking and steering maneuvers.
 2. Check whether the vehicle is fitted with regular tires or run-flat tires.
Run-flat tires, refer to page 185, are labeled with a circular symbol containing the letters RSC marked on the tire sidewall.



Do not continue driving without run-flat tires

Do not continue driving if the vehicle is not equipped with run-flat tires; continued driving may result in serious accidents. ◀

When a low inflation pressure is indicated, DSC Dynamic Stability Control is switched on if necessary.

Actions in the event of a flat tire

Normal tires

1. Identify the damaged tire.

Do this by checking the air pressure in all four tires.

If the tire inflation pressure in all four tires is correct, the Tire Pressure Monitor may not have been initialized. In this case, initialize the system.

If an identification is not possible, please contact the service center.

2. Rectify the flat tire.

Use of tire sealant, e.g., the Mobility System, may damage the TPM wheel electronics. In this case, have the electronics checked at the next opportunity and have them replaced if necessary.

Run-flat tires

Maximum speed

You can continue driving with a damaged tire at speeds up to 50 mph/80 km/h.

Continued driving with a flat tire

If continuing to drive with a damaged tire:

1. Avoid sudden braking and steering maneuvers.
2. Do not exceed a speed of 50 mph/80 km/h.
3. Check the air pressure in all four tires at the next opportunity.

If the tire inflation pressure in all four tires is correct, the Tire Pressure Monitor may not have been initialized. In this case, initialize the system.

Possible driving distance with complete loss of tire inflation pressure:

The possible driving distance after a loss of tire inflation pressure depends on the cargo load and the driving style and conditions.

For a vehicle containing an average load, the possible driving distance is approx. 50 miles/80 km.

When the vehicle is driven with a damaged tire, its handling characteristics change, e.g., re-

duced lane stability during braking, a longer braking distance, and altered self-steering properties. Adjust your driving style accordingly. Avoid abrupt steering maneuvers or driving over obstacles, e.g., curbs, potholes, etc.

Because the possible driving distance depends on how the vehicle is used during the trip, the actual distance may be smaller or greater depending on the driving speed, road conditions, external temperature, cargo load, etc.



Continued driving with a flat tire

Drive moderately and do not exceed a speed of 50 mph/80 km/h.

A loss of tire inflation pressure results in a change in the handling characteristics, e.g., reduced lane stability during braking, a longer braking distance and altered self-steering properties. ◀



Final tire failure

Vibrations or loud noises while driving can indicate the final failure of the tire. Reduce speed and stop; otherwise, pieces of the tire could come loose and cause an accident. Do not continue driving, and contact your service center. ◀

Message when the system was not reset

A Check Control message is displayed.

The system detected a wheel change but was not reset.

Warnings regarding the current tire inflation pressure are not reliable.

Check the tire inflation pressure and reset the system.

Malfunction



The yellow warning lamp flashes and then lights up continuously. A Check Control message is displayed. No flat tire can be detected.

Display in the following situations:

- ▶ A wheel without TPM electronics is fitted: have the service center check it if necessary.
- ▶ Malfunction: have the system checked by your service center.
- ▶ TPM could not be fully reset. Reset the system again.
- ▶ Disturbance by systems or devices with the same radio frequency: after leaving the area of the disturbance, the system automatically becomes active again.

Declaration according to NHTSA/ FMVSS 138 Tire Pressure Monitoring System

Each tire, including the spare (if provided) should be checked monthly when cold and inflated to the inflation pressure recommended by the vehicle manufacturer on the vehicle placard or tire inflation pressure label. (If your vehicle has tires of a different size than the size indicated on the vehicle placard or tire inflation pressure label, you should determine the proper tire inflation pressure for those tires.) As an added safety feature, your vehicle has been equipped with a tire pressure monitoring system (TPMS) that illuminates a low tire pressure telltale when one or more of your tires is significantly under-inflated. Accordingly, when the low tire pressure telltale illuminates, you should stop and check your tires as soon as possible, and inflate them to the proper pressure. Driving on a significantly under-inflated tire causes the tire to overheat and can lead to tire failure. Under-inflation also reduces fuel efficiency and tire tread life, and may affect the vehicle's handling and stopping ability. Please note that the TPMS is not a substitute for proper tire maintenance, and it is the driver's responsibility to maintain correct tire pressure, even if under-inflation has not reached the level to trigger illumination of the TPMS low tire pressure telltale. Your vehicle has also been equipped with a TPMS malfunction indicator to indicate when the system is not operating properly. The TPMS malfunction indicator is combined with the low tire pressure telltale. When

the system detects a malfunction, the telltale will flash for approximately one minute and then remain continuously illuminated. This sequence will continue upon subsequent vehicle start-ups as long as the malfunction exists. When the malfunction indicator is illuminated, the system may not be able to detect or signal low tire pressure as intended. TPMS malfunctions may occur for a variety of reasons, including the installation of replacement or alternate tires or wheels on the vehicle that prevent the TPMS from functioning properly. Always check the TPMS malfunction telltale after replacing one or more tires or wheels on your vehicle to ensure that the replacement or alternate tires and wheels allow the TPMS to continue to function properly.

FTM Flat Tire Monitor

The concept

The system does not measure the actual inflation pressure in the tires.

It detects a pressure loss in a tire by comparing the rotational speeds of the individual wheels while moving.

In the event of a pressure loss, the diameter and therefore the rotational speed of the corresponding wheel change. This is detected and reported as a flat tire.

Functional requirements

The system must have been initialized when the tire inflation pressure was correct; otherwise, reliable signaling of a flat tire is not ensured. Initialize the system after each correction of the tire inflation pressure and after every tire or wheel change.

System limits



Sudden tire damage

Sudden serious tire damage caused by external influences cannot be indicated in advance. ◀

A natural, even pressure loss in all four tires cannot be detected. Therefore, check the tire inflation pressure regularly.

The system could be delayed or malfunction in the following situations:

- ▶ When the system has not been initialized.
- ▶ When driving on a snowy or slippery road surface.
- ▶ Sporty driving style: slip in the drive wheels, high lateral acceleration.
- ▶ When driving with snow chains.

Status display

The current status of the Flat Tire Monitor can be displayed on the Control Display, e.g., whether or not the FTM is active.

1. "Vehicle Info"
2. "Vehicle status"
3.  "Flat Tire Monitor"

The status is displayed.

Initialization

The initialization process adopts the set inflation tire pressures as reference values for the detection of a flat tire. Initialization is started by confirming the inflation pressures.

Do not initialize the system when driving with snow chains.

1. "Vehicle Info"
2. "Vehicle status"
3.  "Reset"
4. Start the engine - do not drive away.
5. Start the initialization with "Reset".
6. Drive away.

The initialization is completed while driving, which can be interrupted at any time.

The initialization automatically continues when driving resumes.

Indication of a flat tire



The yellow warning lamp lights up. A Check Control message is displayed.

There is a flat tire or a major loss in tire inflation pressure.

1. Reduce your speed and stop cautiously. Avoid sudden braking and steering maneuvers.
2. Check whether the vehicle is fitted with regular tires or run-flat tires.

Run-flat tires, refer to page 185, are labeled with a circular symbol containing the letters RSC marked on the tire sidewall.



Do not continue driving without run-flat tires

Do not continue driving if the vehicle is not equipped with run-flat tires; continued driving may result in serious accidents. ◀

When a flat tire is indicated, DSC Dynamic Stability Control is switched on if necessary.

Actions in the event of a flat tire

Normal tires

1. Identify the damaged tire.

Do this by checking the air pressure in all four tires.

If the tire inflation pressure in all four tires is correct, the Flat Tire Monitor may not have been initialized. In this case, initialize the system.

If an identification is not possible, please contact the service center.

2. Rectify the flat tire.

Run-flat tires

Maximum speed

You can continue driving with a damaged tire at speeds up to 50 mph/80 km/h.

Continued driving with a flat tire

If continuing to drive with a damaged tire:

1. Avoid sudden braking and steering maneuvers.
2. Do not exceed a speed of 50 mph/80 km/h.
3. Check the air pressure in all four tires at the next opportunity.

If the tire inflation pressure in all four tires is correct, the Flat Tire Monitor may not have been initialized. In this case, initialize the system.

Possible driving distance with complete loss of tire inflation pressure:

The possible driving distance after a loss of tire inflation pressure depends on the cargo load and the driving style and conditions.

For a vehicle containing an average load, the possible driving distance is approx. 50 miles/80 km.

When the vehicle is driven with a damaged tire, its handling characteristics change, e.g., reduced lane stability during braking, a longer braking distance, and altered self-steering properties. Adjust your driving style accordingly. Avoid abrupt steering maneuvers or driving over obstacles, e.g., curbs, potholes, etc.

Because the possible driving distance depends on how the vehicle is used during the trip, the actual distance may be smaller or greater depending on the driving speed, road conditions, external temperature, cargo load, etc.

Continued driving with a flat tire

Drive moderately and do not exceed a speed of 50 mph/80 km/h.

A loss of tire inflation pressure results in a change in the handling characteristics, e.g., reduced lane stability during braking, a longer braking distance and altered self-steering properties. ◀



Final tire failure

Vibrations or loud noises while driving can indicate the final failure of the tire. Reduce speed and stop; otherwise, pieces of the tire could come loose and cause an accident. Do not continue driving, and contact your service center. ◀

Collision warning with braking function

The concept

If the vehicle is equipped with Active Cruise Control with Stop & Go, the collision warning is controlled via the cruise control radar sensor.

The system issues a two-phase warning of a danger of collision at speeds above approx. 10 mph/15 km/h. The time of these warnings may vary depending on the current driving situation.

The collision warning is available even if cruise control has been deactivated.

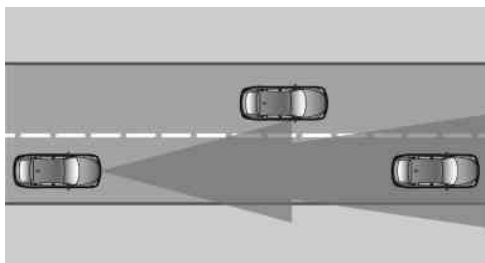

It responds to moving objects that are within the detection range of the radar system.

When the vehicle is intentionally brought into contact with a vehicle, the collision warning is delayed to avoid false warnings.

Switching on/off

Switching the warning function on/off



Press the button

- ▶ On: the LED lights up.
- ▶ Off: the LED goes out.

The state is stored for the remote control currently in use.

Setting the warning time

The warning time can be set via iDrive.

These settings have no effect on the time of the warning with which Active Cruise Control ACC prompts the driver to intervene or brake.

1. Activate collision warning.
2. Activate the desired warning time on the Control Display.

The selected channel is stored for the remote control currently in use.

Display

Warning stages

Prewarning

This warning is issued, for example, when there is the impending danger of a collision or the distance to the vehicle ahead is too small.

Acute warning with braking function

Warning of the imminent danger of a collision when the vehicle approaches another object at a relatively high differential speed.

The acute warning prompts the driver to intervene and, if there is the danger of a collision, is accompanied by a braking intervention.

The braking intervention is executed with limited braking force and for a brief period only. The intervention will not bring the vehicle to a complete standstill.

The braking intervention is executed only if DSC Dynamic Stability Control is switched on.



Adapting your speed and driving style

The acute warning does not relieve the driver of the responsibility to adapt his or her driving speed and style to the traffic conditions. ◀

The braking intervention can be interrupted by pressing on the accelerator or by actively moving the steering wheel.

When towing or tow-starting the vehicle, switch off the collision warning with braking function to prevent undesired interventions.

The braking function is deactivated if the DSC Dynamic Stability Control or DTC Dynamic Traction Control is deactivated.

Display in the instrument cluster

The collision warning can be issued in the instrument cluster, in the Head-up Display, and acoustically.

Warning stages

Symbol	Measure
	The vehicle lights up red: prewarning. Increase distance.
	The vehicle flashes red and an acoustic signal sounds: acute warning. You are requested to intervene by braking or making an evasive maneuver.



Adapting your speed and driving style

The display does not relieve the driver of the responsibility to adapt his or her driving speed and style to the traffic conditions. ◀

System limits



Be alert

Due to system limitations, warnings may be not be issued at all, or may be issued late or improperly. Therefore, always be alert and ready to intervene; otherwise, there is the danger of an accident occurring. ◀

Detection range

The detection capacity of the radar sensor and the collision warning has limitations.

This may result in the warning not being issued or being issued late.

For example, the following situations may not be detected:

- ▷ Slow moving vehicles when you approach them at high speed.
- ▷ Vehicles that suddenly swerve in front of you or sharply decelerating vehicles.
- ▷ Vehicles with an unusual rear appearance.
- ▷ Two-wheeled vehicles ahead of you.
- ▷ Pedestrians.

Functional limitations

The system may not be fully functional in the following situations:

- ▷ In heavy fog, rain, sprayed water or snowfall.
- ▷ In tight curves.
- ▷ If the radar sensor is dirty or obscured.

Prewarning sensitivity

Depending on the set prewarning time, this may result in increased false warnings.

Collision warning

The concept

If the vehicle does not include Active Cruise Control with Stop & Go, the collision warning is controlled via the camera in the base of the interior rearview mirror.

The system issues a two-phase warning of a danger of collision at speeds above approx. 10 mph/15 km/h. The time of these warnings may vary depending on the current driving situation.

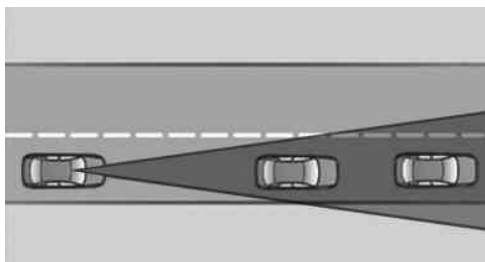

In the process, vehicles in a similar direction of movement are observed if they are located within the detection range of the system.

When the vehicle is intentionally brought into contact with a vehicle, the collision warning is delayed to avoid misleading warnings.

Warning stages

Prewarning

This warning is issued, for example, when there is the impending danger of a collision or the distance to the vehicle ahead is too small.

Acute warning

Warning of the imminent danger of a collision when the vehicle approaches another vehicle at a relatively high differential speed.

Switching the warning function on/off



Press the button

- ▷ On: the LED lights up.
- ▷ Off: the LED goes out.

The state is stored for the remote control currently in use.

Setting the warning time

The warning time can be set via iDrive.

These settings have no effect on the time of the warning with which Active Cruise Control ACC prompts the driver to intervene or brake.

1. Activate collision warning.
2. Activate the desired warning time on the Control Display.

The selected channel is stored for the remote control currently in use.

Display in the instrument cluster

The collision warning can be issued in the instrument cluster, in the Head-up Display, and acoustically.

Warning stages

Symbol Measure



The vehicle lights up red: prewarning.

Increase distance.



The vehicle flashes red and an acoustic signal sounds: acute warning.

You are requested to intervene by braking or making an evasive maneuver.



Adapting your speed and driving style

The display does not relieve the driver of the responsibility to adapt his or her driving speed and style to the traffic conditions. ◀

System limits



Be alert

Due to system limitations, warnings may be not be issued at all, or may be issued late or improperly. Therefore, always be alert and ready to intervene; otherwise, there is the danger of an accident occurring. ◀

Detection range

The detection capacity of the camera and the collision warning has limitations.

This may result in the warning not being issued or being issued late.

For example, the following situations may not be detected:

- ▷ Slow moving vehicles when you approach them at high speed.

- ▷ Vehicles that suddenly swerve in front of you or sharply decelerating vehicles.
- ▷ Vehicles with an unusual rear appearance.
- ▷ Two-wheeled vehicles ahead of you.

Functional limitations

The system may not be fully functional in the following situations:

- ▷ In heavy fog, rain, sprayed water or snowfall.
- ▷ In tight curves.
- ▷ If the camera view field or the front windshield are dirty or covered.
- ▷ When driving toward bright lights.
- ▷ In the case of vehicles with insufficiently visible tail lamps.
- ▷ In the case of partially covered vehicles.
- ▷ Up to 10 seconds after the start of the engine, via the Start/Stop knob.
- ▷ During the calibration process of the camera immediately after vehicle shipment.

Prewarning sensitivity

Depending on the set prewarning time, this may result in increased false warnings.

Camera

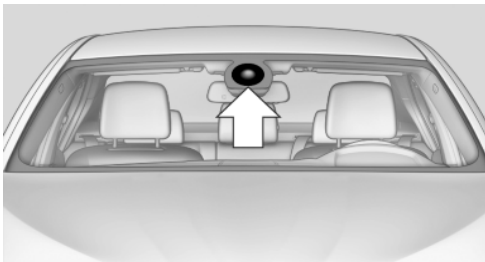

The camera is located near the base of the mirror.

Keep the windshield in the area behind the interior rear view mirror clean and clear.

Lane departure warning

The concept

Starting at a specific speed, this system alerts you when the vehicle on streets with lane markings is about to leave the lane. Depending on the country-specific version of the vehicle, the speed is between 35 mph/55 km/h and 45 mph/70 km/h. When switching on the system below this speed, a message appears in the instrument cluster.

The steering wheel begins vibrating gently in the event of warnings. The time of the warning may vary depending on the current driving situation.

The system does not provide a warning if the turn signal is set before leaving the lane.

Notes



Personal responsibility

The system cannot serve as a substitute for the driver's personal judgment of the course of the road and the traffic situation.

In the event of a warning, do not jerk the steering wheel, as you may lose control of the vehicle. ◀

At a glance

Button in the vehicle



Lane departure warning

Camera

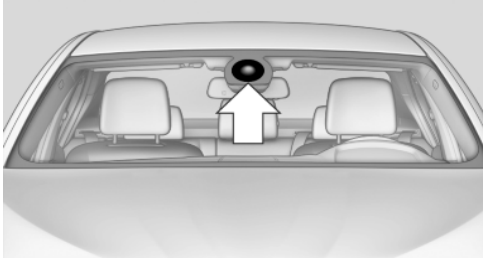

The camera is located near the base of the mirror.

Keep the windshield in the area behind the interior rear view mirror clean and clear.

Switching on/off



Press the button

- ▷ On: the LED lights up.
- ▷ Off: the LED goes out.

The state is stored for the remote control currently in use.

Display in the instrument cluster



- ▷ Lines: system is activated.
- ▷ Arrows: at least one lane marking was detected and warnings can be issued.

Display in the instrument display



- ▷ Symbol red: system is activated.
- ▷ Symbol green: at least one lane marking was detected and warnings can be issued.

Issued warning

If you leave the lane and if a lane marking has been detected, the steering wheel begins vibrating.

If the turn signal is set before changing the lane, a warning is not issued.

End of warning

The warning ends:

- ▷ Automatically after approx. 3 seconds.
- ▷ When returning to your own lane.
- ▷ When braking hard.
- ▷ When using the turn signal.

System limits

The system may not be fully functional in the following situations:

- ▷ In heavy fog, rain or snowfall.
- ▷ In the event of worn, poorly visible, merging, diverging, or multiple lane markings such as in construction areas.
- ▷ When lane markings are covered in snow, ice, dirt or water.
- ▷ In tight curves or on narrow lanes.
- ▷ When the lane markings are covered by objects.
- ▷ When driving very close to the vehicle in front of you.
- ▷ When driving toward bright lights.
- ▷ When the windshield behind the interior rearview mirror is fogged over, dirty or covered with stickers, etc.
- ▷ During calibration of the camera immediately after vehicle shipment.

Active Blind Spot Detection

The concept

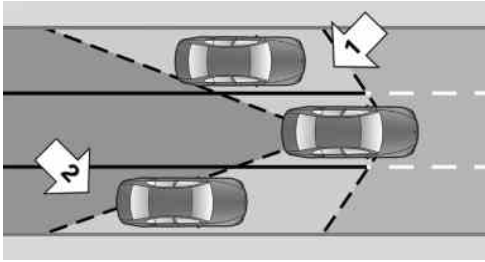

Two radar sensors below the rear bumper monitor the area behind and next to the vehicle at speeds above approx. 30 mph/50 km/h.

The system indicates whether there are vehicles in the blind spot, arrow 1, or approaching from behind on the adjacent lane, arrow 2.

The lamp in the exterior mirror housing lights up dimly.

Before you change lanes after setting the turn signal, the system issues a warning in the situations described above.

The lamp in the housing of the exterior mirror flashes and the steering wheel vibrates.

Notes



Personal responsibility

The system does not serve as a substitute for the driver's personal judgment of the traffic situation.

Be aware of the traffic situation and the vehicle's surroundings at all times, otherwise an accident is still possible despite all warnings. ◀

At a glance

Radar sensors



The radar sensors are located under the rear bumper.

Switching on/off



Press the button.

- ▷ On: the LED lights up.
- ▷ Off: the LED goes out.

The system can issue warnings at speeds above approx. 30 mph/50 km/h.

The state is stored for the remote control currently in use.

Display

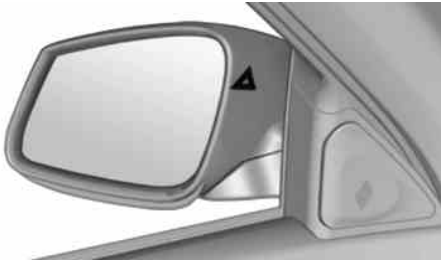

Information stage

The dimmed lamp in the mirror housing indicates when there are vehicles in the blind spot or approaching from behind.

Warning

If the turn signal is set while a vehicle is in the critical zone, the steering wheel vibrates briefly and the lamp in the mirror housing flashes brightly.

The warning stops when the turn signal is switched off, or the other vehicle leaves the critical zone.

System limits

The system may not be fully functional in the following situations:

- ▶ When a vehicle is approaching at a speed much faster than your own.
- ▶ In heavy fog, rain or snowfall.
- ▶ In tight curves or on narrow lanes.
- ▶ If the bumper is dirty or iced up, or covered with stickers.

For US owners only

The transmitter and receiver units comply with part 15 of the FCC/Federal Communication Commission regulations. Operation is governed by the following:

FCC ID:

- ▶ NBG009014A.

Compliance statement:

This device complies with part 15 of the FCC Rules. Operation is subject to the following two conditions:

- ▶ This device may not cause harmful interference, and
- ▶ this device must accept any interference received, including interference that may cause undesired operation.

Any unauthorized modifications or changes to these devices could void the user's authority to operate this equipment.

Adjustable speed limit

The concept

This system can limit the speed starting at a value of . The vehicle can be driven at any speed below the set speed limit.

Exceeding the speed limit

When necessary, the speed limit can be intentionally overcome by pressing the accelerator.

If the vehicle speed exceeds the set speed limit, a warning is issued.

No brake intervention

If the set speed limit is reached or unintentionally exceeded, such as when driving downhill, the vehicle is not actively braked.

If the speed limit is set during a trip to a value below the current speed, the vehicle coasts until its speed drops below the set speed limit.

Controls

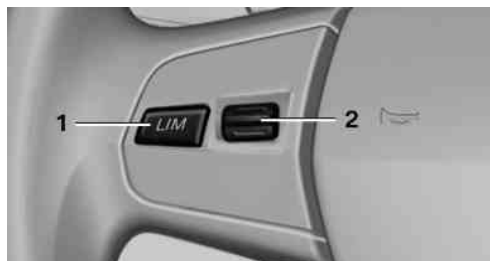

- 1 System on/off
- 2 Changing the speed limit

Switching on

LIM Press the button.

The current speed is accepted as the speed limit.

If the system is switched on while the vehicle is stationary, is set as the speed limit.

The marking in the speedometer is set to the respective speed.

When the speed limit is switched on, DSC Dynamic Stability Control is switched on as well, if necessary and switches to COMFORT mode if applicable.

Switching off

LIM Press the button.

The system also switches off if, for example:

- ▷ Reverse gear is engaged.
- ▷ The engine is switched off.
- ▷ Cruise control is switched on.

The displays go out.

Changing the speed limit

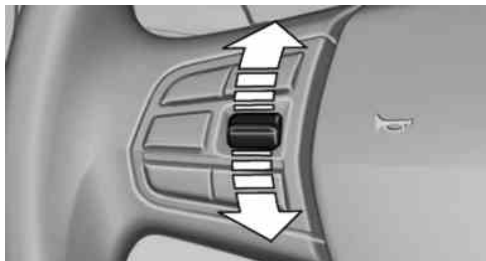

Press the rocker switch up or down repeatedly until the desired speed limit is set.

- ▷ Each time the rocker switch is pressed to the point of resistance, the desired speed increases or decreases by approx. .
- ▷ Each time the rocker switch is pressed past the point of resistance, the speed limit increases or decreases by 10 in the km/h speedometer.

If the speed limit is set during a trip to a value below the current speed, the vehicle coasts until its speed drops below the set speed limit.

Exceeding the speed limit

The speed limit can be exceeded intentionally. There is no acoustic warning in this case.

To intentionally exceed the set speed limit, press the accelerator all the way down.

When the vehicle speed drops below the set speed limit, the limit is automatically reactivated.

Warning

Visual warning

LIM If the set speed limit is exceeded, the indicator lamp in the instrument cluster flashes while the vehicle speed is greater than the speed limit.

Acoustic warning

- ▷ If the speed limit is exceeded unintentionally, a signal sounds after approx. 5 seconds.

- ▷ If the limit is reduced to below the vehicle speed while driving, a signal sounds after approx. 30 seconds.
- ▷ If the limit is intentionally exceeded by pressing the accelerator all the way down, there is no signal.

Displays in the instrument cluster

Speed limit marking

Display in the speedometer:



- ▷ The marking lights up green: the system is active.
- ▷ The marking does not light up: the system is switched off.

Indicator lamp



- ▷ The indicator lamp lights up: the system is switched on.
- ▷ The indicator lamp flashes: the set speed limit has been exceeded.

Brief status display



Brief display of the set speed limit.

Brake force display

The concept



- ▷ During normal brake application, the outer brake lamps light up.
- ▷ During heavy brake application, the inner brake lamps light up in addition.

Active Protection

The concept

The Active Protection safety package consists of systems that are independent of each other:

- ▷ PreCrash
- ▷ PostCrash

PreCrash

The concept

With this system critical driving situations that might result in an accident can be detected above a speed of approx. 19 mph/30 km/h. In these situations, preventative protection measures are automatically undertaken to minimize the risk in the event of an accident as much as possible.

Critical driving situations may include:

- ▷ Full application of the brakes.
- ▷ Severe understeering.
- ▷ Severe oversteering.

If the vehicle includes the collision warning or collision warning with braking feature, impend-

ing collisions with vehicles driving ahead or stopped in front of you can also be detected within the system's range.



Personal responsibility

The system cannot serve as a substitute for the driver's personal judgment of the traffic situation. The system may not always detect critical situations reliably and in a timely manner. Adapt speed to traffic situation and drive alertly; otherwise, a risk to safety may result. ◀

Function

After the safety belt is buckled, the front belts are automatically pretensioned once after the vehicle is driven is away.

In critical driving situations, the following individual functions become active as needed:

- ▷ The front belts are automatically pretensioned.
- ▷ Automatic closing of the windows.
- ▷ Automatic closing of the glass sunroof.

After a critical driving situation without an accident, the front belts are loosened again. All other systems can be restored to the desired setting.

If the belt tension does not loosen automatically, stop the vehicle and unbuckle the belt using the red button in the buckle. Fasten the belt before continuing on your trip.

PostCrash

In the event of an accident, the system can bring the car to a halt automatically without intervention by the driver in certain situations. This can reduce the risk of a further collision.

Depressing the brake pedal can cause the vehicle to brake harder. This interrupts automatic braking. Depressing the accelerator pedal also interrupts automatic braking.

After coming to a halt, the brake is released automatically. Secure the vehicle against rolling.

Driving stability control systems

Vehicle equipment

All standard, country-specific and optional equipment that is offered in the model series is described in this chapter. Therefore, equipment is also described that is not available in a vehicle, e. g., because of the selected optional equipment or country variant. This also applies for safety-related functions and systems.

Antilock Brake System ABS

ABS prevents locking of the wheels during braking.

The vehicle remains steerable even during full brake applications, thus increasing active safety.

ABS is operational every time you start the engine.

Brake assistant

When you apply the brakes rapidly, this system automatically produces the maximum braking force boost. It thus helps to achieve the shortest possible braking distance during full braking. This system utilizes all of the benefits provided by ABS.

Do not reduce the pressure on the brake pedal for the duration of the full braking.

DSC Dynamic Stability Control

The concept

DSC prevents traction loss in the driving wheels when driving away and accelerating.

DSC also recognizes unstable vehicle conditions, such as fishtailing or nose-diving. Subject

to physical limits, DSC helps to keep the vehicle on a steady course by reducing engine speed and by applying brakes at individual wheels.



Adjust your driving style to the situation
An appropriate driving style is always the responsibility of the driver.

The laws of physics cannot be repealed, even with DSC.

Therefore, do not reduce the additional safety margin by driving in a risky manner. ◀

Indicator/warning lamps



The indicator lamp flashes: DSC controls the drive forces and brake forces.
The indicator lamp lights up: DSC has failed.

Deactivating DSC: DSC OFF

When DSC is deactivated, driving stability is reduced during acceleration and when driving in bends.

To increase vehicle stability, activate DSC again as soon as possible.

Deactivating DSC



Press and hold the button, but not longer than approx. 10 seconds, until the indicator lamp for DSC OFF lights up in the instrument cluster and DSC OFF is displayed.

The DSC system is switched off.

Activating DSC



Press the button.
DSC OFF and the DSC OFF indicator lamp go out.

Indicator/warning lamps

When DSC is deactivated, DSC OFF is displayed in the instrument cluster.



The indicator lamp lights up: DSC is deactivated.

DTC Dynamic Traction Control

The concept

The DTC system is a version of the DSC in which forward momentum is optimized.

The system ensures maximum forward momentum on special road conditions, e.g., unplowed snowy roads, but driving stability is limited.

It is therefore necessary to drive with appropriate caution.

You may find it useful to briefly activate DTC under the following special circumstances:

- ▶ When driving in slush or on uncleared, snow-covered roads.
- ▶ When rocking the vehicle or driving off in deep snow or on loose surfaces.
- ▶ When driving with snow chains.

Deactivating/activating DTC Dynamic Traction Control

Activating the Dynamic Traction Control DTC provides maximum traction on loose ground. Driving stability is limited during acceleration and when driving in bends.

Activating DTC



Press the button.

TRACTION is displayed in the instrument cluster and the indicator lamp for DSC OFF lights up.

Deactivating DTC



Press the button again.

TRACTION and the DSC OFF indicator lamp go out.

xDrive

xDrive is the all-wheel-drive system of your vehicle. Concerted action by the xDrive and DSC further optimize traction and driving dynamics. The xDrive all-wheel-drive system variably distributes the drive forces to the front and rear axles as demanded by the driving situation and road surface.

Dynamic Damping Control

The concept

This system reduces undesirable vehicle motion when using a dynamic driving style or traveling on uneven road surfaces.

The system enhances driving dynamics and comfort as required for the road surface and driving style.

Programs

The system offers two different programs.

The programs can be selected via the Driving Experience Switch, refer to page 113.

SPORT

Consistently sporty control of the shock absorbers for greater driving agility.

SPORT+

Consistently sporty control of the shock absorbers for greater driving agility when driving with limited driving stabilization.

COMFORT / ECO PRO

Balanced control of the vehicle.

Variable sport steering

The variable sport steering increases the steering angle of the front wheels at large steering wheel angles, e.g., in tight curves or when parking. Steering becomes more direct.

It also varies the force required to turn the wheels in accordance with the vehicle speed.



This results in a sporty steering response. In addition, it becomes easier to steer during parking and maneuvering.

Driving Experience Switch

The concept

The Driving Experience Switch can be used to adjust the certain characteristics of the vehicle. Various programs can be selected for this purpose. The Driving Experience Switch and the DSC OFF buttons can each be used to activate a program.

Operating the programs

Press the button	Program
	DSC OFF TRACTION
	SPORT+ SPORT COMFORT ECO PRO

Automatic program change

The system automatically switches to COMFORT in the following situations:

- Failure of DSC Dynamic Damping Control.
- The vehicle has a flat tire.
- When activating cruise control in TRACTION or DSC OFF mode.

DSC OFF

When DSC OFF, refer to page 111, is active, driving stability is limited during acceleration and when driving in bends.

TRACTION

When TRACTION is active, the vehicle has maximum traction on loose road surfaces. DTC Dynamic Traction Control, refer to page 112, is activated. Driving stability is limited during acceleration and when driving in bends.

SPORT+

Sporty driving with optimized chassis and suspension with limited driving stabilization.

The driver handles several of the stabilization tasks.

Activating SPORT+

 Press the button repeatedly until SPORT+ appears in the instrument cluster and the DSC OFF indicator lamp lights up.

Automatic program change

When activating cruise control, the program automatically switches to SPORT mode.

Indicator/warning lamps

SPORT+ is displayed in the instrument cluster.

 The DSC OFF indicator lamp lights up.

SPORT

Sporty driving with optimized chassis and suspension with maximum driving stabilization.

The program can be configured to individual specifications. The configuration is stored for the remote control currently in use.

Activating SPORT



Press button repeatedly until SPORT is displayed in the instrument cluster.

Configuring SPORT

When the display is activated on the Control Display, refer to page 115, the SPORT driving mode can be set to individual specifications.

- ▷ Activating SPORT.
- ▷ "Configure SPORT"
- ▷ Configuring the SPORT driving mode.

SPORT can also be configured before it is activated:

1. "Settings"
2. "SPORT mode"



3. Configure driving mode.

This configuration is retrieved when the SPORT driving mode is activated.

COMFORT

For a balanced tuning with maximum driving stabilization.

Activating COMFORT



Press button repeatedly until COMFORT is displayed in the instrument cluster.

In certain situations, the system automatically changes to the NORMAL program, automatic program change, refer to page 113.

ECO PRO

ECO PRO, refer to page 167, provides consistent tuning to minimize fuel consumption for maximum range with maximum driving stabilization.

Comfort functions and the engine controller are adjusted.

The program can be configured to individual specifications.

Activating ECO PRO



Press button repeatedly until ECO PRO is displayed in the instrument cluster.

Configuring ECO PRO

1. Activate ECO PRO.
2. "Configure ECO PRO"

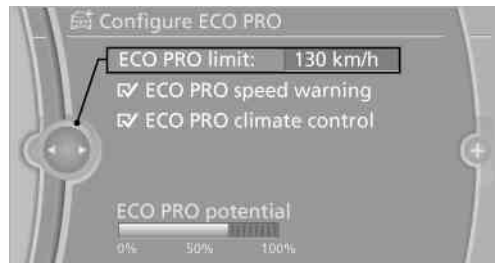

Make the desired settings.

Configure driving mode

Settings can be made for the following driving modes in Driving mode:

- ▷ SPORT mode, refer to page 114.
- ▷ ECO PRO mode, refer to page 168.

Displays

Program selection



Pressing the button displays a list of the selectable programs.

Selected program



The selected program is displayed in the instrument cluster.

Display on the Control Display

Program changes can be displayed on the Control Display.

1. "Settings"
2. "Control display"

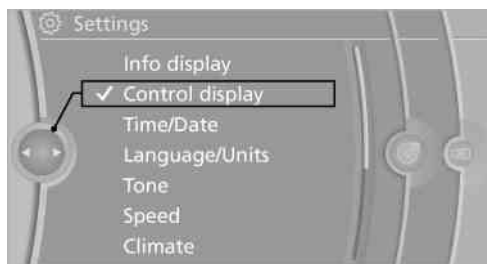

3. "Driving mode info"



Drive-off assistant

This system supports driving away on gradients. The parking brake is not required.

1. Hold the vehicle in place with the foot brake.
2. Release the foot brake and drive away without delay.

After the foot brake is released, the vehicle is held in place for approx. 2 seconds.

Depending on the vehicle load or when a trailer is being used, the vehicle may roll back slightly.



Driving off without delay

After releasing the foot brake, start driving without delay, since the drive-off assistant will not hold the vehicle in place for more than approx. 2 seconds and the vehicle will begin rolling back. ◀

Driving comfort

Vehicle equipment

All standard, country-specific and optional equipment that is offered in the model series is described in this chapter. Therefore, equipment is also described that is not available in a vehicle, e. g., because of the selected optional equipment or country variant. This also applies for safety-related functions and systems.

Active Cruise Control with Stop & Go function, ACC

The concept

This system can be used to select a desired speed that the vehicle will maintain automatically on clear roads.

To the extent possible, the system automatically adjusts the speed to a slower vehicle ahead of you.

The distance that the vehicle maintains to the vehicle ahead of you can be varied.

For safety reasons, it depends on the speed.

To maintain a certain distance, the system automatically decelerates, applies the brakes lightly, or accelerates again if the vehicle ahead begins moving faster.

If the vehicle ahead of you brakes to a halt, the system is able to detect this within the given system limits. If the vehicle ahead of your drives away again from a halt, your vehicle is able to accelerate if operated accordingly.

Even if some time passes before the vehicle drives away again, the BMW can still be accelerated automatically and simply.

As soon as the road is clear, it accelerates to the desired speed.

The speed is also maintained on downhill gradients, but may not be maintained on uphill slopes if engine power is insufficient.

General information

When ECO PRO is activated, cruise control is also set to a driving style that saves on fuel consumption.

Notes



Personal responsibility

The system does not relieve the driver of the responsibility to adapt his or her speed, distance and driving style to the traffic conditions. You should drive attentively and intervene actively when necessary, e.g. by braking or making an evasive maneuver, otherwise, there is danger of an accident. ◀

At a glance

Buttons on the steering wheel



- 1 System on/off, interrupt
- 2 Resume speed
- 3 Store speed
- 4 Reduce distance
- 5 Store, maintain/change speed
- 6 Increase distance

Radar sensor

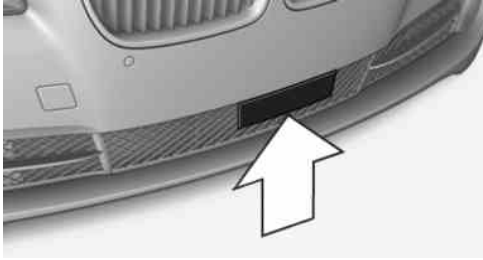

A dirty or covered sensor may hinder the detection of vehicles.

- ▷ If necessary, clean the radar sensor. Remove layers of snow and ice carefully.
- ▷ Do not cover the view field of the radar sensor.

Switching on/off and interrupting cruise control

Switching on



Press the button on the steering wheel.

The indicator lamps in the instrument cluster light up and the mark in the speedometer is set to the current speed.

Cruise control can be used.

Switching off



Deactivated or interrupted system

If the system is deactivated or interrupted, actively intervene by braking and, if necessary, with evasive maneuvers; otherwise, there is the danger of an accident occurring. ◀

If switching off the system while stationary, press on the brake pedal at the same time.



Press the button.

- ▷ If active: press twice.
- ▷ If interrupted: press once.

The displays go out. The stored desired speed and distance are deleted.

Interrupting the system



When active, press the button.

If interrupting the system while stationary, press on the brake pedal at the same time.

The system is automatically interrupted in the following situations:

- ▷ When the brakes are applied.
- ▷ When transmission position D is disengaged.
- ▷ When DTC Dynamic Traction Control is activated or DSC is deactivated.
- ▷ When DSC is actively controlling stability.
- ▷ If the safety belt and the driver's door are opened when the vehicle is standing still.
- ▷ If the system has not detected objects for an extended period, e.g., on a road with very little traffic without road edge line markings.
- ▷ If the radar sensor is dirty.

Maintaining/storing the speed



Press the button.

Or:

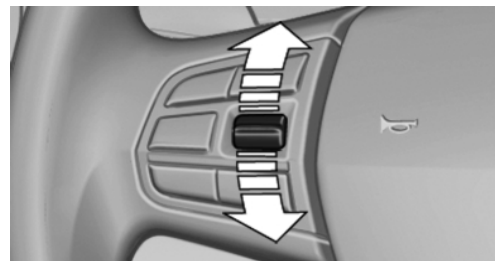

Press the rocker switch while the system is interrupted.

When the system is switched on, the current speed is maintained and stored as the desired speed.

It is displayed in the speedometer and briefly displayed in the instrument cluster, Displays in the instrument cluster, refer to page 119.

When cruise control is maintained or stored, DSC Dynamic Stability Control is switched on, if necessary.

Changing, maintaining, and storing the speed

The rocker switch can be pressed while the system is interrupted to maintain and store the current speed. DSC Dynamic Stability Control is switched on, if necessary.

Adapting the desired speed

Adapt the desired speed to the road conditions and be ready to brake at all times; otherwise, there is the danger of an accident occurring. ◀

Speed differences

Large differences in speed relative to vehicles ahead of the vehicle cannot be compensated by the system for example in the following situations:

- ▷ When catching up rapidly with a truck.
- ▷ When another vehicle suddenly swerves into the wrong lane. ◀

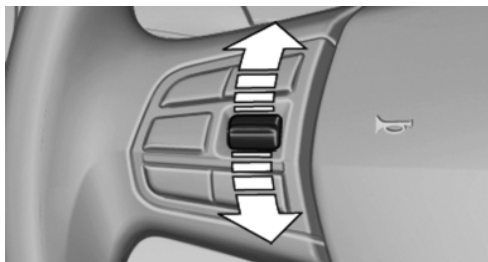

Press the rocker switch up or down repeatedly until the desired speed is set.

If active, the displayed speed is stored and the vehicle reaches the stored speed if the road is clear.

- ▷ Each time the rocker switch is pressed to the point of resistance, the desired speed in-

creases or decreases by approx. 1 mph/1 km/h.

- ▷ Each time the rocker switch is pressed past the point of resistance, the desired speed increases or decreases by a maximum of 5 mph/10 km/h. Max. adjustable speed: 110 mph/180 km/h.

Hold the rocker switch in position to repeat the action.

Distance

Selecting a distance

Adjust the distance according to the traffic and weather conditions; otherwise, there is the danger of an accident occurring. Maintain the prescribed safety distance. ◀

Reduce distance

 Press the button repeatedly until the desired distance is set.

The selected distance, refer to page 119, is displayed in the instrument cluster.

Increase distance

 Press the button repeatedly until the desired distance is set.

The selected distance, refer to page 119, is displayed in the instrument cluster.

Calling up the desired speed and distance

While driving

 Press the button with the system switched on.

In the following cases, the stored speed value is deleted and cannot be called up again:

- ▷ When the system is switched off.
- ▷ When the ignition is switched off.

While standing



Before leaving the vehicle, secure it against rolling.

Before leaving the vehicle with the engine running, engage position P of the automatic transmission and apply the parking brake. Otherwise, the vehicle may begin to roll. ◀

The system brought the vehicle to a complete standstill.

- ▶ Green mark in the speedometer during a brief idle phase:

The vehicle ahead of you drives away while the mark is green: your vehicle accelerates without anything having to be done.

- ▶ Switch to orange of the mark in the speedometer after approx. 2 sec.:

The vehicle ahead of you drives away, while the mark is orange: in order to accelerate, briefly press the gas pedal or press the RES button or SET button.

Rolling bars in the distance indicator mean that the vehicle ahead of you has driven off.

You actively braked your vehicle to a halt by pressing on the brake pedal and it is standing behind another vehicle:

1.  Press the button to call up a stored desired speed.
2. Release the brake pedal.
3. Press on the accelerator briefly, or press the RES button or the rocker switch when the vehicle ahead of you drives away.

Displays in the instrument cluster

Desired speed

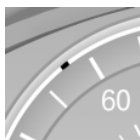

- ▶ The marking lights up green: the system is active.
- ▶ The marking lights up orange: the system has been interrupted.

- ▶ The marking does not light up: the system is switched off.



With instrument display: the symbol is displayed in the speedometer similarly to the mark for the desired speed.

Brief status display



Selected desired speed.

If --- appears briefly on the display for Check Control messages, it is possible that the system requirements for operation are currently not met.

Distance to vehicle ahead of you

The selected distance to the vehicle driving ahead of you is shown.

Distance display



Distance 1



Distance 2



Distance 3



Distance 4

This value is set after the system is switched on.



The system has been interrupted or distance control is deactivated because the accelerator is being pressed; a vehicle was not detected.



Distance control is deactivated because the accelerator is being pressed; a vehicle was detected.

Rolling bars: the detected vehicle has driven away.

Indicator/warning lamps



Personal responsibility

The indicator and warning lamps do not relieve the driver of the responsibility to adapt his or her desired driving speed and style to the traffic conditions. ◀



The vehicle symbol lights up orange:

A vehicle has been detected ahead of you.



The vehicle symbol flashes orange:

The conditions are not adequate for operating the system.

The system was deactivated but applies the brakes until you actively assume control by pressing on the brake pedal or accelerator.



The vehicle symbol flashes red and an acoustic signal sounds:

You are requested to intervene by braking or making an evasive maneuver.

System limits

Speed range

Best results are achieved when using the system on well-developed roads and highways. The desired speed can be selected between 20 mph/30 km/h to 110 mph/180 km/h.

The system can also be activated when stationary.

Comply with the legal speed limit in every situation when using the system.

Detection range

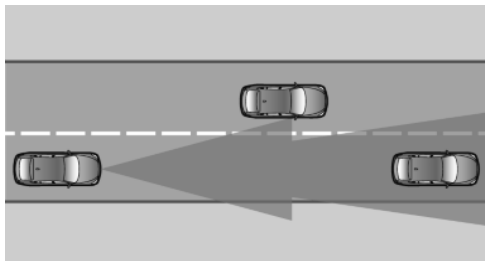

The detection capacity of the system and the automatic braking capacity are limited.

Two-wheeled vehicles driving ahead of you for instance might not be detected.



Limited detection capacity

Because of the limits to the detection capacity, you should be alert at all times so that you can intervene actively, if necessary; otherwise, there is the danger of an accident occurring. ◀

Deceleration

The system does not decelerate when a stationary obstacle is located in the same lane, e.g., a vehicle at a red traffic light or at the end of traffic congestion.

The system also does not respond to:

- ▷ Pedestrians or similar slow-moving road users.
- ▷ Red traffic lights.
- ▷ Stationary objects.
- ▷ Cross traffic.
- ▷ Oncoming traffic.



No warnings

A warning may not be issued when approaching a stationary or very slow-moving obstacle. You must react yourself; otherwise, there is the danger of an accident occurring. ◀

Swerving vehicles

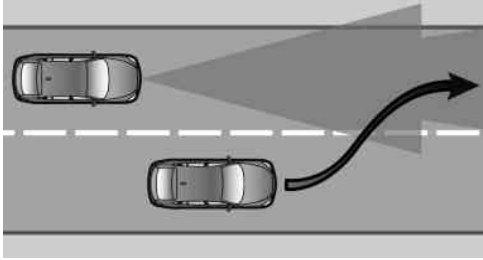

A vehicle driving in front of you is not detected until it is completely within the same lane as your vehicle.

Swerving vehicles

If a vehicle driving ahead of you suddenly swerves into your lane, the system may not be able to automatically restore the selected distance. This also applies to major speed differences to vehicles driving ahead of you, e.g., when rapidly approaching a truck. When a vehicle driving ahead of you is reliably detected, the system requests that the driver intervene by braking and carrying out evasive maneuvers, if necessary. You must react yourself; otherwise, there is the danger of an accident occurring. ◀

Unexpected lane change

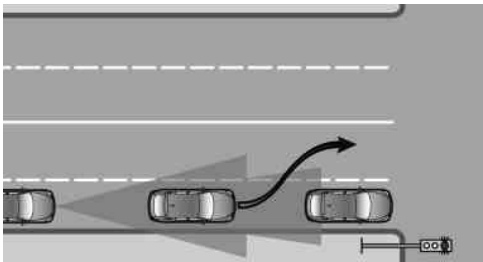

If a vehicle ahead of you unexpectedly moves into another lane from behind a stopped vehicle, you yourself must react, as the system does not react to stopped vehicles.

Cornering



If the desired speed is too high for a curve, the speed is reduced slightly in the curve, although curves cannot be anticipated in advance. Therefore, drive into a curve at an appropriate speed.

In tight curves, situations may result due to the restricted detection range of the system in which a vehicle driving ahead of you may not be detected at all, or not until after a considerable delay.



When approaching a curve, the system may react briefly to the vehicles in the next lane due to the bend of the curve. Any deceleration of the vehicle by the system can be compensated for by briefly accelerating. After the accelerator pedal is released, the system becomes active again and independently controls the speed.

Driving away

In some situations, the vehicle cannot drive away automatically, e.g., on steep inclines or behind bumps in the road.

Radar sensor

For US owners only

The transmitter and receiver units comply with part 15 of the FCC/Federal Communication Commission regulations. Operation is governed by the following:

FCC ID:

- ▷ OAYARS3-A

Compliance statement:

This device complies with part 15 of the FCC Rules. Operation is subject to the following two conditions:

- ▷ This device may not cause harmful interference, and
- ▷ this device must accept any interference received, including interference that may cause undesired operation.

Any unauthorized modifications or changes to these devices could void the user's authority to operate this equipment.

Malfunction

The system cannot be activated if the radar sensor is not aligned correctly. This may be caused by damage incurred during parking, for example.

A Check Control message is displayed if the system fails.

Cruise control

The concept

The system is functional at speeds beginning at approx. 20 mph/30 km/h.

It maintains the speed that was set using the control elements on the steering wheel.

The system brakes on downhill gradients if engine braking action is insufficient.



Unfavorable conditions

Do not use the system if unfavorable conditions make it impossible to drive at a constant speed, for instance:

- ▷ On curvy roads.
- ▷ In heavy traffic.
- ▷ On slippery roads, in fog, snow or rain, or on a loose road surface.

Otherwise, you could lose control of the vehicle and cause an accident. ◀

Controls

At a glance

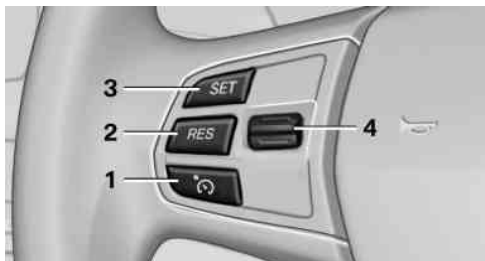

- 1 System on/off, interrupt
- 2 Resume speed
- 3 Store speed
- 4 Store, maintain/change speed

Switching on



Press the button on the steering wheel.

The marking in the speedometer is set to the current speed.

Cruise control can be used.

Switching off



Deactivated or interrupted system

If the system is deactivated or interrupted, actively intervene by braking and, if necessary, with evasive maneuvers; otherwise, there is the danger of an accident occurring. ◀



Press the button.

- ▷ If active: press twice.
- ▷ If interrupted: press once.

The displays go out. The stored desired speed is deleted.

Interrupting the system



When active, press the button.

The system is automatically interrupted if:

- ▷ The brakes are applied.
- ▷ The clutch pedal is depressed for a few seconds or released while a gear is not engaged.
- ▷ The transmission position D is disengaged.
- ▷ DTC Dynamic Traction Control is activated or DSC is deactivated.
- ▷ DSC is actively controlling stability.

Maintaining/storing the current speed



Press the button.

Or

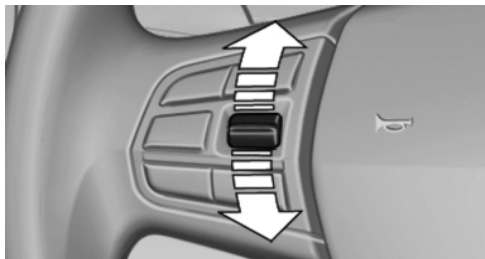

Press the rocker switch while the system is interrupted.

When the system is switched on, the current speed is maintained and stored as the desired speed.

It is displayed in the speedometer and briefly displayed in the instrument cluster. Displays in the speedometer, refer to page 124.

When cruise control is maintained or stored, DSC Dynamic Stability Control is switched on, if necessary.

Changing/maintaining speed

The rocker switch can be pressed while the system is interrupted in order to maintain and store the current speed.



Adapting the desired speed

Adapt the desired speed to the road conditions and be ready to brake at all times; otherwise, there is the danger of an accident occurring. ◀

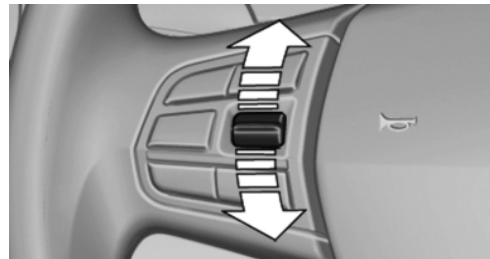

Press the rocker switch up or down repeatedly until the desired speed is set.

If active, the displayed speed is stored and the vehicle reaches the stored speed if the road is clear.

- ▷ Each time the rocker switch is pressed to the point of resistance, the desired speed increases or decreases by approx. 1 mph/1 km/h.
- ▷ Each time the rocker switch is pressed past the point of resistance, the desired speed increases or decreases by a maximum of 5 mph/10 km/h.
- ▷ Pressing the rocker switch to the resistance point and holding it there accelerates or decelerates the vehicle without requiring pressure on the accelerator. After the rocker switch is released, the vehicle maintains its final speed. Pressing the switch beyond the resistance point causes the vehicle to accelerate more rapidly.

Resuming the desired speed

 Press the button.

The stored speed is reached and maintained.

Displays in the instrument cluster

Indicator lamp



Depending on how the vehicle is equipped, the indicator lamp in the instrument cluster indicates whether the system is switched on.

Desired speed

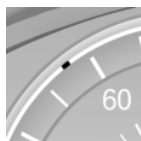

- ▷ The marking lights up green: the system is active.
- ▷ The marking lights up orange: the system has been interrupted.

▷ The marking does not light up: the system is switched off.



With instrument display: the symbol is displayed in the speedometer similarly to the mark for the desired speed.

Brief status display



Selected desired speed.

If --- appears briefly on the display for Check Control messages, it is possible that the system requirements for operation are currently not met.

PDC Park Distance Control

The concept

PDC supports you when parking. Objects that you are approaching slowly in front of or behind your vehicle are indicated with:

- ▷ Signal tones.
- ▷ Visual display.

General information

Measurements are made by ultrasound sensors in the bumpers.

The range is approx. 6 ft/2 m.

An acoustic warning is first given:

- ▷ By the front sensors and two rear corner sensors at approx. 24 in/60 cm.
- ▷ By the rear middle sensors at approx. 5 ft/1.50 m.

Notes



Check the traffic situation as well

PDC cannot serve as a substitute for the driver's personal judgment of the traffic situation. Check the traffic situation around the vehicle with your own eyes. Otherwise, an accident could result from road users or objects located outside of the PDC detection range.

Loud noises from outside and inside the vehicle may prevent you from hearing the PDC's signal tone. ◀



Avoid driving quickly with PDC

Avoid approaching an object quickly.

Avoid driving away quickly while PDC is not yet active.

For technical reasons, the system may otherwise be too late in issuing a warning. ◀

At a glance

Button in the vehicle



PDC Park Distance Control

Switching on/off

Switching on automatically

Select transmission position R with the engine running.

Automatic deactivation during forward travel

The system switches off when a certain driving distance or speed is exceeded.

Switch the system back on if necessary.

Switching on/off manually



Press the button.

- ▷ On: the LED lights up.
- ▷ Off: the LED goes out.

In addition to the PDC Park Distance Control, the backup camera, refer to page 126, can be switched on.

Switching on the backup camera via the iDrive

With PDC activated:

 "Rear view camera"

The backup camera image is displayed. The setting is stored for the remote control currently in use.

Display

Signal tones

When approaching an object, an intermittent tone is sounded that indicates the position of the object. For example, if an object is detected to the left rear of the vehicle, a signal tone sounds from the left rear speaker.

The shorter the distance to the object becomes, the shorter the intervals.

If the distance to a detected object is less than approx. 10 in/25 cm, a continuous tone is sounded.

If objects are located both in front of and behind the vehicle, an alternating continuous signal is sounded.

The intermittent tone is interrupted after approx. 3 seconds:

- ▷ If the vehicle stops in front of an object that is detected by only one of the corner sensors.
- ▷ If moving parallel to a wall.

The signal tone is switched off:

- ▷ When the vehicle moves away from an object by more than approx. 4 in/10 cm.
- ▷ When transmission position P is engaged.

Volume

The volume of the PDC signal can be adjusted, refer to user's manual for Navigation, Entertainment and Communication.

The setting is stored for the remote control currently in use.

Visual warning

The approach of the vehicle to an object can be shown on the Control Display. Objects that are farther away are displayed on the Control Display before a signal tone sounds.

A display appears as soon as Park Distance Control (PDC) is activated.

The range of the sensors is represented in colors: red, green and yellow.

If the backup camera image was selected last, it again appears on the display. To switch to PDC:

1.  "Rear view camera" Select the symbol on the Control Display.
2. Press the controller.

The setting is stored for the remote control currently in use.

System limits

Limits of ultrasonic measurement

The detection of objects can reach the physical limits of ultrasonic measurement, e.g.:

- ▷ With tow bars and trailer hitches.
- ▷ With thin or wedge-shaped objects.
- ▷ With low objects.
- ▷ With objects with corners and sharp edges.

Low objects already displayed, e.g., curbs, can move into the blind area of the sensors before or after a continuous tone sounds.

High, protruding objects such as ledges may not be detected.

False warnings

PDC may issue a warning under the following conditions even though there is no obstacle within the detection range:

- ▷ In heavy rain.
- ▷ When sensors are very dirty or covered in ice.
- ▷ When sensors are covered in snow.
- ▷ On rough road surfaces.
- ▷ In large buildings with right angles and smooth walls, e.g., in underground garages.
- ▷ In heavy exhaust.
- ▷ Due to other ultrasound sources, e.g., sweeping machines, high pressure steam cleaners or neon lights.

The malfunction is signaled by a continuous tone alternating between the front and rear speakers. As soon as the malfunction due to other ultrasound sources is no longer present, the system is again fully functional.

Malfunction

A Check Control message is displayed.

The range of the sensors is shown as a shaded area on the Control Display.

PDC has failed. Have the system checked.

To ensure full operability:

- ▷ Keep the sensors clean and free of ice.
- ▷ When using high-pressure washers, do not spray the sensors for long periods and maintain a distance of at least 12 in/30 cm.

Surround View

The concept

Surround View includes the following systems:

- ▷ Backup camera, refer to page [126](#)
- ▷ Side View, refer to page [131](#).
- ▷ Top View, refer to page [129](#).

It assists the driver when parking, maneuvering and on blind driveways and intersections.

Backup camera

The concept

The backup camera provides assistance in parking and maneuvering backwards. The area behind the vehicle is shown on the Control Display.

Notes



Check the traffic situation as well

Check the traffic situation around the vehicle with your own eyes. Otherwise, an accident could result from road users or objects located outside the picture area of the backup camera. ◀

At a glance

Button in the vehicle



 Backup camera

Camera

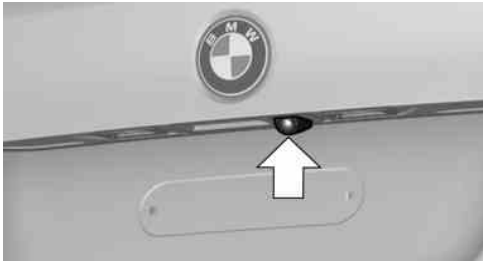

The camera lens is located in the handle of the trunk lid. The image quality may be impaired by dirt.

Clean the lens, refer to page 216.

Switching on/off

Switching on automatically

Select transmission position R with the engine running.

The backup camera image is displayed if the system was switched on via the iDrive.

Automatic deactivation during forward travel

The system switches off when a certain driving distance or speed is exceeded.

Switch the system back on if necessary.

Switching on/off manually



Press the button.

- ▷ On: the LED lights up.
- ▷ Off: the LED goes out.

The PDC is shown on the Control Display.

Switch on the backup camera via the iDrive, refer to page 125.

Switching on the backup camera via the iDrive

With PDC activated:

 "Rear view camera"

The backup camera image is displayed. The setting is stored for the remote control currently in use.



Display on the Control Display

Functional requirement

- ▷ The backup camera is switched on.
- ▷ The trunk lid is fully closed.

Activating the assistance functions

More than one assistance function can be active at the same time.

- ▷ Parking aid lines
 -  "Parking aid lines"
 - Pathway and turning circle lines are displayed.
- ▷ Obstacle marking
 -  "Obstacle marking"
 - Spatially-shaped markings are displayed.

Pathway lines

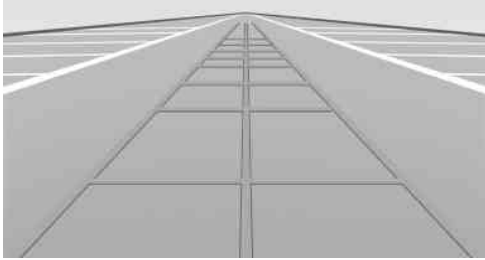

- ▷ Can be shown in the backup camera image when in transmission position R.
- ▷ Help you to estimate the space required when parking and maneuvering on level roads.
- ▷ Are dependent on the current steering angle and are continuously adjusted to the steering wheel movements.

Turning circle lines

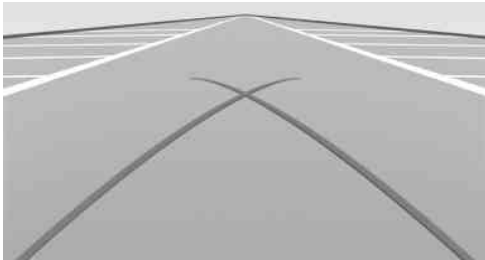

- ▷ Can be shown in the backup camera image.
- ▷ Show the course of the smallest possible turning circle on a level road.
- ▷ Only one turning circle line is displayed when the steering wheel is turned.

Obstacle marking

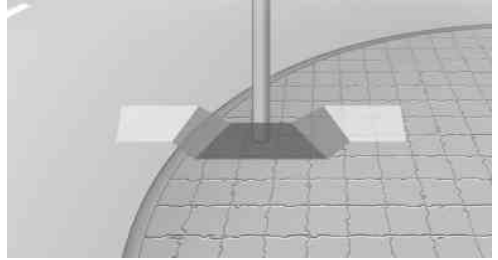

- ▷ Spatially-shaped markings can be shown in the backup camera image.

Their colored steps match the markings of the PDC. This simplifies estimation of the distance to the object shown.

Parking using pathway and turning circle lines

1. Position the vehicle so that the turning circle lines lead to within the limits of the parking space.

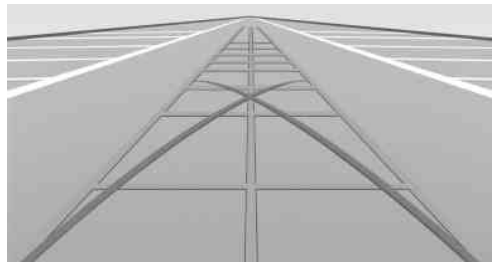

2. Turn the steering wheel to the point where the pathway line covers the corresponding turning circle line.

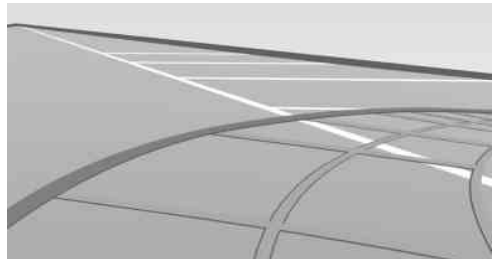

Display settings

Brightness

With the backup camera switched on:

1. ☀ Select the symbol.
2. Turn the controller until the desired setting is reached and press the controller.

Contrast

With the backup camera switched on:

1. ● Select the symbol.
2. Turn the controller until the desired setting is reached and press the controller.

System limits

Detection of objects

High, protruding objects such as ledges may not be detected by the backup camera.

Top View

The concept

Top View assists you in parking and maneuvering. The area around the doors and the road area around the vehicle are shown on the Control Display for this purpose.

General information

The image is captured by two cameras integrated in the exterior mirrors and by the backup camera.

The range is at least 7 ft/2 m to the side and rear. In this way, obstacles up to the height of the exterior mirrors are detected early.

Notes



Check the traffic situation as well

Check the traffic situation around the vehicle with your own eyes. Otherwise, an accident could result from road users or objects located outside the picture area of the cameras. ◀

At a glance

Button in the vehicle



Top View

Cameras

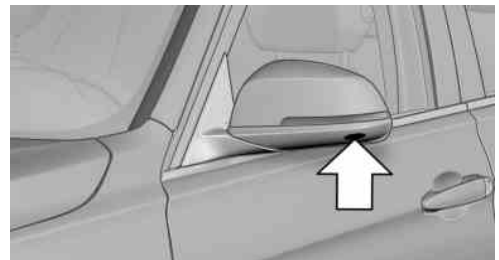

The lenses of the Top View cameras are located at the bottom of the exterior mirror housings. The image quality may be impaired by dirt.

Clean the lens, refer to page 216.

Switching on/off

Switching on automatically

Select transmission position R with the engine running.

The Top View and PDC images are displayed if the system is switched on via iDrive.

Automatic deactivation during forward travel

The system switches off when a certain driving distance or speed is exceeded.

Switch the system back on if necessary.

Switching on/off manually



Press the button.

- ▷ On: the LED lights up.
- ▷ Off: the LED goes out.

Top View is displayed, switch on the backup camera via the iDrive, refer to page 130.

Switching on the backup camera via the iDrive

With Top View switched on:

 "Rear view camera"

The backup camera image is displayed. The setting is stored for the remote control currently in use.

Display

Visual warning

The approach of the vehicle to an object can be shown on the Control Display.

When the distance to an object is small, a red bar is shown in front of the vehicle, as it is in the PDC display.

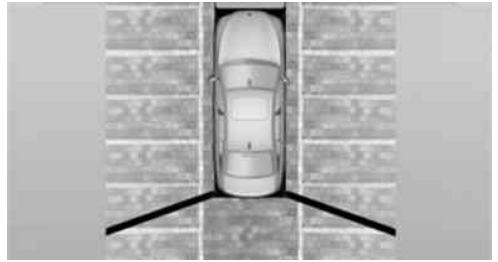

The display appears as soon as Top View is activated.

If the backup camera image was selected last, it again appears on the display when reverse gear is selected. To switch to Top View:

 "Rear view camera" Select the symbol on the Control Display.

The setting is stored for the remote control currently in use.

Brightness

With Top View switched on:

1.  "Brightness"
2. Turn the controller until the desired setting is reached and press the controller.

Contrast

With Top View switched on:

1.  "Contrast"
2. Turn the controller until the desired setting is reached and press the controller.

Displaying the turning circle and pathway lines

- ▷ The static, red turning circle line shows the space needed to the side of the vehicle when the steering wheel is turned all the way.
- ▷ The variable, green pathway line assists you in assessing the amount of space actually needed to the side of the vehicle.

The pathway line is dependent on the current steering angle and is continuously adjusted with the steering wheel movement.

"Parking aid lines"

Turning circle and pathway lines are displayed.

System limits

Top View cannot be used in the following situations:

- ▶ With a door open.
- ▶ With the trunk lid open.
- ▶ With an exterior mirror folded in.
- ▶ In poor light.

A Check Control message is displayed in some of these situations.

Side View

The concept

Side View provides an early look at cross traffic at blind driveways and intersections. Road users concealed by obstacles to the left and right of the vehicle can only be detected relatively late from the driver's seat. To improve visibility, two cameras in the front of the vehicle record the traffic situation on each side.

Notes

The images from both cameras are shown simultaneously on the Control Display.

 Check the traffic situation as well

Check the traffic situation around the vehicle on blind driveways and intersections with your own eyes. Otherwise, an accident could result from road users or objects located outside the picture area of the Side View cameras. ◀

At a glance

Button in the vehicle



 Side View

Cameras

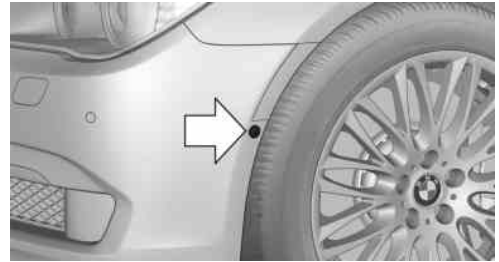

Two cameras integrated in the bumpers capture the image.

The two camera lenses are located on the sides of the bumper.

The image quality may be impaired by dirt.

Clean the lens, refer to page [216](#).

Switching on/off

Switching on/off manually

 Press the button.

Automatic deactivation during forward travel

The system switches off when a certain driving distance or speed is exceeded.

Switch the system back on if necessary.

Display

The traffic area to the left and right is displayed on the Control Display.

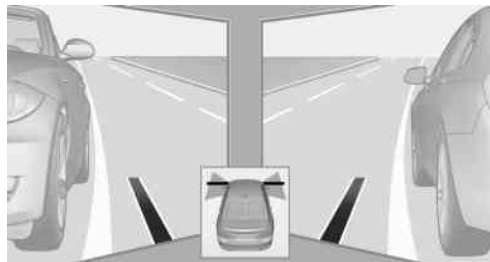

Guidelines at the bottom of the image show the position of the front of the vehicle.

Brightness

With the Side View switched on:

1. ☀ "Brightness"
2. Turn the controller until the desired setting is reached and press the controller.

Contrast

With the Side View switched on:

1. ● "Contrast"
2. Turn the controller until the desired setting is reached and press the controller.

System limits

The cameras capture a maximum range of 330 ft/100 m.

Head-up Display

The concept

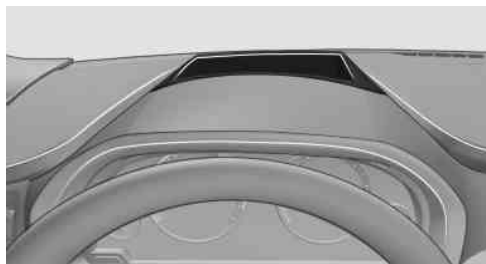

This system projects important information into the driver's field of vision, e.g., the speed.

In this way, the driver can get information without averting his or her eyes from the road.

Display visibility

The visibility of the displays in the Head-up Display is influenced by:

- ▷ Certain sitting positions.
- ▷ Objects on the cover of the Head-up Display.
- ▷ Sunglasses with certain polarization filters.
- ▷ Wet roads.
- ▷ Unfavorable light conditions.

If the image is distorted, check the basic settings.

Switching on/off

1. "Settings"
2. "Head-up display"
3. "Head-up display"

Switch the Head-up Display ON/OFF as required.

Display

Overview

- ▷ Speed.
- ▷ Navigation system.

- ▶ Check Control messages.
- ▶ Collision warning.
- ▶ Speed limit detection.
- ▶ Cruise control.
- ▶ Selection list from the instrument cluster.

Some of this information is only displayed briefly as needed.

Selecting displays in the Head-up Display

1. "Settings"
2. "Head-up display"
3. "Displayed information"
4. Select the desired displays in the Head-up Display.

The settings are stored for the remote control currently in use.

Setting the brightness

The brightness is automatically adjusted to the ambient light.

The basic setting can be adjusted manually.

1. "Settings"
2. "Head-up display"
3. "Brightness"
4. Turn the controller.

The brightness is adjusted.

When the low beams are switched on, the brightness of the Head-up Display can be additionally influenced using the instrument lighting, refer to page 90.

The setting is stored for the remote control currently in use.

Adjusting the height

1. "Settings"
2. "Head-up display"
3. "Height"
4. Turn the controller.

The height is adjusted.

The setting is stored for the remote control currently in use.

Setting the rotation

1. "Settings"
2. "Head-up display"
3. "Rotation"
4. Turn the controller.

Rotation is set.

The setting is stored for the remote control currently in use.

Special windshield

The windshield is part of the system.

The shape of the windshield makes it possible to display a precise image.

A film in the windshield prevents double images from being displayed.

Therefore, have the special windshield replaced by a service center only.

Parking assistant

The concept

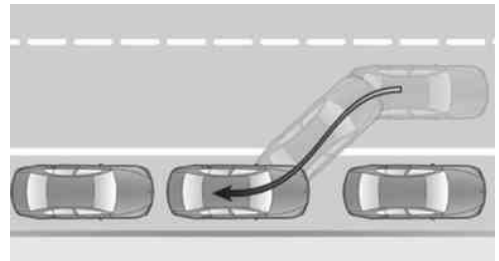

This system assists the driver in parking parallel to the road.

Ultrasound sensors measure parking spaces on both sides of the vehicle.

The parking assistant calculates the best possible parking line and takes control of steering during the parking procedure.

A component of the parking assistant is the PDC Park Distance Control, refer to page 124.

Notes

Personal responsibility

The parking assistant does not relieve the driver of responsibility for the vehicle during the parking procedure.

Watch the parking space and parking procedure closely and intervene if necessary; otherwise, there is the danger of an accident. ◀

Changes to the parking space

Changes to the parking space after it was measured are not taken into account by the system.

Therefore, always be alert and ready to intervene; otherwise, there is the danger of an accident occurring. ◀

Transporting loads

Loads that extend beyond the perimeter of the vehicle are not taken into account by the system during the parking procedure.

Therefore, always be alert and ready to intervene; otherwise, there is the danger of an accident occurring. ◀

Curbs

The parking assistant may steer the vehicle over or onto curbs.

Therefore, always be alert and ready to intervene; otherwise, the wheels, tires, or the vehicle may become damaged. ◀

An engine that has been switched off by the Auto Start Stop function is restarted automatically when the parking assistant is activated.

Requirements

For measuring parking spaces

- ▷ Maximum speed while driving forward approx. 22 mph/35 km/h.

- ▷ Maximum distance to row of parked vehicles: 5 ft/1.5 m.
- ▷ When parking in parking spaces on the driver's side, the corresponding turn signal must be set.

Suitable parking space

- ▷ Gap between two objects with a minimum length of approx. 5 ft/1.5 m.
- ▷ Minimum length of the gap: own vehicle's length plus approx 4 ft/1.2 m.
- ▷ Minimum depth: approx. 5 ft/1.5 m.

For parking procedure

Closed doors.

At a glance

Button in the vehicle



 Parking assistant

Ultrasound sensors



The ultrasound sensors for measuring parking spaces are located on the wheel arches.

To ensure full operability:

- ▷ Keep the sensors clean and free of ice.
- ▷ When using high-pressure washers, do not spray the sensors for long periods and maintain a distance of at least 12 in/30 cm.

Switching on/off

Switching on with the button



Press the button.

The LED lights up.

The current status of the parking space search is indicated on the Control Display.

 Parking assistant is activated automatically.

Switching on with reverse gear

Shift into reverse.

The current status of the parking space search is indicated on the Control Display.

Activate:  "Parking Assistant" Select the symbol in the Control Display.



Switching off

The system can be deactivated as follows:

- ▷  Press the button.
- ▷ Switch off the ignition.

Display on the Control Display

Activating/deactivating the system

Symbol	Meaning
	Gray: the system is not available. White: the system is available but not activated.
	The system is activated.

System status

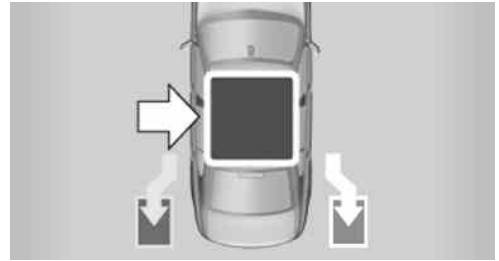

The status is displayed with symbols.



Gray: parking space search.

Blue: the system is activated. A suitable parking space was found.



The parking procedure is active. Steering control has been seized.

Status of the parking space search

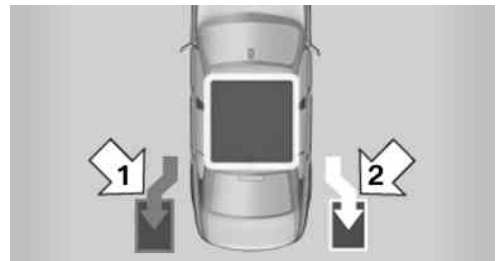

- ▷ Gray, arrow 1: parking space search.
- ▷ Blue, arrow 2: parking space is suitable. The vehicle is parked in the parking space if the parking procedure is active.
- ▷ No display: no parking space search.

Parking using the parking assistant



Check the traffic situation as well

Loud sounds outside and within the vehicle can drown out the signal tones of the parking assistant and PDC.

Check the traffic situation around the vehicle with your own eyes; otherwise, there is the danger of an accident. ◀

1. Switch on the parking assistant and activate it if necessary.

The status of the parking space search is indicated on the Control Display.

2. Follow the instructions on the Control Display.



To achieve the best possible parking position, wait for the automatic steering wheel movement after the gear change when the vehicle is stationary.

The end of the parking procedure is indicated on the Control Display.

3. Adjust the parking position yourself if necessary.

Interrupting manually

The parking assistant can be interrupted at any time:

- ▷  "Parking Assistant" Select the symbol on the Control Display.
- ▷  Press the button.

Interrupting automatically

The system is interrupted automatically in the following situations:

- ▷ If the driver grasps the steering wheel or if he takes over steering.
- ▷ If a gear is selected that does not match the instruction on the Control Display.
- ▷ If a turn signal is activated in the opposite direction to the desired side for parking.

- ▷ If the vehicle speed exceeds approx. 6 mph/10 km/h.
- ▷ On snow-covered or slippery road surfaces if necessary.
- ▷ If doors are open.
- ▷ If the Park Distance Control PDC displays clearances that are too small.
- ▷ If a maximum number of parking attempts or the time taken for parking is exceeded.

A Check Control message is displayed.

Continuing

An interrupted parking procedure can be continued if necessary.

Follow the instructions on the Control Display to do this.

System limits

No parking assistance

The parking assistant does not offer assistance in the following situations:

- ▷ In tight curves.

Functional limitations

The system may not be fully functional in the following situations:

- ▷ When sensors are dirty or iced over.
- ▷ In heavy fog, rain or snowfall.
- ▷ On bumpy road surfaces such as gravel roads.
- ▷ When leaves or snow has collected in the parking space.

Limits of ultrasonic measurement

The detection of objects can reach the physical limits of ultrasonic measurement, e.g. in the following circumstances:

- ▷ With tow bars and trailer hitches.
- ▷ With thin or wedge-shaped objects.

- ▶ With elevated, protruding objects such as ledges or cargo.
- ▶ With objects with corners and sharp edges.
- ▶ With objects with a fine surface structure, such as fences.

Low objects already displayed, e.g., curbs, can move into the blind area of the sensors before or after a continuous tone sounds.

High, protruding objects such as ledges may not be detected.

The parking assistant may identify parking spaces that are not suitable for parking.

Malfunction

A Check Control message is displayed.

The parking assistant failed. Have the system checked.

Climate control

Vehicle equipment

All standard, country-specific and optional equipment that is offered in the model series is described in this chapter. Therefore, equipment

is also described that is not available in a vehicle, e. g., because of the selected optional equipment or country variant. This also applies for safety-related functions and systems.

Automatic climate control

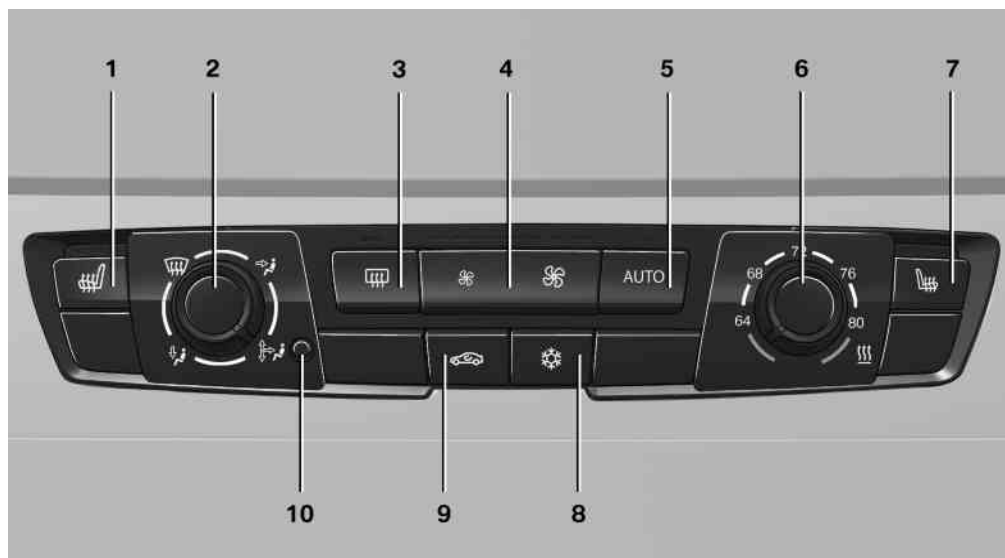

- | | | |
|----|-----------------------------|----|
| 1 | Seat heating, left | 48 |
| 2 | Vent settings | |
| 3 | Rear window defroster | |
| 4 | Air flow | |
| 5 | AUTO program | |
| 6 | Temperature | |
| 7 | Seat heating, right | 48 |
| 8 | Cooling function | |
| 9 | Recirculated-air mode | |
| 10 | Interior temperature sensor | |

Climate control functions in detail

Manual air distribution



Turn the wheel to select the desired program or the desired intermediate setting.

- ▷ Windows.
- ▷ Upper body region.
- ▷ Windows, upper body region, and footwell.
- ▷ Footwell.

Defrosting windows and removing condensation

Direct the air distribution toward windows, increase the air flow and temperature, and, if necessary, use the cooling function.

Rear window defroster



Press the button.

The rear window defroster switches off automatically after a certain period of time.

Air flow, manual



Press the left or right side of the button: decrease or increase air flow.

The air flow of the air conditioner may be reduced automatically to save battery power.

AUTO program



Press the button.

Air flow, air distribution, and temperature are controlled automatically.

Depending on the selected temperature and outside influences, the air is directed to the windshield, side windows, upper body, and into the footwell.

The cooling function, refer to page 139, is switched on automatically with the AUTO program.

Temperature



Turn the wheel to set the desired temperature.

The automatic climate control reaches this temperature as quickly as possible, if necessary by increasing the cooling or heating output, and then keeps it constant.

Avoid rapidly switching between different temperature settings. The automatic climate control will not have sufficient time to adjust the set temperature.

Cooling function

The passenger compartment can only be cooled with the engine running.



Press the button.

The air is cooled and dehumidified and, depending on the temperature setting, warmed again.

Depending on the weather, the windshield may fog up briefly when the engine is started.

The cooling function is switched on automatically with the AUTO program.

When using the automatic climate control, condensation water, refer to page 162, develops that exits underneath the vehicle.

Recirculated-air mode

You can respond to unpleasant odors or pollutants in the immediate environment by temporarily suspending the supply of outside air. The system then recirculates the air currently within the vehicle.



Press the button repeatedly to select an operating mode:

- ▷ LED off: outside air flows in continuously.
- ▷ LED on, recirculated-air mode: the supply of outside air into the vehicle is permanently blocked.

If the windows fog over, switch off recirculated-air mode and increase the air volume, if necessary.



Continuous recirculated-air mode

The recirculated-air mode should not be used for an extended period of time, as the air quality inside the vehicle deteriorates steadily. ◀

Switching the system on/off

Switching off



Press the left button for the minimum speed.

Switching on

Press any button except

- ▷ Rear window defroster.
- ▷ Seat heating.

Microfilter

In external and recirculated air mode the microfilter filters dust and pollen out of the air.

This filter should be replaced during scheduled maintenance, refer to page 193, of your vehicle.

Automatic climate control with enhanced features

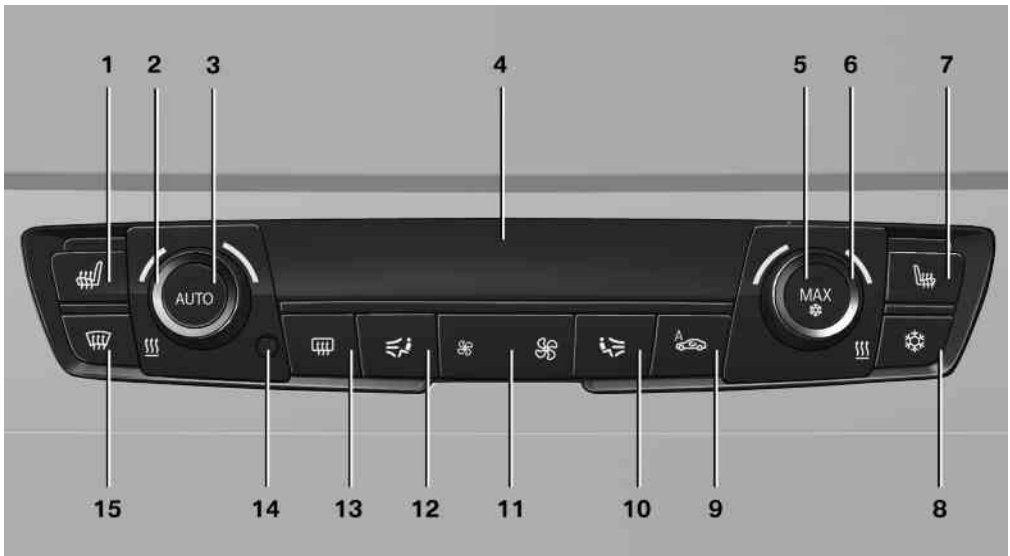

- 1 Seat heating, left 48
- 2 Temperature, left
- 3 AUTO program

- 4 Display
- 5 Maximum cooling
- 6 Temperature, right

- 7 Seat heating, right [48](#)
- 8 Cooling function
- 9 Automatic recirculated-air control/recirculated-air mode
- 10 Air distribution, right
- 11 Air flow, AUTO intensity
- 12 Air distribution, left
- 13 Rear window defroster
- 14 Interior temperature sensor — always keep clear
- 15 Defrosting windows and removing condensation

Climate control functions in detail

Temperature



Turn the wheel to set the desired temperature.

The automatic climate control reaches this temperature as quickly as possible, if necessary by increasing the cooling or heating output, and then keeps it constant.

Avoid rapidly switching between different temperature settings. The automatic climate control will not have sufficient time to adjust the set temperature.

AUTO program



Press the button.

Air flow, air distribution, and temperature are controlled automatically.

Depending on the selected temperature, AUTO intensity, and outside influences, the air is directed to the windshield, side windows, upper body, and into the footwell.

The cooling function, refer to page [141](#), is switched on automatically with the AUTO program.

At the same time, a condensation sensor controls the program so as to prevent window condensation as much as possible.

Intensity of the AUTO program

With the AUTO program switched on, automatic control of the air flow and air distribution can be adjusted.



Press the left or right side of the button: decrease or increase the intensity.

The selected intensity is shown on the display of the automatic climate control.

Maximum cooling



Press the button.

The system is set to the lowest temperature, maximum air flow and recirculated-air mode.

Air flows out of the vents for the upper body region. Open them for this purpose.

The air is cooled fastest when the engine is running.

The air flow can be adjusted when the program is active.

Cooling function

The passenger compartment can only be cooled with the engine running.



Press the button.

The air is cooled and dehumidified and, depending on the temperature setting, warmed again.

Depending on the weather, the windshield may fog up briefly when the engine is started.

The cooling function is switched on automatically with the AUTO program.

When using the automatic climate control, condensation water, refer to page 162, develops that exits underneath the vehicle.

Automatic recirculated-air control/ recirculated-air mode

You can respond to unpleasant odors or pollutants in the immediate environment by temporarily suspending the supply of outside air. The system then recirculates the air currently within the vehicle.



Press the button repeatedly to select an operating mode:

- ▷ LEDs off: outside air flows in continuously.
- ▷ Left LED on, automatic recirculated-air control: a sensor detects pollutants in the outside air and controls the shutoff automatically.
- ▷ Right LED on, recirculated-air mode: the supply of outside air into the vehicle is permanently blocked.

If the windows are fogged over, switch off the recirculated-air mode and press the AUTO button to utilize the condensation sensor. Make sure that air can flow onto the windshield.



Continuous recirculated-air mode

The recirculated-air mode should not be used for an extended period of time, as the air quality inside the vehicle deteriorates steadily. ◀

Manual air distribution



Press the button repeatedly to select a program:

- ▷ Upper body region.
- ▷ Upper body region and footwell.
- ▷ Footwell.
- ▷ Windows and footwell: driver's side only.
- ▷ Windows, upper body region and footwell: driver's side only.

If the windows are fogged over, press the AUTO button to utilize the condensation sensor.

Air flow, manual

To be able to manually adjust the air flow, switch off the AUTO program first.



Press the left or right side of the button: decrease or increase air flow.

The selected air flow is shown on the display of the automatic climate control.

The air flow of the automatic climate control may be reduced automatically to save battery power.

Rear window defroster



Press the button.

The rear window defroster switches off automatically after a certain period of time.

Defrosting windows and removing condensation



Press the button.

Ice and condensation are quickly removed from the windshield and the front side windows.

The air flow can be adjusted when the program is active.

If the windows are fogged over, you can also switch on the cooling function or press the AUTO button to utilize the condensation sensor.

Switching the system on/off

Switching off



Press the left button for the minimum speed.

Switching on

Press any button except

- ▷ Rear window defroster.
- ▷ Seat heating.

Microfilter/activated-charcoal filter

In external and recirculated air mode the microfilter/activated charcoal filter filters dust, pollen, and gaseous pollutants out of the air.

This filter should be replaced during scheduled maintenance, refer to page 193, of your vehicle.

Ventilation

Front ventilation

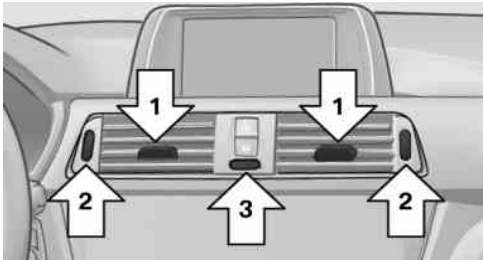

- ▷ Lever for changing the air flow direction, arrow 1.
- ▷ Thumbwheels for opening and closing the vents continuously, arrows 2.
- ▷ Thumbwheel to vary the temperature, arrow 3.
Toward blue: colder.
Toward red: warmer.

Adjusting the ventilation

- ▷ Ventilation for cooling:
Adjust the vent to direct the air in your direction, such as if the vehicle interior is hot from the sun.
- ▷ Draft-free ventilation:
Adjust the vent to let the air flow past you.

Ventilation in the rear

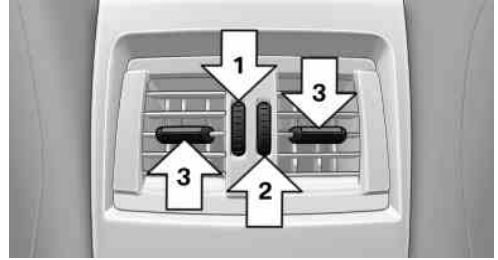

- ▷ Thumbwheel for continuous opening and closing of the vents, arrow 1.
- ▷ Thumbwheel to vary the temperature, arrow 2.
Toward blue: colder.
Toward red: warmer.
- ▷ Lever for changing the air flow direction, arrow 3.

Parked-car ventilation

The concept

The parked-car ventilation ventilates the vehicle interior and lowers its temperature, if necessary.

The system can be switched on and off at any external temperature, either directly or by using two preset switch-on times. It remains switched on for 30 minutes.

Open the vents to allow air to flow out.

Operation can be performed via iDrive.

Switching on/off directly

1. "Settings"
2. "Climate"
3. "Activate parked-car vent."

☞ The symbol on the automatic climate control flashes if the system is switched on.

Preselecting the switch-on time

1. "Settings"
2. "Climate"
3. "Timer 1:" or "Timer 2:"
4. Set the desired time.

Activating the switch-on time

1. "Settings"
2. "Climate"
3. "Activate Timer 1" or "Activate Timer 2"

☞ The symbol on the automatic climate control lights up when the switch-on time is activated.

☞ The symbol on the automatic climate control flashes when the system has been switched on.

The system will only be switched on within the next 24 hours. After that, it needs to be reactivated.

Interior equipment

Vehicle equipment

All standard, country-specific and optional equipment that is offered in the model series is described in this chapter. Therefore, equipment is also described that is not available in a vehicle, e. g., because of the selected optional equipment or country variant. This also applies for safety-related functions and systems.

Integrated universal remote control

The concept

The integrated universal remote control can operate up to 3 functions of remote-controlled systems such as garage door drives or lighting systems. The integrated universal remote control replaces up to 3 different hand-held transmitters. To operate the remote control, the buttons on the interior rearview mirror must be programmed with the desired functions. The hand-held transmitter for the particular system is required in order to program the remote control.



During programming

During programming and before activating a device using the integrated universal remote control, ensure that there are no people, animals, or objects in the range of movement of the remote-controlled device; otherwise, there is a risk of injury or damage.

Also follow the safety instructions of the hand-held transmitter. ◀

Before selling the vehicle, delete the stored functions for the sake of security.

Compatibility



If this symbol is printed on the packaging or in the instructions of the system to be controlled, the system is generally com-

patible with the integrated universal remote control.

If you have any questions, please contact:

- ▷ Your service center.
- ▷ www.homelink.com on the Internet.

HomeLink is a registered trademark of Johnson Controls, Inc.

Controls on the interior rearview mirror

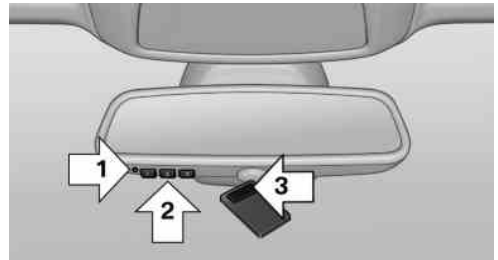

- ▷ LED, arrow 1.
- ▷ Buttons, arrow 2.
- ▷ The hand-held transmitter, arrow 3, is required for programming.

Programming

General information

1. Switch on the ignition.
2. Initial setup:

Press and hold the left and right button on the interior rearview mirror simultaneously for approximately 20 seconds until the LED on the interior rearview mirror flashes. This erases all programming of the buttons on the interior rearview mirror.
3. Hold the hand-held transmitter for the system to be controlled approx. 1 to 3 in/2.5 to 8 cm away from the buttons on the interior

rearview mirror. The required distance depends on the manual transmitter.

4. Simultaneously press and hold the button of the desired function on the hand-held transmitter and the button to be programmed on the interior rearview mirror. The LED on the interior rearview mirror will begin flashing slowly.

5. Release both buttons as soon as the LED flashes more rapidly. When the LED is flashing faster, this indicates that the button on the interior rearview mirror has been programmed.

If the LED does not flash faster after at least 60 seconds, change the distance between the interior rearview mirror and the hand-held transmitter and repeat the step. Several more attempts at different distances may be necessary. Wait at least 15 seconds between attempts.

Canada: if programming with the hand-held transmitter was interrupted, hold down the interior rearview mirror button and repeatedly press and release the hand-held transmitter button for 2 seconds.

6. To program other functions on other buttons, repeat steps 3 to 5.

The systems can be controlled using the interior rearview mirror buttons.

Special feature of the alternating-code wireless system

If you are unable to operate the system after repeated programming, please check if the system to be controlled features an alternating-code system.

Read the system's operating manual, or press the programmed button on the interior rearview mirror longer. If the LED on the interior rearview mirror starts flashing rapidly and then stays lit constantly for 2 seconds, the system features an alternating-code system. Flashing and continuous illumination of the LED will repeat for approximately 20 seconds.

For systems with an alternating-code system, the integrated universal remote control and the system also have to be synchronized.

Please read the operating manual of the system being set up for information on how to synchronize the system.

Synchronizing is easier with the aid of a second person.

To synchronize:

1. Park the vehicle within range of the remote-controlled system.
2. Program the relevant button on the interior rearview mirror as described.
3. Locate and press the synchronizing button on the system being programmed. You have approx. 30 seconds for the next step.
4. Hold down the programmed button on the interior rearview mirror for approximately 3 seconds and then release it. If necessary, repeat this work step up to three times in order to finish synchronization. Once synchronization is complete, the programmed function will be carried out.

Reprogramming individual buttons

1. Switch on the ignition.
2. Press and hold the interior rearview mirror button to be programmed.
3. As soon as the interior rearview mirror LED starts flashing slowly, hold the hand-held transmitter for the system to be controlled approx. 1 to 3 in/2.5 to 8 cm away from the buttons on the interior rearview mirror. The required distance depends on the manual transmitter.
4. Likewise, press and hold the button of the desired function on the hand-held transmitter.
5. Release both buttons as soon as the interior rearview mirror LED flashes more rapidly. When the LED is flashing faster, this indicates that the button on the interior rearview mirror has been programmed. The system

can then be controlled by the button on the interior rearview mirror.

If the LED does not flash faster after at least 60 seconds, change the distance and repeat the step. Several more attempts at different distances may be necessary. Wait at least 15 seconds between attempts.

Canada: if programming with the hand-held transmitter was interrupted, hold down the interior rearview mirror button and repeatedly press and release the hand-held transmitter button for 2 seconds.

Controls



Before operation

Before operating a system using the integrated universal remote control, ensure that there are no people, animals, or objects within the range of movement of the remote-controlled system; otherwise, there is a risk of injury or damage.

Also follow the safety instructions of the hand-held transmitter. ◀

The system, such as the garage door, can be operated using the button on the interior rearview mirror while the engine is running or when the ignition is started. To do this, hold down the button within receiving range of the system until the function is activated. The interior rearview mirror LED stays lit while the wireless signal is being transmitted.

Deleting stored functions

Press and hold the left and right button on the interior rearview mirror simultaneously for approximately 20 seconds until the LED flashes rapidly. All stored functions are deleted. The functions cannot be deleted individually.

Digital compass

At a glance

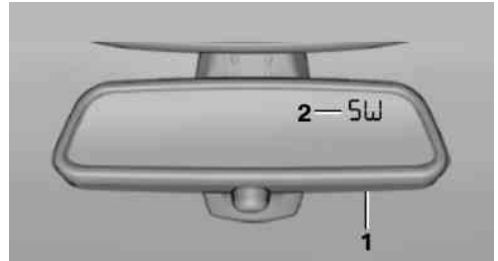

- 1 Control button
- 2 Mirror display

Mirror display

The point of the compass is displayed in the mirror when driving straight.

Operating concept

Various functions can be called up by pressing the control button with a pointed object, such as the tip of a ballpoint pen or similar object. The following setting options are displayed in succession, depending on how long the control button is pressed:

- ▷ Pressed briefly: turns display on/off.
- ▷ 3 to 6 seconds: compass zone setting.
- ▷ 6 to 9 seconds: compass calibration.
- ▷ 9 to 12 seconds: left/right-hand steering setting.
- ▷ 12 to 15 seconds: language setting.

Setting the compass zones

Sets the particular compass zones on the vehicle so that the compass operates correctly; refer to World map with compass zones.

World map with magnetic zones

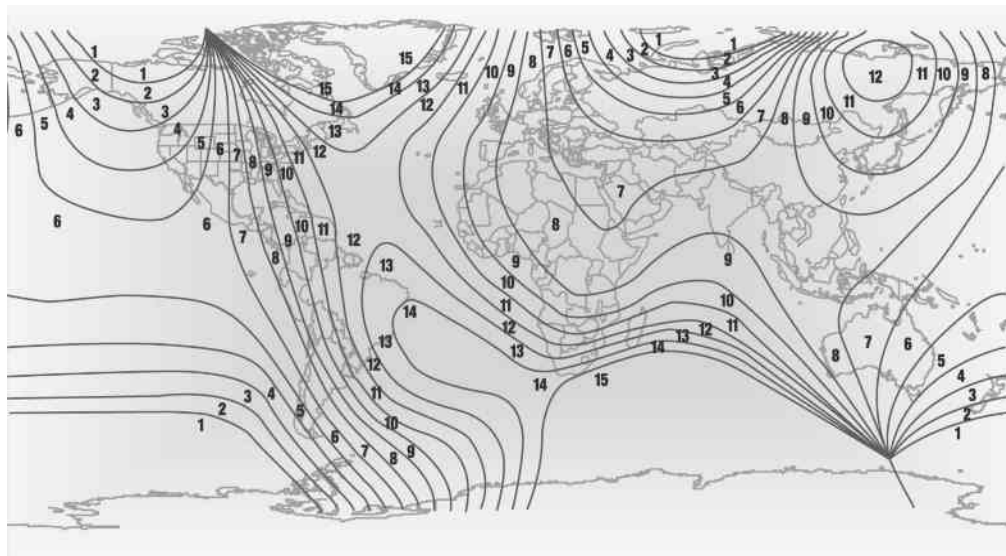

Procedure

1. Press and hold the control button for approx. 3 to 4 seconds. The number of the set compass zone appears in the mirror.
2. To change the zone setting, press the control button quickly and repeatedly until the number of the compass zone corresponding to your location appears in the mirror.

The set zone is stored automatically. The compass is ready for use again after approximately 10 seconds.

Calibrating the digital compass

The digital compass must be calibrated in the event of the following:

- ▷ The wrong point of the compass is displayed.
- ▷ The point of the compass displayed does not change despite changing the direction of travel.
- ▷ Not all points of the compass are displayed.

Procedure

1. Make sure that there are no large metallic objects or overhead power lines near the vehicle and that there is sufficient room to drive around in a circle.
2. Set the currently applicable compass zone.
3. Press and hold the control button for approx. 6 to 7 seconds so that "C" appears on the display. Next, drive in a complete circle at least once at a speed of no more than 4 mph/7 km/h. If calibration is successful, the "C" is replaced by the points of the compass.

Left/right-hand steering

The digital compass is already set for right or left-hand steering at the factory.

Setting the language

Press and hold the control button for approx. 12 to 13 seconds. Briefly press the control button again to switch between English "E" and German "O".

The setting is stored automatically after approximately 10 seconds.

Ashtray/cigarette lighter

Ashtray

Opening



Raise cover.

Emptying

Take out the insert.

Lighter

 Danger of burns

Only hold the hot lighter by its knob; otherwise, there is the danger of getting burned.

Switch off the ignition and take the remote control with you when leaving the vehicle so that children cannot use the lighter and burn themselves. ◀



The lighter is located next to the ashtray.



Push in the lighter.

The lighter can be removed as soon as it pops back out.

Connecting electrical devices

Note



Do not plug the charger into the socket

Do not connect battery chargers to the factory-installed sockets in the vehicle. Doing so may result in damage to the vehicle. ◀

Sockets

The lighter socket can be used as a socket for electrical equipment while the engine is running or when the ignition is switched on. The total load of all sockets must not exceed 140 watts at 12 volts.

Do not damage the socket by using unsuitable connectors.

Front center console



Raise the cap and remove the cover or cigarette lighter.

In the front passenger footwell

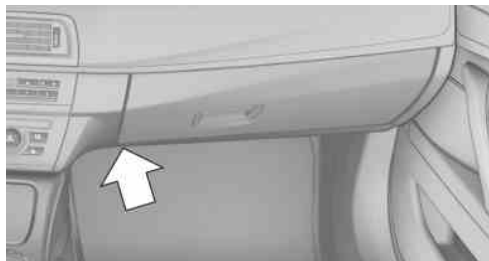

Socket is located below the glove compartment.

Rear center console



Remove cover.

In the cargo area



The socket is located on the left side in the cargo area.

USB interface for data transfer

At a glance

The USB interface for data transmission is located in the glove compartment. Depending on the variant, the USB interface may also be located in the center armrest.

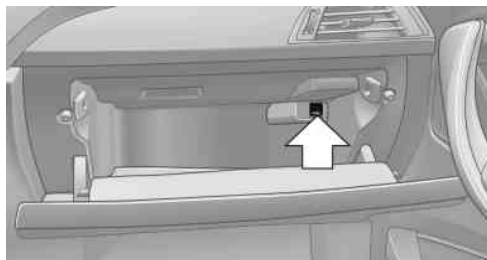

The USB interface is located in the glove compartment

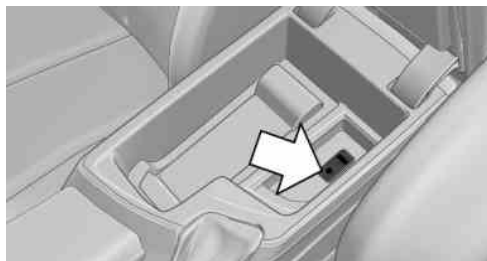

The USB interface is located in the center armrest.

General information

Connection for importing and exporting data on USB devices, e.g.:

- ▷ Personal Profile settings, refer to page 33.
- ▷ Music collection, see user's manual for Navigation, Entertainment and Communication.
- ▷ Importing trips, see user's manual for Navigation, Entertainment and Communication.

Notes

Observe the following when connecting:

- ▷ Do not use force when plugging the connector into the USB interface.
- ▷ Do not connect devices such as fans or lamps to the USB interface.
- ▷ Do not connect USB hard drives.
- ▷ Do not use the USB interface to recharge external devices.

Through-loading system

The concept

The cargo area can be enlarged by folding down the rear seat backrest.

The rear seat backrest is divided at a ratio of 40–20–40.

The sides can be folded down separately or together.

Notes



Danger of pinching

Before folding down the rear seat backrests, ensure that the area of movement of the backrests is clear. In particular, ensure that no one is located in or reaches into the area of movement of the rear seat backrests when the middle section is folded down. Otherwise, injury or damage may result. ◀



Locking the backrest

Before driving with passengers in the rear of the vehicle, make sure that the backrests are engaged and thus locked in place. Otherwise, the restraining effect of the safety belts may be limited in an accident. ◀



Retract the head restraint if necessary before backrest is folded down

With folding head restraints, fold in the head restraints before folding down the backrests, or damage may result. ◀

Opening

1. Unlock the belt lock of the center safety belt in the rear using the latch plate of another safety belt.
2. Insert the latch plate at the end of the belt into the specially designated fixture on the rear window shelf.

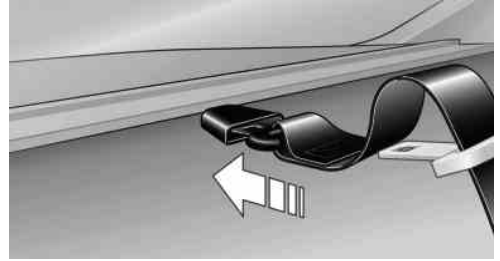

3. Push the corresponding head restraint down as far as it will go.
4. Pull the corresponding lever in the cargo area to release the rear seat backrest.

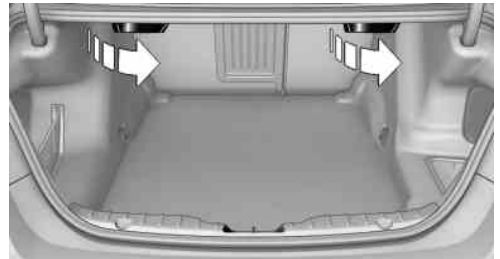

5. The unlocked rear seat backrest moves forward slightly.



6. Fold backrest forward.

Closing

1. Return the rear seat backrest to the upright seating position and engage it.



Ensure that the lock is securely engaged

Make sure that the lock engages properly when folding back, otherwise transported cargo could enter the passenger compartment during braking or evasive maneuvers and endanger the vehicle occupants. ◀

2. Release the belt tongue from the fixture on the rear window shelf.
3. Insert the belt tongue in the belt lock of the center safety belt. Make sure you hear the latch plate engage.

To secure cargo, refer to page 164, with nets or draw straps, the cargo area is fitted with lashing eyes.

Folding down the middle section

1. Fold in the middle head restraint.
2. Reach into the recess and pull the middle section forward.

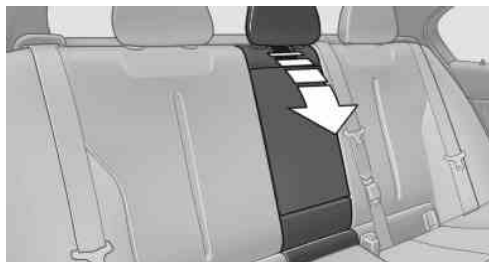

Storage compartments

Vehicle equipment

All standard, country-specific and optional equipment that is offered in the model series is described in this chapter. Therefore, equipment is also described that is not available in a vehicle, e. g., because of the selected optional equipment or country variant. This also applies for safety-related functions and systems.

Notes

 No loose objects in the passenger compartment

Do not stow any objects in the passenger compartment without securing them; otherwise, they may present a danger to occupants for instance during braking and avoidance maneuvers. ◀

 Do not place anti-slip mats on the dashboard

Do not place anti-slip mats on the dashboard. The mat materials could damage the dashboard. ◀

Storage compartments

The following storage compartments are available in the vehicle interior:

- ▶ Glove compartment on the driver's side, refer to page 153.
- ▶ Glove compartment on the front passenger side, refer to page 154.
- ▶ Without Smoker's package: Front storage compartment, in front of the cupholders, refer to page 154.
- ▶ Storage compartment in the front center armrest, refer to page 154.

- ▶ Compartments in the doors, refer to page 154.
- ▶ Nets on the backrests of the front seats.
- ▶ Storage compartment in the rear center console, refer to page 155.

Glove compartment

Driver's side

Opening



Pull the handle.

 Close the glove compartment again immediately

Close the glove compartment immediately after use while driving; otherwise, injury may occur during accidents. ◀

Closing

Fold up the cover.

Front passenger side

Opening

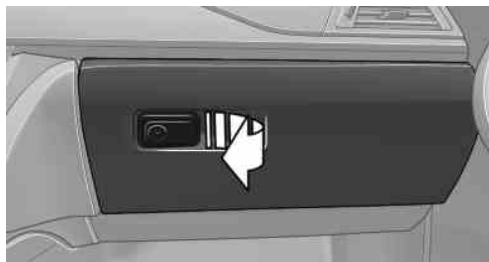

Pull the handle.

The light in the glove compartment switches on.

The net in the glove compartment is provided for stowing the storage tray for the cupholder, refer to page 155.

 Close the glove compartment again immediately

Close the glove compartment immediately after use while driving; otherwise, injury may occur during accidents. ◀

Closing

Fold up the cover.

Locking

The glove compartment can be locked with an integrated key to separately secure the trunk lid, refer to page 38, for example.

After the glove compartment is locked, the remote control can be handed over, such as at a hotel, without the integrated key, refer to page 30.

This prevents access to the glove compartment and to the cargo area.

Front storage compartment



Raise the lid to open it.

Compartments in the doors



Do not stow any breakable objects

Do not store any breakable objects, e. g. glass bottles, in the compartments, or there is an increased risk of injury in the event of an accident. ◀

Center armrest

Front

A storage compartment is located in the center armrest between the front seats.

Opening



Fold the center armrest up.

Repositioning

Center armrest can be pushed forwards or backwards. It engages in the end positions.

Connection for an external audio device



For a description, see the user's manual for Navigation, Entertainment and Communication.

Storage compartment in the rear

Storage compartment is located in the rear center console.

Cupholders

Notes

! Shatter-proof containers and no hot drinks

Use light and shatter-proof containers and do not transport hot drinks. Otherwise, there is the increased danger of injury in an accident. ◀

! Unsuitable containers
Do not forcefully push unsuitable containers into the cupholders. This may result in damage. ◀

Front



Storage tray for front cupholders

The cupholder with the storage tray can be used for additional storage. To do this, place the storage tray in the cupholder.

Only use the storage tray for small objects, such as keys or the remote control.

When not in use, stow the storage tray in the glove compartment net. Insert the storage tray into the net so that the top surface faces up. Note the trapezoidal shape of the net and tray.

Rear

In the center armrest.

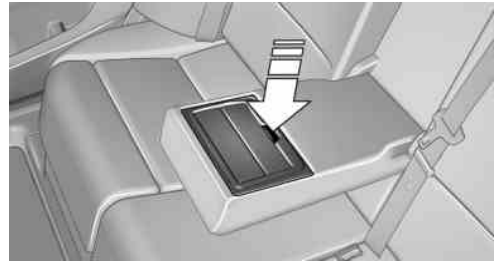

Pull the center armrest forward at the strap.

To open: press the button.

To close: push both covers back in, one after the other.

! Pushing back the covers

Push back the covers before folding up the center armrest; otherwise, the cupholder could become damaged. ◀

Clothes hooks

The clothes hooks are located in the grab handles in the rear.

! Do not obstruct view

When suspending clothing from the hooks, ensure that it will not obstruct the driver's vision. ◀



No heavy objects

Do not hang heavy objects from the hooks; otherwise, they may present a danger to passengers during braking and evasive maneuvers. ◀

Storage compartments in the cargo area

Storage compartment

A storage compartment is located on the left side.

Net

Small objects can be stowed in the net on the left side.

Storage compartment

Located on the right side is a storage compartment for the onboard vehicle tool kit, refer to page 196, and first aid kit, refer to page 208.

Hooks/multi-function hook

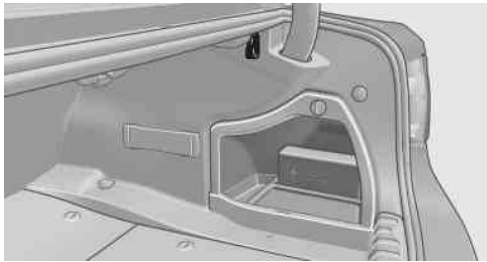

A multi-function hook is located on each side of the cargo area. The multi-function hooks can be loaded up to a max. of 8.8 lbs/4 kg.



Light and suitable objects only

Only hang light bags or suitable objects from the holders. Otherwise, there is a danger of objects flying about during braking and evasive maneuvers.

Only transport heavy luggage in the trunk if it has been appropriately secured. ◀

Retaining strap

A retaining strap is available on the right side trim for fastening small objects.

Lashing eyes in the cargo area

To secure the cargo, refer to page 164, there are four lashing eyes in the cargo area.

Floor net

The floor net can also be used to Secure the load, refer to page 164, and to store small parts.

Storage compartment under cargo floor panel



Maximum load

To avoid damage to the vehicle, do not exceed a maximum permitted load of 44 lbs/20 kg in the storage compartment under the cargo floor panel. ◀

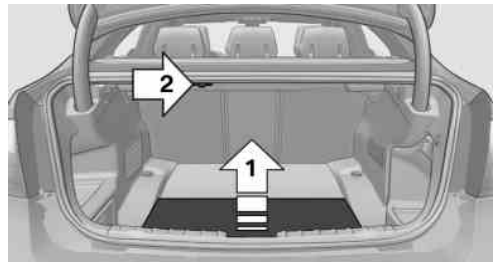

Raise the cargo floor panel, arrow 1, and latch at top, if necessary, arrow 2.

Partitioning the compartment

The compartment can be divided using an attachable partition.



Driving tips

This chapter provides you with information useful in dealing with specific driving and operating modes.

Things to remember when driving

Vehicle equipment

All standard, country-specific and optional equipment that is offered in the model series is described in this chapter. Therefore, equipment is also described that is not available in a vehicle, e. g., because of the selected optional equipment or country variant. This also applies for safety-related functions and systems.

Breaking-in period

General information

Moving parts need to be broken in to adjust to each other.

The following instructions will help achieve a long vehicle life and good economy.

Engine and differential

Always obey the official speed limit.

Up to 1,200 miles/2,000 km

Do not exceed the maximum engine and road speed:

- ▶ For gasoline engine, 4,500 rpm and 100 mph/160 km/h.

Avoid full-throttle operation and use of the transmission's kickdown mode for the initial miles.

From 1,200 miles/2,000 km

The engine and vehicle speed can gradually be increased.

Tires

Due to technical factors associated with their manufacture, tires do not achieve their full traction potential until after an initial breaking-in period.

Drive conservatively for the first 200 miles/300 km.

Brake system

Brakes require an initial break-in period of approx. 300 miles/500 km to achieve optimized contact and wear patterns between brake pads and discs. Drive moderately during this break-in period.

Clutch

The function of the clutch reaches its optimal level only after a distance driven of approx. 300 miles/500 km. During this break-in period, engage the clutch gently.

Following part replacement

The same breaking in procedures should be observed if any of the components mentioned above have to be renewed in the course of the vehicle's operating life.

General driving notes

Closing the trunk lid



Drive with the trunk lid closed

Only drive with the tailgate closed; otherwise, in the event of an accident or braking or evasive maneuvers, passengers or other road users may be injured or the vehicle may be damaged. In addition, exhaust fumes may enter the passenger compartment. ◀

If driving with the tailgate open cannot be avoided:

- ▶ Close all windows and the glass sunroof.
- ▶ Greatly increase the blower speed.
- ▶ Drive moderately.

Hot exhaust system



Hot exhaust system

High temperatures are generated in the exhaust system.

Do not remove the heat shields installed and never apply undercoating to them. When driving, standing at idle and while parking, take care to avoid possible contact between the hot exhaust system and any highly flammable materials such as hay, leaves, grass, etc. Such contact could lead to a fire, and with it the risk of serious personal injury as well as property damage.

Do not touch hot exhaust pipes; otherwise, there is the danger of getting burned. ◀

Mobile communication devices in the vehicle



Mobile communication devices in the vehicle

It is advised that you do not use mobile communication devices, e.g., mobile phones, inside the vehicle without connecting them directly to the external antenna. Otherwise, the vehicle electronics and mobile communication devices can interfere with each other. In addition, there is no assurance that the radiation generated during transmission will be discharged from the vehicle interior. ◀

Hydroplaning

On wet or slushy roads, a wedge of water can form between the tires and road surface.

This phenomenon is referred to as hydroplaning. It is characterized by a partial or complete loss of contact between the tires and the road surface, ultimately undermining your ability to steer and brake the vehicle.



Hydroplaning

When driving on wet or slushy roads, reduce your speed to prevent hydroplaning. ◀

Driving through water

Drive through calm water only if it is not deeper than 9.8 inches/25 cm and at this height, no faster than walking speed, up to 6 mph/10 km/h.



Adhere to water depth and speed limitations

Do not exceed this water depth and walking speed; otherwise, the vehicle's engine, the electrical systems and the transmission may be damaged. ◀

Braking safely

Your vehicle is equipped with ABS as a standard feature.

Applying the brakes fully is the most effective way of braking in situations when this is necessary.

The vehicle maintains steering responsiveness. You can still avoid any obstacles with a minimum of steering effort.

Pulsation of the brake pedal and sounds from the hydraulic circuits indicate that ABS is in its active mode.

Objects in the area around the pedals



No objects in the area around the pedals

Keep floor mats, carpets, and any other objects out of the area of motion of the pedals; otherwise, the function of the pedals could be impeded while driving

Do not place additional floor mats over existing mats or other objects.

Only use floor mats that have been approved for the vehicle and can be properly fixed in place.

Ensure that the floor mats are securely fastened again after they were removed for cleaning, for example. ◀

Driving in wet conditions

When roads are wet or there is heavy rain, briefly exert gentle pressure on the brake pedal every few miles.

Ensure that this action does not endanger other road users.

The heat generated in this process helps dry the brake discs and pads.

In this way braking efficiency will be available when you need it.

Hills

Drive long or steep downhill gradients in the gear in which the least braking is required. Otherwise, the brake system may overheat, resulting in a reduction in the brake system efficiency.

Manual transmission:

You can increase the engine's braking effect by shifting down, going all the way to first gear, if necessary.

Automatic transmission:

You can increase the engine's braking effect by shifting down in the manual mode of the automatic transmission.

 Avoid load on the brakes

Avoid placing excessive load on the brake system. Light but consistent brake pressure can lead to high temperatures, brake wear and possibly even brake failure. ◀

 Do not drive in neutral

Do not drive in neutral or with the engine stopped, as doing so disables engine braking. In addition, steering and brake assist is unavailable with the engine stopped. ◀

Brake disc corrosion

Corrosion on the brake discs and contamination on the brake pads are furthered by:

- ▷ Low mileage.
- ▷ Extended periods when the vehicle is not used at all.
- ▷ Infrequent use of the brakes.

Corrosion occurs when the minimum pressure that must be exerted by the pads during brake applications to clean the discs is not reached.

Should corrosion form on the brake discs, the brakes will tend to respond with a pulsating effect that generally cannot be corrected.

Condensation under the parked vehicle

When using the automatic climate control, condensation water develops that exits underneath the vehicle.

Therefore, traces of condensed water under the vehicle are normal.

Loading

Vehicle equipment

All standard, country-specific and optional equipment that is offered in the model series is described in this chapter. Therefore, equipment is also described that is not available in a vehicle, e. g., because of the selected optional equipment or country variant. This also applies for safety-related functions and systems.

General information

Overloading the vehicle

To avoid exceeding the approved carrying capacity of the tires, never overload the vehicle. Overloading can lead to overheating and increases the rate at which damage develops inside the tires. This could result in a sudden loss of tire inflation pressure. ◀

No fluids in the trunk

Make sure that fluids do not leak into the trunk; otherwise, the vehicle may be damaged. ◀

Determining the load limit



1. Locate the following statement on your vehicle's placard:
 - ▶ The combined weight of occupants and cargo should never exceed XXX kg or YYY lbs. Otherwise, damage to the ve-

hicle and unstable driving situations may result.

2. Determine the combined weight of the driver and passengers that will be riding in your vehicle.
3. Subtract the combined weight of the driver and passengers from XXX kilograms or YYY pounds.
4. The resulting figure equals the available amount of cargo and luggage load capacity. For example, if the YYY amount equals 1,000 lbs and there will be four 150 lbs passengers in your vehicle, the amount of available cargo and luggage load capacity is 400 lbs: 1,000 lbs minus 600 lbs = 400 lbs.
5. Determine the combined weight of luggage and cargo being loaded on the vehicle. That weight may not safely exceed the available cargo and luggage load capacity calculated in Step 4.

Load

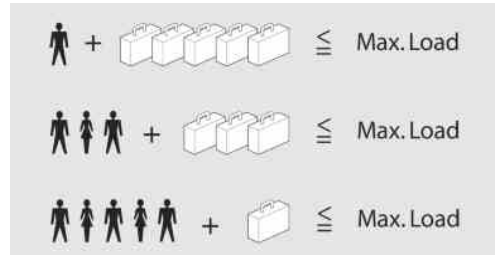

The maximum load is the sum of the weight of the occupants and the cargo.

The greater the weight of the occupants, the less cargo that can be transported.

Stowing cargo



- ▷ Heavy cargo: stow as far forward and as low as possible, ideally directly behind the cargo area separating wall.
- ▷ Very heavy cargo: when the rear seat is not occupied, secure each of the outer safety belts in the opposite buckle.
- ▷ Cover sharp edges and corners.
- ▷ If necessary, fold down the rear backrests to stow cargo.
- ▷ Do not stack cargo above the top edge of the backrests.
- ▷ Place protective material around any sharp-edged or pointed objects that could bump against the rear window while the vehicle is in motion.

Securing cargo

Lashing eyes in the cargo area

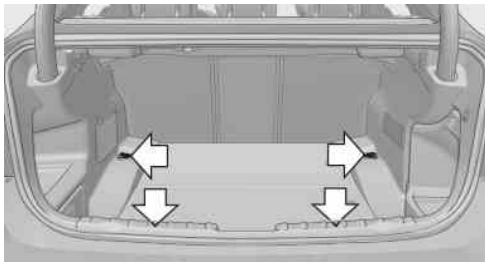

To secure the cargo there are four lashing eyes in the cargo area.

Floor net

The floor net can also be used to Secure the load and to store small parts.

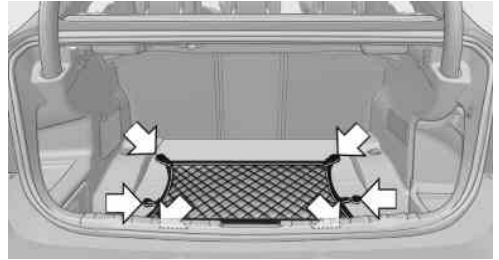

Hook the floor net into the fittings in the cargo area floor.

Securing cargo

- ▷ Smaller and lighter items: secure with retaining straps, the floor net or draw straps.
- ▷ Larger and heavy objects: secure with cargo straps.

Attach the cargo straps, retaining straps or draw straps to the lashing eyes in the cargo area.



Securing cargo

Always position and secure the cargo as described above; otherwise, it can endanger the car's occupants if sudden braking or swerving becomes necessary.

Heavy or hard objects should not be carried loose inside the car; otherwise, they could be thrown around as a result of hard braking, sudden swerves, etc., and endanger the occupants. ◀

Roof-mounted luggage rack

Note

Roof racks are available as special accessories.

Securing

Follow the installation instructions of the roof rack.

Roof drip rail with flaps



The anchorage points are located in the roof drip rail above the doors.

Fold the cover outward.

Loading

Because roof racks raise the vehicle's center of gravity when loaded, they have a major effect on vehicle handling and steering response.

Therefore, note the following when loading and driving:

- ▶ Do not exceed the approved roof/axle loads and the approved gross vehicle weight.
- ▶ Distribute the roof load uniformly.
- ▶ The roof load should not be too large in area.
- ▶ Always place the heaviest pieces on the bottom.
- ▶ Secure the roof luggage firmly, e.g., tie with ratchet straps.
- ▶ Do not let objects project into the opening path of the trunk lid.
- ▶ Drive smoothly. Avoid sudden acceleration and braking maneuvers. Take corners gently.

Saving fuel

Vehicle equipment

All standard, country-specific and optional equipment that is offered in the model series is described in this chapter. Therefore, equipment is also described that is not available in a vehicle, e. g., because of the selected optional equipment or country variant. This also applies for safety-related functions and systems.

General information

Your vehicle contains advanced technology for the reduction of fuel consumption and emissions.

Fuel consumption depends on a number of different factors.

The implementation of certain measures, driving style and regular maintenance can have an influence on fuel consumption and on the environmental impact.

Remove unnecessary cargo

Additional weight increases fuel consumption.

Remove attached parts following use

Remove auxiliary mirrors, roof or rear luggage racks which are no longer required following use.

Attached parts on the vehicle impair the aerodynamics and increase the fuel consumption.

Close the windows and glass sunroof

Driving with the glass sunroof and windows open results in increased air resistance and raises fuel consumption.

Check the tire inflation pressure regularly

Check and, if necessary, correct the tire inflation pressure at least twice a month and before starting on a long trip.

Low tire inflation pressure increases rolling resistance and thus raises fuel consumption and tire wear.

Drive away without delay

Do not wait for the engine to warm up while the vehicle remains stationary. Start driving right away, but at moderate engine speeds.

This is the fastest way for the cold engine to reach its operating temperature.

Look well ahead when driving

Avoid unnecessary acceleration and braking.

By maintaining a suitable distance to the vehicle driving ahead of you.

Driving smoothly and looking ahead reduces fuel consumption.

Avoid high engine speeds

Use 1st gear to get the vehicle in motion. Beginning with 2nd gear, accelerate rapidly. When accelerating, shift up before reaching high engine speeds.

When you reach the desired speed, shift into the highest applicable gear and drive with the engine speed as low as possible and at a constant speed.

As a rule: driving at low engine speeds lowers fuel consumption and reduces wear.

The gear shift indicator of your vehicle indicates the most fuel efficient gear.

Use coasting conditions

When approaching a red light, take your foot off the accelerator and let the vehicle coast to a halt.

On a downhill gradient, take your foot off the accelerator and let the vehicle roll.

The flow of fuel is interrupted while coasting.

Switch off the engine during longer stops

Switch off the engine during longer stops, e.g., at traffic lights, railroad crossings or in traffic congestion.

Auto Start/Stop function

The Auto Start/Stop function of your vehicle automatically switches off the engine during a stop.

If the engine is switched off and then restarted rather than leaving the engine running constantly, fuel consumption and emissions are reduced. Savings can begin within a few seconds of switching off the engine.

Using this system can cause certain components of the vehicle to become worn prematurely.

In addition, fuel consumption is also determined by other factors, such as driving style, road conditions, maintenance or environmental factors.

Switch off any functions that are not currently needed

Functions such as seat heating and the rear window defroster require a lot of energy and consume additional fuel, especially in city and stop-and-go traffic.

Therefore, switch off these functions if they are not actually needed.

Have maintenance carried out

Have vehicles maintained regularly to achieve optimal vehicle economy and operating life. Have the maintenance carried out by your service center.

Please also note the BMW Maintenance System, refer to page 193.

ECO PRO

The concept

ECO PRO supports a driving style that saves on fuel consumption. For this purpose, the engine control and comfort functions, e. g. the climate control output, are adjusted.

In addition, context-sensitive instructions can be displayed that assist in driving in a manner that optimizes fuel consumption.

The extension of the range that is achieved as a result can be displayed in the instrument cluster.

Activating ECO PRO



Press button repeatedly until ECO PRO is displayed in the instrument cluster.

Display in the instrument cluster

ECO PRO bonus range



An extension of the range can be achieved by an adjusted driving style.

This may be displayed as the bonus range in the instrument cluster.

ter.

Driving style



In the tachometer, a mark in the bar display indicates the current efficiency of the driving style corresponding to the accelerator pedal position.

- ▷ Blue display: efficient driving style as long as the mark moves within the blue range.
- ▷ Gray display: adjust driving style, e. g. by backing off the accelerator pedal.



The display switches to blue as soon as all conditions for fuel-economy-optimized driving are met.

ECO PRO Tip - driving instruction



The arrow indicates that the driving style can be adjusted to be more fuel efficient by backing off the accelerator.

Additional symbols

Symbol	Measure
	For efficient driving style, back off the accelerator or delay accelerating to allow time to assess road conditions.
	Reduce speed to the selected ECO PRO speed.

Symbol Measure



Automatic transmission: switch from S/M to D or avoid manual shift interventions.



Manual shift transmission: follow shifting instructions.



Manual shift transmission: engage neutral for engine stop.

Display in the instrument display

When ECO PRO mode is activated, the display switches to a special configuration.

Some of the displays may differ from the display in the instrument cluster.

Configuring ECO PRO

Via the Driving Experience Switch

1. Activate ECO PRO.
2. "Configure ECO PRO"
3. Configure the program.

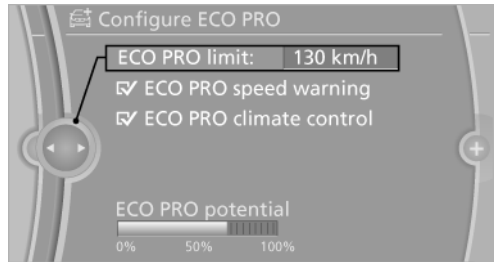

Via the iDrive

1. "Settings"
 2. "ECO PRO mode"
- Or

1. "Settings"
2. "Driving mode"
3. "Configure ECO PRO"

Configure the program.

ECO PRO Tip

- ▷ "ECO PRO limit":
Set ECO Pro speed at which an ECO PRO Tip is to be displayed.
- ▷ "ECO PRO speed warning":
A reminder is displayed if the set ECO PRO speed is exceeded.

ECO PRO climate control

"ECO PRO climate control"

The climate control is adjusted to be fuel-efficient.

By making a slight change to the set temperature, or adjusting the rate of heating or cooling of the passenger compartment fuel consumption can be economized.

The output of the seat heater is also reduced.

ECO PRO Potential

The percentage of potential savings that can be achieved with the current configuration is displayed.

Indications on the Control Display

EfficientDynamics

Information on fuel consumption and technology can be displayed during driving.

1. "Vehicle Info"
2. "EfficientDynamics"

Displaying fuel consumption history

The average fuel consumption can be displayed within an adjustable time frame.

 "Consumption history"

Adjusting fuel consumption history time frame

 Select the symbol.

Resetting fuel consumption history

1. Open "Options".
2. "Reset consumption history"

Displaying EfficientDynamics info

The current efficiency can be displayed.



 "EfficientDynamics Info"

The following systems are displayed:

- ▷ Automatic engine Start/Stop function.
- ▷ Energy recovery.
- ▷ Climate control output.

Display ECO PRO tips

 "ECO PRO Tips"

The setting is stored for the profile currently in use.





Mobility

To ensure that you remain mobile at all times, this chapter supplies you with important information on the topics of fuels and lubricants, wheels and tires, service, maintenance, and Roadside Assistance.

Refueling

Vehicle equipment

All standard, country-specific and optional equipment that is offered in the model series is described in this chapter. Therefore, equipment is also described that is not available in a vehicle, e. g., because of the selected optional equipment or country variant. This also applies for safety-related functions and systems.

General information

 Refuel promptly

Refuel no later than at a range of 30 miles/50 km, or operation of the engine is not ensured and damage may occur. ◀

Fuel cap

Opening

1. Briefly press the rear edge of the fuel filler flap.

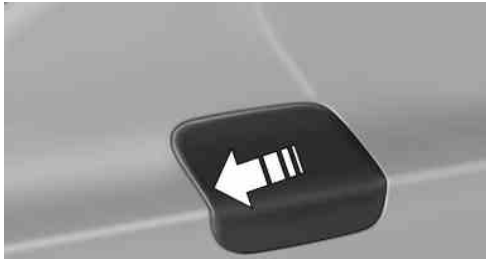

2. Turn the fuel cap counterclockwise.

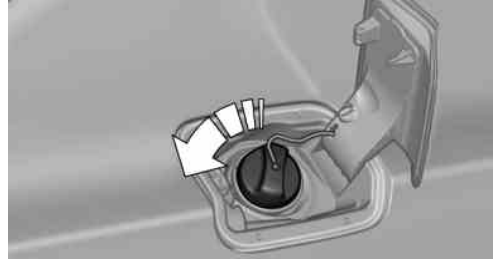

3. Place the fuel cap in the bracket attached to the fuel filler flap.

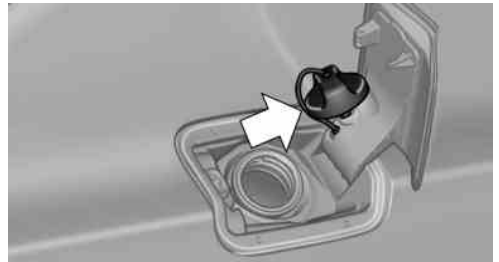

Closing

1. Fit the cap and turn it clockwise until you clearly hear a click.
2. Close the fuel filler flap.



Do not pinch the retaining strap

Do not pinch the retaining strap attached to the cap; otherwise, the cap cannot be closed properly and fuel vapors can escape.

A message is displayed if the cap is loose or missing. ◀

Manually unlocking fuel filler flap

In the event of an electrical malfunction, for example.

1. Open the cover on the right side trim. To do this, turn the cap.



2. Pull the green knob with the fuel pump symbol. This releases the fuel filler flap.

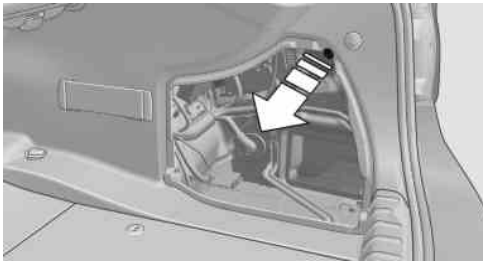

Observe the following when refueling

The fuel tank is full when the filler nozzle clicks off the first time.



Do not overfill the fuel tank

Do not overfill the fuel tank; otherwise fuel may escape, causing harm to the environment and damaging the vehicle. ◀



Handling fuels

Obey safety regulations posted at the gas station. ◀

Fuel

Vehicle equipment

All standard, country-specific and optional equipment that is offered in the model series is described in this chapter. Therefore, equipment is also described that is not available in a vehicle, e. g., because of the selected optional equipment or country variant. This also applies for safety-related functions and systems.

Fuel quality

Gasoline

For the best fuel economy, the gasoline should be sulfur-free or very low in sulfur content.

Fuels that are marked on the gas pump as containing metal must not be used.

 Refuel only with unleaded gasoline without metallic additives.

Do not refuel with any leaded gasoline or gasoline with metallic additives, e. g. manganese or iron, or permanent damage to the catalytic converter and other components.◀

Fuels with a maximum ethanol content of 10 %, i. e., E10, may be used for refueling.

Ethanol should satisfy the following quality standards:

US: ASTM 4806–xx

CAN: CGSB-3.511–xx

xx: comply with the current standard in each case.

 Do not refuel with ethanol E85

Do not refuel with E85, i.e., fuel with an ethanol content of 85 %, or with Flex Fuel, as this would damage the engine and fuel supply system.◀

The engine is knock controlled. Therefore, you can refuel with different gasoline qualities.

Recommended fuel quality

BMW recommends AKI 91.

Minimum fuel grade

BMW recommends AKI 89.

 Minimum fuel grade

Do not use any gasoline below the minimum fuel grade as this may impair engine performance.◀

If you use gasoline with this minimum AKI Rating, the engine may produce knocking sounds when starting at high outside temperatures. This has no effect on the engine life.

 Minimum fuel grade

The use of poor-quality fuels may result in harmful engine deposits or damage. Additionally, problems relating to drivability, starting and stalling, especially under certain environmental conditions such as high ambient temperature and high altitude, may occur.

If drivability problems are encountered, we recommend switching to a high quality gasoline brand and a higher octane grade — AKI number — for a few tank fills. To avoid harmful engine deposits, it is highly recommended to purchase gasoline from BP or Top Tier retailers.

Failure to comply with these recommendations may result in the need for unscheduled maintenance.◀

BMW recommends BP fuels 

Wheels and tires

Vehicle equipment

All standard, country-specific and optional equipment that is offered in the model series is described in this chapter. Therefore, equipment is also described that is not available in a vehicle, e. g., because of the selected optional equipment or country variant. This also applies for safety-related functions and systems.

Tire inflation pressure

Safety information

The tire characteristics and tire inflation pressure influence the following:

- ▷ The service life of the tires.
- ▷ Road safety.
- ▷ Driving comfort.

Checking the pressure

Only check the tire inflation pressure when the tires are cold. This means after driving no more than 1.25 miles/2 km or when the vehicle has been parked for at least 2 hours. When the tires are warm, the tire inflation pressure is higher.

 Check the tire inflation pressure regularly. Regularly check the tire inflation pressure and correct it as needed: at least twice a month and before a long trip. If you fail to observe this precaution, you may be driving on tires with incorrect tire pressures, a condition that may not only compromise your vehicle's driving stability, but also lead to tire damage and the risk of an accident. ◀

After correcting the tire inflation pressure:

- ▷ Reinitialize the Flat Tire Monitor.
- ▷ Reinitialize the Tire Pressure Monitor.

Pressure specifications

The tire inflation pressure table, refer to page 176, contains all pressure specifications for the specified tire sizes at the ambient temperature. Pressure specifications apply to approved tire sizes and recommended tire brands. This information can be obtained from your service center.

To identify the correct tire inflation pressure, please note the following:

- ▷ Tire sizes of your vehicle.
- ▷ Maximum permitted driving speed.

Tire inflation pressures up to 100 mph/160 km/h

For speeds of up to 100 mph/160 km/h and for optimum driving comfort, note the pressure values in the tire inflation pressure table, refer to page 176, and adjust as necessary.

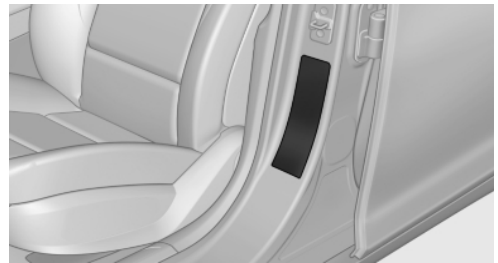

These pressure values can also be found on the tire inflation pressure label on the driver's door pillar.

 Maximum permissible speed. Do not exceed 100 mph/160 km/h; otherwise, tire damage and accidents may result. ◀

Tire inflation pressure values up to 100 mph/160 km/h

320i

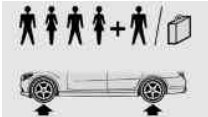
Tire size	Pressure specifications in bar/PSI	
Specifications in bar/PSI with cold tires		
225/50 R 17 94 V M +S A/S RSC	2.2 / 32	2.2 / 32
225/50 R 17 94 H M +S RSC		
225/45 R 18 91 V M +S A/S RSC	2.2 / 32	2.4 / 35
225/45 R 18 91 Y RSC		
225/45 R 18 95 V M +S XL RSC		
Front: 225/45 R 18 91 Y RSC	2.2 / 32	-
Rear: 255/40 R 18 95 Y RSC	-	2.2 / 32
Front: 225/40 R 19 89 Y RSC	2.2 / 32	-
Rear: 255/35 R 19 92 Y RSC	-	2.4 / 35
Front: 225/35 R 20 90 Y XL RSC	2.5 / 36	-
Rear: 255/30 R 20 92 Y XL RSC	-	3.0 / 44
Compact wheel T 135/80 R 17 103 M	Speed up to a max. of 50 mph / 80 km/h	
	4.2 / 60	

328i, 328i xDrive

Tire size	Pressure specifications in bar/PSI	
Specifications in bar/PSI with cold tires		
225/50 R 17 94 V M +S A/S RSC	2.2 / 32	2.2 / 32
225/50 R 17 94 H M +S RSC		
225/45 R 18 91 V M +S A/S RSC	2.2 / 32	2.4 / 35
225/45 R 18 91 Y RSC		
225/45 R 18 95 V M +S XL RSC		
Front: 225/45 R 18 91 Y RSC	2.2 / 32	-
Rear: 255/40 R 18 95 Y RSC	-	2.2 / 32
Front: 225/40 R 19 89 Y RSC	2.2 / 32	-
Rear: 255/35 R 19 92 Y RSC	-	2.4 / 35
Front: 225/35 R 20 90 Y XL RSC	2.5 / 36	-
Rear: 255/30 R 20 92 Y XL RSC	-	3.0 / 44
Compact wheel T 135/80 R 17 103 M	Speed up to a max. of 50 mph / 80 km/h	
	4.2 / 60	

335i, 335i xDrive

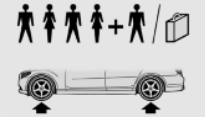
Tire size	Pressure specifications in bar/PSI	
Specifications in bar/PSI with cold tires		
225/45 R 18 91 V M +S A/S RSC	2.2 / 32	2.6 / 38
225/45 R 18 91 Y RSC		
225/50 R 17 94 H M +S RSC		
225/45 R 18 95 V M +S XL RSC		
Front: 225/45 R 18 91 Y RSC	2.2 / 32	-
	-	2.4 / 35
Rear: 255/40 R 18 95 Y RSC		
Front: 225/40 R 19 89 Y RSC	2.4 / 35	-
	-	2.6 / 38
Rear: 255/35 R 19 92 Y RSC		
Front: 225/35 R 20 90 Y XL RSC	2.6 / 38	-
	-	3.0 / 44
Rear: 255/30 R 20 92 Y XL RSC		
Compact wheel T 135/80 R 17 103 M	Speed up to a max. of 50 mph / 80 km/h	4.2 / 60

Tire inflation pressures at max. speeds above 100 mph/160 km/h

 Speeds above 100 mph/160 km/h
In order to drive at maximum speeds in excess of 100 mph/160 km/h, please observe, and, if necessary, adjust tire pressures for speeds

exceeding 100 mph/160 km/h from the relevant table on the following pages. Otherwise tire damage and accidents could occur. ◀

Tire inflation pressure values over 100 mph/160 km/h

320i

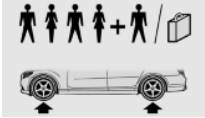
Tire size	Pressure specifications in bar/PSI	
Specifications in bar/PSI with cold tires		
225/50 R 17 94 V M +S A/S RSC	2.2 / 32	2.7 / 39
225/50 R 17 94 H M +S RSC		
225/45 R 18 91 V M +S A/S RSC	2.4 / 35	2.9 / 42
225/45 R 18 91 Y RSC		
225/45 R 18 95 V M +S XL RSC		
Front: 225/45 R 18 91 Y RSC	2.4 / 35	-
	-	2.4 / 35
Rear: 255/40 R 18 95 Y RSC		
Front: 225/40 R 19 89 Y RSC	2.4 / 35	-
	-	2.6 / 38
Rear: 255/35 R 19 92 Y RSC		

Tire size	Pressure specifications in bar/PSI	
Front: 225/35 R 20 90 Y XL RSC	2.5 / 36	- 3.0 / 44
Rear: 255/30 R 20 92 Y XL RSC		
Compact wheel T 135/80 R 17 103 M	Speed up to a max. of 50 mph / 80 km/h 4.2 / 60	

Tire size	Pressure specifications in bar/PSI	
Front: 225/35 R 20 90 Y XL RSC	2.7 / 39	- 3.2 / 46
Rear: 255/30 R 20 92 Y XL RSC		
Compact wheel T 135/80 R 17 103 M	Speed up to a max. of 50 mph / 80 km/h 4.2 / 60	

328i

Without high-speed tuning feature

Tire size	Pressure specifications in bar/PSI	
Specifications in bar/PSI with cold tires		
225/50 R 17 94 V M +S A/S RSC	2.4 / 35	2.9 / 42
225/50 R 17 94 H M +S RSC		
225/45 R 18 91 V M +S A/S RSC	2.6 / 38	3.1 / 45
225/45 R 18 91 Y RSC		
225/45 R 18 95 V M +S XL RSC		
Front: 225/45 R 18 91 Y RSC	2.6 / 38	- 2.6 / 38
Rear: 255/40 R 18 95 Y RSC		
Front: 225/40 R 19 89 Y RSC	2.6 / 38	- 2.8 / 41
Rear: 255/35 R 19 92 Y RSC		

With high-speed tuning feature

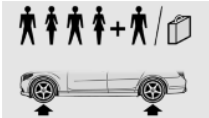
Tire size	Pressure specifications in bar/PSI	
Specifications in bar/PSI with cold tires		
225/50 R 17 94 H M+S RSC	2.4 / 35	2.9 / 42
225/45 R 18 91 Y RSC	2.6 / 38	3.1 / 45
225/45 R 18 95 V M+S XL RSC		
Front: 225/45 R 18 91 Y RSC	2.6 / 38	- 2.6 / 38
Rear: 255/40 R 18 95 Y RSC		
Front: 225/40 R 19 89 Y RSC	2.6 / 38	- 2.8 / 41
Rear: 255/35 R 19 92 Y RSC		

Tire size	Pressure specifications in bar/PSI	
Front: 225/35 R 20 90 Y XL RSC	2.7 / 39	- 3.2 / 46
Rear: 255/30 R 20 92 Y XL RSC		
Compact wheel T 135/80 R 17 103 M	Speed up to a max. of 50 mph / 80 km/h 4.2 / 60	

328i xDrive

Without high-speed tuning feature

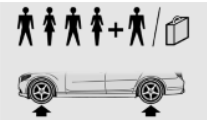
Tire size	Pressure specifications in bar/PSI	
Specifications in bar/PSI with cold tires		
225/50 R 17 94 V M +S A/S RSC	2.4 / 35	2.9 / 42
225/50 R 17 94 H M +S RSC		
225/45 R 18 91 V M +S A/S RSC	2.6 / 38	3.1 / 45
225/45 R 18 91 Y RSC		
225/45 R 18 95 V M +S XL RSC		
Front: 225/45 R 18 91 Y RSC	2.6 / 38	- 2.6 / 38
Rear: 255/40 R 18 95 Y RSC		
Front: 225/40 R 19 89 Y RSC	2.6 / 38	- 2.8 / 41
Rear: 255/35 R 19 92 Y RSC		

Tire size	Pressure specifications in bar/PSI	
Front: 225/35 R 20 90 Y XL RSC	2.7 / 39	- 3.2 / 46
Rear: 255/30 R 20 92 Y XL RSC		
Compact wheel T 135/80 R 17 103 M	Speed up to a max. of 50 mph / 80 km/h 4.2 / 60	

With high-speed tuning feature

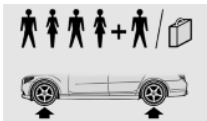
Tire size	Pressure specifications in bar/PSI	
Specifications in bar/PSI with cold tires		
225/50 R 17 94 H M +S RSC	2.4 / 35	2.9 / 42
225/45 R 18 91 Y RSC	2.6 / 38	3.1 / 45
225/45 R 18 95 V M +S XL RSC		
Front: 225/45 R 18 91 Y RSC	2.6 / 38	- 2.6 / 38
Rear: 255/40 R 18 95 Y RSC		
Front: 225/40 R 19 89 Y RSC	2.6 / 38	- 2.8 / 41
Rear: 255/35 R 19 92 Y RSC		

Tire size	Pressure specifications in bar/PSI	
Front: 225/35 R 20 90 Y XL RSC	2.7 / 39	- 3.2 / 46
Rear: 255/30 R 20 92 Y XL RSC		
Compact wheel T 135/80 R 17 103 M	Speed up to a max. of 50 mph / 80 km/h 4.2 / 60	

Tire size	Pressure specifications in bar/PSI	
Front: 225/35 R 20 90 Y XL RSC	2.9 / 42	- 3.4 / 49
Rear: 255/30 R 20 92 Y XL RSC		
Compact wheel T 135/80 R 17 103 M	Speed up to a max. of 50 mph / 80 km/h 4.2 / 60	

335i

Without high-speed tuning feature

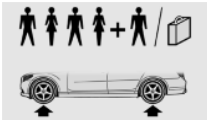
Tire size	Pressure specifications in bar/PSI	
Specifications in bar/PSI with cold tires		
225/45 R 18 91 V M +S A/S RSC	2.7 / 39	3.2 / 46
225/45 R 18 91 Y RSC		
225/50 R 17 94 HM +S RSC		
225/45 R 18 95 V M +S XL RSC		
Front: 225/45 R 18 91 Y RSC	2.7 / 39	- 2.8 / 41
Rear: 255/40 R 18 95 Y RSC		
Front: 225/40 R 19 89 Y RSC	2.7 / 39	- 3.0 / 44
Rear: 255/35 R 19 92 Y RSC		

With high-speed tuning feature

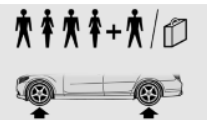
Tire size	Pressure specifications in bar/PSI	
Specifications in bar/PSI with cold tires		
225/45 R 18 91 Y RSC	2.7 / 39	3.2 / 46
225/50 R 17 94 HM +S RSC		
225/45 R 18 95 V M +S XL RSC		
Front: 225/45 R 18 91 Y RSC	2.7 / 39	- 2.8 / 41
Rear: 255/40 R 18 95 Y RSC		
Front: 225/40 R 19 89 Y RSC	2.7 / 39	- 3.0 / 44
Rear: 255/35 R 19 92 Y RSC		

Tire size	Pressure specifications in bar/PSI	
Front: 225/35 R 20 90 Y XL RSC	2.9 / 42	- 3.4 / 49
Rear: 255/30 R 20 92 Y XL RSC		
Compact wheel T 135/80 R 17 103 M	Speed up to a max. of 50 mph / 80 km/h 4.2 / 60	

335i xDrive

Without high-speed tuning feature

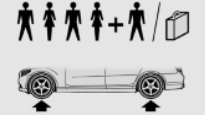
Tire size	Pressure specifications in bar/PSI	
Specifications in bar/PSI with cold tires		
225/45 R 18 91 V M +S A/S RSC	2.7 / 39	3.2 / 46
225/45 R 18 91 Y RSC		
225/50 R 17 94 H M +S RSC		
225/45 R 18 95 V M +S XL RSC		
Front: 225/45 R 18 91 Y RSC	2.7 / 39	- 2.8 / 41
Rear: 255/40 R 18 95 Y RSC		
Front: 225/40 R 19 89 Y RSC	2.7 / 39	- 3.0 / 44
Rear: 255/35 R 19 92 Y RSC		

Tire size	Pressure specifications in bar/PSI	
Front: 225/35 R 20 90 Y XL RSC	2.9 / 42	- 3.4 / 49
Rear: 255/30 R 20 92 Y XL RSC		
Compact wheel T 135/80 R 17 103 M	Speed up to a max. of 50 mph / 80 km/h 4.2 / 60	

With high-speed tuning feature

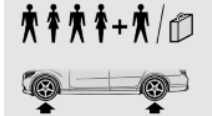
Tire size	Pressure specifications in bar/PSI	
Specifications in bar/PSI with cold tires		
225/45 R 18 91 Y RSC	2.7 / 39	3.2 / 46
225/50 R 17 94 H M +S RSC		
225/45 R 18 95 V M +S XL RSC		
Front: 225/45 R 18 91 Y RSC	2.7 / 39	- 2.8 / 41
Rear: 255/40 R 18 95 Y RSC		
Front: 225/40 R 19 89 Y RSC	2.7 / 39	- 3.0 / 44
Rear: 255/35 R 19 92 Y RSC		

Tire size	Pressure specifications in bar/PSI	
Front: 225/35 R 20 90 Y XL RSC	2.9 / 42	-
Rear: 255/30 R 20 92 Y XL RSC	-	3.4 / 49
Compact wheel T 135/80 R 17 103 M	Speed up to a max. of 50 mph / 80 km/h 4.2 / 60	

Tire identification marks

Tire size

245/45 R 18 96 Y

245: nominal width in mm

45: aspect ratio in %

R: radial tire code

18: rim diameter in inches

96: load rating, not for ZR tires

Y: speed rating, before the R on ZR tires

Speed letter

T = up to 118 mph, 190 km/h

H = up to 131 mph, 210 km/h

V = up to 150 mph, 240 km/h

W = up to 167 mph, 270 km/h

Y = up to 186 mph, 300 km/h

Tire Identification Number

DOT code: DOT xxxx xxx 3510

xxxx: manufacturer code for the tire brand

xxx: tire size and tire design

3510: tire age

Tires with DOT codes meet the guidelines of the U.S. Department of Transportation.

Tire age

DOT ... 3510: the tire was manufactured in the 35th week in 2010.

Recommendation

Regardless of wear, replace tires at least every 6 years.

Uniform Tire Quality Grading

Quality grades can be found where applicable on the tire sidewall between tread shoulder and maximum section width.

For example: Treadwear 200; Traction AA; Temperature A

DOT Quality Grades

Treadwear

Traction AA A B C

Temperature A B C

All passenger car tires must conform to Federal Safety Requirements in addition to these grades.

Treadwear

The treadwear grade is a comparative rating based on the wear rate of the tire when tested under controlled conditions on a specified government test course. For example, a tire graded 150 would wear one and one-half, 1 g, times as well on the government course as a tire graded 100. The relative performance of tires depends upon the actual conditions of their use, however, and may depart significantly from the norm due to variations in driving habits, service practices and differences in road characteristics and climate.

Traction

The traction grades, from highest to lowest, are AA, A, B, and C.

Those grades represent the tire's ability to stop on wet pavement as measured under controlled conditions on specified government test surfa-

ces of asphalt and concrete. A tire marked C may have poor traction performance.

The traction grade assigned to this tire is based on straight-ahead braking traction tests, and does not include acceleration, cornering, hydroplaning, or peak traction characteristics.

Temperature

The temperature grades are A, the highest, B, and C, representing the tire's resistance to the generation of heat and its ability to dissipate heat when tested under controlled conditions on a specified indoor laboratory test wheel. Sustained high temperature can cause the material of the tire to degenerate and reduce tire life, and excessive temperature can lead to sudden tire failure. The grade C corresponds to a level of performance which all passenger car tires must meet under the Federal Motor Vehicle Safety Standard No. 109. Grades Band A represent higher levels of performance on the laboratory test wheel than the minimum required by law.



Temperature grade for this tire

The temperature grade for this tire is established for a tire that is properly inflated and not overloaded. Excessive speed, underinflation, or excessive loading, either separately or in combination, can cause heat buildup and possible tire failure.

If necessary, have the vehicle towed. ◀

RSC – Run-flat tires

Run-flat tires, refer to page 185, are labeled with a circular symbol containing the letters RSC marked on the sidewall.

M+S

Winter and all-season tires with better cold weather performance than summer tires.

Tire tread

Summer tires

Do not drive with a tire tread depth of less than 0.12 in/3 mm.

There is an increased danger of hydroplaning if the tread depth is less than 0.12 in/3 mm.

Winter tires

Do not drive with a tire tread depth of less than 0.16 in/4 mm.

Below a tread depth of 0.16 in/4 mm, tires are less suitable for winter operation.

Minimum tread depth

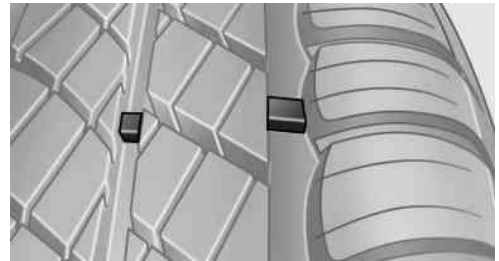

Wear indicators are distributed around the tire's circumference and have the legally required minimum height of 0.063 in/1.6 mm.

They are marked on the side of the tire with TWI, Tread Wear Indicator.

Tire damage

General information

Inspect your tires often for damage, foreign objects lodged in the tread, and tread wear.

Notes

Driving over rough or damaged road surfaces, as well as debris, curbs and other obstacles can cause serious damage to wheels, tires and suspension parts. This is more likely to occur with low-profile tires, which provide less cushioning

between the wheel and the road. Be careful to avoid road hazards and reduce your speed, especially if your vehicle is equipped with low-profile tires.

Indications of tire damage or other vehicle defects:

- ▷ Unusual vibrations during driving.
- ▷ Unusual handling such as a strong tendency to pull to the left or right.

Damage can, e. g., be caused by driving over curbs, road damage, or similar things.

In case of tire damage

If there are indications of tire damage, reduce your speed immediately and have the wheels and tires checked right away; otherwise, there is the increased risk of an accident.

Drive carefully to the next service center or tire shop.

If necessary, have the vehicle towed.

Otherwise, tire damage can be life-threatening for vehicle occupants and other traffic participants. ◀

Repair of tire damage

For safety reasons, the manufacturer of your vehicle recommends that you do not have damaged tires repaired; they should be replaced. Otherwise, damage can occur as a result. ◀

Changing wheels and tires

Mounting

Information on mounting tires

Have mounting and balancing performed only by a service center or tire specialist.

If this work is not carried out properly, there is the danger of subsequent damage and related safety hazards. ◀

Wheel and tire combination

Information on the correct wheel-tire combination and rim versions for your vehicle can be obtained from your service center.

Incorrect wheel and tire combinations impair the function of a variety of systems such as ABS or DSC.

To maintain good handling and vehicle response, use only tires with a single tread configuration from a single manufacturer.

Following tire damage, have the original wheel and tire combination remounted on the vehicle as soon as possible.

Approved wheels and tires

The manufacturer of your vehicle recommends that you use only wheels and tires that have been approved for your particular vehicle model.

For example, despite having the same official size ratings, variations can lead to body contact and with it, the risk of severe accidents.

The manufacturer of your vehicle cannot evaluate non-approved wheels and tires to determine if they are suited for use, and therefore cannot ensure the operating safety of the vehicle if they are mounted. ◀

Recommended tire brands



For each tire size, the manufacturer of your vehicle recommends certain tire brands. These can be identified by a star on the tire sidewall.

With proper use, these tires meet the highest standards for safety and handling.

New tires

Due to technical factors associated with their manufacture, tires do not achieve their full traction potential until after an initial breaking-in period.

Drive conservatively for the first 200 miles/300 km.

Retreaded tires

The manufacturer of your vehicle does not recommend the use of retreaded tires.



Retreaded tires

Possibly substantial variations in the design and age of the tire casing structures can limit service life and have a negative impact on road safety. ◀

Winter tires

The manufacturer of your vehicle recommends winter tires for winter roads or at temperatures below +45 °F/+7 °C.

Although so-called all-season M+S tires do provide better winter traction than summer tires, they do not provide the same level of performance as winter tires.

Maximum speed of winter tires

If the maximum speed of the vehicle is higher than the permissible speed for the winter tires, then display a corresponding sign in the field of vision. You can obtain this sign from the tire specialist or from your service center.



Maximum speed for winter tires

Do not exceed the maximum speed for the winter tires; otherwise, tire damage and accidents can occur. ◀

Run-flat tires

If you are already using run-flat tires, for your own safety you should replace them only with the same kind. No spare tire is available in the

case of a flat tire. Your service center will be glad to advise you.

Rotating wheels between axles

The manufacturer of your vehicle advises against swapping wheels between the front and rear axles.

This can impair the handling characteristics.

Storage

Store wheels and tires in a cool, dry place with as little exposure to light as possible.

Always protect tires against all contact with oil, grease and fuels.

Do not exceed the maximum tire inflation pressure indicated on the side wall of the tire.

Run-flat tires

Label



RSC label on the tire sidewall.

The wheels are composed of special rims and tires that are self-supporting, to a limited degree.

The support of the sidewall allows the tire to remain drivable to a restricted degree in the event of a pressure loss.

Continued driving with a damaged tire, refer to page 100.

Continued driving with a damaged tire, refer to page 97.

Changing run-flat tires

For your own safety, only use run-flat tires. No spare tire is available in the case of a flat tire. Your service center will be glad to advise you.

Snow chains

Fine-link snow chains

Only certain types of fine-link snow chains have been tested by the manufacturer of your vehicle, classified as road-safe and recommended.

Consult your service center for more information.

Use

Use only in pairs on the rear wheels, equipped with the tires of the following size:

- ▷ 205/60 R 16.
- ▷ 225/55 R 16.
- ▷ 225/50 R 17.
- ▷ 225/45 R 18.

Follow the chain manufacturer's instructions.

Make sure that the snow chains are always sufficiently tight. Retighten as needed according to the chain manufacturer's instructions.

Do not initialize the Flat Tire Monitor after mounting snow chains, as doing so may result in incorrect readings.

Do not initialize the Tire Pressure Monitor after mounting snow chains, as doing so may result in incorrect readings.

When driving with snow chains, briefly activate Dynamic Traction Control if necessary.

Maximum speed with snow chains

Do not exceed a speed of 30 mph/50 km/h when using snow chains.

Engine compartment

Vehicle equipment

All standard, country-specific and optional equipment that is offered in the model series is described in this chapter. Therefore, equipment

is also described that is not available in a vehicle, e. g., because of the selected optional equipment or country variant. This also applies for safety-related functions and systems.

Important features in the engine compartment

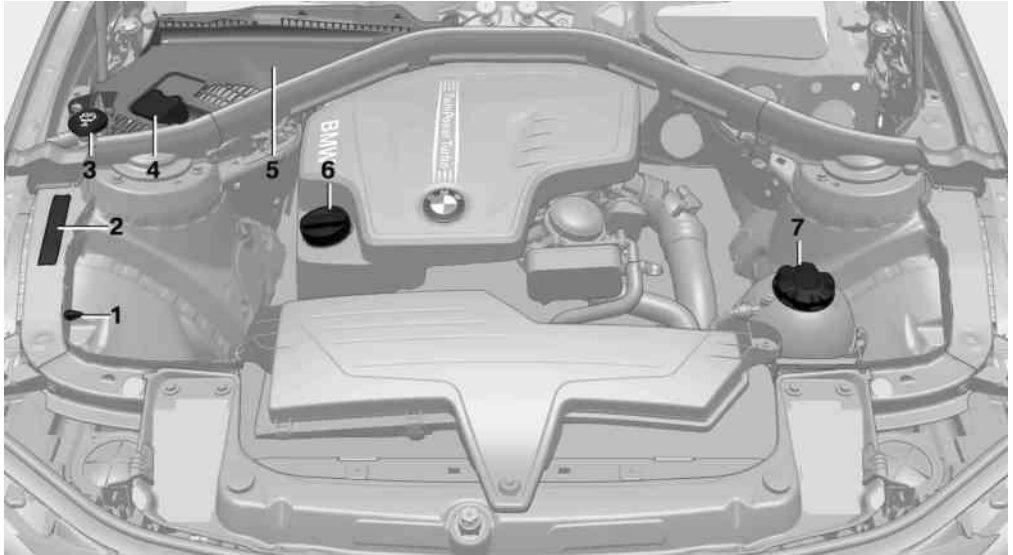

- 1 Jump-starting, negative terminal
- 2 Vehicle identification number
- 3 Washer fluid reservoir
- 4 Jump-starting, positive terminal
- 5 Engine compartment fuse box

- 6 Oil filler neck
- 7 Coolant reservoir

The coolant reservoir for 6-cylinder and diesel engines is located on the opposite side of the engine compartment.

Hood

Notes

 Working in the engine compartment
Never attempt to perform any service or repair operations on your vehicle without the necessary professional technical training.

If you are unfamiliar with the statutory guidelines, have any work on the vehicle performed only by a service center.

If this work is not carried out properly, there is the danger of subsequent damage and related safety hazards. ◀

 Never reach into the engine compartment
Never reach into the intermediate spaces or gaps in the engine compartment. Otherwise, there is risk of injury, e.g. from rotating or hot parts. ◀

 Fold down wiper arm
Before opening the hood, ensure that the wiper arms are against the windshield, or this may result in damage. ◀

Opening the hood

1. Pull lever in the interior:
Engine is released, arrow 1.



2. After the lever is released, pull the lever again:
Hood can be opened, arrow 2.

Indicator/warning lamps

When the hood is opened, a Check Control message is displayed.

Closing the hood

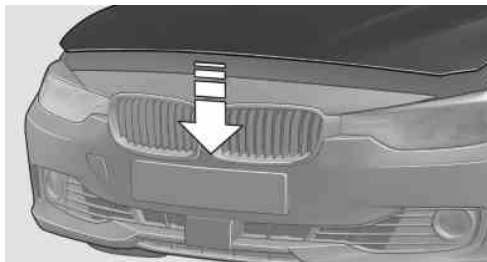

Let the hood drop from a height of approx. 16 in/40 cm and push down on it to lock it fully.
The hood must audibly engage on both sides.

 Hood open when driving
If you see any signs that the hood is not completely closed while driving, pull over immediately and close it securely. ◀

 Danger of pinching
Make sure that the closing path of the hood is clear; otherwise, injuries may result. ◀

Engine oil

Vehicle equipment

All standard, country-specific and optional equipment that is offered in the model series is described in this chapter. Therefore, equipment is also described that is not available in a vehicle, e. g., because of the selected optional equipment or country variant. This also applies for safety-related functions and systems.

General information

Engine oil consumption depends on driving style and driving conditions, e.g., if your driving style is very sporty engine oil consumption will be considerably greater.

Therefore, regularly check the engine oil level after refueling.

Checking the oil level electronically

Status display

The concept

The oil level is monitored electronically during driving and shown on the Control Display.

If the oil level reaches the minimum level, a check control message is displayed.

Requirements

Depending on the previous displays, the status display appears when the engine is running or after the vehicle has been driven for at least 30 minutes.

Displaying the oil level

1. "Vehicle Info"
2. "Vehicle status"

3.  "Engine oil level"

Oil level display messages

Different messages appear on the display depending on the oil level. Pay attention to these messages.

If oil level is too low, immediately add 1 US quart/liter of oil.

Take care not to add too much engine oil.



Too much engine oil

Have the vehicle checked immediately; otherwise, surplus oil can lead to engine damage. ◀

Detailed measurement

The concept

In the detailed measurement the oil level is checked and displayed via a scale.

During the measurement, the idle speed is increased somewhat.

General information

A detailed measurement is only possible with certain engines.

Requirements

- ▶ Manual transmission: shift lever in neutral position, clutch and accelerator pedals not depressed.
- ▶ Automatic transmission: selector lever in transmission position N or P and accelerator not depressed.
- ▶ Vehicle is on a level road and the engine is running at operating temperature.

Performing a detailed measurement

In order to perform a detailed measurement of the engine oil level:

1. "Vehicle Info"
2. "Vehicle status"
3.  "Measure engine oil level"
4. "Start measurement"

The oil level is checked and displayed via a scale.

Duration: approx. 1 minute.

Adding engine oil

Filler neck



When the indicator lights up in the instrument cluster, add 1 US quart/liter of engine oil within the next 125 miles/200 km.

 Do not add too much engine oil
When too much engine oil is added, immediately have the vehicle checked, otherwise, this may cause engine damage. ◀

 Protect children
Keep oil, grease, etc., out of reach of children and heed the warnings on the containers to prevent health risks. ◀

Oil types for refilling

Notes

 No oil additives
Oil additives may lead to engine damage. ◀

 Viscosity grades for engine oils
When selecting an engine oil, ensure that the engine oil belongs to one of the viscosity grades SAE 0W-40, SAE 0W-30, SAE 5W-40, and SAE 5W-30 or malfunctions or engine damage may occur. ◀

The engine oil quality is critical for the life of the engine.

Some types of oils in some cases are not available in all countries.

Approved oil types

Gasoline engine

BMW High Performance SAE 5W-30

BMW Longlife-01

BMW Longlife-01 FE

Additional information about the approved types of oils can be requested from the service center.

Alternative oil types

If the approved engine oils are not available, up to 1 US quart/liter of an oil with the following specification can be added:

Gasoline engine

API SM or superior grade specification

Oil change

An oil change should be carried out by your service center only.

BMW recommends 

Coolant

Vehicle equipment

All standard, country-specific and optional equipment that is offered in the model series is described in this chapter. Therefore, equipment is also described that is not available in a vehicle, e. g., because of the selected optional equipment or country variant. This also applies for safety-related functions and systems.

General information

 **Danger of burns from hot engine**
Do not open the cooling system while the engine is hot; otherwise, escaping coolant may cause burns. ◀

 **Suitable additives**
Only use suitable additives; otherwise, engine damage may occur. The additives are harmful to your health. ◀

Coolant consists of water and additives.

Not all commercially available additives are suitable for your vehicle. Ask your service center for suitable additives.

Coolant level

Checking

1. Let the engine cool.
2. The coolant level is correct if it lies between the minimum and maximum marks. The marks are on the side of the coolant reservoir.

Adding engine oil

1. Let the engine cool.
2. Turn the cap of the coolant reservoir slightly counterclockwise to allow any excess pressure to dissipate, and then open it.



3. If the coolant is low, slowly add coolant up to the specified level; do not overfill.
4. Turn the cap until there is an audible click.
5. Have the cause of the coolant loss eliminated as soon as possible.

Disposal



Comply with the relevant environmental protection regulations when disposing of coolant and coolant additives.

Maintenance

Vehicle equipment

All standard, country-specific and optional equipment that is offered in the model series is described in this chapter. Therefore, equipment is also described that is not available in a vehicle, e. g., because of the selected optional equipment or country variant. This also applies for safety-related functions and systems.

BMW Maintenance System

The maintenance system directs you to required maintenance measures and thereby supports you in maintaining road safety and the operational reliability of the vehicle.

Condition Based Service CBS

Sensors and special algorithms take into account the driving conditions of your vehicle. Based on this, Condition Based Service determines the maintenance requirements.

The system makes it possible to adapt the amount of maintenance you need to your user profile.

Detailed information on service requirements, refer to page 77, can be displayed on the Control Display.

Service data in the remote control

Information on the required maintenance is continuously stored in the remote control. Your service center will read out this data and suggest the right array of service procedures for your vehicle.

Therefore, hand your service specialist the remote control that you used most recently.

Storage periods

Storage periods during which the vehicle battery was disconnected are not taken into account.

If this occurs, have a service center update the time-dependent maintenance procedures, such as checking brake fluid and, if necessary, changing the engine oil and the microfilter/activated-charcoal filter.

Service history

Perform maintenance work at the service center and have them recorded in the vehicle data. The entries are like a service booklet of the documentation of regular maintenance.

Displaying entered maintenance work on the Control Display, refer to page 78.

Service and Warranty Information Booklet for US models and Warranty and Service Guide Booklet for Canadian models

Please consult your Service and Warranty Information Booklet for US models and Warranty and Service Guide Booklet for Canadian models for additional information on service requirements.

Maintenance and repair should be performed by your service center. Make sure to have regular maintenance procedures recorded in the vehicle's Service and Warranty Information Booklet for US models, and in the Warranty and Service Guide Booklet for Canadian models. These entries are proof of regular maintenance.

Socket for OBD Onboard Diagnosis

Position

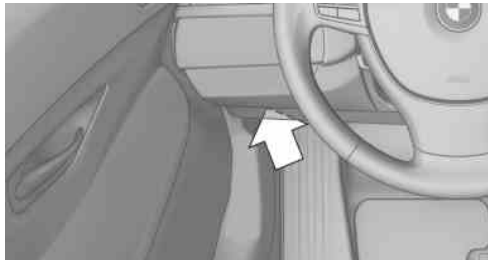

There is an OBD socket on the driver's side for checking the primary components in the vehicle emissions.

Emissions



- ▷ The warning lamp lights up: Emissions are deteriorating. Have the vehicle checked as soon as possible.



Canadian model: warning light indicates the engine symbol.

- ▷ The warning lamp flashes under certain circumstances:

This indicates that there is excessive misfiring in the engine.

Reduce the vehicle speed and have the system checked immediately; otherwise, serious engine misfiring within a brief period can seriously damage emission control components, in particular the catalytic converter.

Fuel cap



The indicator lamp lights up.

If the fuel cap is not properly tightened, the OBD system may conclude that fuel vapor is escaping. If the cap is then tightened, the display should go out in a short time.

Data memory

Your vehicle records data relating to vehicle operation, faults and user settings. These data are stored in the remote control and can be read out with suitable devices, particularly when the vehicle is serviced. The data obtained in this way provide valuable information for service processes and repair or for optimizing and developing vehicle functions further.

In addition, if you signed a service contract for BMW Assist, certain vehicle data can be sent directly from the vehicle to facilitate the desired services.

Event Data Recorder EDR

This vehicle is equipped with an event data recorder EDR. The main purpose of an EDR is to record, in certain crash or near crash-like situations, such as an air bag deployment or hitting a road obstacle, data that will assist in understanding how a vehicle's systems performed. The EDR is designed to record data related to vehicle dynamics and safety systems for a short period of time, typically 30 seconds or less.

The EDR in this vehicle is designed to record such data as:

- ▷ How various systems in your vehicle were operating.
- ▷ Whether or not the driver and passenger safety belts were fastened.
- ▷ How far, if at all, the driver was depressing the accelerator and/or brake pedal.
- ▷ How fast the vehicle was traveling.

These data can help provide a better understanding of the circumstances in which crashes and injuries occur.

EDR data are recorded by your vehicle only if a nontrivial crash situation occurs; no data are recorded by the EDR under normal driving conditions and no personal data, e.g., name, gender, age, and crash location, are recorded.

However, other parties, such as law enforcement, could combine the EDR data with the type of personally identifying data routinely acquired during a crash investigation.

To read data recorded by an EDR, special equipment is required, and access to the vehicle or the EDR is needed. In addition to the vehicle manufacturer, other parties, such as law enforcement, that have the special equipment, can read the information if they have access to the vehicle or the EDR.

Replacing components

Vehicle equipment

All standard, country-specific and optional equipment that is offered in the model series is described in this chapter. Therefore, equipment is also described that is not available in a vehicle, e. g., because of the selected optional equipment or country variant. This also applies for safety-related functions and systems.

Onboard vehicle tool kit



The onboard vehicle tool kit is located on the right side in the cargo area in a storage compartment. Open the cover.

Wiper blade replacement

General information

 Do not fold down the wipers without wiper blades

Do not fold down the wipers if wiper blades have not been installed; this may damage the windshield. ◀

Replacing the wiper blades

1. To change the wiper blades, fold up, refer to page 66, the wiper arms.
2. Fold up and hold the wiper arm firmly.

3. Squeeze the retainer spring, arrow 1, and fold up the wiper blade, arrow 2.

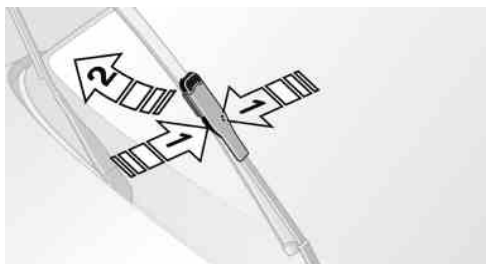

4. Remove the wiper blade forward from the catch.
5. Insert the new wiper blade in reverse order of removal until it locks in place.

 Risk of damage

Before opening the hood, ensure that the wiper arms with the wiper blades are against the windshield to prevent damage. ◀

Lamp and bulb replacement

Notes

Lamps and bulbs

Lamps and bulbs make an essential contribution to vehicle safety.

The manufacturer of the vehicle recommends that you entrust corresponding procedures to the service center if you are unfamiliar with them or they are not described here.

You can obtain a selection of replacement bulbs at the service center.

 Danger of burns

Only change bulbs when they are cool; otherwise, there is the danger of getting burned. ◀

Working on the lighting system

When working on the lighting system, you should always switch off the lights affected to prevent short circuits.

To avoid possible injury or equipment damage when replacing bulbs, observe any instructions provided by the bulb manufacturer. ◀

Do not perform work/bulb replacement on xenon headlamps

Have any work on the xenon lighting system, including bulb replacement, performed only by a service center. Due to the high voltage present in the system, there is the danger of fatal injuries if work is carried out improperly. ◀

Do not touch the bulbs

Do not touch the glass of new bulbs with your bare hands, as even minute amounts of contamination will burn into the bulb's surface and reduce its service life.

Use a clean tissue, cloth or something similar, or hold the bulb by its base. ◀

Light-emitting diodes (LEDs)

Light-emitting diodes installed behind a cover serve as the light source for controls, display elements and other equipment.

These light-emitting diodes, which are related to conventional lasers, are officially designated as Class 1 light-emitting diodes.

Do not remove the covers

Do not remove the covers, and never stare into the unfiltered light for several hours; otherwise, irritation of the retina could result. ◀

Headlamp glass

Condensation can form on the inside of the external lamps in cool or humid weather. When driving with the light switched on, the condensation evaporates after a short time. The headlamp glasses do not need to be changed.

If the headlamps do not dim despite driving with the light switched on, increasing humidity forms, e. g. water droplets in the light, have the service center check this.

Front lamps, bulb replacement

Halogen headlamps

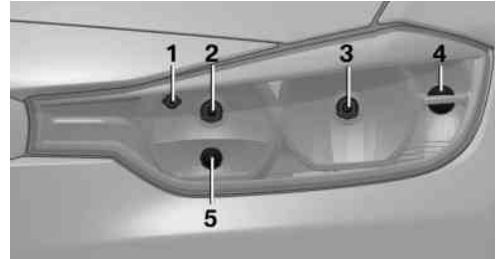

- 1 Parking lamps
- 2 High beams/headlamp flasher
- 3 Low beams
- 4 Turn signal
- 5 Daytime running lights

Accessing the turn signals and low beams

Follow the general instructions on lamps and bulbs, refer to page 196.

1. In the wheel house, loosen the two brackets and remove the cover.

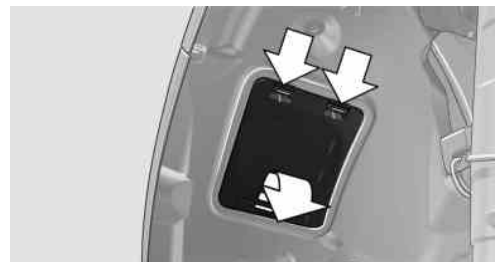

Turn signal

21-watt bulb, PY21W

1. If necessary, pull the inside trim of the wheel house slightly inward. Turn the bulb holder counterclockwise and remove.



2. Press the bulb gently into the socket, turn counterclockwise and remove.
3. Install the new bulb and bulb holder in reverse order of removal.
4. Attach the cover to the wheel house.

Low beams

55-watt bulb, H7

1. Turn the cap counterclockwise and remove.

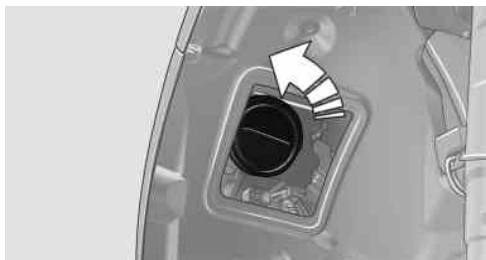

2. Tilt the bulb down and then up to loosen it from the holder and remove.

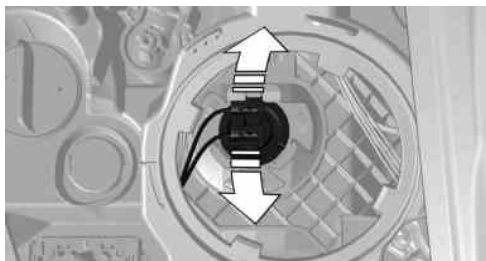

3. Pull the connector off the bulb.
4. Attach the connector to the new bulb.
5. First insert the bulb at the top with the strap, arrow 1, and then press down firmly, arrow 2. Make sure that the bulb snaps into place.

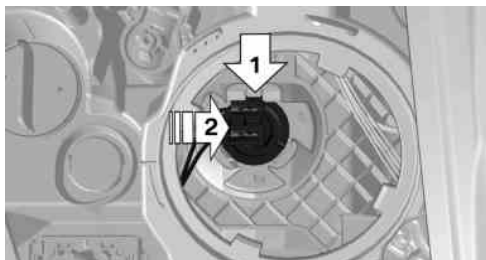

6. Close the headlamp housing with the cap. Make sure that the cap engages.
7. Attach the cover to the wheel house.

Accessing the daytime running lights, high beams/headlamp flasher and parking lamps

Follow the general instructions on lamps and bulbs, refer to page 196.

1. Open the hood, refer to page 188.
2. Turn the cap counterclockwise and remove.

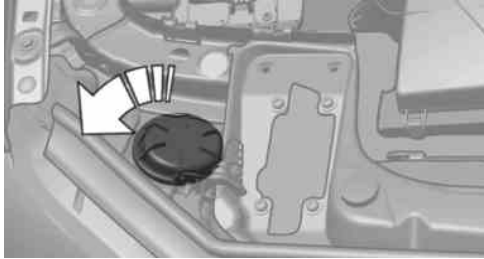

Parking lamps

6-watt bulb, H6W

1. Turn the bulb holder counterclockwise and remove.

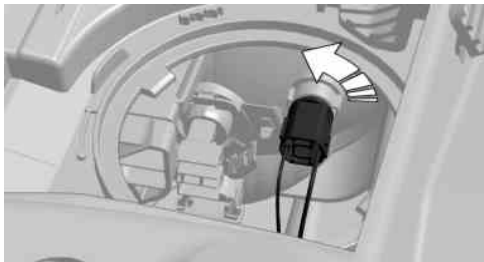

2. Press the bulb gently into the socket, turn counterclockwise and remove.
3. To insert the bulb and bulb holder, proceed in reverse order of removal. Make sure that the bulb holder snaps into place.
4. Close the headlamp housing with the cap. Make sure that the cap engages.

High beams/headlamp flasher

55-watt bulb, H7

1. Tilt the bulb down and then up to loosen it from the holder and remove.

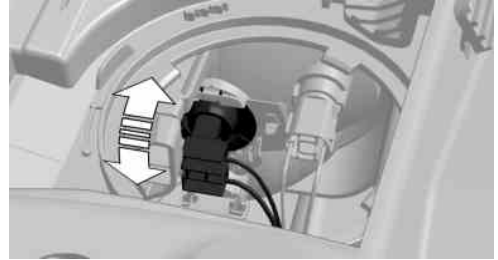

2. Pull the connector off the bulb.
3. Attach the connector to the new bulb.
4. First insert the bulb at the top with the strap, arrow 1, and then press down firmly, arrow 2. Make sure that the bulb snaps into place.

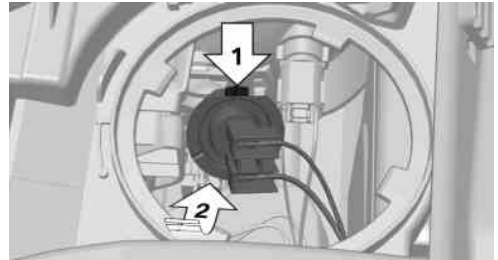

5. Close the headlamp housing with the cap. Make sure that the cap engages.

Daytime running lights

24-watt bulb, PW24W

1. If necessary, remove the high beam bulb connector.
2. Remove the bulb holder.

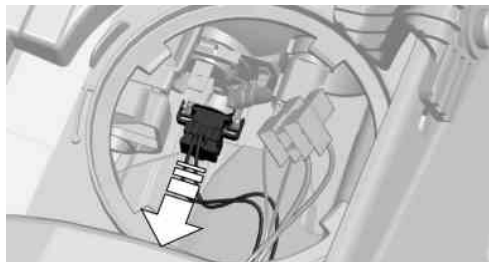

3. Remove the bulb from the bulb holder.
4. To insert the new bulb, proceed in reverse order of removal. During insertion, the bottom of the bulb holder must be facing downward. Make sure that the bulb holder snaps into place.
5. Attach the high beam bulb connector.
6. Close the headlamp housing with the cap. Make sure that the cap engages.

Xenon headlamps

Xenon headlamps

Because of the long life of these bulbs, the likelihood of failure is very low. Switching the lamps on and off frequently shortens their life.

If a xenon bulb fails, switch on the front fog lamps and continue the trip with great care. Comply with local regulations.

 Do not perform work/bulb replacement on xenon headlamps

Have any work on the xenon lighting system, including bulb replacement, performed only by a service center. Due to the high voltage present in the system, there is the danger of fatal injuries if work is carried out improperly. ◀

For checking and adjusting headlamp aim, please contact your BMW center.

Headlamps

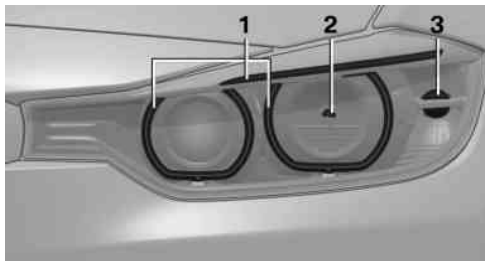

- 1 Parking lamps / daytime running lights
- 2 Low beams/high beams/headlamp flasher
- 3 Turn signal

Low beams and high beams are designed with xenon technology.

The parking lamps and daylight running lights are made using LED technology.

Contact your service center in the event of a malfunction.

Turn signal

Follow the general instructions on lamps and bulbs, refer to page 196.

21-watt bulb, PY21W

1. In the wheel house, loosen the two brackets and remove the cover.

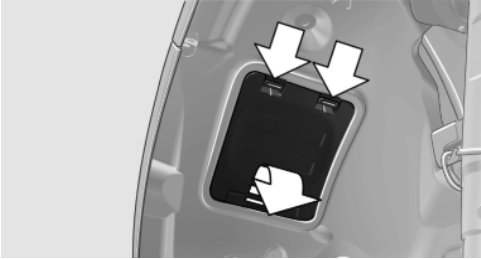

2. If necessary, pull the inside trim of the wheel house slightly inward. Turn the bulb holder counterclockwise and remove.

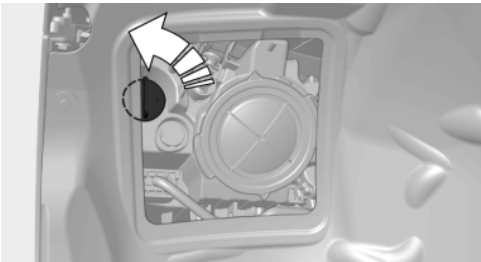

3. Press the bulb gently into the socket, turn counterclockwise and remove.
4. Install the new bulb and bulb holder in reverse order of removal.
5. Attach the cover to the wheel house.

Front fog lamps

Follow the general instructions on lamps and bulbs, refer to page 196.

35-watt bulb, H8

1. Use the back side of the screwdriver from the onboard vehicle tool kit to remove the three wheel house panel screws, arrow 1.

Carefully raise the wheel house panel, arrow 2.

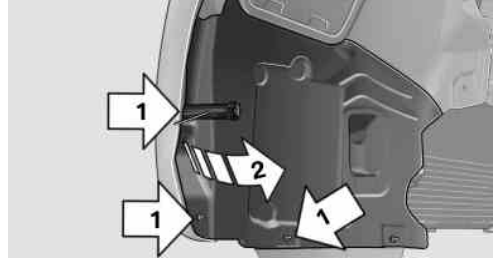

2. Pull off the bulb connector, arrow 1. Turn the bulb, arrow 2.
Left side of vehicle: turn clockwise.
Right side of vehicle: turn counterclockwise.
Remove the bulb.

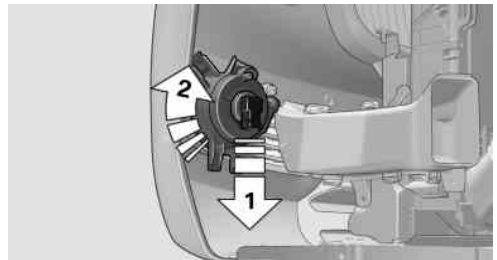

3. Insert the new bulb, connect the connector and screw on the wheel house panel.

Turn signal in exterior mirror

Follow the general instructions on lamps and bulbs, refer to page 196.

The turn signals feature LED technology. Contact your service center in the event of a malfunction.

Tail lamps, bulb replacement

At a glance

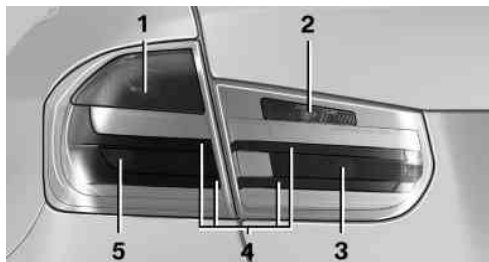

- 1 Turn signal
- 2 Reversing lamp
- 3 Inside brake lamp
- 4 Tail lamps
- 5 Outside brake lamp

Bulb replacement, exterior tail lamps

General information

Follow the general instructions on lamps and bulbs, refer to page 196.

Turn signal: 21-watt bulb, P21W

Exterior brake lamp: 21-watt bulb, P21W

The tail lamps feature LED technology. Contact your service center in the event of a malfunction.



Use caution when replacing the bulb
Use caution and proceed one step at a time when replacing the bulbs to prevent damage to the tail lamps or vehicle. ◀

Removing the exterior tail lamp

1. Open trunk lid.
2. Use the screwdriver from the onboard vehicle tool kit to loosen the screw, arrow 1, and remove the cover, arrow 2.

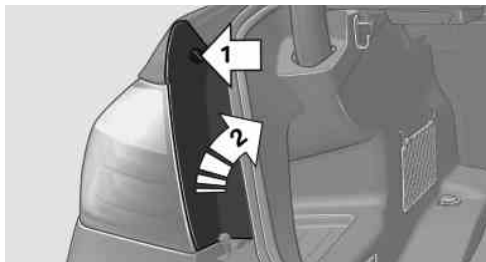

3. Use the screwdriver handle to loosen the two nuts, arrows 1 and 2, and remove. The tail lamp is still attached to a rubber mount on the outside.

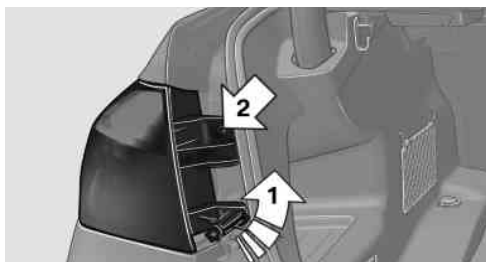

4. Grasp the inner edge of the tail lamp and carefully swing it back and out of the rubber mount, arrow 1. Use your free hand to hold it in place in order to prevent the tail lamp from coming loose suddenly. Make sure that the foam rubber sealing ring is on the centering pin, arrow 2.

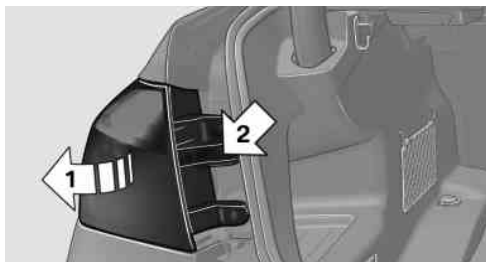

- Remove the connecting line from the clip on the bulb holder.
- Release the catch at the top on the connector of the connecting line and remove the connector from the bulb holder.

Replacing the bulbs

- Loosen the four fasteners, arrow 1, on the bulb holder and remove the bulb holder from the tail lamp, arrow 2.

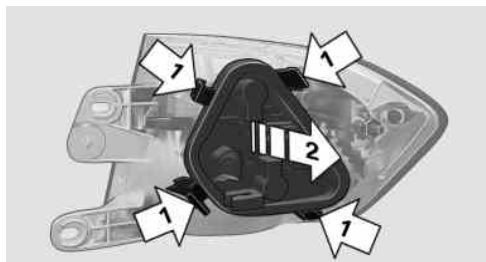

- Press the defective bulb gently into the socket, turn counterclockwise and remove.
- Proceed in the reverse order to insert the new bulb and attach the bulb holder. Make sure that the bulb holder engages in all fasteners.

Installing the tail lamp

- Connect the connecting line to the tail lamp and secure the bulb holder in the clip.
- Make sure that the sealing ring is on the centering pin, arrow 2, and is not damaged.
- Position and firmly press the outer part of the tail lamp onto the rubber mount, arrow 1 and the inner part onto the centering com-

ponent, arrow 2. Make sure that the tail lamp engages in the rubber mount.



- Screw the two nuts onto the tail lamp and mount the cover.
- Fit the cover in place and screw onto the fastener.

Lamps in the trunk lid

General information

Follow the general instructions on lamps and bulbs, refer to page 196.

Reversing lamps: 21-watt bulb, P21W

Inner brake lamps: 21-watt bulb, H21W

Accessing the lamps

- Use the screwdriver from the onboard vehicle tool kit to loosen and completely remove the six screws on the trim.

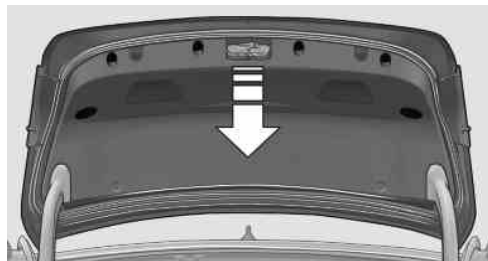

- Carefully loosen the trim from the trunk lid, starting at the edge and working toward the area around the recessed grips. Make sure that the trim does not become stuck.
- Carefully swing out the trim.

Replacing the reversing lamp and inner brake lamp

1. Loosen the two fasteners, arrow 1 and pull down on the lamp holder to remove, arrow 2.

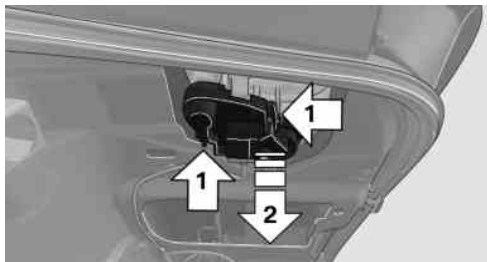

2. Press the defective bulb gently into the socket, turn counterclockwise and remove.
3. Insert the new bulb.

Installing the bulb holder

1. Slide the bulb holder onto the two guide pins, arrow 1. Insert the two contacts, arrow 2, into the connections, arrow 3.

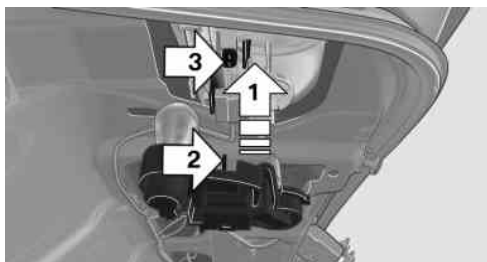

2. Press on the bulb holder. Make sure that the two exterior fasteners latch into place.
3. Swing the trim back onto the trunk lid and secure.

Tail lamp, license plate lamp and central brake lamp

Follow the general instructions on lamps and bulbs, refer to page 196.

The lamps feature LED technology. Contact your service center in the event of a malfunction.

Changing wheels

Notes

The vehicle equipment does not include a spare tire.

When using run-flat tires or tire sealants, a tire does not need to be changed immediately in the event of pressure loss due to a flat tire.

The tools for changing wheels are available as accessories from your service center.

Jacking points for the vehicle jack

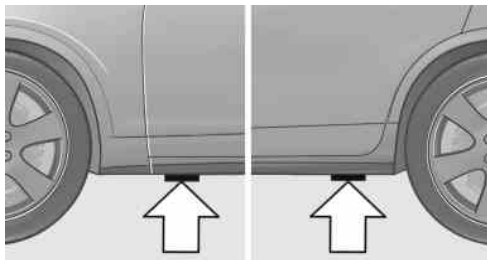

The jacking points for the vehicle jack are located in the positions shown.

Vehicle battery

Maintenance

The battery is maintenance-free, i.e., the electrolyte will last for the life of the battery.

Your service center will be glad to advise you on questions regarding the battery.

Battery replacement



Use approved vehicle batteries only

Only use vehicle batteries that have been approved for your vehicle by the manufacturer; otherwise, the vehicle could be damaged and systems or functions may not be fully available. ◀

After a battery replacement, have the battery registered on the vehicle by your service center

to ensure that all comfort functions are fully available and that any Check Control messages are no longer displayed.

Charging the battery

Note

 Do not plug the charger into the socket
Do not connect battery chargers to the factory-installed sockets in the vehicle. Doing so may result in damage to the vehicle. ◀

Starting aid terminals

In the vehicle, only charge the battery via the starting aid terminals, refer to page 209, in the engine compartment with the engine off.

Power failure

After a temporary power loss, some equipment needs to be reinitialized.

Individual settings need to be reprogrammed:

- ▶ Seat and mirror memory: store the positions again.
- ▶ Time: update.
- ▶ Date: update.
- ▶ Radio station: save again.
- ▶ Navigation system: wait for the operability of the navigation.

Disposing of old batteries



Have old batteries disposed of by your service center or bring them to a recycling center.

Maintain the battery in an upright position for transport and storage. Secure the battery so that it does not tip over during transport.

Fuses

Notes



Replacing fuses

Never attempt to repair a blown fuse and do not replace a defective fuse with a substitute of another color or amperage rating; this could lead to a circuit overload, ultimately resulting in a fire in the vehicle. ◀

Plastic tweezers and information on the fuse types and locations are stored in the fuse box in the cargo area.

In the engine compartment

1. Use the onboard vehicle toolkit to loosen the three cover screws, arrow 1.

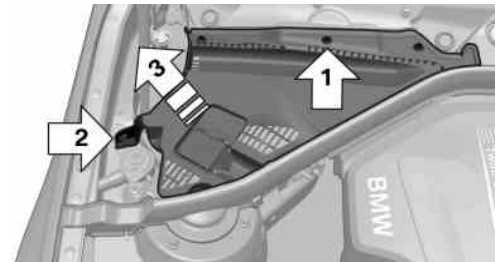

2. Pull up the holder, arrow 2.
3. Remove the cover from one side, arrow 3.
4. Press the four fasteners and remove the cover.

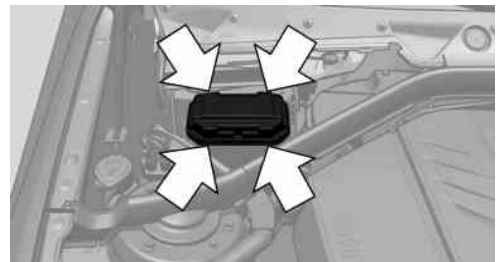

Attaching the covers

1. When attaching the cover, make sure that all four fasteners are engaged.

2. Attach the cover under the rubber lip and then thread it between the bars.

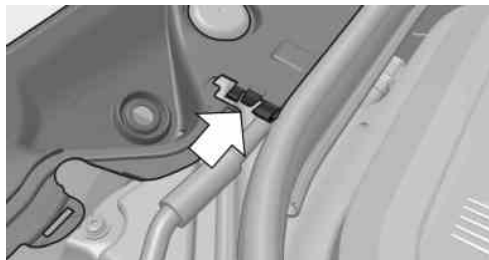

3. Press down on the holder and tighten the three screws.

In the cargo area

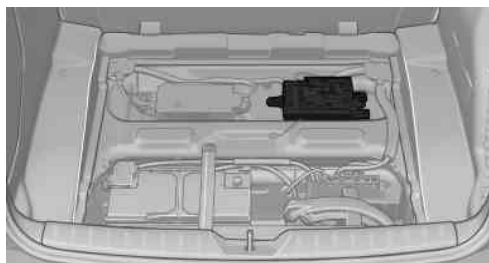

Raise the cargo floor panel.

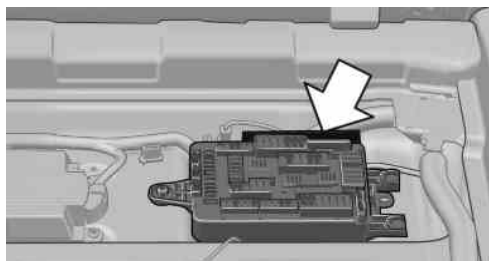

Information on the fuse types and locations is found on a separate sheet.

Breakdown assistance

Vehicle equipment

All standard, country-specific and optional equipment that is offered in the model series is described in this chapter. Therefore, equipment is also described that is not available in a vehicle, e. g., because of the selected optional equipment or country variant. This also applies for safety-related functions and systems.

Hazard warning flashers

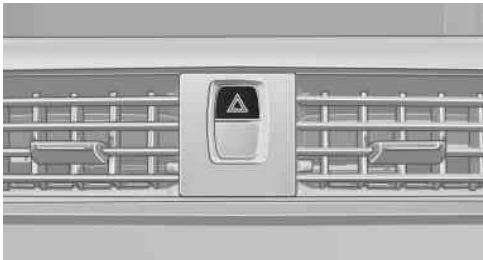

The button is located in the center console.

Emergency Request

Requirements

- ▷ Equipment version with full preparation package mobile phone.
An Emergency Request can be made, even if no mobile phones are paired with the vehicle.
 - ▷ BMW Assist is activated.
 - ▷ The radio ready state is switched on.
 - ▷ The BMW Assist system is logged in to a wireless communications network supported by BMW Assist.
 - ▷ The Assist system is functional.
- Only press the SOS button in an emergency.



Emergency Request not guaranteed

For technical reasons, the Emergency Request cannot be guaranteed under unfavorable conditions. ◀

Service contract

- ▷ After your contract with BMW Assist has expired, the BMW Assist system can be deactivated by the service center without you having to visit a workshop.
After deactivation, an Emergency Request is no longer possible.
- ▷ Under certain circumstances, the system can be reactivated by a service center after you sign a new contract.

Initiating an Emergency Request



1. Press the cover briefly to open it.
2. Press the SOS button until the LED in the button lights up.
 - ▷ The LED lights up: an Emergency Request was initiated.
If the situation allows, wait in your vehicle until the voice connection has been established.
 - ▷ The LED flashes if the connection to the BMW Assist Response Center has been established.
After the Emergency Request arrives at the BMW Assist Response Center, the BMW

Assist Response Center contacts you and takes further steps to help you.

Even if you are unable to respond, the BMW Assist Response Center can take further steps to help you under certain circumstances.

For this purpose, data that are used to determine the necessary rescue measures, such as the current position of the vehicle if it can be established, are transmitted to the BMW Assist Response Center.

- ▶ If the LED is flashing but the BMW Assist Response Center cannot be heard on the hands-free system, the hands-free system may be malfunctioning. However, the BMW Assist Response Center may still be able to hear you.

Initiating an Emergency Request automatically

Under certain conditions, an Emergency Request is automatically initiated immediately after a severe accident. Automatic Collision Notification is not affected by pressing the SOS button.

Warning triangle



The warning triangle is located on the inside of the trunk lid.

To remove, loosen the bracket.

First aid kit



The first aid kit is located in the cargo area in a storage compartment.

Some of the articles have a limited service life.

Check the expiration dates of the contents regularly and replace any expired items promptly.

Roadside Assistance

Service availability

Roadside Assistance can be reached around the clock in many countries. You can obtain assistance there in the event of a vehicle breakdown.

Roadside Assistance

The Roadside Assistance phone number can be viewed on the iDrive or a connection to Roadside Assistance can be established directly.

Jump-starting

Notes

If the battery is discharged, an engine can be started using the battery of another vehicle and two jumper cables. Only use jumper cables with fully insulated clamp handles.

To prevent personal injury or damage to both vehicles, adhere strictly to the following procedure.



Do not touch live parts

To avoid the risk of potentially fatal injury, always avoid all contact with electrical components while the engine is running. ◀

Preparation

1. Check whether the battery of the other vehicle has a voltage of 12 volts. This information can be found on the battery.
2. Switch off the engine of the assisting vehicle.
3. Switch off any electronic systems/power consumers in both vehicles.



Bodywork contact between vehicles

Make sure that there is no contact between the bodywork of the two vehicles; otherwise, there is the danger of short circuits. ◀

Starting aid terminals



Connecting order

Connect the jumper cables in the correct order; otherwise, there is the danger of injury from sparking. ◀

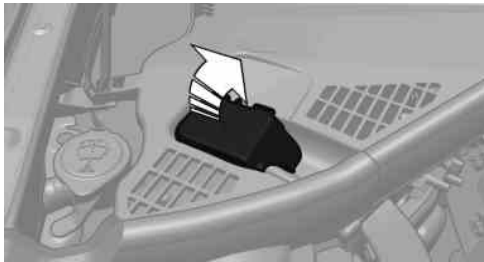

The so-called starting aid terminal in the engine compartment acts as the battery's positive terminal.

Open the cover of the starting aid terminal.

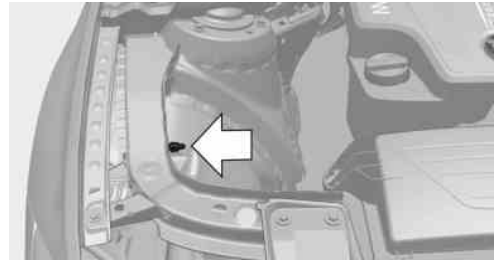

The body ground or a special nut acts as the battery negative terminal.

Connecting the cables

1. Open the cover of the BMW starting aid terminal.
2. Attach one terminal clamp of the positive jumper cable to the positive terminal of the battery, or to the corresponding starting aid terminal of the vehicle providing assistance.
3. Attach the terminal clamp on the other end of the cable to the positive terminal of the battery, or to the corresponding starting aid terminal of the vehicle to be started.
4. Attach one terminal clamp of the negative jumper cable to the negative terminal of the battery, or to the corresponding engine or body ground of assisting vehicle.
5. Attach the second terminal clamp to the negative terminal of the battery, or to the corresponding engine or body ground of the vehicle to be started.

Starting the engine

Never use spray fluids to start the engine.

1. Start the engine of the assisting vehicle and let it run for several minutes at an increased idle speed.
2. Start the engine of the vehicle being started in the usual way.

If the first starting attempt is not successful, wait a few minutes before making another attempt in order to allow the discharged battery to recharge.

3. Let both engines run for several minutes.
4. Disconnect the jumper cables in the reverse order.

Check the battery and recharge if necessary.

Tow-starting and towing

Automatic transmission: transporting your vehicle

Note

Your vehicle is not permitted to be towed. Therefore, contact a service center in the event of a breakdown.

-  Do not have the vehicle towed. Have your vehicle transported on a loading platform only; otherwise, damage may occur. ◀

Tow truck

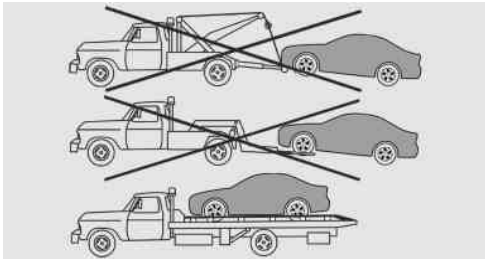

-  Do not lift the vehicle. Do not lift the vehicle by the tow fitting or body and chassis parts; otherwise, damage may result. ◀

Use the tow fitting screwed in at the front for maneuvering the vehicle only.

Manual transmission

Gearshift lever in neutral position.

Towing

-  When the parking brake is blocked. The parking brake cannot be released manually.

Do not tow the vehicle with the parking brake blocked, or the vehicle can be damaged.

Contact your service center. ◀

-  Follow the towing instructions. Follow all towing instructions; otherwise, vehicle damage or accidents may occur. ◀

- ▷ Make sure that the ignition is switched on; otherwise, the low beams, tail lamps, turn signals, and windshield wipers may be unavailable.
- ▷ Do not tow the vehicle with the rear axle tilted, as the front wheels could turn.
- ▷ When the engine is stopped, there is no power assist. Consequently, more force needs to be applied when braking and steering.
- ▷ Larger steering wheel movements are required.
- ▷ The towing vehicle must not be lighter than the vehicle being towed; otherwise, it will not be possible to control the vehicle response.

Tow truck

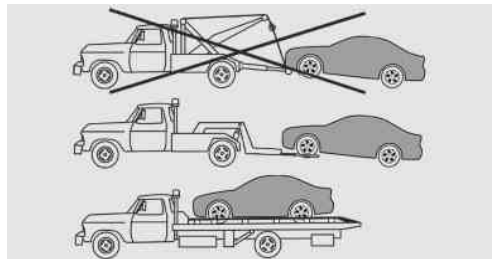



Have your vehicle transported with a tow truck with a so-called lift bar or on a flat bed.

-  Do not lift the vehicle
- Do not lift the vehicle by the tow fitting or body and chassis parts; otherwise, damage may result. ◀

Towing other vehicles

General information

-  Light towing vehicle
- The towing vehicle must not be lighter than the vehicle being towed; otherwise, it will not be possible to control the vehicle response. ◀
-  Attaching the tow bar/tow rope correctly
- Attach the tow bar or tow rope to the tow fitting; connecting it to other vehicle parts may cause damage. ◀
- ▶ Switch on the hazard warning system, depending on local regulations.
- ▶ If the electrical system has failed, clearly identify the vehicle being towed by placing a sign or a warning triangle in the rear window.

Tow bar

The tow fittings used should be on the same side on both vehicles.

Should it prove impossible to avoid mounting the tow bar at an offset angle, please observe the following:

- ▶ Maneuvering capability is limited during cornering.
- ▶ The tow bar will generate lateral forces if it is secured with an offset.

Tow rope

When starting to tow the vehicle, make sure that the tow rope is taut.

To avoid jerking and the associated stresses on the vehicle components when towing, always use nylon ropes or nylon straps.

-  Attaching the tow rope correctly
- Only secure the tow rope on the tow fitting; otherwise, damage can occur when it is secured on other parts of the vehicle. ◀

Tow fitting

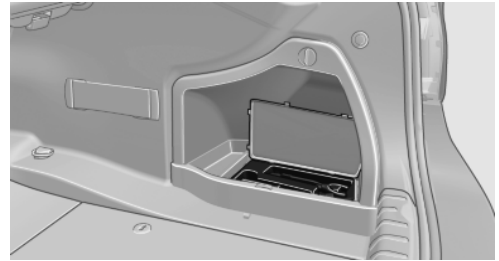

The screw-in tow fitting should always be carried in the vehicle. It can be screwed in at the front or rear of the BMW. It is in the onboard vehicle tool kit located in a storage compartment on the right side in the cargo area. Open the cover.

-  Tow fitting, information on use
- ▶ Use only the tow fitting provided with the vehicle and screw it all the way in.
- ▶ Use the tow fitting for towing on paved roads only.
- ▶ Avoid lateral loading of the tow fitting, e.g., do not lift the vehicle by the tow fitting.

Otherwise, damage to the tow fitting and the vehicle can occur. ◀

Screw thread

Push out the cover by pressing on the top edge.

Front



Rear



Tow-starting

Automatic transmission

Do not tow-start the vehicle.

Due to the automatic transmission, the engine cannot be started by tow-starting.

Have the cause of the starting difficulties remedied.

Manual transmission

If possible, do not tow-start the vehicle but start the engine by jump-starting, refer to page [208](#).

If the vehicle is equipped with a catalytic converter, only tow-start while the engine is cold.

1. Switch on the hazard warning system and comply with local regulations.
2. Ignition, refer to page [59](#), on.
3. Engage third gear.
4. Have the vehicle tow-started with the clutch pressed and slowly release the clutch. After

the engine starts, immediately press on the clutch again.

5. Stop at a suitable location, remove the tow bar or rope, and switch off the hazard warning system.
6. Have the vehicle checked.

Care

Vehicle equipment

All standard, country-specific and optional equipment that is offered in the model series is described in this chapter. Therefore, equipment is also described that is not available in a vehicle, e. g., because of the selected optional equipment or country variant. This also applies for safety-related functions and systems.

Car washes

Notes

 Steam jets or high-pressure washers
When using steam jets or high-pressure washers, hold them a sufficient distance away and use a maximum temperature of 140 °F/60 °C.

Ensure that a distance of at least 31.5 inches/50 cm is maintained at all times. Holding them too close or using excessively high pressures or temperatures can cause damage or preliminary damage that may then lead to long-term damage.

Follow the operating instructions for the high-pressure washer. ◀

 Cleaning sensors/cameras with high-pressure washers

When using high-pressure washers, do not spray the exterior sensors and cameras, e.g., Park Distance Control, for extended periods of time and only from a distance of at least 12 in/30 cm. ◀

Wash your vehicle frequently, particularly in winter.

Intense soiling and road salt can damage the vehicle.

Automatic car washes

Notes

Note the following:

- ▶ Give preference to cloth car washes or those that use soft brushes in order to avoid paint damage.
- ▶ Make sure that the wheels and tires are not damaged by the transport mechanisms.
- ▶ Fold in the exterior mirrors; otherwise, they may be damaged, depending on the width of the vehicle.
- ▶ Deactivate the rain sensor, refer to page 65, to avoid unintentional wiper activation.
- ▶ In some cases, an unintentional alarm can be triggered by the interior motion sensor of the alarm system. Follow the instructions on avoiding an unintentional alarm, refer to page 41.

 Guide rails in car washes
Avoid car washes with guide rails higher than 4 in/10 cm; otherwise, the vehicle body could be damaged. ◀

Before driving into a car wash

In order to ensure that the vehicle can roll in a car wash, take the following steps:

Manual transmission:

1. Release the parking brake.
2. Drive into the car wash.
3. Shift to neutral.
4. Switch the engine off.
5. Switch on the ignition.

Automatic transmission:

1. Release the parking brake, refer to page 63.
2. Drive into the car wash.
3. Depress the brake pedal as needed.

4. Engage transmission position N.
5. Switch the engine off. In this way, the ignition remains switched on, and a Check-Control message is displayed.

 Transmission position P with the ignition off

When the ignition is switched off, position P is engaged automatically. When in an automatic car wash, for example, ensure that the ignition is not switched off accidentally. ◀

The vehicle cannot be locked from the outside when in transmission position N.

A signal is sounded when an attempt is made to lock the vehicle.

Transmission position

Transmission position P is engaged automatically:

- ▷ When the ignition is switched off.
- ▷ After approx. 15 minutes.

Headlamps

- ▷ Do not rub dry and do not use abrasive or caustic cleansers.
- ▷ Soak areas that have been soiled e.g. due to insects, with shampoo and wash off with water.
- ▷ Thaw ice with deicing spray; do not use an ice scraper.

After washing the vehicle

After washing the vehicle, apply the brakes briefly to dry them; otherwise, braking action can be reduced and corrosion of the brake discs can occur.

Remove all residue completely from the windshields, otherwise streaking may cause loss of visibility and wiper noise when the windshield wipers are operated.

Vehicle care

Car care products

BMW recommends using cleaning and care products from BMW, since these have been tested and approved.

 Car care and cleaning products
Follow the instructions on the container.

When cleaning the interior, open the doors or windows.

Only use products intended for cleaning vehicles.

Cleansers can contain substances that are dangerous and harmful to your health. ◀

Vehicle paint

Regular care contributes to driving safety and value retention. Environmental influences in areas with elevated air pollution or natural contaminants, such as tree resin or pollen can affect the vehicle's paintwork. Tailor the frequency and extent of your car care to these influences.

Aggressive substances such as spilled fuel, oil, grease or bird droppings must be removed immediately to prevent the finish from being altered or discolored.

Leather care

Remove dust from the leather often, using a cloth or vacuum cleaner.

Otherwise, particles of dust and road grime chafe in pores and folds, and lead to increased wear and premature degradation of the leather surface.

To guard against discoloration, such as from clothing, provide leather care roughly every two months.

Clean light-colored leather more frequently because soiling on such surfaces is substantially more visible.

Use leather care products; otherwise, dirt and grease will gradually break down the protective layer of the leather surface.

Suitable care products are available from the service center.

Upholstery material care

Vacuum regularly with a vacuum cleaner.

If they are very dirty, e.g., beverage stains, use a soft sponge or microfiber cloth with a suitable interior cleaner.

Clean the upholstery down to the seams using large sweeping motions. Avoid rubbing the material vigorously.



Damage from Velcro® fasteners

Open Velcro® fasteners on pants or other articles of clothing can damage the seat covers. Ensure that any Velcro® fasteners are closed. ◀

Caring for special components

Light-alloy wheels

Use wheel cleaner, particularly during the winter months. Do not use aggressive, acidic, strongly alkaline or abrasive cleaners, or steam jets above 140 °F/60 °C; follow the manufacturer's instructions.

Chrome surfaces

Carefully clean components such as the radiator grille or door handles with an ample supply of water, possibly with shampoo added, particularly when they have been exposed to road salt.

Rubber components

Aside from water, treat only with rubber cleansers.

When cleaning rubber seals, do not use any silicon-containing car care products in order to avoid damage or reduced noise damping.

Fine wood parts

Clean fine wood facing and fine wood components only with a moist rag. Then dry with a soft cloth.

Plastic components

These include:

- ▷ Imitation leather surfaces.
- ▷ Headliner.
- ▷ Lamp lenses.
- ▷ Instrument cluster cover.
- ▷ Matte black spray-coated components.
- ▷ Painted parts in the interior.

Clean with a microfiber cloth.

Lightly dampen the cloth with water.

Do not soak the headliner.



Do not use cleansers that contain alcohol or solvents

Do not use cleansers that contain alcohol or solvents, such as lacquer thinners, heavy-duty grease removers, fuel, or such; this could lead to surface damage. ◀

Safety belts

Dirty belt straps impede the reeling action and thus have a negative impact on safety.



Chemical cleaning

Do not clean chemically; this can destroy the webbing. ◀

Use only a mild soapy solution, with the safety belts clipped into their buckles.

Do not allow the reels to retract the safety belts until they are dry.

Carpets and floor mats



No objects in the area around the pedals

Keep floor mats, carpets, and any other objects out of the area of motion of the pedals; otherwise, the function of the pedals could be impeded while driving

Do not place additional floor mats over existing mats or other objects.

Only use floor mats that have been approved for the vehicle and can be properly fixed in place.

Ensure that the floor mats are securely fastened again after they were removed for cleaning, for example. ◀

Floor mats can be removed from the passenger compartment for cleaning.

If the floor carpets are very dirty, clean with a microfiber cloth and water or a textile cleaner. To prevent matting of the carpet, rub back and forth in the direction of travel only.

Sensors/cameras

To clean sensors and cameras, use a cloth moistened with a small amount of glass cleaner.

Displays/screens

Clean the displays with an antistatic microfiber cloth.



Cleaning displays

Do not use chemical or household cleansers.

Keep all fluids and moisture away from the unit.

Otherwise, they could affect or damage surfaces or electrical components.

Avoid pressing too hard when cleaning and do not use abrasive materials; otherwise, damage can result. ◀

Long-term vehicle storage

Your service center can advise you on what to consider when storing the vehicle for longer than three months.



Reference

This chapter contains technical data, short commands for the voice activation system, and an index that will quickly take you to the information you need.

Technical data

Vehicle equipment

All standard, country-specific and optional equipment that is offered in the model series is described in this chapter. Therefore, equipment

is also described that is not available in a vehicle, e. g., because of the selected optional equipment or country variant. This also applies for safety-related functions and systems.

Dimensions

Width, height

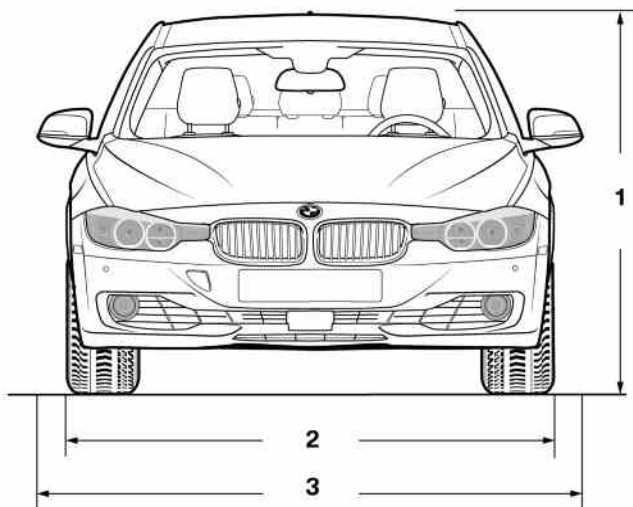

1 Vehicle height, without roof-mounted aerial:
56.3 inches/1,430 mm

Vehicle height, with roof-mounted aerial:
56.7 inches/1,442 mm

2 Vehicle width, without mirrors: 71.3 inches/
1,811 mm

3 Vehicle width with mirrors: 79.9 inches/
2,031 mm

Length, wheel base

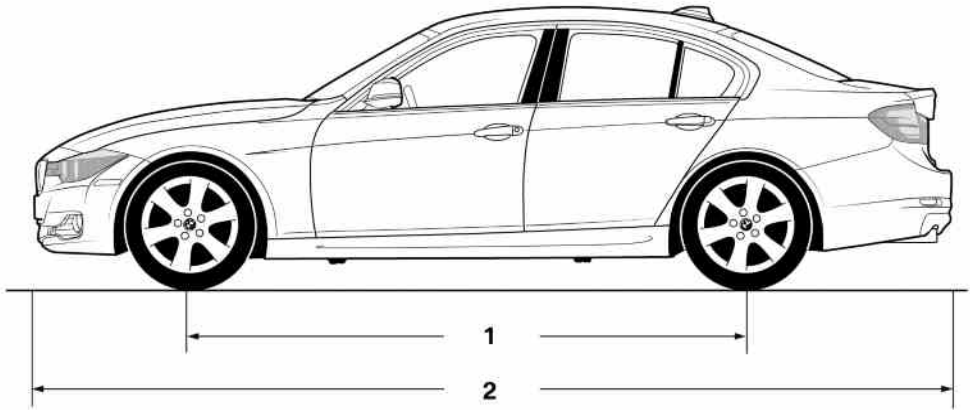

1 Wheel base: 110.6 inches/2,810 mm

2 Vehicle length: 182.5 inches/4,636 mm

Smallest turning circle

Dia.: 37 ft/11.3 m

Weights

The values preceding the slash apply to vehicles with manual transmission; the values following

the slash apply to vehicles with automatic transmission.

For Canadian models: 320i

Approved gross vehicle weight	lbs	4,299/4,354
	kg	1,950/1,975
Load	lbs/kg	903/410
Approved front axle load	lbs/kg	2,006/910
Approved rear axle load	lbs/kg	2,458/1,115
Approved roof load capacity	lbs/kg	165/75
Trunk capacity	cu ft/l	16.9/480

328i

Approved gross vehicle weight	lbs	4,409/4,453
	kg	2,000/2,020
Load	lbs/kg	903/410
Approved front axle load	lbs/kg	2,061/935
Approved rear axle load	lbs/kg	2,513/1,140
Approved roof load capacity	lbs/kg	165/75
Trunk capacity	cu ft/l	16.9/480

335i

Approved gross vehicle weight	lbs	4,541/4,563
	kg	2,060/2,070
Load	lbs/kg	903/410
Approved front axle load	lbs/kg	2,160/980
Approved rear axle load	lbs/kg	2,524/1,145
Approved roof load capacity	lbs/kg	165/75
Cargo area capacity	cu ft/l	16.9/480

328i xDrive

Approved gross vehicle weight	lbs/kg	4,608/2,090
Load	lbs/kg	904/410
Approved front axle load	lbs/kg	2,194/995
Approved rear axle load	lbs/kg	2,535/1,150
Approved roof load capacity	lbs/kg	165/75
Cargo area capacity	cu ft/l	16.9/480

335i xDrive		
Approved gross vehicle weight	lbs	4,696/4,718
	kg	2,130/2,140
Load	lbs/kg	904/410
Approved front axle load	lbs/kg	2,271/1,030
Approved rear axle load	lbs/kg	2,535/1,150
Approved roof load capacity	lbs/kg	165/75
Cargo area capacity	cu ft/l	16.9/480

Capacities

	US gal/liters	Notes
Fuel tank	Gasoline: 15.8/60	Fuel quality, refer to page 174
Windshield and headlamp washer system	0.8/3	

Short commands of the voice act. system

Vehicle equipment

All standard, country-specific and optional equipment that is offered in the model series is described in this chapter. Therefore, equipment is also described that is not available in a vehicle, e. g., because of the selected optional equipment or country variant. This also applies for safety-related functions and systems.

General information

Instructions for voice activation system, refer to page 23.

To have the available spoken instructions read out loud: ›Voice commands‹

Adjusting

Vehicle

Function	Command
Open the main menu.	›Main menu‹
Open the options.	›Options‹
Open the settings.	›Settings‹
Info display of the instrument cluster.	›Info Display‹
Settings on the Control Display.	›Control display‹
Open the time and date.	›Time and date‹
Open the language and units.	›Language and units‹
Open the speed limit.	›Speed‹
Open the light.	›Lighting‹
Open the door lock.	›Door locks‹
Open the profiles.	›Profiles‹
Open the Driving Mode menu.	›Driving mode‹
Open the ECO PRO menu.	›ECO PRO mode‹

Equipment

Function	Command
Open the air conditioning settings.	›Climate‹
Open the Head-up Display.	›head up display‹

Vehicle information

Owner's Manual

Function	Command
Open the Owner's Manual.	›Display Owner's Manual‹
Open the Quick Reference Guide.	›Quick reference‹
Open the index.	›Owner's Manual‹
Open the search by pictures.	›Search by pictures‹

Computer

Function	Command
Call up the onboard computer.	›Onboard info‹
Call up the trip computer.	›Trip computer‹

Vehicle

Function	Command
Open the vehicle information.	›Vehicle info‹
Open the vehicle status.	›Vehicle status‹
Open sport displays.	›Sport displays‹
Call up ECO PRO tips.	›ECO PRO Tips‹
Open EfficientDynamics menu.	›Efficient Dynamics‹
EfficientDynamics split screen.	›Split screen Efficient Dynamics‹

Navigation

General information

Function	Command
Opens the Navigation menu.	›Navigation‹
Open the destination entry.	›Enter address‹
Enter the address.	›Enter address‹
Enter a town/city.	›City‹
Enter a state/province.	›State‹
Enter the postal code.	›Postal Code‹
Open destination guidance.	›Guidance‹
Start destination guidance.	›Start guidance‹
Terminate destination guidance.	›Stop guidance‹
Open the home address.	›Home address‹
Open the route criteria.	›Route preference‹
Open the route.	›Route information‹
Turn on spoken instructions.	›Switch on voice instructions‹
Repeat the spoken instruction.	›Repeat voice instructions‹
Turn off spoken instructions.	›Switch off voice instructions‹
Display the address book.	›Address book‹
Display the most recent destinations.	›Last destinations‹
Open the traffic bulletins.	›Traffic Info‹
Special destinations.	›Points of interest‹

Map

Function	Command
Display the map.	›Map‹
Map facing north.	›Map facing north‹
Map facing the direction of travel.	›Map in direction of travel‹

Function	Command
Perspective map.	›Map perspective view‹
Automatic scaling of the map.	›Map with automatic scaling‹
Scale...feet.	›Map scale‹

Split screen settings

Function	Command
Split screen.	›Switch on splitscreen‹
Switch off the split screen.	›Turn off split screen‹
Adjust the split screen.	›Split screen content‹
Split screen, map facing north.	›Split screen map facing north‹
Split screen, current position.	›Split screen current position‹
Split screen, facing the direction of travel.	›Split screen map in direction of travel‹
Split screen, perspective.	›Split screen perspective‹
Split screen, expanded intersection zoom.	›Splitscreen Exit ramp view‹
Split screen scale...feet.	›Split screen scale ... feet‹ e.g., split screen scale 100 feet
Split screen scale...meters.	›Split screen scale ... meters‹ e.g., split screen scale 100 meters
Split screen scale...kilometers.	›Split screen scale ... kilometers‹ e.g., split screen scale 5 kilometers
Split screen scale...miles.	›Split screen scale ... miles‹ e.g., split screen scale 5 miles
Split screen, highlight the traffic situation.	›Split screen, Traffic conditions‹
Split screen, computer.	›Split screen on board info‹
Split screen, trip computer.	›Splitscreen trip computer‹
Split screen, scale automatically.	›Split screen automatic scaling‹

Destination guidance with intermediate destinations

Function	Command
Enter a new destination.	›Enter address‹
Trip list.	›Stored trips‹

Radio

FM

Function	Command
Open a frequency.	›Frequency ... megahertz‹ e.g., 93.5 megahertz or frequency 93.5
Open the radio.	›Radio‹
Open the FM stations.	›F M‹
Open the manual search.	›Manual‹
Select a frequency range.	›Select frequency‹
Open a station.	›Select station‹

AM

Function	Command
Open a frequency.	›Frequency ... Kilohertz‹ e.g., frequency 753 or 753 kilohertz
Open the AM stations.	›A M‹
Open the manual search.	›Manual‹

Satellite radio

Function	Command
Open the satellite radio.	›Satellite radio‹
Switch on the satellite radio.	›Satellite radio on‹
Select a satellite radio channel.	›Select satellite radio‹ e.g., satellite radio channel 2

Stored stations

Function	Command
Open the stored stations.	›Presets‹
Choose a stored station.	›Select preset‹
Select a stored station.	›Preset ...‹ e. g., stored station 2

CD/multimedia

CD/DVD drive

Function	Command
Select a track.	›Track ...‹ e.g., track 5 Or ›C D track ...‹ e.g., CD track 5
Play back a CD.	›C D on‹
Select a CD.	›Select C D‹
Select a CD and track.	›C D ... track ...‹ e.g., CD 3 track 5
Open the CD and Multimedia menus.	›C D and multimedia‹
CD and DVD.	›C D‹
Select a DVD.	›D V D ...‹ e.g. DVD 3
Display the entertainment details on a split screen.	›Entertainment details‹

Music collection

Function	Command
Search for music, open a menu.	›Music search‹
Open the current playback.	›Current playback‹
Open the music collection.	›Music collection‹
Play back the music collection.	›Music collection on‹
Play back the most frequently played tracks.	›Top fifty‹

External devices

Function	Command
Open the external devices.	›External devices‹
Open the Bluetooth devices.	›Bluetooth‹
AUX at front.	›AUX front‹

Tone

Function	Command
Open the tone settings.	›Tone‹

Telephone

Function	Command
Dial a phone number.	›Dial number‹
Opens the Telephone menu.	›Telephone‹
Display the phone book.	›Phonebook‹
Redialing.	›Redial‹
Display received calls.	›Received calls‹
List of messages.	›Messages‹
Open the Bluetooth devices.	›Bluetooth‹

Office

Function	Command
Open the Office menu.	›Office‹
Display Office Today.	›Current office‹
Display the contacts.	›Contacts‹
Display the messages.	›Messages‹
Display the calendar.	›Calendar‹

Function	Command
Display the tasks.	›Tasks‹
Display the reminders.	›Reminders‹

BMW Assist or ConnectedDrive

Function	Command
Open BMW Assist.	›B M W Assist‹
Open ConnectedDrive.	›Connected Drive‹
Open BMW Search.	›B M W Online‹

Everything from A to Z

Index

A

- ABS, Antilock Brake System **111**
- ACC, Active Cruise Control with Stop & Go **116**
- Activated-charcoal filter **143**
- Active Blind Spot Detection **106**
- Active Cruise Control with Stop & Go, ACC **116**
- Active Protection **109**
- Adaptive brake lights, refer to Brake force display **109**
- Adaptive light control **89**
- Additives, oil **190**
- Adjustable speed limit **107**
- Adjustments, seats/head restraints **45**
- After washing vehicle **214**
- Airbags **92**
- Airbags, indicator/warning light **93**
- Air circulation, refer to Recirculated-air mode **139, 142**
- Air, dehumidifying, refer to Cooling function **139, 141**
- Air distribution, manual **139, 142**
- Air flow, air conditioner **139**
- Air flow, automatic climate control **142**
- Air pressure, tires **175**
- Air vents, refer to Ventilation **143**
- Alarm system **40**
- Alarm, unintentional **41**
- All around the center console **14**
- All around the headliner **15**
- All around the steering wheel **12**
- All-season tires, refer to Winter tires **185**
- All-wheel-drive **112**
- Alternating-code hand-held transmitter **146**
- Alternative oil types **190**
- Antifreeze, washer fluid **66**
- Antilock Brake System, ABS **111**
- Anti-slip control, refer to DSC **111**
- Approved axle load **221**
- Approved engine oils **190**
- Arrival time **82**
- Ash tray **149**
- Assistance, Roadside Assistance **208**
- Assistance when driving off **115**
- Assist system information, on Control Display **85**
- AUTO intensity **141**
- Automatic car wash **213**
- Automatic climate control **138**
- Automatic climate control with enhanced features **140**
- Automatic Cruise Control with Stop & Go **116**
- Automatic Curb Monitor **53**
- Automatic deactivation, front passenger airbags **94**
- Automatic headlamp control **88**
- Automatic locking **37**
- Automatic recirculated-air control **142**
- Automatic transmission with Steptronic **67**
- AUTO program, automatic climate control **141**
- AUTO program, climate control **139**
- AUTO program, intensity **141**
- Auto Start/Stop function **61**
- Average fuel consumption **82**
- Average speed **82**
- Axle loads, weights **221**

B

- Backrest curvature, refer to Lumbar support **47**
- Backrest, width **47**
- Backup camera **126**
- Band-aids, refer to First aid kit **208**
- Bar for tow-starting/towing **211**
- Battery replacement, vehicle battery **204**
- Battery replacement, vehicle remote control **30**
- Battery, vehicle **204**
- Belts, safety belts **48**
- Beverage holder, cupholder **155**
- Blinds, sun protection **43**
- BMW Assist, see user's manual for Navigation, Entertainment and Communication
- BMW Homepage **6**
- BMW Internet page **6**
- BMW Maintenance System **193**
- Bottle holder, refer to Cupholder **155**
- Brake assistant **111**
- Brake discs, breaking in **160**

Brake force display [109](#)
Brake lamps, brake force display [109](#)
Brake lights, adaptive [109](#)
Brake pads, breaking in [160](#)
Braking, notes [161](#)
Breakdown assistance [207](#), [208](#)
Breaking in [160](#)
Brightness of Control Display [85](#)
Bulb replacement [196](#)
Bulb replacement, front [197](#)
Bulb replacement, halogen headlamps [197](#)
Bulb replacement, rear [202](#)
Bulb replacement, xenon headlamps [200](#)
Bulbs and lamps [196](#)
Button, RES [118](#)
Button, Start/Stop [59](#)
Bypassing, refer to Jump-starting [208](#)

C

California Proposition 65 Warning [7](#)
Camera, backup camera [127](#)
Camera, care [216](#)
Camera, Side View [131](#)
Camera, Top View [129](#)
Can holder, refer to Cupholder [155](#)
Car battery [204](#)
Car care products [214](#)
Care, displays [216](#)
Care, vehicle [214](#)
Cargo [163](#)
Cargo area, enlarging [151](#)
Cargo area lid [37](#)
Cargo area, storage compartments [156](#)
Cargo straps, securing cargo [164](#)
Car key, refer to Remote control [30](#)
Carpet, care [215](#)
Car wash [213](#)
Catalytic converter, refer to Hot exhaust system [161](#)
CBS Condition Based Service [193](#)
CD/Multimedia, see user's manual for Navigation, Entertainment and Communication
Center armrest [154](#)
Center console [14](#)
Central locking system [33](#)
Central screen, refer to Control Display [16](#)
Changes, technical, refer to Safety [7](#)
Changing parts [196](#)
Changing wheels [204](#)
Changing wheels/tires [184](#)
Check Control [73](#)
Children, seating position [55](#)
Children, transporting safely [55](#)
Child restraint fixing system [55](#)
Child restraint fixing system LATCH [56](#)
Child restraint fixing systems, mounting [55](#)
Child safety locks [58](#)
Child seat, mounting [55](#)
Child seats [55](#)
Chrome parts, care [215](#)
Cigarette lighter [149](#)
Cleaning, displays [216](#)
Climate control [138](#), [140](#)
Clock [76](#)
Closing/opening from inside [37](#)
Closing/opening via door lock [36](#)
Closing/opening with remote control [34](#)
Clothes hooks [155](#)
Collision warning [100](#), [102](#)
Combination switch, refer to Turn signals [63](#)
Combination switch, refer to Wiper system [64](#)
Comfort Access [38](#)
COMFORT program, Dynamic Driving Control [114](#)
Compartments in the doors [154](#)
Compass [147](#)
Computer [81](#)
Condensation on windows [142](#)
Condensation under the vehicle [162](#)
Condition Based Service CBS [193](#)
Configure driving mode [114](#)
Confirmation signal [35](#)
ConnectedDrive, see user's manual for Navigation, Entertainment and Communication
Control Display [16](#)
Control Display, settings [84](#)
Controller [16](#), [17](#)
Control systems, driving stability [111](#)
Convenient opening [34](#)
Coolant [192](#)
Coolant temperature [76](#)
Cooling function [139](#), [141](#)
Cooling, maximum [141](#)
Cooling system [192](#)
Corrosion on brake discs [162](#)
Cruise control [122](#)
Cruise control, active with Stop & Go [116](#)
Cruising range [77](#)
Cupholder [155](#)
Current fuel consumption [77](#)

D

Damage, tires [183](#)
Damping control, dynamic [112](#)
Data, technical [220](#)
Date [76](#)
Daytime running lights [88](#)
Defrosting, refer to defrosting the windows [139](#)
Defrosting, refer to Windows, defrosting [142](#)
Defrosting the windows [139](#)
Dehumidifying, air [139](#), [141](#)
Destination distance [82](#)
Digital clock [76](#)
Digital compass [147](#)
Dimensions [220](#)
Dimmable exterior mirrors [53](#)
Dimmable interior rearview mirror [53](#)
Direction indicator, refer to Turn signals [63](#)
Display, electronic, instrument cluster [72](#)
Display in windshield [132](#)
Display lighting, refer to Instrument lighting [90](#)
Displays [70](#)
Displays, cleaning [216](#)
Disposal, coolant [192](#)
Disposal, vehicle battery [205](#)
Distance control, refer to PDC [124](#)
Distance, selecting for ACC [118](#)
Distance to destination [82](#)
Divided screen view, split screen [21](#)
Door lock, refer to Remote control [30](#)
Drive-off assistant [115](#)
Drive-off assistant, refer to DSC [111](#)
Driving experience switch [113](#)
Driving instructions, breaking in [160](#)
Driving mode [113](#)
Driving notes, general [160](#)
Driving stability control systems [111](#)
Driving tips [160](#)
DSC Dynamic Stability Control [111](#)
DTC Dynamic Traction Control [112](#)
Dynamic Damping Control [112](#)
Dynamic Stability Control DSC [111](#)
Dynamic Traction Control DTC [112](#)

E

ECO PRO [167](#)
ECO PRO display [167](#)
ECO PRO mode [167](#)
EfficientDynamics [169](#)
Electronic displays, instrument cluster [72](#)
Electronic Stability Program ESP, refer to DSC [111](#)
Emergency detection, remote control [31](#)
Emergency release, door lock [36](#)
Emergency release, fuel filler flap [172](#)
Emergency Request [207](#)
Emergency service, refer to Roadside Assistance [208](#)
Emergency start function, engine start [31](#)
Emergency unlocking, trunk lid [38](#)
Energy Control [77](#)
Energy recovery [77](#)
Engine, automatic Start/Stop function [61](#)
Engine, automatic switch-off [61](#)
Engine compartment [187](#)
Engine compartment, working in [188](#)
Engine coolant [192](#)
Engine oil [189](#)
Engine oil, adding [190](#)
Engine oil additives [190](#)
Engine oil change [190](#)
Engine oil filler neck [190](#)
Engine oil temperature [76](#)
Engine oil types, alternative [190](#)
Engine oil types, approved [190](#)
Engine start during malfunction [31](#)
Engine start, jump-starting [208](#)
Engine start, refer to Starting the engine [60](#)
Engine stop [60](#)
Engine temperature [76](#)
Entering a car wash [213](#)
Equipment, interior [145](#)
ESP Electronic Stability Program, refer to DSC [111](#)
Exchanging wheels/tires [184](#)
Exhaust system [161](#)
Exterior mirror, automatic dimming feature [53](#)
Exterior mirrors [52](#)
External start [208](#)
External temperature display [76](#)
External temperature warning [76](#)
Eyes for securing cargo [164](#)

F

Failure message, refer to Check Control [73](#)
False alarm, refer to Unintentional alarm [41](#)

Fan, refer to Air flow [139, 142](#)
Fault displays, refer to Check Control [73](#)
Filler neck for engine oil [190](#)
Fine wood, care [215](#)
First aid kit [208](#)
Fitting for towing, refer to Tow fitting [211](#)
Flat tire, changing wheels [204](#)
Flat Tire Monitor FTM [98](#)
Flat tire, Tire Pressure Monitor TPM [95](#)
Flat tire, warning lamp [96, 99](#)
Flooding [161](#)
Floor carpet, care [215](#)
Floor mats, care [215](#)
Fogged up windows [139](#)
Fold-out position, windshield wipers [66](#)
Foot brake [161](#)
Front airbags [92](#)
Front fog lamps [90](#)
Front fog lamps, front, bulb replacement [201](#)
Front lamps [197](#)
Front passenger airbags, automatic deactivation [94](#)
Front passenger airbags, indicator lamp [94](#)
FTM Flat Tire Monitor [98](#)
Fuel cap [172](#)
Fuel consumption, current [77](#)
Fuel consumption, refer to Average fuel consumption [82](#)
Fuel filler flap [172](#)
Fuel gauge [76](#)
Fuel quality [174](#)
Fuel, tank capacity [223](#)
Fuse [205](#)

G

Garage door opener, refer to Integrated universal remote control [145](#)

Gasoline [174](#)
Gasoline quality [174](#)
Gear change, automatic transmission [67](#)
Gear shift indicator [79](#)
General driving notes [160](#)
Glass sunroof, powered [43](#)
Glove compartment [153](#)
Gross vehicle weight, approved [221](#)

H

Handbrake, refer to parking brake [63](#)
Hand-held transmitter, alternating code [146](#)
Hazard warning flashers [207](#)
Head airbags [92](#)
Headlamp control, automatic [88](#)
Headlamp courtesy delay feature [88](#)
Headlamp flasher [64](#)
Headlamp glass [197](#)
Headlamps [197](#)
Headlamps, care [214](#)
Headlamp washer system [64](#)
Headliner [15](#)
Head restraints [45](#)
Head restraints, front [49](#)
Head restraints, rear [50](#)
Head-up Display [132](#)
Head-up Display, care [216](#)
Heavy cargo, stowing [164](#)
Height, vehicle [220](#)
High-beam Assistant [89](#)
High beams [64](#)
High beams/low beams, refer to High-beam Assistant [89](#)
Hills [162](#)
Hill start assistant, refer to Drive-off assistant [115](#)
Hints [6](#)
Holder for beverages [155](#)
Homepage [6](#)

Hood [188](#)
Horn [12](#)
Hotel function, trunk lid [38](#)
Hot exhaust system [161](#)
HUD Head-up Display [132](#)
Hydroplaning [161](#)

I

Ice warning, refer to External temperature warning [76](#)
Icy roads, refer to External temperature warning [76](#)
Identification marks, tires [182](#)
Identification number, refer to Important features in the engine compartment [187](#)
iDrive [16](#)
Ignition key, refer to Remote control [30](#)
Ignition off [59](#)
Ignition on [59](#)
Indication of a flat tire [96, 99](#)
Individual air distribution [139, 142](#)
Individual settings, refer to Personal Profile [31](#)
Inflation pressure, tires [175](#)
Inflation pressure warning FTM, tires [98](#)
Info display, refer to Computer [81](#)
Initialize, Tire Pressure Monitor TPM [96](#)
Initializing, Flat Tire Monitor FTM [99](#)
Instrument cluster [70](#)
Instrument cluster, electronic displays [72](#)
Instrument lighting [90](#)
Integrated key [30](#)
Integrated universal remote control [145](#)
Intensity, AUTO program [141](#)
Interior equipment [145](#)
Interior lamps [91](#)

Interior lamps via remote control [35](#)
Interior motion sensor [41](#)
Interior rearview mirror [53](#)
Interior rearview mirror, automatic dimming feature [53](#)
Interior rearview mirror, compass [147](#)
Internet page [6](#)
Interval display, service requirements [77](#)

J

Jacking points for the vehicle jack [204](#)
Jack, refer to Vehicle jack [204](#)
Joystick, automatic transmission [67](#)
Jump-starting [208](#)

K

Key/remote control [30](#)
Keyless Go, refer to Comfort Access [38](#)
Key Memory, refer to Personal Profile [31](#)
Kickdown, automatic transmission [67](#)
Knee airbag [93](#)

L

Lamp replacement [196](#)
Lamp replacement, front [197](#)
Lamp replacement, rear [202](#)
Lamps [87](#)
Lamps and bulbs [196](#)
Lane departure warning [104](#)
Lane margin, warning [104](#)
Language on Control Display [85](#)
Lashing eyes, securing cargo [164](#)

LATCH child restraint fixing system [56](#)
Leather, care [214](#)
LEDs, light-emitting diodes [197](#)
Length, vehicle [221](#)
Letters and numbers, entering [22](#)
Light-alloy wheels, care [215](#)
Light control [89](#)
Light-emitting diodes, LEDs [197](#)
Lighter [149](#)
Lighting [87](#)
Lighting via remote control [35](#)
Light switch [87](#)
Load [163](#)
Loading [163](#)
Lock, door [36](#)
Locking/unlocking from inside [37](#)
Locking/unlocking via door lock [36](#)
Locking/unlocking with remote control [34](#)
Locking, automatic [37](#)
Locking, central [33](#)
Lock, power window [42](#)
Locks, doors, and windows [58](#)
Low beams [87](#)
Low beams, automatic, refer to High-beam Assistant [89](#)
Lower back support [47](#)
Luggage rack, refer to Roof-mounted luggage rack [164](#)
Lumbar support [47](#)

M

Maintenance [193](#)
Maintenance requirements [193](#)
Maintenance, service requirements [77](#)

Maintenance system, BMW [193](#)
Malfunction displays, refer to Check Control [73](#)
Manual air distribution [139](#), [142](#)
Manual air flow [139](#), [142](#)
Manual mode, transmission [68](#)
Manual operation, backup camera [127](#)
Manual operation, door lock [36](#)
Manual operation, exterior mirrors [53](#)
Manual operation, fuel filler flap [172](#)
Manual operation, Park Distance Control PDC [125](#)
Manual operation, Side View [131](#)
Manual operation, Top View [130](#)
Manual transmission [67](#)
Marking on approved tires [184](#)
Marking, run-flat tires [185](#)
Master key, refer to Remote control [30](#)
Maximum cooling [141](#)
Maximum speed, display [79](#)
Maximum speed, winter tires [185](#)
Measure, units of [85](#)
Medical kit [208](#)
Memory, seat, mirror [51](#)
Menu, EfficientDynamics [169](#)
Menu in instrument cluster [81](#)
Menus, operating, iDrive [16](#)
Menus, refer to iDrive operating concept [18](#)
Messages, refer to Check Control [73](#)
Microfilter [140](#), [143](#)
Minimum tread, tires [183](#)
Mirror [52](#)

Mirror memory [51](#)
Mobile communication devices in the vehicle [161](#)
Modifications, technical, refer to Safety [7](#)
Moisture in headlamp [197](#)
Monitor, refer to Control Display [16](#)
Mounting of child restraint fixing systems [55](#)
Multifunction steering wheel, buttons [12](#)

N

Navigation, see user's manual for Navigation, Entertainment and Communication
Neck restraints, front, refer to Head restraints [49](#)
Neck restraints, rear, refer to Head restraints [50](#)
New wheels and tires [184](#)
No Passing Information [79](#)
Nylon rope for tow-starting/towing [211](#)

O

OBD Onboard Diagnostics [194](#)
Obstacle marking, backup camera [128](#)
Octane rating, refer to Gasoline quality [174](#)
Odometer [76](#)
Office, see user's manual for Navigation, Entertainment and Communication
Oil [189](#)
Oil, adding [190](#)
Oil additives [190](#)
Oil change [190](#)
Oil change interval, service requirements [77](#)
Oil filler neck [190](#)

Oil types, alternative [190](#)
Oil types, approved [190](#)
Old batteries, disposal [205](#)
Onboard Diagnostics OBD [194](#)
Onboard monitor, refer to Control Display [16](#)
Onboard vehicle tool kit [196](#)
Opening/closing from inside [37](#)
Opening/closing via door lock [36](#)
Opening/closing with remote control [34](#)
Opening the trunk lid with no-touch activation [39](#)
Operating concept, iDrive [16](#)
Optional equipment, standard equipment [6](#)
Outside air, refer to Automatic recirculated-air control [142](#)
Overheating of engine, refer to Coolant temperature [76](#)
Overtaking prohibitions [79](#)

P

Paint, vehicle [214](#)
Panic mode [35](#)
Parallel parking assistant [133](#)
Park Distance Control PDC [124](#)
Parked-car ventilation [143](#)
Parked vehicle, condensation [162](#)
Parking aid, refer to PDC [124](#)
Parking assistant [133](#)
Parking brake [63](#)
Parking lamps [87](#)
Passenger side mirror, tilting downward [53](#)
Pathway lines, backup camera [128](#)
PDC Park Distance Control [124](#)
Personal Profile [31](#)

Pinch protection system, glass sunroof [44](#)
Pinch protection system, windows [42](#)
Plastic, care [215](#)
Power failure [205](#)
Power sunroof, glass [43](#)
Power windows [41](#)
Pressure, tire air pressure [175](#)
Pressure warning FTM, tires [98](#)
Profile, refer to Personal Profile [31](#)
Programmable memory buttons, iDrive [21](#)
Protective function, glass sunroof [44](#)
Protective function, windows [42](#)
Push-and-turn switch, refer to Controller [16, 17](#)

R

Radiator fluid [192](#)
Radio-operated key, refer to Remote control [30](#)
Radio ready state [60](#)
Radio, see user's manual for Navigation, Entertainment and Communication
Rain sensor [65](#)
Rear lamps [202](#)
Rear socket [150](#)
Rearview mirror [52](#)
Rear window defroster [139, 142](#)
Recirculated-air filter [143](#)
Recirculated-air mode [139, 142](#)
Recommended tire brands [184](#)
Refueling [172](#)
Remaining range [77](#)
Remote control/key [30](#)

- Remote control, malfunction 35
- Remote control, universal 145
- Replacement fuse 205
- Replacing parts 196
- Replacing wheels/tires 184
- Reporting safety defects 8
- RES button 118
- Reserve warning, refer to Range 77
- Reset, Tire Pressure Monitor TPM 96
- Retaining straps, securing cargo 164
- Retreaded tires 185
- Roadside parking lamps 88
- Roller sunblinds 43
- RON gasoline quality 174
- Roof load capacity 221
- Roof-mounted luggage rack 164
- Rope for tow-starting/towing 211
- RSC Run Flat System Component, refer to Run-flat tires 185
- Rubber components, care 215
- Run-flat tires 185
- ## S
- Safe braking 161
- Safety 7
- Safety belt reminder for driver's seat and front passenger seat 49
- Safety belts 48
- Safety belts, care 215
- Safety Package, refer to Active Protection 109
- Safety switch, windows 42
- Safety systems, airbags 92
- Saving fuel 0
- Screen, refer to Control Display 16
- Screwdriver 196
- Screw thread for tow fitting 211
- Seat and mirror memory 51
- Seat belts, refer to Safety belts 48
- Seat heating, front 48
- Seat heating, rear 48
- Seating position for children 55
- Seats 45
- Selection list in instrument cluster 81
- Selector lever, automatic transmission 67
- Sensors, care 216
- Service and warranty 7
- Service history 78
- Service requirements, Condition Based Service CBS 193
- Service requirements, display 77
- Service, Roadside Assistance 208
- Settings on Control Display 84
- Settings, storing for seat, mirror 51
- Shifting, automatic transmission 67
- Shifting, manual transmission 67
- Shift paddles on steering wheel 69
- Short commands 224
- Side airbags 92
- Side View 131
- Signaling, horn 12
- Signals when unlocking 35
- Sitting safely 45
- Size 220
- Slide/tilt glass roof 43
- Smallest turning circle 221
- Snow chains 186
- Socket 149
- Socket, OBD Onboard Diagnostics 194
- SOS button 207
- Spare fuse 205
- Specified engine oil types 190
- Speed, average 82
- Speed limit, adjustable 107
- Speed limit detection, on-board computer 82
- Speed Limit Device, refer to Adjustable speed limit 107
- Speed limiter, display 79
- Speed Limit Information 79
- Speed limit in the computer 82
- Split screen 21
- SPORT+ - program, Dynamic Driving Control 113
- Sport automatic transmission 69
- Sport displays, torque display, performance display 84
- SPORT program, Dynamic Driving Control 113
- Sport program, transmission 68
- Sport steering, variable 113
- Stability control systems 111
- Start/stop, automatic function 61
- Start/Stop button 59
- Start function during malfunction 31
- Starting the engine 60
- Status display, tires 95
- Status information, iDrive 20
- Status of Owner's Manual 6
- Steering wheel, adjusting 54
- Steering wheel heating 54
- Steptronic, automatic transmission 67
- Stopping the engine 60
- Storage compartment in the rear 155
- Storage compartments 153

Storage compartments, locations [153](#)
Storage, tires [185](#)
Storing the vehicle [216](#)
Summer tires, tread [183](#)
Supplementary text message [75](#)
Surround View [126](#)
Switch for Dynamic Driving [113](#)
Switch-on times, parked-car ventilation [144](#)
Switch, refer to Cockpit [12](#)
Symbols [6](#)

T

Tachometer [76](#)
Tailgate [37](#)
Tailgate opening with no-touch activation [39](#)
Tailgate via remote control [35](#)
Tail lamps [202](#)
Technical changes, refer to Safety [7](#)
Technical data [220](#)
Telephone, see user's manual for Navigation, Entertainment and Communication
Temperature, automatic climate control [139](#), [141](#)
Temperature display, external temperature [76](#)
Temperature, engine oil [76](#)
Tempomat, refer to Active Cruise Control [116](#)
Terminal, jump-starting [209](#)
Text message, supplementary [75](#)
Theft alarm system, refer to Alarm system [40](#)
Theft protection, refer to Central locking system [33](#)
Thigh support [47](#)
Through-loading system [151](#)
Tilt alarm sensor [41](#)

Time of arrival [82](#)
Tire damage [183](#)
Tire identification marks [182](#)
Tire inflation pressure [175](#)
Tire inflation pressure monitor, refer to FTM [98](#)
Tire Pressure Monitor TPM [95](#)
Tires, changing [184](#)
Tires, everything on wheels and tires [175](#)
Tires, run-flat tires [185](#)
Tire tread [183](#)
Tone, see user's manual for Navigation, Entertainment and Communication
Tools [196](#)
Top View [129](#)
Total vehicle weight [221](#)
Tow fitting [211](#)
Towing [210](#)
Tow-starting [210](#)
Tow truck [210](#)
TPM Tire Pressure Monitor [95](#)
Traction control [112](#)
TRACTION program, Dynamic Driving Control [112](#)
Transmission, automatic [67](#)
Transmission, manual [67](#)
Transporting children safely [55](#)
Tread, tires [183](#)
Trip computer [83](#)
Triple turn signal activation [64](#)
Trip odometer [76](#)
Truck for tow-starting/towing [210](#)
Trunk lid [37](#)
Trunk lid, emergency unlocking [38](#)
Trunk lid, hotel function [38](#)
Trunk lid opening with no-touch activation [39](#)

Trunk lid via remote control [35](#)
Turning circle [221](#)
Turning circle lines, backup camera [128](#)
Turn signals, operation [63](#)
Turn signals, rear, bulb replacement [202](#)

U

Unintentional alarm [41](#)
Units of measure [85](#)
Universal remote control [145](#)
Unlock button, automatic transmission [67](#)
Unlocking/locking from inside [37](#)
Unlocking/locking via door lock [36](#)
Unlocking/locking with remote control [34](#)
Updates made after the editorial deadline [7](#)
Upholstery care [215](#)
USB interface [150](#)

V

Variable sport steering [113](#)
Vehicle battery [204](#)
Vehicle battery, replacing [204](#)
Vehicle, breaking in [160](#)
Vehicle care [214](#)
Vehicle equipment [6](#)
Vehicle identification number, refer to Identification number in the engine compartment [187](#)
Vehicle jack [204](#)
Vehicle paint [214](#)
Vehicle storage [216](#)
Vehicle wash [213](#)
Ventilation [143](#)
Ventilation, refer to Parked-car ventilation [143](#)

Voice activation, short commands [224](#)

Voice activation system [23](#)

W

Warning messages, refer to
Check Control [73](#)

Warning triangle [208](#)

Washer fluid [66](#)

Washer fluid reservoir, capacity [223](#)

Washer nozzles, windshield [66](#)

Washer system [64](#)

Washing, vehicle [213](#)

Water on roads [161](#)

Weights [221](#)

Welcome lamps [87](#)

Wheel base, vehicle [221](#)

Wheels, changing [184](#)

Wheels, everything on wheels and tires [175](#)

Wheels, Flat Tire Monitor
FTM [98](#)

Wheels, Tire Pressure Monitor
TPM [95](#)

Width, vehicle [220](#)

Window defroster,
rear [139](#), [142](#)

Windows, powered [41](#)

Windshield washer fluid [66](#)

Windshield washer nozzles [66](#)

Windshield washer system [64](#)

Windshield wiper [64](#)

Windshield wipers, fold-out
position [66](#)

Winter storage, care [216](#)

Winter tires, suitable tires [185](#)

Winter tires, tread [183](#)

Wiper blades, replacing [196](#)

Wiper fluid [66](#)

Wiper system [64](#)

Wood, care [215](#)

Word match concept, navigation [22](#)

Wrench [196](#)

X

xDrive [112](#)

Xenon headlamps, bulb replacement [200](#)

More about BMW



The Ultimate Driving
Machine

bmwusa.com

01 40 2 903 880 ue



Online Edition for Part no. 01 40 2 903 880 - 07 12 490