

Contents

A-Z

Owner's Manual for
Vehicle



The Ultimate Driving
Machine



THE BMW X5.

OWNER'S MANUAL.

BMW EfficientDynamics
Less emissions. More driving pleasure.

X5 xDrive35i
X5 xDrive50i
X5 xDrive35d
X6 xDrive35i
X6 xDrive50i
X5 M
X6 M

Owner's Manual for Vehicle

Thank you for choosing a BMW.

The more familiar you are with your vehicle, the better control you will have on the road. We therefore strongly suggest:

Read this Owner's Manual before starting off in your new BMW. It contains important information on vehicle operation that will help you make full use of the technical features available in your BMW. The manual also contains information designed to enhance operating reliability and road safety, and to contribute to maintaining the value of your BMW.

Please also note the additional items of onboard literature, for instance the BMW X5 M / BMW X6 M Supplementary Owner's Manual.

We wish you a safe and enjoyable drive.

BMW AG

© 2012 Bayerische Motoren Werke
Aktiengesellschaft
Munich, Germany
Reprinting, including excerpts, only with the written
consent of BMW AG, Munich.
US English II/12, 03 12 500
Printed on environmentally friendly paper, bleached
without chlorine, suitable for recycling.

Contents

The fastest way to find information on a particular topic or item is by using the index, refer to page 324.

6 Notes

At a glance

12 Cockpit
18 iDrive
25 Voice activation system

Controls

30 Opening and closing
48 Adjusting
60 Transporting children safely
66 Driving
77 Displays
88 Lamps
93 Safety
103 Driving stability control systems
109 Driving comfort
127 Climate
135 Interior equipment
143 Storage compartments

Driving tips

152 Things to remember when driving

Navigation

162 Navigation system
164 Destination entry
173 Destination guidance
181 What to do if...

Entertainment

184 Tone
186 Radio
194 CD/multimedia
215 DVD system in rear

Communication

230 Telephone
242 Office
251 Contacts
253 ConnectedDrive

Mobility

262 Refueling
264 Fuel
269 Wheels and tires
281 Engine compartment
286 Maintenance
288 Replacing components
300 Breakdown assistance
305 Care

Reference

312 Technical data
316 Short commands for voice activation system
324 Everything from A to Z

Notes

Using this Owner's Manual

The fastest way to find information on a particular topic is by using the index.

An initial overview of the vehicle is provided in the first chapter.

Additional sources of information

Should you have any questions, your service center will be glad to advise you at any time.

Information on BMW, e.g., on technology, is available on the Internet: bmwusa.com

Symbols

 Indicates precautions that must be followed precisely in order to avoid the possibility of personal injury and serious damage to the vehicle.

◄ Marks the end of a specific item of information.

"..." Identifies Control Display texts used to select individual functions.

>...< Verbal instructions to use with the voice activation system.

>...<< Identifies the answers generated by the voice activation system.

 Refers to measures that can be taken to help protect the environment.

Symbols on vehicle components

 Indicates that you should consult the relevant section of this Owner's Manual for information on a particular part or assembly.

Vehicle equipment

This Owner's Manual describes all models, all series equipment, as well as country-specific and special equipment offered in the model series. Therefore, this Owner's Manual also de-

scribes and depicts equipment that may not be contained in your vehicle because of the selected special equipment or country version, for example.

This also applies to safety-related functions and systems.

For options and equipment not described in this Owner's Manual, please refer to the Supplementary Owner's Manuals.

On right-hand drive vehicles, some controls are arranged differently than shown in the illustrations.

Status of this Owner's Manual at time of printing

The manufacturer of your vehicle pursues a policy of constant development that is conceived to ensure that our vehicles continue to embody the highest quality and safety standards. In rare cases, therefore, the features described in this Owner's Manual may differ from those in your vehicle.

Updates made after the editorial deadline

Any updates made after the editorial deadline for the Owner's Manuals are located in the appendix of the printed quick reference for the vehicle.

For your own safety

Maintenance and repairs

Advanced technology, e.g., the use of modern materials and high-performance electronics, requires suitable maintenance and repair methods.

Therefore, have this work performed only by a BMW center or a workshop that works accord-

ing to BMW repair procedures with appropriately trained personnel.

If this work is not carried out properly, there is the danger of subsequent damage and related safety hazards.

Parts and accessories

For your own safety, use genuine parts and accessories approved by BMW. When you purchase accessories tested and approved by BMW and Genuine BMW Parts, you simultaneously acquire the assurance that they have been thoroughly tested by BMW to ensure optimum performance when installed on your vehicle. BMW warrants these parts to be free from defects in material and workmanship. BMW will not accept any liability for damage resulting from installation of parts and accessories not approved by BMW. BMW cannot test every product made by other manufacturers to verify if it can be used on a BMW safely and without risk to either the vehicle, its operation, or its occupants. Genuine BMW Parts, BMW Accessories and other products approved by BMW, together with professional advice on using these items, are available from all BMW centers. Installation and operation of non-BMW approved accessories such as alarms, radios, amplifiers, radar detectors, wheels, suspension components, brake dust shields, telephones, including operation of any mobile phone from within the vehicle without using an externally mounted antenna, or transceiver equipment, for instance, CBs, walkie-talkies, ham radios or similar accessories, may cause extensive damage to the vehicle, compromise its safety, interfere with the vehicle's electrical system or affect the validity of the BMW Limited Warranty. See your BMW center for additional information. Maintenance, replacement, or repair of the emission control devices and systems may be performed by any automotive repair establishment or individual using any certified automotive part.

California Proposition 65 Warning

California laws require us to state the following warning:

Engine exhaust and a wide variety of automobile components and parts, including components found in the interior furnishings in a vehicle, contain or emit chemicals known to the State of California to cause cancer and birth defects and reproductive harm. In addition, certain fluids contained in vehicles and certain products of component wear contain or emit chemicals known to the State of California to cause cancer and birth defects or other reproductive harm. Battery posts, terminals and related accessories contain lead and lead compounds. Wash your hands after handling. Used engine oil contains chemicals that have caused cancer in laboratory animals. Always protect your skin by washing thoroughly with soap and water.

Service and warranty

We recommend that you read this publication thoroughly. Your vehicle is covered by the following warranties:

- ▷ New Vehicle Limited Warranty
- ▷ Rust Perforation Limited Warranty
- ▷ Federal Emissions System Defect Warranty
- ▷ Federal Emissions Performance Warranty
- ▷ California Emission Control System Limited Warranty

Detailed information about these warranties is listed in the Service and Warranty Information Booklet for US models or in the Warranty and Service Guide Booklet for Canadian models.

Your vehicle has been specifically adapted and designed to meet the particular operating conditions and homologation requirements in your country and continental region in order to deliver the full driving pleasure while the vehicle is operated under those conditions. If you wish to operate your vehicle in another country or region, you may be required to adapt your vehicle to meet different prevailing operating conditions and homologation requirements. You should

also be aware of any applicable warranty limitations or exclusions for such country or region. In such case, please contact Customer Relations for further information.

Maintenance

Maintain the vehicle regularly to sustain the road safety, operational reliability and the New Vehicle Limited Warranty.

Specifications for required maintenance measures:

- ▷ BMW Maintenance system
- ▷ Service and Warranty Information Booklet for US models
- ▷ Warranty and Service Guide Booklet for Canadian models

If the vehicle is not maintained according to these specifications, this could result in serious damage to the vehicle. Such damage is not covered by the BMW New Vehicle Limited Warranty.

Reporting safety defects

For US customers

The following only applies to vehicles owned and operated in the US.

If you believe that your vehicle has a defect which could cause a crash or could cause injury or death, you should immediately inform the National Highway Traffic Safety Administration NHTSA, in addition to notifying BMW of North America, LLC, P.O. Box 1227, Westwood, New Jersey 07675-1227, Telephone 1-800-831-1117.

If NHTSA receives similar complaints, it may open an investigation, and if it finds that a safety defect exists in a group of vehicles, it may order a recall and remedy campaign.

However, NHTSA cannot become involved in individual problems between you, your dealer, or BMW of North America, LLC.

To contact NHTSA, you may call the Vehicle Safety Hotline toll-free at 1-888-327-4236 (TTY: 1-800-424-9153); go to <http://www.safercar.gov>; or write to: Administrator, NHTSA, 400 Seventh Street, SW., Washington, DC 20590. You can also obtain other information about motor vehicle safety from <http://www.safercar.gov>

For Canadian customers

Canadian customers who wish to report a safety-related defect to Transport Canada, Defect Investigations and Recalls, may telephone the toll-free hotline 1-800-333-0510. You can also obtain other information about motor vehicle safety from <http://www.tc.gc.ca/roadsafety>.



At a glance

These overviews of buttons, switches and displays are intended to familiarize you with your vehicle. You will also become quickly acquainted with the available control concepts and options.

Cockpit

Vehicle equipment

This chapter describes all series equipment as well as country-specific and special equipment offered for this model series. Therefore, it also

describes equipment that may not be found in your vehicle, for instance due to the selected special equipment or the country version. This also applies to safety-related functions and systems.

All around the steering wheel

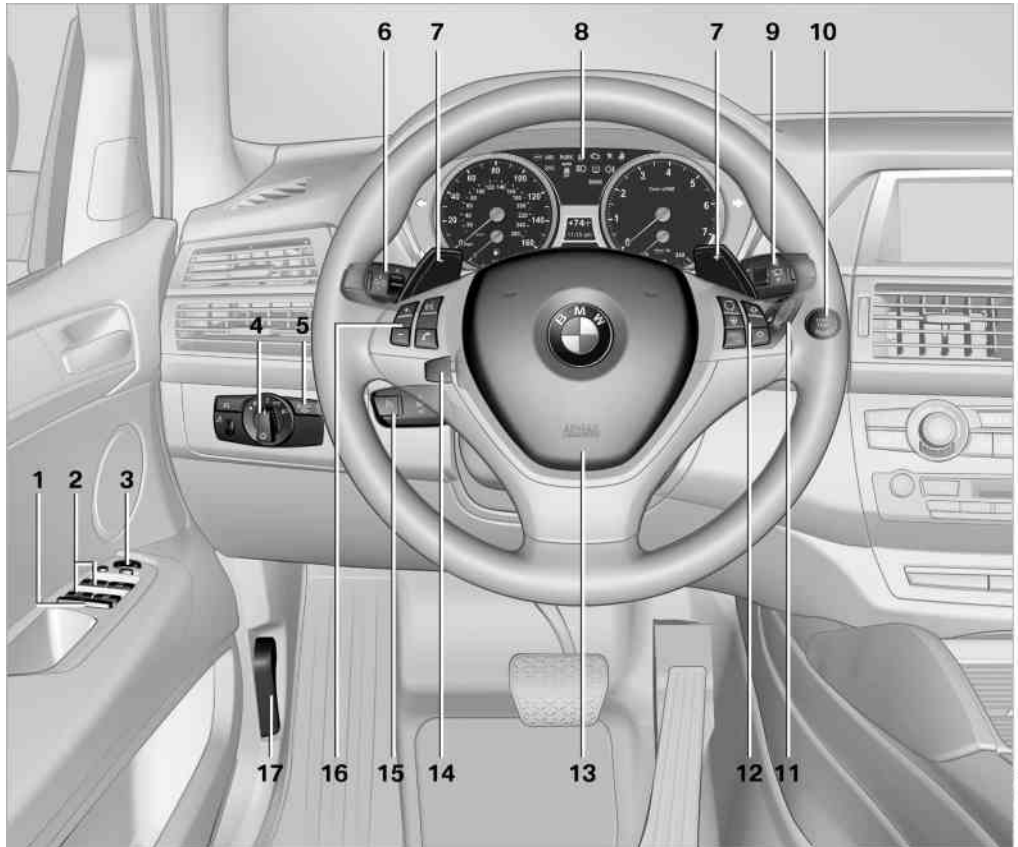



























- 1 Rear window safety switch 44
- 2 Power windows 43
- 3 Exterior mirror operation 57
- 4 Lamps



Instrument lighting 92



Front fog lamps 91

-  Parking lamps [88](#)
-  Low beams [88](#)
-  Automatic headlamp control [89](#)
-  Adaptive light control [89](#)
-  High-beam Assistant [90](#)
- 5**  Head-up Display [125](#)
- 6** Steering column stalk, left
-  Turn signal [71](#)
-  High beams, headlamp flasher [90](#)
-  High-beam Assistant [90](#)
-  Roadside parking lamps [90](#)
-  Computer [79](#)
-  Settings and information about the vehicle [77](#)
- 7** BMW X6: shifting up or down with automatic transmission [74](#)
- 8** Instrument cluster [14](#)
- 9** Steering column stalk, right
-  Windshield wipers [72](#)
-  Rain sensor [72](#)
-  BMW X5: rear window wipers [73](#)
- 10**  Start/stop the engine and switch the ignition on/off [66](#)
- 11** Ignition lock [66](#)
- 12** Steering wheel buttons, right
-  Change the radio station
-  Stopping a traffic announcement
-  Select a music track
-  Scrolling through the redial list
-  Next entertainment source
-  Recirculated-air mode [130](#)
-  Steering wheel heating [59](#)
-  Lane departure warning [100](#)
- 13** Horn, the entire surface
- 14** 
- 15** Cruise control lever
-  Cruise control [116](#)
-  Active cruise control [109](#)
- 16** Steering wheel buttons, left



Telephone 230

17 Releasing the hood 282



Volume



Activate/deactivate the voice activation system 25

Instrument cluster

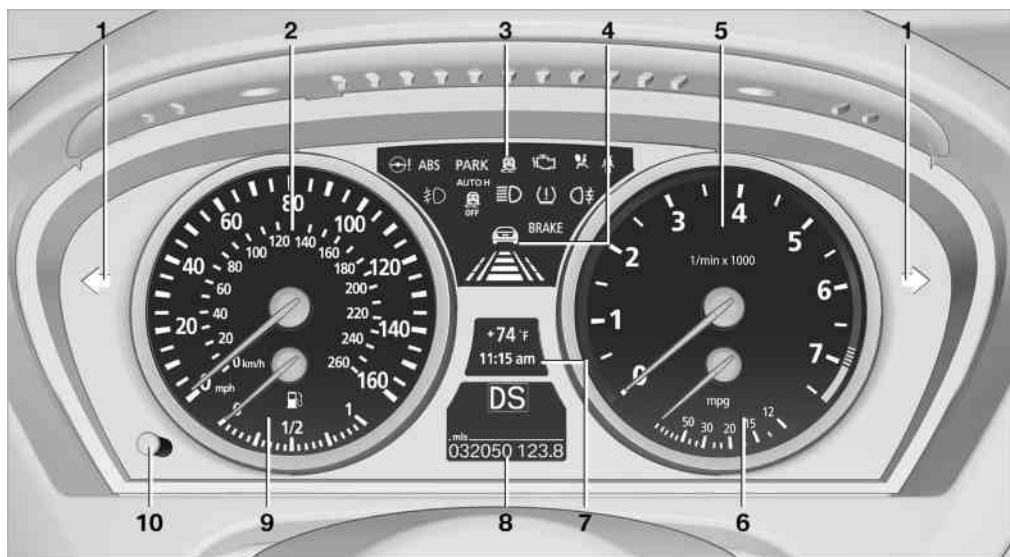

- 1 Turn signal indicator lamp
- 2 Speedometer
- 3 Indicator/warning lamps 15
- 4 Active Cruise Control 109
- 5 Tachometer 78
- 6 BMW X5: current fuel consumption 78
BMW X6: engine oil temperature 78 or current fuel consumption 78
- 7 Display for
 - ▷ Clock 77
 - ▷ External temperature 77
- 8 Display for
 - ▷ Indicator/warning lamps 15
 - ▷ Cruise control 116
 - ▷ Active Cruise Control 109
 - ▷ BMW X5: reserve display for diesel exhaust fluid 265
 - ▷ Automatic transmission position 74
 - ▷ HDC Hill Descent Control 106
 - ▷ Computer 79
 - ▷ Date of next scheduled service, and remaining distance to be driven 81

- ▶ Odometer and trip odometer [77](#)
 - ▶ High-beam Assistant [90](#)
 - ▶ ▲ Check Control message present [83](#)
 - ▶ Adaptive Drive: sport chassis and suspension tuning [107](#)
- 9** Fuel gauge [79](#)
- 10** Resetting the trip odometer [77](#)
- Viewing service requirement display [78](#)

Indicator/warning lamps

The concept



The indicator and warning lamps can light up in a variety of combinations and colors.

Several of the lamps are checked for proper functioning when the engine is started or the ignition is switched on, and light up briefly.

Text messages

Text messages at the upper edge of the Control Display explain the meaning of the displayed indicator and warning lamps.

Supplementary text messages

You can call up more information, e.g., on the cause of a malfunction and on how to respond, via Check Control, refer to page [83](#).

In urgent cases, this information will be shown as soon as the corresponding lamp comes on.







Indicator lamps without text messages

The following indicator lamps notify you that certain functions are active:

Symbol	Function or system
	Parking brake set, refer to page 68
	Canada: parking brake set, refer to page 68 .
	High beams/headlamp flasher, refer to page 90
	Front fog lamps, refer to page 91
	Lamp flashes: DSC or DTC controls the drive and braking forces for maintaining vehicle stability, refer to page 103
	Engine malfunction with adverse effect on emissions, refer to page 287

All around the center console



- | | | | | | | |
|---|---|-----|---|---|---------------------------|-------|
| 1 | Headliner | 17 | 7 |  | Open the tailgate | 36 38 |
| 2 | Control Display | 19 | |  | Active seat | 53 |
| 3 |  Hazard warning system | 300 | |  | Park Distance Control PDC | 117 |
| |  Central locking system | 35 | | | Top View | 122 |
| 4 | Opening glove compartment | 143 | | | Backup camera | 120 |
| 5 | Automatic climate control with 2-zone control | 128 | |  | HDC Hill Descent Control | 104 |
| | Automatic climate control with 4-zone control | 132 | | | | |
| 6 | Radio and CD/DVD drive | 186 | | | | |



DSC Dynamic Stability Control [103](#)

DTC Dynamic Traction Control [104](#)



Side View [124](#)

8 Controller with buttons [18](#)

9 Automatic Hold [69](#)



10  Parking brake [68](#)

11 Adaptive Drive [107](#)

12 Selector lever for automatic transmission [74](#)

All around the headliner

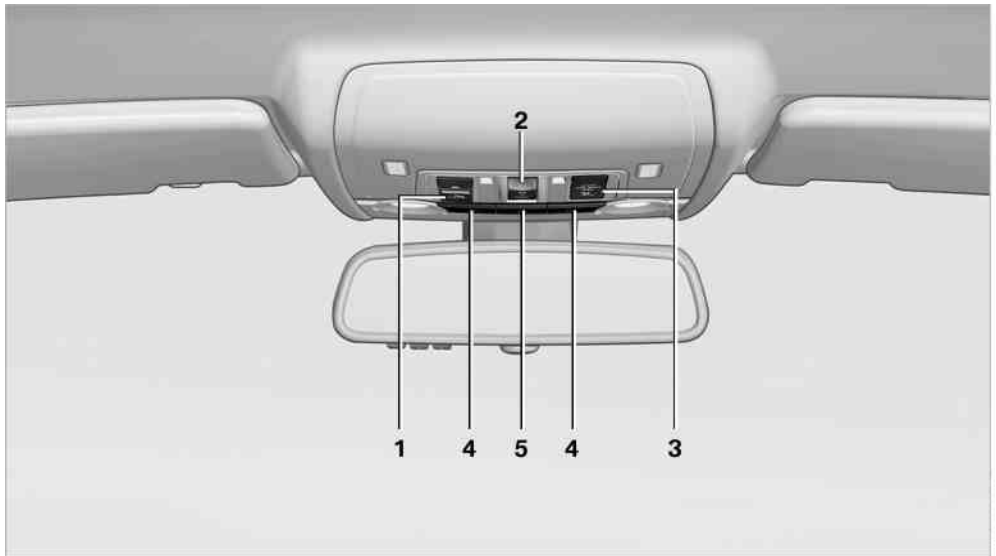

1  Emergency Request [300](#)

2  Glass sunroof [45](#) [46](#)

3  Indicator lamp for the front passenger airbags [95](#)

4  Reading lamps [92](#)

5  Interior lamps [92](#)

iDrive

Vehicle equipment

This chapter describes all series equipment as well as country-specific and special equipment offered for this model series. Therefore, it also describes equipment that may not be found in your vehicle, for instance due to the selected special equipment or the country version. This also applies to safety-related functions and systems.

The concept

The iDrive combines the functions of a multitude of switches. Thus, these functions can be operated from a central location.

Controls at a glance

Controls

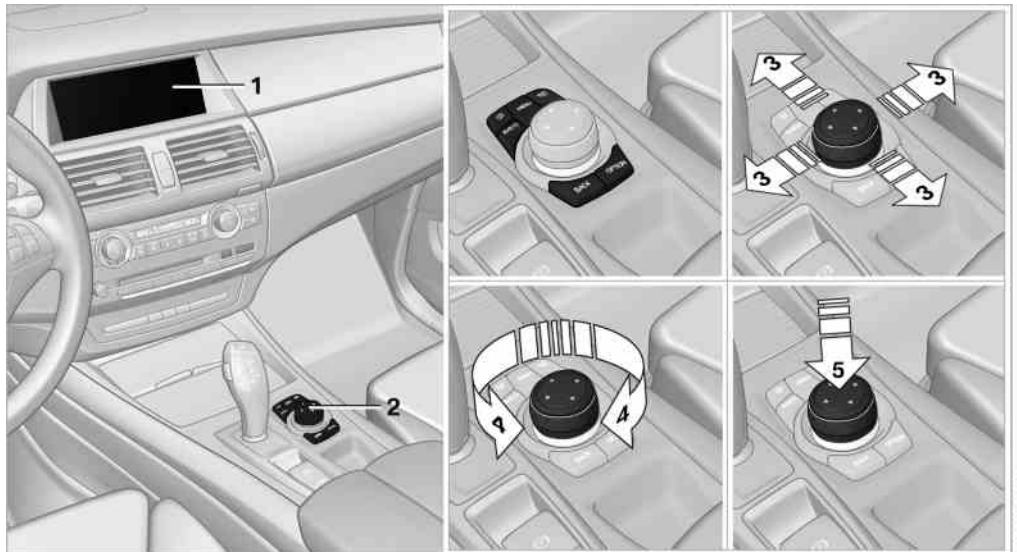

1 Control Display

2 Controller with buttons



Using the iDrive during a trip

To avoid becoming distracted and posing an unnecessary hazard to your vehicle's occupants and to other road users, never attempt to use the controls or enter information unless traffic and road conditions allow this. ◀

The buttons can be used to open the menus directly. The controller can be used to select menu items and create the settings.

The buttons can be used to open the menus directly. The controller can be used to select menu items and create the settings.

- ▶ Move in four directions, arrow 3
- ▶ Turn, arrow 4
- ▶ Push, arrow 5

Buttons on controller

Press the button	Function
MENU	Opens the main menu.
RADIO	Opens the Radio menu.
CD	Opens the CD/Multimedia menu.
NAV	Opens the Navigation menu.
TEL	Opens the Telephone menu.
BACK	Displays the previous panel.
OPTION	Opens the Options menu.

Control Display

Notes

- ▶ To clean the Control Display, follow the care instructions, refer to page 308.
- ▶ Do not place objects close to the Control Display; otherwise, the Control Display can be damaged.

Switching off

1.  Press the button.

2. "Switch off control display"

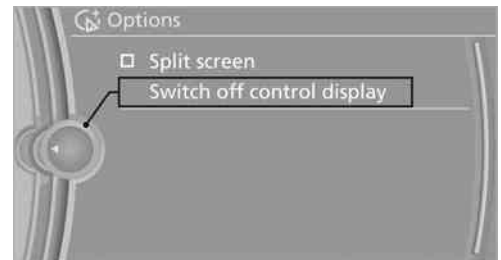

Switching on

Press the controller again to switch the screen back on.

Operating concept

Opening the main menu

1.  Press the button.

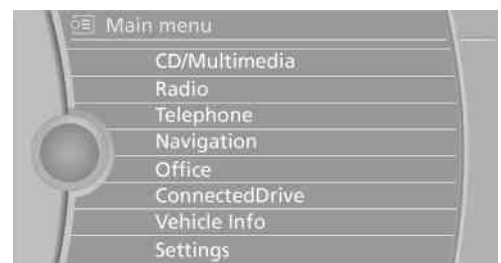

The main menu is displayed.

All iDrive functions can be called up via the main menu.

Selecting menu items

Menu items shown in white can be selected.

1. Turn the controller until the desired menu item is highlighted.

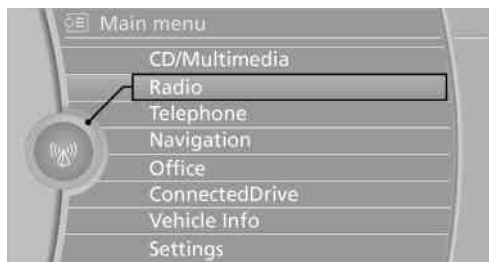

2. Press the controller.

Menu items in the Owner's Manual

In the Owner's Manual, menu items that can be selected are set in quotation marks, e.g., "Settings".

Changing between panels

After a menu item is selected, e.g., "Radio", a new panel is displayed. Panels can overlap.

- ▷ Move the controller to the left.

The current panel is closed and the previous panel is displayed.

The previous panel is opened again by pressing the BACK button. In this case, the current panel is not closed.
- ▷ Move the controller to the right.

A new panel is opened on top of the previous display.

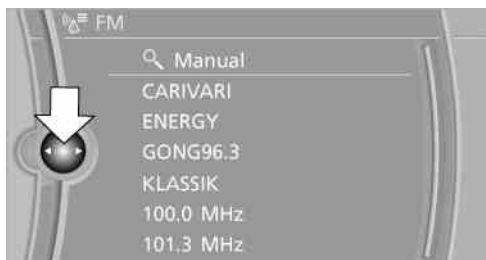

White arrows pointing to the left or right indicate that additional panels can be opened.

View of an opened menu

When a menu is opened, it generally opens with the panel that was last selected in that menu. To display the first panel of a menu:

- ▷ Move the controller to the left repeatedly until the first panel is displayed.
- ▷ Press the menu button on the controller twice.

Opening the Options menu

 Press the button.

The "Options" menu is displayed.



Additional options: move the controller to the right repeatedly until the "Options" menu is displayed.

Options menu

The "Options" menu consists of various areas:

- ▷ Screen settings, e.g., "Switch off control display".

- ▷ Control options for the selected main menu, e.g., for "Radio".
- ▷ If applicable, further operating options for the selected menu, for instance "Store station".

Changing settings

1. Select a field.
2. Turn the controller until the desired setting is displayed.

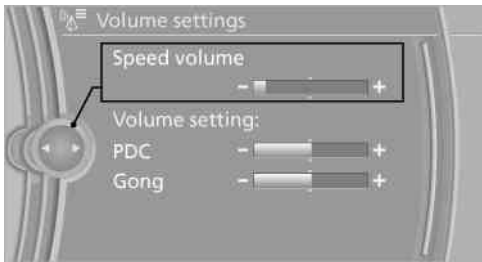

3. Press the controller.

Activating/deactivating the functions

Several menu items are preceded by a checkbox. It indicates whether the function is activated or deactivated. Selecting the menu item activates or deactivates the function.

- The function is activated.
- The function is deactivated.

Example: setting the clock

Setting the clock

1.  Press the button. The main menu is displayed.
2. Turn the controller until "Settings" is highlighted, and then press the controller.

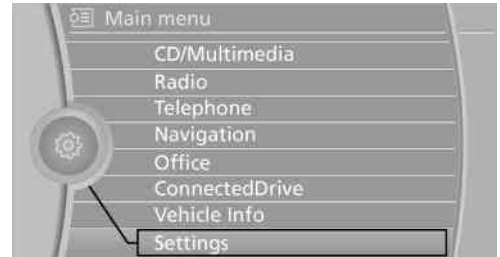

3. If necessary, move the controller to the left to display "Time/Date".
4. Turn the controller until "Time/Date" is highlighted, and then press the controller.



5. Turn the controller until "Time:" is highlighted, and then press the controller.



6. Turn the controller to set the hours and press the controller.
7. Turn the controller to set the minutes and press the controller.

Status information

Status field



The following information is displayed in the status field at the top right:

- ▷ Time.
- ▷ Current entertainment source.
- ▷ Sound output, on/off.
- ▷ Wireless network reception strength.
- ▷ Telephone status.
- ▷ Traffic bulletin reception.





Status field symbols







The symbols are grouped into various categories.

Radio symbols







Symbol	Meaning
	HD Radio™ is switched on.
	Satellite radio is switched on.

Telephone symbols



Symbol	Meaning
	Incoming or outgoing call.
	Missed call.
	Wireless network reception strength Symbol flashes: searching for network.
	Wireless network is not available.
	Bluetooth is switched on.

Symbol	Meaning
	Roaming is active.
	Text message, e-mail was received.
	Check the SIM card.
	SIM card is blocked.
	SIM card is missing.
	Enter the PIN.

Entertainment symbols

Symbol	Meaning
	CD/DVD player.
	Music collection.
	Gracenote® database.
	AUX-IN port.
	USB audio interface.
	Mobile phone audio interface.

Additional symbols

Symbol	Meaning
	Spoken instructions are switched off.
	Request of the current vehicle position.

Split screen

General information

Additional information can be displayed on the right side of the split screen, e.g., information from the computer.

In the divided screen view, the so-called split screen, this information remains visible even when you change to another menu.

Switching the split screen on and off

1.  Press the button.
2. "Split screen"

Selecting the display

1.  Press the button.
2. "Split screen"
3. Move the controller until the split screen is selected.
4. Press the controller or select "Split screen content".
5. Select the desired menu item.



Programmable memory buttons

General information

The iDrive functions can be stored on the programmable memory buttons and called up directly, e.g., radio stations, navigation destinations, phone numbers and entry points into the menu.

The settings are stored for the remote control currently in use.

Saving a function

1. Highlight the function via the iDrive.
2.  Press the desired button for more than two seconds.

Running a function

1.  Press the button. The function will run immediately. This means, for example, that the number is dialed when a phone number is selected.

Displaying the button assignment

Use a finger to touch the buttons. Do not wear gloves or use objects.

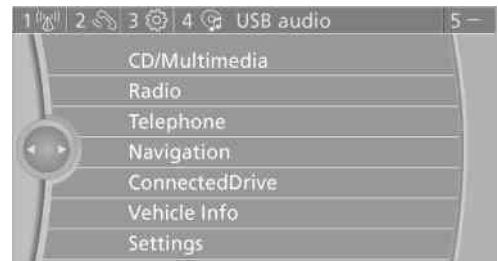

The key assignment is displayed at the top edge of the screen.



- ▶ To display short information: touch the button.
- ▶ To display detailed information: touch the button for an extended period.

Entering letters and numbers

1. Turn the controller: select letters or numbers.
2. Select additional letters or numbers if needed.
3. "OK": confirm the entry.

Symbol	Function
	Press the controller: delete the letter or number.
	Press the controller for an extended period: delete all letters or numbers.
	Enter a blank space.

Switching between letters and numbers

Depending on the menu, you can switch between entering letters and numbers.

Symbol	Function
A^BC	Enter the letters.
1@+	Enter the numbers.

Switching between upper and lower case letters

Depending on the menu, you can switch between entering uppercase and lowercase letters.

Symbol	Function
▲ abc	Move the controller forward: switch from upper to lower case letters.
▲ ABC	Move the controller forward: switch from lower to upper case letters.

Entry comparison

Entry of names and addresses: the selection is narrowed down every time a letter is entered and letters may be added automatically.

The entries are continuously compared to the data stored in the vehicle.

- ▷ Only those letters are offered during the entry for which data is available.
- ▷ Destination search: town/city names can be entered using the spelling of language available on the Control Display.

Voice activation system

Vehicle equipment

This chapter describes all series equipment as well as country-specific and special equipment offered for this model series. Therefore, it also describes equipment that may not be found in your vehicle, for instance due to the selected special equipment or the country version. This also applies to safety-related functions and systems.

The concept

- ▶ Most functions that are displayed on the Control Display can be operated with the voice activation system using spoken commands. The system prompts you to make your entries.
- ▶ Functions that can only be used when the vehicle is stationary cannot be operated using the voice activation system.
- ▶ The system uses a special microphone located in the area of the interior rearview mirror.
- ▶ >...< Verbal instructions in the Owner's Manual to use with the voice activation system.

Requirements

Via the Control Display, set a language that is also supported by the voice activation system so that the spoken commands can be identified. Set the language, refer to page 86.

Using voice activation

Activating the voice activation system

1.  Press the button on the steering wheel.

2. Wait for the signal.

3. Say the command.

The command appears on the Control Display.

 The symbol on the Control Display indicates that the voice activation system is active.

If no other commands are available, operate the function via iDrive in this case.

Terminating the voice activation system

 Briefly press the button on the steering wheel or >Cancel<.

Possible commands

Most menu items on the Control Display can be voiced as commands.

The available commands depend on the menu that is currently displayed on the Control Display.

The functions of the main menu have short commands.

Some list items, such as the phone book entries, can also be selected via the voice activation system. Say the list items exactly as they are displayed on the list.

Having possible commands read aloud

You can have the system read possible commands aloud: >Voice commands<.

For example, if the "Settings" menu is displayed, the commands for the settings are read out loud.

Executing functions using short commands

Functions on the main menu can be performed directly by means of short commands, usually irrespective of which menu item is currently selected, for instance ›Vehicle status‹.

List of short commands of the voice activation system, refer to page 316.

Help dialog for the voice activation system

Calling up help dialog: ›Help‹

Additional commands for the help dialog:

- ▷ ›Help with examples‹: information about the current operating options and the most important commands for them are announced.
- ▷ ›Help with voice activation‹: information about the principle of operation for the voice activation system is announced.

Example: playing back a CD

1. Switch on the Entertainment sound output if necessary.
2.  Press the button on the steering wheel.
3. ›C D and multimedia‹
The medium last played is played back.
4. ›C D track ...‹ e.g., CD track 4.

Setting the voice dialog

You can set whether the system should use the standard dialog or a shorter version.

In the shorter variant of the voice dialog, the announcements from the system are issued in an abbreviated form.

On the Control Display:

1. "Settings"
2. "Language/Units"
3. "Speech mode:"
4. Select the setting.

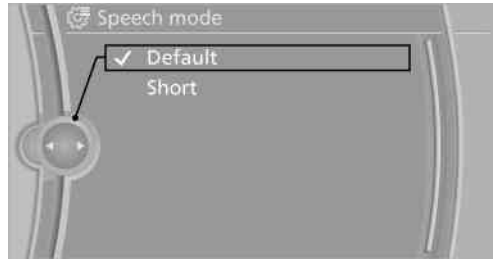

Adjusting the volume

Turn the volume knob while giving an instruction until the desired volume is set.

- ▷ The volume remains constant even if the volume of other audio sources is changed.
- ▷ The volume is stored for the remote control currently in use.

Notes on Emergency Requests

Do not use the voice activation system to initiate an Emergency Request. In stressful situations, the voice and vocal pitch can change. This can unnecessarily delay the establishment of a telephone connection.

Instead, use the SOS button, refer to page 300, in the vicinity of the interior mirror.

Environmental conditions

- ▷ Say the commands, numbers, and letters smoothly and with normal volume, emphasis, and speed.

- ▶ Always say commands in the language of the voice activation system.
- ▶ Keep doors, windows and /panoramic glass sunroof closed to prevent noise interference.
- ▶ Avoid making other noise in the vehicle while speaking.



Controls

This chapter is intended to provide you with information that will give you complete control of your vehicle. All features and accessories that are useful for driving and your safety, comfort and convenience are described here.

Opening and closing

Vehicle equipment

This chapter describes all series equipment as well as country-specific and special equipment offered for this model series. Therefore, it also describes equipment that may not be found in your vehicle, for instance due to the selected special equipment or the country version. This also applies to safety-related functions and systems.

Remote control/key

Buttons on the remote control

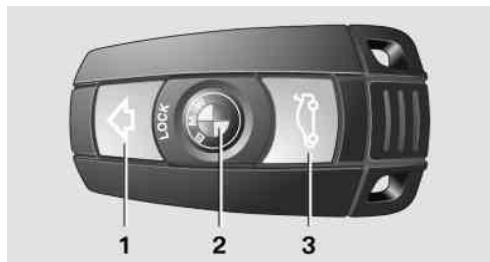

- 1 Unlocking
- 2 Locking
- 3 Opening tailgate

General information

The vehicle is supplied with two remote controls with keys.

Each remote control contains a rechargeable battery that is automatically recharged when it is in the ignition lock while the car is being driven. Use each remote control at least twice a year for longer road trips in order to maintain the batteries' charge status.

In vehicles equipped with Comfort Access, the remote control contains a replaceable battery, refer to page 42.

The settings called up and implemented when the vehicle is unlocked depend on which remote control is used to unlock the vehicle, refer to Personal Profile.

In addition, information about service requirements is stored in the remote control, Service data in the remote control, refer to page 286.

Integrated key

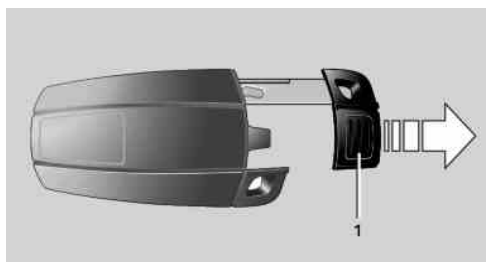

Press button 1 and pull out the key.

The integrated key fits the following locks:

- ▷ Driver's door, refer to page 34.
- ▷ Cargo floor cover in cargo area, refer to page 146.

New remote controls

You can obtain new remote controls from your service center.

Loss of the remote controls

Lost remote controls can be blocked by your service center.

Personal Profile

The concept

You can set several of your vehicle's functions to suit your personal needs and preferences.

- ▷ The settings are automatically saved in the profile currently activated in the remote control.
- ▷ The remote control used is detected when the vehicle is unlocked and the stored profile is called up.
- ▷ Your personal settings will be recognized and called up again even if the vehicle has been used in the meantime by someone else with another remote control.

The individual settings are stored for a maximum of four remote controls. They are stored for two remote controls if Comfort Access is in use.

Personal Profile settings

The following functions and settings can be stored in a profile.

More information on the settings can be found under:

- ▷ Assigning the programmable memory buttons, refer to page 23.
- ▷ Response of the central locking system when the car is being unlocked, refer to page 32.
- ▷ Automatic locking of the vehicle, refer to page 35.
- ▷ Driver's seat, exterior mirror and steering wheel positions, refer to page 56.
- ▷ Settings for the display on the Control Display and in the instrument cluster:
 - ▷ 12h/24h clock format, refer to page 85.
 - ▷ Date format, refer to page 86.
 - ▷ Brightness of the Control Display, refer to page 86.
 - ▷ Language on the Control Display, refer to page 86.
 - ▷ Units of measure for fuel consumption, distance covered/remaining distances, and temperature, refer to page 86.
- ▷ Show visual warning for the Park Distance Control PDC, refer to page 119.
- ▷ Show visual warning for Top View, refer to page 122.
- ▷ Show Side View, refer to page 124.
- ▷ Backup camera:
 - ▷ Function selection, refer to page 120.
 - ▷ Type of display, refer to page 122.
- ▷ Lane departure warning: last setting, on/off, refer to page 100.
- ▷ Head-up Display: selection, brightness and position of the display, refer to page 125.
- ▷ Adaptive Drive: selected chassis and suspension tuning, refer to page 107.
- ▷ Light settings:
 - ▷ Triple turn signal activation, refer to page 71.
 - ▷ Welcome lamps, refer to page 88.
 - ▷ Headlamp courtesy delay feature, refer to page 89.
 - ▷ Daytime running lights, refer to page 89.
 - ▷ High-beam Assistant, refer to page 90.
- ▷ Automatic climate control with 2-zone control: settings, refer to page 128.
- ▷ Navigation:
 - ▷ Voice activation, refer to page 175.
 - ▷ Route criteria, refer to page 173.
 - ▷ Map view settings, refer to page 177.
- ▷ Entertainment:
 - ▷ Tone control, refer to page 184.
 - ▷ Radio, stored stations, refer to page 192.
 - ▷ CD/multimedia, audio source listened to last, refer to page 194.
- ▷ Telephone: volume, refer to page 234.

Central locking system

The concept

The central locking system becomes active when the driver's door is closed.

The system simultaneously engages and releases the locks on the following:

- ▷ Doors.
- ▷ Tailgate.
- ▷ Fuel filler flap.

Operating from the outside

- ▷ Via the remote control.
- ▷ Via the door lock.
- ▷ In cars with Comfort Access, via the door handles.

The following takes place simultaneously when locking/unlocking the vehicle via the remote control:

- ▷ The welcome lamps, interior lamps and courtesy lamps are switched on and off.
- ▷ The alarm system is armed or disarmed, refer to page 42.

Operating from the inside

Via the button for the central locking system, refer to page 35.

If the vehicle is locked from the inside, the fuel filler flap remains unlocked.

If an accident of a certain severity occurs, the central locking system unlocks automatically.

The hazard warning system and interior lamps come on.

Opening and closing: from the outside

Using the remote control

General information



Take the remote control with you

People or animals left unattended in a parked vehicle can lock the doors from the inside. Always take the remote control with you when leaving the vehicle so that the vehicle can then be opened from the outside. ◀

Unlocking



Press the button. The vehicle is unlocked.

The welcome lamps, interior lamps, and courtesy lamps are switched on.

You can set how the vehicle is to be unlocked.

The setting is stored for the remote control currently in use.

1. "Settings"
2. "Door locks"
3. "Unlock button:"

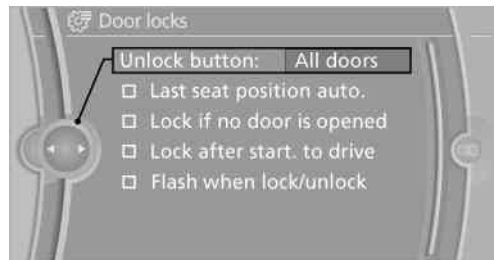

4. Select the desired function:

- ▷ "All doors"



The entire vehicle is unlocked.

- ▷ "Driver's door only"



Only the driver's door and the fuel filler flap are unlocked. Pressing again unlocks the entire vehicle.

Convenient opening

 Press and hold the button on the remote control.

The windows and the glass sunroof/panoramic glass sunroof open.

Locking

 LOCK Press the button on the remote control.

 Locking from the outside

Do not lock the vehicle from the outside if there are people in it, as the vehicle cannot be unlocked from inside without special knowledge. ◀

Switching on the interior lamps and courtesy lamps

 LOCK Press the button on the remote control with the vehicle locked.

Panic mode

You can trigger the alarm system if you find yourself in a dangerous situation.

 Press the button on the remote control for at least 3 seconds.

To switch off the alarm: press any button.

Unlocking tailgate

 Press the button on the remote control for approx. 1 second and release.

The tailgate will open slightly, regardless of whether it was previously locked or unlocked.

With automatic tailgate operation: the tailgate opens automatically.

The tailgate pivots back and up when it opens.

Ensure that adequate clearance is available before opening.

To avoid locking yourself out of the vehicle, do not place the remote control into the cargo area. The tailgate is locked again as soon as it is pushed closed.

Before and after each trip, check that the tailgate has not been inadvertently unlocked.

 Provide edge protection

Sharp or angular objects can hit the rear window while driving and damage the heating wires of the rear window. Provide edge protection. ◀

Confirmation signals from the vehicle

1. "Settings"
2. "Door locks"
3. "Flash when lock/unlock"

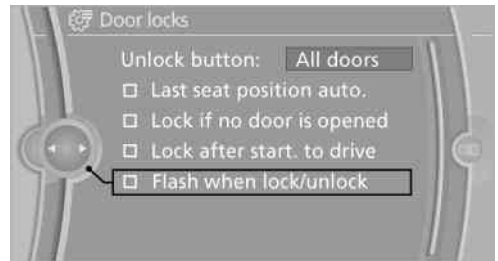

Retrieving the seat, mirror, and steering wheel settings

The driver's seat, exterior mirror, and steering wheel positions selected last are stored for the currently used remote control.

When the vehicle is being unlocked, these positions are automatically retrieved if the setting is activated.

 Pinch hazard when moving back the seat
If this function is used, first make sure that the footwell behind the driver's seat is empty. Failure to do so could cause injury to persons or damage to objects behind the seat as a result of a rearward movement of the seat. ◀

The adjustment procedure is interrupted:

- ▶ When a seat position switch is pressed.
- ▶ When a button of the seat and mirror memory is pressed.

Selecting automatic activation

1. "Settings"
2. "Door locks"
3. "Last seat position auto."

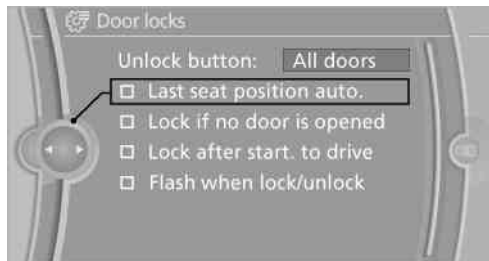

Malfunctions

Local radio waves may interfere with the remote control.

In this case, unlock and lock the car at the door lock with the integrated key.

If the car can no longer be locked with a remote control, the battery in the remote control is discharged. Use the remote control during an extended drive in order to recharge the battery, refer to page 30. The remote control for Comfort Access contains a battery that may need to be replaced, refer to page 42.

For US owners only

The transmitter and receiver units comply with part 15 of the FCC/Federal Communication Commission regulations. Operation is governed by the following:

FCC ID:

LX8766S

LX8766E

LX8CAS

LX8CAS2

Compliance statement:

This device complies with part 15 of the FCC Rules. Operation is subject to the following two conditions:

- ▶ This device may not cause harmful interference, and
- ▶ this device must accept any interference received, including interference that may cause undesired operation.

Any unauthorized modifications or changes to these devices could void the user's authority to operate this equipment.

Using the door lock

General information



Locking from the outside

Do not lock the vehicle from the outside if there are people in it, as the vehicle cannot be unlocked from inside without special knowledge. ◀

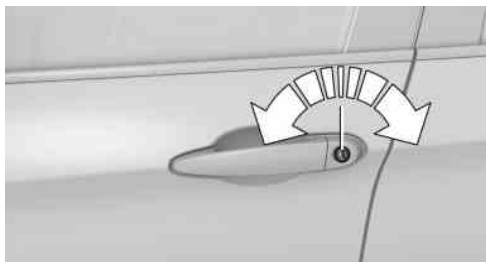

When unlocking:

1. Turning the key once unlocks the driver's door and the fuel filler flap.
2. Turning the key a second time unlocks the remaining doors and the tailgate.

Manual operation

If an electrical malfunction occurs, unlock or lock the driver's door using the integrated key in the door lock.

Opening and closing: from the inside

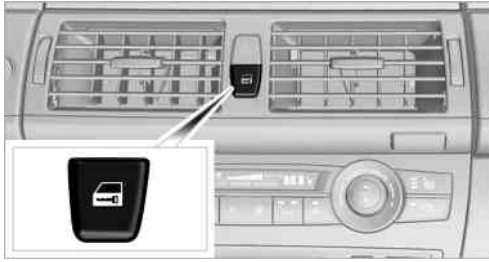

Locking and unlocking



Press the button in the vehicle.

The doors and the tailgate are locked or unlocked when the front doors are closed, but they are not secured against theft.

The fuel filler flap remains unlocked.

Automatic locking

The setting is stored for the remote control currently in use.

1. "Settings"
2. "Door locks"
3. Select the desired function:
 - ▷ "Lock if no door is opened"

The vehicle locks automatically after a short period of time if a door is not opened.
 - ▷ "Lock after start. to drive"

The vehicle locks automatically after you drive away.

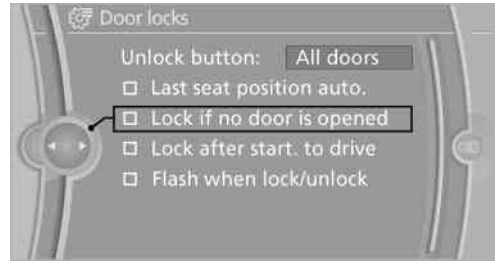

Unlocking and opening

- ▷  Press the button. The doors are unlocked. To open, pull the door handle above the armrest.
- ▷ Pull the door handle above the armrest twice: the door is unlocked the first time and opened the second time.

Locking

- ▷  Press the button. The doors are locked.
- ▷ Press the lock button of a door. To prevent you from being locked out, the opened driver's door cannot be locked using the lock button.



Take the remote control with you. People or animals left unattended in a parked vehicle can lock the doors from the inside. Always take the remote control with you when leaving the vehicle so that the vehicle can then be opened from the outside. ◀

Doors

Automatic soft closing

To close the doors, push lightly. It is closed automatically.



Danger of pinching. Make sure that the closing path of the doors is clear; otherwise, injuries may result. ◀

BMW X5: upper tailgate

Opening

The tailgate pivots back and up when it opens. Ensure that adequate clearance is available before opening.

Provide edge protection

Sharp or angular objects can hit the rear window while driving and damage the heating wires of the rear window. Provide edge protection. ◀

Opening from the inside

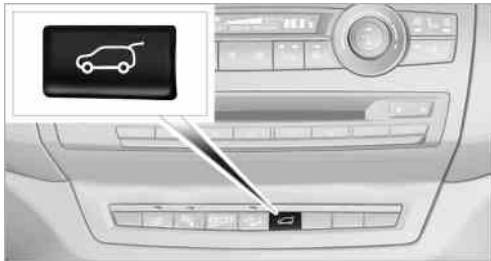

Press the button. The tailgate opens somewhat unless it has been locked.

Opening from the outside

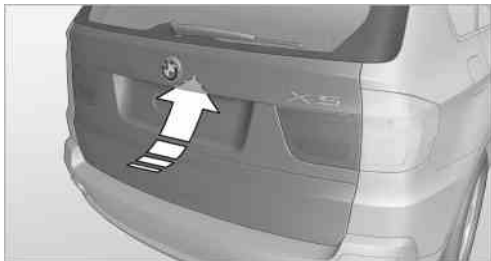

Press the button, see arrow, or the  button of the remote control for approx. 1 second. The tailgate opens slightly. It can be swung upward.

Opening manually

In case of an electrical malfunction:

1. From the cargo area, press out the handle in the tailgate, refer to arrow, with a screwdriver and pull. The tailgate is unlocked.

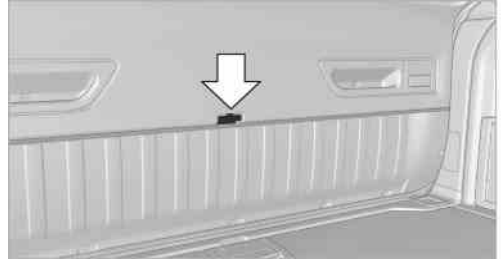

2. Open the tailgate from the outside and press in the handle.

The tailgate is locked again as soon as it is closed.

Closing

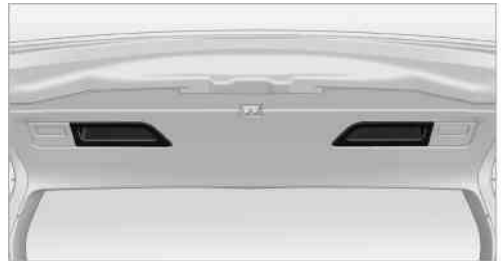

Recessed grips on the inside trim of the tailgate can be used to conveniently pull down the tailgate.

Danger of pinching

Make sure that the closing path of the tailgate is clear; otherwise, injuries may result. ◀

Automatic soft closing

To close the tailgate fully, press down lightly only. It is closed automatically.

Automatic tailgate operation

Adjusting opening height

You can set how far the tailgate should open.

! Adjusting the opening height
When adjusting the opening height, ensure that there is a clearance of at least 4 in/10 cm above the tailgate. Otherwise, the ceiling may not be high enough for the open tailgate if the load situation changes. ◀

1. "Settings"
2. "Tailgate"
3. Turn the controller until the desired opening height is selected.

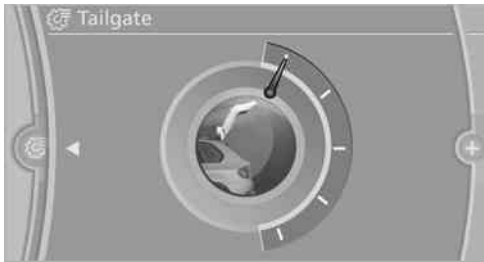

Opening

The tailgate pivots back and up when it opens. Ensure that adequate clearance is available before opening.

The tailgate opens automatically to the adjusted opening height.





- ▶ Press the button on the outside of the tailgate when the vehicle is unlocked.

- ▶  Press the button in the center console.

- ▶  Press the button on the remote control for approx. 1 second and release.

The opening procedure is interrupted:

- ▶ When the engine starts.
- ▶ When the vehicle starts moving.
- ▶  By pressing the button in the center console again.
- ▶  By pressing the button on the remote control for a longer period.
- ▶ By pressing the button on the outside of the tailgate.
- ▶ By pressing the button on the inside of the tailgate.

Closing

! Danger of pinching
Make sure that the closing path of the tailgate is clear; otherwise, injuries may result. ◀

Function requirement:

The lower tailgate is closed and must be locked on both sides.



The tailgate closes automatically when the button on the inside of the tailgate is pressed.

To stop the closing procedure:

- ▶ Press the button on the inside of the tailgate.
- ▶ Press the button on the exterior of the tailgate.

The closing procedure is also stopped:

- ▶ When the engine starts.

- ▷ If the vehicle jerks while driving away.

The closing procedure is not interrupted when the vehicle starts moving.

Manually opening or closing

In case of an electrical defect of the automatic tailgate operation function:

1. Manually release the tailgate, refer to page 36.
2. Open or close the tailgate slowly and without making sudden movements.



Do not use force to open or close

If the tailgate offers increased resistance, do not forcefully open or close the tailgate; otherwise, injury or damage may result. ◀

BMW X5: lower tailgate

Opening

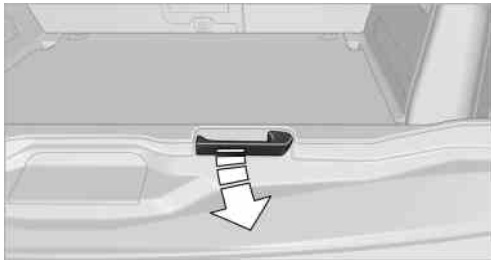

Pull the lever and swing the tailgate downward.

The opened tailgate can be loaded with up to 550 lbs/250 kg.

Closing

Fold the tailgate up and press closed.

BMW X6: tailgate

Automatic tailgate operation

Adjusting opening height

You can set how far the tailgate should open.



Adjusting the opening height

When adjusting the opening height, ensure that there is a clearance of at least 4 in/10 cm above the tailgate. Otherwise, the ceiling may not be high enough for the open tailgate if the load situation changes. ◀

1. "Settings"
2. "Tailgate"
3. Turn the controller until the desired opening height is selected.

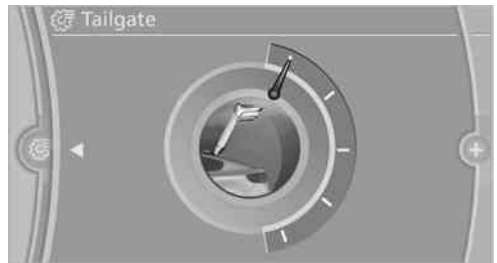



Opening



The tailgate pivots back and up when it opens. Ensure that adequate clearance is available before opening.

The tailgate opens automatically to the adjusted opening height.



- ▷ Press the button on the outside of the tailgate when the vehicle is unlocked.
- ▷  Press the button in the center console.
- ▷  Press the button on the remote control for approx. 1 second and release.

The opening procedure is interrupted:

- ▷ When the engine starts.
- ▷ When the vehicle starts moving.
- ▷  By pressing the button in the center console again.
- ▷  By pressing the button on the remote control for a longer period.
- ▷ By pressing the button on the outside of the tailgate.
- ▷ By pressing the button on the inside of the tailgate.

Closing

Danger of pinching

Make sure that the closing path of the tailgate is clear; otherwise, injuries may result. ◀

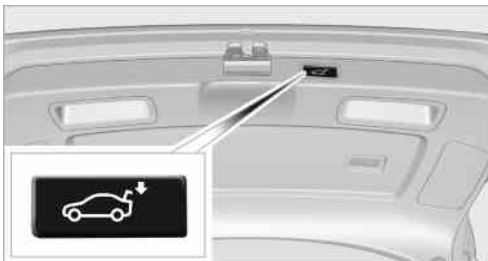

The tailgate closes automatically when the button on the inside of the tailgate is pressed.

To stop the closing procedure:

- ▷ Press the button on the inside of the tailgate.
- ▷ Press the button on the exterior of the tailgate.

The closing procedure is also stopped:

- ▷ When the engine starts.
- ▷ If the vehicle jerks while driving away.

Closing is not canceled when you put the vehicle into motion.

Automatic closing

The tailgate closes automatically without button operation if it is weighed down by an additional weight of approx. 11 lbs/5 kg, such as snow or ice. ◀

Manually opening or closing

In case of an electrical malfunction:

1. Push out cover 1 on the tailgate with a screwdriver.

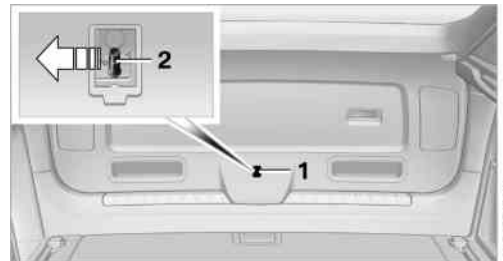

2. Push the catch 2 in the direction of the arrow.
3. Open or close the tailgate slowly and without making sudden movements.

Do not use force to open or close

If the tailgate offers increased resistance, do not forcefully open or close the tailgate; otherwise, injury or damage may result. ◀

Comfort Access

The concept

The vehicle can be accessed without activating the remote control.

All you need to do is to have the remote control with you, e.g., in your jacket pocket.

The vehicle automatically detects the remote control when it is nearby or in the passenger compartment.

Comfort Access supports the following functions:

- ▷ Unlocking/locking of the vehicle.
- ▷ Unlocking of the tailgate separately.
- ▷ Starting the engine.
- ▷ Convenient closing.

Functional requirement

- ▷ To lock the vehicle, the remote control must be located outside of the vehicle.
- ▷ The next unlocking and locking cycle is not possible until after approx. 2 seconds.
- ▷ The engine can only be started if the remote control is inside the vehicle.

Comparison with ordinary remote control

The functions can be controlled by pressing the buttons or via Comfort Access.

Should a short delay occur when opening or closing the windows or the glass sunroof/panoramic glass sunroof, the system checks whether a remote control is located in the vehicle. Please repeat opening or closing if necessary.

Unlocking

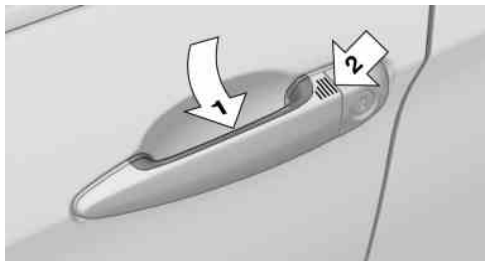

Fully grasp a door handle, arrow 1.

This corresponds to pressing the  button.

Locking

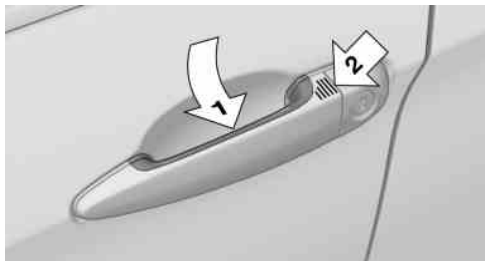

Touch the area on the door handle, arrow 2, with your finger for approx. 1 second.

This corresponds to pressing the  LOCK button.

To save battery power, ensure that the ignition and all electronic systems and/or power consumers are switched off before locking the vehicle.

If a remote control is detected within the vehicle, the vehicle does not lock or is unlocked again.

Convenient closing

Press the area, arrow 2, with your finger and hold.

In addition, the windows and the glass sunroof/panoramic glass sunroof close.



Monitor the closing process

Watch during the closing process to be sure that no one is injured. Removing the hand from the door handle immediately stops the closing process. ◀

Unlocking the tailgate separately

Press the button on the exterior of the tailgate.

This corresponds to pressing the  button.

If a remote control accidentally left in the cargo area is detected in the locked vehicle, the tailgate opens again.

The hazard warning flashers flash and a signal sounds.

Ignition on

Pressing the Start/Stop button switches the ignition on.

When doing so, do not depress the brake pedal, otherwise the engine will start.

Starting the engine

The engine can be started or the ignition can be switched on when a remote control is inside the vehicle. It is not necessary to insert a remote control into the ignition lock, refer to page 66.

As long as no remote control is detected in the vehicle, it is only possible to restart the engine within approx. 10 seconds after it is switched off if no door has been opened.

Switching off the engine

- ▶ Remote control not in ignition lock:
After switching off the engine, the transmission is automatically switched into transmission position P.
- ▶ Remote control in ignition lock:
If transmission position N is engaged, the transmission remains in this position after the engine is switched off.

Malfunction

The Comfort Access functions can be disturbed by local radio waves, such as by a mobile phone in the immediate vicinity of the remote control or when a mobile phone is being charged in the vehicle.

If this occurs, open or close the vehicle using the buttons on the remote control or use the integrated key in the door lock.

To start the engine afterward, insert the remote control into the ignition switch.

Warning lamps



The warning lamp in the instrument cluster lights up when you attempt to start the engine: the engine cannot be started.

The remote control is not in the vehicle or has a malfunction. Take the remote control with you inside the vehicle or have it checked. If necessary, insert another remote control into the ignition switch.



The warning lamp in the instrument cluster lights up while the engine is running: the remote control is no longer inside the vehicle.

After switching off the engine, the engine can only be started again within approx. 10 seconds if no door has been opened.



The indicator lamp in the instrument cluster comes on and a message appears on the Control Display: replace the remote control battery.

Replacing the battery

The remote control for Comfort Access contains a battery that will need to be replaced from time to time.

1. Take the integrated key out of the remote control, refer to page 30.
2. Remove the cover.



3. Insert a new battery of the same type with the positive side facing upwards.
4. Press the cover closed.



Return used battery to a recycling collection point or to your service center.

Alarm system

The concept

The vehicle alarm system responds to:

- ▷ Opening of a door, the hood or the tailgate.
- ▷ Movements in the vehicle: interior motion sensor, refer to page 43.
- ▷ Changes in the vehicle tilt, e.g., during attempts to steal a wheel or tow the car.
- ▷ Interruptions in battery voltage.

The alarm system briefly indicates tampering:

- ▷ By sounding an acoustic alarm.
- ▷ By switching on the hazard warning system.
- ▷ By flashing the high beams.

Arming and disarming the alarm system

General information

When you lock or unlock the vehicle, either with the remote control or at the door lock, the alarm system is armed or disarmed at the same time.

Door lock and armed alarm system

Unlocking via the door lock will trigger the alarm on some market-specific versions.

To stop this alarm, unlock the vehicle with the remote control or switch on the ignition.

Tailgate and armed alarm system

The tailgate can be opened using the remote control, even if the alarm system is armed.



Press the button on the remote control.

After the tailgate is closed, it is locked and monitored again by the alarm system. The hazard warning system flashes once.

In some market-specific versions, the tailgate can only be opened using the remote control if the vehicle was unlocked first.

Switching off the alarm

- ▷ Unlock the vehicle using the remote control, refer to page 32.
- ▷ Insert the remote control all the way into the ignition lock.

Indicator lamp on the interior rearview mirror



- ▷ The indicator lamp flashes continuously:

The system is armed.

- ▶ The indicator lamp flashes after locking:
 - The doors, hood or tailgate is not closed properly, but the rest of the vehicle is secured.
 - The indicator lamp flashes continuously after approx. 10 seconds. The interior motion sensor is not active.
- ▶ The indicator lamp goes out after unlocking:
 - The vehicle has not been tampered with.
- ▶ If the indicator lamp flashes after unlocking until the remote control is inserted in the ignition, but for no longer than approx. 5 minutes:
 - An alarm has been triggered.

Panic mode

In dangerous situations, trigger the alarm system:

 Press the button on the remote control for at least 3 seconds.

To switch off the alarm: press any button.

Tilt alarm sensor

The tilt of the vehicle is monitored.

The alarm system responds in situations such as attempts to steal a wheel or tow the car.

Interior motion sensor

For the sensor to function properly, the windows and glass sunroof/panoramic glass sunroof must be closed.

Avoiding unintentional alarms

The tilt alarm sensor and interior motion sensor can be switched off together, such as in the following situations:

- ▶ In duplex garages.
- ▶ During transport on car-carrying trains, at sea or on a trailer.
- ▶ When animals are to remain in the vehicle.

Switching off the tilt alarm sensor and interior motion sensor

 **LOCK** Press the remote control button again within 10 seconds after the vehicle is locked.

The indicator lamp lights up for approx. 2 seconds and then flashes continuously.

The tilt alarm sensor and interior motion sensor remain switched off until the vehicle is locked again.



Power windows

General information

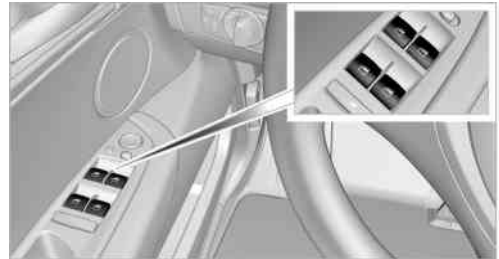
 Take the remote control with you
 Take the remote control with you when leaving the vehicle so that children, for example, cannot operate the power windows and injure themselves. ◀



Opening

- ▶  Press the switch to the resistance point.
 - The window opens while the switch is held.
 - ▶  Press the switch beyond the resistance point.
 - The window opens automatically.
- Pressing again stops the motion.

Closing



Danger of pinching

Monitor the closing process and make sure that the closing path of the window is clear; otherwise, injuries may result. ◀



- ▷ Pull the switch to the resistance point.

The window closes while the switch is held.



- ▷ Pull the switch beyond the resistance point.

The window closes automatically.

Pressing the switch stops the motion.

Convenient operation, refer to page 32, via the remote control or the door lock.

Convenient closing, refer to page 40, with Comfort Access.

After the ignition is switched off

When the remote control is removed or the ignition is switched off, the windows can continue to be operated for approx. 1 minute as long as no door is opened.

Pinch protection system

If the closing force exceeds a specific value as a window closes, the closing action is interrupted.

The window reopens slightly.



Danger of pinching even with pinch protection

Even with the pinch protection system, check that the window's closing path is clear; otherwise, the closing action may not stop in certain situations, e.g., if thin objects are present. ◀



Do not use window accessories

Do not install any accessories in the range of movement of the windows; otherwise, the pinch protection system will be impaired. ◀

Closing without the pinch protection system

For example, if there is an external danger or if ice on the windows prevents a window from closing normally, proceed as follows:

1. Pull the switch past the resistance point and hold it there.

Pinch protection is limited and the window reopens slightly if the closing force exceeds a certain value.

2. Pull the switch past the resistance point again within approx. 4 seconds and hold it there.

The window closes without pinch protection.

Safety switch

With the safety switch, the rear windows are prevented from being opened or closed via the switches in the rear passenger area, such as by children.



Press the button.

The LED lights up if the safety function is switched on.



Safety switch for rear operation

Press the safety switch when transporting children in the rear; otherwise, injury may result if the windows are closed without supervision. ◀

Roller sunblinds for the rear side windows

Pull the loop of the roller sun blind and hook onto bracket.



Do not open the window while the roller sunblind is tilted

Do not open the window while the roller sunblind is tilted; otherwise, there is a risk of damage at high speeds that may result in personal injury. ◀

X5: panoramic glass sunroof

General information

The glass sunroof and the sliding visor can be operated together or separately using the switch.



Danger of pinching

Monitor the closing process and make sure that the closing path of the glass sunroof is clear; otherwise, injuries may result. ◀



Take the remote control with you

Take the remote control with you when leaving the vehicle so that children, for example, cannot operate the roof and injure themselves. ◀



Tilting the glass sunroof



Press the switch.

The closed sunroof is tilted and the sliding visor opens slightly.



Do not use force to close the sliding visor

Do not use force to close the sliding visor with the glass sunroof in its tilted position, otherwise the mechanism will be damaged. ◀

Opening/closing the sliding visor

You can move the sliding visor independently with the sunroof closed or tilted.

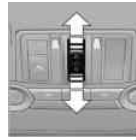

▶ Press the switch in the desired direction to the resistance point and hold it there.

The sliding visor moves while the switch is being held.

▶ Press the switch in the desired direction past the resistance point.

The sliding visor moves automatically. Pressing the switch again stops the motion.

Opening/closing the glass sunroof

With the sliding visor open, proceed as described under Sliding visor.

Opening/closing the glass sunroof and sliding visor together

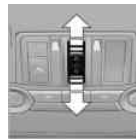

Press the switch twice in the desired direction past the resistance point.

The glass sunroof and sliding visor move together. Pressing the switch again stops the motion.

Convenient operation, refer to page 32, via the remote control or the door lock.

Convenient closing, refer to page 40, with Comfort Access.

Comfort function

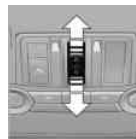

▶ Press the switch twice with the sunroof open:

The sunroof is raised.

▶ When the sunroof is raised, briefly press the switch twice in the opening direction:

The sunroof is opened all the way.

Comfort position

In the comfort position, the roof is not fully open. This reduces wind noise in the passenger compartment.

Each time the glass sunroof is opened or closed all the way, it stops in the comfort position. If desired, continue the motion following this with the switch.

After the ignition is switched off

The roof can still be operated for approx. 1 minute, as long as no door has been opened.

Pinch protection system

If the closing force when closing the glass sunroof exceeds a certain value, the closing movement is stopped, beginning at approximately one-third of the opening in the roof, or from the tilted position during closing.

The roof and the sliding visor open a short distance.

 Danger of pinching even with pinch protection

Despite the pinch protection system, check that the roof's closing path is clear; otherwise, the closing action may not be interrupted in certain extreme situations, such as when thin objects are present. ◀

Closing without the pinch protection system

For example, if there is an external danger, proceed as follows:

Press the switch forward beyond the resistance point and hold. The roof closes without the pinch protection system.

Initialization after a power failure

After a power failure, it is only possible to raise the roof, if necessary.

Have the system initialized by your service center.

BMW X6: glass sunroof, electric

General information

 Danger of pinching
Monitor the closing process and make sure that the closing path of the glass sunroof is clear; otherwise, injuries may result. ◀

 Take the remote control with you
Take the remote control with you when leaving the vehicle so that children, for example, cannot operate the roof and injure themselves. ◀



Tilting the glass sunroof



Press the switch.

The closed sunroof is tilted and the sliding visor opens slightly.

 Do not use force to close the sliding visor
Do not use force to close the sliding visor with the glass sunroof in its tilted position, otherwise the mechanism will be damaged. ◀

Opening/closing the glass sunroof

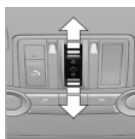

▷ Press the switch in the desired direction to the resistance point and hold it there.

The glass sunroof moves while the switch is being held.

▷ Press the switch in the desired direction past the resistance point.

The glass sunroof moves automatically.
Pressing the switch again stops the motion.

The glass sunroof and sliding visor can be opened together. Close the sliding visor manually.

Convenient operation, refer to page 33, via the remote control or the door lock.

Convenient closing, refer to page 40, with Comfort Access.

Opening/closing the glass sunroof automatically

Press the switch beyond the resistance point.

The following movements are also automatic:

- ▷ Pressing the switch with the sunroof open: the sunroof is tilted fully.
- ▷ Pressing the switch in the Open direction with the sunroof tilted: the sunroof is opened fully.

Pressing the switch again stops the motion.

Comfort position

In the comfort position, the roof is not fully open. This reduces wind noise in the passenger compartment.

Each time the glass sunroof is opened or closed all the way, it stops in the comfort position. If desired, continue the motion following this with the switch.

After the ignition is switched off

The roof can still be operated for approx. 1 minute, as long as no door has been opened.

Pinch protection system

If the closing force when closing the glass sunroof exceeds a certain value, the closing movement is stopped, beginning at approximately the middle of the opening in the roof, or from the tilted position during closing.

The glass sunroof opens again fully.



Danger of pinching even with pinch protection

Despite the pinch protection system, check that the roof's closing path is clear; otherwise, the closing action may not be interrupted in certain extreme situations, such as when thin objects are present. ◀

Closing without the pinch protection system

For example, if there is an external danger, proceed as follows:

1. Press the switch forward beyond the resistance point and hold. The pinch protection system is limited and the sunroof opens slightly if the closing force exceeds a certain value.
2. Within about 4 seconds, slide the switch forward again beyond the resistance point and hold it there. The roof closes without the pinch protection system.

Initialization after a power failure

After a power failure, it is only possible to raise the roof, if necessary.

Have the system initialized by your service center.

Adjusting

Vehicle equipment

This chapter describes all series equipment as well as country-specific and special equipment offered for this model series. Therefore, it also describes equipment that may not be found in your vehicle, for instance due to the selected special equipment or the country version. This also applies to safety-related functions and systems.

Sitting safely

The ideal seating position can make a vital contribution to relaxed, fatigue-free driving.

The seating position plays an important role in an accident in combination with:

- ▷ Safety belts, refer to page 53.
- ▷ Head restraints, refer to page 54.
- ▷ Airbags, refer to page 93.

Seats

Note before adjusting

 Do not adjust the seat while driving
Never attempt to adjust the driver's seat while driving.

The seat could respond with unexpected movement and the ensuing loss of vehicle control could lead to an accident. ◀

 Do not incline the backrest too far to the rear

Do not incline the backrest on the front passenger side too far to the rear during driving. Otherwise, there is the danger of sliding under the safety belt in an accident. This would eliminate the protection normally provided by the belt. ◀

Adjusting manually

Forward/backward

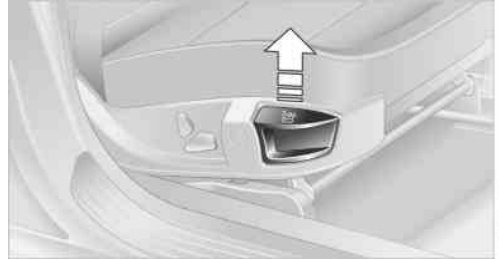

Pull the lever and slide the seat into the desired position. After releasing the lever, move the seat forward or back slightly to make sure it engages properly.

Thigh support



Pull the lever and move the thigh support forward or back.

Adjusting electrically

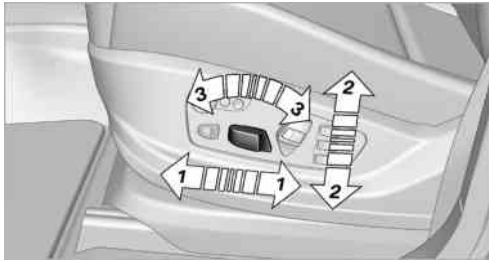

- 1 Forward/backward
- 2 Height
- 3 Seat tilt

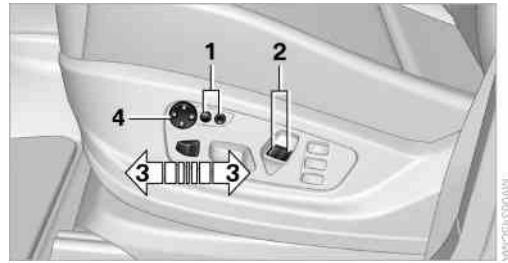

- 1 Backrest width
- 2 Shoulder support
- 3 Thigh support
- 4 Lumbar support



- 4 Backrest

Differs depending on seat:

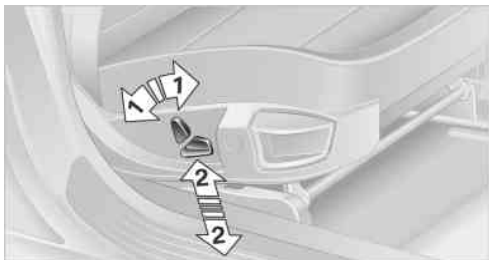

- 1 Backrest
- 2 Height

Additional depending on seat:

Backrest width

The width of the backrest can be changed with the side wings to adjust the side support to your own needs.

Shoulder support

This also supports the back in the shoulder area, This creates a relaxed sitting position and helps relieve stress on the shoulder muscles.

The shoulder support is also used to adjust the distance of the head restraint from the back of the seat occupant's head.

Lumbar support



You can also adjust the contour of the backrest to obtain additional support in the lumbar region. The upper hips and spinal column receive supplementary support to help you maintain a relaxed, upright sitting position.

- ▶ Increase or decrease curvature:

Press front or rear section of switch.

- ▷ Shift curvature up or down:
Press upper or lower section of switch.

BMW X5: rear seats

2nd row seats

If the row of seats is divided, each side can be adjusted separately.

-  Do not adjust the seat while driving
Never adjust the 2nd row seats while the vehicle is moving, as otherwise the passengers on the 3rd row seats could be injured.

Make sure that the locking devices of the 2nd row seats engage properly. Otherwise the restraining effect of the safety belts during an accident could be reduced. ◀

Longitudinal direction

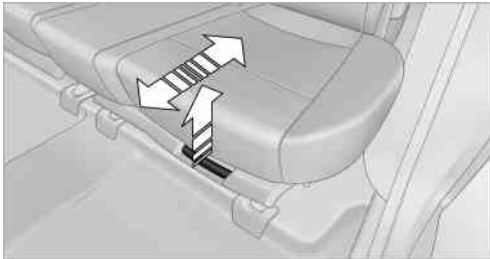

1. Pull the lever and slide the seat into the desired position.
2. Release the lever and move the seat slightly forward or back so that it engages properly.

Backrest

The backrests can be adjusted in four steps.

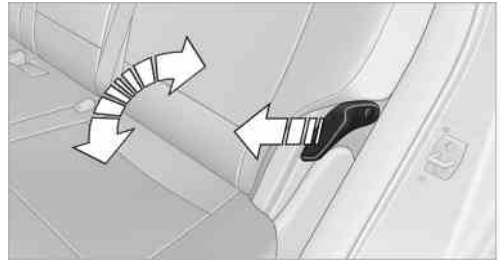

Pull the lever and apply weight to or remove weight from the backrest as needed.

Access to 3rd row seats



Pull the lever and fold the seat forward.

The handle recess on the interior trim of the door pillar makes climbing in easier.

-  Keep the footwell under the 2nd row seats clear

When folding back the 2nd row seats, make sure that the footwell under the 2nd row seats is clear. Otherwise persons in the 3rd row seats could be injured or objects damaged. ◀

-  Warning lamp for the 2nd row seats: lights up if the 2nd row seats are not locked. A message also appears on the Control Display.

3rd row seats

The 3rd row seats are divided and offer space for two persons.

Folding up backrest

Before folding up the backrest, remove the luggage compartment roller cover, refer to page 140, and, if necessary, slide the 2nd row seats slightly forward.

1. Pull the lever, refer to arrow. The backrest is unlocked.



2. Fold up and engage the backrest.



Ensure that the lock is securely engaged

Make sure that the catch engages securely. If it is not properly engaged, transported cargo could enter the passenger compartment during braking or evasive maneuvers and endanger the vehicle occupants. ◀

3. Push the head restraints into the top position.

Folding backrest down

1. Push the head restraints down, refer to page 56.
2. Pull the lever, refer to arrows. The backrests are released.

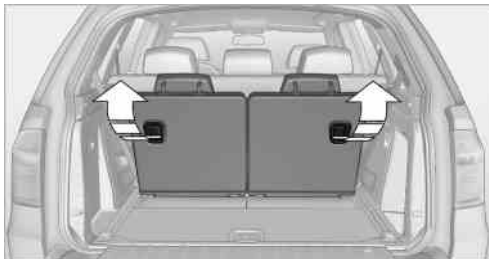

3. Fold the backrest down.

Seat heating

Front

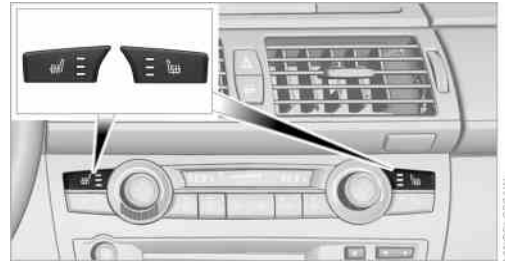

The temperature setting progresses one step through its control sequence each time you press the button. The maximum temperature is reached when three LEDs are lit.

If the trip is continued within approx. 15 minutes, the seat heating is activated automatically with the temperature set last.

To switch off: press and hold the button.

The temperature is reduced, if need be, down to no heat in order to reduce the load on the battery. The LEDs remain lit.

Rear



Operation similar to front seat heating, without temperature distribution.

Active seat ventilation and seat heating

Front

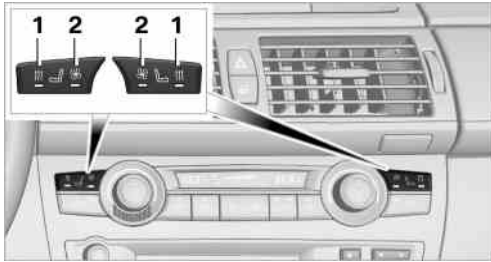

- 1 Seat heating
- 2 Active seat ventilation

Press button 1 or 2 once depending on the temperature or ventilation position. The LED in the respective button lights up.

The temperature and ventilation levels are displayed in bar form on the Control Display. A display of three bars indicates the highest level of seat heating or seat ventilation.

The air flow rate may be reduced or the blower may be switched off entirely to save on battery power. The LEDs remain lit.

If the trip is continued within approx. 15 minutes, the seat heating is activated automatically with the temperature set last.

To switch off: press and hold button 1 or 2.

Temperature distribution without active seat ventilation

The heat output can be distributed variously in the seat cushion and the backrest.

1. Press button 1.

2. "Seat heating distribution"



3. Turn the controller to adjust the distribution. The setting is applied.

Temperature distribution with active seat ventilation

The heat output can be distributed variously in the seat cushion and the backrest.

1. Press button 1.
2. "Seat heating distribution"



3. Turn the controller to adjust the distribution. The setting is applied.

Heated rear seats

Operation similar to front seat heating, without temperature distribution, refer to page 51.

Active seat

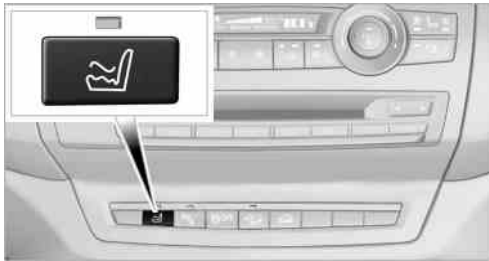

The seat cushion is actively varied by alternately raising and lowering the right and left half of the seat cushion. This reduces muscular tension and fatigue to help prevent lower back pain.

Press the button to switch on; the LED lights up.

The action of the system is reduced and if need be, switched off in order to reduce the load on the battery. The LED remains lit.

When the active seat is switched off, it can take up to 1 minute before the two halves of the seat cushion have returned to their initial position.

Safety belts

General information

Always make sure that safety belts are being worn by all occupants before driving away.

Although airbags enhance safety by providing added protection, they are not a substitute for safety belts.

Number of safety belts

Your vehicle has been fitted with safety belts for the safety of you and your passengers.

- ▶ BMW X5: five or seven safety belts.
- ▶ BMW X6: four or five safety belts.

Notes

 One person per safety belt
Never allow more than one person to wear a single safety belt. Never allow infants or small children to ride on a passenger's lap. ◀

 Putting on the belt
Lay the belt, without twisting, snugly across the lap and shoulders, as close to the body as possible. Make sure that the belt lies low around the hips in the lap area and does not press on the abdomen. Otherwise, the belt can slip over the hips in the lap area in a frontal impact and injure the abdomen.

The safety belt must not lie across the neck, rub on sharp edges, be routed over solid or breakable objects, or be pinched. ◀

 Reduction of restraining effect
Avoid wearing clothing that prevents the belt from fitting properly, and pull the shoulder belt periodically to readjust the tension across your lap; otherwise, the retention effect of the safety belt may be reduced. ◀

 Using the middle safety belt
If the middle safety belt in the rear is used, the larger section of the backrest must be locked. Otherwise, the safety belt will not have a restraining effect. ◀

Buckling the belt



Make sure you hear the latch plate engage in the belt buckle.

Unbuckling the belt

1. Hold the belt firmly.
2. Press the red button in the belt buckle.
3. Guide the belt back into its reel.

The shoulder strap's anchorage point will be correct for adult seat occupants of every build if the seat is correctly adjusted, refer to page 48.

The two rear safety belt buckles integrated into the rear seat are for passengers sitting on the left and right. The belt buckle embossed with the word CENTER is intended exclusively for use by passengers riding in the center position.

Safety belt reminder for the driver's and front passenger seat



The indicator lamp lights up and a signal sounds. In addition, a message appears on the Control Display. Check whether the safety belt has been fastened correctly.

The safety belt reminder is active at speeds above approx. 5 mph/8 km/h. It can also be activated if objects are placed on the front passenger seat.

Damage to safety belts

In the case of strain caused by accidents or damage:

Have the safety belts, including the safety belt tensioners, replaced and have the belt anchors checked.



Checking and replacing safety belts

Have the work performed only by your service center; otherwise, it cannot be ensured that this safety feature will function properly. ◀

Belt-force limiter

The effect of the belt-force limiter on the driver's seat is dependent on the position of the driver's seat.

To maintain the long-term accuracy of this function, the driver's seat must be calibrated if a cor-

responding message is displayed on the Control Display.

Calibrating driver's seat



The warning lamp lights up. A message also appears on the Control Display. Please calibrate the driver's seat.

1. Move the driver's seat forward until it stops.
2. Move the driver's seat forward again. It briefly moves toward the front in the process.
3. Set the desired seating position again.

The calibration is completed when the message on the Control Display disappears. Should this message continue to be displayed, repeat the calibration. If the message does not disappear even after repeated calibration, have the system checked as soon as possible.



Do not carry out calibration while the vehicle is moving

Never carry out calibration while the vehicle is moving, as this can cause accidents.

Make sure that no persons or objects become wedged during the calibration process, as this can cause injuries or damage. ◀

Head restraints

Correctly adjusted head restraints

A correctly adjusted head restraint reduces the risk of spinal injury in the event of an accident.



Adjusting the head restraint

Correctly adjust the head restraints of all occupied seats; otherwise, there is an increased risk of injury in an accident. ◀

BMW X5: push the head restraints of the 3rd row seats into the top position.

Height

Adjust the head restraint so that its center is approx. at ear level.

Distance

Adjust the distance so that the head restraint is as close as possible to the back of the head.

Active front head restraints

In the event of a rear-end collision of sufficient severity, the active head restraint reduces the distance to the head.

-  **Reduced protective function**
- ▷ Do not use seat or head restraint covers.
 - ▷ Do not hang objects, e.g., clothes hangers, directly on the head restraints.
 - ▷ Only attach accessories approved by BMW to the seat or head restraint.

Otherwise, the protective function of the active head restraint will be impaired and the personal safety of the occupants will be endangered.

Have the active head restraints reset after they are triggered in a rear-end collision. Have this work performed by the service center only; otherwise, this safety feature will not be operational. ◀

Please contact the service center if the front head restraints need to be removed or installed.

Front seats: adjusting the height

Adjust the head restraint so that its center is approx. at ear level.

Electrical

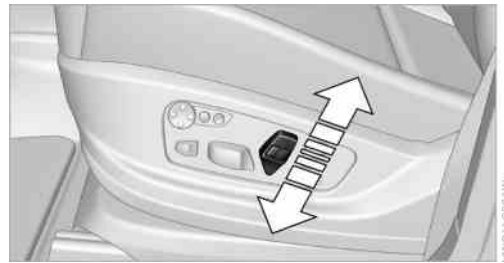

Adjusting electrically.

Front seats: adjusting the distance from the back of the head



Press the button and pull the headrest cushion forward or push it back.

-  **Compromised performance**
- Do not place any objects behind the headrest cushion. Otherwise, you can impair the proper function of the head restraint. ◀

Comfort seat

The distance from the back of the seat occupant's head can be adjusted using the shoulder support, refer to page 49.

Adjusting side extensions

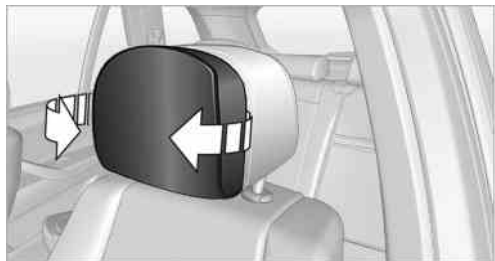

You can fold the side extensions on the head restraint forward for increased lateral support in the resting position.

BMW X5: rear seats and 3rd row seats Adjusting the height

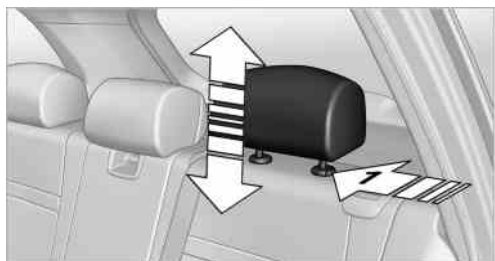

- ▷ To raise: pull.
- ▷ To lower: press the button, arrow 1, and push the head restraint down.

In vehicles equipped with 3rd row seats, the height of the middle head restraint is not adjustable.

Removing

1. Pull the head restraint upward to the stop.
2. Press the button, arrow 1, and pull the head restraint out completely.

BMW X6: rear seats

The head restraints in the rear cannot be adjusted and cannot be removed.

Seat, mirror, and steering wheel memory

General information

Two different driver's seat and front passenger seat positions, exterior mirror positions and steering wheel positions can be stored and retrieved.

The adjustment of the backrest width and the lumbar support is not stored in the memory.

Storing

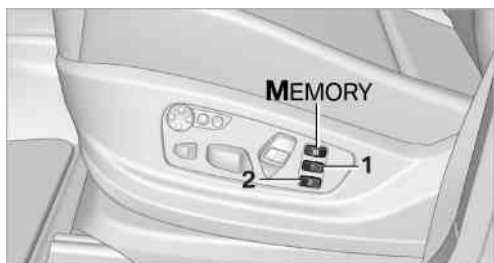

1. Switch on the radio ready state or the ignition, refer to page 66.
2. Set the desired seat, exterior mirror and steering wheel positions.
3.  Press the button. The LED in the button lights up.
4. Press the desired memory button 1 or 2. The LED goes out.

If the M button is pressed accidentally:

-  Press the button again. The LED goes out.

Calling up settings

-  Do not retrieve the memory setting while driving

Do not retrieve the memory setting while driving, as an unexpected seat movement could result in an accident. ◀

Comfort function

1. Open the driver's door after unlocking or switch on the radio ready state, refer to page 66.
2. Briefly press the desired memory button 1 or 2.

The seat is automatically moved to the stored position.

The procedure stops when a switch for setting the seat or one of the memory buttons is pressed.

Safety mode

1. Close the driver's door and switch the ignition on or off, refer to page 66.
2. Press and hold the desired memory button 1 or 2 until the setting procedure is completed.

Mirrors

Exterior mirrors

General information

The mirror on the passenger side is more curved than the driver's mirror.

-  **Estimating distances correctly**
Objects reflected in the mirror are closer than they appear. Do not estimate the distance to the traffic behind you based on what you see in the mirror, as this will increase your risk of an accident. ◀

At a glance

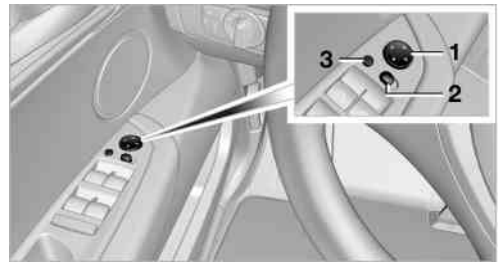

- 1 Adjusting
- 2 Left/right, Automatic Curb Monitor
- 3 Fold in and out

Selecting a mirror



To change over to the other mirror:
Slide the mirror changeover switch.

Adjusting electrically



The setting corresponds to the direction in which the button is pressed.

Saving positions

Seat and mirror memory, refer to page 56.

Adjusting manually

If an electrical malfunction occurs, for example, press the edges of the mirror glass.

Automatic Curb Monitor

When the reverse gear is engaged, the mirror glass tilts downward slightly on the front passenger side. This improves your view of the curb and other low-lying obstacles when parking, for example.

Activating

1.  Slide the mirror changeover switch to the driver's side mirror position.

- Shift into reverse or engage transmission position R.

Deactivating

Slide the mirror changeover switch to the passenger's side mirror position.

Fold in and out

Press button 3.

Possible up to approx. 15 mph/20 km/h.

For example, this is advantageous

- ▷ In car washes.
- ▷ In narrow streets.
- ▷ For folding back mirrors that were folded away manually.

Mirrors that were folded in are folded out automatically at a speed of approx. 25 mph/40 km/h.

 Fold in the mirror in a car wash

Before entering an automatic car wash, fold in the exterior mirrors by hand or with the button; otherwise, they could be damaged, depending on the width of the vehicle. ◀

Automatic heating

Depending on the external temperature, both exterior mirrors are automatically heated when the engine is running or the ignition is switched on.

Interior rearview mirror

Reducing the blinding effect



From behind when driving at night: turn the knob.

Interior and exterior mirrors, automatic dimming feature

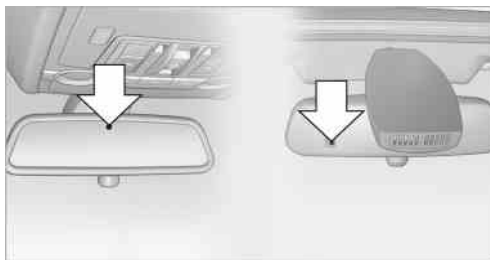

Two photocells are used for control:

- ▷ In the mirror glass, see arrow.
- ▷ On the back of the mirror.

For proper operation:

- ▷ Keep the photocells clean.
- ▷ Do not cover the area between the inside rearview mirror and the windshield.

Steering wheel

General information

- ⚠** Do not adjust while driving
Do not adjust the steering wheel while driving; otherwise, an unexpected movement could result in an accident. ◀

Adjusting

Mechanical

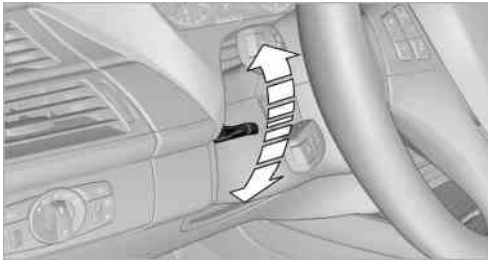

1. Fold the lever down.
2. Move the steering wheel to the preferred height and angle to suit your seating position.
3. Fold the lever back.

- ⚠** Do not use force to swing the lever back.
Do not use force to swing the lever back up; otherwise, the mechanism will be damaged. ◀

Electric

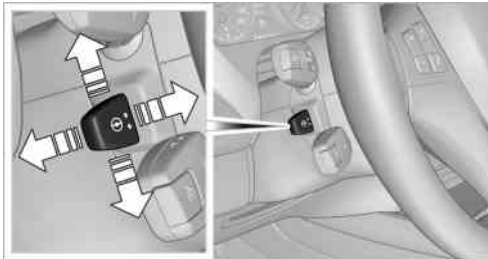

The steering wheel can be adjusted in four directions.

Storing steering wheel positions, refer to Seat, mirror, and steering wheel memory, refer to page 56.

Easy entry/exit

To facilitate entry and exit, the steering wheel temporarily moves into the uppermost position.

Steering wheel heating

Switching on/off



Press the button.

- ▷ On: the LED lights up.
- ▷ Off: the LED goes out.

Transporting children safely

Vehicle equipment

This chapter describes all series equipment as well as country-specific and special equipment offered for this model series. Therefore, it also describes equipment that may not be found in your vehicle, for instance due to the selected special equipment or the country version. This also applies to safety-related functions and systems.

The right place for children

Note

 Children in the vehicle

Do not leave children unattended in the vehicle; otherwise, they could endanger themselves and other persons, e.g., by opening the doors. ◀

Children should always be in the rear

Accident research shows that the safest place for children is on the rear seat.

 Transporting children in the rear

Transport children younger than 13 years of age or shorter than 5 ft/150 cm on the 2nd row seats only, using child restraint fixing systems suitable for the age, weight, and height of the child. Otherwise, there is the increased danger of injury in an accident.

Children 13 years of age or older must wear a safety belt as soon as a suitable child restraint fixing system can no longer be used, due to their age, weight and size. ◀

Children on the front passenger seat

Should it be necessary to use a child restraint fixing system on the front passenger seat, make sure that the front and side airbags on the front

passenger side are deactivated. Automatic deactivation of front passenger airbags, refer to page 94.

 Deactivating the front passenger airbags
If a child restraint fixing system is used in the front passenger seat, the front passenger airbags must be deactivated; otherwise, there is an increased risk of injury to the child when the airbags are triggered, even with a child restraint fixing system. ◀

Installing child restraint fixing systems

Notes

 Manufacturer's information for child restraint fixing systems

To select, mount and use child restraint fixing systems, observe the information provided by the system manufacturer; otherwise, the protective effect can be impaired. ◀

 Note the following in vehicles equipped with 3rd row seats

BMW X5: in vehicles with 3rd row seats, make sure that the seat of the 2nd row seats on which the child restraint fixing system is mounted is properly locked. Otherwise, there is an increased risk of injury for the child in an accident.

Do not mount child restraint fixing systems on the 3rd row seats, as otherwise the protection provided by these child restraint fixing systems may be reduced. ◀

BMW X5: before mounting a child restraint fixing system in the center seat of the 2nd row seats, move the outer seat cushions and backrests into the rearmost positions.

On the front passenger seat

After installing a child restraint fixing system on the front passenger seat, ensure that the front and side airbags on the front passenger side are deactivated.

! Deactivating the front passenger airbags

If a child restraint fixing system is used in the front passenger seat, the front passenger airbags must be deactivated; otherwise, there is an increased risk of injury to the child when the airbags are triggered, even with a child restraint fixing system. ◀

Seat position and height

Before installing a child restraint fixing system, move the front passenger seat as far back as possible and adjust its height to the highest position to obtain the best possible position for the belt and to offer optimal protection in the event of an accident.

Do not change the seat position and height after this.

Backrest width

Before mounting a child restraint fixing system on the front passenger seat, open the backrest width, refer to page 49, completely. Do not change the backrest width after this.

! Backrest width for the child seat

Before installing a child restraint fixing system in the front passenger seat, the backrest width must be opened completely. Do not change the adjustment after this; otherwise, the stability of the child seat will be reduced. ◀

Child seat security



The rear safety belts

- ▶ BMW X5: all safety belts of the 2nd and 3rd row seats
- ▶ BMW X6: all safety belts of the 2nd row seats

And the safety belt for the front passenger can be locked to prevent extension in order to permit attachment of child restraint fixing systems.

Locking the safety belt

1. Pull out the belt webbing completely.
2. Secure the child restraint fixing system with the belt.
3. Allow the belt webbing to be pulled in and pull it taut against the child restraint fixing system. The safety belt is locked.

Unlocking the safety belt

1. Open the belt buckle.
2. Remove the child restraint fixing system.
3. Allow the belt webbing to be pulled in completely.

LATCH child restraint fixing system

LATCH: Lower Anchors and Tether for Children.

Note

 Manufacturer's information for LATCH child restraint fixing systems

To mount and use the LATCH child restraint fixing systems, observe the operating and safety information from the system manufacturer; otherwise, the level of protection may be reduced. ◀

Mounts for the lower LATCH anchors

 Correctly engage the lower LATCH anchors

Make sure that the lower LATCH anchors have properly engaged and that the child restraint fixing system is resting snugly against the backrest; otherwise, the degree of protection offered may be reduced. ◀

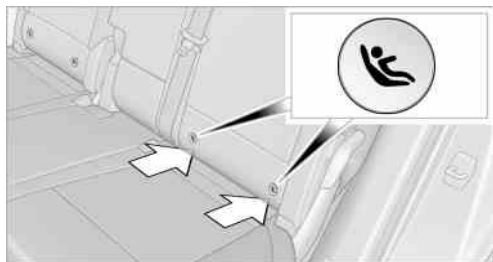

The mounts for the lower LATCH anchors are located at the points indicated by the arrows.

Mounting LATCH child restraint fixing systems

1. Mount the child restraint fixing system; refer to the operating instructions of the system.
2. Ensure that both LATCH anchors are properly connected.

Child restraint fixing system with a tether strap**Mounting points**

 LATCH mounting eyes
Only use the mounting eyes for the upper LATCH retaining strap to secure child restraint fixing systems; otherwise, the mounting eyes could be damaged. ◀

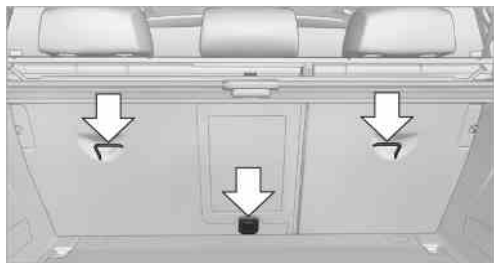
BMW X5

There are additional mounting points for child restraint fixing systems with a tether strap on the 2nd row seats, refer to arrows. Fold out before using the center mounting point.

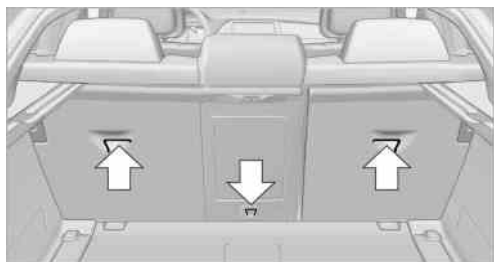
BMW X6

For child restraint fixing systems with tether strap, there are additional mounting points on the back of the rear seat backrests, see arrows.

Retaining strap guide

Retaining strap

Make sure the upper retaining strap does not run over sharp edges and is not twisted as it passes to the top anchor. Otherwise, the strap will not properly secure the child restraint fixing system in the event of an accident. ◀



BMW X5

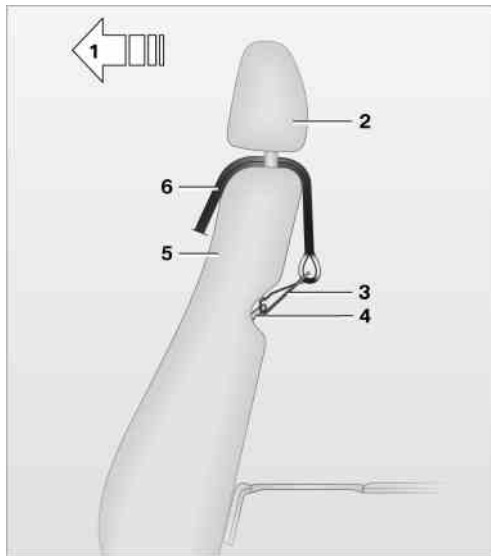

- 1 Direction of travel
- 2 Head restraint
- 3 Hook for upper retaining strap
- 4 Mounting point
- 5 Backrest
- 6 Upper retaining strap of child restraint fixing system

When using the cargo cover, pass the upper retaining strap between the backrest of the 2nd row seats and the cargo cover.

BMW X6: outer rear seats

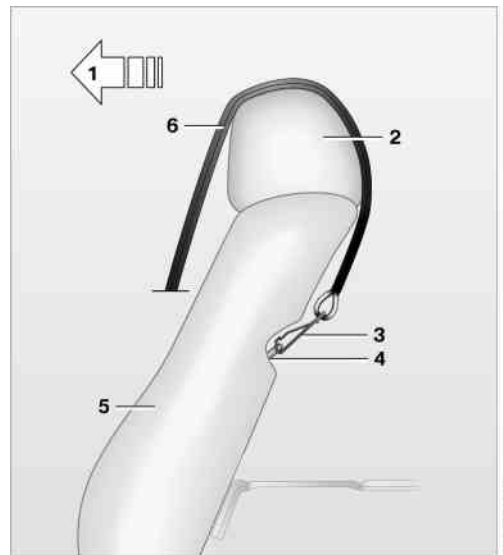

- 1 Direction of travel
- 2 Head restraint
- 3 Hook for upper retaining strap
- 4 Mounting point
- 5 Backrest
- 6 Upper retaining strap of child restraint fixing system

When using the cargo cover, pass the upper retaining strap between the rear seat backrest and the cargo cover.

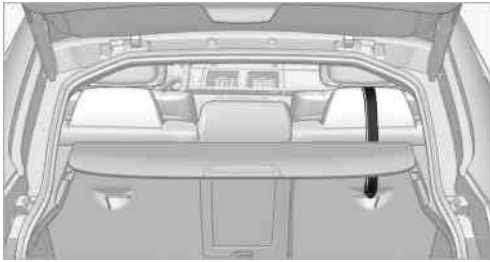

BMW X6: center rear seat

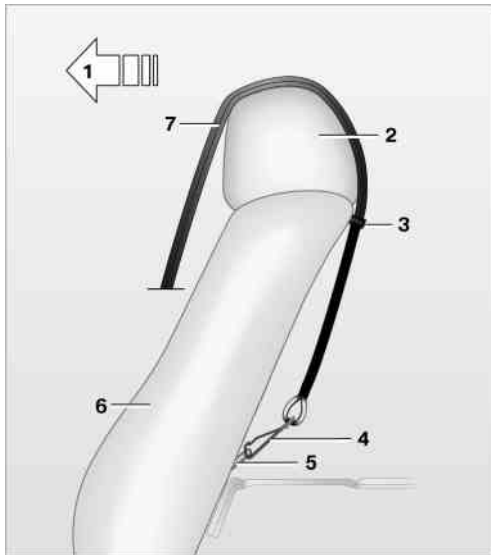

- 1 Direction of travel
- 2 Head restraint
- 3 Strap guide
- 4 Hook for upper retaining strap
- 5 Mounting point
- 6 Backrest
- 7 Upper retaining strap of child restraint fixing system

When using the cargo cover, pass the upper retaining strap between the rear seat backrest and the cargo cover.

Attaching the retaining strap to the backrest of the 2nd row seats

BMW X5

On outer seats:

1. Slide the head restraint upward.
2. Guide the upper retaining strap between the supports of the head restraint.
3. Attach the upper retaining strap to the mounting point with the hook.
4. Slide the head restraint into the bottom position.
5. Pull the upper retaining strap taut.

On the center seat when equipped with two rows of seats:

1. Fold the center armrest somewhat toward the front.
2. Guide the tether strap through the opening in the center armrest.

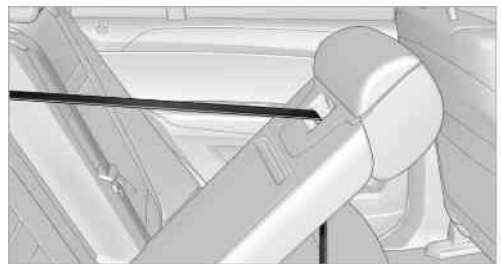

3. Fold back and engage the center armrest.
4. Hook in tether strap on mounting point.
5. Pull tether strap taut.

On the center seat when equipped with three rows of seats:

1. Slide the head restraint upward.
2. Guide the tether strap between the head restraint brackets.
3. Hook in the tether strap on the mounting point with the hook.
4. Slide the head restraint into the bottom position.
5. Pull tether strap taut.

BMW X6

1. Route the upper retaining strap over the middle of the head restraint.
2. Attach the upper retaining strap to the mounting point with the hook.
3. Pull the retaining strap taut until it compresses the cushion of the head restraint, thus preventing the strap from sliding off.

Locking the doors and windows

Rear doors

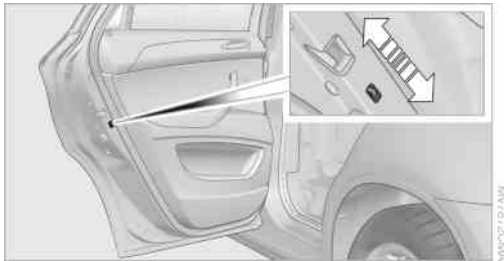

Push the locking lever on the rear doors down. The door can now be opened from the outside only.

Safety switch for the rear



Press the button on the driver's door if children are being transported in the rear.

This locks the rear window switches so that the windows cannot be operated from the rear: safety switch, refer to page 44.

Driving

Vehicle equipment

This chapter describes all series equipment as well as country-specific and special equipment offered for this model series. Therefore, it also describes equipment that may not be found in your vehicle, for instance due to the selected special equipment or the country version. This also applies to safety-related functions and systems.

Ignition lock

Insert the remote control into the ignition lock



Insert the remote control all the way into the ignition lock.

Radio ready state is switched on. Individual electrical consumers can operate.

Comfort Access

If the car is equipped with Comfort Access, only insert the remote control into the ignition lock, refer to page 40, under special circumstances.

Removing the remote control from the ignition lock

 Do not forcibly pull the remote control out of the ignition lock

Do not forcibly pull the remote control out of the ignition lock as this may cause damage. ◀

Before removing the remote control, push it all the way in to release the locking mechanism.

The ignition is switched off if it was on.

Start/Stop button



Pressing the Start/Stop button switches the ignition on or off and starts the engine.

The engine starts if the brake pedal is pressed when you press the Start/Stop button.

Radio ready state

Individual electrical consumers can operate. The time and the external temperature are displayed in the instrument cluster.

Radio ready state is switched off automatically:

- ▶ When the remote control is removed from the ignition lock.
- ▶ In cars with Comfort Access, refer to page 40, by touching the surface above the door lock.

Ignition on

All electrical consumers can operate. The odometer and trip odometer are displayed in the instrument cluster.

To save battery power when the engine is off, switch off the ignition and any unnecessary electronic systems/power consumers.

Radio ready state and ignition off

All indicator and warning lamps as well as displays in the instrument cluster go out.

 Transmission position P with the ignition off

When the ignition is switched off, position P is engaged automatically. When in an automatic car wash, for example, ensure that the ignition is not switched off accidentally. ◀

For example, the ignition is not switched off in the following situations:

- ▶ The brake is applied.
- ▶ The low beams are switched on

Starting the engine

General information

 Enclosed areas
Do not let the engine run in enclosed areas; otherwise, breathing of exhaust fumes may lead to loss of consciousness and death. The exhaust gases contain carbon monoxide, an odorless and colorless but highly toxic gas. ◀

 Unattended vehicle
Do not leave the car unattended with the engine running; otherwise, it presents a potential source of danger.

Before leaving the vehicle with the engine running, set the parking brake and engage transmission position P; otherwise, the vehicle may begin to roll. ◀

 Frequent starting in quick succession
Avoid repeated futile attempts at starting the car and avoid starting the car frequently in quick succession. Otherwise, the fuel is not burned or is inadequately burned, and there is the danger of overheating and damaging the catalytic converter. ◀

Do not wait for the engine to warm up while the vehicle remains stationary. Start driving right away, but at moderate engine speeds.

Starting the engine

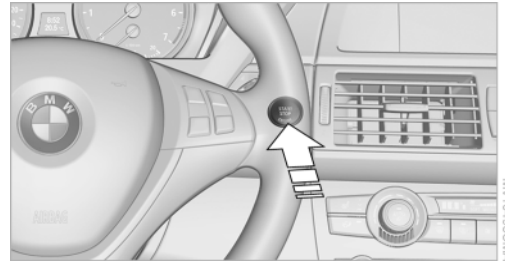

Remote control in the ignition lock or, with Comfort Access, inside the vehicle, refer to page 40.

1. Depress the brake pedal.
2. Press the Start/Stop button.

The starter operates automatically for a certain time, and stops automatically as soon as the engine has started.

Diesel engine

If the engine is cold and temperatures are below approx. 32 °F/0 °C, the start process may be delayed somewhat due to automatic preheating.

A message is displayed.

Engine stop

General information

 Take the remote control with you
Take the remote control with you when leaving the vehicle so that children, for example, cannot operate the windows and injure themselves. ◀

 Set the parking brake and further secure the vehicle as required

Set the parking brake firmly when parking; otherwise, the vehicle could roll. On steep upward and downward inclines, further secure the vehi-

cle, for example, by turning the steering wheel in the direction of the curb. ◀

Before driving into a car wash

To make it possible for the vehicle to roll in an automatic car wash, follow the information on Washing in automatic car washes, refer to page 305.

Switching off the engine

Procedure

1. Engage transmission position P with the vehicle stopped.
2. Press the Start/Stop button.
3. Set the parking brake.
4. Remove the remote control from the ignition lock, refer to page 66.

Parking brake

The concept

The parking brake is primarily intended to prevent the vehicle from rolling while parked; it brakes the rear wheels.

The parking brake can be set manually or automatically:

- ▷ Manual: by pulling and pushing the switch.
- ▷ Automatic: by activating Automatic Hold.

Setting manually

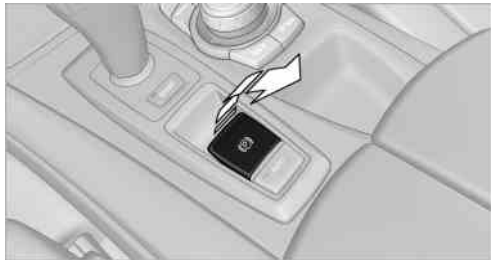

Pull the button. The parking brake is set.

PARK

The indicator lamp lights up in red. The parking brake is set.



Indicator lamp in Canadian models.

To set the parking brake, the remote control does not need to be in the ignition lock.



Set the parking brake and further secure the vehicle as required

Set the parking brake firmly when parking; otherwise, the vehicle could roll. On steep upward and downward inclines, further secure the vehicle, for example, by turning the steering wheel in the direction of the curb. ◀

While driving

Use while driving:

Pull the switch and hold it. The vehicle brakes hard while the button is being pulled.

PARK

The indicator lamp lights up in red, a signal sounds and the brake lamps light up.



Indicator lamp in Canadian models.

If the vehicle is braked to a speed of approx. 2 mph/3 km/h, the parking brake remains set.

Releasing manually



Press the button with the brake depressed.

PARK

The LED and indicator lamp go out.



Indicator lamp in Canadian models.



Take the remote control with you

Take the remote control with you when leaving the vehicle so that children, for example, cannot release the parking brake. ◀

Automatic Hold

The concept

This system assists the driver by automatically setting and releasing the brake, such as when moving in stop-and-go traffic.

The vehicle is automatically held in place when it is stationary.

On inclines, the system prevents the vehicle from rolling backward when driving away.

For your safety

Automatic Hold is deactivated automatically and the parking brake is set when:

- ▶ The engine is switched off.
- ▶ A door is opened and the driver's safety belt is unbuckled.
- ▶ The vehicle is braked to a standstill with the parking brake while driving.



The indicator lamp switches from green to red and the letters AUTO H go out.



Indicator lamp in Canadian models.

Before driving away:

- ▶ Release the parking brake manually.
- ▶ Reactivate Automatic Hold.



Leaving the vehicle with the engine running

Before leaving the vehicle with the engine running, engage position P of the automatic transmission and ensure that the parking brake is set. Otherwise, the vehicle may begin to roll. ◀

Activating

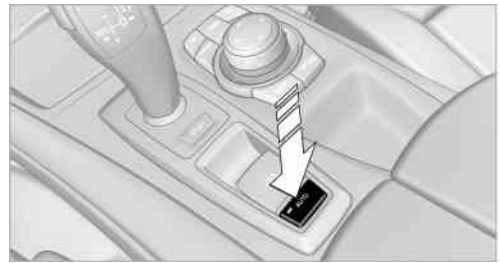

Press the button. The LED in the button lights up and the indication AUTO H appears in the instrument panel.

Automatic Hold is activated.



If the vehicle is being held by Automatic Hold, the indicator light in the instrument panel also lights up in green.



Indicator lamp in Canadian models.

Deactivating

Press the button again, the LED in the button and the indication AUTO H in the instrument panel go out.

Automatic Hold is deactivated.

If the vehicle is being held by Automatic Hold, then press on the brake pedal to deactivate it.

When the parking brake is set manually, refer to page 68, Automatic Hold is deactivated automatically.

Driving

Automatic Hold is activated: the vehicle is automatically secured against rolling when it stops.



The indicator lamp lights up in green.



Indicator lamp in Canadian models.

Step on the accelerator pedal to drive off.

The brake is released automatically.

The indicator lamp goes out.



Before driving into a car wash

Deactivate Automatic Hold; otherwise, the parking brake will be set when the vehicle is stationary and the vehicle will no longer be able to roll. ◀

Parking

The parking brake is automatically set if the engine is switched off while the vehicle is being held by Automatic Hold.

PARK

The indicator lamp changes from green to red.



Indicator lamp in Canadian models.

The parking brake is not set if the engine is switched off while the vehicle is coasting to a halt. Automatic Hold is deactivated.



Take the remote control with you

Take the remote control with you when leaving the vehicle so that children, for example, cannot release the parking brake. ◀

Malfunction

In the event of a failure or malfunction of the parking brake, secure the vehicle against rolling using a wheel chock, for example, when leaving it.

Releasing the parking brake manually

In the event of an electrical power loss or electrical malfunction, you can release the parking brake manually.



Secure the vehicle against rolling

Before releasing the parking brake manually, and whenever you park the vehicle with the parking brake released, ensure that position P of the automatic transmission is engaged. Note the display in the instrument cluster.

In addition, secure the vehicle against rolling, e.g. with a wheel chock. Otherwise there is a danger that the vehicle could roll if parked on a steep slope. ◀

Jump-starting and towing, refer to page 302.

Unlocking

1. Open the left-hand side panel in the cargo area.
2. Remove the first aid kit and the warning triangle. Close the bracket of the warning triangle.
3. Insert the releasing tool or screwdriver, contained in the tool kit under the cargo floor panel, refer to page 288, at the releasing point.



4. Firmly pull the releasing tool or screwdriver upward against the mechanical resistance, refer to arrow, until a considerable increase in force is felt and the parking brake is then clearly heard to release.
5. Stow the releasing tool or screwdriver, warning triangle, and first aid kit and close the left side panel in the cargo area.



Have the malfunction corrected

Have the malfunction corrected at the nearest service center or at a workshop that works according to BMW repair procedures with correspondingly trained personnel. If the parking brake has been released manually in response to a malfunction, only technicians can return it to operation. ◀

Following manual release, the actual status of the parking brake may deviate from that displayed by the indicator lamp.

Putting into operation after a power failure



Putting the parking brake into operation

The parking brake should only be put into operation again if it was manually released due to an interruption in the supply of electrical power. Otherwise the operation of the parking brake is not ensured and there is a danger of the vehicle rolling despite the parking brake being set. ◀

Procedure

1. Switch on the ignition.
2. Press the button with the brake depressed.



The indicator lamp in the instrument cluster goes out as soon as the parking brake is ready for operation.



Indicator lamp in Canadian models.

Any noises which occur are normal. Startup may take several seconds.

Turn signal, high beams, headlamp flasher

At a glance

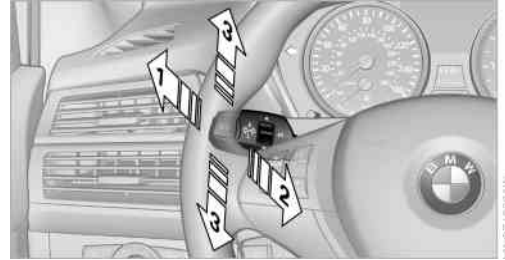

- 1 High beams
- 2 Headlamp flasher
- 3 Turn signal

Turn signal

Press the lever beyond the resistance point.

Press the lever beyond the resistance point.

To switch off manually, press the lever to the resistance point.

Unusually rapid flashing of the indicator lamp indicates that a turn signal bulb has failed.

Signaling a turn briefly

Press the lever to the resistance point and hold it there for as long as you want the turn signal to flash.

Triple turn signal activation

Press the lever to the resistance point.

The turn signal flashes three times.

This function can be activated or deactivated:

1. "Settings"
2. "Lighting"

3. "Triple turn signal"



The setting is stored for the remote control currently in use.

Washer/wiper system

Notes

 Do not switch on the wipers if frozen. Do not switch on the wipers if they are frozen onto the windshield; otherwise, the wiper blades and the windshield wiper motor may be damaged. ◀

 Do not use the wipers on a dry windshield. Do not use the wipers on a dry windshield; otherwise, the wiper blades may wear more rapidly or become damaged. ◀

At a glance

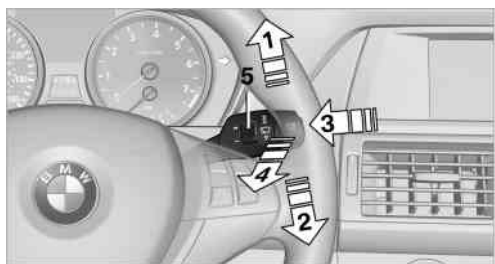

- 1 Switching on wipers
- 2 Switching off wipers or brief wipe
- 3 Activating/deactivating the rain sensor

- 4 Cleaning the windshield and headlamps
- 5 Setting the sensitivity of the rain sensor

Switching on wipers

Press the wiper lever upward, arrow 1.

The lever automatically returns to its initial position when released.

Normal wiper speed

Press up once.

The system switches to operation in the intermittent mode when the vehicle is stationary.

Fast wiper speed

Press up twice or press once beyond the resistance point.

The system switches to normal speed when the vehicle is stationary.

Switching off wipers or brief wipe

Press the wiper lever down, arrow 2.

The lever automatically returns to its initial position when released.

- ▷ Brief wipe: press down once.
- ▷ To switch off normal wipe: press down once.
- ▷ To switch off fast wipe: press down twice.

Rain sensor

If the car is equipped with a rain sensor, the time between wipes is controlled automatically and depends on the intensity of the rainfall.

The rain sensor is mounted on the windshield, directly in front of the interior rearview mirror.

Activating the rain sensor

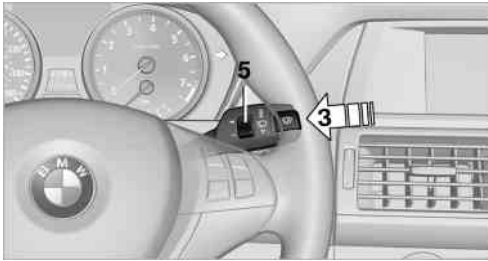

Press the button, arrow 3.
The LED in the button lights up.

Rain sensor sensitivity

Turn thumbwheel 5 up or down.

Deactivating the rain sensor

Press the button again, arrow 3.
The LED goes out.

! Deactivate the rain sensor in car washes
Deactivate the rain sensor when passing through an automatic car wash; otherwise, damage could be caused by undesired wiper activation. ◀

Cleaning the windshield and headlamps

Pull the lever, arrow 4.

The system sprays washer fluid on the windshield and activates the wipers briefly.

When the vehicle lighting system is switched on, the headlamps are cleaned at regular and appropriate intervals.

! Do not use the washer system at freezing temperatures

Do not use the washers if there is any danger that the fluid will freeze on the windshield; otherwise, your vision could be obscured. For this reason, use antifreeze.

Avoid using the washer when the reservoir is empty; otherwise, you could damage the pump. ◀

Windshield washer nozzles

The windshield washer nozzles are heated automatically while the engine is running or the ignition is switched on.

BMW X5: rear window wiper



1 Intermittent wipe

When reverse gear is engaged, the system switches to continuous operation.

2 Cleaning the rear window

! Do not use the washing mechanisms when the washer fluid reservoir is empty

Do not use washing mechanisms when the washer fluid reservoir is empty, otherwise you will damage the washer pump. ◀

Washer fluid

General information

! Antifreeze for washer fluid

Antifreeze is flammable. Therefore, keep it away from sources of ignition.

Only keep it in the closed original container and inaccessible to children.

Follow the instructions on the container. ◀

Washer fluid reservoir



Adding washer fluid

Only add washer fluid when the engine is cool, and then close the cover completely to avoid contact between the washer fluid and hot engine parts.

Otherwise, there is the danger of fire and a risk to personal safety if the fluid is spilled. ◀

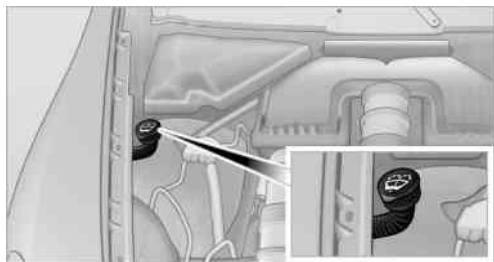

All washer nozzles are supplied from one reservoir.

Fill with water and – if required – with a washer antifreeze, according to the manufacturer's recommendations.

Mix the washer fluid before adding to maintain the correct mixing ratio.

Capacity

Approx. 6.3 US quarts/6 liters.

Automatic transmission with Steptronic

Transmission positions

D Drive, automatic position

Position for normal vehicle operation. All forward gears are available.

Under normal operating conditions, fuel consumption is lowest when you are driving in position D.

Kickdown

Kickdown is used to achieve maximum driving performance. Press on the accelerator beyond the resistance point at the full throttle position.

R is Reverse

Select only when the vehicle is stationary.

N is Neutral

The vehicle can roll.

N remains engaged after the engine is switched off if the remote control remains in the ignition lock. This function can be used in an automatic car wash, refer to page 305, for example. P is automatically engaged after approx. 30 minutes.

P Park

The drive wheels are blocked.

P is engaged automatically when the following conditions are met:

- ▶ The driver's door is opened while the engine is running, the safety belt is not fastened and neither the brake pedal nor the accelerator is activated.
- ▶ The engine is switched off unless N is engaged and the remote control is in the ignition lock.
- ▶ The remote control is removed from the ignition lock.

Before leaving the vehicle, ensure that the transmission position P is engaged; otherwise, the vehicle may begin to roll.

Engaging transmission position

- ▶ Transmission position P can only be disengaged if the engine is running and the brake pedal is pressed.
- ▶ With the vehicle stationary, press on the brake pedal before shifting out of P or N; otherwise, the shift command will not be executed: shift lock.

 Press on the brake pedal until you start driving

To prevent the vehicle from creeping after you select a driving position, maintain pressure on the brake pedal until you are ready to start. ◀

Engaging transmission positions D, R, N

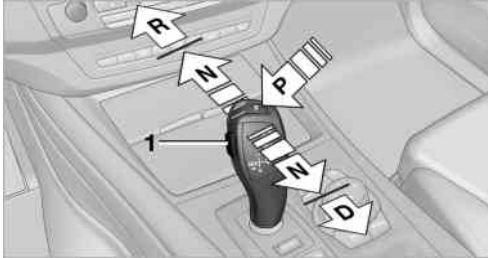

Briefly push the selector lever in the desired direction, beyond a resistance point if necessary. When shifting out of P or into R, simultaneously push the unlock button 1.

The engaged transmission position is displayed on the selector lever.

After releasing the selector lever, it returns to its center position.

Engaging transmission position P

Select only when the vehicle is stationary.



Press button P.

Sport program and manual mode M/S

Activating the Sport program



Push the selector lever to the left out of transmission position D.

The Sport program is activated and DS or the engaged gear is displayed in the instrument cluster, for example S4.

This position is recommended for a performance-oriented driving style.

Activating manual mode

Push the selector lever to the left out of transmission position D.

Push the selector lever forward or backward.

Manual mode becomes active and the gear is changed.

The engaged gear is displayed in the instrument cluster, e.g., M1.

- ▶ To shift down: press the selector lever forward.
- ▶ To shift up: press the selector lever backward.

The transmission only shifts up or down if the rpm and vehicle speed are appropriate. If the engine speed is too high, the transmission does not shift down.

The selected gear is briefly displayed in the instrument panel, followed by the current gear.

Ending the Sport program/manual mode

Push the selector lever to the right.

D is displayed in the instrument cluster.

Shifting gears using the shift paddles on the steering wheel

The shifting paddles make it possible to quickly change gears since both hands can remain on the steering wheel.

- ▷ If the shift paddles on the steering wheel are used to shift gears while in automatic mode D, the transmission temporarily switches to manual mode.
- ▷ If the shift paddles are not used to accelerate or shift gears for a certain amount of time, the transmission switches back to automatic mode D.

With the transmission position M/S selected, the manual mode remains active.



- ▷ Shift up: pull right shift paddle.
- ▷ Shift down: pull left shift paddle.

The vehicle only shifts up or down at appropriate engine and road speeds, e.g., it does not shift down if the engine speed is too high.

The selected gear is briefly displayed in the instrument cluster, followed by the current gear.

Displays in the instrument cluster



The transmission position is displayed and the engaged gear, such as M4, is displayed in manual mode.

Displays

Vehicle equipment

This chapter describes all series equipment as well as country-specific and special equipment offered for this model series. Therefore, it also describes equipment that may not be found in your vehicle, for instance due to the selected special equipment or the country version. This also applies to safety-related functions and systems.

Odometer, external temperature display, clock

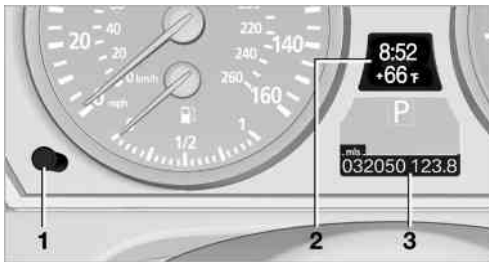

- 1 Knob in the instrument cluster
- 2 Time, external temperature, and date
- 3 Odometer and trip odometer

Knob in the instrument cluster

Press the knob.

- ▶ When the ignition is switched on, the trip odometer is reset.

Press the knob for approx. 5 seconds:

View service requirement display, refer to page 81

- ▶ When the ignition is switched off, the time, external temperature and odometer are displayed.

Units of measure

To set the respective units of measure, miles or km for the odometer and °C or °F for the external temperature, refer to page 86.

The setting is stored for the remote control currently in use.

Time, date, external temperature

From radio readiness the external temperature and the time are displayed.

Set the time, refer to page 85.

Retrieving date

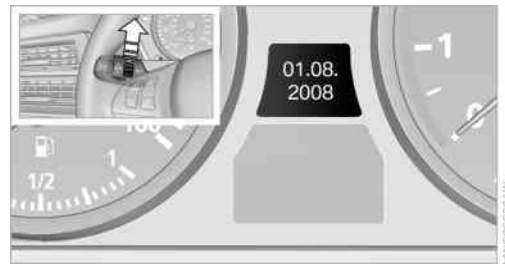

Press the button on turn signal lever upward; the date appears.

Set the date, refer to page 85.

Pressing the button upward or downward several times changes the display between clock, external temperature, date, and Check Control messages, refer to page 83.

External temperature warning

If the display drops to +37 °F/+3 °C, a signal sounds and a warning lamp lights up. There is the increased danger of ice.



Ice on roads

Even at temperatures above +37 °F/+3 °C, there can be a risk of ice on roads.

Therefore, drive carefully on bridges and shady roads, for example, to avoid the increased danger of an accident. ◀

Odometer and trip odometer

Resetting trip odometer:

With the ignition switched on, press button 1 in the instrument cluster.

When the vehicle is parked

If you still want to view the time, external temperature and odometer reading briefly after the remote control has been taken out of the ignition lock:

Press button 1 in the instrument cluster.

Tachometer



Never force the engine speed up into the red warning field, see arrow. In this range, the fuel supply is interrupted to protect the engine.

Coolant temperature

A warning lamp will come on if the coolant, and therefore the engine, becomes too hot. In addition, a message will appear on the Control Display.

Check the coolant level, refer to page 285.

Current fuel consumption



Displays the current fuel consumption. You can check whether you are currently driving in an efficient and environmentally-friendly manner.

Engine oil temperature



- ▶ Cold engine: the pointer is at the low temperature end. Drive at moderate engine and vehicle speeds.
- ▶ Normal operating temperature: the pointer is in the middle or in the right half of the temperature display.
- ▶ Hot engine: the pointer is at the high temperature end. Switch off the engine immediately and allow it to cool down.

If the engine oil temperature is too high, a message appears on the Control Display.
Check the oil level, refer to page 283.

Fuel gauge



The vehicle inclination may cause the display to vary.

Notes on refueling, refer to page 262.

Range

After the reserve range is reached:

- ▶ A message is briefly displayed on the Control Display.
- ▶ The remaining range is shown on the computer.
- ▶ When a dynamic driving style is used, such as when corners are taken rapidly, engine functions are not ensured.

The message appears continuously below a range of approx. 30 miles/50 km.



Refuel promptly

At the latest, refuel at a range of 30 miles/50 km; otherwise, the engine function is not ensured and damage may occur. ◀

Computer

Displaying information on the instrument panel

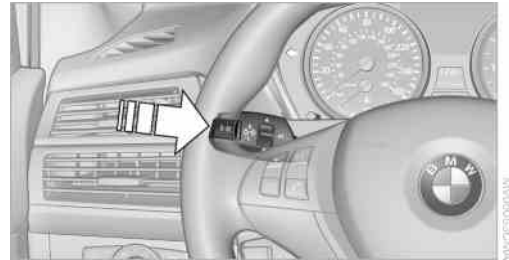

Press the computer button on the turn signal lever.

Information is displayed in the instrument cluster.

Overview of the information

Repeatedly pressing the button on the turn signal lever displays the information on the instrument cluster in the following order:

- ▶ Range.
- ▶ Average speed.
- ▶ Average fuel consumption.

To set the corresponding units of measure, refer to page 86.

Information in detail

Range

Displays the estimated cruising range available with the remaining fuel.

It is calculated based on your driving style over the last 18 miles/30 km.

Average speed

Periods in which the vehicle was parked and the engine was switched off manually are not included in the average speed calculations.

With the trip computer, refer to page 80, you can have the average speed displayed for an additional distance.

To reset the average speed: press the button on the turn indicator lever for approx. 2 seconds.

Average fuel consumption

This is calculated for the period during which the engine is running.

You can have the average consumption for another trip displayed, refer to Displays on the Control Display below.

To reset the average consumption: press the button on the turn indicator lever for approx. 2 seconds.

Displays on the Control Display

Display the computer or trip computer on the Control Display.

1. "Vehicle Info"
2. "Onboard info" or "Trip computer"

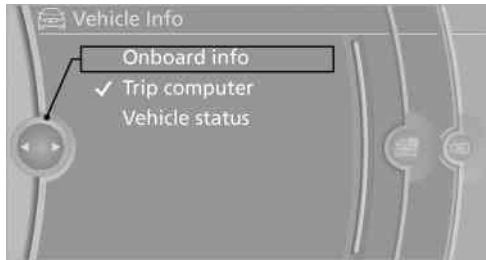

Displays on the "Onboard info":

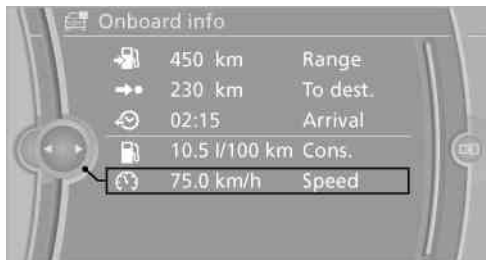

- ▷ Range.
- ▷ Distance to destination.

- ▷ Estimated time of arrival if a destination was entered in the navigation system, refer to page 164.

Displays on the "Trip computer":

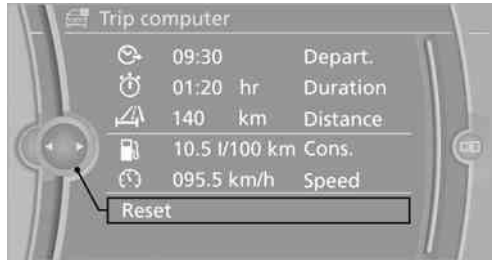

- ▷ Departure time.
- ▷ Trip duration.
- ▷ Trip distance.

Both displays show:

- ▷ Average fuel consumption and
- ▷ Average speed.

Resetting the fuel consumption and speed

Resetting the values for average speed and average fuel consumption:

1. Select the respective menu item and press the controller.
2. Press the controller again to confirm your selection.

Resetting the trip computer

Resetting all values:

1. "Vehicle Info"
2. "Trip computer"
3. "Reset"

Service requirements



The remaining driving distance and the date of the next scheduled service are displayed briefly immediately after you start the engine or switch on the ignition.

The current service requirements can be read out from the remote control by the service specialist.

For certain maintenance operations, you can view the distance remaining or the due date for that operation in the instrument cluster.

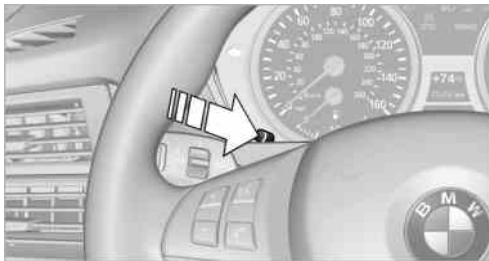

1. With the ignition switched on, press the knob in the instrument cluster, refer to page 77, for approx. 5 seconds until the service requirements are displayed.
2. Press the knob repeatedly to display the individual service requirement items.

Displays

Symbol	Function
	Service requirements
	Engine oil
	Roadworthiness test
	Front brake pads
	Rear brake pads
	Brake fluid

The sequence of displayed service items may vary. First the data for the next maintenance are displayed.

Detailed information on service requirements

More information on the scope of service required can be displayed on the Control Display.

1. "Vehicle Info"
2. "Vehicle status"



3.  "Service required"

Required maintenance procedures and legally mandated inspections are displayed.



Additional information can be displayed on each entry:

Select the entry and press the controller.

To exit from the menu:

Move the controller to the left.

Symbols

Symbols	Description
	No service is currently required.
	The deadline for service or a legally mandated inspection is approaching.
	The service deadline has already passed.

Entering dates

Enter the dates for the required inspections.

Make sure the date on the Control Display is set correctly, refer to page 85.

1. "Vehicle Info"
2. "Vehicle status"
3.  "Service required"
4. "§ Vehicle inspection"

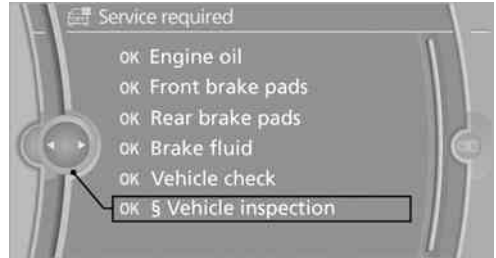

5. Open the menu for entering the deadline.
6. "Date:"
7. Create the settings.
8. Press the controller to apply the setting. The year is highlighted.
9. Turn the controller to make the adjustment.
10. Press the controller to apply the setting. The date entry is stored.

To exit from the menu:

Move the controller to the left.

Automatic Service Request

Data regarding the maintenance status or legally mandated inspections of the vehicle are automatically transmitted to your service center before a service due date.

You can check when your service center was notified.

1. "Vehicle Info"
2. "Vehicle status"
3. Open "Options".
4. "Last Service Request"

Check Control

The concept

The Check Control monitors vehicle functions and alerts you to any malfunctions in the systems monitored.

A Check Control message consists of indicator and warning lamps in the instrument cluster and, in some circumstances, an acoustic signal and text messages at the top of the Control Display.

Indicator/warning lamps



The indicator and warning lamps can light up in a variety of combinations and colors.

Several of the lamps are checked for proper functioning and light up temporarily when the engine is started or the ignition is switched on.

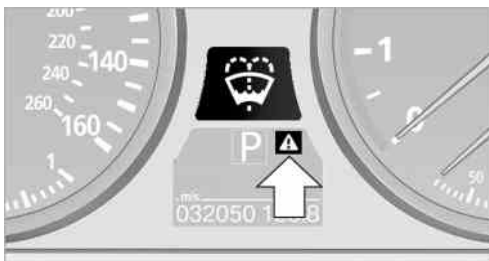

⚠ The symbol indicates that Check Control messages have been stored. The Check Control messages can be displayed later.

Text messages

Text messages at the upper edge of the Control Display in combination with a symbol in the instrument cluster explain a Check Control mes-

sage and the meaning of the indicator and warning lamps.



Supplementary text messages

Addition information, such as on the cause of a fault or the required action, can be called up via Check Control.

In urgent cases, this information will be shown as soon as the corresponding lamp comes on.

Symbols

The following functions can be selected within the supplementary text message, depending on the Check Control message.

- ▶  "Service request"
Contact the service partner.
- ▶  "Roadside Assistance"
Contact Roadside Assistance.

Hiding Check Control messages

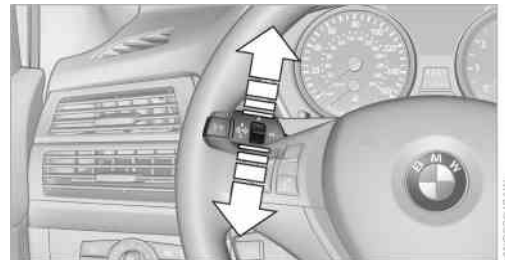

Press the button in the turn signal lever up or down.

- ▶ Some Check Control messages are displayed continuously and are not cleared until the malfunction is eliminated. If several malfunctions occur at once, the messages are displayed consecutively. These messages can be hidden for approx. 8 seconds. After this time, they are displayed again automatically.
- ▶ Other Check Control messages are hidden automatically after approx. 20 seconds.

They are stored and can be displayed again later.

Viewing stored Check Control messages



1. Press the button on the turn signal lever downward. "CHECK OK" or the stored Check Control messages appear on the display.

„CHECK OK“ is shown if no messages are present.

Check Control messages are accompanied by text messages on the Control Display.

2. Press the button to display additional messages, the time and external temperature, or the date.

Displaying stored Check Control messages

1. "Vehicle Info"
2. "Vehicle status"
3.  "Check Control"
4. Select the text message.

Messages after trip completion

Special messages that were displayed during a trip are displayed again after the ignition is switched off.

Speed limit

Entry of a speed limit which, when reached, should cause a Check Control message to be issued.

Renewed warning if the vehicle speed drops below the set speed limit once by at least 3 mph/5 km/h.

Displaying, setting or changing the limit

1. "Settings"
2. "Speed"
3. "Warning at:"

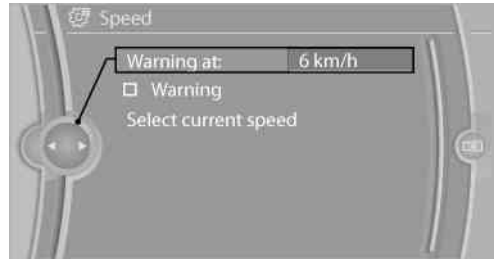

4. Turn the controller until the desired limit is displayed.
5. Press the controller.
The speed limit is stored.

Applying your current speed as the limit

1. "Settings"
2. "Speed"
3. "Select current speed"

The system adopts your current speed as the limit.

Activating/deactivating the limit

1. "Settings"
2. "Speed"
3. "Warning"

Settings on the Control Display

Time

The settings are stored for the remote control currently in use.

Setting the time zone

1. "Settings"
2. "Time/Date"



3. "Time zone:"
4. Select the desired time zone.

The time zone is stored.

Setting the time

1. "Settings"

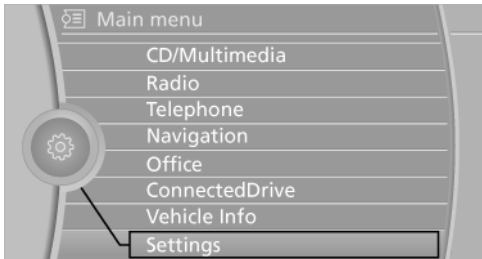

2. "Time/Date"

3. "Time:"



4. Turn the controller until the desired hours are displayed.
5. Press the controller.
6. Turn the controller until the desired minutes are displayed.
7. Press the controller.

The time is stored.

Setting the time format

1. "Settings"
2. "Time/Date"
3. "Format:"
4. Select the desired format.

The time format is stored.

Date

The settings are stored for the remote control currently in use.

Setting the date

1. "Settings"
2. "Time/Date"
3. "Date:"
4. Turn the controller until the desired day is displayed.
5. Press the controller.
6. Make the necessary settings for the month and year.

The date is stored.

Setting the date format

1. "Settings"
2. "Time/Date"
3. "Format:"
4. Select the desired format.



The date format is stored.

Language

Setting the language

To set the language on the Control Display:

1. "Settings"
2. "Language/Units"
3. "Language:"

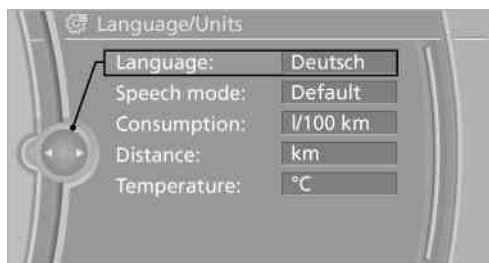

4. Select the desired language.

The setting is stored for the remote control currently in use.

Setting the voice dialog

Voice dialog for the voice activation system, refer to page 26.

Units of measure

Setting the units of measure

To set the units for fuel consumption, route/distance, temperature, and pressure:

1. "Settings"
2. "Language/Units"



3. Select the desired menu item.
4. Select the desired unit.

The setting is stored for the remote control currently in use.

Brightness

Setting the brightness

To set the brightness of the Control Display:

1. "Settings"
2. "Control display"
3. "Brightness"



4. Turn the controller until the desired brightness is set.
5. Press the controller.

The setting is stored for the remote control currently in use.

Depending on the light conditions, the brightness control may not be clearly visible.

Lamps

Vehicle equipment

This chapter describes all series equipment as well as country-specific and special equipment offered for this model series. Therefore, it also describes equipment that may not be found in your vehicle, for instance due to the selected special equipment or the country version. This also applies to safety-related functions and systems.

At a glance

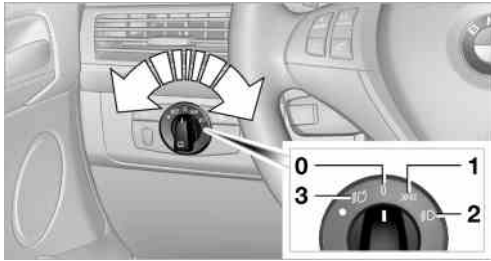

- 0 Lamps off and daytime running lights
- 1 Parking lamps and daytime running lights
- 2 Low-beam headlamps and welcome lamps
- 3 Automatic headlamp control, daytime running lights, welcome lamps, adaptive light control, and High-beam Assistant

Parking lamps/low beams, headlamp control

General information

If the driver's door is opened while the ignition is switched off, the exterior lighting is switched off automatically in the following switch settings:

0, ,

Parking lamps

Switch position : the vehicle lamps light up on all sides, e.g., for parking.

Do not use the parking lamps for extended periods; otherwise, the battery may become discharged and it would then be impossible to start the engine.

When parking, it is preferable to switch on the one-sided roadside parking lamps, refer to page 90.

Low beams

Switch position with the ignition switched on: the low beams light up.

Welcome lamps

When parking the vehicle, leave the switch in position or : the parking and interior lamps light up briefly when the vehicle is unlocked.

Activating/deactivating the welcome lamps

1. "Settings"
2. "Lighting"
3. "Welcome light"

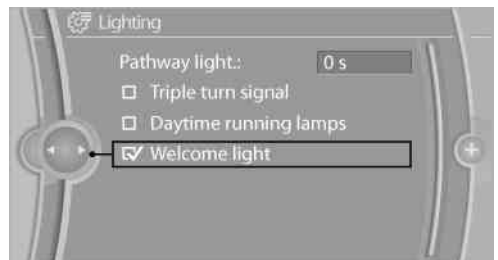

The setting is stored for the remote control currently in use.

Headlamp courtesy delay feature

The low beams stay lit for a short while after the ignition is switched off, if the lamps are switched off and the headlamp flasher is switched on.

Setting the duration

1. "Settings"
2. "Lighting"
3. "Pathway light.: s"



4. Set the duration.

The setting is stored for the remote control currently in use.

Automatic headlamp control

Switch position : the low beams are switched on and off automatically, e.g., in tunnels, in twilight or if there is precipitation. The LED next to the symbol lights up.

A blue sky with the sun low on the horizon can cause the lights to be switched on.

The low beams remain switched on independent of the ambient lighting conditions when you switch on the front fog lamps.





Personal responsibility

The automatic headlamp control cannot serve as a substitute for your personal judgment in determining when the lamps should be switched on in response to ambient lighting conditions.

For example, the sensors are unable to detect fog or hazy weather. To avoid safety risks, you should always switch on the lamps manually under these conditions. ◀

Daytime running lights

The daytime running lights light up in position 0,  and . After the ignition is switched off, the parking lamps light up in position .

Activating/deactivating

1. "Settings"
2. "Lighting"
3. "Daytime running lamps"



The setting is stored for the remote control currently in use.

Adaptive light control

The concept

Adaptive light control is a variable headlamp control system that enables dynamic illumination of the road surface.

Depending on the steering angle and other parameters, the light from the headlamp follows the course of the road.

In sharp curves, e.g. serpentine, or during turning, up to a certain speed one of the two front fog lamps is switched on as a turning lamp. This provides improved illumination of the area inside the curve.

Controls

Activating

Switch position  with the ignition switched on.

The turning lamps are automatically switched on depending on the steering angle or the use of turn signals.

To avoid blinding oncoming traffic, the Adaptive Light Control does not swivel to the driver's side when the vehicle is at a standstill.

When driving in reverse, both turning lamps are active.

Malfunction

A message is displayed.

Adaptive light control is malfunctioning or has failed. Have the system checked as soon as possible.

Self-leveling headlights

LED headlamps

The self-leveling headlights feature adapts the light distribution to the contours of the road.

The light distribution is lowered on hilltops to avoid blinding oncoming traffic and tilted in depressions to increase visibility.

High beams/roadside parking lamps

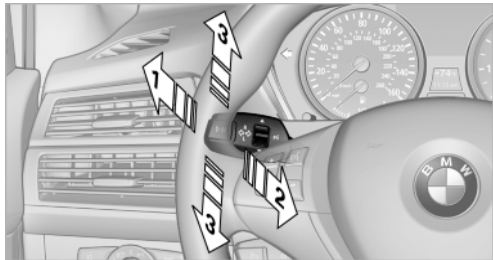

- 1 High beams
- 2 Headlamp flasher
- 3 Roadside parking lamps

Left and right roadside parking lamps

The vehicle can be illuminated on one side.

Switching on

After parking the vehicle, press the lever up or down beyond the resistance point for approx. 2 seconds, arrow 3.

The roadside parking lamps drain the battery. Therefore, do not leave them on for unduly long periods of time; otherwise, the battery might not have enough power to start the engine.

Switching off

Briefly press the lever in the opposite direction to the pressure point, arrow 3.

High-beam Assistant

The concept

When the lights are switched on, this system automatically switches the high beams on and off. The procedure is controlled by a sensor on the front of the interior rearview mirror. The assistant ensures that the high beams are switched on whenever the traffic situation allows. The driver can intervene at any time and switch the high beams on and off as usual.

Activating the High-beam Assistant

1. Turn the light switch to .
2. With the low beams switched on, briefly push the turn indicator lever in the direction of the high beam.





The indicator lamp in the instrument cluster lights up. The high beams are switched on and off automatically.

The system responds to light from oncoming traffic and traffic driving ahead of you, and to adequate illumination, e.g., in towns and cities.

Switching the high beams on and off manually

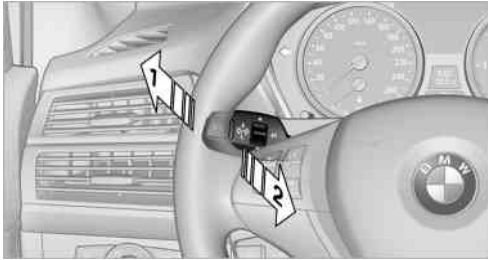

- ▷ High beams on, arrow 1.
- ▷ High beams off/headlamp flasher, arrow 2.

To reactivate the High-beam Assistant, briefly push the turn indicator lever toward the high beams.

Activating/deactivating via iDrive

1. "Settings"
2. "Lighting"
3. "High beam assistant"

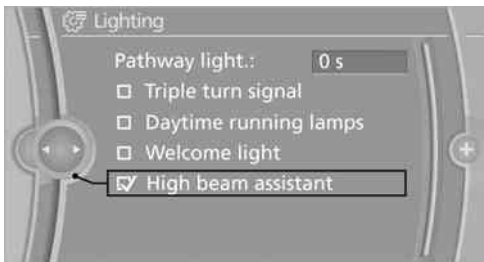

The setting is stored for the remote control currently in use.

System limits



Personal responsibility

The High-beam Assistant cannot serve as a substitute for the driver's personal judgment of when to use the high beams. Therefore, manually switch off the high beams in situations where this is required to avoid a safety risk. ◀

The system is not fully functional in situations such as the following, and driver intervention may be necessary:

- ▷ In very unfavorable weather conditions, such as fog or heavy precipitation.
- ▷ In detecting poorly-lit road users, such as pedestrians, cyclists, horseback riders and wagons; when driving close to train or ship traffic; and at animal crossings.
- ▷ In tight curves, on hilltops or in depressions, in cross traffic or half-obscured oncoming traffic on freeways.
- ▷ In poorly-lit towns and cities and in the presence of highly reflective signs.
- ▷ At low speeds.
- ▷ When the windshield in front of the interior rearview mirror is fogged over, dirty or covered with stickers, etc.
- ▷ If the sensor view field is dirty.

The view field of the sensor is located on the front of the interior rearview mirror.

Do not cover this area with stickers, etc.

Clean the sensor view field with a cloth moistened with a small amount of glass cleaner.

Front fog lamps

The parking lamps or low beams must be switched on.



Press the button. The green indicator lamp in the instrument cluster lights up.

If the automatic headlamp control, refer to page 89, is activated, the low beams will come

on automatically when you switch on the fog lamps.

Instrument lighting



Adjust the brightness using the thumbwheel.

Interior lamps

General information

The interior lamps, footwell lamps, exit lamps, trunk lamps, and courtesy lamps are controlled automatically.

The LEDs for the courtesy lamps are set in the door handles and illuminate the ground in front of the doors.

To avoid draining the battery, all lamps inside the car are switched off about 8 minutes after the ignition is switched off, Start/Stop button, refer to page 66.

Switching the interior lamps on and off

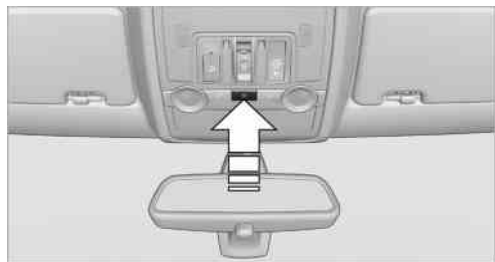

Press the button.

To switch off permanently: press the button for approx. 3 seconds.

To clear this setting: briefly press the button.

Reading lamps

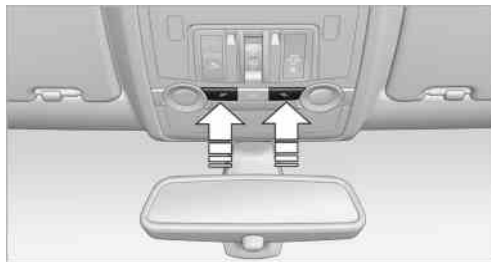

Press the button.

Reading lamps are located at the front and rear next to the interior lamps.



Danger of burns

Do not reach into the opening of the lamps; otherwise, there is a risk of burns. ◀

Safety

Vehicle equipment

This chapter describes all series equipment as well as country-specific and special equipment offered for this model series. Therefore, it also

describes equipment that may not be found in your vehicle, for instance due to the selected special equipment or the country version. This also applies to safety-related functions and systems.

Airbags

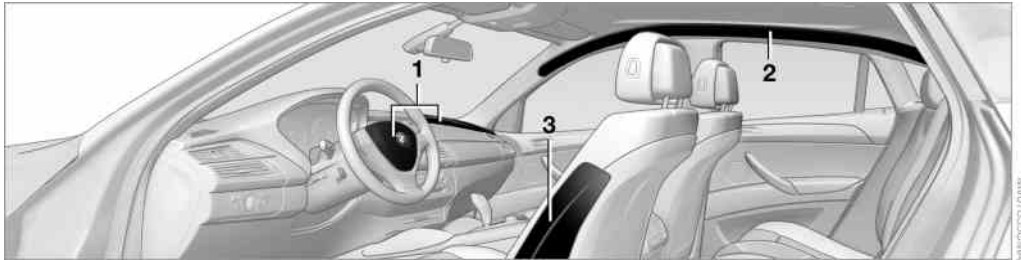

- 1 Front airbags
- 2 Head airbags

- 3 Side airbags

Front airbags

Front airbags help protect the driver and front passenger by responding to frontal impacts in which safety belts alone cannot provide adequate restraint.

Side airbags

In a lateral impact, the side airbag supports the side of the body in the chest and lap area.

Head airbags

In a lateral impact, the head airbag supports the head.

Protective action

Airbags are not triggered in every impact situation, e.g., in less severe accidents or rear-end collisions.



Information on how to ensure the optimal protective effect of the airbags

- ▶ Keep at a distance from the airbags.
- ▶ Always grasp the steering wheel on the steering wheel rim, holding your hands at the 3 o'clock and 9 o'clock positions, to keep the danger of injury to your hands or arms as low as possible if the airbag is triggered.
- ▶ There should be no people, animals, or objects between an airbag and a person.
- ▶ Do not use the cover of the front airbag on the front passenger side as a storage area.
- ▶ Keep the dashboard and window on the front passenger side clear, i.e., do not cover with adhesive labels or coverings, and do not attach holders such as for navigation instruments and mobile phones.
- ▶ Make sure that the front passenger is sitting correctly, i.e., keeps his or her feet and legs in the footwell; otherwise, leg injuries can occur if the front airbag is triggered.

- ▷ Do not place slip covers, seat cushions or other objects on the front passenger seat that are not approved specifically for seats with integrated side airbags.
- ▷ Do not hang pieces of clothing, such as jackets, over the backrests.
- ▷ Make sure that occupants keep their heads away from the side airbag and do not rest against the head airbag; otherwise, injuries can occur if the airbags are triggered.
- ▷ Do not remove the airbag restraint system.
- ▷ Do not remove the steering wheel.
- ▷ Do not apply adhesive materials to the airbag cover panels, cover them or modify them in any way.
- ▷ Never modify either the individual components or the wiring in the airbag system. This also applies to steering wheel covers, the dashboard, the seats, the roof pillars and the sides of the headliner. ◀

Even when all instructions are followed closely, injury from contact with the airbags cannot be ruled out in certain situations.

The ignition and inflation noise may lead to short-term and, in most cases, temporary hearing impairment in sensitive individuals.

 In the case of a malfunction, deactivation and after triggering of the airbags

Do not touch the individual components immediately after the system has been triggered; otherwise, there is the danger of burns.

Only have the airbags checked, repaired or dismantled and the airbag generator scrapped by your service center or a workshop that has the necessary authorization for handling explosives.

Non-professional attempts to service the system could lead to failure in an emergency or undesired triggering of the airbag, either of which could result in injury. ◀

Warnings and information on the airbags are also found on the sun visors.

Automatic deactivation of the front passenger airbags

The occupation of the seat is detected by evaluating the impression on the occupied seat surface of the front passenger seat.

The front and side airbags on the front passenger side are activated or deactivated accordingly by the system.

The indicator lamp above the interior rearview mirror shows the current status of the front passenger airbags, deactivated or activated, refer to Front passenger airbag indicator lamp below.



Leave feet in the footwell

Make sure that the front passenger keeps his or her feet in the footwell; otherwise, the front passenger airbags may not function properly. ◀



Child restraint fixing system in the front passenger seat

Before transporting a child on the front passenger seat, refer to the safety notes and instructions under Children on the front passenger seat, refer to page 60. ◀

Malfunction of the automatic deactivation system

When transporting older children and adults, the front passenger airbags may be deactivated in certain sitting positions. In this case, the indicator lamp for the front passenger airbags lights up.

In this case, change the sitting position so that the front passenger airbags are activated and the indicator lamp goes out.

If it is not possible to activate the airbags, have the person sit in the rear.

To make sure that occupation of the seat cushion can be detected correctly:

- ▷ Do not attach seat covers, seat cushion padding, ball mats or other items to the passenger seat unless they are specifically recommended by BMW.

- ▶ Do not place objects under the seat that could press against the seat from below.

Indicator lamp for the front passenger airbags

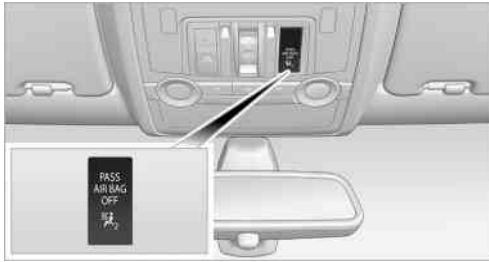

Depending on the vehicle's equipment, the arrangement of the switches and indicator lamps may differ somewhat.

The indicator lamp for the front passenger airbags indicates the operating state of the front passenger airbags.

The lamp indicates whether the airbags are activated or deactivated.

- ▶ The indicator lamp lights up when a child in a child restraint fixing system intended for the purpose is properly detected on the seat. The airbags on the front passenger side are not activated.
- ▶ The indicator lamp does not light up when, for example, a correctly seated person of sufficient size is detected on the seat. The airbags on the front passenger side are activated.
- ▶ The indicator lamp does not light up when the seat is empty. However, the airbags on the front passenger side are not activated.

The system generally detects children seated in a child seat, especially in the child seats that were required by NHTSA when the vehicle was manufactured. After installing a child seat, make sure that the indicator lamp for the front passenger airbags lights up. This indicates that the child seat has been detected and the front passenger airbags are not activated.

Operational readiness of airbag system



When the ignition is switched on,, refer to page 66, the warning lamp comes on briefly to indicate that the entire airbag system and the belt tensioners are operational.

Airbag system malfunction

- ▶ The warning lamp does not light up after the ignition is switched on.
- ▶ Warning lamp remains permanently on.



Have the airbag system checked without delay if there is a malfunction

In the event of a malfunction in the airbag system, have it checked without delay; otherwise, there is the risk that the system will not function as intended even if a sufficiently severe accident occurs.◀

FTM Flat Tire Monitor

The concept

The system does not measure the actual inflation pressure in the tires.

It detects a pressure loss in a tire by comparing the rotational speeds of the individual wheels while moving.

In the event of a pressure loss, the diameter and therefore the rotational speed of the corresponding wheel change. This is detected and reported as a flat tire.

Functional requirements

The system must have been initialized when the tire inflation pressure was correct; otherwise, reliable signaling of a flat tire is not ensured. Initialize the system after each correction of the tire inflation pressure and after every tire or wheel change.

System limits



Sudden tire damage

Sudden serious tire damage caused by external influences cannot be indicated in advance. ◀

A natural, even pressure loss in all four tires cannot be detected. Therefore, check the tire inflation pressure regularly.

The system could be delayed or malfunction in the following situations:

- ▷ When the system has not been initialized.
- ▷ When driving on a snowy or slippery road surface.
- ▷ Sporty driving style: slip in the drive wheels, high lateral acceleration.
- ▷ When driving with snow chains.

When driving with a compact wheel, the Flat Tire Monitor is unable to function.

Status display

The current status of the Flat Tire Monitor can be displayed on the Control Display, e.g., whether or not the FTM is active.

1. "Vehicle Info"
2. "Vehicle status"
3. (⚠) "Flat Tire Monitor"

The status is displayed.

Initialization

The initialization process adopts the set inflation tire pressures as reference values for the detection of a flat tire. Initialization is started by confirming the inflation pressures.

Do not initialize the system when driving with snow chains or with a compact wheel.

1. "Vehicle Info"
2. "Vehicle status"
3. (⚠) "Reset"
4. Start the engine - do not drive away.
5. Start the initialization with "Reset".
6. Drive away.

The initialization is completed while driving, which can be interrupted at any time.

The initialization automatically continues when driving resumes.

Indication of a flat tire



The warning lamp lights up red. A message appears on the Control Display. In addition, a signal sounds.

There is a flat tire or a major loss in tire inflation pressure.

Reduce your speed and stop cautiously. Avoid sudden braking and steering maneuvers.



Do not continue driving without run-flat tires

If the vehicle is not equipped with run-flat tires as provided at the factory, do not continue driving. Continuing to drive could cause severe accidents. ◀

When a flat tire is indicated, DSC Dynamic Stability Control is switched on if necessary.

Actions in the event of a flat tire

Run-flat tires

Maximum speed

You can continue driving with a damaged tire at speeds up to 50 mph/80 km/h.

Continued driving with a flat tire

If continuing to drive with a damaged tire:

1. Avoid sudden braking and steering maneuvers.
2. Do not exceed a speed of 50 mph/80 km/h.
If the defective tire continues to lose pressure, its position will be indicated to you on the Control Display.
3. At the next opportunity, check the inflation pressure in all four tires.

If the tire inflation pressure in all four tires is correct, the Flat Tire Monitor may not have been initialized. In this case, initialize the system.

Possible driving distance with complete loss of tire inflation pressure:

The possible driving distance after a loss of tire inflation pressure depends on the cargo load and the driving style and conditions.

For a vehicle containing an average load, the possible driving distance is approx. 50 miles/80 km.

When the vehicle is driven with a damaged tire, its handling characteristics change, e.g., reduced lane stability during braking, a longer braking distance, and altered self-steering properties. Adjust your driving style accordingly. Avoid abrupt steering maneuvers or driving over obstacles, e. g., curbs, potholes, etc.

Because the possible driving distance depends on how the vehicle is used during the trip, the actual distance may be smaller or greater depending on the driving speed, road conditions, external temperature, cargo load, etc.

Continued driving with a flat tire

Drive moderately and do not exceed a speed of 50 mph/80 km/h.

A loss of tire inflation pressure results in a change in the handling characteristics, e.g., reduced lane stability during braking, a longer braking distance and altered self-steering properties. ◀



Final tire failure

Vibrations or loud noises while driving can indicate the final failure of the tire. Reduce speed and stop; otherwise, pieces of the tire could come loose and cause an accident. Do not continue driving, and contact your service center. ◀

Tire Pressure Monitor TPM

The concept

The tire inflation pressure is measured in the four mounted tires. The system notifies you if there is a significant loss of pressure in one or more tires.

Functional requirements

The system must have been reset while the inflation pressure was correct; otherwise, reliable signaling of a flat tire is not ensured.

Always use wheels with TPM electronics to ensure that the system will operate properly.

Reset the system after each correction of the tire inflation pressure and after every tire or wheel change.

System limits



Sudden tire damage

Sudden serious tire damage caused by external influences cannot be indicated in advance. ◀

The system does not operate correctly if it has not been reset. For example, a flat tire may be indicated despite correct tire inflation pressures.

The system is inactive and cannot indicate a flat tire:

- ▷ If a wheel without TPM electronics is mounted, e.g., compact wheel.
- ▷ When the TPM is disturbed by other systems or devices with the same radio frequency.

Status display

1. "Vehicle Info"
2. "Vehicle status"
3. (!) "TPM"

The status is displayed.

Status indicator on the Control Display

The tire and system status is indicated by the color of the tires.

A change in the tire inflation pressure during driving is taken into account.

A correction is only necessary if this is indicated by the TPM

Wheels, green

The tire inflation pressure is equal to the target state.

One wheel is yellow

A flat tire or major drop in inflation pressure in the indicated tire.

All wheels are yellow

- ▷ A flat tire or major drop in inflation pressure in several tires.
- ▷ The system was not reset after a wheel change and thus issues a warning based on the inflation pressures initialized last.
- ▷ A flat tire in one or more tires while the system is being reset.

Wheels, gray

The system cannot detect a flat tire.

Reasons for this may be:

- ▷ TPM is being reset.
- ▷ Disturbance by systems or devices with the same radio frequency.
- ▷ Malfunction.

Resetting the system

Reset the system after each correction of the tire inflation pressure and after every tire or wheel change.

1. "Vehicle Info"
2. "Vehicle status"
3. (!) "Reset"
4. Start the engine - do not drive away.
5. Reset the tire pressure using "Reset".
6. Drive away.

The tires are shown in gray and "Resetting TPM..." is displayed.

After driving for a few minutes, the set tire inflation pressures are applied as set values. The resetting process is completed automatically as you drive. The tires are shown in green and "TPM active" is shown on the Control Display.

The trip can be interrupted at any time. If you drive away again, the process resumes automatically. Do not reset the system when driving with a compact wheel.

If a flat tire is detected while the system is resetting, all tires on the Control Display are displayed in yellow. The message "Low tire!" is shown.

Low tire pressure message

(!) The small warning lamp lights up yellow and the large warning lamp lights up red. A message appears on the Control Display. In addition, a signal sounds.

- ▷ There is a flat tire or a major loss in tire inflation pressure.
- ▷ The system was not reset after a wheel change and thus issues warnings based on the inflation pressures initialized last.

Reduce your speed and stop cautiously. Avoid sudden braking and steering maneuvers.



Do not continue driving without run-flat tires

If the vehicle is not equipped with run-flat tires as provided at the factory, do not continue driving. Continuing to drive could cause severe accidents. ◀

When a low inflation pressure is indicated, DSC Dynamic Stability Control is switched on if necessary.

Actions in the event of a flat tire

Run-flat tires

Maximum speed

You can continue driving with a damaged tire at speeds up to 50 mph/80 km/h.

Continued driving with a flat tire

If continuing to drive with a damaged tire:

1. Avoid sudden braking and steering maneuvers.
2. Do not exceed a speed of 50 mph/80 km/h.
3. Check the air pressure in all four tires at the next opportunity.

If the tire inflation pressure in all four tires is correct, the Tire Pressure Monitor may not have been reset. Reset the system.

Possible driving distance with complete loss of tire inflation pressure:

The possible driving distance after a loss of tire inflation pressure depends on the cargo load and the driving style and conditions.

For a vehicle containing an average load, the possible driving distance is approx. 50 miles/80 km.

When the vehicle is driven with a damaged tire, its handling characteristics change, e.g., reduced lane stability during braking, a longer braking distance, and altered self-steering properties. Adjust your driving style accordingly. Avoid abrupt steering maneuvers or driving over obstacles, e. g., curbs, potholes, etc.

Because the possible driving distance depends on how the vehicle is used during the trip, the actual distance may be smaller or greater depending on the driving speed, road conditions, external temperature, cargo load, etc.



Continued driving with a flat tire

Drive moderately and do not exceed a speed of 50 mph/80 km/h.

A loss of tire inflation pressure results in a change in the handling characteristics, e.g., reduced lane stability during braking, a longer braking distance and altered self-steering properties. ◀



Final tire failure

Vibrations or loud noises while driving can indicate the final failure of the tire. Reduce speed and stop; otherwise, pieces of the tire could come loose and cause an accident. Do not continue driving, and contact your service center. ◀

Message when the system was not reset



The yellow warning lamp lights up. A message appears on the Control Display.

The system detected a wheel change but was not reset.

Warnings regarding the current tire inflation pressure are not reliable.

Check the tire inflation pressure and reset the system.

Malfunction



The small warning lamp flashes in yellow and then lights up continuously; the larger warning lamp comes on in yellow. On the Control Display, the tires are shown in gray and a message appears. No flat tire can be detected.

Display in the following situations:

- ▶ If a wheel without TPM electronics is fitted, for instance a compact wheel: have the service center check it if necessary.
- ▶ Malfunction: have the system checked by your service center.
- ▶ TPM could not be fully reset. Reset the system again.
- ▶ Disturbance by systems or devices with the same radio frequency: after leaving the area of the disturbance, the system automatically becomes active again.

Declaration according to NHTSA/ FMVSS 138 Tire Pressure Monitoring Systems

Each tire, including the spare (if provided) should be checked monthly when cold and inflated to the inflation pressure recommended by the vehicle manufacturer on the vehicle placard or tire inflation pressure label (If your vehicle has tires of a different size than the size indicated on the vehicle placard or tire inflation pressure label, you should determine the proper tire inflation pressure for those tires.).

As an added safety feature, your vehicle has been equipped with a tire pressure monitoring system (TPMS) that illuminates a low tire pressure telltale when one or more of your tires is significantly under-inflated. Accordingly, when the low tire pressure telltale illuminates, you should stop and check your tires as soon as possible, and inflate them to the proper pressure. Driving on a significantly under-inflated tire causes the tire to overheat and can lead to tire failure. Under-inflation also reduces fuel efficiency and tire tread life, and may affect the vehicle's handling and stopping ability.

Please note that the TPMS is not a substitute for proper tire maintenance, and it is the driver's responsibility to maintain correct tire pressure, even if under-inflation has not reached the level to trigger illumination of the TPMS low tire pressure telltale.

Your vehicle has also been equipped with a TPMS malfunction indicator to indicate when the system is not operating properly. The TPMS malfunction indicator is combined with the low tire pressure telltale. When the system detects a malfunction, the telltale will flash for approximately one minute and then remain continuously illuminated. This sequence will continue upon subsequent vehicle startups as long as the malfunction exists. When the malfunction indicator is illuminated, the system may not be able to detect or signal low tire pressure as intended. TPMS malfunctions may occur for a variety of reasons, including the installation of replacement or alternate tires or wheels on the vehicle that prevent the TPMS from functioning properly. Always check the TPMS malfunction telltale after replacing one or more tires or wheels on your vehicle to ensure that the replacement or alternate tires and wheels allow the TPMS to continue to function properly.

Lane departure warning

The concept

This system issues a warning at speeds above approx. 40 mph/65 km/h if the vehicle is about to leave the lane on roads with lane markings.

The steering wheel begins vibrating lightly. The time when the warning is issued may vary with the current driving situation.

The system does not issue a warning if the turn signal is set before leaving the lane.

Switching on/off

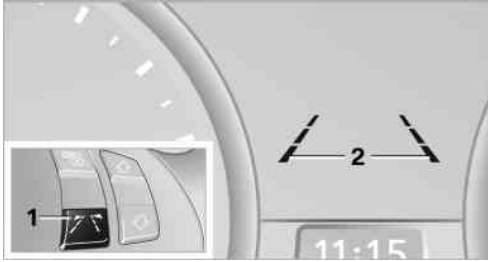

Press button 1 on the steering wheel.

- ▷ On: lane markings 2 are lit.
- ▷ Off: lane markings 2 go out.

The system can issue warnings at speeds above approx. 40 mph/65 km/h.

The state is stored for the remote control currently in use.

Display

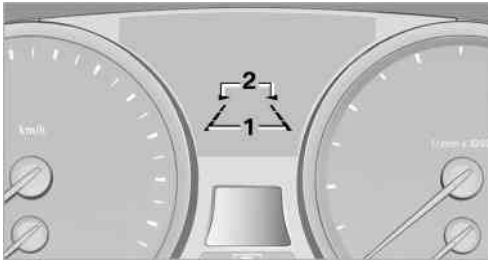

- 1 The system is activated.
- 2 Arrows: at least one lane marking was detected and warnings can be issued.

Issuing a warning

If the vehicle begins leaving the lane and a lane marking has been detected, the steering wheel begins vibrating.

If the turn signal is set before the lane is changed, a warning is not issued.

Canceling a warning

The warning is canceled:

- ▷ Automatically after approx. 3 seconds.
- ▷ After the vehicle returns to its lane.
- ▷ During heavy brake application.
- ▷ When the turn signal flashes.

System limits



Personal responsibility

The system cannot serve as a substitute for the driver's personal judgment of the course of the road and the traffic situation.

In the event of a warning, do not jerk the steering wheel; otherwise, you may lose control over the vehicle. ◀

The system may not be fully functional in the following situations:

- ▷ In heavy fog, rain or snowfall.
- ▷ In the event of worn, poorly visible, merging, diverging, or multiple lane markings such as in construction areas.
- ▷ When the demarcation lines are covered by snow, ice, dirt or water.
- ▷ In tight curves or on narrow lanes.
- ▷ When the demarcation lines are covered by objects.
- ▷ When driving very close to the vehicle in front of you.
- ▷ When driving toward bright lights.
- ▷ When the windshield is fogged over, dirty or covered by a sticker, etc., in front of the interior rearview mirror.

Malfunctions

Steering wheel vibration

Frequent activation of the steering wheel vibration causes the system to overheat.

The lane departure warning system is deactivated.

Let the system cool and reactivate it by pressing the button.

Camera

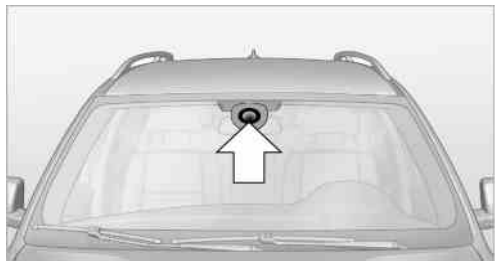

The camera is located on the front of the interior rearview mirror.

Keep the area in front of the interior rearview mirror clear.

BMW X6

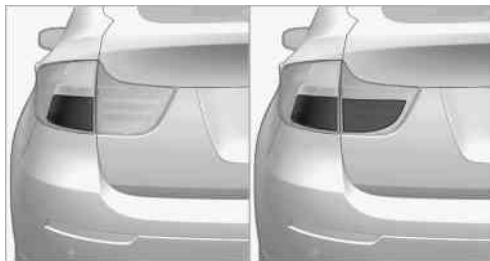

- ▶ During normal brake application, the outer brake lamps light up.
- ▶ During heavy brake application, the inner brake lamps light up in addition.

Brake force display

The concept

BMW X5

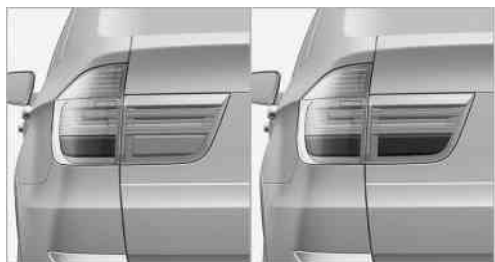

- ▶ During normal brake application, the outer brake lamps light up.
- ▶ During heavy brake application, the inner brake lamps light up in addition.

Driving stability control systems

Vehicle equipment

This chapter describes all series equipment as well as country-specific and special equipment offered for this model series. Therefore, it also describes equipment that may not be found in your vehicle, for instance due to the selected special equipment or the country version. This also applies to safety-related functions and systems.

Antilock Brake System ABS

ABS prevents locking of the wheels during braking.

The vehicle remains steerable even during full brake applications, thus increasing active safety.

ABS is operational every time you start the engine.

CBC Cornering Brake Control

When braking during curves or when braking during a lane change, driving stability and steering response are improved further.

Electronic brake-force distribution

The system controls the brake pressure in the rear wheels to ensure stable braking behavior.

Brake assistant

When you apply the brakes rapidly, this system automatically produces the maximum braking force boost. It thus helps to achieve the shortest possible braking distance during full braking.

This system utilizes all of the benefits provided by ABS.

Do not reduce the pressure on the brake pedal for the duration of the full braking.

Dynamic Stability Control DSC

The concept

DSC prevents traction loss in the driving wheels when driving away and accelerating.

DSC also recognizes unstable vehicle conditions, such as fishtailing or nose-diving. Subject to physical limits, DSC helps to keep the vehicle on a steady course by reducing engine speed and by applying brakes to the individual wheels.



Adjust your driving style to the situation

An appropriate driving style is always the responsibility of the driver.

The laws of physics cannot be repealed, even with DSC.

Do not reduce the additional safety margin with a risky driving style, as otherwise there is a risk of an accident. ◀

Deactivating DSC: DSC OFF

When DSC is deactivated, driving stability is reduced during acceleration and when driving in bends.

To increase vehicle stability, activate DSC again as soon as possible.

Deactivating DSC

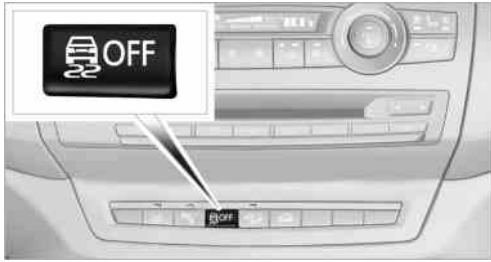

Press and hold the button, but not longer than approx. 10 seconds, until the indicator lamp for DSC lights up in the instrument cluster and DSC OFF is displayed. DTC Dynamic Traction Control and DSC are deactivated together.

A message appears on the Control Display. Please note any supplementary information that appears there.

Activating DSC

Press the button.

DSC OFF and the indicator lamp in the instrument cluster go out.

For better control



The indicator lamp flashes: DSC controls the drive forces and brake forces.

The indicator lamp lights up: DSC and DTC has failed.

DSC deactivated:



The indicator lamp lights up and DSC OFF appears in the instrument cluster.



DSC and DTC deactivated.

Dynamic Traction Control DTC

The concept

The DTC system is a version of the DSC in which forward momentum is optimized.

The system ensures maximum forward momentum on special road conditions, e.g., unplowed snowy roads, but driving stability is limited.

It is therefore necessary to drive with appropriate caution.

You may find it useful to briefly activate DTC under the following special circumstances:

- ▷ When driving in sand, on snowy inclines, in slush, or on unplowed, snow-covered road surfaces
- ▷ When rocking a vehicle free or starting off in deep snow, sand, or on loose ground
- ▷ When driving with snow chains.

Deactivating/activating DTC Dynamic Traction Control

Activating the Dynamic Traction Control DTC provides maximum traction on loose ground. Driving stability is limited during acceleration and when driving in bends.

Activating DTC



Press the button.

TRACTION is displayed in the instrument cluster and the indicator lamp for DSC OFF lights up.

Deactivating DTC

Press the button again.

TRACTION and the indicator lamp in the instrument cluster go out.

For better control



The indicator lamp flashes: DTC controls the drive forces and brake forces.

The indicator lamp lights up: DSC and DTC has failed.

DTC activated:



The indicator lamp lights up and TRACTION appears in the instrument cluster.



DTC is activated.

xDrive

xDrive is the all-wheel-drive system of your vehicle. The combined effects of xDrive and DSC further optimize the traction and dynamic driving characteristics. The 4-wheel drive system xDrive variably distributes the drive forces to the front and rear axle depending on the driving situation and prevailing road conditions.

Dynamic Performance Control

The concept

Dynamic Performance Control optimizes the handling characteristics of your vehicle when starting off, cornering, and during evasive maneuvers.

To achieve this, the system variably distributes the drive torque of the rear axle to the two rear wheels. This further increases the steering precision and tracking stability of your vehicle.

Display

The Control Display shows how xDrive and Dynamic Performance Control are distributing the drive forces.

1. "Vehicle Info"
2. "Torque distribution"

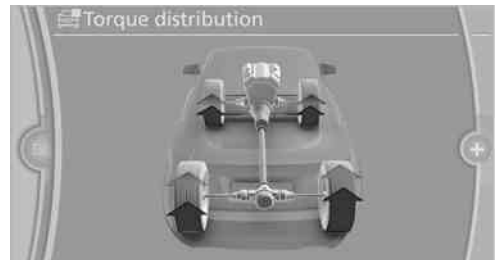

The current distribution of drive forces is indicated by arrows pointing to all four wheels.

The highlighted arrows show the drive forces currently present. The longer an arrow is, the greater the drive forces in the associated wheel.

The transparent arrows indicate the maximum value the drive forces over the last 10 seconds.

Malfunction

Malfunctions are displayed via Check Control, refer to page 83.

Hill Descent Control HDC

The concept

HDC is a downhill driving assistant that automatically controls vehicle speed on steep downhill gradients. The vehicle moves at approximately walking speed without braking intervention by the driver.

You can activate the Hill Descent Control at speeds below approx. 22 mph/35 km/h. When moving downhill at speeds below approx. 22 mph/35 km/h, the vehicle reduces its speed to approximately walking speed, approx. 5 mph/8 km/h and keeps it constant.

Only use HDC in transmission positions D or R.

Increasing or reducing speed

The speed can be changed in the range from approx. 4 mph/6 km/h to approx. 15 mph/25 km/h by pressing the accelerator or brake pedal lightly.

A target speed within the same range can be specified using the lever of the cruise control.

On inclines over 10 %, you can reduce the speed to approx. 3 mph/4 km/h. Pull the lever of the cruise control beyond the resistance point, arrow 3.

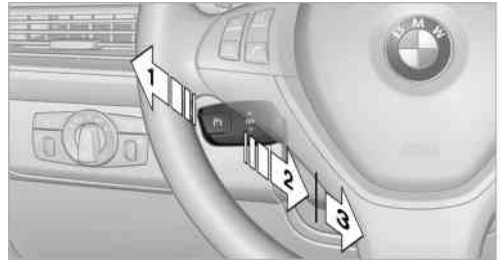

- 1 Increasing speed
- 2 Pull to the resistance point: reduce the speed to approx. 4 mph/6 km/h
- 3 Pull beyond the resistance point: on inclines over 10 %, reduce the speed to approx. 3 mph/4 km/h

Activating HDC

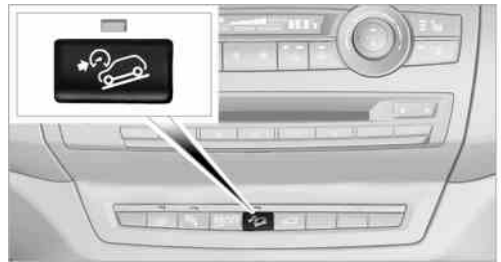

Press the button; the LED above the button lights up.

The LED flashes when the brakes are applied automatically.

Deactivating HDC

Press the button again; the LED goes out. HDC is automatically deactivated above approx. 37 mph/60 km/h.

Displays in the instrument cluster



- 1 Display for target speed
- 2 HDC display

Malfunction

HDC is temporarily unavailable in the following situations due to a high brake temperature:

- ▶ The LED in the button and the display HDC go out during HDC operation.
- ▶ The LED in the button and the HDC display do not light up when the button is pressed.

Malfunction of driving stability control systems



Adapting your driving style

When driving on poor roads, avoid using full throttle or pressing the accelerator beyond the kickdown point and also avoid heavy braking. Otherwise, the drive train may be damaged or accidents can occur. ◀

Adaptive Drive

The concept

Adaptive Drive reduces the body roll which occurs when cornering quickly or during fast evasive maneuvers. In addition, Adaptive Drive reduces the steering angle requirement, improves the running comfort, and enhances the dynamic driving characteristics of your vehicle.

Chassis and suspension tuning

Two chassis and suspension tunings are available for selection.

- ▶ Normal:

The comfortable basic setting offers optimum comfort when traveling.
- ▶ Sport:

The sporty basic setting offers increased driving agility.

Selecting chassis and suspension tuning



Press the button.

The system switches between the two chassis and suspension tuning settings.

- ▶ Sport:

The LED in the button lights up and SPORT is displayed in the instrument panel.
- ▶ Normal:

The LED in the button goes out.

The selection of the chassis and suspension tuning setting is stored for the remote control currently in use.

Drive-off assistant

This system supports driving away on gradients. The parking brake is not required.

1. Hold the vehicle in place with the foot brake.
2. Release the foot brake and drive away without delay.

Depending on the vehicle load, the vehicle may roll back slightly.



Driving off without delay

After releasing the foot brake, start driving without delay, since the drive-off assistant will not hold the vehicle in place for more than approx. 2 seconds and the vehicle will begin rolling back. ◀

Self-leveling suspension

The concept

The self-leveling suspension on the rear axle assures a continuous ground clearance.

To do so, the height of the vehicle is measured by sensors at both rear wheels.

If the actual height deviates from the defined height, such as due to cargo in the vehicle, this difference is compensated very quickly. In addition, spring motions resulting from cornering or irregularities in the road surface are reduced to a minimum.

The system works automatically.

Malfunctions

Malfunctions are displayed via Check Control, refer to page 83.

Active steering

The concept

The active steering actively varies the steering angle of the front wheels in relation to the steering wheel movements. In addition, it also varies the steering force required for steering depending on the vehicle's speed.

When you are driving in the low speed range, for instance in a town or when parking, the steering angle increases, i.e., steering becomes very direct. In the higher speed range, on the other hand, the steering angle is reduced more and

more. This improves the handling of your vehicle over the entire speed range.

In critical situations, the system can make targeted corrections to the steering angle provided by the driver and thus stabilize the vehicle before the driver intervenes.

Malfunction



The warning lamp lights up yellow and a message is shown on the Control Display. The active steering is defective or has been temporarily deactivated. At low speeds, greater steering wheel movements are required, whereas at higher speeds, the vehicle reacts more sensitively to steering wheel movements. The stability-promoting intervention can also be deactivated. Proceed cautiously and drive defensively.

Deactivation

Active steering deactivates in order to carry out an initialization. This deactivation is displayed by means of a message. The initialization can take several minutes.

If the message does not disappear during the current trip, have the system checked.

Defect

In the event of a defect, a corresponding text message is displayed. Have the system checked.

Driving comfort

Vehicle equipment

This chapter describes all series equipment as well as country-specific and special equipment offered for this model series. Therefore, it also describes equipment that may not be found in your vehicle, for instance due to the selected special equipment or the country version. This also applies to safety-related functions and systems.

Active cruise control

With active cruise control you can select a desired speed which is then automatically maintained when driving on open roadways and is varied to maintain a selected distance setting to slower moving vehicles ahead.

Active cruise control represents a technological advance over the familiar cruise control and is a welcome relief from the constant adjustment of speed that can accompany driving in traffic on highways or other high-speed thoroughfares. Especially on longer trips and in traffic congestion, the system can reduce fatigue and tension, while increasing your enjoyment of driving. Please use it safely and responsibly.

In addition to holding a steady cruising speed, if you encounter slower vehicles ahead, active cruise control will, within limits, adjust your vehicle's speed automatically so that you can flow with the traffic without having to make constant adjustments. If, for example, while cruising at the selected speed, you begin to approach a slower vehicle ahead of you in the same lane, the system will reduce your vehicle's speed to the same as that of the vehicle ahead to maintain your selected distance setting. You can vary the following distance, which will vary with speed. Based on your selected distance setting, the system automatically decreases the throttle setting and lightly applies the brakes if necessary. In addition,

if the vehicle ahead of you slows to a complete stop, the system can follow this action within the given scope and can also accelerate from a complete stop if the vehicle ahead of you drives off again shortly thereafter. During braking, your vehicle brake lamps will automatically illuminate to alert a following driver to take action. In addition, it may be necessary for your vehicle to downshift the automatic transmission to maintain the distance setting selected. As soon as the road in front of you has no moving vehicles, the system will accelerate to your desired speed. This set speed is also maintained on downhill grades, however the vehicle speed can drop below the set speed when driving uphill if the engine output is not sufficient.



Personal responsibility

Active cruise control cannot detect stop signs, red lights, or any object that is stopped or is blocking the road. Active cruise control is not and must not be used as a collision avoidance/warning system. Since this active cruise control system is a new technology and operates differently from conventional cruise control systems to which you may be accustomed, it is necessary that you read all of the pages relating to this system before use. Carefully read and observe the information on the system limitations, refer to page 113, to obtain a good command of the system and its range of applications. ◀

Brake pedal feel

When the system brakes and you also depress the brake pedal, a somewhat different braking feel results.

Professional navigation system

If the vehicle is equipped with a Professional navigation system, the system adapts the acceleration and deceleration behavior of the ve-

hicle to the road on which you are currently driving.

To ensure that the system has the latest information on the course of the road, use the most recent version of the navigation data.

If the vehicle position is unknown, e.g., if you have left the region covered by the map, the navigation system ceases to influence vehicle behavior.

Applications

Please try the system first during sparse traffic and clear road conditions so that you can get used to the system. After you have experience and understand the system, only then use it during normal traffic.

As with conventional cruise control systems, active cruise control in no way reduces or substitutes for the driver's own personal experience, responsibility, alertness and awareness in adjusting speed, braking or otherwise controlling the vehicle. The driver should decide when to use the system on the basis of road, traffic, visibility, and weather conditions. Active cruise control is intended for use on highway-type roadways where traffic is moving relatively smoothly as well as in slow-moving traffic congestion. Do not use the system in city driving; in complex driving situations; heavy traffic such as during rush hour; on curvy, winding roads, slippery roads or roads with sharp curves such as highway off-ramps; during inclement weather such as snow, strong rain or fog; or when entering interchanges, service/parking areas or toll booths. It is also important to regulate your vehicle's speed and distance setting within applicable legal limits. Always be ready to take action or apply the brakes if necessary, especially when the system is actively following a vehicle in front of you. Otherwise, driving conditions can result which lead to a violation of the law or elevated risk of an accident.

The minimum initial activation speed is 20 mph/ 30 km/h, and the maximum speed is 110 mph/ 180 km/h. The system can also be ac-

tivated while the vehicle is stationary, refer to page 112.

One lever for all functions

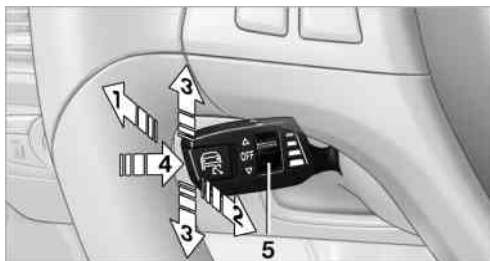

- 1 Storing and increasing the desired speed 110
- 2 Storing and reducing the desired speed 110
- 3 Interrupting 111 or deactivating 112 the system
- 4 Retrieving the stored desired speed and distance 112 or driving away 112
- 5 Selecting the distance to the vehicle ahead 111

Storing the current speed

Push the lever, arrow 1, or pull it briefly, arrow 2.



The system stores the current vehicle speed. It is indicated on the speedometer and briefly in the instrument panel.

Increasing desired speed

Press or briefly push the lever up to or beyond the resistance point, arrow 1, until the desired speed is displayed.

The displayed speed is stored and the vehicle reaches the stored speed if the road is clear.

- ▶ With each activation to the resistance point, the desired speed increases by approx. 1 mph/1 km/h.
- ▶ With each activation beyond the resistance point, the desired speed increases by a maximum of 5 mph/10 km/h.

Reducing the desired speed

Pull the lever, arrow 2, until the desired speed is displayed.

The functions are the same as those when increasing the desired speed.

Selecting the distance

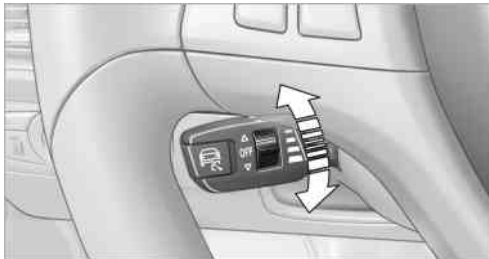

- ▶ Press the rocker down briefly: Increase the distance.
- ▶ Press the rocker up briefly: Decrease the distance.

The selected distance is displayed in the instrument panel.

Distance display



Distance 1, closest



Distance 2



Distance 3



Distance 4, furthest

This distance is set when you activate the system.



Selecting an appropriate distance

Use good judgement to select the appropriate following distance given road conditions, traffic, applicable laws and State driving recommendations for safe following distance. Otherwise, a violation of the law or risk of an accident could result. ◀

Interrupting the system



Press the lever up or down and additionally depress the brake if the vehicle is stationary. The mark in the speedometer changes color and the distance indicator goes out.

In addition, the system is interrupted:

- ▶ When the brakes are applied.
- ▶ When the transmission position D is disengaged.
- ▶ When DTC is activated or DSC is deactivated.

- ▷ When DSC is activated
- ▷ When the safety belt and the driver's door are opened while the vehicle is stationary.
- ▷ When the system has not detected objects for an extended period, e.g., on a road with very little traffic without road edge line markings.
- ▷ The radar sensor is dirty.

 Active intervention if the system is interrupted

If the system is interrupted, actively intervene by braking and, if necessary, with evasive maneuvers; otherwise, there is the danger of an accident occurring. ◀

Calling up the stored desired speed and distance

While driving

Press button 4, refer to page 110. All of the displays in the instrument panel lights up.

While standing

 Before leaving the vehicle

Before leaving the vehicle with the engine running, engage position P of the automatic transmission and apply the parking brake. Otherwise, the vehicle may begin to roll. ◀

If a vehicle detected ahead of you slows to a halt and your vehicle is also brought to a halt by the system:

- ▷ If the vehicle ahead of you drives away, your vehicle accelerates automatically as long as mark 1 for the desired speed in the speedometer is green.
- ▷ If the vehicle ahead of you drives away when mark 1 is orange, depress the accelerator briefly or press button 4. Rolling bars in the distance indicator 3 mean that the vehicle ahead of you has driven away.

If you are standing behind a vehicle with your brake pedal depressed and the system is deactivated or interrupted:

1. Select the desired speed using the lever, arrow 1 or arrow 2, or press button 4 to retrieve a stored speed.
2. Release the brake pedal.
3. When the vehicle ahead of you drives away, press on the accelerator briefly or press button 4.

Deactivating the system

- ▷ When driving, press the lever up or down twice.
- ▷ When stationary, do the same while depressing the brake pedal.
- ▷ Switch off the ignition.

The displays go out, and the stored desired speed and distance are deleted.

Displays in instrument cluster

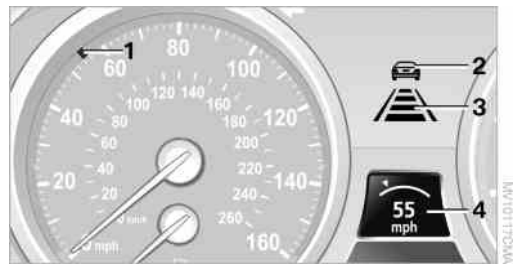

- 1 Stored desired speed
 - ▷ Green: the system is active.
 - ▷ Orange: the system is interrupted.
- 2 Lights up yellow: vehicle detected ahead
Display also used for warnings, please read all information on warnings.
- 3 Selected distance to vehicle ahead The indicator lights up as soon as the system is activated.
The indicator lights up as soon as the system is activated.

The bars roll: the vehicle in front of you has driven off

4 Brief display of stored desired speed

If the display --- mph/---km/h appears briefly, the conditions necessary for operation may currently not be met.

Warning lamps



Display 2 flashes red and a signal sounds.

The system requests that you intervene by braking and carrying out evasive maneuvers, if necessary. The system cannot independently restore the distance to the vehicle ahead.

This display does not relieve the driver of the responsibility to adapt his or her desired driving speed and style to the traffic conditions.



Display 2 flashes yellow.

The conditions necessary for operation of the system are no longer met, e.g., due to ABS or DSC intervention. The system applies the brakes until you actively assume control.

Radar sensor

Position

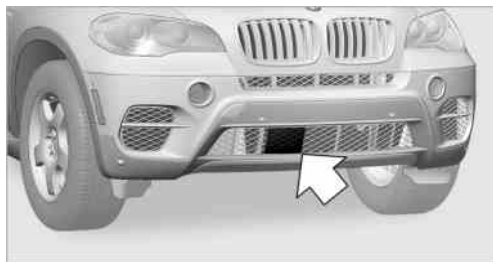

The radar sensor is integrated in the bumper.

Dirty or covered sensor

A dirty or covered sensor may hinder the detection of vehicles.

- ▶ If necessary, clean the radar sensor. Remove layers of snow and ice carefully.
- ▶ Do not cover the view field of the radar sensor.

Malfunction

The system cannot be activated if the radar sensor is not aligned correctly. Misalignment may be caused by damage incurred during parking, for example.

For US owners only

The transmitter and receiver units comply with part 15 of the FCC/Federal Communication Commission regulations. Operation is governed by the following:

FCC ID:

- ▶ OAYARS3-A

Compliance statement:

This device complies with part 15 of the FCC Rules. Operation is subject to the following two conditions:

- ▶ This device may not cause harmful interference, and
- ▶ This device must accept any interference received, including interference that may cause undesired operation.

Any unauthorized modifications or changes to these devices could void the user's authority to operate this equipment.

System limits

Speed range

Best results are achieved when using the system on well-developed roads and highways. The desired speed can be selected between 20 mph/30 km/h and 110 mph/180 km/h.

The system can also be activated when stationary.

Comply with the legal speed limit in every situation when using the system.

Detection range

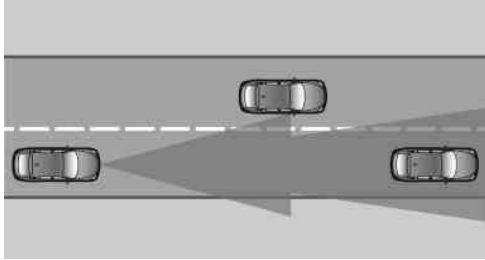

The detection capacity of the system and the automatic braking capacity are limited. Two-wheeled vehicles driving ahead of you for instance might not be detected.

Limited detection capacity

Because of the limits to the detection capacity, you should be alert at all times so that you can intervene actively, if necessary; otherwise, there is the danger of an accident occurring. ◀

Deceleration

The system does not decelerate when a stationary obstacle is located in the same lane, e.g., a vehicle at a red traffic light or at the end of traffic congestion.

The system also does not respond to:

- ▷ Pedestrians or similarly slow road users.
- ▷ Red traffic lights.
- ▷ Stationary objects.
- ▷ Cross traffic.
- ▷ Approaching traffic.

No warnings

A warning may not be issued when approaching a stationary or very slow-moving obstacle. Take action yourself, otherwise there is a risk of an accident. ◀

Swerving vehicles

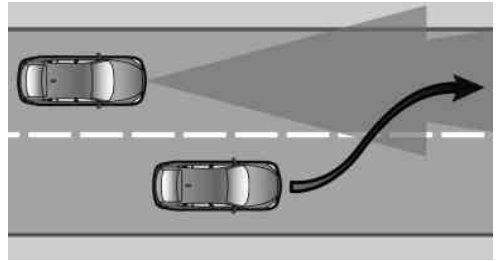

A vehicle driving in front of you is not detected until it is completely within the same lane as your vehicle.

Swerving vehicles

If a vehicle driving ahead of you suddenly swerves into your lane, the system may not be able to automatically restore the selected distance. This also applies to major speed differences to vehicles driving ahead of you, e.g., when rapidly approaching a truck. When a vehicle driving ahead of you is reliably detected, the system requests that the driver intervene by braking and carrying out evasive maneuvers, if necessary. Take action yourself, otherwise there is a risk of an accident. ◀

Unexpected lane change

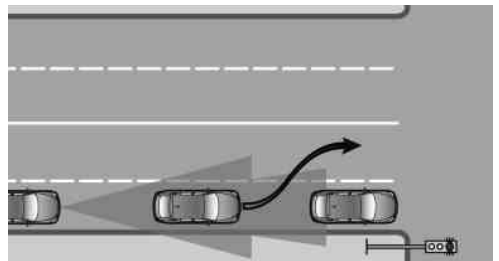

If a vehicle ahead of you unexpectedly moves into another lane from behind a stopped vehicle, you yourself must react, as the system does not react to stopped vehicles.

Cornering



If the desired speed is too high for a curve, the speed is reduced slightly in the curve, although curves cannot be anticipated in advance. Therefore, drive into a curve at an appropriate speed.

In tight curves, situations may result due to the restricted detection range of the system in which a vehicle driving ahead of you may not be detected at all, or not until after a considerable delay.



When approaching a curve, the system may react briefly to the vehicles in the next lane due to the bend of the curve. Any deceleration of the vehicle by the system can be compensated for by briefly accelerating. After the accelerator pedal is released, the system becomes active again and independently controls the speed.

Driving away

In some situations, the vehicle cannot drive away automatically, e.g., on steep inclines, with a heavy trailer or behind bumps in the road.

Driver interventions and your responsibility

Your actions have priority at all times. When you press on the accelerator pedal while driving, automatic braking is not performed and the bars in the distance display go out until you lift your foot from the accelerator pedal. Once you release the accelerator pedal, the desired speed is achieved again on clear roads or the selected distance to the vehicle ahead is maintained.



Making braking possible

Anytime the driver presses down on the accelerator pedal, any braking action by the system is interrupted and the distance indicator goes out until the pedal is fully released. As soon as you fully release the accelerator, the system will again control your cruising speed and distance setting. While driving with the system activated, resting your foot on the accelerator pedal will cause the system not to brake even if necessary. Be certain that floor mats or other objects on the vehicle floor do not interfere with movement of the accelerator pedal. ◀



Limits of automatic braking

While active cruise control is capable of braking your vehicle automatically when you approach a slower vehicle ahead, it is important to be aware that the ability of the system to apply the brakes is also limited, e.g. when you reduce your desired speed sharply. It uses only a portion of braking system capacity and does not utilize the full capacity of the vehicle braking system. Therefore, the system cannot decrease your speed for large differences in speed between your vehicle and the vehicle ahead. Examples: when you approach a vehicle traveling at a much lower speed than your own speed such as approaching a toll booth or when a much slower vehicle cuts in front of you at close range. ◀

Cruise control

The concept

The system is functional at speeds beginning at approx. 20 mph/30 km/h.

The speed specified using the lever on the steering column is maintained.

The system brakes on downhill gradients if engine braking action is insufficient.

 Do not use cruise control

Do not use the system if unfavorable conditions make it impossible to drive at a constant speed, for instance:

- ▷ On curvy roads.
- ▷ In heavy traffic.
- ▷ On slippery roads, in fog, snow or rain, or on a loose road surface.

Otherwise, you could lose control of the vehicle and cause an accident. ◀

One lever for all functions

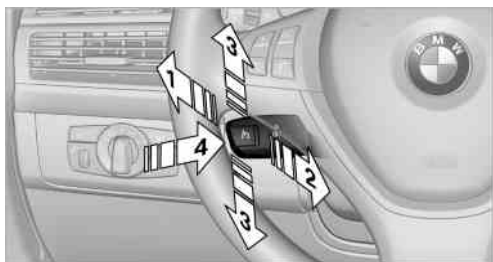

- 1 Storing and maintaining speed or accelerating
- 2 Storing and maintaining speed or decelerating
- 3 Interrupting and deactivating the system
- 4 Resuming a speed stored beforehand

Maintaining current speed

Push, arrow 1, or pull, arrow 2, the lever to the resistance point.

The car's current speed is stored and maintained. It is displayed on the speedometer and briefly in the instrument cluster.

On uphill gradients, it may prove impossible to maintain the set speed if current engine power output is insufficient. If the engine braking effect is insufficient on downhill slopes, the system will brake the vehicle slightly.

Increasing desired speed

Repeatedly press the lever to the resistance point or beyond, arrow 1, until the desired speed is reached.

- ▷ Each time the lever is pressed to the point of resistance, the desired speed increases by approx. 1 mph/1 km/h.
- ▷ Each time the lever is pressed beyond the resistance point, the desired speed is increased by up to 5 mph/10 km/h.

The system stores and maintains the speed.

Accelerating using the lever

Accelerating slightly:

Press the lever to the resistance point, arrow 1, until the desired speed is reached.

Accelerating significantly:

Press the lever beyond the resistance point, arrow 1, until the desired speed is reached.

The vehicle accelerates without pressure on the accelerator pedal. The system stores and maintains the speed.

Decreasing speed

Repeatedly pull the lever to the resistance point or beyond, arrow 2, until the desired speed is displayed.

- ▷ Each time the lever is pulled to the resistance point, the desired speed is decreased by approx. 1 mph/1 km/h.
- ▷ Each time the lever is pulled beyond the resistance point, the desired speed is reduced by up to 5 mph/10 km/h until the minimum speed of 20 mph/30 km/h is achieved.

The system stores and maintains the speed.

Interrupting the system

Press the lever up or down, arrow 3: display 1 in the speedometer changes color, refer to page 117.

In addition, the system is interrupted:

- ▷ When the brakes are applied.
- ▷ When the transmission position D is disengaged.
- ▷ When DTC is activated or DSC is deactivated.
- ▷ When DSC or ABS is intervening.

Warning lamp



The warning lamp lights up if cruise control has been deactivated automatically, e.g., by a control intervention of the DSC. A message appears on the Control Display.

Resuming cruising speed

Press button 4:

The stored speed is resumed and maintained.

Deactivating the system

- ▷ Press the lever upward or downward twice, arrow 3.
- ▷ Switch off the ignition.

The stored speed is cleared.

Displays in the instrument cluster



- 1 Stored desired speed

- ▷ Green: the system is active.
- ▷ Orange: the system is interrupted.

- 2 Selected desired speed appears briefly

If the display --- mph or --- km/h appears briefly, conditions may not be adequate to operate the system.

Call up Check Control messages, refer to page 84.

Malfunction



The warning lamp lights up. The system is malfunctioning or has failed.

A message appears on the Control Display. More information, refer to page 83.

Park Distance Control PDC

The concept

In addition to the PDC Park Distance Control, the backup camera, refer to page 120, can be switched on.

PDC supports you when parking. A slow approach to an object in front of or behind your vehicle is announced by:

- ▷ Signal tones.
- ▷ Visual display.

Measurement

Measurements are made by ultrasound sensors in the bumpers.

The range is approx. 6 ft/2 m.

An acoustic warning is first given:

- ▷ By the front sensors and two rear corner sensors at approx. 24 in/60 cm.
- ▷ By the rear middle sensors at approx. 5 ft/1.50 m.

System limits



Check the traffic situation as well

PDC cannot serve as a substitute for the driver's personal judgment of the traffic situation. Check the traffic situation around the vehicle with your own eyes. Otherwise, an accident could result from road users or objects located outside of the PDC detection range.

Loud noises from outside and inside the vehicle may prevent you from hearing the PDC's signal tone. ◀



Avoid driving quickly with PDC

Avoid approaching an object quickly.

Avoid driving away quickly while PDC is not yet active.

For technical reasons, the system may otherwise be too late in issuing a warning. ◀

Limits of ultrasonic measurement

The detection of objects can reach the physical limits of ultrasonic measurement, for instance:

- ▷ With tow bars and trailer hitches.
- ▷ With thin or wedge-shaped objects.
- ▷ With low objects.
- ▷ With objects with corners and sharp edges.

Low objects already displayed, e.g., curbs, can move into the blind area of the sensors before or after a continuous tone sounds.

High, protruding objects such as ledges may not be detected.

False warnings

PDC may issue a warning under the following conditions even though there is no obstacle within the detection range:

- ▷ In heavy rain.
- ▷ When sensors are very dirty or covered in ice.
- ▷ When sensors are covered in snow.
- ▷ On rough road surfaces.

- ▷ In large buildings with right angles and smooth walls, e.g., in underground garages.
- ▷ In heavy exhaust.
- ▷ Due to other ultrasound sources, e.g., sweeping machines, high pressure steam cleaners or neon lights.

Switching on automatically

With the engine running or the ignition switched on, shift the selector lever into position R.

Switching off automatically when driving forward

The system switches off when a certain distance or speed is exceeded.

Switch on the system again if necessary.

Switching on/off manually



Press the button.

- ▷ On: the LED lights up.
- ▷ Off: the LED goes out.

Signal tones

When approaching an object, an intermittent tone is sounded that indicates the position of the object. For example, if an object is detected to the left rear of the vehicle, a signal tone sounds from the left rear speaker.

The shorter the distance to the object becomes, the shorter the intervals.

If the distance to a detected object is less than approx. 12 in/30 cm, a continuous tone is sounded.

If objects are located both in front of and behind the vehicle, an alternating continuous signal is sounded.

The intermittent tone is interrupted after approx. 3 seconds:

- ▷ If the vehicle stops in front of an object that is detected by only one of the corner sensors.
- ▷ If moving parallel to a wall.

The signal tone is switched off:

- ▷ When the vehicle moves away from an object by more than approx. 4 in/10 cm.
- ▷ When transmission position P is engaged.

Volume

You can set the volume of the PDC signal tone, refer to page 185.

The setting is stored for the remote control currently in use.

Visual warning

The approach to an object can be shown on the Control Display. Objects that are farther away are displayed on the Control Display before a signal tone sounds.



The display appears as soon as PDC is activated.

If the last image selected was the rear view camera, this is displayed again. To switch to PDC:

 "Switch off rear view camera"

The setting is stored for the remote control currently in use.

Image on the Control Display

Switching on the rear view camera using iDrive

With PDC activated:

 "Rear view camera"

The image of the rear view camera is displayed. The setting is stored for the remote control currently in use.

Malfunction

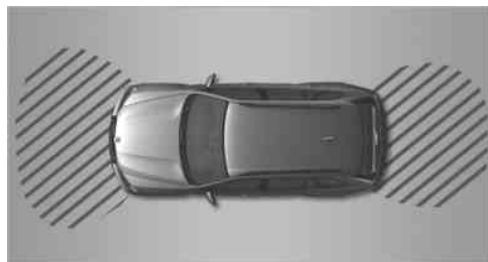

A Check Control message, refer to page 83, is displayed in the instrument cluster.

The areas in front of and behind the vehicle appear in shaded form on the Control Display. PDC has failed. Have the system checked.

To ensure full operability:

- ▷ Keep the sensors clean and free of ice.
- ▷ When using high-pressure washers, do not spray the sensors for long periods and maintain a distance of at least 12 in/30 cm.

Surround View

The concept

Surround View encompasses the following systems:

- ▷ Backup camera, refer to page 120.
- ▷ Top View, refer to page 122.
- ▷ Side View, refer to page 124.

It provides assistance when parking and maneuvering and at blind driveways and intersections.

Rear view camera

The concept

The rear view camera assists you when parking and maneuvering in reverse. To accomplish this, the region behind your vehicle is shown on the Control Display.

System limits

 Check the traffic situation as well
Check the traffic situation around the vehicle with your own eyes. Otherwise, an accident could result from road users or objects located outside the picture area of the backup camera. ◀

 Detection of objects
High, protruding objects such as ledges may not be detected by the backup camera. ◀

Switching on automatically

With the engine running or the ignition switched on, shift the selector lever into position R.

The image of the rear view camera is displayed when the system has been switched on using iDrive.

Switching off automatically when driving forward

The system switches off when a certain distance or speed is exceeded.

Switch on the system again if necessary.

Switching on/off manually



Press the button.

Press the button.

- ▷ On: the LED lights up.
- ▷ Off: the LED goes out.

If PDC is displayed, switch on the backup camera via the iDrive, refer to page 119.

Assistance functions

Functional requirement

- ▷ Rear view camera is switched on.
- ▷ Tailgate is completely closed.

Pathway lines



- ▷ Can be displayed in the image of the rear view camera when the transmission is in reverse.
- ▷ Help estimate the required amount of space when parking and maneuvering on a flat road surface.
- ▷ Depend on the current steering angle and are continuously adapted to movements of the steering wheel.

Show the parking aid lines via the iDrive, refer to page 121.

Turning lines

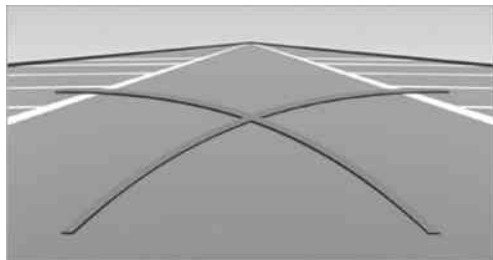

- ▶ Can be displayed in the image of the rear view camera.
- ▶ Show the path of the smallest turning circle on a flat road surface.
- ▶ When the steering wheel is turned, only one turning line is displayed.

Show the parking aid lines via the iDrive, refer to page 121.

Parking using pathway and turning lines

1. Position the vehicle so that the turning lines lead into the margins of the parking space.

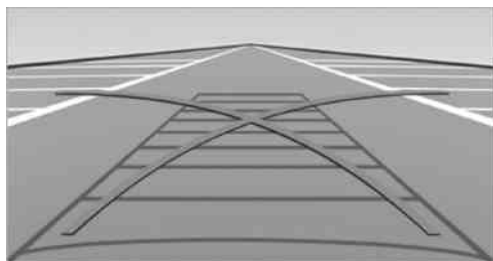

2. Turn the steering wheel to the point where the pathway line covers the corresponding turning circle line.

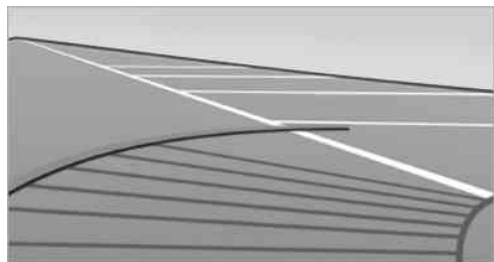

Obstacle marking

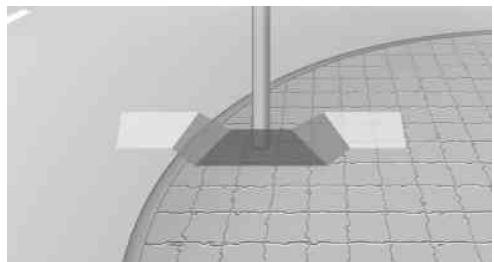

- ▶ Three-dimensionally shaped markings can be displayed in the image of the rear view camera.

Their color gradation corresponds to the markings in PDC. This helps estimate the distance to the object pictured.

Show the obstacle marking via the iDrive, refer to page 121.

Activating assistance functions

Several assistance functions can be active at the same time.

Showing the parking aid lines

 "Parking aid lines"

Pathway and turning lines are displayed.

Showing the obstacle marking

 "Obstacle marking"

Three-dimensionally-shaped markings are displayed.

Image on the Control Display

Switching on the rear view camera using iDrive

With PDC activated:

 "Rear view camera"

The image of the rear view camera is displayed. The setting is stored for the remote control currently in use.

Brightness

With the rear view camera switched on:

1.  Select the symbol.
2. Turn the controller until the desired setting is reached and press the controller.

Contrast

With the rear view camera switched on:

1.  Select the symbol.
2. Turn the controller until the desired setting is reached and press the controller.

Camera



The lens of the rear view camera is under the grasping lip of the tailgate.

The presence of dirt can impair image quality. Clean the lens with a moist, nonabrasive cloth.

Top View

The concept

Top View assists you when parking and maneuvering. To accomplish this, the door region and road surface region are shown on the Control Display.

Detection

Detection is carried out by two cameras integrated into the exterior mirror and the rear view camera.

The range is:

- ▷ Approx. 7 ft/2 m to the side.
- ▷ Approx. 7 ft/2 m to the rear.

Obstacles up to the height of the exterior mirrors are thus detected in a timely fashion.

System limits

Top View cannot be used in the following situations:

- ▷ With a door open.
- ▷ With the tailgate open.
- ▷ With an exterior mirror folded in.
- ▷ In poor light.

The arrows next to the vehicle are displayed in a shaded form on the Control Display and a symbol appears at the corresponding location on the vehicle.



Check the traffic situation as well

Check the traffic situation around the vehicle with your own eyes. Otherwise, an accident could result from road users or objects located outside the picture area of the cameras. ◀

Switching on automatically

Select transmission position R with the engine running.

The images from Top View and PDC are displayed when the system has been switched on using iDrive.

Switching off automatically when driving forward

The system switches off when a certain distance or speed is exceeded.

Switch on the system again if necessary.

Switching on/off manually



Press the button.

- ▶ On: the LED lights up.
- ▶ Off: the LED goes out.

If Top View is displayed, switch on the backup camera via the iDrive, refer to page [122](#).

Visual warning

The approach to an object can be shown on the Control Display.

When the distance to an object is small, the PDC display correspondingly shows a red bar in front of the vehicle.

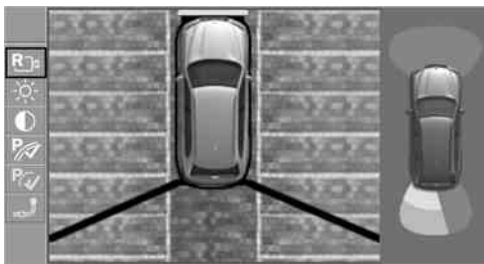

The display appears as soon as Top View is activated.

If the last image selected was the rear view camera, this is displayed again. To switch to Top View:

 "Rear view camera" Select the symbol on the Control Display.

The setting is stored for the remote control currently in use.

Image on the Control Display

Switching on the rear view camera using iDrive

With Top View activated:

 "Rear view camera"

The image of the rear view camera is displayed. The setting is stored for the remote control currently in use.

Brightness

With Top View switched on:

1.  "Brightness"
2. Turn the controller until the desired setting is reached and press the controller.

Contrast

With Top View switched on:

1.  "Contrast"
2. Turn the controller until the desired setting is reached and press the controller.

Displaying turning lines and pathway lines

- ▶ The static, red turning line shows the lateral space required when the wheel is fully turned.
- ▶ The variable, green pathway lines assist you in estimating the amount of lateral space actually required.

The pathway lines depend on the current steering angle and are continuously adapted to movements of the steering wheel.

 "Parking aid lines"

Turning lines and pathway lines are displayed.

Cameras

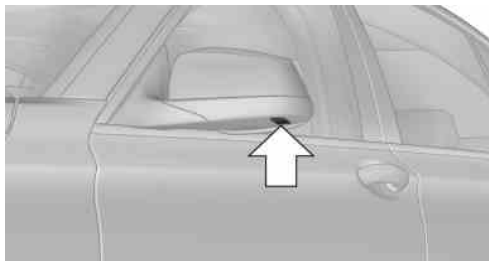

The lenses of the Top View cameras are on the undersides of the exterior mirror housings.

The presence of dirt can impair image quality. Clean the lens with a moist, nonabrasive cloth.

Side View

The concept

Side View provides an early look at cross traffic at blind driveways and intersections. Road users concealed by obstacles to the left and right of the vehicle can only be detected from the driver's seat at the last minute. To improve visibility, two cameras in the front of the vehicle record the traffic situation on each side.

System limits

The cameras capture a maximum range of 330 ft/100 m.

Display

The images from both cameras are shown simultaneously on the Control Display.

-  Check the traffic situation as well
- Check the traffic situation around the vehicle on blind driveways and intersections with your own eyes. Otherwise, an accident could result from road users or objects located outside the picture area of the Side View cameras. ◀

Switching off automatically when driving forward

The system switches off when a certain distance or speed is exceeded.

Switch on the system again if necessary.

Switching on/off manually

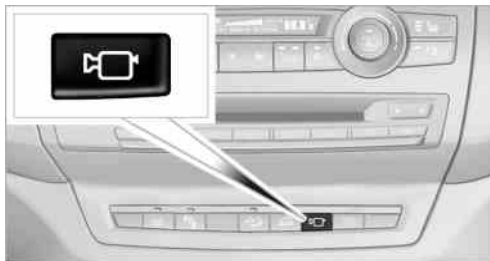

Press the button.

Image on the Control Display

The traffic area to the left and right is displayed on the Control Display.

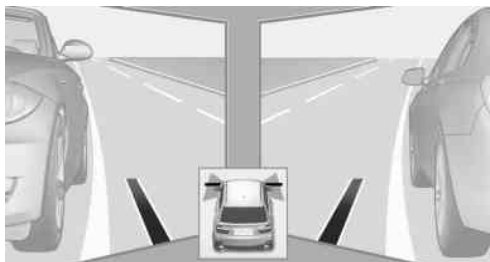

Guidelines at the bottom of the image show the position of the front of the vehicle.

Brightness

With the Side View switched on:

1.  "Brightness"
2. Turn the controller until the desired setting is reached and press the controller.

Contrast

With the Side View switched on:

1.  "Contrast"
2. Turn the controller until the desired setting is reached and press the controller.

Cameras

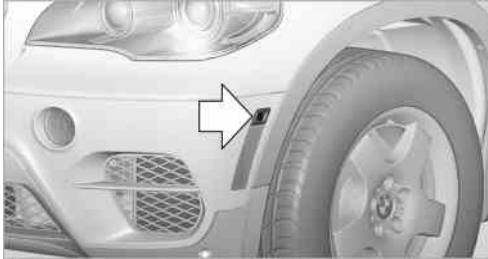

The two camera lenses are located on the sides of the bumper.

The presence of dirt can impair image quality. Clean the lens, refer to page 308.

Head-up Display

The concept

This system projects important information into the driver's field of vision, e.g., navigation instructions.

In this way, the driver can get information without averting his or her eyes from the road.



Switching on/off



Press the button.

Display visibility

The visibility of the displays in the Head-up Display is influenced by:

- ▷ Certain sitting positions.
- ▷ Objects on the cover of the Head-up Display.
- ▷ Sunglasses with certain polarization filters.
- ▷ Wet roads.
- ▷ Unfavorable light conditions.

If the image is distorted, check the basic settings.

Display

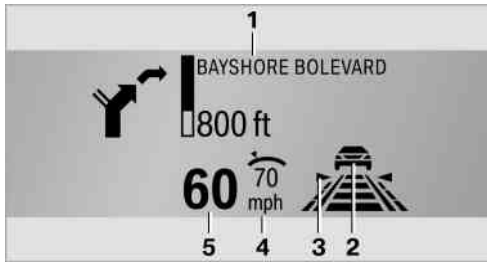

- 1 Navigation instructions
- 2 Active Cruise Control with Stop & Go function
- 3 Lane departure warning
- 4 Cruise control/desired speed
- 5 Current speed

The Check Control messages are displayed briefly if needed.

Selecting displays in the Head-up Display

1. "Settings"
2. "Head-up display"
3. "Displayed information"
4. Select the desired displays in the Head-up Display.

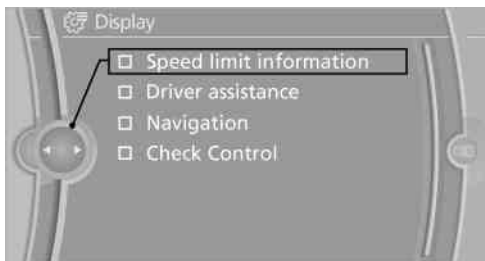

The settings are stored for the remote control currently in use.

Setting the brightness

The brightness is automatically adjusted to the ambient light.

The basic setting can be adjusted manually.

1. "Settings"
2. "Head-up display"
3. "Brightness"
4. Turn the controller.

The brightness is adjusted.

With the low beams switched on, the brightness can also be adjusted with the thumbwheel of the instrument lighting.

The setting is stored for the remote control currently in use.

Height adjustment

1. "Settings"
2. "Head-up display"
3. "Height"
4. Turn the controller.

The height is adjusted.

The setting is stored for the remote control currently in use.

Special windshield

The windshield is part of the system.

The shape of the windshield makes it possible to display a precise image.

A film in the windshield prevents double images from being displayed.

Therefore, have the special windshield replaced by a service center only.

Climate

Vehicle equipment

This chapter describes all series equipment as well as country-specific and special equipment offered for this model series. Therefore, it also

describes equipment that may not be found in your vehicle, for instance due to the selected special equipment or the country version. This also applies to safety-related functions and systems.

At a glance

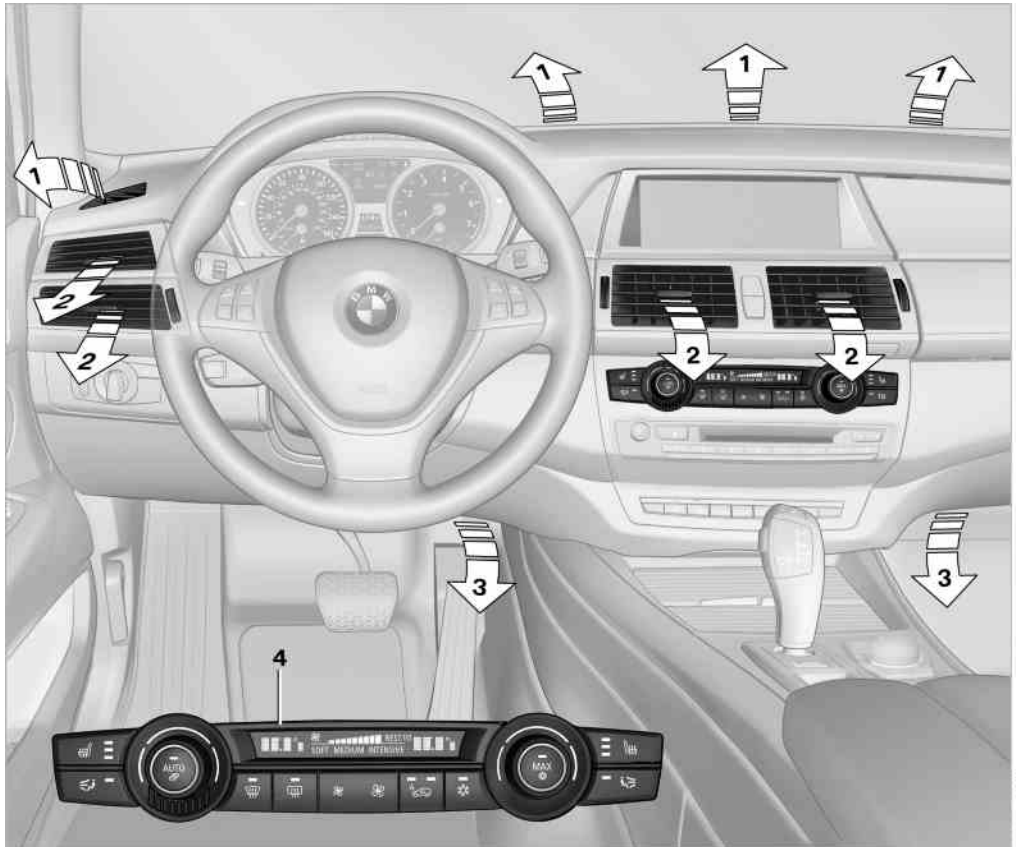

- | | | | |
|---|--|---|---|
| 1 | Air toward the windshield and side windows | 3 | Air to footwell |
| 2 | Air for the upper body | 4 | Automatic climate control with 2-zone control 128 |

Automatic climate control with 4-zone control [132](#)

Automatic climate control with 2-zone control

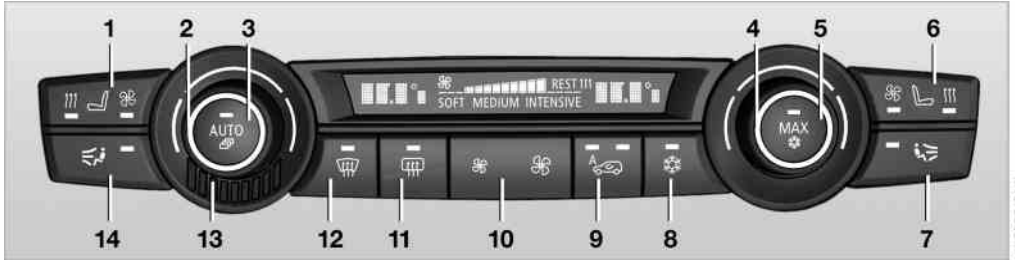

- 1 Seat heating and ventilation, driver's side [52](#)
- 2 Temperature, left side of passenger compartment
- 3 AUTO program
- 4 Temperature, right side of passenger compartment
- 5 Maximum cooling
- 6 Seat heating and ventilation, front passenger side [52](#)
- 7 Passenger side
 - ▷ Manual air distribution
- 8 Switching cooling function on/off manually
- 9 Automatic recirculated air control/recirculated air mode
- 10 Manual air volume, switching off automatic climate control, residual heat
- 11 Rear window defroster
- 12 Defrosting windows and removing condensation
- 13 Air grill for interior temperature sensor, please keep clear and unobstructed
- 14 Driver's side
 - ▷ Manual air distribution
 - ▷ Accessing setting for ventilation temperature on the Control Display

The current setting for manual air distribution is displayed on the Control Display.

Comfortable interior climate

The AUTO program offers the optimum air distribution and air volume for virtually all conditions, refer to AUTO program below. Select a comfortable interior temperature only.

The following sections contain more detailed information on the available setting options.

Most of these settings are stored for the remote control currently in use, Personal Profile settings, refer to page [31](#).

AUTO program



Press the button.

Air volume, air distribution, and temperature are controlled automatically.

Depending on the selected temperature, AUTO intensity, and outside influences, the air is directed to the windshield, side windows, upper body, and into the footwell.

The cooling function is switched on automatically with the AUTO program.

At the same time, a condensation sensor controls the program in such a way that window condensation is prevented as much as possible.

To switch off the program: press the button again or manually adjust the air distribution.

Intensity of the AUTO program

Pressing the AUTO button repeatedly adjusts the intensity of the AUTO program. The selected intensity, SOFT, MEDIUM or INTENSIVE, appears on the display of the automatic climate control.

Temperature



Turn the wheel to set the desired temperature.

The automatic climate control achieves this temperature as quickly as possible, if necessary with the maximum cooling or heating capacity, and then keeps it constant.

Avoid rapidly switching between different temperature settings. The automatic climate control will not have sufficient time to adjust the set temperature.

Maximum heating power can be obtained with the highest setting, regardless of the external temperature.

At the lowest setting, cooling is continuous, regardless of the external temperature.

Adjusting the ventilation temperature

This function can be used to adjust the air temperature for the upper body region.

1. "Settings"
2. "Climate"

3. "Driver ventilation" or "Front passenger ventilation"
4. Turn the controller to adjust the temperature.
 - ▷ Blue: colder
 - ▷ Red: warmer



Defrosting and defogging windows



Press the button.

Ice and condensation are quickly removed from the windshield and the front side windows.

For this purpose, also switch on the cooling function.

Rear window defroster



Press the button.

The rear window defroster switches off automatically after a certain period of time.

Depending on the vehicle equipment, upper wires are used as an antenna and are not part of the rear window defroster.

Air volume, manual



You can vary the air volume by pressing on the corresponding side. You can reactivate the automatic mode for the air volume with the AUTO button.

Manual air distribution

The air flow can be guided into the vehicle interior, separately for the driver's and front passenger side, using one of the following programs:

- ▷ Upper body region.
- ▷ Upper body region and footwell.
- ▷ Footwell.
- ▷ Driver's side: in addition, the windshield, side windows, and footwell.

Selecting program



Press the button repeatedly until the desired program is shown on the Control Display.

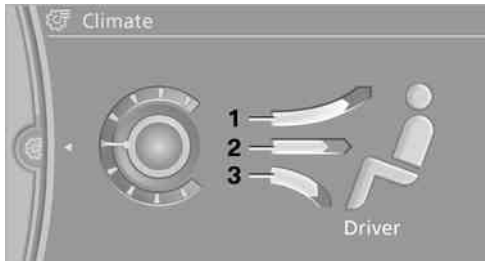

- 1 Air toward the windshield and side windows
- 2 Air for the upper body
- 3 Air to footwell

Pressing the AUTO button cancels the manual air distribution settings.

The automatic mode for the air volume remains effective with manual air distribution.

Cooling function

The passenger compartment can only be cooled with the engine running.



Press the button.

The air is cooled and dehumidified and – depending on the temperature setting – warmed again.

The cooling function helps to prevent condensation on the windows or to remove it quickly.

Depending on the weather, the windshield may fog up briefly when the engine is started.

The cooling function is switched on automatically with the AUTO program.

When using the automatic climate control, condensation water, refer to page 154, develops that exits underneath the vehicle.

Maximum cooling



Press the button.

The system is set to the lowest temperature, maximum air volume and recirculated-air mode.

Air flows out of the vents for the upper body region. Open them for this purpose.

Air is cooled as quickly as possible:

- ▷ At an external temperature of approx. 32 °F/0 °C.
- ▷ When the engine is running.

Automatic recirculated air mode/ recirculated air mode

You can respond to unpleasant odors or pollutants in the immediate environment by temporarily suspending the supply of outside air. The system then recirculates the air currently within the vehicle.



Press the button repeatedly to select an operating mode:

- ▷ LEDs off: outside air flows in continuously.
- ▷ Left LED on, automatic recirculated-air control: a sensor detects pollutants in the outside air and controls the shutoff automatically.
- ▷ Right LED on, recirculated air mode: the supply of outside air into the vehicle is permanently blocked.

If the windows are fogged over, switch off the recirculated-air mode and press the AUTO button to utilize the condensation sensor. Make sure that air can flow onto the windshield.

**Continuous recirculated-air mode**

The recirculated air mode should not be used for an extended period of time, as the air quality inside the vehicle deteriorates steadily. ◀

Residual heat

The heat stored in the engine is used to heat the interior.

Functional requirement

- ▶ Up to 15 minutes after the engine has been switched off.
- ▶ Warm engine.
- ▶ The battery is sufficiently charged.
- ▶ External temperature below 77 °F/25 °C.

Switching on

1. Switch off the ignition.
2. Press the right-hand button.



REST appears on the display of the automatic climate control when the residual heat utilization is switched on.

From radio readiness the interior temperature, the air volume and the air distribution can be set.

Switching off

You can select the lowest blower speed by pressing and holding the left side. Pressing again switches off the residual heat utilization. REST disappears from the display of the automatic climate control.

Switching on/off the automatic climate control**Switching off**

With the blower at its lowest setting, press the left side of the button to switch off the automatic climate control.

Switching on

Press any button to switch the automatic climate control back on.

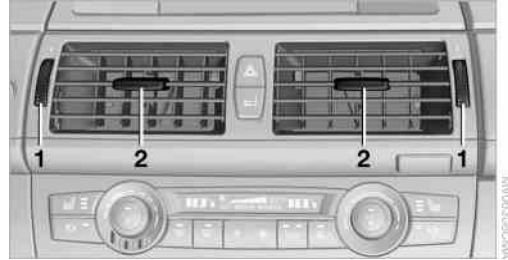
Front ventilation

- 1 Use the thumbwheels to smoothly open and close the air vents
- 2 Use the lever to change the direction of the air flow

**Avoiding injury**

Do not drop any foreign objects into the air vents, otherwise these could be catapulted outwards and lead to injuries. ◀

Ventilation for cooling

Adjust the vents to direct the flow of cool air in your direction, for instance if the interior has become too warm.

Draft-free ventilation

Set the air vents so that the air flows past you and is not directed straight at you.

Ventilation in rear

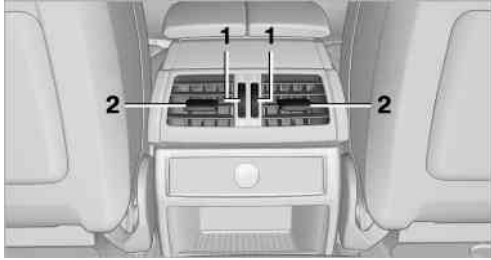

- 1 Use the thumbwheels to smoothly open and close the air vents
- 2 Use the lever to change the direction of the air flow

BMW X5: heating and ventilation, 3rd row seats

The air in the area of the 3rd row seats can be heated or recirculated. Air vents are located in the storage compartment area between the seats and in the footwell of the 3rd row seats.

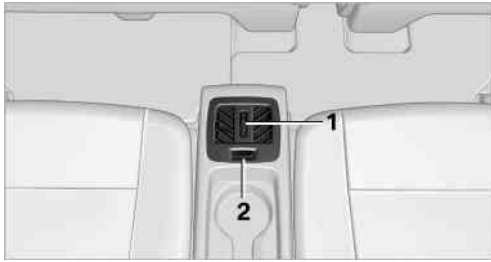

- 1 Thumbwheel
 - ▶ Activating heating and distributing air in footwell:
Turn toward front
 - ▶ Distributing air in storage compartment area between seats:
Turn toward rear
- 2 Button for switching on the blower: LED is lit

The heating is not ready for operation without switching on the blower. After the heating is switched off, the blower can be used to recirculate the air within the vehicle, for instance at high

temperatures. To do this, turn thumbwheel 1 toward the rear and switch on the blower, button 2.

Microfilter/activated-charcoal filter

The microfilter traps dust and pollen in the incoming air.

The activated-charcoal filter removes gaseous pollutants from the outside air that enters the vehicle.

The service center replaces this combined filter during routine maintenance.

More information can be found in the service requirements display, refer to page 81.

Automatic climate control with 4-zone control

Front operation

Corresponds to the operation of automatic climate control with 2-zone control, refer to page 128.

Rear operation

The control unit is located in the center console in the rear.

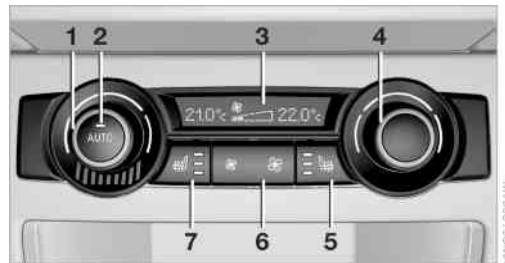

- 1 Temperature, left rear seating area
- 2 AUTO program
- 3 Display
- 4 Temperature, right rear seating area
- 5 Seat heating, right rear seat

- 6 Air volume, manual
- 7 Seat heating, left rear seat

The current setting for the temperature and the air flow rate is shown on display 3.

Activation/deactivation

1. "Settings"
2. "Climate"
3. "Rear climate control"
4. Select the desired settings.

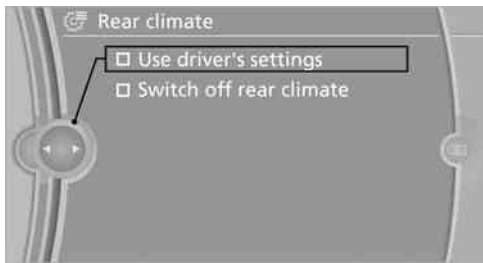

The rear automatic climate control cannot be operated if the front automatic climate control is switched off. With the defrost windows and eliminate condensation function activated, the rear automatic climate control is also not ready for operation.

AUTO program



The AUTO program automatically sets the air distribution toward the upper body and in the footwell, as well as the air flow rate. It also adapts your instructions for the temperature to outside influences throughout the year.

Temperature



Set the desired temperature individually on the left and right side.

The automatic climate control achieves this temperature as quickly as possible regardless of the season, using maximum cooling or heating power if necessary, and then maintains it.

When switching between different temperature settings in rapid succession, the automatic climate control does not have sufficient time to adjust the set temperature.

Air volume, manual



The air flow rate can be varied by pressing on the corresponding side. The automatic mode for the air flow rate can be switched on again using the AUTO button.

Switching off rear automatic climate control



With the blower at its lowest setting, press the left side of the button to switch off the automatic climate control.

The automatic climate control can also be switched off with iDrive. To switch on the automatic climate control again, the system must first be reactivated, refer to Activating/deactivating.

The system is switched on again by pressing any button of the rear automatic climate control.

Ventilation in rear

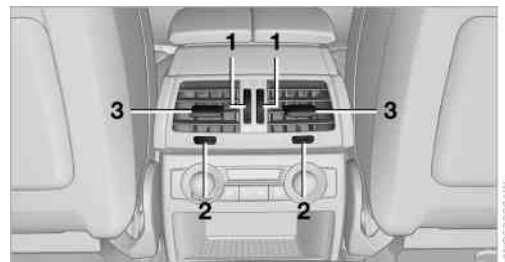

- 1 Use the thumbwheels to smoothly open and close the air vents
- 2 Thumbwheels to adjust temperature in upper body region; can be adjusted separately for left and right:

- ▷ Blue: colder
- ▷ Red: warmer

- 3 Use the lever to change the direction of the air flow

BMW X5

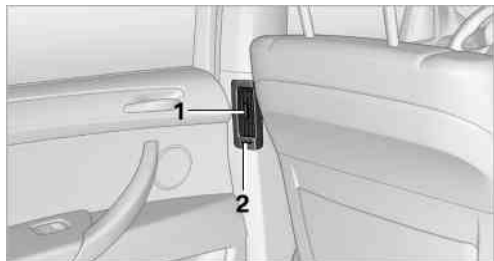

- 1 Use the lever to change the direction of the air flow
- 2 Thumbwheel to smoothly open and close air vents

For ventilation of the 3rd row seats, refer to page [132](#).

Parked-car ventilation

The concept

The parked-car ventilation blows air into the passenger compartment to lower interior temperatures.

The system can be switched on and off at any external temperature, either directly or by using a preset switch-on time. It remains switched on for 30 minutes.

Since the system uses a substantial amount of electrical current, refrain from activating it twice in succession without allowing the battery to be recharged in normal operation between use.

Open the vents to allow air to flow out.

They can be operated via iDrive.

Switching on/off directly

1. "Settings"
2. "Climate"
3. "Activate parked-car vent."

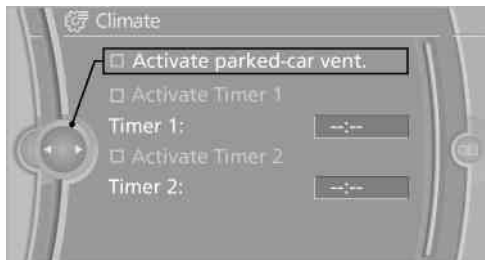

☞ The symbol on the automatic climate control flashes if the system is switched on.

Preselecting activation times

1. "Settings"
2. "Climate"
3. "Activate Timer 1" or "Activate Timer 2"
4. "Timer 1:" or "Timer 2:"

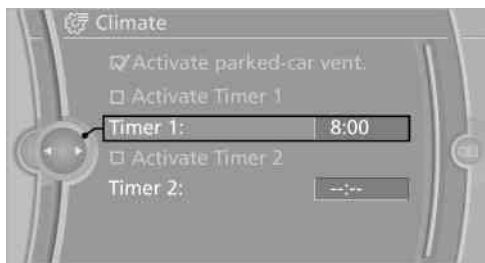

5. Set the desired time.

☞ The symbol on the automatic climate control lights up when the switch-on time is activated.

☞ The symbol on the automatic climate control flashes when the system has been switched on.

The system will only be switched on within the next 24 hours. After that, it needs to be reactivated.

Interior equipment

Vehicle equipment

This chapter describes all series equipment as well as country-specific and special equipment offered for this model series. Therefore, it also describes equipment that may not be found in your vehicle, for instance due to the selected special equipment or the country version. This also applies to safety-related functions and systems.

Universal Garage Door Opener

The concept

The Universal Garage Door Opener can be used to operate up to 3 functions in remote-controlled systems, such as garage door drives or lighting systems. The Universal Garage Door Opener replaces up to 3 different hand-held transmitters. To operate it, the buttons on the interior rearview mirror must be programmed for the desired functions. The hand-held transmitter for the system is needed for the programming procedure.

 During programming

During programming and before activating a device using the Universal Garage Door Opener, ensure that there are no people, animals, or objects in the range of movement of the remote-controlled device; otherwise, there is a risk of injury or damage.

Also follow the safety instructions of the hand-held transmitter. ◀

Before selling the vehicle, delete the stored functions for security reasons.

Compatibility



If this symbol is printed on the packaging or in the operating instructions of the

system being operated, the system is generally compatible with the Universal Garage Door Opener.

If you have any questions, please contact:

- ▷ Your service center.
- ▷ www.homelink.com on the Internet.

HomeLink is a registered trademark of Johnson Controls, Inc.

Controls on the interior rearview mirror

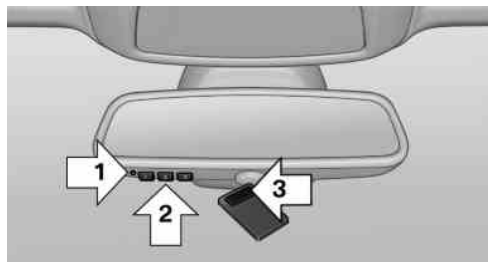

- 1 LED
- 2 Buttons
- 3 Hand-held transmitter, required for programming.

Programming

General information

1. Switch on the ignition.
2. Initial setup:

Press the right and left buttons on the interior rearview mirror simultaneously for approx. 20 seconds until the LED on the interior rearview mirror begins to flash. All programmed settings of the buttons on the interior rearview mirror are deleted.
3. Hold the hand-held transmitter of the system to be operated a distance of approx. 1 to 3 in/2.5 to 8 cm away from the buttons on the interior rearview mirror. The required

distance depends on the particular hand-held transmitter.

4. Press the button of the desired function on the hand-held transmitter and the button being programmed on the interior rearview mirror simultaneously and hold. The LED on the interior rearview mirror flashes slowly at first.
5. When the LED flashes more rapidly, release both buttons. Rapid flashing indicates that the button on the interior rearview mirror has been programmed.

If the LED does not flash faster after 60 seconds, change the distance between the interior rearview mirror and the hand-held transmitter and repeat the step. Multiple trials at different distances may be necessary. Wait at least 15 seconds between trials.

6. To program additional functions on other buttons, repeat steps 3 to 5.

The systems can be operated with the buttons on the interior rearview mirror.

Special characteristics of alternating-code radio systems

If the system cannot be operated after repeated programming, check whether the system to be operated uses an alternating-code system.

Read the operating instructions of the system or press and hold the programmed button on the interior rearview mirror. If the LED on the interior rearview mirror flashes rapidly at first and then lights up continuously for 2 seconds, the system is equipped with an alternating-code system. This flashing LED pattern repeats itself for approx. 20 seconds.

In systems with an alternating-code system, the Universal Garage Door Opener and the system must be additionally synchronized.

Please obtain additional information on synchronization in the operating instructions of the system being set up.

The systems will be easier to synchronize with the aid of a second person.

Synchronization:

1. Park the vehicle within range of the remote-controlled system.
2. Program the corresponding button on the interior rearview mirror as described.
3. Identify and press the synchronization button on the system being set up. You have approx. 30 seconds for the next step.
4. Press and hold the button on the interior rearview mirror for approx. 3 seconds and then release it. Repeat this step up to three times if necessary to complete the synchronization procedure. When synchronization is completed, the programmed function is executed.

Reprogramming individual buttons

1. Switch on the ignition.
2. Hold the hand-held transmitter at a distance of approx. 1 to 3 in/2.5 to 8 cm from the memory buttons.

The required distance depends on the particular hand-held transmitter.

3. Press the memory button of the Universal Garage Door Opener.
4. If the LED flashes slowly after approx. 20 seconds, press the transmit button on the hand-held transmitter.
5. Release both buttons when the LED flashes rapidly.

If the LED does not flash rapidly after approx. 60 seconds, change the distance and repeat the step.

Canada: if the LED does not flash rapidly after approx. 60 seconds, change the distance and repeat the step. If programming was aborted by the hand-held transmitter, hold down the memory button and press and release the button on the hand-held transmitter several times for 2 seconds.

Controls



Prior to operation

Before operating a unit with the Universal Garage Door Opener, ensure that there are no people, animals, or objects in the range of movement of the system; otherwise, there is a risk of injury or damage.

Also follow the safety instructions of the hand-held transmitter. ◀

The system, such as the garage door, can be operated using the button on the interior rearview mirror with the engine running or the ignition switched on. When you are within the reception range of the system, press and hold the button until the function is initiated. The LED on the interior rearview mirror lights up continuously while the radio signal is being transmitted.

Deleting stored functions

Press the right and left buttons on the interior rearview mirror simultaneously for approx. 20 seconds until the LED flashes rapidly. All stored functions are deleted. The functions cannot be deleted individually.

Digital compass

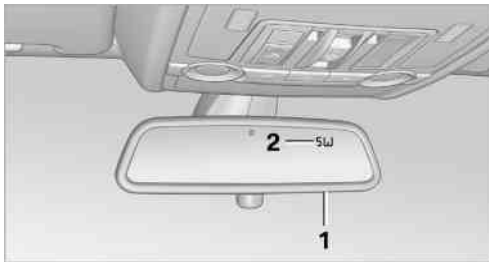

- 1 Adjustment button
- 2 Display

The display shows you the main or secondary compass direction in which you are driving.

Operating concept

Various functions can be called up by pressing the adjustment button with a pointed object such as a pen. The following adjustment options are displayed one after the other, depending on how long the adjustment button is pressed:

- ▷ Press briefly: switch the display on/off.
- ▷ 3 to 6 seconds: set the compass zone.
- ▷ 6 to 9 seconds: calibrate the compass.
- ▷ 9 to 12 seconds: set left-hand/right hand steering.
- ▷ 12 to 15 seconds: set the language.

Setting compass zones

Set the compass zone corresponding to the vehicle's geographic location so that the compass can function correctly; refer to the world map with compass zones.

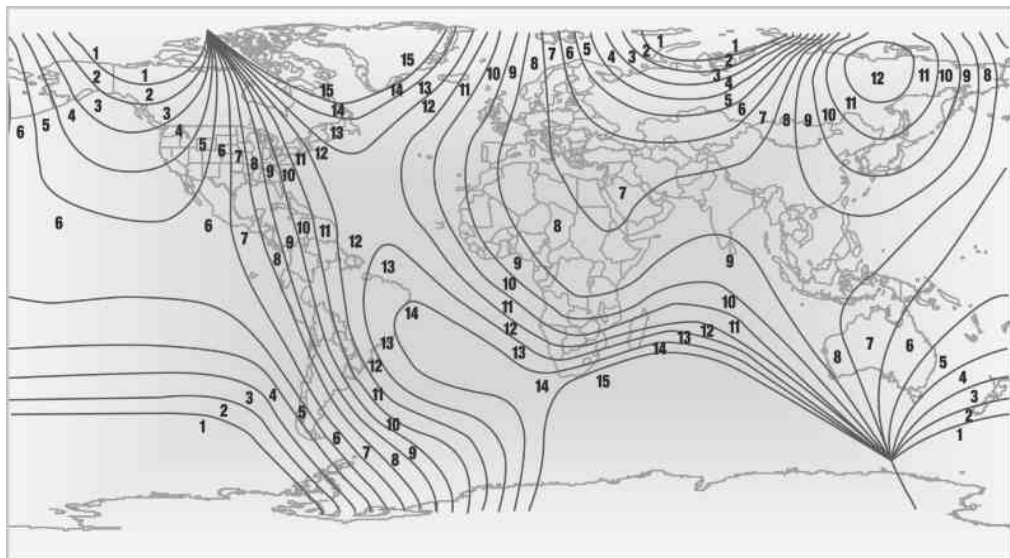

Press the adjustment button for 3-4 seconds. The number of the compass zone set is shown in the display.

To change the zone setting, briefly press the adjustment button repeatedly until the display shows the number of the compass zone corresponding to the current location.

The compass is operational again after approx. 10 seconds.

Calibrating the digital compass

The digital compass must be calibrated in the following situations:

- ▶ An incorrect compass direction is shown.
- ▶ The cardinal direction displayed does not change even if the direction of travel changes.
- ▶ Not all compass directions are shown.

Procedure

1. Make sure that there are no large metal objects or overhead power lines in the vicinity of the vehicle and that there is enough space to drive in a circle.

2. Set the currently valid compass zone.
3. Press the adjustment button for 6-7 seconds to call up C. Then drive at least one full circle at a maximum speed of 4 mph/7 km/h. When the system is calibrated, the C is replaced by the compass directions.

Right-hand/left-hand steering

The digital compass is set for right-hand or left-hand steering at the factory.

Setting the language

Press the adjustment button for 12-13 seconds. Briefly press the adjustment button again to switch between English "E" and German "O".

The setting is automatically saved after approx. 10 seconds.

Ashtray/cigarette lighter

Opening

Front



To open the cover, slide it forward.

Rear

BMW X6



Slide the cover back.

Emptying

Take out the insert.

Lighter

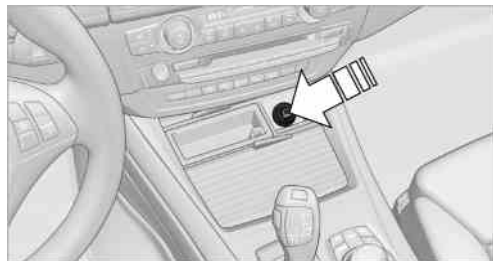

With the engine running or the ignition switched on, press in the cigarette lighter.

The lighter can be removed as soon as it pops back out.



Danger of burns

Only hold the hot lighter by its head; otherwise, there is the danger of getting burned.

Switch off the ignition and take the remote control with you when leaving the vehicle so that children cannot use the lighter and burn themselves. ◀

Connecting electrical devices

Note



Do not connect the charger to the socket

Do not connect the battery charger to the socket installed in the vehicle at the factory as this could damage the vehicle. ◀

Sockets

The lighter socket can be used as a socket for electrical equipment while the engine is running or when the ignition is switched on. The total load of all sockets must not exceed 140 watt at 12 volt.

Avoid damaging the sockets by attempting to insert plugs of unsuitable shape or size.

Front center console

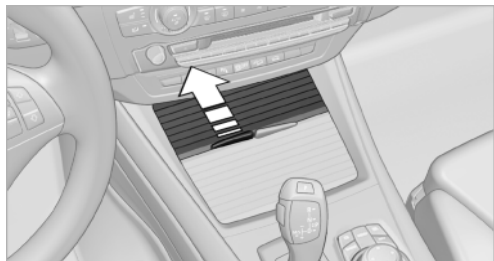

Slide the cover forward.

To access the socket: remove the cap or pull out the cigarette lighter.

Rear center console



The arrangement of the sockets may vary with the equipment.

To access the sockets: remove the caps.

In storage compartment under center armrest

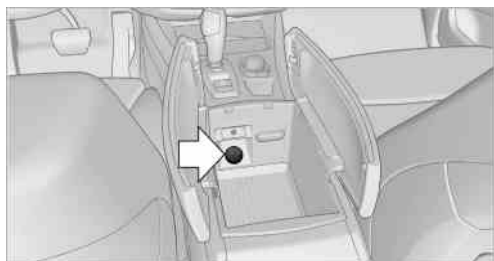

To access the socket: remove the cover.

In cargo area

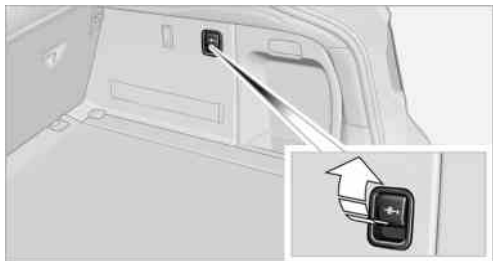

To access the socket: fold open the cover.

BMW X6: in the rear console

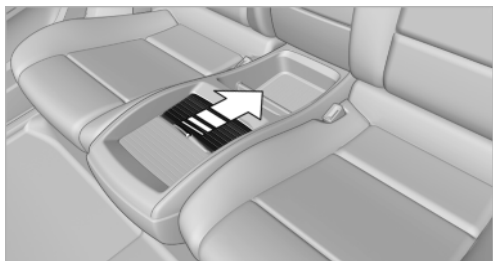

Slide the cover back.

To access the socket: pull off the cover.

Cargo area

BMW X5: luggage compartment roller cover

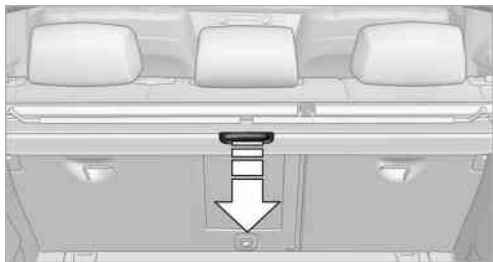

Pull out the luggage compartment roller cover and hook it into the brackets.



Do not deposit heavy objects

Do not deposit heavy or hard objects on the luggage compartment roller cover. Otherwise, they may present a danger to occupants, for instance during braking and evasive maneuvers. ◀



Do not let the luggage area retractable cover snap back

Do not let the luggage compartment retractable cover snap back as this could damage the cover. ◀

Removing

1. Unlock the case with the button, arrow 1.

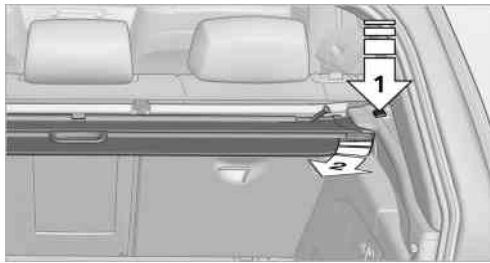

2. Swing the case somewhat to the left, arrow 2, and remove it.

Installing

When installing, proceed in the opposite order of removal.



1. Lay the case on the left-hand side and push it forward, arrow 1.
2. Swing the case toward the inside, see arrow 2.

3. Push the case forward at the ends until it engages in the two side brackets.
4. Check whether the case is properly locked in place by pulling it with a sudden movement.

BMW X6: cargo cover

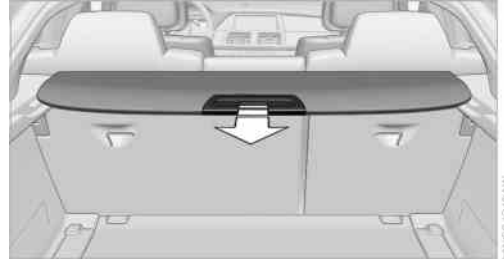

Deploy cargo cover by pulling back.



Do not deposit heavy objects

Do not deposit heavy or hard objects on the cargo cover. Otherwise, they may present a danger to occupants, for instance during braking and evasive maneuvers. ◀

Removing

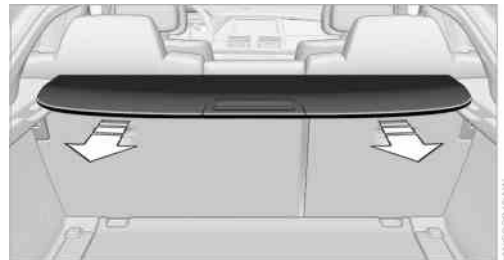

1. Grasp retracted cargo cover underneath the upper fold on both sides.
2. Pull the cover back out of the side brackets.
3. Depending on your vehicle's equipment package, you can store the cover under the floor panel in the cargo area.



Installing

When installing, proceed in the opposite order of removal.

1. Set the cargo cover into place on the left and right sides.
2. Lift the back of the cover slightly and slide forward until it snaps into the two side brackets.

Enlarging the cargo area

The rear seat backrest is divided. You can fold down both sides separately in order to expand the cargo area.

 **BMW X6:** before folding the rear seat backrest forward

Before folding the rear seat backrest forward or using the ski bag, remove beverage containers from the cupholder and close the cupholder. ◀



Reach into the recess and pull toward the front.

 **Locking the backrest**

Before letting passengers ride in the rear, engage the seat backrests, locking them in place. Otherwise, there is the danger of an accident due to unexpected seat movement. ◀

 **Ensure that the lock is securely engaged**

When folding back the backrest, be sure that it locks in place securely. The red warning field in the control display disappears. If it is not properly engaged, transported cargo could enter the passenger compartment during braking or evasive maneuvers and endanger the vehicle occupants. ◀

 **Observe the instructions concerning the safety belt**

Observe the instructions concerning the safety belt, refer to page 53. Otherwise, personal protection may be compromised. ◀

Storage compartments

Vehicle equipment

This chapter describes all series equipment as well as country-specific and special equipment offered for this model series. Therefore, it also describes equipment that may not be found in your vehicle, for instance due to the selected special equipment or the country version. This also applies to safety-related functions and systems.

Notes

 No loose objects in the passenger compartment

Do not stow any objects in the passenger compartment without securing them; otherwise, they may present a danger to occupants for instance during braking and avoidance maneuvers. ◀

 No non-slip mats on the dashboard

Do not use non-slip materials, such as non-slip mats, on the dashboard, or it could be damaged by the substances in the materials. ◀

Glove compartment

Opening



Press the button. The covers open upward and downward and the lighting in the glove compartment switches on.

 Close the glove compartment again immediately

Close the glove compartment immediately after use while driving; otherwise, injury may occur during accidents. ◀

Closing

Push the lower cover closed.

USB interface for data transfer



Port for importing and exporting data, such as music collections, refer to page 201, on USB devices.

Observe the following when connecting:

- ▷ Do not use force when plugging the connector into the USB interface.
- ▷ Do not connect devices such as fans or lamps to the USB interface.
- ▷ Do not connect a USB hard drive.
- ▷ Do not use the USB interface to recharge external devices.

Center armrest front

Storage compartment

A storage compartment is located under the armrest between the front seats and, depending on the vehicle's equipment, also a cover for the mobile phone cradle or the snap-in adapter.

Details on this mobile phone cradle, refer to page 240.

Opening



Push cover down slightly and press the button. The cover folds upward.

Connection for an external audio device

You can connect an external audio device such as a CD or MP3 player and play audio tracks over the car's loudspeaker system:

- ▷ AUX-IN port, refer to page 206.
- ▷ USB audio interface, refer to page 207.

Rear center armrest

BMW X6 and BMW X5 with 3rd row seats



Pull on the loop and fold down the center armrest.

BMW X5 without 3rd row seats

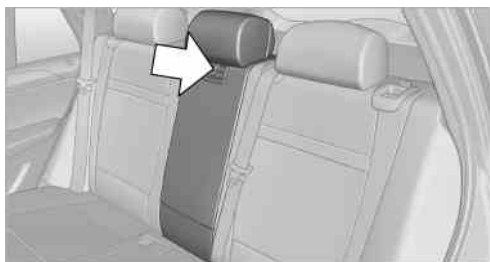

Unlock the center armrest with the button in the lower section of the opening and fold down.

Storage compartments

Compartments are located in the doors, in the center console in the front and rear as well as in the rear console in the BMW X6.

Storage nets are located on the backrests of the front seats.



Items in the storage nets

Do not stow hard or sharp-edged objects in the storage nets; otherwise there is an increased risk of injury in the event of an accident. ◀

Clothes hooks

BMW X5

The clothes hooks are located at the grab handles in the rear.

BMW X6

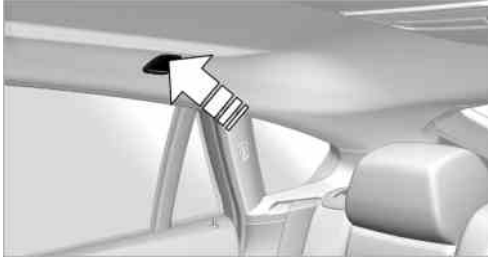

To fold out, press against upper edge.

! Do not obstruct view
When suspending clothing from the hooks, ensure that it will not obstruct the driver's vision. ◀

! No heavy objects
Do not hang heavy objects from the hooks; otherwise, they may present a danger to passengers during braking and evasive maneuvers. ◀

Cupholders

Notes

! Shatter-proof containers and no hot drinks

Use light and shatter-proof containers and do not transport hot drinks. Otherwise, there is the increased danger of injury in an accident. ◀

! Unsuitable containers
Do not forcefully push unsuitable containers into the cupholders. This may result in damage. ◀

Front



Slide the cover back.

Rear

BMW X5

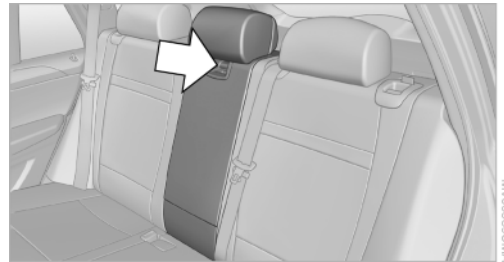

Unlock the center armrest with the button in the lower section of the opening and fold down.



Press the button; the cover folds forward.

With 3rd row seats:

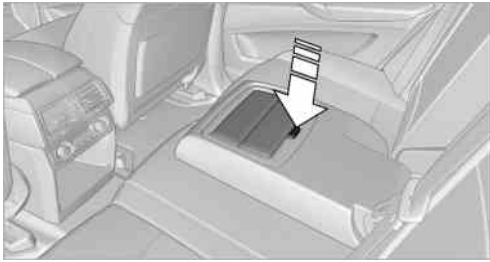

Fold down the center armrest. Press the button; the cupholders are opened.

The cupholders of the 3rd row seats are located in the center console between the seats.

BMW X6



Slide the cover forward.

! Folding down the rear seat backrest and using the ski bag

Remove the beverage container before folding the rear seat backrest forward or using the ski bag; otherwise it may cause damage. ◀

Storage compartments in the cargo area

Depending on the vehicle's equipment, the following storage compartments can be found in the cargo area:

- ▷ Storage compartments behind the removable side panels on the right and left in the cargo area and under the cargo floor cover, storage compartment on the right in the cargo area.

- ▷ Storage well under the cargo floor cover.
- ▷ Retaining straps on the left and right side trim for fastening small objects.
- ▷ Lashing rail with lashing eyes. You can secure heavy-duty cargo straps on the lashing eyes. They can be removed at the notches in the rails. To move the lashing eyes, press the button.

Read and comply with the information enclosed with the heavy-duty cargo straps.

Floor panel flap

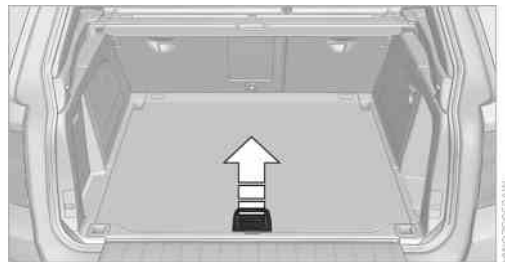

To access the onboard vehicle tool kit etc.

To open, swing up the flap by the handle, refer to arrow.

The cargo floor cover is lockable.

Adaptive fixing system

The adaptive fixing system is used to divide up the cargo area. It consists of two brackets with a telescopic rail and retaining straps. These are guided into the two rails on the cargo area floor.

! Securing cargo

Before using the adaptive fixing system, fold up and lock the rear seat backrest; otherwise, the cargo could be thrown into the vehicle interior in an accident. ◀

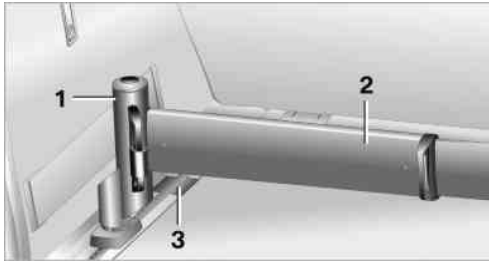

- 1 Brackets
- 2 Telescopic rail
- 3 Notch in the cargo area rail

Mounting brackets

The two brackets are connected with a telescopic rail.

1. Insert the brackets at the respective notch in the rail on the cargo area floor.
2. Press down the brackets to push them into the desired position.
3. Check the firm seating of the brackets. They must be clearly heard to engage.



No cargo on brackets

Do not lay cargo on the brackets, as otherwise they could be unlocked. ◀

Dividing up cargo area

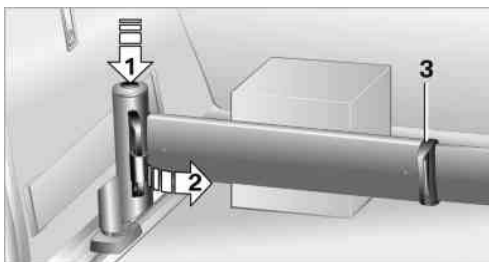

The cargo can be positioned as follows:

- ▶ Between the rear seat backrest and the telescopic rail
- ▶ Between the telescopic rail and the retaining strap

Positioning cargo between telescopic rail and retaining strap:

1. Lay the cargo on the telescopic rail. Press the button, arrow 1, and route the retaining strap around the cargo, arrow 2.
2. Hook the retaining strap into the mount 3 on the telescopic rail.
3. Press the button of the bracket, arrow 1. The retaining strap is tensioned.

It is also possible to hook the two retaining straps onto each other.

When the adaptive fixing system is no longer needed, unhook the retaining strap and guide it back into the bracket holding the hook to prevent damage and injury.

Then slide the fastening system toward the front in order to permit the best possible use of the cargo area.

Removing brackets

Press down the brackets, slide them up to the notches of the rails and remove them.

Depending on the vehicle's equipment, the adaptive fixing system can be stored under the cargo floor panel in the cargo area.

Ski bag

The ski bag is designed for safe, clean transport of up to 4 pairs of standard skis or up to 2 snowboards.

Skis with a length of up to 6 ft/2.10 m can be stowed using the ski bag. When stowing skis with a length of 6 ft/2.10 m, the capacity of the ski bag is reduced as the bag narrows.



Folding in display screen

Before loading the ski bag, fold in the display screen of the DVD systems in the rear; otherwise, the display screen could be damaged. ◀

Loading

1. Fold down the center armrest, press the button and open the cover.

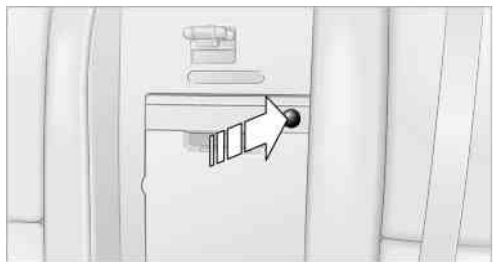

2. Press the button again; the cover in the cargo area opens. If you press the button firmly the first time, this cover also opens.
3. Extend the ski bag between the front seats and fill it.
4. Attach the retaining strap:

BMW X5: insert the latch plate of the ski bag retaining strap into the center safety belt buckle that is marked CENTER.



BMW X6: attach the hook of the ski bag retaining strap to the eyelet on the backrest.



Only stow clean skis in the ski bag. Wrap sharp edges to prevent damage.

Securing cargo

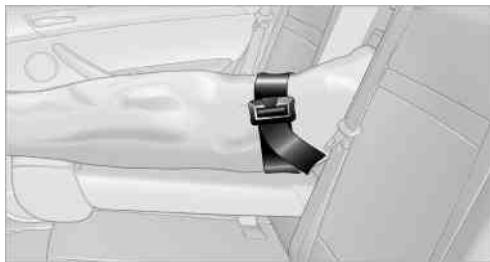

After loading, secure the ski bag and its contents. Tighten the retaining strap on the tensioning buckle for this purpose.



Securing the ski bag

Secure the ski bag in this way. Failure to do so may cause it to endanger occupants during braking or evasive maneuvers. ◀

To store the ski bag, perform the above steps in reverse order.

Removing ski bag

The ski bag can be completely removed, e.g., for faster drying or to allow it to be put to other uses.

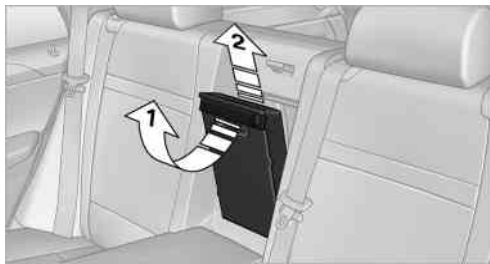

1. Pull the handle forward, arrow 1.
2. Take out the ski bag upward, arrow 2.
3. Close the cover in the cargo area.

More information on the various inserts available can be obtained from the service center.



Driving tips

This section provides you with information useful in dealing with specific driving and operating conditions.

Things to remember when driving

Vehicle equipment

This chapter describes all series equipment as well as country-specific and special equipment offered for this model series. Therefore, it also describes equipment that may not be found in your vehicle, for instance due to the selected special equipment or the country version. This also applies to safety-related functions and systems.

Breaking-in period

General information

Moving parts need to be broken in to adjust to each other.

The following instructions will help achieve a long vehicle life and good economy.

Engine and differential

Always obey all official speed limits.

Up to 1,200 miles/2,000 km

Do not exceed the maximum engine and road speeds:

- ▶ For a gasoline engine, 4,500 rpm and 100 mph/160 km/h.
- ▶ For a diesel engine, 3,500 rpm and 93 mph/150 km/h.

Avoid full-throttle operation and use of the transmission's kickdown mode for the initial miles.

From 1,200 miles/2,000 km

The engine and vehicle speed can gradually be increased.

Tires

Due to technical factors associated with their manufacture, tires do not achieve their full trac-

tion potential until after an initial breaking-in period.

Drive conservatively for the first 200 miles/300 km.

Brake system

Brakes require an initial break-in period of approx. 300 miles/500 km to achieve optimized contact and wear patterns between brake pads and rotors. Drive cautiously during this break-in period.

Following part replacement

The same breaking in procedures should be observed if any of the components mentioned above have to be renewed in the course of the vehicle's operating life.

General driving notes

Closing tailgate



Drive with the tailgate closed

Only drive with the tailgate closed; otherwise, passengers and other road users may be endangered or the vehicle may be damaged if an accident occurs or during braking or evasive maneuvers. In addition, exhaust fumes may enter the passenger compartment. ◀

If the vehicle must be driven with the tailgate open:

1. Drive moderately.
2. Close all windows and the glass sunroof/panoramic glass sunroof.
3. Greatly increase the blower speed.

Hot exhaust system



Hot exhaust system

High temperatures are generated in the exhaust system.

Do not remove the heat shields installed and never apply undercoating to them. Make sure that flammable materials, e. g. hay, leaves, grass, etc. do not come in contact with the hot exhaust system during driving, while in idle position mode, or when parked. Such contact could lead to a fire, and with it the risk of serious personal injury as well as property damage.

Do not touch hot exhaust pipes; otherwise, there is the danger of getting burned. ◀

Diesel particulate filter

Soot particles are collected in the diesel particulate filter and periodically burned away at high temperatures.

During the cleaning period of several minutes:

- ▷ The engine may temporarily run less smoothly.
- ▷ A somewhat higher engine speed may be necessary to achieve the accustomed performance.
- ▷ Noises and a slight amount of smoke may emerge from the exhaust, even for a short period after the engine is switched off.

Mobile communication devices in the vehicle



Mobile communication devices in the vehicle

It is not recommended to use mobile phones, such as mobile phones without a direct connection to an external aerial in the vehicle's passenger compartment. Otherwise, the vehicle electronics and mobile communication devices can interfere with each other. In addition, there is no assurance that the radiation generated during transmission will be discharged from the vehicle interior. ◀

Hydroplaning

On wet or slushy roads, a wedge of water can form between the tires and road surface.

This phenomenon is referred to as hydroplaning. It is characterized by a partial or complete loss of contact between the tires and the road surface, ultimately undermining your ability to steer and brake the vehicle.



Hydroplaning

When driving on wet or slushy roads, reduce your speed to prevent hydroplaning. ◀

The risk of hydroplaning increases as the tire tread depth decreases. Minimum tread depth, refer to page 278.

Driving through water

Maximum water depth:

- ▷ BMW X5: 20 inches/50 cm.
- ▷ BMW X6: 17 inches/45 cm.



Adhere to water depth and speed limitations

Only drive through water up to the above-mentioned depth at no greater than walking speed; otherwise, the engine, electrical system, and transmission can be damaged. ◀

Braking safely

Your vehicle is equipped with ABS as a standard feature.

Applying the brakes fully is the most effective way of braking in situations when this is necessary.

The vehicle maintains steering responsiveness. You can still avoid any obstacles with a minimum of steering effort.

Pulsation of the brake pedal and sounds from the hydraulic circuits indicate that ABS is in its active mode.



Do not let your foot rest on the brake pedal

Do not drive with your foot resting on the brake pedal. Even light but consistent pedal

pressure can lead to high temperatures, brake wear and possibly even brake failure. ◀

Objects in the area around the pedals

 No objects in the area around the pedals
Keep floor mats, carpets, and any other objects out of the area of motion of the pedals; otherwise, the function of the pedals could be impeded while driving

Do not place additional floor mats over existing mats or other objects.

Only use floor mats that have been approved for the vehicle and can be properly fixed in place.

Ensure that the floor mats are securely fastened again when they are returned after being removed, such as for cleaning. ◀

Driving in wet conditions

When roads are wet or there is heavy rain, briefly exert gentle pressure on the brake pedal every few miles.

Ensure that this action does not endanger other road users.

The heat generated in this process helps dry the brake discs and pads.

In this way braking efficiency will be available when you need it.

Hills

Drive long or steep downhill gradients in the gear in which the least braking is required. Otherwise, the brake system may overheat, resulting in a reduction in the brake system efficiency.

You can increase the engine's braking effect by shifting down in the manual mode of the automatic transmission, refer to page 74.

 Avoid load on the brakes
Avoid placing excessive load on the brake system. Light but consistent brake pressure can lead to high temperatures, brake wear and possibly even brake failure. ◀



Do not drive in neutral

Do not drive in neutral or with the engine stopped, as doing so disables engine braking. In addition, steering and brake assist is unavailable with the engine stopped. ◀

Brake disc corrosion

Corrosion on the brake discs and contamination on the brake pads are furthered by:

- ▷ Low mileage.
- ▷ Extended periods when the vehicle is not used at all.
- ▷ Infrequent use of the brakes.

Corrosion occurs when the minimum pressure that must be exerted by the pads during brake applications to clean the discs is not reached.

Should corrosion form on the brake discs, the brakes will tend to respond with a pulsating effect that generally cannot be corrected.

Condensation under the parked vehicle

When using the automatic climate control, condensation water develops that exits underneath the vehicle.

Therefore, traces of condensed water under the vehicle are normal.

Loading



Overloading the vehicle

To avoid exceeding the approved carrying capacity of the tires, never overload the vehicle. Overloading can lead to overheating and increases the rate at which damage develops inside the tires. This could result in a sudden loss of tire inflation pressure. ◀



No fluids in the cargo area

Make sure that fluids do not leak into the cargo area; otherwise, the vehicle may be damaged. ◀

Determining the load limit



1. Locate the following statement on your vehicle's placard:
 - ▶ The combined weight of occupants and cargo should never exceed XXX kg or YYY lbs. Otherwise, damage to the vehicle and unstable driving situations may result.
2. Determine the combined weight of the driver and passengers that will be riding in your vehicle.
3. Subtract the combined weight of the driver and passengers from XXX kilograms or YYY pounds.
4. The resulting figure equals the available amount of cargo and luggage load capacity. For example, if the YYY amount equals 1,400 lbs and there will be five 150 lbs passengers in your vehicle, the amount of available cargo and luggage load capacity is 650 lbs: 1,400 lbs minus 750 lbs = 650 lbs.
5. Determine the combined weight of luggage and cargo being loaded on the vehicle. That weight may not safely exceed the available cargo and luggage load capacity calculated in Step 4.
6. If your vehicle will be towing a trailer, load from your trailer will be transferred to your vehicle. Consult the manual for transporting a trailer to determine how this may reduce the available cargo and luggage load capacity of your vehicle.

Load

BMW X5:

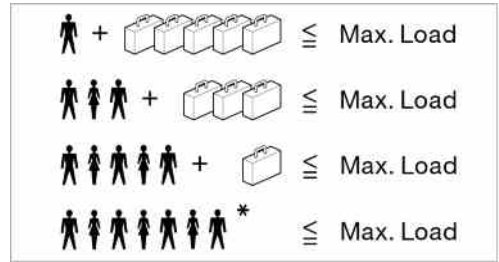

BMW X6:

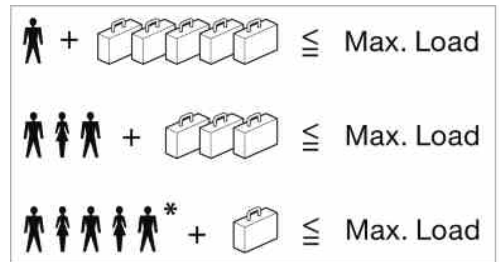

The maximum load is the sum of the weight of the occupants and the cargo.

The greater the weight of the occupants, the less cargo that can be transported.

Stowing cargo

BMW X5

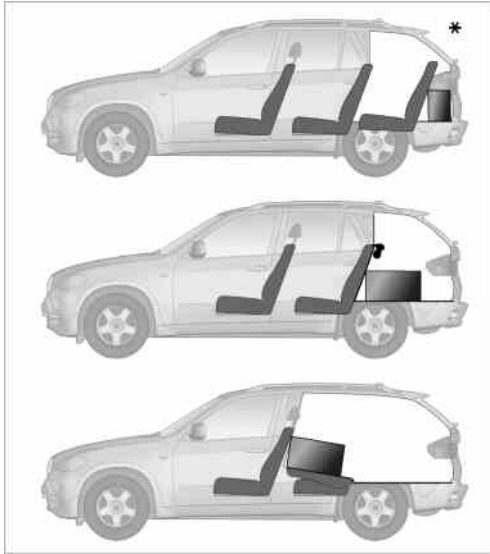

- ▷ Very heavy cargo: when the rear seat is not occupied, secure each of the outer safety belts in the BMW X5 in the opposite buckle.
- ▷ Heavy cargo: stow as far forward and as low as possible, ideally directly behind the backrests.
- ▷ Cover sharp edges and corners.
- ▷ Do not pile objects higher than the top edge of the backrest.
- ▷ If necessary, fold down the rear backrests to stow cargo.
- ▷ Place protective material around any sharp-edged or pointed objects that could bump against the rear window while the vehicle is in motion.

Securing cargo

BMW X5

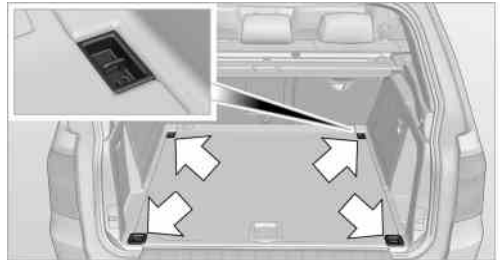

BMW X6

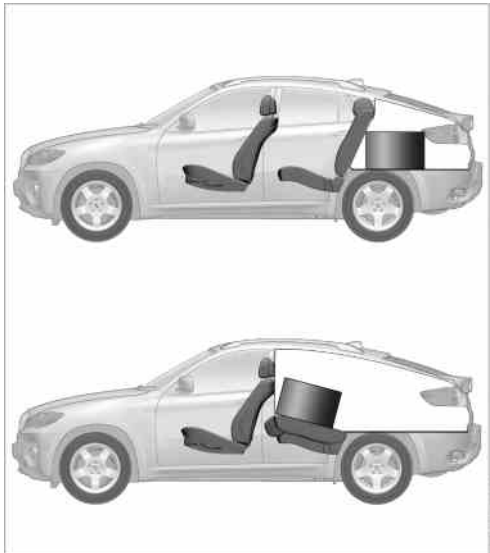

BMW X6

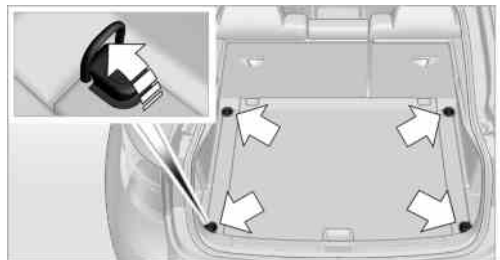

- ▷ Smaller and lighter items: secure with retaining straps, a cargo net or draw straps.
- ▷ Larger and heavy objects: secure with cargo straps.

Four lashing eyes mounted in the cargo area are used to secure these cargo straps, refer to illustrations.

Adhere to the information included with the cargo straps.



Securing cargo

Stow and secure the cargo as described above; otherwise it may present a danger to the occupants, for instance during braking and avoidance maneuvers.

Do not stow any heavy and hard objects in the passenger compartment without securing them; otherwise, they may present a danger to occupants, for instance during braking and avoidance maneuvers.

Never exceed either the approved gross vehicle weight or either of the approved axle loads, as excessive loads can pose a safety hazard, and may also place you in violation of traffic safety laws.

Use only the lashing eyes pictured to fasten the heavy-duty cargo straps. Do not secure cargo using the upper top tether, refer to page 62, mounting points; otherwise, these may become damaged. ◀

Roof-mounted luggage rack

Special rack system as optional accessory

A special rack system is available as an optional accessory.

Follow the directions given in the installation instructions.

Mounting

Be sure that adequate clearance is maintained for tilting and opening the glass sunroof/panoramic glass sunroof.

Loading

Because roof racks raise the vehicle's center of gravity when loaded, they have a major effect on vehicle handling and steering response.

Therefore, note the following when loading and driving:

- ▷ Do not exceed the approved roof/axle loads and the approved gross vehicle weight.
- ▷ Distribute the roof load uniformly.
- ▷ The roof load should not be too large in area.
- ▷ Always load the heaviest pieces on the bottom.
- ▷ Fasten roof-mounted cargo correctly and securely.
- ▷ Do not let objects project into the opening path of the tailgate.
- ▷ Drive smoothly. Avoid sudden acceleration and braking maneuvers. Take corners gently.

Driving on poor roads

Your vehicle combines an all-wheel drive system with the advantages of a normal passenger car.



Do not drive on unpaved terrain

Do not drive on unpaved terrain, as otherwise the vehicle may be damaged. ◀

For your own safety and the safety of passengers and the vehicle, adhere to the following points:

- ▷ Familiarize yourself with the vehicle before driving; never take risks.
- ▷ Adjust speeds according to road conditions. The steeper and rougher the road surface is, the lower the speed should be.
- ▷ When driving on steep uphill and downhill grades: the engine oil and coolant should be filled nearly to the MAX mark.

BMW X5: the vehicle can be driven on uphill and downhill grades up to 50 %.

- ▷ Use Hill Descent Control HDC, refer to page 106, on steep downhill grades.
BMW X5: the vehicle can be driven away on uphill grades of up to 33 %. The permissible body roll is 50 %.
- ▷ Watch for stones, holes, and other obstacles and drive around these where possible.
- ▷ On bumps and rough roads, avoid contact between the vehicle body and the ground. The maximum ground clearance is 8 inches/20 cm and may vary with the loaded cargo.
- ▷ When driving through water, do not exceed the maximum water height.
 - ▷ BMW X5: 20 inches/50 cm
 - ▷ BMW X6: 17 inches/45 cmDrive at walking speed only and do not stop the vehicle.
- ▷ After driving through water, press on the brake pedal several times at low speeds to dry the brakes.
- ▷ Depending on the prevailing terrain, activate Dynamic Traction Control DTC, refer to page 104, briefly.
- ▷ When the wheels spin, accelerate to enable the driving stability control systems to distribute the drive force to the individual wheels.
- ▷ The stone chip guard reduces the risk of damage to painted vehicle components, such as in the area of the side skirts and wheel arches. Your service center will be glad to advise you.

After driving on poor roads

Adhere to the following points to ensure vehicle safety:

- ▷ Remove excessive accumulations of dirt and mud from the vehicle body.
- ▷ Clear mud, snow, ice, etc., from the wheels and tires and check for damage.

Saving fuel

General information

Your vehicle contains advanced technology for the reduction of fuel consumption and emissions.

Fuel consumption depends on a number of different factors.

The implementation of certain measures, driving style and regular maintenance, refer to page 286, can have an influence on fuel consumption and on the environmental impact.

Remove unnecessary cargo

Additional weight increases fuel consumption.

Remove attached parts following use

Remove unneeded auxiliary mirrors, roof or rear luggage racks after use.

Attached parts on the vehicle impair the aerodynamics and increase the fuel consumption.

Closing the windows and glass sunroof/panoramic glass sunroof

Driving with the glass sunroof/panoramic glass sunroof and windows open results in increased air resistance and raises fuel consumption.

Check the tire inflation pressure regularly

Check and, if necessary, correct the tire inflation pressure, refer to page 269, at least twice a month and before starting on a long trip.

Low tire inflation pressure increases rolling resistance and thus raises fuel consumption and tire wear.

Drive away without delay

Do not wait for the engine to warm up while the vehicle remains stationary. Start driving right away, but at moderate engine speeds.

This is the fastest way for the cold engine to reach its operating temperature.

Look well ahead when driving

Avoid unnecessary acceleration and braking.

By maintaining a suitable distance to the vehicle driving ahead of you.

Driving smoothly and looking ahead reduces fuel consumption.

Avoid high engine speeds

Driving at a low engine speed reduces fuel consumption and minimizes wear.

Use coasting conditions

When approaching a red light, take your foot off the accelerator and let the vehicle coast to a halt.

On a downhill gradient, take your foot off the accelerator and let the vehicle roll.

The flow of fuel is interrupted while coasting.

Switch off the engine during longer stops

Switch off the engine during longer stops, e.g., at traffic lights, railroad crossings or in traffic congestion.

Fuel savings are already achieved after the engine is turned off for as little as 4 seconds.

Switch off any functions that are not currently needed

Functions such as seat heating and the rear window defroster require a lot of energy and consume additional fuel, especially in city and stop-and-go traffic.

Therefore, switch off these functions if they are not actually needed.

Have maintenance carried out

Have vehicles maintained regularly to achieve optimal vehicle economy and operating life.

Have the maintenance carried out by your service center.

Please also note the BMW Maintenance System, refer to page [286](#).



Navigation

This chapter contains various examples of how the navigation system can guide you reliably to your destination.

Navigation system

Vehicle equipment

This chapter describes all series equipment as well as country-specific and special equipment offered for this model series. Therefore, it also describes equipment that may not be found in your vehicle, for instance due to the selected special equipment or the country version. This also applies to safety-related functions and systems.

General information

The navigation system can determine the precise position of the vehicle, with the aid of satellites and vehicle sensors, and can reliably guide you to every entered destination.

Entries in stationary vehicle

Enter data only when the vehicle is stationary, and always give priority to the applicable traffic regulations in the event of any contradiction between traffic and road conditions and the instructions issued by the navigation system. Failure to take to this precaution can place you in violation of the law and put vehicle occupants and other road users in danger. ◀

Opening the navigation system

-  Press the button on the controller.
- "Navigation"

 The navigation system can also be called up directly using the button on the controller.

Navigation data

Information on navigation data

- "Navigation"

- Open "Options".
- "Navigation system version"
Information is displayed on the data version.

Updating the navigation data

General information

Navigation data are stored in the vehicle and can be updated.

Current navigation data and the authorization code are available from your service center.

- ▷ Depending on the data volume, a data update may take several hours.
- ▷ Update during the trip to preserve battery.
- ▷ During the update, only the basic functions of the navigation system are available.
- ▷ The status of the update can be viewed.
- ▷ After the updating process is complete, the system restarts.
- ▷ Remove the medium with the navigation data after the update.

Performing an update

- Insert the navigation DVD into the DVD player with the labeled side facing up.
- Follow the instructions on the Control Display.
- Enter the authorization code of the navigation DVD.
- Change the DVD if necessary.

After the trip is interrupted, follow the instructions on the Control Display.

Viewing the status

- Open "Options".
- "Navigation update"

Removing navigation DVD

1.  Press button 1.

The DVD emerges slightly from the drive.

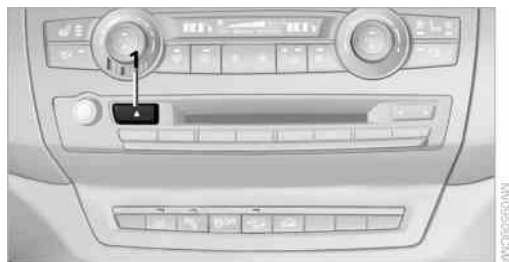

2. Remove the DVD.

Destination entry

Vehicle equipment

This chapter describes all series equipment as well as country-specific and special equipment offered for this model series. Therefore, it also describes equipment that may not be found in your vehicle, for instance due to the selected special equipment or the country version. This also applies to safety-related functions and systems.

At a glance

In entering your destination you can select from the following options:

- ▷ Enter the destination manually, see below.
- ▷ Select the destination from the address book, refer to page 166.
- ▷ Last destinations, refer to page 167.
- ▷ Special destinations, refer to page 167.
- ▷ Destination entry via map, refer to page 169.
- ▷ Using the home address as the destination, refer to page 167.
- ▷ Destination entry by voice, refer to page 170.
- ▷ Enter the destination via BMW Assist, refer to page 169.



Entries in stationary vehicle

Enter data only when the vehicle is stationary, and always give priority to the applicable traffic regulations in the event of any contradiction between traffic and road conditions and the instructions issued by the navigation system. Failure to take to this precaution can place you in violation of the law and put vehicle occupants and other road users in danger. ◀

Manual destination entry

General information

The system supports you in entering street names and house numbers by automatically completing the entry and providing entry comparisons, refer to page 24.

Stored town/city and street names can be called up quickly.

- ▷ If the existing entries should not be changed, the entries for the state/province and town/city can be skipped.
- ▷ Destination guidance is started to the town/city center if no street is entered.

Entering a state/province

1.  Press the button.
2. "Navigation"
3. "Enter address"



4. Select "State/Province" or the displayed state/province.

Entering a town/city

1. Select "Town/City/Postal Code" or the displayed town/city.

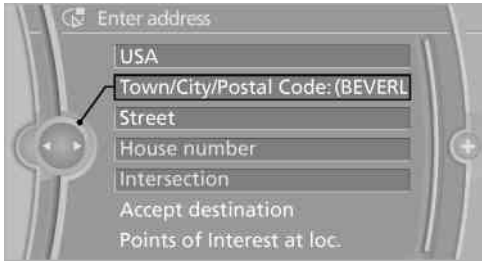

2. Select letters, if necessary.
The list is narrowed down further with each entry.
3. Move the controller to the right.
4. Select the name of the town/city from the list.

If there are several towns/cities with the same name:

1. Change to the list of town/city names.
2. Highlight the town/city.
3. Select the town/city.

Entering the postal code

1. Select "Town/City/Postal Code" or the displayed town/city.
2. 1@+ Select the symbol.
3. Select the numbers.
4. Change to the list of postal codes and towns/cities.
5. Highlight the entry.
6. Selecting an entry.

Entering a street and intersection

1. Select "Street" or the displayed street.
2. Enter a street and intersection in the same way as you would enter a town/city.

If there are several streets with the same name:

1. Change to the list of street names.

2. Highlight the street.
3. Select the street.

Alternative: enter the street address and house number

1. Select "Street" or the displayed street.
2. Enter the street as you would the town/city.
3. "House number"
4. Select the numbers.
5. Change to the list of house numbers.
6. Select a house number or range of house numbers.

Street does not exist in the destination city/town

The desired street does not exist in the specified city/town because it belongs to another part of the city/town.

1. "Navigation"
2. "Enter address"
3. Select "Street" or the displayed street.
4. Change to the list of street names.
5. Select "In" with the state/province currently displayed.

All streets of the selected state/province are offered. The associated town/city is displayed after the street name.

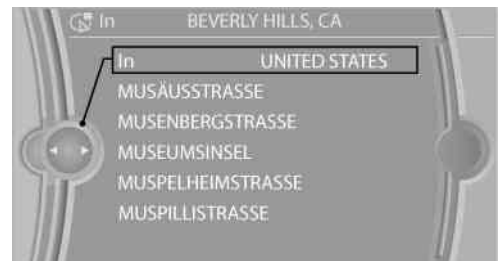

6. Select the letters.
7. Change to the list of street names.
8. Highlight the street.
9. Select the street.

Starting destination guidance after entering the destination

1. "Accept destination"
2. "Start guidance" or "Add as another destination"

Add, refer to page 171, a destination as a further destination.

Address book

Create contacts, refer to page 251.

Selecting a destination from the address book

1. "Navigation"
2. "Address book"

Contacts with addresses are displayed if these have been checked as destinations.

If the contacts with addresses from the mobile phone are not displayed, they first need to be checked as destinations, refer to page 252.

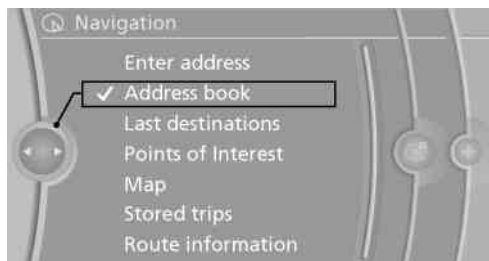

3. Select a contact in the list or, if desired, with "A-Z search".
4. "Business address" or "Home address"

Storing the destination in the address book

After entering the destination, store the destination in the address book.

1. "Navigation"
2. "Map"

3. "Guidance"
4. Open "Options".
5. "Store as new contact" or "Add to existing contact"

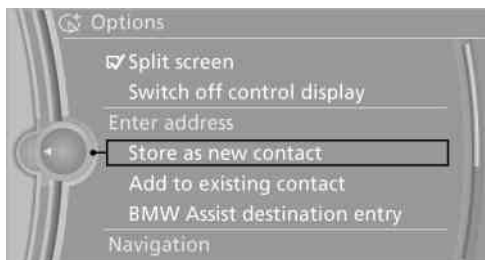

6. Select an existing contact, if available.
7. "Business address" or "Home address"
8. Enter "Last name" and, if necessary, "First name".
9. "Store in vehicle"

Storing the position

The current position can be stored in the address book.

1. "Navigation"
2. Open "Options".
3. "Store position as contact" or "Add position to contact"

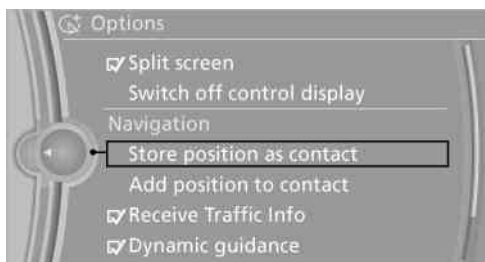

4. Depending on the selection, choose an existing contact from the list. Select the type of address and enter the first and last name.
5. "Store in vehicle"

Editing or deleting an address

1. "Navigation"
2. "Address book"
3. Highlight the entry.
4. Open "Options".
5. "Edit in Contacts" or "Delete entry"

Using the home address as the destination

The home address must be stored. Specify the home address, refer to page 244.

1. "Navigation"
2. "Address book"
3. "Home"

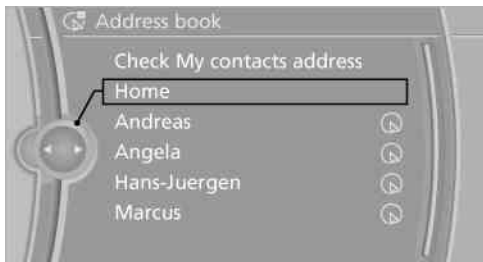

4. "Start guidance"

Last destinations

At a glance

The destinations previously entered are stored automatically.

These destinations can be called up and used as a destination for destination guidance.

Calling up the last destination

1. "Navigation"

2. "Last destinations"



Starting destination guidance

1. "Navigation"
2. "Last destinations"
3. Select the destination.
4. "Start guidance"

Editing the destination

1. "Navigation"
2. "Last destinations"
3. Highlight the destination.
4. Open "Options".
5. "Edit destination"

Deleting the last destinations

1. "Navigation"
2. "Last destinations"
3. Highlight the destination.
4. Open "Options".
5. "Delete entry" or "Delete all last destinations"

Special destinations

General information

Even with the latest navigation data, information on specific special destinations may have changed; for example, gas stations might not be in operation.

Opening the search for special destinations

Selection of special destinations, such as hotels or tourist attractions.

1. "Navigation"
2. "Points of Interest"
3. Select the search function.

Online Search

1. "Google™ Local Search"
2. Select a special destination.
3.  Select the symbol.
4. "Start guidance"

A-Z search

1. "A-Z search"
2. "Town/City"
3. Select or enter the town/city.
4. "Category"
5. Select the category.
6. "Category details"

For some special destinations, multiple category details can be selected. Move the controller to the left to leave the category details.

7. "Keyword"
8. Enter the keyword.
A list of the special destinations is displayed.
9. Select a special destination.
Details are displayed.
If multiple details are stored, you can leaf through the pages.
If a phone number is available, a connection can be established if necessary.
10.  Select the symbol.
11. "Start guidance" or "Add as another destination"
Add a destination as a further destination, refer to page [171](#).

"Start search": if a search term is not entered, the search is repeated with the previous search term.

Category search

1. "Category search"
2. "Town/City"
3. Select or enter the town/city.
4. "Category"
5. Select the category.
6. "Category details"

For some special destinations, multiple category details can be selected. Move the controller to the left to leave the category details.

7. "Start search"
A list of the special destinations is displayed.
8. Select a special destination.
Details are displayed.
If multiple details are stored, you can leaf through the pages.
If a phone number is available, a connection can be established if necessary.
9.  Select the symbol.
10. "Start guidance" or "Add as another destination"
Add a destination as a further destination, refer to page [171](#).

Display of special destinations

List of special destinations: special destinations are arranged by distance and appear with a directional arrow pointing to the special destination.

In the splitscreen, special destinations of the selected category are displayed in the map view as symbols. The display depends on the scale of the map and the category.

Destination entry via BMW Assist

A connection is established to the Concierge service, refer to page [254](#).

1. "Navigation"
2. "Enter address"
3. Open "Options".
4. "BMW Assist dest. entry"

Displaying special destinations in the map

To display symbols of the special destinations in the map view:

1. "Navigation"
2. "Map"
3. Open "Options".
4. "Display Points of Interest"
5. Select the setting.

Destination entry by map

Selecting the destination

1. "Navigation"
2. "Map"
3.  "Interactive map"

The current position of the vehicle is displayed on the map.



4. Select the destination with crosshairs.
 - ▷ To change the scale: turn the controller.
 - ▷ To shift the map: move the controller in the required direction.

- ▷ To shift the map diagonally: move the controller in the required direction and turn it.

Specifying the street

If the system does not recognize the street, one of the following pieces of information is displayed:

- ▷ A street name in the vicinity.
- ▷ The county.
- ▷ The coordinates of the destination.

Additional functions

Additional functions are available on the interactive map after the controller is pressed.



- ▷  Select the symbol. "Start guidance" or "Add as another destination"
- ▷ Add a destination as a further destination, refer to page [171](#).
- ▷ "Exit interactive map": return to the map view.
- ▷ "View in northern direction" or "View in driving direction"
- ▷ "Display destination": the map section around the destination is displayed.
- ▷ "Display current location": the map section around your current location is displayed.
- ▷ "Find points of interest": the search for special destinations is started.

Destination entry by voice

General information

- ▷ Instructions for voice activation system, refer to page 25.
- ▷ When making a destination entry by voice, you can change between voice operation and iDrive.
- ▷ To have the available spoken instructions read out loud: ›Voice commands‹.

Saying the entries

- ▷ The town/city, street, and house number can be entered using a single command.
- ▷ Spell the entry if the spoken language and the language of the system differ.
- ▷ Say the letters smoothly, and avoid exaggerating the pronunciation and inserting lengthy pauses between the letters.
- ▷ The methods of entry depend on the navigation data in use and the country and language settings.

Entering the address in a command

1.  Press the button on the steering wheel.
2. ›Enter address‹
3. Wait for a request from the system.
4. Say the address in the suggested order.
5. Continue making the entry as prompted by the system.
If necessary, individually name the separate components of the address, e.g., the town/city.

Entering a town/city separately

The town/city can be said as a complete word.

With the destination entry menu displayed:

1.  Press the button on the steering wheel.
2. ›City‹ or ›Spell city‹
3. Wait for the system to prompt you for the town/city.
4. Say the name of the town/city, or name at least the first three letters.
Depending on the entry, up to 20 towns/cities may be suggested.
5. Select a location:
 - ▷ Select a recommended town/city: ›Yes‹.
 - ▷ Select a different town/city: ›New entry‹.
 - ▷ Select an entry: ›Entry ...‹, for instance, entry 2.
 - ▷ Spell an entry: ›Spell city‹.
6. Continue making the entry as prompted by the system.

If there are several towns/cities with the same name:

Towns/cities of the same name are grouped in a list and displayed as one location followed by an ellipsis.

1. Select an entry: ›Yes‹ or ›Entry ...‹, e. g., Entry 2.
2. Select the desired town/city.

Entering a street or intersection separately

Enter a street and intersection in the same way as you would enter a town/city.

Entering a house number separately

Depending on the data in the navigation system, house numbers up to number 2,000 can be entered.

1. ›House number‹
2. Say the house number.
Say each digit separately.

- Continue making the entry as prompted by the system.

Starting destination guidance

›Start guidance‹

Planning a trip with intermediate destinations

New trip

A trip can be planned with several intermediate destinations.

- "Navigation"
- "Map"
- Move the controller to the left if necessary.
-  "Guidance"
- "Enter new destination"
- Select the type of destination entry.

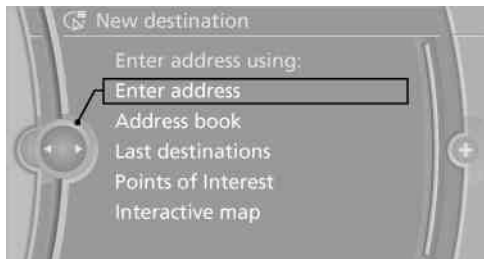

- Enter the intermediate destination.
- "Start guidance"

Entering intermediate destinations

A maximum of 30 intermediate destinations can be entered for a trip.

- "Enter new destination"
- Select the type of destination entry.
- Enter the intermediate destination.
- "Add as another destination"

The intermediate destination is entered in the destination list and is highlighted.

- Turn the controller until the intermediate destination is located at the desired location in the list.
- Press the controller.

Starting the trip

- After all intermediate destinations are entered, highlight the first destination. If the second destination, for example, is highlighted when destination guidance is started, the first destination is skipped.
- "Start guidance"
 -  This symbol marks the active leg of the trip.

Storing a trip

Up to 30 trips can be stored in the trip list. If necessary, delete existing trips to be able to store new trips.

- Open "Options".
- "Store trip"
- Enter a name for the trip.
- "OK"

Selecting a stored trip

- "Navigation"
- "Stored trips"
- Select a stored trip.
- "Start guidance"

Changing the trip direction

Intermediate destinations are displayed in reverse order in the list.

- "Map"
-  "Guidance"
- Open "Options".
- "Reverse order of trip dest."

Intermediate destination options

1. "Map"
2.  "Guidance"
3. "Display all trip destinations"
4. Select an intermediate destination.
 - ▷ "Edit destination"
 - ▷ "Reposition dest. in the trip": move an intermediate destination to another position in the list.
 - ▷ "Delete dest. in the trip"
 - ▷ "Go to next dest. in the trip"

Some options are not available for certain trips.

Deleting a stored trip

1. "Navigation"
2. "Stored trips"
3. Highlight the desired trip.
4. Open "Options".
5. "Delete all trips" or "Delete trip"

Opening the last trip

1. "Navigation"
2. "Stored trips"
3. "Last trip"
4. "Start guidance"

Destination guidance

Vehicle equipment

This chapter describes all series equipment as well as country-specific and special equipment offered for this model series. Therefore, it also describes equipment that may not be found in your vehicle, for instance due to the selected special equipment or the country version. This also applies to safety-related functions and systems.

Starting destination guidance

1. "Navigation"
2. Make a destination entry, refer to page 164.
3. "Accept destination"
4. "Start guidance"

The route is shown on the Control Display.

The distance to the destination/intermediate destination and the estimated time of arrival are displayed in the map view.

The arrow view is displayed in the Head-up Display and in some cases on the Control Display.

Terminating destination guidance

1. "Navigation"
2. "Map"
3.  "Guidance"
4. "Stop guidance"

Continuing destination guidance

If the destination was not reached during the last trip, destination guidance can be resumed.





"Resume guidance"

Route criteria

General information

- ▷ The route calculated can be influenced by selecting certain criteria.
- ▷ The route criteria can be changed when the destination is entered and during destination guidance.
- ▷ Road types are part of the navigation data and are taken into consideration when planning a route, e.g., avoid highways.
- ▷ The recommended route may differ from the route you would take based on personal experience.
- ▷ The settings are stored for the remote control currently in use.
- ▷ Destination guidance with traffic bulletins, refer to page 179.

Changing the route criteria

1. "Navigation"
2. "Map"
3.  "Route preference"
4. Select the criterion:
 - ▷  "Fast route": time-optimized route, being a combination of the shortest possible route and the fastest roads.
 - ▷  "ECO PRO route": optimized combination of the fastest and shortest route.
 - ▷  "Short route": short distance, irrespective of how fast or slow progress will be.
 - ▷ "Alternative routes": if available, alternative routes are suggested during active destination guidance.

The individual suggestions are highlighted in color.

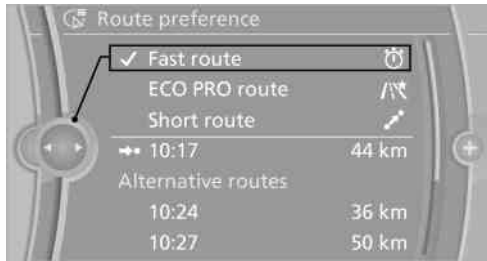

5. Specify additional criteria for the route, if necessary:
 - ▷ "Avoid highways": highways are avoided wherever possible.
 - ▷ "Avoid toll roads": toll roads are avoided wherever possible.
 - ▷ "Avoid ferries": ferries are avoided where possible.

Route

Different views of the route are available during destination guidance:

- ▷ Arrow view.
- ▷ List of route sections.
- ▷ Map view, refer to page 175.
- ▷ Arrow view in the Head-up Display, refer to page 125.

Arrow view

The following information is displayed during destination guidance:

- ▷ Large arrow: indicates the current direction of travel.
- ▷ Street name of the road currently being driven on.
- ▷ Small arrow: indicates the next change in direction.
- ▷ Intersection view.
- ▷ Lane information.

- ▷ Traffic bulletins.
- ▷ Distance to the next change in direction.
- ▷ Street name at the next change in direction.

Lane information

On multi-lane roads, the recommended lanes are marked in the arrow view by a triangle.

- ▷ Solid triangle: best lane.
- ▷ Empty triangle: possible lane. However, another lane change may be needed shortly.

Displaying a list of route sections

When destination guidance is active, a list of the route sections can be displayed. The driving distance and traffic bulletins are displayed for each route section.

1. "Navigation"
2. "Route information"
3. Highlight a route section.

The route section is displayed on the split screen.

Bypassing a section of the route

Calculate a new route for a route section.

1. "Navigation"
2. "Route information"
3. "New route for"

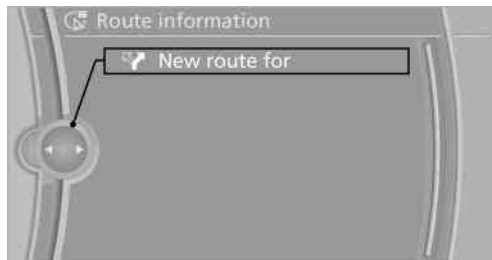

- Turn the controller. Enter the number of kilometers within which you would like to return to the original route.
- Press the controller.

Resuming the original route

If the route section should no longer be bypassed:

- "Navigation"
- "Route information"
- "New route for:"
- "Remove blocking"

Gas station recommendation

The remaining range is calculated and gas stations along the route are displayed.



Even with the latest navigation data, information on individual special destinations may have changed; for example, gas stations might not be in operation.

- "Navigation"
- "Route information"
- "Recommended refuel"
A list of the gas stations is displayed.
- Highlight a gas station.
The position of the gas station is shown on the split screen.
- Select the gas station.
-  Select the symbol.
- "Start guidance": destination guidance to the selected gas station is started.
"Add as another destination": the gas station is added to the route.

Destination guidance through voice instructions

Switching spoken instructions on/off

The setting is stored for the remote control currently in use.

- "Navigation"
- "Map"
-   "Voice instructions"

Repeating a spoken instruction

- "Navigation"
- "Map"
-  Highlight the symbol.
- Press the controller twice.

Volume of spoken instructions

Turn the volume knob while giving an instruction until the desired volume is set.

The setting is stored for the remote control currently in use.

Saving the spoken instructions on the programmable memory buttons

The function for switching the spoken instructions on/off can be stored on a programmable memory button, refer to page 23, for quick access.

Map view

Selecting the map view

- "Navigation"
- "Map"

At a glance

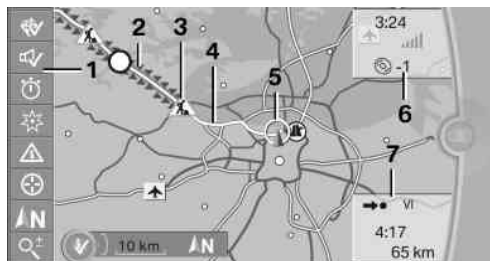

- 1 Function bar
- 2 Route section with traffic obstruction
- 3 Traffic sign for traffic obstruction
- 4 Planned route
- 5 Current location
- 6 Upper status field
- 7 Lower status field

Lines in the map

Streets and routes are displayed in different colors and styles depending on their classification. Dashed lines represent railways and ferry connections. Country borders are indicated by thin lines.

Traffic obstructions

Small triangles along the planned route indicate route sections with traffic obstructions, depending on the map scale. The direction of the triangles indicates the direction of the obstruction.

The traffic signs indicate the significance of the obstruction.

- ▷ Red traffic sign: the obstruction affects the planned route or direction.
- ▷ Grey traffic sign: the obstruction does not affect the planned route or direction.

Traffic bulletins, refer to page 177.

Planned route

After destination guidance is started, the planned route is displayed on the map.

Status fields

Show/hide: press the controller.

- ▷ Upper status field: time, telephone, and entertainment details.
- ▷ Lower status field: symbol for active destination guidance, status of traffic bulletins, time of arrival, and distance to destination.

Function bar

The following functions are available in the function bar:

Symbol	Function
	Start/end destination guidance.
	Switch spoken instructions on/off.
	Change the route criteria.
	Search for a special destination.
	Display traffic bulletins.
	Open the interactive map.
	Set the map view.
	Change the scale.

To change to the function bar, move the controller to the left.

Changing the map section

- ⊕ "Interactive map"
 - ▷ To shift the map: move the controller in the required direction.
 - ▷ To shift the map diagonally: move the controller in the required direction and turn it.

Changing the scale

1. Select the symbol.
2. To change the scale: turn the controller.

Automatically scaled map scale

In the map view facing north, turn the controller in any direction until the AUTO scale is displayed. The entire route between the current location and the destination is displayed on the map.

Settings for the map view

The settings are stored for the remote control currently in use.

1. "Navigation"
2. "Map"
3. Open "Options".
4. "Settings"
5. To set the map view:

▷ "Day/night mode"

Select and create the necessary settings depending on the light conditions.

"Traffic conditions/gray map" active: the setting is disregarded.

▷ "Satellite images"

Depending on availability and resolution, satellite images are displayed at scales of approx. 1 mile to 600 miles/2 km to 1,000 km.

▷ "Perspective view in 3D"

Prominent areas that are contained in the navigation data are displayed on the map in 3D.

▷ "Traffic conditions/gray map"

The map is optimized for displaying traffic bulletins, refer to page 178.

Symbols for the special destinations are no longer displayed.

Map view for splitscreen

The map view can be selected for the split screen independently from the main screen.

1. Open "Options".
2. "Split screen"

3. Move the controller to the right repeatedly until the split screen is selected.
4. Select "Split screen content" or the scale.
5. Select the map view.
 - ▷ "Arrow display"
 - ▷ "Map facing north"
 - ▷ "Map direction of travel"
 - ▷ "Map view with perspective"
 - ▷ "Position"
 - ▷ "Exit ramp view": selected blind drive-ways are displayed three dimensionally.
 - ▷ "Traffic conditions/gray map"
6. To change the scale: select the split screen and turn the controller.

Traffic bulletins

At a glance

- ▷ Display the traffic bulletins from radio stations that broadcast the TI Traffic Information of a traffic information service. Information on traffic obstructions and hazards is updated continuously.

Certain BMW models equipped with navigation have the capability to display real-time traffic information. If your system has this capability the following additional terms and conditions apply:

An End-User shall no longer have the right to use the Traffic Data in the event that the End-User is in material breach of the terms and conditions contained herein.

A. Total Traffic Network, a division of Clear Channel Broadcasting, Inc. ("Total Traffic Network") holds the rights to the traffic incident data and RDS-TMC network through which it is delivered. You may not modify, copy, scan or use any other method to reproduce, duplicate, republish, transmit or distribute in any way any portion of traffic incident data. You agree to indemnify, defend

and hold harmless BMW of North America, LLC. ("BMW NA") and Total Traffic Network, Inrix, Inc (and their affiliates) against any and all claims, damages, costs or other expenses that arise directly or indirectly out of (a) your unauthorized use of the traffic incident data or the RDS-TMC network, (b) your violation of this directive and/or (c) any unauthorized or unlawful activities by you in connection herewith.

B. Total Traffic Network traffic data is informational only. User assumes all risk of use. Total Traffic Network, BMW NA, and their suppliers make no representations about content, traffic and road conditions, route usability, or speed.

C. The licensed material is provided to licensee "as is," and "where is". Total Traffic Network, including, but not limited to, any and all third party providers of any of the licensed material, expressly disclaims, to the fullest extent permitted by law, all warranties or representations with respect to the licensed material (including, without limitation, that the licensed material will be error-free, will operate without interruption or that the traffic data will be accurate), express, implied or statutory, including, without limitation, the implied warranties of merchantability, non-infringement fitness for a particular purpose, or those arising from a course of dealing or usage of trade.

D. Neither Total Traffic Network, Inrix, Inc. or BMW NA will be liable to you for any indirect, special, consequential, exemplary, or incidental damages (including, without limitation, lost revenues, anticipated revenues, or profits relating to the same) arising from any claim relating directly or indirectly to use of the traffic data, and even if Total Traffic Network, Inrix, Inc., or BMW NA are aware of the possibility of such damages. These limitations apply to all claims, including, without limitation, claims in contract and tort (such as negligence, product liability and strict liability). Some states do not allow the exclu-

sion or limitation of incidental or consequential damages, so those particular limitations may not apply to you.

- ▶ The traffic bulletins are indicated on the map by symbols.
 - ▶ The traffic bulletins for the surrounding area are stored in a list.
- ▲ The symbol in the function bar of the map view turns red if there are traffic bulletins that affect the calculated route.

Switching the reception on/off

1. "Navigation"
2. Open "Options".
3. "Receive Traffic Info"

Opening the list of traffic bulletins

1. "Navigation"
2. "Map"
3. ▲ "Traffic Info"

First, traffic bulletins for the calculated route are displayed.

The traffic bulletins are sorted by their distance from the current position of the vehicle.

4. Select a traffic bulletin.
 "More information": display additional information.
5. Scroll to the next or previous traffic bulletin if required.

Traffic bulletins on the map

"Traffic conditions/gray map" active:

The Control Display changes to a black and white display. This enables a better view of the traffic bulletins. The day/night mode is disregarded in this setting. Symbols and special destinations are not displayed.

1. "Navigation"
2. "Map"
3. Open "Options".

4. "Settings"
5. "Traffic conditions/gray map"

Symbols in the map view

Depending on the scale of the map and the location of the traffic obstruction along the route, the symbols for the traffic obstructions are displayed.

Additional information in the map view

Depending on the map scale, a traffic obstruction's length, direction, and impact are displayed in the map using triangles or gray bars along the calculated route.

- ▷ Red: traffic congestion
- ▷ Orange: stop-and-go traffic
- ▷ Yellow: heavy traffic
- ▷ Green: clear roads
- ▷ Gray: general traffic bulletins such as road construction

The displayed information depends on the particular traffic information service.

Filtering traffic bulletins

You can set which traffic bulletins appear on the map.

1. "Navigation"
2. "Map"
3. Open "Options".
4. "Traffic Info categories"
5. Select the desired category.

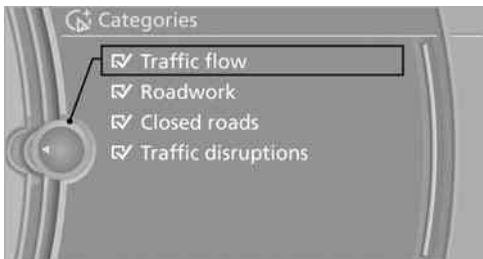

Traffic bulletins of the selected category are displayed on the map.

- ▷ Traffic bulletins that are relevant to the route are always shown.
- ▷ For your own safety, traffic bulletins that notify you of potentially dangerous situations, such as wrong-way drivers, cannot be hidden.

Destination guidance with traffic bulletins

General information

Detour suggestions from the navigation system can be manually accepted when using semi-dynamic destination guidance. When using dynamic destination guidance, they are automatically accepted for route guidance.

Semi-dynamic destination guidance

When traffic bulletin reception is switched on, semi-dynamic destination guidance is active.

The destination guidance system takes the available traffic bulletins into account. A message is displayed depending on the route, the traffic bulletins, and the possible detour routes. If possible, a detour is offered in case of traffic obstructions.

The upper part of the message shows:

- ▷ Symbol of the first traffic obstruction, possibly with the distance to the beginning of the obstruction.
- ▷ Total length of the traffic obstructions on the route.
- ▷ Time by which the trip is extended due to the traffic obstructions.

The lower part of the message shows:

- ▷ Detour recommendation with the distance to the beginning of the detour.
- ▷ Difference between the length of the new route compared to the original route.

- ▷ Time gained if the detour is taken compared to the original route with the traffic obstructions.

Both the original route, shown in white, and the detour are displayed on the split screen.

Accepting the detour

📍 "Detour"

In the event of special hazards, e. g., objects on the road, a message is displayed without a detour suggestion.

Detours can also be accepted if the traffic messages are called up in the list.

1. "Navigation"
2. "Map"
3. ⚠️ "Traffic Info"
4. "Detour information"
5. 📍 "Detour"

Dynamic destination guidance

The route is automatically changed in the event of traffic obstructions.

- ▷ The system does not point out traffic obstructions along the original route.
- ▷ Traffic bulletins continue to be displayed on the map.
- ▷ Depending on road type and the kind and extent of the traffic obstruction, the calculated route may lead through the traffic obstruction.
- ▷ Dangerous situations are displayed regardless of the setting.

Activating dynamic destination guidance

1. "Navigation"
2. Open "Options".
3. "Dynamic guidance"

What to do if...

Vehicle equipment

This chapter describes all series equipment as well as country-specific and special equipment offered for this model series. Therefore, it also describes equipment that may not be found in your vehicle, for instance due to the selected special equipment or the country version. This also applies to safety-related functions and systems.

- ▷ Spoken instructions are no longer output during route guidance in front of intersections?

The area has not yet been fully recorded, or you have left the recommended route and the system requires a few seconds to calculate a new route suggestion.

What to do if...

- ▷ The current transmission position cannot be displayed?

The vehicle is located in an unrecognized region, is in a poor reception area, or the system is currently determining the position. Reception is usually best when you have an unobstructed view of the sky.

- ▷ The destination without street information is not used for route guidance?

When city has been input, no downtown can be determined. Input any street in the selected city and start destination guidance.

- ▷ The destination is not used for route guidance?

The destination data are not contained in the navigation data. Select a destination that is as close as possible to the original.

- ▷ Letters for destination input cannot be selected?

The stored data do not contain the data of the destination. Select a goal that is as close as possible to the original.

- ▷ Is the map displayed in shades of gray?

"Traffic conditions/gray map" active:

The Control Display changes to a black and white display. This enables a better view of the traffic bulletins.



Entertainment

This chapter helps assure your enjoyment when receiving radio stations and playing CDs, DVDs, and tracks from the music collection.

Tone

Vehicle equipment

This chapter describes all series equipment as well as country-specific and special equipment offered for this model series. Therefore, it also describes equipment that may not be found in your vehicle, for instance due to the selected special equipment or the country version. This also applies to safety-related functions and systems.

General information

The sound settings are stored for the remote control currently in use.

Treble, bass, balance, and fader

- ▷ "Treble": treble adjustment.
- ▷ "Bass": depth adjustment.
- ▷ "Balance": left/right volume distribution.
- ▷ "Fader": front/rear volume distribution.

Setting treble, bass, balance, and fader

1. "CD/Multimedia", "Radio" or "Settings"
2. "Tone"



3. Select the desired tone settings.

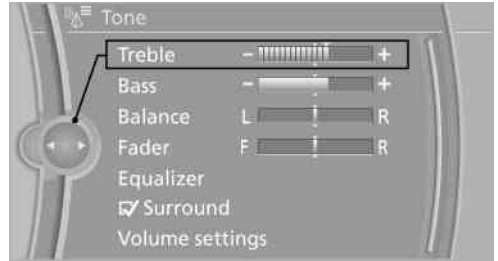

4. To adjust: turn the controller.
5. To store: press the controller.

Equalizer

Setting for individual audio frequency ranges.

Adjusting the equalizer

1. "CD/Multimedia", "Radio" or "Settings"
2. "Tone"
3. "Equalizer"
4. Select the desired setting.



5. To adjust: turn the controller.
6. To store: press the controller.

Multi-channel playback, surround

Choose between stereo and multi-channel playback, surround.

Setting multi-channel playback, surround

1. "CD/Multimedia", "Radio" or "Settings"
2. "Tone"
3. "Surround"

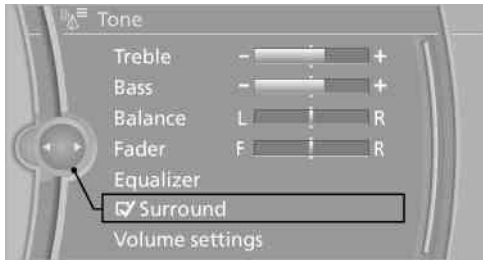

When surround is activated, multi-channel playback is simulated when a stereo audio track is played.

Volume

- ▶ "Speed volume": speed-dependent volume control.
- ▶ "PDC": volume of the PDC signal compared to the entertainment sound output.
- ▶ "Gong": volume of the signal, such as the safety belt reminder, compared to the entertainment sound output.
- ▶ "Microphone": volume of the microphone during a phone call.
- ▶ "Loudspeak.": volume of the loudspeakers during a phone call.

The following volumes are only stored for the respective paired telephone: "Microphone", "Loudspeak."

Adjusting the volume

1. "CD/Multimedia", "Radio" or "Settings"
2. "Tone"
3. "Volume settings"
4. Select the desired volume setting.



5. To adjust: turn the controller.
6. To store: press the controller.

Resetting the tone settings

All tone settings can be reset to the default setting.

1. "CD/Multimedia", "Radio" or "Settings"
2. "Tone"
3. "Reset"

Radio

Vehicle equipment

This chapter describes all series equipment as well as country-specific and special equipment offered for this model series. Therefore, it also describes equipment that may not be found in your vehicle, for instance due to the selected special equipment or the country version. This also applies to safety-related functions and systems.

Controls

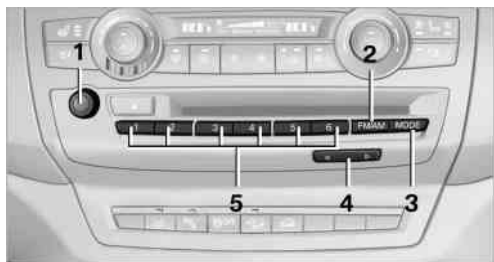

- 1 Volume, on/off
- 2 Change wave band
- 3 Change entertainment sources
- 4 Change station/track
- 5 Programmable memory buttons

Sound output

Switching on/off

When the ignition is switched off: press ON/OFF button on the radio.

Muting

When the ignition is switched on or the engine is running: press the ON/OFF button on the radio.

AM/FM station

Selecting a station

1. "Radio"
2. "FM" or "AM"
3. Select the desired station.

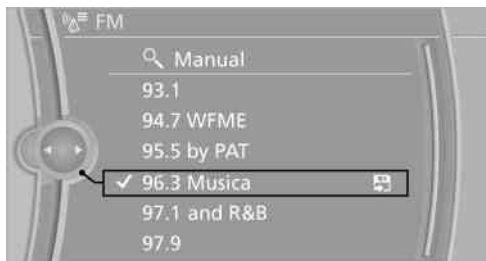

All saved stations are stored for the remote control currently in use.

Changing the station

Turn the controller and press it

or



Press the button

or

Press the buttons on the steering wheel, refer to page 12.

Storing a station

1. "Radio"
2. "FM" or "AM"

- Highlight the desired station.

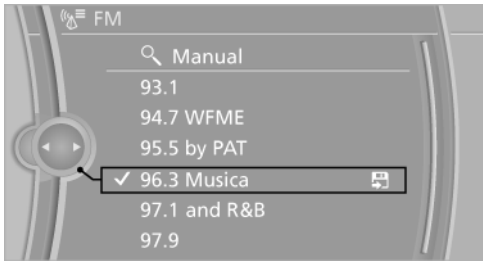

- Press the controller for an extended period.
- Select the desired memory location.

The stations are stored for the remote control currently in use.

The stations can also be stored on the programmable memory buttons, refer to page 23.

Selecting a station manually

Station selection via the frequency.

- "Radio"
- "FM" or "AM"
- "Manual"
- To select the frequency: turn the controller.



To store the station: press the controller for an extended period.

Renaming a station

An FM station with changing station names can be renamed.

- "Radio"
- "FM"
- Select the desired station.

- Open "Options".
- "Rename to:"
If necessary, wait for the desired name to be displayed.

The selected station name is added to the list of current stations and stored stations.

RDS

RDS broadcasts additional information, such as the station name, in the FM wave band.

Switching the RDS on/off

- "Radio"
- "FM"
- Open "Options".
- "RDS"

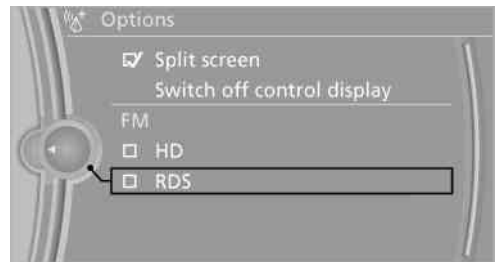

The setting is stored for the remote control currently in use.

HD Radio™ reception

Many stations broadcast both analog and digital signals.

License conditions

HD Radio™ technology manufactured under license from iBiquity Digital Corp. U. S. and Foreign Patents. HD Radio™ and the HD and HD Radio logos are proprietary trademarks of iBiquity Digital Corp.

Activating/deactivating digital radio reception

- "Radio"
- "FM" or "AM"

3. Open "Options".
4. "HD Radio Reception"

The setting is stored for the remote control currently in use.

H) This symbol is displayed in the status line when the audio signal is digital.

When tuning to a station with a digital signal, it may take several seconds for the station to be played back in digital quality.

In areas in which the station is not continuously received in digital mode, the playback switches between analog and digital reception. In this case, switch off digital radio reception.

Displaying additional information

Some stations broadcast additional information on the current track, such as the name of the artist.

1. Select the desired station.
2. Open "Options".
3. "Station info"

Selecting a substation

 This symbol indicates that a main station also broadcasts additional substations. The station name of the main station ends in HD1. Station names of the substations end in HD2, HD3, etc.

1. Select the desired station.
2. Press the controller.
3. Select the substation.







When reception is poor, the substation is muted for several seconds.

Satellite radio

General information

The channels are offered in predefined packages. The packages must be enabled by telephone.

Navigation bar overview

Symbol	Function
	Change the list view.
	Select the category.
	Direct channel entry
	Timeshift
	Open the My Favorites category/ open a favorite.
	Manage the favorites.
	Traffic Jump

The functions of the navigation bar symbols can also be stored on the programmable memory buttons, refer to page 23.

Managing a subscription

To be able to enable or unsubscribe from the channels, you must have reception. It is usually at its best when you have an unobstructed view of the sky. The channel name is displayed in the status line.

Enabling channels

The Unsubscribed Channels category contains all disabled channels.

1. "Radio"
2. "Satellite radio"
3.  "Category"



4. Select the Unsubscribed Channels category.
5. Select the desired channel.
The phone number and an electronic serial number, ESN, are displayed.
6. Select the phone number to have the channel enabled.



You can unsubscribe from the channels again via this phone number.

Unsubscribing from channels

1. "Radio"
2. "Satellite radio"
3. Open "Options".
4. "Manage subscription"



5. The phone number and an electronic serial number, ESN, are displayed.
6. Call Sirius to unsubscribe from the channels.

Selecting channels

You can only listen to enabled channels.

The selected channel is stored for the remote control currently in use.

Via the iDrive

1. "Radio"
2. "Satellite radio"
3. Select "All channels" or the desired category.
4. Select the desired channel.



Via the button on the radio



Press the button.

The next channel is selected.

Via direct channel entry

1. "Radio"
2. "Satellite radio"
3.  "Set channel"
4. Turn the controller until the desired channel is reached and press the controller.

Storing a channel

1. "Radio"
2. "Satellite radio"
3. If necessary, open "All channels" or the desired category.
4. Select the desired channel.
5. Press the controller again.

- Press the controller again to confirm the highlighted channel.

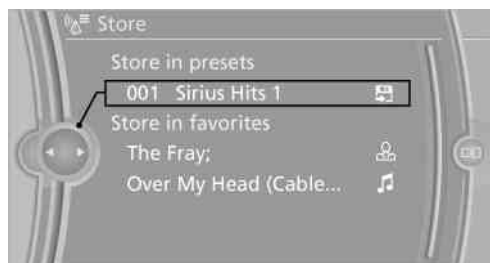

- Select the desired memory location.

The channels are stored for the remote control currently in use.

The channels can also be stored on the programmable memory buttons, refer to page 23.

Changing the list view

The list view changes every time the first symbol on the navigation bar is pressed.

Information on the channel is displayed.

Symbol	Meaning
	Channel name
	Artist
	Track

Selecting a category

- "Radio"
- "Satellite radio"
- "Category"
- Select the desired category.

Timeshift

Approx. one hour of the program being broadcast on the channel currently being listened to is stored in a buffer. Prerequisite: the signal must be available.

The stored audio track can be played with a delay following the live broadcast. When the buffer

is full, the older tracks are overwritten. The buffer is cleared when a new channel is selected.

Opening the timeshift function

- "Radio"
- "Satellite radio"
- "Replay - Time shift"

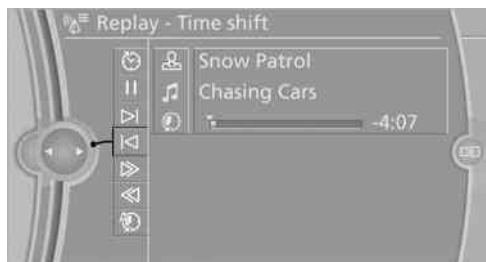

- The red arrow shows the current playback position.
- The time difference to the live broadcast is displayed next to the buffer bar.
- For live transmissions "live".

Timeshift menu

Symbol	Function
	Go to the live broadcast
	Playback/pause
	Next track
	Previous track
	Fast forward
	Reverse
	Automatic timeshift deactivated/activated

Automatic timeshift

When the function is activated, audio playback is stopped automatically in the event of:

- Incoming and outgoing telephone calls.
- Activation of the voice activation system.

▷ Muting.

The audio playback then continues with a time delay.

To activate:

1. "Radio"
2. "Satellite radio"
3. 🔄 "Replay - Time shift"
4. 🔄 "Automatic time shift"

To deactivate:

- 🔄 "Automatic time shift"

Storing favorites

Up to 30 favorites can be stored in the favorites list. Available favorites are artist, track, game, league, and team.

Storing the artist, track, or game

It is only possible to store favorites that are currently being broadcast. The channel information must be available.

1. "Radio"
2. "Satellite radio"
3. If necessary, open "All channels" or the desired category.
4. Select the desired channel.
5. Press the controller again.
6. Select the artist, track, or game.

Storing the league or team

Leagues or teams can be added to the favorites from a selection list.

1. "Radio"
2. "Satellite radio"
3. ⭐+ "Manage favorites"

4. "Add sports information"



5. Select the league.

6. Select "Add all teams" or the desired team.

Opening the favorites

If an activated favorite is played back, the following message appears for approx. 20 seconds "Favorite alert!".

☆☆ "Favorites"

Select the symbol while the message is shown.



The displayed favorite is played.

If there is no message, the system changes to the My Favorites category. All favorites currently being broadcast can be selected from a list.

Managing the favorites

Activating/deactivating the favorites

Favorites can be activated and deactivated globally and individually.

1. "Satellite radio"
2. ⭐+ "Manage favorites"
3. Select "Activate alert" or the desired favorites.

The setting is stored for the remote control currently in use.

Deleting favorites

1. "Satellite radio"
2. ☆+ "Manage favorites"
3. Highlight the desired favorite.
4. Open "Options".
5. "Delete entry"

Traffic Jump

Traffic and weather information for a selected region is broadcast every few minutes.

Selecting a region

1. "Radio"
2. "Satellite radio"
3. Open "Options".
4. "Set jump"
5. Select the desired region.

The region is stored for the remote control currently in use.

Activating/deactivating the jump

1. "Radio"
2. "Satellite radio"
3. ↻ "Jump to:"

Information for the selected region is broadcast as soon as it is available.

A new panel opens.

Canceling the Traffic Jump: "Cancel".

Symbol	Meaning
↻	Information will be broadcast shortly.
↻	Information is currently being broadcast.

Select one of the symbols to deactivate Traffic Jump.

Automatic update

About twice a year, Sirius performs an update of the channel names and positions. The update takes place automatically and may take several minutes.

Notes

- ▷ Reception may not be available in some situations, such as under certain environmental or topographic conditions. The satellite radio has no influence on this.
- ▷ The signal may not be available in tunnels or underground garages; next to tall buildings; or near trees, mountains or other powerful sources of radio interference.

Stored stations

General information

It is possible to store up to 40 stations.

Calling up a station

1. "Radio"
2. "Presets"
3. Select the desired station.

Storing a station

The station currently selected is stored.

1. "Radio"
2. "Presets"
3. "Store station"



4. Select the desired memory location.

The list of stored stations is stored for the remote control currently in use.

The stations can also be stored on the programmable memory buttons, refer to page [23](#).

Deleting a station

1. "Radio"
2. "Presets"
3. Select the desired station.
4. Open "Options".
5. "Delete entry"

CD/multimedia

Vehicle equipment

This chapter describes all series equipment as well as country-specific and special equipment offered for this model series. Therefore, it also describes equipment that may not be found in your vehicle, for instance due to the selected special equipment or the country version. This also applies to safety-related functions and systems.

Controls

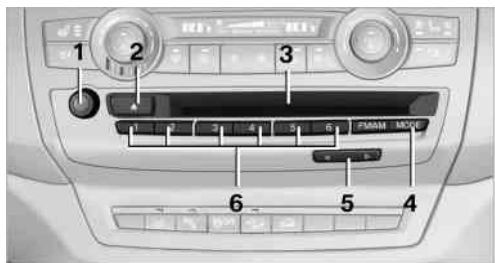

- 1 Volume, on/off
- 2 Eject CD/DVD
- 3 CD/DVD drive
- 4 Change the entertainment source
- 5 Change station/track
- 6 Programmable memory buttons

Sound output

Switching on/off

When the ignition is switched off: press ON/OFF button on the radio.

Muting

When the ignition is switched on or the engine is running: press the ON/OFF button on the radio.

CD/DVD

Playback

Loading the CD/DVD player

Insert the CD/DVD with the printed side up. Playback begins automatically.

Reading can take a few minutes with compressed audio files.

Starting playback

A CD/DVD is located in the CD/DVD player or in the CD/DVD changer.

1. "CD/Multimedia"
2. "CD/DVD"
3. Select the desired CD or DVD.

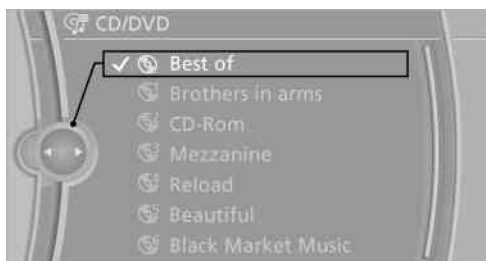

Symbol	Meaning
	CD/DVD player
	CD/DVD changer
	CD/DVD player, rear

Playable formats

- ▶ DVD: DVD-ROM, DVD-R, DVD+R, DVD-RW, DVD+RW, DVD-R DL, DVD+R DL, DVD audio (video part only), DVD video.
- ▶ CD: CD-ROM, CD-R, CD-RW, CD-DA.

- ▶ Compressed audio files: MP3, WMA, AAC, M4A.

Audio playback

Selecting the track using the button

 Press the button for the appropriate direction as often as necessary until the desired track is played back.

Selecting the track using the iDrive

Audio CDs



Select the desired track to begin playback.

CDs/DVDs with compressed audio files

Depending on the data, some letters and numbers of the CD/DVD may not be displayed correctly.

1. Select the directory if necessary.
To change to a higher level directory: move the controller to the left.

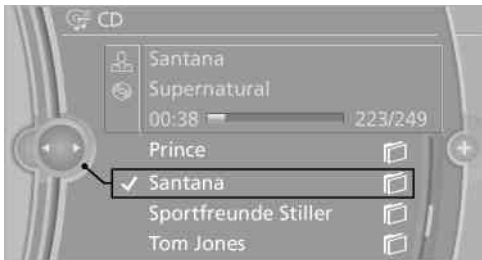

2. Select the desired track to begin playback.



Displaying information on the track

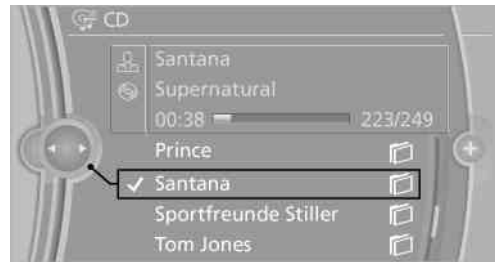

If information about a track has been stored, it is displayed automatically:

- ▶ Interpret.
- ▶ Album track.
- ▶ Number of tracks on the CD/DVD.
- ▶ File name of track.

Random playback

1. "CD/Multimedia"
2. "CD/DVD"
3. Select the desired CD or DVD.

- Open "Options".
- "Random"

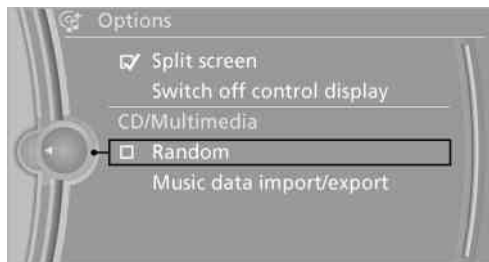

CDs/DVDs with compressed audio files: all tracks within the selected directory are played in random order.

Random mode is switched off when the audio source is changed and the ignition is switched off.

Fast forward/reverse



Press and hold the button.

Video playback

Country codes

Only DVDs with the code of the home region can be played back; also refer to the information on the DVD.

Code	Region
1	USA, Canada
2	Japan, Europe, Middle East, South Africa
3	Southeast Asia
4	Australia, Central and South America, New Zealand
5	Northwest Asia, North Africa
6	China
0	All regions

Playback

The video image is displayed on the Control Display up to a speed of approx. 2 mph/3 km/h; in some countries, it is only displayed while the parking brake is set or the automatic transmission is in position P.

DVD video

- "CD/Multimedia"
- "CD/DVD"
- Select a DVD with video content.
-  "DVD menu"



- Start the DVD via the DVD menu.





VCD/SVCD

- "CD/Multimedia"
- "CD/DVD"
- Select a CD with video content.
-  "Select track"
- Select the desired track.

Video menu

To open the video menu: turn the controller during playback.

Press the controller when "Back" is displayed.

Symbol	Function
	Open DVD menu
	Starting playback
	Pause
	Stop

Symbol	Function
▷	Next chapter
◁	Previous chapter
⏩	Fast forward
◀◀	Reverse

In fast forward/reverse: the speed increases every time the controller is pressed. To stop, start playback.

DVD menu

1. If necessary, turn the controller to open the video menu.
2. **DVD** "DVD menu"
The DVD menu is displayed. The display depends on the contents of the DVD.
3. To select menu items: move the controller and press it.

To change to the video menu: turn the controller and press it.

DVD/VCD settings

For some DVDs, settings can only be made via the DVD menu; refer also to the information on the DVD.

Selecting the language

The languages that are available depend on the DVD.

1. Turn the controller during playback.
2. Open "Options".

3. "Audio/language"



4. Select the desired language.

Selecting the subtitles

The subtitles that are available depend on the DVD.

1. Turn the controller during playback.
2. Open "Options".
3. "Subtitles"
4. Select the desired language or "Do not display subtitles".

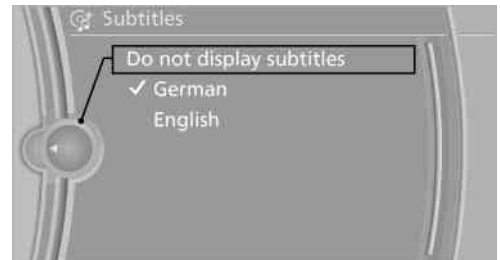

Setting the brightness, contrast and color

1. Turn the controller during playback.
2. Open "Options".
3. "Display settings"

4. "Brightness", "Contrast" or "Color"

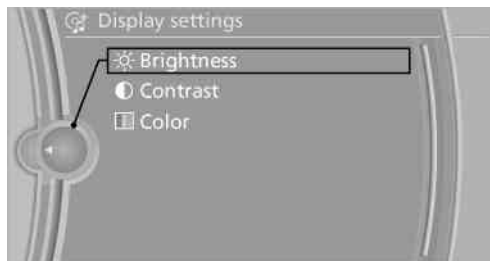

- Turn the controller until the desired setting is reached and press the controller.

Selecting the zoom

Display the video image on the entire screen.

- Turn the controller during playback.
- Open "Options".
- "Additional options"
- "Zoom mode"

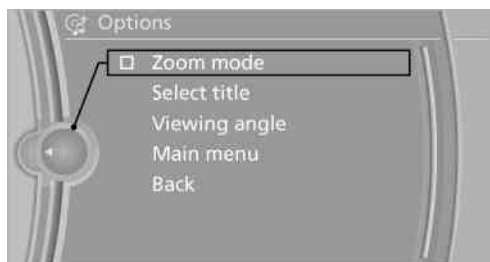

Selecting a track

DVD video:

- Turn the controller when the DVD menu is displayed.
- Open "Options".
- "Additional options"
- "Select title"
- Select the desired track.

VCD/SVCD:

-  "Select track"
- Select the desired track.

Selecting the camera angle

The availability of a different camera angle depends on the DVD and the current DVD track.

- Turn the controller during playback.
- Open "Options".
- "Additional options"
- "Viewing angle"
- Select the desired camera angle.

Opening the main menu, back

These functions are not contained on every DVD. Therefore, they may not be available for use.

CD/DVD changer

In the glove compartment



The BMW CD/DVD changer for six CDs/DVDs is located in the glove compartment.

Controls and displays

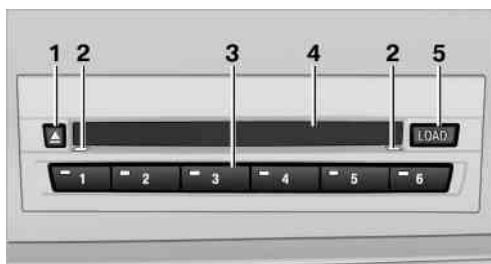

- Empty CD/DVD compartments
- LEDs on the CD/DVD slot

- 3 Buttons for CD/DVD compartments
- 4 CD/DVD slot
- 5 Load CD/DVD compartments

Loading the CD/DVD compartments individually

1.  Press the button.
The LED on the first empty compartment flashes.
2. Select another compartment if necessary.
3. Wait for the LEDs on the DVD slot to flash.
4. Insert a single CD or DVD in the middle.
The CD/DVD is drawn in automatically and placed into the selected compartment.

Sliding in CDs/DVDs

Do not insert the CD/DVD until the LEDs on the DVD slot are flashing; otherwise, the CD/DVD or the CD/DVD changer could be damaged. Do not continue to push on the CD/DVD; this may cause it to jam and prevent it from being able to eject again. ◀

Loading all empty CD/DVD compartments

1.  Press the button for a longer period.
The LEDs on the empty CD compartments flash.
2. Wait for the LEDs on the DVD slot to begin flashing and then insert each CD or DVD into the center of the slot.
The CDs/DVDs are drawn in automatically and placed into the empty compartments.

Sliding in CDs/DVDs

Do not insert the CD/DVD until the LEDs on the DVD slot are flashing; otherwise, the CD/DVD or the CD/DVD changer could be damaged.

Do not continue to push on the CD/DVD; this may cause it to jam and prevent it from being able to eject again. ◀

After they are inserted, it may take several minutes for the CDs/DVDs to be read in.

Removing a single CD/DVD

1.  Press the button.
2. Select the CD/DVD compartment.
The CD/DVD is partially ejected.
3. Remove the CD/DVD.

Removing all CDs/DVDs

1.  Press the button for a longer period.
2. Remove the CDs/DVDs.

Malfunctions

If all LEDs on the CD/DVD changer flash rapidly, the system is malfunctioning.

To eliminate the malfunction:

1. Press one of the buttons:



The CD/DVD last inserted is ejected.

2. Remove the CD/DVD.

If the LEDs stop flashing rapidly, the CD/DVD changer is functional again.

Audio playback

The audio track of a DVD can be played back even if video playback is not possible in the vehicle.

Only the main film without the previews or extras can be played back.

Starting playback

A DVD is located in the DVD changer.

1. "CD/Multimedia"
2. "CD/DVD"
3. Select the desired DVD.

Selecting a chapter using the button



Press the button repeatedly until the desired chapter is played.

Selecting a chapter using iDrive

1. "CD/Multimedia"
2. "CD/DVD"
3. Select the desired DVD.
4. Select the desired chapter.

Fast forward/reverse



Press and hold the button.

Selecting the language

The languages that are available depend on the DVD.

1. "CD/Multimedia"
2. "CD/DVD"
3. Select the desired DVD.
4. Open "Options".
5. "Audio/language"
6. Select the desired language.

Notes

CD/DVD player and changer



Do not remove the cover
BMW CD/DVD players and changers are officially designated Class 1 laser products. Do not operate if the cover is damaged; otherwise, severe eye damage can result. ◀

CDs and DVDs



Use of CDs/DVDs

- ▶ Do not use self-recorded CDs/DVDs with labels applied, as these can become detached during playback due to heat buildup and can cause irreparable damage to the device.
- ▶ Only use round CDs/DVDs with a standard diameter of 4.7 in/12 cm and do not play CDs/DVDs with an adapter, e.g., single CDs; otherwise, the CDs or the adapter may jam and no longer eject.
- ▶ Do not use combined CDs/DVDs, e.g., DVD Plus, as the CDs/DVDs can jam and will no longer eject. ◀

General malfunctions

- ▶ CD/DVD changers and players have been optimized for performance in vehicles. In some instances they may be more sensitive to faulty CDs/DVDs than stationary devices would be.
- ▶ If a CD/DVD cannot be played, first check whether it has been inserted correctly.

Humidity

High levels of humidity can lead to condensation on the CD/DVD or the laser's scan lens, and temporarily prevent playback.

Malfunctions involving individual CDs/DVDs

If malfunctions occur only with particular CDs/DVDs, this can be due to one of the following causes:

Self-recorded CDs/DVDs

- ▶ Possible reasons for malfunctions with self-recorded CDs/DVDs are inconsistent data creation or recording processes, or poor quality or old age of the blank CD/DVD.
- ▶ Only label CDs/DVDs on the upper side with a pen intended for this purpose.

Damage

- ▶ Avoid fingerprints, dust, scratches and moisture.
- ▶ Store CDs/DVDs in a sleeve.
- ▶ Do not subject CDs/DVDs to temperatures over 122 °F/50 °C, high humidity or direct sunlight.

CDs/DVDs with copy protection

CDs/DVDs are often provided with a copy protection feature by the manufacturer. This can mean that some CDs/DVDs cannot be played or can only be played to a limited extent.

MACROVISION

This product contains copyrighted technology that is based on multiple registered US patents and the intellectual property of the Macrovision Corporation and other manufacturers. The use of this copy protection must be approved by Macrovision. Media protected by this product - unless otherwise agreed with Macrovision - may only be used for private purposes. Copying of this technology is prohibited.

DTS Digital Surround™



Manufactured under license under U.S. Patent Numbers: 5,451,942; 5,956,674; 5,974,380; 5,978,762; 6,487,535 & and other patents granted and registered in the USA and worldwide. DTS and the logo are registered trademarks & DTS Digital Surround and the DTS logos are trademarks of DTS Inc. © DTS, Inc. All rights reserved.

Music collection

Storing music

General information

Music tracks from CDs/DVDs and USB devices can be stored in the music collection on a hard disc in the vehicle and played from there.

- ▶ Audio CD: tracks are converted into a compressed audio format. If available, information on the album, such as the artist, is stored as well.
- ▶ CD/DVD or USB device with compressed audio files: the entire content of the CD/DVD or the USB device is stored in the vehicle as an album. The WMA, MP3, M4A, and AAC formats are stored. Individual tracks and directories can be deleted later. Deleting a track and directory, refer to page 205.
Tracks with DRM copy protection can be stored but cannot be played back.



Backing up music data

Regularly back up the music data; otherwise, it could be lost if there is a fault on the hard disc. ◀



Music recognition technology and related data are provided by Gracenote®. Gracenote is the industry standard in music recognition technology and related content delivery. For more information, please visit www.gracenote.com.

CD and music-related data from Gracenote, Inc., copyright © 2000-2011 Gracenote. Gracenote Software, copyright © 2000-2011 Gracenote. This product and service may practice one or more of the following U.S. Patents: #5,987,525; #6,061,680; #6,154,773; #6,161,132; #6,230,192; #6,230,207; #6,240,459; #6,330,593, and other patents issued or pending. Some services supplied under license from Open Globe, Inc. for U.S. Patent: #6,304,523.

Storing from a CD/DVD

1. Insert a CD or DVD into the CD/DVD player.
2. "CD/Multimedia"
3. "CD/DVD"

4.  Select the symbol for the CD/DVD player.
5. "Store in vehicle"



The music collection is displayed and the first track of the CD/DVD is played back. During the storage process, the tracks are played in sequence.

Observe the following during the storage process:

Do not switch to the CD/DVD player and do not remove the CD/DVD from the CD/DVD player as this will interrupt the storage process. You can switch to the other audio sources without interrupting the storage process. Tracks from the current CD/DVD that have already been stored can be called up.

Interrupting storage

1. "CD/Multimedia"
2. "CD/DVD"
3. "Storing..."



4. "Cancel storing"

The storage process is interrupted and can be continued at any time.

Continuing the storage process

1. "CD/Multimedia"
2. "CD/DVD"
3.  Select the symbol for the CD/DVD player.
4. "Continue storing"

Storage of the CD/DVD continues at the beginning of the track at which storage was interrupted.

Album information

During storage, information such as the name of the artist is stored with the track, if this information is available in the vehicle database or on the CD.

To update the database, contact your service center.

Storing from a USB device

To store music, a suitable device must be connected to the USB interface in the glove compartment.

- ▶ Suitable devices: USB mass storage devices, such as USB flash drives or MP3 players with a USB interface.
- ▶ Unsuitable devices: USB hard drives, USB hubs, USB memory card readers with multiple inserts, Apple iPod/iPhone. Music from the Apple iPod/iPhone can be played via the USB audio interface in the center armrest.
- ▶ File systems: standard file systems for USB devices are supported. The FAT 32 format is recommended.

1. Connect the USB device to the USB interface in the glove compartment, refer to page 143.
2. "CD/Multimedia"
3. "Music collection"
4. Open "Options".

5. "Music data import/export"
6. "Import music (USB)"



Playing music

Music search

All tracks for which additional information has been stored can be accessed by the music search. Tracks without additional information can be called up via the corresponding album, refer to page 204.

1. "CD/Multimedia"
2. "Music collection"
3. "Music search"



4. Select the desired category.



5. Select the desired entry.

- ▶ Select "A-Z search", refer to page 23, and input the desired entry.
- ▶ Select the desired entry from the list.

6. Select other categories if you wish.

The tracks found are listed in alphabetical order.

Not all categories need to be selected. For example, to search for all tracks by a certain artist, call up that artist only. All of the tracks by that artist are then displayed.

7. "Start play"

The list of tracks is repeated automatically.

Restarting the music search

"New search"

Music search by voice

Instructions for voice activation system, refer to page 25.

1.  Press the button on the steering wheel.
2. ›Music search
3. Open the desired category, e. g., ›Select artist.
4. Say the desired entry in the list.
5. Select other categories if you wish.

To select a track directly: ›Title ...

Say the voice command and the name of the desired track in a single command.

Current playback

The list of tracks that was generated last by the music search, or the album that was selected last.

1. "CD/Multimedia"
2. "Music collection"

3. "Current playback"



4. Select the desired track, if necessary.



Top 50

The 50 most frequently played tracks.

1. "CD/Multimedia"
2. "Music collection"
3. "Top 50"
4. Select the desired track, if necessary.

Albums

All stored albums, listed in order of their storage dates.

Symbol	Format
	Audio CD
	Compressed audio files

1. "CD/Multimedia"
2. "Music collection"
3. Select the desired album.

Depending on the album, the tracks or the subdirectories of the album are displayed.

The first track is played automatically, if possible.



4. Change directories if needed to select tracks.

To go up a level in the directory: move the controller to the left.

Random playback

All tracks of the selection are played back in random order.

1. "CD/Multimedia"
2. "Music collection"
3. Open "Options".
4. "Random"

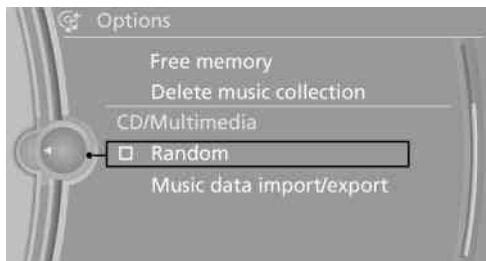

Managing music

Albums

Renaming an album

The name of the album, if available, is automatically entered when the album is stored. If the

name is not available, it can be changed later if desired.

1. "CD/Multimedia"
2. "Music collection"
3. Highlight the desired album.
4. Open "Options".
5. "Rename album"



6. Select the letters individually.

Deleting an album

An album cannot be deleted while a track from that album is being played.

1. "CD/Multimedia"
2. "Music collection"
3. Highlight the desired album.
4. Open "Options".
5. "Delete album"

Deleting a track and directory

A track cannot be deleted while it is being played.

A directory cannot be deleted while a track from that directory is being played.

1. "CD/Multimedia"
2. "Music collection"
3. Highlight the directory or track.
4. Open "Options".
5. "Delete folder" or "Delete track"

Free memory capacity

Display the free memory capacity in the music collection.

1. "CD/Multimedia"
2. "Music collection"
3. Open "Options".
4. "Free memory"

Music collection

Backing up the music collection

The entire music collection can be stored on a USB device. Make sure there is enough free memory capacity on the USB device.

Depending on the number of tracks, backing up the music collection may take several hours. Therefore, it is best to perform the backup during a long trip.

1. Starting the engine.
2. Connect the USB device to the USB interface in the glove compartment, refer to page 143.
3. "CD/Multimedia"
4. "Music collection"
5. Open "Options".

6. "Music data import/export"

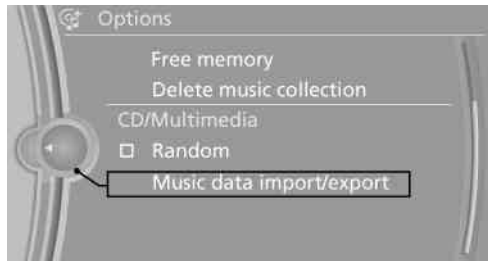

7. "Backup music on USB"



Storing the music collection in the vehicle

When storing from the USB device, the existing music collection in the vehicle is replaced.

1. "CD/Multimedia"
2. "Music collection"
3. Open "Options".
4. "Music data import/export"
5. "Restore music from USB"

Deleting the music collection

1. "CD/Multimedia"
2. "Music collection"
3. Open "Options".
4. "Delete music collection"

External devices

At a glance

Symbol	Meaning
	AUX-IN port
	USB audio interface
	Mobile phone audio interface
	Bluetooth audio

AUX-IN port

At a glance

- ▷ For connecting audio devices, e.g., MP3 player. The sound is output on the vehicle loudspeakers.
- ▷ Recommendation: use medium tone and volume settings on the audio device. The tone depends on the quality of the audio files.

Connecting



The AUX-IN port is in the center armrest.

Connect the headphone connector or line-out connector of the device to the AUX-IN port.

Playback

1. Connect the audio device, switch it on and select a track on the audio device.
2. "CD/Multimedia"

3. If necessary, "External devices"
4.  "AUX front"

Sound is output on the vehicle loudspeakers.

Volume

The volume of the sound output is dependent on the audio device. If this volume differs markedly from the volume of the other audio sources, it is advisable to adjust the volumes.

Adjusting the volume

1. "CD/Multimedia"
2. If necessary "External devices"
3.  "AUX front"
4. "Volume"

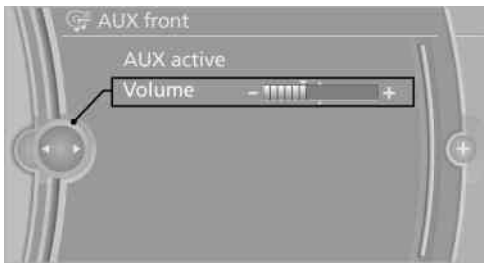

5. Turn the controller until the desired volume is set and press the controller.

USB audio interface/mobile phone audio interface

At a glance

It is possible to connect external audio devices. They can be operated via iDrive. The sound is output on the vehicle loudspeakers.

Connectors for external devices

- Connection via USB audio interface: Apple iPod/iPhone, USB devices, e.g., MP3 players, USB flash drives, or mobile phones that are supported by the USB audio interface.
- Connection via snap-in adapter, refer to page 240, when equipped with extended

connectivity of the music player in the mobile phone: Apple iPhone or mobile phones.

Playback is only possible if no audio device is connected to the analog AUX-IN port.

Due to the large number of different audio devices available on the market, it cannot be ensured that every audio device/mobile phone is operable on the vehicle.

Ask your service center about suitable audio devices/mobile phones.

Audio files

Standard audio files can be played back:

- MP3.
- WMA.
- WAV (PCM).
- AAC, M4A.
- Playback lists: M3U, WPL, PLS.

File system

Standard file systems for USB devices are supported. The FAT 32 format is recommended.

Connecting

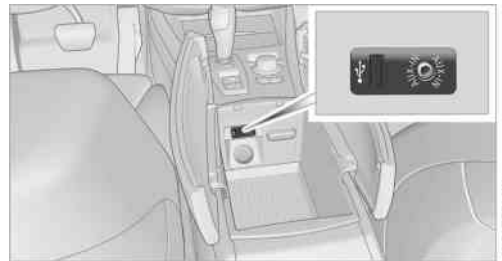

The USB audio interface is in the center armrest.

Connection of Apple iPod/iPhone via USB audio interface

Connect using a flexible adapter cable.

Connect the Apple iPod/iPhone to the USB interface.

The Apple iPod/iPhone menu structure is supported by the USB audio interface.

Connection of a USB device via the USB audio interface

Connect using a flexible adapter cable to protect the USB audio interface and the USB device against physical damage.

Connect the USB device to the USB interface.

After connecting for the first time

Information on all music tracks, e.g. artist or type of music, as well as playback lists are transmitted into the vehicle. This may take some time, depending on the USB device and the number of tracks.

During transmission, the tracks can be called up via the file directory.



Number of tracks

Information from up to four USB devices or for approx. 36,000 tracks can be stored in the vehicle. If a fifth device is connected or if more than 36,000 tracks are stored, information on existing tracks may be deleted.

Copy protection

Music tracks with integrated Digital Rights Management (DRM) cannot be played.

Playback

1. "CD/Multimedia"
2. "External devices"
3. Select the  or  symbol.



The playback starts with the first track.

The CD cover belonging to the track may appear on the Control Display after several seconds.



Track search

Selection is possible via:

- ▷ Playback lists.
- ▷ Information: type of music, artist, and, if available, composer, album, track.
- ▷ Additionally for USB devices: file directory, composer.

Tracks are displayed if they have been saved in the Latin alphabet.

Starting the track search

1. "CD/Multimedia"
2. "External devices"
3. Select the  or  symbol.
4.  "Search"
5. Select the desired category, e.g., "Genre" or "Artist".

All entries are displayed in a list.

- ▷ Open "A-Z search" and input the desired entry. When a letter is entered, the results are filtered using this letter as the first letter. If multiple letters are entered, all results that contain that sequence are displayed.
- ▷ Select the desired entry from the list.

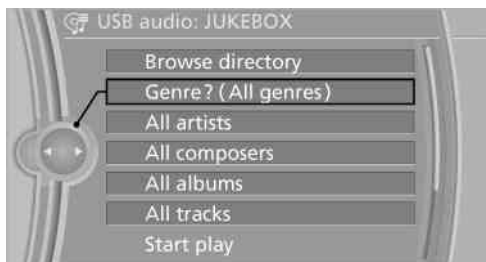

6. Select other categories if you wish.

Not all categories need to be selected. For example, if all of the tracks by a certain artist are to be displayed, call up that artist only. All of the tracks by that artist are then displayed.



7. "Start play"

Restarting a track search

"New search"



Playback lists

Calling up playback lists.

1. "CD/Multimedia"
2. "External devices"
3. Select the  or  symbol.
4.  "Playlists"

Current playback

List of tracks currently being played.

1. "CD/Multimedia"
2. "External devices"
3. Select the  or  symbol.
4.  "Current playback"

Random playback

The current list of tracks is played back in random order.

1. "CD/Multimedia"
2. "External devices"
3. Open "Options".
4. "Random"

Fast forward/reverse



Press and hold the button.

Video playback



At a glance

Video playback via snap-in adapter is possible. They can be operated via iDrive. The sound is output on the vehicle loudspeakers.



Playback

The video image is displayed on the Control Display up to a speed of approx. 2 mph/3 km/h; in some countries, it is only displayed if the parking

brake is set or if the automatic transmission is in position P.

1. "CD/Multimedia"
2. "External devices"
3.  Select the symbol.
4.  "Video"
5. Select the directory if necessary.
To go up a level in the directory: move the controller to the left.
6. Select the desired video file to begin playback.

Video menu

Symbol	Function
	Next video file
	Previous video file
	Double-click on an icon to play back previous video file.

Notes

Do not expose the audio device to extreme environmental conditions, such as very high temperatures; refer to the audio device operating instructions.

Depending on the configuration of the audio files, e.g., bit rates greater than 256 kbit/s, the files may not play back correctly in each case.

Information on connection

- ▶ The connected audio device is supplied with a max. power of 500 mA if supported by the device. Therefore, do not additionally connect the device to a socket in the vehicle; otherwise, playback may be compromised.
- ▶ Do not use force when plugging the connector into the USB interface.
- ▶ Do not connect devices such as fans or lamps to the USB audio interface.
- ▶ Do not connect USB hard drives.

- ▷ Do not use the USB audio interface to re-charge external devices.

Bluetooth audio

At a glance

- ▷ Music files on external devices such as audio devices or mobile phones can be played back via Bluetooth.
Use of a mobile phone as an audio source, refer to page 232.
- ▷ Bluetooth® is a registered trademark of Bluetooth® SIG, Inc.
- ▷ The sound is output on the vehicle loudspeakers.
- ▷ The volume of the sound output is dependent on the device. If necessary, adjust the volume on the device.
- ▷ Up to four external devices can be paired with the vehicle.

Requirements

- ▷ The device is suitable. Information at www.bmwusa.com/bluetooth.
- ▷ The device is ready for operation.
- ▷ The ignition is switched on.
- ▷ Bluetooth is activated on the vehicle, refer to page 231, and on the device.
- ▷ Bluetooth presettings must be made on the device, such as for a connection without confirmation or visibility; refer to the device operating instructions.
- ▷ A number with at least four and a maximum of 16 digits is defined as the Bluetooth passkey. It is only required once for pairing.

Pairing and connecting



Pairing a device

To avoid becoming distracted and posing an unnecessary hazard both to your own vehicle's occupants and to other road users, only pair the device while the vehicle is stationary. ◀

1. "CD/Multimedia"
2. "Bluetooth® (audio)"
3. If necessary, "Bluetooth® audio".
4. "Add new phone"

The Bluetooth name of the vehicle is displayed.



5. Perform additional steps on the device, refer to the device operating instructions: for instance, search for or connect the Bluetooth device or a new device.

The Bluetooth name of the vehicle appears on the device display.

6. Select the Bluetooth name of the vehicle on the device display.

You are prompted by the iDrive or device to enter the same Bluetooth passkey.

7. Enter the passkey and confirm.

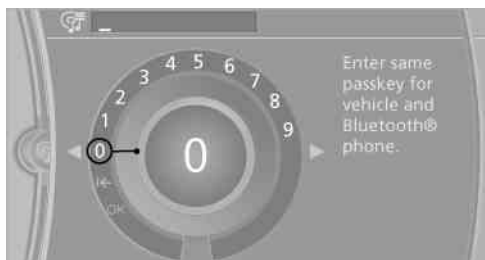

8. Select the desired functions with which the device is to be connected, for instance "Audio".
9. "OK"



If pairing was successful, the device is displayed as connected.

White symbol  : the device is active as an audio source.

If pairing was unsuccessful: What to do if..., refer to page 212.

Connecting a specific device

A device that has already been paired can be connected as an active audio source.

Connecting is not possible when data is exchanged via a mobile phone connected via Bluetooth.

Requirements

If necessary, activate the audio connection of the desired device from the list of paired devices.

1. "CD/Multimedia"
2. "Bluetooth® (audio)"
3. If necessary, "Bluetooth® audio".
4. Select the desired device from the list of paired devices.
5. Open "Options".
6. "Configure phone"
7. Activate "Audio".
8. "OK"

Connecting the device

1. "CD/Multimedia"
2. "Bluetooth® (audio)"
3. If necessary, "Bluetooth® audio".
4. Select the desired device from the list of paired devices.



White symbol  : the device is active as an audio source.

Playback

General information

- ▶ The display of music track information depends on the device.
- ▶ Operation can take place on the device or iDrive.
- ▶ Playback is interrupted when data is exchanged via a mobile phone connected via Bluetooth.

Starting playback

1. Connect the device.
2. "CD/Multimedia"
3. "External devices"

4.  Select the symbol.



5. Select the desired track from the list, if necessary.

Playback menu

Depending on the particular device, some of the functions may not be available.

Symbol	Function
	Next track Fast forward: press and hold the symbol.
	Previous music track Reverse: press and hold the symbol.

Disconnecting the audio connection

1. "CD/Multimedia"
2. "Bluetooth® (audio)"
3. Highlight the desired device.
4. Open "Options".
5. "Configure phone"
6. "Audio"
7. "OK"

Unpairing a device

1. "CD/Multimedia"
2. "Bluetooth® (audio)"
3. If necessary, "Bluetooth® audio".
4. Highlight the device that is to be unpaired.

5. Open "Options".
6. "Remove phone from list"

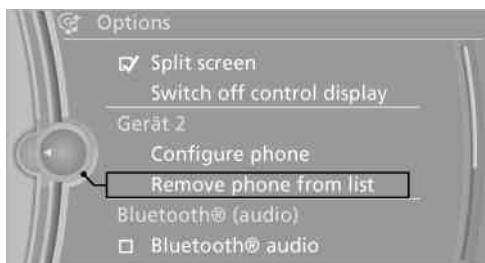

What to do if...

Information on suitable devices can be found at www.bmwusa.com/bluetooth.

Suitable mobile phones, refer to page 230.

The device is not supported by the vehicle.

- ▶ Perform a software update, refer to page 213, if needed.

The device could not be paired or connected.

- ▶ Do the Bluetooth passkeys on the device and the vehicle match? Enter the same passkey on the device and via iDrive.
- ▶ Did it take longer than 30 seconds to enter the passkey? Repeat the pairing procedure.
- ▶ Are too many Bluetooth devices connected to the device or vehicle? Delete connections with other devices if necessary.
- ▶ Is the mobile phone in power-save mode or does it have only a limited remaining battery life? Charge the mobile phone in the snap-in adapter or via a charging cable.
- ▶ Depending on the mobile phone, it is possible that only one device can be connected to the vehicle. Unpair the connected device from the vehicle and pair and connect only one device.
- ▶ The device no longer reacts? Switch the device off and on again.
- ▶ Repeat the pairing procedure.

Music cannot be played back.

- ▶ Start the program for playing back music data on the device and select a track on the device if necessary.

- ▶ Switch the radio on and off again.

Music files can only be played back softly.

- ▶ Adjust the volume settings on the device.

Playback is disturbed when buttons are pressed or by other messages on the device.

- ▶ Switch off the button tones and other signal tones on the device.

Playback is interrupted by a telephone call or traffic bulletin and is not resumed automatically.

- ▶ Switch the radio on and off again.

Playback is not possible if the mobile phone is connected both via Bluetooth Audio and via the extended connectivity of the music player in the mobile phone.

- ▶ Disconnect one of the two connections; for example, disconnect the audio connection, refer to page 212, and restart playback.

If all points in this list have been checked and the required function is still not available, please contact the hotline or service center.

Software Update

The vehicle supports various external devices depending on the current software version. With a software update, the vehicle can support new cell phones or new external device, for example.

- ▶ USB.

Software updates and related current information is available at www.bmw.com/update.

Displaying the current version

The currently installed software is displayed.

1. "Settings"
2. "Software update"
3. "Show current version"

Select desired version to display additional information.

Updating software via USB

The software may only be updated when the vehicle is stationary.

1. Store the file for the software-update in the main director of a USB flash drive.
2. Insert the USB flash drive into the USB interface of the USB audio interface in the center armrest. An update via the USB interface in the glove compartment is not possible.
3. "Settings"
4. "Software update"
5. "Update software"

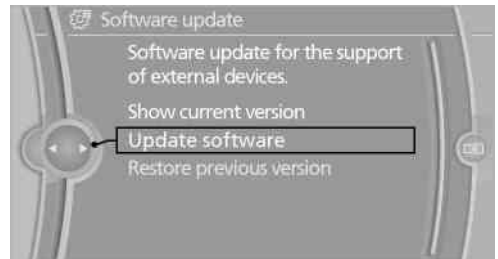

6. If necessary, "USB".
7. "Start update"
8. "OK"

All listed software updates are installed.

Restoring the previous version

The software version prior to the last software update can be restored.

The previous version can only be restored when the vehicle is stationary.

1. "Settings"
2. "Software update"
3. "Restore previous version"
4. "OK" Double-click.

All listed software updates are removed.

Note

While the software is being updated or a previous version is being restored, BMW Assist, Office functions, and the connected devices are temporarily unavailable. Wait several minutes for the functions to become available again.

DVD system in rear

Vehicle equipment

This chapter describes all series equipment as well as country-specific and special equipment offered for this model series. Therefore, it also describes equipment that may not be found in your vehicle, for instance due to the selected special equipment or the country version. This also applies to safety-related functions and systems.

General information

With the DVD system in the rear you can play CDs and DVDs with audio, video and image data. The DVD system can also play data from attached external audio and video devices. Audio output is possible both via headphones and via the vehicle speakers.

You can control the DVD system using the buttons on the CD-/DVD player or using the remote control.

Some functions are operated using the remote control.

Enabling DVD system

The DVD system can be enabled via iDrive.

1. "Settings"
2. "Allow rear control"
3. "Rear DVD system active"



Controls

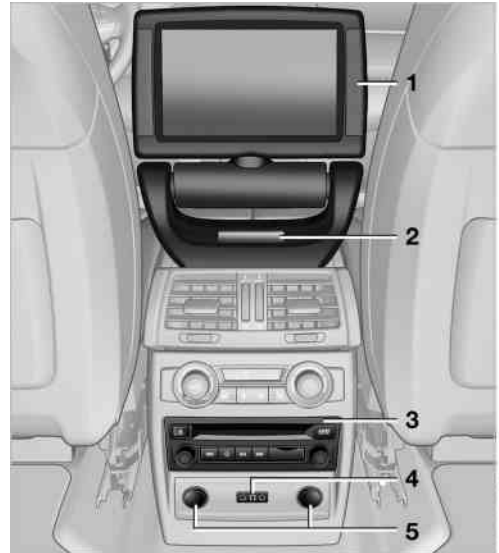

- 1 Display screen
- 2 Infrared interface for headphones
- 3 CD/DVD player
- 4 Headphone connection: jack plug
- 5 12 V sockets [139](#)

Folding in display screen

When using the ski bag or when transporting bulky pieces of luggage, the display screen should be folded in, as otherwise it may be damaged.

 Note when the display screen is folded down

When the screen is folded down, do not open the lid of the center armrest or rest your arm on the screen; otherwise, you may damage the screen. ◀



1. Turn the display screen, arrow 1
The display screen switches off.
2. Fold down the display screen, arrow 2.
The display screen is folded out in the reverse order.

CD/DVD player

Controls

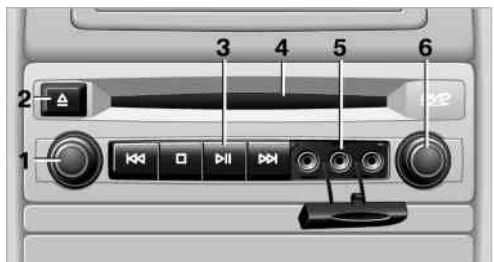

- 1 Press: switch the DVD system on/off
Turn: left headphone volume and vehicle volume
- 2 Eject CD/DVD
- 3 Beginning of track
 Stop
 Playback, pause, freeze frame
 Next track
- 4 CD/DVD slot
- 5 Connectors for external device: cinch sockets
- 6 Press: switch the DVD system on/off

Turn: right headphone volume and vehicle volume

Connecting headphones

You can connect headphones with a jack plug or operate them using the infrared interface.

To enable optimal use of the infrared interface, use infrared headphones that comply with the IEC 61603-2 standard.

Compatible infrared headphones and information about supported headphones are available at your service center.

When using infrared headphones, it is important not to interrupt the infrared connection between the headphones and the infrared interface. This means that no obstacle should come between the two and that the cover of the infrared interface should not be covered or scratched. Unfavorable lighting conditions such as glare from outside can interfere with reception.

Remote control

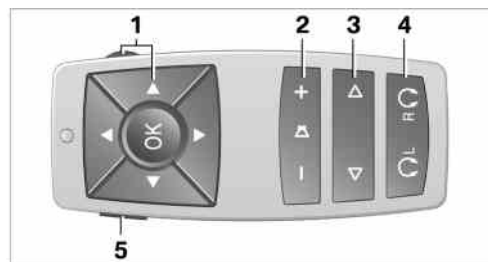

- 1 Menu navigation
- 2 Volume for headphones with jack plug
- 3 Changing track or chapter during CD-, DVD- or AUX playback, fast forward/rewind
- 4 Headphones right/left
- 5 Open start menu for DVD system

Menu navigation

You can use the thumbwheel and buttons 1 to navigate through the menus.

- ▷ Turn the thumbwheel: select a menu item.
- ▷ Press the arrow buttons: change between fields.
- ▷ **OK** Press the button: activate the menu item.

Changing batteries



1. Press the detent and remove the cover.
2. Change the batteries. The type and installation position are marked on the bottom of the battery compartment.
3. Close the cover.



Take the used battery to a recycling center or to your service center.

Setting the language of the DVD system

1. Select a CD/DVD track.
2. **OK** Press the button.
3. Select "Tone".
4. **OK** Press the button.
5. Switch to the top window.
6. Select "Language".
7. **OK** Press the button.
8. Select the desired language.
9. **OK** Press the button.

Sound output via speakers

In addition to the headphones, you can also play the sound via the vehicle speakers.

1. "CD/Multimedia"
2. "External devices"
3. "AUX rear"
4. "Volume"
5. Turn the controller until the desired volume is set and press the controller.

Switching DVD system on/off

Press the button on the CD-/DVD player or under the desired screen.

The DVD system switches on automatically when a CD or DVD is inserted.

Playing CD/DVD

Use the following menu items to access data from a CD/DVD:

- ▷ Video data via "DVD"
- ▷ Audio data via "CD"
- ▷ Images "Photo"



Playing videos from CDs/DVDs

Country codes of DVDs

Your DVD player only plays DVDs with the coding of your home region, e.g., Europe=2. The country codes supported by your DVD are contained in the information on your DVD.

An overview of the coding zones:

Code	Region
1	USA, Canada
2	Japan, Europe, Middle East, South Africa
3	Southeast Asia
4	Australia, Central and South America, New Zealand
5	Northwest Asia, North Africa
6	China

DVDs with the code 0 can be played on all devices.

Starting playback

1. Push the CD/DVD into the drive with the labeled side facing upward. The CD/DVD is automatically pulled in.
 - ▶ Playback begins automatically after a few seconds.
 - ▶ Otherwise: select "DVD".
2. If the DVD control or the DVD-specific menu is displayed when a DVD is inserted, use the remote control buttons for menu navigation to select the desired option.

Or:

 Press the button on the CD/DVD player.

You can control the playback with the buttons on the CD/DVD player or the DVD control.

Video CDs (VCDs) and Super Video CDs (SVCDs) can only be played if they do not have a DVD-specific menu.

Eject CD/DVD

 Press the button on the CD/DVD player. The DVD emerges slightly from the drive.



DVD control

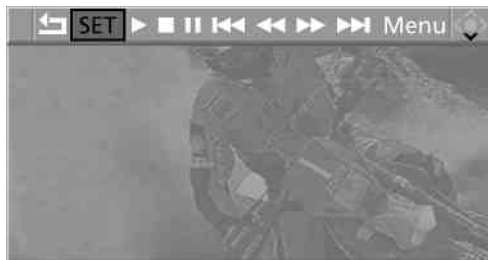

With the DVD control, you can select the title and chapter, open the DVD-specific menu, and operate functions such as Language, Fast forward and Reverse or Freeze frame.

A DVD can briefly deactivate functions of the DVD control, under certain circumstances while the entire DVD is being played. It is not possible to operate the DVD control under these circumstances. In this case, try to make the selection using the DVD-specific menu.

1.  Press the button on the remote control during playback.



2. Press the   buttons on the remote control or turn the thumbwheel to select the desired function.
3.  Press the button.

Symbol	Function
	Exit DVD control
"SET"	Settings for playing DVDs.
	Start playback.
	Stop playback.

Symbol	Function
⏸	Activate and deactivate freeze frame.
⏮ ⏭	Skip a chapter.
⏪ ⏩	Fast forward/reverse.
"Menu"	Open the DVD-specific menu.



The DVD control disappears again after a short time if you have not selected a function.

Or:

 Press the button on the remote control to exit the DVD control.

Fast forward/reverse

Forward/reverse with DVD control

-  Press the button on the remote control during playback.
- ⏪ ⏩ Select the symbol.
-  Press the button.
-  Press the button several times to increase the fast forward/reverse speed.

The DVD playback will be distorted.

To cancel fast forward/reverse:

- ▶ Select the symbol.
-  Press the button.

Or:

 Press the button on the CD/DVD player. The DVD will start play at the point selected.

Forward/reverse with remote control

 Press and hold the button until you reach the desired point.



Or:

- During playback, turn the thumbwheel. Fast forward/reverse is interrupted.
- Continue to turn the thumbwheel. The speed is increased.

-  Press the button on the CD/DVD player. Fast forward/reverse is interrupted. The DVD will start play at the point selected.

Skipping chapter

You can change to the next or previous chapter during playback.

-  Press the button on the remote control during playback.
- ⏮ ⏭ Select the symbol.
-  Press the button repeatedly, continuing until you reach the desired chapter.

Or:

 Press the button on the left or right on the remote control repeatedly until you reach the desired chapter.

Freeze frame

-  Press the button on the remote control during playback.



- ⏸ Select the symbol.
-  Press the button.

To continue playback:

- Select the ▶ or ⏸ symbol.
-  Press the button.

As an alternative, you can also stop and continue playback with the  button on the CD/DVD player.

Making settings for DVD

1.  Press the button during playback.



2. Make the settings with the remote control:

- ▷ "Video settings":
 - ▷ "Brightness", "Color", and "Contrast" on the screen.
 - ▷ After switching to the top window, you can change other settings.
 - "Language": the system language of the DVD system
 - "Display": background brightness of the screen.
- ▷ "Tone":
 - ▷ "Treble / Bass" and "Balance": separately adjustable for the left and right headphones and the infrared headphones.
 - ▷ "Reset": the settings are reset to the default values.
- ▷ "DVD format":
 - ▷ "Standard"
 - ▷ "Zoom": full-screen playback.
- ▷ "Language": language of the DVD playback. The language advances one setting each time the menu item is selected.
- ▷ "Subtitles": language of the subtitles or turn off the subtitles.
- ▷ "Title": select individual tracks on the DVD.
- ▷ "Angle of view": camera angle.

Information or symbols that appear during the playback of a film generally point out dif-

ferent camera angles. These are usually only briefly available.



- ▷ "Menu": open the DVD-specific menu.
- ▷ "Return": exit the menu, or:
 - ▷  Press the buttons on the remote control.

Many DVDs offer dialogs and subtitles in various languages or scene descriptions for the hearing impaired. These functions are stored on the DVD.





With some DVDs, it is only possible to select language, subtitles, camera angle, or title by using the DVD-specific menu. Consult the information accompanying your DVD.

Opening the DVD-specific menu



Additional functions may be available on DVDs. It is thus possible, for example, to select from among several possible actions or to access information about the film.

1.  Press the button on the remote control during playback.
2. Select "Menu".
3.  Press the button.
 - On some DVDs, you can use "Main menu" and "Title" to access additional menus in which you can select music scenes, for example.

To make a selection:

1.  Select the symbol.
2.  Press the button until the desired function is selected.
3. Select the  arrow.
4.  Press the button.

To return to the start menu:

1. Select the  arrow.
2.  Press the button.

You can also select language, subtitles, camera angle, or title in the DVD-specific menu. Consult the information accompanying your DVD.

Compressed video files

Playback

1. Select the directory if necessary.



2. Press the button.
3. Select a track.



4. Press the button.
5. Select "Play".
6. Press the button.

To change the directory:

1. Select the directory.

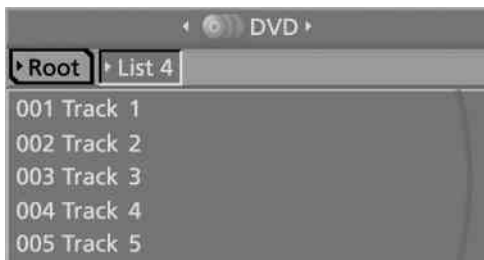

2. Press the button.

Playback functions

1. Select a track.
2. Press the button.
3. Select a menu item:
 - ▷ "Pause": stop and continue playback.
 - ▷ "Repeat track": repeat the selected track.
 - ▷ "Repeat directory": repeat the tracks in the current directory.
4. Press the button.

Playing audio tracks from CD/DVD

Starting playback

Push the CD/DVD into the drive with the labeled side facing upward. The CD/DVD is automatically pulled in.

- ▷ Playback begins automatically after a few seconds.
 - ▷ Otherwise: select "CD".
4. Press the button.

CDs/DVDs with compressed audio files, refer to page 223, can take approx. 1 minute to read, depending on their directory structure.

To play back audio tracks from a DVD, refer to Compressed audio files, refer to page 223.

To start playback if a CD is already in the drive:

1. Open the start menu with the remote control.
2. Select "CD".

3.  Press the button.





As an alternative, you can also control the playback with the buttons on the CD/DVD player.

To eject CD/DVD:

-  Press the button on the CD/DVD player.



Selecting a track

Buttons on CD/DVD player

  Press the button for the corresponding direction repeatedly until you reach the desired track.

Playback begins at the start of the track.

Using the remote control

  Press the button for the corresponding direction repeatedly or turn the thumbwheel until you reach the desired track.

Playback begins at the start of the track.



Settings and playback functions for audio CDs

1. Select "SET".

2.  Press the button.



3. Make the settings with the remote control:



- ▷ "Tone":
 - ▷ "Treble / Bass" and "Balance": separately adjustable for the left and right headphones and the infrared headphones.
 - ▷ "Reset": the settings are reset to the default values.
- ▷ "Pause": stop and continue playback.
- ▷ "Random": the CD tracks are played back once in random sequence.
- ▷ "Scan": brief samples of all CD tracks are automatically played one after another.
- ▷ "Repeat": repeat the current track. Select again to end.

To exit from the menu:

-   Press the buttons on the remote control.

Fast forward/reverse

Buttons on the CD/DVD player:

-   Press and hold the button for the corresponding direction.

Compressed audio files

Playback

1. Select the directory if necessary.



2. **OK** Press the button.
3. Select a track.

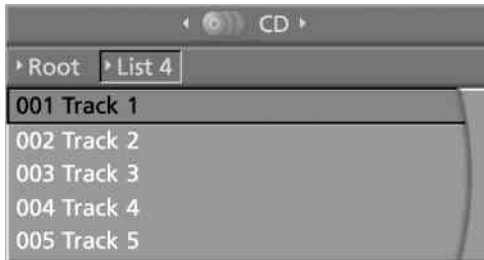

4. **OK** Press the button.
5. Select "Play".
6. **OK** Press the button.

To change the directory:

1. Select the directory.

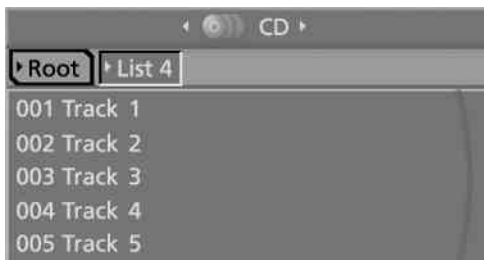

2. **OK** Press the button.

Settings and playback functions for compressed audio files

1. Select a track.
2. **OK** Press the button.
3. Make the settings with the remote control:
 - ▷ "Tone":
 - ▷ "Treble / Bass" and "Balance": separately adjustable for the left and right headphones and the infrared headphones.
 - ▷ "Reset": the settings are reset to the default values.
 - ▷ "Pause": stop and continue playback.
 - ▷ "Scan directory": briefly sample the tracks in the current directory.
 - ▷ "Scan all": briefly sample all tracks.
 - ▷ "Random directory": play the tracks in the current directory in a random sequence.
 - ▷ "Random all": play all tracks in a random sequence.
 - ▷ "Repeat track": repeat the selected track.
 - ▷ "Repeat directory": repeat the tracks in the current directory.
 - ▷ "Details": display any stored information on the current track.

To exit from the menu:

- ▶ ◀ Press the buttons on the remote control.

Displaying images from CD/DVD

1. Push the CD/DVD into the drive with the labeled side facing upward. The CD/DVD is automatically pulled in.
2. Open the start menu with the remote control.
3. Select "Photo".
4. **OK** Press the button.

Displaying overview

1. Select the subdirectory if necessary.
2. Select "Overview".

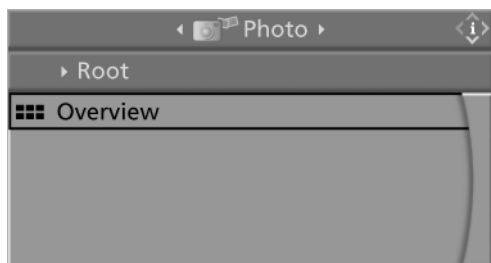

3. Press the button.

It may take some time until the overview is completely displayed.

If a symbol appears instead of an image, the image cannot be displayed in the overview.

Displaying images

1. Use the buttons or the thumbwheel of the remote control to select an image.
2. Press the button.



3. Displaying images:
 - ▷ Scroll using the menu navigation buttons of the remote control.
 - ▷ Display the slide show: turn the thumbwheel to set the display duration of the images.

Stop the slide show: select "Stop".

Adjusting

1. Press the button.



2. Select a menu item:

Symbol	Function
	Return to the photo menu.
"SET"	Adjust the "Display". "Language": after switching to the top window, the system language can be changed.
	Start the slide show.
	Display the first/last image of the current directory.
	Rotate the image by 90°.
"Overview"	Change to the image overview.

Ending display

1. Press the button.
2. Select the symbol.
3. Press the button.

Eject CD/DVD

1. Press the button on the CD/DVD player.

Information on CD/DVD player

Safety notes



Do not remove the cover

The BMW CD/DVD player is a Class 1 laser product. Do not operate if the cover is damaged; otherwise, severe eye damage can result. ◀

Suitable media



Use of CDs/DVDs

- ▷ Do not use self-recorded CDs/DVDs with labels applied, as these can become detached during playback due to heat buildup and can cause irreparable damage to the device.
- ▷ Only use round CDs/DVDs with a standard diameter of 4.7 in/12 cm and do not play CDs/DVDs with an adapter, e.g., single CDs; otherwise, the CDs or the adapter may jam and no longer eject.
- ▷ Do not use combined CDs/DVDs, e.g., DVD Plus, as the CDs/DVDs can jam and will no longer eject. ◀

The CD/DVD player can play the following media:

- ▷ Video DVD.
- ▷ CD-DA (audio CD).
- ▷ CDs/DVDs with compressed image data.
- ▷ CDs/DVDs with compressed audio data.
- ▷ CDs/DVDs with compressed video data.

The DVD player does not support DVD audio. However, many audio DVDs available in stores also contain a video track in the DVD Video format in addition to the audio track. These DVDs can be played back by the DVD player. Refer to the information on your DVD to determine whether your audio DVD contains an additional video track. Depending on the authoring used, it is possible that not all functions are available during playback.

Dual-sided DVDs available from retail suppliers are coated on both sides and bear no markings. This means both sides are information carriers. To play the information on the other side, turn over the DVD.

Supported formats

Depending on the compression method used, not all files of the specified formats can be opened.

Images

- ▷ JPEG/JPG.

With very large image files, it can take longer for the images to be displayed.

Compressed audio files

- ▷ MP3.
- ▷ WMA.
- ▷ OGG.
- ▷ AAC.

Compressed video files

- ▷ SVCD.
- ▷ MPEG1.
- ▷ MPEG2.
- ▷ MPEG4/DivX.

Digital Rights Management (DRM)

In some cases, it may not be possible to play CDs/DVDs with integrated Digital Rights Management (DRM).

General malfunctions

- ▷ CD/DVD changers and players have been optimized for performance in vehicles. In some instances they may be more sensitive to faulty CDs/DVDs than stationary devices would be.
- ▷ If a CD/DVD cannot be played, first check whether it has been inserted correctly.

- !** Foreign bodies/liquids in the CD/DVD slot
Make sure that no foreign objects or liquids get into the CD/DVD slot; otherwise, the CD/DVD player will be damaged. ◀

Humidity

High levels of humidity can lead to condensation on the CD/DVD or the laser's scan lens, and temporarily prevent playback.

Malfunctions involving individual CDs/DVDs

If malfunctions occur only with particular CDs/DVDs, this can be due to one of the following causes.

Copied or self-recorded CDs/DVDs

- ▶ Possible reasons for malfunctions with home-recorded CDs/DVDs are inconsistent data creation or recording processes, or poor quality or old age of the blank CD/DVD.
- ▶ Only label CDs/DVDs on the upper side with a pen intended for this purpose.

Damaged CDs/DVDs

- ▶ Avoid fingerprints, dust, scratches and moisture.
- ▶ Store CDs/DVDs in a sleeve.
- ▶ Do not subject CDs/DVDs to temperatures over 122 °F/50 °C, high humidity or direct sunlight.

CDs/DVDs with copy protection

CDs/DVDs are often provided with a copy protection feature by the manufacturer. As a result, some CDs/DVDs cannot be played, can only be played to a limited degree, or cause the system to switch off. In this case, wait a short while and then switch the system back on again. Then remove the CD/DVD from the drive.

CDs/DVDs with compressed audio files

If the language set for the CD/DVD player does not match the language of the music track, the music tracks may be displayed incorrectly.

External device

Connecting

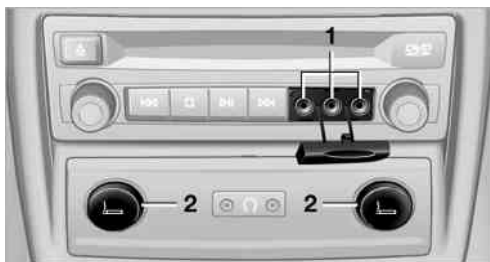

- 1 Connections for audio/video cables. Watch the colors of the sockets when connecting.
Yellow socket: video
White socket: audio on left
Red socket: audio on right
- 2 Power supply for external device: socket with removable cap.

Playback

1. Switch on the external device and start the playback.
2. Open the start menu with the remote control.
3. Select "AUX".



4. **OK** Press the button.

For devices without a video signal, for instance MP3 players, "No video signal" appears on the display. The sound is nevertheless played.

Settings for external devices

1.  Press the button during playback.

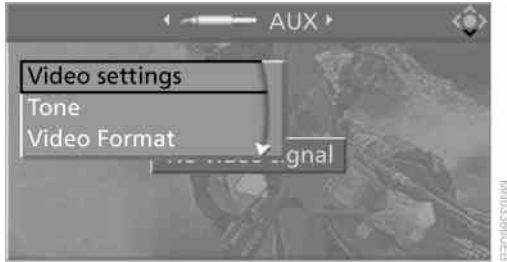

2. Make the settings with the remote control:

- ▷ "Video settings":
 - ▷ "Brightness", "Color", and "Contrast" of the video playback.
 - ▷ "NTSC color": the color can be adjusted on an external device with the NTSC standard.
 - ▷ "Standard": the DVD system can be adapted to external devices with different TV standards; to do so, consult the operating manual of the external device.
 - ▷ "Reset": the settings are reset to the default values.
- ▷ "Tone":
 - ▷ "Treble / Bass" and "Balance": separately adjustable for the left and right headphones and the infrared headphones.
 - ▷ "Reset": your settings are reset.
 - ▷ After switching to the top window, you can change other settings.

"Audio": adjust the volume of the external device to the volume of the CD/DVD player.

"Language": the system language of the DVD system.

"Display": background brightness of the screen.

- ▷ "Video Format":
 - ▷ "Standard"
 - ▷ "Zoom": full-screen playback.

To exit from the menu:

- ▷   Press the buttons on the remote control.



Communication

All of the options available to you for mobile communication with family, friends, business partners, and service providers are described in this chapter.

Telephone

Vehicle equipment

This chapter describes all series equipment as well as country-specific and special equipment offered for this model series. Therefore, it also describes equipment that may not be found in your vehicle, for instance due to the selected special equipment or the country version. This also applies to safety-related functions and systems.

At a glance

The concept

Mobile phones or other external devices such as audio players can be connected to the vehicle via Bluetooth.

Bluetooth® is a registered trademark of Bluetooth® SIG, Inc.

After these devices are paired once, they are recognized automatically when the ignition is switched on as soon as they are in the vehicle and can then be operated via iDrive, the buttons on the steering wheel, and via voice activation.

Depending on their functionality, external devices can be used via the vehicle as a telephone or as an audio source. The telephone functions are described in the following. Operating the audio functions, refer to page 210.

Up to four external devices can be paired.

Certain functions may need to be enabled by the mobile phone provider or service provider.

 Using the mobile phone while driving

Make entries only when traffic and road conditions allow. Do not hold the mobile phone in your hand while you are driving; use the hands-free system instead. If you do not observe this precaution, you can endanger the vehicle occupants and other road users. ◀

Snap-in adapter

The snap-in adapter is used to:

- ▷ Hold the mobile phone.
- ▷ Recharge the battery.
- ▷ Connect the mobile phone to an outside antenna of the vehicle.

This provides for better network reception and consistent sound quality.

Approved mobile phones

Details on which mobile phones and external devices with a Bluetooth interface are supported by the mobile phone preparation package can be obtained at www.bmwusa.com/bluetooth.

Displaying the vehicle identification number and software part number

The vehicle identification number and software part number are needed to determine which mobile phones are supported by the mobile phone preparation package. The software version of the mobile phone may also be required.

1. "Telephone"
2. Open "Options".
3. "Bluetooth® info"
4. "Display system information"

These approved mobile phones with a certain software version, support the vehicle functions described below.

Malfunctions may occur with other mobile phones or software versions.

Do not operate a mobile phone that is connected to the vehicle on the mobile phone keypad, as this may lead to a malfunction.

A software update, refer to page 213, can be performed if necessary.

Notes

At high temperatures, the charging function of the mobile phone may be limited and functions may not be executed.

When using the mobile phone via the vehicle, note the operating instructions of the mobile phone.

Pairing/unpairing the mobile phone

General information

The following functions are available:

- ▶ Use of a mobile phone as a telephone.
- ▶ Use of a mobile phone as an additional telephone.
- ▶ Use of a mobile phone as an audio source.
- ▶ Use of an audio device as an audio source, refer to page 210.

Requirements

- ▶ The mobile phone is suitable, refer to page 230.
- ▶ The mobile phone is ready for operation.
- ▶ Bluetooth is activated in the vehicle and on the mobile phone.
- ▶ Bluetooth presets may need to be made on the mobile phone, e.g., for a connection without confirmation or visibility, refer to the mobile phone operating instructions.
- ▶ Deactivate Bluetooth audio if necessary.
- ▶ A number with at least four and a maximum of 16 digits was defined as the Bluetooth passkey. It is only required once for pairing.
- ▶ The ignition is switched on.

Activating/deactivating Bluetooth

Bluetooth is not permitted everywhere. Comply with all safety guidelines and regulations.

1. "Telephone"

2. Open "Options".
3. "Bluetooth®"

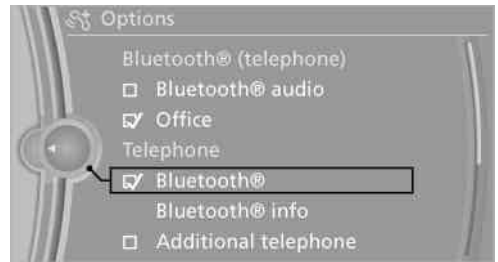

Additional functions

Activating/deactivating the additional functions

Activate the functions before pairing to be able to use them in the vehicle. Information on suitable mobile phones, refer to page 230, that support this function.

1. "Telephone"
2. "Bluetooth® (phone)"
3. Open "Options".
4. "Configure Bluetooth®"
5. Select the desired additional function.
 - ▶ "Additional telephone"
 - ▶ "Office"
 - ▶ "Bluetooth® audio"
6. "OK"

An additional function cannot be assigned to a telephone while it is deactivated.

Additional telephone

A mobile phone can be used as an additional telephone.

The additional telephone can be used to accept incoming calls, refer to page 234. While a call is active on the additional telephone, received calls are displayed on the Control Display.

Audio source

A mobile phone can be used as an audio source.

Pairing and connecting a mobile phone



Pairing the mobile phone

To avoid becoming distracted and posing an unnecessary hazard both to your own vehicle's occupants and to other road users, only pair the mobile phone while the vehicle is stationary. ◀

1. "Telephone"
2. "Bluetooth® (phone)"
3. "Add new phone"

The Bluetooth name of the vehicle is displayed.

4. To perform additional steps on the mobile phone, refer to the mobile phone operating instructions: for instance, search for or connect the Bluetooth device or a new device.

The Bluetooth name of the vehicle appears on the mobile phone display.

5. Select the Bluetooth name of the vehicle on the mobile phone display.
6. You are prompted by the iDrive or mobile phone to enter the same Bluetooth passkey. Enter the passkey and confirm.

or

Compare the control number on the vehicle display with the control number on the mobile phone display. Confirm the control number on the mobile phone and in the vehicle.

"OK"

7. Select the functions for which the mobile phone is to be used.
8. "OK"

If the pairing was successful, the mobile phone appears at the top of the list of mobile phones.

The functions supported by the mobile phone and audio device are displayed as symbols when paired.

White symbol: the function is active.

Gray symbol: the function is inactive.

Symbol	Function
	Telephone.
	Additional telephone.
	Audio source.

Four mobile phones can be paired with the vehicle at once. Three mobile phones can be connected with the vehicle at once.

If pairing was unsuccessful: What to do if..., refer to page 233.

Following the initial pairing

- ▷ The mobile phone is detected/connected in the vehicle within a short period of time when the engine is running or the ignition is switched on.
- ▷ The phone book entries of the telephone stored on the SIM card or mobile phone are transmitted to the vehicle after detection, depending on the mobile phone.
- ▷ Four mobile phones can be paired.
- ▷ Specific settings may be necessary in some mobile phones, e.g., authorization or a secure connection; refer to the mobile phone operating instructions.

Connecting a particular mobile phone

1. "Telephone"
2. "Bluetooth® (phone)"
3. Select the mobile phone that is to be connected.

The functions assigned to the mobile phone before unpairing are assigned to the mobile phone when it is reconnected. These functions are deactivated in a mobile phone that is already connected.

Configuring the mobile phone

Additional functions can be activated or deactivated for paired and connected mobile phones.

1. "Telephone"
2. "Bluetooth® (phone)"
3. Highlight the mobile phone to be configured.
4. Open "Options".
5. "Configure phone"
6. At least one function must be selected.
 - ▷ "Telephone"
 - ▷ "Additional telephone"
 - ▷ "Audio"
7. "OK"

If a function has already been assigned to another connected mobile phone, the function is deactivated in that mobile phone and the mobile phone is unpaired when the function is assigned to a new mobile phone.

Swapping the telephone and additional telephone

The function of the telephone and additional telephone can be swapped automatically.

1. "Telephone"
2. "Bluetooth® (phone)"
3. "Swap phone/addit. phone"

Unpairing the mobile phone

1. "Telephone"
2. "Bluetooth® (phone)"
3. Highlight the mobile phone that is to be unpaired.

4. Open "Options".
5. "Remove phone from list"

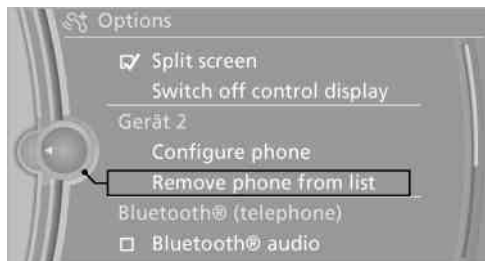

What to do if...

Information on suitable mobile phones, refer to page 230.

The mobile phone could not be paired or connected.

- ▷ Is Bluetooth activated in the vehicle and on the mobile phone? Activate Bluetooth in the vehicle and on the mobile phone.
- ▷ Do the Bluetooth passkeys on the mobile phone and the vehicle match? Enter the same passkey on the mobile phone and via iDrive.
- ▷ Did it take longer than 30 seconds to enter the passkey? Repeat the pairing procedure.
- ▷ Are too many Bluetooth devices connected to the mobile phone or vehicle? Delete connections with other devices if necessary.
- ▷ Is the audio connection activated? Deactivate the audio connection.
- ▷ Is the mobile phone in power-save mode or does it have only a limited remaining battery life? Charge the mobile phone in the snap-in adapter or via the charging cable.
- ▷ Depending on the mobile phone, it is possible that only one mobile phone can be connected to the vehicle. Unpair the connected mobile phone from the vehicle and pair and connect only one mobile phone.

The mobile phone no longer reacts.

- ▷ Switch the mobile phone off and on again.

- ▷ Is the ambient temperature too high or low? Do not expose the mobile phone to extreme environmental conditions.

The telephone functions are not available.

- ▷ Is the mobile phone paired as an additional telephone and is the additional telephone function deactivated? Activate the function.
- ▷ Is an outgoing call not possible? Connect the mobile phone as a telephone.

No phone book entries or only some phone book entries are displayed, or they are incomplete.

- ▷ Transmission of the phone book entries is not yet complete.
- ▷ It is possible that only the phone book entries of the mobile phone or the SIM card are transmitted.
- ▷ It may not be possible to display phone book entries with special characters.
- ▷ The number of phone book entries to be stored is too high.
- ▷ Is the data volume of the contact too large, e. g., due to stored information such as notes? Reduce the data volume of the contact.
- ▷ Is the mobile phone connected as an audio source or additional telephone? The mobile phone must be connected as a telephone.

The phone connection quality is poor.

- ▷ The strength of the Bluetooth signal on the mobile phone can be adjusted, depending on the mobile phone.
- ▷ Insert the mobile phone into the snap-in adapter or place it in the area of the center console.
- ▷ Adjust the volume of the microphone and loudspeakers separately.

If all points in this list have been checked and the required function is still not available, contact Customer Relations or the service center.

Controls

Adjusting the volume

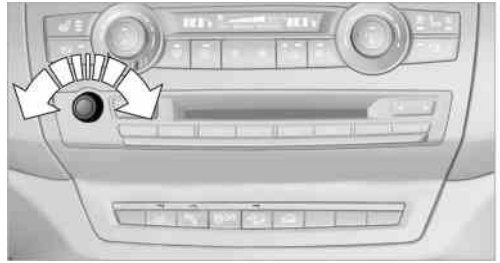

Turn the knob until the desired volume is selected. The setting is stored for the remote control currently in use.

The vehicle automatically adjusts the volume of the microphone on the telephone and the volume of the called party. Depending on the mobile phone, the volumes may need to be adjusted. The settings can only be created during a call and must be adjusted separately for each telephone. The settings are deleted when the telephone is unpaired.

1. "Settings"
2. "Tone"
3. "Volume settings"
4. Select the desired setting: "Microphone" or "Loudspeak."
5. To adjust: turn the controller.
6. To store: press the controller.

Incoming call

Receiving calls

If the number of the caller is stored in the phone book and is transmitted by the network, the name of the contact is displayed. Otherwise, only the phone number is displayed.

If more than one phone number is assigned to a contact, only the name of the contact is displayed.

For calls on the additional telephone, the number is only displayed if it is transmitted by the network.

An incoming call to one of the telephones is automatically rejected if there is an active call on the other telephone.

Accepting a call



Press the button on the steering wheel.

or

"Accept"

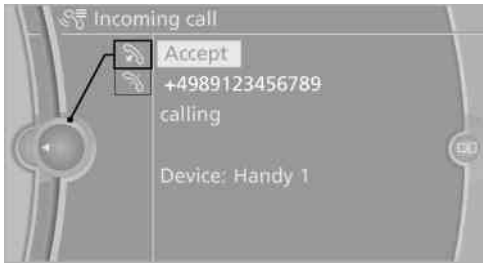

Rejecting a call

"Reject"

Ending a call



Press the button on the steering wheel.

or

1. "Telephone"
2. "End call"

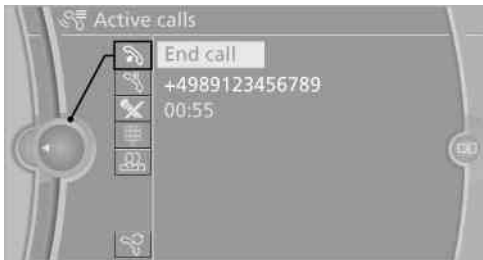

Entering a phone number

Dialing a number

1. "Telephone"
2. "Dial number"
3. Select the digits individually.
4. Select the symbol.



The phone number can also be entered by voice.

Calls with multiple parties

General information

You can switch between calls or connect two calls to a single conference call. These functions must be supported by the mobile phone and service provider.

Accepting a call while speaking to another party

This function might have to be activated by the service provider and the mobile phone must be adjusted accordingly.

If a second call comes in during an ongoing call, a call waiting signal is sounded.

"Accept"

The call is accepted and the existing call is put on hold.

Establishing a second call

Establish an additional call during an active call.

1. "Telephone"
2. "Active calls"
3. "Hold"

The existing call is put on hold.

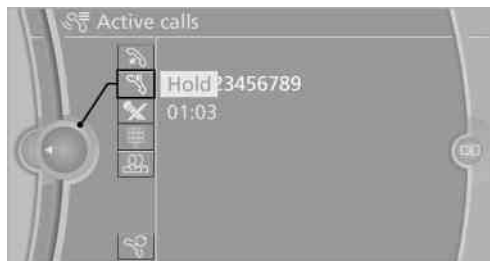

4. Dial the new phone number or select it from a list.

"Return"

The call on hold is resumed.

Switching between two calls, hold call

The active call is displayed in color.

The call on hold is displayed in gray.

"Swap calls"

The call on hold is resumed.

Establishing a conference call

Two calls can be connected to a single telephone conference call.

1. Establish two calls.
2. "Conference call"

When terminating a conference call, both calls are ended. If one call is terminated by another party, the other call can be continued.

Switching the microphone to mute

When a call is active, the microphone can be muted.

1. "Telephone"
2. "Active calls"
3. "Microphone mute"

A microphone that has been switched to mute is automatically reactivated:

- ▷ When a new connection is established.
- ▷ When switching between call parties.

DTMF suffix dialing

DTMF suffix dialing can be used for gaining access to network services or for controlling devices, e.g., to make a remote inquiry of an answering machine. The DTMF code is needed for this purpose.

1. "Telephone"
2. Select the contact from a list or "Dial number".
3. "Keypad dialing"
4. Enter the DTMF code via iDrive.

Phone book

Displays



The phone book accesses the contacts and shows all contacts for which a phone number has been stored. The entries can be selected to make a call.

1. "Telephone"
2. "Phone book"

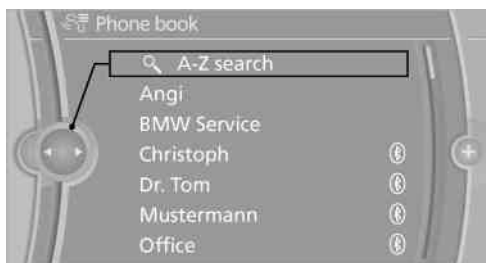
A symbol indicates the storage location of the contacts.



Calling a contact

Symbol	Meaning
	Contact with one stored phone number.
	Contact with more than one stored phone number.
	Call not possible; mobile phone without reception or network, or Service Request is active.

For contacts with one stored phone number: select the required contact. The connection is being established.

For contacts with more than one stored phone number: select the required contact and the phone number. The connection is being established.

Editing a contact

Changing the entries in "Contacts". When a contact is changed, the changes are not stored on the mobile phone. A copy of the entry is stored in the vehicle.

1. Highlight the contact.
2. Open "Options".
3. "Edit entry"

The contact can be edited.

Redialing

General information

The list of dialed numbers in the mobile phone is transmitted to the vehicle depending on the mobile phone. Possibly only those numbers are displayed that were dialed from the vehicle.

The 20 phone numbers dialed last are displayed. The sorting order of the phone numbers depends on the particular mobile phone.

Dialing the number via the iDrive

1. "Telephone"
2. "Redial"

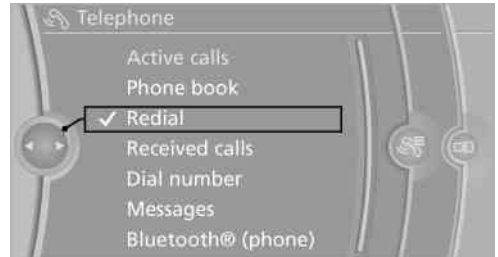

3. Select the desired entry and the phone number if necessary.

The connection is established.

Deleting a single entry or all entries

The deletion of entries depends on your particular mobile phone.

1. Highlight the entry.
2. Open "Options".
3. "Delete entry" or "Delete list"

Saving an entry in the contacts

1. Highlight the entry.
2. Open "Options".
3. "Store as new contact" or "Add to existing contact"
4. Select the contact if necessary.
5. Select the type of number: "Home", "Business", "Mobile" or "Other"
6. Complete the entries if necessary.
7. "Store contact"

Received calls

Displaying calls

The 20 calls that were last received are displayed.

1. "Telephone"

2. "Received calls"



Calling a number from the list

Selecting an entry.

The connection is established.

Deleting a single entry or all entries

The deletion of entries depends on your particular mobile phone.

1. Highlight the entry.
2. Open "Options".
3. "Delete entry" or "Delete list"

Saving an entry in the contacts

1. Highlight the entry.
2. Open "Options".
3. "Store as new contact" or "Add to existing contact"
4. Select the contact if necessary.
5. Select the type of number: "Home", "Business", "Mobile" or "Other"
6. Complete the entries if necessary.
7. "Store contact"

Hands-free system

General information

Calls that are being made on the hands-free system can be continued on the mobile phone and vice versa.

From the mobile phone to the hands-free system

Calls that were begun outside of the Bluetooth range of the vehicle can be continued on the hands-free system with the ignition switched on.

Depending on the mobile phone, the system automatically switches to the hands-free system.

If the system does not switch over automatically, follow the instructions on the mobile phone display; refer also to the mobile phone operating instructions.

From the hands-free system to the mobile phone

Calls that are made on the hands-free system can in some cases be continued on the mobile phone; this depends on the mobile phone.

Follow the instructions on the mobile phone display; refer also to the mobile phone operating instructions.

Voice operation

General information

Vehicles equipped with the voice activation system: operation, refer to page 25.

Vehicles not equipped with the voice activation system: depending on the equipment, the mobile phone can be voice operated as described below.

The list of short commands in the Owner's Manual does not apply to this type of voice operation.

The concept

- ▶ The mobile phone can be operated without taking your hands from the steering wheel.
- ▶ In many cases, the entries are accompanied by announcements or questions.
- ▶ >...< Verbal instructions to use with the voice operation system.

- ▶ »...« Identifies the answers generated by the voice operation system.

Using voice activation

Activating the voice activation system

1.  Press the button on the steering wheel.
2. Say the command.

Terminating the voice activation system

-  Press the button on the steering wheel or ›Cancel«.

Possible commands

Having possible commands read aloud

-  Press the button on the steering wheel.
›Help«.

Possible commands are announced.

The digits from zero to nine are recognized. The digits can be spoken separately or combined in a sequence to accelerate the entry.

Using alternative commands

The system often recognizes a number of different commands to run a function; for instance:

›Dial name« or ›Name«

Example: dialing a phone number

1.  Press the button on the steering wheel.
2. ›Dial number«
The system says: »Please say the number«.
3. For instance, ›123 456 790«
The system says: »123 456 790. Continue?«.
4. ›Dial«

The system says: »Dialing number«.

Calling

Dialing a phone number

1. ›Dial number«
2. Say the phone number.
3. ›Dial«

Correcting the phone number

The sequence of digits can be deleted after the system has repeated the digits.

›Correct number«

The command can be repeated as often as necessary.

Deleting a phone number

›Delete«

All digits entered up to that point are deleted.

Redialing

›Redial«

Voice phone book

Depending on how your vehicle is equipped, it may be necessary to create your own voice phone book.

The entries must be entered using voice activation and are separate from the memory in the mobile phone. Up to 50 entries can be set up.

Saving an entry

1. ›Save name«
2. Say the name. Do not exceed the speaking duration of approx. 2 seconds.
3. Say the phone number after being prompted to do so by the system.
4. ›Save«

Deleting an entry

1. ›Delete name«

2. Say the name after being prompted to do so.
3. Confirm the prompt: ›Yes‹

Deleting all entries

1. ›Delete phone book‹
2. Confirm the prompt: ›Yes‹
3. Confirm the prompt again: ›Yes‹

Reading and selecting entries

1. ›Read phonebook‹
2. When the desired entry is read aloud: say ›Dial number‹

Selecting an entry

1. ›Dial name‹
2. Say the name after being prompted to do so.
3. Confirm the prompt: ›Yes‹

Adjusting the volume

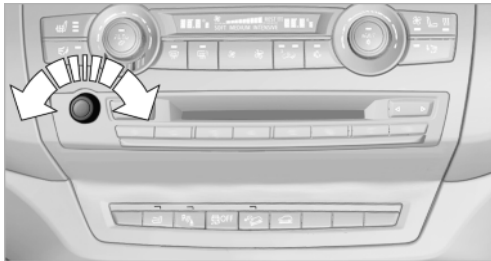

Turn the knob during an announcement.

- ▷ The volume remains constant even if the volume of other audio sources is changed.
- ▷ The volume is stored for the remote control currently in use.

Notes

Do not use voice operation to initiate an Emergency Request. In stressful situations, the voice and vocal pitch can change. This can unnecessarily delay the establishment of a telephone connection.

Instead, use the SOS button, refer to page 300, in the vicinity of the interior mirror.

Environmental conditions

- ▷ Say the commands, numbers, and letters smoothly and with normal volume, emphasis, and speed.
- ▷ Always say commands in the language of the system. The language for the mobile phone voice operation is preset and cannot be changed in the Control Display.
- ▷ Keep the doors, windows, and glass sunroof closed to prevent noise interference.
- ▷ Avoid making other noise in the vehicle while speaking.

Snap-in adapter

General information

More information on compatible snap-in adapters that support the functions of the mobile phone is available at the service center.

Notes

At high temperatures, the charging function of the mobile phone may be limited and functions may not be executed.

When using the mobile phone via the vehicle, note the operating instructions of the mobile phone.

Installation position

In the center armrest.

Inserting/removing the snap-in adapter

1. Press button 1 and remove the cover.

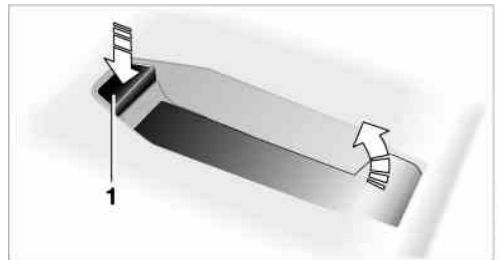

2. Insert the snap-in adapter at the front, arrow 1, and press down, arrow 2, until it engages.

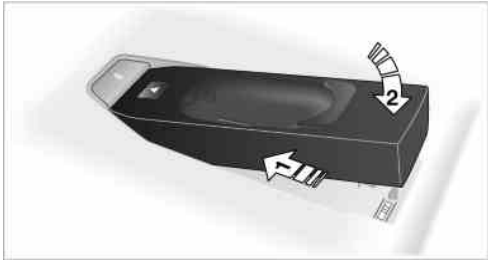

3. To remove the snap-in adapter: press button 1.

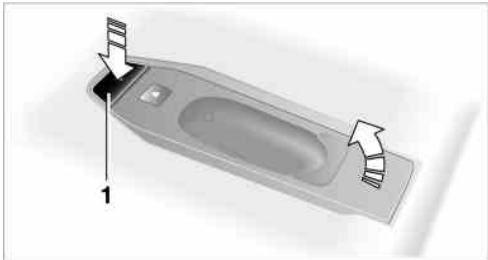

Removing the mobile phone

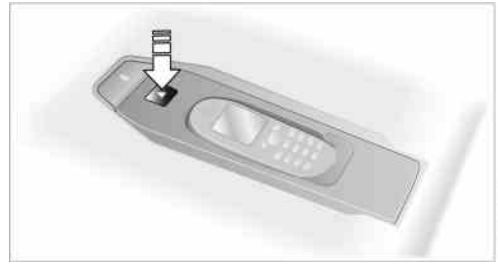

Press the button and remove the mobile phone.

Inserting the mobile phone

1. Depending on the mobile phone, remove the protective cap from the antenna connector and from the USB connection of the mobile phone.
2. With the buttons facing up, slide the mobile phone up toward the electrical contacts and press it down until it engages.

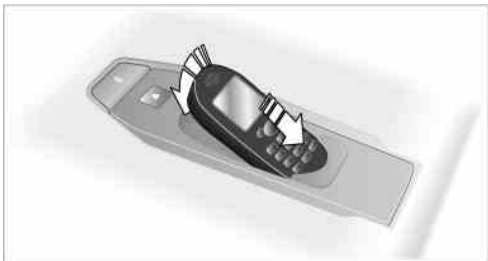

The battery is charged beginning with the radio ready state of the vehicle.

Office

Vehicle equipment

This chapter describes all series equipment as well as country-specific and special equipment offered for this model series. Therefore, it also describes equipment that may not be found in your vehicle, for instance due to the selected special equipment or the country version. This also applies to safety-related functions and systems.

At a glance

General information

Contacts, appointments, tasks, notes, text messages, and e-mails from the mobile phone can be displayed on the Control Display if the mobile phone provides compatible support of these functions and the necessary Bluetooth standards.

Information about which mobile phones support the Office functions can be found at www.bmwusa.com/bluetooth. A limited number of compatible mobile phones is available for Office.

Contents are only displayed in full length when the vehicle is stationary.

The mobile phone has read-access only.

 Do not use Office while driving

To avoid becoming distracted and posing an unnecessary hazard to your vehicle's occupants and to other road users, never attempt to use the controls or enter information unless traffic and road conditions allow this. ◀

Requirements

- ▷ A suitable mobile phone is paired with the vehicle and connected. In some mobile phones, data access must be confirmed on the mobile phone.

- ▷ The time, time zone, and date, refer to page 85, are correctly set on the Control Display and on the mobile phone, for instance to correctly display appointments.
- ▷ Office is activated, refer to page 231.

Updating

Data are updated every time the mobile phone is connected to the vehicle. Appointment entries, tasks, notes and reminders can be updated separately.

1. "Office"
 2. "Current office", "Calendar", "Tasks", "Notes" or "Reminders"
 3. Open "Options".
 4. "Update data"
- Cell phone data are transmitted again to the vehicle.

Office information

The number of unread messages and active tasks as well as the upcoming appointments are displayed.

1. "Office"
2. "Current office"
3. Select the desired entry to display details.

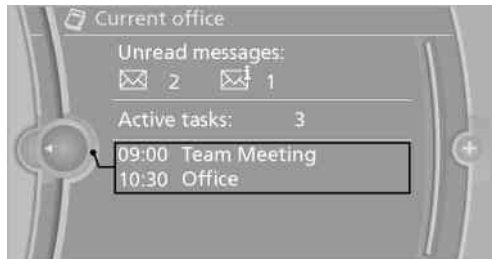

Contacts

Note

Equipment version with the mobile phone preparation package.

At a glance

Contacts can be created and edited. The contacts from the mobile phone are displayed as well if this function is supported by the mobile phone. The addresses can be adopted as destinations for navigation and the phone numbers can be dialed.

Displaying contacts

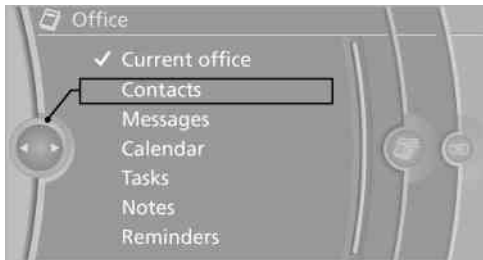

General information

1. "Office"
2. "Contacts"



All contacts are listed in alphabetical order. Depending on the number of contacts, an A-Z search is offered, refer to page 23.

A symbol indicates the storage location of the contacts.

Symbol	Storage location
No symbol	In the vehicle; the address has not been checked as a destination.
	In the vehicle; the address has been checked as a destination.
	Mobile phone.

Dialing phone numbers

1. Select the desired contact.
2. Select the phone number.
The connection is established.

Editing a contact

1. Select the desired contact.
2. "Edit contact"

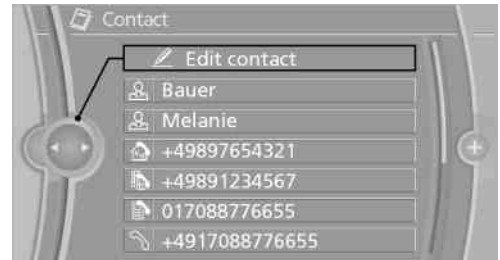

3. Change the entries.
4. "Store contact in vehicle"

When a contact is edited, the changes are not stored on the mobile phone. A copy of the entry is stored in the vehicle.

Selecting the contact as a navigation destination

1. Select the desired contact.
2. Select the address.

When contacts from the mobile phone are used, the address may need to be matched to the navigation data contained in the vehicle. In this case:

Correct the address.

3. "Start guidance" or "Add as another destination"

Checking the address as a destination

An address that is to be used for destination guidance must match the navigation data con-

tained in the vehicle. The address can be checked for this purpose.

1. Select the desired contact and highlight the address.
2. Open "Options".
3. "Check as destination"
4. Correct and store the address if necessary.

If the address is corrected and stored, a copy of it is stored in the vehicle. The address is not changed on the mobile phone.

New contact

General information

A contact can have up to 8 phone numbers, 2 addresses, 3 e-mail addresses and one Internet address.

1. "Office"
2. "Contacts"
3. Open "Options".
4. "New contact"

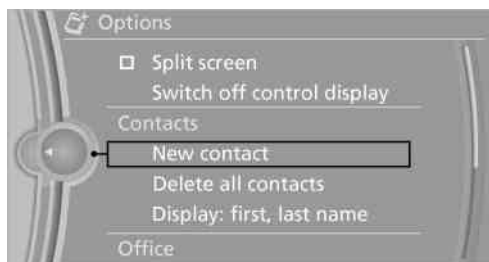

5. The entry fields are still filled with the previous entries: "Delete input fields"
6. Fill in the entry fields: select the symbol next to the entry field.
7. Enter the text and assign the contact type.
8. If the vehicle is equipped with a navigation system: enter the address. Only addresses contained in the navigation data in the vehicle can be entered. This ensures that destination guidance is possible for all addresses.

If necessary, "Accept address".

9. "Store contact in vehicle"

Contact types

Various contact types can be assigned to phone numbers and addresses.

Symbol	Meaning
	Home phone number.
	Business phone number.
	Mobile phone number.
	Other phone number.
	Home address.
	Business address.

Specifying the home address

A home address can be stored. It appears at the top of the contact list.

1. "Office"
2. "Contacts"
3. "Home"
4. Create a contact.
5. "Store contact in vehicle"

Selecting the sorting order of the names

Names can be displayed in a different order.

1. "Office"
2. "Contacts"
3. Open "Options".
4. "Display: last, first name" or "Display: first, last name"

Depending on how the contacts were stored on the mobile phone, the sorting order of the names may differ from the selected sorting order.

Show contact pictures

Pictures stored with the contacts are stored in the vehicle when the mobile phone is connected to the vehicle. The number of transmitted pictures depends on the mobile phone. The mobile phone must support this function.

1. "Office"
2. "Contacts"
3. Open "Options".
4. "Configure Bluetooth®"
5. "Show images"

Display of all contact pictures is activated or deactivated.

Deleting contacts

Only contacts that are stored in the vehicle are deleted. The contacts on the mobile phone cannot be deleted.

1. "Office"
2. "Contacts"
3. Highlight the contact.
4. Open "Options".
5. "Delete contact" or "Delete all contacts"
6. If necessary. "Yes"

Messages

General information

Whether or not text messages and e-mails from the mobile phone are displayed depends on whether transmission from the mobile phone to the vehicle is supported. Text messages and e-mails may not be supported by the service provider, or the function may need to be enabled separately. After the mobile phone is first paired, transmission may take several minutes. Messages are only displayed in full length when the vehicle is stationary. Messages from the additional telephone are not transmitted.

Displaying messages

1. "Office"
2. "Messages"

A symbol identifies the type of message.

Symbol	Message type
✉	Text messages.
✉	My Info
✉	Message from the Concierge service.
✉@	E-mail from mobile phone.

Filtering the message list

The message list can be filtered if more than one type of message exists.

1. "Filter:"



2. Select the type of message.
 - ▶ "All"
 - All messages are displayed.
 - ▶ "E-mail"
 - Only e-mails from the mobile phone are displayed.
 - ▶ "Service message"
 - Only messages from the BMW Assist Concierge service and My Info are displayed.
 - ▶ "Text message"
 - Only text messages from the mobile phone are displayed.

Deleting messages

Messages from the Concierge service and My Info can be deleted.

Delete a message:

1. "Office"
2. "Messages"
3. Select the desired message.
4. Open "Options".
5. "Delete message"

Delete all messages:

1. "Office"
2. "Messages"
3. Open "Options".
4. "Delete all messages" or "Delete service messages"

Text messages

Calling the sender of a text message

1. Select the desired message.
2.  Select the symbol.

Saving the sender in the contacts

1. Highlight the desired message.
2. Open "Options".
3. "Store as new contact" or "Add to existing contact"

Using contact data

Contact data from appointments, tasks, text messages, e-mails, and notes can be saved or selected, refer to page [249](#).



Reading the text message out loud

Read the text message out loud, refer to page [249](#).

My Info

Selecting additional functions

Additional functions are available when a message is selected.

Symbol	Function
	"Start guidance" or "Add as another destination"
	"Call" If the message contains a number, the connection is established.
	"Select phone number" If the message contains more than one number, select the desired number from the list. The connection is established.



Message from the Concierge service



Storing an address

1. Select the desired message.
2. Open "Options".
3. "Store contact in vehicle"

Selecting additional functions

Additional functions are available when a message is selected.

Symbol	Function
	"Start guidance" or "Add as another destination"
	"Call" If the message contains a number, the connection is established.

Symbol	Function
	"Select phone number" If the message contains more than one number, select the desired number from the list. The connection is established.
	"Further information" Display additional information.

E-mail

Displaying e-mails

1. "Office"
2. "Messages"
3. Select the desired e-mail.

Displaying e-mail contacts

If the sender and recipient of an e-mail are transmitted by the mobile phone, this information is displayed in the e-mail.

"Sender/Recipient"

If the e-mail addresses are stored in the contacts, the contact is displayed. Select the contact to display details.

If the e-mail addresses are not stored in the contacts, only the e-mail address is displayed.

Using contact data

Contact data from appointments, tasks, text messages, e-mails, and notes can be saved or selected, refer to page 249.

Deactivating the full display

When an e-mail is opened in the vehicle, the e-mail is fully transmitted to the vehicle. This may result in charges.

1. "Office"
2. "Messages"
3. Open "Options".
4. "Fully download e-mails"

Only a part of the email from the cell phone is loaded into the vehicle.

Reading the e-mail out loud

Read the e-mail out loud, refer to page 249.

Calendar

Display the calendar

Appointments during the last 20 days and the next 50 days can be displayed.

1. "Office"
2. "Calendar"

The appointments on the current day are displayed.

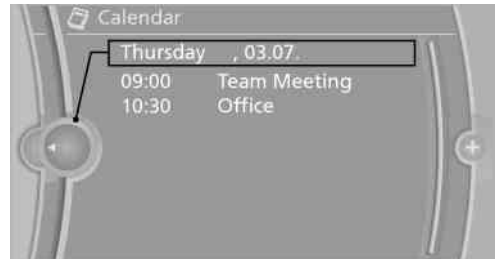

Selecting the calendar day

1. Select the date.



2. Select the desired day or date.
 - ▷ "Next day"
 - ▷ "Date:"
 - ▷ "Previous day"
 - ▷ "Today"

Display the appointment

1. Select the desired appointment.
2. Scroll through the appointment if necessary:
 - ▷ Turn the controller.
 - ▷   Select the symbol.

Using contact data

Contact data from appointments, tasks, text messages, e-mails, and notes can be saved or selected, refer to page 249.

Reading the appointment out loud

Read the appointment out loud, refer to page 249.

Tasks

Displaying the task list

Display tasks that are due within the next 90 days.

1. "Office"
2. "Tasks"

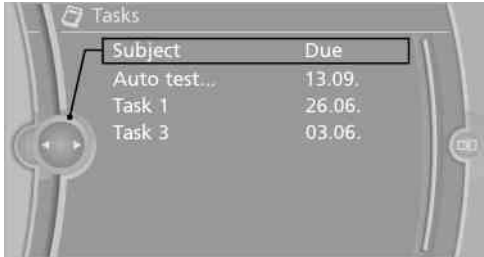

Sorting the task list

1. Select the header in the task list.



2. Select the sorting criterion:
 - ▷ "Priority (!)"
 - ▷ "Subject"
 - ▷ "Due date"

Displaying the task

1. Select the desired task.
2. Scroll in the task if necessary:
 - ▷ Turn the controller.
 - ▷   Select the symbol.

Using contact data

Contact data from appointments, tasks, text messages, e-mails, and notes can be saved or selected, refer to page 249.

Reading the task out loud

Read the task out loud, refer to page 249.

Notes



Displaying notes

1. "Office"
2. "Notes"
 - All notes are displayed.

Displaying the note

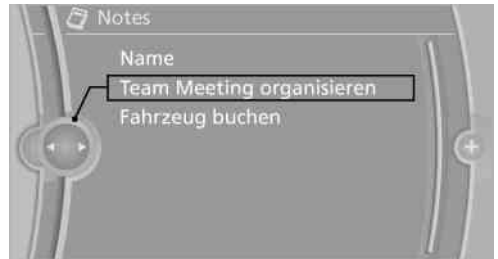
1. Select the desired note.



2. Scroll in the note if necessary:
 - ▷ Turn the controller.
 - ▷   Select the symbol.

Using contact data

Contact data from appointments, tasks, text messages, e-mails, and notes can be saved or selected, refer to page 249.

Reading the note out loud

Read the note out loud, refer to page 249.

Reminders

Displaying reminders

Reminders of pending appointments and tasks are displayed. After an appointment or after a task is due, the reminder is no longer displayed.

1. "Office"
2. "Reminders"
3. Select the desired reminder.

The corresponding appointment or the task are displayed.

Using contact data

At a glance

Contact data from appointments, tasks, text messages, emails, and notes can be stored or selected.

Displaying contact or selecting phone number

1.  "Use contact data"
2. Display the contact or select the phone number:
 - ▷ Select the contact to display contact details.
 - ▷ Select the phone number to establish a connection directly.

Storing contact data

1.  "Use contact data"
2. Highlight the phone number or e-mail address.
3. Open "Options".
4. "Add to existing contact" or "Store as new contact"





Reading out loud

Text messages, e-mails, appointment entries, tasks, and notes can be read out loud.

1. Select the desired message, appointment, task, or note.

2.  Select the symbol.

The following options are available during reading:

- ▷  "Pause"
Interrupt reading. Select again to restart reading.
- ▷  "Back to beginning"
Start reading the message again from the beginning.
- ▷  Select the symbol.
Go back one paragraph.
- ▷  Select the symbol.
Skip a paragraph.
- ▷ To end reading, turn the controller to the left.

What to do if...

Information on suitable mobile phones, refer to page [230](#).

Appointments, tasks, notes, text messages, or e-mails from the mobile phone are not displayed.

- ▷ The mobile phone is not capable of the missing function or is not connected correctly.
- ▷ The Office function is deactivated.
- ▷ The mobile phone is connected as an additional phone.
- ▷ Appointments are older than 20 days or are more than 50 days in the future.
- ▷ The tasks have been marked as completed or have a due date that lies more than 90 days in the future.

- ▷ Depending on the number of stored appointments, task notes, and messages in the mobile phone, not all are displayed in the vehicle.

Not all appointments and tasks from the mobile phone are displayed at the right time?

- ▷ The time zone, time, or date is incorrectly set on the Control Display and mobile phone.

The e-mail attachment is not displayed.

- ▷ E-mails are transmitted without an attachment.

Entries are not displayed in full length.

- ▷ Text were already transmitted from the mobile phone in a shortened form.
- ▷ Synchronization between the mobile phone and vehicle may take several minutes.

The contact pictures are not being displayed?

- ▷ Up to 200 contact pictures can be stored in the vehicle.

The E-mail is displayed with a delay?

- ▷ Check the e-mail settings on the telephone and adjust if necessary.

If all points in this list have been checked and the required function is still not available, please contact the hotline or service center.

Contacts

Vehicle equipment

This chapter describes all series equipment as well as country-specific and special equipment offered for this model series. Therefore, it also describes equipment that may not be found in your vehicle, for instance due to the selected special equipment or the country version. This also applies to safety-related functions and systems.

Note

Equipment version without the mobile phone preparation package.

General information

Contacts can be created and edited and the addresses can be adopted as destinations for navigation.

New contact

1. "Contacts"
2. "New contact"



3. The entry fields are still filled with the previous entries: "Delete input fields"

4. Fill in the entry fields: select the symbol next to the entry field.



5. Enter the text, refer to page 23.

In vehicles equipped with a navigation system: it is only possible to enter addresses that are contained in the vehicle navigation data. This ensures that destination guidance is possible for all addresses.

6. If necessary, "Store".
7. "Store contact in vehicle"

Specifying the home address

A home address can be stored. It appears at the top of the contact list.

1. "Home"
2. Create a contact.
3. "Store contact in vehicle"

My contacts

General information

List of all contacts stored in the vehicle.

Displaying contacts

1. "Contacts"

2. "My contacts"



All contacts are listed in alphabetical order. Depending on the number of contacts, an A-Z search is offered, refer to page 23.

A symbol indicates the storage location of the contacts:

Symbol	Storage location
No symbol	In the vehicle; the address has not been checked as a destination.
	In the vehicle; the address has been checked as a destination.

Editing a contact

1. Select the desired contact.
2. "Edit contact"



3. Change the entries.
4. Move the controller to the left.
5. "Yes"

Selecting the contact as a navigation destination

1. Select the desired contact.

2. Select the address.
3. "Start guidance" or "Add as another destination"

Checking the address as a destination

An address that is to be used for destination guidance must match the navigation data contained in the vehicle. The address can be checked for this purpose.

1. Select the desired contact and highlight the address.
2. Open "Options".
3. "Check as destination"
4. Correct and store the address if necessary.

Selecting the sorting order of the names

Names can be displayed in a different order.

1. "My contacts"
2. Open "Options".
3. "Display: last, first name" or "Display: first, last name"

Deleting contacts

1. "My contacts"
2. Highlight the contact.
3. Open "Options".
4. "Delete contact" or "Delete all contacts"

ConnectedDrive

Vehicle equipment

This chapter describes all series equipment as well as country-specific and special equipment offered for this model series. Therefore, it also describes equipment that may not be found in your vehicle, for instance due to the selected special equipment or the country version. This also applies to safety-related functions and systems.

BMW Assist

General information

BMW Assist provides you with certain services, e.g., transmission of the position data of your vehicle to the BMW Assist Response Center if an Emergency Request has been initiated.

Many BMW Assist services depend on the individually agreed upon contract.

After your contract has expired, the BMW Assist system will be deactivated by the BMW Assist Response Center without your having to visit a service center. After the BMW Assist system has been deactivated, no BMW Assist services will be available. The BMW Assist system can be reactivated by a service center after you sign a new contract.

Requirements

- ▶ The installed BMW Assist system is logged in to a wireless communications network. This network must be capable of transmitting the services.
- ▶ To transmit position data, the vehicle must be able to determine the current position.
- ▶ The BMW Assist service contract was signed with your service center or with the BMW Assist Response Center. Enabling must have been completed.

- ▶ BMW Assist is activated.

Services offered

- ▶ **Emergency Request:** when you press the SOS button, a connection to the BMW Assist Response Center is established. The BMW Assist Response Center then speaks with you and takes further steps to help you.
- ▶ **Automatic Collision Notification:** under certain conditions, a connection is established to the BMW Assist Response Center after a serious accident. If possible, the BMW Assist Response Center then speaks with you and takes further steps to help you.
- ▶ **Enhanced Roadside Assistance:** BMW Roadside Assistance can be contacted if assistance is needed in the event of a breakdown. If possible, the vehicle and position data are transmitted in the process.
- ▶ **Customer Relations:** connection with Customer Relations for information on all aspects of your vehicle.
- ▶ **TeleService:** data on your vehicle's service status or required inspections are transmitted to your service center, either automatically before a service due date or when you request a BMW service appointment.
- ▶ **Remote Door Unlock:** the BMW Assist Response Center provides assistance if, for example, the remote control is not available and the vehicle needs to be opened.
- ▶ **Stolen Vehicle Recovery:** after you report that your vehicle was stolen to the police, the BMW Assist Response Center can determine its position.
- ▶ In addition to these services, the optional Convenience Plan offers Concierge service and information for route planning, traffic, and weather. A limited number of calls can be made via the BMW Assist Response Center with Critical Calling if, for example,

the mobile phone is not available or discharged.

Press the SOS button to contact the BMW Assist Response Center.

TeleService

General information

TeleService supports communication with your service center.

- ▷ Data on the vehicle's service requirements can be sent directly to the service center. In this way, the service center can plan its work in advance. This shortens the duration of the service appointment.
- ▷ In the event of a breakdown, data on the vehicle's condition can be sent directly to Roadside Assistance.
- ▷ The service varies by country.
- ▷ Connection costs may ensue.
- ▷ Services may be restricted abroad.

Requirements

- ▷ BMW Assist is activated.
If BMW Assist is not activated, a mobile phone that has been recommended by BMW for TeleService and that is configured for mobile data communication must be connected with the vehicle.
- ▷ Wireless reception is available.
- ▷ The ignition is switched on.

Using TeleService

The TeleServices are typically activated in the vehicle.

Even if the TeleServices are not active, a voice contact to Roadside Assistance is still possible.

To continue using or to deactivate the services, please contact your service partner or the BMW customer hotline.

Concierge service

General information

The BMW Assist Concierge service offers information on events, gas stations, and hotels, and provides phone numbers and addresses. Hotels can be booked directly by the BMW Assist Concierge service. The Concierge service is part of the optional Convenience Plan.

Starting the Concierge service

1. "BMW Assist" or "ConnectedDrive"
2. "Concierge"



3. "Start service"

A voice connection is established with the BMW Assist Concierge service. Phone numbers and addresses can be transmitted to the vehicle.

Messages

Information on messages, refer to page [245](#).

Roadside Assistance

At a glance

BMW Roadside Assistance can be contacted if assistance is needed in the event of a breakdown.

Roadside Assistance can also be contacted via a Check Control message, refer to page [83](#).

Starting Roadside Assistance without BMW Assist or TeleService

1. "BMW Assist" or "ConnectedDrive"
2. "Roadside Assistance"

The Roadside Assistance number is displayed. If the mobile phone is paired, a connection is established to Roadside Assistance.



Starting Roadside Assistance with BMW Assist or TeleService

General information

In vehicles equipped with TeleService, support is first offered by TeleService Diagnosis and then, if necessary, by TeleService Help.

1. "BMW Assist" or "ConnectedDrive"
2. "Roadside Assistance"
3. "Start service"

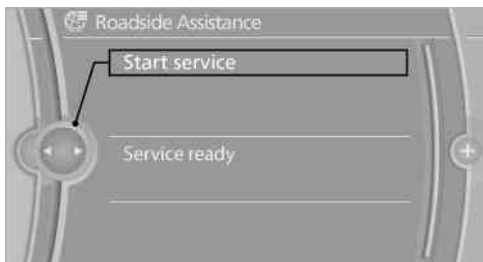

TeleService Diagnosis

TeleService Diagnosis enables the wireless transmission of detailed vehicle data that are important for vehicle diagnosis. These data are transmitted automatically.

After the data are transmitted, the voice connection to Roadside Assistance is re-established.

BMW Online

At a glance

A business search can be opened via BMW Online.

License conditions

This product contains NetFront Browser software of ACCESS Co., Ltd. Copyright © 2007 ACCESS Co., Ltd. All rights reserved.

NetFront is a trademark or registered trademark of ACCESS CO., LTD., in Japan and other countries.

This software is based in part on the work of the Independent JPEG Group.

Requirements

- ▶ Subscription to the optional Convenience Plan.
- ▶ The date setting on the Control Display is current.
- ▶ The vehicle is located within wireless network coverage.

Starting BMW Online

1. "BMW Assist" or "ConnectedDrive"
2. "BMW Online"



3. If necessary, "OK".

The BMW Online home page is displayed.

Operating BMW Online

To start a search:

- ▷ Turn the controller to highlight an element.
- ▷ Press the controller to display an element.

Opening the start page

1. Open "Options".
2. "Display start page"

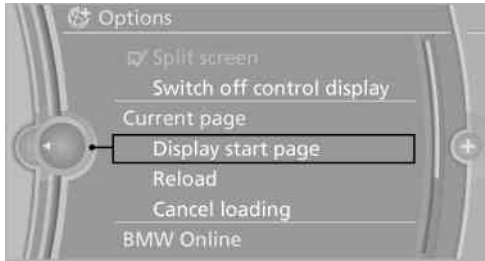

Loading a new page

1. Open "Options".
2. "Reload"

Cancel

1. Open "Options".
2. "Cancel loading"

Customer Relations

At a glance

Contact Customer Relations for information on all aspects of your vehicle.

Calling Customer Relations

Vehicle not equipped with BMW Assist or TeleService

1. "BMW Assist" or "ConnectedDrive"
2. "Customer Relations"

The Customer Relations phone number is displayed. If the mobile phone is paired, a connection is established to Customer Relations.

Vehicle equipped with BMW Assist or TeleService

1. "BMW Assist" or "ConnectedDrive"
2. "Customer Relations"
3. "Start service"

Service Request

At a glance

Sends information to your service partner to request the arrangement of a service appointment. The TeleService data is transmitted during a Service Request. If possible, your service partner will establish contact with you.

Starting a Service Request

1. "BMW Assist" or "ConnectedDrive"
2. "Service Request"
3. "Start service"



A Service Request can be started via a Check Control message, refer to page 83.

Automatic Service Request

The TeleService data necessary for servicing the vehicle are automatically sent to your service partner prior to the service deadline. If possible, the service partner will contact you and a service appointment can be arranged.

To check when your service partner was notified:

1. "Vehicle Info"
2. "Vehicle status"

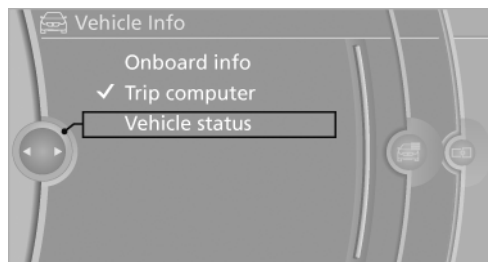

3. Open "Options".
4. "Last Service Request"

Services status

Displaying available services

Display of all services available in the vehicle.

1. "BMW Assist" or "ConnectedDrive"
2. "Service Status"
3. "Available services"

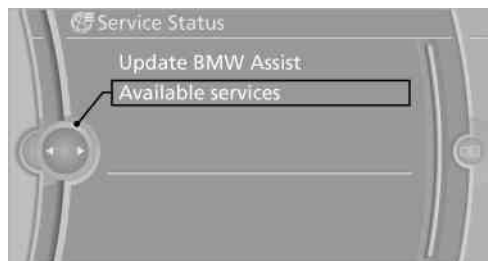

Updating BMW Assist

Manual update of TeleService and BMW Assist.

1. "BMW Assist" or "ConnectedDrive"
2. "Service Status"
3. "Update BMW Assist"

Data transfer

During the updating of BMW services, display the status of the data transfer.

1. "BMW Assist" or "ConnectedDrive"
2. Open "Options".
3. "Data transfer"

Apps

At a glance

Certain software applications of a suitable cell phone can be integrated in the vehicle. These software applications are displayed on the Control Display.

They are operated via iDrive.

Requirements

- ▷ The mobile phone is suitable.
- ▷ The mobile phone operating system supports the software applications of Apps.
- ▷ Software applications are installed on the cell phone and ready to use.
- ▷ Corresponding mobile wireless contract. Any additionally incurred costs are not a part of Apps.
- ▷ Use only BMW approved software applications; otherwise, it may result in malfunctions.

Information about suitable cell phones, available software applications and their installation can be found at www.bmw.com/connectivity or at the service center.



Create the entries.

Make entries only when traffic and road conditions allow. Otherwise, the vehicle occupants and other road users may be put in danger because of the distraction from driving.

For reasons of safety, some software applications are usable only while the vehicle is stationary. ◀

Operating Apps

1. Connect the cell phone via the snap-in adapter or via the USB audio interface.
2. "ConnectedDrive"
3. Select the desired software application.

Displaying status

Information about the currently available software applications can be displayed.

1. "ConnectedDrive"
2. "BMW apps"

PlugIn

Selected functions of the cell phone are displayed on the Control Display. They can be operated via iDrive.

1. Connect cell phone via the snap-in adapter.
2. "ConnectedDrive"
3. "PlugIn"
4. "Activate PlugIn"
5. Navigate to the displayed functions via the controller and select, for example, a desired category or track.



Press button to switch within the cell phone functions to a higher level or back.



Press button twice to switch back to the main menu.

Notes

- ▷ The ranges of Apps that can be displayed on the Control Display depend on the range of installed software applications on the mobile phone.
- ▷ The data transmission of the software applications from the cell phone to the vehicle can last some time. Some software applications depend on the speed of the available Internet connection of the cell phone.

- ▷ Some mobile phones cannot simultaneously use Apps and the Bluetooth hands-free system.

If necessary, restart the software application on the cell phone after a phone conversation.





Mobility

In order to always ensure your mobility, you will find important information on operating fluids, wheels and tires, maintenance and Roadside Assistance in the following.

Refueling

Vehicle equipment

This chapter describes all series equipment as well as country-specific and special equipment offered for this model series. Therefore, it also describes equipment that may not be found in your vehicle, for instance due to the selected special equipment or the country version. This also applies to safety-related functions and systems.

General information

Refuel promptly

At the latest, refuel at a range of 30 miles/50 km; otherwise, the engine function is not ensured and damage may occur. ◀

For Diesel engines

The filler neck is designed for refueling at diesel fuel pumps.

Notes

 Switch off the engine before refueling
Always switch off the engine before refueling; otherwise, fuel cannot be added to the tank and a message will be displayed. ◀

-  Observe when handling fuel
- ▶ Take all precautionary measures and observe all applicable regulations when handling fuel.
 - ▶ Do not carry any spare fuel containers in your vehicle. They can develop a leak and cause an explosion or cause a fire in the event of an accident. ◀

Fuel cap

Opening

1. Briefly press the rear edge of the fuel filler flap.

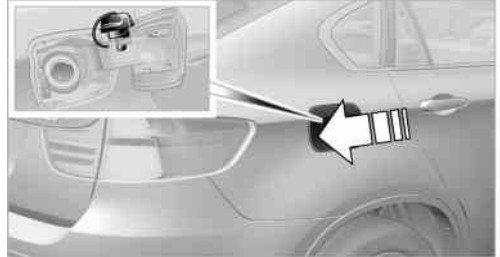

2. Turn the fuel cap counterclockwise.
3. Place the fuel cap in the bracket attached to the fuel filler flap.

Closing

1. Fit the fuel cap and turn it clockwise until you clearly hear a click.
2. Close the fuel filler flap.

 Do not pinch the retaining strap
Do not pinch the retaining strap attached to the cap; otherwise, the cap cannot be closed properly and fuel vapors can escape. ◀

A message is displayed if the cap is loose or missing.

Manually unlocking fuel filler flap

In the event of a malfunction, the fuel filler flap can be released manually:

1. Open the right-hand side panel in the cargo area.

2. Pull the knob with the gas pump symbol.

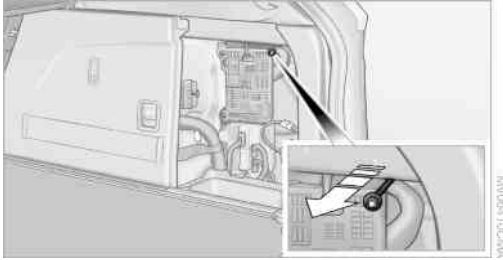

Observe the following when refueling

When refueling, insert the filler nozzle completely into the filler pipe. Lifting up the fuel pump nozzle during refueling causes:

- ▷ Premature pump shutoff.
- ▷ Reduced efficiency in the fuel-vapor recovery system.

The fuel tank is full when the filler nozzle clicks off the first time.



Do not overfill the fuel tank

Do not overfill the fuel tank; otherwise, escaping fuel may harm the environment or damage the vehicle. ◀



Handling fuels

Follow the safety instructions provided at gas stations; otherwise, there is a danger of personal injury and property damage. ◀

Fuel tank capacity

Approx. 22.5 US gallons/85 liters, including the reserve capacity of approx. 2.1 US gallons/8 liters.

X5 xDrive50i/X6 xDrive50i: reserve capacity of approx. 3.2 gallons/12 liters.

Fuel

Vehicle equipment

This chapter describes all series equipment as well as country-specific and special equipment offered for this model series. Therefore, it also describes equipment that may not be found in your vehicle, for instance due to the selected special equipment or the country version. This also applies to safety-related functions and systems.

Fuel quality

Gasoline

For the best fuel economy, the gasoline should be sulfur-free or very low in sulfur content.

Do not use fuels that are labeled at the fuel pump as containing metals.

 Only refuel with lead-free gasoline without metal additives

Do not refuel with leaded gasoline or gasoline with metal additives, e. g., manganese or iron; otherwise, the catalytic converter and other components will be permanently damaged. ◀

Fuels with a maximum ethanol content of 10 %, i.e., E10, may be used for refueling.

The ethanol should fulfill the following quality standards:

US: ASTM 4806-xx

CAN: CGSB-3.511-xx

xx: always adhere to the currently applicable standard.

 Do not refuel with ethanol E85
Do not refuel with E85, i.e., fuel with an ethanol content of 85 %, or with Flex Fuel, as this would damage the engine and fuel supply system. ◀

The engine is knock controlled. Therefore, you can refuel with different gasoline qualities.

Recommended fuel quality

BMW recommends AKI 91.

Minimum fuel grade

BMW recommends AKI 89.



Minimum fuel grade

Do not fill up with fuel below the specified minimum quality; otherwise, the engine may not run properly. ◀

If you use gasoline with this minimum AKI Rating, the engine may produce knocking sounds when starting at high outside temperatures. This has no effect on the engine life.



Minimum fuel grade

The use of poor-quality fuels may result in harmful engine deposits or damage. Additionally, problems relating to drivability, starting and stalling, especially under certain environmental conditions such as high ambient temperature and high altitude, may occur.

If drivability problems are encountered, we recommend switching to a high quality gasoline brand and a higher octane grade — AKI number — for a few tank fills. To avoid harmful engine deposits, it is highly recommended to purchase gasoline from BP or Top Tier retailers.

Failure to comply with these recommendations may result in the need for unscheduled maintenance. ◀

Diesel

Ultra-Low Sulfur Diesel

The engine of your BMW is designed for diesel with a low sulfur content:

Ultra-low sulfur diesel ASTM D 975-xx.

xx: always adhere to the currently applicable standard.

! Only refuel with ultra-low sulfur diesel.

The percentage of biodiesel in the fuel must not exceed 5%, referred to as B5. Do not refuel with gasoline. If the vehicle has been refueled with incorrect fuel such as gasoline, do not start the engine; otherwise, there is a danger of engine damage. ◀

If you added the wrong fuel, contact the service center.

If the nozzle cannot be inserted into the fuel filler pipe of your BMW, please check to make sure that you are refueling with a diesel fuel pump and whether this is equipped with a diesel nozzle.

In the event the Ultra-Low Sulfur Diesel fuel cannot be fully inserted into the fuel filler neck, please contact BMW Roadside Assistance for instructions on how to add fuel. For more information on BMW Roadside Assistance, refer to page 301.

Winter diesel

To ensure that the diesel engine remains operational in the winter, use winter diesel.

It is available at gas stations during winter months.

The standard fuel filter heating prevents the supply of fuel from stalling during driving.

! Do not use diesel additives

Do not use additives, including gasoline; otherwise, engine damage may occur. ◀

BMW recommends BP fuels 

BMW X5 with BMW Advanced Diesel

The concept

BMW Advanced Diesel reduces nitrogen oxides in the diesel exhaust of your vehicle by injecting the reducing agent diesel exhaust fluid into the exhaust line. In the catalytic converter, a chemical reaction occurs that minimizes nitrogen oxides.

In order to be able to start the engine in the usual way, there must be a sufficient supply of diesel exhaust fluid in the separate reservoir.

System heating

In order to bring the system to operating temperature after a cold start of the engine, the automatic transmission shifts into the next higher gear at a later point.

Reserve display

A display in the instrument panel informs you about the remaining distance can be covered with the amount of fuel currently in the tank.

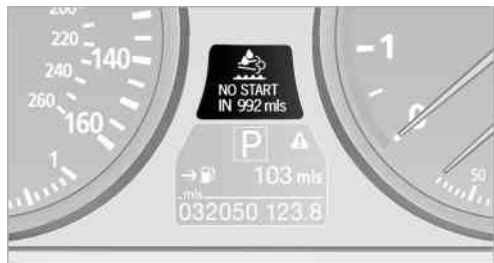

The reserve display appears approx. 1,000 miles/1,600 km before the tank is empty.

As soon as the reserve display has appeared in the instrument panel, have the diesel exhaust fluid refilled to prevent the engine from being unable to restart.

Diesel exhaust fluid at minimum

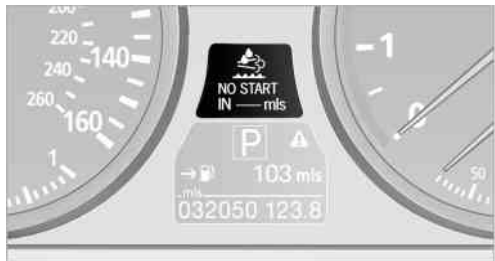

Even with a display of -- mls, the engine will continue to run, provided that it is not switched off, and all other operating requirements are met, e.g. sufficient fuel.

 No engine start

Do not drive until the displayed remaining distance runs out. Otherwise, it may not be possible to restart the engine. ◀

Incorrect fueling



The warning lamp lights up:

The reservoir has been filled with an incorrect fluid.

Please contact your service center.

Have diesel exhaust fluid refilled

This exhaust fluid is refilled by your service center during regular maintenance. If you adhere to this maintenance schedule, it is usually not necessary to refill any fluids between the maintenance dates.

Under certain circumstances, for example, due to a particularly sporty driving style or operation of the vehicle at high altitudes, it may be necessary to refill fluids between maintenance dates.

As soon as the reserve display has appeared in the instrument panel, have the diesel exhaust fluid refilled to prevent the engine from being unable to restart.

You can have the fluid refilled by a service center.

Diesel exhaust fluid at low temperatures

Due to its physical properties, it may be necessary to replenish the level of diesel exhaust fluid at temperatures below +23 °F/ -5 °C, even between the regular maintenance dates.

If the fluid needs to be refilled, this will be indicated with the reserve display in the instrument cluster, refer to page 265.

Only refill the diesel exhaust fluid yourself in exceptional circumstances

To be able to reach the nearest service center with your vehicle, you may refill the diesel exhaust fluid yourself, making sure to heed the warning notices specified below.

 Handling diesel exhaust fluid

Do not allow diesel exhaust fluid to come into contact with you. This can lead to skin and eye irritation. Wear protective goggles and gloves as needed. Follow the safety instructions on the bottle. When opening the bottle or reservoir, pungent smelling vapors can escape. Before refilling, close the vehicle completely so that the vapors do not get into the interior of the vehicle. When handling diesel exhaust fluid in enclosed spaces, make sure to have sufficient ventilation. After handling diesel exhaust fluid, wash hands thoroughly. Failure to do so may lead to irritation, for instance, due to inadvertent contact with the eyes. If eye irritation occurs, immediately rinse eyes with ample water and contact a doctor if necessary. If diesel exhaust fluid comes into contact with surfaces of your vehicle, rinse the affected surfaces with water or else damage may occur. Keep diesel exhaust fluid out of reach of children. ◀

Suitable diesel exhaust fluid

- ▶ Preferred: BMW Diesel Exhaust Fluid. This bottle and its special adapter permit convenient refilling with diesel exhaust fluid.
- ▶ Alternative: NOx reduction agent AUS 32

Diesel exhaust fluid can be obtained from your service center.

Refilling quantity

Refilling quantity at the start of the reserve display:

Approx. 0.75 gallons/2.7 liters

Open reservoir for diesel exhaust fluid

1. Open the hood, refer to page 282.
2. Fit the releasing tool from the tool kit, refer to page 288, into place and open the lock, see arrow.

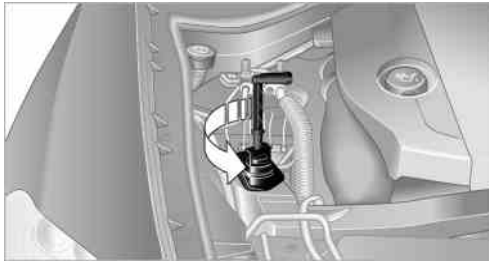

Refilling BMW diesel exhaust fluid

1. Set bottle into place and rotate until it comes into contact with the stop, refer to arrow.

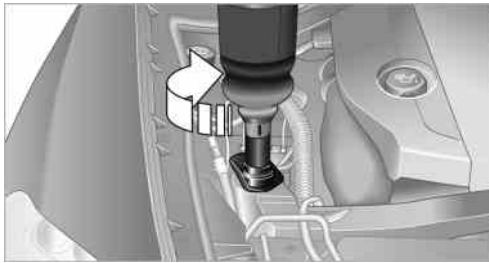

2. Press bottle down, refer to arrow.

The reservoir of the vehicle is filled.

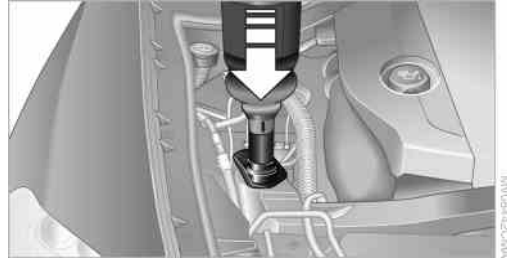

3. The reservoir is full when the fill level in the bottle stops changing. It is not possible to overfill.
Pull bottle back, refer to arrow, and unscrew it.

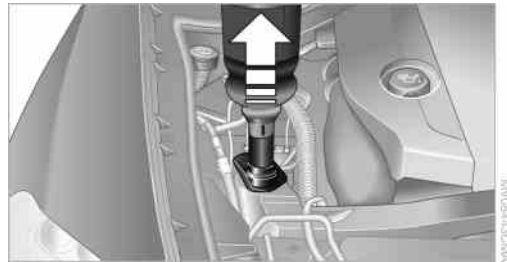

Closing reservoir

After the reservoir is filled, close it again with the releasing tool.

After refilling diesel exhaust fluid

Incorrect fluid



Incorrect fluids

After refilling with the incorrect fluid, e.g., antifreeze for windshield wiper fluid, do not start the engine because this could result in a fire hazard. ◀

Contact your service center.

Bottle disposal



Diesel exhaust fluid bottles can be disposed of by your service center.

Only dispose of empty bottles in your household garbage if the local legal regulations permit it.

Reserve display

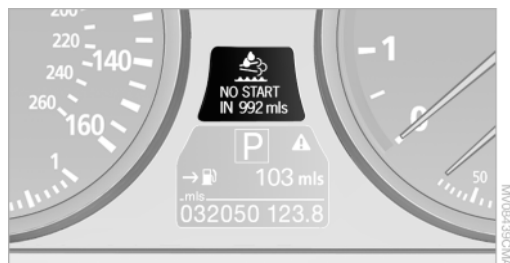

After refilling, the reserve continues to appear after the engine is restarted. After the vehicle has been driven for a few more minutes, this display will disappear.

Wheels and tires

Vehicle equipment

This chapter describes all series equipment as well as country-specific and special equipment offered for this model series. Therefore, it also describes equipment that may not be found in your vehicle, for instance due to the selected special equipment or the country version. This also applies to safety-related functions and systems.

Tire inflation pressure

Safety information

It is not merely the tires' service life, but also driving comfort and, to a great extent, driving safety that depend on the condition of the tires and the maintenance of the specified tire pressure.

Checking the pressure

Only check the tire inflation pressure when the tires are cold. This means after a maximum of 1.25 miles/2 km driving or when the vehicle has been parked for at least 2 hours. When the tires are warm, the tire inflation pressure is higher.



Check the tire inflation pressure regularly

Check the tire inflation pressure regularly and correct it if necessary, even in the compact wheel: usually twice monthly or before embarking on a long trip. If you fail to observe this precaution, you may be driving on tires with incorrect tire pressures, a condition that may not only compromise your vehicle's driving stability, but also lead to tire damage and the risk of an accident.

Do not drive with depressurized or flat tires, except for run-flat tires. A flat tire will seriously impair your vehicle's handling and braking response. Attempts to drive on a flat tire can lead to a loss of control over the vehicle. ◀

After adjusting the tire inflation pressure, reset the Tire Pressure Monitor, refer to page 97, or reinitialize the Flat Tire Monitor, refer to page 95.

Pressure specifications

The tables below provide all the correct inflation pressures for the specified tire sizes at ambient temperature.

The inflation pressures apply to the tire sizes approved and tire brands recommended by BMW; a list of these is available from your service center.

For correct identification of the right tire inflation pressures, observe the following:

- ▷ Tire sizes of your vehicle.
- ▷ Maximum allowable driving speed.

Tire inflation pressures for driving up to 100 mph or 160 km/h

For normal driving up to 100 mph/160 km/h, adjust pressures to the respective tire inflation pressures listed on the following pages in the column for traveling speeds up to 100 mph/160 km/h to achieve optimum driving comfort.

These tire inflation pressures can also be found on the driver's side door pillar when the driver's door is open.



Tire inflation pressures for driving above 100 mph or 160 km/h



Adjust the tire inflation pressures

To drive at maximum speeds in excess of 100 mph/160 km/h, adjust pressures to the respective tire inflation pressures listed on the following pages in the column for traveling speeds including those exceeding 100 mph or 160 km/h. Otherwise, tire damage and accidents could occur. ◀



Do not exceed the maximum permissible speed

The maximum permissible speed for these tire pressures is 100 mph/160 km/h Do not exceed this speed; otherwise, tire damage and accidents could occur. ◀



Observe all national and local maximum speed limits; otherwise, violations of the laws could occur.

Tire inflation pressures X5 xDrive35i/X5 xDrive35d with two rows of seats

Tire size	Pressure specifications in bar/PSI			
	Traveling speeds of up to 100 mph/160 km/h		Traveling speeds including those exceeding 100 mph/160 km/h	
All pressure specifications in the table are indicated in bar/PSI with cold tires. Cold = ambient temperature				
Compact wheel: T 155/90 D 18 113 M T 155/80 R 19 114 M	Speeds of up to 50 mph/80 km/h 4.2/60			
Without Sport Package:				
255/55 R 18 109 H M+S XL A/S RSC	2.2/32	2.5/36	2.4/35	2.8/41
255/55 R 18 109 H M+S XL RSC				
255/50 R 19 107 H M+S XL A/S RSC	2.2/32	2.6/38	2.4/35	2.9/42
255/50 R 19 107 H M+S XL RSC				
Front: 255/50 R 19 107 V XL RSC	2.2/32	-	2.4/35	-
Rear: 285/45 R 19 111 V XL RSC	-	2.4/35	-	2.6/38



Tire size	Pressure specifications in bar/PSI			
Front: 275/40 R 20 106 W XL RSC	2.3/33	-	2.4/35	-
Rear: 315/35 R 20 110 W XL RSC	-	2.4/35	-	2.6/38
Front: 285/35 R 21 105 W XL RSC	2.3/33	-	2.5/36	-
Rear: 325/30 R 21 108 W XL RSC	-	2.6/38	-	2.8/41
Front: 275/40 R 20 106 VM+S XL RSC	2.3/33	-	2.4/35	-
Rear: 315/35 R 20 110 V M+S XL RSC	-	2.4/35	-	2.7/39
With Sport Package:				
255/55 R 18 109 H M+S XL RSC	2.2/32	2.5/36	2.4/35	2.8/41
255/50 R 19 107 H M+S XL RSC	2.2/32	2.6/38	2.4/35	2.9/42
Front: 255/50 R 19 107 V XL RSC	2.2/32	-	2.7/39	-
Rear: 285/45 R 19 111 V XL RSC	-	2.4/35	-	2.9/42
Front: 275/40 R 20 106 W XL RSC	2.3/33	-	2.6/38	-
Rear: 315/35 R 20 110 W XL RSC	-	2.4/35	-	2.8/41
Front: 285/35 R 21 105 W XL RSC	2.3/33	-	2.6/38	-
Rear: 325/30 R 21 108 W XL RSC	-	2.6/38	-	3.1/45
Front: 275/40 R 20 106 VM+S XL RSC	2.3/33	-	2.7/39	-
Rear: 315/35 R 20 110 V M+S XL RSC	-	2.4/35	-	3.0/44

Tire inflation pressures X5 xDrive50i with two rows of seats

Tire size	Pressure specifications in bar/PSI	
	Traveling speeds of up to 100 mph/160 km/h	Traveling speeds including those exceeding 100 mph/160 km/h
All pressure specifications in the table are indicated in bar/PSI with cold tires. Cold = ambient temperature		
	Compact wheel: T 155/90 D 18 113 M T 155/80 R 19 114 M	Speeds of up to 50 mph/80 km/h 4.2/60
Without Sport Package:		



Tire size	Pressure specifications in bar/PSI			
255/55 R 18 109 H M+S XL A/S RSC	2.2/32	2.5/36	2.4/35	2.8/41
255/55 R 18 109 H M+S XL RSC				
255/50 R 19 107 H M+S XL A/S RSC	2.2/32	2.7/39	2.5/36	3.0/44
255/50 R 19 107 H M+S XL RSC				
Front: 255/50 R 19 107 W XL RSC	2.2/32	-	2.5/36	-
Rear: 285/45 R 19 111 W XL RSC	-	2.4/35	-	2.6/38
Front: 275/40 R 20 106 W XL RSC	2.3/33	-	2.4/35	-
Rear: 315/35 R 20 110 W XL RSC	-	2.5/36	-	2.7/39
Front: 285/35 R 21 105 Y XL RSC	2.3/33	-	2.5/36	-
Rear: 325/30 R 21 108 Y XL RSC	-	2.7/39	-	2.8/41
Front: 275/40 R 20 106 V M+S XL RSC	2.3/33	-	2.4/35	-
Rear: 315/35 R 20 110 V M+S XL RSC	-	2.5/36	-	2.7/39
With Sport Package:				
255/55 R 18 109 H M+S XL RSC	2.2/32	2.5/36	2.4/35	2.8/41
255/50 R 19 107 H M+S XL RSC	2.2/32	2.7/39	2.5/36	3.0/44
Front: 255/50 R 19 107 W XL RSC	2.2/32	-	2.8/41	-
Rear: 285/45 R 19 111 W XL RSC	-	2.4/35	-	3.1/45
Front: 275/40 R 20 106 W XL RSC	2.3/33	-	2.9/42	-
Rear: 315/35 R 20 110 W XL RSC	-	2.5/36	-	3.2/46
Front: 285/35 R 21 105 Y XL RSC	2.3/33	-	2.6/38	-
Rear: 325/30 R 21 108 Y XL RSC	-	2.7/39	-	3.1/45
Front: 275/40 R 20 106 V M+S XL RSC	2.3/33	-	2.9/42	-
Rear: 315/35 R 20 110 V M+S XL RSC	-	2.5/36	-	3.2/46

Tire inflation pressures X5 xDrive35i/X5 xDrive35d with three rows of seats

Tire size	Pressure specifications in bar/PSI			
	Traveling speeds of up to 100 mph/160 km/h		Traveling speeds including those exceeding 100 mph/160 km/h	
All pressure specifications in the table are indicated in bar/PSI with cold tires. Cold = ambient temperature				
Without Sport Package:				
255/55 R 18 109 H M+S XL A/S RSC	2.3/33	2.8/41	2.6/38	3.1/45
255/55 R 18 109 H M+S XL RSC				
255/50 R 19 107 H M+S XL A/S RSC	2.5/36	3.0/44	2.8/41	3.3/48
255/50 R 19 107 H M+S XL RSC				
Front: 255/50 R 19 107 V XL RSC	2.2/32	-	2.4/35	-
Rear: 285/45 R 19 111 V XL RSC	-	2.6/38	-	2.9/42
Front: 275/40 R 20 106 W XL RSC	2.3/33	-	2.4/35	-
Rear: 315/35 R 20 110 W XL RSC	-	2.7/39	-	2.9/42
Front: 285/35 R 21 105 W XL RSC	2.4/35	-	2.6/38	-
Rear: 325/30 R 21 108 W XL RSC	-	2.9/42	-	3.1/45
Front: 275/40 R 20 106 VM+S XL RSC	2.3/33	-	2.4/35	-
Rear: 315/35 R 20 110 V M+S XL RSC	-	2.7/39	-	2.9/42
With Sport Package:				
255/55 R 18 109 H M+S XL RSC	2.3/33	2.8/41	2.6/38	3.1/45
255/50 R 19 107 H M+S XL RSC	2.5/36	3.0/44	2.8/41	3.3/48
Front: 255/50 R 19 107 V XL RSC	2.2/32	-	2.8/41	-
Rear: 285/45 R 19 111 V XL RSC	-	2.6/38	-	3.3/48
Front: 275/40 R 20 106 W XL RSC	2.3/33	-	2.8/41	-
Rear: 315/35 R 20 110 W XL RSC	-	2.7/39	-	3.3/48

Tire size	Pressure specifications in bar/PSI			
Front: 285/35 R 21 105 W XL RSC	2.4/35	-	2.9/42	-
Rear: 325/30 R 21 108 W XL RSC	-	2.9/42	-	3.4/49
Front: 275/40 R 20 106 V M+S XL RSC	2.3/33	-	2.8/41	-
Rear: 315/35 R 20 110 V M+S XL RSC	-	2.7/39	-	3.3/48

Tire inflation pressures X5 xDrive50i with three rows of seats

Tire size	Pressure specifications in bar/PSI			
	Traveling speeds of up to 100 mph/160 km/h		Traveling speeds including those exceeding 100 mph/160 km/h	
All pressure specifications in the table are indicated in bar/PSI with cold tires. Cold = ambient temperature				

Without Sport Package:



255/55 R 18 109 H M+S XL A/S RSC	2.3/33	2.8/41	2.6/38	3.1/45
255/55 R 18 109 H M+S XL RSC				
255/50 R 19 107 H M+S XL A/S RSC	2.5/36	3.0/44	2.8/41	3.3/48
255/50 R 19 107 H M+S XL RSC				
Front: 255/50 R 19 107 W XL RSC	2.2/32	-	2.4/35	-
Rear: 285/45 R 19 111 W XL RSC	-	2.6/38	-	2.9/42
Front: 275/40 R 20 106 W XL RSC	2.3/33	-	2.4/35	-
Rear: 315/35 R 20 110 W XL RSC	-	2.7/39	-	2.9/42
Front: 285/35 R 21 105 Y XL RSC	2.4/35	-	2.6/38	-
Rear: 325/30 R 21 108 Y XL RSC	-	2.9/42	-	3.1/45
Front: 275/40 R 20 106 V M+S XL RSC	2.3/33	-	2.4/35	-
Rear: 315/35 R 20 110 V M+S XL RSC	-	2.7/39	-	2.9/42

With Sport Package:



255/55 R 18 109 H M+S XL RSC	2.3/33	2.8/41	2.6/38	3.1/45
255/50 R 19 107 H M+S XL RSC	2.5/36	3.0/44	2.8/41	3.3/48

Tire size	Pressure specifications in bar/PSI			
Front: 255/50 R 19 107 W XL RSC	2.2/32	-	2.8/41	-
Rear: 285/45 R 19 111 W XL RSC	-	2.6/38	-	3.3/48
Front: 275/40 R 20 106 W XL RSC	2.3/33	-	2.9/42	-
Rear: 315/35 R 20 110 W XL RSC	-	2.7/39	-	3.4/49
Front: 285/35 R 21 105 Y XL RSC	2.4/35	-	2.8/41	-
Rear: 325/30 R 21 108 Y XL RSC	-	2.9/42	-	3.2/46
Front: 275/40 R 20 106 VM+S XL RSC	2.3/33	-	2.9/42	-
Rear: 315/35 R 20 110 V M+S XL RSC	-	2.7/39	-	3.4/49

Tire inflation pressure X6 xDrive35i

Tire size	Pressure specifications in bar/PSI			
	Traveling speeds of up to 100 mph/160 km/h		Traveling speeds including those exceeding 100 mph/160 km/h	
All pressure specifications in the table are indicated in bar/PSI with cold tires. Cold = ambient temperature				
	255/50 R 19 107 H M+S XL A/S RSC	2.2/32	2.4/35	2.5/36
255/50 R 19 107 H M+S XL RSC				
255/50 R 19 107 V M+S XL RSC				
Front: 255/50 R 19 107 V XL RSC	2.2/32	-	2.5/36	-
Rear: 285/45 R 19 111 V XL RSC	-	2.2/32	-	2.6/38
Front: 275/40 R 20 106 W XL RSC	2.2/32	-	2.5/36	-
Rear: 315/35 R 20 110 W XL RSC	-	2.2/32	-	2.5/36
Front: 285/35 R 21 105 W XL RSC	2.2/32	-	2.6/38	-
Rear: 325/30 R 21 108 W XL RSC	-	2.3/33	-	2.7/39
Front: 275/40 R 20 106 VM+S XL RSC	2.2/32	-	2.5/36	-
Rear: 315/35 R 20 110 V M+S XL RSC	-	2.2/32	-	2.7/39
Compact wheel:	Speeds of up to 50 mph/80 km/h			
T 155/90 D 18 113 M	4.2/60			
T 155/80 R 19 114 M				

Tire inflation pressures for X6 xDrive50i

Tire size	Pressure specifications in bar/PSI			
	Traveling speeds of up to 100 mph/160 km/h		Traveling speeds including those exceeding 100 mph/160 km/h	
All pressure specifications in the table are indicated in bar/PSI with cold tires. Cold = ambient temperature				
	255/50 R 19 107 H M+S XL A/S RSC	2.3/33	2.5/36	2.8/41
255/50 R 19 107 H M+S XL RSC				
255/50 R 19 107 V M+S XL RSC				
Front: 255/50 R 19 107 W XL RSC	2.5/36	-	2.9/42	-
Rear: 285/45 R 19 111 W XL RSC	-	2.5/36	-	2.9/42
Front: 275/40 R 20 106 W XL RSC	2.5/36	-	3.0/44	-
Rear: 315/35 R 20 110 W XL RSC	-	2.5/36	-	3.0/44
Front: 285/35 R 21 105 W XL RSC	2.5/36	-	3.1/45	-
Rear: 325/30 R 21 108 W XL RSC	-	2.5/36	-	3.1/45
Front: 275/40 R 20 106 V M+S XL RSC	2.5/36	-	3.0/44	-
Rear: 315/35 R 20 110 V M+S XL RSC	-	2.5/36	-	3.0/44
Compact wheel:	Speeds of up to 50 mph/80 km/h			
T 155/90 D 18 113 M	4.2/60			
T 155/80 R 19 114 M				

Tire identification marks

Knowledge of the labeling on the side of the tire makes it easier to identify and choose the right tires.

Tire size

Example: 255/55 R 19 107 V

255: nominal width in mm

55: aspect ratio in %

R: radial tire code

19: rim diameter in inches

107: load rating, not for ZR tires

V: speed rating, before the R on ZR tires

Speed letter

Q = up to 100 mph/160 km/h

T = up to 118 mph/190 km/h

H = up to 131 mph/210 km/h

V = up to 150 mph/240 km/h

W = up to 167 mph/270 km/h

Y = up to 186 mph/300 km/h

Tire Identification Number

Tires with DOT codes meet the guidelines of the U.S. Department of Transportation.

DOT code:

DOT xxxx xxx 1012

xxxx: manufacturer code for the tire brand

xxx: tire size and tire design

1012: tire age

Tire age

The tire manufacturing date is contained in the tire identification mark: DOT ... 1012 means that the tire was manufactured in the week 10 of 2012.

BMW recommends that you replace all tires after 6 years at most, even if some tires may last for 10 years.

Uniform Tire Quality Grading

Quality grades can be found where applicable on the tire sidewall between tread shoulder and maximum section width. For example:

Treadwear 200 Traction AA

Temperature A

DOT Quality Grades

Treadwear

Traction AA A B C

Temperature A B C



Conform to Federal Safety Requirements

All passenger car tires must conform to Federal Safety Requirements in addition to these grades. ◀

Treadwear

The treadwear grade is a comparative rating based on the wear rate of the tire when tested under controlled conditions on a specified government test course. For example, a tire graded 150 would wear one and one-half (1 1/2) times as well on the government course as a tire

graded 100. The relative performance of tires depends upon the actual conditions of their use, however, and may depart significantly from the norm due to variations in driving habits, service practices and differences in road characteristics and climate.

Traction

The traction grades, from highest to lowest, are AA, A, B, and C.

Those grades represent the tire's ability to stop on wet pavement as measured under controlled conditions on specified government test surfaces of asphalt and concrete. A tire marked C may have poor traction performance.

The traction grade assigned to this tire is based on straight-ahead braking traction tests, and does not include acceleration, cornering, hydroplaning, or peak traction characteristics.

Temperature

The temperature grades are A, the highest, B, and C, representing the tire's resistance to the generation of heat and its ability to dissipate heat when tested under controlled conditions on a specified indoor laboratory test wheel. Sustained high temperature can cause the material of the tire to degenerate and reduce tire life, and excessive temperature can lead to sudden tire failure. The grade C corresponds to a level of performance which all passenger car tires must meet under the Federal Motor Vehicle Safety Standard No. 109. Grades B and A represent higher levels of performance on the laboratory test wheel than the minimum required by law.



Temperature grade for this tire

The temperature grade for this tire is established for a tire that is properly inflated and not overloaded. Excessive speed, underinflation, or excessive loading, either separately or in combination, can cause heat buildup and possible tire failure. ◀

RSC – Run-flat tires

The symbol identifying run-flat tires is a circle with the letters RSC on the sidewall, refer to page 280.

M+S

Winter and all-season tires.

These have better winter properties than summer tires.

XL

Designation for specially reinforced tires.

Tire tread

Summer tires

Do not drive with a tire tread depth of less than 0.12 in/3 mm.

There is an increased danger of hydroplaning if the tread depth is less than 0.12 in/3 mm.

Winter tires

Do not drive with a tire tread depth of less than 0.16 in/4 mm.

Below a tread depth of 0.16 in/4 mm, tires are less suitable for winter operation.

Minimum tread depth

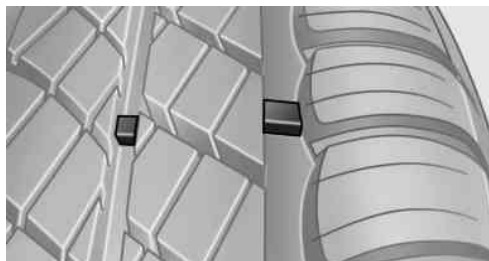

Wear indicators are distributed around the tire's circumference and have the legally required minimum height of 0.063 in/1.6 mm.

They are marked on the side of the tire with TWI, Tread Wear Indicator.

Tire damage

General information

Inspect your tires often for damage, foreign objects lodged in the tread, and tread wear.

Notes

Driving over rough or damaged road surfaces, as well as debris, curbs and other obstacles can cause serious damage to wheels, tires and suspension parts. This is more likely to occur with low-profile tires, which provide less cushioning between the wheel and the road. Be careful to avoid road hazards and reduce your speed, especially if your vehicle is equipped with low-profile tires.

Indications of tire damage or other vehicle defects:

- ▷ Unusual vibrations during driving.
- ▷ Unusual handling such as a strong tendency to pull to the left or right.

Damage can be caused by driving over curbs, road damage and similar situations.



In case of tire damage

If there are indications of tire damage, reduce your speed immediately and have the wheels and tires checked right away; otherwise, there is the increased risk of an accident.

Drive carefully to the next service center or tire shop.

If necessary, have the vehicle towed.

Otherwise, tire damage can present a life-threatening hazard to vehicle occupants and other road users. ◀



Repair of tire damage

For safety reasons, the manufacturer of your vehicle recommends that you do not have damaged tires repaired; they should be replaced. Otherwise, damage can occur as a result. ◀

Changing wheels and tires

Mounting

 Information on mounting tires

Have mounting and balancing performed only by a service center or tire specialist.

If this work is not carried out properly, there is the danger of subsequent damage and related safety hazards. ◀

Wheel and tire combination

Information on the right wheel and tire combination and rim version for your vehicle can be obtained from the service center.

Incorrect wheel and tire combinations impair the function of a variety of systems such as ABS or DSC.

To maintain good handling and vehicle response, use only tires with a single tread configuration from a single manufacturer.

Following tire damage, have the original wheel and tire combination remounted on the vehicle as soon as possible.

 Approved wheels and tires

The manufacturer of your vehicle recommends that you use only wheels and tires that have been approved for your particular vehicle model.

For example, despite having the same official size ratings, variations can lead to body contact and with it, the risk of severe accidents.

The manufacturer of your vehicle cannot evaluate non-approved wheels and tires to determine if they are suited for use, and therefore cannot ensure the operating safety of the vehicle if they are mounted. ◀

Wheels with electronics for TPM Tire Pressure Monitor

When mounting new tires or changing from summer to winter tires or vice versa, only use wheels with TPM electronics; otherwise, the

Tire Pressure Monitor will not be able to detect a flat tire, refer to page 97. Your service center will be glad to advise you.

Recommended tire brands

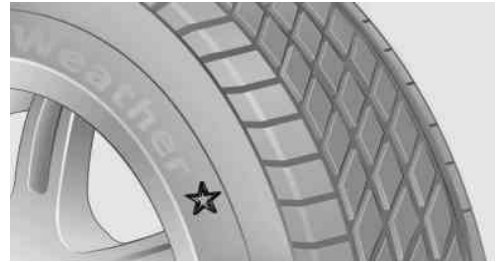

For each tire size, the manufacturer of your vehicle recommends certain tire brands. These can be identified by a star on the tire sidewall. With proper use, these tires meet the highest standards for safety and handling.

Retreaded tires

The manufacturer of your vehicle does not recommend the use of retreaded tires.

 Retreaded tires

Possibly substantial variations in the design and age of the tire casing structures can limit service life and have a negative impact on road safety. ◀

Winter tires

The manufacturer of your vehicle recommends winter tires for winter roads or at temperatures below +45 °F/+7 °C.

Although so-called all-season M+S tires do provide better winter traction than summer tires, they do not provide the same level of performance as winter tires.

Maximum speed of winter tires

If the maximum speed of the vehicle is higher than the permissible speed for the winter tires, then display a corresponding sign in the field of

vision. You can obtain this sign from the tire specialist or from your service center.



Maximum speed for winter tires

Do not exceed the maximum speed for the winter tires; otherwise, tire damage and accidents can occur. ◀

Run-flat tires

For your own safety, only use run-flat tires. Your service center will be glad to advise you.

Rotating wheels between axles

The manufacturer of your vehicle advises against swapping wheels between the front and rear axles.

This can impair the handling characteristics.

Rotating the tires is not permissible when using different types of tires.

Storage

Store wheels and tires in a cool, dry place with as little exposure to light as possible.

Always protect tires against all contact with oil, grease and fuels.

Do not exceed the maximum tire inflation pressure indicated on the side wall of the tire.

Run-flat tires

Label



RSC label on the tire sidewall.

The wheels are composed of special rims and tires that are self-supporting, to a limited degree.

The support of the sidewall allows the tire to remain drivable to a restricted degree in the event of a pressure loss.

Driving with a damaged tire:

- ▷ Flat Tire Monitor FTM, refer to page 95
- ▷ Tire Pressure Monitor TPM, refer to page 97

Snow chains

Only certain fine-link snow chains have been tested by BMW, classified as safe for use and recommended. Consult your service center for more information.

BMW X5: use only in pairs on the rear wheels, equipped with tires of the following size:

- ▷ 255/55 R 18
- ▷ 255/50 R 19

BMW X6: use only in pairs on rear wheels of size 255/50 R 19.

Observe the manufacturer's instructions when mounting snow chains. Do not exceed a speed of 30 mph/50 km/h when using snow chains.

Do not initialize the Flat Tire Monitor if snow chains are mounted; otherwise, the instrument might issue an incorrect reading.

When driving with snow chains, it can be beneficial to temporarily activate DTC, refer to page 104.

Engine compartment

Vehicle equipment

This chapter describes all series equipment as well as country-specific and special equipment offered for this model series. Therefore, it also

describes equipment that may not be found in your vehicle, for instance due to the selected special equipment or the country version. This also applies to safety-related functions and systems.

Important features in the engine compartment

BMW X5

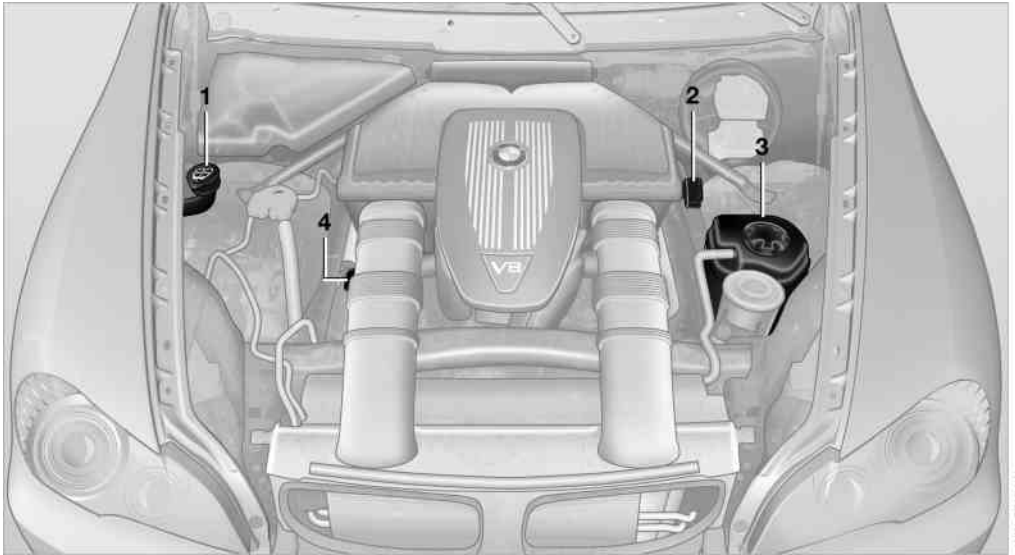

- | | |
|--|---|
| 1 Filler neck for washer fluid for the headlamp and window washer system 72 | 3 Coolant expansion tank 285 |
| 2 Starting aid terminal 302 | 4 Engine oil filler neck 284 |

BMW X6

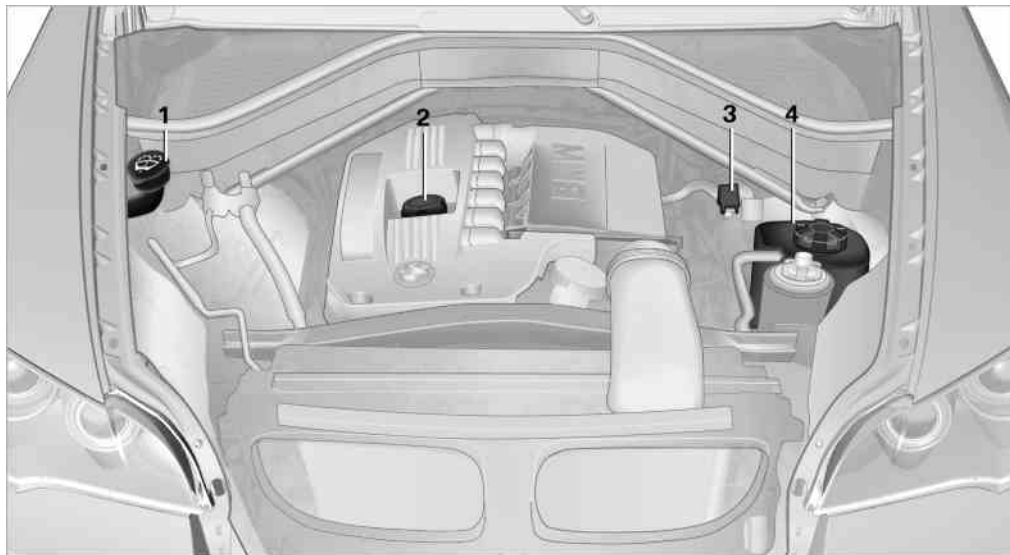

- | | |
|---|--|
| <p>1 Filler neck for the washer fluid for the head-lamp and window washer system 73</p> <p>2 Engine oil filler neck 284</p> | <p>3 Starting aid terminal 302</p> <p>4 Coolant expansion tank 285</p> |
|---|--|

Hood

Opening the hood



Working in the engine compartment

Never attempt to perform any service or repair operations on your vehicle without the necessary professional technical training.

If you are unfamiliar with the statutory guidelines, have any work on the vehicle performed only by a service center.

If this work is not carried out properly, there is the danger of subsequent damage and related safety hazards. ◀

1. Pull the lever.



- Press the release handle and open the hood.

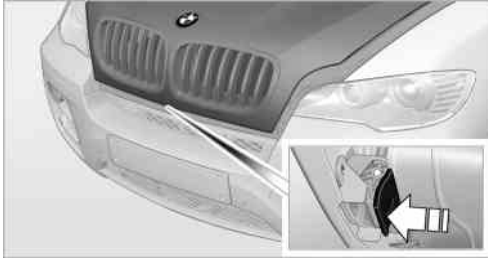

Closing the hood

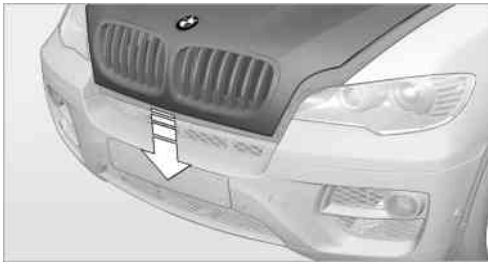

Drop the hood from a height of approx. 16 in/40 cm. It must be clearly heard to engage.

 Hood open when driving

If you see any signs that the hood is not completely closed while driving, pull over immediately and close it securely. ◀

 Danger of pinching

Make sure that the closing path of the hood is clear; otherwise, injuries may result. ◀

Engine oil

General information

Engine oil consumption depends on the driving style and the conditions of use. A highly sporty driving style, for example, results in considerably higher engine oil consumption.

Therefore, regularly check the engine oil level after refueling.

Checking the engine oil level

Your car is equipped with an electronic engine oil level check.

Requirements

- ▷ The engine must be running and warm after the vehicle has been driven for at least 6.2 miles/10 km.
- ▷ The vehicle is stopped or being driven on a level roadway.

Displaying the oil level

- "Vehicle Info"
- "Vehicle status"

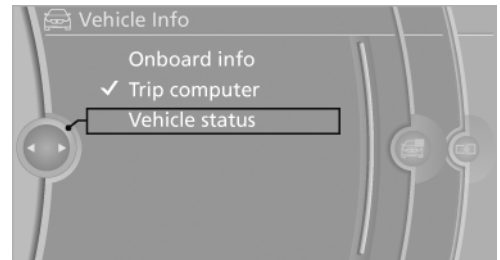

-  "Engine oil level"

Possible messages

- ▷ "Engine oil level OK"
- ▷ "Measurement not possible at this time."
- ▷ "Measuring engine oil level..."
 - Duration with the engine running: approx. 3 minutes.
 - Duration while driving: approx. 5 minutes.
 - If engine oil was added, it may take up to 30 minutes to obtain an oil level reading.
- ▷ "Engine oil level below minimum. Add 1 quart!"
 - Add a maximum quantity of 1 US quart/1 liter of engine oil at the next opportunity, refer also to Adding engine oil below.
- ▷ "Engine oil level too high! Have this checked."



Too much engine oil

Have the vehicle checked immediately; otherwise, surplus oil can lead to engine damage. ◀

- ▷ "Measurement inactive. Have this checked." Do not add engine oil. It is possible to continue driving. Note the newly calculated remaining mileage until the next oil service, refer to page 81. Have the system checked as soon as possible.

Adding engine oil

Filler neck

BMW X5

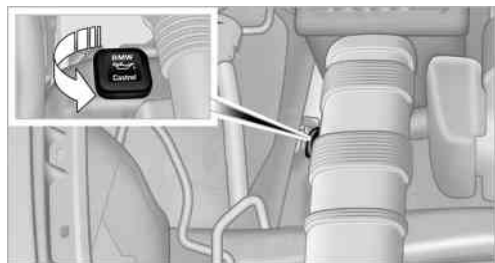

BMW X6

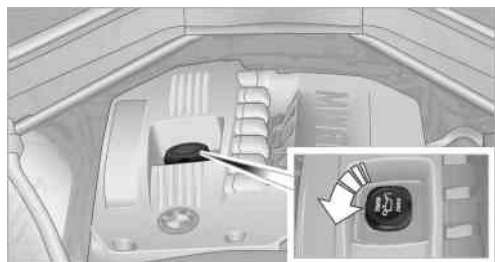

Add a maximum quantity of 1 US quart/1 liter of oil only after the corresponding message appears on the Control Display.



Add oil promptly

Add oil within the next 125 miles/200 km; otherwise, engine damage could result. ◀



Too much engine oil

Have the vehicle checked immediately; otherwise, surplus oil can lead to engine damage. ◀



Protect children

Keep oil, grease, etc., out of reach of children and heed the warnings on the containers to prevent health risks. ◀

Oil types for refilling

Notes



No oil additives

Do not use oil additives as these may cause engine damage. ◀



Viscosity classes of engine oils

When selecting an engine oil, ensure that the engine oil belongs to one of the SAE viscosity classes 0W-40, 0W-30, 5W-40, or 5W-30, or malfunctions or engine damage may occur. ◀

The engine oil quality is critical for the life of the engine.

Due to national regulations, some oil types are not available in every country.

Approved oil types

Gasoline engine

BMW High Performance SAE 5W-30

BMW Longlife-01

BMW Longlife-01 FE

Diesel engine

BMW Longlife-04

Further information on approved oil types can be obtained from the service center.

Alternative oil types

If the approved engine oils are not available, up to 1 US quart/liter of an oil with the following specification can be used:

Gasoline engine

API SM or a higher quality standard

Diesel engine

API ILSAC GF-5

Oil change

An oil change should be carried out by the service center only.

BMW recommends 

Checking the coolant level

1. Do not open the hood until the engine has cooled down.
2. Turn the expansion tank cap counterclockwise slightly to allow any accumulated pressure to escape; then continue turning to open.
3. The coolant level is correct if it is between the maximum and minimum marks in the filler neck, refer also to the diagram next to the filler neck.
4. If the coolant is low, slowly add coolant up to the specified level; do not overfill.
5. Turn the cap until there is an audible click.
6. Have the cause of the coolant loss eliminated as soon as possible.

Disposal



Comply with the appropriate environmental protection regulations when disposing of coolant additives.

Coolant

General information



Danger of burns from hot engine

Do not open the cooling system while the engine is hot; otherwise, escaping coolant may cause burns. ◀



Suitable additives

Only use suitable additives; otherwise, engine damage may occur. The additives are harmful to your health. ◀

Coolant consists of water and additives.

Not all commercially available additives are suitable for your vehicle. Ask your service center for suitable additives.

Maintenance

Vehicle equipment

This chapter describes all series equipment as well as country-specific and special equipment offered for this model series. Therefore, it also describes equipment that may not be found in your vehicle, for instance due to the selected special equipment or the country version. This also applies to safety-related functions and systems.

BMW Maintenance System



The maintenance system provides information on required maintenance measures and thus provides support in maintaining road safety and the operational reliability of the vehicle.

Condition Based Service CBS

Sensors and special algorithms take into account the driving conditions of your vehicle. Based on this, Condition Based Service determines the maintenance requirements.

The system makes it possible to adapt the amount of maintenance you need to your user profile.

Details on the service requirements, refer to page 81, can be displayed on the Control Display.

On the Control Display, the remaining distances and times for selected maintenance requirements and any legally required deadlines can be displayed individually, refer to page 81.

Service data in the remote control

Information on the required maintenance is continuously stored in the remote control. Your service center will read out this data and suggest the right array of service procedures for your vehicle.

Therefore, hand your service specialist the remote control that you used most recently.



Setting the correct date

Make sure the date is set correctly, refer to page 85; otherwise, the effectiveness of CBS Condition Based Service is not ensured. ◀

Storage periods

Storage periods during which the vehicle battery was disconnected are not taken into account.

If this occurs, have a service center update the time-dependent maintenance procedures, such as checking brake fluid and, if necessary, changing the engine oil and the microfilter/activated-charcoal filter.

Service and Warranty Information Booklet for US models and Warranty and Service Guide Booklet for Canadian models

Please consult your Service and Warranty Information Booklet for US models and Warranty and Service Guide Booklet for Canadian models for additional information on service requirements.

Maintenance and repair should be performed by your service center. Make sure to have regular maintenance procedures recorded in the vehicle's Service and Warranty Information Booklet for US models, and in the Warranty and Service Guide Booklet for Canadian models. These entries are proof of regular maintenance.

Socket for OBD Onboard Diagnosis

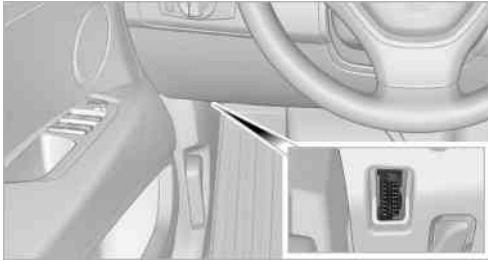

On the driver's side is an OBD socket for checking the primary components in the vehicle emissions.

Emissions



- ▷ The warning lamp lights up:
Emissions are deteriorating. Have the vehicle checked as soon as possible.

- ▷ The warning lamp flashes under certain circumstances:

This indicates that there is excessive misfiring in the engine.

Reduce the vehicle speed and have the system checked immediately; otherwise, serious engine misfiring within a brief period can seriously damage emission control components, in particular the catalytic converter.



- ▷ Display of the previously described malfunctions on Canadian models.

Fuel cap



The indicator lamp lights up.

If the fuel cap is not properly tightened, the OBD system may conclude that fuel vapor is escaping. If the cap is then tightened, the display should go out in a short time.

Data memory

Your vehicle records data relating to vehicle operation, faults and user settings. These data are stored in the remote control and can be read out with suitable devices, particularly when the vehicle is serviced. The data obtained in this way provide valuable information for service processes and repair or for optimizing and developing vehicle functions further. In addition, if you signed a service contract for Assist, certain vehicle data can be sent directly from the vehicle to facilitate the desired services.

Replacing components

Vehicle equipment

This chapter describes all series equipment as well as country-specific and special equipment offered for this model series. Therefore, it also describes equipment that may not be found in your vehicle, for instance due to the selected special equipment or the country version. This also applies to safety-related functions and systems.

Tool kit

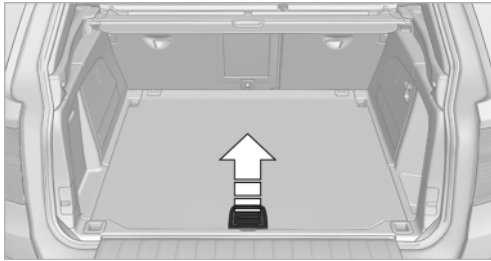

The tool kit is stowed under the cargo floor panel in the cargo area.

Wiper blade replacement



Do not fold down the wipers without wiper blades

Do not fold down the wipers if wiper blades have not been installed; this may damage the windshield. ◀

Front

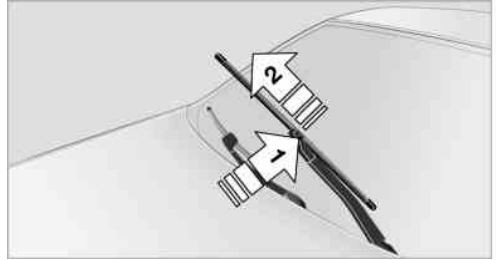

1. Fold up the wiper arm.
2. Press the release button on the wiper arm, see arrow 1.
3. Pull off the wiper blade toward the front, see arrow 2.

BMW X5: rear



1. Lift off the wiper arm completely and pull off the wiper blade, refer to arrow.
2. Mount the new wiper blade and press on until it is heard to engage.

Lamp and bulb replacement

Notes

Lamps and bulbs

Lamps and bulbs make an essential contribution to vehicle safety.

The manufacturer of the vehicle recommends that you entrust corresponding procedures to the service center if you are unfamiliar with them or they are not described here.

You can obtain a selection of replacement bulbs at the service center.

 Danger of burns

Only change bulbs when they are cool; otherwise, there is the danger of getting burned. ◀

 Working on the lighting system

When working on the lighting system, you should always switch off the lights affected to prevent short circuits.

To avoid possible injury or equipment damage when replacing bulbs, observe any instructions provided by the bulb manufacturer. ◀

 Do not perform work/bulb replacement on xenon headlamps

Have any work on the xenon lighting system, including bulb replacement, performed only by a service center.

Due to the high voltage present in the system, there is the danger of fatal injuries if work is carried out improperly. ◀

 Wear protective goggles and gloves

Halogen bulbs are pressurized. Therefore, wear protective goggles and gloves. Otherwise, there is a danger of injuries if the bulb is accidentally damaged during replacement. ◀

 Do not touch the bulbs

Do not touch the glass of new bulbs with your bare hands, as even minute amounts of contamination will burn into the bulb's surface and reduce its service life.

Use a clean tissue, cloth or something similar, or hold the bulb by its base. ◀

Light-emitting diodes LED

Light-emitting diodes installed behind translucent lenses serve as the light source for many of the controls, displays and other equipment in your vehicle.

These light-emitting diodes, which operate using a concept similar to that applied in conventional lasers, are officially designated as Class 1 light-emitting diodes.

 Do not remove the covers

Do not remove the covers, and never stare into the unfiltered light for several hours; otherwise, irritation of the retina could result. ◀

Headlamp glass

Condensation can form on the inside of the headlamps in cool or humid weather. When you drive with the lights switched on, the condensation evaporates after a short time. The headlamps do not need to be changed.

If the condensation in the headlamps does not evaporate after trips with the lights switched on, and the amount of moisture in the headlamps increases, for example if water droplets form, have them checked by your service center.

BMW X5: bulb replacement

Xenon headlamps

Notes

Because of the long life of these bulbs, the likelihood of failure is very low. Switching the lamps on and off frequently shortens their life.

If a xenon bulb fails, switch on the front fog lamps and continue the trip with great care. Comply with local regulations.

 Do not perform work/bulb replacement on xenon headlamps

Have any work on the xenon lighting system, including bulb replacement, performed only by a service center.

Due to the high voltage present in the system, there is the danger of fatal injuries if work is carried out improperly. ◀

Follow the general instructions on lamps and bulbs, refer to page 288.

Parking lamps, roadside parking lamps, daytime running lights

These lamps are made using LED technology. Contact your service center in the event of a malfunction.

Turn signals, front

Follow the general instructions on lamps and bulbs, refer to page 288.

The illustration shows the right side of the engine compartment.

24-watt bulb, PY24W

1. Rotate bulb holder to the left and remove it along with the bulb.

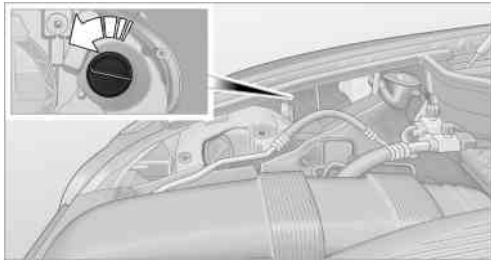

2. Rotate the bulb to the right along with the socket and replace.
3. Install in the reverse order.

Side marker lamps, rear

Contact the service center for bulb replacement.

Fog lamps

Follow the general instructions on lamps and bulbs, refer to page 288.

Contact your service center in the event of a malfunction.

Tail lamps

- ▷ Turn signal, brake lamp: 21-watt bulb, P21W.
 - ▷ Brake force display: 21-watt bulb, P21W.
 - ▷ Backup lamp: 16-watt bulb, W16W
 - ▷ Tail lamp: LED technology.
- Contact your service center in the event of a malfunction.

Arrangement of tail lamps

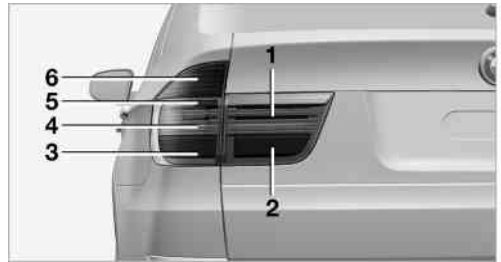

- 1 Tail lamp
- 2 Brake force display
- 3 Brake lamp
- 4 Tail lamp/side marker lamp
- 5 Backup lamp
- 6 Turn signal

Turn signals, brake lamps and backup lamps

Follow the general instructions on lamps and bulbs, refer to page 288.

The bulbs are integrated in a single bulb holder.

1. Open the side panel in the cargo area.
2. Remove the first aid kit and warning triangle if necessary. Fold up the insulation.

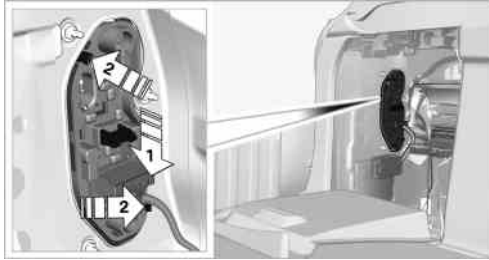

3. Press the button, arrow 1, down, press the catches, arrows 2, outward slightly, and remove the bulb holder.
4. Apply gentle pressure to the P21W bulb while turning it to the left for removal and replacement.

Remove the W16W bulb and replace.

5. Re-engage the bulb holder so that it audibly clicks into place.
6. Remount the side panel.

Brake Force Display

Follow the general instructions on lamps and bulbs, refer to page 288.

1. Carefully remove the cover in the tailgate panel with a screwdriver.

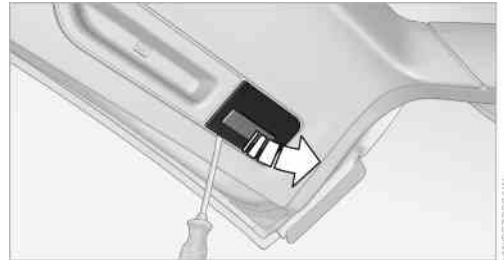

2. Push the catch on the bulb holder to the left, arrow, and remove it.

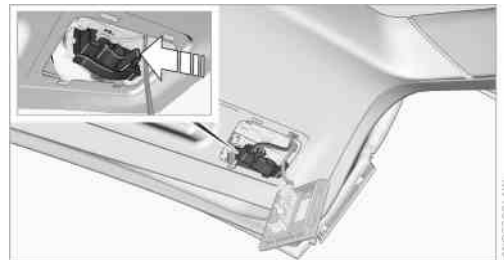

3. Apply gentle pressure to the bulb while turning it to the left for removal and replacement.
4. Re-engage the bulb holder so that it audibly clicks into place.
5. Before installing the cap, unclip the cargo area lamp.

Then lay the cap on its upper side and close it, refer to arrow.

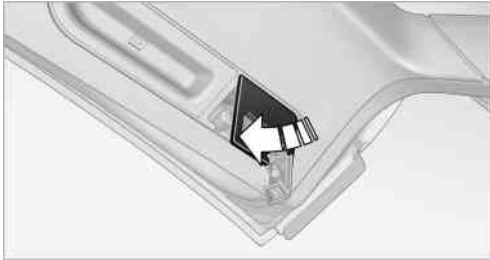

6. Position the cargo area lamp and clip it in, refer to arrow.

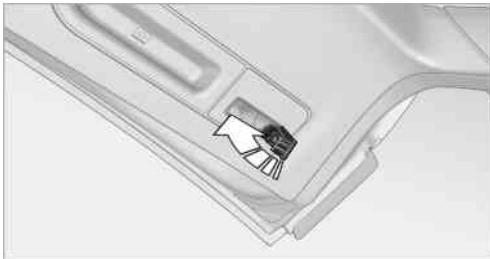

License plate lamps

Follow the general instructions on lamps and bulbs, refer to page 288.

These lamps are made using LED technology.

Contact your service center in the event of a malfunction.

Center brake lamp

Follow the general instructions on lamps and bulbs, refer to page 288.

This lamp uses LED technology for operation.

Contact your service center in the event of a malfunction.

BMW X6: bulb replacement

Xenon headlamps

Notes

Because of the long life of these bulbs, the likelihood of failure is very low. Switching the lamps on and off frequently shortens their life.

If a xenon bulb fails, switch on the front fog lamps and continue the trip with great care. Comply with local regulations.

⚠ Do not perform work/bulb replacement on xenon headlamps

Have any work on the xenon lighting system, including bulb replacement, performed only by a service center.

Due to the high voltage present in the system, there is the danger of fatal injuries if work is carried out improperly. ◀

Follow the general instructions on lamps and bulbs, refer to page 288.

Parking lamps, roadside parking lamps, daytime running lights

The illustration shows the left side of the engine compartment.

35-watt bulb, H8

1. Turn the cover to the left and remove.

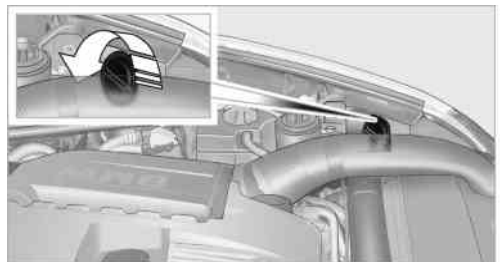

2. Left side of vehicle: rotate the bulb holder to the right, see arrow, and remove.

Right side of vehicle: rotate the bulb holder to the left and remove.

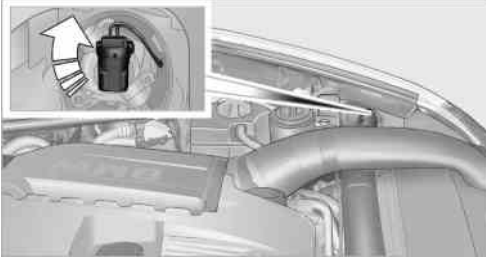

3. Disconnect plug and replace bulb.
4. Install in the reverse order.

Side marker lamps

The illustration shows the left side of the engine compartment.

5-watt bulb, WY5W XLL

1. Rotate the bulb holder to the left and remove.

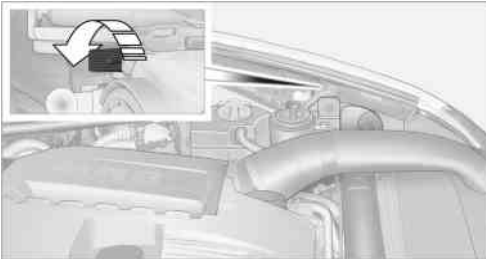

2. Pull the bulb out of the bulb holder and replace.
3. Install in the reverse order.

LED headlamps

Follow the general instructions on lamps and bulbs, refer to page 288.

With LED headlamps, the following lamps are designed with LED technology:

- ▷ Low beams/high beams
- ▷ Adaptive Light Control
- ▷ Parking and roadside parking lamps

- ▷ Daytime running lights.
- ▷ Side marker lights.

Contact your service center in the event of a malfunction.

Turn signals, front

Follow the general instructions on lamps and bulbs, refer to page 288.

The illustration shows the left side of the engine compartment.

24-watt bulb, PY24W

1. Rotate bulb holder to the left and remove it along with the bulb.

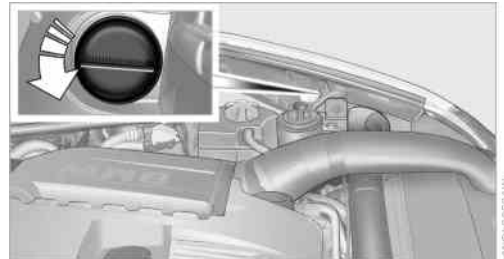

2. Rotate the bulb to the right along with the socket and replace.
3. Install in the reverse order.

Fog lamps

Follow the general instructions on lamps and bulbs, refer to page 288.

Contact your service center in the event of a malfunction.

Tail lamps

- ▷ Turn signal, backup lamp: 21-watt bulb, H21W.
- ▷ Brake lamp, brake force display: 21-watt bulb, P21W
- ▷ Tail lamp: LED technology.

Contact your service center in the event of a malfunction.

Arrangement of tail lamps

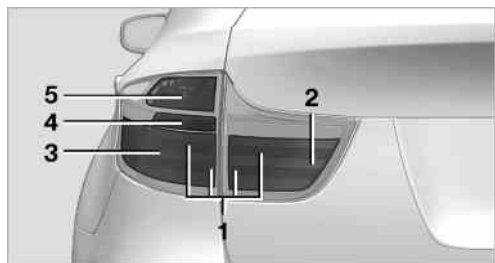

- 1 Tail lamps
- 2 Brake force display
- 3 Brake lamp
- 4 Backup lamp
- 5 Turn signal

Brake lamps

Follow the general instructions on lamps and bulbs, refer to page 288.

1. Open the side panel in the cargo area.
2. Remove the first aid kit and warning triangle if necessary.
3. Rotate the relevant bulb socket to the left and remove.

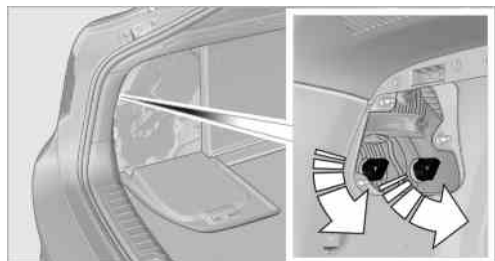

4. Apply gentle pressure to the bulb while turning it to the left for removal and replacement.
5. Install in the reverse order.

Turn signal

Follow the general instructions on lamps and bulbs, refer to page 288.

1. Open the side panel in the cargo area.
2. Remove the first aid kit and warning triangle if necessary.
3. Remove bulb holder along with bulb and replace.

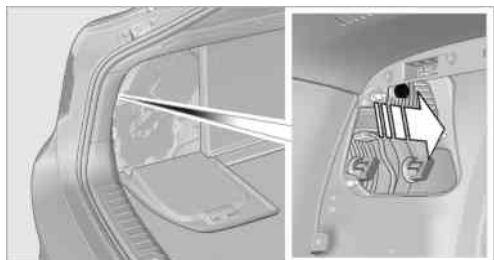

4. Install in the reverse order.

Backup lamp

Follow the general instructions on lamps and bulbs, refer to page 288.

1. Open the side panel in the cargo area.
2. Remove the first aid kit and warning triangle if necessary.
3. Remove bulb holder along with bulb and replace.

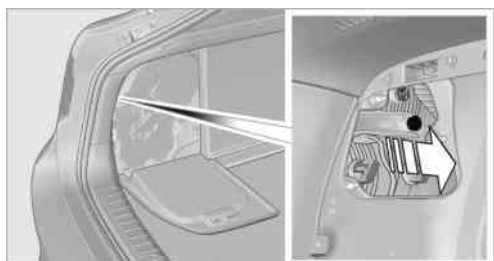

4. Install in the reverse order.

Brake force display

Follow the general instructions on lamps and bulbs, refer to page 288.

1. Carefully remove the cover in the tailgate panel with a screwdriver.

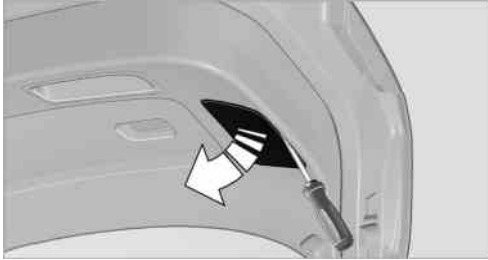

2. Rotate the bulb socket to the left and remove.

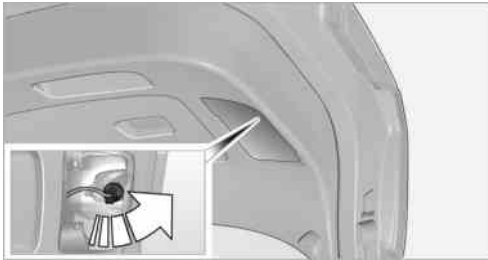

3. Apply gentle pressure to the bulb while turning it to the left for removal and replacement.
4. Insert the bulb socket in the tailgate and engage it.
5. Replace the cover.

License plate lamps

Follow the general instructions on lamps and bulbs, refer to page 288.

These lamps are made using LED technology. Contact your service center in the event of a malfunction.

Center brake lamp

Follow the general instructions on lamps and bulbs, refer to page 288.

This lamp uses LED technology for operation.

Contact your service center in the event of a malfunction.

Changing wheels

Notes

Your vehicle is equipped with run-flat tires, refer to page 280, as standard equipment.

They do not need to be replaced immediately in the event of a puncture.

When mounting new tires or changing from summer to winter tires or vice versa, use run-flat tires for your own safety.

BMW X6: do not rotate the front wheels to the rear or vice versa, as otherwise the handling characteristics will be negatively affected.

The tools for changing wheels are available as accessories from your service center.

Jacking points for the vehicle jack

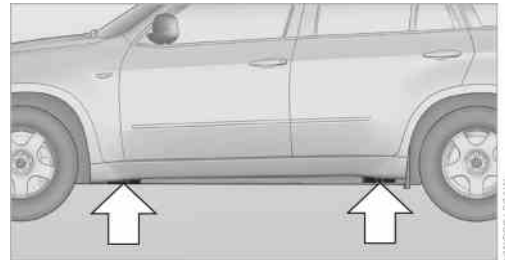

The jacking points for the vehicle jack are located in the positions shown.

Compact wheel



Safety precautions in the event of a flat tire or wheel change

Park the vehicle as far as possible from passing traffic and on solid ground. Switch on the hazard warning system.

Set the parking brake and engage transmission position P.

Have all vehicle occupants get out of the vehicle and ensure that they remain outside the immediate area in a safe place, such as behind a guardrail.

If a warning triangle or portable hazard warning lamp is required, set it up on the roadside at an appropriate distance from the rear of the vehicle. Comply with all safety guidelines and regulations.

Change the wheel only on a level, firm surface which is not slippery. The vehicle or the jack could slip to the side if you attempt to raise the vehicle on a soft or slippery surface such as snow, ice, tiles, etc.

Position the jack on a firm support surface.

Do not use a wooden block or similar object as a support base for the jack, as this would prevent it from extending to its full support height and reduce its load-carrying capacity.

To avoid serious or fatal injury: never lie under the vehicle, and never start the engine while it is supported by the jack. ◀

What you will need

To avoid rattling noises later on, note the positions of the tools before removing them, then return them to their initial positions after completing work.

The tools are located in the mount under the floor panel flap.

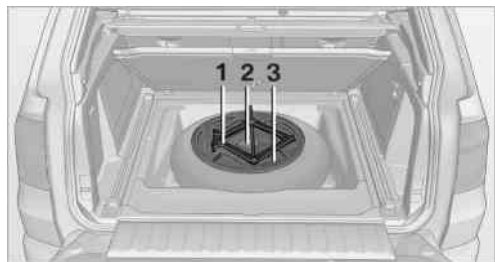

- 1 Vehicle jack
- 2 Vehicle jack crank
- 3 Lug bolts wrench

Removing compact wheel

The compact wheel is located in the cargo area under the floor panel.

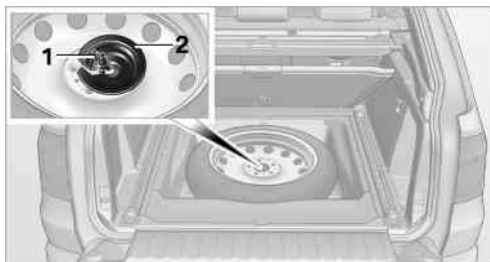

1. Remove the tool mount.
2. Release the wing nut 1.
3. Remove the washer 2 laterally.
4. Remove the compact wheel.

Preparing wheel change

1. Observe the safety precautions above.
2. Loosen the lug bolts a half turn.

Jacking up vehicle

1. Position the vehicle jack at the jacking point closest to the wheel so that the entire surface of the jack base rests on the ground perpendicularly beneath the jacking point.



The vehicle jack is designed for changing wheels only.

The vehicle jack is designed for changing wheels only. Do not attempt to raise another vehicle model with it or to raise any load of any kind. To do so could cause accidents and personal injury. ◀

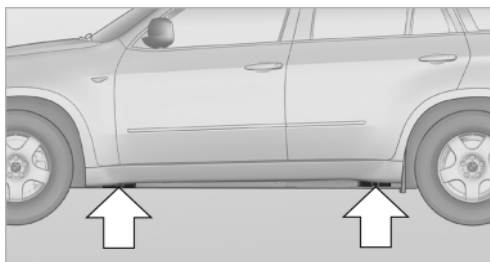

2. Guide the jack head into the rectangular recess of the jacking point when cranking up, refer to illustration detail.

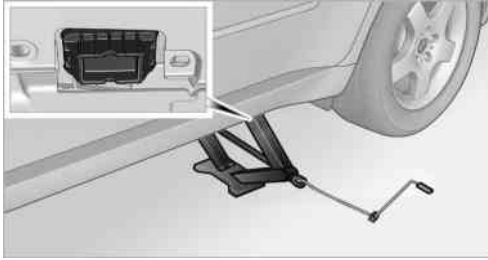

3. Jack the vehicle up until the wheel you are changing is raised from the ground.

Mounting a wheel

1. Unscrew the lug bolts and remove the wheel.
2. Remove accumulations of mud or dirt from the mounting surfaces of the wheel and hub. Also clean the lug bolts.
3. Position the new wheel or compact wheel. Secure the wheel by screwing at least two lug bolts into opposite bolt holes.

When you mount wheels other than Genuine BMW light-alloy wheels, different lug bolts may also be required.

4. Screw in the remaining lug bolts. Tighten all the bolts securely in a diagonal pattern.
5. Lower the vehicle and remove the jack from beneath the vehicle.

After mounting

1. Tighten the lug bolts in a diagonal pattern.



Checking that the lug bolts are tight

To ensure safety, always have the lug bolts checked with a calibrated torque wrench as soon as possible to ensure that they are tightened to the specified torque. Otherwise, incorrectly tightened lug bolts

are a hidden safety risk. The tightening torque equals 101 lb ft/140 Nm. ◀

2. Stow the defective wheel in the cargo area. The defective wheel cannot be stored under the floor panel flap due to its size.
3. Check and correct the tire inflation pressure at the earliest opportunity.
4. Initialize the Flat Tire Monitor, refer to page 95, or reset the Tire Pressure Monitor, refer to page 97.
5. Replace the damaged tire as soon as possible and have the new wheel/tire balanced.

Driving with compact wheel



Do not exceed a speed of 50 mph/80 km/h.

Drive conservatively and do not exceed a speed of 50 mph/80 km/h. Otherwise, changes in the driving characteristics could result, for example reduced track stability on braking, extended braking distance, and altered self-steering characteristics in the limit range. In conjunction with winter tires, these characteristics are more pronounced. ◀



Only mount one compact wheel

Only one compact wheel may be mounted. Restore the wheels and tires to their original size as quickly as possible. Failure to do so is a safety risk. ◀

Vehicle battery

Maintenance

The battery is maintenance-free, i.e., the electrolyte will last for the life of the battery.

Your service center will be glad to advise you on questions regarding the battery.

Battery replacement



Use approved vehicle batteries

Only use vehicle batteries that have been approved for your vehicle by the manufacturer; otherwise, the vehicle could be damaged and systems or functions may not be fully available. ◀

After a battery replacement, have the battery registered on the vehicle by your service center to ensure that all comfort functions are fully available.

Charging the battery

Note



Do not connect the charger to the socket

Do not connect the battery charger to the socket installed in the vehicle at the factory as this could damage the vehicle. ◀

Starting aid terminals

Only charge using the starting aid terminals, refer to page 302, in the engine compartment while the engine is switched off.

Power failure

After a temporary power loss, some equipment needs to be reinitialized.

Individual settings need to be reprogrammed:

- ▷ Seat and mirror memory: store the positions again, refer to page 56.
- ▷ Time: update, refer to page 85.
- ▷ Date: update, refer to page 85.
- ▷ Radio station: save again, refer to page 186.
- ▷ Navigation system: wait for the navigation system to be operational.
- ▷ Glass sunroof/panoramic glass sunroof: it may only be possible to raise the roof. Have the system initialized by the service center.
- ▷ Digital compass: recalibrate, refer to page 137.

- ▷ Active steering: the system automatically initializes for a short time as you drive. During this time, the system is deactivated, refer to page 108.
- ▷ xDrive: the system automatically initializes as you drive. During this time, indicator lamps light up. If the lamps do not disappear during the current trip, have the system checked.

Disposing of old batteries



Have old batteries disposed of by your service center or bring them to a recycling center.

Maintain the battery in an upright position for transport and storage. Secure the battery so that it does not tip over during transport.

Fuses



Replacing fuses

Never attempt to repair a blown fuse and do not replace a defective fuse with a substitute of another color or amperage rating; this could lead to a circuit overload, ultimately resulting in a fire in the vehicle. ◀

In interior

The fuses are located in the front passenger footwell on the underside of the instrument cluster.

1. Unscrew screws, refer to arrows, of footwell trim panel.



2. Lay the trim panel in the footwell.
3. Release the screw, arrow 1, and fold the fuse carrier down, arrow 2.

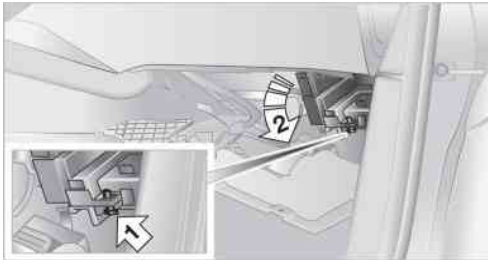

4. Replace the fuse concerned.
5. Installation is carried out in the reverse order of removal. Ensure correct and secure attachment of the footwell trim panel in the process.

In cargo area

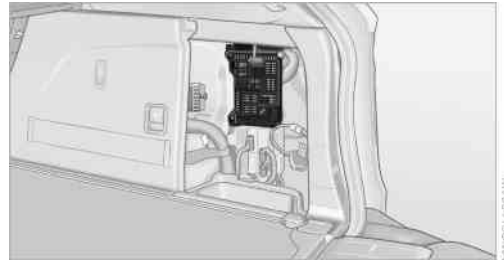

Open the right-hand side panel in the cargo area.

Breakdown assistance

Vehicle equipment

This chapter describes all series equipment as well as country-specific and special equipment offered for this model series. Therefore, it also describes equipment that may not be found in your vehicle, for instance due to the selected special equipment or the country version. This also applies to safety-related functions and systems.

Hazard warning flashers



The button for the hazard warning system is located on the center console.

Emergency Request

Requirements

- ▶ Equipment version with full preparation package mobile phone.
An Emergency Request can be made, even if no mobile phones are paired with the vehicle.
- ▶ BMW Assist is activated.
- ▶ Radio readiness is switched on.
- ▶ The BMW Assist system is logged in to a wireless communications network supported by BMW Assist.
- ▶ The Assist system is operable.

Only press the SOS button in an emergency.



Emergency Request not guaranteed

For technical reasons, the Emergency Request cannot be guaranteed under unfavorable conditions. ◀

Service contract

- ▶ After your contract with BMW Assist has expired, the BMW Assist system can be deactivated by the service center without you having to visit a workshop.
After deactivation, an Emergency Request is no longer possible.
- ▶ Under certain circumstances, the system can be reactivated by a service center after you sign a new contract.

Initiating an Emergency Request

1. Press the cover briefly to open it.



2. Press the SOS button until the LED in the button lights up.
 - ▶ The LED lights up: an Emergency Request was initiated.
If the circumstances allow this, remain in the vehicle until the connection has been established.
 - ▶ The LED flashes if the connection to the BMW Assist Response Center has been established.

Once the BMW Assist Response Center has received your Emergency Request, the BMW Assist Response Center contacts you and takes further steps to help you.

Even if you are unable to respond, the BMW Assist Response Center can take further steps to help you under certain circumstances.

For this purpose, data that are used to determine the necessary rescue measures, such as the current position of the vehicle if it can be established, are transmitted to the BMW Assist Response Center.

- ▶ If the LED is flashing but the BMW Assist Response Center cannot be heard on the hands-free system, the hands-free system may be malfunctioning. However, the BMW Assist Response Center may still be able to hear you.

Initiating an Emergency Request automatically

Under certain conditions, an Emergency Request is automatically initiated immediately after a severe accident. Automatic Collision Notification is not affected by pressing the SOS button.

Roadside Assistance

Service availability

Roadside Assistance can be reached around the clock in many countries. You can obtain assistance there in the event of a vehicle breakdown.

Roadside Assistance

The Roadside Assistance, refer to page [254](#) phone number can be viewed on the iDrive or a connection to Roadside Assistance can be established directly.

Warning triangle

The warning triangle is located in the cargo area.

First aid kit

The first aid kit is located in a storage compartment on the right side in the cargo area.

Some of the articles contained in the first aid pouch have a limited service life.

Check the expiration dates of the contents regularly and replace any items promptly.

Jump-starting

Notes

If the battery is discharged, an engine can be started using the battery of another vehicle and two jumper cables. Only use jumper cables with fully insulated clamp handles.

To prevent personal injury or damage to both vehicles, adhere strictly to the following procedure.



Do not touch live parts

To avoid the risk of potentially fatal injury, always avoid all contact with electrical components while the engine is running. ◀

Preparation

1. Check whether the battery of the other vehicle has a voltage of 12 volts and approximately the same capacitance in Ah. This information can be found on the battery.
2. Switch off the engine of the assisting vehicle.
3. Switch off any electronic systems/power consumers in both vehicles.



Bodywork contact between vehicles

There must not be any contact between the bodies of the two vehicles, otherwise there is a danger of shorting. ◀

Starting aid terminals



Connecting order

Connect the jumper cables in the correct order; otherwise, there is the danger of injury from sparking. ◀

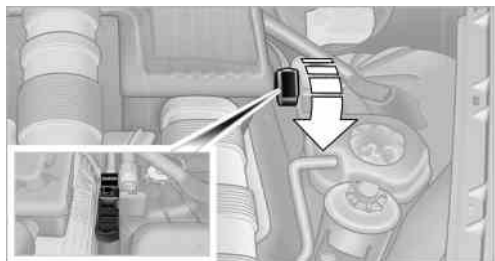

The so-called starting aid terminal in the engine compartment acts as the battery's positive terminal. Fold open the cover. To do so, pull the tab.

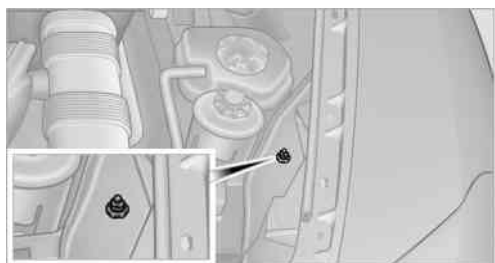

The body ground or a special nut acts as the negative terminal.

Connecting jumper cables

1. Fold open the cover of the BMW starting-aid terminal. To do so, pull the tab.
2. Attach one terminal clamp of the positive jumper cable to the positive terminal of the battery, or to the corresponding starting aid terminal of the vehicle providing assistance.
3. Attach the other end of the cable to the positive terminal of the battery, or to the corresponding starting aid terminal of the vehicle to be started.
4. Attach one terminal clamp of the negative jumper cable to the negative terminal of the

battery, or to the corresponding engine or body ground of the vehicle providing assistance.

5. Attach the other end of the cable to the negative terminal of the battery, or to the corresponding engine or body ground of the vehicle to be started.

Starting the engine

Never use spray fluids to start the engine.

1. Start the engine of the assisting vehicle and let it run for several minutes at an increased idle speed.

If the vehicle being started has a diesel engine: let the engine of the assisting vehicle run for approx. 10 minutes.

2. Start the engine of the vehicle being started in the usual way.

If the first starting attempt is not successful, wait a few minutes before making another attempt in order to allow the discharged battery to recharge.

3. Let both engines run for several minutes.
4. Disconnect the jumper cables in the reverse order.

Check the battery and recharge if necessary.

Tow-starting and towing



Observe applicable laws and regulations

Observe applicable laws and regulations for tow-starting and towing. ◀



No additional passengers

Do not transport any passengers other than the driver in a vehicle that is being towed. ◀

Transporting your vehicle

Note

Your vehicle is not permitted to be towed. Therefore, contact a service center in the event of a breakdown.

 Do not have the vehicle towed. Have your vehicle transported on a loading platform only; otherwise, damage may occur. ◀

Tow truck

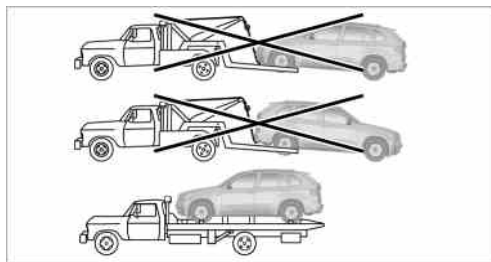

 Do not tow with only the front or rear axle raised.

Do not tow the BMW with just the front or rear axle raised; otherwise, the wheels could lock up and the transfer case could be damaged. ◀

 Do not lift the vehicle. Do not lift the vehicle by the tow fitting or body and chassis parts; otherwise, damage may result. ◀

Towing other vehicles

General information

 Light towing vehicle. Your vehicle must not be lighter than the vehicle being towed; otherwise, it will not be possible to control vehicle response. ◀

 Attaching the tow bar/tow rope correctly. Attach the tow bar or tow rope to the tow fitting; connecting it to other vehicle parts may cause damage. ◀

- ▷ Switch on the hazard warning system, depending on local regulations.
- ▷ If the electrical system has failed, clearly identify the vehicle being towed by placing a sign or a warning triangle in the rear window.

Towing methods when towing other vehicles

Tow bar

The tow fittings used should be on the same side on both vehicles.

Should it prove impossible to avoid mounting the tow bar at an offset angle, please observe the following:

- ▷ Clearance and maneuvering capability will be sharply limited during cornering.
- ▷ The tow bar will generate lateral forces if it is attached offset.

Tow rope

When starting to tow the vehicle, make sure that the tow rope is taut.

To avoid jerking and the associated stresses on the vehicle components when towing, always use nylon ropes or nylon straps.

 Attaching the tow rope correctly. Only secure the tow rope on the tow fitting; otherwise, damage can occur when it is secured on other parts of the vehicle. ◀

Tow fitting

The screw-in tow fitting should always be carried in the vehicle. It can be screwed in at the front or rear of the BMW.

It is stored with the tool kit under the cargo floor cover in the cargo area, refer to page 288.

 Tow fitting, information on use

- ▷ Use only the tow fitting provided with the vehicle and screw it all the way in.

- ▶ Use the tow fitting for towing on paved roads only.
- ▶ Avoid lateral loading of the tow fitting, e.g., do not lift the vehicle by the tow fitting.

Otherwise, damage to the tow fitting and the vehicle can occur. ◀

Screw thread

Left/right cover in the bumper: press on the arrow symbol on the cover.

BMW X5: front



BMW X6: front

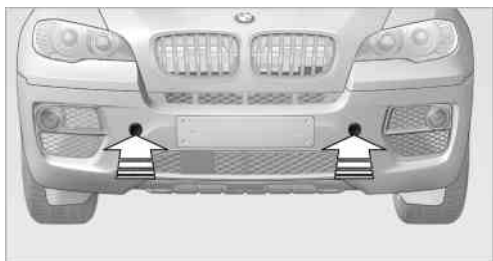

Rear



Tow-starting

Note

Do not tow-start your vehicle.

Due to the automatic transmission, the engine cannot be started by tow-starting.

Have the cause of the starting difficulties remedied.

Care

Vehicle equipment

This chapter describes all series equipment as well as country-specific and special equipment offered for this model series. Therefore, it also describes equipment that may not be found in your vehicle, for instance due to the selected special equipment or the country version. This also applies to safety-related functions and systems.

Car washes

Notes

 Steam jets or high-pressure washers
When using steam jets or high-pressure washers, hold them a sufficient distance away and use a maximum temperature of 140 °F/60 °C.

Holding them too close or using excessively high pressures or temperatures can cause damage or preliminary damage that may then lead to long-term damage.

Follow the operating instructions for the high-pressure washer. ◀

 Cleaning sensors/cameras with high-pressure washers

When using high-pressure washers, do not spray the exterior sensors and cameras, for Park Distance Control or the backup camera, for instance, for extended periods of time and only from a distance of at least 12 in/30 cm. ◀

Wash your vehicle frequently, particularly in winter.

Intense soiling and road salt can damage the vehicle.

Washing in automatic car washes

Give preference to cloth car washes or those that use soft brushes in order to avoid paint damage.

Notes

Note the following:

- ▶ Make sure that the wheels and tires are not damaged by the transport mechanisms.
- ▶ Fold in the exterior mirrors; otherwise, they may be damaged, depending on the width of the vehicle.
- ▶ Deactivate rain sensor, refer to page 72, to prevent unintentional wiper action.
- ▶ BMW X5: deactivate the rear window wiper and protect it from damage. Ask the car wash operator about any necessary protective measures.
- ▶ Remove additional attachments, for instance a spoiler or telephone antenna, if there is a risk that these may be damaged.

 Guide rails in car washes
Avoid car washes with guide rails higher than 4 in/10 cm; otherwise, the vehicle body could be damaged. ◀

Before driving into a car wash

The vehicle is able to roll if the following steps are taken.

1. Insert the remote control into the ignition lock, even with Comfort Access.
2. Engage transmission position N.
3. Release the parking brake.
4. Deactivating Automatic Hold, refer to page 69.
5. Switch the engine off.
6. Leave the remote control in the ignition lock so that the vehicle can roll.

Transmission position P will be engaged:

- ▷ Automatically after approx. 30 minutes.
- ▷ When the remote control is removed from the ignition lock.

Mixed tires



Note the vehicle width

Before driving into a car wash, make sure that the vehicle width is not too large for the car wash, as otherwise the vehicle and the car wash could be damaged. ◀

Headlamps

- ▷ Do not rub dry and do not use abrasive or caustic cleansers.
- ▷ Soak areas that have been soiled e.g. due to insects, with shampoo and wash off with water.
- ▷ Thaw ice with de-icing spray; do not use an ice scraper.

After washing the vehicle

After washing the vehicle, apply the brakes briefly to dry them; otherwise, braking action can be reduced and corrosion of the brake discs can occur.

Fully remove an residue from the windows; otherwise, streaking may occur when the windshield wipers are activated, impairing your view and causing wiper noise.

Vehicle care

Car care products

BMW recommends using cleaning and care products from BMW, since these have been tested and approved.



Car care and cleaning products

Follow the instructions on the container.

When cleaning the interior, open the doors or windows.

Only use products intended for cleaning vehicles.

Cleansers can contain substances that are dangerous and harmful to your health. ◀

Vehicle paint

Regular care contributes to driving safety and value retention. Environmental influences in areas with high air pollution or natural contaminants, such as tree resin or pollen, can have an impact on the vehicle paint. Tailor the frequency and extent of your car care to these influences.

Immediately remove aggressive substances, such as spilled fuel, oil, grease, or bird droppings, to prevent damage to or discoloration of the paintwork.

Leather care

Remove dust from the leather often, using a cloth or vacuum cleaner.

Otherwise, particles of dust and road grime chafe in pores and folds, and lead to increased wear and premature degradation of the leather surface.

To guard against discoloration, such as from clothing, provide leather care roughly every two months.

Clean light-colored leather more frequently as dust and dirt are more noticeable.

Use leather care products; otherwise, dirt and grease will gradually break down the protective layer of the leather surface.

Suitable care products are available from the service center.

Upholstery material care

Vacuum regularly with a vacuum cleaner.

If they are very dirty, e.g., beverage stains, use a soft sponge or microfiber cloth with a suitable interior cleaner.

Clean the upholstery down to the seams using large sweeping motions. Avoid rubbing the material vigorously.



Damage from Velcro® fasteners

Open Velcro® fasteners on pants or other articles of clothing can damage the seat covers. Ensure that any Velcro® fasteners are closed. ◀

Caring for special components

Light-alloy wheels

Use wheel cleaner, particularly during the winter months. Do not use aggressive, acidic, strongly alkaline or abrasive cleaners, or steam jets above 140 °F/60 °C; follow the manufacturer's instructions.

Chrome surfaces

Carefully clean components such as the radiator grille or door handles with an ample supply of water, possibly with shampoo added, particularly when they have been exposed to road salt.

Aluminum running boards

A rust film on the aluminum running boards can be removed with a special cleaning agent.

Rubber components

Aside from water, treat only with rubber cleansers.

When cleaning rubber seals, do not use any silicon-containing car care products in order to avoid damage or reduced noise damping.

Fine wood parts

Clean fine wood facing and fine wood components only with a moist rag. Then dry with a soft cloth.

Plastic components

These include:

- ▶ Imitation leather surfaces.
- ▶ Headliner.
- ▶ Lamp lenses.
- ▶ Instrument cluster cover.

- ▶ Matte black spray-coated components.
- ▶ Painted parts in the interior.

Clean with a microfiber cloth.

Moisten the cloth lightly with water if necessary.

Do not soak the headliner.



Do not use cleansers that contain alcohol or solvents

Do not use cleansers that contain alcohol or solvents, such as lacquer thinners, heavy-duty grease removers, fuel, or such; this could lead to surface damage. ◀

Safety belts

Dirty belt straps impede the reeling action and thus have a negative impact on safety.



No chemical cleaning

Do not clean chemically; this can destroy the webbing. ◀

Use only a mild soapy solution, with the safety belts clipped into their buckles.

Do not allow the reels to retract the safety belts until they are dry.

Carpets and floor mats



No objects in the area around the pedals

Keep floor mats, carpets, and any other objects out of the area of motion of the pedals; otherwise, the function of the pedals could be impeded while driving

Do not place additional floor mats over existing mats or other objects.

Only use floor mats that have been approved for the vehicle and can be properly fixed in place.

Ensure that the floor mats are securely fastened again when they are returned after being removed, such as for cleaning. ◀

Floor mats can be removed from the passenger compartment for cleaning.

When returning the floor mats, secure them again to prevent slipping.

If the floor carpets are very dirty, clean with a microfiber cloth and water or a textile cleaner. To prevent matting of the carpet, rub back and forth in the direction of travel only.

Sensors/cameras

To clean sensors or cameras, use a cloth moistened with a small amount of glass cleaner.

Displays/screens

Clean the displays with an anti-static microfiber cloth.



Cleaning displays

Do not use chemical or household cleansers.

Keep all fluids and moisture away from the unit.

Otherwise, they could affect or damage surfaces or electrical components.

Avoid pressing too hard when cleaning and do not use abrasive materials; otherwise, damage can result. ◀

Long-term vehicle storage

Your service center can advise you on what to consider when storing the vehicle for longer than three months.



Reference

This chapter contains technical data, short commands for the voice activation system, and an index that will quickly take you to the information you need.

Technical data

Vehicle equipment

This chapter describes all series equipment as well as country-specific and special equipment offered for this model series. Therefore, it also

describes equipment that may not be found in your vehicle, for instance due to the selected special equipment or the country version. This also applies to safety-related functions and systems.

Dimensions

BMW X5

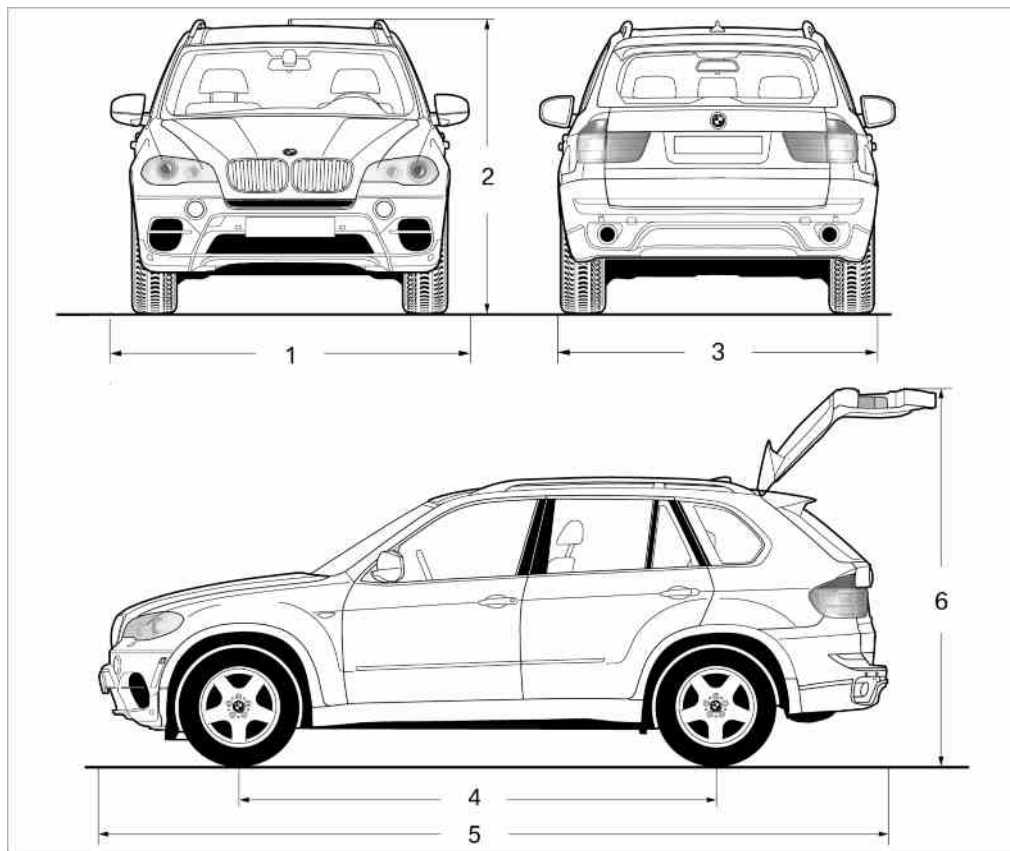

1 Vehicle width, with exterior mirrors: 86.5 inches/2,197 mm

2 Vehicle height: 69.9 inches/1,776 mm

3 Vehicle width, without exterior mirrors: 76.1 inches/1,933 mm

4 Wheelbase: 115.5 inches/2,933 mm

- 5 Vehicle length: 191.2 inches/4,857 mm
- 6 Tailgate opening height: 83.6 inches/2,124 mm

Smallest turning circle dia.: 42.0 ft/12.8 m

With mixed tires the vehicle width may exceed the specified dimension.

BMW X6

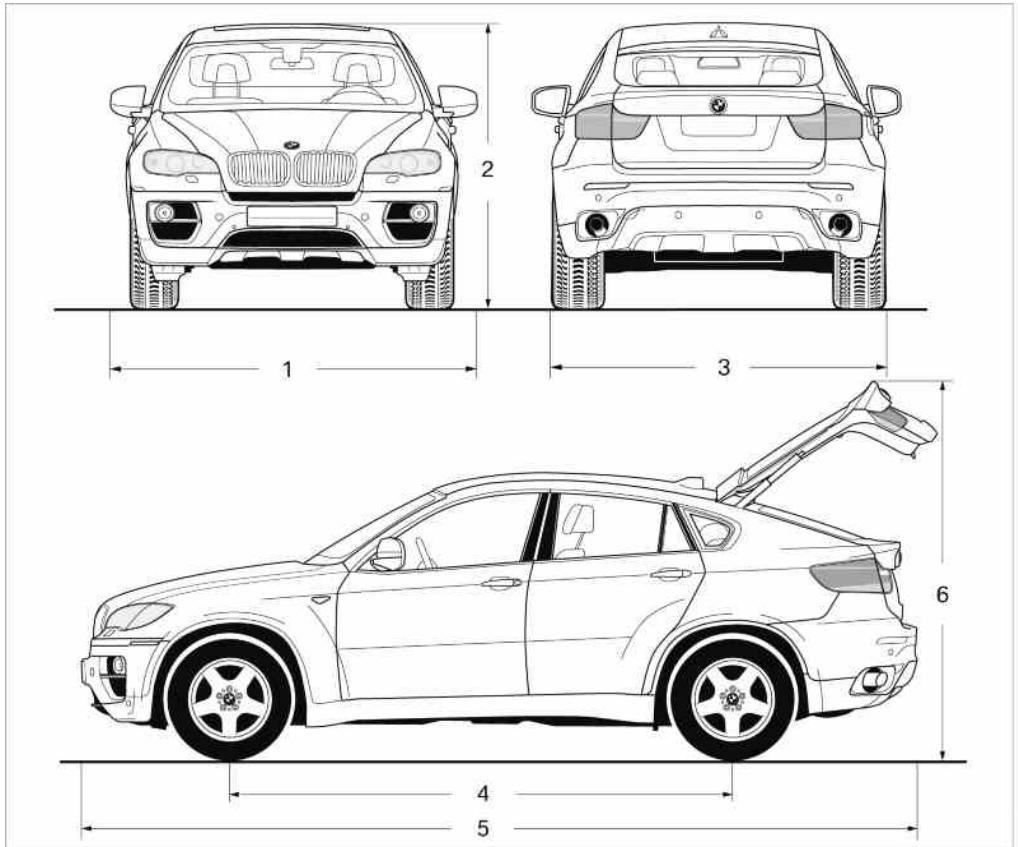

- 1 Vehicle width, with exterior mirrors: 86.4 inches/2,195 mm
- 2 Vehicle height: 66.5 inches/1,690 mm
- 3 Vehicle width, without exterior mirrors: 78.1 inches/1,983 mm
- 4 Wheelbase: 115.5 inches/2,933 mm
- 5 Vehicle length: 192.0 inches/4,877 mm
- 6 Tailgate opening height: 90.0 inches/2,287 mm

Smallest turning circle dia.: 42.0 ft/12.8 m

Height with roof rack: 66.9 in/1,699 mm

With mixed tires the vehicle width may exceed the specified dimension.

Weights

BMW X5		X5 xDrive35i	X5 xDrive50i	X5 xDrive35d
Approved gross vehicle weight	lbs/kg	6,371/2,890	6,669/3,025	6,581/2,985
without 3rd row seats	lbs/kg	6,052/2,745	6,327/2,870	6,261/2,840
Load	lbs/kg	1,290/585	1,290/585	1,290/585
without 3rd row seats	lbs/kg	1,102/500	1,102/500	1,102/500
Approved front axle load	lbs/kg	2,800/1,270	3,020/1,370	2,976/1,350
without 3rd row seats	lbs/kg	2,800/1,270	3,020/1,370	2,976/1,350
Approved rear axle load	lbs/kg	3,792/1,720	3,858/1,750	3,858/1,750
without 3rd row seats	lbs/kg	3,439/1,560	3,549/1,610	3,483/1,580
Approved roof load capacity	lbs/kg	220/100	220/100	220/100
Cargo area capacity	cu ft/li- ter	35.8-75.2/620-1, 750	35.8-75.2/620- 1,750	35.8-75.2/620-1, 750

Never exceed either the approved axle loads or the gross vehicle weight.

BMW X6		X6 xDrive35i	X6 xDrive50i
Approved gross vehicle weight	lbs/kg	6,008/2,725	6,250/2,835
Load	lbs/kg	937/425	937/425
Approved front axle load	lbs/kg	2,822/1,280	3,042/1,380
Approved rear axle load	lbs/kg	3,263/1,480	3,351/1,520
Approved roof load capacity	lbs/kg	220/100	220/100
Cargo area capacity	cu ft/li- ter	25.6-59.7/570- 1,450	25.6-59.7/570-1, 450

Never exceed either the approved axle loads or the gross vehicle weight.

Capacities

BMW X5			Notes
Fuel tank	US gal/liters	approx. 22.4/85	Fuel specifications, refer to page 264
Including reserve of			
X5 xDrive35i, X5 xDrive35d	US gal/liters	Approx. 2.1/8	
X5 xDrive50i	US gal/liters	approx. 2.6/10	
Window washer system	US qt/liters	approx. 6.9/6.5	Details, refer to page 73
With headlamp washer system			
BMW X6			Notes
Fuel tank	US gal/liters	approx. 22.4/85	Fuel specifications, refer to page 264
Including reserve of			
X6 xDrive35i	US gal/liters	Approx. 2.1/8	
X6 xDrive50i	US gal/liters	approx. 3.2/12	
Window washer system	US qt/liters	approx. 6.9/6.5	Details, refer to page 73
With headlamp washer system			

Short commands for voice activation system

Vehicle equipment

This chapter describes all series equipment as well as country-specific and special equipment offered for this model series. Therefore, it also describes equipment that may not be found in your vehicle, for instance due to the selected special equipment or the country version. This also applies to safety-related functions and systems.

To have the available spoken instructions read out loud: ›Voice commands‹

The following short commands apply to vehicles equipped with a voice activation system. They have no function in vehicles in which only the mobile phone is operated using the voice.

General information

Instructions for voice activation system, refer to page 25.

Adjusting

Vehicle

Function	Command
Opens the main menu.	›Main menu‹
Open the options.	›Options‹
Open the settings.	›Settings‹
Settings on the Control Display.	›Control display‹
Open the time and date.	›Time and date‹
Open the language and units.	›Language and units‹
Open the speed limit.	›Speed‹
Open the light.	›Lighting‹
Open the door lock.	›Door locks‹

Equipment

Function	Command
Open the air conditioning settings.	›Climate‹
Open the Head-up Display.	›head up display‹
Enable the rear.	›Allow rear control‹

Vehicle information

Computer

Function	Command
Open the computer.	›Onboard info‹
Open the trip computer.	›Trip computer‹

Vehicle

Function	Command
Open the vehicle information.	›Vehicle info‹
Open the vehicle status.	›Vehicle status‹

Navigation

General information

Function	Command
Navigation menu.	›Navigation‹
Open the destination entry.	›Enter address‹
Enter the address.	›Enter address‹
Enter the town/city.	›City‹
Enter the country.	›State‹
Enter the postal code.	›Postal Code‹
Open destination guidance.	›Guidance‹

Function	Command
Start destination guidance.	›Start guidance‹
Terminate destination guidance.	›Stop guidance‹
Open the home address.	›Home address‹
Open the route criteria.	›Route preference‹
Open the route.	›Route information‹
Switch on the spoken instruction.	›Switch on voice instructions‹
Repeat the spoken instruction.	›Repeat voice instructions‹
Switch off the spoken instruction.	›Switch off voice instructions‹
Display the address book.	›Address book‹
Display the most recent destinations.	›Last destinations‹
Open the traffic bulletins.	›Traffic Info‹
Special destinations.	›Points of interest‹

Map

Function	Command
Display the map.	›Map‹
Map facing north.	›Map facing north‹
Map facing the direction of travel.	›Map in direction of travel‹
Perspective map.	›Map perspective view‹
Automatic scaling of the map.	›Map with automatic scaling‹
Scale...feet.	›Map scale ... feet‹
Scale...meters.	›Map scale ... meters‹ e.g., map scale 100 meters
Scale...kilometers.	›Map scale ... kilometers‹ e.g., map scale 5 kilometers
Scale...miles.	›Map scale ... miles‹ e.g., map scale 5 miles

Split screen settings

Function	Command
Split screen.	›Switch on splitscreen‹
Switch off the split screen.	›Turn off split screen‹
Adjust the split screen.	›Split screen content‹
Split screen, map facing north.	›Split screen map facing north‹
Split screen, current position.	›Split screen current position‹
Split screen, facing the direction of travel.	›Split screen map in direction of travel‹
Split screen, perspective.	›Split screen perspective‹
Split screen, expanded intersection zoom.	›Splitscreen Exit ramp view‹
Split screen scale...feet.	›Split screen scale ... feet‹ e.g., split screen scale 100 feet
Split screen scale...meters.	›Split screen scale ... meters‹ e.g., split screen scale 100 meters
Split screen scale...kilometers.	›Split screen scale ... kilometers‹ e.g., split screen scale 5 kilometers
Split screen scale...miles.	›Split screen scale ... miles‹ e.g., split screen scale 5 miles
Split screen, highlight the traffic situation.	›Split screen, Traffic conditions‹
Split screen, computer.	›Split screen on board info‹
Split screen, trip computer.	›Splitscreen trip computer‹
Split screen, scale automatically.	›Split screen automatic scaling‹

Destination guidance with intermediate destinations

Function	Command
Enter a new destination.	›Enter address‹
Trip list.	›Stored trips‹

Radio

FM

Function	Command
Open a frequency.	›Frequency ... megahertz‹ e.g., 93.5 megahertz or frequency 93.5
Open the radio.	›Radio‹
Open the FM stations.	›F M‹
Open the manual search.	›Manual‹
Select a frequency range.	›Select frequency‹
Open a station.	›Select station‹

AM

Function	Command
Open a frequency.	›Frequency ... Kiloherzt‹ e.g., frequency 753 or 753 kilohertz
Open the AM stations.	›A M‹
Open the manual search.	›Manual‹

Satellite radio

Function	Command
Open the satellite radio.	›Satellite radio‹
Switch on the satellite radio.	›Satellite radio on‹
Select a satellite radio channel.	›Select satellite radio‹ e.g., satellite radio channel 2

Stored stations

Function	Command
Open the stored stations.	›Presets‹
Choose a stored station.	›Select preset‹
Select a stored station.	›Preset ...‹ e.g., stored station 2

CD/multimedia

CD/DVD drive

Function	Command
Select a track.	›Track ...‹ e.g., track 5 or ›C D track ...‹ e. g., CD track 5
Play back a CD.	›C D on‹
Select a CD.	›Select C D‹
Select a CD and track.	›C D ... track ...‹ e.g., CD 3 track 5
Open the CD and Multimedia menu.	›C D and multimedia‹
CD and DVD.	›C D‹
Select a DVD.	›D V D ...‹ e.g., DVD 3
Display the entertainment details on a split screen.	›Entertainment details‹

Music collection

Function	Command
Search for music, open a menu.	›Music search‹
Open the current playback.	›Current playback‹
Open the music collection.	›Music collection‹
Play back the music collection.	›Music collection on‹
Play back the most frequently played tracks.	›Top fifty‹

External devices

Function	Command
Open the external devices.	›External devices‹
Open the Bluetooth devices.	›Bluetooth‹

Tone

Function	Command
Open the tone settings.	›Tone‹

Telephone

Function	Command
Dial a phone number.	›Dial number‹
Open the Telephone menu.	›Telephone‹
Display the phone book.	›Phonebook‹
Redialing.	›Redial‹
Display received calls.	›Received calls‹
List of messages.	›Messages‹
Open the Bluetooth devices.	›Bluetooth‹

Office

Function	Command
Open the Office menu.	›Office‹
Display Office Today.	›Current office‹
Display the contacts.	›Contacts‹
Display the messages.	›Messages‹
Display the calendar.	›Calendar‹
Display the tasks.	›Tasks‹
Display the reminders.	›Reminders‹

Contacts

Function	Command
Select a name.	›Choose name‹
My contacts.	›My contacts‹
Open the contacts.	›Contacts‹
New contact.	›New contact‹

ConnectedDrive or BMW Assist

Function	Command
Open BMW Assist.	›B M W Assist‹
Open ConnectedDrive.	›Connected Drive‹
Open BMW Online.	›B M W Online‹

Everything from A to Z

Index

0-9

3rd row seats [50](#)

A

ABS, Antilock Brake System [103](#)

ACC Active Cruise Control [109](#)

Access to 3rd row seats [50](#)

Accident, refer to Emergency Request, initiating [300](#)

Acoustic signal, refer to Check Control [83](#)

Activated-charcoal filter [132](#)

Active Cruise Control

ACC [109](#)

Active cruise control, indicator lamp [112](#)

Active Cruise Control, radar sensor [113](#)

Active Cruise Control, selecting the distance [111](#)

Active Cruise Control, warning lamps [113](#)

Active seat [53](#)

Active seat ventilation [52](#)

Active steering [108](#)

Adaptive brake lights, refer to Brake force display [102](#)

Adaptive Drive [107](#)

Adaptive fixing system [146](#)

Adaptive light control [89](#)

Additional telephone [230](#)

Additives, coolant [285](#)

Additives, engine oil [284](#)

After washing vehicle [306](#)

Airbags [93](#)

Airbags, indicator/warning light [95](#)

Air circulation, refer to Recirculated air mode [130](#)

Air distribution, automatic [128](#), [133](#)

Air distribution, manual [130](#)

Air drying, refer to Cooling function [130](#)

Air flow rate [129](#)

Air flow rate, blower, refer to Air volume [133](#)

Airing, refer to Ventilation [131](#)

Air pressure, refer to Tire inflation pressure [269](#)

Air vents [127](#)

Air vents, refer to Ventilation [131](#)

Alarm system [42](#)

Alarm system

– Avoiding unintentional alarms [43](#)

– Ending an alarm [42](#)

– Interior motion sensor [43](#)

– Tilt alarm sensor [43](#)

All around the headliner [17](#)

All-season tires, refer to Winter tires [279](#)

All-wheel drive, refer to xDrive [105](#)

Alternating-code hand-held transmitter [136](#)

AM/FM station [186](#)

Announcement, navigation, refer to Spoken instructions [175](#)

Antifreeze, coolant [285](#)

Antifreeze, washer fluid [73](#)

Antilock Brake System, ABS [103](#)

Anti-slip control, refer to Dynamic Stability Control DSC [103](#)

Anti-theft protection [32](#)

Appointments [247](#)

Approved axle loads, refer to Weights [314](#)

Approved engine oils [284](#)

Approved gross vehicle weight, refer to Weights [314](#)

Armrest, refer to Center armrest [144](#)

Arrival time, refer to Computer [80](#)

Ashtray [139](#)

Ashtray, front [139](#)

Ashtray, rear [139](#)

Assist [253](#)

Assistance, Roadside Assistance [301](#)

Assistance with driving off, refer to Drive-off assistant [107](#)

Assistance with starting engine, refer to Jump-starting [301](#)

Audio CD with rear DVD system [221](#)

Audio device, external [144](#)

Audio playback [195](#)

Audio playback, Bluetooth [210](#)

Automatic, air distribution [128](#), [133](#)

Automatic air distribution [133](#)

Automatic, air flow rate [128](#)

Automatic car wash [305](#)

Automatic climate control [127](#)

Automatic climate control, automatic air distribution [128](#), [133](#)

Automatic climate control, in rear [132](#)

- Automatic climate control in rear, activating on Control Display [133](#)
- Automatic climate control in rear, air supply [133](#)
- Automatic climate control in rear, deactivating on Control Display [133](#)
- Automatic climate control in rear, switching off [133](#)
- Automatic climate control, switching off [131](#), [133](#)
- Automatic climate control, ventilation in rear [132](#)
- Automatic climate control, with 2-zone control [128](#)
- Automatic climate control, with 4-zone control [132](#)
- Automatic, cruise control [116](#)
- Automatic Cruise Control [109](#)
- Automatic Curb Monitor [57](#)
- Automatic headlamp control [88](#), [89](#)
- Automatic Hold [69](#)
- Automatic Hold, activating [69](#)
- Automatic Hold, deactivating [69](#)
- Automatic Hold, parking [70](#)
- Automatic recirculated air control [130](#)
- Automatic Soft Closing, doors [35](#)
- Automatic Soft Closing, tailgate [36](#)
- Automatic tailgate operation [37](#), [38](#)
- Automatic transmission with Steptronic [74](#)
- Automatic transmission with Steptronic – Kickdown [74](#)
- AUTO program with automatic climate control [128](#), [133](#)
- AUX-IN port [144](#), [206](#)
- Average fuel consumption [80](#)
- Average fuel consumption, setting the units [86](#)
- Average speed [79](#)
- Average speed, refer to Computer [79](#)
- Axle loads, refer to Weights [314](#)
- ## B
- Backrest curvature, refer to Lumbar support [49](#)
- Backrest width [49](#)
- Back seats, adjusting the head restraints [56](#)
- Backup camera [120](#)
- Backup camera, cleaning [122](#)
- Backup camera, obstacle marking [121](#)
- Backup camera, pathway lines [120](#)
- Backup camera, turning lines [121](#)
- Balance [184](#)
- Band-aids, refer to First aid kit [301](#)
- Bass [184](#)
- Battery
- Remote control [30](#)
- Battery change, remote control for rear DVD system [217](#)
- Battery disposal [298](#)
- Battery, refer to Vehicle battery [297](#)
- Battery replacement, remote control for vehicle [42](#)
- Before entering the car wash [305](#)
- Belts, refer to Safety belts [53](#)
- Belt tensioners, refer to Safety belts [53](#)
- Beverage holder, refer to Cupholder [145](#)
- Black and white map display [178](#)
- Blower, refer to Air flow rate [129](#)
- Bluetooth audio [210](#)
- Bluetooth connection, activating/deactivating [231](#)
- BMW Advanced Diesel [265](#)
- BMW Apps [257](#)
- BMW Apps, video playback [209](#)
- BMW Assist [253](#)
- BMW Assist, refer to ConnectedDrive [253](#)
- BMW EfficientDynamics, refer to Saving fuel [158](#)
- BMW Homepage [6](#)
- BMW Internet page [6](#)
- BMW maintenance system [286](#)
- BMW Online [255](#)
- Bottle holder, refer to Cupholder [145](#)
- Brake assistant [103](#)
- Brake discs, breaking in [152](#)
- Brake fluid, refer to Service requirements [81](#)
- Brake force display [102](#)
- Brake force distribution, electronic [103](#)
- Brake lamps, brake force display [102](#)
- Brake lights, adaptive [102](#)
- Brake pads, breaking in [152](#)
- Brakes, BMW maintenance system [286](#)
- Brakes, parking brake [68](#)
- Brakes, service requirements [81](#)
- Brake system, BMW maintenance system [286](#)
- Braking, notes [153](#)
- Breakdown assistance [301](#)
- Breakdown, transporting the vehicle [303](#)
- Breaking in [152](#)
- Brightness, on the Control Display [86](#)
- Bulb replacement, refer to Lamp and bulb replacement [288](#)

Button for starting the engine, refer to Start/Stop button [66](#)

C

Calendar [247](#)

Calibration, driver's seat [54](#)

California Proposition 65
Warning [7](#)

Camera, care [308](#)

Camera, refer to Backup camera [120](#)

Camera, Side View [125](#)

Camera, Top View [124](#)

Can holder, refer to Cupholder [145](#)

Car battery, refer to Vehicle battery [297](#)

Car care products [306](#)

Care [305](#)

Care, displays [308](#)

Care, vehicle [306](#)

Cargo [154](#)

Cargo area

– Comfort Access [41](#)

Cargo area, capacities [314](#)

Cargo area, enlarging [142](#)

Cargo area lamp, refer to Interior lamps [92](#)

Cargo area lid, refer to Tailgate [36, 38](#)

Cargo area, opening/closing, refer to Lower tailgate [38](#)

Cargo area, opening/closing, refer to Tailgate [36, 38](#)

Cargo area, opening from the inside [36](#)

Cargo area, opening from the outside [36](#)

Cargo area, refer to Cargo area [140](#)

Cargo cover, refer to Luggage compartment roller cover [140](#)

Cargo, securing with ski bag, refer to Securing cargo [148](#)

Cargo straps, securing cargo [156](#)

Car key, refer to Integrated key/remote control [30](#)

Carpet, care [307](#)

Car phone, installation location, refer to Center armrest [144](#)

Car phone, refer to Telephone [230](#)

Car vacuum cleaner, connecting, refer to Connecting electrical devices [139](#)

Car wash [305](#)

Catalytic converter, refer to Hot exhaust system [153](#)

CBC, refer to Cornering Brake Control [103](#)

CBS Condition Based Service [286](#)

CD/DVD [194](#)

CD/DVD changer [198](#)

CD/DVD in rear [216](#)

CD/DVD notes [200](#)

CD, refer to Playing audio tracks, rear DVD system [221](#)

CDs, storing [201](#)

Cell phone [230](#)

Cell phone, installation location, refer to Center armrest [144](#)

Center armrest, front [144](#)

Center armrest, rear [144](#)

Center brake lamp [292, 295](#)

Center console, refer to Around the center console [16](#)

Central locking

– Comfort Access [40](#)

– From the inside [35](#)

– Setting the unlocking characteristics [32](#)

Central locking system

– From the outside [32](#)

– Principle [32](#)

Central screen, refer to Control Display [19](#)

Changes, technical, refer to Safety [6](#)

Changing wheels/tires [279](#)

Chassis number, refer to Engine compartment [281](#)

Check Control [83](#)

Children, transporting [60](#)

Child restraint fixing system LATCH [61](#)

Child restraint fixing systems [60](#)

Child restraint fixing systems, mounting [60](#)

Child safety locks [65](#)

Child seat, mounting [60](#)

Child seats, refer to Transporting children safely [60](#)

Chrome parts, care [307](#)

Cigarette lighter, connecting electrical devices [139](#)

Cigarette lighter, refer to Lighter [139](#)

Cigarette lighter socket [139](#)

Circulation of air, refer to Recirculated air mode [130](#)

Cleaning, displays [308](#)

Cleaning your BMW, refer to Care [305](#)

Clock [77](#)

Clock, 12h/24h mode [85](#)

Closing

– From the inside [35](#)

– From the outside [32](#)

Clothes hooks [145](#)

Cockpit [12](#)

Cold start, refer to Starting the engine [67](#)

Combination instrument, refer to Instrument cluster [14](#)

Combination switch, refer to Turn signal/high beams/headlamp flasher [71](#)

Combination switch, refer to Washer/wiper system [72](#)

Comfort Access

– Battery replacement [42](#)

- Comfort area, refer to Around the center console [16](#)
- Compact wheel, inflation pressure [269](#), [270](#)
- Compartment for remote control, refer to Ignition lock [66](#)
- Compartments, refer to Storage compartments [143](#), [144](#)
- Compass, digital [137](#)
- Computer [79](#)
- Computer, displaying information [79](#)
- Computer, displays on the Control Display [80](#)
- Concierge service [254](#)
- Condensation on windows, removing [129](#)
- Condensation under the vehicle [154](#)
- Condition Based Service CBS [286](#)
- Confirmation signals for locking/unlocking the vehicle [33](#)
- ConnectedDrive [253](#)
- Connecting, mobile phone, refer to Pairing the mobile phone [231](#)
- Consumption, refer to Average fuel consumption [80](#)
- Contacts [243](#), [251](#)
- Control Display [19](#)
- Control Display, care [308](#)
- Control Display, setting the brightness [86](#)
- Controller, refer to Controls [18](#)
- Controls and displays [12](#)
- Controls, rear DVD system [215](#)
- Control systems, driving stability [103](#)
- Convenient operation
- Glass sunroof [33](#)
 - Window [33](#)
- Coolant [285](#)
- Coolant, checking the level [285](#)
- Coolant temperature [78](#)
- Cooling function, switching on and off [130](#)
- Cooling, maximum [130](#)
- Cooling system, refer to Coolant [285](#)
- Cornering Brake Control CBC [103](#)
- Corrosion on brake discs [154](#)
- Courtesy lamps, refer to Interior lamps [92](#)
- Cradle for telephone or mobile phone, refer to Snap-in adapter [240](#)
- Cruise control [116](#)
- Cruise control
- Malfunction [117](#)
- Cruise control, active [109](#)
- Cupholder [145](#)
- Curb weight, refer to Weights [314](#)
- Current fuel consumption [78](#)
- Current location, storing [166](#)
- Curve lights, refer to Adaptive light control [89](#)
- ## D
- Dashboard lighting, refer to Instrument lighting [92](#)
- Dashboard, refer to Cockpit [12](#)
- Data memory [287](#)
- Data, technical [312](#)
- Date [77](#)
- Date, display format [86](#)
- Date, retrieving [77](#)
- Date, setting [85](#)
- Daytime running lights [89](#)
- Defroster, rear window [129](#)
- Defrosting windows [129](#)
- Defrost setting, refer to Defrosting windows [129](#)
- Destination entry via the address book [166](#)
- Destination guidance [173](#)
- Destination guidance with intermediate destinations [171](#)
- Destination input, navigation [164](#)
- Diesel exhaust fluid, at low temperatures [266](#)
- Diesel exhaust fluid, at minimum [266](#)
- Diesel exhaust fluid, having refilled [266](#)
- Diesel exhaust fluid, refilling yourself [266](#)
- Diesel particulate filter [153](#)
- Digital clock [77](#)
- Digital compass [137](#)
- Digital radio [187](#)
- Dimming mirrors [58](#)
- Directional indicators, refer to Turn signals [71](#)
- Display in front windshield [125](#)
- Display lighting, refer to Instrument lighting [92](#)
- Displays and controls [12](#)
- Displays, care [308](#)
- Displays, cleaning [308](#)
- Displays, refer to Instrument cluster [14](#)
- Disposal, coolant [285](#)
- Disposal, vehicle battery [298](#)
- Distance control, refer to Active Cruise Control [109](#)
- Distance, selecting, with Active Cruise Control [111](#)
- Distance warning, refer to Park Distance Control PDC [117](#)
- Divided screen view, split screen [22](#)
- Door key, refer to Remote control with integrated key [30](#)
- Door lock [34](#)
- Doors, manual operation [34](#)
- Doors, unlocking and locking
- Confirmation signals [33](#)
 - From the inside [35](#)
 - From the outside [32](#)
- DOT Quality Grades [277](#)

- Downhill control [106](#)
 - Draft-free ventilation [131](#)
 - Drive-off assistant [107](#)
 - Driver's seat, calibrating [54](#)
 - Driving away on inclines, refer to Drive-off assistant [107](#)
 - Driving notes, breaking in [152](#)
 - Driving notes, general [152](#)
 - Driving on poor roads [157](#)
 - Driving stability control systems [103](#)
 - Driving through water [153](#)
 - Driving tips, refer to Driving notes [152](#)
 - Dry air, refer to Cooling function [130](#)
 - DSC Dynamic Stability Control [103](#)
 - DTC Dynamic Traction Control [104](#)
 - DTMF suffix dialing [236](#)
 - DVD/CD [194](#)
 - DVDs, storing [201](#)
 - DVD system in rear [215](#)
 - DVD, video [196](#)
 - Dynamic destination guidance [180](#)
 - Dynamic Performance Control [105](#)
 - Dynamic Stability Control DSC [103](#)
 - Dynamic Traction Control DTC [104](#)
- E**
- Easy entry/exit [59](#)
 - EfficientDynamics, refer to Saving fuel [158](#)
 - Electrical malfunction
 - Door lock [34](#)
 - Driver's door [34](#)
 - Fuel filler flap [262](#)
 - Electrical malfunction of upper tailgate [36](#)
 - Electrical malfunction, parking brake [70](#)
 - Electric seat adjustment [49](#)
 - Electric steering wheel adjustment [59](#)
 - Electronic brake-force distribution [103](#)
 - Electronic engine oil level check [283](#)
 - Electronic Stability Program ESP, refer to Dynamic Stability Control DSC [103](#)
 - Emergency operation
 - Door lock, refer to Manual operation [34](#)
 - Emergency operation, fuel filler flap, unlocking manually [262](#)
 - Emergency Request [300](#)
 - Emergency service, refer to Roadside Assistance [301](#)
 - Energy-conscious driving, refer to Current fuel consumption [78](#)
 - Energy, saving, refer to Saving fuel [158](#)
 - Engine, breaking in [152](#)
 - Engine compartment [281](#)
 - Engine coolant, refer to Coolant [285](#)
 - Engine oil, adding [284](#)
 - Engine oil, additives, refer to Approved engine oils [284](#)
 - Engine oil, alternative oil types [285](#)
 - Engine oil, BMW maintenance system [286](#)
 - Engine oil change intervals, refer to Service requirements [81](#)
 - Engine oil, checking the level [283](#)
 - Engine oil, filling capacity [315](#)
 - Engine oil temperature [78](#)
 - Engine oil types, alternative [284](#)
 - Engine oil types, approved [284](#)
 - Engine, overheating, refer to Coolant temperature [78](#)
 - Engine start, assistance [301](#)
 - Engine, starting [67](#)
 - Engine, starting
 - Comfort Access [40](#)
 - Engine, starting, Start/Stop button [66](#)
 - Engine, stopping, Start/Stop button [66](#)
 - Engine, switching off [67](#)
 - Entry lamps, refer to Interior lamps [92](#)
 - Environmentally friendly driving, refer to Current fuel consumption [78](#)
 - Equalizer [184](#)
 - Equipment, interior [135](#)
 - ESP Electronic Stability Program, refer to Dynamic Stability Control DSC [103](#)
 - Exchanging wheels/tires [279](#)
 - Exhaust system [153](#)
 - Exterior mirrors [57](#)
 - Exterior mirrors, adjusting [57](#)
 - Exterior mirrors, automatic dimming [58](#)
 - Exterior mirrors, automatic heating [58](#)
 - Exterior mirrors, folding in and out [58](#)
 - External audio device [144](#)
 - External devices [206](#)
 - External temperature display [77](#)
 - External temperature display, changing the units of measure, changing the units of measure on the Control Display [86](#)
 - External temperature warning [77](#)
 - External temperature display [77](#)
 - Eyes for securing cargo [156](#)

F

Fader [184](#)
 Failure messages, refer to
 Check Control [83](#)
 False alarm
 – Avoiding unintentional
 alarms [43](#)
 – Ending an alarm [42](#)
 Fastening safety belts, refer to
 Safety belts [53](#)
 Fault messages, refer to
 Check Control [83](#)
 Filling capacities [315](#)
 Filter, refer to Microfilter/acti-
 vated-charcoal filter [132](#)
 Fine wood, care [307](#)
 First aid kit [301](#)
 Fitting for towing [303](#)
 Fixing system, adaptive [146](#)
 Flashing when locking/unlock-
 ing [33](#)
 Flat Tire Monitor FTM [95](#)
 Flat Tire Monitor FTM, snow
 chains [280](#)
 Flat tire, run-flat tires [280](#)
 Flat tire, Tire Pressure Monitor
 TPM [97](#)
 Flat tire, warning lamp [96, 98](#)
 Flat tire, wheel change [295](#)
 Flooding, refer to Driving
 through water [153](#)
 Floor carpet, care [307](#)
 Floor mats, care [307](#)
 FM/AM station [186](#)
 Fog on windows, remov-
 ing [129](#)
 Foldable rear seat back-
 rest [142](#)
 Foot brake [153](#)
 Footwell lamps, refer to Inte-
 rior lamps [92](#)
 For your own safety [6](#)
 Four-wheel drive, refer to
 xDrive [105](#)
 Front airbags [93](#)
 Front fog lamps [91](#)

Front fog lamps, bulb replace-
 ment [290, 293](#)
 Front fog lamps, indicator
 lamp [91](#)
 FTM Flat Tire Monitor [95](#)
 Fuel [264](#)
 Fuel
 – Refer to Average fuel con-
 sumption [80](#)
 Fuel, additives [264](#)
 Fuel, average consump-
 tion [80](#)
 Fuel cap [262](#)
 Fuel cap, closing [262](#)
 Fuel consumption display
 – Average fuel consump-
 tion [80](#)
 Fuel consumption display,
 current fuel consumption [78](#)
 Fuel-efficient driving, refer to
 Current fuel consumption [78](#)
 Fuel filler flap, closing [262](#)
 Fuel filler flap, opening [262](#)
 Fuel filler flap, unlocking in
 case of an electrical malfunc-
 tion [262](#)
 Fuel gauge [79](#)
 Fuel, saving [158](#)
 Fuel tank capacity, refer to Fill-
 ing capacities [315](#)
 Fuel tank contents, refer to
 Filling capacities [315](#)
 Fuel tank, refer to Filling ca-
 pacities [315](#)
 Fuse [298](#)

G

Garage door opener, refer to
 Universal Garage Door
 Opener [135](#)
 Gasoline [264](#)
 Gasoline gauge, refer to Fuel
 gauge [79](#)
 Gasoline quality [264](#)
 Gas station recommenda-
 tion [175](#)

Gear change, automatic trans-
 mission with Steptronic [75](#)
 Gear change, via shift pad-
 dles [76](#)
 General driving notes [152](#)
 Glass sunroof, closing [46](#)
 Glass sunroof, electric
 – Convenient operation [33](#)
 – Remote control [33](#)
 Glass sunroof, initializing [47](#)
 Glass sunroof, opening [46](#)
 Glass sunroof, pinch protec-
 tion [47](#)
 Glass sunroof, power fail-
 ure [47](#)
 Glass sunroof, refer to Panor-
 amic glass sunroof [45](#)
 Glass sunroof, tilting [46](#)
 Glove compartment [143](#)
 Glove compartment
 – USB interface [143](#)
 Glove compartment, light-
 ing [143](#)
 GPS navigation, refer to Navi-
 gation system [162](#)
 Gross vehicle weight, refer to
 Weights [314](#)

H

Handbrake, refer to Parking
 brake [68](#)
 Hand-held transmitter, alter-
 nating code [136](#)
 Hands-free microphone [16](#)
 Hazard warning sys-
 tem [16, 300](#)
 HDC Hill Descent Control [106](#)
 HD Radio [187](#)
 Head airbags [93](#)
 Headlamp control, auto-
 matic [88, 89](#)
 Headlamp courtesy delay fea-
 ture [89](#)
 Headlamp flasher [71, 90](#)
 Headlamp flasher, indicator
 lamp [15](#)

- Headlamps **88**
Headlamps, care **306**
Headlamps, cleaning **73**
Headlamps, cleaning, washer fluid **74**
Headliner **17**
Headphones, connecting, rear DVD system **216**
Head restraints **54**
Head-up Display **125**
Head-up Display, care **308**
Heatable rear window **129**
Heating **127**
Heating
– Seats **51**
Heating, interior **127**
Heating, mirrors **58**
Heating, residual heat **131**
Heating with the engine switched off, refer to Residual heat **131**
Heavy cargo, refer to Stowing cargo **156**
Height, refer to Dimensions **312**
High-beam Assistant **90**
High beams **90**
High beams/low beams, automatic, refer to High-beam Assistant **90**
High beams, indicator lamp **15**
High-pressure washers **305**
Hill Descent Control HDC **106**
Hill drive-off assistant, refer to Drive-off assistant **107**
Hills **154**
Holder for beverages **145**
Holder for remote control, refer to Ignition lock **66**
Homepage **6**
Hood **282**
Hood, opening **282**
Horn **12**
Hot exhaust system **153**
Hotline **256**
House number, entering for navigation **165**
Hydraulic brake assistant **103**
Hydroplaning **153**
- I**
- Ice warning, refer to External temperature warning **77**
Icy roads, refer to External temperature warning **77**
Identification marks, tires **276**
iDrive **18**
iDrive, changing settings **85**
iDrive, changing the language **86**
iDrive, changing the units of measure and display format **86**
iDrive, setting the brightness **86**
iDrive, setting the date **85**
iDrive, setting the time **85**
Ignition **66**
Ignition key position 1, refer to Radio ready state **66**
Ignition key position 2, refer to Ignition on **66**
Ignition key, refer to Remote control with integrated key **30**
Ignition lock **66**
Ignition, switched off **67**
Ignition, switched on **66**
Images, displaying, rear DVD system **223**
Indication of a flat tire **96, 98**
Indicator and warning lamps **15**
Inflation pressure monitor, refer to Flat Tire Monitor **95**
Inflation pressure, refer to Tire inflation pressure **269**
Information on the navigation data **162**
Initialization after power failure **298**
Initializing
– Compass, refer to Calibrating **138**
– Panoramic glass sunroof **46**
Initializing, Flat Tire Monitor FTM **96**
Initializing, glass sunroof **47**
Initializing, refer to Setting the date **85**
Initializing, refer to Setting the time **85**
Initializing, Tire Pressure Monitor TPM **98**
Installation location, telephone **144**
Instrument cluster **14**
Instrument lighting **92**
Instrument panel, refer to Instrument cluster **14**
Instruments, refer to Cockpit **12**
Integrated key **30**
Interactive map **169**
Interior equipment **135**
Interior lamps **92**
Interior lamps
– Remote control **33**
Interior mirror **58**
Interior rearview mirror, automatic dimming **58**
Interior rearview mirror, compass **137**
Interior temperature, setting, automatic climate control **127**
Intermediate destinations **171**
Internet page **6**
Intersection, entering for navigation **165**
iPod/iPhone **207**
- J**
- Jacking points for the vehicle jack **295**

Jack, refer to Vehicle jack [295](#)
Joystick, refer to Selector lever [74](#)
Jump-starting [301](#)

K

Keyless Go, refer to Comfort Access [40](#)
Keyless opening and closing, refer to Comfort Access [40](#)
Key Memory, refer to Personal Profile [30](#)
Key, refer to Integrated key/remote control [30](#)
Kickdown
– Automatic transmission with Steptronic [74](#)
Knocking control [264](#)

L

Label, run-flat tire [280](#)
Lamp and bulb replacement, lamp replacement [288](#)
Lamps [88](#)
Lamps, automatic headlamp control [88](#), [89](#)
Lamps, High-beam Assistant [90](#)
Lamps, parking lamps/low beams [88](#)
Lamps, replacing, refer to Lamp and bulb replacement [288](#)
Lane departure warning [100](#)
Lane margin, warning [100](#)
Language, changing on Control Display [86](#)
Lap-and-shoulder belt, refer to Safety belts [53](#)
Lashing eyes, securing cargo [156](#)
LATCH child restraint fixing system [61](#)
Leather, care [306](#)

LEDs, light-emitting diodes [289](#)
Length, refer to Dimensions [312](#)
Letters and numbers, entering [23](#)
License plate lamps, replacing bulbs [292](#), [295](#)
Light-alloy wheels, care [307](#)
Light-emitting diodes, LEDs [289](#)
Lighter [139](#)
Lighting
– Instruments [92](#)
Lighting, vehicle, refer to Lamps [88](#)
Light switch [88](#)
Limit, refer to Speed limit [84](#)
Load [155](#)
Loading [154](#)
Lock buttons, doors, refer to Locking [35](#)
Locking
– From the inside [35](#)
– From the outside [33](#)
– Setting the confirmation signals [33](#)
– Without remote control, refer to Comfort Access [40](#)
Locking the vehicle
– From the inside [35](#)
– From the outside [32](#)
Locks, doors, and windows [65](#)
Longlife oils, alternative oil types [285](#)
Longlife oils, refer to Approved engine oils [284](#)
Low beams [88](#)
Low beams
– Automatic [89](#)
Low beams, automatic [88](#)
Low beams, automatic, refer to High-beam Assistant [90](#)
Lower back support, refer to Lumbar support [49](#)
Lower tailgate [38](#)

Low-sulfur diesel [264](#)
Luggage compartment roller cover [140](#)
Luggage rack, refer to Roof-mounted luggage rack [157](#)
Lumbar support [49](#)

M

Main inspection, refer to Service requirements [81](#)
Maintenance [286](#)
Maintenance, refer to Service booklet
Maintenance, refer to Service requirements [81](#)
Maintenance requirements [286](#)
Maintenance system
BMW [286](#)
Malfunction
– Door lock [34](#)
– Fuel filler flap [262](#)
Malfunction of upper tailgate [36](#)
Malfunction, parking brake [70](#)
Malfunction warnings, refer to Check Control [83](#)
Manual air distribution [130](#)
Manual mode, automatic transmission with Steptronic [75](#)
Manual operation
– Door lock [34](#)
– Driver's door [34](#)
Manual operation, fuel filler flap [262](#)
Manual operation of upper tailgate [36](#)
Manual operation, Side View [124](#)
Manual operation, Top View [123](#)
Map, destination entry [169](#)
Map display in black and white [178](#)
Map in split screen [177](#)

- Map view [175](#)
- Marking on approved tires [279](#)
- Master key, refer to Remote control with integrated key [30](#)
- Maximum cooling [130](#)
- Maximum speed, winter tires [279](#)
- Medical kit, refer to First aid kit [301](#)
- Memory, refer to Seat and mirror memory [56](#)
- Menus, operating, iDrive [18](#)
- Menus, refer to iDrive operating concept [19](#)
- Message list, traffic bulletins [177](#)
- Messages [245](#)
- Microfilter [132](#)
- Minimum tread, tires [278](#)
- Mirror
- Mirror memory, refer to Seat and mirror memory [56](#)
- Mirrors [57](#)
- Mirrors
- Automatic Curb Monitor [57](#)
- Mirrors, folding in and out [58](#)
- Mirrors, heating [58](#)
- Mirrors, interior mirror [58](#)
- Mobile communication devices in the vehicle [153](#)
- Mobile phone, installation location, refer to Center armrest [144](#)
- Mobile phone, refer to Telephone [230](#)
- Modifications, technical, refer to Safety [6](#)
- Monitor, refer to Control Display [19](#)
- Mounting of child restraint fixing systems [60](#)
- MP3 player [206](#)
- Multimedia [194](#)
- Music collection [201](#)
- Music search [203](#)
- Music, storing [201](#)
- ## N
- Navigation [162](#)
- Navigation data [162](#)
- Navigation data, updating [162](#)
- Navigation system
- Destination entry by voice [170](#)
- Neck restraints, refer to Head restraints [54](#)
- Nets, refer to Storage compartments [144](#)
- New wheels and tires [279](#)
- Notes [6](#), [248](#)
- Nozzles of automatic climate control [127](#)
- Nozzles, refer to Ventilation [131](#)
- ## O
- OBD Onboard Diagnostics [287](#)
- OBD socket, refer to Socket for OBD Onboard Diagnosis [287](#)
- Octane number, refer to Fuel quality [264](#)
- Octane rating, refer to Gasoline quality [264](#)
- Odometer [78](#)
- Office [242](#)
- Oil additives [284](#)
- Oil consumption [283](#)
- Oil level [283](#)
- Oil, refer to Engine oil [283](#)
- Oil types, alternative [284](#)
- Oil types, approved [284](#)
- Old batteries, disposal [298](#)
- Onboard Diagnostics
- OBD [287](#)
- Onboard monitor, refer to Control Display [19](#)
- Onboard vehicle tool kit [288](#)
- Opening and closing
- Comfort Access [40](#)
 - From the inside [35](#)
 - From the outside [32](#)
 - Using the door lock [34](#)
 - Using the remote control [32](#)
- Opening height, adjusting [37](#), [38](#)
- Operating concept, iDrive [18](#)
- Outside-air mode, automatic climate control [130](#)
- Outside air, refer to Recirculated air mode [130](#)
- Overheating of engine, refer to Coolant temperature [78](#)
- ## P
- Paint, vehicle [306](#)
- Pairing, mobile phone [231](#)
- Panic mode [33](#)
- Panoramic glass sunroof
- Convenient operation [33](#)
 - Initializing [46](#)
 - Opening, closing [45](#)
 - Pinch protection [46](#)
 - Power failure [46](#)
 - Remote control [33](#)
 - Tilting [45](#)
- Park Distance Control PDC [117](#)
- Parked-car ventilation [134](#)
- Parked vehicle, condensation [154](#)
- Parking aid, refer to Park Distance Control PDC [117](#)
- Parking assistant, refer to Park Distance Control PDC [117](#)
- Parking brake [68](#)
- Parking brake, Automatic Hold [69](#)
- Parking brake, releasing manually [68](#), [70](#)
- Parking brake, setting manually [68](#)
- Parking lamps [88](#)
- Parking lamps/low beams [88](#)

Parking with Automatic Hold [70](#)
Particulate filter, refer to Diesel particulate filter [153](#)
Passenger airbags, deactivating [94](#)
Passenger side mirror, tilting [57](#)
PDC Park Distance Control [117](#)
Personal information [242](#)
Personal Profile [30](#)
Pinch protection
– Panoramic glass sunroof [46](#)
– Windows [44](#)
Pinch protection, glass sunroof [47](#)
Plastic, care [307](#)
Playing videos, rear DVD system [218](#)
PlugIn [258](#)
Pollen, refer to Microfilter/activated-charcoal filter [132](#)
Poor road operation [157](#)
Position, storing [166](#)
Postal code, entering in navigation [165](#)
Power windows
– Safety switch [44](#)
Power windows, opening and closing [43](#)
Power windows, refer to Windows [43](#)
Preheating, refer to Diesel engine [67](#)
Prescribed engine oils, refer to Approved engine oils [284](#)
Pressure, tires [269](#)
Pressure warning, tires [95](#)
Profile depth, refer to Minimum tread depth [278](#)
Profile, tires [278](#)
Programmable memory buttons, iDrive [23](#)
Protection function, refer to Pinch protection [47](#)

Protection function, refer to Pinch protection
– Panoramic glass sunroof [46](#)
Protective function, refer to Pinch protection
– Windows [44](#)
Push-and-turn switch, refer to Controls [18](#)

R

Radiator fluid, refer to Coolant [285](#)
Radio-operated key, refer to Remote control with integrated key [30](#)
Radio ready state [66](#)
Radio ready state, switched off [67](#)
Radio ready state, switched on [66](#)
Radio setting, refer to Radio ready state [66](#)
Rain sensor [72](#)
Random [195](#)
Random playback [195](#)
Range [79](#)
RDS [187](#)
Reading lamps [92](#)
Reading out loud [249](#)
Rear entertainment, refer to DVD system in rear [215](#)
Rear lamps, refer to Tail lamps [290](#), [293](#)
Rear seat backrest, foldable [142](#)
Rear seats, adjusting [50](#)
Rear seats, adjusting the head restraints [56](#)
Rear seats, heating [51](#)
Rear socket [140](#)
Rear ventilation [132](#)
Rear ventilation, 3rd row seats [132](#)
Rear ventilation, automatic climate control in rear [132](#)
Rearview mirror, refer to Mirrors [57](#)
Rear window defroster [129](#)
Rear window, washing [73](#)
Rear window wiper [73](#)
Recirculated air mode [130](#)
Recommended tire brands [279](#)
Redialing [237](#)
Refueling [262](#)
Remaining distance to destination, refer to Computer [80](#)
Remaining range for service, refer to Service requirements [81](#)
Remaining range, refer to Range [79](#)
Reminders [249](#)
Remote control
– Battery replacement [42](#)
– Comfort Access [40](#)
– Garage door opener [135](#)
– Malfunction [34](#), [41](#)
– Tailgate [33](#)
– Universal [135](#)
Remote control, rear DVD system [216](#)
Remote control, removing from the ignition lock [66](#)
Remote control, service data [286](#)
Remote inquiry [236](#)
Replacement fuse [298](#)
Replacement remote control [30](#)
Replacing wheels/tires [279](#)
Reporting safety defects [8](#)
Reserve warning, refer to Fuel gauge [79](#)
Reservoir for washer fluid, refer to Washer fluid reservoir [74](#)
Resetting, Tire Pressure Monitor TPM [98](#)
Residual heat [131](#)
Restraining systems
– Refer to Safety belts [53](#)

Restraint systems for children **60**
Retaining straps, securing cargo **156**
Retreaded tires **279**
Road, avoiding **173**
Road detour **173**
Roadside Assistance **254**
Roadside parking lamps **90**
Roller sunblinds **44**
RON gasoline quality **264**
RON, refer to Fuel quality **264**
Roof load capacity **314**
Roof-mounted luggage rack **157**
Rope, refer to Towing **303**
Route **174**
Route criteria, route **173**
Route, displaying **174**
Route section, bypassing **174**
RSC Runflat System Component, refer to Run-flat tires **280**
Rubber components, care **307**
Run-flat tires **280**
Run-flat tires, tire inflation pressure **269**
Running lights, refer to Parking lamps/low beams **88**

S

Safe braking **153**
Safety **6**
Safety belts **53**
Safety belts
– Damage **54**
Safety belts, care **307**
Safety belts, indicator/warning lamp **54**
Safety belts, reminder **54**
Safety switch for rear windows **44**
Safety systems
– Safety belts **53**
Safety systems, airbags **93**
Safety tires, refer to Run-flat tires **280**
Satellite radio **188**
Saving fuel **158**
Scale, changing during navigation **176**
Screen, folding open/closed, rear DVD system **215**
Screen, refer to Control Display **19**
Search, refer to BMW Online **255**
Seat adjustment, electric **49**
Seat adjustment, manual **48**
Seat and mirror memory **56**
Seat belts
– Refer to Safety belts **53**
Seat heating **51, 52**
Seat heating, rear **51**
Seats
– Adjusting electrically **49**
– Heating **51**
– Memory, refer to Seat and mirror memory **56**
– Sitting safely **48**
– Storing the setting, refer to Seat and mirror memory **56**
– Ventilation, refer to Active seat ventilation and seat heating **52**
Seats, adjusting **48**
Seats, backrest width **49**
Seats in the rear **50**
Seats, shoulder support **49**
2nd row seats **50**
Selector lever, automatic transmission with Steptronic **74**
Selector lever lock, releasing **75**
Self-leveling suspension **108**
Sensors, care **308**
Service and warranty **7**
Service data in the remote control **286**
Service interval display, refer to Condition Based Service CBS **286**
Service interval display, refer to Service requirements **81**
Service requirements **81**
Service requirements, CBS Condition Based Service **286**
Service, Roadside Assistance **301**
Settings, clock, 12h/24h mode **85**
Settings, configuring, refer to Personal Profile **30**
Settings, DVD **197**
Settings on the Control Display, changing **85**
Shifting, automatic transmission with Steptronic **75**
Shift paddles **76**
Short commands, voice activation **316**
Side airbags **93**
Side View **124**
Side windows, refer to Windows **43**
Size, refer to Dimensions **312**
Ski bag **147**
Slide/tilt glass roof, refer to Glass sunroof **46**
Slide/tilt glass roof, refer to Panoramic glass sunroof **45**
Slot for remote control **66**
Smokers' package, refer to Ashtray **139**
Snap-in adapter, mobile phone **240**
Snap-in adapter, refer to Storage compartment of center armrest **144**
Snow chains **280**
Socket, OBD Onboard Diagnosis **287**
Socket, refer to Connecting electrical devices **139**

- Software applications,
 iPhone [257](#)
- Software part number [230](#)
- Software update [213](#)
- Soot particulate filter, refer to
 Diesel particulate filter [153](#)
- SOS, refer to Emergency Request, initiating [300](#)
- Sound output [186](#), [194](#)
- Spare fuse [298](#)
- Special destinations, navigation [167](#)
- Special equipment, series equipment [6](#)
- Speed, average [79](#)
- Speed limit [84](#)
- Speed limit, setting [84](#)
- Speedometer [14](#)
- Speed, with winter tires [279](#)
- Split screen [22](#)
- Split screen map settings [177](#)
- Spoken instructions, navigation [175](#)
- Sport program, automatic transmission with Step-tronic [75](#)
- Spray nozzles, refer to Cleaning the windshield and headlamps [73](#)
- Spray nozzles, refer to Windshield washer nozzles [73](#)
- Stability control systems [103](#)
- Start/Stop button [66](#)
- Start/Stop button, starting the engine [67](#)
- Start/Stop button, switching off the engine [67](#)
- Starting the engine [67](#)
- Start problems, refer to Jump-starting [301](#)
- State/province, selecting for navigation [164](#)
- Stations, stored [192](#)
- Station, storing [186](#)
- Status information, iDrive [22](#)
- Status of Owner's Manual [6](#)
- Steam jets [305](#)
- Steering wheel [59](#)
- Steering wheel, adjusting [59](#)
- Steering wheel, easy entry/exit [59](#)
- Steering wheel lock [66](#)
- Steering with variable translation, refer to Active steering [108](#)
- Steptronic, refer to Sport program and manual mode M/S [75](#)
- Stopping, engine [67](#)
- Storage compartment nets [144](#)
- Storage compartments [143](#), [144](#)
- Storage, tires [280](#)
- Storing the seat position, refer to Seat and mirror memory [56](#)
- Storing the vehicle [308](#)
- Street, entering for navigation [165](#)
- Summer tires, refer to Wheels and tires [269](#)
- Summer tires, tread [278](#)
- Sunblinds, roller sunblinds [44](#)
- Surround View [119](#)
- Switches, refer to Cockpit [12](#)
- Switching off, engine [67](#)
- Switching off, vehicle [67](#)
- Switch-on times, parked-car ventilation [134](#)
- Symbols [6](#)
- ## T
- Tachometer [78](#)
- Tailgate
 – Comfort Access [41](#)
 – Remote control [33](#)
- Tailgate, adjusting the opening height [37](#), [38](#)
- Tailgate, automatic operation [38](#)
- Tail lamps [290](#), [293](#)
- Tank gauge, refer to Fuel gauge [79](#)
- Tasks [248](#)
- Technical changes, refer to Safety [6](#)
- Technical data [312](#)
- Telephone [230](#)
- Telephone, adjusting the volume [234](#)
- Telephone, installation location, refer to Center armrest [144](#)
- TeleService [254](#)
- Temperature, adjusting in upper body region [129](#)
- Temperature, coolant, refer to Coolant temperature [78](#)
- Temperature display
 – External temperature [77](#)
 – External temperature warning [77](#)
- Temperature display, setting the units [86](#)
- Temperature, engine oil [78](#)
- Temperature, setting with automatic climate control [129](#), [133](#)
- Temperature warning [77](#)
- Text messages [245](#)
- Theft alarm system, refer to Alarm system [42](#)
- Thigh support adjustment [48](#)
- Third brake lamp, refer to Center brake lamp [292](#), [295](#)
- Seats, 3rd row seats [50](#)
- Tilting the passenger side mirror [57](#)
- Time, setting [85](#)
- Tire age [277](#)
- Tire identification marks [276](#)
- Tire inflation pressure [269](#)
- Tire inflation pressure, checking [269](#)
- Tire pressure monitor, refer to Flat Tire Monitor [95](#)
- Tire Pressure Monitor
 TPM [97](#)

- Tire Quality Grading [277](#)
 - Tires
 - Inflation pressure [269](#)
 - Tires, breaking in [152](#)
 - Tires, changing [279](#)
 - Tires, condition [278](#)
 - Tires, damage [278](#)
 - Tire size [276](#)
 - Tires, minimum tread [278](#)
 - Tires, retreaded tires [279](#)
 - Tires, run-flat tires [280](#)
 - Tires, storage [280](#)
 - Tire tread [278](#)
 - Toll roads, route [173](#)
 - Tone [184](#)
 - Tool kit, refer to Onboard vehicle tool kit [288](#)
 - Tools, refer to Onboard vehicle tool kit [288](#)
 - Top View [122](#)
 - Tow bar [303](#)
 - Tow fitting [303](#)
 - Towing [302](#)
 - Town/city, navigation [165](#)
 - Tow rope [303](#)
 - Tow-starting [302](#), [304](#)
 - TPM Tire Pressure Monitor [97](#)
 - Traction control [104](#)
 - Traffic bulletins, navigation [177](#)
 - Transmission, automatic transmission with Steptronic [74](#)
 - Transmission positions, automatic transmission with Steptronic [74](#)
 - Transporting children safely [60](#)
 - Treble, tone [184](#)
 - Trip computer, refer to Displays on the Control Display [80](#)
 - Trip-distance counter, refer to Trip odometer [78](#)
 - Triple turn signal activation [71](#)
 - Trip odometer [78](#)
 - Trips, planning [171](#)
 - Trunk lid, refer to Tailgate [38](#)
 - Turning circle, refer to Dimensions [312](#)
 - Turning lamps, refer to Adaptive light control [89](#)
 - Turn signal, indicator lamp [14](#)
 - Turn signals [71](#)
 - Turn signals, triple turn signal activation [71](#)
- ## U
- Uniform Tire Quality Grading/UTQG [277](#)
 - Unintentional alarms, avoiding [43](#)
 - Units, average fuel consumption [86](#)
 - Units, temperature [86](#)
 - Universal Garage Door Opener [135](#)
 - Universal remote control [135](#)
 - Unlocking
 - From the outside [32](#)
 - Setting the unlocking characteristics [32](#)
 - Tailgate [41](#)
 - Without remote control, refer to Comfort Access [40](#)
 - Unlocking, from the inside [35](#)
 - Unlocking, hood [282](#)
 - Updates made after the editorial deadline [6](#)
 - Update, software [213](#)
 - Upholstery care [306](#)
 - Upper tailgate [36](#)
 - Upper tailgate, automatic operation [37](#)
 - Upper tailgate, closing [36](#)
 - Upper tailgate, emergency operation, refer to Opening manually [36](#)
 - Upper tailgate, opening from the inside [36](#)
 - Upper tailgate, opening from the outside [36](#)
 - Upper tailgate, opening manually [36](#)
 - USB audio interface [207](#)
- ## V
- Vacuum cleaner, connecting, refer to Connecting electrical devices [139](#)
 - Vehicle
 - Identification number [230](#)
 - Identification number, refer to Engine compartment [281](#)
 - Vehicle battery, changing [298](#)
 - Vehicle, breaking in [152](#)
 - Vehicle care [306](#)
 - Vehicle care, refer to Care [305](#)
 - Vehicle equipment [6](#)
 - Vehicle jack [295](#)
 - Vehicle paint [306](#)
 - Vehicle storage [308](#)
 - Vehicle, switching off [67](#)
 - Vehicle wash [305](#)
 - Ventilation [131](#)
 - Ventilation, 3rd row seats [132](#)
 - Ventilation, automatic climate control in rear [133](#)
 - Ventilation, draft-free [131](#)
 - Ventilation, in rear [132](#)
 - Ventilation, refer to Parked-car ventilation [134](#)
 - Vents of automatic climate control [127](#)
 - Version of the navigation data [162](#)
 - Video playback [196](#)
 - Video playback, iPhone [209](#)
 - Video playback, snap-in adapter [209](#)
 - Voice activation
 - Navigation [170](#)
 - Voice activation, mobile phone [238](#)

Voice activation, short commands [316](#)
Voice activation system [25](#)
Volume, setting [184](#)

W

Warning and indicator lamps [15](#)
Warning messages, refer to Check Control [83](#)
Warning signal volumes [185](#)
Warning triangle [301](#)
Washer/wiper system [72](#)
Washer/wiper system, rain sensor [72](#)
Washer/wiper system, washer fluid [73](#)
Washer/wiper system, windshield washer nozzles [73](#)
Washer fluid [73](#)
Washer fluid reservoir [74](#)
Washing, vehicle [305](#)
Waste tray, refer to Ash-tray [139](#)
Water on roads, refer to Driving through water [153](#)
Weights [314](#)
Welcome lamps [88](#)
Wheelbase, refer to Dimensions [312](#)
Wheel change [295](#)
Wheels and tires [269](#)
Wheels, changing [279](#)
Wheels, Flat Tire Monitor FTM [95](#)
Wheels, Tire Pressure Monitor TPM [97](#)
Width, refer to Dimensions [312](#)
Window, convenient operation [33](#)
Windows
– Safety switch [44](#)
Windows, defrosting and defogging, automatic climate control [129](#)

Windows, pinch protection [44](#)
Windshield, cleaning [73](#)
Windshield, defrosting, refer to Defrosting windows [129](#)
Windshield wash [72](#)
Windshield washer fluid [73](#)
Windshield wash, rear window [73](#)
Windshield wash, reservoir for washer fluid [74](#)
Windshield wash, washer fluid [74](#)
Windshield wash, washer nozzles [73](#)
Windshield wiper blades, changing [288](#)
Windshield wiper, refer to Washer/wiper system [72](#)
Winter diesel [265](#)
Winter storage, care [308](#)
Winter tires, setting the speed limit [84](#)
Winter tires, suitable tires [279](#)
Winter tires, tread [278](#)
Wiper blades, changing [288](#)
Wiper fluid [73](#)
Wood, care [307](#)
Word match concept, navigation [24](#)
Working in the engine compartment [282](#)
Wrench/screwdriver, refer to Onboard vehicle tool kit [288](#)

X

xDrive [105](#)
Xenon headlamps [289](#), [292](#)

Y

Your individual vehicle
– Settings, refer to Personal Profile [30](#)

More about BMW



The Ultimate Driving
Machine

bmwusa.com

01 40 2 901 869 ue



Online Edition for Part no. 01 40 2 901 869 - 03 12 500