

# 2004 Buick Park Avenue Owner Manual

---

<b>Seats and Restraint Systems</b> .....	1-1	<b>Driving Your Vehicle</b> .....	4-1
Front Seats .....	1-2	Your Driving, the Road, and Your Vehicle .....	4-2
Safety Belts .....	1-6	Towing .....	4-31
Child Restraints .....	1-27	<b>Service and Appearance Care</b> .....	5-1
Air Bag Systems .....	1-49	Service .....	5-3
Restraint System Check .....	1-58	Fuel .....	5-4
<b>Features and Controls</b> .....	2-1	Checking Things Under the Hood .....	5-10
Keys .....	2-3	Headlamp Aiming .....	5-49
Doors and Locks .....	2-10	Bulb Replacement .....	5-51
Windows .....	2-17	Windshield Wiper Blade Replacement .....	5-61
Theft-Deterrent Systems .....	2-19	Tires .....	5-62
Starting and Operating Your Vehicle .....	2-23	Appearance Care .....	5-90
Mirrors .....	2-36	Vehicle Identification .....	5-98
OnStar <sup>®</sup> System .....	2-41	Electrical System .....	5-98
HomeLink <sup>®</sup> Transmitter .....	2-43	Capacities and Specifications .....	5-108
Storage Areas .....	2-47	Normal Maintenance Replacement Parts .....	5-109
Sunroof .....	2-50	<b>Maintenance Schedule</b> .....	6-1
Vehicle Personalization .....	2-51	Maintenance Schedule .....	6-2
<b>Instrument Panel</b> .....	3-1	<b>Customer Assistance Information</b> .....	7-1
Instrument Panel Overview .....	3-2	Customer Assistance Information .....	7-2
Climate Controls .....	3-24	Reporting Safety Defects .....	7-10
Warning Lights, Gages and Indicators .....	3-32	<b>Index</b> .....	1
Driver Information Center (DIC) .....	3-47		
Audio System(s) .....	3-57		

---



GENERAL MOTORS, GM, the GM Emblem, BUICK, the BUICK Emblem and the name PARK AVENUE are registered trademarks of General Motors Corporation.

This manual includes the latest information at the time it was printed. We reserve the right to make changes after that time without further notice. For vehicles first sold in Canada, substitute the name "General Motors of Canada Limited" for Buick Motor Division whenever it appears in this manual.

Please keep this manual in your vehicle, so it will be there if you ever need it when you're on the road. If you sell the vehicle, please leave this manual in it so the new owner can use it.

## Canadian Owners

You can obtain a French copy of this manual from your dealer or from:

Helm, Incorporated  
P.O. Box 07130  
Detroit, MI 48207

## How to Use This Manual

Many people read their owner's manual from beginning to end when they first receive their new vehicle. If you do this, it will help you learn about the features and controls for your vehicle. In this manual, you will find that pictures and words work together to explain things.

## Index

A good place to look for what you need is the Index in back of the manual. It is an alphabetical list of what is in the manual, and the page number where you will find it.

## Safety Warnings and Symbols

You will find a number of safety cautions in this book. We use a box and the word CAUTION to tell you about things that could hurt you if you were to ignore the warning.

 **CAUTION:**

**These mean there is something that could hurt you or other people.**

In the caution area, we tell you what the hazard is. Then we tell you what to do to help avoid or reduce the hazard. Please read these cautions. If you don't, you or others could be hurt.

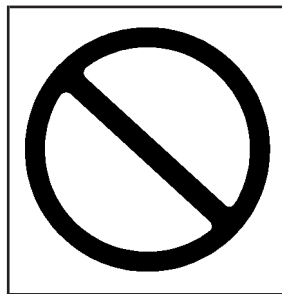

You will also find a circle with a slash through it in this book. This safety symbol means “Don’t,” “Don’t do this” or “Don’t let this happen.”

## Vehicle Damage Warnings

Also, in this book you will find these notices:

**Notice:** These mean there is something that could damage your vehicle.

A notice will tell you about something that can damage your vehicle. Many times, this damage would not be covered by your warranty, and it could be costly. But the notice will tell you what to do to help avoid the damage.

When you read other manuals, you might see CAUTION and NOTICE warnings in different colors or in different words.

You'll also see warning labels on your vehicle. They use the same words, CAUTION or NOTICE.

































## Vehicle Symbols

Your vehicle has components and labels that use symbols instead of text. Symbols, used on your vehicle, are shown along with the text describing the operation or information relating to a specific component, control, message, gage or indicator.

If you need help figuring out a specific name of a component, gage or indicator, reference the following topics:

- Seats and Restraint Systems in Section 1
- Features and Controls in Section 2
- Instrument Panel Overview in Section 3
- Climate Controls in Section 3
- Warning Lights, Gages and Indicators in Section 3
- Audio System(s) in Section 3
- Engine Compartment Overview in Section 5

These are some examples of vehicle symbols you may find on your vehicle:

CAUTION POSSIBLE INJURY 	LATCH BOTH LAP AND SHOULDER BELTS TO PROTECT OCCUPANT DO NOT TWIST SAFETY BELT WHEN ATTACHING  	MASTER LIGHTING SWITCH 	ENGINE COOLANT TEMP 	FUSE BOX ACCESS 	
PROTECT EYES BY SHIELDING 	FASTEN SEAT BELTS 	AIR BAG 	TURN SIGNALS 	ENGINE COOLANT FAN 	
CAUSTIC BATTERY ACID COULD CAUSE BURNS 	MOVE SEAT FULLY REARWARD SECURE CHILD SEAT 	DO NOT INSTALL A REAR-FACING CHILD RESTRAINT IN THIS SEATING POSITION 	PARKING LAMPS 	BATTERY CHARGING SYSTEM 	FUEL 
AVOID SPARKS OR FLAMES 	PULL BELT OUT COMPLETELY THEN SECURE CHILD SEAT 	DO NOT INSTALL A FORWARD-FACING CHILD RESTRAINT IN THIS SEATING POSITION 	HAZARD WARNING FLASHER 	BRAKE 	OWNER'S MANUAL 
SPARK OR FLAME COULD EXPLODE BATTERY 	POWER WINDOW 	DOOR LOCK UNLOCK 	DAYTIME RUNNING LAMPS 	COOLANT 	SERVICE 
			FOG LAMPS 	ENGINE OIL PRESSURE 	SERVICE MANUAL 
			ANTI-LOCK BRAKES 		



# Section 1 Seats and Restraint Systems

---

<b>Front Seats</b> .....	1-2	Top Strap .....	1-38
Power Seats .....	1-2	Top Strap Anchor Location .....	1-39
Power Lumbar .....	1-3	Lower Anchorages and Top Tethers for Children (LATCH System) .....	1-40
Heated Seats .....	1-3	Securing a Child Restraint Designed for the LATCH System .....	1-42
Reclining Seatbacks .....	1-4	Securing a Child Restraint in a Rear Outside Seat Position .....	1-42
Head Restraints .....	1-5	Securing a Child Restraint in a Center Rear Seat Position .....	1-44
<b>Safety Belts</b> .....	1-6	Securing a Child Restraint in the Right Front Seat Position .....	1-46
Safety Belts: They Are for Everyone .....	1-6	<b>Air Bag Systems</b> .....	1-49
Questions and Answers About Safety Belts .....	1-10	Where Are the Air Bags? .....	1-51
How to Wear Safety Belts Properly .....	1-12	When Should an Air Bag Inflate? .....	1-54
Driver Position .....	1-12	What Makes an Air Bag Inflate? .....	1-55
Safety Belt Use During Pregnancy .....	1-18	How Does an Air Bag Restrain? .....	1-55
Right Front Passenger Position .....	1-19	What Will You See After an Air Bag Inflates? .....	1-56
Center Passenger Position .....	1-19	Servicing Your Air Bag-Equipped Vehicle .....	1-58
Rear Seat Passengers .....	1-21	<b>Restraint System Check</b> .....	1-58
Rear Safety Belt Comfort Guides for Children and Small Adults .....	1-24	Checking Your Restraint Systems .....	1-58
Safety Belt Extender .....	1-26	Replacing Restraint System Parts After a Crash .....	1-59
<b>Child Restraints</b> .....	1-27		
Older Children .....	1-27		
Infants and Young Children .....	1-30		
Child Restraint Systems .....	1-33		
Where to Put the Restraint .....	1-36		

## Front Seats

### Power Seats



The power seat controls are located on the outboard sides of both the driver's and front passenger's seats.

To adjust the power seats, do the following:

**Horizontal Control:** Raise or lower the front of the seat cushion by pressing the forward edge of the control up or down.

Raise or lower the rear of the seat cushion by pressing the rear edge of the control up or down.

Move the seat forward or rearward by pressing the control toward the front or rear of the vehicle.

Move the seat higher or lower by holding the whole control up or down.

**Vertical Control:** Adjust the angle of the seatback by pressing the top of the control forward or rearward.

Move the seatback forward by pressing the top of the control forward.



## Power Lumbar

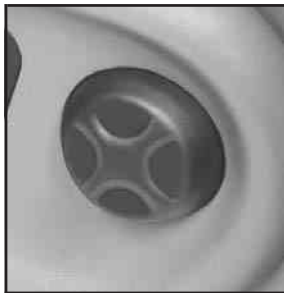

If your vehicle has this feature, the power lumbar control is located on the outboard side of each front seat. Use the power seat control first to get the proper position. Then continue with the lumbar adjustment.

To reshape the lower seatback, press the lumbar control forward to increase support and rearward to decrease support. Press the control up or down to raise or lower the support mechanism.

Keep in mind that as your seating position changes, as it may during long trips, so should the position of your lumbar support. Adjust the seat as needed.

If you have the independent front cushion moved down as far as it will go, you may feel the lumbar support higher in your back. Readjust the location of the cushion until you are comfortable. You may also want to adjust the seatback for maximum comfort.

## Heated Seats

If your vehicle has this option, press this button to turn on the heating element in the seat.



The heated seat controls are located next to the climate controls on the instrument panel.

When the heated seat control is first pressed, the HI setting is activated. Press the button again for the LO setting. The third press of the button turns the feature off.

The LO setting warms the seatback and cushion until the seat nears body temperature. The HI setting heats the seat to a slightly higher temperature.

A light on the control reminds you that the heating system is in use. When the ignition is turned off, the heating element is also turned off.

## Reclining Seatbacks

The vertical control described previously in this section reclines the front seatbacks.



But don't have a seatback reclined if your vehicle is moving.

### CAUTION:

Sitting in a reclined position when your vehicle is in motion can be dangerous. Even if you buckle up, your safety belts can't do their job when you're reclined like this.

The shoulder belt can't do its job. In a crash, you could go into it, receiving neck or other injuries.

The lap belt can't do its job either. In a crash the belt could go up over your abdomen. The belt forces would be there, not at your pelvic bones. This could cause serious internal injuries.

For proper protection when the vehicle is in motion, have the seatback upright. Then sit well back in the seat and wear your safety belt properly.

## Head Restraints



Adjust your head restraint so that the top of the restraint is closest to the top of your head. This position reduces the chance of a neck injury in a crash.

On some models, the head restraints tilt forward and rearward also.

Adjust the head restraint by grasping the top of the restraint and moving it forward or rearward until it is in the desired position.

Some rear seats have adjustable head restraints. Slide an adjustable head restraint up or down so that the top of the restraint is closest to the top of your head. This position reduces the chance of a neck injury in a crash.

On some models, the rear seat head restraints tilt forward and rearward also.

There are three different positions for the rear seat head restraints. Adjust a rear head restraint by grasping the top of the restraint and moving it forward the way you want it to go until you hear a click. It will then be locked into position until you need to move it again. Pulling it forward past the last position will allow the head restraint to return to its full rear position.

# Safety Belts

## Safety Belts: They Are for Everyone

This part of the manual tells you how to use safety belts properly. It also tells you some things you should not do with safety belts.

### CAUTION:

Don't let anyone ride where he or she can't wear a safety belt properly. If you are in a crash and you're not wearing a safety belt, your injuries can be much worse. You can hit things inside the vehicle or be ejected from it. You can be seriously injured or killed. In the same crash, you might not be, if you are buckled up. Always fasten your safety belt, and check that your passengers' belts are fastened properly too.

### CAUTION:

It is extremely dangerous to ride in a cargo area, inside or outside of a vehicle. In a collision, people riding in these areas are more likely to be seriously injured or killed. Do not allow people to ride in any area of your vehicle that is not equipped with seats and safety belts. Be sure everyone in your vehicle is in a seat and using a safety belt properly.



Your vehicle has a light that comes on as a reminder to buckle up. See *Safety Belt Reminder Light* on page 3-36.

In most states and in all Canadian provinces, the law says to wear safety belts. Here's why: *They work.*

You never know if you'll be in a crash. If you do have a crash, you don't know if it will be a bad one.

A few crashes are mild, and some crashes can be so serious that even buckled up, a person wouldn't survive. But most crashes are in between. In many of them, people who buckle up can survive and sometimes walk away. Without belts they could have been badly hurt or killed.

After more than 30 years of safety belts in vehicles, the facts are clear. In most crashes buckling up does matter... a lot!

## Why Safety Belts Work

When you ride in or on anything, you go as fast as it goes.

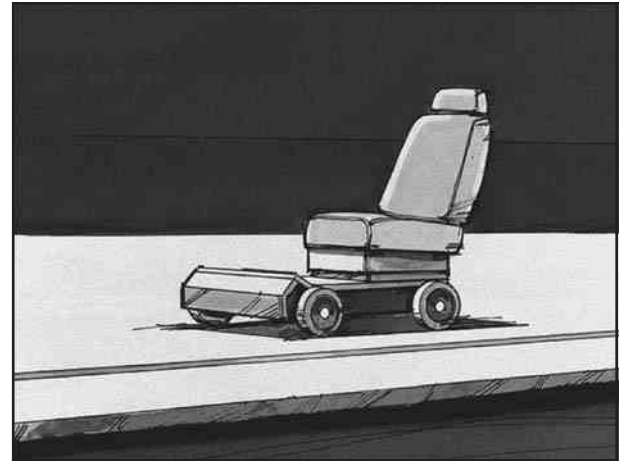

Take the simplest vehicle. Suppose it's just a seat on wheels.

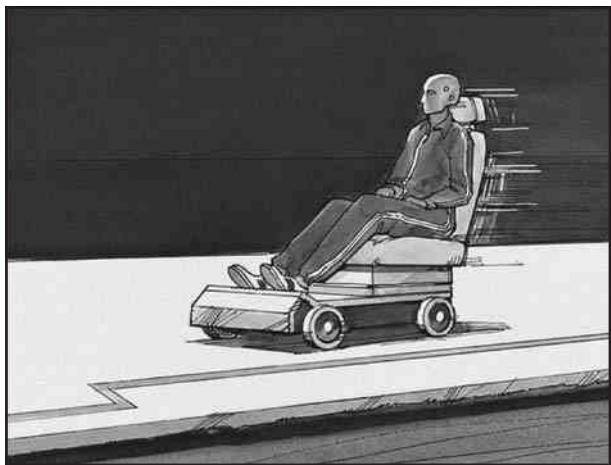

Put someone on it.

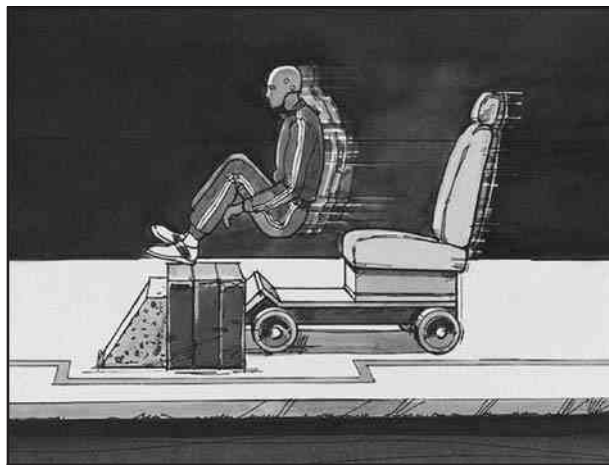

Get it up to speed. Then stop the vehicle. The rider doesn't stop.



The person keeps going until stopped by something.  
In a real vehicle, it could be the windshield...

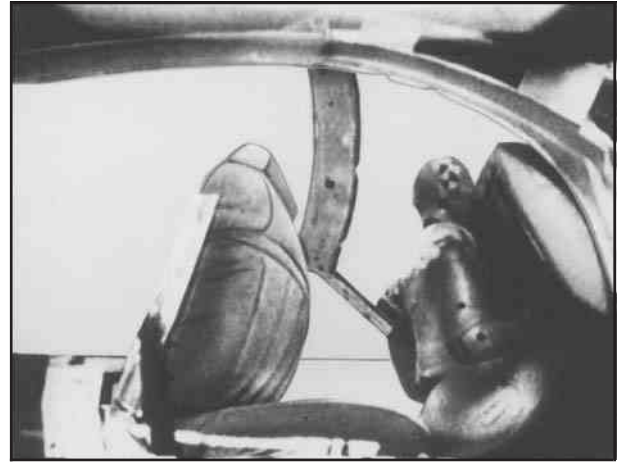

or the instrument panel...

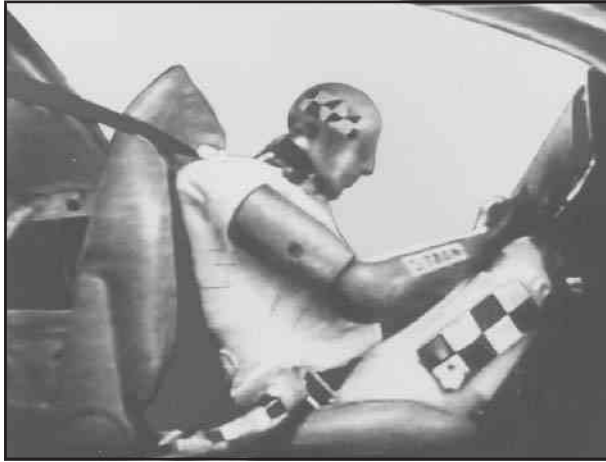

## Questions and Answers About Safety Belts

**Q:** Won't I be trapped in the vehicle after an accident if I'm wearing a safety belt?

**A:** You *could* be – whether you're wearing a safety belt or not. But you can unbuckle a safety belt, even if you're upside down. And your chance of being conscious during and after an accident, so you *can* unbuckle and get out, is *much* greater if you are belted.

or the safety belts!

With safety belts, you slow down as the vehicle does. You get more time to stop. You stop over more distance, and your strongest bones take the forces. That's why safety belts make such good sense.



**Q:** If my vehicle has air bags, why should I have to wear safety belts?

**A:** Air bags are in many vehicles today and will be in most of them in the future. But they are supplemental systems only; so they work *with* safety belts – not instead of them. Every air bag system ever offered for sale has required the use of safety belts. Even if you're in a vehicle that has air bags, you still have to buckle up to get the most protection. That's true not only in frontal collisions, but especially in side and other collisions.

**Q:** If I'm a good driver, and I never drive far from home, why should I wear safety belts?

**A:** You may be an excellent driver, but if you're in an accident – even one that isn't your fault – you and your passengers can be hurt. Being a good driver doesn't protect you from things beyond your control, such as bad drivers.

Most accidents occur within 25 miles (40 km) of home. And the greatest number of serious injuries and deaths occur at speeds of less than 40 mph (65 km/h).

Safety belts are for everyone.

## How to Wear Safety Belts Properly

This part is only for people of adult size.

Be aware that there are special things to know about safety belts and children. And there are different rules for smaller children and babies. If a child will be riding in your vehicle, see *Older Children on page 1-27* or *Infants and Young Children on page 1-30*. Follow those rules for everyone's protection.

First, you'll want to know which restraint systems your vehicle has.

We'll start with the driver position.

### Driver Position

This part describes the driver's restraint system.

#### Lap-Shoulder Belt

The driver has a lap-shoulder belt. Here's how to wear it properly.

1. Close and lock the door.
2. Adjust the seat so you can sit up straight. To see how, see "Seats" in the Index.



3. Pick up the latch plate and pull the belt across you. Don't let it get twisted.

The lap-shoulder belt may lock if you pull the belt across you very quickly. If this happens, let the belt go back slightly to unlock it. Then pull the belt across you more slowly.

4. Push the latch plate into the buckle until it clicks.

Pull up on the latch plate to make sure it is secure. If the belt isn't long enough, see *Safety Belt Extender on page 1-26*.

Make sure the release button on the buckle is positioned so you would be able to unbuckle the safety belt quickly if you ever had to.

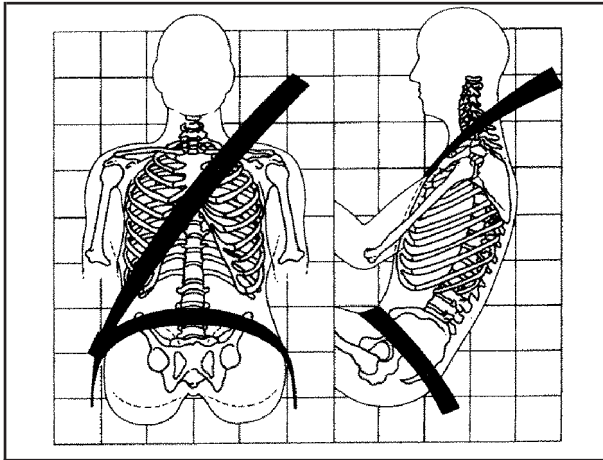

The lap part of the belt should be worn low and snug on the hips, just touching the thighs. In a crash, this applies force to the strong pelvic bones. And you'd be less likely to slide under the lap belt. If you slid under it, the belt would apply force at your abdomen. This could cause serious or even fatal injuries. The shoulder belt should go over the shoulder and across the chest. These parts of the body are best able to take belt restraining forces.

The safety belt locks if there's a sudden stop or crash, or if you pull the safety belt very quickly out of the retractor.

**Q:** What's wrong with this?

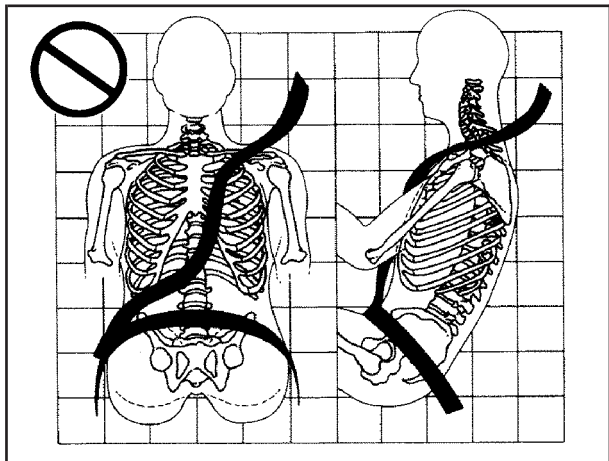

**A:** The shoulder belt is too loose. It won't give nearly as much protection this way.

**⚠ CAUTION:**

You can be seriously hurt if your shoulder belt is too loose. In a crash, you would move forward too much, which could increase injury. The shoulder belt should fit against your body.

**Q:** What's wrong with this?

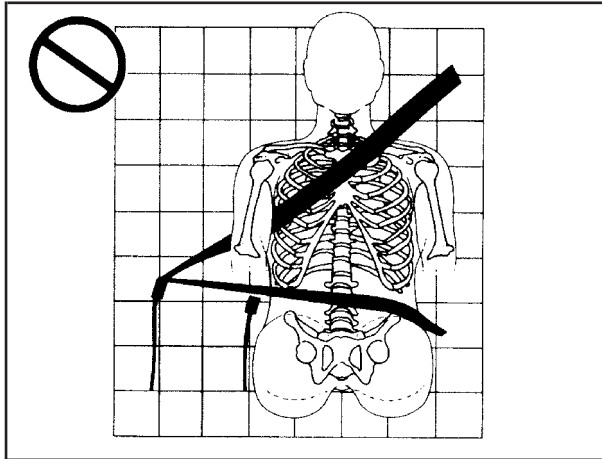

**A:** The belt is buckled in the wrong place.

**⚠ CAUTION:**

You can be seriously injured if your belt is buckled in the wrong place like this. In a crash, the belt would go up over your abdomen. The belt forces would be there, not at the pelvic bones. This could cause serious internal injuries. Always buckle your belt into the buckle nearest you.

**Q:** What's wrong with this?

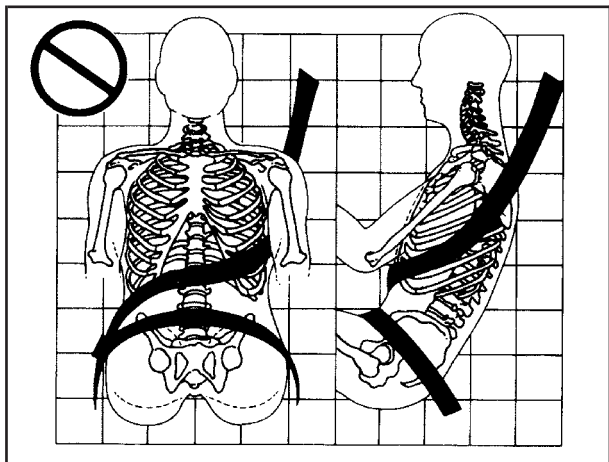

**A:** The shoulder belt is worn under the arm. It should be worn over the shoulder at all times.

**⚠ CAUTION:**

You can be seriously injured if you wear the shoulder belt under your arm. In a crash, your body would move too far forward, which would increase the chance of head and neck injury. Also, the belt would apply too much force to the ribs, which aren't as strong as shoulder bones. You could also severely injure internal organs like your liver or spleen.

**Q:** What's wrong with this?

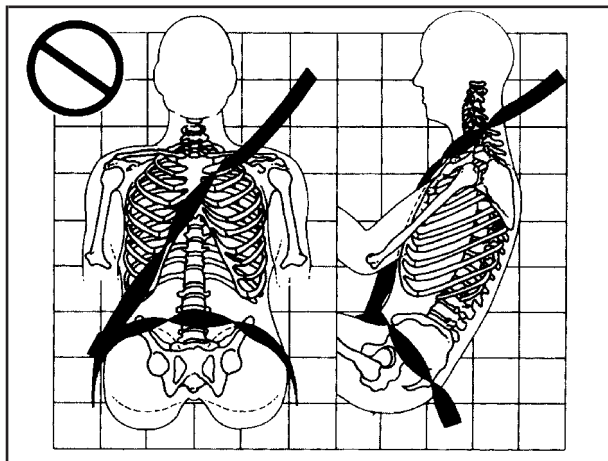

**A:** The belt is twisted across the body.

**⚠ CAUTION:**

You can be seriously injured by a twisted belt. In a crash, you wouldn't have the full width of the belt to spread impact forces. If a belt is twisted, make it straight so it can work properly, or ask your dealer to fix it.



To unlatch the belt, just push the button on the buckle. The belt should go back out of the way.

Before you close the door, be sure the belt is out of the way. If you slam the door on it, you can damage both the belt and your vehicle.

## Safety Belt Use During Pregnancy

Safety belts work for everyone, including pregnant women. Like all occupants, they are more likely to be seriously injured if they don't wear safety belts.

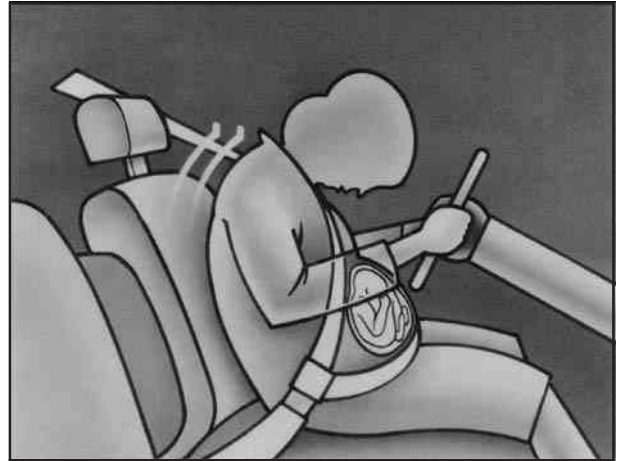

A pregnant woman should wear a lap-shoulder belt, and the lap portion should be worn as low as possible, below the rounding, throughout the pregnancy.



The best way to protect the fetus is to protect the mother. When a safety belt is worn properly, it's more likely that the fetus won't be hurt in a crash. For pregnant women, as for anyone, the key to making safety belts effective is wearing them properly.

## Right Front Passenger Position

To learn how to wear the right front passenger's safety belt properly, see *Driver Position on page 1-12*.

The right front passenger's safety belt works the same way as the driver's safety belt – except for one thing. If you ever pull the lap portion of the belt out all the way, you will engage the child restraint locking feature. If this happens, just let the belt go back all the way and start again.

If your vehicle has a center passenger position, be sure to use the correct buckle when buckling your lap-shoulder belt. If you find that the latch plate will not go fully into the buckle, see if you are using the buckle for the center passenger position.

## Center Passenger Position

### Lap Belt

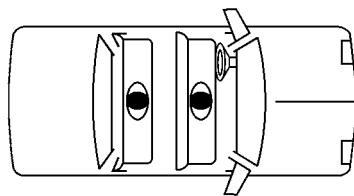

If your vehicle has a front split seat and a rear bench seat, someone can sit in the center positions.

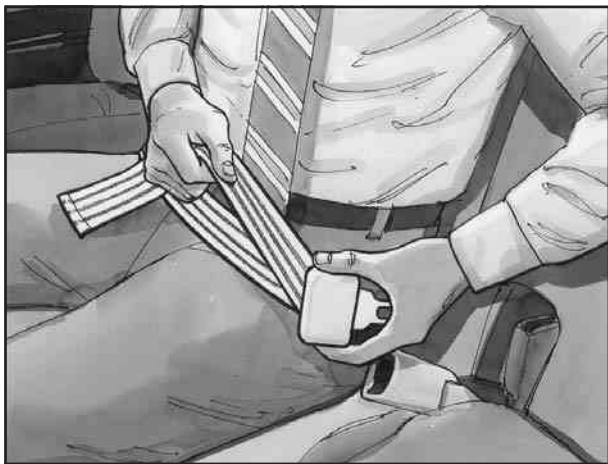

When you sit in the center seating position, you have a lap safety belt, which has no retractor. To make the belt longer, tilt the latch plate and pull it along the belt.



To make the belt shorter, pull its free end as shown until the belt is snug.

Buckle, position and release it the same way as the lap part of a lap-shoulder belt. If the belt isn't long enough, see *Safety Belt Extender* on page 1-26.

Make sure the release button on the buckle is positioned so you would be able to unbuckle the safety belt quickly if you ever had to.

## Rear Seat Passengers

It's very important for rear seat passengers to buckle up! Accident statistics show that unbelted people in the rear seat are hurt more often in crashes than those who are wearing safety belts.

Rear passengers who aren't safety belted can be thrown out of the vehicle in a crash. And they can strike others in the vehicle who are wearing safety belts.

## Rear Seat Outside Passenger Positions

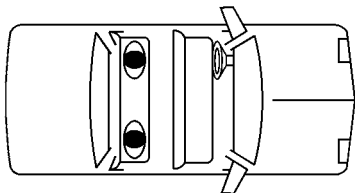

## Lap-Shoulder Belt

The positions next to the windows have lap-shoulder belts. Here's how to wear one properly.



1. Pick up the latch plate and pull the belt across you. Don't let it get twisted.

The shoulder belt may lock if you pull the belt across you very quickly. If this happens, let the belt go back slightly to unlock it. Then pull the belt across you more slowly.

2. Push the latch plate into the buckle until it clicks.



If the belt stops before it reaches the buckle, tilt the latch plate and keep pulling until you can buckle it. Pull up on the latch plate to make sure it is secure. If the belt is not long enough, see *Safety Belt Extender* on page 1-26.

Make sure the release button on the buckle is positioned so you would be able to unbuckle the safety belt quickly if you ever had to.



3. To make the lap part tight, pull down on the buckle end of the belt as you pull up on the shoulder belt.

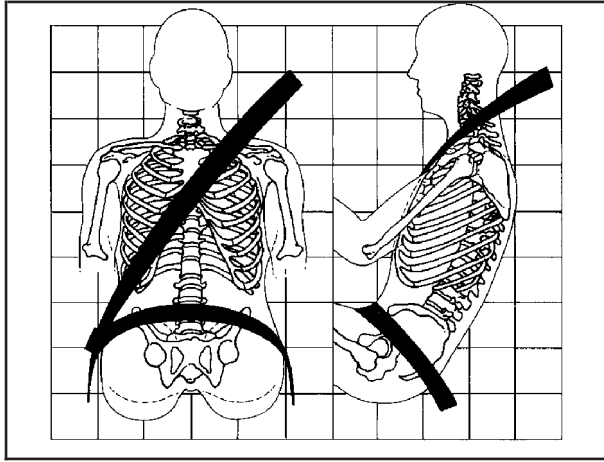

The lap part of the belt should be worn low and snug on the hips, just touching the thighs. In a crash, this applies force to the strong pelvic bones. And you'd be less likely to slide under it, the belt would apply force at your abdomen. This could cause serious or even fatal injuries. The shoulder belt should go over the shoulder and across the chest. These parts of the body are best able to take belt restraining forces.

The safety belt locks if there's a sudden stop or a crash, or if you pull the belt very quickly out of the retractor.

**⚠ CAUTION:**

You can be seriously hurt if your shoulder belt is too loose. In a crash, you would move forward too much, which could increase injury. The shoulder belt should fit against your body.



To unlatch the belt, just push the button on the buckle.

## Rear Safety Belt Comfort Guides for Children and Small Adults

Rear shoulder belt comfort guides provide added safety belt comfort for older children who have outgrown booster seats and for small adults. When installed on a shoulder belt, the comfort guide better positions the belt away from the neck and head.

There is one guide for each outside passenger position in the rear seat. To provide added safety belt comfort for children who have outgrown child restraints and booster seats and for smaller adults, the comfort guides may be installed on the shoulder belts. Here's how to install a comfort guide and use the safety belt:



1. Remove the guide from its storage pocket on the side of the seatback.



2. Slide the guide under and past the belt. The elastic cord must be under the belt. Then, place the guide over the belt, and insert the two edges of the belt into the slots of the guide.

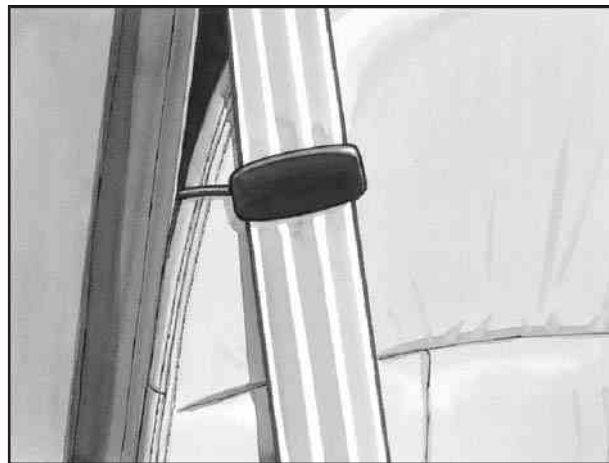

3. Be sure that the belt is not twisted and it lies flat. The elastic cord must be under the belt and the guide on top.



## Safety Belt Extender

If the vehicle's safety belt will fasten around you, you should use it.

But if a safety belt isn't long enough to fasten, your dealer will order you an extender. It's free. When you go in to order it, take the heaviest coat you will wear, so the extender will be long enough for you. The extender will be just for you, and just for the seat in your vehicle that you choose. Don't let someone else use it, and use it only for the seat it is made to fit. To wear it, just attach it to the regular safety belt.

4. Buckle, position and release the safety belt as described in *Rear Seat Passengers* on page 1-21. Make sure that the shoulder belt crosses the shoulder.

To remove and store the comfort guides, squeeze the belt edges together so that you can take them out of the guides. Slide the guide into its storage pocket on the side of the seatback.



# Child Restraints

## Older Children



Older children who have outgrown booster seats should wear the vehicle's safety belts.

If you have the choice, a child should sit next to a window so the child can wear a lap-shoulder belt and get the additional restraint a shoulder belt can provide.

**Q:** What is the proper way to wear safety belts?

**A:** If possible, an older child should wear a lap-shoulder belt and get the additional restraint a shoulder belt can provide. The shoulder belt should not cross the face or neck. The lap belt should fit snugly below the hips, just touching the top of the thighs. It should never be worn over the abdomen, which could cause severe or even fatal internal injuries in a crash.

Accident statistics show that children are safer if they are restrained in the rear seat.

In a crash, children who are not buckled up can strike other people who are buckled up, or can be thrown out of the vehicle. Older children need to use safety belts properly.



**⚠ CAUTION:**

**Never do this.**

**Here two children are wearing the same belt. The belt can't properly spread the impact forces. In a crash, the two children can be crushed together and seriously injured. A belt must be used by only one person at a time.**

**Q:** What if a child is wearing a lap-shoulder belt, but the child is so small that the shoulder belt is very close to the child's face or neck?

**A:** Move the child toward the center of the vehicle, but be sure that the shoulder belt still is on the child's shoulder, so that in a crash the child's upper body would have the restraint that belts provide.

If the child is sitting in a rear seat outside position, see *Rear Safety Belt Comfort Guides for Children and Small Adults* on page 1-24.

If the child is so small that the shoulder belt is still very close to the child's face or neck, you might want to place the child in the center seat position, the one that has only a lap belt.



**⚠ CAUTION:**

**Never do this.**

Here a child is sitting in a seat that has a lap-shoulder belt, but the shoulder part is behind the child. If the child wears the belt in this way, in a crash the child might slide under the belt. The belt's force would then be applied right on the child's abdomen. That could cause serious or fatal injuries.

Wherever the child sits, the lap portion of the belt should be worn low and snug on the hips, just touching the child's thighs. This applies belt force to the child's pelvic bones in a crash.

## Infants and Young Children

Everyone in a vehicle needs protection! This includes infants and all other children. Neither the distance traveled nor the age and size of the traveler changes the need, for everyone, to use safety restraints. In fact, the law in every state in the United States and in every Canadian province says children up to some age must be restrained while in a vehicle.

Every time infants and young children ride in vehicles, they should have the protection provided by appropriate restraints. Young children should not use the vehicle's adult safety belts alone, unless there is no other choice. Instead, they need to use a child restraint.



### CAUTION:

People should never hold a baby in their arms while riding in a vehicle. A baby doesn't weigh much – until a crash. During a crash a baby will become so heavy it is not possible to hold it.

CAUTION: (Continued)

**CAUTION: (Continued)**

For example, in a crash at only 25 mph (40 km/h), a 12-lb. (5.5 kg) baby will suddenly become a 240-lb. (110 kg) force on a person's arms. A baby should be secured in an appropriate restraint.



**⚠ CAUTION:**

Children who are up against, or very close to, any air bag when it inflates can be seriously injured or killed. Air bags plus lap-shoulder belts offer outstanding protection for adults and older children, but not for young children and infants. Neither the vehicle's safety belt system nor its air bag system is designed for them. Young children and infants need the protection that a child restraint system can provide.

**Q:** What are the different types of add-on child restraints?

**A:** Add-on child restraints, which are purchased by the vehicle's owner, are available in four basic types. Selection of a particular restraint should take into consideration not only the child's weight, height, and age but also whether or not the restraint will be compatible with the motor vehicle in which it will be used.

For most basic types of child restraints, there are many different models available. When purchasing a child restraint, be sure it is designed to be used in a motor vehicle. If it is, the restraint will have a label saying that it meets federal motor vehicle safety standards.

The restraint manufacturer's instructions that come with the restraint state the weight and height limitations for a particular child restraint. In addition, there are many kinds of restraints available for children with special needs.

 **CAUTION:**

**Newborn infants need complete support, including support for the head and neck. This is necessary because a newborn infant's neck is weak and its head weighs so much compared with the rest of its body. In a crash, an infant in a rear-facing seat settles into the restraint, so the crash forces can be distributed across the strongest part of an infant's body, the back and shoulders. Infants always should be secured in appropriate infant restraints.**

**⚠ CAUTION:**

The body structure of a young child is quite unlike that of an adult or older child, for whom the safety belts are designed. A young child's hip bones are still so small that the vehicle's regular safety belt may not remain low on the hip bones, as it should. Instead, it may settle up around the child's abdomen. In a crash, the belt would apply force on a body area that's unprotected by any bony structure. This alone could cause serious or fatal injuries. Young children always should be secured in appropriate child restraints.

## Child Restraint Systems

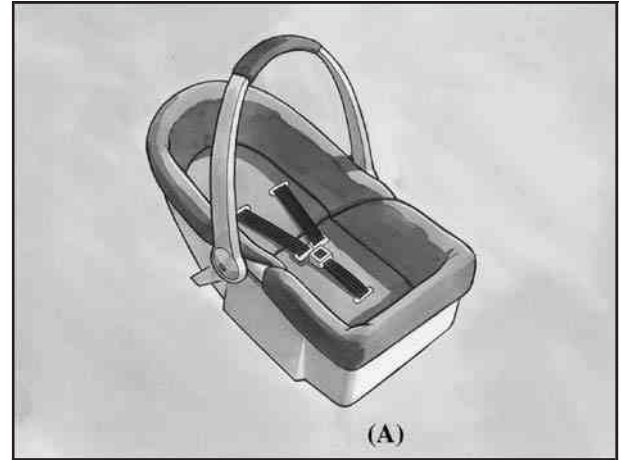

An infant car bed (A), a special bed made for use in a motor vehicle, is an infant restraint system designed to restrain or position a child on a continuous flat surface. Make sure that the infant's head rests toward the center of the vehicle.

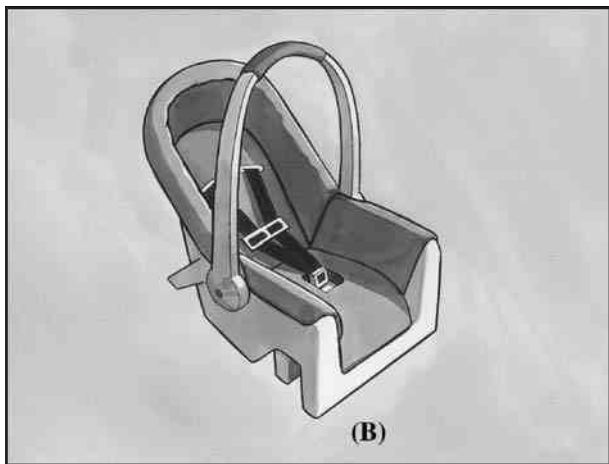

A rear-facing infant seat (B) provides restraint with the seating surface against the back of the infant. The harness system holds the infant in place and, in a crash, acts to keep the infant positioned in the restraint.

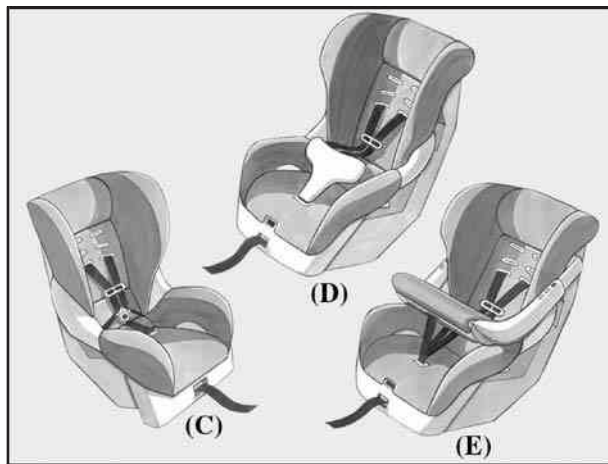

A forward-facing child seat (C-E) provides restraint for the child's body with the harness and also sometimes with surfaces such as T-shaped or shelf-like shields.



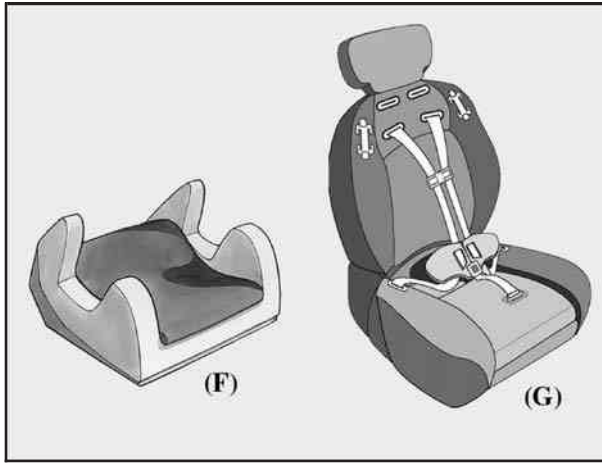

A booster seat (F-G) is a child restraint designed to improve the fit of the vehicle's safety belt system. Some booster seats have a shoulder belt positioner, and some high-back booster seats have a five-point harness. A booster seat can also help a child to see out the window.

**Q: How do child restraints work?**

**A:** A child restraint system is any device designed for use in a motor vehicle to restrain, seat, or position children. A built-in child restraint system is a permanent part of the motor vehicle. An add-on child restraint system is a portable one, which is purchased by the vehicle's owner.

For many years, add-on child restraints have used the adult belt system in the vehicle. To help reduce the chance of injury, the child also has to be secured within the restraint. The vehicle's belt system secures the add-on child restraint in the vehicle, and the add-on child restraint's harness system holds the child in place within the restraint.

One system, the three-point harness, has straps that come down over each of the infant's shoulders and buckle together at the crotch. The five-point harness system has two shoulder straps, two hip straps and a crotch strap. A shield may take the place of hip straps. A T-shaped shield has shoulder straps that are attached to a flat pad which rests low against the child's body. A shelf- or armrest-type shield has straps that are attached to a wide, shelf-like shield that swings up or to the side.

When choosing a child restraint, be sure the child restraint is designed to be used in a vehicle. If it is, it will have a label saying that it meets federal motor vehicle safety standards.

Then follow the instructions for the restraint. You may find these instructions on the restraint itself or in a booklet, or both. These restraints use the belt system in your vehicle, but the child also has to be secured within the restraint to help reduce the chance of personal injury. When securing an add-on child restraint, refer to the instructions that come with the restraint which may be on the restraint itself or in a booklet, or both, and to this manual. The child restraint instructions are important, so if they are not available, obtain a replacement copy from the manufacturer.

## Where to Put the Restraint

Accident statistics show that children are safer if they are restrained in the rear rather than the front seat. We, therefore, recommend that child restraints be secured in a rear seat, including an infant riding in a rear-facing infant seat, a child riding in a forward-facing child seat and an older child riding in a booster seat. *Never* put a rear-facing child restraint in the front passenger seat. Here is why:

### CAUTION:

**A child in a rear-facing child restraint can be seriously injured or killed if the right front passenger's air bag inflates. This is because the back of the rear-facing child restraint would be very close to the inflating air bag.**

**CAUTION: (Continued)**

**CAUTION: (Continued)**

Always secure a rear-facing child restraint in a rear seat.

If you secure a forward-facing child restraint in the right front seat, always move the front passenger seat as far back as it will go. It is better to secure the child restraint in a rear seat.

 **CAUTION:**

A child in a child restraint in the center front seat can be badly injured or killed by the right front passenger's air bag if it inflates. Never secure a child restraint in the center front seat. It is always better to secure a child restraint in the rear seat.

If you secure a forward-facing child restraint in the right front passenger seat, always move the front passenger seat as far back as it will go. It is better to secure the child restraint in a rear seat.

Wherever you install it, be sure to secure the child restraint properly.

Keep in mind that an unsecured child restraint can move around in a collision or sudden stop and injure people in the vehicle. Be sure to properly secure any child restraint in your vehicle – even when no child is in it.

## Top Strap

Some child restraints have a top strap, or “top tether.” It can help restrain the child restraint during a collision. For it to work, a top strap must be properly anchored to the vehicle. Some top strap-equipped child restraints are designed for use with or without the top strap being anchored. Others require the top strap always to be anchored. Be sure to read and follow the instructions for your child restraint. If yours requires that the top strap be anchored, don’t use the restraint unless it is anchored properly.

If the child restraint does not have a top strap, one can be obtained, in kit form, for many child restraints. Ask the child restraint manufacturer whether or not a kit is available.

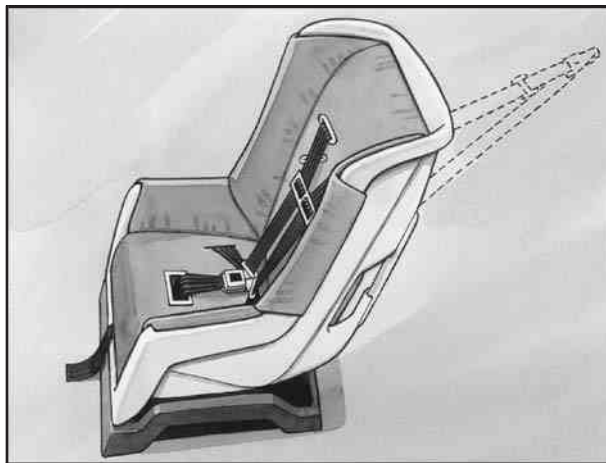

In Canada, the law requires that forward-facing child restraints have a top strap, and that the strap be anchored. In the United States, some child restraints also have a top strap. If your child restraint has a top strap, it should be anchored.

Anchor the top strap to one of the following anchor points. Be sure to use an anchor point located on the same side of the vehicle as the seating position where the child restraint will be placed.

If you have an adjustable head restraint, route the top strap under it.

Once you have the top strap anchored, you'll be ready to secure the child restraint itself. Tighten the top strap when and as the child restraint manufacturer's instructions say.

## Top Strap Anchor Location

Your vehicle has top strap anchors already installed for the rear seating positions. You'll find them behind the rear seat on the filler panel.

Do not use a child restraint with a top strap in the right front passenger's position because there is no place to anchor the top strap.

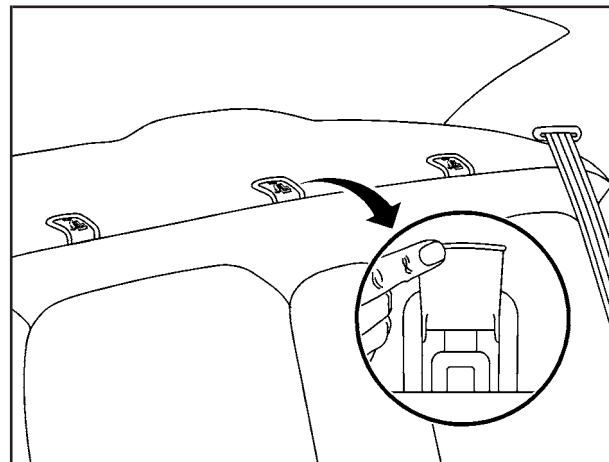

In order to get to a bracket, you'll have to open the trim cover.

## Lower Anchorages and Top Tethers for Children (LATCH System)

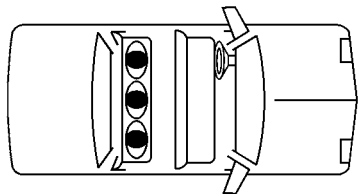

Your vehicle has the LATCH system. You will find anchors (A) for all three rear seating positions.

This system, designed to make installation of child restraints easier, does not use the vehicle's safety belts. Instead, it uses vehicle anchors (A, B) and child restraint attachments to secure the restraints. Some restraints also use another vehicle anchor to secure a top tether strap (C).

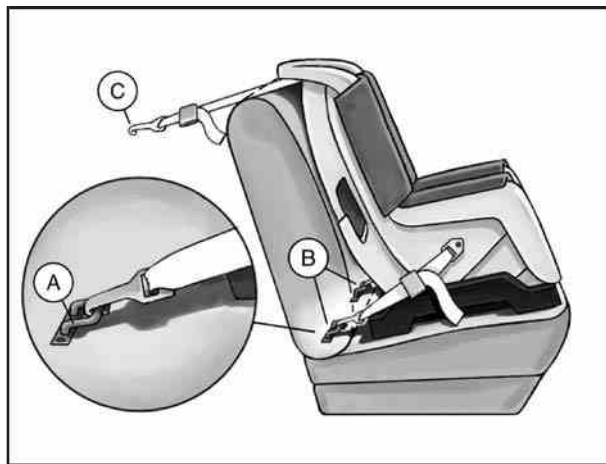

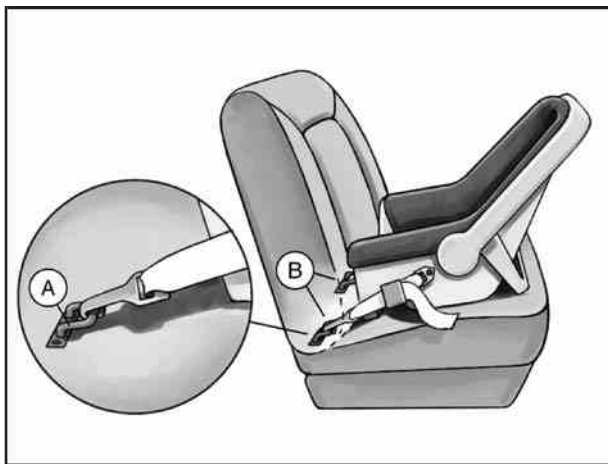

In order to use the LATCH system in your vehicle, you need a child restraint designed for that system.

To assist you in locating the lower anchors for this child restraint system, each seating position with the LATCH system has a label on the seatback at each lower anchor position.



The labels are located near the base of all three rear seating positions.

### **CAUTION:**

If a LATCH-type child restraint isn't attached to its anchorage points, the restraint won't be able to protect the child correctly. In a crash, the child could be seriously injured or killed. Make sure that a LATCH-type child restraint is properly installed using the anchorage points, or use the vehicle's safety belts to secure the restraint. See "Securing a Child Restraint Designed for the LATCH System" or "Securing a Child Restraint in a Rear Seat Position" in the Index for information on how to secure a child restraint in your vehicle.

## Securing a Child Restraint Designed for the LATCH System

1. Find the anchors for the seating position you want to use, where the bottom of the seatback meets the back of the seat cushion.
2. Put the child restraint on the seat.
3. Attach the anchor points on the child restraint to the anchors in the vehicle. The child restraint instructions will show you how.
4. If the child restraint is forward-facing, attach the top strap to the top strap anchor. See *Top Strap on page 1-38*. Tighten the top strap according to the child restraint instructions.
5. Push and pull the child restraint in different directions to be sure it is secure.

To remove the child restraint, simply unhook the top strap from the top tether anchor and then disconnect the anchor points.

## Securing a Child Restraint in a Rear Outside Seat Position

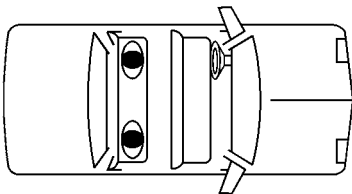

If your child restraint is equipped with the LATCH system, see *Lower Anchorages and Top Tethers for Children (LATCH System) on page 1-40*. See *Top Strap on page 1-38* if the child restraint has one.

If your child restraint does not have the LATCH system, you'll be using the lap-shoulder belt to secure the child restraint in this position. Be sure to follow the instructions that came with the child restraint. Secure the child in the child restraint when and as the instructions say.

1. Put the restraint on the seat.
2. Pick up the latch plate, and run the lap and shoulder portions of the vehicle's safety belt through or around the restraint. The child restraint instructions will show you how.





Tilt the latch plate to adjust the belt if needed.



3. Buckle the belt. Make sure the release button is positioned so you would be able to unbuckle the safety belt quickly if you ever had to.

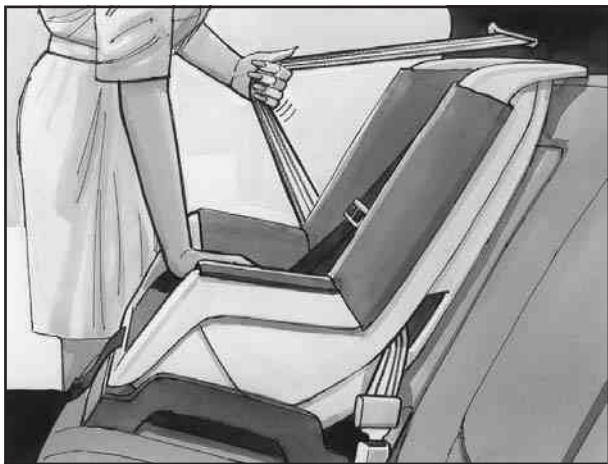

To remove the child restraint, just unbuckle the vehicle's safety belt and let it go back all the way. The safety belt will move freely again and be ready to work for an adult or larger child passenger.

## Securing a Child Restraint in a Center Rear Seat Position

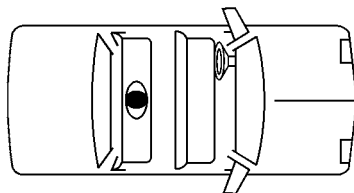

If your child restraint is equipped with the LATCH system, see *Lower Anchorages and Top Tethers for Children (LATCH System)* on page 1-40. See *Top Strap* on page 1-38 if the child restraint has one.

If your child restraint does not have the LATCH system, you'll be using the lap belt to secure the child restraint in this position.

4. To tighten the belt, pull up on the shoulder belt while you push down on the child restraint. If you're using a forward-facing child restraint, you may find it helpful to use your knee to push down on the child restraint as you tighten the belt.
5. Push and pull the child restraint in different directions to be sure it is secure.

Be sure to follow the instructions that came with the child restraint. Secure the child restraint when and as the instructions say.

**⚠ CAUTION:**

**A child in a child restraint in the center front seat can be badly injured or killed by the right front passenger's air bag if it inflates. Never secure a child restraint in the center front seat. It is always better to secure a child restraint in the rear seat.**

**If you secure a forward-facing child restraint in the right front passenger seat, always move the front passenger seat as far back as it will go. It is better to secure the child restraint in a rear seat.**



1. Make the belt as long as possible by tilting the latch plate and pulling it along the belt.
2. Put the restraint on the seat.
3. Run the vehicle's safety belt through or around the restraint. The child restraint instructions will show you how.



To remove the child restraint, just unbuckle the vehicle's safety belt. It will be ready to work for an adult or larger child passenger.

## Securing a Child Restraint in the Right Front Seat Position

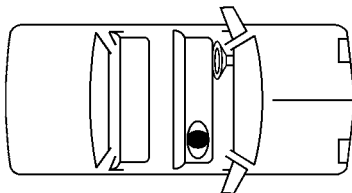

If your child restraint is equipped with the LATCH system, see *Lower Anchorages and Top Tethers for Children (LATCH System)* on page 1-40. See *Top Strap* on page 1-38 if the child restraint has one.

4. Buckle the belt. Make sure the release button is positioned so you would be able to unbuckle the safety belt quickly if you ever had to.
5. To tighten the belt, pull its free end while you push down on the child restraint. If you're using a forward-facing child restraint, you may find it helpful to use your knee to push the child restraint as you tighten the belt.
6. Push and pull the child restraint in different directions to be sure it is secure.

Your vehicle has a right front passenger air bag. *Never* put a rear-facing child restraint in this seat. Here is why:

**⚠ CAUTION:**

**A child in a rear-facing child restraint can be seriously injured or killed if the right front passenger's air bag inflates. This is because the back of the rear-facing child restraint would be very close to the inflating air bag. Always secure a rear-facing child restraint in a rear seat.**

A rear seat is a safer place to secure a forward-facing child restraint. If you need to secure a forward-facing child restraint in the right front seat you will be using the lap-shoulder belt to secure the child restraint in this position. Be sure to follow the instructions that came with the child restraint. Secure the child in the child restraint when and as the instructions say.

1. Because your vehicle has a right front passenger air bag, always move the seat as far back as it will go before securing a forward-facing child restraint. See *Power Seats on page 1-2*.

2. Put the restraint on the seat.
3. Pick up the latch plate, and run the lap and shoulder portions of the vehicle's safety belt through or around the restraint. The child restraint instructions will show you how.



4. Buckle the belt. Make sure the release button is positioned so you would be able to unbuckle the safety belt quickly if you ever had to.



5. Pull the rest of the shoulder belt all the way out of the retractor to set the lock.



6. To tighten the belt, feed the lap belt back into the retractor while you push down on the child restraint. You may find it helpful to use your knee to push down on the child restraint as you tighten the belt.
7. Push and pull the child restraint in different directions to be sure it is secure.

To remove the child restraint, just unbuckle the vehicle's safety belt and let it go back all the way. The safety belt will move freely again and be ready to work for an adult or larger child passenger.

## Air Bag Systems

This part explains the frontal and side impact air bag systems.

Your vehicle has four air bags – a frontal air bag for the driver, another frontal air bag for the right front passenger, a side impact air bag for the driver, and another side impact air bag for the right front passenger.

Frontal air bags are designed to help reduce the risk of injury from the force of an inflating air bag. But these air bags must inflate very quickly to do their job and comply with federal regulations.

Here are the most important things to know about the air bag systems:

### CAUTION:

**You can be severely injured or killed in a crash if you aren't wearing your safety belt – even if you have air bags. Wearing your safety belt during a crash helps reduce your chance of hitting things inside the vehicle or being ejected from it. Air bags are designed to work with safety belts but don't replace them.**

**CAUTION: (Continued)**

### **CAUTION: (Continued)**

**Frontal air bags for the driver and right front passenger are designed to deploy only in moderate to severe frontal and near frontal crashes. They aren't designed to inflate at all in rollover, rear or low-speed frontal crashes, or in many side crashes. And, for some unrestrained occupants, frontal air bags may provide less protection in frontal crashes than more forceful air bags have provided in the past.**

**The side impact air bags for the driver and right front passenger are designed to inflate only in moderate to severe crashes where something hits the side of your vehicle. They aren't designed to inflate in frontal, in rollover or in rear crashes.**

**Everyone in your vehicle should wear a safety belt properly – whether or not there's an air bag for that person.**

 **CAUTION:**

Both frontal and side impact air bags inflate with great force, faster than the blink of an eye. If you're too close to an inflating air bag, as you would be if you were leaning forward, it could seriously injure you. Safety belts help keep you in position for air bag inflation before and during a crash. Always wear your safety belt, even with frontal air bags. The driver should sit as far back as possible while still maintaining control of the vehicle. Front occupants should not lean on or sleep against the door.

 **CAUTION:**

Anyone who is up against, or very close to, any air bag when it inflates can be seriously injured or killed. Air bags plus lap-shoulder belts offer the best protection for adults, but not for young children and infants. Neither the vehicle's safety belt system nor its air bag system is designed for them. Young children and infants need the protection that a child restraint system can provide. Always secure children properly in your vehicle. To read how, see the part of this manual called "Older Children" or "Infants and Young Children."



## AIR BAG

There is an air bag readiness light on the instrument panel, which shows AIR BAG.

The system checks the air bag electrical system for malfunctions. The light tells you if there is an electrical problem. See *Air Bag Readiness Light* on page 3-36 for more information.

## Where Are the Air Bags?



The driver's frontal air bag is in the middle of the steering wheel.



The right front passenger's frontal air bag is in the instrument panel on the passenger's side.



The driver's side impact air bag is in the side of the driver's seatback closest to the door.



The right front passenger's side impact air bag is in the side of the passenger's seatback closest to the door.

**⚠ CAUTION:**

If something is between an occupant and an air bag, the bag might not inflate properly or it might force the object into that person causing severe injury or even death. The path of an inflating air bag must be kept clear. Don't put anything between an occupant and an air bag, and don't attach or put anything on the steering wheel hub or on or near any other air bag covering. Don't let seat covers block the inflation path of a side impact air bag.

## When Should an Air Bag Inflate?

The driver's and right front passenger's frontal air bags are designed to inflate in moderate to severe frontal or near-frontal crashes. But they are designed to inflate only if the impact speed is above the system's designed "threshold level."

If your vehicle goes straight into a wall that doesn't move or deform, the threshold level is about 9 to 15 mph (14 to 24 km/h). The threshold level can vary, however, with specific vehicle design, so that it can be somewhat above or below this range.

If your vehicle strikes something that will move or deform, such as a parked car, the threshold level will be higher. The driver's and right front passenger's frontal air bags are not designed to inflate in rollovers, rear impacts, or in many side impacts because inflation would not help the occupant.

The side impact air bags are designed to inflate in moderate to severe side crashes. A side impact air bag will inflate if the crash severity is above the system's designed "threshold level." The threshold level can vary with specific vehicle design. Side impact air bags are not designed to inflate in frontal or near-frontal impacts, rollovers or rear impacts, because inflation would not help the occupant. A side impact air bag will only deploy on the side of the vehicle that is struck.

In any particular crash, no one can say whether an air bag should have inflated simply because of the damage to a vehicle or because of what the repair costs were. For frontal air bags, inflation is determined by the angle of the impact and how quickly the vehicle slows down in frontal and near-frontal impacts. For side impact air bags, inflation is determined by the location and severity of the impact.

## What Makes an Air Bag Inflate?

In an impact of sufficient severity, the air bag sensing system detects that the vehicle is in a crash. For both frontal and side impact air bags, the sensing system triggers a release of gas from the inflator, which inflates the air bag. The inflator, the air bag and related hardware are all part of the air bag modules inside the steering wheel, the instrument panel, and the side of the front seatbacks closest to the door.

## How Does an Air Bag Restrain?

In moderate to severe frontal or near frontal collisions, even belted occupants can contact the steering wheel or the instrument panel. In moderate to severe side collisions, even belted occupants can contact the inside of the vehicle. The air bag supplements the protection provided by safety belts. Air bags distribute the force of the impact more evenly over the occupant's upper body, stopping the occupant more gradually.

But the frontal air bags would not help you in many types of collisions, including rollovers, rear impacts, and many side impacts, primarily because an occupant's motion is not toward the air bag. Side impact air bags would not help you in many types of collisions, including frontal or near frontal collisions, rollovers, and rear impacts, primarily because an occupant's motion is not toward those air bags. Air bags should never be regarded as anything more than a supplement to safety belts, and then only in moderate to severe frontal or near-frontal collisions for the driver's and right front passenger's frontal air bags, and only in moderate to severe side collisions for the driver's and right front passenger's side impact air bag.

## What Will You See After an Air Bag Inflates?

After the air bag inflates, it quickly deflates, so quickly that some people may not even realize the air bag inflated. Some components of the air bag module will be hot for a short time. These components include the steering wheel hub for the driver's frontal air bag and the instrument panel for the right front passenger's frontal air bag. For vehicles with side impact air bags, the side of the seatback closest to the driver's and/or right front passenger's door will be hot. The parts of the bag that come into contact with you may be warm, but not too hot to touch. There will be some smoke and dust coming from the vents in the deflated air bags. Air bag inflation doesn't prevent the driver from seeing or being able to steer the vehicle, nor does it stop people from leaving the vehicle.

### CAUTION:

**When an air bag inflates, there is dust in the air. This dust could cause breathing problems for people with a history of asthma or other breathing trouble. To avoid this, everyone in the vehicle should get out as soon as it is safe to do so. If you have breathing problems but can't get out of the vehicle after an air bag inflates, then get fresh air by opening a window or a door. If you experience breathing problems following an air bag deployment, you should seek medical attention.**

In many crashes severe enough to inflate an air bag, windshields are broken by vehicle deformation. Additional windshield breakage may also occur from the right front passenger air bag.

- Air bags are designed to inflate only once. After an air bag inflates, you'll need some new parts for your air bag system. If you don't get them, the air bag system won't be there to help protect you in another crash. A new system will include air bag modules and possibly other parts. The service manual for your vehicle covers the need to replace other parts.
- Your vehicle is equipped with a crash sensing and diagnostic module, which records information about the frontal air bag system. The module records information about the readiness of the system, when the system commands air bag inflation and driver's safety belt usage at deployment. The module also records speed, engine rpm, brake and throttle data.

- Let only qualified technicians work on your air bag systems. Improper service can mean that an air bag system won't work properly. See your dealer for service.

**Notice:** If you damage the covering for the driver's or the right front passenger's air bag, or the air bag covering on the driver's and right front passenger's seatback, the bag may not work properly. You may have to replace the air bag module in the steering wheel, both the air bag module and the instrument panel for the right front passenger's air bag, or both the air bag module and seatback for the driver's and right front passenger's side impact air bag. Do not open or break the air bag coverings.

## Servicing Your Air Bag-Equipped Vehicle

Air bags affect how your vehicle should be serviced. There are parts of the air bag systems in several places around your vehicle. Your dealer and the service manual have information about servicing your vehicle and the air bag systems. To purchase a service manual, see *Service Publications Ordering Information on page 7-11*.

### CAUTION:

**For up to 10 seconds after the ignition key is turned off and the battery is disconnected, an air bag can still inflate during improper service. You can be injured if you are close to an air bag when it inflates. Avoid yellow connectors. They are probably part of the air bag systems. Be sure to follow proper service procedures, and make sure the person performing work for you is qualified to do so.**

The air bag systems do not need regular maintenance.

## Restraint System Check

### Checking Your Restraint Systems

Now and then, make sure the safety belt reminder light and all your belts, buckles, latch plates, retractors and anchorages are working properly. Look for any other loose or damaged safety belt system parts. If you see anything that might keep a safety belt system from doing its job, have it repaired.

Torn or frayed safety belts may not protect you in a crash. They can rip apart under impact forces. If a belt is torn or frayed, get a new one right away.

Also look for any opened or broken air bag covers, and have them repaired or replaced. (The air bag system does not need regular maintenance.)



## Replacing Restraint System Parts After a Crash

### CAUTION:

**A crash can damage the restraint systems in your vehicle. A damaged restraint system may not properly protect the person using it, resulting in serious injury or even death in a crash. To help make sure your restraint systems are working properly after a crash, have them inspected and any necessary replacements made as soon as possible.**

If you've had a crash, do you need new belts or LATCH system parts?

After a very minor collision, nothing may be necessary. But if the belts were stretched, as they would be if worn during a more severe crash, then you need new parts.

If the LATCH system was being used during a more severe crash, you may need new LATCH system parts.

If belts are cut or damaged, replace them. Collision damage also may mean you will need to have LATCH system, safety belt or seat parts repaired or replaced. New parts and repairs may be necessary even if the belt or LATCH system wasn't being used at the time of the collision.

If an air bag inflates, you'll need to replace air bag system parts. See the part on the air bag system earlier in this section.



## Section 2 Features and Controls

---

<b>Keys</b> .....	2-3	<b>Starting and Operating Your Vehicle</b> .....	2-23
Remote Keyless Entry System .....	2-5	New Vehicle Break-In .....	2-23
Remote Keyless Entry System Operation .....	2-6	Ignition Positions .....	2-24
<b>Doors and Locks</b> .....	2-10	Starting Your Engine .....	2-25
Door Locks .....	2-10	Engine Coolant Heater .....	2-26
Central Door Unlocking System .....	2-11	Automatic Transaxle Operation .....	2-27
Power Door Locks .....	2-11	Parking Brake .....	2-29
Door Ajar Reminder .....	2-11	Shifting Into Park (P) .....	2-30
Delayed Locking .....	2-11	Shifting Out of Park (P) .....	2-33
Programmable Automatic Door Locks .....	2-12	Parking Over Things That Burn .....	2-33
Rear Door Security Locks .....	2-14	Engine Exhaust .....	2-34
Lockout Protection .....	2-14	Running Your Engine While You Are Parked .....	2-35
Leaving Your Vehicle .....	2-14	<b>Mirrors</b> .....	2-36
Trunk .....	2-15	Manual Rearview Mirror .....	2-36
<b>Windows</b> .....	2-17	Automatic Dimming Rearview Mirror .....	2-36
Power Windows .....	2-18	Automatic Dimming Rearview Mirror with Compass .....	2-37
Sun Visors .....	2-19	Outside Power Mirrors .....	2-39
<b>Theft-Deterrent Systems</b> .....	2-19	Outside Curb View Assist Mirror .....	2-40
Content Theft-Deterrent .....	2-19	Outside Convex Mirror .....	2-40
PASS-Key® III .....	2-21	Outside Automatic Dimming Heated Mirror .....	2-41
PASS-Key® III Operation .....	2-22		

## Section 2 Features and Controls

---

<b>OnStar® System</b> .....	2-41	Rear Storage Area .....	2-49
<b>HomeLink® Transmitter</b> .....	2-43	Rear Seat Armrest .....	2-49
Programming the HomeLink® Transmitter .....	2-43	Rear Seat Pass Through .....	2-49
<b>Storage Areas</b> .....	2-47	Convenience Net .....	2-49
Glove Box .....	2-47	<b>Sunroof</b> .....	2-50
Garage Door Opener Compartment .....	2-47	<b>Vehicle Personalization</b> .....	2-51
Center Console Storage Area .....	2-48	Memory Seat and Mirrors .....	2-51
Assist Handles .....	2-49		

## Keys

### CAUTION:

Leaving children in a vehicle with the ignition key is dangerous for many reasons. A child or others could be badly injured or even killed.

They could operate the power windows or other controls or even make the vehicle move.

Do not leave the keys in a vehicle with children.



Your vehicle has a two-key system. One key is the master and the other is a valet key.



The master key is used for the ignition, as well as the driver's door lock, trunk and glove box.



The VALET key is used for the ignition and the driver's door only. It will not open the trunk or glove box. This is a theft-deterrent feature. The VALET key should always be used when valet parking your vehicle.

Your vehicle has the PASS-Key<sup>®</sup> III vehicle theft system. Both the master and VALET key have a transponder in the key head that matches a decoder in the vehicle's steering column. If a replacement key or any additional key is needed, you must purchase this key from your dealer. The key will have PK3 stamped on it. Keep the bar code tag that came with the original keys. Give this tag to your dealer if you need a new key made.

Any new PASS-Key<sup>®</sup> III key must be programmed before it will start your vehicle. See *PASS-Key<sup>®</sup> III Operation on page 2-22* for more information on programming your new key.

If your vehicle is equipped with the OnStar<sup>®</sup> System with an active subscription and you lock your keys inside the vehicle, OnStar<sup>®</sup> may be able to send a command to unlock your vehicle. See *OnStar<sup>®</sup> System on page 2-41* for more information.

**Notice:** If you ever lock your keys in your vehicle, you may have to damage the vehicle to get in. Be sure you have spare keys.

## Remote Keyless Entry System

If equipped, the remote keyless entry system operates on a radio frequency subject to Federal Communications Commission (FCC) Rules and with Industry Canada.

This device complies with Part 15 of the FCC Rules. Operation is subject to the following two conditions:

1. This device may not cause interference, and
2. This device must accept any interference received, including interference that may cause undesired operation of the device.

This device complies with RSS-210 of Industry Canada. Operation is subject to the following two conditions:

1. This device may not cause interference, and
2. This device must accept any interference received, including interference that may cause undesired operation of the device.

Changes or modifications to this system by other than an authorized service facility could void authorization to use this equipment.

At times you may notice a decrease in range. This is normal for any remote keyless entry system. If the transmitter does not work or if you have to stand closer to your vehicle for the transmitter to work, try this:

- Check the distance. You may be too far from your vehicle. You may need to stand closer during rainy or snowy weather.
- Check the location. Other vehicles or objects may be blocking the signal. Take a few steps to the left or right, hold the transmitter higher, and try again.
- Check to determine if battery replacement or resynchronization is necessary. See “Battery Replacement” and “Resynchronization” under “Remote Keyless Entry System Operation” following this section.
- If you are still having trouble, see your dealer or a qualified technician for service.

## Remote Keyless Entry System Operation

If your vehicle has this feature, you can lock and unlock your doors or unlock your trunk from about 3 feet (1 m) up to 30 feet (9 m) away using the remote keyless entry transmitter supplied with your vehicle.

If your vehicle has the Driver Information Center (DIC), the numbers on the back of the transmitters correspond to the DIC's Driver #1 and Driver #2. See *Driver Information Center (DIC)* on page 3-47 for more information.



 **(Unlock):** Press this button to unlock the driver's door. Press this button again within five seconds to unlock all of the doors.

 **(Lock):** Press this button to lock all of the doors.

 **(Trunk):** Press this button to unlock the trunk when the ignition is in LOCK or OFF. The trunk button will also work when the ignition is on, but only while the transaxle is in PARK (P).

 **(Remote Alarm):** Your transmitter comes equipped with a remote alarm. Press this button to make the horn sound and the exterior lamps flash for up to 30 seconds. The remote alarm can be turned off by pressing this button again or by turning the ignition on.

With the content theft-deterrent feature, you may also turn off the remote alarm by unlocking the vehicle with a key.

Pressing any button will also illuminate the interior lamps. See "Entry Lighting" under *Interior Lamps* on page 3-15.



## Personalization Features

Each remote keyless entry transmitter can be programmed to the driver's preference for automatic door locks, security feedback, delayed locking, memory seat, perimeter lighting, outside curb view assist mirror and window lockout. Each of these personalization features will be explained in this manual.

If your vehicle is equipped with the Driver Information Center (DIC), you can also program any of these features through the DIC. See *Driver Information Center (DIC)* on page 3-47.

You can also personalize your climate control temperature, air delivery mode and fan speed. See *Climate Controls Personalization* on page 3-31.

## Security Feedback

This feature provides feedback when the vehicle receives a command from the remote keyless entry transmitter. The following modes may be selected:

**Mode 0:** No feedback when locking or unlocking vehicle.

**Mode 1:** No feedback when locking; exterior lamps flash when unlocking vehicle.

**Mode 2:** Exterior lamps flash when locking; no feedback when unlocking vehicle.

**Mode 3:** Exterior lamps flash when locking and when unlocking vehicle.

**Mode 4:** Exterior lamps flash and horn chirps when locking; no feedback when unlocking vehicle.

**Mode 5:** Exterior lamps flash and horn chirps when locking; exterior lamps flash when unlocking vehicle.

Each remote keyless entry transmitter can be programmed to a different mode according to the user's preference. To change to another mode do the following:

1. Press and hold LOCK on the power door lock switch on the driver's door throughout the procedure.
2. Press the trunk button on the transmitter. The horn will chirp and the transmitter will remain in its current mode.
3. Press the trunk button again. Each time the trunk button is pressed, the horn will chirp and the transmitter will advance to the next mode.
4. Release the power door lock switch.

If your vehicle is equipped with the Driver Information Center (DIC), you can also program these features through the DIC. See *Driver Information Center (DIC) on page 3-47*.

## Theft-Deterrent System

The remote keyless entry transmitter will arm the theft-deterrent system whenever the doors are closed and you push the lock button when the ignition is off. It will disarm the system when you push the unlock button.

## Matching Transmitter(s) to Your Vehicle

Each remote keyless entry transmitter is coded to prevent another transmitter from unlocking your vehicle. If a transmitter is lost or stolen, a replacement can be purchased through your dealer. Remember to bring any remaining transmitters with you when you go to your dealer. When the dealer matches the replacement transmitter to your vehicle, any remaining transmitters must also be matched. Once your dealer has coded the new transmitter, the lost transmitter will not unlock your vehicle. Each vehicle can have a maximum of four transmitters matched to it.

See your dealer to match additional transmitters to your vehicle.

## Battery Replacement

Under normal use, the battery in your remote keyless entry transmitter should last about four years.

You can tell the battery is weak if the transmitter won't work at the normal range in any location. If you have to get close to your vehicle before the transmitter works, it's probably time to change the battery.

**Notice:** When replacing the battery, use care not to touch any of the circuitry. Static from your body transferred to these surfaces may damage the transmitter.



To replace the battery, do the following:

1. Insert a thin coin, or similar object, into the notch near the key ring. Turn it counterclockwise to separate the two halves of the transmitter.
2. Once the transmitter is separated, use a pencil eraser to remove the old battery. Do not use a metal object.
3. Remove and replace the battery as the instructions under the cover indicate. Use a Duracell® battery, type DL-2032, or a similar type.
4. Snap the transmitter back together tightly to be sure no moisture can enter.
5. Test the operation of the transmitter with your vehicle. If the transmitter does not work, resynchronize the transmitter.

## Resynchronization

After replacing the battery in your transmitter, or if only the remote alarm works, the transmitter needs to be resynchronized to the receiver. Do this by pressing and holding both the lock and unlock buttons at the same time for about eight seconds. You must be within range of the vehicle.

Once the transmitter has been resynchronized, the horn will chirp and the exterior lamps will flash once. The system should now operate properly.

# Doors and Locks

## Door Locks

### CAUTION:

Unlocked doors can be dangerous.

- Passengers — especially children — can easily open the doors and fall out of a moving vehicle. When a door is locked, the handle will not open it. You increase the chance of being thrown out of the vehicle in a crash if the doors are not locked. So, wear safety belts properly and lock the doors whenever you drive.
- Young children who get into unlocked vehicles may be unable to get out. A child can be overcome by extreme heat and can suffer permanent injuries or even death from heat stroke. Always lock your vehicle whenever you leave it.
- Outsiders can easily enter through an unlocked door when you slow down or stop your vehicle. Locking your doors can help prevent this from happening.

There are several ways to lock and unlock your vehicle.

To lock or unlock the driver's door from the outside, use your door key or remote keyless entry transmitter (if equipped).



To lock or unlock the doors from the inside, move the manual lock on the door handle forward or rearward.

## Central Door Unlocking System

If your vehicle has a theft-deterrent system, all doors will unlock if the key is held in the outside key cylinder unlock position for more than two seconds. The doors will also unlock if the key is turned to the unlock position twice in three seconds.

## Power Door Locks



With power door locks, you can lock or unlock all doors on your vehicle using either the driver's or the front passenger's power door lock switch.

## Door Ajar Reminder

If your vehicle is equipped with the Driver Information Center (DIC), and a door is not fully closed, the DIC will display a DOOR AJAR message. See *Driver Information Center (DIC)* on page 3-47.

## Delayed Locking

This feature lets the driver delay the actual locking of the doors. When the power door lock switch or the remote keyless entry transmitter lock button is pressed with the key removed from the ignition and the driver's door open, a chime will sound three times to signal that the lock delay mode is active. When all doors have been closed, the doors will lock automatically after five seconds. If any door is opened before this, the five-second timer will reset itself once all the doors have been closed again.

Pressing the door lock switch or the remote keyless entry lock button a second time will override this feature.

The delayed locking feature can be turned on or off for each remote keyless entry transmitter.

To turn the feature on do the following:

1. Press and hold LOCK on the power door lock switch on the driver's door throughout this procedure. All the doors will lock.
2. Press the unlock button on the transmitter to enter the programming mode. The lock delay is still off and all doors will remain locked.
3. Press the unlock button on the transmitter again. Lock delay is now active and all doors will unlock.
4. Release the power door lock switch.

To turn this feature off, repeat the above procedure.

If your vehicle is equipped with the Driver Information Center (DIC), you can also program this feature through the DIC. See *Driver Information Center (DIC) on page 3-47*.

## Programmable Automatic Door Locks

Close the doors and turn on the ignition. If all the doors are closed, every time you move the shift lever out of PARK (P) all of the doors will lock. And, every time you stop and move the shift lever into PARK (P), the doors will unlock. If someone needs to get out while you're not in PARK (P), have that person use the manual or power lock switch. When the door is closed again, it will not lock automatically. Just use the manual or power lock switch to lock the door again. If you need to lock the doors before shifting out of PARK (P), just use the manual or power lock switch.

## Customizing Your Automatic Door Locks Feature

You can program the automatic door locks feature to one of the following modes:

**Mode 0:** No automatic door lock or unlock.

**Mode 1:** All doors automatically lock when shifted out of PARK (P). No automatic door unlock.

**Mode 2:** All doors automatically lock when shifted out of PARK (P). Only the driver's door automatically unlocks when shifted into PARK (P).

**Mode 3:** All doors automatically lock when shifted out of PARK (P). All doors automatically unlock when shifted into PARK (P).

Use the following procedure to change modes:

1. Close all the doors and turn the ignition on.  
Keep all doors closed throughout this procedure.
2. Press and hold LOCK on the power door lock switch on the driver's door through Step 4.
3. Press the lock button on the remote keyless entry transmitter to enter the programming mode.  
The automatic door lock mode will remain in the current mode.

4. Press the lock button on the transmitter again.  
Each time the lock button is pressed, the mode will advance by one, going from Mode 3 to Mode 0 to Mode 1, etc.

For each press of the lock button, the door locks will activate in the same manner they would activate in the corresponding automatic door lock mode.

For example, pressing the lock button on the transmitter to advance to Mode 2 would result in all doors locking and then, only the driver's door would unlock. For Mode 0, no locking or unlocking will occur.

5. Release the power door lock switch and turn the ignition off. The automatic door locks will remain in the most recent mode selected.

This procedure only changes the mode for the transmitter used to change this setting.

If your vehicle is equipped with the Driver Information Center (DIC), you can also program the automatic door locks feature through the DIC. See *Driver Information Center (DIC)* on page 3-47.

## Rear Door Security Locks

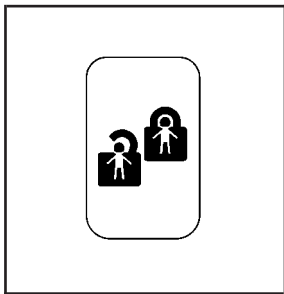

Your vehicle is equipped with rear door security locks that prevent passengers from opening the rear doors of your vehicle from the inside.

To use one of these locks, do the following:

1. Open the rear door you want to lock.
2. Move the lever located on the inside door edge, all the way to the lock symbol.
3. Close the door.
4. Do the same thing to the other rear door lock.

The rear doors of your vehicle cannot be opened from the inside when this feature is in use.

To open a rear door when the security lock is on, do the following:

1. Unlock the door.
2. Then open the door from the outside.

If you don't cancel the security lock feature, adults or older children who ride in the rear seat won't be able to open the rear door from the inside. You should let adults and older children know how these security locks work, and how to cancel the locks.

To cancel the rear door lock, do the following:

1. Unlock and open the door from the outside.
2. Move the lever all the way to the unlock symbol.
3. Do the same for the other rear door.

The rear door locks will now work normally.

## Lockout Protection

The power door locks will not work if the key is left in the ignition and the driver's door is open. You can override this feature by holding the power door lock switch on the driver's door for more than three seconds.

## Leaving Your Vehicle

If you are leaving the vehicle, take the keys, open the door and set the locks from the inside, then get out and close the door.



## Trunk

### CAUTION:

**It can be dangerous to drive with the trunk lid open because carbon monoxide (CO) gas can come into your vehicle. You can't see or smell CO. It can cause unconsciousness and even death. If you must drive with the trunk lid open or if electrical wiring or other cable connections must pass through the seal between the body and the trunk lid:**

- **Make sure all other windows are shut.**
- **Turn the fan on your heating or cooling system to its highest speed and select the control setting that will force outside air into your vehicle. See "Climate Control System" in the Index.**
- **If you have air outlets on or under the instrument panel, open them all the way.**

**See "Engine Exhaust" in the Index.**

## Trunk Lock Release

To unlock the trunk from the outside, insert the master key and turn it.

## Remote Trunk Release

Press the TRUNK button located to the left of the steering column to release the trunk lid.

The trunk will open if the transaxle is in PARK (P) or NEUTRAL (N) and the trunk release lockout is in the unlocked position.

The remote keyless entry system will also unlock your trunk if the ignition is off, or if the ignition is on and the transaxle is in PARK (P).

## Remote Trunk Release Lockout

The remote trunk release lockout button allows you to secure items in the trunk.



Insert the ignition key into the TRUNK button, located to the left of the steering column. Turn the key one-quarter turn clockwise to LK then remove it from the button.

This will disable the trunk release button and prevent the trunk from opening when this button is pressed.

## Trunk Security Override

The remote keyless entry transmitter will open the trunk when the ignition is on or off and the vehicle is in PARK (P), even if the trunk release lockout is activated.

## Emergency Trunk Release Handle

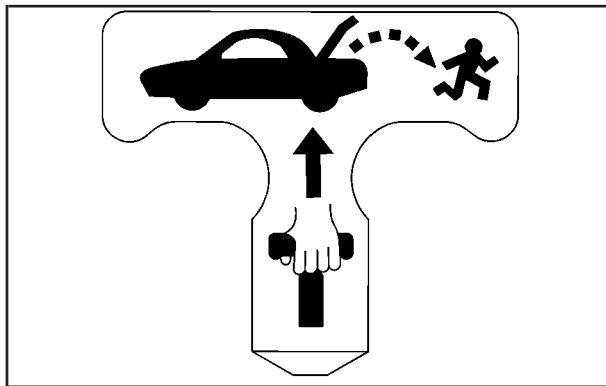

**Notice:** Using the emergency trunk release handle as a tie-down or anchor point when securing items in the trunk may damage it. Use the emergency trunk release handle only to help you open the trunk lid.

There is a glow-in-the-dark emergency trunk release handle located near the trunk latch. This handle will glow following exposure to light. Pull the release handle up to open the trunk from the inside.

## Windows

### CAUTION:

Leaving children in a vehicle with the windows closed is dangerous. A child can be overcome by the extreme heat and can suffer permanent injuries or even death from heat stroke. Never leave a child alone in a vehicle, especially with the windows closed in warm or hot weather.



## Power Windows



Use the switches on the driver's door armrest to control each of the windows while the ignition is on or while Retained Accessory Power (RAP) is active. See "Retained Accessory Power (RAP)" under *Ignition Positions* on page 2-24 for more information. In addition, each passenger door has a window switch.

## Express-Down Window

The AUTO switch on the driver's door armrest has an express-down feature. Pull the switch back all the way; then release it and the window will lower automatically. To stop the window from lowering, pull the switch again. To partially open the window, pull the switch back half way. When the switch is released, the window will stop moving. To raise the window, press and hold the switch forward.

## Window Lock Out

Press the WINDOW LOCK button on the driver's door armrest to disable all passenger window switches, or just the rear passenger switches. The middle of the switch will light to indicate that window lock out is active. Even when the passenger's windows are disabled, the driver's window controls will still be operable.

Press the WINDOW LOCK button a second time to allow passengers to use their window controls again. The light in the center of the button will go off to indicate that the feature is disabled.

If you have the DIC, you can choose to lock out only the rear windows. See *DIC Vehicle Personalization* on page 3-51 for programming instructions.

## Sun Visors

### Lighted Visor Vanity Mirror

If your vehicle has this feature, when you open the visor vanity mirrors, the lamps turn on.

To block out glare, swing down the visors. The larger sun visor can be removed from the center mount and moved to the side, while the auxiliary sun visor remains to block glare from the front.

The front side of the driver's sun visor also contains a pocket for map storage.

## Theft-Deterrent Systems

Vehicle theft is big business, especially in some cities. Although your vehicle has a number of theft-deterrent features, we know that nothing we put on it can make it impossible to steal.

### Content Theft-Deterrent



United States

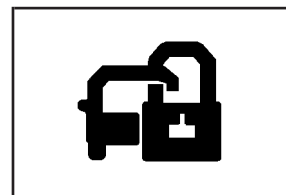

Canada

Your vehicle is equipped with a content theft-deterrent alarm system. With this system, the SECURITY light will flash as you open the door if your ignition is off.

This light reminds you to activate the theft-deterrent system. Here's how to do it:

1. Open the door.
2. Lock the door with the power door lock switch or the remote keyless entry transmitter (if equipped). The SECURITY light should come on and stay on.
3. Close all doors. The SECURITY light should go off after approximately 30 seconds. The alarm is not armed until the SECURITY light goes off.

If a door is opened without the key or the remote keyless entry transmitter, the alarm will go off. Your vehicle's lamps will flash and the horn will sound for 30 seconds. The lamps and horn will then turn off to save battery power.

Remember, the theft-deterrent system won't activate if you lock the doors with a key or use the manual door lock. It activates only if you use a power door lock switch with the door open, or with the remote keyless entry transmitter. You should also remember that you can start your vehicle with the correct ignition key if the alarm has been set off.

Here's how to avoid setting off the alarm by accident:

- If you don't want to activate the theft-deterrent system, the vehicle should be locked with the door key *after* the doors are closed.
- Always unlock a door with a key, or use the remote keyless entry transmitter. Unlocking a door any other way will set off the alarm.

If you set off the alarm by accident, unlock any door with your key. You can also turn off the alarm by pressing the unlock button on the remote keyless entry transmitter. The alarm won't stop if you try to unlock a door any other way.

## Testing the Alarm

The alarm can be tested by following these steps:

1. From inside the vehicle, roll down the driver's window and open the driver's door.
2. Activate the system by locking the doors using the power door lock switch while the door is open, or using the remote keyless entry transmitter.
3. Get out of the car, close the door and wait for the SECURITY light to go out.
4. Then reach in through the window, unlock the door with the manual door lock and open the door. This should set off the alarm.

If the alarm does not sound when it should, but the vehicle's lamps flash, check to see if the horn works. The horn fuse may be blown. To replace the fuse, see *Fuses and Circuit Breakers on page 5-99*.

If the alarm does not sound or the vehicle's lamps do not flash, the vehicle should be serviced by an authorized service center.

## PASS-Key® III

Your PASS-Key® III system operates on a radio frequency subject to Federal Communications Commission (FCC) Rules and with Industry Canada.

This device complies with Part 15 of the FCC Rules. Operation is subject to the following two conditions:

1. this device may not cause harmful interference, and
2. this device must accept any interference received, including interference that may cause undesired operation.

This device complies with RSS-210 of Industry Canada. Operation is subject to the following two conditions:

1. this device may not cause interference, and
2. this device must accept any interference received, including interference that may cause undesired operation of the device.

Changes or modifications to this system by other than an authorized service facility could void authorization to use this equipment.

PASS-Key® III uses a radio frequency transponder in the key that matches a decoder in your vehicle.

## PASS-Key® III Operation



Your vehicle is equipped with the PASS-Key® III (Personalized Automotive Security System) theft-deterrent system. PASS-Key® III is a passive theft-deterrent system. This means you don't have to do anything different to arm or disarm the system. It works when you insert or remove the key from the ignition.

When the PASS-Key® III system senses that someone is using the wrong key, it shuts down the vehicle's starter and fuel systems. The starter will not work and fuel will stop being delivered to the engine. Anyone using a trial-and-error method to start the vehicle will be discouraged because of the high number of electrical key codes.

When trying to start the vehicle, if the engine does not start and the SECURITY light comes on, the key may have a damaged transponder. Turn the ignition off and try again.

If the engine still does not start, and the key appears to be undamaged, try another ignition key. At this time, you may also want to check the fuse. See *Fuses and Circuit Breakers on page 5-99*. If the engine still does not start with the other key, your vehicle needs service. If your vehicle does start, the first key may be faulty. See your dealer who can service the PASS-Key® III to have a new key made.

It is possible for the PASS-Key® III decoder to learn the transponder value of a new or replacement key. Up to 10 additional keys may be programmed for the vehicle. This procedure is for programming additional keys only.

**Canadian Owners:** If you lose or damage your keys, only a GM dealer can service PASS-Key® III to have new keys made. To program additional keys you will need two current driver's keys. You must add a step to the following procedure. After Step 2, repeat Steps 1 and 2 with the second current driver's key. Then continue with Step 3.



To program the new key, do the following:

1. Verify that the new key has PK3 stamped on it.
2. Insert the current driver's key in the ignition and start the engine. If the engine will not start, see your dealer for service.
3. After the engine has started, turn the key to OFF, and remove the key.
4. Insert the key to be programmed and turn it to RUN within 10 seconds of removing the previous key.
5. The SECURITY light will turn off once the key has been programmed. It may not be apparent that the SECURITY light went on due to how quickly the key is programmed.
6. Repeat Steps 1 through 4 if additional keys are to be programmed.

If you are ever driving and the SECURITY light comes on and stays on, you will be able to restart your engine if you turn it off. Your PASS-Key® III system, however, is not working properly and must be serviced by your dealer. Your vehicle is not protected by the PASS-Key® III system at this time.

If you lose or damage a PASS-Key® III, see your dealer to have a new key made.

## Starting and Operating Your Vehicle

### New Vehicle Break-In

**Notice:** Your vehicle does not need an elaborate “break-in.” But it will perform better in the long run if you follow these guidelines:

- Do not drive at any one speed — fast or slow — for the first 500 miles (805 km). Do not make full-throttle starts.
- Avoid making hard stops for the first 200 miles (322 km) or so. During this time your new brake linings are not yet broken in. Hard stops with new linings can mean premature wear and earlier replacement. Follow this breaking-in guideline every time you get new brake linings.
- Do not tow a trailer during break-in. See *Towing a Trailer* on page 4-38 for more information.

## Ignition Positions

With the key in the ignition switch, you can turn to five different positions.

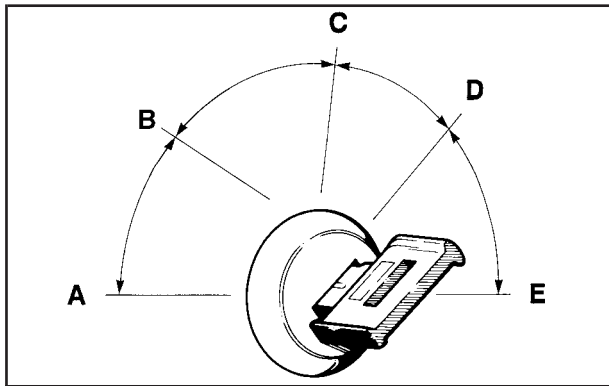

**A (ACCESSORY):** In this position you can operate your electrical accessories. Press in the ignition switch as you turn the top of it toward you.

**B (LOCK):** This is the only position from which you can remove the key. This position locks your ignition, steering wheel and transaxle. It's a theft-deterrent feature.

**Notice:** If your key seems stuck in LOCK and you can't turn it, be sure you are using the correct key; if so, is it all the way in? If it is, then turn the steering wheel left and right while you turn the key hard. Turn the key only with your hand. Using a tool to force it could break the key or the ignition switch. If none of these works, then your vehicle needs service.

**C (OFF):** This position lets you turn off the engine but still turn the steering wheel. It doesn't lock the steering wheel like LOCK and it doesn't send any power to the accessories. The instrument panel cluster will remain powered in OFF to illuminate the gear shift indicator. The cluster will also activate the parking brake light when the parking brake is set. Use OFF if you must have your vehicle in motion while the engine is not running.

**D (RUN):** This is the position that the switch returns to after you start your engine and release the ignition key. This is the position for driving. Even when the engine is not running, you can use RUN to operate your electrical accessories and to display some instrument panel warning lights.

**E (START):** This position starts your engine. When the engine starts, release the ignition key. The switch will return to RUN for normal driving.

## Key Reminder Warning

If you leave your key in the ignition, with the engine off, you will hear a warning chime when you open the driver's door.

## Retained Accessory Power (RAP)

After you turn the ignition off and remove the key, you will still have power to such accessories as the radio, sunroof (option) and power windows for up to 10 minutes. Power is stopped if you open a door.

## Starting Your Engine

Move your shift lever to PARK (P) or NEUTRAL (N). Your engine will not start in any other position — that is a safety feature. To restart when you are already moving, use NEUTRAL (N) only.

**Notice:** Shifting into PARK (P) with the vehicle moving could damage the transaxle. Shift into PARK (P) only when your vehicle is stopped.

1. With your foot off the accelerator pedal, turn your ignition key to START. When the engine starts, let go of the key. The idle speed will go down as your engine gets warm.

**Notice:** Holding your key in START for longer than 15 seconds at a time will cause your battery to be drained much sooner. And the excessive heat can damage your starter motor. Wait about 15 seconds between each try to help avoid draining your battery or damaging your starter.

2. If it does not start within 10 seconds, hold your key in START for about 10 seconds at a time until your engine starts. Wait about 15 seconds between each try.
3. If your engine still will not start, or starts but then stops, it could be flooded with too much gasoline. Try pushing your accelerator pedal all the way to the floor and holding it there as you hold the key in START for about three seconds. If the vehicle starts briefly but then stops again, do the same thing. This time keep the pedal down for five or six seconds to clear the extra gasoline from the engine. After waiting about 15 seconds, repeat the normal starting procedure.

**Notice:** Your engine is designed to work with the electronics in your vehicle. If you add electrical parts or accessories, you could change the way the engine operates. Before adding electrical equipment, check with your dealer. If you do not, your engine might not perform properly.

## Engine Coolant Heater

If your vehicle has this feature, in very cold weather, 0°F (-18°C) or colder, the engine coolant heater can help. You'll get easier starting and better fuel economy during engine warm-up. Usually, the coolant heater should be plugged in a minimum of four hours prior to starting your vehicle. At temperatures above 32°F (0°C), use of the coolant heater is not required.

### To Use the Engine Coolant Heater

1. Turn off the engine.
2. Open the hood and unwrap the electrical cord.  
The engine coolant heater cord is located on the passenger's side of the vehicle, above the headlamp assembly.
3. Plug it into a normal, grounded 110-volt AC outlet.

### CAUTION:

**Plugging the cord into an ungrounded outlet could cause an electrical shock. Also, the wrong kind of extension cord could overheat and cause a fire. You could be seriously injured. Plug the cord into a properly grounded three-prong 110-volt AC outlet. If the cord will not reach, use a heavy-duty three-prong extension cord rated for at least 15 amps.**

4. Before starting the engine, be sure to unplug and store the cord as it was before to keep it away from moving engine parts. If you don't, it could be damaged.

How long should you keep the coolant heater plugged in? The answer depends on the outside temperature, the kind of oil you have, and some other things. Instead of trying to list everything here, we ask that you contact your dealer in the area where you'll be parking your vehicle. The dealer can give you the best advice for that particular area.

## Automatic Transaxle Operation

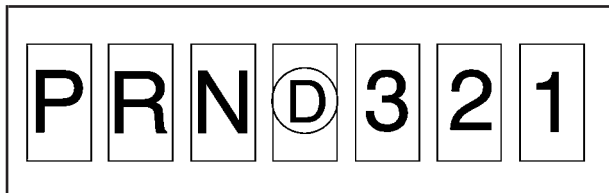

Your automatic transaxle has a shift lever located on the steering column.

**PARK (P):** This position locks your front wheels. It's the best position to use when you start your engine because your vehicle can't move easily.

### CAUTION:

**It is dangerous to get out of your vehicle if the shift lever is not fully in PARK (P) with the parking brake firmly set. Your vehicle can roll.**

**CAUTION: (Continued)**

### **CAUTION: (Continued)**

**Do not leave your vehicle when the engine is running unless you have to. If you have left the engine running, the vehicle can move suddenly. You or others could be injured. To be sure your vehicle will not move, even when you are on fairly level ground, always set your parking brake and move the shift lever to PARK (P). See *Shifting Into Park (P)* on page 2-30. If you are pulling a trailer, see *Towing a Trailer* on page 4-38.**

Ensure the shift lever is fully in PARK (P) before starting the engine. Your vehicle has an automatic transaxle shift lock control system. You have to fully apply your regular brakes before you can shift from PARK (P) when the ignition is in RUN. If you cannot shift out of PARK (P), ease pressure on the shift lever and push the shift lever all the way into PARK (P) as you maintain brake application. Then move the shift lever into the gear you wish. See *Shifting Out of Park (P)* on page 2-33.

**REVERSE (R):** Use this gear to back up.

**Notice:** Shifting to **REVERSE (R)** while your vehicle is moving forward could damage the transaxle. The repairs would not be covered by your warranty. Shift to **REVERSE (R)** only after your vehicle is stopped.

To rock your vehicle back and forth to get out of snow, ice or sand without damaging your transaxle, see *If You Are Stuck: In Sand, Mud, Ice or Snow on page 4-30.*

**NEUTRAL (N):** In this position, your engine doesn't connect with the wheels. To restart when you're already moving, use **NEUTRAL (N)** only. Also, use **NEUTRAL (N)** when your vehicle is being towed.

 **CAUTION:**

**Shifting into a drive gear while your engine is running at high speed is dangerous. Unless your foot is firmly on the brake pedal, your vehicle could move very rapidly. You could lose control and hit people or objects. Do not shift into a drive gear while your engine is running at high speed.**

**Notice:** Shifting out of **PARK (P)** or **NEUTRAL (N)** with the engine racing may damage the transaxle. The repairs would not be covered by your warranty. Be sure the engine is not racing when shifting your vehicle.

**AUTOMATIC OVERDRIVE (D):** This position is for normal driving. If you need more power for passing, and you're:

- Going less than about 35 mph (55 km/h), push your accelerator pedal about halfway down.
- Going about 35 mph (55 km/h) or more, push the accelerator all the way down.

You'll shift down to the next gear and have more power.

**THIRD (3):** This position is also used for normal driving. However, it offers more power and lower fuel economy than **AUTOMATIC OVERDRIVE (D)**.

Here are some times you might choose **THIRD (3)** instead of **AUTOMATIC OVERDRIVE (D)**:

- When driving on hilly, winding roads.
- When towing a trailer, so there is less shifting between gears.
- When going down a steep hill.

**SECOND (2):** This position gives you more power but lower fuel economy than THIRD (3). You can use SECOND (2) on hills. It can help control your speed as you go down steep mountain roads, but then you would also want to use your brakes off and on.

**Notice:** Driving in SECOND (2) for more than 25 miles (40 km) or at speeds over 55 mph (90 km/h) may damage the transaxle. Also, shifting into SECOND (2) at speeds above 65 mph (105 km/h) can cause damage. Drive in THIRD (3) or AUTOMATIC OVERDRIVE (D) instead of SECOND (2).

**FIRST (1):** This position gives you even more power but lower fuel economy than SECOND (2). You can use it on very steep hills, or in deep snow or mud. If the shift lever is put in FIRST (1), the transaxle won't shift into first gear until the vehicle is going slowly enough.

**Notice:** Spinning the tires or holding the vehicle in one place on a hill using only the accelerator pedal may damage the transaxle. If you are stuck, do not spin the tires. When stopping on a hill, use the brakes to hold the vehicle in place.

## Parking Brake

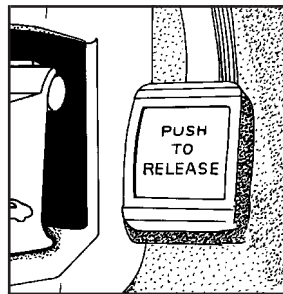

This vehicle has a PUSH TO RELEASE parking brake pedal. To set the parking brake, hold the regular brake pedal down with your right foot. Push down the parking brake pedal with your left foot.

Whether the ignition key is in RUN or OFF, the brake system warning light stays on while the parking brake is set.

The parking brake uses the brakes on the rear wheels.

To release the parking brake, hold the regular brake pedal down and push the parking brake pedal with your left foot. When you lift your left foot, the parking brake pedal will follow it to the release position.

If you try to drive with the parking brake on, after about 20 feet (6.1 m) a chime will sound continuously until you release the parking brake. Also, the brake light will stay on until the parking brake is released.

**Notice:** Driving with the parking brake on can overheat the brake system and cause premature wear or damage to brake system parts. Verify that the parking brake is fully released and the brake warning light is off before driving.

If you are towing a trailer and are parking on any hill, see *Towing a Trailer on page 4-38*. That part shows what to do first to keep the trailer from moving.

## Shifting Into Park (P)

### CAUTION:

It can be dangerous to get out of your vehicle if the shift lever is not fully in PARK (P) with the parking brake firmly set. Your vehicle can roll. If you have left the engine running, the vehicle can move suddenly. You or others could be injured. To be sure your vehicle will not move, even when you are on fairly level ground, use the steps that follow. If you are pulling a trailer, see *Towing a Trailer on page 4-38*.



1. Hold the brake pedal down with your right foot and set the parking brake.
2. Move the shift lever into PARK (P) like this:

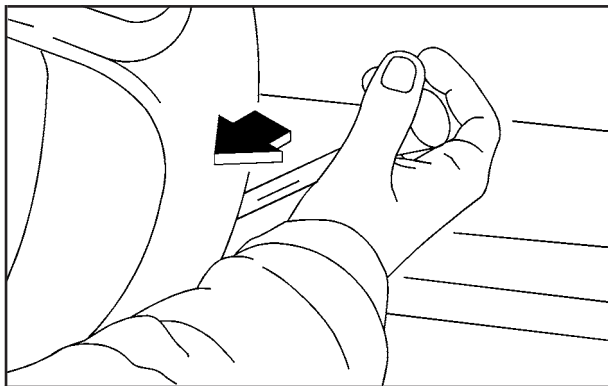

- Pull the lever toward you.

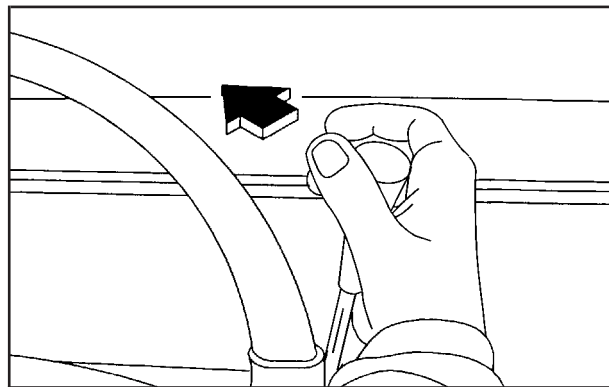

- Move the lever up as far as it will go.
3. Turn the ignition key to LOCK.
  4. Remove the key and take it with you. If you can leave your vehicle with the ignition key in your hand, your vehicle is in PARK (P).

## Leaving Your Vehicle With the Engine Running

### CAUTION:

**It can be dangerous to leave your vehicle with the engine running. Your vehicle could move suddenly if the shift lever is not fully in PARK (P) with the parking brake firmly set. And, if you leave the vehicle with the engine running, it could overheat and even catch fire. You or others could be injured. Do not leave your vehicle with the engine running.**

If you have to leave your vehicle with the engine running, be sure your vehicle is in PARK (P) and your parking brake is firmly set before you leave it. After you've moved the shift lever into PARK (P), hold the regular brake pedal down. Then, see if you can move the shift lever away from PARK (P) without first pulling it toward you. If you can, it means that the shift lever wasn't fully locked into PARK (P).

## Torque Lock

If you are parking on a hill and you don't shift your transaxle into PARK (P) properly, the weight of the vehicle may put too much force on the parking pawl in the transaxle. You may find it difficult to pull the shift lever out of PARK (P). This is called "torque lock." To prevent torque lock, set the parking brake and then shift into PARK (P) properly before you leave the driver's seat. To find out how, see *Shifting Into Park (P)* on page 2-30.

When you are ready to drive, move the shift lever out of PARK (P) *before* you release the parking brake.

If torque lock does occur, you may need to have another vehicle push yours a little uphill to take some of the pressure from the parking pawl in the transaxle, so you can pull the shift lever out of PARK (P).

## Shifting Out of Park (P)

Your vehicle has an automatic transaxle shift lock control system, which locks the shift lever in PARK (P) when the ignition is in the LOCK position. In addition, you have to fully apply your regular brakes before you can shift from PARK (P) when the ignition is in RUN. See *Automatic Transaxle Operation* on page 2-27.

If you cannot shift out of PARK (P), ease pressure on the shift lever and push the shift lever all the way up into PARK (P) as you maintain brake application. Then, move the shift lever into the gear you want.

If you ever hold the brake pedal down but still can't shift out of PARK (P), try this:

1. Turn the key to OFF. Open and close the driver's door to turn off the RAP feature. (There is no shift interlock in this key position.)
2. Apply and hold the brake until the end of Step 4.
3. Shift the transaxle to NEUTRAL (N).
4. Start the vehicle and then shift to the gear you want.
5. Have the system fixed as soon as you can.

## Parking Over Things That Burn

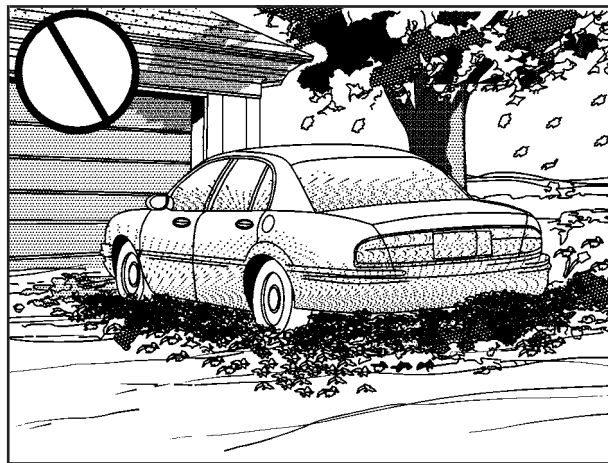

### CAUTION:

Things that can burn could touch hot exhaust parts under your vehicle and ignite. Do not park over papers, leaves, dry grass or other things that can burn.

## Engine Exhaust

### CAUTION:

Engine exhaust can kill. It contains the gas carbon monoxide (CO), which you can not see or smell. It can cause unconsciousness and death.

You might have exhaust coming in if:

- Your exhaust system sounds strange or different.
- Your vehicle gets rusty underneath.
- Your vehicle was damaged in a collision.

CAUTION: (Continued)

### CAUTION: (Continued)

- Your vehicle was damaged when driving over high points on the road or over road debris.
- Repairs were not done correctly.
- Your vehicle or exhaust system had been modified improperly.

If you ever suspect exhaust is coming into your vehicle:

- Drive it only with all the windows down to blow out any CO; and
- Have your vehicle fixed immediately.

## Running Your Engine While You Are Parked

It is better not to park with the engine running. But if you ever have to, here are some things to know.

### CAUTION:

Idling the engine with the climate control system off could allow dangerous exhaust into your vehicle. See the earlier Caution under *Engine Exhaust on page 2-34*.

Also, idling in a closed-in place can let deadly carbon monoxide (CO) into your vehicle even if the climate control fan is at the highest setting. One place this can happen is a garage. Exhaust — with CO — can come in easily. NEVER park in a garage with the engine running.

Another closed-in place can be a blizzard. See *Winter Driving on page 4-26*.

### CAUTION:

It can be dangerous to get out of your vehicle if the shift lever is not fully in PARK (P) with the parking brake firmly set. Your vehicle can roll. Do not leave your vehicle when the engine is running unless you have to. If you have left the engine running, the vehicle can move suddenly. You or others could be injured. To be sure your vehicle will not move, even when you are on fairly level ground, always set your parking brake and move the shift lever to PARK (P).

Follow the proper steps to be sure your vehicle will not move. See *Shifting Into Park (P) on page 2-30*.

If you are parking on a hill and if you are pulling a trailer, also see *Towing a Trailer on page 4-38*.

# Mirrors

## Manual Rearview Mirror

When you are sitting in a comfortable driving position, adjust the mirror so you can see clearly behind your vehicle. Grip the mirror in the center to move it up or down and side to side. The day/night adjustment allows you to adjust the mirror to avoid glare from the lamps behind you. Pull the tab forward for daytime use; push it back for night use.

## Automatic Dimming Rearview Mirror

Your vehicle may have an automatic dimming rearview mirror. Your vehicle's mirror may also contain OnStar® controls. See *OnStar® System on page 2-41* for more information.

At night, when the glare is too high, the mirror will gradually darken to reduce glare. This change may take a few seconds. The mirror will return to its clear daytime state when the glare is reduced.

### Mirror Operation

**AUTO:** Press this button to turn on the automatic dimming feature.

**OFF:** Press this button to turn off the automatic dimming feature.

 **(On/Off):** For mirrors equipped with OnStar® controls, press this button to turn on the automatic dimming feature. To turn off automatic dimming, press this button again.

The indicator light will be illuminated when this feature is active.

## Automatic Dimming Rearview Mirror with Compass

Your vehicle may have an automatic dimming rearview mirror with a compass. Your vehicle's mirror may also contain OnStar® controls. See *OnStar® System on page 2-41* for more information.

The mirror also includes an eight-point compass display in the upper right corner of the mirror face.

When cleaning the mirror, use a paper towel or similar material dampened with glass cleaner. Do not spray glass cleaner directly on the mirror as that may cause the liquid cleaner to enter the mirror housing.

### Mirror Operation

**MIRROR:** Press this button to turn on the automatic dimming feature. Press it again to turn off the automatic dimming feature.

 **(On/Off):** For mirrors equipped with OnStar® controls, press and hold this button for several seconds to turn on the automatic dimming feature. Press and hold it again to turn the automatic dimming feature off.

The green indicator light will come on when this feature is active. The automatic dimming feature will be active each time the vehicle is started.

## Compass Operation

**COMPASS:** Press this button once to turn the compass on or off.

 **(On/Off):** For mirrors equipped with OnStar® controls, press this button once to turn the compass on or off.

When the ignition and the compass feature are on, the compass will show two character boxes for about two seconds. After two seconds, the mirror will display the compass heading.

### Compass Calibration

When on, the compass automatically calibrates as the vehicle is driven. If, after two seconds, the display does not show a compass heading (N for North, for example), there may be a strong magnetic field interfering with the compass. Such interference may be caused by a magnetic antenna mount, magnetic note pad holder or a similar magnetic item. If the letter C should ever appear in the compass window, the compass may need calibration.

The mirror can be calibrated by driving the vehicle in circles at 5 mph (8 km/h) or less until the display reads a direction.

Mirrors equipped with OnStar® controls can be placed in calibration mode by pressing and holding the on/off button until a C is shown in the compass display.

## Compass Variance

Compass variance is the difference between earth's magnetic north and true geographic north. The mirror is set in zone eight upon leaving the factory. It will be necessary to adjust the compass to compensate for compass variance if you live outside zone eight. Under certain circumstances, as during a long distance cross-country trip, it will be necessary to adjust for compass variance. If not adjusted to account for compass variance, your compass could give false readings.

To adjust for compass variance, do the following:

1. Find your current location and variance zone number on the following zone map.

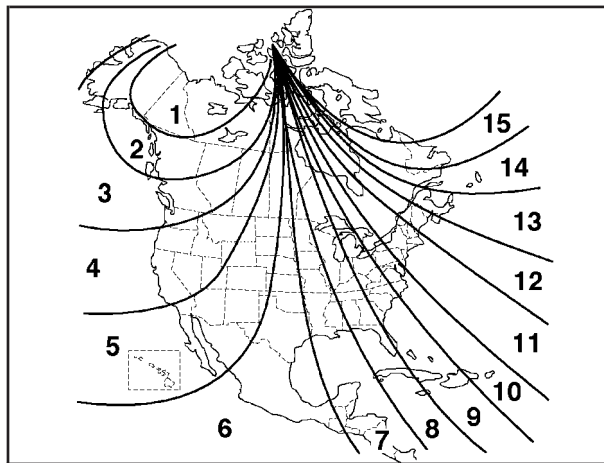

2. Press and hold COMPASS (or the on/off button for mirrors equipped with OnStar<sup>®</sup> controls) until a zone number appears in the display.
3. Once a zone number appears in the display, press the COMPASS button (or the on/off button for mirrors equipped with OnStar<sup>®</sup> controls) quickly until the correct zone number appears in the display. Stop pressing the button and the mirror will return to normal operation. If C appears in the compass window, the compass may need calibration. See "Compass Calibration" explained previously.



## Outside Power Mirrors



Your vehicle has power mirror controls located on the driver's door armrest.

Press L or R on the selector switch located below the control pad to choose the left or right mirror. If you place the switch in the center position, no mirror movement will occur. To adjust a mirror, use the arrows located on the control pad to move the mirror in the direction you want it to go.

Adjust each mirror so you can see some of the side of your vehicle and the area behind your vehicle.

The mirrors may also have an arrow that flashes when the turn signal is used. See *Turn Signal/Multifunction Lever* on page 3-5.

If your vehicle is equipped with the memory seat and mirrors feature, these mirror positions, along with the driver's seat position can be stored in memory. See *Memory Seat and Mirrors* on page 2-51.

## Outside Curb View Assist Mirror

If you have the DIC feature, the passenger's outside rearview mirror also includes a tilt-down feature that operates when the shift lever is in REVERSE (R). When the vehicle is shifted out of REVERSE (R), the passenger mirror will return to its original position after a five-second delay. This delay prevents movement of the mirror if multiple gear transitions (REVERSE (R) to DRIVE (D) to REVERSE (R)) occur during a parallel parking maneuver. This feature can be programmed on or off through the personal choice selection menu. See *Driver Information Center (DIC) on page 3-47* or *DIC Vehicle Personalization on page 3-51* for programming instructions.

## Outside Convex Mirror

Your passenger's side mirror is convex. A convex mirror's surface is curved so you can see more from the driver's seat.

### CAUTION:

**A convex mirror can make things (like other vehicles) look farther away than they really are. If you cut too sharply into the right lane, you could hit a vehicle on your right. Check your inside mirror or glance over your shoulder before changing lanes.**

## Outside Automatic Dimming Heated Mirror

If you have this feature, the driver's side outside rearview mirror will adjust for the glare of headlamps behind you. This feature is controlled using the on and off settings on the automatic dimming rearview mirror. See "Automatic Dimming Rearview Mirror" or "Automatic Dimming Rearview Mirror with Compass" earlier in this section.

If you have this feature, the left and right outside mirrors are also heated when you activate the rear window defogger. See "Rear Window Defogger" under *Dual Automatic Climate Control System on page 3-24.*

Both outside mirrors can be folded forward or rearward. In the rearward position, they will fold flush with the vehicle. This feature is particularly useful in automatic car washes.

## OnStar® System



Your vehicle may have this feature. OnStar® uses global positioning system (GPS) satellite technology, wireless communications, and state of the art call centers to provide you with a wide range of safety, security, information and convenience services.

A complete OnStar® user's guide and the terms and conditions of the OnStar® Subscription Service Agreement are included in your OnStar®-equipped vehicle's glove box literature. For more information, visit [www.onstar.com](http://www.onstar.com), contact OnStar® at 1-888-4-ONSTAR (1-888-466-7827), or press the blue OnStar® button to speak to an OnStar® advisor 24 hours a day, 7 days a week.

A completed Subscription Service Agreement is required prior to delivery of OnStar® services and prepaid calling minutes are also required for OnStar® Personal Calling and OnStar® Virtual Advisor use. Terms and conditions of the Subscription Service Agreement can be found at [www.onstar.com](http://www.onstar.com).

## **OnStar® Services**

One of the following plans is normally included for a specific duration with each vehicle equipped with OnStar®. You can upgrade or extend your OnStar® service plan to meet your needs.

### **Safe and Sound Plan**

- Automatic Notification of Air Bag Deployment
- Emergency Services
- Roadside Assistance
- Stolen Vehicle Assistance
- AccidentAssist
- Remote Door Unlock
- Remote Diagnostics
- Online Concierge

### **Directions and Connections Plan**

- All Safe and Sound Plan services
- Route Support
- RideAssist
- Information and Convenience Services

### **Luxury and Leisure Plan**

- All Directions and Connections Plan services
- Personal Concierge

### **OnStar® Personal Calling**

With OnStar® Personal Calling, you have a safer way to stay connected while driving. It's a hands-free wireless phone that's integrated into your vehicle. You can place calls nationwide using voice-activated dialing with no contracts and no additional roaming charges. To find out more about OnStar® Personal Calling, refer to the OnStar® owner's guide in your vehicle's glove box, or call OnStar® at 1-888-4-ONSTAR (1-888-466-7827).

### **OnStar® Virtual Advisor**

With OnStar® Virtual Advisor you can listen to your favorite news, entertainment and information topics, such as traffic and weather reports, stock quotes and sports scores. You listen to your e-mail through your vehicle's speakers, and reply with your hands on the wheel and your eyes on the road.

## HomeLink<sup>®</sup> Transmitter



HomeLink<sup>®</sup>, a combined universal transmitter and receiver, provides a way to replace up to three hand-held transmitters used to activate devices such as gate operators, garage door openers, entry door locks, security systems and home lighting.

Additional HomeLink<sup>®</sup> information can be found on the internet at [www.homelink.com](http://www.homelink.com) or by calling 1-800-355-3515.

If your vehicle is equipped with the HomeLink<sup>®</sup> transmitter, it complies with Part 15 of the FCC Rules. Operation is subject to the following two conditions:  
(1) this device may not cause harmful interference, and  
(2) this device must accept any interference received, including interference that may cause undesired operation.

This device complies with RSS-210 of Industry Canada. Operation is subject to the following two conditions:  
(1) this device may not cause interference, and  
(2) this device must accept any interference, including interference that may cause undesired operation of the device.

Changes and modifications to this system by other than an authorized service facility could void authorization to use this equipment.

### Programming the HomeLink<sup>®</sup> Transmitter

Do not use the HomeLink<sup>®</sup> Transmitter with any garage door opener that does not have the “stop and reverse” feature. This includes any garage door opener model manufactured before April 1, 1982. If you have a newer garage door opener with rolling codes, please be sure to follow steps 6 through 8 to complete the programming of your HomeLink<sup>®</sup> Transmitter.

Read the instructions completely before attempting to program the HomeLink<sup>®</sup> Transmitter. Because of the steps involved, it may be helpful to have another person available to assist you in programming the transmitter.

Keep the original transmitter for use in other vehicles as well as for future HomeLink® programming. It is also recommended that upon the sale of the vehicle, the programmed HomeLink® buttons should be erased for security purposes. Refer to “Erasing HomeLink® Buttons” or, for assistance, contact HomeLink® on the internet at: [www.homelink.com](http://www.homelink.com) or by calling 1-800-355-3515.

Be sure that people and objects are clear of the garage door or gate operator you are programming. When programming a garage door, it is advised to park outside of the garage.

It is recommended that a new battery be installed in your hand-held transmitter for quicker and more accurate transmission of the radio frequency.

Your vehicle’s engine should be turned off while programming the transmitter. Follow these steps to program up to three channels:

1. Press and hold down the two outside buttons, releasing only when the indicator light begins to flash, after 20 seconds. Do not hold down the buttons for longer than 30 seconds and do not repeat this step to program a second and/or third transmitter to the remaining two HomeLink® buttons.
2. Position the end of your hand-held transmitter about 1 to 3 inches (3 to 8 cm) away from the HomeLink® buttons while keeping the indicator light in view.

3. Simultaneously press and hold both the desired button on HomeLink® and the hand-held transmitter button. Do not release the buttons until Step 4 has been completed.

Some entry gates and garage door openers may require you to substitute Step 3 with the procedure noted in “Gate Operator and Canadian Programming” later in this section.

4. The indicator light will flash slowly at first and then rapidly after HomeLink® successfully receives the frequency signal from the hand-held transmitter. Release both buttons.
5. Press and hold the newly-trained HomeLink® button and observe the indicator light.

If the indicator light stays on constantly, programming is complete and your device should activate when the HomeLink® button is pressed and released.

To program the remaining two HomeLink® buttons, begin with Step 2 under “Programming HomeLink®.” Do not repeat Step 1 as this will erase all of the programmed channels.

If the indicator light blinks rapidly for two seconds and then turns to a constant light, continue with Steps 6 through 8 following to complete the programming of a rolling-code equipped device (most commonly, a garage door opener).

6. Locate in the garage, the garage door opener receiver (motor-head unit). Locate the “Learn” or “Smart” button. This can usually be found where the hanging antenna wire is attached to the motor-head unit.
7. Firmly press and release the “Learn” or “Smart” button. The name and color of the button may vary by manufacturer.

You will have 30 seconds to start Step 8.

8. Return to the vehicle. Firmly press and hold the programmed HomeLink<sup>®</sup> button for two seconds, then release. Repeat the press/hold/release sequence a second time, and depending on the brand of the garage door opener (or other rolling code device), repeat this sequence a third time to complete the programming.

HomeLink<sup>®</sup> should now activate your rolling-code equipped device.

To program the remaining two HomeLink<sup>®</sup> buttons, begin with Step 2 of “Programming HomeLink<sup>®</sup>.” Do not repeat Step 1.

## Gate Operator and Canadian Programming

Canadian radio-frequency laws require transmitter signals to “time out” or quit after several seconds of transmission. This may not be long enough for HomeLink<sup>®</sup> to pick up the signal during programming. Similarly, some U.S. gate operators are manufactured to “time out” in the same manner.

If you live in Canada, or you are having difficulty programming a gate operator by using the “Programming HomeLink<sup>®</sup>” procedures (regardless of where you live), replace Step 3 under “Programming HomeLink<sup>®</sup>” with the following:

Continue to press and hold the HomeLink<sup>®</sup> button while you press and release every two seconds (cycle) your hand-held transmitter until the frequency signal has been successfully accepted by HomeLink<sup>®</sup>. The indicator light will flash slowly at first and then rapidly. Proceed with Step 4 under “Programming HomeLink<sup>®</sup>” to complete.

## Using HomeLink®

Press and hold the appropriate HomeLink® button for at least half of a second. The indicator light will come on while the signal is being transmitted.

## Erasing HomeLink® Buttons

To erase programming from the three buttons do the following:

1. Press and hold down the two outside buttons until the indicator light begins to flash, after 20 seconds.
2. Release both buttons. Do not hold for longer than 30 seconds.

HomeLink® is now in the train (learning) mode and can be programmed at any time beginning with Step 2 under “Programming HomeLink®.”

Individual buttons can not be erased, but they can be reprogrammed. See “Reprogramming a Single HomeLink® Button” next.

## Reprogramming a Single HomeLink® Button

To program a device to HomeLink® using a HomeLink® button previously trained, follow these steps:

1. Press and hold the desired HomeLink® button. Do not release the button.
2. The indicator light will begin to flash after 20 seconds. While still holding the HomeLink® button, proceed with Step 2 under “Programming HomeLink®.”

## Resetting Defaults

To reset HomeLink® to default settings do the following:

1. Hold down the two outside buttons for about 20 seconds until the indicator light begins to flash.
2. Continue to hold both buttons until the HomeLink® indicator light turns off.
3. Release both buttons.

For questions or comments, contact HomeLink® at 1-800-355-3515, or on the internet at [www.homelink.com](http://www.homelink.com).



## Storage Areas

### Glove Box

Use the key to lock and unlock the glove box. To open the glove box, pull the handle upward until the latch opens.

### Garage Door Opener Compartment



If your vehicle has this feature, the garage door opener storage area is located in the headliner near the front reading lamps.

To install your garage door opener, do the following:

1. Push the extended tab above the GARAGE button or insert a tool between the tab and outer edge of the cover. The garage door opener cover will flip down.



2. Remove the square height adapters from the cover.

- Place the height adapters on the proper peg by lining up the height adapters and the transmitter button on your garage door opener.

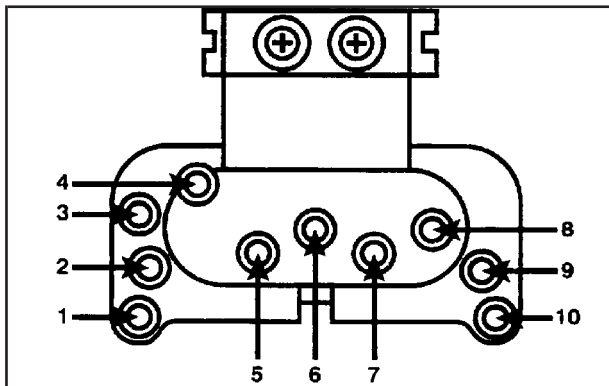

- Use the hook and loop fastener found in the storage area and attach the garage door opener securely inside the console. Line up the transmitter button with the height adapters.
- Close the cover and test the GARAGE button.

If your garage door opener doesn't work after it is installed, try another combination.

## Center Console Storage Area

Your vehicle has a center console with two storage compartments and cupholders. The cupholders have removable liners to hold beverage containers of different sizes. To access the cupholders and the front storage area, push the doors covering them back into the console. In the front storage area you will find a place to store a cellular phone, as well as a built-in writing surface. Underneath this tray is a CD storage area and another door which can be opened to retrieve items which may fall into the space between the console and the sliding door. To access the CD storage area, place your finger in the oval in the top tray and lift up.

To access the rear storage area, press the lift latch at the front edge of the armrest and pull up. Inside are areas which can be used to store a variety of items. The back of the console may contain either additional cupholders or air vents for the rear seat passengers.

You will also find two accessory power outlets located inside the rear storage area. These outlets can be used for accessories requiring power, such as a cellular phone or fax machine. See *Accessory Power Outlets on page 3-22*.

## Assist Handles

An assist handle over each rear door and the front passenger's door can be used to help passenger's get in or out of your vehicle.

## Rear Storage Area

If your vehicle has this feature, the rear storage armrest contains two cupholders. To access the cupholders, pull the armrest down from the rear seatback.

This armrest also includes a storage area inside the armrest. To open it, pull up on the lever at the front edge of the armrest.

## Rear Seat Armrest

Your vehicle's rear seat armrest contains two cupholders. To access the cupholders, pull the armrest down from the rear seatback.

## Rear Seat Pass Through

Your vehicle may be equipped with a rear storage armrest with a pass-through feature that allows for trunk access. Pull the rear armrest down, then push down on the trunk access panel latch to open the panel. To close, push the access panel until it latches.

## Convenience Net

Your vehicle may have a convenience net. You'll see it just inside the back wall of the trunk.

Put small loads, like grocery bags, behind the net. It can help keep them from falling over during sharp turns or quick starts and stops.

The net isn't for larger, heavier loads. Store them in the trunk as far forward as you can.

You can unhook the net so that it will lie flat when you're not using it.

# Sunroof

Your vehicle may be equipped with a sunroof. The sunroof has both manual and express features for opening the glass panel and sunshade.



The switch for the sunroof is located on the headliner between the sun visors.

The sunroof switch has a number of positions that control sunroof movement.

The switch will only work when the ignition is on or when the RAP is active. See "Retained Accessory Power (RAP)" under *Ignition Positions on page 2-24*.

**Open:** Press and hold the switch rearward to the first position to open the glass panel and sunshade. The sunshade can also be opened manually.

**Comfort Stop:** Press and release the switch rearward to the second position to express open the glass panel to the comfort stop position. The comfort stop position is designed to help reduce noise and make passengers more comfortable.

**Express Open:** When the glass panel is express opening, pressing the switch in any direction will stop it in a partially-opened position. The glass panel may be fully opened by pressing the switch rearward again. If you press and hold the switch in the express open position for more than one and a half seconds, the express open operation will be overridden and the sunroof will operate manually.

**Close:** To close the glass panel, press and hold the switch forward. As the glass panel reaches the closed position, it will open slightly toward the vent position and then drop down to the closed position to provide a better seal. The sunshade must be closed manually.

**Vent:** Once the sunroof is closed, it can be opened to the vent position by pushing the switch upward. To close the glass panel, pull the switch downward. The sunshade must be opened and closed manually for vent operation.

# Vehicle Personalization

## Memory Seat and Mirrors



If your vehicle has this feature, the controls are located on the driver's door panel, and are used to program and recall memory settings for the driver's seating, outside mirror positions and climate controls. See *Climate Controls Personalization on page 3-31* for more information.

To save your seat and mirror positions into memory, use the following procedure:

1. First identify the DRIVER # on the Driver Information Center (DIC) by pressing the MEMORY button 1 or 2 or by pressing the unlock button on the remote keyless entry transmitter. See *Driver Information Center (DIC) on page 3-47*.

2. Adjust the driver's seat and lumbar position to a safe and comfortable driving position. Adjust both outside mirrors to suit you. See *Outside Power Mirrors on page 2-39*.
3. Press and hold the MEMORY button 1 or 2 corresponding with your DRIVER # displayed on the DIC for longer than three seconds. You will hear two beeps confirming that the seat and mirror positions have been entered into memory.

To set the seat and mirror positions for a second driver, follow the previous steps, but start by pressing the unlock button on the transmitter that displays the other DRIVER # on the DIC. Be sure to use the MEMORY button which corresponds to the DRIVER # identified by the second transmitter.

To recall your memory positions, your vehicle must be in PARK (P). Push and release the MEMORY button 1 or 2 corresponding to the desired driving position. The seat and mirrors will move to the position previously stored for the identified driver. You will hear one beep.

To store the exit position for an easy exit, use the following procedure:

1. First identify the DRIVER # by pressing the MEMORY button 1 or 2 or by pressing the unlock button on the transmitter.
2. Adjust the driver's seat to the desired exit position.
3. Press and hold the EXIT button for longer than three seconds. You will hear two beeps confirming that the seat exit position has been entered into memory.

To set the exit position for a second driver, follow the previous steps, but start by pressing the unlock button on the transmitter that displays the other DRIVER # on the DIC. Be sure to use the MEMORY button which corresponds to the DRIVER # identified by the other transmitter.

To recall the exit position, your vehicle must be in PARK (P). Push and release the EXIT button and the seat will move to the exit position previously stored for the currently identified driver. You will hear one beep. If an exit position has not been stored for the currently identified driver, the seat will move all the way back.

To stop recall movement of the seat at any time, press the driver's power seat control located on the outboard side of the front seat.

Mirrors and lumbar positions will not be stored or recalled for the exit position.

If you would like your stored driving or exit position to be recalled when unlocking your vehicle with the transmitter, see *DIC Vehicle Personalization on page 3-51*.

## Section 3 Instrument Panel

---

<b>Instrument Panel Overview</b> .....	3-2	Anti-Lock Brake System Warning Light .....	3-39
Hazard Warning Flashers .....	3-4	Traction Control System (TCS) Warning Light .....	3-39
Other Warning Devices .....	3-4	Engine Coolant Temperature Gage .....	3-40
Horn .....	3-5	Malfunction Indicator Lamp .....	3-41
Tilt Wheel .....	3-5	Oil Pressure Light .....	3-44
Turn Signal/Multifunction Lever .....	3-5	Security Light .....	3-45
Exterior Lamps .....	3-12	Cruise Control Light .....	3-45
Interior Lamps .....	3-15	Service Vehicle Soon Light .....	3-45
Head-Up Display (HUD) .....	3-18	Fuel Gage .....	3-46
Ultrasonic Rear Parking Assist (URPA) .....	3-20	<b>Driver Information Center (DIC)</b> .....	3-47
Accessory Power Outlets .....	3-22	DIC Controls and Displays .....	3-47
Ashtrays and Cigarette Lighter .....	3-23	DIC Warnings and Messages .....	3-50
<b>Climate Controls</b> .....	3-24	DIC Vehicle Personalization .....	3-51
Dual Automatic Climate Control System .....	3-24	<b>Audio System(s)</b> .....	3-57
Outlet Adjustment .....	3-29	Setting the Time .....	3-58
Passenger Compartment Air Filter .....	3-30	Radio with Cassette .....	3-58
Steering Wheel Climate Controls .....	3-30	Radio with Cassette and CD .....	3-63
Climate Controls Personalization .....	3-31	Trunk-Mounted CD Changer .....	3-71
<b>Warning Lights, Gages and Indicators</b> .....	3-32	Personal Choice Radio Controls .....	3-75
Instrument Panel Cluster .....	3-33	Theft-Deterrent Feature .....	3-75
Speedometer and Odometer .....	3-35	Audio Steering Wheel Controls .....	3-78
Tachometer .....	3-35	Understanding Radio Reception .....	3-78
Safety Belt Reminder Light .....	3-36	Care of Your Cassette Tape Player .....	3-79
Air Bag Readiness Light .....	3-36	Care of Your CDs .....	3-80
Battery Warning Light .....	3-37	Care of Your CD Player .....	3-80
Brake System Warning Light .....	3-38	Heated Backlite Antenna .....	3-80

# Instrument Panel Overview

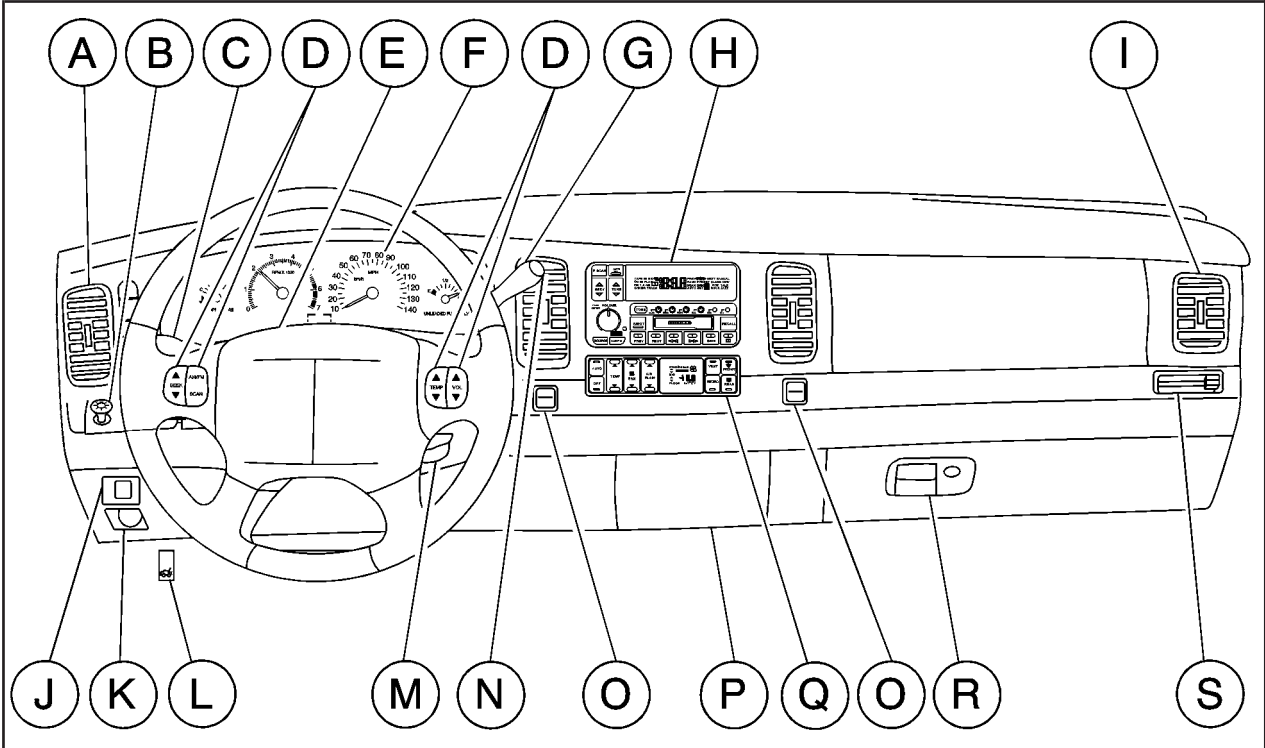



The main components of your instrument panel are the following:

- A. Air Outlet. See *Outlet Adjustment on page 3-29*.
- B. Exterior Lamps Control. See *Exterior Lamps on page 3-12*.
- C. Turn Signal/Multifunction Lever. See *Turn Signal/Multifunction Lever on page 3-5*.
- D. Steering Wheel Controls (If Equipped). See *Steering Wheel Climate Controls on page 3-30* and *Audio Steering Wheel Controls on page 3-78*.
- E. Hazard Warning Flashers Button. See *Hazard Warning Flashers on page 3-4*.
- F. Instrument Panel Cluster. See *Instrument Panel Cluster on page 3-33*.
- G. Shift Lever. See *Automatic Transaxle Operation on page 2-27*.
- H. Audio System. See *Audio System(s) on page 3-57*.
  - I. Air Outlet. See *Outlet Adjustment on page 3-29*.
  - J. Fuel Door Release Button. See *Filling Your Tank on page 5-6*.
  - K. Trunk Release and Lockout Button. See “Remote Trunk Release” and “Remote Trunk Release Lockout” under *Trunk on page 2-15*.
  - L. Hood Release. See *Hood Release on page 5-10*.
  - M. Ignition Switch. See *Ignition Positions on page 2-24*.
  - N. Traction Control Button (If Equipped). See *Traction Control System (TCS) on page 4-9*.
  - O. Heated Seat Controls (Option). See *Heated Seats on page 1-3*.
  - P. Ashtray and Cigarette Lighter. See *Ashtrays and Cigarette Lighter on page 3-23*.
  - Q. Climate Control System. See *Dual Automatic Climate Control System on page 3-24*.
  - R. Glove Box. See *Glove Box on page 2-47*.
  - S. Passenger Climate Control (Option). See “Passenger Temperature Control” under *Dual Automatic Climate Control System on page 3-24*.

## Hazard Warning Flashers

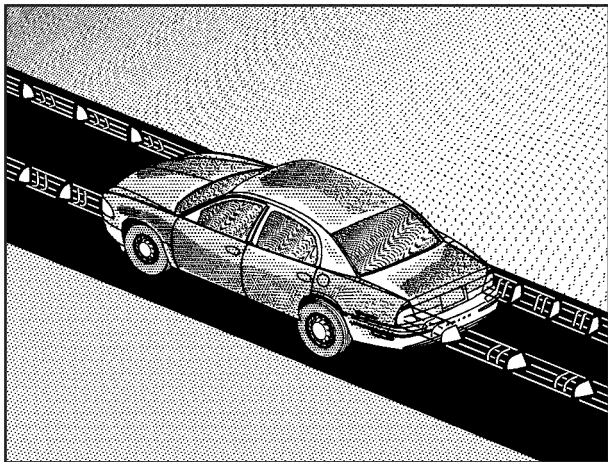

Your hazard warning flashers let you warn others. They also let police know you have a problem. Your front and rear turn signal lamps will flash on and off.



The hazard warning flasher button is located on top of the steering column.

Your hazard warning flashers work no matter what position your key is in, and even if the key isn't in.

Press the button to make the front and rear turn signal lamps flash on and off. To turn off the flashers, press the button again.

When the hazard warning flashers are on, your turn signals won't work.

## Other Warning Devices

If you carry reflective triangles, you can set one up at the side of the road about 300 feet (100 m) behind your vehicle.

## Horn

Press on the center area of the steering wheel to sound the horn.

## Tilt Wheel

A tilt wheel allows you to adjust the steering wheel before you drive. You can also raise it to the highest level to give your legs more room when you exit and enter the vehicle.

The lever that allows you to tilt the steering wheel is located on the left side of the steering column.



To tilt the wheel, hold the wheel and pull the lever toward you. Then move the steering wheel to a comfortable position and release the lever to lock the wheel in place.

## Turn Signal/Multifunction Lever

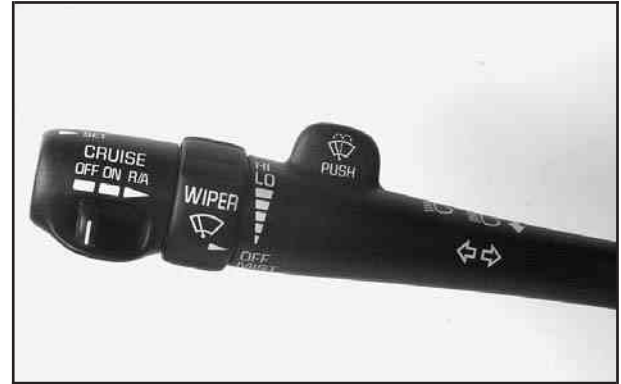

The lever on the left side of the steering column includes the following:

- Turn and Lane-Change Signals
- Headlamp High/Low-Beam Changer
- Flash-to-Pass
- Windshield Wipers
- Windshield Washer
- Cruise Control

For information on the exterior lamps, see *Exterior Lamps* on page 3-12.

## Turn and Lane-Change Signals

The turn signal has two upward (for right) and two downward (for left) positions. These positions allow you to signal a turn or a lane change.

To signal a turn, move the lever all the way up or down. When the turn is finished, the lever will return automatically.

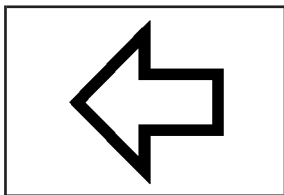

An arrow on the instrument panel cluster will flash in the direction of the turn or lane change.

If your vehicle is equipped with the Head-Up Display (HUD), an arrow will also appear in the display area to indicate the direction of the turn or lane change. See *Head-Up Display (HUD)* on page 3-18 for more information.

You may also have an arrow in the outside mirror that flashes when the turn signal is used. See *Outside Power Mirrors* on page 2-39 for more information.

To signal a lane change, just raise or lower the lever until the arrow starts to flash. Hold it there until you complete your lane change. The lever will return by itself when you release it.

As you signal a turn or a lane change, if the arrows flash at twice the normal rate, this may indicate that a signal bulb may be burned out and other drivers will not see your turn signal.

If a bulb is burned out, replace it to help avoid an accident. If the arrows do not go on at all when you signal a turn, check the fuse and check for burned-out bulbs. See *Fuses and Circuit Breakers* on page 5-99.

If you have a trailer towing option with added wiring for the trailer lamps, the signal indicator will flash even if a turn signal bulb is burned out. Check the front and rear turn signal lamps regularly to make sure they are working. You do not need to add a different flasher.

### Turn Signal On Chime

If your turn signal is left on for more than 3/4 of a mile (1.2 km), a chime will sound at each flash of the turn signal. To turn off the chime, move the turn signal lever to the off position.

## Headlamp High/Low-Beam Changer

To change the headlamps from low beam to high or high to low, pull the turn signal lever toward you, then release it.

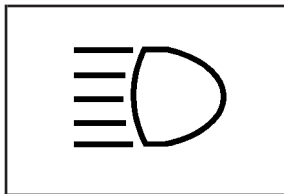

When the high beams are on, a light on the instrument panel cluster will also be on. If your vehicle is equipped with HUD, this light will also appear in the display area.

## Flash-To-Pass

This feature lets you use your high-beam headlamps to signal a driver in front of you that you want to pass. It works even if your headlamps are off.

To use it, pull the turn signal lever toward you, but not so far that you hear a click.

If your headlamps are off or on low beam, your high-beam headlamps will turn on. They will stay on as long as you hold the lever toward you and the high-beam indicator on the instrument panel cluster will come on. Release the lever to turn the high-beam headlamps off.

## Windshield Wipers

The windshield wipers are controlled by turning the band marked WIPER.

**OFF:** Turn the band to OFF to turn the wipers off.

**MIST:** For a single wiping cycle, turn the band to MIST. Hold it there until the wipers start, then let go. The wipers will stop after one cycle. If you want more cycles, hold the band on MIST longer.

**LO (Low Speed):** Turn the band to LO for steady wiping at a slow speed.

**HI (High Speed):** Turn the band to HI for steady wiping at a high speed.

The wiper speed may be set for a long or short delay between wipes. Turn the band to choose the delay time. The closer to LO, the shorter the delay.

Heavy snow or ice can overload your wiper motor. A circuit breaker will stop the motor until it cools. Clear away snow or ice to prevent an overload.

Keep in mind that damaged wiper blades may prevent you from seeing well enough to drive safely. To avoid damage, be sure to clear ice and snow from the wiper blades before using them. If your blades do become damaged, get new blades or blade inserts.

## Rainsense™ II Wipers

If your vehicle has this feature, the moisture sensor is mounted on the interior of the windshield below the rearview mirror and is used to automatically operate the wipers. This system operates by monitoring the amount of moisture build-up on the windshield. Wipes occur as needed to clear the windshield depending on the driving conditions and the sensitivity setting. In light rain or snow, fewer wipes will occur. In heavy rain or snow, wipes will occur more frequently. The system will operate in the delay, low speed and high speed modes. If the system is left on for long periods of time, occasional wipes may occur without any moisture on the windshield. This is normal and indicates that the Rainsense™ system is active.

The Rainsense™ system is activated by turning the wiper control band to one of the five sensitivity levels within the delay area. The delay position closest to OFF/MIST is the lowest sensitivity setting, level one. This allows more rain or snow to collect on the windshield between wipes. You can increase the sensitivity of the system and the frequency of wipes by turning the wiper control band away from you to the

higher sensitivity levels. The highest sensitivity setting, level five, is closest to the LO position. A single wipe will occur each time you turn the wiper control band to a higher sensitivity level to indicate that the sensitivity level has been increased.

The windshield wipers also remain in a “high park” position (the wipers are stopped on the windshield and are not in the normal park position), even when the ignition is turned off.

**Notice:** If you do not turn off the windshield wipers when driving through an automatic car wash, you could damage the wipers. Always turn off the windshield wipers before entering an automatic car wash.

The MIST and wash cycles operate as normal and are not affected by the moisture-sensing function. The system can be overridden at any time by manually turning the wiper band to LO or HI speed.

**Notice:** Do not place stickers or other items on the exterior glass surface directly in front of the moisture sensor. Doing this could cause the moisture sensor to malfunction.

## Windshield Washer

At the top of the multifunction lever there is a paddle with the word PUSH on it. For “programmed” operation, press and release the paddle. The washer will provide a measured amount of fluid to the windshield and the wiper will either stop or return to your original wiping speed. For “demand” operation, press and hold the paddle for at least two seconds. Release the paddle when you have enough fluid and the wipers will either stop or return to your original wiping speed.

### CAUTION:

**In freezing weather, do not use your washer until the windshield is warmed. Otherwise the washer fluid can form ice on the windshield, blocking your vision.**

If your vehicle is equipped with a DIC, a WINDSHIELD WASHER FLUID LOW message will appear on the instrument panel cluster when the vehicle is low on washer fluid. See *DIC Warnings and Messages on page 3-50*.

## Cruise Control

With cruise control, you can maintain a speed of about 25 mph (40 km/h) or more without keeping your foot on the accelerator. This can really help on long trips.

Cruise control does not work at speeds below about 25 mph (40 km/h).

When you apply your brakes, the cruise control shuts off.

### CAUTION:

- **Cruise control can be dangerous where you can not drive safely at a steady speed. So, do not use your cruise control on winding roads or in heavy traffic.**
- **Cruise control can be dangerous on slippery roads. On such roads, fast changes in tire traction can cause needless wheel spinning, and you could lose control. Do not use cruise control on slippery roads.**

If your vehicle is in cruise control when the optional traction control system begins to limit wheel spin, the cruise control will automatically disengage. See *Traction Control System (TCS) on page 4-9*. When road conditions allow you to safely use it again, you may turn the cruise control back on.

## Setting Cruise Control

### CAUTION:

**If you leave your cruise control on when you are not using cruise, you might hit a button and go into cruise when you do not want to. You could be startled and even lose control. Keep the cruise control switch off until you want to use cruise control.**



1. Move the cruise control switch to ON.

2. Get up to the speed you want.
3. Push in the SET button at the end of the turn signal lever and release it. The CRUISE light on the instrument panel cluster will come on.
4. Take your foot off the accelerator pedal.



## Resuming a Set Speed

Setting the cruise control at a desired speed and then applying the brake will end the cruise control function.

Once you are going about 25 mph (40 km/h) or more, you can move the cruise control switch from ON to R/A (Resume/Accelerate) briefly to reset. This returns you to your desired preset speed.

Remember, if you hold the switch at R/A, the vehicle will accelerate until you release the switch or apply the brake. So unless you want to go faster, do not hold the switch at R/A.

## Increasing Speed While Using Cruise Control

There are two ways to go to a higher speed:

- Use the accelerator pedal to go to a higher speed. Push the SET button at the end of the lever, then release the button and the accelerator pedal. You will now cruise at the higher speed.
- Move the cruise switch from ON to R/A. Hold it there until you reach a desired speed and then release the switch. To increase your speed in very small amounts, briefly move the switch to R/A, then release it.

Each time you do this, your vehicle will go about 1 mph (1.6 km/h) faster.

The accelerate feature will only work after you have set the cruise control speed by pushing the SET button.

## Reducing Speed While Using Cruise Control

There are two ways to reduce your speed while using cruise control:

- Push in the SET button at the end of the lever until you reach a desired lower speed, then release it.
- To slow down in very small amounts, push the button briefly. Each time you do this, you will go about 1 mph (1.6 km/h) slower.

## Passing Another Vehicle While Using Cruise Control

Use the accelerator pedal to increase your speed. When you take your foot off the pedal, your vehicle will slow down to the cruise control speed you set earlier.

## Using Cruise Control on Hills

How well your cruise control will work on hills depends upon your speed, load and the steepness of the hills. When going up steep hills, you may have to step on the accelerator pedal to maintain your speed. When going downhill, you may have to brake or shift to a lower gear to keep your speed down. Of course, applying the brake takes you out of cruise control. Many drivers find this to be too much trouble and do not use cruise control on steep hills.

## Ending Cruise Control

There are two ways to turn off the cruise control:

- Step lightly on the brake pedal.
- Move the cruise switch to OFF. The CRUISE light will also go out.

## Erasing Speed Memory

When you turn off the cruise control or the ignition, your cruise control set speed memory is erased.

## Exterior Lamps



This control, located to the left of the steering column, operates the following systems:

- Headlamps
- Taillamps
- Parking Lamps
- License Lamps
- Sidemarkers Lamps
- Instrument Panel Lights
- Interior Courtesy Lamps

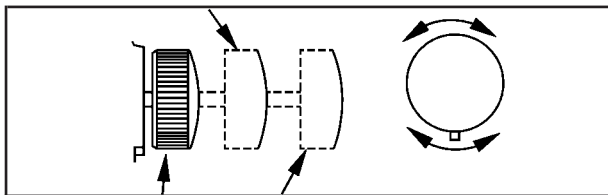

**OFF:** Pushing the exterior lamps control all the way in turns off all lamps and lights.

**Parking Lamps:** Pulling the exterior lamps control out to the first position turns on the parking lamps, license plate lamps, the sidemarker lamps and the instrument panel lights.

**Headlamps:** Pulling the exterior lamps control out to the second position turns on the headlamps, together with the previously listed lamps and lights.

For information on the interior lights, see *Interior Lamps* on page 3-15.

## Headlamps On Reminder

If you leave the exterior lamp control on, remove the key from the ignition and open the driver's door, you will hear a continuous warning chime. The chime will turn off when the lamps are turned off.

## Daytime Running Lamps

Daytime Running Lamps (DRL) can make it easier for others to see the front of your vehicle during the day. DRL can be helpful in many different driving conditions, but they can be especially helpful in the short periods after dawn and before sunset. Fully functional daytime running lamps are required on all vehicles first sold in Canada.

A light sensor on top of the instrument panel monitors the exterior light level for the operation of DRL and Twilight Sentinel<sup>®</sup>, so be sure it is not covered.

The DRL system will make your high-beam headlamps come on at reduced brightness in daylight when the following conditions are met:

- The ignition is on.
- The exterior lamps control is off.
- The transaxle is not in PARK (P).

When DRL are on, only your high-beam headlamps will be on. The parking lamps, taillamps, sidemarker and other lamps will not be on. Your instrument panel will not be lit up either.

When it is dark enough outside, your high-beam headlamps will change to low-beam headlamps at full brightness. The other lamps that turn on with your headlamps will also turn on. When it is bright enough outside, the regular lamps will turn off, and your high-beam headlamps change to the reduced brightness of DRL.

To idle your vehicle with the DRL off, shift the transaxle into PARK (P). The DRL will stay off until you shift out of PARK (P).

To turn off all exterior lighting at night when you are parked, turn off the exterior lamp control and slide the Twilight Sentinel® control all the way to the left.

When released, the control will return to the Twilight Sentinel® minimum delay position and the lights will turn off.

As with any vehicle, you should turn on the regular headlamp system when you need it.

## Cornering Lamps

The cornering lamps come on when the headlamps or parking lamps are on and you signal a turn with the multifunction lever. They provide more light for cornering.

## Twilight Sentinel®



Twilight Sentinel® turns your headlamps on and off by sensing how dark it is outside.

To operate this feature, slide the control to any position to vary the lamp time-out.

You can set the delay time from only a few seconds to three minutes. If you move the control all the way to MAX, your lamps will remain on for three minutes after you turn off your engine. If you move the control almost all the way in the other direction, so it is just on, the lamps will go off quickly when you turn off your engine. Sliding the control to OFF, turns off the Twilight Sentinel® feature.

## Light Sensor

Your Twilight Sentinel® and DRL work with the light sensor on top of the instrument panel. Do not cover it up. If you do, it will sense "dark" and the headlamps will come on.

## **Interior Lamps**

### **Instrument Panel Brightness**

Adjust the instrument panel light brightness by turning the exterior lamps control.

### **Courtesy Lamps**

When any door is opened, several lamps go on. They make it easy for you to enter and leave your vehicle. You can also turn these lamps on by turning the exterior lamps control clockwise all the way past the normal stop.

### **Entry Lighting**

When you open either front door or press the unlock button on the remote keyless entry transmitter, the lamps inside your vehicle will turn on. These lamps will turn off after about 40 seconds. These lamps will also turn off if you start the engine or activate the power door locks.

### **Delayed Entry Lighting**

When you open the door, the interior lamps will come on. When you close the door with the ignition off, the interior lamps will stay on for 25 seconds or until the ignition is turned to an on position. Locking the doors with the

power door lock switch will override the delayed entry lighting feature and the lamps will turn off right away.

Using the remote keyless entry transmitter to lock the door will not cancel delayed lighting.

### **Theater Dimming**

This feature allows for a three to five-second fade out of the courtesy lamps instead of immediate turn off.

### **Delayed Exit Lighting**

With this feature, the interior lamps will come on for 25 seconds after you remove the key from the ignition. This will give you time to find the door handle or lock switches.

### **Parade Dimming**

This feature prohibits the dimming of your instrument panel displays during daylight while your headlamps are on. This feature operates with the light sensor for the Twilight Sentinel<sup>®</sup> and is fully automatic. When the light sensor reads darkness outside, you will be able to dim your instrument panel displays once again.

## Perimeter Lighting

When the unlock button on the remote keyless entry transmitter is pressed, the DRL, parking lamps and back-up lamps will come on if it is dark enough outside.

This feature will only be activated when the security feedback feature is programmed to be in Modes 1, 3 or 5 on the transmitter. Modes 0, 2 and 4 do not respond with exterior lights flashing when unlocking the vehicle so perimeter lighting will not be active.

This feature can be programmed on or off for each transmitter.

To turn the feature off do the following:

1. Press and hold LOCK on the driver's door lock switch throughout this procedure. All doors will lock.
2. Press the remote alarm button on the transmitter to enter the programming mode. Perimeter lighting remains on at this time and the horn will chirp two times.
3. Press the remote alarm button on the transmitter again. Perimeter lighting is disabled and the horn will chirp one time.
4. Release the door lock switch. The perimeter lighting feature is now off.

To turn the feature on do the following:

1. Press and hold LOCK on the driver's door lock switch throughout this procedure. All doors will lock.
2. Press the remote alarm button on the transmitter to enter the programming mode. Perimeter lighting remains off at this time and the horn will chirp one time.
3. Press the remote alarm button on the transmitter again. Perimeter lighting is now enabled and the horn will chirp two times.
4. Release the door lock switch. The perimeter lighting feature is now on.

Perimeter lighting can also be activated through the DIC. See *DIC Vehicle Personalization on page 3-51* or *Driver Information Center (DIC) on page 3-47*.

## Front Reading Lamps



The front reading lamps, located on the headliner, and the interior courtesy lamps will come on when you open a door. They will turn off when you turn on the ignition.

To turn on the front reading lamps when the doors are closed, press the button behind the lamp you want to turn on. Press it again to turn the lamp off.

These lamps work even when the ignition is off.

## Rear Reading Lamps



To turn on a rear reading lamp, press the button above that rear door. To turn off the reading lamp, press the button again.

## Trunk Lamp

When you open the trunk to its full open position, a lamp will come on inside the trunk. This lamp will automatically turn off when the trunk is closed.

## Glove Box Lamp

When you open the glove box, a lamp will come on inside the glove box. This will automatically turn off when the glove box is closed.

## Battery Rundown Protection

This feature shuts off all lamps that are left on for more than 10 minutes when the ignition is off. This will keep your battery from running down.

## Head-Up Display (HUD)

### CAUTION:

If the HUD image is too bright, or too high in your field of view, it may take you more time to see things you need to see when it is dark outside. Be sure to keep the HUD image dim and placed low in your field of view.

If your vehicle is equipped with the Head-Up Display (HUD), you can see some of the driver information that appears on your instrument panel cluster.

The information may be displayed in English or metric units and appears as a reflection in the windshield. The HUD consists of the following information:

- Speedometer Reading
- Turn Signal Indicators
- High-Beam Headlamp Indicator
- CHECK GAGES Message

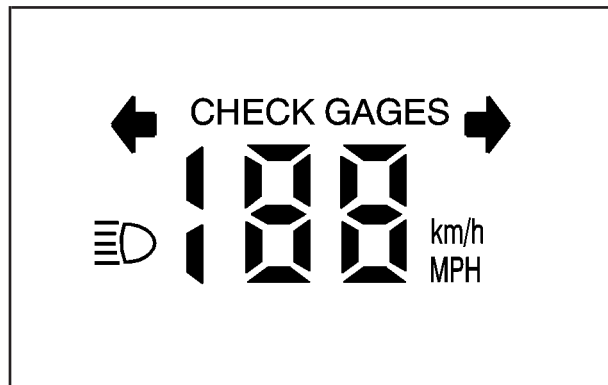

The HUD shows these images when they are lighted on the instrument panel cluster.



Be sure to continue scanning your displays, controls and driving environment just as you would in a vehicle without HUD. If you never look at your instrument panel, you may not see something important, such as a warning light.

**Notice:** If you try to use the HUD image as a parking aid, you may misjudge the distance and damage your vehicle. Do not use the HUD image as a parking aid.



The HUD controls are located in the overhead console.

1. Start your engine and slide the HUD dimmer switch all the way up.

The brightness of the HUD image is determined by whether the headlamps are on or off, and where you have the HUD dimmer switch set.

2. Adjust the seat to a comfortable driving position. Keep pressing the top arrow on the image height adjuster to raise the image as far as possible.
3. Keep pressing the bottom arrow on the image height adjuster to move the image as low as possible, while still keeping it in full view.
4. Slide the dimmer switch downward until the HUD image is no brighter than necessary.

To turn the HUD display off, slide the dimmer switch all the way down.

If the sun comes out, the sky becomes cloudy, or if you turn your headlamps on, you may need to adjust the HUD brightness using the dimmer switch. Polarized sunglasses could make the HUD image harder to see.

To change the display from English to metric units, push the ENG/MET button located to the left of the steering column.

## Care of the HUD

Clean the inside of the windshield as necessary to remove any dirt or film that reduces the sharpness or clarity of the HUD image.

To clean the HUD lens, spray household glass cleaner on a soft, clean cloth. Gently wipe and dry the HUD lens. Do not spray cleaner directly on the lens to avoid cleaner leaking inside the unit.

## If You Can't See The HUD Image When the Ignition is On

If the ignition is on and you can't see the HUD image, check to see if:

- The headlamps are on.
- Something is covering the HUD unit.
- The HUD dimmer control is adjusted properly.
- The HUD image is adjusted to the proper height.
- A fuse is blown. See *Fuses and Circuit Breakers* on page 5-99.

Keep in mind that your windshield is part of the HUD system. If you ever have to have your windshield replaced, be sure to get one that is designed for HUD or your HUD image may look blurred or out of focus.

## Ultrasonic Rear Parking Assist (URPA)

Your vehicle may be equipped with Ultrasonic Rear Parking Assist (URPA). URPA is designed to help you park while in REVERSE (R) and operates only at speeds less than 3 mph (5 km/h). URPA can help you avoid colliding with objects such as parked vehicles. The system can detect objects 5 feet (1.5 m) behind your vehicle and tell you how close those objects are to your rear bumper.

The URPA display is located inside the vehicle, above the rear window. It has three color-coded lights that can be seen through the rearview mirror.

### CAUTION:

**Even with the Ultrasonic Rear Park Assist system, the driver must check carefully before backing up. The system does not operate above typical backing speeds of 3 mph (5 km/h) while**

**CAUTION: (Continued)**

## **CAUTION: (Continued)**

**parking. And, the system does not detect objects that are more than 5 feet (1.5 meters) behind the vehicle.**

**So, unless you check carefully behind you before and when you back up, you could strike children, pedestrians, bicyclists or pets behind you, and they could be injured or killed.**

**Whether or not you are using Rear Park Assist, always check carefully behind your vehicle before you back up and then watch closely as you do.**

## **How the System Works**

URPA comes on automatically when the shift lever is moved into REVERSE (R). When the system comes on, the three lights on the display will briefly illuminate to let you know that the system is working. If your vehicle is moving in REVERSE (R) at a speed greater than 3 mph (5 km/h), the red light will flash to remind you the system does not work at this speed.

The first time an object is detected while in REVERSE (R), a chime will sound and the following will occur in sequence, depending on the distance from the object:

- At 5 feet (1.5 m) a chime will sound and one amber light will be lit.
- At 40 inches (1.0 m) both amber lights will be lit.
- At 20 inches (0.5 m) a continuous chime will sound and all three lights (amber/amber/red) will be lit.
- At 1 foot (0.3 m) a continuous chime will sound and all three lights (amber/amber/red) will flash.

URPA can detect objects 3 inches (7.6 cm) and wider, and at least 10 inches (25.4 cm) tall, but it cannot detect objects that are above trunk level. In order for the rear sensors to recognize an object, it must be within operating range.

If the URPA system is not functioning properly, the display will flash red, indicating that there is a problem. The light will also flash red while driving if a trailer is attached to your vehicle, or a bicycle or object is on the back of, or hanging out of your trunk. The light will continue to flash until the trailer or the object is removed and your vehicle is driven forward at at least 15 mph (25 km/h).

It may also flash red if the ultrasonic sensors are not kept clean. So be sure to keep your rear bumper free of mud, dirt, snow, ice and slush or materials such as paint or the system may not work properly. If after cleaning the rear bumper and driving forward at at least 15 mph (25 km/h), the display continues to flash red, see your dealer. For cleaning instructions, see *Cleaning the Outside of Your Vehicle on page 5-93*.

It may also flash red if your vehicle is moving in REVERSE (R) at a speed greater than 3 mph (5 km/h). Other conditions that may affect system performance include things like the vibrations from a jackhammer or the compression of airbrakes on a very large truck.

As always, drivers should use care when backing up a vehicle. Always look behind you, being sure to check for other vehicles, obstructions and blind spots.

## Accessory Power Outlets

The accessory power outlets can be used to plug in electrical equipment such as a cellular telephone or CB radio.

Your vehicle has two power outlets located in the rear storage area of the front center console. See *Center Console Storage Area on page 2-48* for more information on location.

Your vehicle may have a small cap that must be pulled down to access the accessory power outlet. If it does, when not using the outlet be sure to cover it with the protective cap.

The accessory power outlets will only operate while the ignition key is in RUN and for 10 minutes after turning the ignition off. If you would like to operate an accessory for an extended period of time, contact your dealer for more information.

**Notice:** Leaving electrical equipment on for extended periods will drain the battery. Always turn off electrical equipment when not in use and do not plug in equipment that exceeds the maximum amperage rating.

Certain electrical accessories may not be compatible to the accessory power outlet and could result in blown vehicle or adapter fuses. If you experience a problem see your dealer for additional information on accessory power outlets.

**Notice:** Adding any electrical equipment to your vehicle may damage it or keep other components from working as they should. The repairs would not be covered by your warranty. Check with your dealer before adding electrical equipment.

When adding electrical equipment, be sure to follow the proper installation instructions included with the equipment.

**Notice:** Improper use of the power outlet can cause damage not covered by your warranty. Do not hang any type of accessory or accessory bracket from the plug because the power outlets are designed for accessory power plugs only.

## Ashtrays and Cigarette Lighter

The front ashtray is located under the climate control panel on the center console. Press on the door to release the ashtray. To close, press on the door again.

To empty the ashtray, remove it from the center console by gripping the edges and pulling straight out. To reinstall, push the tray back into place.

The rear ashtrays are located on each rear door panel. To remove a rear ashtray, open the lid and ease the ashtray upward until the edge can be grasped to pull the ashtray up and out.

**Notice:** If you put papers or other flammable items in the ashtray, hot cigarettes or other smoking materials could ignite them and possibly damage your vehicle. Never put flammable items in the ashtray.

There is a cigarette lighter near the front ashtray. To use it, push it in all the way and let go. When it's ready, it will pop back out by itself.

**Notice:** Holding a cigarette lighter in while it is heating will not allow the lighter to back away from the heating element when it is hot. Damage from overheating may occur to the lighter or heating element, or a fuse could be blown. Do not hold a cigarette lighter in while it is heating.

# Climate Controls

## Dual Automatic Climate Control System

With this system you can control the heating, cooling and ventilation for your vehicle.



### Automatic Operation

**AUTO (Automatic):** Press the AUTO button for automatic control of the inside temperature, the air delivery mode and the fan speed.

1. Press the AUTO button.
2. Adjust the temperature to 75° F (24° C).

Choosing the coldest or warmest temperature setting will not cause the system to heat or cool any faster. If you set the system at the warmest temperature setting, the system will remain in manual mode at that temperature and it will not go into automatic mode.

In cold weather, the system will start at reduced fan speeds to avoid blowing cold air into your vehicle until warmer air is available. The system will start out blowing air at the floor but may change modes automatically as the vehicle warms up to maintain the chosen temperature setting. The length of time needed for warm up will depend on the outside temperature and the length of time that has elapsed since your vehicle was last driven.

3. Wait for the system to regulate. This may take from 10 to 30 minutes. Then adjust the temperature, if necessary.

Do not cover the solar sensor located in the center of the instrument panel, near the windshield. For more information on the solar sensor, see “Sensors” later in this section.

## Manual Operation

Pressing the FAN or AIR FLOW buttons cancels automatic operation and places the system in manual mode. Press the AUTO button to return to automatic operation.

**TEMP (Temperature):** To manually adjust the temperature inside the vehicle, push the TEMP arrow. Push the TEMP up arrow for warmer temperature settings and the TEMP down arrow for cooler temperature settings. The setting will be shown on the display. The display will return to the outside temperature after a few seconds.

 **FAN:** Pressing the FAN button will display and hold the current fan speed while in manual mode. If you want the fan to run at a lower speed, push the down arrow on the FAN button. If you want to increase the fan speed, push the up arrow on the FAN button. The fan indicators will also be shown on the display.

If the airflow seems low when the fan is at the highest setting, the passenger compartment air filter may need to be replaced. For more information, see *Passenger Compartment Air Filter on page 3-30*.

**AIR FLOW:** Pressing the AIR FLOW button will display and hold the current setting while in manual mode.

Use the up and down arrows on the AIR FLOW button to cycle through the available modes.

- **WINDSHIELD-FLOOR:** This mode directs most of the airflow to the windshield with some airflow to the outboard outlets (for the side windows) and the floor outlets.
- **MID:** This mode directs airflow through the instrument panel outlets.
- **FLOOR-MID:** This mode directs airflow through both the floor and the instrument panel outlets. There is also a small amount of air directed to the windshield and the outboard outlets (for the side windows).
- **FLOOR:** This mode directs most of the airflow to the floor outlets with some directed to the outboard outlets (for the side windows) and the windshield.

**OFF:** Press the OFF button once to turn off the passenger climate control, if it has been activated. Pressing the OFF button a second time will turn off the main system. The outside temperature will be shown on the display when the system is off.

**VENT:** Pressing the VENT button allows outside air to flow through your vehicle without the air conditioning compressor working. To turn off the VENT selection, push the VENT button again.

Selecting the VENT and AUTO buttons at the same time allows the system to control the airflow automatically without using the air conditioning compressor or the recirculation mode.

**RECIRC (Recirculation):** Press this button to limit the amount of outside air coming into the vehicle. It can be used to prevent outside air and odors from entering your vehicle or to help heat or cool the air inside your vehicle more quickly. Press this button to turn the recirculation mode on or off. When the button is pressed, an indicator light will come on. The recirculation mode cannot be used with the FRONT defrost or VENT mode.

On hot days, open the windows to let hot air escape; then close them. This helps to reduce the time it takes for your vehicle to cool down. It also helps the system to operate more efficiently.

For quick cool down on hot days, press the AUTO button and the system will automatically enter recirculation mode and the temperature will be at the full cold position for maximum cooling.

Using these settings together for long periods of time may cause the air inside of your vehicle to become too dry. To prevent this from happening, after the air in your vehicle has cooled, turn the recirculation mode off.

The air conditioning system removes moisture from the air, so you may sometimes notice a small amount of water dripping underneath your vehicle while idling or after turning off the engine. This is normal.

## Sensors

The solar sensor on your vehicle monitors the solar radiation and the air inside of your vehicle, then uses the information to maintain the selected temperature by initiating needed adjustments to the temperature, the fan speed and the air delivery system. The system may also supply cooler air to the side of the vehicle facing the sun. The recirculation mode will also be activated, as necessary. Do not cover the solar sensor located in the center of the instrument panel, near the windshield, or the system will not work properly.



## Defogging and Defrosting

Fog on the inside of windows is a result of high humidity (moisture) condensing on the cool window glass.

This can be minimized if the climate control system is used properly.

 **FRONT:** Press the FRONT button to defrost the windshield by directing airflow toward the windshield and outboard outlets (for the side windows). To turn off FRONT, press the AUTO or AIR FLOW buttons.

If the AIR FLOW up button is pressed while in the FRONT defrost mode, the system will direct the air toward the instrument panel outlets. If the AIR FLOW down button is pressed while in the FRONT defrost mode, the system will direct the air toward the floor, and the FRONT defrost mode will cancel. Do not drive the vehicle until all the windows are clear.

## Rear Window Defogger

The rear window defogger uses a warming grid to remove fog or frost from the rear window.

 **REAR:** Press this button to turn the rear window defogger on or off. Be sure to clear as much snow from the rear window as possible.

At speeds above 30 mph (48 km/h), the defogger will operate continuously until you press the REAR button again. After 10 minutes of driving below 30 mph (48 km/h), the defogger will turn off automatically. If you need additional warming time, push the button again. The system will then operate for five minutes before going off by itself.

If your vehicle has heated outside rearview mirrors, the mirrors will heat to help clear fog or frost from the surface of the mirror when the rear window defogger button is pressed.

**Notice:** Using a razor blade or sharp object to clear the inside rear window may damage the rear window defogger. Repairs would not be covered by your warranty. Do not clear the inside of the rear window with sharp objects.

## Passenger Temperature Control

If your vehicle has the optional separate passenger's temperature control, then the driver and the right front passenger can select separate temperature settings. This feature allows the front passenger to select a temperature that is 5° F (3° C) warmer or cooler than the driver's selected temperature.



The lever for this feature is located on the right side of the instrument panel.

Slide the lever toward WARM for warmer air or toward COOL for cooler air. Press OFF on the main climate control system once to turn off the passenger's temperature control.

When this lever is moved, the current inside temperature will appear on the display for a few seconds, then the outside temperature will appear.

## Outlet Adjustment



Use the thumbwheel located in the middle of the front outlets to change the direction of the airflow and to open and close the outlets.



Use the thumbwheel located between the rear passenger outlets to open and close the outlets. Adjust the direction of the airflow from side to side with the levers in the center of each rear outlet.

## Operation Tips

- Clear away any ice, snow or leaves from the air inlets at the base of the windshield that may block the flow of air into your vehicle.
- Use of non-GM approved hood deflectors may adversely affect the performance of the system.
- Keep the path under the front seats clear of objects to help circulate the air inside of your vehicle more effectively.
- If the airflow seems low when the fan is at the highest setting, the passenger compartment air filter may need to be replaced. See *Passenger Compartment Air Filter* on page 3-30.

## Passenger Compartment Air Filter

Passenger compartment air, both outside air and recirculated air, is routed through a passenger compartment filter, which is part of a three piece filter system. The filter removes certain particles from the air, including pollen and dust particles. Reductions in airflow, which may occur more quickly in dusty areas, indicate that the filter needs to be replaced early.



The particle filter is located inside of the air control module. The air control module is located behind an access panel near the accelerator pedal.

The filter should be replaced as part of routine scheduled maintenance. See *Part A: Scheduled Maintenance Services on page 6-4* for replacement intervals. See your dealer for details on changing the filter.

Once you remove your filter, if you choose not to replace it, it will not damage your vehicle. However, the air will no longer be filtered.

## Steering Wheel Climate Controls



If your vehicle has this feature, you can control the temperature function by using the switch located on your steering wheel.

△ **TEMP** ▽ **(Temperature)**: Press the up or down arrow on this switch to increase or decrease the temperature.

## Climate Controls Personalization

If your vehicle is equipped with this feature, up to two drivers are able to store and recall climate control settings for the temperature, the fan speed and the direction of the airflow.

Memory buttons 1 and 2 are located on the driver's door panel and correspond to the numbers 1 or 2 found on the back of each remote keyless entry transmitter.

To store settings, do the following:

1. Select the desired temperature, fan speed and airflow mode. If desired, a separate temperature setting may also be selected for the front seat passenger. For information on how to do this, see *Dual Automatic Climate Control System on page 3-24*.
2. Locate memory buttons 1 and 2 on the driver's door panel.

3. Press the memory button on the door panel that corresponds to the number on the back of the transmitter you are programming, until you hear two beeps. The beeps confirm that your selection has been saved and can now be recalled. For more information on the memory feature, see *Memory Seat and Mirrors on page 2-51*.

Follow these steps each time you want to change the stored settings.

To recall the climate control settings last stored on your transmitter, press the unlock button on your remote keyless entry transmitter and put the ignition in ACCESSORY or RUN. The settings will be recalled.

## Warning Lights, Gages and Indicators

This part describes the warning lights and gages that may be on your vehicle. The pictures will help you locate them.

Warning lights and gages can signal that something is wrong before it becomes serious enough to cause an expensive repair or replacement. Paying attention to your warning lights and gages could also save you or others from injury.

Warning lights come on when there may be or is a problem with one of your vehicle's functions. As you will see in the details on the next few pages, some warning lights come on briefly when you start the engine just to let you know they are working. If you are familiar with this section, you should not be alarmed when this happens.

Gages can indicate when there may be or is a problem with one of your vehicle's functions. Often gages and warning lights work together to let you know when there is a problem with your vehicle.

When one of the warning lights comes on and stays on when you are driving, or when one of the gages shows there may be a problem, check the section that tells you what to do about it. Please follow this manual's advice. Waiting to do repairs can be costly — and even dangerous. So please get to know your warning lights and gages. They are a big help.

Your vehicle may also have a DIC that works along with the warning lights and gages. See *Driver Information Center (DIC)* on page 3-47.

## Instrument Panel Cluster

Your vehicle is equipped with one of the following instrument panel clusters. Your instrument panel cluster is designed to let you know at a glance how your vehicle is running. It includes indicator warning lights and gages that are explained on the following pages. Be sure to read about those that apply to the instrument panel cluster for your vehicle.

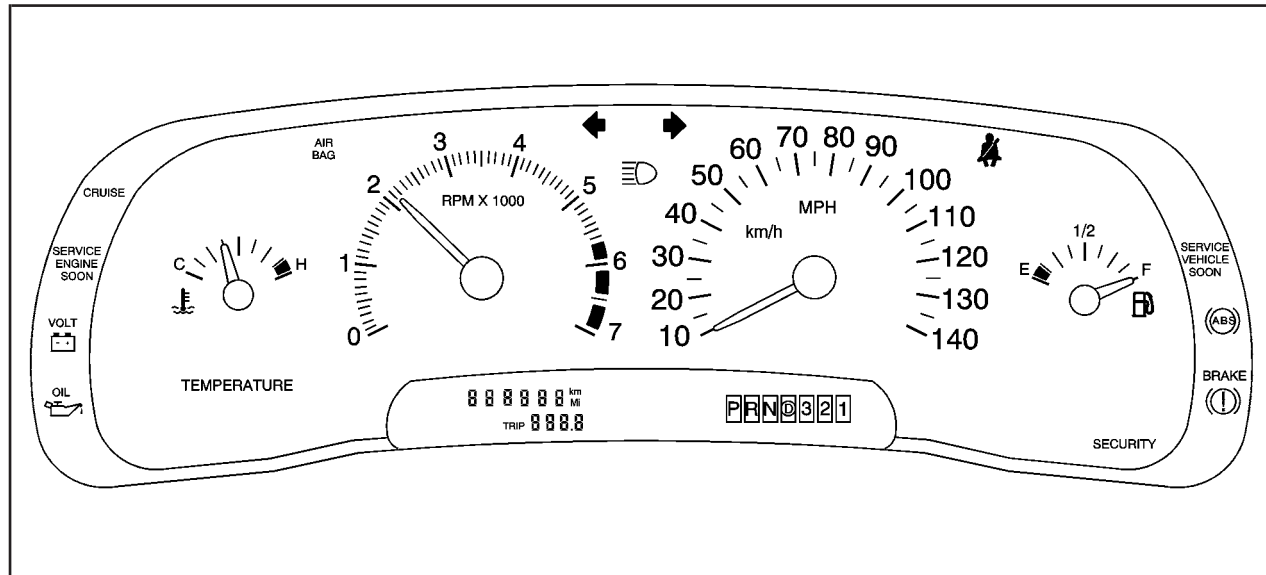

Base Cluster, Uplevel Similar (United States version shown, Canada similar)

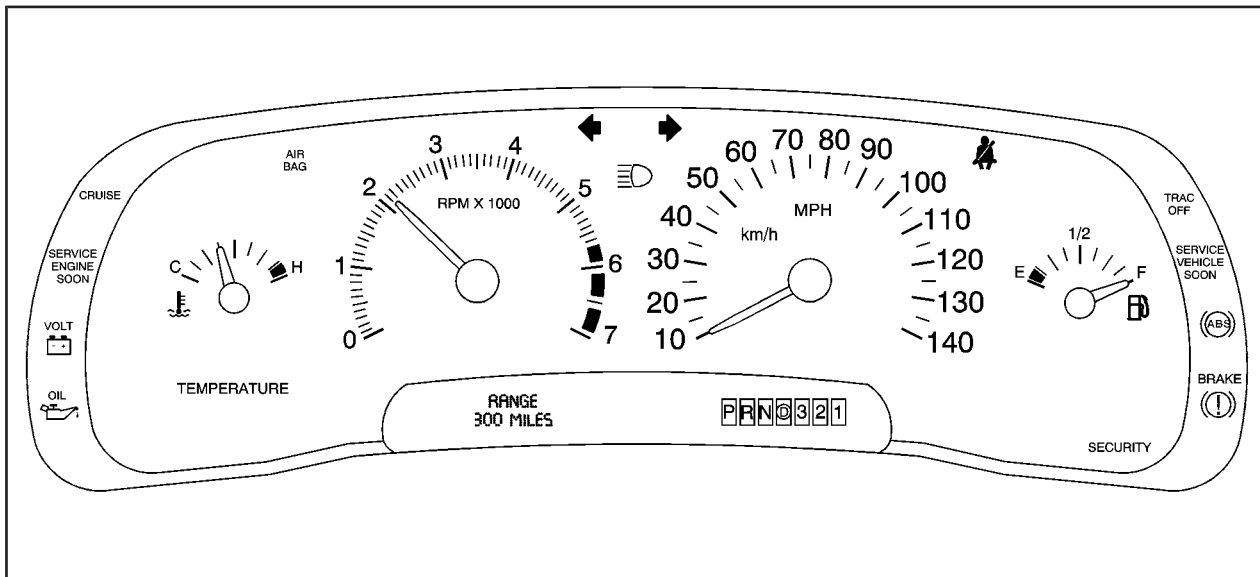

Cluster with Driver Information Center (DIC) (United States version shown, Canada similar)



## Speedometer and Odometer

Your speedometer lets you see your speed in both miles per hour (mph) and kilometers per hour (km/h). Your odometer shows how far your vehicle has been driven, in either miles (used in the United States) or kilometers (used in Canada).

Your vehicle has a tamper-resistant odometer. You may wonder what happens if your vehicle needs a new odometer installed. If possible, the new one has to be set to the same reading the old one had. If it can't be, then it's set at zero and a label must be put on the driver's door to show the old mileage reading and when the new odometer was installed.

## Trip Odometer

A trip odometer can tell how far you've driven since you last set it back to zero. To reset it, push the RESET button. The trip odometer is reset through the Driver Information Center (DIC) if your vehicle is equipped with this feature. See *DIC Controls and Displays* on page 3-47 for more information.

## Tachometer

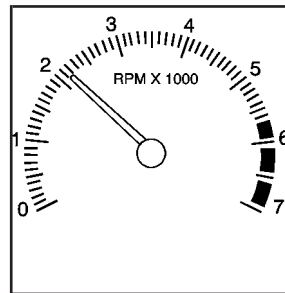

The tachometer tells you how fast the engine is running. It displays engine speed in thousands of revolutions per minute (rpm).

**Notice:** If you operate the engine with the tachometer in the shaded warning area, your vehicle could be damaged, and the damages would not be covered by your warranty. Do not operate the engine with the tachometer in the shaded warning area.

## Safety Belt Reminder Light

When the key is turned to RUN, a chime will come on for several seconds to remind people to fasten their safety belts, unless the driver's safety belt is already buckled.



The safety belt light will also come on and stay on for several seconds, then it will flash for several more.

If the driver's belt is already buckled, neither the chime nor the light will come on.

## Air Bag Readiness Light

There is an air bag readiness light on the instrument panel, which shows AIR BAG. The system checks the air bag's electrical system for malfunctions. The light tells you if there is an electrical problem. The system check includes the air bag sensors, the air bag modules, the wiring and the crash sensing and diagnostic module. For more information on the air bag system, see *Air Bag Systems on page 1-49*.



This light will come on when you start your vehicle, and it will flash for a few seconds. Then the light should go out. This means the system is ready.

If the air bag readiness light stays on after you start the vehicle or comes on when you are driving, your air bag system may not work properly. Have your vehicle serviced right away.

**⚠ CAUTION:**

**If the air bag readiness light stays on after you start your vehicle, it means the air bag system may not be working properly. The air bags in your vehicle may not inflate in a crash, or they could even inflate without a crash. To help avoid injury to yourself or others, have your vehicle serviced right away if the air bag readiness light stays on after you start your vehicle.**

The air bag readiness light should flash for a few seconds when you turn the ignition key to RUN. If the light doesn't come on then, have it fixed so it will be ready to warn you if there is a problem.

## Battery Warning Light

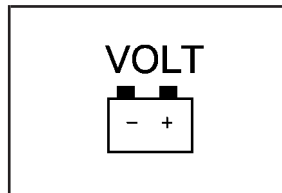

When you turn the key to RUN, this light will come on briefly, to show the battery charging system is working.

When the light goes off and stays off, the charging system is working.

If the light stays on, a chime will sound indicating you need service, and you should take your vehicle to the dealer at once. To save your battery until you get there, turn off all accessories and turn off your climate control system.

## Brake System Warning Light

Your vehicle's hydraulic brake system is divided into two parts. If one part isn't working, the other part can still work and stop you. For good braking, though, you need both parts working well.

If the warning light comes on, there is a brake problem. Have your brake system inspected right away.

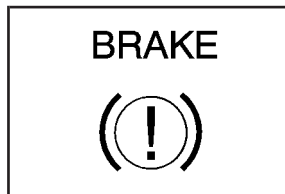

This light should come on when you turn the key to RUN. If it doesn't come on then, have it fixed so it will be ready to warn you if there's a problem.

When the ignition is on, the brake system warning light will also come on when you set your parking brake. The light will stay on if your parking brake doesn't release fully. If you try to drive off with the parking brake set, a chime will also come on until you release the parking brake. If the light stays on after your parking brake is fully released, it means you have a brake problem.

If the light comes on while you are driving, pull off the road and stop carefully. You may notice that the pedal is harder to push. Or, the pedal may go closer to the floor. It may take longer to stop. If the light is still on, have the vehicle towed for service. See *Towing Your Vehicle on page 4-31*.

### CAUTION:

**Your brake system may not be working properly if the brake system warning light is on. Driving with the brake system warning light on can lead to an accident. If the light is still on after you have pulled off the road and stopped carefully, have the vehicle towed for service.**

## Anti-Lock Brake System Warning Light

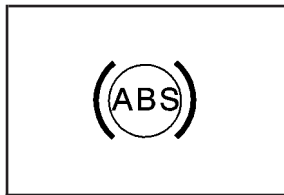

With the anti-lock brake system, the light(s) will come on when your engine is started and may stay on for several seconds. That's normal.

If the light stays on and the chime sounds, turn the ignition to OFF. Or, if the light comes on and the chime sounds when you're driving, stop as soon as possible and turn the ignition off. Then start the engine again to reset the system. If the light still stays on and the chime sounds, or the light comes on again while you're driving, your vehicle needs service. If the regular brake system warning light isn't on, you still have brakes, but you don't have anti-lock brakes. If the regular brake system warning light is also on, you don't have anti-lock brakes and there's a problem with your regular brakes. See *Brake System Warning Light on page 3-38*.

The anti-lock brake system warning light will come on briefly when you turn the ignition key to RUN. This is normal. If the light doesn't come on then, have it fixed so it will be ready to warn you if there is a problem.

## Traction Control System (TCS) Warning Light

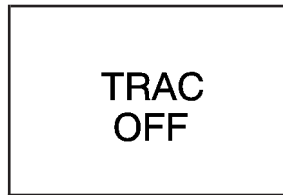

If your vehicle has this feature, this warning light should come on briefly when the engine is started.

If the warning light doesn't come on then, have it fixed so it will be ready to warn you if there's a problem. If it stays on, or comes on when you're driving, there may be a problem with your traction control system and your vehicle may need service. When this warning light is on, the system will not limit wheel spin. Adjust your driving accordingly.

The traction control system warning light may come on for the following reasons:

- If you turn the system off by pressing the button located on the end of the shift lever, the warning light will come on and stay on. To turn the system back on, press the button again. The warning light should go off. See *Traction Control System (TCS) on page 4-9* for more information.
- If there's a brake system problem that is specifically related to traction control, the traction control system will turn off, the warning light will come on and the chime will sound.
- If the traction control system is affected by an engine-related problem, the system will turn off, the warning light will come on and the chime will sound.

If the traction control system warning light comes on and stays on for an extended period of time when the system is turned on, your vehicle needs service.

## Engine Coolant Temperature Gage

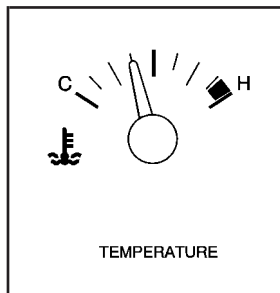

This gage measures the temperature of the vehicle's engine. If the pointer moves into the shaded area, the engine is too hot. A temperature indicator light will turn on and a chime will sound.

If you have been operating your vehicle under normal driving conditions, and the temperature indicator light comes on, you should pull off the road, stop your vehicle and turn off the engine as soon as possible.

## Malfunction Indicator Lamp

### Service Engine Soon Light



SERVICE  
ENGINE  
SOON

Your vehicle is equipped with a computer which monitors operation of the fuel, ignition and emission control systems.

This system is called OBD II (On-Board Diagnostics-Second Generation) and is intended to assure that emissions are at acceptable levels for the life of the vehicle, helping to produce a cleaner environment. The SERVICE ENGINE SOON light comes on to indicate that there is a problem and service is required. Malfunctions often will be indicated by the system before any problem is apparent. This may prevent more serious damage to your vehicle. This system is also designed to assist your service technician in correctly diagnosing any malfunction.

**Notice:** If you keep driving your vehicle with this light on, after a while, your emission controls may not work as well, your fuel economy may not

be as good and your engine may not run as smoothly. This could lead to costly repairs that may not be covered by your warranty.

**Notice:** Modifications made to the engine, transaxle, exhaust, intake or fuel system of your vehicle or the replacement of the original tires with other than those of the same Tire Performance Criteria (TPC) can affect your vehicle's emission controls and may cause this light to come on. Modifications to these systems could lead to costly repairs not covered by your warranty. This may also result in a failure to pass a required Emission Inspection/Maintenance test.

This light should come on, as a check to show you it is working, when the ignition is on and the engine is not running. If the light does not come on, have it repaired. This light will also come on during a malfunction in one of two ways:

- **Light Flashing** — A misfire condition has been detected. A misfire increases vehicle emissions and may damage the emission control system on your vehicle. Diagnosis and service may be required.
- **Light On Steady** — An emission control system malfunction has been detected on your vehicle. Diagnosis and service may be required.

## If the Light Is Flashing

The following may prevent more serious damage to your vehicle:

- Reducing vehicle speed.
- Avoiding hard accelerations.
- Avoiding steep uphill grades.
- If you are towing a trailer, reduce the amount of cargo being hauled as soon as it is possible.

If the light stops flashing and remains on steady, see “If the Light Is On Steady” following.

If the light continues to flash, when it is safe to do so, *stop the vehicle*. Find a safe place to park your vehicle. Turn the key off, wait at least 10 seconds and restart the engine. If the light remains on steady, see “If the Light Is On Steady” following. If the light is still flashing, follow the previous steps and see your dealer for service as soon as possible.

## If the Light Is On Steady

You may be able to correct the emission system malfunction by considering the following:

Did you recently put fuel into your vehicle?

If so, reinstall the fuel cap, making sure to fully install the cap. See *Filling Your Tank on page 5-6*. The diagnostic system can determine if the fuel cap has been left off or improperly installed. A loose or missing fuel cap will allow fuel to evaporate into the atmosphere. A few driving trips with the cap properly installed should turn the light off.

Did you just drive through a deep puddle of water?

If so, your electrical system may be wet. The condition will usually be corrected when the electrical system dries out. A few driving trips should turn the light off.



Have you recently changed brands of fuel?

If so, be sure to fuel your vehicle with quality fuel. See *Gasoline Octane on page 5-4*. Poor fuel quality will cause your engine not to run as efficiently as designed. You may notice this as stalling after start-up, stalling when you put the vehicle into gear, misfiring, hesitation on acceleration or stumbling on acceleration. (These conditions may go away once the engine is warmed up.) This will be detected by the system and cause the light to turn on.

If you experience one or more of these conditions, change the fuel brand you use. It will require at least one full tank of the proper fuel to turn the light off.

If none of the above steps have made the light turn off, your dealer can check the vehicle. Your dealer has the proper test equipment and diagnostic tools to fix any mechanical or electrical problems that may have developed.

## **Emissions Inspection and Maintenance Programs**

Some state/provincial and local governments have or may begin programs to inspect the emission control equipment on your vehicle. Failure to pass this inspection could prevent you from getting a vehicle registration.

Here are some things you need to know in order to help your vehicle pass an inspection:

Your vehicle will not pass this inspection if the SERVICE ENGINE SOON light is on or not working properly.

Your vehicle will not pass this inspection if the OBD (on-board diagnostic) system determines that critical emission control systems have not been completely diagnosed by the system. The vehicle would be considered not ready for inspection. This can happen if you have recently replaced your battery or if your battery has run down. The diagnostic system is designed to evaluate critical emission control systems during normal driving. This may take several days of routine driving. If you have done this and your vehicle still does not pass the inspection for lack of OBD system readiness, your GM dealer can prepare the vehicle for inspection.

## Oil Pressure Light

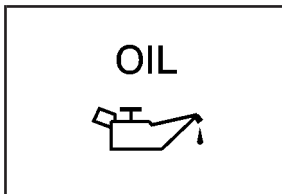

This light tells you if there could be a problem with your vehicle's engine oil pressure.

The oil pressure light will come on briefly when you turn your key to RUN. It goes off once you turn the key to START. That's just a check to be sure the light works. This is normal and doesn't show a problem. If it doesn't come on and then go off, be sure to have it fixed so it will be there to warn you if there is a problem.

When this light *comes* on and *stays* on, and a chime sounds, it means oil isn't going through the engine properly. The oil could be low, or there might be some other oil problem. See your dealer for service.

### CAUTION:

**Do not keep driving if the oil pressure is low. If you do, your engine can become so hot that it catches fire. You or others could be burned. Check your oil as soon as possible and have your vehicle serviced.**

***Notice:* Lack of proper engine oil maintenance may damage the engine. The repairs would not be covered by your warranty. Always follow the maintenance schedule in this manual for changing engine oil.**

## Security Light



**United States**

Your vehicle is equipped with a content theft-deterrent alarm system. With this system, the SECURITY light will flash as you open the door if your ignition is off.

For more information see *Content Theft-Deterrent on page 2-19*.

## Cruise Control Light

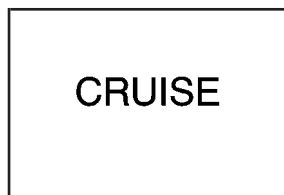

The CRUISE light comes on when you set the vehicle's cruise control.

See "Cruise Control" under *Turn Signal/Multifunction Lever on page 3-5*.

## Service Vehicle Soon Light



This light will come on if your vehicle has certain non-emission related problems.

For example, if the entire electrical system fails to send and receive messages from the vehicle's components, the SERVICE VEHICLE SOON warning light comes on.

These problems may not be obvious and may affect vehicle performance or durability. Consult a qualified dealership for necessary repairs to maintain top vehicle performance. This light will come on briefly when the ignition is turned on to show that it is working properly.

## Fuel Gage

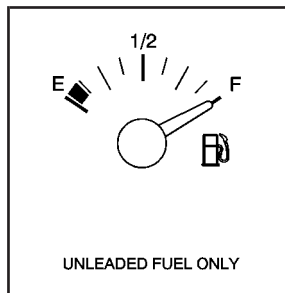

**United States**

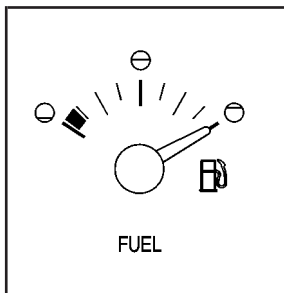

**Canada**

The fuel gage shows about how much fuel is in your tank. It works only when the ignition is on. When the indicator moves to the edge of the low fuel warning band, the low fuel warning light will come on and a chime will sound. You still have a little fuel left, but you need to get more fuel right away.

Here are some things that some owners ask about. None of these show a problem with your fuel gage:

- At the service station, the gas pump shuts off before the gage reads full.
- It takes more (or less) fuel to fill up than the gage indicated. For example, the gage may have indicated half full, but it took more (or less) than half the tank's capacity to fill it.
- The gage moves up a little when you turn a corner, speed up or make a hard stop.
- The gage doesn't go back to empty when you turn off the ignition.

## Driver Information Center (DIC)

Your vehicle may be equipped with a Driver Information Center (DIC). The DIC will display information about how your vehicle is functioning, as well as warning messages if a system problem is detected.



The following buttons are on the DIC control panel located to the left of the steering column:

**ODO/TRIP (Odometer/Trip):** Use this button to display your total and trip miles.

**FUEL INFO (Information):** Press this button to display fuel information such as fuel used, fuel range and fuel economy.

**GAGE INFO (Information):** Use this button to display oil pressure, oil life, coolant temperature, tire pressure and battery information.

**RESET:** This button, used along with other buttons, will reset system functions.

**ENG/MET (English/Metric):** Use this button to change the display between English and metric units.

## DIC Controls and Displays

When you turn the ignition on, the DIC will display your driver number. You can have your dealer program your name to appear on this display line. See your dealer for more information.

The system will then perform a status check and display any messages if a problem is detected. If there are no problems detected, the display will return to the mode selected by that driver the last time the ignition was turned off.

If a problem is detected, a diagnostic message will appear in the display. The following pages will show the messages you may see on the DIC display.

The message center is continuously updated with the vehicle's performance status.

## ODO/TRIP (Odometer/Trip)

When this button is pressed, the display will show the total mileage, and TRIP 1 or TRIP 2 miles. TRIP 1 and TRIP 2 will display the miles traveled since the last reset. To reset the trip odometer, press the ODO/TRIP button until the trip miles are shown in the DIC display, then press the RESET button. The trip odometer will now accumulate miles until the next reset.

## FUEL INFO (Information)

**Fuel Used:** Press the FUEL INFO button until the display shows FUEL USED. This display will show you how much fuel has been used since the last reset. To learn how much fuel is used from a new starting point, press the RESET button while the fuel used is displayed in the DIC.

**Fuel Range:** Press the FUEL INFO button until the display shows FUEL RANGE. The fuel range will calculate the remaining distance you can drive without refueling. This calculation is based on the average fuel economy for the last 25 miles (40.25 km) driven, and the fuel remaining in the fuel tank. The RESET button does not function in this mode.

**Instantaneous Fuel Economy:** Press the FUEL INFO button until the display shows FUEL ECONOMY INST. Instantaneous fuel economy varies with your driving conditions, such as acceleration, braking and the grade of the road being traveled. The RESET button does not function in this mode.

**Average Fuel Economy:** Press the FUEL INFO button until the display shows FUEL ECONOMY AVERAGE. Average fuel economy is viewed as a long term approximation of your overall driving conditions. To learn the average fuel economy from a new starting point, press the RESET button while the average fuel economy is displayed in the DIC.

## GAGE INFO (Information)

**Coolant Temperature:** Press the GAGE INFO button until COOLANT TEMP appears in the display. If there are no problems detected with the temperature, COOLANT TEMP NORMAL will appear in the display. If the temperature is too high, COOLANT TEMP HOT will appear in the display. If you see the COOLANT TEMP HOT message, your engine is overheated. You should pull off the road, stop your vehicle and turn off your engine as soon as possible. This manual explains what to do. See *Engine Overheating on page 5-28*.

**Tire Pressure:** Press the GAGE INFO button until TIRE PRESSURE appears in the display. TIRE PRESSURE NORMAL is displayed when the Check Tire Pressure System believes your vehicle's tire pressures are normal. If a potential tire pressure problem is detected, the display will show TIRE PRESSURE LOW. See *Check Tire Pressure System on page 5-70* for information on how to reset the system.

**Battery Volts:** Press the GAGE INFO button until the display shows BATTERY STATE. If the voltage is normal the display will show BATTERY STATE NORMAL. If the voltage drops below 10.5 volts, the display will show BATTERY STATE LOW. If the voltage is above 16 volts, the display will show BATTERY STATE HIGH. If the display shows the high or low message, you need to have your battery checked.

**Oil Pressure:** Press the GAGE INFO button until OIL PRESSURE appears in the display. If there are no problems detected with the oil pressure, the display will show OIL PRESSURE NORMAL. If a low oil pressure condition is detected, the display will show OIL PRESSURE LOW. If you see the OIL PRESSURE LOW message, you could be low on oil or your oil is not going through the engine properly. See your dealer for service.

**Oil Life System:** Press the GAGE INFO button until OIL LIFE INDEX appears in the display. The OIL LIFE INDEX NORMAL display will show an estimate of the oil's remaining useful life. When the oil life index is less than 10% the display will show OIL LIFE INDEX CHANGE OIL. When you have the oil changed, you will have to reset the GM Oil Life System. To reset the Oil Life System, see *Engine Oil on page 5-14*.

## DIC Warnings and Messages

Other warning messages may appear in the DIC display. For Canadian drivers, in addition to the DIC message your DIC will display EXP with a number after it which reflects the following messages:

EXP (Export ID)	Warning Message
23	DOOR AJAR
24	TRUNK AJAR
25	WINDSHIELD WASHER FLUID LOW
36	ENGINE OIL LOW – CHECK LEVEL
54	SERVICE STABILITY SYSTEM
55	STABILITY SYSTEM ACTIVE
82	CHANGE ENGINE OIL SOON
91	TRACTION CONTROL SYSTEM ACTIVE
140	TIRE PRESSURE LOW
The EXP codes are used to make translation from English to other languages easier.	
Pressing any of the DIC control buttons will remove the messages or warnings from the DIC display.	

**SERVICE STABILITY SYSTEM – 54:** If you ever see the SERVICE STABILITY SYSTEM message, it means there may be a problem with your stability enhancement system. If you see this message, try to reset the system: stop, turn off the engine, then start the engine again. If the SERVICE STABILITY SYSTEM message still comes on, it means there is a problem. You should see your dealer for service. Reduce your speed and drive accordingly.

**STABILITY SYSTEM ACTIVE – 55:** You may see the STABILITY SYSTEM ACTIVE message on the Driver Information Center. It means that an advanced, computer-controlled system has come on to help your vehicle continue to go in the direction in which you are steering. This stability enhancement system activates when the computer senses that your vehicle is just starting to spin, as it might if you hit a patch of ice or other slippery spot on the road. When the system is on, you may hear a noise or feel a vibration in the brake pedal. This is normal.



When the STABILITY SYSTEM ACTIVE message is on, you should continue to steer in the direction you want to go. The system is designed to help you in bad weather or other difficult driving situations by making the most of whatever road conditions will permit. If the STABILITY SYSTEM ACTIVE message comes on, you will know that something has caused your vehicle to start to spin, so you should consider slowing down.

**Tire Pressure Status – 140:** If you see the TIRE PRESSURE LOW message, you should stop as soon as you can and check all your tires for damage. If a tire is flat, see *If a Tire Goes Flat on page 5-79*. Also check the tire pressure in all four tires as soon as you can. See *Inflation - Tire Pressure on page 5-69* and *Check Tire Pressure System on page 5-70*.

There are times when you will have to reset (calibrate) the Check Tire Pressure System. See *Check Tire Pressure System on page 5-70*.

## DIC Vehicle Personalization

The DIC is used to program personal choices for up to two drivers. The drivers are recognized as DRIVER #1 and DRIVER #2. The DIC will identify a person as UNKNOWN DRIVER if neither DRIVER #1 nor DRIVER #2 is identified by the system. You will let the DIC know which driver you are by using your remote keyless entry transmitter or by pressing one of the MEMORY buttons located on the driver's door. Each remote keyless entry transmitter was pre-programmed to belong to DRIVER #1 or DRIVER #2 and is numbered on the back. Each transmitter may be programmed differently.

After you press the unlock button on your transmitter with the ignition in RUN, the DIC will display the identified driver number. The vehicle will recall the personal choice settings that were last made to correspond to your transmitter, including your radio and climate control settings. See *Climate Controls Personalization on page 3-31*.

If you unlock the vehicle using your door key instead of your transmitter, the DIC will not identify the driver and will recall the information from the last transmitter used or the last driver using one of the MEMORY buttons. If this happens and you were not the last driver of the vehicle, press your correct driver number on the appropriate MEMORY button or press the unlock button on your transmitter.

The DIC can be used to program the following personal choice features available with your vehicle:

- Outside Curb View Assist Mirror
- Programmable Automatic Door Locks
- Delayed Locking
- Security Feedback
- Perimeter Lighting
- Memory Seat Recall
- Window Lock Out

See the following steps for personalization programming instructions.

1. Turn the ignition on and keep the transaxle in PARK (P).
2. Inform the DIC which driver you are by pressing the unlock button on your transmitter or the appropriate MEMORY button.
3. Press and hold the ENG/MET button for five seconds. WELCOME TO BUICK OPTION FEATURE will appear in the display.

The next display will be your driver number and the message ARMREST BUTTON CHANGES DRIVER #. Follow the instructions in the display. You are now in the selection mode and the DIC is ready to program your personal choices in memory.

The selections you make for the personal choice features will be saved after the display reads FEATURE OPTION SELECTION DONE.

Each feature that can be personalized will appear in the display. Once you have made a selection for a feature, the DIC will move on to the next personal choice feature.

4. Scroll through the following messages and feature options:

- PARALLEL PARK – OFF/ON
- AUTO DOOR LOCKS – OFF/ON
- UNLOCK IN PARK – OFF/ON
- WHICH DOORS – ALL/DRIVER
- DELAYED LOCKING – OFF/ON
- LOCK FEEDBACK – OFF/ON
- LOCK FEEDBACK – LIGHTS/LIGHTS + HORN
- UNLOCK FEEDBACK – OFF/LIGHTS
- PERIMETER LIGHTS – OFF/ON
- SEAT RECALL – OFF/ON
- RECALL POSITION – MEMORY/EXIT
- WINDOW LOCKOUT – ALL PASS/REAR

If you would like to exit the selection mode without moving through each of the personal choice features, simply press a different button on the DIC or turn off the ignition. However, personal choices you made may not be retained.

If you happen to move past a selection you would like to make a personal choice for, press the unlock button on your transmitter or press the appropriate MEMORY button. This will return you to the beginning of the option feature programming mode.

A description of each feature programmable through the DIC follows.

### **Outside Curb View Assist Mirror**

The outside curb view assist mirror, which tilts the passenger mirror while the vehicle is in REVERSE (R), can be made active or inactive through the DIC.

When PARALLEL PARK-OFF-ON appears on the display, use the ENG/MET button to toggle the arrow between OFF and ON. When you have made your choice, press the RESET button to record your selection. For more information on this feature, see *Outside Curb View Assist Mirror on page 2-40*.

## Programmable Automatic Door Locks

The automatic door lock modes, when shifting in and out of PARK (P), can be changed through the DIC. You can change these modes using different selections from the following DIC displays:

- AUTO DOOR LOCKS – OFF/ON
- UNLOCK IN PARK – OFF/ON

If you choose OFF for AUTO DOOR LOCKS, your door locks will operate normally with no automatic feature.

If you choose ON for AUTO DOOR LOCKS, and ON for UNLOCK IN PARK, your doors will lock every time you shift out of PARK (P), and the doors will unlock every time you stop and shift into PARK (P).

If you choose ON for AUTO DOOR LOCKS, and OFF for UNLOCK IN PARK, your door locks will lock every time you shift out of PARK (P), and there will be no automatic door unlock when shifting back into PARK (P).

When you choose ON for UNLOCK IN PARK, the DIC will display WHICH DOORS-ALL/DRIVER. You have the choice of unlocking all doors, or just the driver's door.

To change modes, do the following:

1. Move the arrow on the display between ON and OFF by pressing the ENG/MET button.
2. Once you have made your selection, press the RESET button and your choice will be retained in memory.

See *Programmable Automatic Door Locks on page 2-12* for more information about this feature.

## Delayed Locking

The delayed locking feature, which delays the actual locking of the vehicle, can be made active or inactive through the DIC. When DELAYED LOCKING-OFF-ON appears on the display, use the ENG/MET button to toggle the arrow between OFF and ON. When you have made your choice, press the RESET button to record your selection.

For more information on this feature, see *Delayed Locking on page 2-11*.

## Security Feedback

By choosing different combinations of these selections, you can choose the type of transmitter activated feedback you receive when locking and unlocking your vehicle with your transmitter. Each time you make a selection by pressing the ENG/MET button, press the RESET button to record your choice.

- LOCK FEEDBACK – OFF/ON
- LOCK FEEDBACK – LIGHTS/LIGHTS + HORN
- UNLOCK FEEDBACK – OFF/LIGHTS

If you choose ON for LOCK FEEDBACK you will also need to choose LIGHTS or LIGHTS + HORN.

You can select the following modes:

- If you choose OFF for LOCK FEEDBACK and OFF for UNLOCK FEEDBACK, you will receive no security feedback when locking or unlocking your vehicle.
- If you choose OFF for LOCK FEEDBACK and LIGHTS for UNLOCK FEEDBACK, you will receive no security feedback when locking your vehicle and the exterior lamps will flash when unlocking your vehicle.

- If you choose LIGHTS for LOCK FEEDBACK and OFF for UNLOCK FEEDBACK, your exterior lamps will flash when locking your vehicle and you will receive no security feedback when unlocking your vehicle.
- If you choose LIGHTS for LOCK FEEDBACK and LIGHTS for UNLOCK FEEDBACK, your exterior lamps will flash when locking and unlocking your vehicle.
- If you choose LIGHTS + HORN for LOCK FEEDBACK and OFF for UNLOCK FEEDBACK, your exterior lamps will flash and the horn will chirp when locking your vehicle and you will receive no security feedback when unlocking your vehicle.
- If you choose LIGHTS + HORN for LOCK FEEDBACK and LIGHTS for UNLOCK FEEDBACK, your exterior lamps will flash and the horn will chirp when locking your vehicle and your exterior lamps will flash when unlocking your vehicle.

For more information on this feature, see “Security Feedback” under *Remote Keyless Entry System Operation* on page 2-6.

## Perimeter Lighting

When the unlock button on the transmitter is pressed, the DRL lamps (high-beams at reduced intensity), parking lamps and back-up lamps will turn on, if it is dark enough according to the Twilight Sentinel®.

You can control activation of this feature by choosing OFF or ON when the PERIMETER LIGHTS choice is displayed on the DIC. Make your choice by pressing the ENG/MET button and record your choice by pressing the RESET button.

If you want to choose PERIMETER LIGHTS ON, you must also choose LIGHTS for UNLOCK FEEDBACK while making the security feedback choices.

For more information on this feature, see “Perimeter Lighting” under *Exterior Lamps on page 3-12*.

## Memory Seat Recall

This feature recalls the position of your seat. When this feature is active, the memory seat and mirror positions will be recalled for the identified driver when the remote keyless entry transmitter is used to enter the vehicle.

You can program this feature to be active by choosing ON when the SEAT RECALL choice appears, or inactive by choosing OFF when the SEAT RECALL choice appears on the DIC.

You can also program this feature to recall your memory seat position or the exit seat position.

- **Memory Position:** Choose ON when the SEAT RECALL choice appears, and then choose MEMORY when the RECALL POSITION choice appears.
- **Exit Position:** Choose ON when the SEAT RECALL choice appears, then choose EXIT when the RECALL POSITION choice appears and your seat will move to the stored exit position. The seat will also move when you enter the vehicle after unlocking it with a remote keyless entry transmitter. This will allow for easy entry as well.

For more information on this feature, see *Memory Seat and Mirrors on page 2-51*.

## Window Lock Out

The number of passenger windows locked out by the WINDOW LOCK button can be programmed through the DIC.

If you choose ALL PASS, all three passenger window switches will be inactive when the WINDOW LOCK button is enabled.

If you choose REAR, only the two rear passenger window switches will be locked out when the WINDOW LOCK button is enabled.

To change modes do the following:

1. Move the arrow on the display between ALL PASS and REAR by pressing the ENG/MET button.
2. Once you have made your selection, press the RESET button. Your choice will be retained in memory.

For more information on this feature, see “Window Lock Out” under *Power Windows on page 2-18*.

## Audio System(s)

**Notice:** Before you add any sound equipment to your vehicle – like a tape player, CB radio, mobile telephone or two-way radio – be sure you can add what you want. If you can, it’s very important to do it properly. Added sound equipment may interfere with the operation of your vehicle’s engine, radio or other systems, and even damage them. Your vehicle’s systems may interfere with the operation of sound equipment that has been added improperly.

**So, before adding sound equipment, check with your dealer and be sure to check federal rules covering mobile radio and telephone units.**

Your audio system has been designed to operate easily and to give years of listening pleasure. You will get the most enjoyment out of it if you acquaint yourself with it first. Figure out which radio you have in your vehicle, find out what your audio system can do and how to operate all of its controls to be sure you’re getting the most out of the advanced engineering that went into it.

Your vehicle may have a feature called Retained Accessory Power (RAP). With RAP, you can play your audio system even after the ignition is turned off. See “Retained Accessory Power (RAP)” under *Ignition Positions on page 2-24*.

## Setting the Time

Press the HRS knob lightly so it extends. Turn the knob until the correct hour appears on the display. Press the MIN knob lightly so it extends. Turn the knob until the correct minute appears on the display.

Return these knobs to their stored positions when you are not using them.

You may set the time with the ignition off if you press **RECALL** first and follow the same procedure described above.

## Radio with Cassette



## Playing the Radio

**ON/OFF:** Push this knob to turn the system on and off.

**VOLUME:** Turn this knob to increase or to decrease the volume.

**RECALL:** Press this button to switch the display between the radio station frequency and the time. Pressing this button with the ignition is off, will display the time.



To change the default on the display, station or time, press this button until you see the display you want, then hold the button until the display flashes. The selected display will now be the default.

## Finding a Station

**AM-FM:** Press this button to switch between FM1, FM2, and AM. The display will show your selection.

**△ TUNE ▽:** Press the up or the down arrow to select radio stations.

**△ SEEK ▽:** Press the up or the down arrow to go to the next or to the previous station and stay there.

To scan stations, press and hold either SEEK arrow for two seconds and SCAN will appear on the display. The radio will go to a station, play for a few seconds, then go on to the next station. Press either SEEK arrow again to stop scanning.

The radio will seek and scan only to stations that are in the selected band and only to those with a strong signal.

**P SCAN (Preset Scan):** Press this button to listen to each of your preset stations for a few seconds. The radio will go to the first preset station, play for a few seconds, then go on to the next preset station. Press P SCAN again to stop scanning presets.

The radio will scan only to preset stations that are in the selected band and only to those with a strong signal.

**AUTO SET (Automatic Set):** Press this button, after selecting AM or FM, to seek and set the 12 strongest FM or the 6 strongest AM stations on your preset pushbuttons. AUTO SET will appear on the display and will flash while seeking until this function is complete. To return to the stations you manually set, press AUTO SET again.

## Setting Preset Stations

The six numbered pushbuttons let you return to your favorite stations. You can set up to 18 stations (six FM1, six FM2, and six AM) by performing the following steps:

1. Turn the radio on.
2. Press AM-FM to select FM1, FM2, or AM.
3. Tune in the desired station.
4. Press TONE to select the equalization.
5. Press and hold one of the six numbered pushbuttons. The sound will mute. When the sound returns, release the pushbutton. Whenever you press that numbered pushbutton, the station you set will return and the equalization you selected will be automatically stored for that pushbutton.
6. Repeat the steps for each pushbutton.

## Setting the Tone (Bass/Treble)

**BASS:** Press this knob lightly so it extends. Turn the knob to increase or to decrease bass.

**TREB (Treble):** Press this knob lightly so it extends. Turn the knob to increase or to decrease treble. If a station is weak or noisy, you may want to decrease the treble.

Return these knobs to their stored positions when you are not using them.

**TONE:** Press this button to select customized equalization settings designed for country/western, jazz, talk, pop, and classical.

To return the bass and treble to the manual mode, press TONE until MANUAL appears on the display or press and release the BASS or TREB knob and turn it until the display goes blank. See “Setting Preset Stations” listed previously to program the auto tone feature.

## Adjusting the Speakers (Balance/Fade)

**BAL (Balance):** Press this knob lightly so it extends. Turn the knob to move the sound toward the left or the right speakers. The middle position balances the sound between the speakers.

**FADE:** Press this knob lightly so it extends. Turn the knob to move the sound toward the front or the rear speakers. The middle position balances the sound between the speakers.

Return these knobs to their stored positions when you are not using them.

## Playing a Cassette Tape

Your tape player is built to work best with tapes that are up to 30 to 45 minutes long on each side. Tapes longer than that are so thin they may not work well in this player. The longer side with the tape visible should face to the right. If the ignition is on and the radio is off, the tape can be inserted and will begin playing. If you hear nothing but a garbled sound, the tape may not be in squarely. Press EJECT to remove the tape and start over.

While the tape is playing, use the VOLUME, SEEK, FADE, BAL, BASS, and TREB controls just as you do for the radio. The display will show an arrow to show which side of the tape is playing.

The tape player automatically begins playing the other side when it reaches the end of the tape.

If you want to insert a tape while the ignition or radio is off, first press EJECT or RECALL. Cassette tape adapter kits for portable compact disc players will work in your cassette tape player.

Your tape bias is set automatically when a metal or chrome tape is inserted.

If an error appears on the display, see “Cassette Tape Messages” later in this section.

**1 PREV (Previous):** Press this pushbutton to search for the previous selection on the tape. Your tape must have at least three seconds of silence between each selection for previous to work.

**2 NEXT:** Press this pushbutton to search for the next selection on the tape. Your tape must have at least three seconds of silence between each selection for next to work.

**3 ◀◀ (Reverse):** Press this pushbutton to reverse quickly within a tape. The radio will play while the tape reverses. Press the pushbutton again to return to playing speed.

**4 ▶▶ (Forward):** Press this pushbutton to advance quickly within a tape. The radio will play while the tape advances. Press the pushbutton again to return to playing speed.

**5 SIDE:** Press this pushbutton to play the other side of the tape.

**6 DD (Dolby®):** Press this pushbutton to reduce background noise. The double-D symbol will appear on the display.

Dolby® Noise Reduction is manufactured under a license from Dolby® Laboratories Licensing Corporation. Dolby® and the double-D symbol are trademarks of Dolby® Laboratories Licensing Corporation.

**AM-FM:** Press this button to listen to the radio when a cassette tape is playing. The inactive tape will remain safely inside the radio for future listening.

**SOURCE:** Press this button to play a tape when listening to the radio. TAPE PLAY with an arrow will appear on the display while the tape is active.

**△ SEEK ▽:** Press the up or the down arrow to go to the next or to the previous selection on the tape. Your tape must have at least three seconds of silence between each selection for seek to work.

**EJECT:** Press this button to stop a tape when it is playing and to remove a tape when it is not playing. Eject may be activated with the radio off. Cassettes may be loaded with the ignition and the radio off if this button is pressed first.

## Cassette Tape Messages

**E (Error):** If this message and a number appears on the display, it could be for one of the following reasons:

- **E10:** The tape is tight and the player cannot turn the tape hubs. Remove the tape. Hold the tape with the open end down and try to turn the right hub counterclockwise with a pencil. Turn the tape over and repeat. If the hubs do not turn easily, your tape may be damaged and should not be used in the player. Try a new tape to make sure your player is working properly.
- **E11:** The tape is broken. Try a new tape.

**CLN (Clean):** If this message appears on the display, the cassette tape player needs to be cleaned. It will still play tapes, but you should clean it as soon as possible to prevent damage to the tapes and player. See *Care of Your Cassette Tape Player* on page 3-79.

If any error occurs repeatedly or if an error cannot be corrected, contact your dealer. If your radio displays an error number, write it down and provide it to your dealer when reporting the problem.

## Radio with Cassette and CD



### Playing the Radio

**ON/OFF:** Push this knob to turn the system on and off.

**VOLUME:** Turn this knob to increase or to decrease volume.

**RECALL:** Press this button to switch the display between the radio station frequency and the time. Pressing this button with the ignition off will display the time.

To change the default on the display, station or time, press this button until you see the display you want, then hold this button until the display flashes. The select display will now be the default.

## Finding a Station

**AM-FM:** Press this button to switch between FM1, FM2, and AM. The display will show your selection.

△ **TUNE** ▽: Press the up or the down arrow to select radio stations.

△ **SEEK** ▽: Press the up or the down arrow to go to the next or to the previous station and stay there.

To scan, press either SEEK arrow for two seconds and SCAN will appear on the display. The radio will go to a station, play for a few seconds, then go on to the next station. Press either SEEK arrow again to stop scanning.

The radio will seek and scan only to stations that are in the selected band and only to those with a strong signal.

**P SCAN (Preset Scan):** Press this button to listen to each of your preset stations for a few seconds. The radio will go to the first preset station, play for a few seconds, then go on to the next preset station. Press P SCAN again to stop scanning.

The radio will scan only to preset stations that are in the selected band and only to those with a strong signal.

**AUTO SET (Automatic Set):** Press this button, after selecting AM or FM, to seek and set the 12 strongest FM or the 6 strongest AM stations on your preset pushbuttons. AUTO SET will appear on the display and flash while seeking until this function is complete. To return to the stations you manually set, press AUTO SET again.

## Setting Preset Stations

The six numbered pushbuttons let you return to your favorite stations. You can set up to 18 stations (six FM1, six FM2, and six AM) by performing the following steps:

1. Turn the radio on.
2. Press AM-FM to select FM1, FM2, or AM.
3. Tune in the desired station.
4. Press TONE to select the equalization.
5. Press and hold one of the six numbered pushbuttons. The sound will mute. When the sound returns, release the pushbutton. Whenever you press that numbered pushbutton, the station you set will return and the equalization you selected will be automatically stored for that pushbutton.
6. Repeat the steps for each pushbutton.

## Setting the Tone (Bass/Treble)

**BASS:** Press this knob lightly so it extends. Turn the knob to increase or to decrease bass.

**TREB (Treble):** Press this knob lightly so it extends. Turn the knob to increase or to decrease treble. If a station is weak or noisy, you may want to decrease the treble.

Return these knobs to their stored positions when you are not using them.

**TONE:** Press this button to select customized equalization settings designed for country/western, jazz, talk, pop, and classical.

To return the bass and treble to the manual mode, press TONE until MANUAL appears on the display or press and release the BASS or TREB knob and turn it until the display goes blank. See “Setting Preset Stations” listed previously to program the auto tone feature.

## Adjusting the Speakers (Balance/Fade)

**BAL (Balance):** Press this knob lightly so it extends. Turn the knob to move the sound toward the left or the right speakers. The middle position balances the sound between the speakers.

**FADE:** Press this knob lightly so it extends. Turn the knob to move the sound toward the front or the rear speakers. The middle position balances the sound between the speakers.

Return these knobs to their stored positions when you are not using them.

## Playing a Cassette Tape

Your tape player is built to work best with tapes that are up to 30 to 45 minutes long on each side. Tapes longer than that are so thin they may not work well in this player. The longer side with the tape visible should face to the right. If the ignition is on and the radio is off, the tape can be inserted and will begin playing. If you hear nothing but a garbled sound, the tape may not be in squarely. Press EJECT to remove the tape and start over.

While the tape is playing, use the VOLUME, SEEK, FADE, BAL, BASS, and TREB controls just as you do for the radio. The display will show an arrow to show which side of the tape is playing.

The tape player automatically begins playing the other side when it reaches the end of the tape.

If you want to insert a tape while the ignition or radio is off, first press EJECT or RECALL. Cassette tape adapter kits for portable CD players will work in your cassette tape player.

Your tape bias is set automatically when a metal or chrome tape is inserted.

If an error appears on the display, see "Cassette Tape Messages" later in this section.

**1 PREV (Previous):** Press this pushbutton to search for the previous selection on the tape. Your tape must have at least three seconds of silence between each selection for previous to work.

**2 NEXT:** Press this pushbutton to search for the next selection on the tape. Your tape must have at least three seconds of silence between each selection for next to work.



**3 ◀ (Reverse):** Press this pushbutton to reverse quickly within the tape. The radio will play while the tape reverses. Press the pushbutton again to return to playing speed.

**4 ▶ (Forward):** Press this pushbutton to advance quickly within the tape. The radio will play while the tape advances. Press the pushbutton again to return to playing speed.

**5 SIDE:** Press this pushbutton to play the other side of the tape.

**6 RAND (Dolby®):** Press this pushbutton to reduce background noise. The double-D symbol will appear on the display.

Dolby® Noise Reduction is manufactured under a license from Dolby® Laboratories Licensing Corporation. Dolby® and the double-D symbol are trademarks of Dolby® Laboratories Licensing Corporation.

**AM-FM:** Press this button to listen to the radio when a cassette tape is playing. The inactive tape will remain safely inside the radio for future listening.

**SOURCE:** Press this button to play a cassette tape or a CD when listening to the radio. TAPE SIDE and an arrow will appear on the display. If this button is pressed again, the system will go to CD play; CD PLAY will appear on the display.

△ **SEEK** ▽: Press the up or the down arrow to go to the next or to the previous selection on the tape. Your tape must have at least three seconds of silence between each selection for seek to work.

**EJECT:** Press this button, located next to the cassette tape slot, to stop a tape when it is playing and to remove a tape when it is not playing. Eject may be activated with the radio off. Cassettes may be loaded with the ignition and radio off if this button is pressed first.

## Cassette Tape Messages

**E (Error):** If this message and a number appears on the display, it could be for one of the following reasons:

- **E10:** The tape is tight and the player cannot turn the tape hubs. Remove the tape. Hold the tape with the open end down and try to turn the right hub counterclockwise with a pencil. Turn the tape over and repeat. If the hubs do not turn easily, your tape may be damaged and should not be used in the player. Try a new tape to make sure your player is working properly.
- **E11:** The tape is broken. Try a new tape.

**CLN (Clean):** If this message appears on the display, the cassette tape player needs to be cleaned. It will still play tapes, but you should clean it as soon as possible to prevent damage to the tapes and player. See *Care of Your Cassette Tape Player on page 3-79*.

If any error occurs repeatedly or if an error cannot be corrected, contact your dealer. If your radio displays an error number, write it down and provide it to your dealer when reporting the problem.

## Playing a CD

With the ignition on, insert a CD partway into the slot, label side up. The player will pull it in. The CD should begin playing. If you want to insert a CD while the ignition or the radio is off, first press EJECT or RECALL.

If you turn off the ignition or radio with a CD in the player, it will stay in the player. When you turn on the ignition or system, the CD will start playing where it stopped, if it was the last selected audio source.

Also, as a protection feature, if a CD is ejected and left in the player, it will be pulled back in the player with the ignition on or off.

As each new track starts to play, the track number will appear on the display.

The CD player can play the smaller 8 cm single CDs with an adapter ring. Full-size CDs and the smaller CDs are loaded in the same manner.

If playing a CD-R the sound quality may be reduced due to CD-R quality, the method of recording, the quality of the music that has been recorded, and the way the CD-R has been handled. You may experience an increase in skipping, difficulty in finding tracks, and/or difficulty in loading and ejecting. If these problems occur try a known good CD.

Do not add paper labels to CDs, they could get caught in the CD player.

Do not play 3 inch CDs without a standard adapter CD.

If an error appears on the display, see "CD Messages" later in this section.

**1 PREV (Previous):** Press this pushbutton to go to the start of the current track, if more than eight seconds have played. If you hold this pushbutton or press it more than once, the player will continue moving back through the CD.

**2 NEXT:** Press this pushbutton to go to the next track. If you hold this pushbutton or press it more than once, the player will continue moving forward through the CD.

**3 ◀ (Reverse):** Press and hold this pushbutton to quickly reverse within a track. You will hear sound at a reduced level. Release the pushbutton to play the passage.

**4 ▶ (Forward):** Press and hold this pushbutton to quickly advance within a track. You will hear sound at a reduced level. Release the pushbutton to play the passage.

**6 RAND (Random):** Press this pushbutton to hear the tracks in random, rather than sequential, order. Press it again to turn off random play.

**RECALL:** Press this button to see which track is playing. Press it again within five seconds to see how long it has been playing. To change the default on the display, track or elapsed time, press this button until you see the display you want, then hold this button until the display flashes. The selected display will now be the default.

**AM-FM:** Press this button to listen to the radio when a CD is playing. The inactive CD will remain safely inside the radio for future listening.

**SOURCE:** Press this button to play a cassette tape or a CD when listening to the radio. TAPE SIDE and an arrow will appear on the display. If this button is pressed again, the system will go to CD play; CD PLAY will appear on the display.

△ **SEEK** ▽ : Press the up or the down arrow to go to the previous or to the next track on the CD.

**EJECT:** Press this button, located next to the CD slot, to stop a CD when it is playing and to remove a CD when it is not playing. Eject may be activated with the radio off. CDs may be loaded with the ignition and radio off if this button is pressed first.

## CD Messages

**E (Error):** The CD may not play and an E and a number may appear on the display for one of the following reasons:

- You are driving on a very rough road. When the road becomes smooth, the CD should play
- It is very hot. When the temperature returns to normal, the CD should play.

If E20 appears on the display and the CD comes out, it could be for one of the following reasons:

- The CD is dirty, scratched, wet, or upside down.
- The air is very humid. Wait about an hour and try again.
- There may have been a problem while burning the CD.
- The label may be caught in the CD player.

If the CD is not playing correctly, for any other reason, try a known good CD.

If any error occurs repeatedly or if an error cannot be corrected, contact your dealer. If your radio displays an error number, write it down and provide it to your dealer when reporting the problem.

## Trunk-Mounted CD Changer

With the optional CD changer, you can play up to 12 CDs continuously. Normal size CDs may be played using the trays supplied in the magazine.

The small CDs (8 cm) can be played only with specially designed trays.

**Notice:** Placing heavy objects, which may shift or slide while driving, in the trunk could damage the CD changer. If your vehicle has the optional CD changer, do not put heavy objects in the trunk.

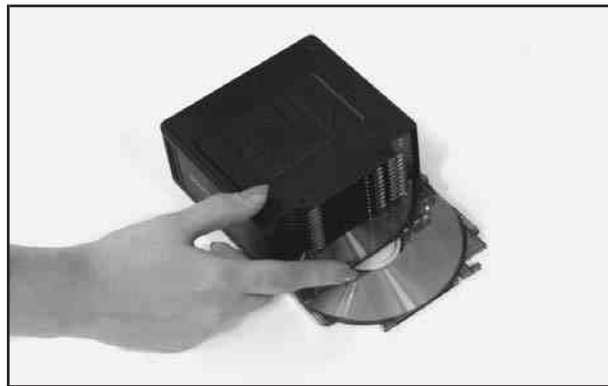

You must first load the magazine with CDs before you can play a CD. Each of the 12 trays holds one CD. Press the button on the back of the magazine and pull gently on one of the trays. Load the trays from bottom to top, placing a CD on the tray label side down. If you load a CD with the label side up, the CD will not play and an error will occur. Gently push the tray back into the magazine slot. Repeat this procedure for loading up to 12 CDs in the magazine.



Once you have loaded the CDs in the magazine, slide open the door of the CD changer. Push the magazine into the changer in the direction of the arrow marked on top of the magazine.



Close the door by sliding it all the way to the left. If the door is left partially open, the changer will not operate and an error will occur. When the door is closed, the changer will begin checking for CDs in the magazine. This will continue for up to two minutes depending on the number of CDs loaded.

To eject the magazine from the player, slide the CD changer door all the way open. The magazine will automatically eject. Remember to keep the door closed whenever possible to keep dirt and dust from getting inside the changer.

All of the CD functions are controlled by the radio buttons except for ejecting the magazine. Whenever a CD magazine with CDs is loaded in the changer, CHNGR will appear on the display. If the CD changer is checking the magazine for CDs, CHNGR will flash on the display until the changer is ready to play. When a CD begins playing, the CD and track number will appear on the display. The CD numbers are listed on the front of the magazine.

## Playing a CD

If an error appears on the display, see “CD Messages” later in this section.

**1 PREV (Previous):** Press this pushbutton to go to the start of the current track, if more than eight seconds have played. If you hold this button or press it more than once, the player will continue moving back through the CD.

**2 NEXT:** Press this pushbutton to go to the next track on the CD. If you hold this button or press it more than once, the player will continue moving forward through the CD.

**3 ◀ (Reverse):** Press and hold this pushbutton to reverse quickly within a track. You will hear sound at a reduced level. Release the pushbutton to play the passage.

**4 ▶ (Forward):** Press and hold this pushbutton to advance quickly within a track. You will hear sound at a reduced level. Release the pushbutton to play the passage.

**5 SIDE:** Press this pushbutton to select the next CD in the magazine. Each time you press this button, the CD number on the radio display will go to that of the next available CD. If a CD cannot be played, the number will be skipped when selecting CDs while using this button.

**6 RAND (Random):** Press this pushbutton to hear tracks and CDs in random, rather than sequential, order. RAND will appear on the display. Press RAND again to turn off random play.

**RECALL:** Press this button to see what track is currently playing. Press it again within five seconds to see how long the track has been playing. EL TM will appear on the display when in elapsed time mode. When a new track starts to play, the track number will appear on the display. Press this button a third time and the time of day will appear on the display.

**AM-FM:** Press this button to listen to the radio when a CD is playing. The inactive CD(s) will remain safely inside the radio for future listening.

**SOURCE:** Press this button to play a CD when listening to the radio. You can press this button to switch between a cassette tape, CD, or the CD changer if all three are loaded.

## CD Changer Errors

**E (Error):** If this message and a number appear on the display, an error has occurred and the CD temporarily cannot play.

The CD changer will send an error message to the receiver to indicate:

- **E30:** Disc Loaded Incorrectly (Label Side Up)
- **E34:** CD Changer Door Open (Completely close the door to restore normal operation.)
- **E35:** CD Changer Cartridge Empty (Try the magazine again with a CD loaded on one of the trays.)

If the error occurred while trying to play a CD in the CD player or changer, it could be for one of the following reasons:

- It is very hot. When the temperature returns to normal, the CD should play.
- You are driving on a very rough road. When the road becomes smooth, the CD should play.
- The CD is dirty, scratched, wet, or upside down.
- The air is very humid. If so, wait about an hour and try again.
- There may have been a problem while burning the CD.
- The label may be caught in the CD player.

If any error occurs repeatedly or if an error cannot be corrected, contact your dealer. If your radio displays an error number other than the error codes listed previously, write it down and provide it to your dealer when reporting the problem.



## Personal Choice Radio Controls

If your vehicle has this feature it will enable two drivers to store and recall personal settings for radio presets, last tuned station, volume, tone, and audio source (radio, cassette, or CD).

The memory buttons 1 and 2 for this feature are located on the driver's door panel and correspond to the numbers 1 and 2 found on the back of each remote keyless entry transmitter.

To recall audio sources, press the unlock button on the remote keyless entry transmitter and turn the ignition on. The source last listened to will be recalled for the identified driver 1 or 2.

To program this feature, do the following:

1. Set all radio preferences. For more information see "Setting Preset Stations" and "Setting the Tone" listed for your particular radio.
2. Locate the memory buttons on the driver's door panel.
3. Press one of the memory buttons 1 or 2 until you hear two beeps. The beeps confirm that your selection has been saved and can now be recalled.

Follow these steps each time you want to change the stored settings.

## Theft-Deterrent Feature

THEFTLOCK® is designed to discourage theft of your radio. It works by using a secret code to disable all radio functions whenever battery power is interrupted.

If THEFTLOCK® is active, the THEFTLOCK® indicator will flash when the ignition is off.

The THEFTLOCK® feature for the radio may be used or ignored. If ignored, the system plays normally and the radio is not protected by the feature. If THEFTLOCK® is activated, your radio will not operate if stolen.

When THEFTLOCK® is activated, the radio will display LOC to indicate a locked condition anytime battery power is removed. If your battery loses power for any reason, you must unlock the radio with the secret code before it will operate.

### Activating the Theft-Deterrent Feature

The instructions which follow explain how to enter your secret code to activate the THEFTLOCK® system. Read through all nine steps before starting the procedure.

If you allow more than 15 seconds to elapse between any steps, the radio automatically reverts to time and you must start the procedure over at Step 4.

1. Write down any three or four-digit number from 000 to 1999 and keep it in a safe place separate from the vehicle.
2. Turn the ignition on.
3. Turn the radio off.
4. Press the 1 and 4 pushbuttons at the same time. Hold them down until --- shows on the display. Next you will use the secret code number which you have written down.
5. Press MIN and 000 will appear on the display.
6. Press MIN again to make the last two digits agree with your code.
7. Press HRS to make the first one or two digits agree with your code.
8. Press AM-FM after you have confirmed that the code matches the secret code you have written down. The display will show REP to let you know that you need to repeat Steps 5 through 7 to confirm your secret code.
9. Press AM-FM again, SEC will appear on the display indicating that your radio is secure.

## Unlocking the Theft-Deterrent Feature After a Power Loss

Enter your secret code as follows; pause no more than 15 seconds between steps:

1. Turn the ignition on. LOC will appear on the display.
2. Press MIN and 000 will appear on the display.
3. Press MIN again to make the last two digits agree with your code.
4. Press HRS to make the first one or two digits agree with your code.
5. Press AM-FM after you have confirmed that the code matches the secret code you have written down. SEC will appear on the display, indicating the radio is now operable and secure.

If you enter the wrong code eight times, INOP will appear on the display. You will have to wait an hour with the ignition on before you can try again. When you try again, you will only have three more chances (eight tries per chance) to enter the correct code before INOP appears.

If you lose or forget your code, contact your dealer.

## Disabling the Theft-Deterrent Feature

Enter your secret code as follows; pause no more than 15 seconds between steps:

1. Turn the ignition on.
2. Turn the radio off.
3. Press the 1 and 4 pushbuttons at the same time. Hold them down until SEC appears on the display.
4. Press MIN and 000 will appear on the display.
5. Press MIN again to make the last two digits agree with your code.
6. Press HRS to make the first one or two digits agree with your code.
7. Press AM-FM after you have confirmed that the code matches the secret code you have written down. --- will appear on the display, indicating that the radio is no longer secured.

If the code entered is incorrect, SEC will appear on the display. The radio will remain secured until the correct code is entered.

When battery power is removed and later applied to a secured radio, the radio will not turn on and LOC will appear on the display.

To unlock a secured radio see "Unlocking the Theft-Deterrent Feature After a Power Loss" earlier in this section.

## Audio Steering Wheel Controls

If your vehicle has this feature, you can control certain radio functions using the buttons on your steering wheel.



△ **VOL** ▽ (**Volume**): Press the up or the down arrow to increase or to decrease volume.

△ **SEEK** ▽ : Press the up or the down arrow to seek to the next station or to the previous station. When playing a cassette tape or a CD, press the up arrow to hear the next selection.

**AM/FM**: Press this button to choose FM1, FM2, or AM.

**SCAN**: Press this button to scan your radio preset stations. The radio will scan to the first preset station stored on your pushbuttons, play for a few seconds, then go on to the next preset station. The radio will scan only to preset stations that are in the selected band and only to those with a strong signal. Press this button again to stop scanning.

## Understanding Radio Reception

### AM

The range for most AM stations is greater than for FM, especially at night. The longer range, however, can cause stations to interfere with each other. AM can pick up noise from things like storms and power lines. Try reducing the treble to reduce this noise.

### FM

FM stereo will give you the best sound, but FM signals will reach only about 10 to 40 miles (16 to 65 km). Tall buildings or hills can interfere with FM signals, causing the sound to come and go.

## Care of Your Cassette Tape Player

A tape player that is not cleaned regularly can cause reduced sound quality, ruined cassettes, or a damaged mechanism. Cassette tapes should be stored in their cases away from contaminants, direct sunlight, and extreme heat. If they are not, they may not operate properly or may cause failure of the tape player.

Your tape player should be cleaned regularly after every 50 hours of use. Your radio may display CLN to indicate that you have used your tape player for 50 hours without resetting the tape clean timer. If CLN appears on the display, your cassette tape player needs to be cleaned. It will still play tapes, but you should clean it as soon as possible to prevent damage to your tapes and player. If you notice a reduction in sound quality, try a known good cassette to see if the tape or the tape player is at fault. If this other cassette has no improvement in sound quality, clean the tape player.

For best results, use a scrubbing action, non-abrasive cleaning cassette with pads which scrub the tape head as the hubs of the cleaner cassette turn. The recommended cleaning cassette is available through your dealer.

The cut tape detection feature of your cassette tape player may identify the cleaning cassette as a damaged tape, in error. If the cleaning cassette ejects, insert the cassette at least three times to ensure thorough cleaning.

You may also choose a non-scrubbing action, wet-type cleaner which uses a cassette with a fabric belt to clean the tape head. This type of cleaning cassette will not eject on its own. A non-scrubbing action cleaner may not clean as thoroughly as the scrubbing type cleaner. The use of a non-scrubbing action, dry-type cleaning cassette is not recommended.

After you clean the player, press and hold the EJECT button for five seconds to reset the CLN indicator. The radio will display --- to show the indicator was reset.

Cassettes are subject to wear and the sound quality may degrade over time. Always make sure the cassette tape is in good condition before you have your tape player serviced.

## Care of Your CDs

Handle CDs carefully. Store them in their original cases or other protective cases and away from direct sunlight and dust. If the surface of a CD is soiled, dampen a clean, soft cloth in a mild, neutral detergent solution and clean it, wiping from the center to the edge.

Be sure never to touch the side without writing when handling CDs. Pick up CDs by grasping the outer edges or the edge of the hole and the outer edge.

## Care of Your CD Player

The use of CD lens cleaners for CDs is not advised, due to the risk of contaminating the lens of the CD optics with lubricants internal to the CD mechanism.

## Heated Backlite Antenna

Your AM-FM antenna is integrated with your rear window defogger, located in the rear window. Be sure that the inside surface of the rear window is not scratched and that the lines on the glass are not damaged. If the inside surface is damaged, it could interfere with radio reception.

**Notice:** Do not apply aftermarket glass tinting with metallic film. The metallic film in some tinting materials will interfere with or distort the incoming radio reception. Any damage caused to your backglass antenna due to metallic tinting materials will not be covered by your warranty.

**Notice:** Using a razor blade or sharp object to clear the inside rear window may damage the rear window antenna and/or the rear window defogger. Repairs would not be covered by your warranty. Do not clear the inside rear window with sharp objects.

If, when you turn on your rear window defogger, you hear static on your radio station, it could mean that a defogger grid line has been damaged. If this is true, the grid line must be repaired.

If you choose to add a cellular telephone to your vehicle, and the antenna needs to be attached to the glass, be sure that you do not damage the grid lines for the AM-FM antenna. Be sure the antenna does not touch a grid line.

## Section 4 Driving Your Vehicle

---

<b>Your Driving, the Road, and Your Vehicle</b> .....	4-2	Freeway Driving .....	4-22
Defensive Driving .....	4-2	Before Leaving on a Long Trip .....	4-23
Drunken Driving .....	4-3	Highway Hypnosis .....	4-24
Control of a Vehicle .....	4-6	Hill and Mountain Roads .....	4-24
Braking .....	4-6	Winter Driving .....	4-26
Traction Control System (TCS) .....	4-9	If You Are Stuck: In Sand, Mud, Ice or Snow .....	4-30
Steering .....	4-11	<b>Towing</b> .....	4-31
Off-Road Recovery .....	4-13	Towing Your Vehicle .....	4-31
Passing .....	4-14	Recreational Vehicle Towing .....	4-31
Loss of Control .....	4-15	Loading Your Vehicle .....	4-33
Driving at Night .....	4-17	Towing a Trailer .....	4-38
Driving in Rain and on Wet Roads .....	4-18		
City Driving .....	4-21		

# Your Driving, the Road, and Your Vehicle

## Defensive Driving

The best advice anyone can give about driving is: Drive defensively.

Please start with a very important safety device in your vehicle: Buckle up. See *Safety Belts: They Are for Everyone* on page 1-6.

Defensive driving really means “be ready for anything.” On city streets, rural roads or freeways, it means “always expect the unexpected.”

Assume that pedestrians or other drivers are going to be careless and make mistakes. Anticipate what they might do. Be ready for their mistakes.

Rear-end collisions are about the most preventable of accidents. Yet they are common. Allow enough following distance. It is the best defensive driving maneuver, in both city and rural driving. You never know when the vehicle in front of you is going to brake or turn suddenly.

Defensive driving requires that a driver concentrate on the driving task. Anything that distracts from the driving task — such as concentrating on a cellular telephone call, reading, or reaching for something on the floor — makes proper defensive driving more difficult and can even cause a collision, with resulting injury. Ask a passenger to help do things like this, or pull off the road in a safe place to do them yourself. These simple defensive driving techniques could save your life.



## Drunken Driving

Death and injury associated with drinking and driving is a national tragedy. It is the number one contributor to the highway death toll, claiming thousands of victims every year.

Alcohol affects four things that anyone needs to drive a vehicle:

- Judgment
- Muscular Coordination
- Vision
- Attentiveness.

Police records show that almost half of all motor vehicle-related deaths involve alcohol. In most cases, these deaths are the result of someone who was drinking and driving. In recent years, more than 16,000 annual motor vehicle-related deaths have been associated with the use of alcohol, with more than 300,000 people injured.

Many adults — by some estimates, nearly half the adult population — choose never to drink alcohol, so they never drive after drinking. For persons under 21, it is against the law in every U.S. state to drink alcohol. There are good medical, psychological and developmental reasons for these laws.

The obvious way to eliminate the leading highway safety problem is for people never to drink alcohol and then drive. But what if people do? How much is “too much” if someone plans to drive? It is a lot less than many might think. Although it depends on each person and situation, here is some general information on the problem.

The Blood Alcohol Concentration (BAC) of someone who is drinking depends upon four things:

- The amount of alcohol consumed
- The drinker's body weight
- The amount of food that is consumed before and during drinking
- The length of time it has taken the drinker to consume the alcohol.

According to the American Medical Association, a 180 lb (82 kg) person who drinks three 12 ounce (355 ml) bottles of beer in an hour will end up with a BAC of about 0.06 percent. The person would reach the same BAC by drinking three 4 ounce (120 ml) glasses of wine or three mixed drinks if each had 1-1/2 ounces (45 ml) of liquors like whiskey, gin or vodka.



It is the amount of alcohol that counts. For example, if the same person drank three double martinis (3 ounces or 90 ml of liquor each) within an hour, the person's BAC would be close to 0.12 percent. A person who consumes food just before or during drinking will have a somewhat lower BAC level.

There is a gender difference, too. Women generally have a lower relative percentage of body water than men. Since alcohol is carried in body water, this means that a woman generally will reach a higher BAC level than a man of her same body weight will when each has the same number of drinks.

The law in an increasing number of U.S. states, and throughout Canada, sets the legal limit at 0.08 percent. In some other countries, the limit is even lower. For example, it is 0.05 percent in both France and Germany. The BAC limit for all commercial drivers in the United States is 0.04 percent.

The BAC will be over 0.10 percent after three to six drinks (in one hour). Of course, as we have seen, it depends on how much alcohol is in the drinks, and how quickly the person drinks them.

But the ability to drive is affected well below a BAC of 0.10 percent. Research shows that the driving skills of many people are impaired at a BAC approaching 0.05 percent, and that the effects are worse at night. All drivers are impaired at BAC levels above 0.05 percent. Statistics show that the chance of being in a collision increases sharply for drivers who have a BAC of 0.05 percent or above. A driver with a BAC level of 0.06 percent has doubled his or her chance of having a collision. At a BAC level of 0.10 percent, the chance of this driver having a collision is 12 times greater; at a level of 0.15 percent, the chance is 25 times greater!

The body takes about an hour to rid itself of the alcohol in one drink. No amount of coffee or number of cold showers will speed that up. “I will be careful” is not the right answer. What if there is an emergency, a need to take sudden action, as when a child darts into the street? A person with even a moderate BAC might not be able to react quickly enough to avoid the collision.

There is something else about drinking and driving that many people do not know. Medical research shows that alcohol in a person’s system can make crash injuries worse, especially injuries to the brain, spinal cord or heart. This means that when anyone who has been drinking — driver or passenger — is in a crash, that person’s chance of being killed or permanently disabled is higher than if the person had not been drinking.

 **CAUTION:**

**Drinking and then driving is very dangerous. Your reflexes, perceptions, attentiveness and judgment can be affected by even a small amount of alcohol. You can have a serious — or even fatal — collision if you drive after drinking. Please do not drink and drive or ride with a driver who has been drinking. Ride home in a cab; or if you are with a group, designate a driver who will not drink.**

## Control of a Vehicle

You have three systems that make your vehicle go where you want it to go. They are the brakes, the steering and the accelerator. All three systems have to do their work at the places where the tires meet the road.

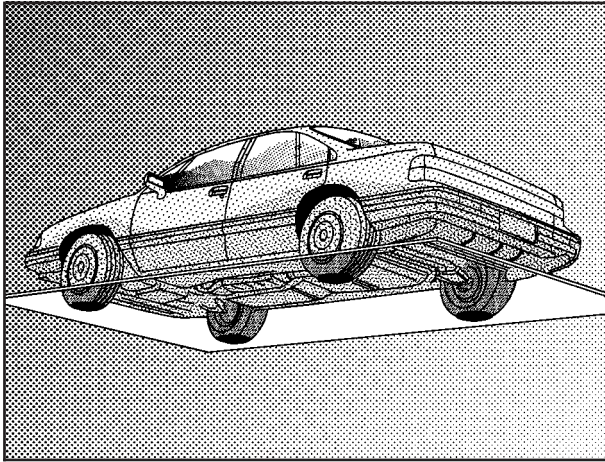

Sometimes, as when you are driving on snow or ice, it is easy to ask more of those control systems than the tires and road can provide. That means you can lose control of your vehicle. Also see *Traction Control System (TCS)* on page 4-9.

## Braking

Braking action involves *perception time* and *reaction time*.

First, you have to decide to push on the brake pedal. That is *perception time*. Then you have to bring up your foot and do it. That is *reaction time*.

Average *reaction time* is about 3/4 of a second.

But that is only an average. It might be less with one driver and as long as two or three seconds or more with another. Age, physical condition, alertness, coordination and eyesight all play a part. So do alcohol, drugs and frustration. But even in 3/4 of a second, a vehicle moving at 60 mph (100 km/h) travels 66 feet (20 m). That could be a lot of distance in an emergency, so keeping enough space between your vehicle and others is important.

And, of course, actual stopping distances vary greatly with the surface of the road (whether it is pavement or gravel); the condition of the road (wet, dry, icy); tire tread; the condition of your brakes; the weight of the vehicle and the amount of brake force applied.

Avoid needless heavy braking. Some people drive in spurts — heavy acceleration followed by heavy braking — rather than keeping pace with traffic. This is a mistake. Your brakes may not have time to cool between hard stops. Your brakes will wear out much faster if you do a lot of heavy braking. If you keep pace with the traffic and allow realistic following distances, you will eliminate a lot of unnecessary braking. That means better braking and longer brake life.

If your engine ever stops while you are driving, brake normally but do not pump your brakes. If you do, the pedal may get harder to push down. If your engine stops, you will still have some power brake assist. But you will use it when you brake. Once the power assist is used up, it may take longer to stop and the brake pedal will be harder to push.

## Anti-lock Brake System (ABS)

Your vehicle has anti-lock brakes. ABS is an advanced electronic braking system that will help prevent a braking skid.

When you start your engine, or when you begin to drive away, your anti-lock brake system will check itself. You may hear a momentary motor or clicking noise while this test is going on, and you may even notice that your brake pedal moves or pulses a little. This is normal.

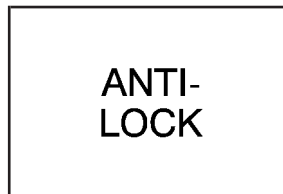

**United States**

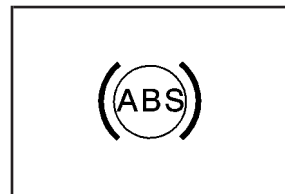

**Canada**

If there is a problem with the anti-lock brake system, this warning light will stay on. See *Anti-Lock Brake System Warning Light* on page 3-39.



Let us say the road is wet and you are driving safely. Suddenly, an animal jumps out in front of you. You slam on the brakes and continue braking. Here is what happens with ABS:

A computer senses that wheels are slowing down. If one of the wheels is about to stop rolling, the computer will separately work the brakes at each front wheel and at both rear wheels.

The anti-lock system can change the brake pressure faster than any driver could. The computer is programmed to make the most of available tire and road conditions. This can help you steer around the obstacle while braking hard.



As you brake, your computer keeps receiving updates on wheel speed and controls braking pressure accordingly.

Remember: Anti-lock does not change the time you need to get your foot up to the brake pedal or always decrease stopping distance. If you get too close to the vehicle in front of you, you will not have time to apply your brakes if that vehicle suddenly slows or stops. Always leave enough room up ahead to stop, even though you have anti-lock brakes.

### **Using Anti-Lock**

Do not pump the brakes. Just hold the brake pedal down firmly and let anti-lock work for you. You may feel a slight brake pedal pulsation or notice some noise, but this is normal.

### **Braking in Emergencies**

With anti-lock, you can steer and brake at the same time. In many emergencies, steering can help you more than even the very best braking.

## **Traction Control System (TCS)**

Your vehicle may have a traction control system that limits wheel spin. This is especially useful in slippery road conditions. The system operates only if it senses that one or both of the front wheels are spinning or beginning to lose traction. When this happens, the system works the front brakes and reduces engine power to limit wheel spin.

You may feel or hear the system working, but this is normal.

If your vehicle is in cruise control when the traction control system begins to limit wheel spin, the cruise control will automatically disengage. When road conditions allow you to safely use it again, you may reengage the cruise control. See “Cruise Control” under *Turn Signal/Multifunction Lever on page 3-5*.

## TRAC OFF

This light should come on briefly when you start the engine. If it stays on or comes on while you are driving, there is a problem with your traction control system.

See *Traction Control System (TCS) Warning Light* on page 3-39. When this warning light is on, the system will not limit wheel spin. Adjust your driving accordingly.

The traction control system automatically comes on whenever you start your vehicle. To limit wheel spin, especially in slippery road conditions, you should always leave the system on. But you can turn the traction control system off if you ever need to. You should turn the system off if your vehicle ever gets stuck in sand, mud or snow and rocking the vehicle is required. See *If You Are Stuck: In Sand, Mud, Ice or Snow* on page 4-30.



To turn the system off, press the button located at the end of the shift lever.

The traction control system warning light will come on and stay on. If the system is limiting wheel spin when you press the button, the warning light will come on — but the system will not turn off right away. It will wait until there is no longer a current need to limit wheel spin.

You can turn the system back on at any time by pressing the button again. The traction control system warning light should go off.



## Steering

### Power Steering

If you lose power steering assist because the engine stops or the system is not functioning, you can steer but it will take much more effort.

### Magnetic Speed Variable Assist

#### Steering

Your vehicle may be equipped with this steering system that continually adjusts the effort you feel when steering at all vehicle speeds. It provides ease when parking yet a firm, solid feel at highway speeds.

### Steering Tips

#### Driving on Curves

It is important to take curves at a reasonable speed.

A lot of the “driver lost control” accidents mentioned on the news happen on curves. Here is why:

Experienced driver or beginner, each of us is subject to the same laws of physics when driving on curves.

The traction of the tires against the road surface makes it possible for the vehicle to change its path when you turn the front wheels. If there is no traction, inertia will keep the vehicle going in the same direction. If you have ever tried to steer a vehicle on wet ice, you will understand this.

The traction you can get in a curve depends on the condition of your tires and the road surface, the angle at which the curve is banked, and your speed. While you are in a curve, speed is the one factor you can control.

Suppose you are steering through a sharp curve. Then you suddenly accelerate. Both control systems — steering and acceleration — have to do their work where the tires meet the road. Adding the sudden acceleration can demand too much of those places. You can lose control. See *Traction Control System (TCS)* on page 4-9.

What should you do if this ever happens? Ease up on the accelerator pedal, steer the vehicle the way you want it to go, and slow down.

If you have Stabilitrak<sup>®</sup>, you may see the STABILITY SYSTEM ACTIVE message on the Driver Information Center. See “Stability System Active Message” under *DIC Warnings and Messages on page 3-50*.

Speed limit signs near curves warn that you should adjust your speed. Of course, the posted speeds are based on good weather and road conditions. Under less favorable conditions, you will want to go slower.

If you need to reduce your speed as you approach a curve, do it before you enter the curve, while your front wheels are straight ahead.

Try to adjust your speed so you can “drive” through the curve. Maintain a reasonable, steady speed. Wait to accelerate until you are out of the curve, and then accelerate gently into the straightaway.

## Steering in Emergencies

There are times when steering can be more effective than braking. For example, you come over a hill and find a truck stopped in your lane, or a car suddenly pulls out from nowhere, or a child darts out from between parked cars and stops right in front of you. You can avoid these problems by braking — if you can stop in time. But sometimes you can not; there is not room. That is the time for evasive action — steering around the problem.

Your vehicle can perform very well in emergencies like these. First apply your brakes.

See *Braking on page 4-6*. It is better to remove as much speed as you can from a possible collision. Then steer around the problem, to the left or right depending on the space available.

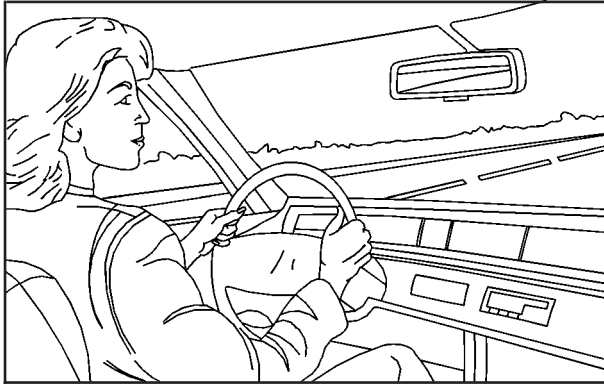

An emergency like this requires close attention and a quick decision. If you are holding the steering wheel at the recommended 9 and 3 o'clock positions, you can turn it a full 180 degrees very quickly without removing either hand. But you have to act fast, steer quickly, and just as quickly straighten the wheel once you have avoided the object.

The fact that such emergency situations are always possible is a good reason to practice defensive driving at all times and wear safety belts properly.

## Off-Road Recovery

You may find that your right wheels have dropped off the edge of a road onto the shoulder while you're driving.

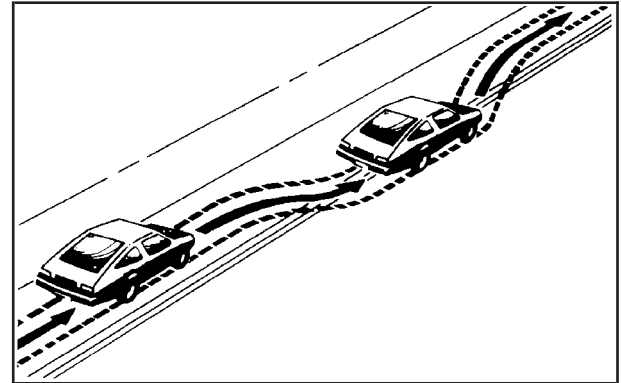

If the level of the shoulder is only slightly below the pavement, recovery should be fairly easy. Ease off the accelerator and then, if there is nothing in the way, steer so that your vehicle straddles the edge of the pavement. You can turn the steering wheel up to one-quarter turn until the right front tire contacts the pavement edge. Then turn your steering wheel to go straight down the roadway.

## Passing

The driver of a vehicle about to pass another on a two-lane highway waits for just the right moment, accelerates, moves around the vehicle ahead, then goes back into the right lane again. A simple maneuver?

Not necessarily! Passing another vehicle on a two-lane highway is a potentially dangerous move, since the passing vehicle occupies the same lane as oncoming traffic for several seconds. A miscalculation, an error in judgment, or a brief surrender to frustration or anger can suddenly put the passing driver face to face with the worst of all traffic accidents — the head-on collision.

So here are some tips for passing:

- “Drive ahead.” Look down the road, to the sides and to crossroads for situations that might affect your passing patterns. If you have any doubt whatsoever about making a successful pass, wait for a better time.
- Watch for traffic signs, pavement markings and lines. If you can see a sign up ahead that might indicate a turn or an intersection, delay your pass. A broken center line usually indicates it is all right to pass (providing the road ahead is clear). Never cross a solid line on your side of the lane or a double solid line, even if the road seems empty of approaching traffic.

- Do not get too close to the vehicle you want to pass while you are awaiting an opportunity. For one thing, following too closely reduces your area of vision, especially if you are following a larger vehicle. Also, you will not have adequate space if the vehicle ahead suddenly slows or stops. Keep back a reasonable distance.
- When it looks like a chance to pass is coming up, start to accelerate but stay in the right lane and do not get too close. Time your move so you will be increasing speed as the time comes to move into the other lane. If the way is clear to pass, you will have a “running start” that more than makes up for the distance you would lose by dropping back. And if something happens to cause you to cancel your pass, you need only slow down and drop back again and wait for another opportunity.
- If other vehicles are lined up to pass a slow vehicle, wait your turn. But take care that someone is not trying to pass you as you pull out to pass the slow vehicle. Remember to glance over your shoulder and check the blind spot.

- Check your mirrors, glance over your shoulder, and start your left lane change signal before moving out of the right lane to pass. When you are far enough ahead of the passed vehicle to see its front in your inside mirror, activate your right lane change signal and move back into the right lane. (Remember that your right outside mirror is convex. The vehicle you just passed may seem to be farther away from you than it really is.)
- Try not to pass more than one vehicle at a time on two-lane roads. Reconsider before passing the next vehicle.
- Do not overtake a slowly moving vehicle too rapidly. Even though the brake lamps are not flashing, it may be slowing down or starting to turn.
- If you are being passed, make it easy for the following driver to get ahead of you. Perhaps you can ease a little to the right.

## Loss of Control

Let us review what driving experts say about what happens when the three control systems (brakes, steering and acceleration) do not have enough friction where the tires meet the road to do what the driver has asked.

In any emergency, do not give up. Keep trying to steer and constantly seek an escape route or area of less danger.

## Skidding

In a skid, a driver can lose control of the vehicle. Defensive drivers avoid most skids by taking reasonable care suited to existing conditions, and by not “overdriving” those conditions. But skids are always possible.

The three types of skids correspond to your vehicle’s three control systems. In the braking skid, your wheels are not rolling. In the steering or cornering skid, too much speed or steering in a curve causes tires to slip and lose cornering force. And in the acceleration skid, too much throttle causes the driving wheels to spin.

A cornering skid is best handled by easing your foot off the accelerator pedal.

If you have the traction control system, remember: It helps avoid only the acceleration skid. If you do not have traction control, or if the system is off, then an acceleration skid is also best handled by easing your foot off the accelerator pedal.

If your vehicle starts to slide, ease your foot off the accelerator pedal and quickly steer the way you want the vehicle to go. If you start steering quickly enough, your vehicle may straighten out. Always be ready for a second skid if it occurs.

If you have StabiliTrak<sup>®</sup>, you may see the STABILITY SYSTEM ACTIVE message on the Driver Information Center. See “Stability System Active Message” under *DIC Warnings and Messages on page 3-50*.

Of course, traction is reduced when water, snow, ice, gravel or other material is on the road. For safety, you will want to slow down and adjust your driving to these conditions. It is important to slow down on slippery surfaces because stopping distance will be longer and vehicle control more limited.

While driving on a surface with reduced traction, try your best to avoid sudden steering, acceleration or braking (including engine braking by shifting to a lower gear). Any sudden changes could cause the tires to slide. You may not realize the surface is slippery until your vehicle is skidding. Learn to recognize warning clues — such as enough water, ice or packed snow on the road to make a “mirrored surface” — and slow down when you have any doubt.

Remember: Any anti-lock brake system (ABS) helps avoid only the braking skid.

## Driving at Night

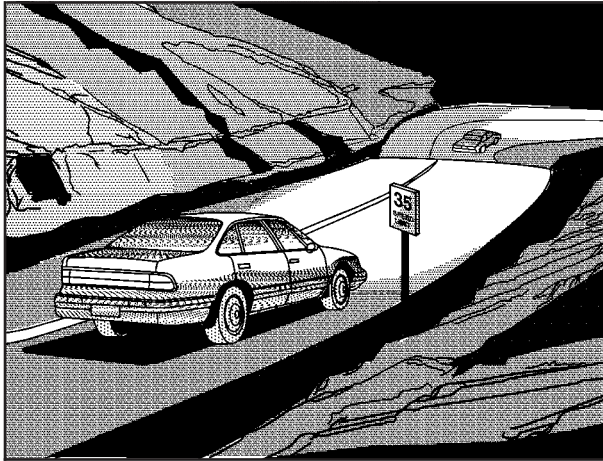

Night driving is more dangerous than day driving. One reason is that some drivers are likely to be impaired — by alcohol or drugs, with night vision problems, or by fatigue.

Here are some tips on night driving.

- Drive defensively.
- Do not drink and drive.
- Adjust your inside rearview mirror to reduce the glare from headlamps behind you.
- Since you can not see as well, you may need to slow down and keep more space between you and other vehicles.
- Slow down, especially on higher speed roads. Your headlamps can light up only so much road ahead.
- In remote areas, watch for animals.
- If you are tired, pull off the road in a safe place and rest.

No one can see as well at night as in the daytime. But as we get older these differences increase. A 50-year-old driver may require at least twice as much light to see the same thing at night as a 20-year-old.

What you do in the daytime can also affect your night vision. For example, if you spend the day in bright sunshine you are wise to wear sunglasses. Your eyes will have less trouble adjusting to night. But if you are driving, do not wear sunglasses at night. They may cut down on glare from headlamps, but they also make a lot of things invisible.

## Driving in Rain and on Wet Roads

You can be temporarily blinded by approaching headlamps. It can take a second or two, or even several seconds, for your eyes to readjust to the dark. When you are faced with severe glare (as from a driver who does not lower the high beams, or a vehicle with misaimed headlamps), slow down a little. Avoid staring directly into the approaching headlamps.

Keep your windshield and all the glass on your vehicle clean — inside and out. Glare at night is made much worse by dirt on the glass. Even the inside of the glass can build up a film caused by dust. Dirty glass makes lights dazzle and flash more than clean glass would, making the pupils of your eyes contract repeatedly.

Remember that your headlamps light up far less of a roadway when you are in a turn or curve. Keep your eyes moving; that way, it is easier to pick out dimly lighted objects. Just as your headlamps should be checked regularly for proper aim, so should your eyes be examined regularly. Some drivers suffer from night blindness — the inability to see in dim light — and are not even aware of it.

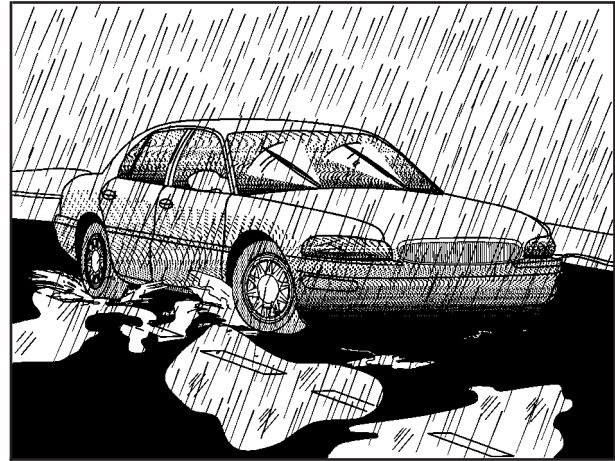

Rain and wet roads can mean driving trouble. On a wet road, you can not stop, accelerate or turn as well because your tire-to-road traction is not as good as on dry roads. And, if your tires do not have much tread left, you will get even less traction. It is always wise to go slower and be cautious if rain starts to fall while you are driving. The surface may get wet suddenly when your reflexes are tuned for driving on dry pavement.



The heavier the rain, the harder it is to see. Even if your windshield wiper blades are in good shape, a heavy rain can make it harder to see road signs and traffic signals, pavement markings, the edge of the road and even people walking.

It is wise to keep your windshield wiping equipment in good shape and keep your windshield washer tank filled with washer fluid. Replace your windshield wiper inserts when they show signs of streaking or missing areas on the windshield, or when strips of rubber start to separate from the inserts.

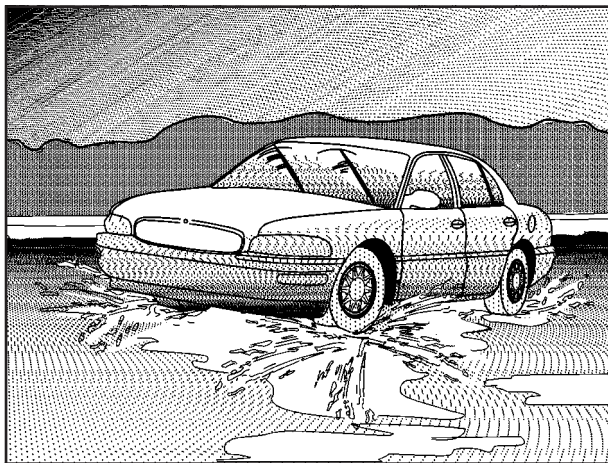

Driving too fast through large water puddles or even going through some car washes can cause problems, too. The water may affect your brakes. Try to avoid puddles. But if you can not, try to slow down before you hit them.

**⚠ CAUTION:**

**Wet brakes can cause accidents. They will not work as well in a quick stop and may cause pulling to one side. You could lose control of the vehicle.**

**After driving through a large puddle of water or a car wash, apply your brake pedal lightly until your brakes work normally.**

## Hydroplaning

Hydroplaning is dangerous. So much water can build up under your tires that they can actually ride on the water. This can happen if the road is wet enough and you are going fast enough. When your vehicle is hydroplaning, it has little or no contact with the road.

Hydroplaning does not happen often. But it can if your tires do not have much tread or if the pressure in one or more is low. It can happen if a lot of water is standing on the road. If you can see reflections from trees, telephone poles or other vehicles, and raindrops “dimple” the water’s surface, there could be hydroplaning.

Hydroplaning usually happens at higher speeds. There just is not a hard and fast rule about hydroplaning. The best advice is to slow down when it is raining.

## Driving Through Deep Standing Water

**Notice:** If you drive too quickly through deep puddles or standing water, water can come in through your engine’s air intake and badly damage your engine. Never drive through water that is slightly lower than the underbody of your vehicle. If you can not avoid deep puddles or standing water, drive through them very slowly.

## Driving Through Flowing Water

### CAUTION:

**Flowing or rushing water creates strong forces. If you try to drive through flowing water, as you might at a low water crossing, your vehicle can be carried away. As little as six inches of flowing water can carry away a smaller vehicle. If this happens, you and other vehicle occupants could drown. Do not ignore police warning signs, and otherwise be very cautious about trying to drive through flowing water.**

## Some Other Rainy Weather Tips

- Besides slowing down, allow some extra following distance. And be especially careful when you pass another vehicle. Allow yourself more clear room ahead, and be prepared to have your view restricted by road spray.
- Have good tires with proper tread depth. See *Tires on page 5-62*.

## City Driving



One of the biggest problems with city streets is the amount of traffic on them. You will want to watch out for what the other drivers are doing and pay attention to traffic signals.

Here are ways to increase your safety in city driving:

- Know the best way to get to where you are going. Get a city map and plan your trip into an unknown part of the city just as you would for a cross-country trip.
- Try to use the freeways that rim and crisscross most large cities. You will save time and energy. See *Freeway Driving on page 4-22*.
- Treat a green light as a warning signal. A traffic light is there because the corner is busy enough to need it. When a light turns green, and just before you start to move, check both ways for vehicles that have not cleared the intersection or may be running the red light.

## Freeway Driving

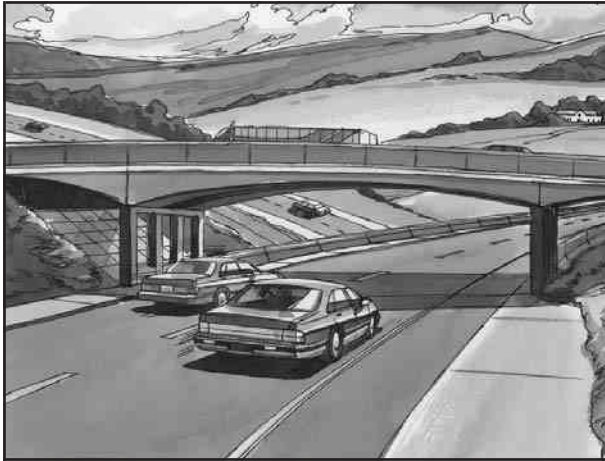

Mile for mile, freeways (also called thruways, parkways, expressways, turnpikes or superhighways) are the safest of all roads. But they have their own special rules.

The most important advice on freeway driving is: Keep up with traffic and keep to the right. Drive at the same speed most of the other drivers are driving. Too-fast or too-slow driving breaks a smooth traffic flow. Treat the left lane on a freeway as a passing lane.

At the entrance, there is usually a ramp that leads to the freeway. If you have a clear view of the freeway as you drive along the entrance ramp, you should begin to check traffic. Try to determine where you expect to blend with the flow. Try to merge into the gap at close to the prevailing speed. Switch on your turn signal, check your mirrors and glance over your shoulder as often as necessary. Try to blend smoothly with the traffic flow.

Once you are on the freeway, adjust your speed to the posted limit or to the prevailing rate if it is slower. Stay in the right lane unless you want to pass.

Before changing lanes, check your mirrors. Then use your turn signal.

Just before you leave the lane, glance quickly over your shoulder to make sure there is not another vehicle in your “blind” spot.

Once you are moving on the freeway, make certain you allow a reasonable following distance.

Expect to move slightly slower at night.

When you want to leave the freeway, move to the proper lane well in advance. If you miss your exit, do not, under any circumstances, stop and back up. Drive on to the next exit.

The exit ramp can be curved, sometimes quite sharply. The exit speed is usually posted. Reduce your speed according to your speedometer, not to your sense of motion. After driving for any distance at higher speeds, you may tend to think you are going slower than you actually are.

## Before Leaving on a Long Trip

Make sure you are ready. Try to be well rested. If you must start when you are not fresh — such as after a day's work — do not plan to make too many miles that first part of the journey. Wear comfortable clothing and shoes you can easily drive in.

Is your vehicle ready for a long trip? If you keep it serviced and maintained, it is ready to go. If it needs service, have it done before starting out. Of course, you will find experienced and able service experts in GM dealerships all across North America. They will be ready and willing to help if you need it.

Here are some things you can check before a trip:

- *Windshield Washer Fluid*: Is the reservoir full? Are all windows clean inside and outside?
- *Wiper Blades*: Are they in good shape?
- *Fuel, Engine Oil, Other Fluids*: Have you checked all levels?
- *Lamps*: Are they all working? Are the lenses clean?
- *Tires*: They are vitally important to a safe, trouble-free trip. Is the tread good enough for long-distance driving? Are the tires all inflated to the recommended pressure?
- *Weather Forecasts*: What is the weather outlook along your route? Should you delay your trip a short time to avoid a major storm system?
- *Maps*: Do you have up-to-date maps?

## Highway Hypnosis

Is there actually such a condition as “highway hypnosis”? Or is it just plain falling asleep at the wheel? Call it highway hypnosis, lack of awareness, or whatever.

There is something about an easy stretch of road with the same scenery, along with the hum of the tires on the road, the drone of the engine, and the rush of the wind against the vehicle that can make you sleepy. Do not let it happen to you! If it does, your vehicle can leave the road in *less than a second*, and you could crash and be injured.

What can you do about highway hypnosis? First, be aware that it can happen.

Then here are some tips:

- Make sure your vehicle is well ventilated, with a comfortably cool interior.
- Keep your eyes moving. Scan the road ahead and to the sides. Check your rearview mirrors and your instruments frequently.
- If you get sleepy, pull off the road into a rest, service or parking area and take a nap, get some exercise, or both. For safety, treat drowsiness on the highway as an emergency.

## Hill and Mountain Roads



Driving on steep hills or mountains is different from driving in flat or rolling terrain.

If you drive regularly in steep country, or if you are planning to visit there, here are some tips that can make your trips safer and more enjoyable.

- Keep your vehicle in good shape. Check all fluid levels and also the brakes, tires, cooling system and transaxle. These parts can work hard on mountain roads.
- Know how to go down hills. The most important thing to know is this: let your engine do some of the slowing down. Shift to a lower gear when you go down a steep or long hill.

 **CAUTION:**

**If you do not shift down, your brakes could get so hot that they would not work well. You would then have poor braking or even none going down a hill. You could crash. Shift down to let your engine assist your brakes on a steep downhill slope.**

 **CAUTION:**

**Coasting downhill in NEUTRAL (N) or with the ignition off is dangerous. Your brakes will have to do all the work of slowing down. They could get so hot that they would not work well. You would then have poor braking or even none going down a hill. You could crash. Always have your engine running and your vehicle in gear when you go downhill.**

- Know how to go uphill. Drive in the highest gear possible.
- Stay in your own lane when driving on two-lane roads in hills or mountains. Do not swing wide or cut across the center of the road. Drive at speeds that let you stay in your own lane.
- As you go over the top of a hill, be alert. There could be something in your lane, like a stalled car or an accident.
- You may see highway signs on mountains that warn of special problems. Examples are long grades, passing or no-passing zones, a falling rocks area or winding roads. Be alert to these and take appropriate action.

## Winter Driving



Here are some tips for winter driving:

- Have your vehicle in good shape for winter.
- You may want to put winter emergency supplies in your trunk.



Include an ice scraper, a small brush or broom, a supply of windshield washer fluid, a rag, some winter outer clothing, a small shovel, a flashlight, a red cloth and a couple of reflective warning triangles. And, if you will be driving under severe conditions, include a small bag of sand, a piece of old carpet or a couple of burlap bags to help provide traction. Be sure you properly secure these items in your vehicle.



## Driving on Snow or Ice

Most of the time, those places where your tires meet the road probably have good traction.

However, if there is snow or ice between your tires and the road, you can have a very slippery situation. You will have a lot less traction or “grip” and will need to be very careful.



What is the worst time for this? “Wet ice.” Very cold snow or ice can be slick and hard to drive on. But wet ice can be even more trouble because it may offer the least traction of all. You can get wet ice when it is about freezing (32°F; 0°C) and freezing rain begins to fall. Try to avoid driving on wet ice until salt and sand crews can get there.

Whatever the condition — smooth ice, packed, blowing or loose snow — drive with caution.

If you have traction control, keep the system on. It will improve your ability to accelerate when driving on a slippery road. Even though your vehicle has a traction control system you will want to slow down and adjust your driving to the road conditions. See *Traction Control System (TCS)* on page 4-9.

If you do not have a traction control system, accelerate gently. Try not to break the fragile traction. If you accelerate too fast, the drive wheels will spin and polish the surface under the tires even more.

Your anti-lock brakes improve your vehicle's stability when you make a hard stop on a slippery road. Even though you have the anti-lock braking system, you will want to begin stopping sooner than you would on dry pavement. See *Braking on page 4-6*.

- Allow greater following distance on any slippery road.
- Watch for slippery spots. The road might be fine until you hit a spot that is covered with ice. On an otherwise clear road, ice patches may appear in shaded areas where the sun can not reach: around clumps of trees, behind buildings or under bridges. Sometimes the surface of a curve or an overpass may remain icy when the surrounding roads are clear. If you see a patch of ice ahead of you, brake before you are on it. Try not to brake while you are actually on the ice, and avoid sudden steering maneuvers.

## If You Are Caught in a Blizzard

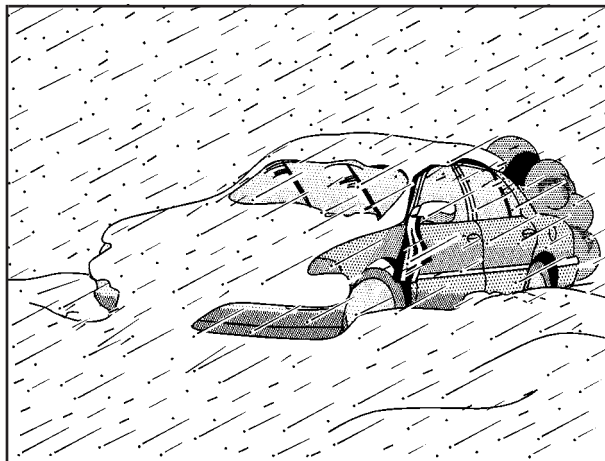

If you are stopped by heavy snow, you could be in a serious situation. You should probably stay with your vehicle unless you know for sure that you are near help and you can hike through the snow. Here are some things to do to summon help and keep yourself and your passengers safe:

- Turn on your hazard flashers.
- Tie a red cloth to your vehicle to alert police that you have been stopped by the snow.

- Put on extra clothing or wrap a blanket around you. If you have no blankets or extra clothing, make body insulators from newspapers, burlap bags, rags, floor mats — anything you can wrap around yourself or tuck under your clothing to keep warm.

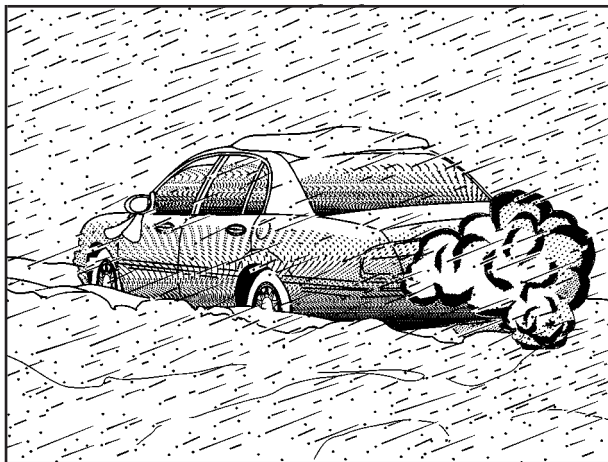

You can run the engine to keep warm, but be careful.

## **⚠ CAUTION:**

**Snow can trap exhaust gases under your vehicle. This can cause deadly CO (carbon monoxide) gas to get inside. CO could overcome you and kill you. You can not see it or smell it, so you might not know it is in your vehicle. Clear away snow from around the base of your vehicle, especially any that is blocking your exhaust pipe. And check around again from time to time to be sure snow does not collect there.**

**Open a window just a little on the side of the vehicle that is away from the wind. This will help keep CO out.**

Run your engine only as long as you must. This saves fuel. When you run the engine, make it go a little faster than just idle. That is, push the accelerator slightly. This uses less fuel for the heat that you get and it keeps the battery charged. You will need a well-charged battery to restart the vehicle, and possibly for signaling later on with your headlamps. Let the heater run for a while.

Then, shut the engine off and close the window almost all the way to preserve the heat. Start the engine again and repeat this only when you feel really uncomfortable from the cold. But do it as little as possible. Preserve the fuel as long as you can. To help keep warm, you can get out of the vehicle and do some fairly vigorous exercises every half hour or so until help comes.

## If You Are Stuck: In Sand, Mud, Ice or Snow

In order to free your vehicle when it is stuck, you will need to spin the wheels, but you don't want to spin your wheels too fast. The method known as "rocking" can help you get out when you're stuck, but you must use caution.

### CAUTION:

**If you let your tires spin at high speed, they can explode, and you or others could be injured. And, the transaxle or other parts of the vehicle can overheat. That could cause an engine compartment fire or other damage. When you are stuck, spin the wheels as little as possible. Do not spin the wheels above 35 mph (55 km/h) as shown on the speedometer.**

**Notice:** Spinning your wheels can destroy parts of your vehicle as well as the tires. If you spin the wheels too fast while shifting your transaxle back and forth, you can destroy your transaxle. See "Rocking Your Vehicle To Get It Out."

For information about using tire chains on your vehicle, see *Tire Chains* on page 5-78.

## Rocking Your Vehicle To Get It Out

First, turn your steering wheel left and right. That will clear the area around your front wheels. If your vehicle has traction control, you should turn the system off.

See *Traction Control System (TCS) on page 4-9*.

Then shift back and forth between REVERSE (R) and a forward gear, spinning the wheels as little as possible.

Release the accelerator pedal while you shift, and press lightly on the accelerator pedal when the transaxle is in gear. By slowly spinning your wheels in the forward and reverse directions, you will cause a rocking

motion that may free your vehicle. If that doesn't get you out after a few tries, you may need to be towed out.

If you do need to be towed out, see "Towing Your Vehicle" following.

## Towing

### Towing Your Vehicle

Consult your dealer or a professional towing service if you need to have your disabled vehicle towed.

See *Roadside Assistance Program on page 7-6*.

If you want to tow your vehicle behind another vehicle for recreational purposes (such as behind a motorhome), see "Recreational Vehicle Towing" following.

### Recreational Vehicle Towing

Recreational vehicle towing means towing your vehicle behind another vehicle — such as behind a motorhome. The two most common types of recreational vehicle towing are known as "dinghy towing" (towing your vehicle with all four wheels on the ground) and "dolly towing" (towing your vehicle with two wheels on the ground and two wheels up on a device known as a "dolly").

With the proper preparation and equipment, many vehicles can be towed in these ways. See "Dinghy Towing" and "Dolly Towing," following.

Here are some important things to consider before you do recreational vehicle towing:

- What is the towing capacity of the towing vehicle? Be sure you read the tow vehicle manufacturer's recommendations.
- How far will you tow? Some vehicles have restrictions on how far and how long they can tow.
- Do you have the proper towing equipment? See your dealer or trailering professional for additional advice and equipment recommendations.
- Is your vehicle ready to be towed? Just as you would prepare your vehicle for a long trip, you will want to make sure your vehicle is prepared to be towed. See *Before Leaving on a Long Trip* on page 4-23.

## Dinghy Towing

**Notice:** If you tow your vehicle with all four wheels on the ground, the drivetrain components could be damaged. The repairs would not be covered by your warranty. Do not tow your vehicle with all four wheels on the ground.

Your vehicle was not designed to be towed with all four wheels on the ground. If your vehicle must be towed, you should use a dolly. See "Dolly Towing" that follows for more information.

## Dolly Towing

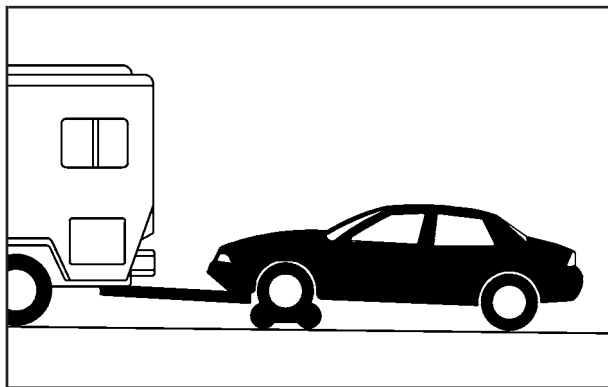

Your vehicle can be towed using a dolly. To tow your vehicle using a dolly, follow these steps:

1. Put the front wheels on the dolly.
2. Put the vehicle in PARK (P).
3. Set the parking brake and then remove the key.
4. Clamp the steering wheel in a straight-ahead position.
5. Release the parking brake.

## Loading Your Vehicle

It is very important to know how much weight your vehicle can carry. This weight is called the vehicle capacity weight and includes the weight of all occupants, cargo and all nonfactory-installed options. Two labels on your vehicle show how much weight it may properly carry, the Tire and Loading Information label and the Certification label.

### CAUTION:

Do not load your vehicle any heavier than the GVWR, or either the maximum front or rear GAWR. If you do, parts on your vehicle can break, and it can change the way your vehicle handles. These could cause you to lose control and crash. Also, overloading can shorten the life of your vehicle.

## Tire and Loading Information Label

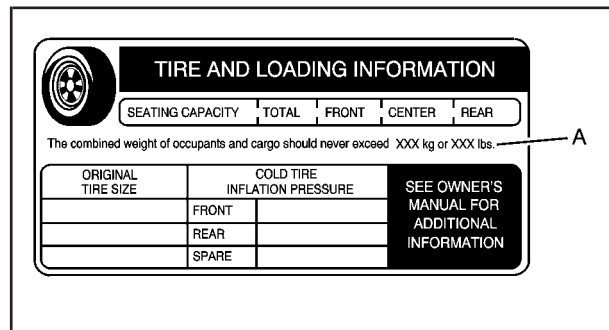

The label is titled "TIRE AND LOADING INFORMATION" and features a tire icon on the left. It includes a row of five boxes for "SEATING CAPACITY", "TOTAL", "FRONT", "CENTER", and "REAR". Below this is a line of text: "The combined weight of occupants and cargo should never exceed XXX kg or XXX lbs." with a line pointing to the "XXX" values labeled "A". At the bottom, there is a table for tire information and a box for the owner's manual.

ORIGINAL TIRE SIZE	COLD TIRE INFLATION PRESSURE		SEE OWNER'S MANUAL FOR ADDITIONAL INFORMATION
	FRONT	REAR	

Example 1

A. Vehicle Capacity Weight

TIRE-LOADING INFORMATION					
OCCUPANTS			VEHICLE CAP. WT.		
FRT.	CTR.	RR.	TOTAL	LBS.	KG.
<input type="text"/>	<input type="text"/>	<input type="text"/>	<input type="text"/>	<input type="text"/>	<input type="text"/>
MAX. LOADING & GVWR SAME AS VEHICLE					
CAPACITY WEIGHT			XXX	COLD TIRE	
TIRE SIZE			SPEED	PRESSURE	
			RTG	PSI/KPa	
FRT.					
RR.					
SPA.					
IF TIRES ARE HOT, ADD 4PSI/28KPa					
SEE OWNER'S MANUAL FOR ADDITIONAL INFORMATION					

**Example 2**

A. Vehicle Capacity Weight

The Tire and Loading Information label shows the seating capacity and the total weight your vehicle can properly carry. This weight is called the vehicle capacity weight. If your vehicle has the Tire and Loading Information label, Example 1, the label is attached to the center pillar, near the driver's door latch. If your vehicle has the Tire-Loading Information label, Example 2, the label is on the rear edge of the driver's door.

The Tire and Loading Information label also gives you the size and recommended inflation pressure for the factory-installed, original equipment tires on your vehicle. For more information on tires and inflation see *Tires on page 5-62 and Inflation - Tire Pressure on page 5-69.*

There is also important loading information on the Certification label. It tells you the Gross Vehicle Weight Rating (GVWR) and the Gross Axle Weight Rating (GAWR) for the front and rear axle; see "Certification Label" later in this section.

### Steps for Determining Correct Load Limit

1. Locate the statement "The combined weight of occupants and cargo should never exceed XXX pounds" on your vehicle placard.
2. Determine the combined weight of the driver and passengers that will be riding in your vehicle.
3. Subtract the combined weight of the driver and passengers from XXX kilograms or XXX pounds.



4. The resulting figure equals the available amount of cargo and luggage load capacity. For example, if the “XXX” amount equals 1400 lbs. and there will be five 150 lb. passengers in your vehicle, the amount of available cargo and luggage load capacity is 650 lbs. (1400 – 750 (5 x 150) = 650 lbs.).
5. Determine the combined weight of luggage and cargo being loaded on the vehicle. That weight may not safely exceed the available cargo and luggage load capacity calculated in Step 4.
6. If your vehicle will be towing a trailer, the load from your trailer will be transferred to your vehicle. Consult this manual to determine how this reduces the available cargo and luggage load capacity of your vehicle.

If your vehicle can tow a trailer, see *Towing a Trailer on page 4-38* for important information on towing a trailer, towing safety rules, and trailering tips.

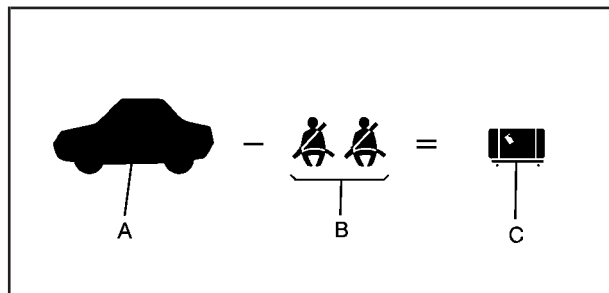

**Example 1**

### Loading Your Vehicle

Item	Description	Total
A	Vehicle Capacity Weight for Example 1 =	1,000 lbs (453 kg)
B	Subtract Occupant Weight 150 lbs (68 kg) × 2 =	300 lbs (136 kg)
C	Available Occupant and Cargo Weight =	700 lbs (317 kg)

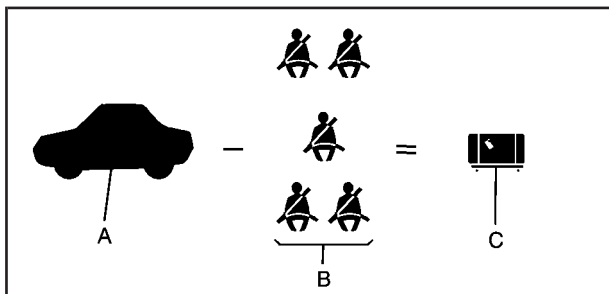

Example 2

### Loading Your Vehicle

Item	Description	Total
A	Vehicle Capacity Weight for Example 2 =	1,000 lbs (453 kg)
B	Subtract Occupant Weight 150 lbs (68 kg) × 5 =	750 lbs (340 kg)
C	Available Cargo Weight =	250 lbs (113 kg)

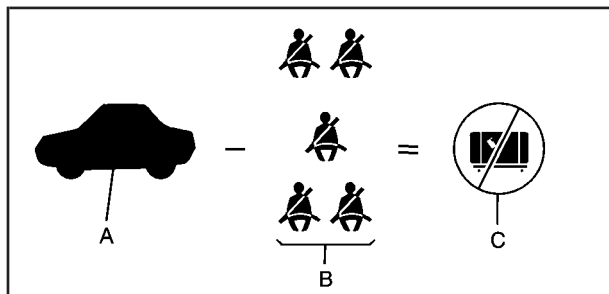

Example 3

### Loading Your Vehicle

Item	Description	Total
A	Vehicle Capacity Weight for Example 3 =	1,000 lbs (453 kg)
B	Subtract Occupant Weight 200 lbs (91 kg) × 5 =	1,000 lbs (453 kg)
C	Available Cargo Weight =	0 lbs (0 kg)

Refer to your vehicle's Tire and Loading Information label for specific information about your vehicle's capacity weight and seating positions. The combined weight of the driver, passengers, and cargo should never exceed your vehicle's capacity weight.

## Certification Label

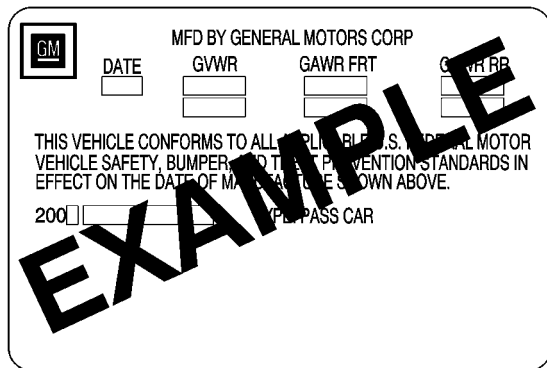

The image shows a certification label for a GM vehicle. It features the GM logo in a square box on the left. To the right of the logo, the text reads "MFD BY GENERAL MOTORS CORP". Below this, there are four columns of information: "DATE", "GVWR", "GAWR FRT", and "GAWR RR". Each column has a small rectangular box for the value. Below these boxes, the text states: "THIS VEHICLE CONFORMS TO ALL APPLICABLE U.S. FEDERAL MOTOR VEHICLE SAFETY, BUMPER, AND TRAFFIC PREVENTION STANDARDS IN EFFECT ON THE DATE OF MANUFACTURE SHOWN ABOVE." At the bottom left, there is a "200" followed by a small box. At the bottom right, it says "TYPE: PASS CAR". A large, bold, black "EXAMPLE" watermark is diagonally overlaid across the entire label.

The Certification label, found on the rear edge of the driver's door, tells you the gross weight capacity of your vehicle, called the Gross Vehicle Weight Rating (GVWR). The GVWR includes the weight of the vehicle, all occupants, fuel and cargo. Never exceed the GVWR for your vehicle, or the Gross Axle Weight Rating (GAWR) for either the front or rear axle.

And, if you do have a heavy load, you should spread it out. Do not carry more than 176 lbs (80 kg) in your trunk.

### CAUTION:

Do not load your vehicle any heavier than the GVWR, or either the maximum front or rear GAWR. If you do, parts on your vehicle can break, and it can change the way your vehicle handles. These could cause you to lose control and crash. Also, overloading can shorten the life of your vehicle.

**Notice:** Overloading your vehicle may cause damage. Repairs would not be covered by your warranty. Do not overload your vehicle.

If you put things inside your vehicle — like suitcases, tools, packages, or anything else — they will go as fast as the vehicle goes. If you have to stop or turn quickly, or if there is a crash, they will keep going.

### **CAUTION:**

Things you put inside your vehicle can strike and injure people in a sudden stop or turn, or in a crash.

- Put things in the trunk of your vehicle. In a trunk, put them as far forward as you can. Try to spread the weight evenly.
- Never stack heavier things, like suitcases, inside the vehicle so that some of them are above the tops of the seats.
- Don't leave an unsecured child restraint in your vehicle.
- When you carry something inside the vehicle, secure it whenever you can.

## Automatic Level Control

This feature keeps the rear of your vehicle level as the load changes. It is automatic — you do not need to adjust anything.

## Towing a Trailer

### **CAUTION:**

If you do not use the correct equipment and drive properly, you can lose control when you pull a trailer. For example, if the trailer is too heavy, the brakes may not work well — or even at all. You and your passengers could be seriously injured. You may also damage your vehicle; the resulting repairs would not be covered by your warranty. Pull a trailer only if you have followed all the steps in this section. Ask your dealer for advice and information about towing a trailer with your vehicle.

Your vehicle can tow a trailer if it is equipped with the proper trailer towing equipment. To identify what the vehicle trailering capacity is for your vehicle, you should read the information in “Weight of the Trailer” that appears later in this section. But trailering is different than just driving your vehicle by itself. Trailering means changes in handling, acceleration, braking, durability and fuel economy. Successful, safe trailering takes correct equipment, and it has to be used properly.

That is the reason for this part. In it are many time-tested, important trailering tips and safety rules. Many of these are important for your safety and that of your passengers. So please read this section carefully before you pull a trailer.

Load-pulling components such as the engine, transaxle, wheel assemblies and tires are forced to work harder against the drag of the added weight. The engine is required to operate at relatively higher speeds and under greater loads, generating extra heat. Also, the trailer adds considerably to wind resistance, increasing the pulling requirements.

## If You Do Decide To Pull A Trailer

If you do, here are some important points:

- There are many different laws, including speed limit restrictions, having to do with trailering. Make sure your rig will be legal, not only where you live but also where you will be driving. A good source for this information can be state or provincial police.
- Consider using a sway control. You can ask a hitch dealer about sway controls.
- Do not tow a trailer at all during the first 1,000 miles (1 600 km) your new vehicle is driven. Your engine, axle or other parts could be damaged.
- Then, during the first 500 miles (800 km) that you tow a trailer, do not drive over 50 mph (80 km/h) and do not make starts at full throttle. This helps your engine and other parts of your vehicle wear in at the heavier loads.
- Obey speed limit restrictions when towing a trailer. Do not drive faster than the maximum posted speed for trailers, or no more than 55 mph (90 km/h), to save wear on your vehicle's parts.

Three important considerations have to do with weight:

- The weight of the trailer.
- The weight of the trailer tongue.
- The total weight on your vehicle's tires.

## Weight of the Trailer

How heavy can a trailer safely be?

It should never weigh more than 1,000 lbs (450 kg).  
But even that can be too heavy.

It depends on how you plan to use your rig. For example, speed, altitude, road grades, outside temperature and how much your vehicle is used to pull a trailer are all important. And, it can also depend on any special equipment that you have on your vehicle.

You can ask your dealer for our trailering information or advice, or you can write us at:

Buick Customer Assistance Center  
P.O. Box 33136  
Detroit, MI 48232-5136

In Canada, write to:

General Motors of Canada Limited  
Customer Communication Centre, 163-005  
1908 Colonel Sam Drive  
Oshawa, Ontario L1H 8P7

## Weight of the Trailer Tongue

The tongue load (A) of any trailer is an important weight to measure because it affects the total or gross weight of your vehicle. The Gross Vehicle Weight (GVW) includes the curb weight of the vehicle, any cargo you may carry in it, and the people who will be riding in the vehicle. If you have a lot of options, equipment, passengers, or cargo in your vehicle, it will reduce the tongue weight your vehicle can carry, which will also reduce the trailer weight your vehicle can tow. And if you tow a trailer, you must add the tongue load to the GVW because your vehicle will be carrying that weight, too. See *Loading Your Vehicle on page 4-33* for more information about your vehicle's maximum load capacity.

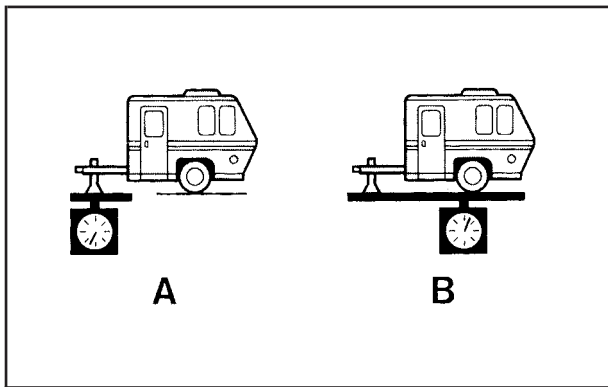

If you are using a weight-carrying hitch, the trailer tongue (A) should weigh 10 to 15 percent of the total loaded trailer weight (B).

After you have loaded your trailer, weigh the trailer and then the tongue, separately, to see if the weights are proper. If they are not, you may be able to get them right simply by moving some items around in the trailer.

## Total Weight on Your Vehicle's Tires

Be sure your vehicle's tires are inflated to the upper limit for cold tires. You will find these numbers on the Tire-Loading Information label. See *Loading Your Vehicle* on page 4-33. Then be sure you do not go over the GVW limit for your vehicle, including the weight of the trailer tongue.

## Hitches

It is important to have the correct hitch equipment. Crosswinds, large trucks going by and rough roads are a few reasons why you will need the right hitch. Here are some rules to follow:

- The rear bumper on your vehicle is not intended for hitches. Do not attach rental hitches or other bumper-type hitches to it. Use only a frame-mounted hitch that does not attach to the bumper.
- Will you have to make any holes in the body of your vehicle when you install a trailer hitch? If you do, then be sure to seal the holes later when you remove the hitch. If you do not seal them, deadly carbon monoxide (CO) from your exhaust can get into your vehicle. See *Engine Exhaust* on page 2-34. Dirt and water can also enter the vehicle.

## Safety Chains

You should always attach chains between your vehicle and your trailer. Cross the safety chains under the tongue of the trailer so that the tongue will not drop to the road if it becomes separated from the hitch. Instructions about safety chains may be provided by the hitch manufacturer or by the trailer manufacturer. Follow the manufacturer's recommendation for attaching safety chains and do not attach them to the bumper. Always leave just enough slack so you can turn with your rig. And, never allow safety chains to drag on the ground.

## Trailer Brakes

Be sure to read and follow the instructions for the trailer brakes so you will be able to install, adjust and maintain them properly.

Because you have anti-lock brakes, do not try to tap into your vehicle's brake system. If you do, both brake systems will not work well, or at all.

## Driving with a Trailer

Towing a trailer requires a certain amount of experience. Before setting out for the open road, you will want to get to know your rig. Acquaint yourself with the feel of handling and braking with the added weight of the trailer. And always keep in mind that the vehicle you are driving is now a good deal longer and not nearly as responsive as your vehicle is by itself.

Before you start, check all trailer hitch parts and attachments, safety chains, electrical connector, lamps, tires and mirror adjustment. If the trailer has electric brakes, start your vehicle and trailer moving and then apply the trailer brake controller by hand to be sure the brakes are working. This lets you check your electrical connection at the same time.

During your trip, check occasionally to be sure that the load is secure, and that the lamps and any trailer brakes are still working.



## Following Distance

Stay at least twice as far behind the vehicle ahead as you would when driving your vehicle without a trailer. This can help you avoid situations that require heavy braking and sudden turns.

## Passing

You will need more passing distance up ahead when you are towing a trailer. And, because the vehicle is a good deal longer, you will need to go much farther beyond the passed vehicle before you can return to your lane.

## Backing Up

Hold the bottom of the steering wheel with one hand. Then, to move the trailer to the left, just move that hand to the left. To move the trailer to the right, move your hand to the right. Always back up slowly and, if possible, have someone guide you.

## Making Turns

**Notice:** Making very sharp turns while trailering could cause the trailer to come in contact with the vehicle. Your vehicle could be damaged. Avoid making very sharp turns while trailering.

When you are turning with a trailer, make wider turns than normal. Do this so your trailer will not strike soft shoulders, curbs, road signs, trees or other objects. Avoid jerky or sudden maneuvers. Signal well in advance.

## Turn Signals When Towing a Trailer

When you tow a trailer, your vehicle may need a different turn signal flasher and/or extra wiring. Check with your dealer. The arrows on your instrument panel will flash whenever you signal a turn or lane change. Properly hooked up, the trailer lamps will also flash, telling other drivers you are about to turn, change lanes or stop.

When towing a trailer, the arrows on your instrument panel will flash for turns even if the bulbs on the trailer are burned out. Thus, you may think drivers behind you are seeing your signal when they are not. It is important to check occasionally to be sure the trailer bulbs are still working.

Your vehicle has bulb warning lights. When you plug a trailer lighting system into your vehicle's lighting system, its bulb warning lights may not let you know if one of your lamps goes out. So, when you have a trailer lighting system plugged in, be sure to check your vehicle and trailer lamps from time to time to be sure they are all working. Once you disconnect the trailer lamps, the bulb warning lights again can tell you if one of your vehicle lamps is out.

## Driving On Grades

Reduce speed and shift to a lower gear *before* you start down a long or steep downgrade. If you do not shift down, you might have to use your brakes so much that they would get hot and no longer work well.

On a long uphill grade, shift to THIRD (3) and reduce your speed to around 45 mph (70 km/h) to reduce the possibility of engine and transaxle overheating.

## Parking on Hills

### CAUTION:

**You really should not park your vehicle, with a trailer attached, on a hill. If something goes wrong, your rig could start to move. People can be injured, and both your vehicle and the trailer can be damaged.**

But if you ever have to park your rig on a hill, here is how to do it:

1. Apply your regular brakes, but do not shift into PARK (P) yet.
2. Have someone place chocks behind the trailer wheels.
3. When the wheel chocks are in place, release the regular brakes until the chocks absorb the load.
4. Reapply the regular brakes. Then apply your parking brake, and then shift to PARK (P).
5. Release the regular brakes.

## When You Are Ready to Leave After Parking on a Hill

1. Apply your regular brakes and hold the pedal down while you:
  - Start your engine.
  - Shift into a gear.
  - Release the parking brake.
2. Let up on the brake pedal.
3. Drive slowly until the trailer is clear of the chocks.
4. Stop and have someone pick up and store the chocks.

## Maintenance When Trailer Towing

Your vehicle will need service more often when you are pulling a trailer. See the Maintenance Schedule for more on this. Things that are especially important in trailer operation are automatic transaxle fluid (do not overfill), engine oil, drive belt, cooling system and brake system. Each of these is covered in this manual, and the Index will help you find them quickly. If you are trailering, it is a good idea to review this information before you start your trip.

Check periodically to see that all hitch nuts and bolts are tight.

## Engine Cooling When Trailer Towing

Your cooling system may temporarily overheat during severe operating conditions. See *Engine Overheating on page 5-28*.



## Section 5 Service and Appearance Care

---

<b>Service</b> .....	5-3	Radiator Pressure Cap .....	5-27
Doing Your Own Service Work .....	5-3	Engine Overheating .....	5-28
Adding Equipment to the Outside of Your Vehicle .....	5-4	Cooling System .....	5-30
<b>Fuel</b> .....	5-4	Power Steering Fluid .....	5-38
Gasoline Octane .....	5-4	Windshield Washer Fluid .....	5-39
Gasoline Specifications .....	5-5	Brakes .....	5-40
California Fuel .....	5-5	Battery .....	5-43
Additives .....	5-5	Jump Starting .....	5-44
Fuels in Foreign Countries .....	5-6	<b>Headlamp Aiming</b> .....	5-49
Filling Your Tank .....	5-6	<b>Bulb Replacement</b> .....	5-51
Filling a Portable Fuel Container .....	5-9	Halogen Bulbs .....	5-51
<b>Checking Things Under the Hood</b> .....	5-10	Headlamps .....	5-51
Hood Release .....	5-10	Front Turn Signal Lamps .....	5-54
Engine Compartment Overview .....	5-12	Rear Turn Signal, Stoplamps and Back-Up Lamps .....	5-54
Engine Oil .....	5-14	Rear Quarter Panel Turn Signal and Stoplamps .....	5-58
Supercharger Oil .....	5-19	Replacement Bulbs .....	5-60
Engine Air Cleaner/Filter .....	5-20	<b>Windshield Wiper Blade Replacement</b> .....	5-61
Automatic Transaxle Fluid .....	5-23		
Engine Coolant .....	5-25		

## Section 5 Service and Appearance Care

---

<b>Tires</b> .....	5-62	Cleaning the Outside of Your Vehicle .....	5-93
Inflation - Tire Pressure .....	5-69	Sheet Metal Damage .....	5-95
Check Tire Pressure System .....	5-70	Finish Damage .....	5-96
Tire Inspection and Rotation .....	5-72	Underbody Maintenance .....	5-96
When It Is Time for New Tires .....	5-73	Chemical Paint Spotting .....	5-96
Buying New Tires .....	5-74	Vehicle Care/Appearance Materials .....	5-96
Uniform Tire Quality Grading .....	5-75	<b>Vehicle Identification</b> .....	5-98
Wheel Alignment and Tire Balance .....	5-76	Vehicle Identification Number (VIN) .....	5-98
Wheel Replacement .....	5-76	Service Parts Identification Label .....	5-98
Tire Chains .....	5-78	<b>Electrical System</b> .....	5-98
If a Tire Goes Flat .....	5-79	Add-On Electrical Equipment .....	5-98
Changing a Flat Tire .....	5-80	Fuses and Circuit Breakers .....	5-99
Compact Spare Tire .....	5-89	Removing the Rear Seat Cushion .....	5-104
<b>Appearance Care</b> .....	5-90	<b>Capacities and Specifications</b> .....	5-108
Cleaning the Inside of Your Vehicle .....	5-90	<b>Normal Maintenance Replacement Parts</b> .....	5-109
Care of Safety Belts .....	5-93		
Weatherstrips .....	5-93		

## Service

Your dealer knows your vehicle best and wants you to be happy with it. We hope you will go to your dealer for all your service needs. You will get genuine GM parts and GM-trained and supported service people.

We hope you will want to keep your GM vehicle all GM. Genuine GM parts have one of these marks:

***ACDelco***

---

**GM** Parts

---

**GM**  
Goodwrench

---

**GM** Accessories

## Doing Your Own Service Work

If you want to do some of your own service work, you will want to use the proper service manual. It tells you much more about how to service your vehicle than this manual can. To order the proper service manual, see *Service Publications Ordering Information on page 7-11*.

Your vehicle has an air bag system. Before attempting to do your own service work, see *Servicing Your Air Bag-Equipped Vehicle on page 1-58*.

You should keep a record with all parts receipts and list the mileage and the date of any service work you perform. See *Part E: Maintenance Record on page 6-26*.

### CAUTION:

You can be injured and your vehicle could be damaged if you try to do service work on a vehicle without knowing enough about it.

CAUTION: (Continued)

## CAUTION: (Continued)

- **Be sure you have sufficient knowledge, experience, the proper replacement parts and tools before you attempt any vehicle maintenance task.**
- **Be sure to use the proper nuts, bolts and other fasteners. “English” and “metric” fasteners can be easily confused. If you use the wrong fasteners, parts can later break or fall off. You could be hurt.**

## Adding Equipment to the Outside of Your Vehicle

Things you might add to the outside of your vehicle can affect the airflow around it. This may cause wind noise and affect windshield washer performance. Check with your dealer before adding equipment to the outside of your vehicle.

## Fuel

The 8th digit of your vehicle identification number (VIN) shows the code letter or number that identifies your engine. You will find the VIN at the top left of the instrument panel. See *Vehicle Identification Number (VIN) on page 5-98*.

## Gasoline Octane

If your vehicle has the 3800 V6 engine (VIN Code K), use regular unleaded gasoline with a posted octane of 87 or higher. If the octane is less than 87, you may get a heavy knocking noise when you drive. If this occurs, use a gasoline rated at 87 octane or higher as soon as possible. Otherwise, you might damage your engine. A little pinging noise when you accelerate or drive uphill is considered normal. This does not indicate a problem exists or that a higher-octane fuel is necessary. If you are using 87 octane or higher-octane fuel and you hear heavy knocking, your engine needs service.

If your vehicle has the 3800 Supercharged V6 engine (VIN Code 1), use only premium unleaded gasoline with a posted octane of 91 or higher. In an emergency, you may be able to use a lower octane — as low as 87 — if heavy knocking does not occur.



Refill your tank with premium fuel as soon as possible. Otherwise, you might damage your engine. If you are using 91 octane or higher-octane fuel and you hear heavy knocking, your engine needs service.

## Gasoline Specifications

It is recommended that gasoline meet specifications which were developed by automobile manufacturers around the world and contained in the World-Wide Fuel Charter which is available from the Alliance of Automobile Manufacturers at [www.autoalliance.org](http://www.autoalliance.org). Gasoline meeting these specifications could provide improved driveability and emission control system performance compared to other gasoline.



Canada Only

In Canada, look for the “Auto Makers’ Choice” label on the pump.

## California Fuel

If your vehicle is certified to meet California Emission Standards (see the underhood emission control label), it is designed to operate on fuels that meet California specifications. If this fuel is not available in states adopting California emissions standards, your vehicle will operate satisfactorily on fuels meeting federal specifications, but emission control system performance may be affected. The malfunction indicator lamp may turn on (see *Malfunction Indicator Lamp on page 3-41*) and your vehicle may fail a smog-check test. If this occurs, return to your authorized GM dealer for diagnosis. If it is determined that the condition is caused by the type of fuel used, repairs may not be covered by your warranty.

## Additives

To provide cleaner air, all gasolines in the United States are now required to contain additives that will help prevent engine and fuel system deposits from forming, allowing your emission control system to work properly. You should not have to add anything to your fuel. However, some gasolines contain only the minimum amount of additive required to meet U.S. Environmental Protection Agency regulations.

General Motors recommends that you buy gasolines that are advertised to help keep fuel injectors and intake valves clean. If your vehicle experiences problems due to dirty injectors or valves, try a different brand of gasoline.

Gasolines containing oxygenates, such as ethers and ethanol, and reformulated gasolines may be available in your area to contribute to clean air. General Motors recommends that you use these gasolines, particularly if they comply with the specifications described earlier.

**Notice: Your vehicle was not designed for fuel that contains methanol. Do not use fuel containing methanol. It can corrode metal parts in your fuel system and also damage the plastic and rubber parts. That damage would not be covered under your warranty.**

Some gasolines that are not reformulated for low emissions may contain an octane-enhancing additive called methylcyclopentadienyl manganese tricarbonyl (MMT); ask the attendant where you buy gasoline whether the fuel contains MMT. General Motors does not recommend the use of such gasolines. Fuels containing MMT can reduce the life of spark plugs and the performance of the emission control system may be affected. The malfunction indicator lamp may turn on. If this occurs, return to your authorized GM dealer for service.

## Fuels in Foreign Countries

If you plan on driving in another country outside the United States or Canada, the proper fuel may be hard to find. Never use leaded gasoline or any other fuel not recommended in the previous text on fuel. Costly repairs caused by use of improper fuel would not be covered by your warranty.

To check the fuel availability, ask an auto club, or contact a major oil company that does business in the country where you will be driving.

## Filling Your Tank

### CAUTION:

**Fuel vapor burns violently and a fuel fire can cause bad injuries. To help avoid injuries to you and others, read and follow all the instructions on the pump island. Turn off your engine when you are refueling. Do not smoke if you are near fuel or refueling your vehicle.**

**CAUTION: (Continued)**

## CAUTION: (Continued)

Keep sparks, flames and smoking materials away from fuel. Do not leave the fuel pump unattended when refueling your vehicle — this is against the law in some places. Keep children away from the fuel pump; never let children pump fuel.

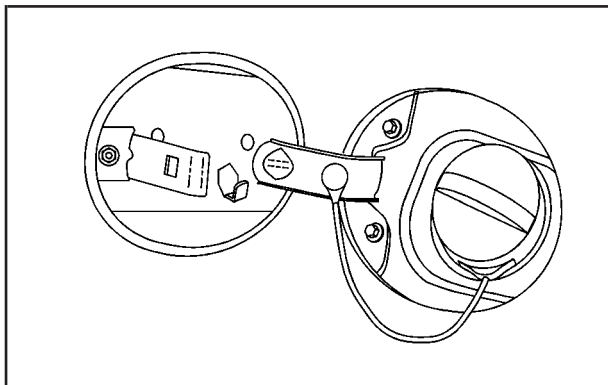

The tethered fuel cap is located behind a hinged fuel door on the driver's side of the vehicle.



The release button for the fuel door is located to the left of the steering column.



There is also a manual fuel door release. It is located in the top of the trunk compartment, on the driver's side of the vehicle.

Pull the tab to release the fuel door.

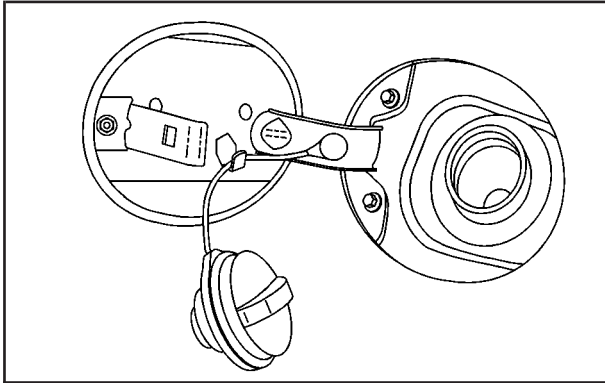

While refueling, hang the tethered fuel cap from the hook on the fuel door.

To remove the fuel cap, turn it slowly to the left (counterclockwise). The fuel cap has a spring in it; if you let the cap go too soon, it will spring back to the right.

## **⚠ CAUTION:**

**If you spill fuel and then something ignites it, you could be badly burned. Fuel can spray out on you if you open the fuel cap too quickly. This spray can happen if your tank is nearly full, and is more likely in hot weather. Open the fuel cap slowly and wait for any “hiss” noise to stop. Then unscrew the cap all the way.**

Be careful not to spill fuel. Don't top off or overfill your tank and wait a few seconds after you've finished pumping before you remove the nozzle. Clean fuel from painted surfaces as soon as possible. See *Cleaning the Outside of Your Vehicle* on page 5-93.

When you put the fuel cap back on, turn it to the right (clockwise) until you hear a clicking sound. Make sure you fully install the cap. The diagnostic system can determine if the fuel cap has been left off or improperly installed. This would allow fuel to evaporate into the atmosphere. See *Malfunction Indicator Lamp on page 3-41*.

 **CAUTION:**

If a fire starts while you are refueling, do not remove the nozzle. Shut off the flow of fuel by shutting off the pump or by notifying the station attendant. Leave the area immediately.

**Notice:** If you need a new fuel cap, be sure to get the right type. Your dealer can get one for you. If you get the wrong type, it may not fit properly. This may cause your malfunction indicator lamp to light and may damage your fuel tank and emissions system. See “Malfunction Indicator Lamp” in the Index.

## Filling a Portable Fuel Container

 **CAUTION:**

Never fill a portable fuel container while it is in your vehicle. Static electricity discharge from the container can ignite the gasoline vapor. You can be badly burned and your vehicle damaged if this occurs. To help avoid injury to you and others:

- Dispense gasoline only into approved containers.
- Do not fill a container while it is inside a vehicle, in a vehicle’s trunk, pickup bed or on any surface other than the ground.
- Bring the fill nozzle in contact with the inside of the fill opening before operating the nozzle. Contact should be maintained until the filling is complete.
- Do not smoke while pumping gasoline.

## Checking Things Under the Hood

### CAUTION:

An electric fan under the hood can start up and injure you even when the engine is not running. Keep hands, clothing and tools away from any underhood electric fan.

### CAUTION:

Things that burn can get on hot engine parts and start a fire. These include liquids like fuel, oil, coolant, brake fluid, windshield washer and other fluids, and plastic or rubber. You or others could be burned. Be careful not to drop or spill things that will burn onto a hot engine.

## Hood Release

To open the hood, do the following:



1. Pull the handle inside the vehicle. It is located on the lower left side of the instrument panel.



2. Then go to the front of the vehicle and locate the secondary hood release lever under the front edge of the grille.

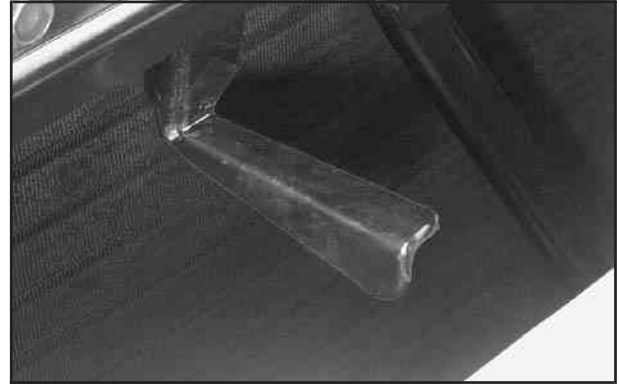

3. Lift up on this lever as you lift up the hood.  
Before closing the hood, be sure all the filler caps are on properly. Then pull the hood down and close it firmly.

## Engine Compartment Overview

When you open the hood on the 3800 (L36) engine (3800 Supercharged (L67) engine similar), here's what you will see:

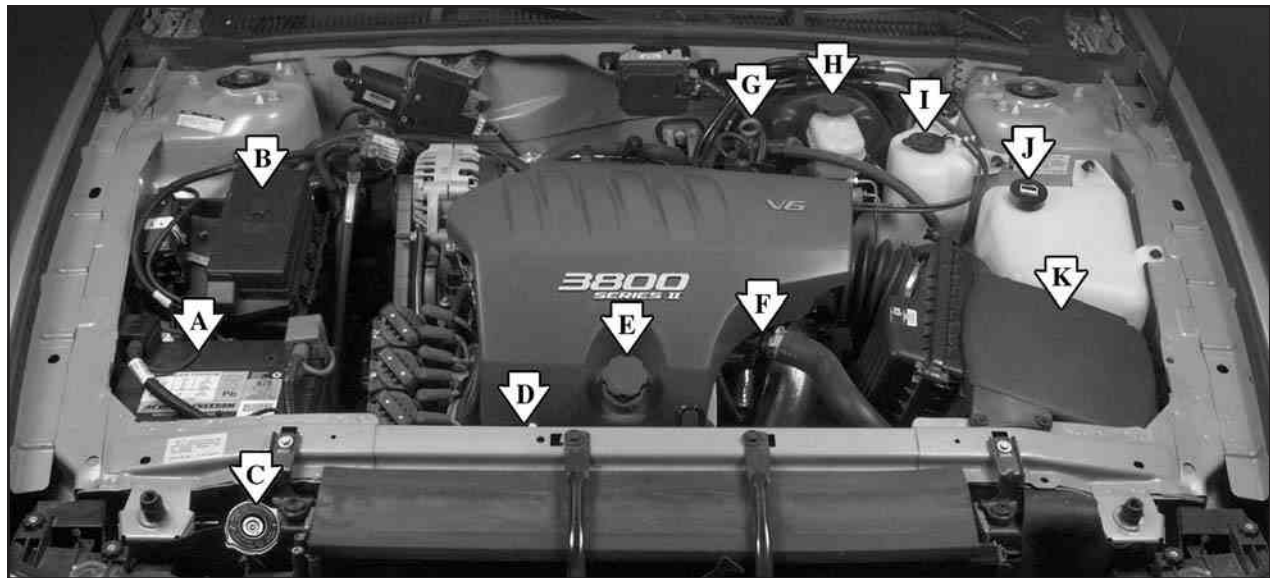



- A. Battery. See *Battery on page 5-43.*
- B. Underhood Fuse Block. See “Underhood Fuse Block” under *Fuses and Circuit Breakers on page 5-99.*
- C. Radiator Pressure Cap. See *Radiator Pressure Cap on page 5-27.*
- D. Engine Oil Dipstick. See “Checking Engine Oil” under *Engine Oil on page 5-14.*
- E. Engine Oil Fill Cap. See “When to Add Engine Oil” under *Engine Oil on page 5-14.*
- F. Engine Coolant Air Bleed Valve. See “How to Add Coolant to the Radiator” under *Cooling System on page 5-30.*
- G. Automatic Transaxle Fluid Dipstick. See “Checking the Fluid Level” under *Automatic Transaxle Fluid on page 5-23.*
- H. Brake Master Cylinder Reservoir. See “Brake Fluid” under *Brakes on page 5-40.*
- I. Windshield Washer Fluid Reservoir. See “Adding Washer Fluid” under *Windshield Washer Fluid on page 5-39.*
- J. Engine Coolant Recovery Tank. See *Cooling System on page 5-30.*
- K. Engine Air Cleaner/Filter. See *Engine Air Cleaner/Filter on page 5-20.*

## Engine Oil

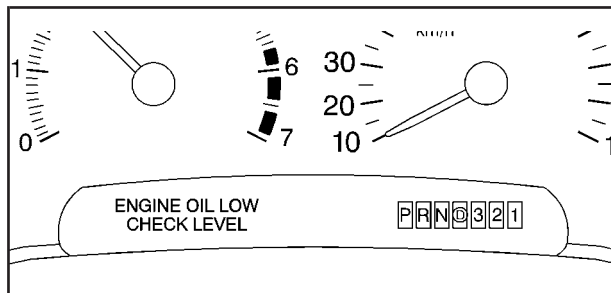

If the DIC message, ENGINE OIL LOW — CHECK LEVEL appears on the instrument cluster, it means you need to check your engine oil level right away. For more information, see *Driver Information Center (DIC)* on page 3-47.

You should check your engine oil level regularly; this is an added reminder.

## Checking Engine Oil

It is a good idea to check your engine oil every time you get fuel. In order to get an accurate reading, the oil must be warm and the vehicle must be on level ground.

The engine oil dipstick handle is a yellow loop. See *Engine Compartment Overview* on page 5-12 for the location of the engine oil dipstick.

Turn off the engine and give the oil several minutes to drain back into the oil pan. If you don't, the oil dipstick might not show the actual level.

Pull out the dipstick and clean it with a paper towel or cloth, then push it back in all the way. Remove it again, keeping the tip down, and check the level.

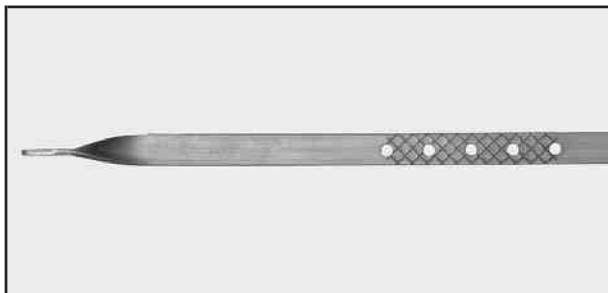

## When to Add Engine Oil

If the oil is at or below the cross-hatched area at the tip of the dipstick, then you will need to add at least one quart of oil. But you must use the right kind. This section explains what kind of oil to use. For engine oil crankcase capacity, see *Capacities and Specifications on page 5-108*.

**Notice:** Do not add too much oil. If your engine has so much oil that the oil level gets above the cross-hatched area that shows the proper operating range, your engine could be damaged.



See *Engine Compartment Overview on page 5-12* for the location of the engine oil fill cap.

Be sure to add enough oil to put the level somewhere in the proper operating range in the cross-hatched area. Push the dipstick all the way back in when you are through.

## What Kind of Engine Oil to Use

Look for two things:

- GM6094M  
Your vehicle's engine requires oil meeting GM Standard GM6094M. You should look for and use only an oil that meets GM Standard GM6094M.

RECOMMENDED SAE VISCOSITY GRADE ENGINE OILS

HOT  
WEATHER

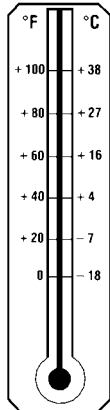

COLD  
WEATHER

LOOK FOR  
THIS SYMBOL  
AND GM  
STANDARD  
GM 6094M



SAE 5W-30  
RECOMMENDED

SAE 10W-30  
ACCEPTABLE  
IF 5W-30 IS NOT  
AVAILABLE

DO NOT USE SAE 10W-40, SAE 20W-50 OR ANY OTHER  
VISCOSITY GRADE OIL NOT RECOMMENDED

- SAE 5W-30

As shown in the viscosity chart, SAE 5W-30 is best for your vehicle. However, if it is going to be 0°F (-18°C) or above and SAE 5W-30 is not available, you may use SAE 10W-30.

These numbers on an oil container show its viscosity, or thickness. Do not use other viscosity oils such as SAE 20W-50.

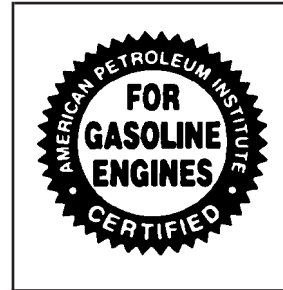

Oils meeting these requirements should also have the starburst symbol on the container. This symbol indicates that the oil has been certified by the American Petroleum Institute (API).

You should look for this information on the oil container, and use *only* those oils that are identified as meeting GM Standard GM6094M and have the starburst symbol on the front of the oil container.

**Notice:** Use only engine oil identified as meeting GM Standard GM6094M and showing the American Petroleum Institute Certified For Gasoline Engines starburst symbol. Failure to use the recommended oil can result in engine damage not covered by your warranty.

GM Goodwrench® oil meets all the requirements for your vehicle.

If you are in an area of extreme cold, where the temperature falls below  $-20^{\circ}\text{F}$  ( $-29^{\circ}\text{C}$ ) it is recommended that you use either an SAE 5W-30 synthetic oil or an SAE 0W-30 oil. Both will provide easier cold starting and better protection for your engine at extremely low temperatures.

## Engine Oil Additives

Do not add anything to your oil. The recommended oils with the starburst symbol that meet GM Standard GM6094M are all you will need for good performance and engine protection.

## When to Change Engine Oil (Vehicles Without the GM Oil Life System)

If any one of these is true for you, use the short trip/city maintenance schedule:

- Most trips are less than 5 miles (8 km). This is particularly important when outside temperatures are below freezing.
- Most trips include extensive idling (such as frequent driving in stop-and-go traffic).
- You frequently tow a trailer or use a carrier on top of your vehicle.
- The vehicle is used for delivery service, police, taxi or other commercial application.

Driving under these conditions causes engine oil to break down sooner. If any one of these is true for your vehicle, then you need to change your oil and filter every 3,000 miles (5 000 km) or 3 months — whichever occurs first.

If none of them is true, use the long trip/highway maintenance schedule. Change the oil and filter every 7,500 miles (12 500 km) or 12 months — whichever occurs first. Driving a vehicle with a fully warmed engine under highway conditions will cause engine oil to break down slower.

## When to Change Engine Oil (Vehicles With the GM Oil Life System)

If so equipped, your vehicle has a computer system that lets you know when to change the engine oil and filter. This is based on engine revolutions and engine temperature, and not on mileage. Based on driving conditions, the mileage at which an oil change will be indicated can vary considerably. For the oil life system to work properly, you must reset the system every time the oil is changed.

When the system has calculated that oil life has been diminished, it will indicate that an oil change is necessary. A CHANGE ENGINE OIL SOON message will come on. Change your oil as soon as possible within the next two times you stop for fuel. It is possible that, if you are driving under the best conditions, the oil life system may not indicate that an oil change is necessary for over a year. However, your engine oil and filter must be changed at least once a year and at this time the system must be reset. Your dealer has GM-trained service people who will perform this work using genuine GM parts and reset the system. It is also important to check your oil regularly and keep it at the proper level.

If the system is ever reset accidentally, you must change your oil at 3,000 miles (5 000 km) since your last oil change. Remember to reset the oil life system whenever the oil is changed.

## How to Reset the Oil Life System

The GM Oil Life System calculates when to change your engine oil and filter based on vehicle use. Anytime your oil is changed, reset the system so it can calculate when the next oil change is required. If a situation occurs where you change your oil prior to a CHANGE ENGINE OIL SOON message being turned on, reset the system.

Always reset the engine oil life to 100% after every oil change. It will not reset itself. To reset the Oil Life System, do the following:

1. Display OIL LIFE INDEX on the DIC.
2. Press and hold the DIC RESET button for more than five seconds. The oil life will change to 100%.
3. Turn the key to OFF.

If the CHANGE ENGINE OIL SOON message comes back on when you start your vehicle, the engine oil life system has not reset. Repeat the procedure.

## What to Do with Used Oil

Used engine oil contains certain elements that may be unhealthy for your skin and could even cause cancer. Do not let used oil stay on your skin for very long. Clean your skin and nails with soap and water, or a good hand cleaner. Wash or properly dispose of clothing or rags containing used engine oil. See the manufacturer's warnings about the use and disposal of oil products.

Used oil can be a threat to the environment. If you change your own oil, be sure to drain all the oil from the filter before disposal. Never dispose of oil by putting it in the trash, pouring it on the ground, into sewers, or into streams or bodies of water. Instead, recycle it by taking it to a place that collects used oil. If you have a problem properly disposing of your used oil, ask your dealer, a service station or a local recycling center for help.

## Supercharger Oil

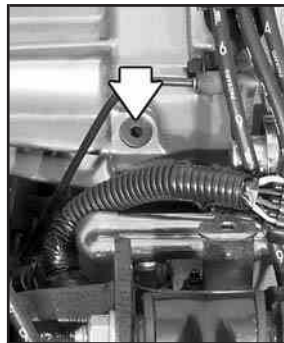

Unless you are technically qualified and have the proper tools, you should let your dealer or a qualified service center perform this maintenance.

### When to Check

Check oil level every 30,000 miles (50 000 km) or every 36 months, whichever occurs first.

### What Kind of Oil to Use

Use only the recommended supercharger oil. See *Part D: Recommended Fluids and Lubricants* on page 6-25.

## How to Check and Add Oil

Park the vehicle on a level surface. Check oil only when the engine is cold. Allow the engine to cool two to three hours after running.

### CAUTION:

**If you remove the supercharger oil fill plug while the engine is hot, pressure may cause hot oil to blow out of the oil fill hole. You may be burned. Do not remove the plug until the engine cools.**

1. Clean the area around the oil fill plug before removing it.
2. Remove the oil fill plug.
3. The oil level is correct when it just reaches the bottom of the threads of the inspection hole.
4. Replace the oil plug with the O-ring in place. Tighten to 88 lb-in (10 N•m).

## Engine Air Cleaner/Filter



See *Engine Compartment Overview* on page 5-12 for the location of the engine air cleaner/filter.

### When to Inspect the Engine Air Cleaner/Filter

Inspect the air cleaner/filter every 15,000 miles (25 000 km) and replace every 30,000 miles (50 000 km). If you are driving in dusty/dirty conditions, inspect the filter at each engine oil change.



## How to Inspect the Engine Air Cleaner/Filter

To inspect the air cleaner/filter remove the filter from the vehicle and lightly shake the filter to release loose dust and dirt. If the filter remains caked with dirt, a new filter is required.

To inspect or replace the engine air cleaner/filter, do the following:



1. Remove the wing nuts on the engine air cleaner/filter housing cover.



2. Remove the air intake hose that snaps over the throttle body by pulling the hose upward and away from the throttle body. As you are detaching the hose, remove the housing cover by pulling upward and rearward.

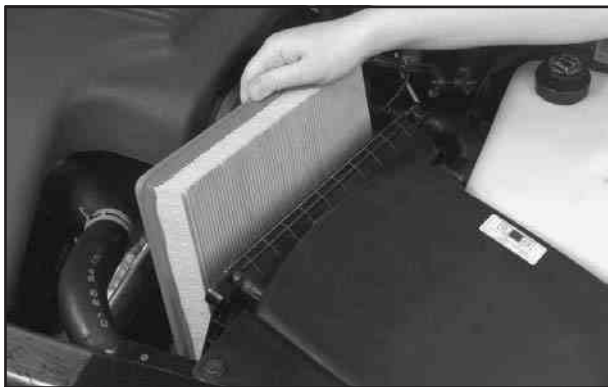

3. Inspect or replace the engine air cleaner/filter.
4. Reattach the air intake hose.
5. Reinstall the air cleaner housing cover.

**⚠ CAUTION:**

Operating the engine with the air cleaner/filter off can cause you or others to be burned. The air cleaner not only cleans the air, it helps to stop flame if the engine backfires. If it is not there and the engine backfires, you could be burned. Do not drive with it off, and be careful working on the engine with the air cleaner/filter off.

**Notice:** If the air cleaner/filter is off, a backfire can cause a damaging engine fire. And, dirt can easily get into your engine, which will damage it. Always have the air cleaner/filter in place when you're driving.

## Automatic Transaxle Fluid

### When to Check and Change

A good time to check your automatic transaxle fluid level is when the engine oil is changed.

Change both the fluid and filter every 50,000 miles (83 000 km) if the vehicle is mainly driven under one or more of these conditions:

- In heavy city traffic where the outside temperature regularly reaches 90°F (32°C) or higher.
- In hilly or mountainous terrain.
- When doing frequent trailer towing.
- Uses such as found in taxi, police or delivery service.

If you do not use your vehicle under any of these conditions, change the fluid and filter at 100,000 miles (166 000 km).

### How to Check

Because this operation can be a little difficult, you may choose to have this done at the dealership service department.

If you do it yourself, be sure to follow all the instructions here, or you could get a false reading on the dipstick.

**Notice:** Too much or too little fluid can damage the transaxle. Too much can mean that some of the fluid could come out and fall on hot engine or exhaust system parts, starting a fire. Too little fluid could cause the transaxle to overheat. Be sure to get an accurate reading if you check the transaxle fluid.

Wait at least 30 minutes before checking the transaxle fluid level if you have been driving:

- When outside temperatures are above 90°F (32°C).
- At high speed for quite a while.
- In heavy traffic — especially in hot weather.
- While pulling a trailer.

To get the right reading, the fluid should be at normal operating temperature, which is 180°F to 200°F (82°C to 93°C).

Get the vehicle warmed up by driving about 15 miles (24 km) when outside temperatures are above 50°F (10°C). If it is colder than 50°F (10°C), you may have to drive longer.

## Checking the Fluid Level

Prepare your vehicle as follows:

- Park your vehicle on a level place. Keep the engine running.
- With the parking brake applied, place the shift lever in PARK (P).
- With your foot on the brake pedal, move the shift lever through each gear range, pausing for about three seconds in each range. Then, position the shift lever in PARK (P).
- Let the engine run at idle for three to five minutes.

Then, without shutting off the engine, follow these steps:



The transaxle fluid dipstick top is a round, red loop and is located next to the brake master cylinder reservoir behind the engine block. See *Engine Compartment Overview* on page 5-12 for more information on location.

1. Pull out the dipstick and wipe it with a clean rag or paper towel.
2. Push it back in all the way, wait three seconds and then pull it back out again.

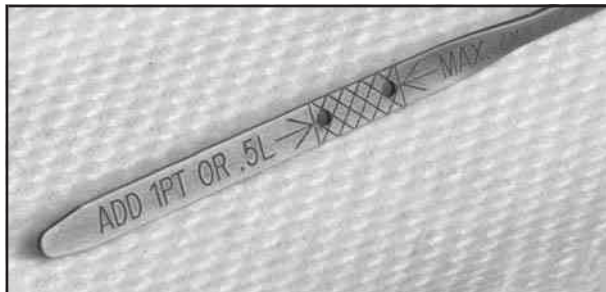

3. Check both sides of the dipstick, and read the lower level. The fluid level must be in the cross-hatched area.
4. If the fluid level is in the acceptable range, push the dipstick back in all the way.

## How to Add Fluid

Refer to the Maintenance Schedule to determine what kind of transaxle fluid to use. See *Part D: Recommended Fluids and Lubricants on page 6-25*.

If the fluid level is low, add only enough of the proper fluid to bring the level into the cross-hatched area on the dipstick.

1. Pull out the dipstick.
2. Using a long-neck funnel, add enough fluid at the dipstick hole to bring it to the proper level.

It does not take much fluid, generally less than one pint (0.5 L). *Do not overfill.*

**Notice:** We recommend you use only fluid labeled DEXRON®-III, because fluid with that label is made especially for your automatic transmission. Damage caused by fluid other than DEXRON®-III is not covered by your new vehicle warranty.

3. After adding fluid, recheck the fluid level as described under “How to Check,” earlier in this section.
4. When the correct fluid level is obtained, push the dipstick back in all the way.

## Engine Coolant

The cooling system in your vehicle is filled with DEX-COOL® engine coolant. This coolant is designed to remain in your vehicle for 5 years or 150,000 miles (240 000 km), whichever occurs first, if you add only DEX-COOL® extended life coolant.

The following explains your cooling system and how to add coolant when it is low. If you have a problem with engine overheating, see *Engine Overheating on page 5-28*.

A 50/50 mixture of clean, drinkable water and DEX-COOL® will:

- Give freezing protection down to -34°F (-37°C).
- Give boiling protection up to 265°F (129°C).
- Protect against rust and corrosion.
- Help keep the proper engine temperature.
- Let the warning lights and gages work as they should.

**Notice:** Using coolant other than DEX-COOL® may cause premature engine, heater core or radiator corrosion. In addition, the engine coolant may require changing sooner, at 30,000 miles (50 000 km) or 24 months, whichever occurs first. Any repairs would not be covered by your warranty. Always use DEX-COOL®(silicate-free) coolant in your vehicle.

## What to Use

Use a mixture of one-half *clean, drinkable water* and one-half DEX-COOL<sup>®</sup> coolant which will not damage aluminum parts. If you use this coolant mixture you do not need to add anything else.

### CAUTION:

Adding only plain water to your cooling system can be dangerous. Plain water, or some other liquid such as alcohol, can boil before the proper coolant mixture will. Your vehicle's coolant warning system is set for the proper coolant mixture. With plain water or the wrong mixture, your engine could get too hot but you would not get the overheat warning. Your engine could catch fire and you or others could be burned. Use a 50/50 mixture of clean, drinkable water and DEX-COOL<sup>®</sup> coolant.

**Notice:** If you use an improper coolant mixture, your engine could overheat and be badly damaged. The repair cost wouldn't be covered by your warranty. Too much water in the mixture can freeze and crack the engine, radiator, heater core and other parts.

If you have to add coolant more than four times a year, have your dealer check your cooling system.

**Notice:** If you use the proper coolant, you don't have to add extra inhibitors or additives which claim to improve the system. These can be harmful.

## Checking Coolant



The coolant recovery tank is located in the engine compartment on the driver's side of the vehicle. See *Engine Compartment Overview* on page 5-12 for more information on location.

The vehicle must be on a level surface. When your engine is cold, the coolant level should be at FULL COLD or a little higher. When your engine is warm, the level should be up to FULL HOT or a little higher.

## Adding Coolant

If you need more coolant, add the proper DEX-COOL<sup>®</sup> coolant mixture *at the coolant recovery tank*, but be careful not to spill it.

### CAUTION:

Turning the radiator pressure cap when the engine and radiator are hot can allow steam and scalding liquids to blow out and burn you badly. With the coolant recovery tank, you will almost never have to add coolant at the radiator. Never turn the radiator pressure cap — even a little — when the engine and radiator are hot.

### CAUTION:

You can be burned if you spill coolant on hot engine parts. Coolant contains ethylene glycol, and it will burn if the engine parts are hot enough. Don't spill coolant on a hot engine.

Occasionally check the coolant level in the radiator. For information on how to add coolant to the radiator, see *Cooling System* on page 5-30.

## Radiator Pressure Cap

**Notice:** The radiator cap on your vehicle is a pressure-type cap and must be tightly installed to prevent coolant loss and possible engine damage from overheating. Be sure the arrows on the cap line up with the overflow tube on the radiator filler neck.

See *Engine Compartment Overview* on page 5-12 for more information on location.

## Engine Overheating

You will find a warning light about a hot engine, as well as a coolant temperature gage, on your instrument panel.

### If Steam Is Coming From Your Engine



### CAUTION:

Steam from an overheated engine can burn you badly, even if you just open the hood. Stay away from the engine if you see or hear steam coming from it. Just turn it off and get everyone away from the vehicle until it cools down. Wait until there is no sign of steam or coolant before you open the hood.

If you keep driving when your engine is overheated, the liquids in it can catch fire. You or others could be badly burned. Stop your engine if it overheats, and get out of the vehicle until the engine is cool.

**Notice:** If your engine catches fire because you keep driving with no coolant, your vehicle can be badly damaged. The costly repairs would not be covered by your warranty.



## If No Steam Is Coming From Your Engine

If you get an engine overheat warning but see or hear no steam, the problem may not be too serious. Sometimes the engine can get a little too hot when you:

- Climb a long hill on a hot day.
- Stop after high-speed driving.
- Idle for long periods in traffic.
- Tow a trailer.

If you get the overheat warning with no sign of steam, try this for a minute or so:

1. In heavy traffic, let the engine idle in NEUTRAL (N) while stopped. If it is safe to do so, pull off the road, shift to PARK (P) or NEUTRAL (N) and let the engine idle.
2. Turn on your heater to full hot at the highest fan speed and open the window as necessary.

If you no longer have the overheat warning, you can drive. Just to be safe, drive slower for about 10 minutes. If the warning doesn't come back on, you can drive normally.

If the warning continues and you have not stopped, pull over, stop, and park your vehicle right away.

If there's still no sign of steam, you can idle the engine for three minutes while you're parked. If you still have the warning, *turn off the engine and get everyone out of the vehicle* until it cools down.

You may decide not to lift the hood but to get service help right away.

## Cooling System

When you decide it is safe to lift the hood, here is what you will see:

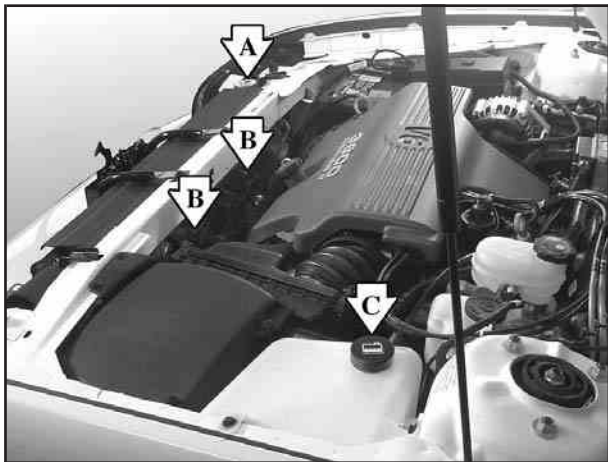

- A. Radiator Pressure Cap
- B. Electric Engine Cooling Fans
- C. Coolant Recovery Tank

### CAUTION:

An electric engine cooling fan under the hood can start up even when the engine is not running and can injure you. Keep hands, clothing and tools away from any underhood electric fan.

If the coolant inside the coolant recovery tank is boiling, do not do anything else until it cools down. The vehicle should be parked on a level surface.



See *Engine Compartment Overview* on page 5-12 for more information on location.

The coolant level should be at or above the FULL COLD mark. If it is not, you may have a leak at the pressure cap or in the radiator hoses, heater hoses, radiator, water pump or somewhere else in the cooling system.

 **CAUTION:**

Heater and radiator hoses, and other engine parts, can be very hot. Do not touch them. If you do, you can be burned.

Do not run the engine if there is a leak. If you run the engine, it could lose all coolant. That could cause an engine fire, and you could be burned. Get any leak fixed before you drive the vehicle.

If there seems to be no leak, with the engine on, check to see if the electric engine cooling fans are running. If the engine is overheating, both fans should be running. If they are not, your vehicle needs service.

**Notice:** Engine damage from running your engine without coolant isn't covered by your warranty.

**Notice:** Using coolant other than DEX-COOL<sup>®</sup> may cause premature engine, heater core or radiator corrosion. In addition, the engine coolant may require changing sooner, at 30,000 miles (50 000 km) or 24 months, whichever occurs first. Any repairs would not be covered by your warranty. Always use DEX-COOL<sup>®</sup>(silicate-free) coolant in your vehicle.

## How to Add Coolant to the Coolant Recovery Tank

If you have not found a problem yet, but the coolant level is not at or above the FULL COLD mark, add a 50/50 mixture of *clean, drinkable water* and DEX-COOL<sup>®</sup> engine coolant at the coolant recovery tank. See *Engine Coolant* on page 5-25 for more information.

### CAUTION:

Adding only plain water to your cooling system can be dangerous. Plain water, or some other liquid such as alcohol, can boil before the proper coolant mixture will. Your vehicle's coolant warning system is set for the proper coolant mixture. With plain water or the wrong mixture, your engine could get too hot but you would not get the overheat warning. Your engine could catch fire and you or others could be burned. Use a 50/50 mixture of clean, drinkable water and DEX-COOL<sup>®</sup> coolant.

**Notice:** In cold weather, water can freeze and crack the engine, radiator, heater core and other parts. Use the recommended coolant and the proper coolant mixture.



### CAUTION:

You can be burned if you spill coolant on hot engine parts. Coolant contains ethylene glycol and it will burn if the engine parts are hot enough. Do not spill coolant on a hot engine.

When the coolant in the coolant recovery tank is at or above the FULL COLD mark, start your vehicle.

If the overheat warning continues, there is one more thing you can try. You can add the proper coolant mixture directly to the radiator, but be sure the cooling system is cool before you do it.

**⚠ CAUTION:**

**Steam and scalding liquids from a hot cooling system can blow out and burn you badly. They are under pressure, and if you turn the radiator pressure cap — even a little — they can come out at high speed. Never turn the cap when the cooling system, including the radiator pressure cap, is hot. Wait for the cooling system and radiator pressure cap to cool if you ever have to turn the pressure cap.**

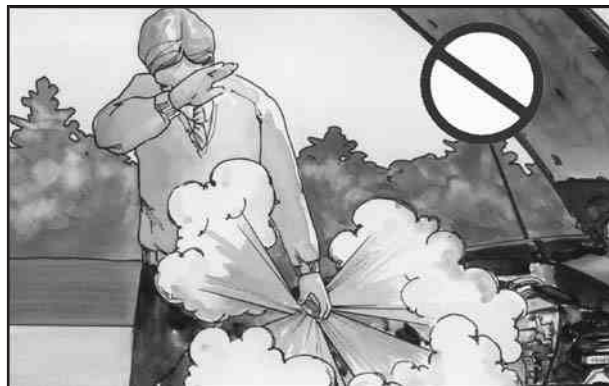

## How to Add Coolant to the Radiator

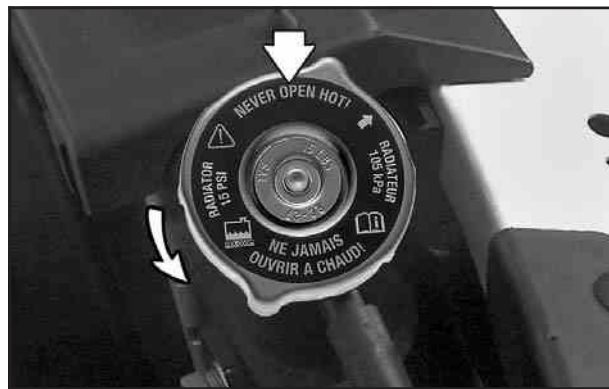
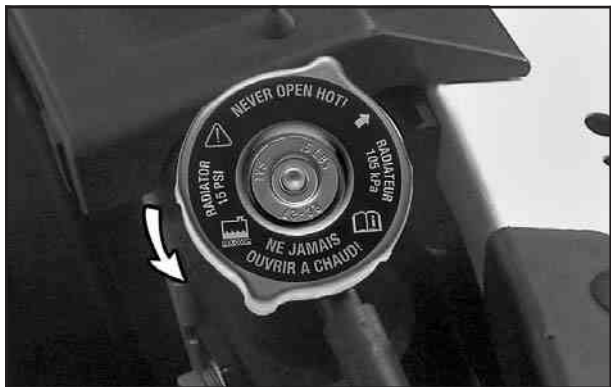

1. You can remove the radiator pressure cap when the cooling system, including the radiator pressure cap and upper radiator hose, is no longer hot. Turn the pressure cap slowly counterclockwise until it first stops. Do not press down while turning the pressure cap.

If you hear a hiss, wait for that to stop. A hiss means there is still some pressure left.

2. Then keep turning the pressure cap, but now push down as you turn it. Remove the pressure cap.
3. Remove the 3800 Series II V6 engine cover shield to access the bleed valve.

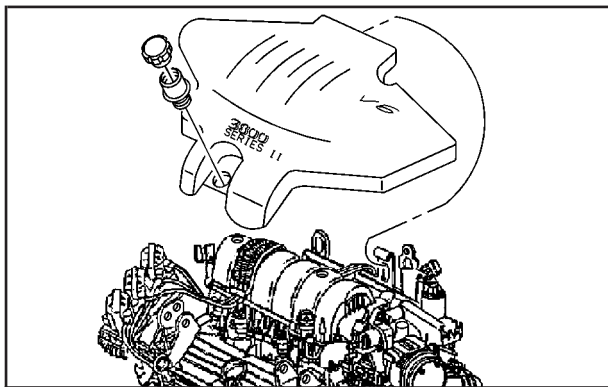

- 3.1. Clean the area around the engine oil fill tube and cap before removing. Twist the oil fill tube, with cap attached, counterclockwise and remove it.
- 3.2. If you have the supercharged engine, remove the nut in the center of the cover shield.

- 3.3. Lift the engine cover shield at the front, slide the catch tab out of the engine bracket and remove the cover shield.
- 3.4. Put the oil fill tube, with cap attached, in the valve cover oil fill hole until you are ready to replace the cover shield.



4. After the engine cools, open the coolant air bleed valve. There is one bleed valve. It is located on the thermostat housing.



5. Fill the radiator with the proper DEX-COOL® coolant mixture, up to the base of the filler neck. See *Engine Coolant on page 5-25* for more information about the proper coolant mixture.

If you see a stream of coolant coming from an air bleed valve, close the valve. Otherwise, close the valve after the radiator is filled.

6. Rinse or wipe any spilled coolant from the engine and the compartment.
7. Replace the 3800 Series II V6 engine cover shield.
  - 7.1. Remove the oil fill tube, with cap attached, from the valve cover.
  - 7.2. Insert the catch tab on the cover shield under the bracket on the engine.
  - 7.3. Place the hole in the cover shield over the hole in the valve cover. Install oil fill tube and cap by twisting clockwise.
  - 7.4. If you have the supercharged engine, install the nut in the center of the cover shield.
8. Then fill the coolant recovery tank to the FULL COLD mark.
9. Put the cap back on the coolant recovery tank, but leave the radiator pressure cap off.





10. Start the engine and let it run until you can feel the upper radiator hose getting hot. Watch out for the engine cooling fans.
11. By this time, the coolant level inside the radiator filler neck may be lower. If the level is lower, add more of the proper DEX-COOL<sup>®</sup> coolant mixture through the filler neck until the level reaches the base of the filler neck.



12. Then replace the pressure cap. At any time during this procedure if coolant begins to flow out of the filler neck, reinstall the pressure cap. Be sure the arrow on the pressure cap lines up like this.

## Power Steering Fluid

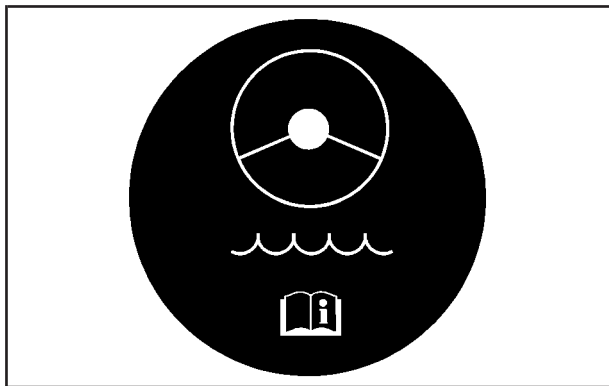

The power steering fluid reservoir is located below the generator and behind the accessory drive belt in the rear of the engine compartment on the passenger's side of the vehicle.

### When to Check Power Steering Fluid

It is not necessary to regularly check power steering fluid unless you suspect there is a leak in the system or you hear an unusual noise. A fluid loss in this system could indicate a problem. Have the system inspected and repaired.

## How to Check Power Steering Fluid

1. Turn the key off and let the engine compartment cool down.
2. Wipe the cap and the top of the reservoir clean.
3. Unscrew the cap and wipe the dipstick with a clean rag.
4. Replace the cap and completely tighten it.
5. Then remove the cap again and look at the fluid level on the dipstick.

The level should be at the FULL COLD mark. If necessary, add only enough fluid to bring the level up to the mark.

## What to Use

To determine what kind of fluid to use, see *Part D: Recommended Fluids and Lubricants on page 6-25*. Always use the proper fluid. Failure to use the proper fluid can cause leaks and damage hoses and seals.

## Windshield Washer Fluid

### What to Use

When you need windshield washer fluid, be sure to read the manufacturer's instructions before use. If you will be operating your vehicle in an area where the temperature may fall below freezing, use a fluid that has sufficient protection against freezing.

### Adding Washer Fluid

When the windshield washer fluid reservoir is low, a WINDSHIELD WASHER FLUID LOW message will be displayed on the DIC (if equipped). See *Engine Compartment Overview on page 5-12* for reservoir location.

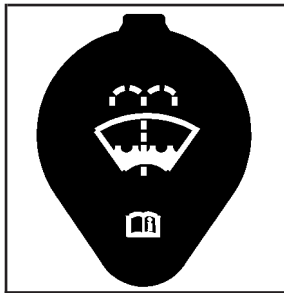

Open the cap with the washer symbol on it. Add washer fluid until the tank is full.

### Notice:

- **When using concentrated washer fluid, follow the manufacturer's instructions for adding water.**
- **Don't mix water with ready-to-use washer fluid. Water can cause the solution to freeze and damage your washer fluid tank and other parts of the washer system. Also, water doesn't clean as well as washer fluid.**
- **Fill your washer fluid tank only three-quarters full when it's very cold. This allows for expansion if freezing occurs, which could damage the tank if it is completely full.**
- **Don't use engine coolant (antifreeze) in your windshield washer. It can damage your washer system and paint.**

## Brakes

### Brake Fluid

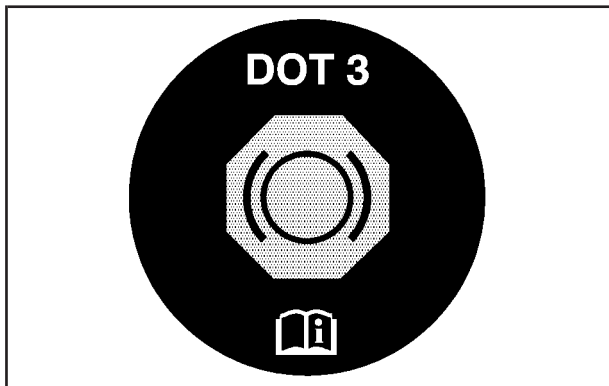

Your master cylinder reservoir is filled with DOT-3 brake fluid. See *Engine Compartment Overview on page 5-12* for the location of the reservoir.

There are only two reasons why the brake fluid level in the reservoir might go down. The first is that the brake fluid goes down to an acceptable level during normal brake lining wear. When new linings are put in, the fluid level goes back up. The other reason is that fluid is

leaking out of the brake system. If it is, you should have your brake system fixed, since a leak means that sooner or later your brakes will not work well, or will not work at all.

So, it is not a good idea to “top off” your brake fluid. Adding brake fluid will not correct a leak. If you add fluid when your linings are worn, then you will have too much fluid when you get new brake linings. You should add (or remove) brake fluid, as necessary, only when work is done on the brake hydraulic system.

#### CAUTION:

**If you have too much brake fluid, it can spill on the engine. The fluid will burn if the engine is hot enough. You or others could be burned, and your vehicle could be damaged. Add brake fluid only when work is done on the brake hydraulic system.**

When your brake fluid falls to a low level, your brake warning light will come on. A chime will sound if you try to drive with this warning light on. See *Brake System Warning Light on page 3-38*.

## What to Add

When you do need brake fluid, use only DOT-3 brake fluid. Refer to *Part D: Recommended Fluids and Lubricants on page 6-25*. Use new brake fluid from a sealed container only.

Always clean the brake fluid reservoir cap and the area around the cap before removing it. This will help keep dirt from entering the reservoir.

### **CAUTION:**

**With the wrong kind of fluid in your brake system, your brakes may not work well, or they may not even work at all. This could cause a crash. Always use the proper brake fluid.**

### **Notice:**

- **Using the wrong fluid can badly damage brake system parts. For example, just a few drops of mineral-based oil, such as engine oil, in your brake system can damage brake system parts so badly that they will have to be replaced. Do not let someone put in the wrong kind of fluid.**
- **If you spill brake fluid on your vehicle's painted surfaces, the paint finish can be damaged. Be careful not to spill brake fluid on your vehicle. If you do, wash it off immediately. See *Appearance Care on page 5-90*.**

## Brake Wear

Your vehicle has four-wheel disc brakes.

Disc brake pads have built-in wear indicators that make a high-pitched warning sound when the brake pads are worn and new pads are needed. The sound may come and go or be heard all the time your vehicle is moving (except when you are pushing on the brake pedal firmly).

### CAUTION:

**The brake wear warning sound means that soon your brakes will not work well. That could lead to an accident. When you hear the brake wear warning sound, have your vehicle serviced.**

**Notice:** Continuing to drive with worn-out brake pads could result in costly brake repair.

Some driving conditions or climates may cause a brake squeal when the brakes are first applied or lightly applied. This does not mean something is wrong with your brakes.

Properly torqued wheel nuts are necessary to help prevent brake pulsation. When tires are rotated, inspect brake pads for wear and evenly tighten wheel nuts in the proper sequence to GM torque specifications.

Brake linings should always be replaced as complete axle sets.

See *Brake System Inspection* on page 6-24.

## Brake Pedal Travel

See your dealer if the brake pedal does not return to normal height, or if there is a rapid increase in pedal travel. This could be a sign of brake trouble.

## Brake Adjustment

Every time you apply the brakes, with or without the vehicle moving, your brakes adjust for wear.

## Replacing Brake System Parts

The braking system on a vehicle is complex. Its many parts have to be of top quality and work well together if the vehicle is to have really good braking. Your vehicle was designed and tested with top-quality GM brake parts. When you replace parts of your braking system — for example, when your brake linings wear down and you need new ones put in — be sure you get new approved GM replacement parts. If you do not, your brakes may no longer work properly. For example, if someone puts in brake linings that are wrong for your vehicle, the balance between your front and rear brakes can change — for the worse. The braking performance you have come to expect can change in many other ways if someone puts in the wrong replacement brake parts.

## Battery

Your new vehicle comes with a maintenance free ACDelco® battery. When it is time for a new battery, get one that has the replacement number shown on the original battery's label. We recommend an ACDelco® battery. See *Engine Compartment Overview on page 5-12* for battery location.

**Warning:** Battery posts, terminals and related accessories contain lead and lead compounds, chemicals known to the State of California to cause cancer and reproductive harm. Wash hands after handling.

## Vehicle Storage

If you are not going to drive your vehicle for 25 days or more, remove the black, negative (–) cable from the battery. This will help keep your battery from running down.

### CAUTION:

**Batteries have acid that can burn you and gas that can explode. You can be badly hurt if you are not careful. See *Jump Starting on page 5-44* for tips on working around a battery without getting hurt.**

Contact your dealer to learn how to prepare your vehicle for longer storage periods.

Also, for your audio system, see *Theft-Deterrent Feature on page 3-75*.

## Jump Starting

If your battery has run down, you may want to use another vehicle and some jumper cables to start your vehicle. Be sure to follow the steps below to do it safely.

### CAUTION:

**Batteries can hurt you. They can be dangerous because:**

- They contain acid that can burn you.
- They contain gas that can explode or ignite.
- They contain enough electricity to burn you.

**If you do not follow these steps exactly, some or all of these things can hurt you.**

**Notice:** Ignoring these steps could result in costly damage to your vehicle that wouldn't be covered by your warranty.

**Trying to start your vehicle by pushing or pulling it won't work, and it could damage your vehicle.**

1. Check the other vehicle. It must have a 12-volt battery with a negative ground system.

**Notice:** If the other vehicle's system is not a 12-volt system with a negative ground, both vehicles can be damaged. Only use vehicles with 12-volt systems with negative grounds to jump start your vehicle.

2. Get the vehicles close enough so the jumper cables can reach, but be sure the vehicles are not touching each other. If they are, it could cause a ground connection you do not want. You would not be able to start your vehicle, and the bad grounding could damage the electrical systems.

To avoid the possibility of the vehicles rolling, set the parking brake firmly on both vehicles involved in the jump start procedure. Put an automatic transaxle in PARK (P) or a manual transaxle in NEUTRAL (N) before setting the parking brake.

**Notice:** If you leave your radio or other accessories on during the jump starting procedure, they could be damaged. The repairs would not be covered by your warranty. Always turn off your radio and other accessories when jump starting your vehicle.

3. Turn off the ignition on both vehicles. Unplug unnecessary accessories plugged into the cigarette lighter or in the accessory power outlet(s). Turn off the radio and all lamps that are not needed. This will avoid sparks and help save both batteries. And it could save your radio!



4. Open the hoods and locate the batteries. Find the positive (+) and negative (-) terminal locations on each vehicle. See *Engine Compartment Overview* on page 5-12 for more information on location.

 **CAUTION:**

An electric fan can start up even when the engine is not running and can injure you. Keep hands, clothing and tools away from any underhood electric fan.

 **CAUTION:**

Using a match near a battery can cause battery gas to explode. People have been hurt doing this, and some have been blinded. Use a flashlight if you need more light.

**CAUTION:** (Continued)

**CAUTION:** (Continued)

Be sure the battery has enough water. You do not need to add water to the ACDelco® battery installed in your new vehicle. But if a battery has filler caps, be sure the right amount of fluid is there. If it is low, add water to take care of that first. If you do not, explosive gas could be present.

Battery fluid contains acid that can burn you. Do not get it on you. If you accidentally get it in your eyes or on your skin, flush the place with water and get medical help immediately.

 **CAUTION:**

Fans or other moving engine parts can injure you badly. Keep your hands away from moving parts once the engine is running.

5. Check that the jumper cables do not have loose or missing insulation. If they do, you could get a shock. The vehicles could be damaged too.

Before you connect the cables, here are some basic things you should know. Positive (+) will go to positive (+) or to a remote positive (+) terminal if the vehicle has one. Negative (-) will go to a heavy, unpainted metal engine part or to a remote negative (-) terminal if the vehicle has one.

Do not connect positive (+) to negative (-) or you will get a short that would damage the battery and maybe other parts too. And do not connect the negative (-) cable to the negative (-) terminal on the dead battery because this can cause sparks.

6. Connect the red positive (+) cable to the positive (+) terminal on the vehicle with the dead battery. Use a remote positive (+) terminal if the vehicle has one.



7. Do not let the other end touch metal. Connect it to the positive (+) terminal of the good battery. Use a remote positive (+) terminal if the vehicle has one.



8. Now connect the black negative (-) cable to the negative (-) terminal of the good battery. Use a remote negative (-) terminal if the vehicle has one.

Do not let the other end touch anything until the next step. The other end of the negative (-) cable *does not* go to the dead battery. It goes to a heavy, unpainted metal engine part or to a remote negative (-) terminal on the vehicle with the dead battery.



9. Connect the other end of the negative (-) cable at least 18 inches (45 cm) away from the dead battery, but not near engine parts that move. The electrical connection is just as good there, and the chance of sparks getting back to the battery is much less.

10. Now start the vehicle with the good battery and run the engine for a while.
11. Try to start the vehicle that had the dead battery. If it will not start after a few tries, it probably needs service.

**Notice:** If the jumper cables are removed in the wrong order, electrical shorting may occur and damage the vehicle. The repairs would not be covered by your warranty. Remove the jumper cables in the correct order, making sure that the cables do not touch each other or other metal.

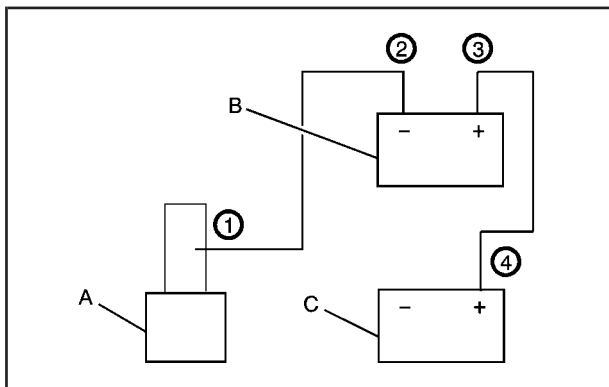

### Jumper Cable Removal

- A. Heavy, Unpainted Metal Engine Part or Remote Negative (-) Terminal
- B. Good Battery or Remote Positive (+) or Remote Negative (-) Terminals
- C. Dead Battery or Remote Positive (+) Terminal

To disconnect the jumper cables from both vehicles, do the following:

1. Disconnect the black negative (-) cable from the vehicle that had the dead battery.
2. Disconnect the black negative (-) cable from the vehicle with the good battery.
3. Disconnect the red positive (+) cable from the vehicle with the good battery.
4. Disconnect the red positive (+) cable from the other vehicle.

## Headlamp Aiming

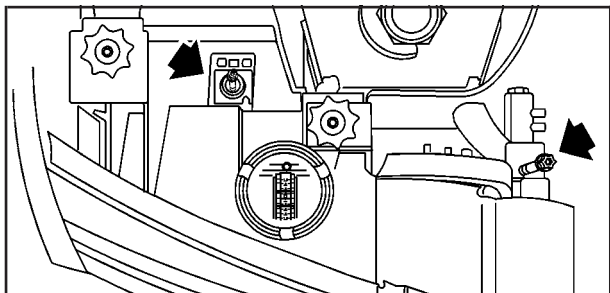

The headlamp aiming device is under the hood, directly behind the headlamps.

Your vehicle has a headlamp system equipped with horizontal and vertical aim indicators. The aim has been pre-set at the factory and should need no further adjustment. This is true even though your vertical and horizontal aim indicators may not fall exactly on the "0" (zero) marks on their scales.

If your vehicle is damaged in an accident, the headlamp aim may be affected. Aim adjustment may be necessary if it is difficult to see lane markers (for horizontal aim), or if oncoming drivers flash their high beams at you (for vertical aim). If you believe your headlamps need to be re-aimed, we recommend that you take it to your dealer for service; however, it is possible for you to re-aim your headlamps as described in the following procedure.

**Notice:** To make sure your headlamps are aimed properly, read all the instructions before beginning. Failure to follow these instructions could cause damage to headlamp parts.

To check the aim, the vehicle should be properly prepared as follows:

- The vehicle must have all four tires on a perfectly level surface.
- If necessary, pads may be used on an uneven surface.
- The vehicle should not have any snow, ice or mud attached to it.
- The vehicle should be fully assembled and all other work stopped while headlamp aiming is being done.
- There should not be any cargo or loading of the vehicle, except it should have a full tank of fuel and one person or 160 lbs (75 kg) on the driver's seat.
- Close all doors.
- Tires should be properly inflated.
- Rock the vehicle to stabilize the suspension.

Start with the horizontal aim. The adjustment screws can be turned with an E8 Torx® socket or T15 Torx® screwdriver.

Once the horizontal aim is adjusted, then adjust the vertical aim.

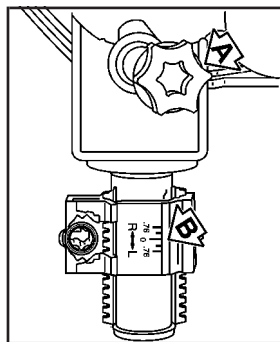

1. Turn the horizontal aiming screw (A) until the indicator (B) is lined up with zero.

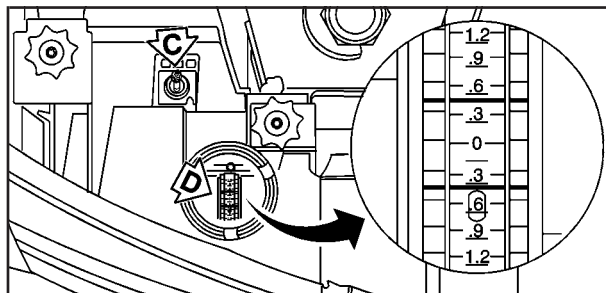

2. Turn the vertical aiming screw (C) until the level bubble (D) is lined up with zero.

## Bulb Replacement

For the type of bulb to use, see *Replacement Bulbs* on page 5-60.

For any bulb changing procedure not listed in this section, contact your dealer.

## Halogen Bulbs

### CAUTION:

Halogen bulbs have pressurized gas inside and can burst if you drop or scratch the bulb. You or others could be injured. Be sure to read and follow the instructions on the bulb package.

## Headlamps

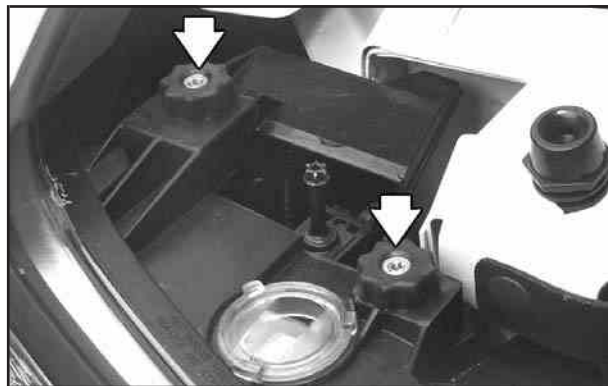

Each headlamp is attached by thumb screws.



1. Remove the thumb screws by turning them counterclockwise.



2. Pull the headlamp assembly away from the vehicle.



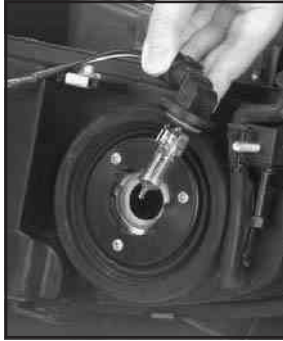

3. Remove the bulb socket by turning it one-quarter turn counterclockwise, while pressing it firmly. Then pull it out. You can use a tool to remove the bulb socket if you are unable to do it by hand.

4. Remove the wire connector from the bulb by lifting the lock tab and pulling it away from the plastic base.
5. Replace the old bulb with a new bulb. Make sure not to touch the new bulb element with your fingers, as the oils on your hands will reduce bulb life.

6. Reverse Steps 1 through 4 to reassemble the headlamp assembly.



When reassembling, make sure to align the pin at the outboard edge of the headlamp assembly to the plastic retainer at the outboard edge of the vehicle.

## Front Turn Signal Lamps

1. Once the headlamp assembly has been removed, reach down from the top of the vehicle, and while pressing the lock tab on the socket, turn the socket one-quarter turn counterclockwise and pull it out.

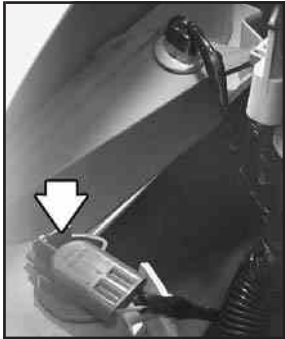

2. Remove the old bulb by pulling it straight out of the socket.

## Rear Turn Signal, Stoplamps and Back-Up Lamps



3. Replace the bulb and turn the bulb assembly back into place.



1. There are four studs located at the inside edge of the trunk lid. Remove the protective vinyl caps from the studs.

2. Remove the nuts from the studs.

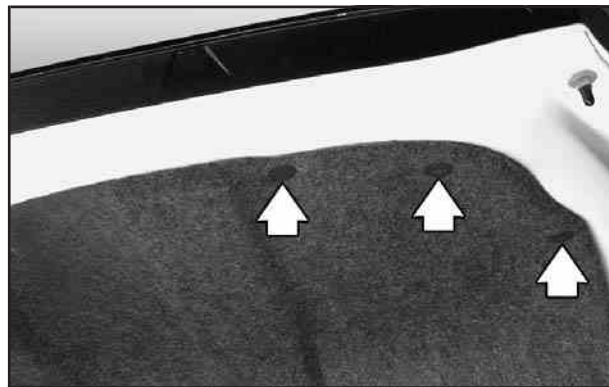

3. Remove the six fasteners along the top of the trunk lid (three on each side), holding the trunk trim in place.

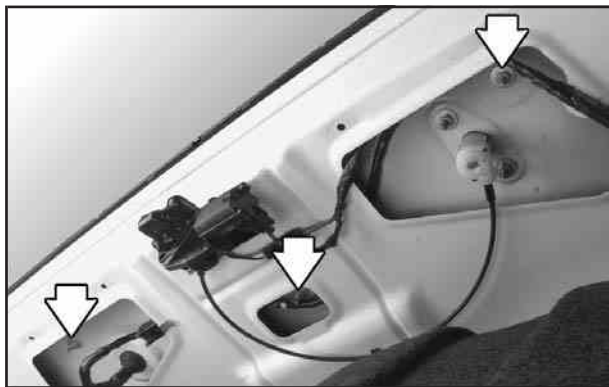

4. Pull the trunk trim back to expose the three remaining nuts holding the taillamp assembly in place. Remove the protective vinyl caps from the studs.



5. From inside the trunk compartment, remove the nuts from the studs.

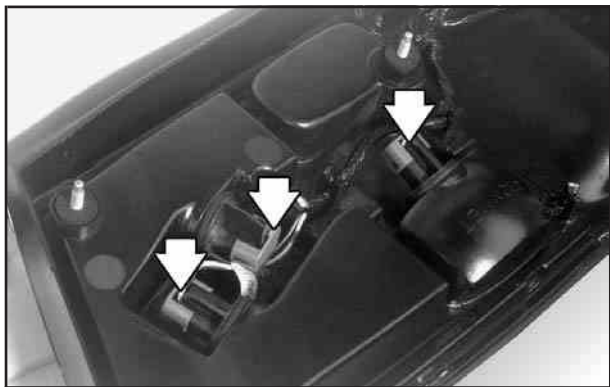

6. Pull the taillamp assembly away from the trunk lid. The bulbs are located on the back side of the assembly.



7. Turn the bulb socket one-quarter turn counterclockwise and pull it out. You can use a tool to remove the bulb socket if you are unable to do it by hand.



8. Once the socket has been removed, pull the bulb straight out to remove it from the socket.

9. Replace it with a new bulb.
10. Reverse Steps 1 through 8 to reinstall the taillamp assembly.

## Rear Quarter Panel Turn Signal and Stoplamps

1. Open the trunk.
2. On either side of the rear of the trunk is a plastic retainer that holds the cargo net and taillamp assembly in place. Unhook the cargo net from the cargo net retainer and remove the retainer by turning it counterclockwise.



3. Remove the plastic retaining screws on the trunk's interior.

4. Pull back the trunk trim panel.



5. Beneath the trim panel are three nuts that secure the taillamp assembly. Remove the nuts only from the side you want to access. The turn signal and a stoplamp can now be accessed.



6. Pull the taillamp assembly away from the vehicle.



7. Remove the bulb socket assembly by turning the socket one-quarter turn counterclockwise and pulling it out.



8. Once the socket has been removed, pull the bulb straight out to remove it from the socket.

9. Replace it with a new bulb.

10. Reverse Steps 1 through 8 to reinstall the taillamp assembly.

## Replacement Bulbs

Lamp	Bulb Number
High Beam Headlamp	9005
Low Beam Headlamp	9006
Parking/Turn, Front	3057
Back-Up	3057
Tail/Turn	194
Tail/Stop	3057
For any bulb not listed here contact your dealer.	



# Windshield Wiper Blade Replacement

Windshield wiper blades should be inspected at least twice a year for wear or cracking. See “Wiper Blade Check” under *Part B: Owner Checks and Services on page 6-19* for more information.

Replacement blades come in different types and are removed in different ways. For proper type and length, see *Normal Maintenance Replacement Parts on page 5-109*.

To replace the wiper blade assembly, do the following:

1. Position the wipers on the windshield in the “mid” wipe position.
2. Lift the windshield wiper arm away from the windshield. The windshield wiper does not have a locking upright position feature.
3. Push the tab on the wiper blade assembly and pull the assembly down enough to release it from the U-hooked end of the wiper arm. Slide the assembly away from the arm.
4. Replace the blade.
5. To reinstall the wiper blade assembly, slide it over the wiper arm to engage the U-hooked end on the wiper blade assembly. Pull up on the assembly to lock it into place.



# Tires

Your new vehicle comes with high-quality tires made by a leading tire manufacturer. If you ever have questions about your tire warranty and where to obtain service, see your GM Warranty booklet for details. For additional information refer to the tire manufacturer's booklet included with your vehicle's Owner's Manual.

## CAUTION:

Poorly maintained and improperly used tires are dangerous.

- **Overloading your tires can cause overheating as a result of too much friction. You could have an air-out and a serious accident. See "Loading Your Vehicle" in the Index.**

**CAUTION: (Continued)**

## **CAUTION: (Continued)**

- **Underinflated tires pose the same danger as overloaded tires. The resulting accident could cause serious injury. Check all tires frequently to maintain the recommended pressure. Tire pressure should be checked when your tires are cold.**
- **Overinflated tires are more likely to be cut, punctured or broken by a sudden impact — such as when you hit a pothole. Keep tires at the recommended pressure.**
- **Worn, old tires can cause accidents. If your tread is badly worn, or if your tires have been damaged, replace them.**

## Tire Sidewall Labeling

Useful information about a tire is molded into its sidewall. The examples below show a typical passenger car tire and a compact spare tire sidewall.

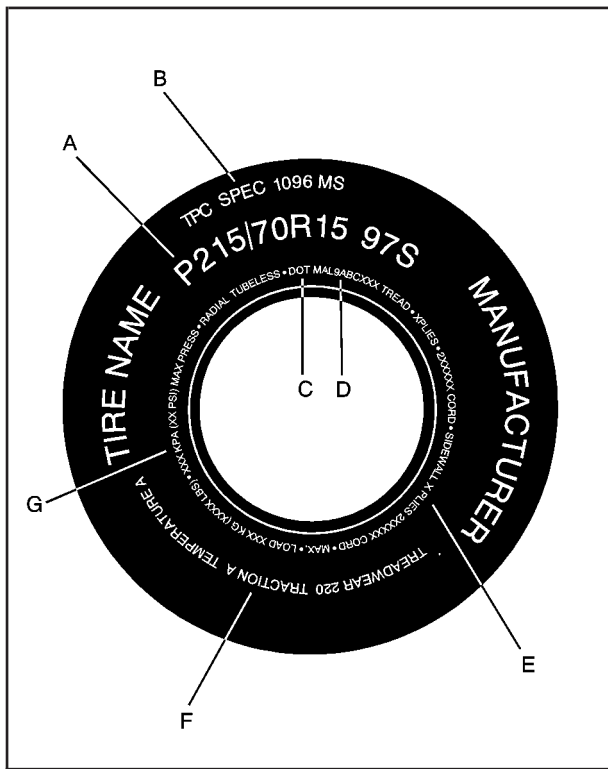

Passenger Car Tire Example

**(A) Tire Size:** The tire size code is a combination of letters and numbers used to define a particular tire's width, height, aspect ratio, construction type and service description. See the "Tire Size" illustration later in this section for more detail.

**(B) Tire Performance Criteria Specification (TPC Spec):** Original equipment tires designed to GM's specific tire performance criteria have a TPC specification code molded onto the sidewall. GM's TPC specifications meet or exceed all federal safety guidelines.

**(C) Department of Transportation (DOT):** The Department of Transportation (DOT) code indicates that the tire is in compliance with the U.S. Department of Transportation Motor Vehicle Safety Standards.

**(D) Tire Identification Number (TIN):** The letters and numbers following DOT code are the Tire Identification Number (TIN). The TIN shows the manufacturer and plant code, tire size, and date the tire was manufactured. The TIN is molded onto both sides of the tire, although only one side may have the date of manufacture.

**(E) Tire Ply Material:** The type of cord and number of plies in the sidewall and under the tread.

**(F) Uniform Tire Quality Grading (UTQG):** Tire manufacturers are required to grade tires based on three performance factors: treadwear, traction and temperature resistance. For more information see *Uniform Tire Quality Grading* on page 5-75.

**(G) Maximum Cold Inflation Load Limit:** Maximum load that can be carried and the maximum pressure needed to support that load. For more information on recommended tire pressure see *Inflation - Tire Pressure* on page 5-69 and *Loading Your Vehicle* on page 4-33.

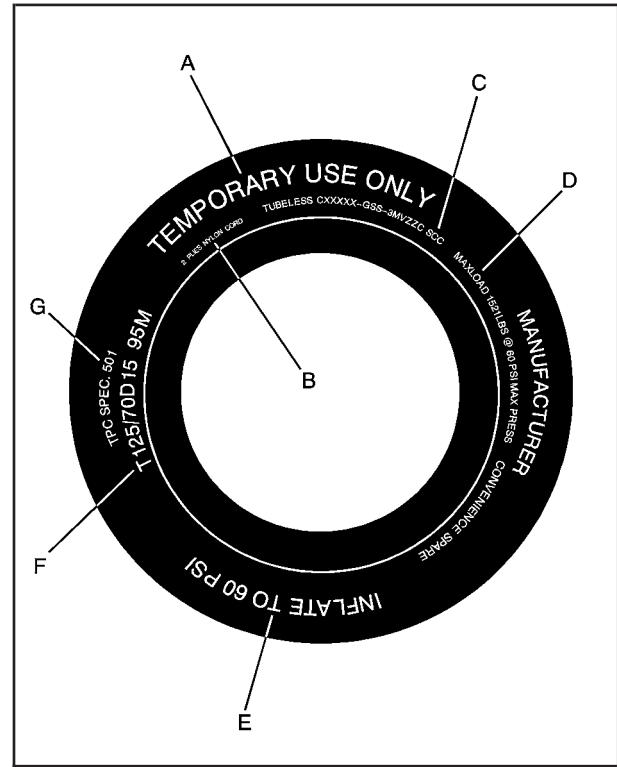

Compact Spare Tire Example

**(A) Temporary Use Only:** The compact spare tire or temporary use tire has a tread life of approximately 3,000 miles (5 000 km) and should not be driven at speeds over 65 mph (105 km/h). The compact spare tire is for emergency use when a regular road tire has lost air and gone flat. See *Compact Spare Tire on page 5-89* and *If a Tire Goes Flat on page 5-79*.

**(B) Tire Ply Material:** The type of cord and number of plies in the sidewall and under the tread.

**(C) Tire Identification Number (TIN):** The Tire Identification Number (TIN). The TIN shows the manufacturer and plant code, tire size, and date the tire was manufactured. The TIN is molded onto both sides of the tire, although only one side may have the date of manufacture.

**(D) Maximum Cold Inflation Load Limit:** Maximum load that can be carried and the maximum pressure needed to support that load. See *Compact Spare Tire on page 5-89* and *Loading Your Vehicle on page 4-33*.

**(E) Tire Inflation:** The temporary use tire or compact spare tire should be inflated to 60 psi (420 kPa). For more information on tire pressure and inflation see *Inflation - Tire Pressure on page 5-69*.

**(F) Tire Size:** A combination of letters and numbers define a tire's width, height, aspect ratio, construction type and service description. The letter "T" as the first character in the tire size means the tire is for temporary use only.

**(G) Tire Performance Criteria Specification (TPC Spec):** Original equipment tires designed to GM's specific tire performance criteria have a TPC specification code molded onto the sidewall. GM's TPC specifications meet or exceed all federal safety guidelines.

## Tire Size

The following illustration shows an example of a typical passenger car tire size.

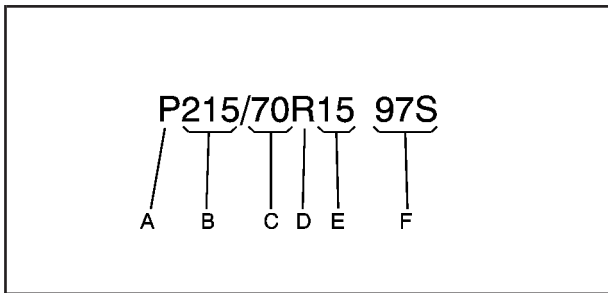

**(A) P-Metric Tire:** The United States version of a metric tire sizing system. The letter "P" as the first character in the tire size means a passenger vehicle tire engineered to standards set by the U. S. Tire and Rim Association.

**(B) Tire Width:** The three-digit number indicates the tire section width in millimeters from sidewall to sidewall.

**(C) Aspect Ratio:** A two-digit number that indicates the tire height-to-width measurements. For example, if the tire size aspect ratio is "70," as shown in item "C" of the illustration, it would mean that the tire's sidewall is 70% as high as it is wide.

**(D) Construction Code:** A letter code is used to indicate the type of ply construction in the tire. The letter "R" means radial ply construction; the letter "D" means diagonal or bias ply construction; and the letter "B" means belted-bias ply construction.

**(E) Rim Diameter:** Diameter of the wheel in inches.

**(F) Service Description:** These characters represent the load range and the speed rating of a tire. The load range represents the load carrying capacity a tire is certified to carry. The load index can range from 1 to 279. The speed rating is the maximum speed a tire is certified to carry a load. Speed ratings range from "A" to "Z".

## Tire Terminology and Definitions

**Air Pressure:** The amount of air inside the tire pressing outward on each square inch of the tire. Air pressure is expressed in pounds per square inch (psi) or kilopascal (kPa).

**Accessory Weight:** This means the combined weight of optional accessories. Some examples of optional accessories are, automatic transmission, power steering, power brakes, power windows, power seats, and air conditioning.

**Aspect Ratio:** The relationship of a tire's height to its width.

**Belt:** A rubber coated layer of cords that is located between the plies and the tread. Cords may be made from steel or other reinforcing materials.

**Bead:** The tire bead contains steel wires wrapped by steel cords that hold the tire onto the rim.

**Bias Ply Tire:** A pneumatic tire in which the plies are laid at alternate angles substantially less than 90 degrees to the centerline of the tread.

**Cold Inflation Pressure:** The amount of air pressure in a tire, measured in pounds per square inch (psi) before a tire has built up heat from driving. See *Inflation - Tire Pressure on page 5-69*.

**Curb Weight:** This means the weight of a motor vehicle with standard and optional equipment including the maximum capacity of fuel, oil and coolant, but without passengers and cargo.

**DOT Markings:** A code molded into the sidewall of a tire signifying that the tire is in compliance with the U.S. Department of Transportation motor vehicle safety standards. The DOT code includes the Tire Identification Number (TIN), an alphanumeric designator which can also identify the tire manufacturer, production plant, brand and date of production.

**GVWR:** Gross Vehicle Weight Rating, see *Loading Your Vehicle on page 4-33*.

**GAWR FRT:** Gross Axle Weight Rating for the front axle, see *Loading Your Vehicle on page 4-33*.

**GAWR RR:** Gross Axle Weight Rating for the rear axle, see *Loading Your Vehicle on page 4-33*.

**Intended Outboard Sidewall:** The side of an asymmetrical tire that must always face outward when mounted on a vehicle.

**Kilopascal (kPa):** The metric unit for air pressure. There are 6.9 kPa's to one psi.

**Light Truck (LT-Metric) Tire:** A tire used on light duty trucks and some multipurpose passenger vehicles.

**Load Index:** An assigned number ranging from 1 to 279 that corresponds to the load carrying capacity of a tire.

**Maximum Inflation Pressure:** The maximum air pressure to which a cold tire may be inflated. The maximum air pressure is molded onto the sidewall.

**Maximum Load Rating:** The load rating for a tire at the maximum permissible inflation pressure for that tire.

**Maximum Loaded Vehicle Weight:** The sum of curb weight; accessory weight; vehicle capacity weight; and production options weight.

**Normal Occupant Weight:** The number of occupants a vehicle is designed to seat multiplied by 150 pounds (68 kg). See *Loading Your Vehicle on page 4-33*.

**Occupant Distribution:** Designated seating positions.

**Outward Facing Sidewall:** The side of an asymmetrical tire that has a particular side that faces outward when mounted on a vehicle. The side of the tire that contains a whitewall, bears white lettering or bears manufacturer, brand and or model name molding that is higher or deeper than the same moldings on the other sidewall of the tire.

**Passenger (P-Metric) Tire:** A tire used on passenger cars and some light duty trucks and multipurpose vehicles.

**Recommended Inflation Pressure:** Vehicle manufacturer's recommended tire inflation pressure and shown on the tire placard. See *Inflation - Tire Pressure on page 5-69* and *Loading Your Vehicle on page 4-33*.

**Radial Ply tire:** A pneumatic tire in which the ply cords that extend to the beads are laid at 90 degrees to the centerline of the tread.

**Rim:** A metal support for a tire and upon which the tire beads are seated.

**Sidewall:** The portion of a tire between the tread and the bead.

**Speed Rating:** An alphanumeric code assigned to a tire indicating the maximum speed at which a tire can operate.

**Traction:** The friction between the tire and the road surface. The amount of grip provided.

**Tread:** The portion of a tire that comes into contact with the road.



**Treadwear Indicators:** Narrow bands, sometimes called “wear bars,” that show across the tread of a tire when only 2/32 inch of tread remains. See *When It Is Time for New Tires on page 5-73*.

**UTQGS:** Uniform Tire Quality Grading Standards, a tire information system that provides consumers with ratings for a tire’s traction, temperature and treadwear. Ratings are determined by tire manufacturers using government testing procedures. The ratings are molded into the sidewall of the tire. See *Uniform Tire Quality Grading on page 5-75*.

**Vehicle Capacity Weight:** The number of designated seating positions multiplied by 150 lbs. (68 kg) plus the rated cargo load. See *Loading Your Vehicle on page 4-33*.

**Vehicle Maximum Load on the Tire:** Load on an individual tire due to curb weight, accessory weight, occupant weight and cargo weight.

**Vehicle Placard:** A label permanently attached to a vehicle showing the original equipment tire size and recommended inflation pressure. See *Loading Your Vehicle on page 4-33*.

## Inflation - Tire Pressure

The tire and loading information label, shows the correct inflation pressures for your tires when they’re cold. “Cold” means your vehicle has been sitting for at least three hours or driven no more than 1 mile (1.6 km). See *Loading Your Vehicle on page 4-33*, for the location of your vehicle’s tire and loading information label.

**Notice:** Don’t let anyone tell you that underinflation or overinflation is all right. It’s not. If your tires don’t have enough air (underinflation), you can get the following:

- Too much flexing
- Too much heat
- Tire overloading
- Bad wear
- Bad handling
- Bad fuel economy

If your tires have too much air (overinflation), you can get the following:

- Unusual wear
- Bad handling
- Rough ride
- Needless damage from road hazards

## When to Check

Check your tires once a month or more.

Don't forget your compact spare tire. It should be at 60 psi (420 kPa).

## How to Check

Use a good quality pocket-type gage to check tire pressure. You can't tell if your tires are properly inflated simply by looking at them. Radial tires may look properly inflated even when they're underinflated. Check the tire's inflation pressure when the tires are cold. Cold means your vehicle has been sitting for at least three hours or driven no more than 1 mile (1.6 km).

Remove the valve cap from the tire valve stem. Press the tire gage firmly onto the valve to get a pressure measurement. If the cold tire inflation pressure matches the recommended pressure on the Tire and Loading Information label, no further adjustment is necessary. If the inflation pressure is low, add air until you reach the recommended amount.

If you overfill the tire, release air by pushing on the metal stem in the center of the tire valve. Recheck the tire pressure with the tire gage.

Be sure to put the valve caps back on the valve stems. They help prevent leaks by keeping out dirt and moisture.

## Check Tire Pressure System

If your vehicle has this feature, the check tire pressure system can alert you to a large change in the pressure of one tire. The system will not alert you before you drive that a tire is low or flat. You must begin driving before the system will work properly.

The TIRE PRESSURE LOW message will appear on the Driver Information Center (DIC) if pressure difference (low pressure) is detected in one tire. The check tire pressure system may not alert you if:

- More than one tire is low.
- The vehicle is moving faster than 65 mph (105 km/h).
- The system is not yet calibrated.
- The tire treadwear is uneven.
- The compact spare tire is installed.
- Tire chains are being used.
- The vehicle is being driven on a rough or frozen road.

If the anti-lock brake system warning light comes on, the check tire pressure system may not be working properly. See your dealer for service. Also, see *Anti-Lock Brake System Warning Light on page 3-39*.

The check tire pressure system detects differences in tire rotation speeds that are caused by changes in tire pressure. The system can alert you about a low tire — but it does not replace normal tire maintenance. See *Tires on page 5-62*.

When the TIRE PRESSURE LOW message appears on the Driver Information Center, you should stop as soon as you can and check all your tires for damage. If a tire is flat, see *If a Tire Goes Flat on page 5-79*. Also check the tire pressure in all four tires as soon as you can. See *Inflation - Tire Pressure on page 5-69*.

Any time you adjust a tire's pressure or have one or more tires repaired or replaced, you will need to reset (calibrate) the check tire pressure system. You will also need to reset the system whenever you rotate the tires, buy new tires and install or remove the compact spare tire.

Do not reset the check tire pressure system without first correcting the cause of the problem and checking and adjusting the pressure in all four tires. If you reset the system when the tire pressures are incorrect, the check tire pressure system will not work properly and may not alert you when a tire is low or high.

To reset (calibrate) the system:

1. Turn the ignition switch to RUN.
2. Press the GAGE INFO button on the DIC until TIRE PRESSURE appears on the display.
3. Press and hold the DIC RESET button for about five seconds. After five seconds, the display will show TIRE PRESSURE RESET. If TIRE PRESSURE RESET does not appear on the display after about five seconds, see your dealer for service. After you release the DIC RESET button, TIRE PRESSURE NORMAL will appear on the display.

The system completes the calibration process during driving. Calibration time can take 45 to 90 minutes, depending on your driving habits. After the system has been calibrated, the system will alert the driver that a tire is low, up to a maximum speed of 65 mph (105 km/h).

## Tire Inspection and Rotation

Tires should be rotated every 5,000 to 8,000 miles (8 000 to 13 000 km).

Any time you notice unusual wear rotate your tires as soon as possible and check wheel alignment. Also check for damaged tires or wheels. See *When It Is Time for New Tires* on page 5-73 and *Wheel Replacement* on page 5-76 for more information.

The purpose of regular rotation is to achieve more uniform wear for all tires on the vehicle. The first rotation is the most important. See *Part A: Scheduled Maintenance Services* on page 6-4, for scheduled rotation intervals.

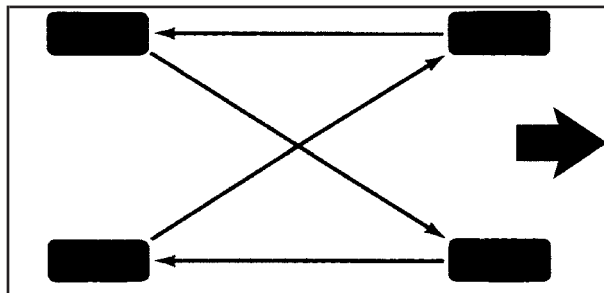

When rotating your tires, always use the correct rotation pattern shown here.

Don't include the compact spare tire in your tire rotation.

After the tires have been rotated, adjust the front and rear inflation pressures as shown on the Tire and Loading Information label.

Reset the check tire pressure system, if equipped.  
See *Check Tire Pressure System* on page 5-70.

Make certain that all wheel nuts are properly tightened.  
See "Wheel Nut Torque" under *Capacities and Specifications* on page 5-108.

### **CAUTION:**

Rust or dirt on a wheel, or on the parts to which it is fastened, can make wheel nuts become loose after a time. The wheel could come off and cause an accident. When you change a wheel, remove any rust or dirt from places where the wheel attaches to the vehicle. In an emergency, you can use a cloth or a paper towel to do this; but be sure to use a scraper or wire brush later, if you need to, to get all the rust or dirt off. See "Changing a Flat Tire" in the Index.

## When It Is Time for New Tires

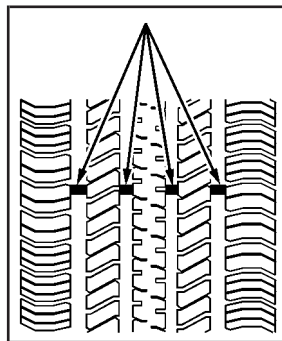

One way to tell when it's time for new tires is to check the treadwear indicators, which will appear when your tires have only 1/16 inch (1.6 mm) or less of tread remaining.

You need a new tire if any of the following statements are true:

- You can see the indicators at three or more places around the tire.
- You can see cord or fabric showing through the tire's rubber.
- The tread or sidewall is cracked, cut or snagged deep enough to show cord or fabric.
- The tire has a bump, bulge or split.
- The tire has a puncture, cut or other damage that can't be repaired well because of the size or location of the damage.

## Buying New Tires

To find out what kind and size of tires you need, look at the tire and loading information label. For an example of this label and its location, see *Loading Your Vehicle on page 4-33*.

The tires installed on your vehicle when it was new had a Tire Performance Criteria Specification (TPC Spec) number on each tire's sidewall. When you get new tires, get ones with that same TPC Spec number. That way your vehicle will continue to have tires that are designed to give proper endurance, handling, speed rating, load range, traction, ride and other things during normal service on your vehicle. If your tires have an all-season tread design, the TPC number will be followed by an "MS" (for mud and snow).

If you ever replace your tires with those not having a TPC Spec number, make sure they are the same size, load range, speed rating and construction type (bias, bias-belted or radial) as your original tires.

### CAUTION:

**Mixing tires could cause you to lose control while driving. If you mix tires of different sizes or types (radial and bias-belted tires), the vehicle may not handle properly, and you could have a crash. Using tires of different sizes may also cause damage to your vehicle. Be sure to use the same size and type tires on all wheels. It's all right to drive with your compact spare temporarily, it was developed for use on your vehicle. See "Compact Spare Tire" in the index.**

### CAUTION:

**If you use bias-ply tires on your vehicle, the wheel rim flanges could develop cracks after many miles of driving. A tire and/or wheel could fail suddenly, causing a crash. Use only radial-ply tires with the wheels on your vehicle.**

## Uniform Tire Quality Grading

Quality grades can be found where applicable on the tire sidewall between tread shoulder and maximum section width. For example:

### **Treadwear 200 Traction AA Temperature A**

The following information relates to the system developed by the United States National Highway Traffic Safety Administration, which grades tires by treadwear, traction and temperature performance. (This applies only to vehicles sold in the United States.)

The grades are molded on the sidewalls of most passenger car tires. The Uniform Tire Quality Grading system does not apply to deep tread, winter-type snow tires, space-saver or temporary use spare tires, tires with nominal rim diameters of 10 to 12 inches (25 to 30 cm), or to some limited-production tires.

While the tires available on General Motors passenger cars and light trucks may vary with respect to these grades, they must also conform to federal safety requirements and additional General Motors Tire Performance Criteria (TPC) standards.

## Treadwear

The treadwear grade is a comparative rating based on the wear rate of the tire when tested under controlled conditions on a specified government test course. For example, a tire graded 150 would wear one and a half (1.5) times as well on the government course as a tire graded 100. The relative performance of tires depends upon the actual conditions of their use, however, and may depart significantly from the norm due to variations in driving habits, service practices and differences in road characteristics and climate.

### **Traction – AA, A, B, C**

The traction grades, from highest to lowest, are AA, A, B, and C. Those grades represent the tire's ability to stop on wet pavement as measured under controlled conditions on specified government test surfaces of asphalt and concrete. A tire marked C may have poor traction performance. Warning: The traction grade assigned to this tire is based on straight-ahead braking traction tests, and does not include acceleration, cornering, hydroplaning, or peak traction characteristics.

## Temperature – A, B, C

The temperature grades are A (the highest), B, and C, representing the tire's resistance to the generation of heat and its ability to dissipate heat when tested under controlled conditions on a specified indoor laboratory test wheel. Sustained high temperature can cause the material of the tire to degenerate and reduce tire life, and excessive temperature can lead to sudden tire failure. The grade C corresponds to a level of performance which all passenger car tires must meet under the Federal Motor Vehicle Safety Standard No. 109. Grades B and A represent higher levels of performance on the laboratory test wheel than the minimum required by law.

Warning: The temperature grade for this tire is established for a tire that is properly inflated and not overloaded. Excessive speed, underinflation, or excessive loading, either separately or in combination, can cause heat buildup and possible tire failure.

## Wheel Alignment and Tire Balance

The wheels on your vehicle were aligned and balanced carefully at the factory to give you the longest tire life and best overall performance.

Scheduled wheel alignment and wheel balancing are not needed. However, if you notice unusual tire wear or your vehicle pulling one way or the other, the alignment may need to be reset. If you notice your vehicle vibrating when driving on a smooth road, your wheels may need to be rebalanced.

## Wheel Replacement

Replace any wheel that is bent, cracked or badly rusted or corroded. If wheel nuts keep coming loose, the wheel, wheel bolts and wheel nuts should be replaced. If the wheel leaks air, replace it (except some aluminum wheels, which can sometimes be repaired). See your dealer if any of these conditions exist.

Your dealer will know the kind of wheel you need.



Each new wheel should have the same load-carrying capacity, diameter, width, offset and be mounted the same way as the one it replaces.

If you need to replace any of your wheels, wheel bolts or wheel nuts, replace them only with new GM original equipment parts. This way, you will be sure to have the right wheel, wheel bolts and wheel nuts for your vehicle.

 **CAUTION:**

Using the wrong replacement wheels, wheel bolts or wheel nuts on your vehicle can be dangerous. It could affect the braking and handling of your vehicle, make your tires lose air and make you lose control. You could have a collision in which you or others could be injured. Always use the correct wheel, wheel bolts and wheel nuts for replacement.

**Notice:** The wrong wheel can also cause problems with bearing life, brake cooling, speedometer or odometer calibration, headlamp aim, bumper height, vehicle ground clearance and tire or tire chain clearance to the body and chassis.

See *Changing a Flat Tire* on page 5-80 for more information.

## Used Replacement Wheels

 **CAUTION:**

Putting a used wheel on your vehicle is dangerous. You can't know how it's been used or how far it's been driven. It could fail suddenly and cause a crash. If you have to replace a wheel, use a new GM original equipment wheel.

## Tire Chains

### CAUTION:

If your vehicle has P235/55R17 size tires, don't use tire chains, there's not enough clearance.

Tire chains used on a vehicle without the proper amount of clearance can cause damage to the brakes, suspension or other vehicle parts. The area damaged by the tire chains could cause you to lose control of your vehicle and you or others may be injured in a crash.

Use another type of traction device only if its manufacturer recommends it for use on your vehicle and tire size combination and road conditions. Follow that manufacturer's instructions. To help avoid damage to your

CAUTION: (Continued)

### CAUTION: (Continued)

vehicle, drive slowly, readjust or remove the device if it's contacting your vehicle, and don't spin your wheels.

If you do find traction devices that will fit, install them on the front tires.

**Notice:** If your vehicle has a tire size other than P235/55R17 size tires, use tire chains only where legal and only when you must. Use only SAE Class "S" type chains that are the proper size for your tires. Install them on the front tires and tighten them as tightly as possible with the ends securely fastened. Drive slowly and follow the chain manufacturer's instructions. If you can hear the chains contacting your vehicle, stop and retighten them. If the contact continues, slow down until it stops. Driving too fast or spinning the wheels with chains on will damage your vehicle.

## If a Tire Goes Flat

It's unusual for a tire to "blowout" while you're driving, especially if you maintain your tires properly. If air goes out of a tire, it's much more likely to leak out slowly. But if you should ever have a "blowout," here are a few tips about what to expect and what to do:

If a front tire fails, the flat tire will create a drag that pulls the vehicle toward that side. Take your foot off the accelerator pedal and grip the steering wheel firmly. Steer to maintain lane position, and then gently brake to a stop well out of the traffic lane.

A rear blowout, particularly on a curve, acts much like a skid and may require the same correction you'd use in a skid. In any rear blowout, remove your foot from the accelerator pedal. Get the vehicle under control by steering the way you want the vehicle to go. It may be very bumpy and noisy, but you can still steer. Gently brake to a stop, well off the road if possible.

### CAUTION:

**Lifting a vehicle and getting under it to do maintenance or repairs is dangerous without the appropriate safety equipment and training. The jack provided with your vehicle is designed only for changing a flat tire. If it is used for anything else, you or others could be badly injured or killed if the vehicle slips off the jack. Use the jack provided with your vehicle only for changing a flat tire.**

If a tire goes flat, the next part shows how to use your jacking equipment to change a flat tire safely.

## Changing a Flat Tire

If a tire goes flat, avoid further tire and wheel damage by driving slowly to a level place. Turn on your hazard warning flashers.

### CAUTION:

Changing a tire can cause an injury. The vehicle can slip off the jack and roll over you or other people. You and they could be badly injured. Find a level place to change your tire.

To help prevent the vehicle from moving:

1. Set the parking brake firmly.
2. Put the shift lever in PARK (P).
3. Turn off the engine.

To be even more certain the vehicle won't move, you can put blocks at the front and rear of the tire farthest away from the one being changed. That would be the tire on the other side of the vehicle, at the opposite end.

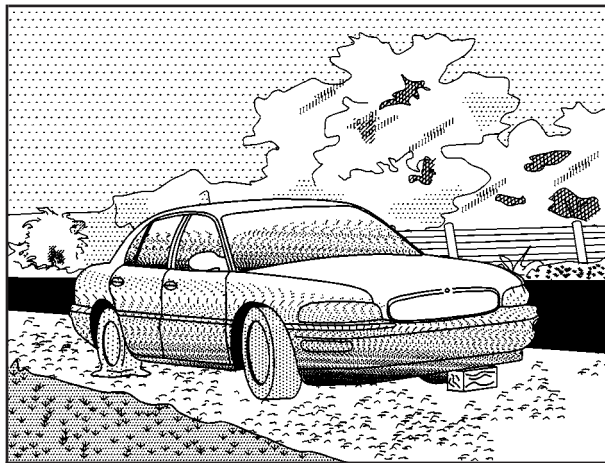

The following steps will tell you how to use the jack and change a tire.

## Removing the Spare Tire and Tools



The equipment you will need is in the trunk.

Instructions for changing your tires are on the inside of the tire cover. You can rest the cover near you for easy reference while you change the tire.

1. Lift the tire cover to gain access to the compact spare tire and jacking equipment.
2. Remove the wheel wrench and jack from the jack container.

3. Remove the compact spare tire from the trunk. See *Compact Spare Tire* on page 5-89 for more information about the compact spare tire.

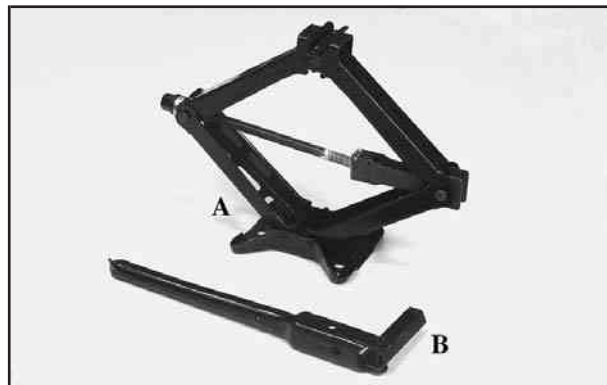

The tools you will be using include the jack (A) and wheel wrench (B).

## Removing the Flat Tire and Installing the Spare Tire

1. If your vehicle is equipped with the 8 inch (20 cm) hubcap, use the wheel wrench to begin loosening the plastic wheel nut caps. Once you have loosened the plastic wheel nut caps with the wheel wrench, you can finish loosening them with your fingers. Once the plastic wheel nuts have been loosened, pull the hubcap off by hand.

If your vehicle is equipped with either the 2 1/2 inch (6 cm) or the 4 inch (10 cm) hubcap, first remove the decorative nut caps using the wheel wrench.

2. Then use the wheel wrench to loosen the wheel nuts, but do not remove them yet.



3. The jack has a bolt at the end. Attach the wheel wrench to the bolt to create a jack handle.

4. Turn the wheel wrench counterclockwise to lower the jack head until it fits under the vehicle.

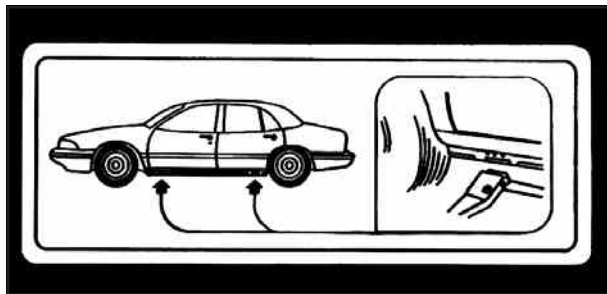

5. Near each wheel well is a notch in the plastic trim panel to position the jack head. You will find the word JACK and an arrow stamped into the plastic near each notch. Position the jack under the vehicle and raise the jack head until it fits firmly against the sheet metal next to the word JACK. Do not raise the vehicle yet. Put the compact spare tire near you.

**⚠ CAUTION:**

Getting under a vehicle when it is jacked up is dangerous. If the vehicle slips off the jack you could be badly injured or killed. Never get under a vehicle when it is supported only by a jack.

**⚠ CAUTION:**

Raising your vehicle with the jack improperly positioned can damage the vehicle and even make the vehicle fall. To help avoid personal injury and vehicle damage, be sure to fit the jack lift head into the proper location before raising the vehicle.



6. Raise the vehicle by turning the wheel wrench clockwise in the jack. Raise the vehicle far enough off the ground so there is enough room for the compact spare tire to fit underneath the wheel well.

7. Remove all the wheel nuts and take off the flat tire.

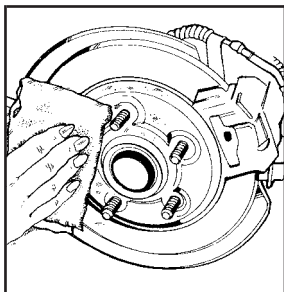

8. Remove any rust or dirt from the wheel bolts, mounting surfaces and spare wheel.

**⚠ CAUTION:**

Rust or dirt on the wheel, or on the parts to which it is fastened, can make the wheel nuts become loose after a time. The wheel could come off and cause an accident. When you change a wheel, remove any rust or dirt from

**CAUTION: (Continued)**

**CAUTION: (Continued)**

the places where the wheel attaches to the vehicle. In an emergency, you can use a cloth or a paper towel to do this; but be sure to use a scraper or wire brush later, if you need to, to get all the rust or dirt off.

**⚠ CAUTION:**

Never use oil or grease on studs or nuts. If you do, the nuts might come loose. Your wheel could fall off, causing a serious accident.



9. Install the compact spare tire on the wheel-mounting surface.



10. Then reinstall the wheel nuts with the rounded end of the nuts toward the wheel. Tighten each nut by hand until the wheel is held against the hub.



11. Lower the vehicle by turning the wheel wrench counterclockwise. Lower the jack completely.

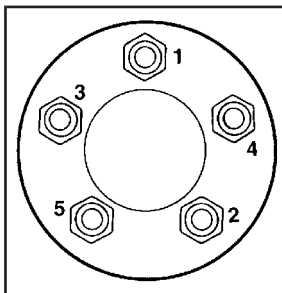

12. Using the wheel wrench, tighten the wheel nuts firmly in a crisscross sequence.

**⚠ CAUTION:**

Incorrect wheel nuts or improperly tightened wheel nuts can cause the wheel to come loose and even come off. This could lead to an accident. Be sure to use the correct wheel nuts. If you have to replace them, be sure to get new GM original equipment wheel nuts. Stop somewhere as soon as you can and have the nuts tightened with a torque wrench to the proper torque specification. See “Capacities and Specifications” in the Index for wheel nut torque specification.

**Notice:** Improperly tightened wheel nuts can lead to brake pulsation and rotor damage. To avoid expensive brake repairs, evenly tighten the wheel nuts in the proper sequence and to the proper torque specification. See “Capacities and Specifications” in the index for the wheel nut torque specification.

13. Do not try to put the wheel cover on the compact spare tire. It will not fit.

Store the wheel cover in the trunk until you have the flat tire repaired or replaced.

**Notice:** Wheel covers will not fit on your compact spare. If you try to put a wheel cover on the compact spare, you could damage the cover or the spare.

## Storing the Flat Tire and Tools

### CAUTION:

**Storing a jack, a tire, or other equipment in the passenger compartment of the vehicle could cause injury. In a sudden stop or collision, loose equipment could strike someone. Store all these in the proper place.**

After you have put the compact spare tire on your vehicle, you will need to store the flat tire in your trunk. Use the following procedure to secure the flat tire in the trunk.

Store the flat tire as far forward in the trunk as possible. Store the jack and wheel wrench in their compartment in the trunk.



## Storing the Spare Tire and Tools

### CAUTION:

Storing a jack, a tire, or other equipment in the passenger compartment of the vehicle could cause injury. In a sudden stop or collision, loose equipment could strike someone. Store all these in the proper place.

Store the compact spare tire and tools as shown in the diagram.

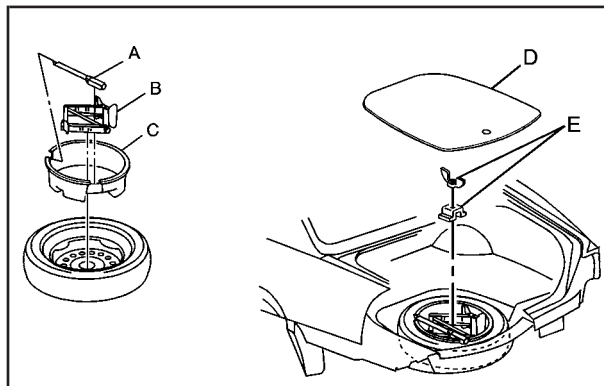

A. Wrench  
B. Jack  
C. Jack Container

D. Compact Spare  
Tire Cover  
E. Washer and  
Retainer

The compact spare tire is for temporary use only. Replace the compact spare tire with a full-size tire as soon as you can. See "Compact Spare Tire" later in this section.

## Compact Spare Tire

Although the compact spare tire was fully inflated when your vehicle was new, it can lose air after a time. Check the inflation pressure regularly. It should be 60 psi (420 kPa).

After installing the compact spare on your vehicle, you should stop as soon as possible and make sure your spare tire is correctly inflated. The compact spare is made to perform well at speeds up to 65 mph (105 km/h) for distances up to 3,000 miles (5 000 km), so you can finish your trip and have your full-size tire repaired or replaced where you want. You must calibrate the Check Tire Pressure System after installing or removing the compact spare. See *Check Tire Pressure System on page 5-70*. Of course, it's best to replace your spare with a full-size tire as soon as you can. Your spare will last longer and be in good shape in case you need it again.

**Notice:** When the compact spare is installed, don't take your vehicle through an automatic car wash with guide rails. The compact spare can get caught on the rails. That can damage the tire and wheel, and maybe other parts of your vehicle.

Don't use your compact spare on other vehicles.

And don't mix your compact spare tire or wheel with other wheels or tires. They won't fit. Keep your spare tire and its wheel together.

**Notice:** Tire chains won't fit your compact spare. Using them can damage your vehicle and can damage the chains too. Don't use tire chains on your compact spare.

## Appearance Care

Remember, cleaning products can be hazardous. Some are toxic. Others can burst into flames if you strike a match or get them on a hot part of the vehicle. Some are dangerous if you breathe their fumes in a closed space. When you use anything from a container to clean your vehicle, be sure to follow the manufacturer's warnings and instructions. And always open your doors or windows when you are cleaning the inside.

Never use these to clean your vehicle:

- Gasoline
- Benzene
- Naphtha
- Carbon Tetrachloride
- Acetone
- Paint Thinner
- Turpentine
- Lacquer Thinner
- Nail Polish Remover

They can all be hazardous — some more than others — and they can all damage your vehicle, too.

Do not use any of these unless this manual says you can. In many uses, these will damage your vehicle:

- Alcohol
- Laundry Soap
- Bleach
- Reducing Agents

## Cleaning the Inside of Your Vehicle

Use a vacuum cleaner often to get rid of dust and loose dirt. Wipe vinyl, leather, plastic and painted surfaces with a clean, damp cloth.

### Cleaning Fabric/Carpet

Your dealer has cleaners for the cleaning of fabric and carpet. They will clean normal spots and stains very well.

You can get GM-approved cleaning products from your dealer. See *Vehicle Care/Appearance Materials on page 5-96*.

Here are some cleaning tips:

- Always read the instructions on the cleaner label.
- Clean up stains as soon as you can — before they set.
- Carefully scrape off any excess stain.
- Use a clean cloth or sponge, and change to a clean area often. A soft brush may be used if stains are stubborn.
- If a ring forms on fabric after spot cleaning, clean the entire area immediately or it will set.

## Using Cleaner on Fabric

1. Vacuum and brush the area to remove any loose dirt.
2. Always clean a whole trim panel or section. Mask surrounding trim along stitch or welt lines.
3. Follow the directions on the container label.
4. Apply cleaner with a clean sponge. Don't saturate the material and don't rub it roughly.
5. As soon as you've cleaned the section, use a sponge to remove any excess cleaner.
6. Wipe cleaned area with a clean, water-dampened towel or cloth.
7. Wipe with a clean cloth and let dry.

## Special Fabric Cleaning Problems

Stains caused by such things as catsup, coffee (black), egg, fruit, fruit juice, milk, soft drinks, vomit, urine and blood can be removed as follows:

1. Carefully scrape off excess stain, then sponge the soiled area with cool water.
2. If a stain remains, follow the cleaner instructions described earlier.
3. If an odor lingers after cleaning vomit or urine, treat the area with a water/baking soda solution: 1 teaspoon (5 ml) of baking soda to 1 cup (250 ml) of lukewarm water.
4. Let dry.

Stains caused by candy, ice cream, mayonnaise, chili sauce and unknown stains can be removed as follows:

1. Carefully scrape off excess stain.
2. First, clean with cool water and allow to dry completely.
3. If a stain remains, follow the cleaner instructions described earlier.

## Cleaning Vinyl

Use warm water and a clean cloth.

- Rub with a clean, damp cloth to remove dirt. You may have to do this more than once.
- Things like tar, asphalt and shoe polish will stain if you don't get them off quickly. Use a clean cloth and vinyl cleaner. See your dealer for this product.

## Cleaning Leather

Use a soft cloth with lukewarm water and a mild soap or saddle soap and wipe dry with a soft cloth. Then, let the leather dry naturally. Do not use heat to dry.

- For stubborn stains, use a leather cleaner.
- *Never* use oils, varnishes, solvent-based or abrasive cleaners, furniture polish or shoe polish on leather.
- Soiled or stained leather should be cleaned immediately. If dirt is allowed to work into the finish, it can harm the leather.

## Cleaning the Top of the Instrument Panel

Use only mild soap and water to clean the top surfaces of the instrument panel. Sprays containing silicones or waxes may cause annoying reflections in the windshield and even make it difficult to see through the windshield under certain conditions.

## Cleaning Interior Plastic Components

Use only a mild soap and water solution on a soft cloth or sponge. Commercial cleaners may affect the surface finish.

## Cleaning the Speaker Covers

Vacuum around a speaker cover gently, so that the speaker won't be damaged. Clean spots with just water and mild soap.

## Cleaning Glass Surfaces

Glass should be cleaned often. GM Glass Cleaner or a liquid household glass cleaner will remove normal tobacco smoke and dust films on interior glass. See *Vehicle Care/Appearance Materials* on page 5-96.

**Notice:** If you use abrasive cleaners when cleaning glass surfaces on your vehicle, you could scratch the glass and/or cause damage to the rear window defogger and the integrated radio antenna. When cleaning the glass on your vehicle, use only a soft cloth and glass cleaner.



## Care of Safety Belts

Keep belts clean and dry.

### CAUTION:

**Do not bleach or dye safety belts. If you do, it may severely weaken them. In a crash, they might not be able to provide adequate protection. Clean safety belts only with mild soap and lukewarm water.**

## Weatherstrips

Silicone grease on weatherstrips will make them last longer, seal better, and not stick or squeak. Apply silicone grease with a clean cloth at least every six months. During very cold, damp weather more frequent application may be required. See *Part D: Recommended Fluids and Lubricants* on page 6-25.

## Cleaning the Outside of Your Vehicle

The paint finish on your vehicle provides beauty, depth of color, gloss retention and durability.

### Washing Your Vehicle

The best way to preserve your vehicle's finish is to keep it clean by washing it often with lukewarm or cold water.

Do not wash your vehicle in the direct rays of the sun. Use a car washing soap. Do not use strong soaps or chemical detergents. Be sure to rinse the vehicle well, removing all soap residue completely. You can get GM-approved cleaning products from your dealer.

See *Vehicle Care/Appearance Materials* on page 5-96.

Do not use cleaning agents that are petroleum based, or that contain acid or abrasives. All cleaning agents should be flushed promptly and not allowed to dry on the surface, or they could stain. Dry the finish with a soft, clean chamois or an all-cotton towel to avoid surface scratches and water spotting.

High pressure car washes may cause water to enter your vehicle.

## Cleaning Exterior Lamps/Lenses

Use only lukewarm or cold water, a soft cloth and a car washing soap to clean exterior lamps and lenses. Follow instructions under “Washing Your Vehicle.”

## Finish Care

Occasional waxing or mild polishing of your vehicle by hand may be necessary to remove residue from the paint finish. You can get GM-approved cleaning products from your dealer. See *Vehicle Care/Appearance Materials* on page 5-96.

Your vehicle has a “basecoat/clearcoat” paint finish. The clearcoat gives more depth and gloss to the colored basecoat. Always use waxes and polishes that are non-abrasive and made for a basecoat/clearcoat paint finish.

**Notice:** Machine compounding or aggressive polishing on a basecoat/clearcoat paint finish may damage it. Use only non-abrasive waxes and polishes that are made for a basecoat/clearcoat paint finish on your vehicle.

Foreign materials such as calcium chloride and other salts, ice melting agents, road oil and tar, tree sap, bird droppings, chemicals from industrial chimneys, etc., can damage your vehicle's finish if they remain on painted

surfaces. Wash the vehicle as soon as possible. If necessary, use non-abrasive cleaners that are marked safe for painted surfaces to remove foreign matter.

Exterior painted surfaces are subject to aging, weather and chemical fallout that can take their toll over a period of years. You can help to keep the paint finish looking new by keeping your vehicle garaged or covered whenever possible.

## Cleaning Windshield and Wiper Blades

If the windshield is not clear after using the windshield washer, or if the wiper blade chatters when running, wax, sap or other material may be on the blade or windshield.

Clean the outside of the windshield with a full-strength glass cleaning liquid. The windshield is clean if beads do not form when you rinse it with water.

Grime from the windshield will stick to the wiper blades and affect their performance. Clean the blade by wiping vigorously with a cloth soaked in full-strength windshield washer solvent. Then rinse the blade with water.

Check the wiper blades and clean them as necessary; replace blades that look worn.

## Cleaning Aluminum or Chrome-Plated Wheels

Your vehicle may be equipped with either aluminum or chrome-plated wheels.

Keep your wheels clean using a soft clean cloth with mild soap and water. Rinse with clean water. After rinsing thoroughly, dry with a soft clean towel. A wax may then be applied.

The surface of these wheels is similar to the painted surface of your vehicle. Do not use strong soaps, chemicals, abrasive polishes, abrasive cleaners, cleaners with acid, or abrasive cleaning brushes on them because you could damage the surface. Do not use chrome polish on aluminum wheels.

Use chrome polish only on chrome-plated wheels, but avoid any painted surface of the wheel, and buff off immediately after application.

Do not take your vehicle through an automatic car wash that has silicone carbide tire cleaning brushes. These brushes can also damage the surface of these wheels.

## Cleaning Tires

To clean your tires, use a stiff brush with tire cleaner.

**Notice:** Using petroleum-based tire dressing products on your vehicle may damage the paint finish and/or tires. When applying a tire dressing, always wipe off any overspray from all painted surfaces on your vehicle.

## Sheet Metal Damage

If your vehicle is damaged and requires sheet metal repair or replacement, make sure the body repair shop applies anti-corrosion material to parts repaired or replaced to restore corrosion protection.

Original manufacturer replacement parts will provide the corrosion protection while maintaining the warranty.

## Finish Damage

Any stone chips, fractures or deep scratches in the finish should be repaired right away. Bare metal will corrode quickly and may develop into major repair expense.

Minor chips and scratches can be repaired with touch-up materials available from your dealer. Larger areas of finish damage can be corrected in your dealer's body and paint shop.

## Underbody Maintenance

Chemicals used for ice and snow removal and dust control can collect on the underbody. If these are not removed, corrosion and rust can develop on the underbody parts such as fuel lines, frame, floor pan and exhaust system even though they have corrosion protection.

At least every spring, flush these materials from the underbody with plain water. Clean any areas where mud and debris can collect. Dirt packed in close areas of the frame should be loosened before being flushed. Your dealer or an underbody car washing system can do this for you.

## Chemical Paint Spotting

Some weather and atmospheric conditions can create a chemical fallout. Airborne pollutants can fall upon and attack painted surfaces on your vehicle. This damage can take two forms: blotchy, ring-shaped discolorations, and small, irregular dark spots etched into the paint surface.

Although no defect in the paint job causes this, GM will repair, at no charge to the owner, the surfaces of new vehicles damaged by this fallout condition within 12 months or 12,000 miles (20 000 km) of purchase, whichever occurs first.

## Vehicle Care/Appearance Materials

See your GM dealer for more information on purchasing the following products.

### Vehicle Care/Appearance Materials

Description	Usage
Polishing Cloth Wax-Treated	Interior and exterior polishing cloth.
Tar and Road Oil Remover	Removes tar, road oil and asphalt.
Chrome Cleaner and Polish	Use on chrome or stainless steel.

## Vehicle Care/Appearance Materials (cont'd)

Description	Usage
White Sidewall Tire Cleaner	Removes soil and black marks from whitewalls.
Vinyl Cleaner	Cleans vinyl tops, upholstery and convertible tops.
Glass Cleaner	Removes dirt, grime, smoke and fingerprints.
Chrome and Wire Wheel Cleaner	Removes dirt and grime from chrome wheels and wire wheel covers.
Finish Enhancer	Removes dust, fingerprints, and surface contaminants. Spray on wipe off.
Swirl Remover Polish	Removes swirl marks, fine scratches and other light surface contamination.
Cleaner Wax	Removes light scratches and protects finish.

## Vehicle Care/Appearance Materials (cont'd)

Description	Usage
Foaming Tire Shine Low Gloss	Cleans, shines and protects in one easy step, no wiping necessary.
Wash Wax Concentrate	Medium foaming shampoo. Cleans and lightly waxes. Biodegradable and phosphate free.
Spot Lifter	Quickly and easily removes spots and stains from carpets, vinyl and cloth upholstery.
Odor Eliminator	Odorless spray odor eliminator used on fabrics, vinyl, leather and carpet.
See your General Motors parts department for these products. See <i>Part D: Recommended Fluids and Lubricants</i> on page 6-25.	

## Vehicle Identification

### Vehicle Identification Number (VIN)



This is the legal identifier for your vehicle. It appears on a plate in the front corner of the instrument panel, on the driver's side. You can see it if you look through the windshield from outside your vehicle. The VIN also appears on the Vehicle Certification and Service Parts labels and the certificates of title and registration.

### Engine Identification

The 8th character in your VIN is the engine code. This code will help you identify your engine, specifications and replacement parts.

## Service Parts Identification Label

You will find this label on your spare tire cover. It is very helpful if you ever need to order parts. On this label, you will find the following:

- VIN
- Model designation
- Paint information
- Production options and special equipment

Be sure that this label is not removed from the vehicle.

## Electrical System

### Add-On Electrical Equipment

**Notice:** Don't add anything electrical to your vehicle unless you check with your dealer first. Some electrical equipment can damage your vehicle and the damage wouldn't be covered by your warranty. Some add-on electrical equipment can keep other components from working as they should.

Your vehicle has an air bag system. Before attempting to add anything electrical to your vehicle, see *Servicing Your Air Bag-Equipped Vehicle* on page 1-58.

## Fuses and Circuit Breakers

The wiring circuits in your vehicle are protected from short circuits by a combination of fuses and circuit breakers. This greatly reduces the chance of damage caused by electrical problems.

Look at the silver-colored band inside the fuse. If the band is broken or melted, replace the fuse. Be sure you replace a bad fuse with a new one of the identical size and rating.

There are four fuse blocks in your vehicle: the main and auxiliary instrument panel fuse blocks, the underhood fuse block and the rear fuse block.

## Main and Auxiliary Instrument Panel Fuse Blocks

The main and auxiliary instrument panel fuse blocks are located under the instrument panel, on the passenger's side of the vehicle. Lamps, connectors and the HVAC duct temperature sensors may need to be disconnected and removed to allow access to these fuse blocks.

Remove the hush panel on the passenger's side to reveal the fuses by performing the following steps:

1. Remove the two screws located along the front edge of the panel.
2. Lower the hush panel.
3. Remove the fuse block cover.
4. Place the wide end of the fuse puller over the plastic end of the fuse.
5. Squeeze the ends over the fuse and pull it out.

When finished, reinstall the fuse block cover and the hush panel. Reinstall lamps, connectors and HVAC duct temperature sensors if they were removed.

## Main Instrument Panel Fuse Block

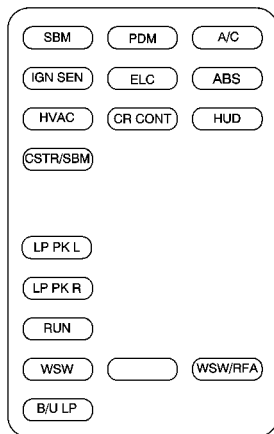

Fuses	Usage
SBM	Interior Lamps
PDM	PDM Module
A/C	HVAC Motor, HVAC Mix Motors

Fuses	Usage
IGN SEN	Auto Dimming Mirror, Driver HTS Seat, Rear Defog Relay, MEM Module, Cool LVL Sensor, Pass Heated Seat
ELC	HVAC Flat Pk Mtrs, Electronic Level Control Sensor, Electronic Level Control Sensor (R Bec)
ABS	Anti-Lock Brake System Module
HVAC	HVAC Main Con Head, HVAC Programmer, Instrument Panel Cluster
CR CONT	Stepper Motor Cruise, Cruise Switch
HUD	Head-Up Display Switch, Head-Up Display
CSTR/SBM	HVAC Programmer, Instrument Panel Cluster, SBM (275 to LCM) (1135 to BTSI SL)
LP PK L	Underhood Lamp, Left Park/Sidemark, Left Park/Turn Lamp, SBM, Left Tail Signal Lamp, Left Tail/Stoplamp, Left Rear Sidemark



Fuses	Usage
LP PK R	Right Park/Sidemarkers Lamp, Right Park/Turn Lamp, Right Tail/Sign Lamp, Right Tail/Stoplamp, Right Rear Sidemarkers, Stop/Taillamp, Tail/Signal Lamp, License Lamp, RFA
RUN	Run/Accessory
WSW	Wiper Motor
Blank	Not Used
WSW/RFA	Wiper Switch, RFA, Rain Sense
B/U LP	Auto Dimming Mirror, Back-Up Lamps

## Auxiliary Instrument Panel Fuse Block

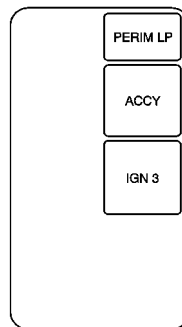

Fuses	Usage
PERIM LP	Perimeter Lamps
ACCY	Accessory
IGN 3	Ignition 3

## Underhood Fuse Block



There are additional fuses located in the engine compartment on the passenger's side of the vehicle. See *Engine Compartment Overview on page 5-12* for more information on location.

To check the fuses in this underhood fuse block, turn the knob counterclockwise and remove the cover. There is a chart inside the cover that explains the features and controls governed by each fuse and relay.

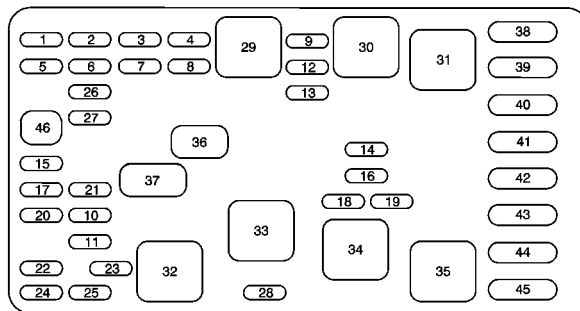

Fuses	Usage
1	Not Used
2	SBM, LCM
3	Turn Signal
4	Pre-Oxygen Sensor, Post-Oxygen Sensor
5	Air Bag (SIR)
6	Powertrain Control Module
7	Air Conditioning Clutch
8	Ignition Feed
9	Horn Relay

<b>Fuses</b>	<b>Usage</b>
10	Spare
11	Spare
12	Injectors #1-6
13	C-31
14	Right High Beam
15	Spare
16	Left High Beam
17	Spare
18	Right Low Beam
19	Left Low Beam
20	Stop
21	Fuel Pump Relay (Wire in BEC)
22	Run/Crank
23	Powertrain Control Module
24	Parking Lamps
25	Hazard Flashers
26	Spare
27	Spare
28	ABS #2

<b>Relays</b>	<b>Usage</b>
29	Ignition
30	Horn
31	Cooling Fan 1
32	Starter
33	Not Used
34	Cooling Fan SP
35	Cooling Fan 2
36	Air Conditioning Clutch
37	Fuel Pump

<b>Fuses</b>	<b>Usage</b>
38	Bat #1
39	Blower Motor
40	Cooling Fan 1
41	Headlamp
42	BAT #2
43	Ignition
44	Starter
45	ABS
46	Fuse Puller

## Removing the Rear Seat Cushion

**Notice:** If, when removing or reinstalling the rear seat, you do not do it carefully, you could damage the fuse center. Avoid contact between the rear seat and the fuse center whenever you remove or reinstall the rear seat.

To remove the rear seat cushion, do the following:

1. Pull up on the front of the cushion to release the front hooks.
2. Pull the cushion up and out toward the front of the vehicle.

To reinstall the rear seat cushion, do the following:

### CAUTION:

**A safety belt that isn't properly routed through the seat cushion or is twisted won't provide the protection needed in a crash. If the safety belt hasn't been routed through the seat cushion at all, it won't be there to work for the next passenger. The person sitting in that position could be badly injured. After reinstalling the seat cushion, always check to be sure that the safety belts are properly routed and are not twisted.**

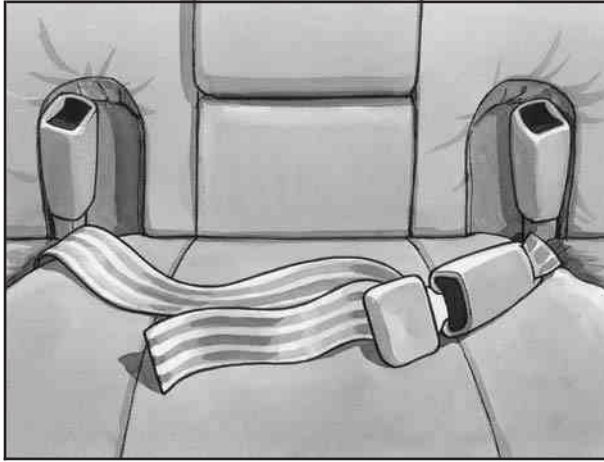

1. Buckle the center passenger position safety belt, then route the safety belts through the proper slots in the seat cushion. Do not let the safety belts get twisted.
2. Slide the rear of the cushion up and under the seatback so the rear locating guides hook into the wire loops on the back frame.
3. With the seat cushion lowered, push rearward and then press down on the seat cushion until the spring locks on both ends engage.
4. Check to make sure the safety belts are properly routed and that no portion of any safety belt is trapped under the seat. Also make sure the seat cushion is secured.

## Rear Compartment Fuse Block

Additional fuses are located in the fuse center under the rear seat.

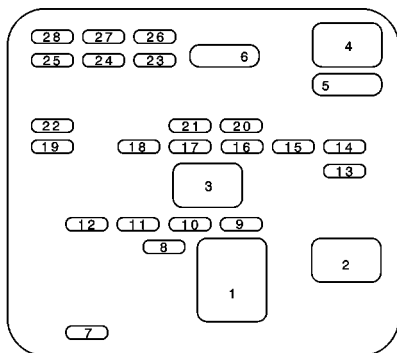

Circuit Breakers	Usage
5	Power Seat
6	Electronic Level Control Sensor, Electronic Level Control Compressor Solenoid

Fuses	Usage
7	Crank
8	Accessory Outlet
9	Powertrain Control Module for Cruise
10	SBM Module
11	Radio/Phone
12	Sunroof
13	Spare
14	CD Changer, Phone
15	Driver Door Module
16	Spare

Relays	Usage
1	Heated Backlite
2	Retained Accessory Power (RAP)
3	Trunk Release
4	Electronic Level Control

<b>Fuses</b>	<b>Usage</b>
17	Radio
18	Driver Heated Seat Module
19	Rear Door Module
20	Trunk Release
21	Spare
22	Instrument Panel Ashtray Cigarette Lighter

<b>Fuses</b>	<b>Usage</b>
23	Spare
24	Spare
25	Passenger Heated Seat Module
26	Right Rear Cig Lighter
27	Left Rear Cig Lighter
28	RFA, Memory Seat Module, Driver Seat Switch

## Capacities and Specifications

The following approximate capacities are given in English and metric conversions. Please refer to *Part D: Recommended Fluids and Lubricants* on page 6-25 for more information.

### Capacities

Application	Capacities	
	English	Metric
Air Conditioning Refrigerant R134a	2.2 lbs	1.0 kg
Automatic Transaxle	7.4 quarts	7.0 L
Engine Cooling System	13.0 quarts	12.3 L
Engine Oil with Filter	4.5 quarts	4.3 L
Fuel Tank	18.5 gallons	70.0 L
Wheel Nut Torque	100 lb-ft	140 N•m

All capacities are approximate. When adding, be sure to fill to the appropriate level, as recommended in this manual.

Engine	VIN Code	Transmission	Spark Plug Gap
3800 3.8L V6 (L36)	K	Automatic	0.060 inch (0.152 cm)
3800 3.8L V6 Supercharged Engine (L67)	1	Automatic	0.060 inch (0.152 cm)



## Normal Maintenance Replacement Parts

Replacement parts identified below by name, part number, or specification can be obtained from your dealer.

<b>Part</b>	<b>GM Part Number</b>	<b>ACDelco® Part Number</b>
Engine Air Cleaner/Filter	25096932	A1096C
Engine Oil Filter	25010792	PF-47
Fuel Filter	25121293	GF-627
Passenger Compartment Air Filter	52472175	—
Spark Plugs	12568387	41-101
Windshield Wiper Blades	12463075	—
Type	Hook Style	
Length	22.0 inches (56.0 cm)	



## Section 6 Maintenance Schedule

---

<b>Maintenance Schedule</b> .....	6-2	At Least Twice a Year .....	6-20
Introduction .....	6-2	At Least Once a Year .....	6-20
Maintenance Requirements .....	6-2	Part C: Periodic Maintenance Inspections .....	6-23
Your Vehicle and the Environment .....	6-2	Steering, Suspension and Front Drive Axle	
How This Section is Organized .....	6-3	Boot and Seal Inspection .....	6-23
Part A: Scheduled Maintenance Services .....	6-4	Exhaust System Inspection .....	6-23
Using Your Maintenance Schedule .....	6-4	Fuel System Inspection .....	6-24
Selecting the Right Schedule .....	6-5	Engine Cooling System Inspection .....	6-24
Short Trip/City Scheduled Maintenance .....	6-7	Throttle System Inspection .....	6-24
Long Trip/Highway Scheduled Maintenance .....	6-14	Brake System Inspection .....	6-24
Part B: Owner Checks and Services .....	6-19	Part D: Recommended Fluids	
At Each Fuel Fill .....	6-19	and Lubricants .....	6-25
At Least Once a Month .....	6-19	Part E: Maintenance Record .....	6-26

## Maintenance Schedule

### Introduction

**Important: Keep engine oil at the proper level and change as recommended.**



*Have you purchased the GM Protection Plan? The Plan supplements your new vehicle warranties. See your Warranty and Owner Assistance booklet or your dealer for details.*

## Maintenance Requirements

Maintenance intervals, checks, inspections and recommended fluids and lubricants as prescribed in this manual are necessary to keep your vehicle in good working condition. Any damage caused by failure to follow scheduled maintenance may not be covered by warranty.

### Your Vehicle and the Environment

Proper vehicle maintenance not only helps to keep your vehicle in good working condition, but also helps the environment. Improper vehicle maintenance can even affect the quality of the air we breathe. Improper fluid levels or the wrong tire inflation can increase the level of emissions from your vehicle. To help protect our environment, and to keep your vehicle in good condition, be sure to maintain your vehicle properly.

## How This Section is Organized

This maintenance schedule is divided into five parts:

**“Part A: Scheduled Maintenance Services”** explains what to have done and how often. Some of these services can be complex, so unless you are technically qualified and have the necessary equipment, you should let your GM dealer’s service department do these jobs.

Your GM dealer has GM-trained and supported service people that will perform the work using genuine GM parts.

### **CAUTION:**

**Performing maintenance work on a vehicle can be dangerous. In trying to do some jobs, you can be seriously injured. Do your own maintenance work only if you have the required know-how and the proper tools and equipment for the job. If you have any doubt, have a qualified technician do the work.**

If you want to get the service information, see *Service Publications Ordering Information* on page 7-11.

**“Part B: Owner Checks and Services”** tells you what should be checked and when. It also explains what you can easily do to help keep your vehicle in good condition.

**“Part C: Periodic Maintenance Inspections”** explains important inspections that your dealer’s service department can perform for you.

**“Part D: Recommended Fluids and Lubricants”** lists some recommended products necessary to help keep your vehicle properly maintained. These products, or their equivalents, should be used whether you do the work yourself or have it done.

**“Part E: Maintenance Record”** is a place for you to record and keep track of the maintenance performed on your vehicle. Keep your maintenance receipts. They may be needed to qualify your vehicle for warranty repairs.

## Part A: Scheduled Maintenance Services

In this part are scheduled maintenance services which are to be performed at the mileage intervals specified.

### Using Your Maintenance Schedule

We at General Motors want to keep your vehicle in good working condition. But we do not know exactly how you will drive it. You may drive short distances only a few times a week. Or you may drive long distances all the time in very hot, dusty weather. You may use your vehicle in making deliveries. Or you may drive it to work, to do errands or in many other ways.

Because of the different ways people use their vehicles, maintenance needs may vary. You may need more frequent checks and replacements. So please read the following and note how you drive. If you have questions on how to keep your vehicle in good condition, see your dealer.

This part tells you the maintenance services you should have done and when to schedule them.

When you go to your dealer for your service needs, you will know that GM-trained and supported service people will perform the work using genuine GM parts.

The proper fluids and lubricants to use are listed in Part D. Make sure whoever services your vehicle uses these. All parts should be replaced and all necessary repairs done before you or anyone else drives the vehicle.

These schedules are for vehicles that:

- carry passengers and cargo within recommended limits. You will find these on the tire and loading information label. See *Loading Your Vehicle on page 4-33*.
- are driven on reasonable road surfaces within legal driving limits.
- use the recommended fuel. See *Gasoline Octane on page 5-4*.

## Selecting the Right Schedule

First you'll need to decide which of the two schedules is right for your vehicle. Here's how to decide which schedule to follow:

### Short Trip/City Definition

Follow the Short Trip/City Scheduled Maintenance if any one of these conditions is true for your vehicle:

- Most trips are less than 5 miles (8 km). This is particularly important when outside temperatures are below freezing.
- Most trips include extensive idling (such as frequent driving in stop-and-go traffic).
- You frequently tow a trailer or use a carrier on top of your vehicle.
- If the vehicle is used for delivery service, police, taxi or other commercial application.

*One of the reasons you should follow this schedule if you operate your vehicle under any of these conditions is that these conditions cause engine oil to break down sooner.*

## Short Trip/City Intervals

**Every 3,000 Miles (5 000 km):** Engine Oil and Filter Change (or 3 months, whichever occurs first).

**Every 6,000 Miles (10 000 km):** Tire Rotation.

**Every 15,000 Miles (25 000 km):** Engine Air Cleaner Filter Inspection. Passenger Compartment Air Filter Replacement.

**Every 30,000 Miles (50 000 km):** Engine Air Cleaner Filter Replacement. Supercharger Oil Check (or every 36 months, whichever occurs first) (3800 Code 1 V6 engine only).

**Every 50,000 Miles (83 000 km):** Automatic Transaxle Service (severe conditions only).

**Every 100,000 Miles (166 000 km):** Spark Plug Wire Inspection. Spark Plug Replacement. Automatic Transaxle Service (normal conditions).

**Every 150 000 Miles (240 000 km):** Cooling System Service (or every 60 months, whichever occurs first). Engine Accessory Drive Belt Inspection.

*These intervals only summarize maintenance services. Be sure to follow the complete scheduled maintenance on the following pages.*

## Long Trip/Highway Definition

Follow this scheduled maintenance *only* if none of the conditions from the Short Trip/City Scheduled Maintenance are true. Do not use this schedule if the vehicle is used for trailer towing, driven in a dusty area or used off paved roads. Use the Short Trip/City schedule for these conditions

*Driving a vehicle with a fully warmed engine under highway conditions will cause engine oil to break down slower.*

## Long Trip/Highway Intervals

**Every 7,500 Miles (12 500 km):** Engine Oil and Filter Change (or every 12 months, whichever occurs first). Tire Rotation.

**Every 15,000 Miles (25 000 km):** Engine Air Cleaner Filter Inspection. Passenger Compartment Air Filter Replacement.

**Every 30,000 Miles (50 000 km):** Supercharger Oil Check (or every 36 months, whichever occurs first) (3800 Code 1 V6 engine only). Engine Air Cleaner Filter Replacement.

**Every 50,000 Miles (83 000 km):** Automatic Transaxle Service (severe conditions only).

**Every 100,000 Miles (166 000 km):** Spark Plug Wire Inspection. Spark Plug Replacement. Automatic Transaxle Service (normal conditions).

**Every 150,000 Miles (240 000 km):** Cooling System Service (or every 60 months, whichever occurs first). Engine Accessory Drive Belt Inspection.

*These intervals only summarize maintenance services. Be sure to follow the complete scheduled maintenance on the following pages.*



## Short Trip/City Scheduled Maintenance

The services shown in this schedule up to 100,000 miles (166 000 km) should be repeated after 100,000 miles (166 000 km) at the same intervals for the life of this vehicle. The services shown at 150,000 miles (240 000 km) should be repeated at the same interval after 150,000 miles (240 000 km) for the life of this vehicle.

See *Part B: Owner Checks and Services on page 6-19* and *Part C: Periodic Maintenance Inspections on page 6-23*.

### Footnotes

† *The U.S. Environmental Protection Agency or the California Air Resources Board has determined that the failure to perform this maintenance item will not nullify the emission warranty or limit recall liability prior to the completion of the vehicle's useful life. We, however, urge that all recommended maintenance services be performed at the indicated intervals and the maintenance be recorded.*

\* *If your vehicle has the GM Oil Life System, a computer system lets you know when to change the oil and filter. This is based on engine revolutions and engine*

*temperature, and not on mileage. Based on driving conditions, the mileage at which an oil change will be indicated can vary considerably. For the oil life system to work properly, you must reset the system every time the oil is changed.*

*When the system has calculated that oil life has been diminished, it will indicate that an oil change is necessary. A CHANGE ENGINE OIL SOON message will come on. Change your oil as soon as possible within the next two times you stop for fuel. It is possible that, if you are driving under the best conditions, the oil life system may not indicate that an oil change is necessary for over a year. However, your engine oil and filter must be changed at least once a year and at this time the system must be reset. It is also important to check your oil regularly and keep it at the proper level.*

*If the system is ever reset accidentally, you must change your oil at 3,000 miles (5 000 km) since your last oil change. Remember to reset the oil life system whenever the oil is changed. See Engine Oil on page 5-14 for information on resetting the system.*

*Whenever the tires are rotated, the Check Tire Pressure System (if equipped) must be reset.*

+ *A good time to check your brakes is during tire rotation. See Brake System Inspection on page 6-24.*

### **3,000 Miles (5 000 km)**

- Change engine oil and filter (or every 3 months, whichever occurs first). *An Emission Control Service.* (See footnote \*.)

### **6,000 Miles (10 000 km)**

- Change engine oil and filter (or every 3 months, whichever occurs first). *An Emission Control Service.* (See footnote \*.)
- Rotate tires. See *Tire Inspection and Rotation* on page 5-72 for proper rotation pattern and additional information. (See footnote .) (See footnote +.)

### **9,000 Miles (15 000 km)**

- Change engine oil and filter (or every 3 months, whichever occurs first). *An Emission Control Service.* (See footnote \*.)

### **12,000 Miles (20 000 km)**

- Change engine oil and filter (or every 3 months, whichever occurs first). *An Emission Control Service.* (See footnote \*.)
- Rotate tires. See *Tire Inspection and Rotation* on page 5-72 for proper rotation pattern and additional information. (See footnote .) (See footnote +.)

### **15,000 Miles (25 000 km)**

- Change engine oil and filter (or every 3 months, whichever occurs first). *An Emission Control Service.* (See footnote \*.)
- Inspect engine air cleaner filter. If necessary, replace the filter. If vehicle is driven in dusty/dirty conditions, inspect filter at every engine oil change. See *Engine Air Cleaner/Filter* on page 5-20 for more information. *An Emission Control Service.* (See footnote †.)
- Replace passenger compartment air filter.

### **18,000 Miles (30 000 km)**

- Change engine oil and filter (or every 3 months, whichever occurs first). *An Emission Control Service.* (See footnote \*.)
- Rotate tires. See *Tire Inspection and Rotation* on page 5-72 for proper rotation pattern and additional information. (See footnote .) (See footnote +.)

### **21,000 Miles (35 000 km)**

- Change engine oil and filter (or every 3 months, whichever occurs first). *An Emission Control Service.* (See footnote \*.)

## **24,000 Miles (40 000 km)**

- Change engine oil and filter (or every 3 months, whichever occurs first). *An Emission Control Service.* (See footnote \*.)
- Rotate tires. See *Tire Inspection and Rotation on page 5-72* for proper rotation pattern and additional information. (See footnote .) (See footnote +.)

## **27,000 Miles (45 000 km)**

- Change engine oil and filter (or every 3 months, whichever occurs first). *An Emission Control Service.* (See footnote \*.)

## **30,000 Miles (50 000 km)**

- Change engine oil and filter (or every 3 months, whichever occurs first). *An Emission Control Service.* (See footnote \*.)
- Replace passenger compartment air filter.
- Replace engine air cleaner filter. See *Engine Air Cleaner/Filter on page 5-20* for more information. *An Emission Control Service.*

- For supercharged engine only: Check the supercharger oil level and add the proper supercharger oil as needed (or every 36 months, whichever occurs first). See *Part D: Recommended Fluids and Lubricants on page 6-25.* *An Emission Control Service.* (See footnote †.)
- Rotate tires. See *Tire Inspection and Rotation on page 5-72* for proper rotation pattern and additional information. (See footnote .) (See footnote +.)

## **33,000 Miles (55 000 km)**

- Change engine oil and filter (or every 3 months, whichever occurs first). *An Emission Control Service.* (See footnote \*.)

## **36,000 Miles (60 000 km)**

- Change engine oil and filter (or every 3 months, whichever occurs first). *An Emission Control Service.* (See footnote \*.)
- Rotate tires. See *Tire Inspection and Rotation on page 5-72* for proper rotation pattern and additional information. (See footnote .) (See footnote +.)

### **39,000 Miles (65 000 km)**

- ❑ Change engine oil and filter (or every 3 months, whichever occurs first). *An Emission Control Service.* (See footnote \*.)

### **42,000 Miles (70 000 km)**

- ❑ Change engine oil and filter (or every 3 months, whichever occurs first). *An Emission Control Service.* (See footnote \*.)
- ❑ Rotate tires. See *Tire Inspection and Rotation on page 5-72* for proper rotation pattern and additional information. (See footnote .) (See footnote +.)

### **45,000 Miles (75 000 km)**

- ❑ Change engine oil and filter (or every 3 months, whichever occurs first). *An Emission Control Service.* (See footnote \*.)
- ❑ Replace passenger compartment air filter.
- ❑ Inspect engine air cleaner filter. If necessary, replace the filter. If vehicle is driven in dusty/dirty conditions, inspect filter at every engine oil change. See *Engine Air Cleaner/Filter on page 5-20* for more information. *An Emission Control Service.* (See footnote †.)

### **48,000 Miles (80 000 km)**

- ❑ Change engine oil and filter (or every 3 months, whichever occurs first). *An Emission Control Service.* (See footnote \*.)
- ❑ Rotate tires. See *Tire Inspection and Rotation on page 5-72* for proper rotation pattern and additional information. (See footnote .) (See footnote +.)

### **50,000 Miles (83 000 km)**

- ❑ Change automatic transaxle fluid and filter if the vehicle is mainly driven under one or more of these conditions:
  - In heavy city traffic where the outside temperature regularly reaches 90°F (32°C) or higher.
  - In hilly or mountainous terrain.
  - When doing frequent trailer towing.
  - Uses such as found in taxi, police or delivery service.

*If you do not use your vehicle under any of these conditions, change the fluid and filter at 100,000 miles (166 000 km).*

## 51,000 Miles (85 000 km)

- ❑ Change engine oil and filter (or every 3 months, whichever occurs first). *An Emission Control Service.* (See footnote \*.)

## 54,000 Miles (90 000 km)

- ❑ Change engine oil and filter (or every 3 months, whichever occurs first). *An Emission Control Service.* (See footnote \*.)
- ❑ Rotate tires. See *Tire Inspection and Rotation on page 5-72* for proper rotation pattern and additional information. (See footnote .) (See footnote +.)

## 57,000 Miles (95 000 km)

- ❑ Change engine oil and filter (or every 3 months, whichever occurs first). *An Emission Control Service.* (See footnote \*.)

## 60,000 Miles (100 000 km)

- ❑ Change engine oil and filter (or every 3 months, whichever occurs first). *An Emission Control Service.* (See footnote \*.)
- ❑ Replace passenger compartment air filter.
- ❑ Replace engine air cleaner filter. See *Engine Air Cleaner/Filter on page 5-20* for more information. *An Emission Control Service.*

- ❑ For supercharged engines only: Check the supercharger oil level and add the proper supercharger oil as needed (or every 36 months, whichever occurs first). See *Part D: Recommended Fluids and Lubricants on page 6-25.* *An Emission Control Service.* (See footnote †.)
- ❑ Rotate tires. See *Tire Inspection and Rotation on page 5-72* for proper rotation pattern and additional information. (See footnote .) (See footnote +.)

## 63,000 Miles (105 000 km)

- ❑ Change engine oil and filter (or every 3 months, whichever occurs first). *An Emission Control Service.* (See footnote \*.)

## 66,000 Miles (110 000 km)

- ❑ Change engine oil and filter (or every 3 months, whichever occurs first). *An Emission Control Service.* (See footnote \*.)
- ❑ Rotate tires. See *Tire Inspection and Rotation on page 5-72* for proper rotation pattern and additional information. (See footnote .) (See footnote +.)

## 69,000 Miles (115 000 km)

- ❑ Change engine oil and filter (or every 3 months, whichever occurs first). *An Emission Control Service.* (See footnote \*.)

## **72,000 Miles (120 000 km)**

- Change engine oil and filter (or every 3 months, whichever occurs first). *An Emission Control Service.* (See footnote \*.)
- Rotate tires. See *Tire Inspection and Rotation on page 5-72* for proper rotation pattern and additional information. (See footnote .) (See footnote +.)

## **75,000 Miles (125 000 km)**

- Change engine oil and filter (or every 3 months, whichever occurs first). *An Emission Control Service.* (See footnote \*.)
- Inspect engine air cleaner filter. If necessary, replace the filter. If vehicle is driven in dusty/dirty conditions, inspect filter at every engine oil change. See *Engine Air Cleaner/Filter on page 5-20* for more information. *An Emission Control Service.* (See footnote †.)
- Replace passenger compartment air filter.

## **78,000 Miles (130 000 km)**

- Change engine oil and filter (or every 3 months, whichever occurs first). *An Emission Control Service.* (See footnote \*.)
- Rotate tires. See *Tire Inspection and Rotation on page 5-72* for proper rotation pattern and additional information. (See footnote .) (See footnote +.)

## **81,000 Miles (135 000 km)**

- Change engine oil and filter (or every 3 months, whichever occurs first). *An Emission Control Service.* (See footnote \*.)

## **84,000 Miles (140 000 km)**

- Change engine oil and filter (or every 3 months, whichever occurs first). *An Emission Control Service.* (See footnote \*.)
- Rotate tires. See *Tire Inspection and Rotation on page 5-72* for proper rotation pattern and additional information. (See footnote .) (See footnote +.)

## **87,000 Miles (145 000 km)**

- Change engine oil and filter (or every 3 months, whichever occurs first). *An Emission Control Service.* (See footnote \*.)

## **90,000 Miles (150 000 km)**

- Change engine oil and filter (or every 3 months, whichever occurs first). *An Emission Control Service.* (See footnote \*.)
- Replace passenger compartment air filter.
- Replace engine air cleaner filter. See *Engine Air Cleaner/Filter on page 5-20* for more information. *An Emission Control Service.*

- ❑ For supercharged engines only: Check the supercharger oil level and add the proper supercharger oil as needed (or every 36 months, whichever occurs first). See *Part D: Recommended Fluids and Lubricants on page 6-25. An Emission Control Service.* (See footnote †.)
- ❑ Rotate tires. See *Tire Inspection and Rotation on page 5-72* for proper rotation pattern and additional information. (See footnote .) (See footnote +.)

### **93,000 Miles (155 000 km)**

- ❑ Change engine oil and filter (or every 3 months, whichever occurs first). *An Emission Control Service.* (See footnote \*.)

### **96,000 Miles (160 000 km)**

- ❑ Change engine oil and filter (or every 3 months, whichever occurs first). *An Emission Control Service.* (See footnote \*.)
- ❑ Rotate tires. See *Tire Inspection and Rotation on page 5-72* for proper rotation pattern and additional information. (See footnote .) (See footnote +.)

### **99,000 Miles (165 000 km)**

- ❑ Change engine oil and filter (or every 3 months, whichever occurs first). *An Emission Control Service.* (See footnote \*.)

### **100,000 Miles (166 000 km)**

- ❑ Inspect spark plug wires. *An Emission Control Service.*
- ❑ Replace spark plugs. *An Emission Control Service.*
- ❑ Change automatic transaxle fluid and filter if the vehicle is mainly driven under one or more of these conditions:
  - In heavy city traffic where the outside temperature regularly reaches 90°F (32°C) or higher.
  - In hilly or mountainous terrain.
  - When doing frequent trailer towing.
  - Uses such as found in taxi, police or delivery service.
- ❑ If you haven't used your vehicle under severe service conditions listed previously and, therefore, haven't changed your automatic transaxle fluid, change both the fluid and filter.

### **150,000 Miles (240 000 km)**

- ❑ Drain, flush and refill cooling system (or every 60 months since last service, whichever occurs first). See *Engine Coolant on page 5-25* for what to use. Inspect hoses. Clean radiator, condenser, pressure cap and neck. Pressure test cooling system and pressure cap. *An Emission Control Service.*
- ❑ Inspect engine accessory drive belt. *An Emission Control Service.*

## Long Trip/Highway Scheduled Maintenance

The services shown in this schedule up to 100,000 miles (166 000 km) should be repeated after 100,000 miles (166 000 km) at the same intervals for the life of this vehicle. The services shown at 150,000 miles (240 000 km) should be repeated at the same interval after 150,000 miles (240 000 km) for the life of this vehicle.

See *Part B: Owner Checks and Services on page 6-19* and *Part C: Periodic Maintenance Inspections on page 6-23*.

### Footnotes

† *The U.S. Environmental Protection Agency or the California Air Resources Board has determined that the failure to perform this maintenance item will not nullify the emission warranty or limit recall liability prior to the completion of the vehicle's useful life. We, however, urge that all recommended maintenance services be performed at the indicated intervals and the maintenance be recorded.*

\* *If your vehicle has the GM Oil Life System, a computer system lets you know when to change the engine oil and filter. This is based on engine revolutions and engine temperature, and not on mileage. Based on*

*driving conditions, the mileage at which an oil change will be indicated can vary considerably. For the oil life system to work properly, you must reset the system every time the oil is changed.*

*When the system has calculated that oil life has been diminished, it will indicate that an oil change is necessary. A CHANGE ENGINE OIL SOON message will come on. Change your oil as soon as possible within the next two times you stop for fuel. It is possible that, if you are driving under the best conditions, the oil life system may not indicate that an oil change is necessary for over a year. However, your engine oil and filter must be changed at least once a year and at this time the system must be reset. It is also important to check your oil regularly and keep it at the proper level.*

*If the system is ever reset accidentally, you must change your oil at 3,000 miles (5 000 km) since your last oil change. Remember to reset the oil life system whenever the oil is changed. See Engine Oil on page 5-14 for information on resetting the system.*

*Whenever the tires are rotated, the Check Tire Pressure System (if equipped) must be reset.*

+ *A good time to check your brakes is during tire rotation. See Brake System Inspection on page 6-24.*



## 7,500 Miles (12 500 km)

- ❑ Change engine oil and filter (or every 12 months, whichever occurs first). *An Emission Control Service.* (See footnote \*.)
- ❑ Rotate tires. See *Tire Inspection and Rotation* on page 5-72 for proper rotation pattern and additional information. (See footnote .) (See footnote +.)

## 15,000 Miles (25 000 km)

- ❑ Change engine oil and filter (or every 12 months, whichever occurs first). *An Emission Control Service.* (See footnote \*.)
- ❑ Inspect engine air cleaner filter. See *Engine Air Cleaner/Filter* on page 5-20 for more information. *An Emission Control Service.* (See footnote †.)
- ❑ Replace passenger compartment air filter.
- ❑ Rotate tires. See *Tire Inspection and Rotation* on page 5-72 for proper rotation pattern and additional information. (See footnote .) (See footnote +.)

## 22,500 Miles (37 500 km)

- ❑ Change engine oil and filter (or every 12 months, whichever occurs first). *An Emission Control Service.* (See footnote \*.)
- ❑ Rotate tires. See *Tire Inspection and Rotation* on page 5-72 for proper rotation pattern and additional information. (See footnote .) (See footnote +.)

## 30,000 Miles (50 000 km)

- ❑ Change engine oil and filter (or every 12 months, whichever occurs first). *An Emission Control Service.* (See footnote \*.)
- ❑ Replace passenger compartment air filter.
- ❑ Rotate tires. See *Tire Inspection and Rotation* on page 5-72 for proper rotation pattern and additional information. (See footnote .) (See footnote +.)
- ❑ Replace engine air cleaner filter. See *Engine Air Cleaner/Filter* on page 5-20 for more information. *An Emission Control Service.*
- ❑ For supercharged engines only: Check the supercharger oil level and add the proper supercharger oil as needed (or every 36 months, whichever occurs first). See *Part D: Recommended Fluids and Lubricants* on page 6-25. *An Emission Control Service.* (See footnote †.)

## 37,500 Miles (62 500 km)

- ❑ Change engine oil and filter (or every 12 months, whichever occurs first). *An Emission Control Service.* (See footnote \*.)
- ❑ Rotate tires. See *Tire Inspection and Rotation* on page 5-72 for proper rotation pattern and additional information. (See footnote .) (See footnote +.)

## 45,000 Miles (75 000 km)

- ❑ Change engine oil and filter (or every 12 months, whichever occurs first). *An Emission Control Service.* (See footnote \*.)
- ❑ Inspect engine air cleaner filter. See *Engine Air Cleaner/Filter* on page 5-20 for more information. *An Emission Control Service.* (See footnote †.)
- ❑ Replace passenger compartment air filter.
- ❑ Rotate tires. See *Tire Inspection and Rotation* on page 5-72 for proper rotation pattern and additional information. (See footnote .) (See footnote +.)

## 50,000 Miles (83 000 km)

- ❑ Change automatic transaxle fluid and filter if the vehicle is mainly driven under one or more of these conditions:
  - In heavy city traffic where the outside temperature regularly reaches 90°F (32°C) or higher.
  - In hilly or mountainous terrain.
  - When doing frequent trailer towing.
  - Uses such as found in taxi, police or delivery service.

*If you do not use your vehicle under any of these conditions, change the fluid and filter at 100,000 miles (166 000 km).*

## 52,500 Miles (87 500 km)

- ❑ Change engine oil and filter (or every 12 months, whichever occurs first). *An Emission Control Service.* (See footnote \*.)
- ❑ Rotate tires. See *Tire Inspection and Rotation* on page 5-72 for proper rotation pattern and additional information. (See footnote .) (See footnote +.)

## 60,000 Miles (100 000 km)

- ❑ Change engine oil and filter (or every 12 months, whichever occurs first). *An Emission Control Service.* (See footnote \*.)
- ❑ Replace passenger compartment air filter.
- ❑ For supercharged engines only: Check the supercharger oil level and add the proper supercharger oil as needed (or every 36 months, whichever occurs first). See *Part D: Recommended Fluids and Lubricants* on page 6-25. *An Emission Control Service.* (See footnote †.)
- ❑ Rotate tires. See *Tire Inspection and Rotation* on page 5-72 for proper rotation pattern and additional information. (See footnote .) (See footnote +.)
- ❑ Replace engine air cleaner filter. See *Engine Air Cleaner/Filter* on page 5-20 for more information. *An Emission Control Service.*

## 67,500 Miles (112 500 km)

- ❑ Change engine oil and filter (or every 12 months, whichever occurs first). *An Emission Control Service.* (See footnote \*.)
- ❑ Rotate tires. See *Tire Inspection and Rotation* on page 5-72 for proper rotation pattern and additional information. (See footnote .) (See footnote +.)

## 75,000 Miles (125 000 km)

- ❑ Change engine oil and filter (or every 12 months, whichever occurs first). *An Emission Control Service.* (See footnote \*.)
- ❑ Inspect engine air cleaner filter. See *Engine Air Cleaner/Filter* on page 5-20 for more information. *An Emission Control Service.* (See footnote †.)
- ❑ Replace passenger compartment air filter.
- ❑ Rotate tires. See *Tire Inspection and Rotation* on page 5-72 for proper rotation pattern and additional information. (See footnote .) (See footnote +.)

## 82,500 Miles (137 500 km)

- ❑ Change engine oil and filter (or every 12 months, whichever occurs first). *An Emission Control Service.* (See footnote \*.)
- ❑ Rotate tires. See *Tire Inspection and Rotation* on page 5-72 for proper rotation pattern and additional information. (See footnote .) (See footnote +.)

## 90,000 Miles (150 000 km)

- ❑ Change engine oil and filter (or every 12 months, whichever occurs first). *An Emission Control Service.* (See footnote \*.)
- ❑ Replace passenger compartment air filter.
- ❑ Replace engine air cleaner filter. See *Engine Air Cleaner/Filter* on page 5-20 for more information. *An Emission Control Service.*
- ❑ For supercharged engines only: Check the supercharger oil level and add the proper supercharger oil as needed (or every 36 months, whichever occurs first). See *Part D: Recommended Fluids and Lubricants* on page 6-25. *An Emission Control Service.* (See footnote †.)
- ❑ Rotate tires. See *Tire Inspection and Rotation* on page 5-72 for proper rotation pattern and additional information. (See footnote .) (See footnote +.)

## 97,500 Miles (162 500 km)

- ❑ Change engine oil and filter (or every 12 months, whichever occurs first). *An Emission Control Service.* (See footnote \*.)
- ❑ Rotate tires. See *Tire Inspection and Rotation* on page 5-72 for proper rotation pattern and additional information. (See footnote .) (See footnote +.)

## 100,000 Miles (166 000 km)

- Inspect spark plug wires. *An Emission Control Service.*
- Replace spark plugs. *An Emission Control Service.*
- Change automatic transaxle fluid and filter if the vehicle is mainly driven under one or more of these conditions:
  - In heavy city traffic where the outside temperature regularly reaches 90°F (32°C) or higher.
  - In hilly or mountainous terrain.
  - When doing frequent trailer towing.
  - Uses such as found in taxi, police or delivery service.
- If you haven't used your vehicle under severe service conditions listed previously and, therefore, haven't changed your automatic transaxle fluid, change both the fluid and filter.

## 150,000 Miles (240 000 km)

- Drain, flush and refill cooling system (or every 60 months since last service, whichever occurs first). See *Engine Coolant on page 5-25* for what to use. Inspect hoses. Clean radiator, condenser, pressure cap and neck. Pressure test the cooling system and pressure cap. *An Emission Control Service.*
- Inspect engine accessory drive belt. *An Emission Control Service.*

## Part B: Owner Checks and Services

Listed in this part are owner checks and services which should be performed at the intervals specified to help ensure the safety, dependability and emission control performance of your vehicle.

Be sure any necessary repairs are completed at once. Whenever any fluids or lubricants are added to your vehicle, make sure they are the proper ones, as shown in Part D.

### At Each Fuel Fill

*It is important for you or a service station attendant to perform these underhood checks at each fuel fill.*

#### Engine Oil Level Check

Check the engine oil level and add the proper oil if necessary. See *Engine Oil* on page 5-14 for further details.

#### Engine Coolant Level Check

Check the engine coolant level and add DEX-COOL<sup>®</sup> coolant mixture if necessary. See *Engine Coolant* on page 5-25 for further details.

#### Windshield Washer Fluid Level Check

Check the windshield washer fluid level in the windshield washer tank and add the proper fluid if necessary. See *Windshield Washer Fluid* on page 5-39 for further details.

### At Least Once a Month

#### Tire Inflation Check

Visually inspect your tires and make sure tires are inflated to the correct pressures. Don't forget to check your spare tire. See *Tires* on page 5-62 for further details.

#### Cassette Tape Player Service

Clean cassette tape player. Cleaning should be done every 50 hours of tape play. See *Audio System(s)* on page 3-57 for further details.

## At Least Twice a Year

### Restraint System Check

Make sure the safety belt reminder light and all your belts, buckles, latch plates, retractors and anchorages are working properly. Look for any other loose or damaged safety belt system parts. If you see anything that might keep a safety belt system from doing its job, have it repaired. Have any torn or frayed safety belts replaced.

Also look for any opened or broken air bag coverings, and have them repaired or replaced. (The air bag system does not need regular maintenance.)

### Wiper Blade Check

Inspect wiper blades for wear or cracking. Replace blade inserts that appear worn or damaged or that streak or miss areas of the windshield. Also see “Windshield Wiper and Wiper Blades” under *Cleaning the Outside of Your Vehicle on page 5-93*.

### Weatherstrip Lubrication

Silicone grease on weatherstrips will make them last longer, seal better, and not stick or squeak. Apply silicone grease with a clean cloth. During very cold, damp weather more frequent application may be required. See *Part D: Recommended Fluids and Lubricants on page 6-25*.

## Automatic Transaxle Check

Check the transaxle fluid level; add if needed. See *Automatic Transaxle Fluid on page 5-23*. A fluid loss may indicate a problem. Check the system and repair if needed.

## At Least Once a Year

### Key Lock Cylinders Service

Lubricate the key lock cylinders with the lubricant specified in Part D.

### Body Lubrication Service

Lubricate all body door hinges. Also lubricate all hinges and latches, including those for the hood, glove box door and console door. Part D tells you what to use. More frequent lubrication may be required when exposed to a corrosive environment.

## Starter Switch Check

### CAUTION:

When you are doing this inspection, the vehicle could move suddenly. If the vehicle moves, you or others could be injured.

1. Before you start, be sure you have enough room around the vehicle.
2. Firmly apply both the parking brake and the regular brake. See *Parking Brake on page 2-29* if necessary.

Do not use the accelerator pedal, and be ready to turn off the engine immediately if it starts.

3. Try to start the engine in each gear. The starter should work only in PARK (P) or NEUTRAL (N). If the starter works in any other position, your vehicle needs service.

## Automatic Transaxle Shift Lock Control System Check

### CAUTION:

When you are doing this inspection, the vehicle could move suddenly. If the vehicle moves, you or others could be injured.

1. Before you start, be sure you have enough room around the vehicle. It should be parked on a level surface.
2. Firmly apply the parking brake. See *Parking Brake on page 2-29* if necessary.  
Be ready to apply the regular brake immediately if the vehicle begins to move.
3. With the engine off, turn the key to the RUN position, but don't start the engine. Without applying the regular brake, try to move the shift lever out of PARK (P) with normal effort. If the shift lever moves out of PARK (P), your vehicle needs service.

## Ignition Transaxle Lock Check

While parked, and with the parking brake set, try to turn the ignition key to LOCK in each shift lever position.

- The key should turn to LOCK only when the shift lever is in PARK (P).
- The key should come out only in LOCK.

## Parking Brake and Automatic Transaxle Park (P) Mechanism Check

### CAUTION:

**When you are doing this check, your vehicle could begin to move. You or others could be injured and property could be damaged. Make sure there is room in front of your vehicle in case it begins to roll. Be ready to apply the regular brake at once should the vehicle begin to move.**

Park on a fairly steep hill, with the vehicle facing downhill. Keeping your foot on the regular brake, set the parking brake.

- To check the parking brake's holding ability: With the engine running and transaxle in NEUTRAL (N), slowly remove foot pressure from the regular brake pedal. Do this until the vehicle is held by the parking brake only.
- To check the PARK (P) mechanism's holding ability: With the engine running, shift to PARK (P). Then release the parking brake followed by the regular brake.

## Underbody Flushing Service

At least every spring, use plain water to flush any corrosive materials from the underbody. Take care to clean thoroughly any areas where mud and other debris can collect.



## Part C: Periodic Maintenance Inspections

Listed in this part are inspections and services which should be performed at least twice a year (for instance, each spring and fall). *You should let your dealer's service department do these jobs. Make sure any necessary repairs are completed at once.*

Proper procedures to perform these services may be found in a service manual. See *Service Publications Ordering Information on page 7-11.*

## Steering, Suspension and Front Drive Axle Boot and Seal Inspection

Inspect the front and rear suspension and steering system for damaged, loose or missing parts, signs of wear or lack of lubrication. Inspect the power steering lines and hoses for proper hook-up, binding, leaks, cracks, chafing, etc. Clean and then inspect the drive axle boot seals for damage, tears or leakage. Replace seals if necessary.

## Exhaust System Inspection

Inspect the complete exhaust system. Inspect the body near the exhaust system. Look for broken, damaged, missing or out-of-position parts as well as open seams, holes, loose connections or other conditions which could cause a heat build-up in the floor pan or could let exhaust fumes into the vehicle. See *Engine Exhaust on page 2-34.*

## Fuel System Inspection

Inspect the complete fuel system for damage or leaks.

## Engine Cooling System Inspection

Inspect the hoses and have them replaced if they are cracked, swollen or deteriorated. Inspect all pipes, fittings and clamps; replace as needed. Clean the outside of the radiator and air conditioning condenser. To help ensure proper operation, a pressure test of the cooling system and pressure cap is recommended at least once a year.

## Throttle System Inspection

Inspect the throttle system for interference or binding, and for damaged or missing parts. Replace parts as needed. Replace any components that have high effort or excessive wear. Do not lubricate accelerator and cruise control cables.

## Brake System Inspection

Inspect the complete system. Inspect brake lines and hoses for proper hook-up, binding, leaks, cracks, chafing, etc. Inspect disc brake pads for wear and rotors for surface condition. Inspect other brake parts, including calipers, parking brake, etc. Check parking brake adjustment. You may need to have your brakes inspected more often if your driving habits or conditions result in frequent braking.

## Part D: Recommended Fluids and Lubricants

Fluids and lubricants identified below by name, part number or specification may be obtained from your dealer.

Usage	Fluid/Lubricant
Engine Oil	Engine oil which meets GM Standard GM6094M and displays the American Petroleum Institute Certified for Gasoline Engines starburst symbol. To determine the proper viscosity for your vehicle's engine, see <i>Engine Oil on page 5-14</i> .
Engine Coolant	50/50 mixture of clean, drinkable water and use only DEX-COOL <sup>®</sup> Coolant. See <i>Engine Coolant on page 5-25</i> .
Hydraulic Brake System	Delco Supreme 11 Brake Fluid or equivalent DOT-3 brake fluid.
Windshield Washer Solvent	GM Optikleen <sup>®</sup> Washer Solvent.
Parking Brake Cable Guides	Chassis Lubricant (GM Part No. U.S. 12377985, in Canada 88901242t) or lubricant meeting requirements of NLGI #2, Category LB or GC-LB.
Power Steering System	GM Power Steering Fluid (GM Part No. U.S. 89021184, in Canada 89021186).

Usage	Fluid/Lubricant
Automatic Transaxle	DEXRON <sup>®</sup> -III Automatic Transmission Fluid.
Key Lock Cylinders	Multi-Purpose Lubricant, Superlube (GM Part No. U.S. 12346241, in Canada 10953474).
Supercharger	Supercharger Oil (GM Part No. U.S. 12345982, in Canada 10953513). See <i>Supercharger Oil on page 5-19</i> .
Hood Latch Assembly, Secondary Latch, Pivots, Spring Anchor and Release Pawl	Lubriplate Lubricant Aerosol (GM Part No. U.S. 12346293, in Canada 992723) or lubricant meeting requirements of NLGI #2, Category LB or GC-LB.
Hood and Door Hinges	Multi-Purpose Lubricant, Superlube (GM Part No. U.S. 12346241, in Canada 10953474).
Fuel Door, Glove Box Door, Console Door and Rear Compartment Lid Hinges	Multi-Purpose Lubricant, Superlube (GM Part No. U.S. 12346241, in Canada 10953474).
Weatherstrip Conditioning	Dielectric Silicone Grease (GM Part No. U.S. 12345579, in Canada 992887).

# Part E: Maintenance Record

After the scheduled services are performed, record the date, odometer reading and who performed the service and any additional information from "Owner Checks and Services" or "Periodic Maintenance" on the following record pages. Also, you should retain all maintenance receipts.

## Maintenance Record

Date	Odometer Reading	Serviced By	Maintenance Record



### Maintenance Record (cont'd)

Date	Odometer Reading	Serviced By	Maintenance Record

## Section 7 Customer Assistance Information

---

<b>Customer Assistance Information</b> .....	7-2	<b>Reporting Safety Defects</b> .....	7-10
Customer Satisfaction Procedure .....	7-2	Reporting Safety Defects to the	
Online Owner Center .....	7-3	United States Government .....	7-10
Customer Assistance for Text Telephone		Reporting Safety Defects to the	
(TTY) Users .....	7-4	Canadian Government .....	7-11
Customer Assistance Offices .....	7-4	Reporting Safety Defects to	
GM Mobility Program for Persons with		General Motors .....	7-11
Disabilities .....	7-5	Service Publications Ordering Information .....	7-11
Roadside Assistance Program .....	7-6		
Courtesy Transportation .....	7-7		
Vehicle Data Collection and Event Data			
Records .....	7-9		

# Customer Assistance Information

## Customer Satisfaction Procedure

Your satisfaction and goodwill are important to your dealer and to Buick. Normally, any concerns with the sales transaction or the operation of your vehicle will be resolved by your dealer's sales or service departments. Sometimes, however, despite the best intentions of all concerned, misunderstandings can occur. If your concern has not been resolved to your satisfaction, the following steps should be taken:

**STEP ONE:** Discuss your concern with a member of dealership management. Normally, concerns can be quickly resolved at that level. If the matter has already been reviewed with the sales, service or parts manager, contact the owner of the dealership or the general manager.

**STEP TWO:** If after contacting a member of dealership management, it appears your concern cannot be resolved by the dealership without further help, contact the Buick Customer Assistance Center by calling 1-800-521-7300. In Canada, contact GM of Canada Customer Communication Centre in Oshawa by calling 1-800-263-3777 (English) or 1-800-263-7854 (French).

We encourage you to call the toll-free number in order to give your inquiry prompt attention. Please have the following information available to give the Customer Assistance Representative:

- Vehicle Identification Number (This is available from the vehicle registration or title, or the plate at the top left of the instrument panel and visible through the windshield.)
- Dealership name and location
- Vehicle delivery date and present mileage

When contacting Buick, please remember that your concern will likely be resolved at a dealer's facility. That is why we suggest you follow Step One first if you have a concern.

**STEP THREE:** Both General Motors and your dealer are committed to making sure you are completely satisfied with your new vehicle. However, if you continue to remain unsatisfied after following the procedure outlined in Steps One and Two, you should file with the BBB Auto Line Program to enforce any additional rights you may have. Canadian owners refer to your Warranty and Owner Assistance Information booklet for information on the Canadian Motor Vehicle Arbitration Plan (CAMVAP).



The BBB Auto Line Program is an out of court program administered by the Council of Better Business Bureaus to settle automotive disputes regarding vehicle repairs or the interpretation of the New Vehicle Limited Warranty. Although you may be required to resort to this informal dispute resolution program prior to filing a court action, use of the program is free of charge and your case will generally be heard within 40 days. If you do not agree with the decision given in your case, you may reject it and proceed with any other venue for relief available to you.

You may contact the BBB Auto Line Program using the toll-free telephone number or write them at the following address:

BBB Auto Line Program  
Council of Better Business Bureaus, Inc.  
4200 Wilson Boulevard  
Suite 800  
Arlington, VA 22203-1804  
Telephone: 1-800-955-5100

This program is available in all 50 states and the District of Columbia. Eligibility is limited by vehicle age, mileage and other factors. General Motors reserves the right to change eligibility limitations and/or discontinue its participation in this program.

## Online Owner Center

The Owner Center is a resource for your GM ownership needs. You can find your specific vehicle information all in one place.

### The Owner Center allows you to:

- Get e-mail service reminders.
- Access information about your specific vehicle, including tips and videos and an electronic version of this owner's manual. (United States only)
- Keep track of your vehicle's service history and maintenance schedule.
- Find GM dealers for service nationwide.
- Receive special promotions and privileges only available to members. (United States only)

Refer to the web for updated information.

To register your vehicle, visit [www.MyGMLink.com](http://www.MyGMLink.com). (United States) or My GM Canada within [www.gmcanada.com](http://www.gmcanada.com) (Canada).

## **Customer Assistance for Text Telephone (TTY) Users**

To assist customers who are deaf, hard of hearing, or speech-impaired and who use Text Telephones (TTYs), Buick has TTY equipment available at its Customer Assistance Center. Any TTY user can communicate with Buick by dialing: 1-800-83-BUICK. (TTY users in Canada can dial 1-800-263-3830.)

## **Customer Assistance Offices**

Buick encourages customers to call the toll-free number for assistance. If a U.S. customer wishes to write to Buick, the letter should be addressed to Buick's Customer Assistance Center.

## **United States – Customer Assistance**

Buick Customer Assistance Center  
P.O. Box 33136  
Detroit, MI 48232-5136

1-800-521-7300  
1-800-832-8425 (For Text Telephone devices (TTYs))  
Roadside Assistance: 1-800-252-1112  
Fax Number: 313-381-0022

From Puerto Rico:  
1-800-496-9992 (English)  
1-800-496-9993 (Spanish)  
Fax Number: 313-381-0022

From U.S. Virgin Islands  
1-800-496-9994  
Fax Number: 313-381-0022

## **Canada – Customer Assistance**

General Motors of Canada Limited  
Customer Communication Centre, 163-005  
1908 Colonel Sam Drive  
Oshawa, Ontario L1H 8P7

1-800-263-3777 (English)  
1-800-263-7854 (French)  
1-800-263-3830 (For Text Telephone devices (TTYs))  
Roadside Assistance: 1-800-268-6800

## Overseas – Customer Assistance

Please contact the local General Motors Business Unit.

### **Mexico, Central America and Caribbean Islands/Countries (Except Puerto Rico and U.S. Virgin Islands) – Customer Assistance**

General Motors de Mexico, S. de R.L. de C.V.  
Customer Assistance Center  
Paseo de la Reforma # 2740  
Col. Lomas de Bezares  
C.P. 11910, Mexico, D.F.  
01-800-508-0000  
Long Distance: 011-52-53 29 0 800

## GM Mobility Program for Persons with Disabilities

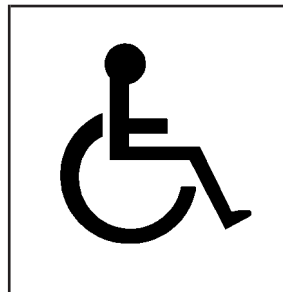

This program, available to qualified applicants, can reimburse you up to \$1,000 toward eligible aftermarket driver or passenger adaptive equipment you may require for your vehicle (hand controls, wheelchair/scooter lifts, etc.).

This program can also provide you with free resource information, such as area driver assessment centers and mobility equipment installers. The offer is available for a limited period of time from the date of vehicle purchase/lease. For more details, or to determine your vehicle's eligibility, see your GM dealer or call the GM Mobility Assistance Center at 1-800-323-9935. Text telephone (TTY) users, call 1-800-833-9935.

GM of Canada also has a Mobility Program. Call 1-800-GM-DRIVE (463-7483) for details. All TTY users call 1-800-263-3830.

## Roadside Assistance Program

Buick Motor Division is proud to offer Buick Premium Roadside Assistance to customers for vehicles covered under the 3 year/36,000 mile (60 000 km) new car warranty (whichever occurs first).

Our commitment to Buick owners has always included superior service through our network of Buick dealers. Buick Premium Roadside Assistance provides an extra measure of convenience and security.

Buick's Roadside Assistance toll-free number is staffed by a team of technically trained advisors, who are available 24 hours a day, 365 days a year.

We take anxiety out of uncertain situations by providing minor repair information over the phone or making arrangements to tow your vehicle to the nearest Buick dealer.

We will provide the following services for 3 years/36,000 miles (60 000 km), at no expense to you:

- Fuel delivery
- Lock-out service (identification required)
- Tow to nearest dealership for warranty service
- Change a flat tire
- Jump starts

We have quick, easy access to telephone numbers of the following additional services depending on your needs:

- Hotels
- Glass replacement
- Tire repair facilities
- Rental vehicle or taxis
- Airports or train stations
- Police, fire department or hospitals

In many instances, mechanical failures are covered under Buick's comprehensive warranty. However, when other services are utilized, our advisors will explain any payment obligations you might incur.

For prompt and efficient assistance when calling, please provide the following information to give the advisor:

- Location of vehicle
- Telephone number of your location
- Vehicle model, year and color
- Mileage of vehicle
- Vehicle Identification Number (VIN)
- Vehicle license plate number

Buick reserves the right to limit services or reimbursement to an owner or driver when, in Buick's judgement, the claims become excessive in frequency or type of occurrence.

While we hope you never have the occasion to use our service, it is added security while traveling for you and your family. Remember, we're only a phone call away. Buick Roadside Assistance: 1-800-252-1112, text telephone (TTY) users, call 1-888-889-2438.

## **Canadian Roadside Assistance**

Vehicles purchased in Canada have an extensive Roadside Assistance program accessible from anywhere in Canada or the United States. Please refer to the Warranty and Owner Assistance Information book.

## **Courtesy Transportation**

Buick has always exemplified quality and value in its offering of motor vehicles. To enhance your ownership experience, we and our participating dealers are proud to offer Courtesy Transportation, a customer support program for new vehicles.

The Courtesy Transportation program is offered to retail purchase/lease customers in conjunction with the Bumper-to-Bumper coverage provided by the New Vehicle Limited Warranty. Several transportation options are available when warranty repairs are required. This will reduce your inconvenience during warranty repairs.

## **Plan Ahead When Possible**

When your vehicle requires warranty service, you should contact your dealer and request an appointment. By scheduling a service appointment and advising your service consultant of your transportation needs, your dealer can help minimize your inconvenience.

If your vehicle cannot be scheduled into the service department immediately, keep driving it until it can be scheduled for service, unless, of course, the problem is safety-related. If it is, please call your dealership, let them know this, and ask for instructions.

If the dealer requests that you simply drop the vehicle off for service, you are urged to do so as early in the work day as possible to allow for same day repair.

## **Transportation Options**

Warranty service can generally be completed while you wait. However, if you are unable to wait Buick helps minimize your inconvenience by providing several transportation options. Depending on the circumstances, your dealer can offer you one of the following:

### **Shuttle Service**

Participating dealers can provide you with shuttle service to get to your destination with minimal interruption of your daily schedule. This includes a one way or round trip shuttle ride to a destination up to 10 miles from the dealership.

### **Public Transportation or Fuel Reimbursement**

If your vehicle requires overnight warranty repairs, reimbursement (five days maximum) may be available for the use of public transportation such as a taxi or bus. In addition, should you arrange transportation through a friend or relative, reimbursement for reasonable fuel expenses (five day maximum) may be available. Claim amounts should reflect actual costs and be supported by original receipts.

## **Courtesy Rental Vehicle**

Your dealer may arrange to provide you with a courtesy rental vehicle or reimburse you for a rental vehicle you obtained if your vehicle is kept for a warranty repair. Reimbursement will be limited to a maximum of \$30 a day and must be supported by receipts. This requires that you sign and complete a rental agreement and meet state, local and rental vehicle provider requirements. Requirements vary and may include minimum age requirements, insurance coverage, credit card, etc. You are responsible for taxes, levies, usage fees, excessive mileage or rental usage beyond the completion of the repair.

Generally it is not possible to provide a like-vehicle as a courtesy rental.

## Additional Program Information

Courtesy Transportation is available during the Bumper-to-Bumper warranty coverage period, but it *is not* part of the New Vehicle Limited Warranty. A separate booklet entitled Warranty and Owner Assistance Information furnished with each new vehicle provides detailed warranty coverage information.

Courtesy Transportation is available only at participating dealers and all program options, such as shuttle service, may not be available at every dealer. Please contact your dealer for specific information about availability. All Courtesy Transportation arrangements will be administered by appropriate dealer personnel.

**Canadian Vehicles:** For warranty repairs during the Complete Vehicle Coverage period of the General Motors of Canada New Vehicle Limited Warranty, alternative transportation may be available under the Courtesy Transportation Program. Please consult your dealer for details.

*General Motors reserves the right to unilaterally modify, change or discontinue Courtesy Transportation at any time and to resolve all questions of claim eligibility pursuant to the terms and conditions described herein at its sole discretion.*

## Vehicle Data Collection and Event Data Records

Your vehicle, like other modern motor vehicles, has a number of sophisticated computer systems that monitor and control several aspects of the vehicle's performance. Your vehicle uses on-board vehicle computers to monitor emission control components to optimize fuel economy, to monitor conditions for airbag deployment and, if so equipped, to provide anti-lock braking and to help the driver control the vehicle in difficult driving situations. Some information may be stored during regular operations to facilitate repair of detected malfunctions; other information is stored only in a crash or near crash event by computer systems commonly called event data recorders (EDR).

In a crash or near crash event, computer systems, such as the Airbag Sensing and Diagnostic Module (SDM) in your vehicle may record information about the condition of the vehicle and how it was operated, such as engine speed, brake applications, throttle position, vehicle speed, seat belt usage, airbag readiness, airbag performance data, and the severity of a collision. This information has been used to improve vehicle crash performance and may be used to improve crash performance of future vehicles and driving safety. Unlike the data recorders on many airplanes, these on-board systems do not record sounds, such as conversation of vehicle occupants.

To read this information, special equipment is needed and access to the vehicle or the SDM is required. GM will not access information about a crash event or share it with others other than

- with the consent of the vehicle owner or, if the vehicle is leased, with the consent of the lessee,
- in response to an official request of police or similar government office,
- as part of GM's defense of litigation through the discovery process, or
- as required by law.

In addition, once GM collects or receives data, GM may

- use the data for GM research needs,
- make it available for research where appropriate confidentiality is to be maintained and need is shown, or
- share summary data which is not tied to a specific vehicle with non-GM organizations for research purposes.

Others, such as law enforcement, may have access to the special equipment that can read the information if they have access to the vehicle or SDM.

If your vehicle is equipped with OnStar, please check the OnStar subscription service agreement or manual for information on its operations and data collection.

## Reporting Safety Defects

### Reporting Safety Defects to the United States Government

If you believe that your vehicle has a defect which could cause a crash or could cause injury or death, you should immediately inform the National Highway Traffic Safety Administration (NHTSA), in addition to notifying General Motors.

If NHTSA receives similar complaints, it may open an investigation, and if it finds that a safety defect exists in a group of vehicles, it may order a recall and remedy campaign. However, NHTSA cannot become involved in individual problems between you, your dealer or General Motors.

To contact NHTSA, you may either call the Auto Safety Hotline toll-free at 1-800-424-9393 (or 366-0123 in the Washington, D.C. area) or write to:

NHTSA, U.S. Department of Transportation  
Washington, D.C. 20590

You can also obtain other information about motor vehicle safety from the hotline.



## Reporting Safety Defects to the Canadian Government

If you live in Canada, and you believe that your vehicle has a safety defect, you should immediately notify Transport Canada, in addition to notifying General Motors of Canada Limited. You may write to:

Transport Canada  
330 Sparks Street  
Tower C  
Ottawa, Ontario K1A 0N5

## Reporting Safety Defects to General Motors

In addition to notifying NHTSA (or Transport Canada) in a situation like this, we certainly hope you'll notify us.

Please call us at 1-800-521-7300, or write:

Buick Customer Assistance Center  
P.O. Box 33136  
Detroit, MI 48232-5136

In Canada, please call us at 1-800-263-3777 (English) or 1-800-263-7854 (French). Or, write:

General Motors of Canada Limited  
Customer Communication Centre, 163-005  
1908 Colonel Sam Drive  
Oshawa, Ontario L1H 8P7

## Service Publications Ordering Information

### Service Manuals

Service Manuals have the diagnosis and repair information on engines, transmission, axle, suspension, brakes, electrical, steering, body, etc.

RETAIL SELL PRICE: \$120.00

### Transmission, Transaxle, Transfer Case Unit Repair Manual

This manual provides information on unit repair service procedures, adjustments, and specifications for GM transmissions, transaxles, and transfer cases.

RETAIL SELL PRICE: \$50.00

### Service Bulletins

Service Bulletins give technical service information needed to knowledgeable service General Motors cars and trucks. Each bulletin contains instructions to assist in the diagnosis and service of your vehicle.

In Canada, information pertaining to Product Service Bulletins can be obtained by contacting your General Motors dealer or by calling 1-800-GM-DRIVE (1-800-463-7483).

## Owner's Information

Owner publications are written specifically for owners and intended to provide basic operational information about the vehicle. The owner's manual will include the Maintenance Schedule for all models.

In-Portfolio: Includes a Portfolio, Owner's Manual, and Warranty Booklet.

RETAIL SELL PRICE: \$35.00

Without Portfolio: Owner's Manual only.

RETAIL SELL PRICE: \$25.00

## Current and Past Model Order Forms

Service Publications are available for current and past model GM vehicles. To request an order form, please specify year and model name of the vehicle.

## ORDER TOLL FREE: 1-800-551-4123 Monday-Friday 8:00 AM - 6:00 PM Eastern Time

For Credit Card Orders Only  
(VISA-MasterCard-Discover), visit Helm, Inc. on the  
World Wide Web at: [www.helminc.com](http://www.helminc.com)

Or you can write to:

Helm, Incorporated  
P. O. Box 07130  
Detroit, MI 48207

Prices are subject to change without notice and without incurring obligation. Allow ample time for delivery.

Note to Canadian Customers: All listed prices are quoted in U.S. funds. Canadian residents are to make checks payable in U.S. funds.

# A

Accessory Power Outlets .....	3-22	Appearance Care (cont.)	
Activating the Theft-Deterrent Feature .....	3-75	Finish Damage .....	5-96
Adding Washer Fluid .....	5-39	Sheet Metal Damage .....	5-95
Additional Program Information .....	7-9	Underbody Maintenance .....	5-96
Additives, Fuel .....	5-5	Vehicle Care/Appearance Materials .....	5-96
Add-On Electrical Equipment .....	5-98	Weatherstrips .....	5-93
Adjusting the Speakers (Balance/Fade) .....	3-61, 3-66	Ashtrays .....	3-23
Air Bag		Assist Handles .....	2-49
Readiness Light .....	3-36	Audio System(s) .....	3-57
Air Bag Systems .....	1-49	Audio Steering Wheel Controls .....	3-78
How Does an Air Bag Restrain? .....	1-55	Care of Your Cassette Tape Player .....	3-79
Servicing Your Air Bag-Equipped Vehicle .....	1-58	Care of Your CD Player .....	3-80
What Makes an Air Bag Inflate? .....	1-55	Care of Your CDs .....	3-80
What Will You See After an		Heated Backlite Antenna .....	3-80
Air Bag Inflates? .....	1-56	Personal Choice Radio Controls .....	3-75
When Should an Air Bag Inflate? .....	1-54	Radio with Cassette .....	3-58
Where Are the Air Bags? .....	1-51	Radio with Cassette and CD .....	3-63
Air Cleaner/Filter, Engine .....	5-20	Setting the Time .....	3-58
Airbag Sensing and Diagnostic Module (SDM) .....	7-9	Theft-Deterrent Feature .....	3-75
AM .....	3-78	Trunk-Mounted CD Changer .....	3-71
Antenna, Heated Backlite .....	3-80	Understanding Radio Reception .....	3-78
Anti-lock Brake System (ABS) .....	4-7	Automatic Level Control .....	4-38
Anti-Lock Brake, System Warning Light .....	3-39	Automatic Operation .....	3-24
Appearance Care .....	5-90	Automatic Transaxle	
Care of Safety Belts .....	5-93	Fluid .....	5-23
Chemical Paint Spotting .....	5-96	Operation .....	2-27
Cleaning the Inside of Your Vehicle .....	5-90	Automatic Transaxle Check .....	6-20
Cleaning the Outside of Your Vehicle .....	5-93	Automatic Transaxle Shift Lock Control	
		System Check .....	6-21
		Auxiliary Instrument Panel Fuse Block .....	5-101

## B

Backing Up .....	4-43
Battery .....	5-43
Battery Replacement .....	2-9
Battery Rundown Protection .....	3-18
Battery Warning Light .....	3-37
Before Leaving on a Long Trip .....	4-23
Body Lubrication Service .....	6-20
Brake	
Parking .....	2-29
System Inspection .....	6-24
System Warning Light .....	3-38
Brake Fluid .....	5-40
Brake Wear .....	5-42
Brakes .....	5-40
Braking .....	4-6
Braking in Emergencies .....	4-9
Break-In, New Vehicle .....	2-23
Bulb Replacement .....	5-51
Front Turn Signal Lamps .....	5-54
Halogen Bulbs .....	5-51
Headlamp Aiming .....	5-49
Headlamps .....	5-51
Rear Quarter Panel Turn Signal and Stoplamps .....	5-58
Rear Turn Signal, Stoplamps and Back-Up Lamps .....	5-54
Replacement Bulbs .....	5-60
Buying New Tires .....	5-74

## C

California Fuel .....	5-5
Canada – Customer Assistance .....	7-4
Canadian Owners .....	ii
Canadian Roadside Assistance .....	7-7
Capacities and Specifications .....	5-108
Carbon Monoxide .....	4-26, 4-38, 2-15, 2-34
Care of	
Safety Belts .....	5-93
Your Cassette Tape Player .....	3-79
Your CD Player .....	3-80
Your CDs .....	3-80
Care of the HUD .....	3-20
Cassette Tape Messages .....	3-63, 3-68
Cassette Tape Player Service .....	6-19
CD Changer Errors .....	3-74
CD Changer, Trunk-Mounted .....	3-71
CD Messages .....	3-70
Center Console Storage Area .....	2-48
Center Passenger Position, Safety Belts .....	1-19
Chains, Tires .....	5-78
Check	
Engine Light .....	3-41
Tire Pressure System .....	5-70
Checking Coolant .....	5-26
Checking Engine Oil .....	5-14
Checking Things Under the Hood .....	5-10
Checking Your Restraint Systems .....	1-58

Chemical Paint Spotting .....	5-96	Cleaning the Speaker Covers .....	5-92
Child Restraints		Cleaning the Top of the Instrument Panel .....	5-92
Child Restraint Systems .....	1-33	Cleaning Tires .....	5-95
Infants and Young Children .....	1-30	Cleaning Vinyl .....	5-92
Lower Anchorages and Top Tethers for Children (LATCH System) .....	1-40	Cleaning Windshield and Wiper Blades .....	5-94
Older Children .....	1-27	Climate Control System	
Securing a Child Restraint Designed for the LATCH System .....	1-42	Air Filter, Passenger Compartment .....	3-30
Securing a Child Restraint in a Center Rear Seat Position .....	1-44	Climate Controls Personalization .....	3-31
Securing a Child Restraint in a Rear Outside Seat Position .....	1-42	Dual Automatic .....	3-24
Securing a Child Restraint in the Right Front Seat Position .....	1-46	Outlet Adjustment .....	3-29
Top Strap .....	1-38	Steering Wheel Controls .....	3-30
Top Strap Anchor Location .....	1-39	Compact Spare Tire .....	5-89
Where to Put the Restraint .....	1-36	Compass Calibration .....	2-37
Cigarette Lighter .....	3-23	Compass Operation .....	2-37
Cleaning		Compass Variance .....	2-38
Inside of Your Vehicle .....	5-90	Content Theft-Deferrant .....	2-19
Outside of Your Vehicle .....	5-93	Control of a Vehicle .....	4-6
Underbody Maintenance .....	5-96	Convenience Net .....	2-49
Weatherstrips .....	5-93	Coolant	
Cleaning Aluminum or Chrome-Plated Wheels .....	5-95	Engine Temperature Gage .....	3-40
Cleaning Exterior Lamps/Lenses .....	5-94	Heater, Engine .....	2-26
Cleaning Fabric/Carpet .....	5-90	Cooling System .....	5-30
Cleaning Glass Surfaces .....	5-92	Cornering Lamps .....	3-14
Cleaning Interior Plastic Components .....	5-92	Courtesy Lamps .....	3-15
Cleaning Leather .....	5-92	Cruise Control .....	3-9
		Cruise Control Light .....	3-45
		Current and Past Model Order Forms .....	7-12
		Customer Assistance Information	
		Courtesy Transportation .....	7-7

Customer Assistance Information (cont.)	
Customer Assistance for Text	
Telephone (TTY) Users .....	7-4
Customer Assistance Offices .....	7-4
Customer Satisfaction Procedure .....	7-2
GM Mobility Program for Persons with	
Disabilities .....	7-5
Reporting Safety Defects to General Motors .....	7-11
Reporting Safety Defects to the	
Canadian Government .....	7-11
Reporting Safety Defects to the	
United States Government .....	7-10
Roadside Assistance Program .....	7-6
Service Publications Ordering Information .....	7-11
Customizing Your Automatic Door Locks	
Feature .....	2-13

## D

Daytime Running Lamps .....	3-13
Defensive Driving .....	4-2
Defogging and Defrosting .....	3-27
Delayed Entry Lighting .....	3-15
Delayed Exit Lighting .....	3-15
Delayed Locking .....	2-11, 3-54
Dinghy Towing .....	4-32
Disabling the Theft-Deterrent Feature .....	3-77
Doing Your Own Service Work .....	5-3
Dolly Towing .....	4-32

Door	
Central Door Unlocking System .....	2-11
Delayed Locking .....	2-11
Door Ajar Reminder .....	2-11
Locks .....	2-10
Power Door Locks .....	2-11
Programmable Automatic Door Locks .....	2-12
Rear Door Security Locks .....	2-14
Driver	
Position, Safety Belt .....	1-12
Driver Information Center (DIC) .....	3-47
DIC Controls and Displays .....	3-47
DIC Vehicle Personalization .....	3-51
DIC Warnings and Messages .....	3-50
Driving	
At Night .....	4-17
City .....	4-21
Defensive .....	4-2
Drunken .....	4-3
Freeway .....	4-22
Hill and Mountain Roads .....	4-24
In Rain and on Wet Roads .....	4-18
Winter .....	4-26
Driving On Grades .....	4-44
Driving on Snow or Ice .....	4-27
Driving Through Deep Standing Water .....	4-20
Driving Through Flowing Water .....	4-20
Driving with a Trailer .....	4-42
Dual Automatic Climate Control System .....	3-24

## E

Electrical System	
Add-On Equipment .....	5-98
Fuses and Circuit Breakers .....	5-99
Removing the Rear Seat Cushion .....	5-104
Emergency Trunk Release Handle .....	2-16
Emissions Inspection and Maintenance Programs .....	3-43
Engine	
Air Cleaner/Filter .....	5-20
Battery .....	5-43
Check and Service Engine Soon Light .....	3-41
Coolant .....	5-25
Coolant Heater .....	2-26
Coolant Temperature Gage .....	3-40
Cooling System Inspection .....	6-24
Engine Compartment Overview .....	5-12
Exhaust .....	2-34
Oil .....	5-14
Overheating .....	5-28
Starting .....	2-25
Supercharger Oil .....	5-19
Engine Coolant Level Check .....	6-19
Engine Cooling When Trailer Towing .....	4-45
Engine Oil Additives .....	5-17
Engine Oil Level Check .....	6-19
Entry Lighting .....	3-15
Erasing HomeLink® Buttons .....	2-46

Event Data Records (EDR) .....	7-9
Express-Down Window .....	2-18
Extender, Safety Belt .....	1-26
Exterior Lamps .....	3-12

## F

Filter	
Engine Air Cleaner .....	5-20
Finding a Station .....	3-59, 3-64
Finish Care .....	5-94
Finish Damage .....	5-96
Flash-To-Pass .....	3-7
Flat Tire .....	5-79
Flat Tire, Changing .....	5-80
Fluid	
Automatic Transaxle .....	5-23
Power Steering .....	5-38
Windshield Washer .....	5-39
FM .....	3-78
Following Distance .....	4-43
Footnotes .....	6-7, 6-14
Front Reading Lamps .....	3-17
Fuel .....	5-4
Additives .....	5-5
California Fuel .....	5-5
Filling a Portable Fuel Container .....	5-9
Filling Your Tank .....	5-6

Fuel (cont.)	
Fuels in Foreign Countries .....	5-6
Gage .....	3-46
Gasoline Octane .....	5-4
Gasoline Specifications .....	5-5
System Inspection .....	6-24
FUEL INFO (Information) .....	3-48
Fuses	
Fuses and Circuit Breakers .....	5-99

## G

Gage	
Engine Coolant Temperature .....	3-40
Fuel .....	3-46
Speedometer .....	3-35
Tachometer .....	3-35
GAGE INFO (Information) .....	3-48
Garage Door Opener .....	2-43
Garage Door Opener Compartment .....	2-47
Gasoline	
Octane .....	5-4
Specifications .....	5-5
Gate Operator and Canadian Programming .....	2-45
Glove Box .....	2-47
Glove Box Lamp .....	3-18
GM Mobility Program for Persons with Disabilities .....	7-5

## H

Hazard Warning Flashers .....	3-4
Head Restraints .....	1-5
Headlamp	
Aiming .....	5-49
Headlamp High/Low-Beam Changer .....	3-7
Headlamps .....	5-51
Bulb Replacement .....	5-51
Front Turn Signal Lamps .....	5-54
Halogen Bulbs .....	5-51
Headlamps On Reminder .....	3-13
Head-Up Display (HUD) .....	3-18
Heated Backlite Antenna .....	3-80
Heated Seats .....	1-3
Highway Hypnosis .....	4-24
Hill and Mountain Roads .....	4-24
Hitches .....	4-41
HomeLink <sup>®</sup> Transmitter .....	2-43
HomeLink <sup>®</sup> Transmitter, Programming .....	2-43
Hood	
Checking Things Under .....	5-10
Release .....	5-10
Horn .....	3-5
How the System Works .....	3-21
How to Add Coolant to the Coolant Recovery Tank .....	5-32
How to Add Coolant to the Radiator .....	5-34
How to Add Fluid .....	5-25



How to Check .....	5-23, 5-70
How to Check and Add Oil .....	5-20
How to Check Power Steering Fluid .....	5-38
How to Inspect the Engine Air Cleaner/Filter .....	5-21
How to Use This Manual .....	ii
How to Wear Safety Belts Properly .....	1-12
Hydroplaning .....	4-20

## I

If No Steam Is Coming From Your Engine .....	5-29
If Steam Is Coming From Your Engine .....	5-28
If the Light Is Flashing .....	3-42
If the Light Is On Steady .....	3-42
If You Are Caught in a Blizzard .....	4-28
If You Are Stuck in Sand, Mud, Ice or Snow .....	4-30
If You Can't See The HUD Image When the Ignition is On .....	3-20
If You Do Decide To Pull A Trailer .....	4-39
Ignition Positions .....	2-24
Ignition Transaxle Lock Check .....	6-22
Infants and Young Children, Restraints .....	1-30
Inflation - Tire Pressure .....	5-69
Inspection	
Brake System .....	6-24
Engine Cooling System .....	6-24
Exhaust System .....	6-23
Fuel System .....	6-24
Part C - Periodic Maintenance .....	6-23

Inspection (cont.)	
Steering, Suspension and Front Drive Axle	
Boot and Seal .....	6-23
Throttle System .....	6-24
Instrument Panel	
Cluster .....	3-33
Overview .....	3-2
Instrument Panel Brightness .....	3-15
Interior Lamps .....	3-15

## J

Jump Starting .....	5-44
---------------------	------

## K

Key Lock Cylinders Service .....	6-20
Key Reminder Warning .....	2-25
Keyless Entry System .....	2-5
Keys .....	2-3

## L

Lamps	
Exterior .....	3-12
Interior .....	3-15
Lap Belt .....	1-19
Lap-Shoulder Belt .....	1-12, 1-21

LATCH System	
Child Restraints .....	1-40
Securing a Child Restraint Designed for the LATCH System .....	1-42
Leaving Your Vehicle .....	2-14
Leaving Your Vehicle With the Engine Running .....	2-32
Light	
Air Bag Readiness .....	3-36
Anti-Lock Brake System Warning .....	3-39
Battery Warning .....	3-37
Brake System Warning .....	3-38
Cruise Control .....	3-45
Malfunction Indicator .....	3-41
Oil Pressure .....	3-44
Safety Belt Reminder .....	3-36
Security .....	3-45
Service Vehicle Soon .....	3-45
TCS Warning Light .....	3-39
Traction Control System (TCS) Warning .....	3-39
Lighted Visor Vanity Mirror .....	2-19
Loading Your Vehicle .....	4-33
Lockout Protection .....	2-14
Locks	
Central Door Unlocking System .....	2-11
Delayed Locking .....	2-11
Door .....	2-10
Leaving Your Vehicle .....	2-14
Lockout Protection .....	2-14

Locks (cont.)	
Power Door .....	2-11
Programmable Automatic Door Locks .....	2-12
Rear Door Security Locks .....	2-14
Long Trip/Highway Definition .....	6-6
Long Trip/Highway Intervals .....	6-6
Long Trip/Highway Scheduled Maintenance .....	6-14
Loss of Control .....	4-15
Lumbar	
Power Controls .....	1-3

## M

Magnetic Speed Variable Assist Steering .....	4-11
Main and Auxiliary Instrument Panel	
Fuse Blocks .....	5-99
Main Instrument Panel Fuse Block .....	5-100
Maintenance, Normal Replacement Parts .....	5-109
Maintenance Schedule	
At Each Fuel Fill .....	6-19
At Least Once a Month .....	6-19
At Least Once a Year .....	6-20
At Least Twice a Year .....	6-20
Brake System Inspection .....	6-24
Engine Cooling System Inspection .....	6-24
Exhaust System Inspection .....	6-23
Fuel System Inspection .....	6-24
How This Section is Organized .....	6-3
Introduction .....	6-2

Maintenance Schedule (cont.)	
Long Trip/Highway Scheduled Maintenance .....	6-14
Maintenance Requirements .....	6-2
Part A - Scheduled Maintenance Services .....	6-4
Part B - Owner Checks and Services .....	6-19
Part C - Periodic Maintenance Inspections .....	6-23
Part D - Recommended Fluids and Lubricants .....	6-25
Part E - Maintenance Record .....	6-26
Selecting the Right Schedule .....	6-5
Short Trip/City Scheduled Maintenance .....	6-7
Steering, Suspension and Front Drive Axle	
Boot and Seal Inspection .....	6-23
Throttle System Inspection .....	6-24
Using Your .....	6-4
Your Vehicle and the Environment .....	6-2
Maintenance When Trailer Towing .....	4-45
Making Turns .....	4-43
Malfunction Indicator Light .....	3-41
Manual Operation .....	3-25
Matching Transmitter(s) to Your Vehicle .....	2-8
Memory Mirrors .....	2-51
Memory Seat .....	2-51
Memory Seat Recall .....	3-56
Message	
DIC Warnings and Messages .....	3-50
Mexico, Central America and Caribbean Islands/ Countries (Except Puerto Rico and U.S. Virgin Islands) – Customer Assistance .....	7-5

Mirror Operation .....	2-36, 2-37
Mirrors	
Automatic Dimming Rearview .....	2-36
Automatic Dimming Rearview with Compass .....	2-37
Manual Rearview Mirror .....	2-36
Memory .....	2-51
Outside Automatic Dimming Heated Mirror .....	2-41
Outside Convex Mirror .....	2-40
Outside Curb View Assist Mirror .....	2-40
Outside Power Mirrors .....	2-39
MyGMLink.com .....	7-3

## N

New Vehicle Break-In .....	2-23
Normal Maintenance Replacement Parts .....	5-109

## O

Odometer .....	3-35
ODO/TRIP (Odometer/Trip) .....	3-48
Off-Road Recovery .....	4-13
Oil	
Engine .....	5-14
Pressure Light .....	3-44
Supercharger, Engine .....	5-19
Older Children, Restraints .....	1-27

Online Owner Center .....	7-3
OnStar <sup>®</sup> Personal Calling .....	2-42
OnStar <sup>®</sup> Services .....	2-42
OnStar <sup>®</sup> System .....	2-41
OnStar <sup>®</sup> Virtual Advisor .....	2-42
Other Warning Devices .....	3-4
Outlet Adjustment .....	3-29
Outside	
Automatic Dimming Heated Mirror .....	2-41
Convex Mirror .....	2-40
Curb View Assist Mirror .....	2-40
Power Mirrors .....	2-39
Outside Curb View Assist Mirror .....	3-53
Overseas – Customer Assistance .....	7-5
Owners, Canadian .....	ii
Owner's Information .....	7-12

## P

Parade Dimming .....	3-15
Park Aid .....	3-20
Park (P)	
Shifting Into .....	2-30
Shifting Out of .....	2-33
Parking	
Assist .....	3-20
Brake .....	2-29
Over Things That Burn .....	2-33

Parking Brake and Automatic Transaxle	
Park (P) Mechanism Check .....	6-22
Parking on Hills .....	4-44
Part A - Scheduled Maintenance Services .....	6-4
Part B - Owner Checks and Services .....	6-19
Part C - Periodic Maintenance Inspections .....	6-23
Part D - Recommended Fluids and Lubricants .....	6-25
Part E - Maintenance Record .....	6-26
Passenger Compartment Air Filter .....	3-30
Passenger Temperature Control .....	3-28
Passing .....	4-14, 4-43
PASS-Key <sup>®</sup> III .....	2-21
PASS-Key <sup>®</sup> III Operation .....	2-22
Perimeter Lighting .....	3-16, 3-56
Personal Choice Radio Controls .....	3-75
Personalization, Climate Controls .....	3-31
Personalization Features .....	2-7
Plan Ahead When Possible .....	7-7
Playing a Cassette Tape .....	3-61, 3-66
Playing a CD .....	3-68, 3-73
Playing the Radio .....	3-58, 3-63
Power	
Accessory Outlets .....	3-22
Door Locks .....	2-11
Lumbar Controls .....	1-3
Seat .....	1-2
Steering Fluid .....	5-38
Windows .....	2-18

Power Steering .....	4-11
Programmable Automatic Door Locks .....	2-12, 3-54
Programming the HomeLink® Transmitter .....	2-43

## Q

Questions and Answers About Safety Belts .....	1-10
--	------

## R

Radiator Pressure Cap .....	5-27
Radios .....	3-57
Care of Your Cassette Tape Player .....	3-79
Care of Your CD Player .....	3-80
Care of Your CDs .....	3-80
Personal Choice Radio Controls .....	3-75
Radio with Cassette .....	3-58
Radio with Cassette and CD .....	3-63
Setting the Time .....	3-58
Theft-Deterrent .....	3-75
Trunk-Mounted CD Changer .....	3-71
Understanding Reception .....	3-78
Rainsense™ II Wipers .....	3-8
Rear Compartment Fuse Block .....	5-106
Rear Door Security Locks .....	2-14
Rear Quarter Panel Turn Signal and Stoplamps .....	5-58

Rear Reading Lamps .....	3-17
Rear Safety Belt Comfort Guides .....	1-24
Rear Seat Armrest .....	2-49
Rear Seat Outside Passenger Positions .....	1-21
Rear Seat Pass Through .....	2-49
Rear Seat Passengers, Safety Belts .....	1-21
Rear Storage Area .....	2-49
Rear Turn Signal, Stoplamps and Back-Up Lamps .....	5-54
Rear Window Defogger .....	3-27
Rearview Mirror, Automatic Dimming .....	2-36
Rearview Mirror, Automatic Dimming with Compass .....	2-37
Rearview Mirrors .....	2-36
Reclining Seatbacks .....	1-4
Recreational Vehicle Towing .....	4-31
Remote Keyless Entry System .....	2-5
Remote Keyless Entry System, Operation .....	2-6
Remote Trunk Release .....	2-15
Remote Trunk Release Lockout .....	2-16
Removing the Flat Tire and Installing the Spare Tire .....	5-82
Removing the Spare Tire and Tools .....	5-81
Replacement Bulbs .....	5-60
Replacing Brake System Parts .....	5-43
Replacing Restraint System Parts After a Crash .....	1-59

Reporting Safety Defects	
Canadian Government .....	7-11
General Motors .....	7-11
United States Government .....	7-10
Reprogramming a Single HomeLink® Button .....	2-46
Resetting Defaults .....	2-46
Restraint System Check .....	6-20
Checking Your Restraint Systems .....	1-58
Replacing Restraint System Parts	
After a Crash .....	1-59
Restraint Systems	
Checking .....	1-58
Replacing Parts .....	1-59
Resynchronization .....	2-9
Retained Accessory Power (RAP) .....	2-25
Right Front Passenger Position, Safety Belts .....	1-19
Roadside	
Assistance Program .....	7-6
Rocking Your Vehicle To Get It Out .....	4-31
Running Your Engine While You Are Parked .....	2-35

## S

Safety Belt	
Reminder Light .....	3-36
Safety Belts	
Care of .....	5-93
Center Passenger Position .....	1-19

Safety Belts (cont.)	
Driver Position .....	1-12
How to Wear Safety Belts Properly .....	1-12
Questions and Answers About Safety Belts .....	1-10
Rear Safety Belt Comfort Guides for	
Children and Small Adults .....	1-24
Rear Seat Passengers .....	1-21
Right Front Passenger Position .....	1-19
Safety Belt Extender .....	1-26
Safety Belt Use During Pregnancy .....	1-18
Safety Belts Are for Everyone .....	1-6
Safety Chains .....	4-42
Safety Warnings and Symbols .....	iii
Seats	
Head Restraints .....	1-5
Heated Seats .....	1-3
Memory .....	2-51
Power Lumbar .....	1-3
Power Seats .....	1-2
Reclining Seatbacks .....	1-4
Securing a Child Restraint	
Center Rear Seat Position .....	1-44
Designed for the LATCH System .....	1-42
Rear Outside Seat Position .....	1-42
Right Front Seat Position .....	1-46
Security Feedback .....	2-7, 3-55
Security Light .....	3-45
Selecting the Right Schedule, Maintenance .....	6-5



Theft-Deterrent Systems .....	2-19	Torque Lock .....	2-32
Content Theft-Deterrent .....	2-19	Total Weight on Your Vehicle's Tires .....	4-41
PASS-Key® III .....	2-21	Towing .....	
PASS-Key® III Operation .....	2-22	Recreational Vehicle .....	4-31
Throttle System Inspection .....	6-24	Towing a Trailer .....	4-38
Tilt Wheel .....	3-5	Your Vehicle .....	4-31
Tire Inflation Check .....	6-19	Traction .....	
Tire Sidewall Labeling .....	5-62	Control System (TCS) .....	4-9
Tire Size .....	5-66	Control System Warning Light .....	3-39
Tire Terminology and Definitions .....	5-67	Trailer Brakes .....	4-42
Tires .....	5-62	Transaxle .....	
Buying New Tires .....	5-74	Fluid, Automatic .....	5-23
Chains .....	5-78	Transaxle Operation, Automatic .....	2-27
Changing a Flat Tire .....	5-80	Transmission, Transaxle, Transfer Case Unit	
Check Tire Pressure System .....	5-70	Repair Manual .....	7-11
Compact Spare Tire .....	5-89	Transportation Options .....	7-8
If a Tire Goes Flat .....	5-79	Trip Odometer .....	3-35
Inflation - Tire Pressure .....	5-69	Trunk .....	2-15
Inspection and Rotation .....	5-72	Trunk Lamp .....	3-17
Uniform Tire Quality Grading .....	5-75	Trunk Lock Release .....	2-15
Wheel Alignment and Tire Balance .....	5-76	Trunk Security Override .....	2-16
Wheel Replacement .....	5-76	Trunk-Mounted CD Changer .....	3-71
When It Is Time for New Tires .....	5-73	Turn and Lane-Change Signals .....	3-6
To Use the Engine Coolant Heater .....	2-26	Turn Signal/Multifunction Lever .....	3-5
Top Strap .....	1-38	Turn Signals When Towing a Trailer .....	4-43
Top Strap Anchor Location .....	1-39	Twilight Sentinel® .....	3-14



## U

Ultrasonic Rear Parking Assist (URPA) .....	3-20
Underbody Flushing Service .....	6-22
Underhood Fuse Block .....	5-102
Understanding Radio Reception .....	3-78
Uniform Tire Quality Grading .....	5-75
United States – Customer Assistance .....	7-4
Unlocking the Theft-Deterrent Feature	
After a Power Loss .....	3-76
Used Replacement Wheels .....	5-77
Using Cleaner on Fabric .....	5-91
Using HomeLink® .....	2-46

## V

Vehicle	
Control .....	4-6
Damage Warnings .....	iv
Loading .....	4-33
Service Soon Light .....	3-45
Symbols .....	iv
Vehicle Data Collection and Event Data	
Records .....	7-9
Vehicle Identification	
Number (VIN) .....	5-98
Service Parts Identification Label .....	5-98

Vehicle Personalization	
DIC .....	3-51
Memory Seat and Mirrors .....	2-51
Vehicle Storage .....	5-43
Ventilation Adjustment .....	3-29
Visors .....	2-19

## W

Warning Lights, Gages and Indicators .....	3-32
Warnings	
DIC Warnings and Messages .....	3-50
Hazard Warning Flashers .....	3-4
Other Warning Devices .....	3-4
Safety and Symbols .....	iii
Vehicle Damage .....	iv
Washing Your Vehicle .....	5-93
Weatherstrip Lubrication .....	6-20
Weight of the Trailer .....	4-40
Weight of the Trailer Tongue .....	4-40
What Kind of Engine Oil to Use .....	5-15
What Kind of Oil to Use .....	5-19
What to Do with Used Oil .....	5-19
What to Use .....	5-26, 5-38, 5-39
Wheels	
Alignment and Tire Balance .....	5-76
Replacement .....	5-76

When to Add Engine Oil .....	5-15
When to Change Engine Oil (Vehicles Without the GM Oil Life System) .....	5-17
When to Change Engine Oil (Vehicles With the GM Oil Life System) .....	5-18
When to Check .....	5-19, 5-70
When to Check and Change .....	5-23
When to Check Power Steering Fluid .....	5-38
When to Inspect the Engine Air Cleaner/Filter .....	5-20
When You Are Ready to Leave After Parking on a Hill .....	4-45
Where to Put the Restraint .....	1-36
Why Safety Belts Work .....	1-7
Window Lock Out .....	2-18, 3-57

Windows .....	2-17
Power .....	2-18
Windshield Washer .....	3-9
Fluid .....	5-39
Windshield Washer Fluid Level Check .....	6-19
Windshield Wiper Blade Replacement .....	5-61
Windshield Wipers .....	3-7
Winter Driving .....	4-26
Wiper Blade Check .....	6-20

## Y

Your Vehicle and the Environment .....	6-2
--	-----