

2005 Buick LaCrosse Owner Manual

Seats and Restraint Systems	1-1	Driving Your Vehicle	4-1
Front Seats	1-3	Your Driving, the Road, and Your Vehicle	4-2
Rear Seats	1-8	Towing	4-34
Safety Belts	1-10	Service and Appearance Care	5-1
Child Restraints	1-31	Service	5-3
Airbag System	1-51	Fuel	5-5
Restraint System Check	1-65	Checking Things Under the Hood	5-10
Features and Controls	2-1	Headlamp Aiming	5-43
Keys	2-2	Bulb Replacement	5-45
Doors and Locks	2-10	Windshield Wiper Blade Replacement	5-51
Windows	2-15	Tires	5-52
Theft-Deterrent Systems	2-17	Appearance Care	5-78
Starting and Operating Your Vehicle	2-21	Vehicle Identification	5-86
Mirrors	2-32	Electrical System	5-87
OnStar [®] System	2-34	Capacities and Specifications	5-92
HomeLink [®] Transmitter	2-36	Maintenance Schedule	6-1
Storage Areas	2-40	Maintenance Schedule	6-2
Sunroof	2-42	Customer Assistance and Information	7-1
Instrument Panel	3-1	Customer Assistance and Information	7-2
Instrument Panel Overview	3-4	Reporting Safety Defects	7-10
Climate Controls	3-21	Index	1
Warning Lights, Gages, and Indicators	3-30		
Driver Information Center (DIC)	3-47		
Audio System(s)	3-79		



GENERAL MOTORS, GM, the GM Emblem, BUICK, and the BUICK Emblem are registered trademarks, and the name LACROSSE is a trademark of General Motors Corporation.

This manual includes the latest information at the time it was printed. We reserve the right to make changes after that time without notice. For vehicles first sold in Canada, substitute the name "General Motors of Canada Limited" for Buick Motor Division whenever it appears in this manual.

Keep this manual in the vehicle, so it will be there if it is needed while you are on the road. If the vehicle is sold, leave this manual in the vehicle.

Canadian Owners

A French language copy of this manual can be obtained from your dealer or from:

Helm, Incorporated
P.O. Box 07130
Detroit, MI 48207

How to Use This Manual

Many people read the owner manual from beginning to end when they first receive their new vehicle. If this is done, it can help you learn about the features and controls for the vehicle. Pictures and words work together in the owner manual to explain things.

Index

A good place to quickly locate information about the vehicle is the Index in the back of the manual. It is an alphabetical list of what is in the manual and the page number where it can be found.

Safety Warnings and Symbols

There are a number of safety cautions in this book. We use a box and the word CAUTION to tell about things that could hurt you if you were to ignore the warning.

 **CAUTION:**

These mean there is something that could hurt you or other people.

In the caution area, we tell you what the hazard is. Then we tell you what to do to help avoid or reduce the hazard. Please read these cautions. If you do not, you or others could be hurt.

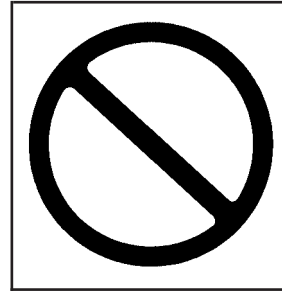

You will also find a circle with a slash through it in this book. This safety symbol means “Do Not,” “Do Not do this” or “Do Not let this happen.”

Vehicle Damage Warnings

Also, in this manual you will find these notices:

Notice: These mean there is something that could damage your vehicle.

A notice tells about something that can damage the vehicle. Many times, this damage would not be covered by your vehicle's warranty, and it could be costly. But the notice will tell what to do to help avoid the damage.

When you read other manuals, you might see CAUTION and NOTICE warnings in different colors or in different words.

There are also warning labels on the vehicle. They use the same words, CAUTION or NOTICE.

































Vehicle Symbols

The vehicle has components and labels that use symbols instead of text. Symbols are shown along with the text describing the operation or information relating to a specific component, control, message, gage, or indicator.

If you need help figuring out a specific name of a component, gage, or indicator, reference the following topics:

- Seats and Restraint Systems in Section 1
- Features and Controls in Section 2
- Instrument Panel Overview in Section 3
- Climate Controls in Section 3
- Warning Lights, Gages, and Indicators in Section 3
- Audio System(s) in Section 3
- Engine Compartment Overview in Section 5

These are some examples of symbols that may be found on the vehicle:

CAUTION POSSIBLE INJURY		LATCH BOTH LAP AND SHOULDER BELTS TO PROTECT OCCUPANT DO NOT TWIST SAFETY BELT WHEN ATTACHING	 	MASTER LIGHTING SWITCH		ENGINE COOLANT TEMP		FUSE BOX ACCESS			
PROTECT EYES BY SHIELDING		FASTEN SEAT BELTS		AIRBAG		TURN SIGNALS		BATTERY CHARGING SYSTEM		ENGINE COOLANT FAN	
CAUSTIC BATTERY ACID COULD CAUSE BURNS		MOVE SEAT FULLY REARWARD SECURE CHILD SEAT		DO NOT INSTALL A REAR-FACING CHILD RESTRAINT IN THIS SEATING POSITION		PARKING LAMPS		BRAKE		FUEL	
AVOID SPARKS OR FLAMES		PULL BELT OUT COMPLETELY THEN SECURE CHILD SEAT		DO NOT INSTALL A FORWARD-FACING CHILD RESTRAINT IN THIS SEATING POSITION		HAZARD WARNING FLASHER		COOLANT		OWNER'S MANUAL	
SPARK OR FLAME COULD EXPLODE BATTERY		POWER WINDOW		DOOR LOCK UNLOCK		DAYTIME RUNNING LAMPS		ENGINE OIL PRESSURE		SERVICE MANUAL	
						FOG LAMPS		ANTI-LOCK BRAKES			

Section 1 Seats and Restraint Systems

Front Seats	1-3	Child Restraints	1-31
Manual Seats	1-3	Older Children	1-31
Six-Way Power Seats	1-4	Infants and Young Children	1-33
Power Lumbar	1-4	Child Restraint Systems	1-37
Heated Seats	1-5	Where to Put the Restraint	1-40
Reclining Seatbacks	1-5	Top Strap	1-41
Head Restraints	1-7	Top Strap Anchor Location	1-43
Center Seat	1-7	Lower Anchorages and Top Tethers for Children (LATCH System)	1-43
Rear Seats	1-8	Securing a Child Restraint Designed for the LATCH System	1-45
Split Folding Rear Seat	1-8	Securing a Child Restraint in a Rear Seat Position	1-46
Safety Belts	1-10	Securing a Child Restraint in the Center Front Seat Position	1-48
Safety Belts: They Are for Everyone	1-10	Securing a Child Restraint in the Right Front Seat Position	1-48
Questions and Answers About Safety Belts	1-14	Airbag System	1-51
How to Wear Safety Belts Properly	1-15	Where Are the Airbags?	1-53
Driver Position	1-15	When Should an Airbag Inflate?	1-56
Shoulder Belt Height Adjustment	1-22	What Makes an Airbag Inflate?	1-57
Safety Belt Use During Pregnancy	1-23	How Does an Airbag Restrain?	1-57
Right Front Passenger Position	1-23	What Will You See After an Airbag Inflates?	1-58
Center Front Passenger Position	1-24		
Rear Seat Passengers	1-25		
Rear Safety Belt Comfort Guides	1-27		
Safety Belt Pretensioners	1-30		
Safety Belt Extender	1-30		

Section 1 Seats and Restraint Systems

Passenger Sensing System1-60
Servicing Your Airbag-Equipped Vehicle1-64
Adding Equipment to Your Airbag-Equipped
Vehicle1-64

Restraint System Check1-65
Checking the Restraint Systems1-65
Replacing Restraint System Parts After a
Crash1-65

Front Seats

Manual Seats

CAUTION:

You can lose control of the vehicle if you try to adjust a manual driver's seat while the vehicle is moving. The sudden movement could startle and confuse you, or make you push a pedal when you do not want to. Adjust the driver's seat only when the vehicle is not moving.

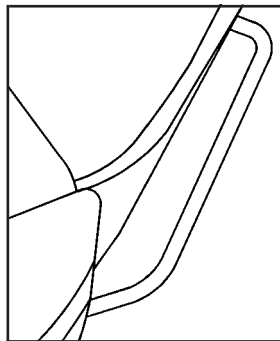

Lift the bar located under the front seat cushion to unlock the seat.

Slide the seat to the desired position and release the bar. Try to move the seat back and forth to make sure it is locked in place.

Six-Way Power Seats

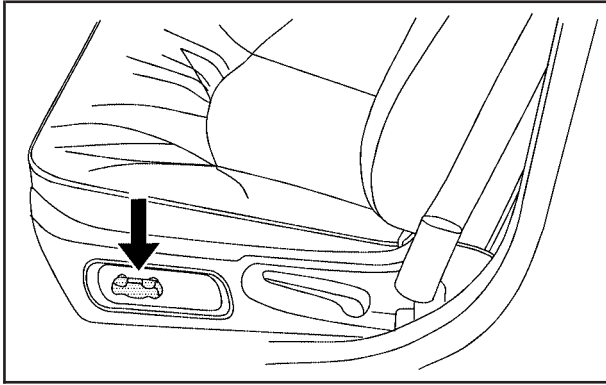

If your vehicle has power seats, the controls are located on the outboard sides of the seat cushions.

- To move the entire seat forward or rearward, move the control forward or rearward.
- To raise or lower the entire seat, move the control up or down.
- To raise or lower the front of the seat, move the front of the control up or down.
- To raise or lower the rear of the seat, move the rear of the control up or down.

Power Lumbar

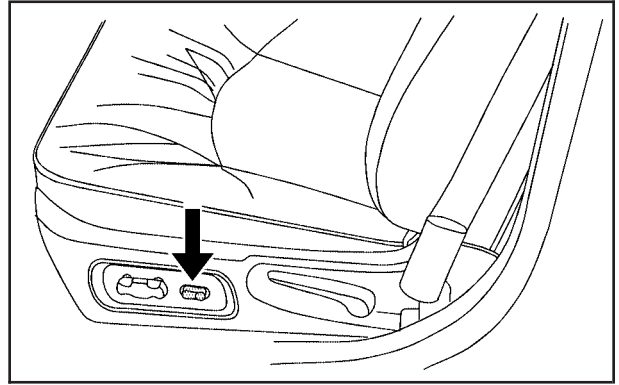

Your vehicle may have power lumbar. The control is located on the outboard side of the driver's seat cushion.

Press the front of the control to increase lumbar support. Press the rear of the control to decrease lumbar support.

Keep in mind that as your seating position changes, as it may during long trips, so should the position of your lumbar support. Adjust the seat as needed.

Heated Seats

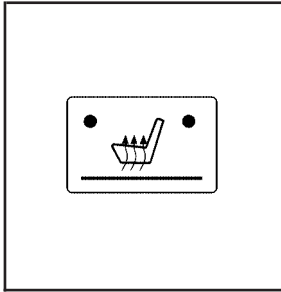

If your vehicle has this feature, the buttons are located on the climate control panel.

Press the button once to activate a high heat setting. Both indicator lights above the button will come on. Press the button again to select a lower temperature setting. Only one indicator light will come on. Press the button a third time to turn the heat off.

This feature only works when the ignition is on.

Reclining Seatbacks

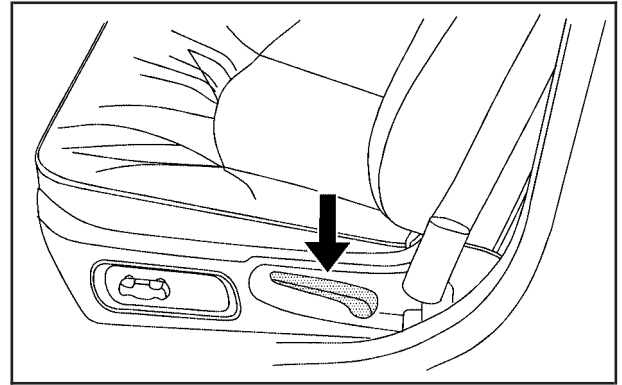

Lift the lever located on the outboard side of the seat to release the seatback, then move the seatback to the desired position. Release the lever to lock the seatback in place.



But do not have a seatback reclined if your vehicle is moving.

⚠ CAUTION:

Sitting in a reclined position when your vehicle is in motion can be dangerous. Even if you buckle up, your safety belts can not do their job when you are reclined like this.

The shoulder belt can not do its job because it will not be against your body. Instead, it will be in front of you. In a crash you could go into it, receiving neck or other injuries.

The lap belt can not do its job either. In a crash the belt could go up over your abdomen. The belt forces would be there, not at your pelvic bones. This could cause serious internal injuries.

For proper protection when the vehicle is in motion, have the seatback upright. Then sit well back in the seat and wear your safety belt properly.

Head Restraints

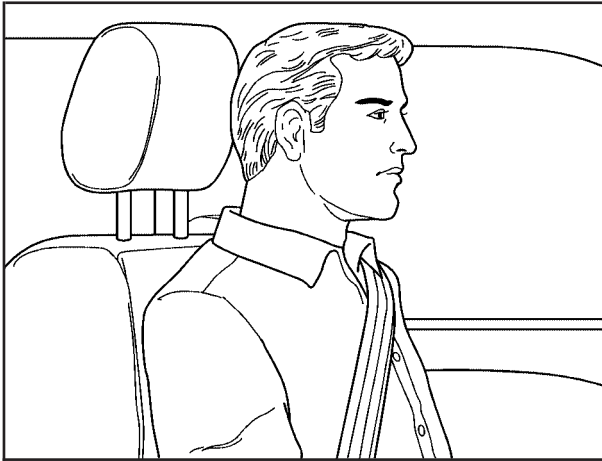

Adjust the head restraint so that the top of the restraint is closest to the top of the occupant's head in each front seat. This position reduces the chance of a neck injury in a crash. Push the release button, located under the head restraint, to lower the head restraint.

Center Seat

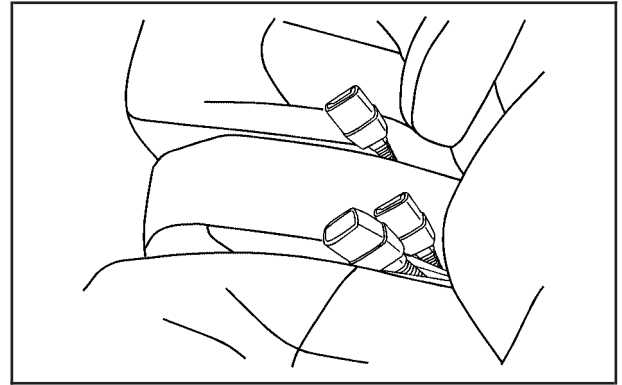

Your vehicle may have a front center seat. This seat can be converted to a storage area by lowering the armrest. See *Center Console Storage Area* on page 2-41.

For information on safety belts for this position, see *Center Front Passenger Position* on page 1-24.

Rear Seats

Split Folding Rear Seat

If your vehicle has this feature, both sides of the rear seatback can be folded down in the vehicle. Make sure the front seat is not reclined. If it is, the rear seatback may not fold down all the way.

To lower the rear seatback, follow these steps:

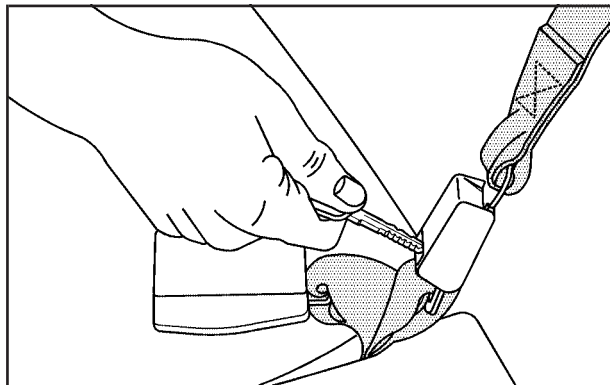

1. Disconnect the rear center lap-shoulder belt latch, if equipped, by using a pointed object to press the release button.



2. Pull forward on the seatback tab located on the outboard side of the rear seat cushion to fold the seatback down.

This gives direct access to the trunk.

CAUTION:

If the seatback is not locked, it could move forward in a sudden stop or crash. That could cause injury to the person sitting there. Always press rearward on the seatback to be sure it is locked.

⚠ CAUTION:

A safety belt that is improperly routed, not properly attached, or twisted will not provide the protection needed in a crash. The person wearing the belt could be seriously injured. After raising the rear seatback, always check to be sure that the safety belts are properly routed and attached, and are not twisted.

To raise the rear seatback, follow these steps:

1. Raise the seatback up and make sure it latches. Push and pull on the seatback to be sure it is locked in position.

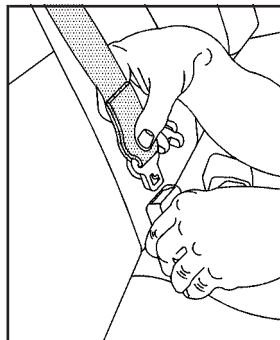

2. Reconnect the center safety belt latch plate to the buckle.

Make sure the safety belt label is pointing to the release button, and that both are facing the front of the vehicle. Make sure the belt is not twisted. Push and pull on the latch plate to be sure it is secure.

When the seat is not in use, the seatback should be kept in the upright, locked position.

Safety Belts

Safety Belts: They Are for Everyone

This part of the manual tells you how to use safety belts properly. It also tells you some things you should not do with safety belts.

CAUTION:

Do not let anyone ride where he or she can not wear a safety belt properly. If you are in a crash and you are not wearing a safety belt, your injuries can be much worse. You can hit things inside the vehicle or be ejected from it. You can be seriously injured or killed. In the same crash, you might not be, if you are buckled up. Always fasten your safety belt, and check that your passengers' belts are fastened properly too.

CAUTION:

It is extremely dangerous to ride in a cargo area, inside or outside of a vehicle. In a collision, people riding in these areas are more likely to be seriously injured or killed. Do not allow people to ride in any area of your vehicle that is not equipped with seats and safety belts. Be sure everyone in your vehicle is in a seat and using a safety belt properly.



Your vehicle has a light that comes on as a reminder to buckle up. See *Safety Belt Reminder Light* on page 3-32.

In most states and in all Canadian provinces, the law says to wear safety belts. Here is why: *They work.*

You never know if you will be in a crash. If you do have a crash, you do not know if it will be a bad one.

A few crashes are mild, and some crashes can be so serious that even buckled up, a person would not survive. But most crashes are in between. In many of them, people who buckle up can survive and sometimes walk away. Without belts they could have been badly hurt or killed.

After more than 30 years of safety belts in vehicles, the facts are clear. In most crashes buckling up does matter...a lot!

Why Safety Belts Work

When you ride in or on anything, you go as fast as it goes.

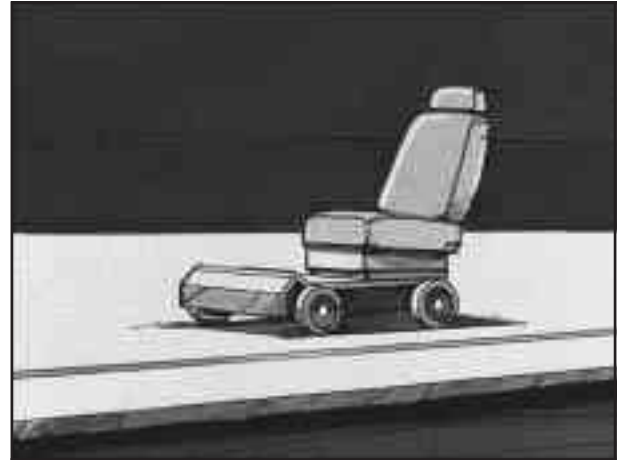

Take the simplest vehicle. Suppose it is just a seat on wheels.



Put someone on it.

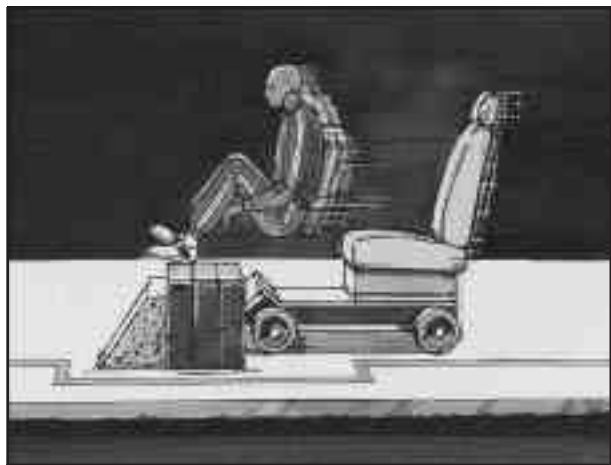

Get it up to speed. Then stop the vehicle. The rider does not stop.



The person keeps going until stopped by something. In a real vehicle, it could be the windshield...



or the instrument panel...



Questions and Answers About Safety Belts

Q: Will I be trapped in the vehicle after an accident if I am wearing a safety belt?

A: You *could* be — whether you are wearing a safety belt or not. But you can unbuckle a safety belt, even if you are upside down. And your chance of being conscious during and after an accident, so you *can* unbuckle and get out, is *much* greater if you are belted.

Q: If my vehicle has airbags, why should I have to wear safety belts?

A: Airbags are in many vehicles today and will be in most of them in the future. But they are supplemental systems only; so they work *with* safety belts — not instead of them. Every airbag system ever offered for sale has required the use of safety belts. Even if you are in a vehicle that has airbags, you still have to buckle up to get the most protection. That is true not only in frontal collisions, but especially in side and other collisions.

or the safety belts!

With safety belts, you slow down as the vehicle does. You get more time to stop. You stop over more distance, and your strongest bones take the forces. That is why safety belts make such good sense.

Q: If I am a good driver, and I never drive far from home, why should I wear safety belts?

A: You may be an excellent driver, but if you are in an accident — even one that is not your fault — you and your passengers can be hurt. Being a good driver does not protect you from things beyond your control, such as bad drivers.

Most accidents occur within 25 miles (40 km) of home. And the greatest number of serious injuries and deaths occur at speeds of less than 40 mph (65 km/h).

Safety belts are for everyone.

How to Wear Safety Belts Properly

This part is only for people of adult size.

Be aware that there are special things to know about safety belts and children. And there are different rules for smaller children and babies. If a child will be riding in your vehicle, see *Older Children on page 1-31* or *Infants and Young Children on page 1-33*. Follow those rules for everyone's protection.

First, you will want to know which restraint systems your vehicle has.

We will start with the driver position.

Driver Position

This part describes the driver's restraint system.

Lap-Shoulder Belt

The driver has a lap-shoulder belt. Here is how to wear it properly.

1. Close and lock the door.
2. Adjust the seat so you can sit up straight. To see how, see "Seats" in the Index.

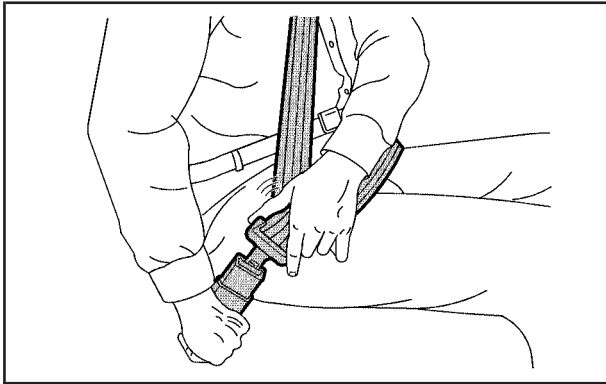

3. Pick up the latch plate and pull the belt across you. Do not let it get twisted.

The shoulder belt may lock if you pull the belt across you very quickly. If this happens, let the belt go back slightly to unlock it. Then pull the belt across you more slowly.

4. Push the latch plate into the buckle until it clicks. Pull up on the latch plate to make sure it is secure. If the belt is not long enough, see *Safety Belt Extender* on page 1-30.

Make sure the release button on the buckle is positioned so you would be able to unbuckle the safety belt quickly if you ever had to.

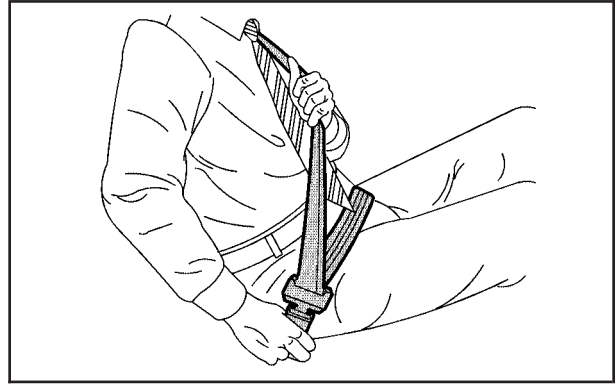

5. To make the lap part tight, pull down on the buckle end of the belt as you pull up on the shoulder belt.

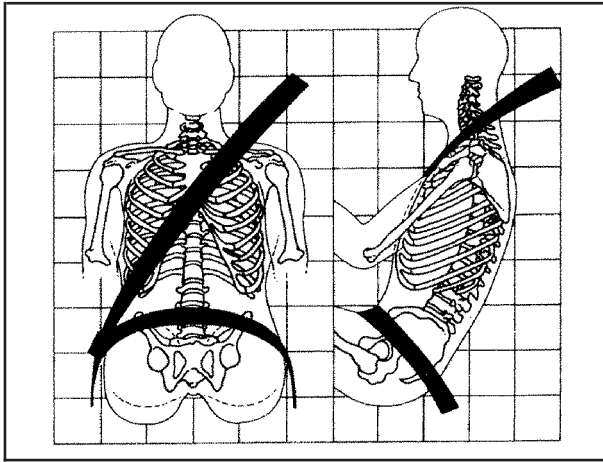

The lap part of the belt should be worn low and snug on the hips, just touching the thighs. In a crash, this applies force to the strong pelvic bones. And you would be less likely to slide under the lap belt. If you slid under it, the belt would apply force at your abdomen. This could cause serious or even fatal injuries. The shoulder belt should go over the shoulder and across the chest. These parts of the body are best able to take belt restraining forces.

The safety belt locks if there is a sudden stop or crash, or if you pull the belt very quickly out of the retractor.

Q: What is wrong with this?

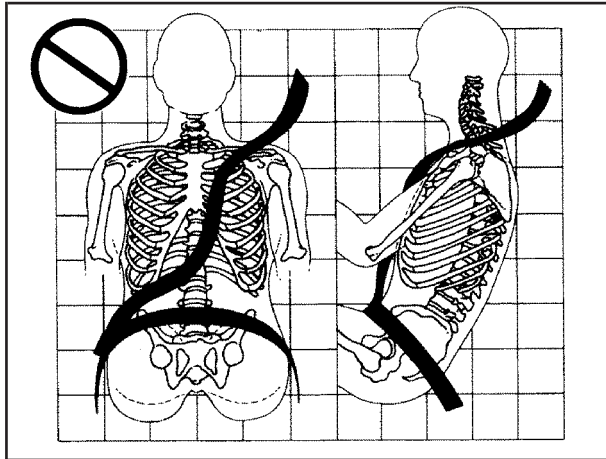

A: The shoulder belt is too loose. It will not give nearly as much protection this way.

⚠ CAUTION:

You can be seriously hurt if your shoulder belt is too loose. In a crash, you would move forward too much, which could increase injury. The shoulder belt should fit against your body.

Q: What is wrong with this?

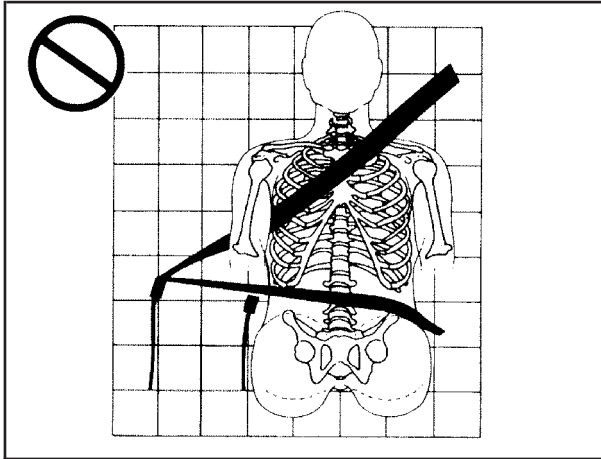

A: The belt is buckled in the wrong place.

⚠ CAUTION:

You can be seriously injured if your belt is buckled in the wrong place like this. In a crash, the belt would go up over your abdomen. The belt forces would be there, not at the pelvic bones. This could cause serious internal injuries. Always buckle your belt into the buckle nearest you.

Q: What is wrong with this?

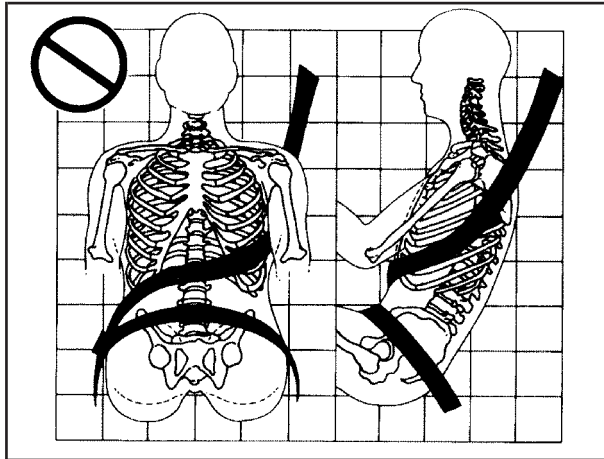

A: The shoulder belt is worn under the arm. It should be worn over the shoulder at all times.

⚠ CAUTION:

You can be seriously injured if you wear the shoulder belt under your arm. In a crash, your body would move too far forward, which would increase the chance of head and neck injury. Also, the belt would apply too much force to the ribs, which are not as strong as shoulder bones. You could also severely injure internal organs like your liver or spleen.

Q: What is wrong with this?

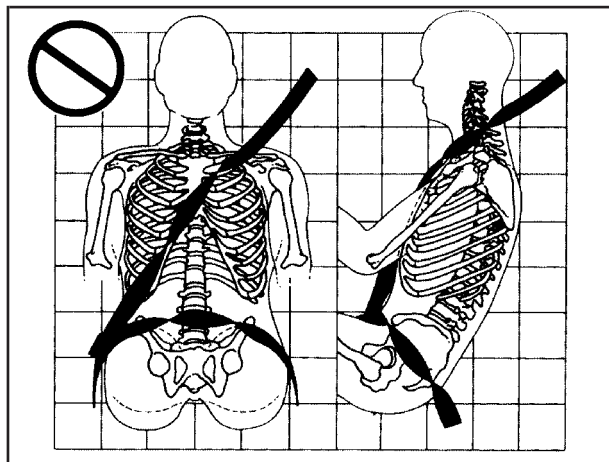

A: The belt is twisted across the body.

⚠ CAUTION:

You can be seriously injured by a twisted belt. In a crash, you would not have the full width of the belt to spread impact forces. If a belt is twisted, make it straight so it can work properly, or ask your dealer to fix it.

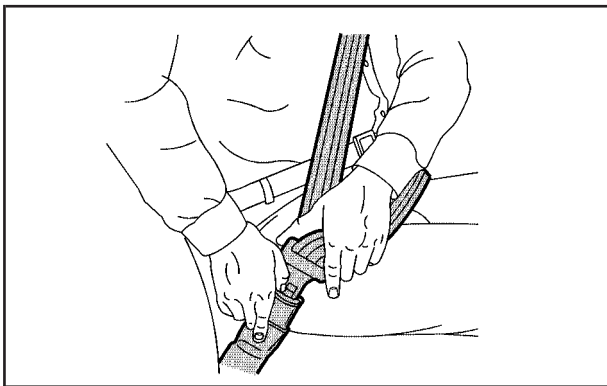

To unlatch the belt, just push the button on the buckle. The belt should go back out of the way.

Before you close the door, be sure the belt is out of the way. If you slam the door on it, you can damage both the belt and your vehicle.

Shoulder Belt Height Adjustment

Before you begin to drive, move the shoulder belt adjuster to the height that is right for you.

Adjust the height so that the shoulder portion of the belt is centered on your shoulder. The belt should be away from your face and neck, but not falling off your shoulder.

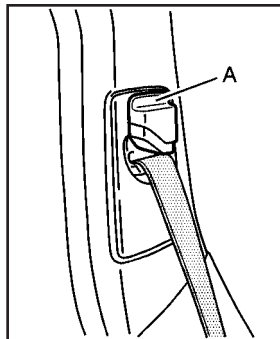

To move it down, push down on the release lever (A) move the height adjuster to the desired position. You can move the adjuster up just by pushing up on the shoulder belt guide.

After you move the adjuster to where you want it, try to move it down without squeezing the release lever to make sure it has locked into position.

Safety Belt Use During Pregnancy

Safety belts work for everyone, including pregnant women. Like all occupants, they are more likely to be seriously injured if they do not wear safety belts.

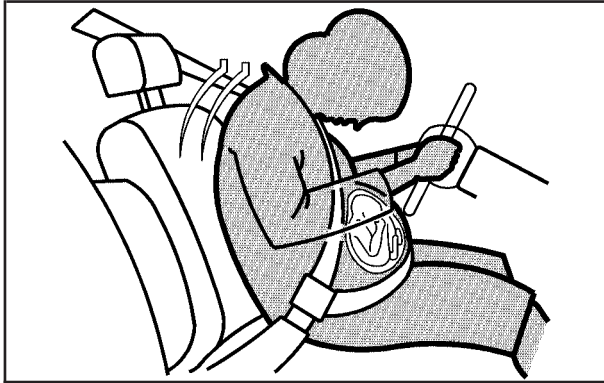

A pregnant woman should wear a lap-shoulder belt, and the lap portion should be worn as low as possible, below the rounding, throughout the pregnancy.

The best way to protect the fetus is to protect the mother. When a safety belt is worn properly, it is more likely that the fetus will not be hurt in a crash. For pregnant women, as for anyone, the key to making safety belts effective is wearing them properly.

Right Front Passenger Position

To learn how to wear the right front passenger's safety belt properly, see *Driver Position on page 1-15*.

The right front passenger's safety belt works the same way as the driver's safety belt — except for one thing. If you ever pull the shoulder portion of the belt out all the way, you will engage the child restraint locking feature. If this happens, just let the belt go back all the way and start again.

Center Front Passenger Position

Lap Belt

If your vehicle has a front bench seat, someone can sit in the center position.

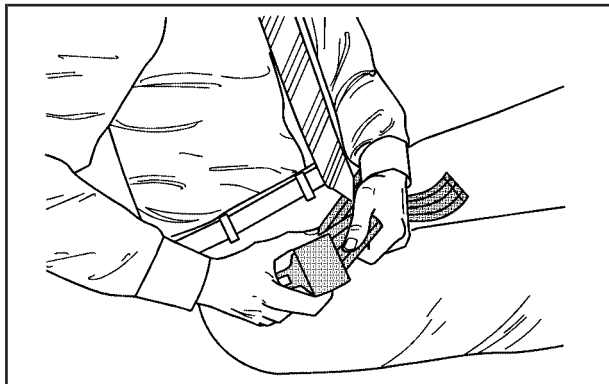

When you sit in the center front seating position, you have a lap safety belt, which has no retractor. To make the belt longer, tilt the latch plate and pull it along the belt.

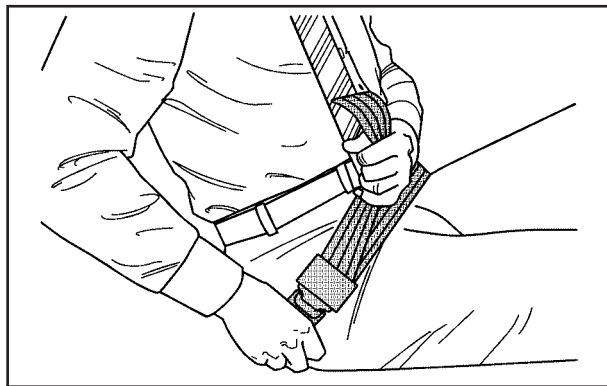

To make the belt shorter, pull its free end as shown until the belt is snug.

Buckle, position and release it the same way as the lap part of a lap-shoulder belt. If the belt is not long enough, see *Safety Belt Extender* on page 1-30.

Make sure the release button on the buckle is positioned so you would be able to unbuckle the safety belt quickly if you ever had to.

Rear Seat Passengers

It is very important for rear seat passengers to buckle up! Accident statistics show that unbelted people in the rear seat are hurt more often in crashes than those who are wearing safety belts.

Rear passengers who are not safety belted can be thrown out of the vehicle in a crash. And they can strike others in the vehicle who are wearing safety belts.

Lap-Shoulder Belt

All rear seat positions have lap-shoulder belts. Here is how to wear one properly.

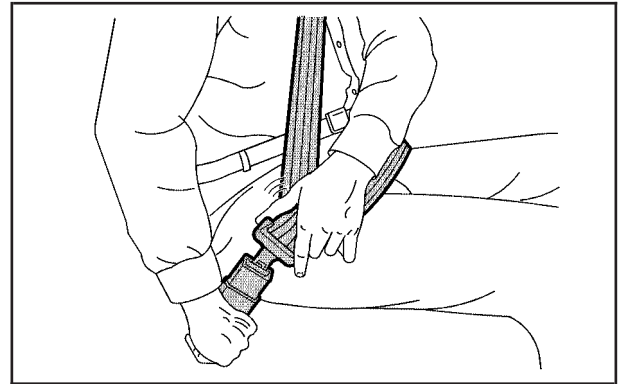

1. Pick up the latch plate and pull the belt across you. Do not let it get twisted. The shoulder belt may lock if you pull the belt across you very quickly. If this happens, let the belt go back slightly to unlock it. Then pull the belt across you more slowly.
2. Push the latch plate into the buckle until it clicks. Pull up on the latch plate to make sure it is secure. When the shoulder belt is pulled out all the way, it will lock. If it does, let it go back all the way and start again. If the belt is not long enough, see *Safety Belt Extender on page 1-30*. Make sure the release button on the buckle is positioned so you would be able to unbuckle the safety belt quickly if you ever had to.

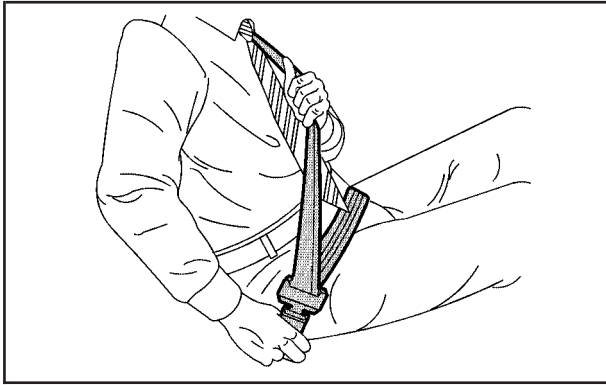

3. To make the lap part tight, pull down on the buckle end of the belt as you pull up on the shoulder part.

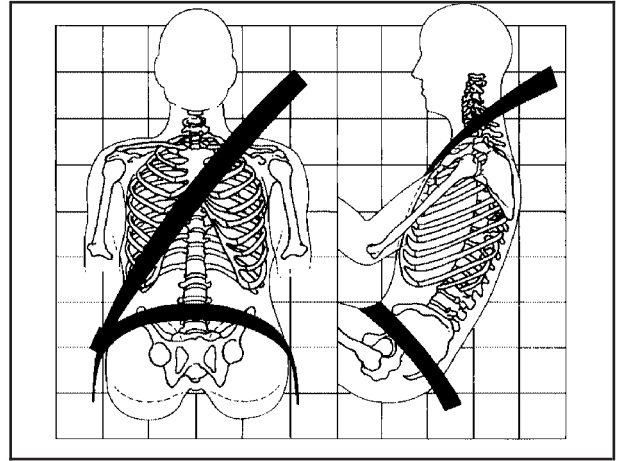

The lap part of the belt should be worn low and snug on the hips, just touching the thighs. In a crash this applies force to the strong pelvic bones. And you would be less likely to slide under the lap belt. If you slid under it, the belt would apply force at your abdomen. This could cause serious or even fatal injuries. The shoulder belt should go over the shoulder and across the chest. These parts of the body are best able to take belt restraining forces.

The safety belt locks if there is a sudden stop or a crash, or if you pull the belt very quickly out of the retractor.

⚠ CAUTION:

You can be seriously hurt if your shoulder belt is too loose. In a crash, you would move forward too much, which could increase injury. The shoulder belt should fit against your body.

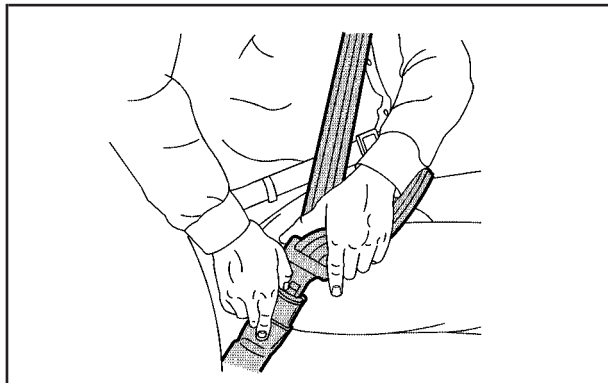

To unlatch the belt, just push the button on the buckle.

Rear Safety Belt Comfort Guides

Rear shoulder belt comfort guides may provide added safety belt comfort for older children who have outgrown booster seats and for some adults. When installed on a shoulder belt, the comfort guide positions the belt away from the neck and head.

There is one guide for each outside passenger position in the rear seat. Here is how to install a comfort guide and use the safety belt:

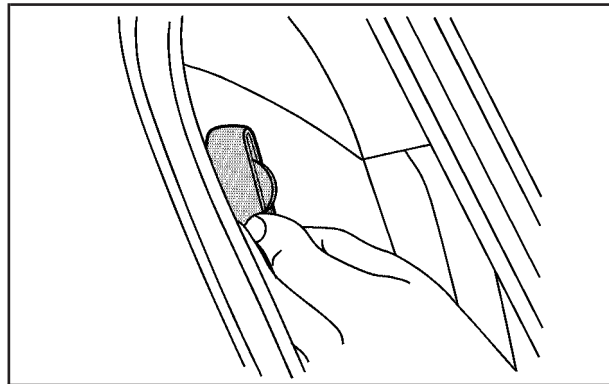

1. Pull the elastic cord out from between the edge of the seatback and the interior body to remove the guide from its storage clip.

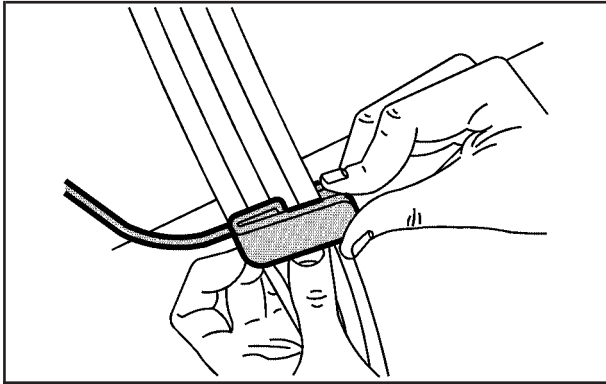

2. Slide the guide under and past the belt. The elastic cord must be under the belt. Then, place the guide over the belt, and insert the two edges of the belt into the slots of the guide.

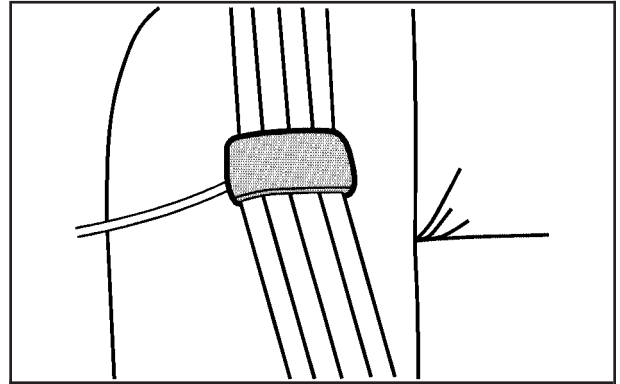

3. Be sure that the belt is not twisted and it lies flat. The elastic cord must be under the belt and the guide on top.

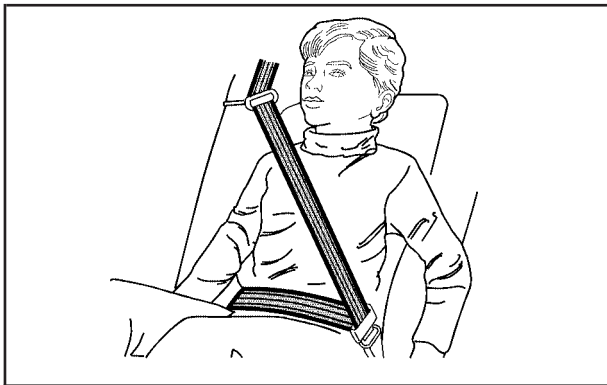

⚠ CAUTION:

A safety belt that is not properly worn may not provide the protection needed in a crash. The person wearing the belt could be seriously injured. The shoulder belt should go over the shoulder and across the chest. These parts of the body are best able to take belt restraining forces.

4. Buckle, position and release the safety belt as described in *Rear Seat Passengers* on page 1-25. Make sure that the shoulder belt crosses the shoulder.

To remove and store the comfort guides, squeeze the belt edges together so that you can take them out of the guides. Pull the guide upward to expose its storage clip, and then slide the guide onto the clip. Turn the guide and clip inward and slide them between the seatback and the interior body, leaving only the loop of the elastic cord exposed.

Safety Belt Pretensioners

Your vehicle has safety belt pretensioners. They are on the buckle end of the safety belts for the driver and right front passenger. They help the safety belts reduce a person's forward movement in a moderate to severe frontal and near frontal crash.

Pretensioners work only once. If they activate in a crash, you will need to get new ones, and probably other new parts for your safety belt system. See *Replacing Restraint System Parts After a Crash* on page 1-65.

Safety Belt Extender

If the vehicle's safety belt will fasten around you, you should use it.

But if a safety belt is not long enough, your dealer will order you an extender. It is free. When you go in to order it, take the heaviest coat you will wear, so the extender will be long enough for you. To help avoid personal injury, do not let someone else use it, and use it only for the seat it is made to fit. The extender has been designed for adults. Never use it for securing child seats. To wear it, just attach it to the regular safety belt. For more information, see the instruction sheet that comes with the extender.

Child Restraints

Older Children

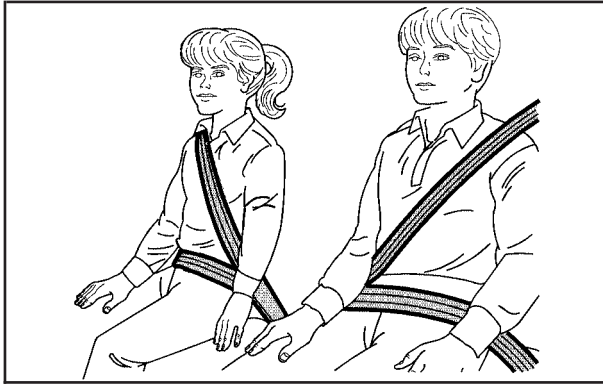

Older children who have outgrown booster seats should wear the vehicle's safety belts.

Q: What is the proper way to wear safety belts?

A: If possible, an older child should wear a lap-shoulder belt and get the additional restraint a shoulder belt can provide. The shoulder belt should not cross the face or neck. The lap belt should fit snugly below the hips, just touching the top of the thighs. It should never be worn over the abdomen, which could cause severe or even fatal internal injuries in a crash.

Accident statistics show that children are safer if they are restrained in the rear seat.

In a crash, children who are not buckled up can strike other people who are buckled up, or can be thrown out of the vehicle. Older children need to use safety belts properly.

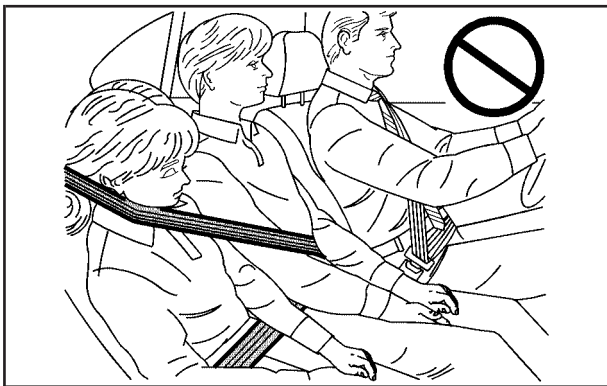

Q: What if a child is wearing a lap-shoulder belt, but the child is so small that the shoulder belt is very close to the child's face or neck?

A: If the child is sitting in a seat next to a window, move the child toward the center of the vehicle. Also see *Rear Safety Belt Comfort Guides on page 1-27*. If the child is sitting in the center rear seat passenger position, move the child toward the safety belt buckle. In either case, be sure that the shoulder belt still is on the child's shoulder, so that in a crash the child's upper body would have the restraint that belts provide.

⚠ CAUTION:

Never do this.

Here two children are wearing the same belt. The belt can not properly spread the impact forces. In a crash, the two children can be crushed together and seriously injured. A belt must be used by only one person at a time.



⚠ CAUTION:

Never do this.

Here a child is sitting in a seat that has a lap-shoulder belt, but the shoulder part is behind the child. If the child wears the belt in this way, in a crash the child might slide under the belt. The belt's force would then be applied right on the child's abdomen. That could cause serious or fatal injuries.

Wherever the child sits, the lap portion of the belt should be worn low and snug on the hips, just touching the child's thighs. This applies belt force to the child's pelvic bones in a crash.

Infants and Young Children

Everyone in a vehicle needs protection! This includes infants and all other children. Neither the distance traveled nor the age and size of the traveler changes the need, for everyone, to use safety restraints. In fact, the law in every state in the United States and in every Canadian province says children up to some age must be restrained while in a vehicle.

Every time infants and young children ride in vehicles, they should have the protection provided by appropriate restraints. Young children should not use the vehicle's adult safety belts alone, unless there is no other choice. Instead, they need to use a child restraint.

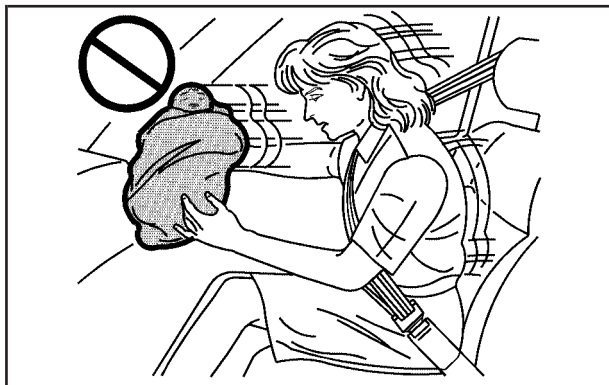

⚠ CAUTION:

People should never hold a baby in their arms while riding in a vehicle. A baby does not weigh much — until a crash. During a crash a baby will become so heavy it is not possible to hold it. For example, in a crash at only 25 mph (40 km/h), a 12 lb (5.5 kg) baby will suddenly become a 240 lb (110 kg) force on a person's arms. A baby should be secured in an appropriate restraint.

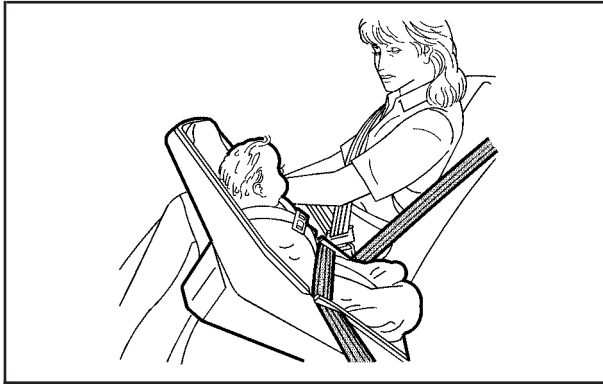

⚠ CAUTION:

Children who are up against, or very close to, any airbag when it inflates can be seriously injured or killed. Airbags plus lap-shoulder belts offer protection for adults and older children, but not for young children and infants. Neither the vehicle's safety belt system nor its airbag system is designed for them. Young children and infants need the protection that a child restraint system can provide.

Q: What are the different types of add-on child restraints?

A: Add-on child restraints, which are purchased by the vehicle's owner, are available in four basic types. Selection of a particular restraint should take into consideration not only the child's weight, height and age but also whether or not the restraint will be compatible with the motor vehicle in which it will be used.

For most basic types of child restraints, there are many different models available. When purchasing a child restraint, be sure it is designed to be used in a motor vehicle. If it is, the restraint will have a label saying that it meets federal motor vehicle safety standards.

The restraint manufacturer's instructions that come with the restraint, state the weight and height limitations for a particular child restraint. In addition, there are many kinds of restraints available for children with special needs.

 **CAUTION:**

Newborn infants need complete support, including support for the head and neck. This is necessary because a newborn infant's neck is weak and its head weighs so much compared with the rest of its body. In a crash, an infant in a rear-facing seat settles into the restraint, so the crash forces can be distributed across the strongest part of an infant's body, the back and shoulders. Infants always should be secured in appropriate infant restraints.

⚠ CAUTION:

The body structure of a young child is quite unlike that of an adult or older child, for whom the safety belts are designed. A young child's hip bones are still so small that the vehicle's regular safety belt may not remain low on the hip bones, as it should. Instead, it may settle up around the child's abdomen. In a crash, the belt would apply force on a body area that is unprotected by any bony structure. This alone could cause serious or fatal injuries. Young children always should be secured in appropriate child restraints.

Child Restraint Systems

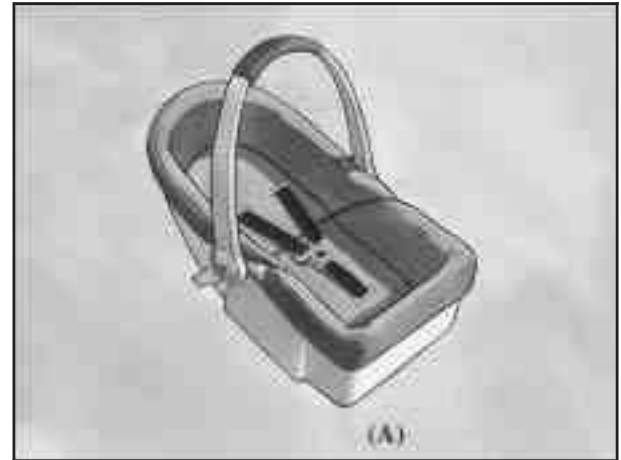

An infant car bed (A), a special bed made for use in a motor vehicle, is an infant restraint system designed to restrain or position a child on a continuous flat surface. Make sure that the infant's head rests toward the center of the vehicle.

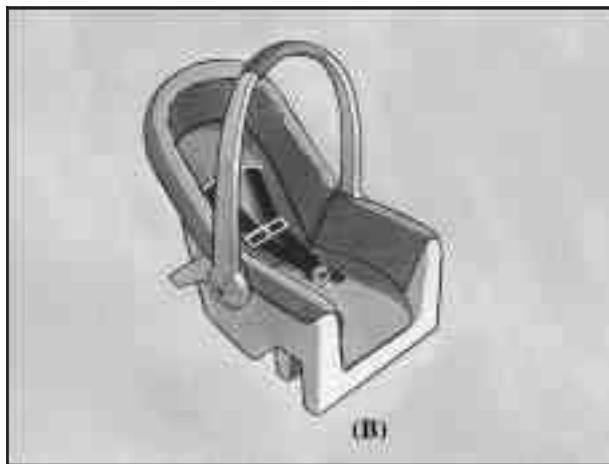

A rear-facing infant seat (B) provides restraint with the seating surface against the back of the infant. The harness system holds the infant in place and, in a crash, acts to keep the infant positioned in the restraint.

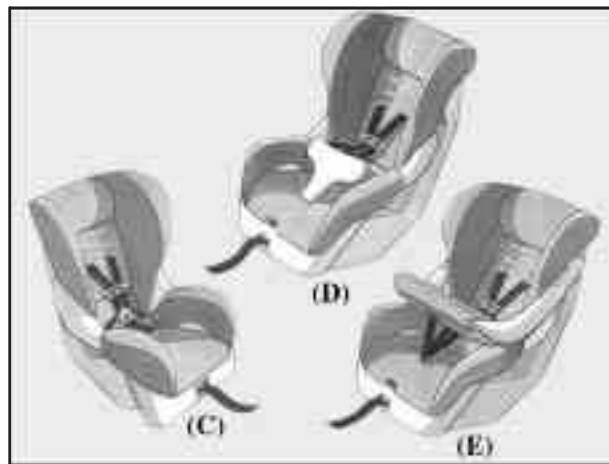

A forward-facing child seat (C-E) provides restraint for the child's body with the harness and also sometimes with surfaces such as T-shaped or shelf-like shields.

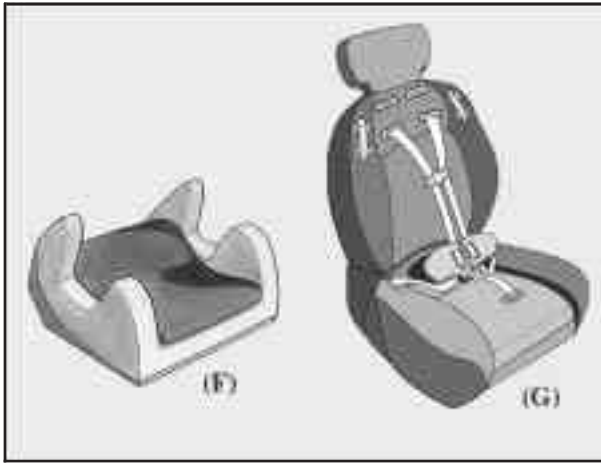

A booster seat (F-G) is a child restraint designed to improve the fit of the vehicle's safety belt system. Some booster seats have a shoulder belt positioner, and some high-back booster seats have a five-point harness. A booster seat can also help a child to see out the window.

Q: How do child restraints work?

A: A child restraint system is any device designed for use in a motor vehicle to restrain, seat, or position children. A built-in child restraint system is a permanent part of the motor vehicle. An add-on child restraint system is a portable one, which is purchased by the vehicle's owner.

For many years, add-on child restraints have used the adult belt system in the vehicle. To help reduce the chance of injury, the child also has to be secured within the restraint. The vehicle's belt system secures the add-on child restraint in the vehicle, and the add-on child restraint's harness system holds the child in place within the restraint.

One system, the three-point harness, has straps that come down over each of the infant's shoulders and buckle together at the crotch. The five-point harness system has two shoulder straps, two hip straps and a crotch strap. A shield may take the place of hip straps. A T-shaped shield has shoulder straps that are attached to a flat pad which rests low against the child's body. A shelf- or armrest-type shield has straps that are attached to a wide, shelf-like shield that swings up or to the side.

When choosing a child restraint, be sure the child restraint is designed to be used in a vehicle. If it is, it will have a label saying that it meets federal motor vehicle safety standards.

Then follow the instructions for the restraint. You may find these instructions on the restraint itself or in a booklet, or both. These restraints use the belt system or the LATCH system in your vehicle, but the child also has to be secured within the restraint to help reduce the chance of personal injury. When securing an add-on child restraint, refer to the instructions that come with the restraint which may be on the restraint itself or in a booklet, or both, and to this manual. The child restraint instructions are important, so if they are not available, obtain a replacement copy from the manufacturer.

Where to Put the Restraint

Accident statistics show that children are safer if they are restrained in the rear rather than the front seat. We, therefore, recommend that child restraints be secured in a rear seat, including an infant riding in a rear-facing infant seat, a child riding in a forward-facing child seat and an older child riding in a booster seat. *Never* put a rear-facing child restraint in the front passenger seat.

Here is why:

CAUTION:

A child in a rear-facing child restraint can be seriously injured or killed if the right front passenger's airbag inflates. This is because the back of the rear-facing child restraint would be very close to the inflating airbag.

Even though the passenger sensing system is designed to turn off the passenger's frontal airbag if the system detects a rear-facing child restraint, no system is fail-safe, and no one can guarantee that an airbag will not deploy under some unusual circumstance, even though it is turned off. General Motors recommends that rear-facing child restraints be secured in the rear seat, even if the airbag is off.

If you need to secure a forward-facing child restraint in the right front seat, always move the front passenger seat as far back as it will go. It is better to secure the child restraint in a rear seat.

 **CAUTION:**

A child in a child restraint in the center front seat can be badly injured or killed by the right front passenger's airbag if it inflates. Never secure a child restraint in the center front seat. It is always better to secure a child restraint in the rear seat.

If you need to secure a forward-facing child restraint in the right front passenger seat, always move the front passenger seat as far back as it will go. It is better to secure the child restraint in a rear seat.

Wherever you install it, be sure to secure the child restraint properly.

Keep in mind that an unsecured child restraint can move around in a collision or sudden stop and injure people in the vehicle. Be sure to properly secure any child restraint in your vehicle — even when no child is in it.

Top Strap

Some child restraints have a top strap, or “top tether.” It can help restrain the child restraint during a collision. For it to work, a top strap must be properly anchored to the vehicle. Some top strap-equipped child restraints are designed for use with or without the top strap being anchored. Others require the top strap always to be anchored. Be sure to read and follow the instructions for your child restraint. If yours requires that the top strap be anchored, do not use the restraint unless it is anchored properly.

If the child restraint does not have a top strap, one can be obtained, in kit form, for many child restraints. Ask the child restraint manufacturer whether or not a kit is available.

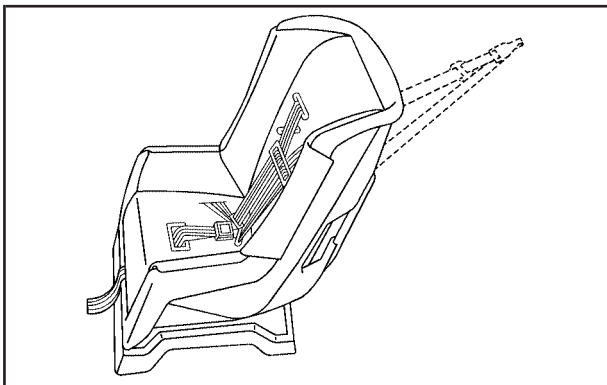

In Canada, the law requires that forward-facing child restraints have a top strap, and that the strap be anchored. In the United States, some child restraints also have a top strap. If your child restraint has a top strap, it should be anchored.

Anchor the top strap to an anchor point specified in *Top Strap Anchor Location on page 1-43*. Be sure to use an anchor point located on the same side of the vehicle as the seating position where the child restraint will be placed.

⚠ CAUTION:

Each top tether bracket is designed to anchor only one child restraint. Attaching more than one child restraint to a single bracket could cause the anchor to come loose or even break during a crash. A child or others could be injured if this happens. To help prevent injury to people and damage to your vehicle, attach only one child restraint per bracket.

Once you have the top strap anchored, you will be ready to secure the child restraint itself. Tighten the top strap when and as the child restraint manufacturer's instructions say.

Top Strap Anchor Location

The vehicle has top strap anchors installed for the rear seating positions.

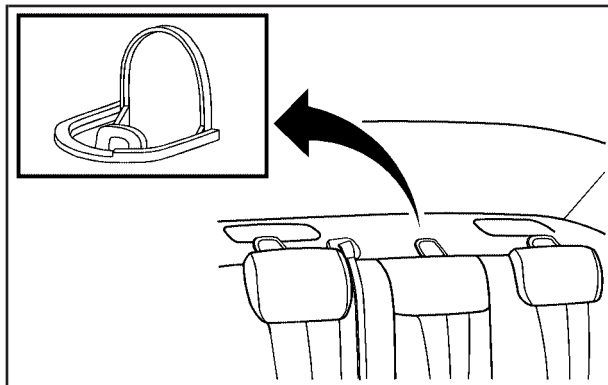

They are located under trim covers on the rear seatback filler panel.

Do not secure a child restraint with a top strap in the right front passenger's position if a national or local law requires that the top strap be anchored, or if the instructions that come with the child restraint say that the top strap must be anchored. There is no place to anchor the top strap in this position.

If your child restraint is equipped with the LATCH system, *Lower Anchorages and Top Tethers for Children (LATCH System)* on page 1-43.

Lower Anchorages and Top Tethers for Children (LATCH System)

The vehicle has the LATCH system. You will find anchors in all three rear seating positions.

This system, designed to make installation of child restraints easier, does not use the vehicle's safety belts. Instead it uses vehicles anchors and child restraint attachments to secure the restraints. Some restraints also use another vehicle anchor to secure a top tether strap.

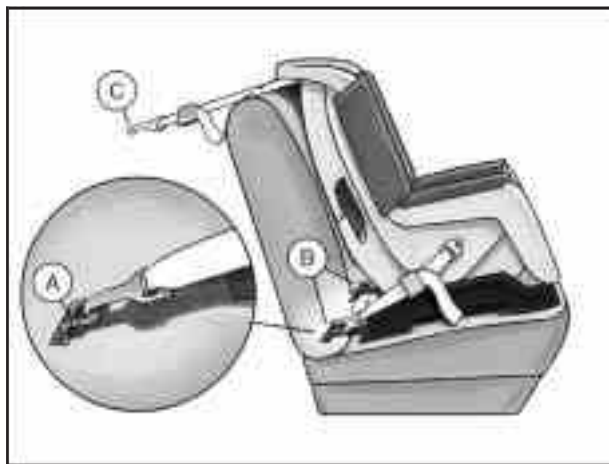

- A. Lower Anchorage
- B. Lower Anchorage
- C. Top Tether

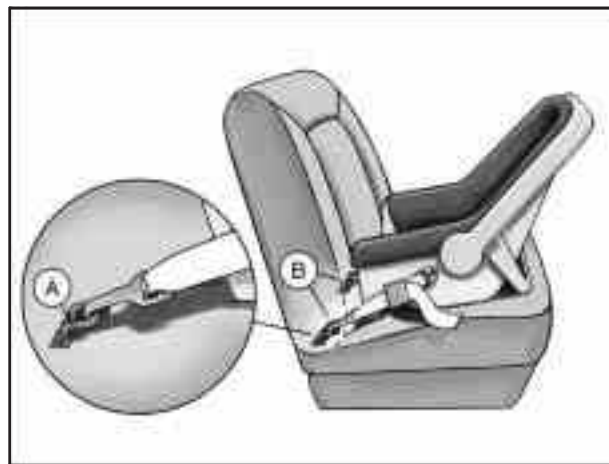

- A. Lower Anchorage
- B. Lower Anchorage

In order to use the LATCH system in your vehicle, you need a child restraint designed for that system.



To assist you in locating the lower anchors for this child restraint system, each seating position with the LATCH system has a label on the seatback at each lower anchor position.

The labels are located near the base of all three rear seating positions.

CAUTION:

If a LATCH-type child restraint is not attached to its anchorage points, the restraint will not be able to protect the child correctly. In a crash, the child could be seriously injured or killed. Make sure that a LATCH-type child restraint is properly installed using the anchorage points, or use the vehicle's safety belts to secure the restraint, following the instructions that came with that restraint, and also the instructions in this manual.

Securing a Child Restraint Designed for the LATCH System

1. Find the LATCH anchorages for the seating position you want to use, where the bottom of the seatback meets the back of the seat cushion. See *Lower Anchorages and Top Tethers for Children (LATCH System)* on page 1-43.
2. Put the child restraint on the seat.
3. Attach and tighten the LATCH attachments on the child restraint to the LATCH anchorages in the vehicle. The child restraint instructions will show you how.
4. If the child restraint is forward-facing, attach and tighten the top tether to the top tether anchorage. The child restraint instructions will show you how. Also see *Top Strap* on page 1-41.
5. Push and pull the child restraint in different directions to be sure it is secure.

To remove the child restraint, simply unhook the top tether from the top tether anchorage and then disconnect the LATCH attachments from the LATCH anchorages.

Securing a Child Restraint in a Rear Seat Position

If your child restraint is equipped with the LATCH system, see *Lower Anchorages and Top Tethers for Children (LATCH System)* on page 1-43. See *Top Strap* on page 1-41 if the child restraint has one.

If your child restraint does not have the LATCH system, you will be using the lap-shoulder belt to secure the child restraint in this position. Be sure to follow the instructions that came with the child restraint. Secure the child in the child restraint when and as the instructions say.

1. Put the child restraint on the seat.
2. Pick up the latch plate, and run the lap and shoulder portions of the vehicle's safety belt through or around the restraint. The child restraint instructions will show you how.

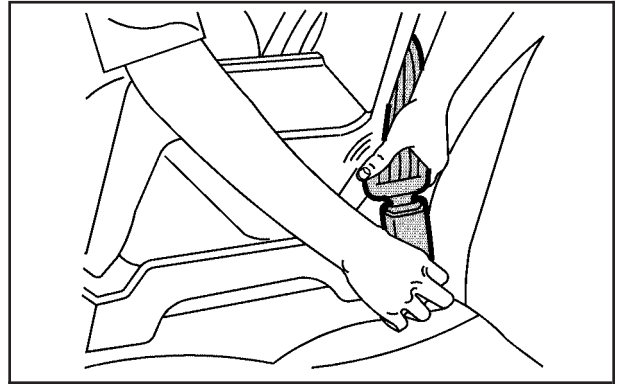

3. Buckle the belt. Make sure the release button is positioned so you would be able to unbuckle the safety belt quickly if you ever had to.

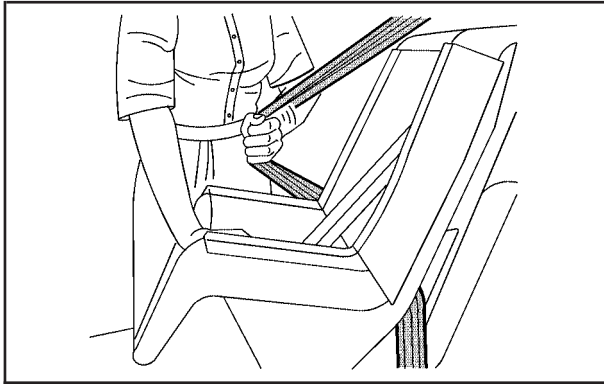

4. Pull the rest of the shoulder belt all the way out of the retractor to set the lock.

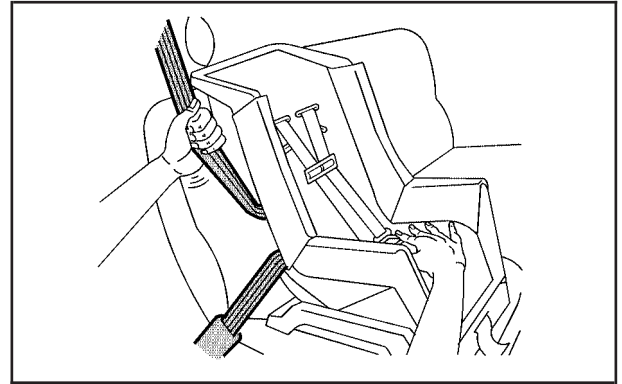

5. To tighten the belt, push down on the child restraint, pull the shoulder portion of the belt to tighten the lap portion of the belt and feed the shoulder belt back into the retractor. If you are using a forward-facing child restraint, you may find it helpful to use your knee to push down on the child restraint as you tighten the belt.
6. Push and pull the child restraint in different directions to be sure it is secure.

To remove the child restraint, just unbuckle the vehicle's safety belt and let it go back all the way. The safety belt will move freely again and be ready to work for an adult or larger child passenger.

Securing a Child Restraint in the Center Front Seat Position

CAUTION:

A child in a child restraint in the center front seat can be badly injured or killed by the right front passenger's airbag if it inflates. Never secure a child restraint in the center front seat. It is always better to secure a child restraint in the rear seat.

If you need to secure a forward-facing child restraint in the right front passenger seat, always move the front passenger seat as far back as it will go. It is better to secure the child restraint in a rear seat.

Do not secure a child restraint in the center front seat position.

Securing a Child Restraint in the Right Front Seat Position

Your vehicle has a right front passenger airbag. A rear seat is a safer place to secure a forward-facing child restraint. See *Where to Put the Restraint on page 1-40*.

In addition, your vehicle has the passenger sensing system. The passenger sensing system is designed to turn off the right front passenger's frontal airbag when an infant in a rear-facing infant seat or a small child in a forward-facing child restraint or booster seat is detected. See *Passenger Sensing System on page 1-60* and *Passenger Airbag Status Indicator on page 3-34* for more information on this including important safety information.

A label on your sun visor says, "Never put a rear-facing child seat in the front." This is because the risk to the rear-facing child is so great, if the airbag deploys.

 **CAUTION:**

A child in a rear-facing child restraint can be seriously injured or killed if the right front passenger's airbag inflates. This is because the back of the rear-facing child restraint would be very close to the inflating airbag.

Even though the passenger sensing system is designed to turn off the passenger's frontal airbag if the system detects a rear-facing child restraint, no system is fail-safe, and no one can guarantee that an airbag will not deploy under some unusual circumstance, even though it is turned off. General Motors recommends that rear-facing child restraints be secured in the rear seat, even if the airbag is off.

If you need to secure a forward-facing child restraint in the right front seat position, move the seat as far back as it will go before securing the forward-facing child restraint. See *Manual Seats on page 1-3* or *Six-Way Power Seats on page 1-4*.

If your child restraint is equipped with the LATCH system, see *Lower Anchorages and Top Tethers for Children (LATCH System) on page 1-43*.

You will be using the lap-shoulder belt to secure the child restraint in this position. See *Top Strap on page 1-41* if your child restraint has one. Be sure to follow the instructions that came with the child restraint. Secure the child in the child restraint when and as the instructions say.

1. Your vehicle has a right front passenger's frontal airbag. See *Passenger Sensing System on page 1-60*. General Motors recommends that rear-facing child restraints be secured in a rear seat, even if the airbag is off. If your child restraint is forward-facing, move the seat as far back as it will go before securing the child restraint in this seat. See *Manual Seats on page 1-3* or *Six-Way Power Seats on page 1-4*.

When the passenger sensing system has turned off the right front passenger's frontal airbag, the off indicator in the passenger airbag status indicator should light and stay lit when you turn the ignition to RUN or START. See *Passenger Airbag Status Indicator on page 3-34*.

2. Put the child restraint on the seat.

3. Pick up the latch plate, and run the lap and shoulder portions of the vehicle's safety belt through or around the restraint. The child restraint instructions will show you how.

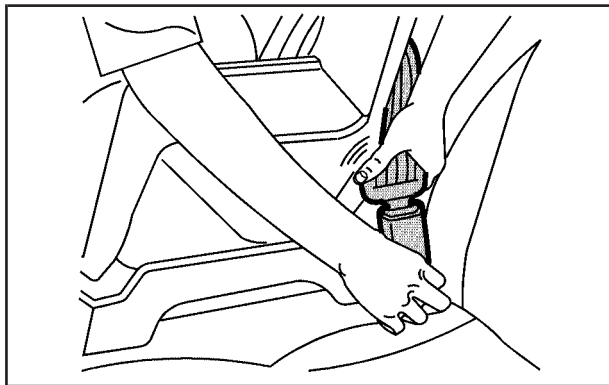

4. Buckle the belt. Make sure the release button is positioned so you would be able to unbuckle the safety belt quickly if you ever had to.

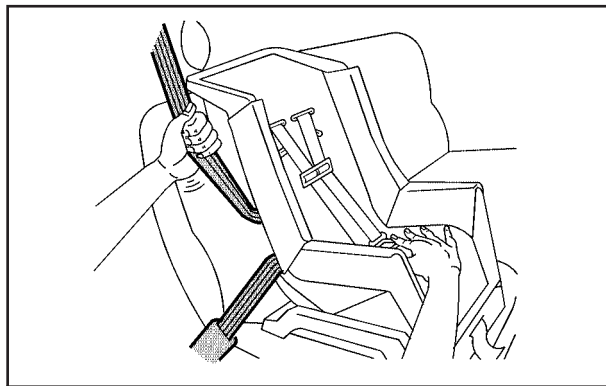

5. To tighten the belt, push down on the child restraint, pull the shoulder portion of the belt to tighten the lap portion of the belt and feed the shoulder belt back into the retractor. If you are using a forward-facing child restraint, you may find it helpful to use your knee to push down on the child restraint as you tighten the belt. You should not be able to pull more of the belt from the retractor once the lock has been set.
6. Push and pull the child restraint in different directions to be sure it is secure.
7. If the airbag is off, the off indicator on the instrument panel will be lit and stay lit when the key is turned to RUN or START.

If a child restraint has been installed and the on indicator is lit, turn the vehicle off. Remove the child restraint from the vehicle and reinstall the child restraint.

If after reinstalling the child restraint and restarting the vehicle, the on indicator is still lit, check to make sure that the vehicle's seatback is not pressing the child restraint into the seat cushion. If this happens, slightly recline the vehicle's seatback and adjust the seat cushion if possible. Also make sure the child restraint is not trapped under the vehicle head restraint. If this happens, adjust the head restraint.

If the on indicator is still lit, secure the child in the child restraint in a rear seat position in the vehicle and check with your dealer.

To remove the child restraint, just unbuckle the vehicle's safety belt and let it go back all the way. The safety belt will move freely again and be ready to work for an adult or larger child passenger.

Airbag System

Your vehicle has a frontal airbag for the driver and another frontal airbag for the right front passenger. Your vehicle may also have roof mounted side impact airbags. Roof mounted side impact airbags are available for the driver and the passenger seated directly behind the driver and for the right front passenger and the passenger seated directly behind that passenger.

If your vehicle has side impact airbags, the word AIRBAG will appear on the airbag covering on the ceiling near the side windows.

Frontal airbags are designed to help reduce the risk of injury from the force of an inflating frontal airbag. But these airbags must inflate very quickly to do their job and comply with federal regulations.

Here are the most important things to know about the airbag system:

 **CAUTION:**

You can be severely injured or killed in a crash if you are not wearing your safety belt — even if you have airbags. Wearing your safety belt during a crash helps reduce your chance of hitting things inside the vehicle or being ejected from it. Airbags are “supplemental restraints” to the safety belts. All airbags are designed to work with safety belts but do not replace them.

Frontal airbags for the driver and right front passenger are designed to deploy only in moderate to severe frontal and near frontal crashes. They are not designed to inflate in rollover, rear or low-speed frontal crashes, or in many side crashes. And, for some unrestrained occupants, frontal airbags may provide less protection in frontal crashes than more forceful airbags have provided in the past. The roof-mounted side impact airbags

CAUTION: (Continued)

CAUTION: (Continued)

are designed to inflate only in moderate to severe crashes where something hits the side of your vehicle. They are not designed to inflate in frontal, in rollover or in rear crashes. Everyone in your vehicle should wear a safety belt properly — whether or not there is an airbag for that person.

 **CAUTION:**

Both frontal and side impact airbags inflate with great force, faster than the blink of an eye. If you are too close to an inflating airbag, as you would be if you were leaning forward, it could seriously injure you. Safety belts help keep you in position for airbag inflation before and during a crash. Always wear your safety belt even with frontal airbags. The driver should sit as far back as possible while still maintaining control of the vehicle. Occupants should not lean on or sleep against the door.

CAUTION:

Anyone who is up against, or very close to, any airbag when it inflates can be seriously injured or killed. Airbags plus lap-shoulder belts offer the best protection for adults, but not for young children and infants. Neither the vehicle's safety belt system nor its airbag system is designed for them. Young children and infants need the protection that a child restraint system can provide. Always secure children properly in your vehicle. To read how, see *Older Children* on page 1-31 or *Infants and Young Children* on page 1-33.



There is an airbag readiness light on the instrument panel cluster, which shows the airbag symbol.

The system checks the airbag electrical system for malfunctions. The light tells you if there is an electrical problem. See *Airbag Readiness Light* on page 3-33 for more information.

Where Are the Airbags?



The driver's airbag is in the middle of the steering wheel.



The right front passenger's airbag is in the instrument panel on the passenger's side.



If your vehicle has a side impact airbag for the driver and the person seated directly behind the driver, it is located in the ceiling above the side windows.



If your vehicle has a side impact airbag for the right front passenger and the person directly behind that passenger, it is located in the ceiling above the side windows.

CAUTION:

If something is between an occupant and an airbag, the bag might not inflate properly or it might force the object into that person causing severe injury or even death. The path of an inflating airbag must be kept clear. Do not put anything between an occupant and an airbag, and do not attach or put anything on the steering wheel hub or on or near any other airbag covering. And, if your vehicle has roof-mounted side impact airbags, never secure anything to the roof of your vehicle by routing the rope or tiedown through any door or window opening. If you do, the path of an inflating side impact airbag will be blocked. The path of an inflating airbag must be kept clear.

When Should an Airbag Inflate?

The driver's and right front passenger's frontal airbags are designed to inflate in moderate to severe frontal or near-frontal crashes. But they are designed to inflate only if the impact exceeds a predetermined deployment threshold. Deployment thresholds take into account a variety of desired deployment and non-deployment events and are used to predict how severe a crash is likely to be in time for the airbags to inflate and help restrain the occupants. Whether your frontal airbags will or should deploy is not based on how fast your vehicle is traveling. It depends largely on what you hit, the direction of the impact and how quickly your vehicle slows down.

In addition, your vehicle has “dual-stage” frontal airbags, which adjust the restraint according to crash severity. Your vehicle is equipped with electronic frontal sensors which help the sensing system distinguish between a moderate frontal impact and a more severe frontal impact. For moderate frontal impacts, these airbags inflate at a level less than full deployment. For more severe frontal impacts, full deployment occurs. If the front of your vehicle goes straight into a wall that does not move or deform, the threshold level for the reduced deployment is about 12 to 16 mph (19 to 26 km/h), and the threshold level for a full deployment is about 18 to 24 mph (29 to 38.5 km/h).

The threshold level can vary, however, with specific vehicle design, so that it can be somewhat above or below this range.

Airbags may inflate at different crash speeds. For example:

- If the vehicle hits a stationary object, the airbag could inflate at a different crash speed than if the object were moving.
- If the object deforms, the airbag could inflate at a different crash speed than if the object does not deform.
- If the vehicle hits a narrow object (like a pole) the airbag could inflate at a different crash speed than if the vehicle hits a wide object (like a wall).
- If the vehicle goes into an object at an angle the airbag could inflate at a different crash speed than if the vehicle goes straight into the object.

Frontal airbags (driver and right front passenger) are not intended to inflate during vehicle rollovers, rear impacts, or in many side impacts.

Your vehicle may or may not have side impact airbags. See *Airbag System on page 1-51*. Side impact airbags are intended to inflate in moderate to severe side crashes. A side impact airbag will inflate if the crash severity is above the system's designed threshold level. The threshold level can vary with specific vehicle design. Side impact airbags are not intended to inflate in frontal or near-frontal impacts, rollovers or rear impacts. A side impact airbag is intended to deploy on the side of the vehicle that is struck.

In any particular crash, no one can say whether an airbag should have inflated simply because of the damage to a vehicle or because of what the repair costs were. For frontal airbags, inflation is determined by the angle of the impact and how quickly the vehicle slows down in frontal or near-frontal impacts. For side impact airbags, inflation is determined by the location and severity of the impact.

What Makes an Airbag Inflate?

In an impact of sufficient severity, the airbag sensing system detects that the vehicle is in a crash. For both frontal and side impact airbags, the sensing system triggers a release of gas from the inflator, which inflates the airbag. The inflator, airbag, and related

hardware are all part of the airbag modules inside the steering wheel and in the instrument panel in front of the right front passenger. For vehicles with side impact airbags, the airbag modules are located in the ceiling of the vehicle, near the side windows.

How Does an Airbag Restrain?

In moderate to severe frontal or near frontal collisions, even belted occupants can contact the steering wheel or the instrument panel. In moderate to severe side collisions, even belted occupants can contact the inside of the vehicle. The airbag supplements the protection provided by safety belts. Airbags distribute the force of the impact more evenly over the occupant's upper body, stopping the occupant more gradually. But the frontal airbags would not help you in many types of collisions, including rollovers, rear impacts, and many side impacts, primarily because an occupant's motion is not toward the airbag. Side impact airbags would not help you in many types of collisions, including frontal or near frontal collisions, rollovers, and rear impacts, primarily because an occupant's motion is not toward those airbags. Airbags should never be regarded as anything more than a supplement to safety belts, and then only in moderate to severe frontal or near-frontal collisions for the driver's and right front passenger's frontal airbags, and only in moderate to severe side collisions for side impact airbags.

What Will You See After an Airbag Inflates?

After an airbag inflates, it quickly deflates, so quickly that some people may not even realize the airbag inflated. Some components of the airbag module — the steering wheel hub for the driver's airbag, the instrument panel for the right front passenger's airbag, or the ceiling of your vehicle near the side windows — will be hot for a short time. The parts of the bag that come into contact with you may be warm, but not too hot to touch. There will be some smoke and dust coming from the vents in the deflated airbags. Airbag inflation does not prevent the driver from seeing or being able to steer the vehicle, nor does it stop people from leaving the vehicle.

CAUTION:

When an airbag inflates, there is dust in the air. This dust could cause breathing problems for people with a history of asthma or other breathing trouble. To avoid this, everyone in the vehicle should get out as soon as it is safe to do so. If you have breathing problems but cannot get out of the vehicle after an airbag inflates, then get fresh air by opening a window or a door. If you experience breathing problems following an airbag deployment, you should seek medical attention.

Your vehicle has a feature that will automatically unlock the doors, turn the interior lamps on, and flash the hazard warning flashers when the airbag inflates, if battery power is available. You can lock the doors and turn the interior lamps and hazard warning flashers off by using the controls for those features.

In many crashes severe enough to inflate an airbag, windshields are broken by vehicle deformation. Additional windshield breakage may also occur from the right front passenger airbag.

- Airbags are designed to inflate only once. After an airbag inflates, you will need some new parts for your airbag system. If you do not get them, the airbag system will not be there to help protect you in another crash. A new system will include airbag modules and possibly other parts. The service manual for your vehicle covers other parts that need to be replaced.

- Your vehicle is equipped with a crash sensing and diagnostic module which records information after a crash. See *Vehicle Data Collection and Event Data Recorders* on page 7-9.
- Let only qualified technicians work on your airbag system. Improper service can mean that your airbag system will not work properly. See your GM dealer for service.

Notice: If you damage the covering for the driver's or the right front passenger's airbag, or the side impact airbag covering on the ceiling near the side windows, the airbag may not work properly. You may have to replace the airbag module in the steering wheel, both the airbag module and the instrument panel for the right front passenger's airbag, or side impact airbag module and ceiling covering for roof-mounted side impact airbags. Do not open or break the airbag coverings.

Passenger Sensing System

Your vehicle has a passenger sensing system. The passenger airbag status indicator on the instrument panel will be visible when you turn your ignition key to RUN or START. The words ON and OFF will be visible during the system check. If you use remote start to start your vehicle from a distance, if equipped, you may not see the system check. When the system check is complete, either the word ON or the word OFF, will be visible. See *Passenger Airbag Status Indicator* on page 3-34.



Passenger Airbag Status Indicator

The passenger sensing system will turn off the right front passenger's frontal airbag under certain conditions. The driver's airbag and the side airbags are not part of the passenger sensing system.

The passenger sensing system works with sensors that are part of the right front passenger's seat. The sensors are designed to detect the presence of a properly-seated occupant and determine if the passenger's frontal airbag should be enabled (may inflate) or not.

Accident statistics show that children are safer if they are restrained in the rear rather than the front seat. General Motors recommends that child restraints be secured in a rear seat, including an infant riding in a rear-facing infant seat, a child riding in a forward-facing child seat, and an older child riding in a booster seat.

Your vehicle has a rear seat that will accommodate a rear-facing child restraint. A label on your sun visor says, "Never put a rear-facing child seat in the front." This is because the risk to the rear-facing child is so great, if the airbag deploys.

 **CAUTION:**

A child in a rear-facing child restraint can be seriously injured or killed if the right front passenger's airbag inflates. This is because the back of the rear-facing child restraint would be very close to the inflating airbag.

Even though the passenger sensing system is designed to turn off the passenger's frontal airbag if the system detects a rear-facing child restraint, no system is fail-safe, and no one can guarantee that an airbag will not deploy under some unusual circumstance, even though it is turned off. General Motors recommends that rear-facing child restraints be secured in the rear seat, even if the airbag is off.

The passenger sensing system is designed to turn off the right front passenger's frontal airbag if:

- the right front passenger seat is unoccupied
- the system determines that an infant is present in a rear-facing infant seat
- the system determines that a small child is present in a forward-facing child restraint
- the system determines that a small child is present in a booster seat
- a right front passenger takes his/her weight off of the seat for a period of time
- the right front passenger seat is occupied by a smaller person, such as a child who has outgrown child restraints
- or if there is a critical problem with the airbag system or the passenger sensing system.

When the passenger sensing system has turned off the right front passenger's frontal airbag, the off indicator on the instrument panel will light and stay lit to remind you that the airbag is off.

If a child restraint has been installed and the on indicator is lit, turn the vehicle off. Remove the child restraint from the vehicle and reinstall the child restraint following the child restraint manufacturer's directions and refer to *Securing a Child Restraint in the Right Front Seat Position on page 1-48*.

If after reinstalling the child restraint and restarting the vehicle, the on indicator is still lit, check to make sure that the vehicle's seatback is not pressing the child restraint into the seat cushion. If this happens, slightly recline the vehicle's seatback and adjust the seat cushion if possible. Also make sure the child restraint is not trapped under the vehicle head restraint. If this happens, adjust the head restraint.

If the on indicator is still lit, secure the child in the child restraint in a rear seat position in the vehicle and check with your dealer.

The passenger sensing system is designed to enable (may inflate) the right front passenger's frontal airbag anytime the system senses that a person of adult size is sitting properly in the right front passenger's seat. When the passenger sensing system has allowed the airbag to be enabled, the on indicator will light and stay lit to remind you that the airbag is active.

For some children who have outgrown child restraints and for very small adults, the passenger sensing system may or may not turn off the right front passenger's frontal airbag, depending upon the person's seating posture and body build. Everyone in your vehicle who has outgrown child restraints should wear a safety belt properly — whether or not there is an airbag for that person.

If a person of adult-size is sitting in the right front passenger's seat, but the off indicator is lit, it could be because that person is not sitting properly in the seat. If this happens, turn the vehicle off and ask the person to place the seatback in the fully upright position, then sit upright in the seat, centered on the seat cushion, with the person's legs comfortably extended. Restart the vehicle and have the person remain in this position for about two minutes. This will allow the system to detect that person and then enable the passenger's airbag.



 **CAUTION:**

If the airbag readiness light in the instrument panel cluster ever comes on and stays on, it means that something may be wrong with the airbag system. If this ever happens, have the vehicle serviced promptly, because an adult-size person sitting in the right front passenger's seat may not have the protection of the frontal airbag. See *Airbag Readiness Light* on page 3-33 for more on this, including important safety information.

A thick layer of additional material such as a blanket, or aftermarket equipment such as seat covers, seat heaters, and seat massagers, can affect how well the passenger sensing system operates. Remove any additional material from the seat cushion before reinstalling or securing the child restraint or small occupant. You may want to consider not using seat covers or other aftermarket equipment if your vehicle has the passenger sensing system. See *Adding Equipment to Your Airbag-Equipped Vehicle* on page 1-64 for more information about modifications that can affect how the system operates.

The passenger sensing system may suppress the airbag deployment when liquid is soaked into the seat. If this happens, the off indicator in the passenger airbag status indicator and the airbag readiness light on the instrument panel will be lit. The system should resume normal operation after the seat is allowed to dry. If the system operates incorrectly after the seat has dried, have your dealer check the system.

 **CAUTION:**

Stowing of articles under the passenger's seat or between the passenger's seat cushion and seatback may interfere with the proper operation of the passenger sensing system.

Servicing Your Airbag-Equipped Vehicle

Airbags affect how your vehicle should be serviced. There are parts of the airbag system in several places around your vehicle. You do not want the system to inflate while someone is working on your vehicle. Your dealer and the service manual have information about servicing your vehicle and the airbag system. To purchase a service manual, see *Service Publications Ordering Information on page 7-11*.

CAUTION:

For up to 10 minutes after the ignition key is turned off and the battery is disconnected, an airbag can still inflate during improper service. You can be injured if you are close to an airbag when it inflates. Avoid yellow connectors. They are probably part of the airbag system. Be sure to follow proper service procedures, and make sure the person performing work for you is qualified to do so.

The airbag system does not need regular maintenance.

Adding Equipment to Your Airbag-Equipped Vehicle

Q: Because I have a disability, I have to get my vehicle modified. How can I find out whether this will affect my airbag system?

A: Changing or moving any parts of the front seats, safety belts, the airbag sensing and diagnostic module (located under the right front passenger's seat), or the instrument panel can affect the operation of the airbag system. If you have questions, call Customer Assistance. The phone numbers and addresses for Customer Assistance are in Step Two of the Customer Satisfaction Procedure in this manual. See *Customer Satisfaction Procedure on page 7-2*.

Restraint System Check

Checking the Restraint Systems

Now and then, make sure the safety belt reminder light and all your belts, buckles, latch plates, retractors and anchorages are working properly. Look for any other loose or damaged safety belt system parts. If you see anything that might keep a safety belt system from doing its job, have it repaired.

Torn or frayed safety belts may not protect you in a crash. They can rip apart under impact forces. If a belt is torn or frayed, get a new one right away.

Also look for any opened or broken airbag covers, and have them repaired or replaced. (The airbag system does not need regular maintenance.)

Replacing Restraint System Parts After a Crash

CAUTION:

A crash can damage the restraint systems in your vehicle. A damaged restraint system may not properly protect the person using it, resulting in serious injury or even death in a crash. To help make sure your restraint systems are working properly after a crash, have them inspected and any necessary replacements made as soon as possible.

If you have had a crash, do you need new belts or LATCH system parts?

After a very minor collision, nothing may be necessary. But if the belts were stretched, as they would be if worn during a more severe crash, then you need new parts.

If the LATCH system was being used during a more severe crash, you may need new LATCH system parts.

If belts are cut or damaged, replace them. Collision damage also may mean you will need to have LATCH system, safety belt or seat parts repaired or replaced. New parts and repairs may be necessary even if the belt or LATCH system was not being used at the time of the collision.

If an airbag inflates, you will need to replace airbag system parts. See the part on the airbag system earlier in this section.

If the frontal airbags inflate, you will also need to replace the driver's and right front passenger's safety belt buckle assembly. Be sure to do so. Then the new buckle assembly will be there to help protect you in a collision.

After a crash you may need to replace the driver and front passenger's safety belt buckle assemblies, even if the frontal airbags have not deployed. The driver and front passenger's safety belt buckle assemblies contain the safety belt pretensioners. Have your safety belt pretensioners checked if your vehicle has been in a collision, or if your airbag readiness light stays on after you start your vehicle or while you are driving. See *Airbag Readiness Light* on page 3-33.

Section 2 Features and Controls

Keys	2-2	Shifting Into Park (P)	2-28
Remote Keyless Entry System	2-3	Shifting Out of Park (P)	2-29
Remote Keyless Entry System Operation	2-4	Parking Over Things That Burn	2-30
Doors and Locks	2-10	Engine Exhaust	2-30
Door Locks	2-10	Running the Engine While Parked	2-31
Power Door Locks	2-11	Mirrors	2-32
Delayed Locking	2-11	Manual Rearview Mirror	2-32
Automatic Door Locks	2-12	Manual Rearview Mirror with OnStar®	2-32
Lockout Protection	2-12	Automatic Dimming Rearview Mirror	2-32
Trunk	2-13	Automatic Dimming Rearview Mirror with OnStar®	2-33
Windows	2-15	Outside Power Mirrors	2-33
Power Windows	2-16	Outside Power Heated Mirrors	2-34
Sun Visors	2-17	Outside Convex Mirror	2-34
Theft-Deterrent Systems	2-17	OnStar® System	2-34
Content Theft-Deterrent	2-17	HomeLink® Transmitter	2-36
PASS-Key® III	2-19	HomeLink®	2-36
PASS-Key® III Operation	2-19	Programming the HomeLink®	2-36
Starting and Operating Your Vehicle	2-21	Storage Areas	2-40
New Vehicle Break-In	2-21	Glove Box	2-40
Ignition Positions	2-21	Cupholder(s)	2-40
Retained Accessory Power (RAP)	2-22	Center Console Storage Area	2-41
Starting the Engine	2-22	Convenience Net	2-41
Engine Coolant Heater	2-23	Sunroof	2-42
Automatic Transaxle Operation	2-24		
Parking Brake	2-27		

Keys

CAUTION:

Leaving children in a vehicle with the ignition key is dangerous for many reasons. They could operate the power windows or other controls or even make the vehicle move. The children or others could be badly injured or even killed. Do not leave the keys in a vehicle with children.

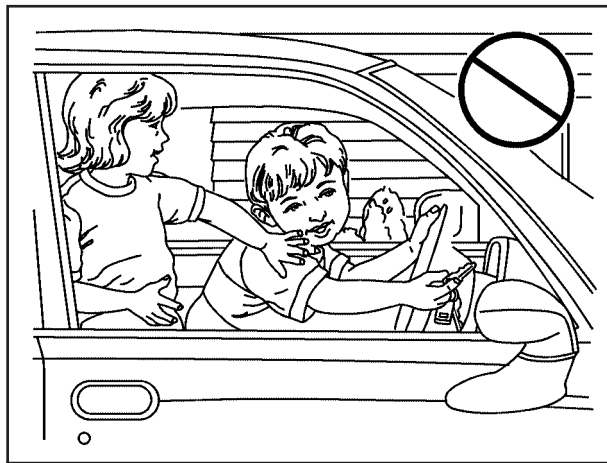

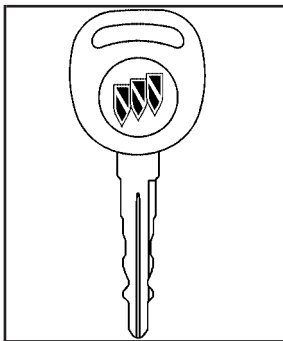

One key is used for the ignition and all locks.

When a new vehicle is delivered, the key has a bar-coded key tag. This tag may be removed by your dealer before it is delivered.

The vehicle has the PASS-Key[®] III vehicle theft system. The key has a transponder in the key head that matches a decoder in the vehicle's instrument panel. The key will have PK3 stamped on it. If a replacement key or an additional key is needed, it must be purchased from your dealer or certified locksmith.

Any new PASS-Key[®] III key must be programmed before it will start the vehicle. See *PASS-Key[®] III* on page 2-19 for more information on programming a new key.

In an emergency, contact Buick Roadside Assistance. See *Roadside Assistance Program* on page 7-6 for more information.

Notice: If you ever lock your keys in your vehicle, you may have to damage the vehicle to get in. Be sure you have spare keys.

If your vehicle is equipped with the OnStar[®] system with an active subscription and you lock your keys inside the vehicle, OnStar[®] may be able to send a command to unlock your vehicle. See *OnStar[®] System* on page 2-34 for more information.

Remote Keyless Entry System

Your keyless entry system operates on a radio frequency subject to Federal Communications Commission (FCC) Rules and with Industry Canada.

This device complies with Part 15 of the FCC Rules. Operation is subject to the following two conditions:

1. This device may not cause interference.
2. This device must accept any interference received, including interference that may cause undesired operation of the device.

This device complies with RSS-210 of Industry Canada. Operation is subject to the following two conditions:

1. This device may not cause interference.
2. This device must accept any interference received, including interference that may cause undesired operation of the device.

Changes or modifications to this system by other than an authorized service facility could void authorization to use this equipment.

At times you may notice a decrease in range. This is normal for any remote keyless entry system. If the transmitter does not work or if you have to stand closer to your vehicle for the transmitter to work, try this:

- Check the distance. You may be too far from your vehicle. You may need to stand closer during rainy or snowy weather.
- Check the location. Other vehicles or objects may be blocking the signal. Take a few steps to the left or right, hold the transmitter higher, and try again.
- Check to determine if battery replacement is necessary. See "Battery Replacement" under *Remote Keyless Entry System Operation on page 2-4*.
- If you are still having trouble, see your dealer or a qualified technician for service.

Remote Keyless Entry System Operation

The vehicle's doors can be locked and unlocked, and the trunk can be unlatched from about 3 feet (1 m) up to 60 feet (18 m) away with the remote keyless entry transmitter.

If your vehicle has the remote start feature you can also start your vehicle with the remote keyless entry transmitter. Your remote keyless entry transmitter, with the remote start button, provides an increased range of operation. You can start your vehicle from an average range of 492 feet (150 m) away. However, the range may be less while the vehicle is running and you may need to be closer to your vehicle to turn it off than you were to turn it on.

There are other conditions which can affect the performance of the transmitter. See *Remote Keyless Entry System on page 2-3*.

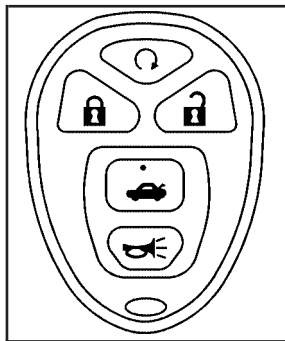

**Remote Keyless Entry
with Remote Start**

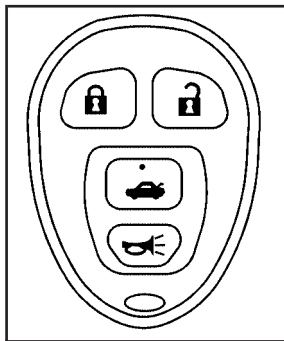

**Remote Keyless Entry
without Remote Start**

The following functions may be available if your vehicle has the remote keyless entry system:

⌚ (Remote Vehicle Start): If your vehicle has this feature, it may be started from outside the vehicle using the remote keyless entry transmitter. See “Remote Vehicle Start” at the end of this section for more detailed information.

🔒 (Lock): Press the lock button to lock all the doors. If enabled through the Driver Information Center (DIC), the parking lamps may flash once to indicate locking has occurred, or the horn may chirp when the lock button is pressed again within 5 seconds from the previous press of the lock button. See “*FOB LOCK FEEDBACK*” under *DIC Vehicle Personalization* on page 3-71 for additional information. Pressing the lock button may also arm the content theft-deterrent system, if equipped. See *Content Theft-Deterrent* on page 2-17.

🔓 (Unlock): Press the unlock button to unlock the driver’s door. If the button is pressed again within five seconds, all remaining doors will unlock. The interior lamps will come on and stay on for 20 seconds or until the ignition is turned on. If enabled through the DIC, the parking lamps can be programmed to come on for a set amount of time when the vehicle is unlocked using the remote keyless entry transmitter. See “*EXT LIGHT DELAY*” under *DIC Vehicle Personalization* on page 3-71. Pressing the unlock button on the remote keyless entry transmitter may disarm the content theft-deterrent system, if equipped. See *Content Theft-Deterrent* on page 2-17.

 **(Remote Trunk Release):** Press this button to release the trunk lid. The transaxle must be in PARK (P) for this feature to operate.

 **(Remote Alarm):** Press this button to activate an alarm. The ignition must be in off or accessory for the alarm to work. When the alarm button is pressed, the headlamps will flash and the horn will sound repeatedly for two minutes. The alarm will turn off when the ignition is moved to RUN or the alarm button is pressed again.

Matching Transmitter(s) to Your Vehicle

Each remote keyless entry transmitter is coded to prevent another transmitter from unlocking your vehicle. If a transmitter is lost or stolen, a replacement can be purchased through your GM dealer. Remember to bring any additional transmitters so they can also be re-coded to match the new transmitter. Once your dealer has coded the new transmitter, the lost transmitter will not unlock your vehicle. The vehicle can have a maximum of four transmitters matched to it.

Battery Replacement

Under normal use, the battery in your remote keyless entry transmitter should last about four years.

You can tell the battery is weak if the transmitter will not work at the normal range in any location. If you have to get close to your vehicle before the transmitter works, it is probably time to change the battery.

The KEY FOB BATT LOW message in the vehicle's DIC will display if the remote keyless entry transmitter battery is low.

Notice: When replacing the battery, use care not to touch any of the circuitry. Static from your body transferred to these surfaces may damage the transmitter.

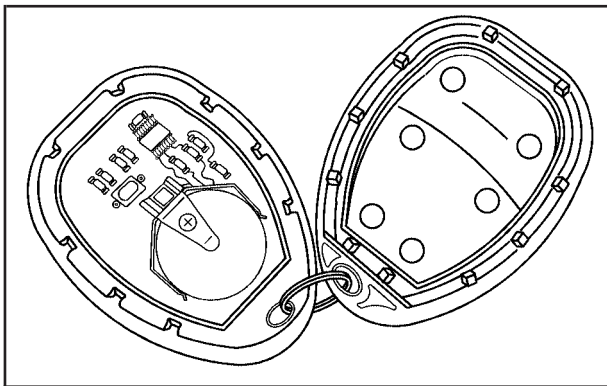

To replace the battery in the remote keyless entry transmitter, do the following:

1. Insert a flat object, with a thin edge, into the notch located below the remote alarm button, and separate the bottom half from the top half of the transmitter.
2. Remove the old battery. Do not use a metal object to do this.

3. Slide the new battery into the transmitter with the positive side of the battery facing up. Use a type CR2032 battery, or equivalent type.
4. Snap the front and the back of the transmitter together. Make sure the cover is on tight, so water will not get in.
5. Test the operation of the transmitter with the vehicle.

Remote Vehicle Start

Your vehicle may have a remote starting feature. This feature allows you to start the engine from outside of the vehicle. It may also start up the vehicle's heating or air conditioning systems and rear window defogger. When the remote start system is active and the vehicle has an automatic climate control system, it will automatically regulate the inside temperature. Normal operation of the system will return after the key is turned to RUN.

Laws in some communities may restrict the use of remote starters. For example, some laws may require a person using remote start to have the vehicle in view when doing so. Check local regulations for any requirements on remote starting of vehicles.

Do not use the remote start feature if your vehicle is low on fuel. Your vehicle may run out of fuel.

Your vehicle's remote keyless entry transmitter, with the remote start button, provides an increased range of operation. However, the range may be less while the vehicle is running and as a result, you may need to be closer to your vehicle to turn it off, than you were to turn it on.

There are other conditions which can affect the performance of the transmitter, see *Remote Keyless Entry System* on page 2-3 for additional information.

The remote vehicle start feature needs to be reset after your vehicle's engine is started two times using the transmitter's remote start button. The remote start system is reset by Inserting the vehicle's key into the ignition lock cylinder and turning it to RUN and then to OFF. See *Ignition Positions* on page 2-21 for information regarding the ignition positions on your vehicle.

 **(Remote Start):** If your vehicle has the remote start feature, the keyless entry transmitter will have a button with this symbol on it.

To start the vehicle using the remote start feature, do the following:

1. Aim the transmitter at the vehicle.
2. Press and release the transmitter's lock button, then immediately press and hold the transmitter's remote start button until the turn signal lamps flash or for four seconds, if the vehicle's lights are not visible. The vehicle's doors will lock.
3. When the vehicle starts, the parking lamps will turn on and remain on while the engine is running.

The engine will shut off automatically after 10 minutes, unless a time extension has been done or the vehicle's key is inserted into the ignition lock cylinder and turned to RUN.

4. To manually shut off a remote start, do any of the following:
 - Aim the remote keyless entry transmitter at the vehicle and press the remote start button until the parking lamps turn off.
 - Turn on the hazard warning flashers.
 - Turn the ignition switch to RUN and then to OFF.

If you enter the vehicle after a remote start, and the engine is still running, insert the key into the ignition lock cylinder and turn it to the RUN position to drive the vehicle.

Your vehicle's engine can be started two times using the transmitter's remote start feature.

If only one remote start procedure has been done, since last driving the vehicle or resetting the remote start system, the engine may be started again remotely following the remote start procedure a second time.

If the remote start procedure is used again before the first ten minute time frame has ended, 10 minutes will be added to the remaining minutes. The added 10 minutes are considered a second remote start.

The remote vehicle start feature will not operate if:

- The remote start system is disabled.
- The vehicle's key is in the ignition.
- A door is open or the vehicle's hood is not closed.

- The hazard warning flashers are on.
- There is an emission control system malfunction.
- The engine coolant temperature is too high.
- The oil pressure is low.
- Two remote vehicle starts have already been provided. The maximum number of remote starts or remote start attempts between ignition cycles with the key is two.

If a remote start is attempted and is unsuccessful, the Driver Information Center (DIC) will display REMOTE START DISABLED.

Vehicles equipped with the remote vehicle start feature are shipped from the factory with the remote vehicle start system enabled. The system may be disabled through the DIC. See "REMOTE START" under *DIC Vehicle Personalization on page 3-71* for additional information.

Doors and Locks

Door Locks

CAUTION:

Unlocked doors can be dangerous.

- Passengers — especially children — can easily open the doors and fall out of a moving vehicle. When a door is locked, the handle will not open it. You increase the chance of being thrown out of the vehicle in a crash if the doors are not locked. So, wear safety belts properly and lock the doors whenever you drive.

CAUTION: (Continued)

CAUTION: (Continued)

- Young children who get into unlocked vehicles may be unable to get out. A child can be overcome by extreme heat and can suffer permanent injuries or even death from heat stroke. Always lock your vehicle whenever you leave it.
- Outsiders can easily enter through an unlocked door when you slow down or stop your vehicle. Locking your doors can help prevent this from happening.

There are several ways to lock and unlock the vehicle.

From the outside, turn the door/ignition key in the driver's door lock cylinder briefly counterclockwise to unlock the driver's door. Turn and hold it to unlock all the doors. You can also use the remote keyless entry transmitter. From the inside use the manual or power door locks.

Power Door Locks

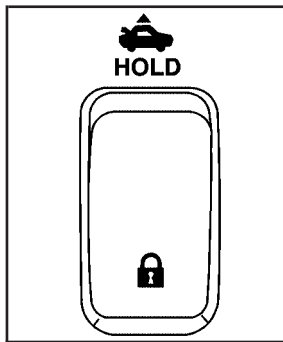

To lock or unlock all doors from inside the vehicle, use the power door lock switch located on either front door armrest.

Press the bottom of the switch to lock all doors. Press the top of the switch to unlock all doors.

The driver's and front passenger's power door lock switch also releases the trunk lid. Press the top of the switch for approximately one and a half seconds to open the trunk.

If the vehicle has the content theft-deterrent system, the vehicle is programmed from the factory to arm the system with the power door lock switch. If your vehicle has a Driver Information Center (DIC) this feature can be turned off. See "Content Theft" under *DIC Vehicle Personalization on page 3-71*.

Delayed Locking

This feature delays the locking of the vehicle's doors for five seconds after the last door is closed. Two chimes will sound when the power door lock switch or the LOCK button on the remote keyless entry transmitter is pressed when a door is open. The chimes indicate that the delayed locking feature is on. If your vehicle has a Driver Information Center (DIC), a warning will be displayed.

The doors can be locked immediately by pressing the power door lock switch or the LOCK button on the transmitter a second time.

The delayed locking feature will not activate when the ignition is in RUN or ACCESSORY.

You can program this feature on or off through the Driver Information Center (DIC), if equipped. See "Delayed Locking" under *DIC Vehicle Personalization on page 3-71*.

Automatic Door Locks

The vehicle's doors are programmed from the factory to lock when the shift lever is moved into a forward gear, and to unlock when the shift lever is moved into PARK (P).

If someone needs to get in or out of the vehicle after the doors have been locked, place the shift lever into PARK (P). You may also unlock all doors using the power door lock switch or unlock one door using the inside manual door lock.

If your vehicle has a Driver Information Center (DIC), there are different programming options for locking and unlocking the doors automatically. See *DIC Vehicle Personalization on page 3-71*.

Lockout Protection

The lockout protection feature makes it more difficult to lock the key in the vehicle. If the driver's door is open while the key is in the ignition, the door cannot be locked with the power door lock switch.

This feature cannot guarantee that you will never be locked out of the vehicle. If the key is not left in the ignition, or, if the manual door lock pin is used, the key could still be locked inside the vehicle. Always remember to take the key with you.

Trunk

CAUTION:

It can be dangerous to drive with the trunk lid open because carbon monoxide (CO) gas can come into your vehicle. You cannot see or smell CO. It can cause unconsciousness and even death. If you must drive with the trunk lid open or if electrical wiring or other cable connections must pass through the seal between the body and the trunk lid:

- Make sure all other windows are shut.
- Turn the fan on your heating or cooling system to its highest speed and select the control setting that will force outside air into your vehicle. See **Climate Control System** in the Index.
- If you have air outlets on or under the instrument panel, open them all the way.

See *Engine Exhaust* on page 2-30.

Trunk Lock

To unlock the trunk from the outside, use the remote keyless entry transmitter. See *Remote Keyless Entry System Operation* on page 2-4 for more information.

The ignition must be off, or the transaxle must be in PARK (P), to unlock the trunk.

Remote Trunk Release

This feature is used to unlock the trunk from inside the vehicle using the power door lock switch.

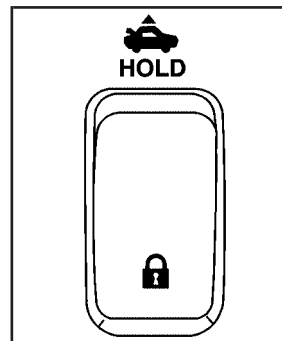

Press and hold the top of the driver's or front passenger's power door lock switch for one and one-half seconds to unlock the trunk.

The vehicle must be in PARK (P) to unlock the trunk.

Emergency Trunk Release Handle

Notice: Using the emergency trunk release handle as a tie-down or anchor point when securing items in the trunk may damage it. Use the emergency trunk release handle only to help you open the trunk lid.

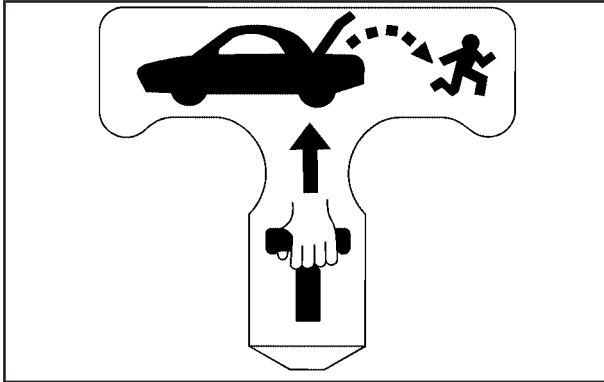

There is a glow-in-the-dark emergency trunk release handle located on the trunk latch of the trunk lid. This handle will glow following exposure to light. If ever needed, pull the emergency trunk release handle to open the trunk from the inside.

Tie-Down Feature

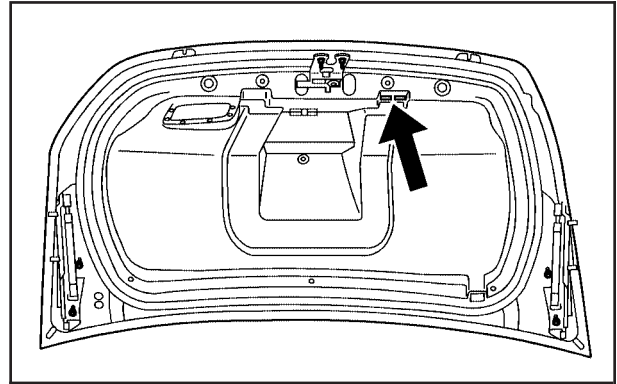

Your vehicle has a tie-down feature inside the trunk lid that can be used to secure the trunk lid when large items are stored in the trunk.

Windows

CAUTION:

Leaving children, helpless adults, or pets in a vehicle with the windows closed is dangerous. They can be overcome by the extreme heat and suffer permanent injuries or even death from heat stroke. Never leave a child, a helpless adult, or a pet alone in a vehicle, especially with the windows closed in warm or hot weather.

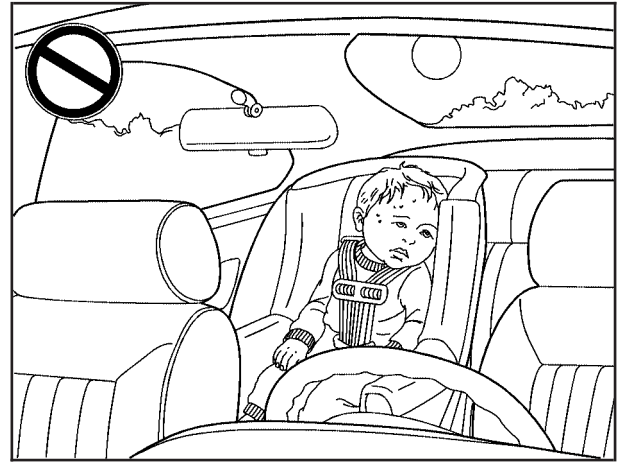

Power Windows

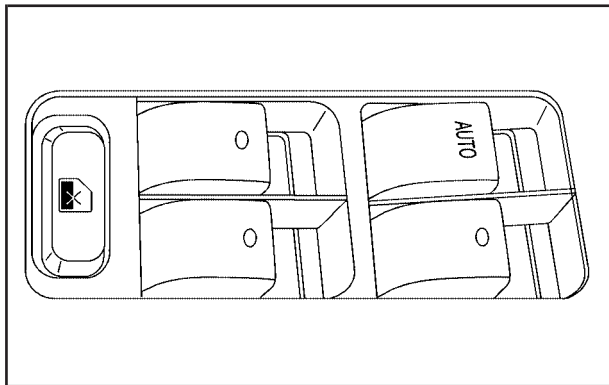

The switches on the driver's door armrest are used to control each of the windows. The power window switches work while the ignition is on, in ACCESSORY, or while Retained Accessory Power (RAP) is active. See *Retained Accessory Power (RAP)* on page 2-22. Each passenger door has its own window switch.

To lower the window, press and hold the front of the switch to the first position until the window is at the desired level. To raise the window, pull up and hold the front of the switch.

Express-Down Window

The driver's window switch has an express-down feature labeled AUTO. This allows you to lower the window completely without holding the switch. Press the front of the switch all the way down and release.

To stop the window while it is lowering, briefly pull up on the switch.

Window Lockout

 **(Window Lockout):** The driver's window switches also include a lockout switch. Press the right side of the switch to prevent the rear passengers from using their window switches. The driver can still control all the windows and the front passenger can control their own window with the lockout on. Press the left side of the switch to return to normal window operation. A red bar on the right side of the switch will indicate that the lockout is off.

Sun Visors

To block out glare, you can swing down the visors and slide them along the rod to cover different areas of the front window. You can also move them to cover the side windows.

Visor Vanity Mirror

Swing down the sun visors and lift the cover to expose the vanity mirror. If your vehicle has lighted vanity mirrors, the light will come on when you lift the cover.

Theft-Deterrent Systems

Vehicle theft is big business, especially in some cities. Although your vehicle has a number of theft-deterrent features, we know that nothing we put on it can make it impossible to steal.

Content Theft-Deterrent

Your vehicle may have a content theft-deterrent alarm system.



A red light located on top of the instrument panel, toward the center of the vehicle and near the windshield, will flash slowly when the system is armed.

The theft-deterrent alarm system needs to be activated through the Driver Information Center (DIC). See “CONTENT THEFT” under “Customization Menu Items” in *DIC Vehicle Personalization on page 3-71*. While armed, the doors will not unlock with the power door lock switch. The remote alarm will sound if someone tampers with the trunk, enters the vehicle without using the remote keyless entry transmitter or key to unlock the doors, or turns the ignition on without the proper key. The horn will sound and the headlamps will flash for up to two minutes. The system will also cut off the fuel supply, preventing the vehicle from being driven.

Arming with the Power Lock Switch

The vehicle's content theft-deterrent alarm system can be activated when the key is removed from the ignition and the power door lock switch of either the driver's or front passenger's door is used to lock the vehicle. The door needs to be in the open position when pressing the power door lock switch. The alarm system will not activate if the door is closed when the power door lock switch is pressed. This system can be activated through the Driver Information Center (DIC). See "CONTENT THEFT" under "Customization Menu Items" in *DIC Vehicle Personalization on page 3-71*.

When the doors are locked using the power door lock switch of either front door, the red light on top of the instrument panel will start flashing at a fast rate, indicating that the system is arming. After all the doors are locked there will be a time delay and then the red light will begin to flash at a very slow rate, indicating the system is armed.

Arming with the Remote Keyless Entry Transmitter

The alarm system will arm when the remote keyless entry transmitter is used to lock the doors after the key is removed from the ignition. The red light will come

on to indicate that the system is arming. After all doors are closed and locked, and after a time delay, the red light will begin flashing at a very slow rate to show the system is armed.

Arming Confirmation

A red light located on top of the instrument panel, towards the center of the vehicle and near the windshield, will flash slowly to confirm when the system is armed.

Disarming with the Remote Keyless Entry Transmitter

The alarm system will disarm when the remote keyless entry transmitter is used to unlock the doors. The red light will go out to show that the system is disarmed.

Disarming with Your Key

The alarm system will disarm when the key is used to unlock the doors. The red light will stop flashing when the system is disarmed. If you would like the key to disarm the alarm system, see "CONTENT THEFT" under *DIC Vehicle Personalization on page 3-71* for more information.

PASS-Key® III

Your PASS-Key® III system operates on a radio frequency subject to Federal Communications Commission (FCC) Rules and with Industry Canada.

This device complies with Part 15 of the FCC Rules. Operation is subject to the following two conditions:

1. This device may not cause harmful interference.
2. This device must accept any interference received, including interference that may cause undesired operation.

This device complies with RSS-210 of Industry Canada. Operation is subject to the following two conditions:

1. This device may not cause interference.
2. This device must accept any interference received, including interference that may cause undesired operation of the device.

Changes or modifications to this system by other than an authorized service facility could void authorization to use this equipment.

PASS-Key® III uses a radio frequency transponder in the key that matches a decoder in your vehicle.

PASS-Key® III Operation

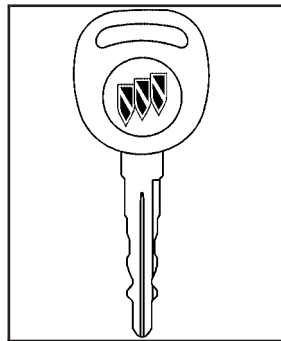

Your vehicle is equipped with PASS-Key® III (Personalized Automotive Security System) theft-deterrent system. PASS-Key® III is a passive theft-deterrent system. This means nothing special needs to be done to arm or disarm the system. It works when the key is inserted or removed from the ignition.

PASS-Key III® uses a transponder in the ignition key that matches a decoder in the vehicle.

When the PASS-Key® III system senses that the wrong key has been inserted into the ignition, it shuts down the vehicle's starter and fuel systems. The starter will not work and fuel will stop flowing to the engine. If someone tries to start the vehicle again with the wrong key, the vehicle will not start. Anyone using a trial-and-error method to start the vehicle will be discouraged to do so because of the high number of electrical key codes.

When trying to start the vehicle, if the engine does not start and the STARTING DISABLED warning message on the Driver Information Center (DIC) comes on, the key may have a damaged transponder. Turn the ignition off and try again.

If the engine still does not start, and the key appears to be undamaged, try another ignition key. At this time, you may also want to check the fuse. See *Fuses and Circuit Breakers on page 5-88*. If the engine still does not start with the other key, the vehicle needs service. If the vehicle does start, the first key may be faulty. See your dealer who can service the PASS-Key® III to have a new key made. In an emergency, contact Roadside Assistance. See *Roadside Assistance Program on page 7-6* for more information.

It is possible for the PASS-Key® III decoder to accept the transponder value of a new or replacement key. Up to 10 keys may be programmed for the vehicle. The following procedure is for programming additional keys only. If all the programmed keys are lost or do not operate, see your dealer or a locksmith who can service PASS-Key® III to have keys made and programmed to the system.

To program the new key do the following:

1. Verify that the new key has PK3 stamped on it.
2. Insert the master key in the ignition and start the engine. If the engine will not start, see your dealer for service.
3. After the engine has started, turn the key to OFF, and remove the key.
4. Insert the key to be programmed and turn it to RUN within five seconds of removing the original key.
5. The STARTING DISABLED warning message on the DIC will turn off, once the key has been programmed. It may not be apparent that the STARTING DISABLED warning message went on due to how quickly the key is programmed.
6. Repeat Steps 1 through 5 if additional keys are to be programmed.

If the STARTING DISABLED warning message appears and stays on the DIC while the vehicle is being driven, the engine will be able to be restarted if it is turned off. Your PASS-Key® III system, however, is not working properly and must be serviced by your dealer. The vehicle is not protected by the PASS-Key® III system at this time.

If the PASS-Key® III key is lost or stolen, see your dealer or a locksmith who can service PASS-Key® III to have a new key made.

Starting and Operating Your Vehicle

New Vehicle Break-In

Notice: Your vehicle does not need an elaborate break-in. But it will perform better in the long run if you follow these guidelines:

- Do not drive at any one speed, fast or slow, for the first 500 miles (805 km). Do not make full-throttle starts.
- Avoid making hard stops for the first 200 miles (322 km) or so. During this time your new brake linings are not yet broken in. Hard stops with new linings can mean premature wear and earlier replacement. Follow this breaking-in guideline every time you get new brake linings.
- Do not tow a trailer during break-in. See *Towing a Trailer* on page 4-35 for more information.

Ignition Positions

With the ignition key in the ignition, the key can be turned to four different positions:

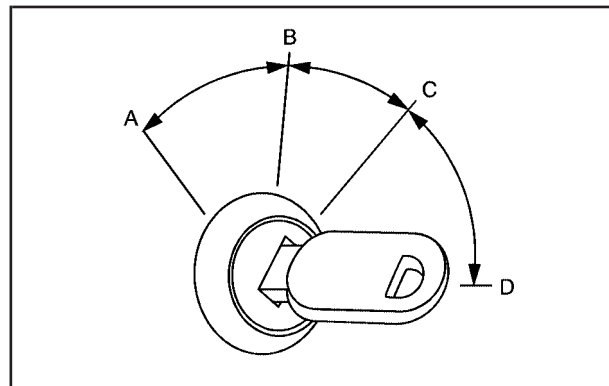

A (OFF): This is the only position in which the ignition key can be inserted or removed. This position locks the ignition and transaxle. It is a theft-deterrent feature.

B (ACCESSORY): This position lets the radio and windshield wipers operate while the engine is off. To use ACCESSORY, turn the key clockwise.

C (RUN): This position is where the key returns to after the vehicle is started. This position displays some of the warning and indicator lights.

D (START): This position starts the engine.

A warning chime will sound and the Driver Information Center will display a warning message when the driver's door is opened if the ignition is in OFF, LOCK or ACCESSORY and the key is in the ignition. See *DIC Warnings and Messages on page 3-53* for more information.

Retained Accessory Power (RAP)

If the vehicle has Retained Accessory Power (RAP), certain features will continue to operate for up to 10 minutes after the ignition key is turned to OFF unless a door is opened.

Starting the Engine

Move your shift lever to PARK (P) or NEUTRAL (N). The engine will not start in any other position — that is a safety feature. To restart when you are already moving, use NEUTRAL (N) only.

Notice: Shifting into PARK (P) with the vehicle moving could damage the transaxle. Shift into PARK (P) only when your vehicle is stopped.

1. With your foot off the accelerator pedal, turn the ignition key to START. When the engine starts, let go of the key. The idle speed will go down as the engine gets warm.

Notice: Holding your key in START for longer than 15 seconds at a time will cause your battery to be drained much sooner. And the excessive heat can damage your starter motor. Wait about 15 seconds between each try to help avoid draining your battery or damaging your starter.

2. If the engine does not start within 10 seconds, hold your key in START for about 10 seconds at a time until the engine starts. Wait about 15 seconds between each try.

When your engine has run for about 10 seconds to warm up, your vehicle is ready to be driven. Do not race your engine when it is cold.

If the weather is below freezing (32°F or 0°C), let the engine run for a few minutes to warm up.

3. If your engine still will not start, or starts but then stops, it could be flooded with too much gasoline. Try pushing your accelerator pedal all the way to the floor and holding it there as you hold the key in START for about three seconds. If the vehicle starts briefly but then stops again, do the same thing. This time keep the pedal down for five or six seconds to clear the extra gasoline from the engine. After waiting about 15 seconds, repeat the normal starting procedure.

Notice: Your engine is designed to work with the electronics in your vehicle. If you add electrical parts or accessories, you could change the way the engine operates. Before adding electrical equipment, check with your dealer. If you do not, your engine might not perform properly.

Engine Coolant Heater

Your vehicle may be equipped with this feature. In very cold weather, 0°F (–18°C) or colder, the engine coolant heater can help. You will get easier starting and better fuel economy during engine warm-up. Usually, the coolant heater should be plugged in a minimum of four hours prior to starting your vehicle. At temperatures above 32°F (0°C), use of the coolant heater is not required. Your vehicle may also have an internal thermostat in the plug end of the cord. This will prevent operation of the engine coolant heater when the temperature is at or above 0°F (–18°C) as noted on the cord.

To Use the Engine Coolant Heater

1. Turn off the engine.
2. Open the hood and unwrap the electrical cord. The cord is attached to the underside of the diagonal brace, which is located above the engine air cleaner/filter assembly.

3. Plug it into a normal, grounded 110-volt AC outlet.

CAUTION:

Plugging the cord into an ungrounded outlet could cause an electrical shock. Also, the wrong kind of extension cord could overheat and cause a fire. You could be seriously injured. Plug the cord into a properly grounded three-prong 110-volt AC outlet. If the cord will not reach, use a heavy-duty three-prong extension cord rated for at least 15 amps.

4. Before starting the engine, be sure to unplug and store the cord as it was before to keep it away from moving engine parts. If you do not, it could be damaged.

How long should you keep the coolant heater plugged in? The answer depends on the outside temperature, the kind of oil you have, and some other things. Instead of trying to list everything here, we ask that you contact your dealer in the area where you will be parking your vehicle. The dealer can give you the best advice for that particular area.

Automatic Transaxle Operation

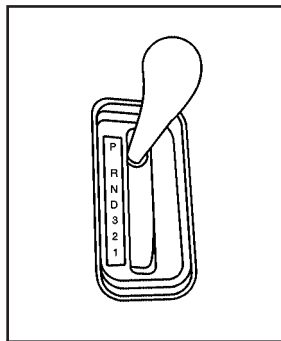

Console Shift Lever

Your vehicle's automatic transaxle may have a shift lever on the steering column or on the console between the seats.

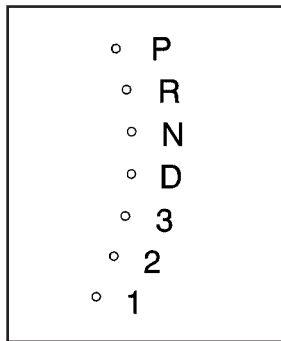

There is also a display located on the instrument panel cluster that will indicate the gear the vehicle is in.

 **CAUTION:**

It is dangerous to get out of your vehicle if the shift lever is not fully in PARK (P) with the parking brake firmly set. Your vehicle can roll.

Do not leave your vehicle when the engine is running unless you have to. If you have left the engine running, the vehicle can move suddenly. You or others could be injured. To be sure your vehicle will not move, even when you are on fairly level ground, always set your parking brake and move the shift lever to PARK (P). See *Shifting Into Park (P)* on page 2-28. If you are pulling a trailer, see *Towing a Trailer* on page 4-35.

The positions for the shift lever are:

PARK (P): This position locks the vehicle's front wheels. It is the best position to use when the engine is started because the vehicle cannot move easily.

Make sure the shift lever is fully in PARK (P) before starting the engine. The vehicle has an automatic transaxle shift lock control system. You must fully apply the regular brakes before shifting from PARK (P) when the ignition is in RUN. If you cannot shift out of PARK (P), ease pressure on the shift lever by pushing it all the way into PARK (P) while keeping the brake pedal pushed down. Release the shift lever button. Then move the shift lever out of PARK (P). See *Shifting Out of Park (P)* on page 2-29

Notice: Shifting to REVERSE (R) while your vehicle is moving forward could damage the transaxle. The repairs would not be covered by your warranty. Shift to REVERSE (R) only after your vehicle is stopped.

REVERSE (R): Use this gear to back up.

To rock the vehicle back and forth in order to get it out of snow, ice, or sand without damaging the transaxle, see *If Your Vehicle is Stuck in Sand, Mud, Ice or Snow* on page 4-28.

NEUTRAL (N): In this position, the engine does not connect with the wheels. To restart when you are already moving, use NEUTRAL (N) only. Also, use NEUTRAL (N) when the vehicle is being towed.

 **CAUTION:**

Shifting into a drive gear while your engine is running at high speed is dangerous. Unless your foot is firmly on the brake pedal, your vehicle could move very rapidly. You could lose control and hit people or objects. Do not shift into a drive gear while your engine is running at high speed.

Notice: Shifting out of PARK (P) or NEUTRAL (N) with the engine racing may damage the transaxle. The repairs would not be covered by your warranty. Be sure the engine is not racing when shifting your vehicle.

Notice: Driving your vehicle if you notice that it is moving slowly or not shifting gears as you increase speed may damage the transaxle. Have your vehicle serviced right away. You can drive in SECOND (2) when you are driving less than 35 mph (55 km/h) and AUTOMATIC OVERDRIVE (D) for higher speeds until then.

AUTOMATIC OVERDRIVE (D): This position is for normal driving. If more power is needed for passing, and the vehicle is:

- Going less than 35 mph (55 km/h), push the accelerator pedal about halfway down.
- Going about 35 mph (55 km/h) or more, push the accelerator pedal all the way down.

By doing this the vehicle will automatically shift down to the next gear and have more power.

THIRD (3): This position is also used for normal driving, but it offers more power and lower fuel economy than AUTOMATIC OVERDRIVE (D).

Here are some times you might choose THIRD (3) instead of AUTOMATIC OVERDRIVE (D):

- When driving on hilly, winding roads.
- When towing a trailer, so there is less shifting between gears.
- When going down a steep hill.
- When driving in no-highway scenarios such as city streets.

Notice: Driving in **SECOND (2)** for more than 25 miles (40 km) or at speeds over 55 mph (90 km/h) may damage the transaxle. Also, shifting into **SECOND (2)** at speeds above 65 mph (105 km/h) can cause damage. Drive in **THIRD (3)** or **AUTOMATIC OVERDRIVE (D)** instead of **SECOND (2)**.

SECOND (2): This position gives the vehicle more power but lower fuel economy than **THIRD (3)**. You can use **SECOND (2)** on hills. It can help control the speed going down steep mountain roads, but then you would also want to use the brakes off and on.

FIRST (1): This position gives the vehicle even more power but lower fuel economy than **SECOND (2)**. You can use it on very steep hills, or in deep snow or mud. If the shift lever is put in **FIRST (1)**, the transaxle will not shift into first gear until the vehicle is going slowly enough.

Notice: Spinning the tires or holding the vehicle in one place on a hill using only the accelerator pedal may damage the transaxle. If you are stuck, do not spin the tires. When stopping on a hill, use the brakes to hold the vehicle in place.

Parking Brake

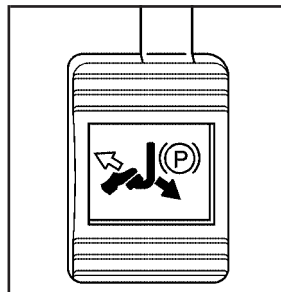

To set the parking brake, hold the regular brake pedal down with your right foot. Push down the parking brake pedal with your left foot.

To release the parking brake, hold the regular brake pedal down with your right foot and push the parking brake pedal with your left foot. When you lift your left foot, the parking brake pedal will follow it to the released position.

A warning chime will sound if the parking brake is set, the ignition is on, and the vehicle speed is greater than 5 mph (8 km/h).

Notice: Driving with the parking brake on can overheat the brake system and cause premature wear or damage to brake system parts. Verify that the parking brake is fully released and the brake warning light is off before driving.

If you are towing a trailer and parking on any hill, see *Towing a Trailer on page 4-35*. That section shows what to do first to keep the trailer from moving.

Shifting Into Park (P)

CAUTION:

It can be dangerous to get out of your vehicle if the shift lever is not fully in PARK (P) with the parking brake firmly set. Your vehicle can roll. If you have left the engine running, the vehicle can move suddenly. You or others could be injured. To be sure your vehicle will not move, even when you are on fairly level ground, use the steps that follow. If you are pulling a trailer, see *Towing a Trailer on page 4-35*.

Steering Column Shift Lever

1. Hold the brake pedal down and set the parking brake.
2. Move the shift lever into the PARK (P) like this:
 - Pull the lever toward you.
 - Move the lever up as far as it will go.
3. Turn the ignition key to LOCK.
4. Remove the key and take it with you. If you can leave your vehicle with the ignition key in your hand, your vehicle is in PARK (P).

Console Shift Lever

1. Hold the brake pedal down and set the parking brake.
2. Move the shift lever into the PARK (P) position by holding in the button on the shift lever and pushing it all the way toward the front of the vehicle.
3. Turn the ignition key to LOCK.
4. Remove the key and take it with you. If you can leave your vehicle with the ignition key in your hand, your vehicle is in PARK (P).

Leaving Your Vehicle With the Engine Running

CAUTION:

It can be dangerous to leave your vehicle with the engine running. Your vehicle could move suddenly if the shift lever is not fully in PARK (P) with the parking brake firmly set. And, if you leave the vehicle with the engine running, it could overheat and even catch fire. You or others could be injured. Do not leave your vehicle with the engine running.

If you have to leave your vehicle with the engine running, be sure your vehicle is in PARK (P) and your parking brake is firmly set before you leave it. After you have moved the shift lever into PARK (P), hold the regular brake pedal down. Then, see if you can move the shift lever away from PARK (P) without first pushing the button. If you can, it means that the shift lever was not fully locked into PARK (P).

Torque Lock

If you are parking on a hill and you do not shift your transaxle into PARK (P) properly, the weight of the vehicle may put too much force on the parking pawl in the transaxle. You may find it difficult to pull the shift lever out of PARK (P). This is called “torque lock.” To prevent torque lock, set the parking brake and then shift into PARK (P) properly before you leave the driver’s seat. To find out how, see *Shifting Into Park (P) on page 2-28*.

When you are ready to drive, move the shift lever out of PARK (P) before you release the parking brake.

If torque lock does occur, you may need to have another vehicle push yours a little uphill to take some of the pressure from the parking pawl in the transaxle, so you can pull the shift lever out of PARK (P).

Shifting Out of Park (P)

The vehicle has an automatic transaxle shift lock control system which locks the shift lever in PARK (P) when the ignition is in the OFF position. The regular brakes must be fully applied before the vehicle can be shifted from PARK (P) when the ignition is RUN. See *Automatic Transaxle Operation on page 2-24*.

If the vehicle cannot be shifted out of PARK (P), ease pressure on the shift lever and push the shift lever all the way into PARK (P) as brake application is maintained. Then, move the shift lever into the desired gear.

Parking Over Things That Burn

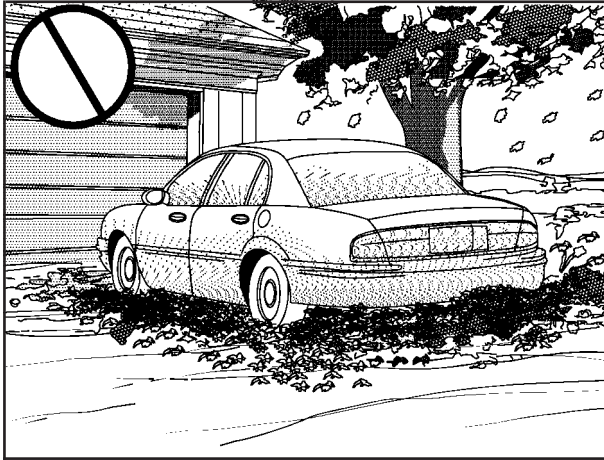

CAUTION:

Things that can burn could touch hot exhaust parts under your vehicle and ignite. Do not park over papers, leaves, dry grass or other things that can burn.

Engine Exhaust

CAUTION:

Engine exhaust can kill. It contains the gas carbon monoxide (CO), which you cannot see or smell. It can cause unconsciousness and death.

You might have exhaust coming in if:

- Your exhaust system sounds strange or different.
- Your vehicle gets rusty underneath.
- Your vehicle was damaged in a collision.
- Your vehicle was damaged when driving over high points on the road or over road debris.
- Repairs were not done correctly.
- Your vehicle or exhaust system had been modified improperly.

If you ever suspect exhaust is coming into your vehicle:

- Drive it only with all the windows down to blow out any CO; and
- Have your vehicle fixed immediately.

Running the Engine While Parked

It is better not to park with the engine running. But if you ever have to, here are some things to know.

CAUTION:

Idling the engine with the climate control system off could allow dangerous exhaust into your vehicle. See the earlier caution under *Engine Exhaust on page 2-30*.

Also, idling in a closed-in place can let deadly carbon monoxide (CO) into your vehicle even if the climate control fan is at the highest setting. One place this can happen is a garage. Exhaust — with CO — can come in easily. **NEVER** park in a garage with the engine running.

Another closed-in place can be a blizzard. See *Winter Driving on page 4-24*.

CAUTION:

It can be dangerous to get out of your vehicle if the shift lever is not fully in PARK (P) with the parking brake firmly set. Your vehicle can roll. Do not leave your vehicle when the engine is running unless you have to. If you have left the engine running, the vehicle can move suddenly. You or others could be injured. To be sure your vehicle will not move, even when you are on fairly level ground, always set your parking brake and move the shift lever to PARK (P).

Follow the proper steps to be sure your vehicle will not move. See *Shifting Into Park (P) on page 2-28*.

If you are parking on a hill and if you are pulling a trailer, also see *Towing a Trailer on page 4-35*.

Mirrors

Manual Rearview Mirror

While sitting in a comfortable driving position, adjust the mirror so you can see clearly behind your vehicle. Grip the mirror in the center to move it up or down and side to side. The day/night control at the bottom of the mirror lets you adjust the mirror to avoid glare from the lamps behind you. Turn the control to the right for nighttime conditions and to the center for daytime conditions.

Manual Rearview Mirror with OnStar[®]

The vehicle may have a mirror with OnStar[®]. While sitting in a comfortable driving position, adjust the mirror so you can see clearly behind your vehicle. Grip the mirror in the center to move it up and down and side to side.

The mirror has a day/night control located at the bottom. Turn the control to the right for the night position to reduce glare from other vehicles' headlamps. Turn the control to the front for the day position.

There are also three OnStar[®] buttons located at the bottom of the mirror. See your dealer for more information on the system and how to subscribe to OnStar[®]. See *OnStar[®] System on page 2-34* for more information about the services OnStar[®] provides.

Automatic Dimming Rearview Mirror

While sitting in a comfortable driving position, adjust the mirror so you can see clearly behind your vehicle. Grip the mirror in the center to move it up or down and side to side.

The vehicle may have an automatic dimming rearview mirror that darkens gradually to reduce the glare of headlamps from behind. Push the button in the center of the mirror to turn this feature on or off.

One photocell on the front of the mirror senses when it is becoming dark outside. Another photocell, facing rearward, senses headlamps behind you.

To keep the photocells operating well, occasionally clean them with a cotton swab and glass cleaner.

Push the two outer buttons at the bottom of the mirror to turn the map lamps on or off.

Automatic Dimming Rearview Mirror with OnStar®

While sitting in a comfortable driving position, adjust the mirror so you can see clearly behind your vehicle. Grip the mirror in the center to move it up or down and side to side.

The vehicle may have an automatic dimming rearview mirror with the OnStar® System.

The automatic dimming feature is turned on or off by pressing the left button, located on the lower part of the mirror, for up to three seconds. When turned on, this mirror functions like the automatic dimming rearview mirror described previously. See *Automatic Dimming Rearview Mirror on page 2-32*.

There are also three OnStar® buttons located at the bottom of the mirror. See your dealer for more information on the system and how to subscribe to OnStar®. See *OnStar® System on page 2-34* for more information about the services OnStar® provides.

Outside Power Mirrors

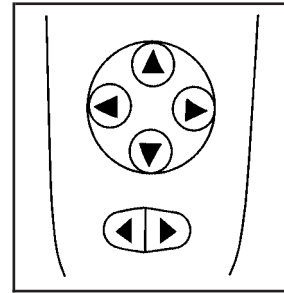

The controls for the outside power mirrors, are located on the driver's door armrest.

Move the selector switch located below the four-way control pad to the left or right to choose either the driver's side or passenger's side mirror. To adjust a mirror, use the arrows located on the four-way control pad to move the mirror in the desired direction. Adjust each outside mirror so that a little of the vehicle and the area behind it can be seen while sitting in a comfortable driving position. Keep the selector switch in the center position when not adjusting either outside mirror.

Outside Power Heated Mirrors

For information on the operation of the outside power mirrors see *Outside Power Mirrors on page 2-33*.

If the vehicle has heated mirrors, they will warm up to melt ice and snow, and dissolve condensation when the defroster is turned on. See *Dual Automatic Climate Control System on page 3-24* or *Climate Control System on page 3-21*.

Outside Convex Mirror

CAUTION:

A convex mirror can make things (like other vehicles) look farther away than they really are. If you cut too sharply into the right lane, you could hit a vehicle on your right. Check your inside mirror or glance over your shoulder before changing lanes.

The passenger's side mirror is convex. A convex mirror's surface is curved so more can be seen from the driver's seat, but it also makes things look farther away than they really are.

OnStar[®] System

OnStar[®] uses global positioning system (GPS) satellite technology, wireless communications, and call centers to provide you with a wide range of safety, security, information, and convenience services.

A complete OnStar[®] user's guide and the terms and conditions of the OnStar[®] Subscription Service Agreement are included in the vehicle's glove box literature. For more information, visit www.onstar.com or www.onstarcanada.com. Contact OnStar[®] at 1-888-4-ONSTAR (1-888-466-7827), or press the OnStar[®] button to speak to an OnStar[®] advisor 24 hours a day, 7 days a week.

Terms and conditions of the Subscription Service Agreement can be found at www.onstar.com or www.onstarcanada.com.

OnStar[®] Services

For new vehicles equipped with OnStar[®], the Safe and Sound Plan is included for the first year. You can extend this plan beyond the first year, or upgrade to the Directions and Connections Plan to meet your needs. For more information, press the OnStar[®] button to speak with an advisor.

Safe and Sound Plan

- Automatic Notification of Airbag Deployment
- Emergency Services
- Roadside Assistance
- Stolen Vehicle Tracking
- AccidentAssist
- Remote Door Unlock/Vehicle Alert
- Remote Diagnostics
- Online Concierge

Directions and Connections Plan

- All Safe and Sound Plan Services
- Driving Directions
- RideAssist
- Information and Convenience Services

OnStar® Personal Calling

As an OnStar® subscriber, the Personal Calling capability is available if your hand-held cell phone is lost, forgotten, or has a low battery. It is a hands-free wireless phone that is integrated into the vehicle. Calls can be placed nationwide using simple voice commands with no additional contracts and no additional roaming charges. To find out more about OnStar® Personal Calling, refer to the OnStar® user's guide in the vehicle's glove box or visit www.onstar.com or www.onstarcanada.com; or speak with an OnStar® advisor by pressing the OnStar® button or by calling 1-888-4-ONSTAR (1-888-466-7827).

OnStar® Virtual Advisor

Virtual Advisor is a feature of OnStar® Personal Calling that uses minutes to access up-to-date weather and traffic reports for your area, news and sports updates, stock quotes, entertainment and more. Customize your information profile at www.myonstar.com. See the OnStar® user's guide for more information.

HomeLink® Transmitter

HomeLink®



If your vehicle has this feature, the control buttons are located on the driver's sun visor.

HomeLink® Wireless Control System provides a way to replace up to three hand-held radio-frequency (RF) transmitters used to activate devices such as gate operators, garage door openers, entry door locks, security systems, and home lighting. Additional HomeLink® information can be found on the Internet at www.homelink.com or by calling 1-800-355-3515.

This device complies with Part 15 of the FCC Rules. Operation is subject to the following two conditions:

1. This device may not cause harmful interference.
2. This device must accept any interference received, including interference that may cause undesired operation.

This device complies with RSS-210 of Industry Canada. Operation is subject to the following two conditions:

1. This device may not cause interference.
2. This device must accept any interference received, including interference that may cause undesired operation of the device.

Changes or modifications to this system by other than an authorized service facility could void authorization to use this equipment.

Programming the HomeLink®

Do not use HomeLink® with any garage door opener that does not have the “stop and reverse” feature. This includes any garage door opener model manufactured before April 1, 1982. If you have a newer garage door opener with rolling codes, please be sure to follow Steps 6 through 8 to complete the programming of your HomeLink® Transmitter.

Read the instructions completely before attempting to program HomeLink®. Because of the steps involved, it may be helpful to have another person available to assist you in the programming steps.

Keep the original hand-held transmitter for use in other vehicles as well as for future HomeLink® programming. It is also recommended that upon the sale of the vehicle, the programmed HomeLink® buttons should be erased for security purposes. See “Erasing HomeLink® Buttons” later in this section or, for assistance, contact HomeLink® on the Internet at: www.homelink.com or by calling 1-800-355-3515.

Be sure that people and objects are clear of the garage door or gate operator you are programming. When programming a garage door, it is advised to park outside of the garage.

It is recommended that a new battery be installed in your hand-held transmitter for quicker and more accurate transmission of the radio-frequency signal.

Programming HomeLink®

Your vehicle's engine should be turned off while programming HomeLink®. Follow these steps to program up to three channels:

1. Press and hold down the two outside HomeLink® buttons, releasing only when the HomeLink® indicator light begins to flash, after 20 seconds. Do not hold down the buttons for longer than 30 seconds and do not repeat this step to program a second and/or third hand-held transmitter to the remaining two HomeLink® buttons.
2. Position the end of your hand-held transmitter about 1 to 3 inches (3 to 8 cm) away from the HomeLink® buttons while keeping the indicator light in view.
3. Simultaneously press and hold both the desired HomeLink® button and the hand-held transmitter button. Do not release the buttons until Step 4 has been completed.

Some entry gates and garage door openers may require you to substitute Step 3 with the procedure noted in “Gate Operator and Canadian Programming” later in this section.

4. The indicator light will flash slowly at first and then rapidly after HomeLink[®] successfully receives the frequency signal from the hand-held transmitter. Release both buttons.
5. Press and hold the newly-trained HomeLink[®] button and observe the indicator light.

If the indicator light stays on constantly, programming is complete and your device should activate when the HomeLink[®] button is pressed and released.

To program the remaining two HomeLink[®] buttons, begin with Step 2 under "Programming HomeLink[®]." Do not repeat Step 1 as this will erase all of the programmed channels.

If the indicator light blinks rapidly for two seconds and then turns to a constant light, continue with Steps 6 through 8 following to complete the programming of a rolling-code equipped device, most commonly, a garage door opener.

6. Locate in the garage, the garage door opener receiver (motor-head unit). Locate the "Learn" or "Smart" button. This can usually be found where the hanging antenna wire is attached to the motor-head unit.
7. Firmly press and release the "Learn" or "Smart" button. The name and color of the button may vary by manufacturer.

You will have 30 seconds to start Step 8.

8. Return to the vehicle. Firmly press and hold the programmed HomeLink[®] button for two seconds, then release. Repeat the press/hold/release sequence a second time, and depending on the brand of the garage door opener, or other rolling code device, repeat this sequence a third time to complete the programming.

HomeLink[®] should now activate your rolling-code equipped device.

To program the remaining two HomeLink[®] buttons, begin with Step 2 of "Programming HomeLink[®]." You do not want to repeat Step 1, as this will erase all previous programming from the HomeLink[®] buttons.

Gate Operator and Canadian Programming

Canadian radio-frequency laws require transmitter signals to time out or quit after several seconds of transmission. This may not be long enough for HomeLink® to pick up the signal during programming. Similarly, some U.S. gate operators are manufactured to time out in the same manner.

If you live in Canada, or you are having difficulty programming a gate operator or garage door opener by using the “Programming HomeLink®” procedures, regardless of where you live, replace Step 3 under “Programming HomeLink®” with the following:

Continue to press and hold the HomeLink® button while you press and release every two seconds (cycle) the hand-held transmitter button until the frequency signal has been successfully accepted by HomeLink®. The HomeLink® indicator light will flash slowly at first and then rapidly. Proceed with Step 4 under “Programming HomeLink®” to complete.

Using HomeLink®

Press and hold the appropriate HomeLink® button for at least half of a second. The indicator light will come on while the signal is being transmitted.

Erasing HomeLink® Buttons

To erase programming from the three HomeLink® buttons do the following:

1. Press and hold down the two outside buttons until the indicator light begins to flash, after 20 seconds. Do not hold the two outside buttons for longer than 30 seconds.
2. Release both buttons.

HomeLink® is now in the train (learning) mode and can be programmed at any time beginning with Step 2 under “Programming HomeLink®” shown earlier in this section.

Individual buttons cannot be erased, but they can be reprogrammed. See “Reprogramming a Single HomeLink® Button” following this section.

Reprogramming a Single HomeLink® Button

To program a device to HomeLink® using a HomeLink® button previously trained, follow these steps:

1. Press and hold the desired HomeLink® button. Do not release the button.
2. The indicator light will begin to flash after 20 seconds. While still holding the HomeLink® button, proceed with Step 2 under “Programming HomeLink®” shown earlier in this section.

For questions or comments, contact HomeLink® at 1-800-355-3515, or on the internet at www.homelink.com.

Storage Areas

Glove Box

To open the glove box, lift up on the lever. The glove box has a light inside and a shelf for storing manuals. The shelf is located at the top of the glove box.

Cupholder(s)

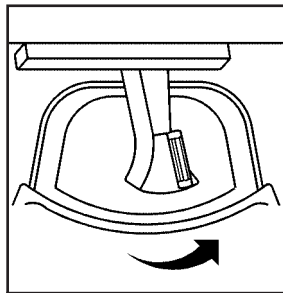

If your vehicle has the five-passenger console, there is a cupholder in front of the center console. The cupholder has an arm that adjusts to two positions to fit either a large cup or two smaller cups.

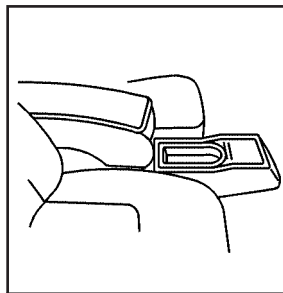

If your vehicle has the six-passenger console, a front console cupholder is accessible by turning the bottom of the armrest/seat forward.

Your vehicle has cupholders in the rear seat armrest.

Center Console Storage Area

If your vehicle has a five-passenger console, the center console has a padded lid that can be used as an armrest. Lift the armrest lid to access a storage bin with a coin holder and a CD holder. Located under the lid is a card clip.

If your vehicle has a six-passenger console, there is a flip and fold center armrest that allows you to choose between a three-passenger front row bench seat or a center console. For more information see *Center Seat on page 1-7*. In the upward position the armrest acts as a back support for the front row bench seat. Flip the center armrest down and it can be used as an armrest for the driver and passenger seat. Lift the armrest lid to access the storage area.

Convenience Net

The vehicle may have a convenience net located on the back wall of the trunk.

Put small loads, like grocery bags, behind the net. It can help keep them from falling over.

The net is not for larger, heavier loads. Store those in the trunk as far forward as possible.

Unhook the net so that it will lie flat when not in use.

Sunroof

The vehicle may have a sunroof. It includes a sliding glass panel and a sunshade.

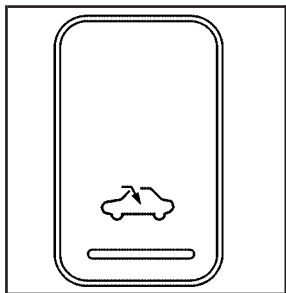

The sunroof control is on the headliner, by the map lamps.

The sunroof control works only when the ignition is on or in accessory, or when Retained Accessory Power (RAP) is active. See *Retained Accessory Power (RAP)* on page 2-22.

To raise the sunroof to the vent position, press the back of the control. Push and hold the front of the control to close the sunroof from the vent position.

With the sunroof in the vent position, press and release the back of the control to express-open the sunroof. The sunshade will automatically open with the sunroof. To stop the express-open function, press the back of the control again.

To close the sunroof, press and hold the front of the control. To stop the sunroof, release the control. The sunshade must be closed manually.

The sunroof panel cannot be opened or closed if your vehicle has an electrical failure.

Section 3 Instrument Panel

Instrument Panel Overview	3-4	Overhead Console Reading Lamps	3-18
Hazard Warning Flashers	3-6	Rear Assist Handle Reading Lamps	3-18
Other Warning Devices	3-6	Battery Run-Down Protection	3-18
Horn	3-6	Ultrasonic Rear Parking Assist (URPA)	3-18
Tilt Wheel	3-6	Accessory Power Outlets	3-20
Turn Signal/Multifunction Lever	3-7	Climate Controls	3-21
Turn and Lane-Change Signals	3-8	Climate Control System	3-21
Headlamp High/Low-Beam Changer	3-8	Dual Automatic Climate Control System	3-24
Flash-to-Pass	3-8	Outlet Adjustment	3-28
Windshield Wipers	3-9	Passenger Compartment Air Filter	3-28
Windshield Washer	3-9	Steering Wheel Climate Controls	3-30
Cruise Control	3-10	Warning Lights, Gages, and Indicators	3-30
Exterior Lamps	3-13	Instrument Panel Cluster	3-31
Daytime Running Lamps (DRL)/Automatic Headlamp System	3-14	Speedometer and Odometer	3-32
Fog Lamps	3-15	Tachometer	3-32
Exterior Lighting Battery Saver	3-15	Safety Belt Reminder Light	3-32
Interior Lamps	3-16	Airbag Readiness Light	3-33
Instrument Panel Brightness	3-16	Passenger Airbag Status Indicator	3-34
Courtesy Lamps	3-16	Charging System Light	3-35
Entry Lighting	3-16	Brake System Warning Light	3-36
Delayed Entry Lighting	3-17	Anti-Lock Brake System Warning Light	3-37
Theater Dimming	3-17	Traction Control System (TCS) Warning Light	3-37
Delayed Exit Lighting	3-17	Engine Coolant Temperature Warning Light	3-38
Perimeter Lighting	3-18		

Section 3 Instrument Panel

Engine Coolant Temperature Gage	3-38	Driver Information Center (DIC)	3-47
Low Coolant Warning Light	3-39	DIC Operation and Displays	3-47
Malfunction Indicator Lamp	3-39	DIC Warnings and Messages	3-53
Oil Pressure Light	3-42	DIC Vehicle Personalization	3-71
Change Engine Oil Light	3-43	Audio System(s)	3-79
Security Light	3-43	Setting the Time	3-79
Cruise Control Light	3-43	Radio with CD (Base)	3-79
Reduced Engine Power Light	3-44	Radio with CD (UpLevel)	3-84
Highbeam On Light	3-44	Radio with CD (MP3)	3-92
Headlamps Suggested Light	3-44	Radio with Six-Disc CD	3-105
Low Washer Fluid Warning Light	3-45	Theft-Deterrent Feature	3-117
Door Ajar Light	3-45	Audio Steering Wheel Controls	3-118
Trunk Ajar Light	3-45	Radio Reception	3-119
Service Vehicle Soon Light	3-45	Care of Your CDs	3-119
Fuel Gage	3-46	Care of Your CD Player	3-119
Low Fuel Warning Light	3-46	Backglass Antenna	3-120
Check Gas Cap Light	3-46	Chime Level Adjustment	3-120

Instrument Panel Overview

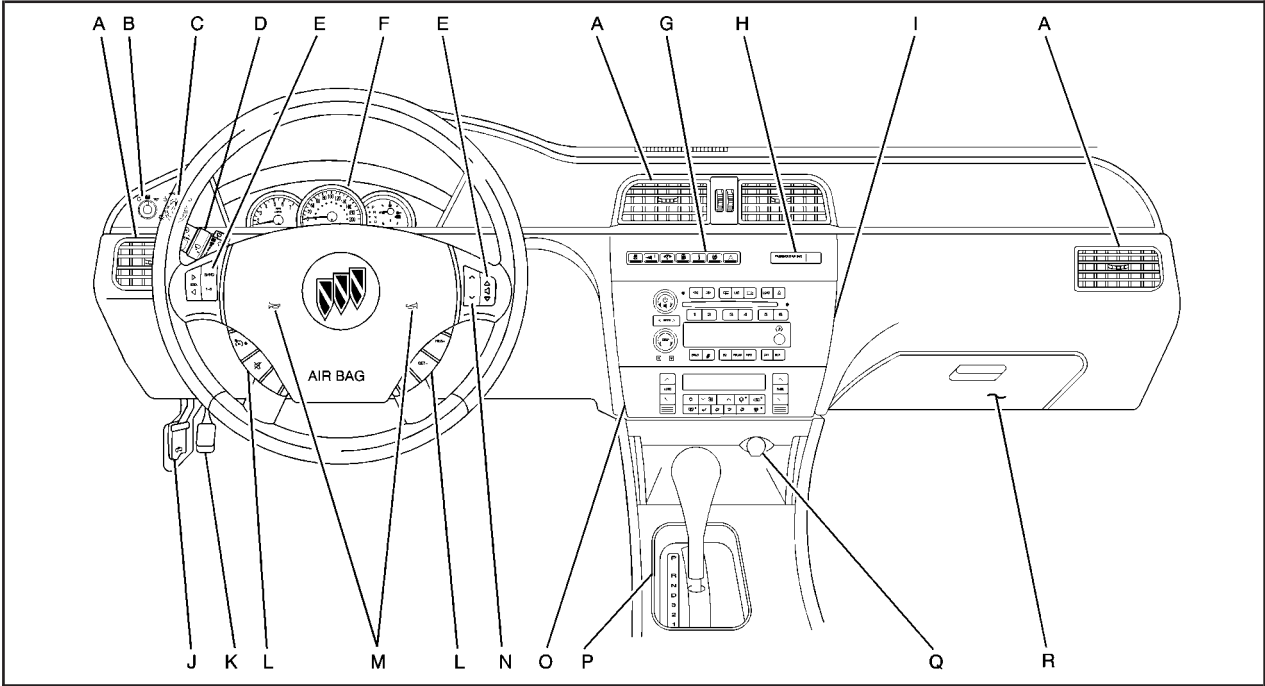

The main components of the instrument panel are the following:

- A. Air Outlets. See *Outlet Adjustment on page 3-28.*
- B. Interior Lamps Control. See *Interior Lamps on page 3-16.*
- C. Exterior Lamps Control. See *Exterior Lamps on page 3-13.* Fog Lamp Control. See *Fog Lamps on page 3-15.*
- D. Turn Signal/Multifunction Lever. See *Turn Signal/Multifunction Lever on page 3-7.*
- E. Audio Steering Wheel Controls. See *Audio Steering Wheel Controls on page 3-118.*
- F. Instrument Panel Cluster. See *Instrument Panel Cluster on page 3-31.*
- G. DIC Buttons. See *DIC Operation and Displays on page 3-47.*
- H. Passenger Airbag Status Indicator. See *Passenger Airbag Status Indicator on page 3-34.*
- I. Audio System Controls. See *Audio System(s) on page 3-79.*
- J. Hood Release. See *Hood Release on page 5-11.*
- K. Parking Brake. See *Parking Brake on page 2-27.*
- L. Cruise Controls. See *Cruise Control on page 3-10.*
- M. Horn. See *Horn on page 3-6.*
- N. Steering Wheel Climate Controls. See *Steering Wheel Climate Controls on page 3-30.*
- O. Climate Controls. See *Climate Control System on page 3-21* or *Dual Automatic Climate Control System on page 3-24.*
- P. Shift Lever. See *Shifting Into Park (P) on page 2-28.*
- Q. Accessory Power Outlet. See *Accessory Power Outlets on page 3-20.*
- R. Glove Box. See *Glove Box on page 2-40.*

Hazard Warning Flashers

Your hazard warning flashers let you warn others. They also let police know you have a problem. Your front and rear turn signal lamps will flash on and off.

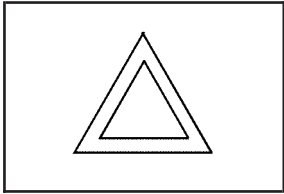

The hazard warning flasher button is located near the center of the instrument panel.

Your hazard warning flashers work no matter what position your key is in, and even if the key is not in.

Press the button to make the front and rear turn signal lamps flash on and off. Press the button again to turn the flashers off.

When the hazard warning flashers are on, your turn signals will not work.

Other Warning Devices

If you carry reflective triangles, you can set them up at the side of the road about 300 feet (100 m) behind your vehicle.

Horn

Press near or on the horn symbols on your steering wheel pad to sound the horn.

Tilt Wheel

A tilt wheel allows adjustment of the steering wheel before you drive. The steering wheel can be raised to the highest level to give the driver's legs more room when you enter and exit the vehicle.



The lever that allows you to tilt the steering wheel is located on the left side of the steering column.

To tilt the wheel, pull the lever down. Then move the wheel to a comfortable position and pull the lever up to lock the wheel in place.

Telescoping Column

A telescoping column on the steering wheel allows adjustment of the distance of the steering wheel and the driver without moving the driver's seat.

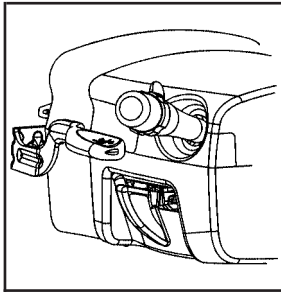



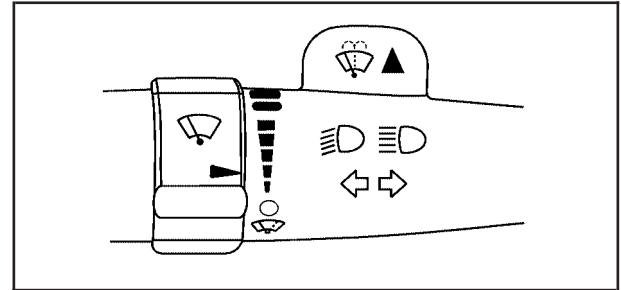

The lever on the steering wheel column that enables telescoping is located on the left side of the steering column and behind the tilt lever.

To adjust the steering wheel, pull the steering wheel column lever down and push or pull the steering wheel to a comfortable position. Then pull the lever up to lock the wheel in place.

Turn Signal/Multifunction Lever



The lever on the left side of the steering column includes the following:

-  Turn and Lane Change Signals. See *Turn and Lane-Change Signals* on page 3-8.
-  Headlamp High/Low-Beam Changer. See *Headlamp High/Low-Beam Changer* on page 3-8.
- Flash-to-Pass. See *Flash-to-Pass* on page 3-8.
-  Windshield Wipers. See *Windshield Wipers* on page 3-9.
-   Windshield Washer. See *Windshield Washer* on page 3-9.

For information on the headlamps, see *Exterior Lamps* on page 3-13.

Turn and Lane-Change Signals

To signal a turn, move the lever up or down. The lever returns to its original position when the turn is completed.

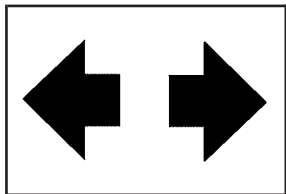

An arrow on the instrument panel cluster will flash in the direction of the turn or lane change.

To signal a lane change, raise or lower the lever until the arrow starts to flash. Hold it there until the lane change is completed. The lever will return to its original position when released.

Arrows that flash rapidly when signaling for a turn or lane change, or that fail to work, may indicate a burned-out signal bulb or fuse. Other drivers will not see the signal. See *Front Turn Signal and Parking Lamps* on page 5-47 and *Taillamps, Turn Signal, Sidemarker, Stoplamps and Back-up Lamps* on page 5-48 for turn signal bulb replacement procedures. Also see *Fuses and Circuit Breakers* on page 5-88 for location of fuses.

A chime will sound if the turn signal is left on for more than 3/4 mile (1.2 km).

Headlamp High/Low-Beam Changer

To change the headlamps from low beam to high beam, push the turn signal/multifunction lever away from you.

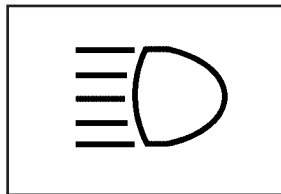

When the high beams are on, a light on the instrument panel cluster also will be on if the ignition is in ON.

To change the headlamps from high beam to low beam, pull the turn signal lever toward you.

Flash-to-Pass

This feature lets you use your high-beam headlamps momentarily to signal a driver in front of you that you want to pass.

To use it, pull the turn signal/multifunction lever toward you until the high-beam headlamps come on, then release the lever to turn them off.

Windshield Wipers

You control the windshield wipers by turning the band with the wiper symbol on it.

 **(Mist):** For a single wiping cycle, turn the band to mist. Hold it there until the wipers start. Then let go. The wipers will stop after one wipe. If you want more wipes, hold the band on mist longer.



 **(Delay):** You can set the wiper speed for a long or short delay between wipes. This can be very useful in light rain or snow. Turn the band to choose the delay time. The closer to the top of the lever, the shorter the delay.

 **(Low Speed):** For steady wiping at low speed, turn the band away from you to the first solid band past the delay settings. For high-speed wiping, turn the band further, to the second solid band past the delay settings. To stop the wipers, move the band to off.

 **(High Speed):** For high-speed wiping, turn the band further, to the second solid band past the delay settings.

 **(Off):** To stop the wipers, move the band to off. Be sure to clear ice and snow from the wiper blades before using them. If they're frozen to the windshield, carefully loosen or thaw them. If your blades do become worn or damaged, get new blades or blade inserts.

Windshield Washer

  **(Washer Fluid):** There is a paddle marked with the windshield washer symbol at the top of the multifunction lever. To spray washer fluid on the windshield, push the paddle. The wipers will clear the window and then either stop or return to your preset speed.

CAUTION:

In freezing weather, do not use your washer until the windshield is warmed. Otherwise the washer fluid can form ice on the windshield, blocking your vision.

Cruise Control

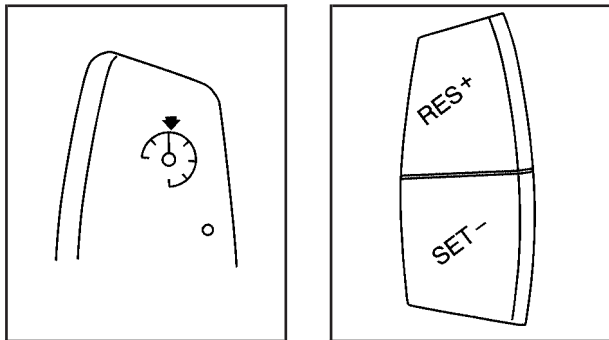

The buttons for the cruise control are located on the steering wheel.

 **(Cruise On/Off):** Push this button to turn the system on and off.

RES + (Resume/Accelerate): Push this button to make the vehicle resume a previously set speed or to accelerate when cruise is already active.

SET - (Set/Decelerate): Push this button to set the speed or to decrease the speed when cruise is already active.

With cruise control, a speed of about 25 mph (40 km/h) or more can be maintained without keeping your foot on the accelerator. This can really help on long trips. Cruise control does not work at speeds below about 25 mph (40 km/h).

When the brakes are applied, the cruise control shuts off.

CAUTION:

Cruise control can be dangerous where you cannot drive safely at a steady speed. So, do not use your cruise control on winding roads or in heavy traffic.

Cruise control can be dangerous on slippery roads. On such roads, fast changes in tire traction can cause needless wheel spinning, and you could lose control. Do not use cruise control on slippery roads.

The cruise control will automatically disengage if the vehicle has the traction control system and begins to limit wheel spin. See *Traction Control System (TCS) on page 4-8*. When road conditions allow, the cruise control can be used again.

Setting Cruise Control

CAUTION:

If you leave your cruise control on when you are not using cruise, you might hit a button and go into cruise when you do not want to. You could be startled and even lose control. Keep the cruise control switch off until you want to use cruise control.

1. Press the cruise on/off button. The indicator light in the button will come on.
2. Get up to the speed you want.
3. Press the SET – button. The cruise symbol will display in the instrument panel cluster when the system is engaged.
4. Take your foot off the accelerator pedal.

Resuming a Set Speed

Suppose you set your cruise control at a desired speed and then you apply the brake. This, of course, disengages the cruise control. The cruise symbol in the instrument panel cluster will go out, indicating cruise control is no longer engaged.

To return to your previously set speed, press the RES + button once you are going about 25 mph (40 km/h) or more.

You will go right back up to your chosen speed and stay there.

If you hold the RES + button, the vehicle will keep going faster until you release the button or apply the brake. So unless you want to go faster, do not hold the RES + button.

Increasing Speed While Using Cruise Control

There are two ways to go to a higher speed:

- Use the accelerator pedal to get to the higher speed. Press the SET – button, then release the button and the accelerator pedal. You'll now cruise at the higher speed.
- Press the RES + button. Hold it there until you get up to the speed you want, and then release the button. To increase your speed in very small amounts, press the button briefly. Each time you do this, your vehicle will go about 1 mph (1.6 km/h) faster.

Reducing Speed While Using Cruise Control

There are two ways to reduce your speed while using cruise control:

- Press the SET – button until you reach the lower speed you want, then release it.
- To slow down in very small amounts, briefly press the SET – button. Each time you do this, you will go about 1 mph (1.6 km/h) slower.

Passing Another Vehicle While Using Cruise Control

Use the accelerator pedal to increase the vehicle's speed. When you take your foot off the pedal, the vehicle will slow down to the cruise control speed you set earlier.

Using Cruise Control on Hills

How well the cruise control will work on hills depends upon the speed and load of the vehicle, and the steepness of the hills. When going up steep hills, you may have to step on the accelerator pedal to maintain the vehicle's speed. When going downhill, you may have to brake or shift to a lower gear to keep the vehicle's speed down. Of course, applying the brake takes the vehicle out of cruise control. Many drivers find this to be too much trouble and do not use cruise control on steep hills.

Ending Cruise Control

To end a cruise control session, step lightly on the brake pedal.

Stepping on the brake will end the current cruise control session only. Press the cruise on/off button to turn off the system completely.

Erasing Speed Memory

When you turn off the cruise control or the ignition, your cruise control set speed memory is erased.

Exterior Lamps

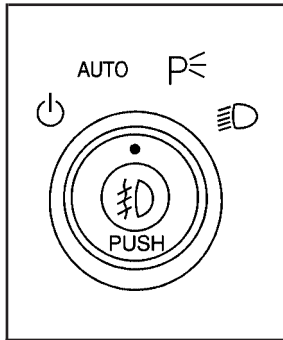

The control located to the left of the cluster on the instrument panel, operates the exterior lamps.

⏻ (On/Off): Turn the control to this position to manually turn the headlamps on and off. This is a momentary control that will spring back to AUTO when released.

AUTO (Automatic): Turn the control to this position to set your headlamps in automatic mode. AUTO mode, if enabled, will turn the exterior lamps on and off automatically depending on how much light is available outside the vehicle.

Due to the momentary switch design, your automatic lights may be disabled even if the control is in the AUTO position.

To enable automatic lighting, do any of the following:

- Turn the headlamp control from AUTO to off and release the control. It will return back to the AUTO position by itself.
- Turn the headlamp control from the parking lamp position to AUTO.
- Turn the headlamp control from the headlamp position to AUTO.

To disable automatic lighting, do any of the following:

- Turn the headlamp control from AUTO to off and release the control. It will return back to the AUTO position by itself.
- Turn the headlamp control from AUTO to the parking lamp position.
- Turn the headlamp control from AUTO to the headlamp position.

 **(Parking Lamps):** Turn the control to this position to turn on the parking lamps together with the following:

- Taillamps
- License Plate Lamps
- Sidemarker Lamps
- Instrument Panel Lights

 **(Headlamps):** Turn the control to this position to turn your headlamps on, together with the previously listed lamps and lights.

A warning chime will sound if the driver's door is opened when the ignition switch is turned to OFF or ACCESSORY and the headlamps are on.

 **(Foglamps):** Press this button to turn the foglamps on and off. See *Fog Lamps on page 3-15* for additional information.

Daytime Running Lamps (DRL)/Automatic Headlamp System

Daytime Running Lamps (DRL) can make it easier for others to see the front of your vehicle during the day. DRL can be helpful in many different driving conditions, but they can be especially helpful in the short periods after dawn and before sunset. Daytime running lamps are required to function at all times on all vehicles first sold in Canada.

A light sensor on top of the instrument panel makes the DRL work, so be sure it is not covered.

The DRL system will make the low-beam headlamps come on at reduced brightness when the following conditions are met:

- The ignition is on.
- The exterior lamps control is off.
- The parking brake is released.

While the DRL are on, only the vehicle's low-beam headlamps will be on at reduced brightness. The turn signal, taillamps, sidemarker and other lamps will not be on. The instrument panel will not be lit up either.

When it is dark enough outside, the DRL will turn off and the vehicle's headlamps and parking lamps will turn on. The other lamps that come on with the headlamps will also come on.

When it is bright enough outside, the headlamps will go off and the DRL will come on.

To idle the vehicle with the DRL off, turn the exterior lamp control off and then do one of the following:

- Turn the exterior lamp control to the parking lamp position.
- Turn the exterior lamp control to the headlamp position.
- Turn the exterior lamp control from AUTO to off and back to AUTO.

This feature is not available for vehicles first sold in Canada.

To turn off the automatic headlamp feature when it is dark outside, move the exterior lamp control to the parking lamp position. The parking lamps will remain illuminated and the headlamps will turn off. The fog lamps will also go on if they were on previously.

As with any vehicle, the regular headlamp system should be turned on when needed.

Fog Lamps



Press the fog lamps button, located in the center of the exterior lamps control on the left side of the steering column, to turn the fog lamps on or off.

While the high-beam headlamps are on, the fog lamps are off.

Exterior Lighting Battery Saver

If the parking lamps or headlamps have been left on after the ignition has been turned to off, the exterior lamps will turn off after approximately 10 minutes. This protects the battery from being drained.

If the lamps need to be left on for more than 10 minutes, use the exterior lamp control to turn the lamps back on.

Interior Lamps

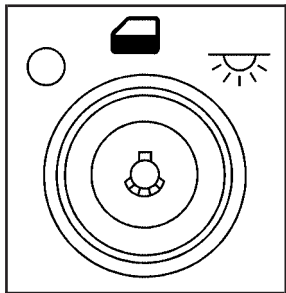

Your interior lamps control is located next to the exterior lamps control and to the left of the steering wheel on the instrument panel.

○ **(Off):** Turn the control to this position to disable courtesy lamps, entry lighting, delayed entry lighting, and delayed exit lighting.

🚪 **(Door):** Turn the control to this position to turn the interior lamps on when any door is open and when the ignition key is removed from the ignition.

☀️ **(On):** Turn the control to this position to turn the interior lamps on.

The interior lamps can be controlled, or automatically turned on or off under certain conditions. They are explained in the following text.

Instrument Panel Brightness

The instrument panel lights can be brightened or dimmed by pressing the center knob of the interior lamp controls until it pops out. Turn the knob clockwise to brighten the lights or counterclockwise to dim them.

Courtesy Lamps

Courtesy lamps come on to make it easier to enter and exit the vehicle. These lamps will come on when the interior lamp control is in the door position and any door is opened.

Entry Lighting

The courtesy lamps will come on and stay on for a set time whenever the interior lamp control is in the door position and the UNLOCK button on the remote keyless entry transmitter is pressed.

The lamps will stay on while a door is opened and then turn off automatically about 25 seconds after it is closed. If the UNLOCK button is pressed and a door is not opened, the lamps will turn off after about 25 seconds.

Entry lighting includes a feature called theater dimming. With theater dimming, the lamps do not turn off at the end of the delay time. Instead, they slowly dim after the delay time and then turn off.

The courtesy lamps turn off when the ignition key is turned to RUN or START. They will come on again when a door is opened.

Delayed Entry Lighting

Delayed entry lighting lights the vehicle's interior for a period of time after all the doors have been closed.

After all the doors have been closed, the delayed entry lighting feature will continue to work until one of the following occurs:

- The ignition is in run.
- The doors are locked.
- Twenty-five seconds has elapsed.

If during the illumination period a door is opened, the timed illumination period will be canceled and the interior lamps will remain on.

Theater Dimming

This feature allows for a three to five-second fade out of the courtesy lamps instead of immediate turn off.

Delayed Exit Lighting

This feature can be programmed either on or off using the Driver Information Center. See *DIC Vehicle Personalization on page 3-71* under INT LIGHTS KEYS REMOVED. When activated, this feature illuminates the interior for a period of time after the ignition key is removed from the ignition.

The ignition must be off and the interior lamp control must be in the door position for delayed exit lighting to work. When the ignition key is removed, interior illumination will activate and remain on until one of the following occurs:

- The ignition is in run.
- The power door locks are activated.
- Twenty-five seconds has elapsed.

If during the illumination period a door is opened, the timed illumination period will be canceled and the interior lamps will remain on.

Perimeter Lighting

Perimeter lighting provides a period of exterior vehicle lighting. Perimeter lighting activates when the key is removed from the ignition or the vehicle is unlocked using the remote keyless entry transmitter. The amount of time the exterior lamps will remain on can be programmed using the Driver Information Center (DIC). See “EXIT LIGHT DELAY” under *DIC Vehicle Personalization on page 3-71* for additional information.

Overhead Console Reading Lamps

Your vehicle may have reading lamps located on the overhead console. Press the lens to turn them on and off.

Rear Assist Handle Reading Lamps

Your vehicle may have reading lamps located near the rear assist handles. Press the lens to turn them on and off.

Battery Run-Down Protection

This helps prevent the vehicle's battery from draining in case the interior courtesy lamps, reading lamps, trunk lamp, underhood lamp, glove box lamps, or sun visor vanity lamps, if equipped, are accidentally left on. If any of these lamps are left on while the ignition is off, they will automatically turn off after 10 minutes. The lamps will not come back on again until one of the following occurs:

- The ignition is turned on.
- The interior lamps control is turned off, then to door or on.

Ultrasonic Rear Parking Assist (URPA)

Your vehicle may be equipped with Ultrasonic Rear Parking Assist (URPA). URPA is designed to help you park while in REVERSE (R) and operates only at speeds less than 3 mph (5 km/h). URPA can help you avoid colliding with objects such as parked vehicles. The system can detect objects 5 feet (1.5 m) behind your vehicle and tell you how close those objects are to your rear bumper.

The URPA display is located inside the vehicle, above the rear window. It has three color-coded lights that can be seen through the rearview mirror or by turning around.

 **CAUTION:**

Even with the Ultrasonic Rear Park Assist system, the driver must check carefully before backing up. The system does not operate above typical backing speeds of 3 mph (5 km/h) while parking. And, the system does not detect objects that are more than 5 feet (1.5 meters) behind the vehicle.

So, unless you check carefully behind you before and when you back up, you could strike children, pedestrians, bicyclists or pets behind you, and they could be injured or killed.

Whether or not you are using rear park assist, always check carefully behind your vehicle before you back up and then watch closely as you do.

How the System Works

URPA comes on automatically when the shift lever is moved into REVERSE (R). When the system comes on, the three lights on the display will briefly illuminate to let you know that the system is working. If your vehicle is moving in REVERSE (R) at a speed greater than 3 mph (5 km/h), the red light will flash to remind you the system does not work at this speed.

The first time an object is detected while in REVERSE (R), a chime will sound and the following will occur in sequence, depending on the distance from the object:

- At 5 feet (1.5 m) a chime will sound and one amber light will be lit.
- At 40 inches (1.0 m) both amber lights will be lit.
- At 20 inches (0.5 m) a continuous chime will sound and all three lights (amber/amber/red) will be lit.
- At 1 foot (0.3 m) a continuous chime will sound and all three lights (amber/amber/red) will flash.

URPA can detect objects 3 inches (7.6 cm) and wider, and at least 10 inches (25.4 cm) tall, but it cannot detect objects that are above trunk level. In order for the rear sensors to recognize an object, it must be within operating range.

If the URPA system is not functioning properly, the display will flash red, indicating that there is a problem. The light will also flash red while driving if a trailer is attached to your vehicle, or a bicycle or object is on the back of, or hanging out of your trunk. The light will continue to flash until the trailer or the object is removed and your vehicle is driven forward at least 15 mph (25 km/h).

It may also flash red if the ultrasonic sensors are not kept clean. So be sure to keep your rear bumper free of mud, dirt, snow, ice and slush or materials such as paint or the system may not work properly. If after cleaning the rear bumper and driving forward at least 15 mph (25 km/h), the display continues to flash red, see your GM dealer. For cleaning instructions, see *Washing Your Vehicle on page 5-81*.

It may also flash red if your vehicle is moving in REVERSE (R) at a speed greater than 3 mph (5 km/h). Other conditions that may affect system performance include things like the vibrations from a jackhammer or the compression of airbrakes on a very large truck.

As always, drivers should use care when backing up a vehicle. Always look behind you, being sure to check for other vehicles, obstructions and blind spots.

Accessory Power Outlets

The accessory power outlets enable power electrical equipment such as a cellular telephone or a CB radio to be used inside the vehicle.

Your vehicle is equipped with 12-volt outlets. One outlet is located on the center console below the climate controls. There may be another outlet located inside the center storage console or in the flip and fold console.

Open the cover to use the outlet. Be sure to close the cover when the outlet is not in use.

Notice: Adding any electrical equipment to your vehicle may damage it or keep other components from working as they should. The repairs would not be covered by your warranty. Check with your dealer before adding electrical equipment.

Certain power accessory plugs may not be compatible to the power accessory outlet and could result in blown vehicle or adapter fuses. If you experience a problem, see your dealer.

Notice: Improper use of the power outlet can cause damage not covered by your warranty. Do not hang any type of accessory or accessory bracket from the plug because the power outlets are designed for accessory power plugs only.

Notice: Leaving electrical equipment on for extended periods will drain the battery. Always turn off electrical equipment when not in use and do not plug in equipment that exceeds the maximum amperage rating.

When adding electrical equipment, be sure to follow the proper installation instructions included with the equipment.

Climate Controls

Climate Control System

With this system you can control the heating, cooling and ventilation for your vehicle.

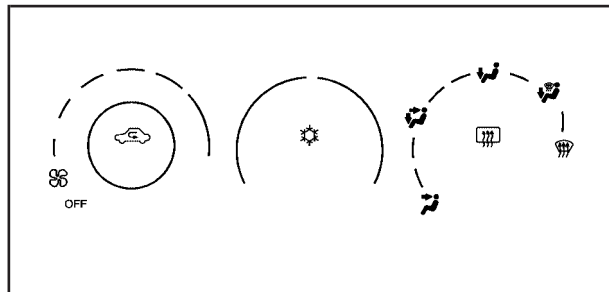

Operation

OFF: Turn the left knob to this position to turn the climate control system off.

 **(Fan):** Turn the knob by this symbol, located on the left side of the climate control panel, clockwise or counterclockwise to increase or decrease the fan speed. During the highest fan speed selections, the fan speed will be temporarily reduced between the transition to a new mode. The fan will resume the original speed when the transition to the new mode is complete.

Temperature Control: Turn the center knob clockwise or counterclockwise to increase or decrease the temperature inside your vehicle.

Use the right knob to select from the following modes:

 **(Vent):** This mode directs outside air to the instrument panel outlets. If driving in city traffic, and the vehicle is stopped and idling, or the weather is hot, switch from this mode to the recirculation mode. To prevent the air inside the vehicle from becoming stale, be sure to return to the vent mode periodically.

 **(Bi-Level):** This mode directs half of the air to the instrument panel outlets, and the remaining air to the floor outlets. Some air may be directed toward the windshield. Slightly cooler air is directed to the instrument panel outlets and warmer air is directed to the floor outlets.

 **(Floor):** This mode directs most of the air to the floor outlets with some air directed toward the side window outlets and a little air directed to the windshield.

In this mode, the system will automatically use outside air. The air conditioning compressor will be engaged unless the outside temperature is 40°F (4°C) or below.

Recirculation cannot be selected when in this mode.

You can also select modes by using the following buttons:

 **(Recirculate):** Press this button to recirculate cabin air through the vehicle. It can be used to prevent outside air and odors from entering your vehicle or to help heat or cool the air inside your vehicle more quickly. An indicator light below the button will come on in this mode. Operation in this mode during periods of high humidity and cool outside temperatures may result in increased window fogging. If window fogging is experienced, select the defrost mode.

 **(Air Conditioning):** Press this button to turn the air conditioning system on or off. When this button is pressed, an indicator light below the button will come on to let you know the air conditioning is activated. Air conditioning can be selected in any mode as long as the fan switch is on.

On hot days during the vehicle's initial start-up, open the windows to let hot inside air escape; then close them. This helps to reduce the time it takes for the vehicle to cool down. It also helps the system to operate more efficiently.

For quicker cool down on hot days, do the following:

1. Select the vent/outside air mode.
2. Select the recirculation mode.
3. Select the air conditioner.
4. Select the coolest temperature.
5. Select the highest fan speed.

The air-conditioning system removes moisture from the air, so you may sometimes notice a small amount of water dripping underneath your vehicle while idling or after turning off the engine. This is normal.

Defogging and Defrosting

Fog on the inside of the vehicle is a result of high humidity causing moisture to condense on the cool window glass. This can be minimized if the climate control system is used properly. There are two modes to clear frost or fog from the windshield. Use the defog mode to clear the windows of condensation and to warm the vehicle's occupants. Use the defrost mode to remove frost or condensation from the windshield quickly. Recirculation cannot be selected when in these modes.

See "Rear Window Defogger" later in this section for information on clearing the rear window of fog or ice.

Turn the right knob to select the defog or defrost mode.

 **(Defog):** This mode directs half of the air to the windshield and the side window outlets and half to the floor outlets.

 **(Defrost):** This mode directs most of the air to the windshield and the side window outlets, with some air directed to the floor outlets.

Rear Window Defogger

The rear window defogger uses a warming grid to remove fog from the rear window.

 **(Rear):** Press the button to turn the rear window defogger on or off. An indicator light below the button will come on to let you know that the rear window defogger is activated.

The rear window defogger will only work when the ignition is in run. The rear window defogger will stay on for approximately 15 minutes after the button is pressed, unless the ignition is turned to ACC or LOCK. If turned on again, the defogger will only run for approximately five minutes before turning off. The defogger can also be turned off by pressing the button again or by turning off the engine.

Notice: Do not use anything sharp on the inside of the rear window. If you do, you could cut or damage the warming grid, and the repairs would not be covered by your warranty. Do not attach a temporary vehicle license, tape, a decal or anything similar to the defogger grid.

Dual Automatic Climate Control System

Your vehicle may have this climate control system. The heating, cooling and ventilation can be controlled with it.

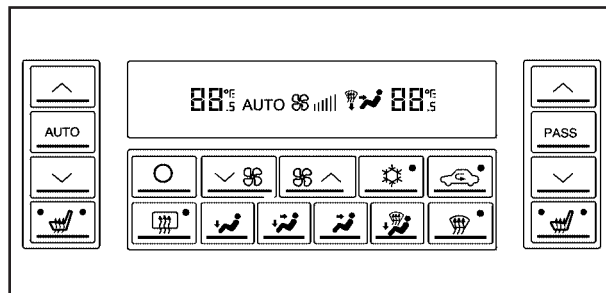

Automatic Operation

AUTO (Automatic): Press the AUTO button for automatic control of the inside temperature, the air delivery mode and the fan speed. There might be a delay of two to three minutes before the fan comes on when the automatic operation is used in cold weather. For the automatic system to function, the temperature must be set between 60°F (15°C) and 90°F (32°C).

1. Adjust the temperature to a comfortable setting.

2. Press the PASS button or the up or down arrows on the passenger side to turn the passenger temperature set on and off. When turned on, the passenger temperature will be the same as the driver setting. Press the up or down arrow on passenger side to adjust the passenger temperature setting.

When the passenger temperature set is off, the passenger display will be off and the driver's set temperature will be for the driver and passenger.

In cold weather, the system will start at reduced fan speeds to avoid blowing cold air into the vehicle until warmer air is available. The system will start out blowing air at the floor but may change modes automatically as the vehicle warms up to maintain the chosen temperature setting. The length of time needed for warm up will depend on the outside temperature and the length of time that has elapsed since the vehicle was last driven.

3. Wait for the system to regulate. This may take from 10 to 30 minutes. Then, adjust the temperature, if necessary.

Do not cover the solar sensor located in the center of the instrument panel, near the windshield. For more information on the solar sensor, see "Sensors" later in this section.

4. Press OFF to turn the climate control system off. Only the rear defog and heated seats will function. Press AUTO or any other button except the heated seats or rear defog to turn the climate control system back on.

This control has 4 types of operation.

- Automatic can set/change the temperature only. AUTO and temperature only will appear on the display.
- Semi-Automatic Fan can set/change the temperature and mode. The fan operates automatically. The temperature and mode will appear on the display.
- Semi-Automatic Mode can set/change the temperature and fan speed. The mode operates automatically. The fan speed and temperature will appear on the display.
- Manual can set/change the temperature, mode and fan. The fan speed, temperature and mode will appear on the display.

If your vehicle has the remote start feature, the climate control system will automatically regulate the inside temperature of your vehicle when the remote start system is activated. Normal operation and the last setting of the climate control system will return after the key is turned to the ON position.

Manual Operation

During daylight hours, the instrument panel brightness control might need to be adjusted to the highest setting, in order to see the indicator lights for the various climate control settings.

 **(Off):** Press this button to turn the climate control system off.

 **(Temperature):** Press these buttons to manually adjust the temperature inside the vehicle. Press the up arrow on the driver or passenger side to raise the temperature and press the down arrow to lower the temperature. The display will show the selected temperature.

You may also have controls on your steering wheel that can be used to adjust the temperature inside your vehicle. See *Steering Wheel Climate Controls on page 3-30* for additional information.

 **(Fan):** Press this button to decrease the fan speed. Pressing the arrows cancels the automatic operation and places the system in manual or semi-automatic mode. Press the AUTO button to return to automatic operation. If the airflow seems low when the fan is at the highest setting, the passenger compartment air filter may need to be replaced. For more information see *Passenger Compartment Air Filter on page 3-28* and *Scheduled Maintenance on page 6-4*.

 **(Fan):** Press this button to increase the fan speed. Pressing the arrows cancels the automatic operation and places the system in manual or semi-automatic mode. Press the AUTO button to return to automatic operation. If the airflow seems low when the fan is at the highest setting, the passenger compartment air filter may need to be replaced. For more information see *Passenger Compartment Air Filter on page 3-28* and *Scheduled Maintenance on page 6-4*.

 **(Floor):** This mode directs most of the air to the floor, with some air directed to the side window outlets and a small amount to the windshield.

 **(Bi-Level):** This setting directs airflow to the instrument panel and floor outlets. A small amount of air is also directed to the windshield and the side window outlets.

 **(Vent):** This mode directs air through the instrument panel outlets.

 **(Recirculation):** Press this button to turn recirculation mode on or off. This mode keeps outside air from coming into the vehicle. It can be used to prevent outside air and odors from entering your vehicle or to help cool the air inside the vehicle more quickly.

Recirculation is not available while in the defrost or floor/defog modes. Using recirculation for long periods of time may cause the air inside your vehicle to become too dry. To prevent this from happening, after the air in your vehicle has cooled, turn the recirculation mode off.

 **(Air Conditioning):** Press this button to turn the air conditioning compressor on and off. The indicator light on the button will come on when the air conditioning is on.

 **(Heated Seats):** Press this button to turn the driver or passenger heated seats on and off. See *Heated Seats on page 1-5* for additional information.

Defogging and Defrosting

Fog on the inside of windows is a result of high humidity (moisture) condensing on the cool window glass. This can be minimized if the climate control system is used properly. There are two modes to clear fog or frost from your windshield. Use the floor/defog mode to clear the windows of fog or moisture and warm the passengers. Use defrost to remove fog or frost from the windshield more quickly.

 **(Floor/Defog):** Press this button to direct the air between the windshield, floor outlets and side windows. When you select this mode, the system turns recirculation off and runs the air conditioning compressor

unless the outside temperature is near or below freezing. Pressing the recirculation button will have no effect other than turning on the telltale light while in floor/defog mode.

 **(Defrost):** Press this button to direct most of the air to the windshield, with some air directed to the side windows. In this mode, the system will automatically turn off the recirculation and run the air conditioning compressor, unless the outside temperature is near or below freezing. Pressing the recirculation button will have no effect other than turning on the telltale light while in defrost mode.

Do not drive the vehicle until all windows are clear.

Sensors

The solar sensor on the vehicle monitors the solar heat and the air inside of the vehicle. This information is used to maintain the selected temperature by initiating needed adjustments to the temperature, the fan speed, and the air delivery system. The system may also supply cooler air to the side of the vehicle facing the sun. The recirculation mode will also be activated, as necessary. Do not cover the solar sensor located in the center of the instrument panel, near the windshield, or the system will not work properly.

Rear Window Defogger

The rear window defogger uses a warming grid to remove fog or frost from the rear window. The rear window defogger will only work when the engine is running.

 **(Rear Window Defogger):** Press this button to turn the rear window defogger on and off. Be sure to clear as much snow from the rear window as possible.

The rear window defogger will turn off approximately 20 minutes after the button is pressed. If turned on again, the defogger will only run for approximately 20 minutes before turning off. The defogger can also be turned off by pressing the button again or by turning off the engine.

Do not drive the vehicle until all the windows are clear.

Notice: Using a razor blade or sharp object to clear the inside rear window may damage the rear window defogger. Repairs would not be covered by your warranty. Do not clear the inside of the rear window with sharp objects.

Outlet Adjustment

Use the thumbwheels located between the center outlets to open and close the outlets. Move the lever in the center of each air outlet to adjust the direction of the airflow.

Operation Tips

- Clear away any ice, snow or leaves from the air inlets at the base of the windshield that may block the flow of air into the vehicle.
- Use of non-GM approved hood deflectors may adversely affect the performance of the system.
- Keep the path under the front seats clear of objects to help circulate the air inside of the vehicle more effectively.
- If the vehicle has a passenger compartment air filter and the airflow seems low when the fan is at the highest setting it may need to be replaced. For more information, see *Passenger Compartment Air Filter* on page 3-28.

Passenger Compartment Air Filter

The passenger compartment air filter is located in the engine compartment below the air inlet grille, near the passenger's side windshield wiper arm. See *Engine Compartment Overview* on page 5-12.

The filter traps most of the pollen from the air entering the air conditioning module. Like the engine's air cleaner filter, it may need to be changed periodically. For information on how often to change the passenger compartment air filter, see *Scheduled Maintenance* on page 6-4.

To change the passenger compartment air filter, use the following steps:

1. Turn the ignition to ACCESSORY and turn the windshield wipers on.
2. Turn the ignition to OFF when the windshield wipers are in the upright position.
3. Raise the hood.
4. Disconnect the windshield washer pump hose from the fender rail and air inlet grille.
5. Peel back the hood weather-strip from the passenger's side of the vehicle halfway to the center of the hood.



6. Remove the three air inlet grille retainers.
7. Remove the air inlet grille.



8. Remove the old air filter by pulling up on its tab.

9. Install a new passenger compartment air filter. See *Normal Maintenance Replacement Parts* on page 6-13 for the type of filter to use. Make sure it slides under the compartment retainers.
10. Reverse Steps 1 through 7.

Steering Wheel Climate Controls

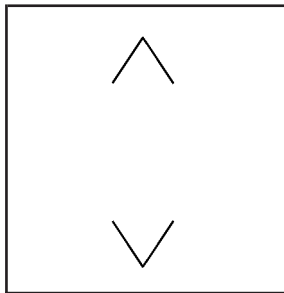

If your vehicle has this feature, you can control the temperature inside your vehicle by using the controls located on your steering wheel.

^ v (Temperature): Press the up arrow to increase or the down arrow decrease the temperature inside your vehicle.

Warning Lights, Gages, and Indicators

This part describes the warning lights and gages that may be on the vehicle. The pictures will help you locate them.

Warning lights and gages can signal that something is wrong before it becomes serious enough to cause an expensive repair or replacement. Paying attention to the warning lights and gages could also save you or others from injury.

Warning lights come on when there may be or is a problem with one of the vehicle's functions. As you will see in the details on the next few pages, some warning lights come on briefly when you start the engine just to let you know they are working. If you are familiar with this section, you should not be alarmed when this happens.

Gages can indicate when there may be or is a problem with one of your vehicle's functions. Often gages and warning lights work together to let you know when there is a problem with your vehicle.

When one of the warning lights comes on and stays on when you are driving, or when one of the gages shows there may be a problem, check the section that tells you what to do about it. Please follow this manual's advice. Waiting to do repairs can be costly – and even dangerous. So please get to know the warning lights and gages. They are a big help.

Instrument Panel Cluster

The instrument panel cluster is designed to let the driver know at a glance how the vehicle is running. It will show how fast the vehicle is going, about how much fuel is in the fuel tank and many other things needed to drive safely and economically.

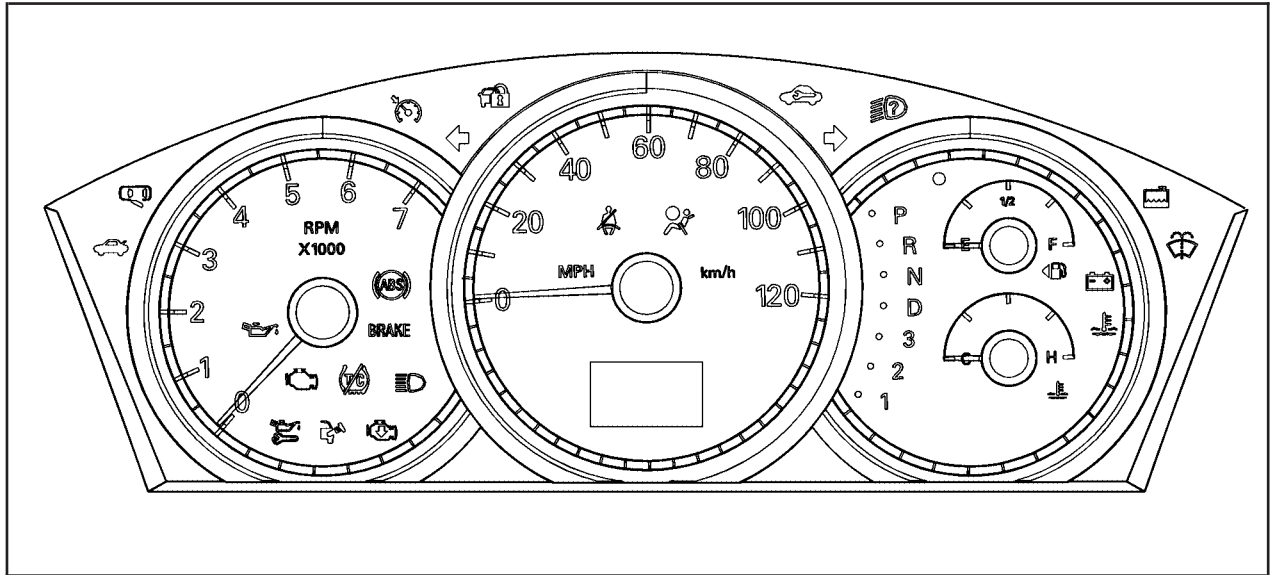

Speedometer and Odometer

Your speedometer lets you see your speed in both miles per hour (mph) and kilometers per hour (km/h).

Your vehicle's odometer works together with the driver information center. You can set a Trip A and Trip B odometer. See "Trip Information" under *DIC Operation and Displays on page 3-47*.

The odometer mileage can be checked without the vehicle running. Simply press the odometer/trip switch on the instrument panel cluster.

If your vehicle ever needs a new odometer installed, the new one will be set to the correct mileage total of the old odometer.

Tachometer

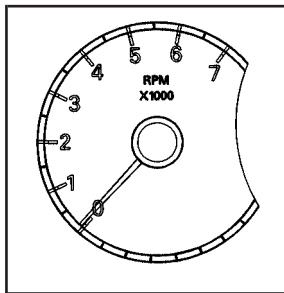

The tachometer displays the engine speed in thousands of revolutions per minute (rpm).

Safety Belt Reminder Light

When the ignition key is turned to RUN or START or the vehicle is started remotely, a chime will come on for several seconds to remind occupants to fasten their safety belts.



The safety belt light will also come on and stay on for several seconds, then it will flash for several more.

If the driver's belt is already buckled, neither the chime nor the light will come on.

Airbag Readiness Light

There is an airbag readiness light on the instrument panel, which shows the airbag symbol. The system checks the airbag's electrical system for malfunctions. The system check includes the airbag modules, the wiring and the crash sensing and diagnostic module. For more information on the airbag system, see *Airbag System* on page 1-51.

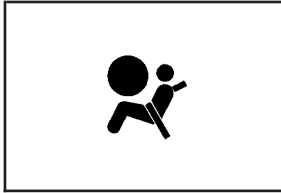

This light will come on when the vehicle is started, and it will flash for a few seconds. Then the light should go out. This means the system is functioning properly.

If the airbag readiness light stays on after the vehicle is started, or comes on as the vehicle is being driven, there may be an electrical problem and the airbag system may not work properly. Have the vehicle serviced right away.

CAUTION:

If the airbag readiness light stays on after you start your vehicle, it means the airbag system may not be working properly. The airbags in your vehicle may not inflate in a crash, or they could even inflate without a crash. To help avoid injury to yourself or others, have your vehicle serviced right away if the airbag readiness light stays on after you start your vehicle.

The airbag readiness light should flash for a few seconds when you turn the ignition key to RUN. If the light does not come on then, have it fixed so it will be ready to warn you if there is a problem.

Passenger Airbag Status Indicator

Your vehicle has the passenger sensing system. Your instrument panel has a passenger airbag status indicator.



Passenger Airbag Status Indicator

When the ignition key is turned to RUN or START, the passenger airbag status indicator will light ON and OFF for several seconds as a system check. If you use remote start to start your vehicle from a distance (if equipped), you may not see the system check. Then, after several more seconds, the status indicator will light either ON or OFF to let you know the status of the right front passenger's frontal airbag.

If the word ON is lit on the passenger airbag status indicator, it means that the right front passenger's frontal airbag is enabled (may inflate).

CAUTION:

If the on indicator comes on when you have a rear-facing child restraint installed in the right front passenger's seat, it means that the passenger sensing system has not turned off the passenger's frontal airbag. A child in a rear-facing child restraint can be seriously injured or killed if the right front passenger's airbag inflates. This is because the back of the rear-facing child restraint would be very close to the inflating airbag. Do not use a rear-facing child restraint in the right front passenger's seat unless the airbag has been turned off.

If the word OFF is lit on the airbag status indicator, it means that the passenger sensing system has turned off the right front passenger's frontal airbag. See *Passenger Sensing System on page 1-60* for more on this, including important safety information.

If, after several seconds, all status indicator lights remain on, or if there are no lights at all, there may be a problem with the lights or the passenger sensing system. See your dealer for service.

CAUTION:

If the off indicator and the airbag readiness light ever come on together, it means that something may be wrong with the airbag system. If this ever happens, have the vehicle serviced promptly, because an adult-size person sitting in the right front passenger seat may not have the protection of the frontal airbag. See *Airbag Readiness Light on page 3-33*.

Charging System Light

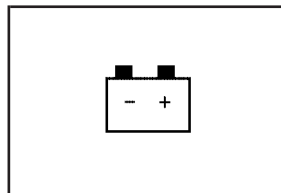

The charging system light will come on briefly when the ignition is turned on, as a check to show that it is working. Then it should go out.

If it stays on, or comes on while the vehicle is being driven, a chime will sound and there may be a problem with the charging system. It could indicate that the vehicle has a loose accessory belt or another electrical problem. Have it checked right away. Driving while this light is on could drain the battery.

If the vehicle must be driven a short distance with the light on, be certain to turn off all the accessories, such as the radio and air conditioner.

Brake System Warning Light

Your vehicle's hydraulic brake system is divided into two parts. If one part is not working, the other part can still work and stop you. For good braking, though, you need both parts working well.

If the warning light comes on and the parking brake is not applied, there is a brake problem. Have your brake system inspected right away.



This light should come on briefly when you turn the ignition key to RUN.

If it does not come on then, have it fixed so it will be ready to warn you if there is a problem.

When the ignition is on, the brake system warning light will also come on when you set your parking brake. The light will stay on if your parking brake does not release fully. If it stays on after your parking brake is fully released, it means you have a brake problem.

If the light comes on while you are driving, a chime will sound and you should pull off the road and stop carefully. You may notice that the pedal is harder to push. Or, the pedal may go closer to the floor. It may take longer to stop. If the light is still on, have the vehicle towed for service. See *Towing Your Vehicle* on page 4-34.

CAUTION:

Your brake system may not be working properly if the brake system warning light is on. Driving with the brake system warning light on can lead to an accident. If the light is still on after you have pulled off the road and stopped carefully, have the vehicle towed for service.

Anti-Lock Brake System Warning Light

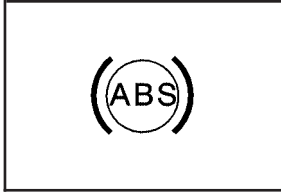

With the anti-lock brake system, the light will come on when your engine is started and may stay on for several seconds. That is normal.

If the ABS warning light comes on and stays on, there may be a problem with the anti-lock portion of the brake system. If the brake system warning light is not on, you still have brakes, but you do not have anti-lock brakes. See *Brake System Warning Light on page 3-36*.

If the light stays on, turn the ignition to OFF. If the light comes on when you are driving, stop as soon as possible and turn the ignition off. Then start the engine again to reset the system. If the light still stays on, or comes on again while you are driving, your vehicle needs service. If the regular brake system warning light is not on, you still have brakes, but you do not have anti-lock brakes. If the regular brake system warning light is also on, you do not have anti-lock brakes and there is a problem with your regular brakes. See *Brake System Warning Light on page 3-36*.

Traction Control System (TCS) Warning Light

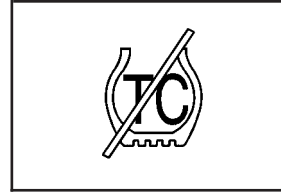

If the TC (traction control) warning light comes on and stays on, there may be a problem with the traction control system and, if equipped, the StabiliTrak[®] system.

The TC (traction control) warning light will come on briefly when you turn the ignition to RUN. If it does not come on then, have it fixed so it will be ready to warn you if there is a problem.

The light will also come on if you turn the traction control system off using the TC (traction control) on/off button located near the shift lever.

If the TC (traction control) warning light stays on or comes on while you are driving, pull off the road as soon as possible and stop carefully. Try resetting the system by turning the ignition off then back on. If the light still stays on or comes back on again while you are driving, your vehicle needs service. Have the traction control system and, if equipped, the StabiliTrak[®] system inspected as soon as possible. See *Traction Control System (TCS) on page 4-8* and *StabiliTrak[®] System on page 4-9* for more information.

Engine Coolant Temperature Warning Light

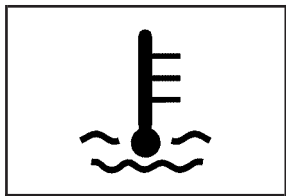

This light tells you that your engine is very hot.

This light will come on when you first start the vehicle as a check to let you know that the light is working. It will go out after a few seconds. If the light does not come on, the bulb may be burned out. See your GM dealer to have it corrected.

If the light does not go out or if the light comes on and stays on while you are driving, your vehicle may have a problem with the cooling system. You should stop the vehicle and turn off the engine as soon as possible to avoid damage to the engine. A warning chime will sound when this light is on, also.

See *Engine Overheating on page 5-24*.

Engine Coolant Temperature Gage

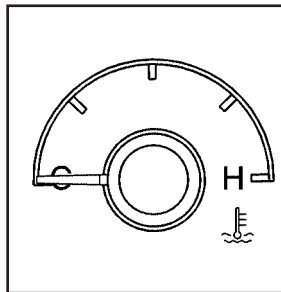

The vehicle has a gage that shows the engine coolant temperature.

If the gage pointer moves towards the H, the engine is too hot.

This reading indicates the same thing as the warning light. It means that the engine coolant has overheated. If the vehicle has been operating under normal driving conditions, pull off the road, stop the vehicle, and turn off the engine as soon as possible. See *Engine Overheating on page 5-24*.

Low Coolant Warning Light

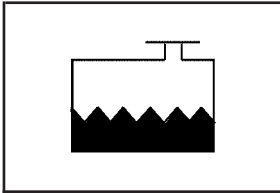

If equipped, this light comes on briefly when you turn your ignition on as a bulb check only.

Malfunction Indicator Lamp

Check Engine Light

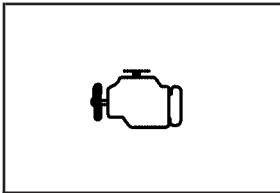

Your vehicle is equipped with a computer which monitors operation of the fuel, ignition, and emission control systems.

This system is called OBD II (On-Board Diagnostics-Second Generation) and is intended to assure that emissions are at acceptable levels for the

life of the vehicle, helping to produce a cleaner environment. The check engine light comes on to indicate that there is a problem and service is required. Malfunctions often will be indicated by the system before any problem is apparent. This may prevent more serious damage to your vehicle. This system is also designed to assist your service technician in correctly diagnosing any malfunction.

Notice: If you keep driving your vehicle with this light on, after awhile, your emission controls may not work as well, your fuel economy may not be as good, and your engine may not run as smoothly. This could lead to costly repairs that may not be covered by your warranty.

Notice: Modifications made to the engine, transaxle, exhaust, intake, or fuel system of your vehicle or the replacement of the original tires with other than those of the same Tire Performance Criteria (TPC) can affect your vehicle's emission controls and may cause this light to come on. Modifications to these systems could lead to costly repairs not covered by your warranty. This may also result in a failure to pass a required Emission Inspection/Maintenance test.

This light should come on, as a check to show you it is working, when the ignition is on and the engine is not running. If the light does not come on, have it repaired. This light will also come on during a malfunction in one of two ways:

- **Light Flashing** — A misfire condition has been detected. A misfire increases vehicle emissions and may damage the emission control system on your vehicle. Diagnosis and service may be required.
- **Light On Steady** — An emission control system malfunction has been detected on your vehicle. Diagnosis and service may be required.

If the Light is Flashing

The following may prevent more serious damage to your vehicle:

- Reducing vehicle speed
- Avoiding hard accelerations
- Avoiding steep uphill grades
- If you are towing a trailer, reduce the amount of cargo being hauled as soon as it is possible

If the light stops flashing and remains on steady, see “If the Light Is On Steady” following.

If the light continues to flash, when it is safe to do so, stop the vehicle. Find a safe place to park your vehicle. Turn the key off, wait at least 10 seconds and restart the engine. If the light remains on steady, see “If the Light Is On Steady” following. If the light is still flashing, follow the previous steps, and see your dealer for service as soon as possible.

If the Light Is On Steady

You may be able to correct the emission system malfunction by considering the following:

Did you recently put fuel into your vehicle?

If so, reinstall the fuel cap, making sure to fully install the cap. See *Filling the Tank on page 5-8*. The diagnostic system can determine if the fuel cap has been left off or improperly installed. A loose or missing fuel cap will allow fuel to evaporate into the atmosphere. A few driving trips with the cap properly installed should turn the light off.

Did you just drive through a deep puddle of water?

If so, your electrical system may be wet. The condition will usually be corrected when the electrical system dries out. A few driving trips should turn the light off.

Have you recently changed brands of fuel?

If so, be sure to fuel your vehicle with quality fuel. See *Gasoline Octane on page 5-5*. Poor fuel quality will cause your engine not to run as efficiently as designed. You may notice this as stalling after start-up, stalling when you put the vehicle into gear, misfiring, hesitation on acceleration, or stumbling on acceleration. (These conditions may go away once the engine is warmed up.) This will be detected by the system and cause the light to turn on.

If you experience one or more of these conditions, change the fuel brand you use. It will require at least one full tank of the proper fuel to turn the light off.

If none of the above steps have made the light turn off, your dealer can check the vehicle. Your dealer has the proper test equipment and diagnostic tools to fix any mechanical or electrical problems that may have developed.

Emissions Inspection and Maintenance Programs

Some state/provincial and local governments have or may begin programs to inspect the emission control equipment on your vehicle. Failure to pass this inspection could prevent you from getting a vehicle registration.

Here are some things you need to know to help your vehicle pass an inspection:

Your vehicle will not pass this inspection if the check engine light is on or not working properly.

Your vehicle will not pass this inspection if the OBD (on-board diagnostic) system determines that critical emission control systems have not been completely diagnosed by the system. The vehicle would be considered not ready for inspection. This can happen if you have recently replaced your battery or if your battery has run down. The diagnostic system is designed to evaluate critical emission control systems during normal driving. This may take several days of routine driving. If you have done this and your vehicle still does not pass the inspection for lack of OBD system readiness, your GM dealer can prepare the vehicle for inspection.

Oil Pressure Light

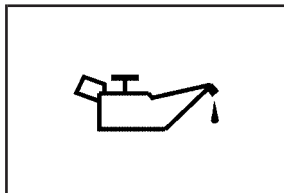

If the vehicle has an oil problem, this light may stay on after the engine is started, or come on while you are driving.

This light indicates that oil is not going through the engine quickly enough to keep it lubricated. The engine could be low on oil or could have some other oil problem. Have it fixed right away.

The oil light could also come on in the following situations:

- The light will come on briefly when the ignition is turned on to show that it is working properly. If it does not come on with the ignition on, there may be a problem with the fuse or bulb. Have it fixed right away.
- Sometimes when the engine is idling at a stop, a chime will sound and the light may blink on and off. This is normal.

CAUTION:

Do not keep driving if the oil pressure is low. If you do, your engine can become so hot that it catches fire. You or others could be burned. Check your oil as soon as possible and have your vehicle serviced.

***Notice:* Lack of proper engine oil maintenance may damage the engine. The repairs would not be covered by your warranty. Always follow the maintenance schedule in this manual for changing engine oil.**

Change Engine Oil Light

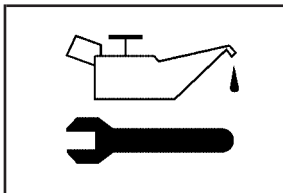

If this light comes on, it means that service is required for your vehicle. See *Scheduled Maintenance* on page 6-4 and *Engine Oil* on page 5-15 for more information.

After having the oil changed you will need to reset the light. See *Engine Oil* on page 5-15 for more information.

If this light is blinking, a chime will sound indicating low engine oil.

Security Light

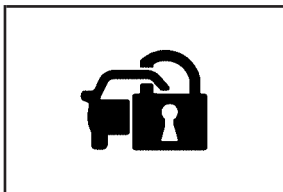

For information regarding this light, see *Theft-Deterrent Systems* on page 2-17.

Cruise Control Light

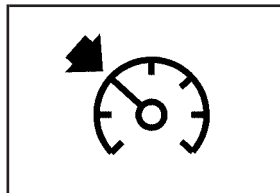

This light comes on whenever you set your cruise control.

The light will go out when the cruise control is turned off. See *Cruise Control* on page 3-10 for more information.

Reduced Engine Power Light

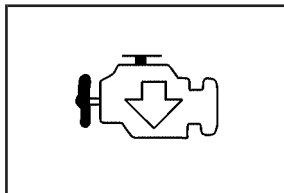

If the reduced engine power light is on, a chime will sound and a noticeable reduction in the vehicle's performance may occur.

If the reduced engine power light is on, but there is no reduction in performance, proceed to your destination. The performance may be reduced the next time the vehicle is driven. The vehicle may be driven at a reduced speed while the reduced engine power light is on, but acceleration and speed may be reduced.

Anytime the reduced engine power light stays on, the vehicle should be taken to an authorized GM dealer as soon as possible for service.

Highbeam On Light

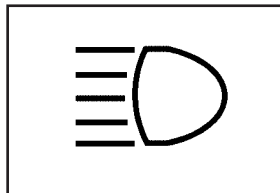

This light will come on when the high-beam headlamps are in use.

See *Headlamp High/Low-Beam Changer* on page 3-8.

Headlamps Suggested Light

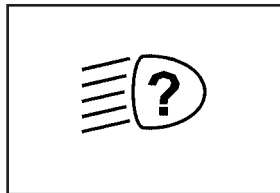

This light will come on when the use of headlamps is suggested.

Low Washer Fluid Warning Light

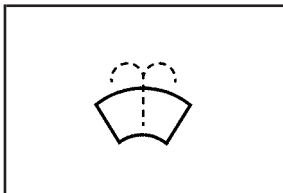

This light will come on briefly when the ignition is on. If the light stays on, a chime will sound indicating your windshield washer fluid is low.

See *Windshield Washer Fluid* on page 5-34 for more information.

Door Ajar Light

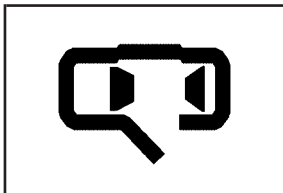

When the ignition is on, this light will stay on until all doors are closed and completely latched.

You will hear a chime if a door is unlatched after the engine is started and the vehicle is not in PARK (P).

Trunk Ajar Light

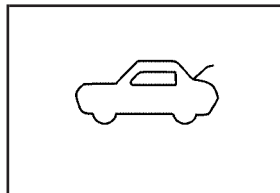

This light will come on and a chime will sound if the trunk is ajar and the vehicle is not in Park (P). Try closing the trunk again. Never drive with the trunk open.

Service Vehicle Soon Light



If equipped, this light will come on and a chime will sound if it detects a problem on the vehicle.

Fuel Gage

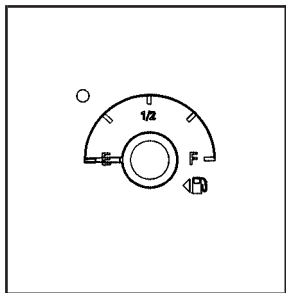

The fuel gage indicates about how much fuel is left in the fuel tank when the ignition is on.

When the indicator nears empty, there is still a little fuel left, but you should get more fuel soon.

Here are four things that some owners ask about. All these things are normal and do not indicate that anything is wrong with the fuel gage:

- At the gas station, the pump shuts off before the gage reads full.
- It takes more, or less, fuel to fill up than the gage reads. For example, the gage reads half full, but it took more, or less, than half of the tank's capacity to fill it.
- The gage pointer may move while cornering, braking or accelerating.
- The gage may not indicate empty when the ignition is turned off.

Low Fuel Warning Light

If the vehicle's fuel is low, a light on the fuel gage, if equipped, will come on and a chime will sound periodically until fuel is added to the fuel tank.

It will also come on for a few seconds when the ignition is turned on as a check to indicate it is working. If it does not come on then, have it fixed.

For vehicles with a DIC, a LOW FUEL message will appear. See *DIC Warnings and Messages on page 3-53* for more information.

Check Gas Cap Light

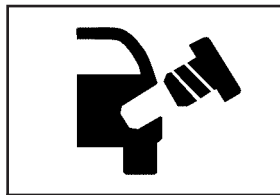

If equipped, this light will come on and a chime will sound if your gas cap is not securely fastened.

See *Malfunction Indicator Lamp on page 3-39* for more information.

Driver Information Center (DIC)

Your vehicle may have a Driver Information Center (DIC).

All messages will appear in the DIC display located in the instrument panel cluster, below the speedometer. The DIC buttons are located on the center of the instrument panel, below the center outlets.

The DIC comes on when the ignition is on. After a short delay, the DIC on the uplevel vehicle will display the WELCOME DRIVER (1 or 2) if a personalized key 1 or 2 is used, and then the information that was last displayed before the engine was turned off.

The DIC on the base level vehicle displays the odometer and trip odometers only.

The DIC on the uplevel vehicle displays the odometer, trip odometers, fuel economy, trip computer, vehicle system, and compass display information. It also displays warning messages if a system problem is detected. In addition, the DIC on the uplevel vehicle displays phone numbers that are called using the OnStar® system, if equipped. See *OnStar® System on page 2-34*.

The outside air temperature automatically appears in the bottom right corner of the uplevel DIC display when viewing the trip/odometer screens, fuel screens and some of the gages screens. If the outside air temperature is at or below 37°F (3°C), the temperature reading will toggle between displaying the outside temperature and the word ICE for two minutes. If there is a problem with the system that controls the temperature display, the letters OC (open circuit) or SC (short circuit) will appear on the display. If this occurs, have the vehicle serviced by your GM dealer.

The DIC on the uplevel vehicle also allows some features to be customized or personalized. See *DIC Vehicle Personalization on page 3-71* for more information.

DIC Operation and Displays

The DIC has different modes which can be accessed by pressing the DIC buttons located on the center of the instrument panel. Depending on whether your vehicle has the base level or uplevel DIC, the buttons and modes available will differ.

The buttons on the base level vehicle are the trip/odometer and English/Metric buttons.

The buttons on the uplevel vehicle are the trip/odometer, set/reset, gages, fuel, and option buttons.

The button functions are detailed in the following pages.

DIC Buttons

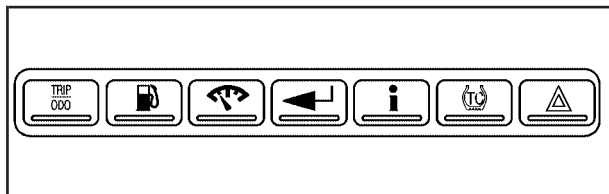

Uplevel shown

TRIP/ODO (Trip/Odometer): Press this button on the base level vehicle to display the odometer and trip distance.

Press this button on the uplevel vehicle to display the odometer, trip distance, time elapsed, and average speed.

E/M (English/Metric):** Press this button on the base level vehicle to select between English or Metric units.

To select between English or Metric units on the uplevel vehicle, see “Units” later in this section.

(Fuel)*: Press this button to display the fuel range, average fuel economy, and instantaneous fuel economy.

(Gages)*: Press this button to display the battery voltage and oil life.

(Set/Reset)*: Press this button to set or reset certain functions and to turn off or acknowledge messages on the DIC.

i (Option)*: Press this button to display the units, language, personalization, compass zone, and compass calibration. See *DIC Vehicle Personalization on page 3-71* for more information.

(TC) (Traction Control)*: If your vehicle has the traction control system, press this button to turn traction control on or off. See *Traction Control System (TCS) on page 4-8* for more information.

(Hazard): Press this button to turn the hazard warning flashers on and off. See *Hazard Warning Flashers on page 3-6* for more information.

*These buttons are available on uplevel vehicles only.

**This button is available on base level vehicles only.

Trip/Odometer Menu Items

TRIP/ODO (Trip Odometer): Press this button to scroll through the following menu items:

Odometer

Press the trip/odometer button until the odometer displays. This mode shows the distance the vehicle has been driven in either miles or kilometers.

Trip A and Trip B

Press the trip/odometer button until A or B displays. This mode shows the current distance traveled in either miles or kilometers since the last reset for each trip odometer. Both trip odometers can be used at the same time.

Each trip odometer can be reset to zero separately by pressing the set/reset button on the uplevel vehicle or by pressing and holding the trip odometer button on the base level vehicle while the desired trip odometer is displayed.

The display will show the odometer on the top line and the trip odometer information, either A or B, on the bottom line.

Time Elapsed (Uplevel Only)

Press the trip/odometer button until TIME ELAPSED :00 displays. This mode is like a stopwatch, in that you can clock the time it takes to get from one point to another. Each of the fields for the hours, minutes, and seconds are two numeric digits.

Once TIME ELAPSED :00 is displayed, press the set/reset button on the uplevel vehicle to start the timing feature. Press the set/reset button again to stop it. If you will be starting and stopping your vehicle, during a trip for instance, the TIME ELAPSED feature will automatically start timing where it left off when you last stopped. To reset it, press and hold the set/reset button for approximately 1.5 seconds. The display will return to zero. Press the trip/odometer button to exit from the TIME ELAPSED display.

Average Speed (Uplevel Only)

Press the trip/odometer button until AVERAGE SPEED displays. This mode shows the average speed of the vehicle in miles per hour (mph) or kilometers per hour (km/h). This average is calculated based on the various vehicle speed recorded since the last reset of this value. To reset the value, press the trip/odometer button to display AVERAGE SPEED, then press and hold the set/reset button on the uplevel vehicle. The display will return to zero.

Fuel Menu Items (Uplevel Only)

 **(Fuel):** Press this button to scroll through the following menu items:

Fuel Range

Press the fuel button until FUEL RANGE displays. This mode shows the approximate number of remaining miles or kilometers the vehicle can be driven without refueling.

Fuel range is based on several factors, including distance travelled, fuel used, fuel capacity, etc. This estimate will change if driving conditions change. For example, if driving in traffic and making frequent stops, this mode may read one number, but if the vehicle is driven on a freeway, the number may change even though the same amount of fuel is in the fuel tank. This is because different driving conditions produce different fuel economies. Generally, freeway driving produces better fuel economy than city driving. Fuel range cannot be reset.

If your vehicle is low on fuel, FUEL RANGE LOW will display followed by the LOW FUEL message. See “LOW FUEL” under *DIC Warnings and Messages on page 3-53* for more information.

Average Fuel Economy

Press the fuel button until AVG ECONOMY displays. This mode shows the approximate average miles per gallon (mpg) or liters per 100 kilometers (L/100 km). This number is calculated based on the number of mpg (L/100 km) recorded since the last time this menu item was reset. To reset AVG ECONOMY, press and hold the set/reset button. The display will return to zero.

Instantaneous Fuel Economy

Press the fuel button until INST ECONOMY displays. This mode shows the current fuel economy at a particular moment and will change frequently as driving conditions change. This mode shows the instantaneous fuel economy in miles per gallon (mpg) or liters per 100 kilometers (L/100 km). Unlike average fuel economy, this screen cannot be reset.

Gages Menu Items (Uplevel Only)

 **(Gages):** Press this button to scroll through the following menu items:

Battery

Press the gages button until BATTERY displays. This mode shows the current battery voltage.

If there is a problem with the battery charging system, a DIC message will display. See *DIC Warnings and Messages on page 3-53* for more information.

Your vehicle's charging system regulates voltage based on the state of the battery. The battery voltage may fluctuate when viewing this information on the DIC. This is normal.

Oil Life

Press the gages button until OIL LIFE displays. This mode shows an estimate of the oil's remaining useful life. If you see OIL LIFE 99% on the display, that means 99% of the current oil life remains. The engine oil life system will alert you to change your oil on a schedule consistent with your driving conditions.

When the remaining oil life is low, the CHANGE OIL SOON message will appear on the display. You should change your oil as soon as possible. See *Engine Oil on page 5-15*. In addition to the engine oil life system monitoring the oil life, additional maintenance is recommended in the Maintenance Schedule in this manual. See *Scheduled Maintenance on page 6-4* for more information.

Remember, you must reset the OIL LIFE yourself after each oil change. It will not reset itself. Also, be careful not to reset the OIL LIFE accidentally at any time other than when the oil has just been changed. It cannot be reset accurately until the next oil change.

To reset the engine oil life system, press and hold the set/reset button while OIL LIFE is displayed. The display will show 100% when the system is reset. See *Engine Oil Life System on page 5-18* for more information.

Option Menu Items (Uplevel Only)

i (Option): Press this button to scroll through the following menu items:

Units

Press the option button until UNITS displays. This mode allows you to select between English or Metric units of measurement. Once in this mode, press the set/reset button to select between ENGLISH or METRIC units.

Language

Press the option button until the language screen displays. This mode allows you to select the language in which the DIC messages will appear. Once in this mode, press the set/reset button to select among the following choices:

- English
- Francais (French)
- Espanol (Spanish)

Personalization

Press the option button until PERSONAL PROGRAM displays. Your vehicle may have personalization capabilities that allow you to program certain features to a preferred setting for up to two drivers.

Your vehicle may also have customization capabilities that allow you to program certain features to one preferred setting. Customization features can only be programmed to one setting on the vehicle and cannot be programmed to a preferred setting for up to two drivers. See *DIC Vehicle Personalization on page 3-71* for additional information on personal programming.

Compass Zone

Under certain circumstances, such as during a long distance cross-country trip, it will be necessary to compensate for compass variance and reset the zone through the DIC.

Compass variance is the difference between the earth's magnetic north and true geographic north. If not adjusted to account for compass variance, the compass in the vehicle could give false readings.

In order to do this, the compass must be set or calibrated to the variance zone in which the vehicle is travelling.

To adjust for compass variance, use the following procedure:

Compass Variance Procedure

1. Press the option button until COMPASS ZONE displays.

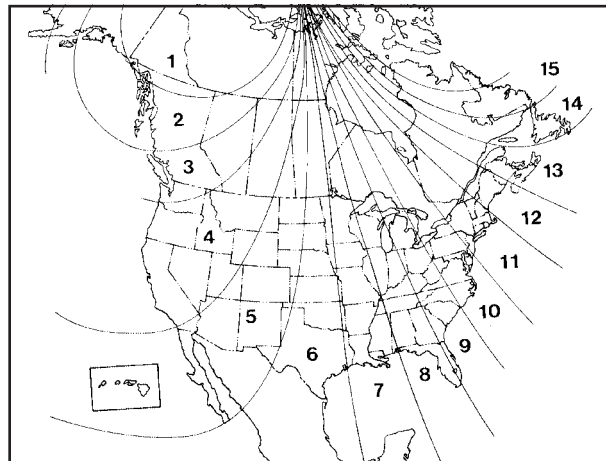

2. Find the vehicle's current location and variance zone number on the map.
Zones 1 through 15 are available.

3. Press the set/reset button to scroll through and select the appropriate variance zone.

The direction the vehicle is moving will be displayed in the top right corner of the DIC display.

4. If you need to calibrate the compass, use the compass calibration procedure. See “Compass Calibration Procedure” following.

Compass Calibration

The compass is manually calibrated. Only calibrate the compass in a safe location where driving the vehicle in circles is not a problem.

To calibrate the compass, use the following procedure:

Compass Calibration Procedure

1. Press the option button until the COMPASS CALIBRATION screen is displayed.
2. Press the set/reset button to start the compass calibration.
3. The DIC will display CALIBRATION BEGUN DRIVE IN CIRCLES. Drive the vehicle in a circle until the DIC displays CALIBRATION FINISHED. The DIC will display CALIBRATION FINISHED for several seconds and then will display the COMPASS CALIBRATION screen.

DIC Warnings and Messages

Messages are displayed on the uplevel DIC to notify the driver that the status of the vehicle has changed and that some action may be needed by the driver to correct the condition. Multiple messages may appear one after another.

Some messages may not require immediate action, but you can press any of the DIC buttons on the uplevel vehicle to acknowledge that you received the message and clear it from the DIC display.

Some messages cannot be cleared from the DIC display because they are more urgent. These messages require action before they can be cleared.

If there are any active warning messages when the vehicle is turned off, two chimes will sound and the DIC will go into a reminder mode. The reminder mode displays any active message. If there are multiple messages, the DIC will display each message for five seconds. After each active message is displayed once, the reminder mode will turn off.

You should take any messages that appear on the display seriously and remember that clearing the messages will only make the messages disappear, not correct the problem.

The following are the possible messages that can be displayed and some information about them.

A/C OFF FOR ENGINE PROTECTION

This message will display when the engine coolant becomes hotter than the normal operating temperature. See *Engine Coolant Temperature Gage on page 3-38*. To avoid added strain on a hot engine, the air conditioning compressor is automatically turned off. When the coolant temperature returns to normal, the air conditioning compressor will turn back on. You can continue to drive your vehicle.

This message will come on while the ignition is in RUN. Press any of the DIC buttons to acknowledge this warning message and to clear it from the screen.

This message will continue to display for two seconds if it has not been acknowledged when the engine is turned off. It will also re-display for two seconds if the message has been acknowledged, but the condition still exists when the engine is turned off.

If the condition still exists, the message will re-appear when the engine is turned on. If this message continues to appear, have the system repaired by your GM dealer as soon as possible to avoid damage to your engine.

BATTERY SAVER ACTIVE

This message will display when the system detects that the battery voltage is dropping beyond a reasonable level. The battery saver system will start reducing certain features of the vehicle that you may be able to notice.

At the point that the features are disabled, this message is displayed. It means that the vehicle is trying to save the charge in the battery.

Turn off all unnecessary accessories to allow the battery to recharge.

The normal battery voltage range is 11.5 to 15.5 volts. If you have an uplevel DIC, you can monitor the battery voltage by pressing the gages button until BATTERY displays.

CHANGE OIL SOON

This message will display when service is required for the vehicle. See your GM dealer. See *Engine Oil on page 5-15* and *Scheduled Maintenance on page 6-4* for more information.

The CHANGE OIL SOON message is reset by acknowledging the message. The OIL LIFE screen under the gages menu on the DIC must also be reset. See "Oil Life" under *DIC Operation and Displays on page 3-47* and *Engine Oil Life System on page 5-18*.

This message will display while the ignition is in RUN. Press any of the DIC buttons to acknowledge this message and to clear it from the screen.

This message will continue to display for two seconds if it has not been acknowledged when the engine is turned off. It will also re-display for two seconds if the message has been acknowledged, but the condition still exists when the engine is turned off.

If the condition still exists, the message will re-appear when the engine is turned on.

CHARGING SYSTEM FAILURE

This message will display when there is a problem with the generator and battery charging systems. Driving with this problem could drain your battery. Turn off all unnecessary accessories. Stop and turn off the vehicle as soon as it is safe to do so. Have the electrical system checked by your GM dealer immediately.

This message will display and a chime will sound while the ignition is in RUN. Press any of the DIC buttons to acknowledge this message and to clear it from the screen.

This message will continue to display for two seconds if it has not been acknowledged when the engine is turned off. It will also re-display for two seconds if the message has been acknowledged, but the condition still exists when the engine is turned off.

If the condition still exists, the message will re-appear when the engine is turned on.

CHECK GAS CAP

This message may be displayed if the gas cap is not on, or is not fully tightened. Check the gas cap to ensure that it is on properly. The diagnostic system can determine if the fuel cap has been left off or improperly installed. A loose or missing fuel cap will allow fuel to evaporate into the atmosphere. A few driving trips with the cap properly installed should turn this message off. See *Filling the Tank on page 5-8* for more information.

This message will display while the ignition is in RUN. Press any of the DIC buttons to acknowledge this message and to clear it from the screen.

This message will continue to display for two seconds if it has not been acknowledged when the engine is turned off. It will also re-display for two seconds if the message has been acknowledged, but the condition still exists when the engine is turned off.

If the condition still exists, the message will re-appear when the engine is turned on.

DELAYED LOCKING

This message will display to inform the driver that even though a door lock switch has been pressed, that actual locking of the doors is being delayed because the delayed locking feature has been activated in the DIC. See “DELAYED LOCKING” under *DIC Vehicle Personalization on page 3-71* for more information.

This message will appear and a chime will sound when the ignition is off.

This message cannot be acknowledged.

DRIVER’S DOOR AJAR

This message will display when the driver’s door is not closed properly. When this message appears, you should make sure that the driver’s door is closed completely.

This message will display while the ignition is in RUN. A chime will sound when the ignition is shifted out of PARK (P). Press any of the DIC buttons to acknowledge this message and to clear it from the screen.

This message will continue to display for two seconds if it has not been acknowledged when the engine is turned off. It will also re-display for two seconds if the message has been acknowledged, but the condition still exists when the engine is turned off.

If the condition still exists, the message will re-appear when the engine is turned on.

DRIVER’S REAR DOOR AJAR

This message will display when the driver’s side rear door is not closed properly. When this message appears, you should make sure that the passenger’s door is closed completely.

This message will display while the ignition is in RUN. A chime will sound when the ignition is shifted out of PARK (P). Press any of the DIC buttons to acknowledge this message and to clear it from the screen.

This message will continue to display for two seconds if it has not been acknowledged when the engine is turned off. It will also re-display for two seconds if the message has been acknowledged, but the condition still exists when the engine is turned off.

If the condition still exists, the message will re-appear when the engine is turned on.

ENGINE COOLANT HOT

Notice: If you drive your vehicle while the engine is overheating, severe engine damage may occur. If an overheat warning appears on the instrument panel cluster and/or DIC, stop the vehicle as soon as possible. Do not increase the engine speed above normal idling speed. See *Engine Overheating on page 5-24* for more information.

This message will display when the engine coolant temperature is too hot. The engine coolant temperature warning light will also appear on the instrument panel cluster. See *Engine Coolant Temperature Warning Light on page 3-38* and *Engine Coolant Temperature Gage on page 3-38* for more information.

To avoid added strain on the engine, turn off the air conditioner if it is on. When the coolant temperature returns to normal, the air conditioner can be turned back on.

This message will display only when the ignition is in RUN. A chime will sound continuously when this message is displayed. Press any of the DIC buttons to acknowledge this message and to clear it from the screen.

This message will continue to display for two seconds if it has not been acknowledged when the engine is turned off. It will also re-display for two seconds if the message has been acknowledged, but the condition still exists when the engine is turned off.

If the condition still exists, the message will re-appear when the engine is turned on.

HEADLAMPS SUGGESTED

This message will display when the amount of available light outside of the vehicle is low, or the windshield wipers have been on for approximately 30 seconds, and the exterior lamps control is off or in the park lamps position. This message informs the driver that turning on the exterior lamps is recommended. See *Exterior Lamps on page 3-13* for more information.

This message will display while the ignition is in RUN. Press any of the DIC buttons to acknowledge this message and to clear it from the screen.

This message will continue to display for two seconds if it has not been acknowledged when the engine is turned off. It will also re-display for two seconds if the message has been acknowledged, but the condition still exists when the engine is turned off.

If the condition still exists, the message will re-appear when the engine is turned on.

HOOD AJAR

This message will display when the hood is not closed properly. When this message appears, you should make sure that the hood is closed completely. See *Hood Release on page 5-11*.

This message will display while the ignition is in RUN. Press any of the DIC buttons to acknowledge this message and to clear it from the screen.

This message will continue to display for two seconds if it has not been acknowledged when the engine is turned off. It will also re-display for two seconds if the message has been acknowledged, but the condition still exists when the engine is turned off.

If the condition still exists, the message will re-appear when the engine is turned on.

HOT TRANS FLUID

This message will display when the transaxle fluid in your vehicle is too hot. Stop the vehicle and allow it to idle until it cools down. If the warning message continues to display, have the vehicle serviced by your GM dealer as soon as possible.

This message will display and a chime will sound only while the ignition is in RUN. Press any of the DIC buttons to acknowledge this message and to clear it from the screen.

This message will continue to display for two seconds if it has not been acknowledged when the engine is turned off. It will also re-display for two seconds if the message has been acknowledged, but the condition still exists when the engine is turned off.

If the condition still exists, the message will re-appear when the engine is turned on.

KEY FOB BATTERY LOW

This message will display when the battery in the remote keyless entry transmitter needs to be replaced. To replace the battery, see “Battery Replacement” under *Remote Keyless Entry System Operation on page 2-4*.

This message will display while the ignition is in RUN. Press any of the DIC buttons to acknowledge this message and to clear it from the screen.

This message will continue to display for two seconds if it has not been acknowledged when the engine is turned off. It will also re-display for two seconds if the message has been acknowledged, but the condition still exists when the engine is turned off.

If the condition still exists, the message will re-appear when the engine is turned on.

KEY IN IGNITION

This message will display and a chime will sound continuously when the driver's door is open and the key is in the ignition and in the accessory or off position.

This message cannot be acknowledged.

This message will disappear and the chiming will stop when the key is removed from the ignition.

LEFT FRONT TURN LAMP OUT

This message will display when the left front turn signal bulb needs to be replaced. See *Front Turn Signal and Parking Lamps on page 5-47*.

This message will display while the ignition is in RUN. Press any of the DIC buttons to acknowledge this message and to clear it from the screen.

This message will continue to display for two seconds if it has not been acknowledged when the engine is turned off. It will also re-display for two seconds if the message has been acknowledged, but the condition still exists when the engine is turned off.

If the condition still exists, the message will re-appear when the engine is turned on.

LEFT REAR TURN LAMP OUT

This message will display when the left rear turn signal bulb needs to be replaced. See *Taillamps, Turn Signal, Sidemarker, Stoplamps and Back-up Lamps on page 5-48*.

This message will display while the ignition is in RUN. Press any of the DIC buttons to acknowledge this message and to clear it from the screen.

This message will continue to display for two seconds if it has not been acknowledged when the engine is turned off. It will also re-display for two seconds if the message has been acknowledged, but the condition still exists when the engine is turned off.

If the condition still exists, the message will re-appear when the engine is turned on.

LOW BRAKE FLUID

This message will display when the brake fluid level is low. Fill the brake master cylinder to the proper level. See *Engine Compartment Overview on page 5-12* for the location of the brake master cylinder reservoir. Also, see *Brakes on page 5-35* for proper fluid level.

The brake system warning light will also appear on the instrument panel cluster when this message appears on the DIC. See *Brake System Warning Light on page 3-36*.

This message will display and a chime will sound only while the ignition is in RUN. Press any of the DIC buttons to acknowledge this message and to clear it from the screen.

This message will continue to display for two seconds if it has not been acknowledged when the engine is turned off. It will also re-display for two seconds if the message has been acknowledged, but the condition still exists when the engine is turned off.

If the condition still exists, the message will re-appear when the engine is turned on.

LOW FUEL

This message will display when your vehicle is low on fuel. You should refill the tank as soon as possible. See *Fuel Gage on page 3-46* and *Filling the Tank on page 5-8* for more information.

The message will display and a chime will sound while the ignition is in RUN. Press any of the DIC buttons to acknowledge this message and to clear it from the screen.

If the condition still exists, the message will re-appear when the engine is turned on.

LOW OIL LEVEL

This message will display when the vehicle's engine oil is low. Fill the oil to the proper level as soon as possible. See *Engine Compartment Overview on page 5-12* for the engine oil fill location. Also, see *Engine Oil on page 5-15* for information on the kind of oil to use and the proper oil level.

The message will display and a chime will sound while the ignition is in RUN. Press any of the DIC buttons to acknowledge this message and to clear it from the screen.

This message will continue to display for two seconds if it has not been acknowledged when the engine is turned off. It will also re-display for two seconds if the message has been acknowledged, but the condition still exists when the engine is turned off.

If the condition still exists, the message will re-appear when the engine is turned on.

LOW OIL PRESSURE

Notice: If the LOW OIL PRESSURE warning message appears on the DIC display, stop the vehicle immediately. Do not drive the vehicle until the cause of the low oil pressure is corrected. Severe engine damage can result from driving a vehicle with low oil pressure. See *Engine Oil* on page 5-15 for more information.

This message will display when the vehicle's engine oil pressure is low. The oil pressure light will also appear on the instrument panel cluster. See *Oil Pressure Light* on page 3-42.

Stop the vehicle immediately, as engine damage can result from driving a vehicle with low oil pressure. Have the vehicle serviced by your GM dealer as soon as possible when this message is displayed.

This message will display only when the ignition is in RUN. A chime will sound continuously when this message is displayed.

This message cannot be acknowledged and cleared from the screen. This message will re-display for a few seconds if the condition still exists when the engine is turned off.

If the condition still exists, the message will re-appear when the engine is turned on.

LOW WASHER FLUID

This message will display when the windshield washer fluid is low. Fill the windshield washer reservoir as soon as possible. See *Engine Compartment Overview* on page 5-12 for the location of the windshield washer reservoir. Also, see *Windshield Washer Fluid* on page 5-34 for more information.

This message will display and a chime will sound only when the ignition is in RUN. Press any of the DIC buttons to acknowledge this message and to clear it from the screen.

This message will continue to display for two seconds if it has not been acknowledged when the engine is turned off. It will also re-display for two seconds if the message has been acknowledged, but the condition still exists when the engine is turned off.

If the condition still exists, the message will re-appear when the engine is turned on.

PARKING BRAKE ON

This message will display to alert the driver when the vehicle's parking brake is on, the ignition is in RUN, and the vehicle speed is greater than 5 mph (8 km/h).

Release the parking brake before driving. See *Parking Brake on page 2-27* for more information.

The brake light will also appear on the instrument panel cluster when this message appears on the DIC. See *Brake System Warning Light on page 3-36*.

A chime will sound continuously while this message is displayed if driving above 5 mph (8 km/h). Press any of the DIC buttons to acknowledge this message and to clear it from the screen.

This message will continue to display for two seconds if it has not been acknowledged when the engine is turned off. It will also re-display for two seconds if the message has been acknowledged, but the condition still exists when the engine is turned off.

If the condition still exists, the message will re-appear when the engine is turned on.

PARK LAMPS ON

This message will display to alert the driver when the headlamps or parking lamps are on while the ignition is off and the driver's door is opened. See *Exterior Lamps on page 3-13* for more information.

A chime will sound continuously while this message is displayed. Press any of the DIC buttons to acknowledge this message and to clear it from the screen.

PASSENGER'S DOOR AJAR

This message will display when the front passenger's door is not closed properly. When this message appears, you should make sure that the front passenger's door is closed completely.

This message will display while the ignition is in RUN. A chime will sound when the ignition is shifted out of PARK (P). Press any of the DIC buttons to acknowledge this message and to clear it from the screen.

This message will continue to display for two seconds if it has not been acknowledged when the engine is turned off. It will also re-display for two seconds if the message has been acknowledged, but the condition still exists when the engine is turned off.

If the condition still exists, the message will re-appear when the engine is turned on.

PASSENGER'S REAR DOOR AJAR

This message will display when the passenger's side rear door is not closed properly. When this message appears, you should make sure that the passenger's door is closed completely.

This message will display while the ignition is in RUN. A chime will sound when the ignition is shifted out of PARK (P). Press any of the DIC buttons to acknowledge this message and to clear it from the screen.

This message will continue to display for two seconds if it has not been acknowledged when the engine is turned off. It will also re-display for two seconds if the message has been acknowledged, but the condition still exists when the engine is turned off.

If the condition still exists, the message will re-appear when the engine is turned on.

REDUCED ENGINE POWER

This message will display when the vehicle's engine power is reduced. Reduced engine power can affect the vehicle's ability to accelerate. If this message is on, but there is no reduction in performance, proceed to your destination. The performance may be reduced the next time the vehicle is driven. The vehicle may be driven at a reduced speed while this message is on, but acceleration and speed may be reduced. Anytime this message stays on, the vehicle should be taken to your GM dealer for service as soon as possible.

This message will display and a chime will sound only when the ignition is in RUN. Press any of the DIC buttons to acknowledge this message and to clear it from the screen.

This message will continue to display for two seconds if it has not been acknowledged when the engine is turned off. It will also re-display for two seconds if the message has been acknowledged, but the condition still exists when the engine is turned off.

If the condition still exists, the message will re-appear when the engine is turned on.

REDUCED POWER STOP WHEN SAFE

This message will display when your vehicle is in an overheated engine operating mode. This operating mode allows your vehicle to be driven to a safe place in an emergency. In this mode, you will notice a significant loss in power and engine performance. See *Overheated Engine Protection Operating Mode on page 5-26* for more information. Anytime this message is on, the vehicle should be taken to your GM dealer for service as soon as possible.

This message will display and a chime will sound only when the ignition is in RUN. Press any of the DIC buttons to acknowledge this message and to clear it from the screen.

This message will continue to display for two seconds if it has not been acknowledged when the engine is turned off. It will also re-display for two seconds if the message has been acknowledged, but the condition still exists when the engine is turned off.

If the condition still exists, the message will re-appear when the engine is turned on.

REMOTE START DISABLED

This warning message will come on if a remote start attempt is unsuccessful. This may be caused if any of the following conditions are true when a remote start attempt is made:

- The remote start system is disabled through the DIC.
- The key is in the ignition.
- The hood or the doors are not closed.
- There is an emission control system malfunction.
- The engine coolant temperature is too high.
- The oil pressure is low.
- The hazard warning flashers are turned on.
- The maximum number of remote starts or remote start attempts between ignition cycles has been reached.
- The content theft-deterrent alarm is on while attempting to remote start the vehicle.

See “REMOTE START” under *DIC Vehicle Personalization on page 3-71* and “Remote Vehicle Start” under *Remote Keyless Entry System Operation on page 2-4* for more information.

RIGHT FRONT TURN LAMP OUT

This message will display when the right front turn signal bulb needs to be replaced. See *Front Turn Signal and Parking Lamps on page 5-47*.

This message will display while the ignition is in RUN. Press any of the DIC buttons to acknowledge this message and to clear it from the screen.

This message will continue to display for two seconds if it has not been acknowledged when the engine is turned off. It will also re-display for two seconds if the message has been acknowledged, but the condition still exists when the engine is turned off.

If the condition still exists, the message will re-appear when the engine is turned on.

RIGHT REAR TURN LAMP OUT

This message will display when the right rear turn signal bulb needs to be replaced. See *Taillamps, Turn Signal, Sidemarker, Stoplamps and Back-up Lamps on page 5-48*.

This message will display while the ignition is in RUN. Press any of the DIC buttons to acknowledge this message and to clear it from the screen.

This message will continue to display for two seconds if it has not been acknowledged when the engine is turned off. It will also re-display for two seconds if the message has been acknowledged, but the condition still exists when the engine is turned off.

If the condition still exists, the message will re-appear when the engine is turned on.

SERVICE ABS SYSTEM

If the vehicle has the Anti-Lock Brake System (ABS), this message will display when the system is not functioning properly. Have the brake system serviced by your GM dealer as soon as possible.

The anti-lock brake system warning light will also appear on the instrument panel cluster when this message appears on the DIC. See *Anti-Lock Brake System Warning Light on page 3-37*.

This message will only display while the ignition is in RUN. Press any of the DIC buttons to acknowledge this message and to clear it from the screen.

This message will continue to display for two seconds if it has not been acknowledged when the engine is turned off. It will also re-display for two seconds if the message has been acknowledged, but the condition still exists when the engine is turned off.

If the condition still exists, the message will re-appear when the engine is turned on.

SERVICE BRAKE APPLY SENSOR

This message will come on when the brake apply sensor is not functioning properly. The vehicle still has brakes when this warning message displays, but you should have the vehicle serviced by your GM dealer as soon as possible.

This message will display only while the ignition is in RUN. A chime will sound for two seconds while this message is displayed. Press any of the DIC buttons to acknowledge this message and to clear it from the screen.

This message will continue to display if it has not been acknowledged when the engine is turned off. It will also re-display for two seconds if the message has been acknowledged, but the condition still exists when the engine is turned off.

If the condition still exists, the message will re-appear when the engine is turned on.

SERVICE BRAKE SYSTEM

This message will display when a problem with the brake system has been detected. Have your vehicle serviced by your GM dealer as soon as possible.

The brake system warning light will also appear on the instrument panel cluster when this message appears on the DIC. See *Brake System Warning Light on page 3-36*.

This message will only display while the ignition is in RUN. Press any of the DIC buttons to acknowledge this message and to clear it from the screen.

This message will continue to display for two seconds if it has not been acknowledged when the engine is turned off. It will also re-display for two seconds if the message has been acknowledged, but the condition still exists when the engine is turned off.

If the condition still exists, the message will re-appear when the engine is turned on.

SERVICE PARK LAMPS

This message will display when there is a problem with the park lamps. Check to see if the park lamp fuse is blown and replace the fuse if necessary. See *Fuses and Circuit Breakers on page 5-88* and *Instrument Panel Fuse Block on page 5-88* for more information. If changing the fuse does not correct the problem, see your GM dealer.

This message will only display while the ignition is in RUN. Press any of the DIC buttons to acknowledge this message and to clear it from the screen.

This message will continue to display for two seconds if it has not been acknowledged when the engine is turned off. It will also re-display for two seconds if the message has been acknowledged, but the condition still exists when the engine is turned off.

If the condition still exists, the message will re-appear when the engine is turned on.

SERVICE STABILITY SYSTEM

If your vehicle has StabiliTrak[®], this message will display if there has been a problem detected with StabiliTrak[®]. A warning light will also appear on the instrument panel cluster. See *Traction Control System (TCS) Warning Light on page 3-37*. See *StabiliTrak[®] System on page 4-9* for more information.

If this message turns on while you are driving, pull off the road as soon as possible and stop carefully. Try resetting the system by turning the ignition off and then back on. If this message still stays on or turns back on again while you are driving, your vehicle needs service. Have the StabiliTrak[®] System inspected by your GM dealer as soon as possible.

This message will display only while the ignition is in RUN. Press any of the DIC buttons to acknowledge this message and to clear it from the screen.

This message will continue to display for two seconds if it has not been acknowledged when the engine is turned off. It will also re-display for two seconds if the message has been acknowledged, but the condition still exists when the engine is turned off.

If the condition still exists, the message will re-appear when the engine is turned on.

SERVICE THEFT SYSTEM

This message will display when there is a problem with the theft-deterrent system programmed in the key. A fault has been detected in the system which means that the system is disabled and it is not protecting the vehicle. The vehicle usually restarts; however, you may want to take the vehicle to your GM dealer before turning off the engine. See *PASS-Key[®] III Operation on page 2-19* for more information.

This message will display and a chime will sound only while the ignition is in RUN. Press any of the DIC buttons to acknowledge this message and to clear it from the screen.

This message will continue to display for two seconds if it has not been acknowledged when the engine is turned off. It will also re-display for two seconds if the message has been acknowledged, but the condition still exists when the engine is turned off.

If the condition still exists, the message will re-appear when the engine is turned on.

SERVICE TRACTION SYSTEM

If your vehicle has the traction control system, this message will display when the system is not functioning properly. A warning light will also appear on the instrument panel cluster. See *Traction Control System (TCS) Warning Light on page 3-37*. See *Traction Control System (TCS) on page 4-8* for more information.

Have the traction control system serviced by your GM dealer as soon as possible.

This message will display only while the ignition is in RUN. Press any of the DIC buttons to acknowledge this message and to clear it from the screen.

This message will continue to display for two seconds if it has not been acknowledged when the engine is turned off. It will also re-display for two seconds if the message has been acknowledged, but the condition still exists when the engine is turned off.

If the condition still exists, the message will re-appear when the engine is turned on.

SERVICE VARIABLE EFFORT STEERING

If your vehicle has variable effort steering, this message will display when if this system is not functioning properly. See *Steering on page 4-10* for more information. Have your system serviced by your GM dealer as soon as possible.

This message will display only while the ignition is in RUN. Press any of the DIC buttons to acknowledge this message and to clear it from the screen.

This message will continue to display for two seconds if it has not been acknowledged when the engine is turned off. It will also re-display for two seconds if the message has been acknowledged, but the condition still exists when the engine is turned off.

If the condition still exists, the message will re-appear when the engine is turned on.

SERVICE VEHICLE SOON

This message will display when a non-emissions related malfunction occurs. Have the vehicle serviced by your GM dealer as soon as possible.

This message will display only while the ignition is in RUN. Press any of the DIC buttons to acknowledge this message and to clear it from the screen.

This message will continue to display for two seconds if it has not been acknowledged when the engine is turned off. It will also re-display for two seconds if the message has been acknowledged, but the condition still exists when the engine is turned off.

If the condition still exists, the message will re-appear when the engine is turned on.

STABILITY CONTROL ACTIVE

If your vehicle has StabiliTrak[®], this message will display when StabiliTrak[®] is actively assisting you with directional control of the vehicle. Slippery road conditions may exist when this message is displayed, so adjust your driving accordingly. See *StabiliTrak[®] System* on page 4-9.

This message will display only while the ignition is in RUN. This message stays on until road conditions change and StabiliTrak[®] is not active.

This message cannot be acknowledged and cleared from the screen.

STABILITY CONTROL OFF

If your vehicle has StabiliTrak[®], this message will display any time the system turns off. When this message has been displayed, StabiliTrak[®] is no longer available to assist you with directional control of the vehicle. Adjust your driving accordingly. See *StabiliTrak[®] System* on page 4-9.

This message will display only while the ignition is in RUN.

Any of the following conditions may cause the StabiliTrak[®] system to turn off:

- The battery is low.
- There is a StabiliTrak[®] system failure. See your GM dealer for service.

STARTING DISABLED

This message will display if the starting of the engine is disabled due to the electronic throttle control system or vehicle theft-deterrent system. Have your vehicle serviced by your GM dealer immediately.

This message will only appear while the ignition is in RUN, and will not disappear until the problem is resolved.

This message cannot be acknowledged.

TRACTION CONTROL ACTIVE

If your vehicle has the traction control system, this message will display when the system is on. Slippery road conditions may exist if this message is displayed, so adjust your driving accordingly. See *Traction Control System (TCS)* on page 4-8 for more information.

This message only displays while the ignition is in RUN and will not disappear until driving conditions change and the traction control is no longer active.

This message cannot be acknowledged or cleared from the screen.

TRACTION CONTROL OFF

If your vehicle has the traction control system, this message will display when the traction control system turns off. See *Traction Control System (TCS) on page 4-8* for more information.

This message will only display while the ignition is in RUN and will disappear after two seconds.

Any of the following conditions may cause the traction control system to turn off:

- The traction control system is turned off by pressing the traction control button located on the center of the instrument panel. See *Traction Control System (TCS) on page 4-8*.
- The battery is low.
- There is a traction control system failure. See your GM dealer for service.

TRUNK AJAR

This message will display when the trunk is not closed completely. You should make sure that the trunk is closed completely. See *Trunk on page 2-13*.

This message will display while the ignition is in RUN. A chime will sound when the ignition is shifted out of PARK (P). Press any of the DIC buttons to acknowledge this message and to clear it from the screen.

This message will continue to display for two seconds if it has not been acknowledged when the engine is turned off. It will also re-display for two seconds if the message has been acknowledged, but the condition still exists when the engine is turned off.

If the condition still exists, the message will re-appear when the engine is turned on.

TURN SIGNAL ON

This message will display as a reminder to turn off the turn signal if you drive your vehicle for more than about 0.75 mile (1.2 km) with a turn signal on. See *Turn Signal/Multifunction Lever on page 3-7*.

This message displays and a chime sounds only when the ignition is in RUN. This message will clear from the screen if the turn signal is manually turned off, a turn is completed, or the message is acknowledged.

DIC Vehicle Personalization

Your vehicle may have customization capabilities that allow you to program certain features to one preferred setting. Customization features can only be programmed to one setting on the vehicle and cannot be programmed to a preferred setting for two different drivers. The customization features include the following:

- Exterior lighting delay
- Interior lighting delay
- Delayed locking
- Content theft
- Remote keyless entry feedback
- Remote start

Your vehicle may also have personalization capabilities that allow you to program certain features to a preferred setting for up to two drivers. The first personalized key corresponds to driver 1 and the second personalized key corresponds to driver 2. The personalization features include the following:

- Radio station presets
- Auto door lock preferences
- Auto door unlock preferences
- Remote keyless entry unlock preferences

All of the customization and personalization options may not be available on your vehicle. Only the options available will be displayed on your DIC.

The default settings for the customization and personalization features were set when your vehicle left the factory, but may have been changed from their default state since then.

The customization preferences are automatically recalled.

The driver's personalization preferences are recalled by using the key programmed for driver 1 or 2.

To change customization and personalization preferences, use the following procedure.

Entering the Personal Program Menu

1. Turn the ignition on and place the vehicle in PARK (P).
2. Press the option button until PERSONAL PROGRAM displays.

If the vehicle is not in PARK (P), PERSONAL PROGRAM ONLY IN PARK will display.

If the vehicle is not able to enter the personal program menu, PERSONAL PROGRAM NOT AVAILABLE will display.

3. Press the set/reset button to begin.
4. The DIC will then display an instruction screen.
Press the option button to display the features that are available to program.
Press the set/reset button to change the setting of each feature.

Customization Menu Items

The following are customization features that allow you to program settings to the vehicle:

FACTORY DEFAULTS

This feature allows you to set all of the customization and personalization features back to their factory default settings.

Press the option button until FACTORY DEFAULTS appears on the DIC display. Press the set/reset button to scroll through the following choices:

NO (default): The customization and personalization features will not be set to their factory default settings.

YES: The customization and personalization features will be set to their factory default settings.

Select one of the available choices and press the option button while it is displayed on the DIC to select it and move on to the next feature.

ALL KEYS WILL BE RESET

This screen will only display if YES was selected on the FACTORY DEFAULTS screen.

Press the set/reset button to scroll through the following choices:

CANCEL (default): The features will not be set to their factory default settings and the DIC will return to the PERSONAL PROGRAM menu.

OK: The features will be set to their factory default settings, the DIC will exit the personal program menu, and PERSONAL OPTIONS SAVED will display.

EXT LIGHT DELAY

This feature allows you to set the amount of time the exterior lamps remain on after the key is removed from the ignition or the vehicle is unlocked using the remote keyless entry transmitter.

Press the option button until EXT LIGHT DELAY appears on the DIC display. Press the set/reset button to scroll through the following choices:

OFF: The exterior lamps will not turn on.

15 seconds: The exterior lamps will stay on for 15 seconds.

30 seconds (default): The exterior lamps will stay on for 30 seconds.

60 seconds: The exterior lamps will stay on for 60 seconds.

90 seconds: The exterior lamps will stay on for 90 seconds.

Select one of the available choices and press the option button while it is displayed on the DIC to select it and move on to the next feature.

INT LIGHTS KEYS REMOVED

This feature enables the interior lamps in the vehicle to turn on for about 25 seconds after the key is removed from the ignition.

Press the option button until INT LIGHTS KEYS REMOVED appears on the DIC display. Press the set/reset button to scroll through the following choices:

OFF: Removing the key from the ignition will not cause the interior lamps to turn on.

ON (default): Removing the key from the ignition will cause the interior lamps to be turned on for about 25 seconds.

Select one of the available choices and press the option button while it is displayed on the DIC to select it and move on to the next feature.

DELAYED LOCKING

This feature allows the locking of the vehicle to be delayed until all of the doors have been closed for approximately five seconds.

When the delayed locking feature is enabled, it may be activated when the key is out of the ignition by doing one of the following:

- Pressing the driver's door power lock switch one time while the driver's door is open.
- Pressing the passenger's door power lock switch one time while the passenger's door is open.
- Pressing the lock button on the remote keyless entry transmitter one time while any door is open.

Two chimes will sound to signal that delayed locking is active.

The doors may be locked immediately by repeating one of the above actions more than one time.

If a door remains open, without any other door being opened or closed, the vehicle will lock after approximately 45 seconds.

If a key is in the ignition, this feature will not lock the doors. See *Delayed Locking on page 2-11* for more information.

Press the option button until DELAYED LOCKING appears on the DIC display. Press the set/reset button to scroll through the following choices:

OFF: There will be no delayed locking of the vehicle's doors.

ON (default): The locking of the vehicle's doors will be delayed by five seconds while a door is open after a power door lock switch is pressed, or the lock button on the remote keyless entry transmitter is pressed while a door is open.

Select one of the available choices and press the option button while it is displayed on the DIC to select it and move on to the next feature.

CONTENT THEFT

If your vehicle has the content theft-deterrent system, once this feature is turned on, the system will activate if someone tries to enter the vehicle without using the remote keyless entry transmitter or the correct key. It will also activate when an incorrect key is used in the ignition.

Press the option button until CONTENT THEFT appears on the DIC display. Press the set/reset button to scroll through the following choices:

OFF: The content theft-deterrent system will be turned off.

ON (default): The content theft-deterrent system will be turned on.

When ON is selected, the content theft-deterrent system will be armed when the vehicle is locked by pressing the lock button on the remote keyless entry transmitter or by pressing the power door lock switch. See *Content Theft-Deterrent on page 2-17* and *Power Door Locks on page 2-11* for more information.

Select one of the available choices and press the option button while it is displayed on the DIC to select it and move on to the next feature.

FOB LOCK FEEDBACK

This feature allows you to select the type of feedback you will receive when locking the vehicle with the remote keyless entry transmitter.

Press the option button until FOB LOCK FEEDBACK appears on the DIC display. Press the set/reset button to scroll through the following choices:

OFF: There will be no feedback when locking the vehicle.

LIGHTS: The exterior lamps will flash when you press the lock button on the remote keyless entry transmitter.

LIGHTS and HORN (default): The exterior lamps will flash when you press the lock button on the remote keyless entry transmitter, and the horn will sound when the lock button is pressed again within five seconds of the previous command.

Select one of the available choices and press the option button while it is displayed on the DIC to select it and move on to the next feature.

REMOTE START

If your vehicle has remote start, this feature allows the remote start to be turned OFF or ON. The remote start feature allows you to start the engine from outside of the vehicle using your remote keyless entry transmitter. See “Remote Vehicle Start” under *Remote Keyless Entry System Operation on page 2-4* for more information.

Press the option button until REMOTE START appears on the DIC display. Press the set/reset button to scroll through the following choices:

OFF: The remote start feature will be disabled.

ON (default): The remote start feature will be enabled.

Select one of the available choices and press the option button while it is displayed on the DIC to select it and move on to the next feature.

Personalization Menu Items

The following are personalization features that allow you to program setting for up to two drivers:

PERSONALIZE KEY

This feature allows you to personalize a key to be recognized as key 1 or 2. A personalized key allows you to program personalization features to a preferred setting to correspond to key 1 or 2. If you are using a key that has already been personalized, this screen will not display.

Press the option button until PERSONALIZE KEY appears on the DIC display. Press the set/reset button to scroll through the following choices:

NO (default): The key will not be personalized.

YES: The key will be personalized.

Select one of the available choices and press the option button while it is displayed on the DIC to select it and move on to the next feature.

REPLACE KEY

This screen displays only if YES was selected for the PERSONALIZE KEY feature, keys 1 and 2 have already been personalized, and the current key being used is not key 1 or 2. This feature allows you to program a key to be recognized as key 1 or 2 in the event that the previously programmed key needs to be replaced.

1: The key will be programmed to be recognized as key 1.

2: The key will be programmed to be recognized as key 2.

CANCEL (default): The key will not be programmed.

RADIO STATIONS PERSONALIZED

This screen displays only if YES was selected for the PERSONALIZE KEY feature. This feature allows you to set the radio station presets to be recognized for the key, 1 or 2, that is being used. You may notice a change to the radio after this message displays. Once this message displays, set the radio station presets. If the presets are not set at this time, the presets will not be recognized for key 1 or 2, however, the vehicle radio station presets will be maintained.

AUTO DOOR LOCK

This feature allows automatic door locking to be turned OFF or ON.

Press the option button until AUTO DOOR LOCK appears on the DIC display. Press the set/reset button to scroll through the following choices:

OFF: All automatic door locking is disabled. The doors will always need to be locked manually before driving, to increase occupant safety.

ON (default): The vehicle's doors automatically lock when the doors are closed and the vehicle is shifted into DRIVE (D).

Select one of the available choices and press the option button while it is displayed on the DIC to select it and move on to the next feature.

AUTO DOOR UNLOCK

This feature displays only if ON was selected for the AUTO DOOR LOCK feature. This feature allows automatic door unlocking to be turned off, used for the driver's door only, or for all of the doors.

Press the option button until AUTO DOOR UNLOCK appears on the DIC display. Press the set/reset button to scroll through the following choices:

OFF: None of the doors will unlock when the vehicle is shifted into PARK (P) or the key is taken out of the ignition.

DRIVER: Only the driver's door will unlock when the vehicle is shifted into PARK (P) or the key is taken out of the ignition.

ALL (default): All of the doors will unlock when the vehicle is shifted into PARK (P) or the key is taken out of the ignition.

Select one of the available choices and press the option button while it is displayed on the DIC to select it and move on to the next feature.

AUTO UNLOCK ON

This feature displays only if DRIVER or ALL was selected for the AUTO DOOR UNLOCK feature. This feature allows the selection of when the vehicle's doors will unlock.

Press the option button until AUTO UNLOCK ON appears on the DIC display. Press the set/reset button to scroll through the following choices:

KEY-OUT: The door(s) will unlock when the key is taken out of the ignition.

PARK (default): The door(s) will unlock when the vehicle is shifted into PARK (P).

Select one of the available choices and press the option button while it is displayed on the DIC to select it and move on to the next feature.

FOB UNLOCK ON 1ST PRESS

This feature allows the selection of which doors will unlock on the first press of the unlock button on the remote keyless entry transmitter. See *Remote Keyless Entry System Operation on page 2-4* for more information.

Press the option button until FOB UNLOCK ON 1ST PRESS appears on the DIC display. Press the set/reset button to scroll through the following choices:

DRIVER (default): The driver's door will unlock on the first press of the unlock button on the remote keyless entry transmitter.

ALL: All of the doors will unlock on the first press of the unlock button on the remote keyless entry transmitter.

Select one of the available choices and press the option button while it is displayed on the DIC to select it. The DIC will then display PRESS UNLOCK SWITCH ON KEY FOB. Press the unlock button on the remote keyless entry transmitter and your setting will be saved for that remote keyless entry transmitter.

After programming the last option, the message PERSONAL OPTIONS SAVED appears on the DIC display for a few seconds, then the display returns to the PERSONAL PROGRAM main screen.

Exiting the Personal Program Menu

The personal program menu will be exited when any of the following occurs:

- The vehicle is shifted out of PARK (P).
- The vehicle is no longer in RUN.
- The end of the personal program menu is reached.

Audio System(s)

Notice: Before adding any sound equipment to your vehicle, like a tape player, CB radio, mobile telephone, or two-way radio, make sure that it can be added by checking with your dealer. Also, check federal rules covering mobile radio and telephone units. If sound equipment can be added, it is very important to do it properly. Added sound equipment may interfere with the operation of your vehicle's engine, radio, or other systems, and even damage them. Your vehicle's systems may interfere with the operation of sound equipment that has been added improperly.

Figure out which audio system is in your vehicle, find out what your audio system can do, and how to operate all of its controls.

Your vehicle has a feature called Retained Accessory Power (RAP). With RAP, the audio system can be played even after the ignition is turned off. See *Retained Accessory Power (RAP)* on page 2-22 for more information.

Setting the Time

Press and hold H until the correct hour appears on the display. AM or PM will appear on the display (Radio with CD (UpLevel, MP3, and Six-Disc CD)). Press and hold M until the correct minute appears on the display. The time can be set with the ignition on or off.

Radio with CD (Base)

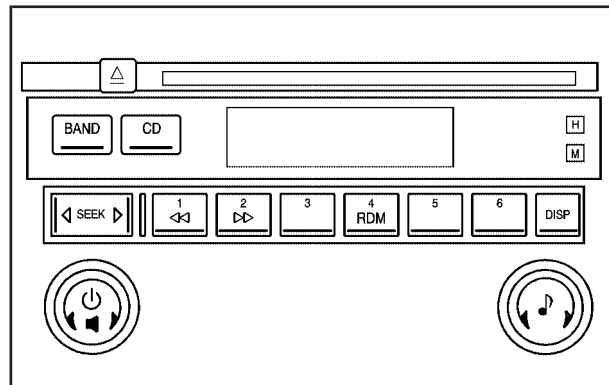

Playing the Radio

⏻ (Power): Press this knob to turn the system on and off.

🔊 (Volume): Turn this knob to increase or to decrease the volume.



DISP (Display): Press this button to switch the display between the radio station frequency, band, and time of day. When the ignition is turned off, press this knob to display the time.

To change the default on the display, press the DISP button until you see the display you want, then hold this button for two seconds. The radio will produce one beep and the selected display will now be the default.

Finding a Station

BAND: Press this button to switch between FM1, FM2, and AM. The display will show the selection.

 **(Tune):** Turn this knob to select radio stations.

 **SEEK**  : Press and release the right or the left arrow to go to the next or to the previous station and stay there.

To scan stations, press and hold either arrow for more than two seconds. SCN will appear on the display and the radio will produce one beep. The radio will go to a station, play for a few seconds, then go on to the next station. Press either arrow again or one of the pushbuttons to stop scanning presets.

To scan preset stations, press and hold either arrow for more than four seconds. PSC will appear on the display and the radio will produce two beeps. The radio will go to a preset station, play for a few seconds, then go on to the next preset station. Press either arrow again or one of the pushbuttons to stop scanning presets.

The radio will only seek and scan stations with a strong signal that are in the selected band.

Setting Preset Stations

Up to 18 stations (six FM1, six FM2, and six AM), can be programmed on the six numbered pushbuttons, by performing the following steps:

1. Turn the radio on.
2. Press BAND to select FM1, FM2, or AM.
3. Tune in the desired station.
4. Press and hold one of the six numbered pushbuttons until you hear a beep. Whenever that numbered pushbutton is pressed, the station that was set will return.
5. Repeat the steps for each pushbutton.

Setting the Tone (Bass/Treble)

 **(Bass/Treble):** Push and release this knob until BAS or TRE appears on the display. Turn this knob to increase or to decrease. The display will show the bass or the treble level. If a station is weak or noisy, decrease the treble.

To adjust the bass and the treble to the middle position, push and hold the tone knob. The radio will produce one beep.

To adjust all tone and speaker controls to the middle position, push and hold the tone knob when no tone or speaker control is displayed. CEN will appear on the display and you will hear a beep.

Adjusting the Speakers (Balance/Fade)

 **(Balance/Fade):** To adjust the balance between the right and the left speakers, push and release this knob until BAL appears on the display. Turn the knob to move the sound toward the right or the left speakers.

To adjust the fade between the front and the rear speakers, push and release the speaker knob until FAD appears on the display. Turn the knob to move the sound toward the front or the rear speakers.

To adjust the balance and the fade to the middle position, push the speaker knob, then push it again and hold it until you hear one beep.

To adjust all tone and speaker controls to the middle position, push and hold the speaker knob when no tone or speaker control is displayed. CEN will appear on the display and you will hear a beep.

Radio Messages

CAL (Calibration): The audio system has been calibrated for your vehicle from the factory. If CAL appears on the display it means that the radio has not been configured properly for your vehicle and it must be returned to your GM dealer for service.

LOC (Locked): This message is displayed when the THEFTLOCK[®] system has locked up. Take your vehicle to your GM dealer for service.

If any error occurs repeatedly or if an error cannot be corrected, contact your GM dealer.

Playing a CD

Insert a CD partway into the slot, label side up. The player will pull it in and the CD should begin playing. If you want to insert a CD with the ignition off, first press the eject button or the DISP knob.

If the ignition or radio is turned off with a CD in the player it will stay in the player. When the ignition or radio is turned on, the CD will start to play where it stopped, if it was the last selected audio source.

When the CD is inserted, CD will appear on the display. As each new track starts to play, the track number will appear on the display.

The CD player can play the smaller 3 inch (8 cm) single CDs with an adapter ring. Full-size CDs and the smaller CDs are loaded in the same manner.

If playing a CD-R the sound quality may be reduced due to CD-R quality, the method of recording, the quality of the music that has been recorded, and the way the CD-R has been handled. There may be an increase in skipping, difficulty in finding tracks, and/or difficulty in loading and ejecting. If these problems occur try a known good CD.

Do not add paper labels to CDs, they could get caught in the CD player.

If an error appears on the display, see “CD Messages” later in this section.

1 ◀◀ (Reverse): Press this button to reverse within the current track.

2 ▶▶ (Fast Forward): Press this button to fast forward within the current track.

4 RDM (Random): Press this pushbutton to hear the tracks in random, rather than sequential, order. RND will appear on the display. Press this pushbutton again to turn off random play.

◀ SEEK ▶ : Press the left arrow to go to the start of the current or the previous track. Press the right arrow to go to the start of the next track.

To scan tracks, press either arrow for more than two seconds until SCN appears on the display. The CD will search the previous or next tracks at two seconds per track. Press either arrow to stop scanning.

DISP (Display): Press this button to see how long the current track has been playing. The elapsed time of the track will appear on the display. To change the default on the display, track, elapsed time, or time of day, press this button until you see the display you want, then hold the button for two seconds. The radio will produce one beep and the selected display will now be the default.

BAND: Press this button to listen to the radio when a CD is playing. The inactive CD will remain safely inside the radio for future listening.

CD: Press this button to play a CD when listening to the radio. The CD symbol will appear on the display when a CD is loaded.

 **(Eject):** Press this button to eject a CD. Eject may be activated with either the ignition or radio off. CDs may be loaded with the ignition and radio off if this button is pressed first.

CD Messages

CHECK CD: If this message appears on the display and/or the CD comes out, it could be for one of the following reasons:

- It is very hot. When the temperature returns to normal, the CD should play.
- You are driving on a very rough road. When the road becomes smoother, the CD should play.
- The CD is dirty, scratched, wet, or upside down.
- The air is very humid. If so, wait about an hour and try again.
- There may have been a problem while burning the CD.
- The label may be caught in the CD player.

If the CD is not playing correctly, for any other reason, try a known good CD.

If any error occurs repeatedly or if an error cannot be corrected, contact your GM dealer. If the radio displays an error message, write it down and provide it to your GM dealer when reporting the problem.

Radio with CD (UpLevel)

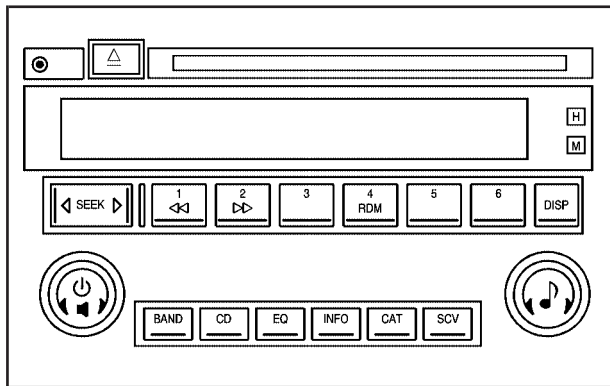

XM™ Satellite Radio Service

XM™ is a satellite radio service that is based in the 48 contiguous United States. XM™ offers 100 coast-to-coast channels including music, news, sports, talk, and children's programming. XM™ provides digital quality audio and text information that includes song title and artist name. A service fee is required in order to receive the XM™ service. For more information, contact XM™ at www.xmradio.com or call 1-800-852-XXMX (9696).

Playing the Radio

Power: Press this knob to turn the system on and off.

Volume: Turn this knob to increase or to decrease the volume.

DISP (Display): When the ignition is turned off, press this button to display the time.

For XM™ (if equipped), press the DISP button while in XM™ mode to retrieve four different categories of information related to the current song or channel: Artist, Song Title, Category or PTY, Channel Number/Channel Name.

To change the default on the display, press the DISP button until you see the display you want, then hold this button for two seconds. The radio will produce one beep and the selected display will now be the default.

SCV (Speed Compensated Volume): With SCV, the audio system adjusts automatically to make up for road and wind noise as you drive.



Set the volume at the desired level. Press this button to select SPEED VOL MIN, SPEED VOL MED, or SPEED VOL MAX. Each higher setting will allow for more volume compensation at faster vehicle speeds.

Then as you drive, SCV increases the volume, as necessary, to overcome noise at any speed. The volume level should always sound the same to you as you drive. NONE will appear on the display if the radio cannot determine the vehicle speed. To turn SCV off, press this button until SPEED VOL OFF appears on the display.

Finding a Station

BAND: Press this button to switch between FM1, FM2, AM, or XM1 or XM2 (if equipped). The display will show the selection.

 **(Tune):** Turn this knob to select radio stations.

 **SEEK**  : Press and release the right or the left arrow to go to the next or to the previous station and stay there.

To scan stations, press and hold either arrow for more than two seconds. SCAN will appear on the display and the radio will produce one beep. The radio will go to a station, play for a few seconds, then go on to the next station. Press either arrow again or one of the pushbuttons to stop scanning presets.

To scan preset stations, press and hold either arrow for more than four seconds. PSCAN will appear on the display and the radio will produce two beeps. The radio will go to a preset station, play for a few seconds, then go on to the next preset station. Press either arrow again or one of the pushbuttons to stop scanning presets.

The radio will only seek and scan stations with a strong signal that are in the selected band.

INFO (Information) (XM™ Satellite Radio Service

Only): If the current station has a message, the information symbol will appear on the display. Press this button to see the message. The message may display the artist, song title, call in phone numbers, etc.

If the entire message is not displayed, parts of the message will appear every three seconds. To scroll through the message, press and release the INFO button. A new group of words will appear on the display after every press of this button. Once the complete message has been displayed, the information symbol will disappear from the display until another new message is received. The last message can be displayed by pressing the INFO button. You can view the last message until a new message is received or a different station is tuned to.

When a message is not available from a station, NO INFO will appear on the display.

Setting Preset Stations

Up to 30 stations (six FM1, six FM2, and six AM, six XM1 and six XM2 (if equipped)), can be programmed on the six numbered pushbuttons, by performing the following steps:

1. Turn the radio on.
2. Press BAND to select FM1, FM2, AM, or XM1 or XM2.
3. Tune in the desired station.
4. Press EQ to select the equalization.
5. Press and hold one of the six numbered pushbuttons until you hear a beep. Whenever that numbered pushbutton is pressed, the station that was set will return and the equalization that was selected will be stored for that pushbutton.
6. Repeat the steps for each pushbutton.

Setting the Tone (Bass/Treble)

 **(Bass/Treble):** Push and release this knob until BASS or TREBLE appears on the display. Turn this knob to increase or to decrease. The display will show the bass or the treble level. If a station is weak or noisy, decrease the treble.

To adjust the bass and the treble to the middle position, push and hold the tone knob. The radio will produce one beep.

To adjust all tone and speaker controls to the middle position, push and hold the tone knob when no tone or speaker control is displayed. ALL CENTERED will appear on the display and you will hear a beep.

EQ (Equalization): Press this button to select customized equalization settings designed for country/western, jazz, talk, pop, rock, classical, and custom.

To return the bass and treble to the manual mode, push and release the tone knob until BASS or TREBLE appears on the display.

Adjusting the Speakers (Balance/Fade)

 **(Balance/Fade):** To adjust the balance between the right and the left speakers, push and release this knob until BAL appears on the display. Turn the knob to move the sound toward the right or the left speakers.

To adjust the fade between the front and the rear speakers, push and release the speaker knob until FAD appears on the display. Turn the knob to move the sound toward the front or the rear speakers.

To adjust the balance and the fade to the middle position, push the speaker knob, then push it again and hold it until you hear one beep.

To adjust all tone and speaker controls to the middle position, push and hold the speaker knob when no tone or speaker control is displayed. ALL CENTERED will appear on the display and you will hear a beep.

Finding a Category (CAT) Station (XM™ Satellite Radio Service Only)

To select and find a desired category perform the following:

1. Press the CAT button to activate category select mode. The current category will appear on the display.
2. Turn the tune knob to select a category.
3. Once the desired category is displayed, press either SEEK arrow to take you to the categories first station.
4. To go to another station within that category and the category is displayed, press either SEEK arrow again. If CAT times out and is no longer on the display, go back to Step 1.
5. Press CAT to exit category select mode or wait for CAT to time out.

If the radio cannot find the desired category, NOT FOUND will appear on the display and the radio will return to the last station you were listening to.

Scanning Categories (CAT) (XM™ Satellite Radio Service Only)

To scan a desired category perform the following:

1. Press the CAT button to activate category select mode. The current category will appear on the display.
2. Turn the tune knob to select a category.
3. Once the desired category is displayed, press either SEEK arrow for two seconds to scan the stations in the category.
4. Press either SEEK arrow again to stop scanning.

If the radio cannot find the desired category, NOT FOUND will appear on the display and the radio will return to the last station you were listening to.

Radio Messages

CALIBRATE: The audio system has been calibrated for your vehicle from the factory. If CALIBRATE appears on the display it means that the radio has not been configured properly for your vehicle and it must be returned to your GM dealer for service.

LOCKED: This message is displayed when the THEFTLOCK® system has locked up. Take your vehicle to your GM dealer for service.

If any error occurs repeatedly or if an error cannot be corrected, contact your GM dealer.

XM™ Radio Messages

Radio Display Message	Condition	Action Required
XL (Explicit Language Channels)	XL on the radio display, after the channel name, indicates content with explicit language	These channels, or any others, can be blocked at a customer's request, by calling 1-800-852-XXXM (9696).
Updating	Updating encryption code	The encryption code in the receiver is being updated, and no action is required. This process should take no longer than 30 seconds.
No Signl	Loss of signal	The system is functioning correctly, but the vehicle is in a location that is blocking the XM™ signal. When the vehicle is moved into an open area, the signal should return.
Loading	Acquiring channel audio (after 4 second delay)	The radio system is acquiring and processing audio and text data. No action is needed. This message should disappear shortly.
Off Air	Channel not in service	This channel is not currently in service. Tune to another channel.
CH Unavl	Channel no longer available	This previously assigned channel is no longer assigned. Tune to another station. If this station was one of the presets, choose another station for that preset button.
No Info	Artist Name/Feature not available	No artist information is available at this time on this channel. The system is working properly.
No Info	Song/Program Title not available	No song title information is available at this time on this channel. The system is working properly.

XM™ Radio Messages (cont'd)

Radio Display Message	Condition	Action Required
No Info	Category Name not available	No category information is available at this time on this channel. The system is working properly.
No Info	No Text/Informational message available	No text or informational messages are available at this time on this channel. The system is working properly.
Not Found	No channel available for the chosen category	There are no channels available for the selected category. The system is working properly.
XM Lock	Theft lock active	The XM™ receiver in your vehicle may have previously been in another vehicle. For security purposes, XM™ receivers cannot be swapped between vehicles. If this message is received after having your vehicle serviced, check with your GM dealer.
Radio ID	Radio ID label (channel 0)	If tuned to channel 0, this message will alternate with the XM™ Radio eight-digit radio ID label. This label is needed to activate the service.
Unknown	Radio ID not known (should only be if hardware failure)	If this message is received when tuned to channel 0, there may be a receiver fault. Consult with your GM dealer.
Check XM	Hardware failure	If this message does not clear within a short period of time, the receiver may have a fault. Consult with your GM dealer.

Playing a CD

Insert a CD partway into the slot, label side up. The player will pull it in and the CD should begin playing. If you want to insert a CD with the ignition off, first press the eject button or the DISP knob.

If the ignition or radio is turned off with a CD in the player it will stay in the player. When the ignition or radio is turned on, the CD will start to play where it stopped, if it was the last selected audio source.

When the CD is inserted, the CD symbol will appear on the display. As each new track starts to play, the track number will appear on the display.

The CD player can play the smaller 3 inch (8 cm) single CDs with an adapter ring. Full-size CDs and the smaller CDs are loaded in the same manner.

If playing a CD-R the sound quality may be reduced due to CD-R quality, the method of recording, the quality of the music that has been recorded, and the way the CD-R has been handled. There may be an increase in skipping, difficulty in finding tracks, and/or difficulty in loading and ejecting. If these problems occur try a known good CD.



Do not add paper labels to CDs, they could get caught in the CD player.

If an error appears on the display, see "CD Messages" later in this section.

1  **(Reverse):** Press this pushbutton to go to the start of the current track if more than eight seconds have played. The reverse symbol and the track number will appear on the display. If this pushbutton is held or pressed more than once, the player will continue moving backward through the CD.

2  **(Fast Forward):** Press this pushbutton to go to the next track. The fast forward symbol and the track number will appear on the display. If this pushbutton is held or pressed more than once, the player will continue moving forward through the CD.

4 **RDM (Random):** Press this pushbutton to hear the tracks in random, rather than sequential, order. The random symbol will appear on the display. Press this pushbutton again to turn off random play.

 **SEEK**  : Press the left arrow to go to the start of the current or the previous track. Press the right arrow to go to the start of the next track. Pressing either arrow for more than two seconds will search the previous or next tracks at two tracks per second. Release the arrow to stop searching and to play the track.

To scan tracks, press either arrow for more than two seconds until SCAN appears on the display. The CD will search the previous or next tracks at two seconds per track. Press either arrow to stop scanning.

DISP (Display): Press this button to see how long the current track has been playing. The elapsed time of the track will appear on the display. To change the default on the display, track or elapsed time, press this button until you see the display you want, then hold the button for two seconds. The radio will produce one beep and the selected display will now be the default.

BAND: Press this button to listen to the radio when a CD is playing. The inactive CD will remain safely inside the radio for future listening.

CD: Press this button to play a CD when listening to the radio. The CD symbol will appear on the display when a CD is loaded.

EQ (Equalization): Press EQ to select an equalization setting while playing a CD. The equalization will be set whenever a CD is played. See “EQ” listed previously for more information. If you select an EQ setting for your CD, it will be activated each time you play a CD.

 **(Eject):** Press this button to eject a CD. Eject may be activated with either the ignition or radio off. CDs may be loaded with the ignition and radio off if this button is pressed first.

CD Messages

CHECK CD: If this message appears on the display and/or the CD comes out, it could be for one of the following reasons:

- It is very hot. When the temperature returns to normal, the CD should play.
- You are driving on a very rough road. When the road becomes smoother, the CD should play.
- The CD is dirty, scratched, wet, or upside down.
- The air is very humid. If so, wait about an hour and try again.
- There may have been a problem while burning the CD.
- The label may be caught in the CD player.

If the CD is not playing correctly, for any other reason, try a known good CD.

If any error occurs repeatedly or if an error cannot be corrected, contact your GM dealer. If the radio displays an error message, write it down and provide it to your GM dealer when reporting the problem.

Radio with CD (MP3)

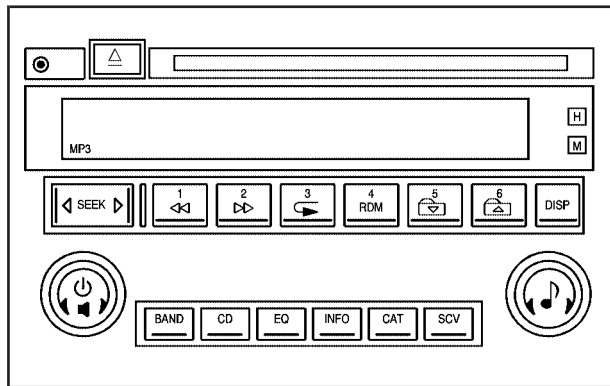

XM™ Satellite Radio Service

XM™ is a satellite radio service that is based in the 48 contiguous United States. XM™ offers 100 coast-to-coast channels including music, news, sports, talk, and children's programming. XM™ provides digital quality audio and text information that includes song title and artist name. A service fee is required in order to receive the XM™ service. For more information, contact XM™ at www.xmradio.com or call 1-800-852-XMXX (9696).

Playing the Radio

Power: Press this knob to turn the system on and off.

Volume: Turn this knob to increase or to decrease the volume.

DISP (Display): Press this button to switch the display between the radio station frequency and time of day. When the ignition is turned off, press this knob to display the time.

For XM™ (if equipped), press the DISP button while in XM™ mode to retrieve four different categories of information related to the current song or channel: Artist, Song Title, Category or PTY, Channel Number/Channel Name.

To change the default on the display, press the DISP button until you see the display you want, then hold this knob for two seconds. The radio will produce one beep and the selected display will now be the default.



SCV (Speed Compensated Volume): With SCV, the audio system adjusts automatically to make up for road and wind noise as you drive.

Set the volume at the desired level. Press this button to select LOW, MEDIUM, or HIGH. Each higher setting will allow for more volume compensation at faster vehicle speeds. Then as you drive, SCV increases the volume, as necessary, to overcome noise at any speed. The volume level should always sound the same to you as you drive. NONE will appear on the display if the radio cannot determine the vehicle speed. To turn SCV off, press this button until OFF appears on the display.

Finding a Station

BAND: Press this button to switch between FM1, FM2, AM, or XM1 or XM2 (if equipped). The display will show the selection.

 **(Tune):** Turn this knob to select radio stations.

 **SEEK**  : Press and release the right or the left arrow to go to the next or to the previous station and stay there.

To scan stations, press and hold either arrow for more than two seconds. SCAN will appear on the display and the radio will produce one beep. The radio will go to a station, play for a few seconds, then go on to the next station. Press either arrow again or one of the pushbuttons to stop scanning presets.

To scan preset stations, press and hold either arrow for more than four seconds. PSCAN will appear on the display and the radio will produce two beeps. The radio will go to a preset station, play for a few seconds, then go on to the next preset station. Press either arrow again or one of the pushbuttons to stop scanning presets.

The radio will only seek and scan stations with a strong signal that are in the selected band.

INFO (Information) (XM™ Satellite Radio Service

Only): If the current station has a message, the information symbol will appear on the display. Press this button to see the message. The message may display the artist, song title, call in phone numbers, etc.

If the entire message is not displayed, parts of the message will appear every three seconds. To scroll through the message, press and release the INFO button. A new group of words will appear on the display after every press of this button. Once the complete message has been displayed, the information symbol will disappear from the display until another new message is received. The last message can be displayed by pressing the INFO button. You can view the last message until a new message is received or a different station is tuned to.

When a message is not available from a station, NO INFO will appear on the display.

Setting Preset Stations

Up to 30 stations (six FM1, six FM2, and six AM, six XM1 and six XM2 (if equipped)), can be programmed on the six numbered pushbuttons, by performing the following steps:

1. Turn the radio on.
2. Press BAND to select FM1, FM2, AM, or XM1 or XM2.
3. Tune in the desired station.
4. Press EQ to select the equalization.
5. Press and hold one of the six numbered pushbuttons until you hear a beep. Whenever that numbered pushbutton is pressed, the station that was set will return and the equalization that was selected will be stored for that pushbutton.
6. Repeat the steps for each pushbutton.

Setting the Tone (Bass/Treble)

 **(Bass/Treble):** Push and release this knob until BASS or TREBLE appears on the display. Turn this knob to increase or to decrease. The display will show the bass or the treble level. If a station is weak or noisy, decrease the treble.

To adjust the bass and the treble to the middle position, push and hold the tone knob. The radio will produce one beep.

To adjust all tone and speaker controls to the middle position, push and hold the tone knob when no tone or speaker control is displayed. ALL CENTERED will appear on the display and you will hear a beep.

EQ (Equalization): Press this button to select customized equalization settings designed for country/western, jazz, talk, pop, rock, classical, and custom.

To return the bass and treble to the manual mode, push and release the tone knob until BASS or TREBLE appears on the display.

Adjusting the Speakers (Balance/Fade)

 **(Balance/Fade):** To adjust the balance between the right and the left speakers, push and release this knob until BAL appears on the display. Turn the knob to move the sound toward the right or the left speakers.

To adjust the fade between the front and the rear speakers, push and release the speaker knob until FAD appears on the display. Turn the knob to move the sound toward the front or the rear speakers.

To adjust the balance and the fade to the middle position, push the speaker knob, then push it again and hold it until you hear one beep.

To adjust all tone and speaker controls to the middle position, push and hold the speaker knob when no tone or speaker control is displayed. ALL CENTERED will appear on the display and you will hear a beep.

Finding a Category (CAT) Station (XM™ Satellite Radio Service Only)

To select and find a desired category perform the following:

1. Press the CAT button to activate category select mode. The current category will appear on the display.
2. Turn the tune knob to select a category.
3. Once the desired category is displayed, press either SEEK arrow to take you to the categories first station.
4. To go to another station within that category and the category is displayed, press either SEEK arrow again. If CAT times out and is no longer on the display, go back to Step 1.
5. Press CAT to exit category select mode or wait for CAT to time out.

If the radio cannot find the desired category, NOT FOUND will appear on the display and the radio will return to the last station you were listening to.

Scanning Categories (CAT) (XM™ Satellite Radio Service Only)

To scan a desired category perform the following:

1. Press the CAT button to activate category select mode. The current category will appear on the display.
2. Turn the tune knob to select a category.
3. Once the desired category is displayed, press either SEEK arrow for two seconds to scan the stations in the category.
4. Press either SEEK arrow again to stop scanning.

If the radio cannot find the desired category, NOT FOUND will appear on the display and the radio will return to the last station you were listening to.

Radio Messages

CALIBRATE: The audio system has been calibrated for your vehicle from the factory. If CALIBRATE appears on the display it means that the radio has not been configured properly for your vehicle and it must be returned to your GM dealer for service.

LOCKED: This message is displayed when the THEFTLOCK® system has locked up. Take your vehicle to your GM dealer for service.

If any error occurs repeatedly or if an error cannot be corrected, contact your GM dealer.

XM™ Radio Messages

Radio Display Message	Condition	Action Required
XL (Explicit Language Channels)	XL on the radio display, after the channel name, indicates content with explicit language	These channels, or any others, can be blocked at a customer's request, by calling 1-800-852-XXXM (9696).
Updating	Updating encryption code	The encryption code in the receiver is being updated, and no action is required. This process should take no longer than 30 seconds.
No Signl	Loss of signal	The system is functioning correctly, but the vehicle is in a location that is blocking the XM™ signal. When the vehicle is moved into an open area, the signal should return.
Loading	Acquiring channel audio (after 4 second delay)	The radio system is acquiring and processing audio and text data. No action is needed. This message should disappear shortly.
Off Air	Channel not in service	This channel is not currently in service. Tune to another channel.
CH Unavl	Channel no longer available	This previously assigned channel is no longer assigned. Tune to another station. If this station was one of the presets, choose another station for that preset button.
No Info	Artist Name/Feature not available	No artist information is available at this time on this channel. The system is working properly.
No Info	Song/Program Title not available	No song title information is available at this time on this channel. The system is working properly.

XM™ Radio Messages (cont'd)

Radio Display Message	Condition	Action Required
No Info	Category Name not available	No category information is available at this time on this channel. The system is working properly.
No Info	No Text/Informational message available	No text or informational messages are available at this time on this channel. The system is working properly.
Not Found	No channel available for the chosen category	There are no channels available for the selected category. The system is working properly.
XM Lock	Theft lock active	The XM™ receiver in your vehicle may have previously been in another vehicle. For security purposes, XM™ receivers cannot be swapped between vehicles. If this message is received after having your vehicle serviced, check with your GM dealer.
Radio ID	Radio ID label (channel 0)	If tuned to channel 0, this message will alternate with the XM™ Radio eight-digit radio ID label. This label is needed to activate the service.
Unknown	Radio ID not known (should only be if hardware failure)	If this message is received when tuned to channel 0, there may be a receiver fault. Consult with your GM dealer.
Check XM	Hardware failure	If this message does not clear within a short period of time, the receiver may have a fault. Consult with your GM dealer.

Playing a CD

Insert a CD partway into the slot, label side up. The player will pull it in and the CD should begin playing. If you want to insert a CD with the ignition off, first press the eject button or the DISP knob.

If the ignition or radio is turned off with a CD in the player it will stay in the player. When the ignition or radio is turned on, the CD will start to play where it stopped, if it was the last selected audio source.

When the CD is inserted, the CD symbol will appear on the display. As each new track starts to play, the track number will appear on the display.

The CD player can play the smaller 3 inch (8 cm) single CDs with an adapter ring. Full-size CDs and the smaller CDs are loaded in the same manner.

If playing a CD-R the sound quality may be reduced due to CD-R quality, the method of recording, the quality of the music that has been recorded, and the way the CD-R has been handled. There may be an increase in skipping, difficulty in finding tracks, and/or difficulty in loading and ejecting. If these problems occur try a known good CD.

Do not add paper labels to CDs, they could get caught in the CD player.

If an error appears on the display, see “CD Messages” later in this section.

1  **(Reverse):** Press this button to reverse within the current track.

2  **(Fast Forward):** Press this button to fast forward within the current track.

3  **(Repeat):** Press this pushbutton to hear a track over again. REPEAT TRACK will appear on the display. The current track will continue to repeat. Press this pushbutton again to turn off repeat play.

4 **RDM (Random):** Press this pushbutton to hear the tracks in random, rather than sequential, order. RANDOM ON will appear on the display. Press this pushbutton again to turn off random play.

◀ **SEEK** ▶ : Press the left arrow to go to the start of the current or the previous track. Press the right arrow to go to the start of the next track.

To scan tracks, press and hold either arrow for more than two seconds. SCAN will appear on the display. The CD will search the previous or next tracks at two seconds per track. Press either arrow to stop scanning.

DISP (Display): Press this button to see how long the current track has been playing. The elapsed time of the track will appear on the display. To change the default on the display, track or elapsed time, press this button until you see the display you want, then hold the button for two seconds. The radio will produce one beep and the selected display will now be the default.

BAND: Press this button to listen to the radio when a CD is playing. The inactive CD will remain safely inside the radio for future listening.

CD: Press this button to play a CD when listening to the radio. The CD symbol will appear on the display when a CD is loaded.

EQ (Equalization): Press EQ to select an equalization setting while playing a CD. The equalization will be set whenever a CD is played. See “EQ” listed previously for more information. If you select an EQ setting for your CD, it will be activated each time you play a CD.

⏏ (**Eject**): Press this button to eject a CD. Eject may be activated with either the ignition or radio off. CDs may be loaded with the ignition and radio off if this button is pressed first.

Using an MP3 CD MP3 Format

This MP3 player will accept MP3 files that were recorded on an up to 700 MB CD-R CD. The files can be recorded with the following fixed bit rates: 32 kpbs, 40 kpbs, 56 kpbs, 64 kpbs, 80 kpbs, 96 kpbs, 112 kpbs, 128 kpbs, 160 kpbs, 192 kpbs, 224 kpbs, 256 kpbs, and 320 kpbs or a variable bit rate. Song title, artist name, and album will be available when recorded using ID3 tags versions 1 and 2.

The player will be able to read and play a maximum of 50 folders, 50 playlists, 10 sessions, and 255 files. Long file, folder, or playlist names or a combination of a large number of files and folders or playlists may cause the player to be unable to play up to the maximum number of files, folders, playlists, or sessions. If you wish to play large numbers of files, folders, playlists or sessions minimize the length of the file, folder or playlist name. You can also play an MP3 CD that was recorded using no file folders. The system can support up to 11 folders in depth, though, keep the depth of the folders to a minimum in order to keep down the complexity and confusion in trying to locate a particular folder during playback. If a CD contains more than the maximum of 50 folders, 50 playlists, 10 sessions, and 255 files the player will let you access and navigate up to the maximum, but all items over the maximum will be ignored.

Root Directory

The root directory will be treated as a folder. If the root directory has compressed audio files, the directory will be displayed as F1 ROOT. All files contained directly under the root directory will be accessed prior to any root directory folders. However, playlists (Px) will always be accessed before root folders or files.

Empty Directory or Folder

If a root directory or a folder exists somewhere in the file structure that contains only folders/subfolders and no compressed files directly beneath them, the player will advance to the next folder in the file structure that contains compressed audio files and the empty folder will not be displayed or numbered.

No Folder

When the CD contains only compressed files, the files will be located under the root folder. The next and previous folder functions will have no function on a CD that was recorded without folders or playlists. When displaying the name of the folder the radio will display ROOT.

When the CD contains only playlists and compressed audio files, but no folders, all files will be located under the root folder. The folder down and the folder up buttons will search playlists (Px) first and then go to the root folder. When the radio displays the name of the folder the radio will display ROOT.

Order of Play

Tracks will be played in the following order:

- Play will begin from the first track in the first playlist and will continue sequentially through all tracks in each playlist. When the last track of the last playlist has been played, play will continue from the first track of the first playlist.
- If the CD does not contain any playlists, then play will begin from the first track under the root directory. When all tracks from the root directory have been played, play will continue from files according to their numerical listing. After playing the last track from the last folder, play will begin again at the first track of the first folder or root directory.

When play enters a new folder, the display will not automatically show the new folder name unless you have chosen the folder mode as the default display. See DISP later in this section for more information. The new track name will appear on the display.

File System and Naming

The song name that will be displayed will be the song name that is contained in the ID3 tag. If the song name is not present in the ID3 tag, then the radio will display the file name without the extension (such as .mp3) as the track name.

Track names longer than 32 characters or four pages will be shortened. The display will not show parts of words on the last page of text and the extension of the filename will not be displayed.

Preprogrammed Playlists

You can access preprogrammed playlists which were created by WinAmp™, MusicMatch™, or Real Jukebox™ software, however, you will not have editing capability. These playlists will be treated as special folders containing compressed audio song files.

Playing an MP3

Insert a CD partway into the slot, label side up. The player will pull it in, and READING DISC will appear on the display. The CD should begin playing and the CD symbol will appear on the display. If you want to insert a CD with the ignition off, first press the eject button or the DISP knob.

If the ignition or radio is turned off with a CD in the player it will stay in the player. When the ignition or radio is turned on, the CD will start to play where it stopped, if it was the last selected audio source.

The CD player can play the smaller 3 inch (8 cm) single CDs with an adapter ring. Full-size CDs and the smaller CDs are loaded in the same manner.

If playing a CD-R the sound quality may be reduced due to CD-R quality, the method of recording, the quality of the music that has been recorded, and the way the CD-R has been handled. There may be an increase in skipping, difficulty in finding tracks, and/or difficulty in loading and ejecting. If these problems occur try a known good CD.

Do not add paper labels to CDs, they could get caught in the CD player.

If an error appears on the display, see “CD Messages” later in this section.

1  **(Reverse):** Press this button to reverse within the current track.

2  **(Fast Forward):** Press this button to fast forward within the current track.

3  **(Repeat):** With repeat, one track, the entire folder, or playlist can be repeated.

Press and release this pushbutton until REPEAT TRACK, REPEAT FOLDER, or REPEAT P-LIST appears on the display. The current track, folder or playlist will continue to repeat. Press and release this pushbutton until REPEAT OFF appears on the display to turn off repeated play.

4 RDM (Random): Press this pushbutton to hear tracks in random, rather than sequential order. You can random the entire folder, playlist, or CD.

Press and release this pushbutton until RANDOM FOLDER, RANDOM P-LIST, or RANDOM DISC appears on the display. Once all of the tracks in the current folder or playlist have been played the system will move on to the next folder or playlist and play all of the tracks in random order.

When in random, pressing and releasing either SEEK arrow will take you to the next or previous random track.

Press and release this pushbutton until RANDOM OFF appears on the display, to turn off random play.

5  **(Previous Folder):** Press this pushbutton to go to the first track in the previous folder. Pressing this button while in folder random mode will take you to the previous folder and random the tracks in that folder.

6  **(Next Folder):** Press this pushbutton to go to the first track in the next folder. Pressing this button while in folder random mode will take you to the next folder and random the tracks in that folder.

◀ **SEEK** ▶ : Press the left arrow to go to the start of the previous track. Press the right arrow to go to the start of the next track.

To scan tracks, press either arrow for more than two seconds until SCAN appears on the display. The CD will search the previous or next tracks at two seconds per track. Press either arrow to stop scanning.

DISP (Display): Press this button to switch between track mode, folder/playlist mode, and ID3 tag. The display will show only eight characters, but there can be up to four pages of text. If there are more than eight characters in the song, folder, or playlist name, pressing this knob within two seconds will take you to the next page of text. If there are no other pages to be shown, pressing this button within two seconds will take you to the next display mode.

- Song name and time of day mode will display the current song name and time of day.
- Folder/playlist mode will display the current folder or playlist number the track number and the elapsed time of the track.
- Song name and track number mode will display the current song name and track number.
- ID3 Tag and folder mode will display the ID3 tag information and the folder number.
- Song and folder mode will display the number of songs in the folder and the folder number.

To change the default on the display, press the DISP knob until you see the display you want, then hold this knob for two seconds. The radio will produce one beep and the selected display will now be the default.

INFO (Information): INFO will appear on the display whenever a current track has ID3 tag information. Press this button to display the artist name and album contained in the tag.

BAND: Press this button to listen to the radio when a CD is playing. The inactive CD will remain safely inside the radio for future listening.

CD: Press this button to play a CD when listening to the radio. The CD symbol will appear on the display when a CD is loaded.

EQ (Equalization): Press EQ to select an equalization setting while playing a CD. The equalization will be set whenever a CD is played. See “EQ” listed previously for more information. If you select an EQ setting for your CD, it will be activated each time you play a CD.

⏏ (Eject): Press this button to eject a CD. Eject may be activated with either the ignition or radio off. CDs may be loaded with the ignition and radio off if this button is pressed first.

CD Messages

CHECK CD: If this message appears on the display and/or the CD comes out, it could be for one of the following reasons:

- It is very hot. When the temperature returns to normal, the CD should play.
- You are driving on a very rough road. When the road becomes smoother, the CD should play.
- The CD is dirty, scratched, wet, or upside down.
- The air is very humid. If so, wait about an hour and try again.
- The format of the CD may not be compatible. See “MP3 Format” earlier in this section.
- There may have been a problem while burning the CD.
- The label may be caught in the CD player.

If the CD is not playing correctly, for any other reason, try a known good CD.

If any error occurs repeatedly or if an error cannot be corrected, contact your GM dealer. If the radio displays an error message, write it down and provide it to your GM dealer when reporting the problem.

Radio with Six-Disc CD

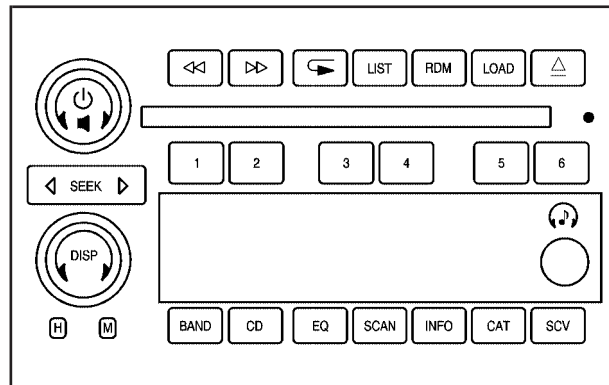

XM™ Satellite Radio Service

XM™ is a satellite radio service that is based in the 48 contiguous United States. XM™ offers 100 coast-to-coast channels including music, news, sports, talk, and children's programming. XM™ provides digital quality audio and text information that includes song title and artist name. A service fee is required in order to receive the XM™ service. For more information, contact XM™ at www.xmradio.com or call 1-800-852-XXXM (9696).

Playing the Radio

 **(Power):** Press this knob to turn the system on and off.

 **(Volume):** Turn this knob to increase or to decrease the volume.

DISP (Display): When the ignition is turned off, press this knob to display the time.

For XM™ (if equipped), press the DISP knob while in XM™ mode to retrieve four different categories of information related to the current song or channel: Artist, Song Title, Category or PTY, Channel Number/Channel Name.

To change the default on the display, press the DISP knob until you see the display you want, then hold this knob for two seconds. The radio will produce one beep and the selected display will now be the default.



SCV (Speed Compensated Volume): With SCV, the audio system adjusts automatically to make up for road and wind noise as you drive.

Set the volume at the desired level. Press this button to select LOW, MEDIUM, or HIGH. Each higher setting will allow for more volume compensation at faster vehicle speeds. Then as you drive, SCV increases the volume, as necessary, to overcome noise at any speed. The volume level should always sound the same to you as you drive. To turn SCV off, press this button until OFF appears on the display.

Finding a Station

BAND: Press this button to switch between FM1, FM2, AM, or XM1 or XM2 (if equipped). The display will show the selection.

 **(Tune):** Turn this knob to select radio stations.

 **SEEK**  : Press and release the right or the left arrow to go to the next or to the previous station and stay there.

To scan radio stations, press and hold either arrow for more than two seconds. SCAN will appear on the display and the radio will produce one beep. The radio will go to a station, play for a few seconds, then go on to the next station. Press either arrow again or one of the pushbuttons to stop scanning presets.

To scan the preset stations, press and hold either arrow for more than four seconds. PSC will appear on the display and the radio will produce two beeps. The radio will go to a preset station, play for a few seconds, then go on to the next preset station. Press either arrow again or one of the pushbuttons to stop scanning presets.

The radio will only seek and scan stations with a strong signal that are in the selected band.

SCAN: Press this button until SC appears on the display. The radio will go to a station, play for a few seconds, then go on to the next station. Press this button again to stop scanning stations.

The radio will only scan stations with a strong signal that are in the selected band.

INFO (Information) (XM™ Satellite Radio Service Only): If the current station has a message, the information symbol will appear on the display. Press this button to see the message. The message may display the artist, song title, call in phone numbers, etc.

If the entire message is not displayed, parts of the message will appear every three seconds. To scroll through the message, press and release the INFO button. A new group of words will appear on the display after every press of this button. Once the complete message has been displayed, the information symbol

will disappear from the display until another new message is received. The last message can be displayed by pressing the INFO button. You can view the last message until a new message is received or a different station is tuned to.

When a message is not available from a station, NO INFO will appear on the display.

Setting Preset Stations

Up to 30 stations (six FM1, six FM2, and six AM, six XM1 and six XM2 (if equipped)), can be programmed on the six numbered pushbuttons, by performing the following steps:

1. Turn the radio on.
2. Press BAND to select FM1, FM2, AM, or XM1 or XM2.
3. Tune in the desired station.
4. Press EQ to select the equalization.
5. Press and hold one of the six numbered pushbuttons until you hear a beep. Whenever that numbered pushbutton is pressed, the station that was set will return and the equalization that was selected will be stored for that pushbutton.
6. Repeat the steps for each pushbutton.

Setting the Tone (Bass/Treble)

 **(Bass/Treble):** Push and release this knob until BASS or TREB appears on the display. Turn this knob to increase or to decrease. The display will show the bass or the treble level. If a station is weak or noisy, decrease the treble.

To adjust the bass and the treble to the middle position, push and hold the tone knob. The radio will produce one beep.

To adjust all tone and speaker controls to the middle position, push and hold the tone knob when no tone or speaker control is displayed. ALL CENTERED will appear on the display and you will hear a beep.

EQ (Equalization): Press this button to select customized equalization settings designed for country/western, jazz, talk, pop, rock, classical, and custom.

To return the bass and treble to the manual mode, push and release the tone knob until BASS or TREBLE appears on the display.

Adjusting the Speakers (Balance/Fade)

 **(Balance/Fade):** To adjust the balance between the right and the left speakers, push and release this knob until BAL appears on the display. Turn the knob to move the sound toward the right or the left speakers.

To adjust the fade between the front and the rear speakers, push and release the speaker knob until FADE appears on the display. Turn the knob to move the sound toward the front or the rear speakers.

To adjust the balance and the fade to the middle position, push the speaker knob, then push it again and hold it until you hear one beep.

To adjust all tone and speaker controls to the middle position, push and hold the speaker knob when no tone or speaker control is displayed. CEN will appear on the display and you will hear a beep.

Finding a Category (CAT) Station (XM™ Satellite Radio Service Only)

To select and find a desired category perform the following:

1. Press the CAT button to activate category select mode. The current category will appear on the display.
2. Turn the tune knob to select a category.
3. Once the desired category is displayed, press either SEEK arrow to take you to the categories first station.
4. To go to another station within that category and the category is displayed, press either SEEK arrow again. If CAT times out and is no longer on the display, go back to Step 1.
5. Press CAT to exit category select mode or wait for CAT to time out.

If the radio cannot find the desired category, NOT FOUND will appear on the display and the radio will return to the last station you were listening to.

Scanning Categories (CAT) (XM™ Satellite Radio Service Only)

To scan a desired category perform the following:

1. Press the CAT button to activate category select mode. The current category will appear on the display.
2. Turn the tune knob to select a category.
3. Once the desired category is displayed, press either SEEK arrow for two seconds to scan the stations in the category.
4. Press either SEEK arrow again to stop scanning.

If the radio cannot find the desired category, NOT FOUND will appear on the display and the radio will return to the last station you were listening to.

Radio Messages

CALIBRATE: The audio system has been calibrated for your vehicle from the factory. If CALIBRATE appears on the display it means that the radio has not been configured properly for your vehicle and it must be returned to your GM dealer for service.

LOCKED: This message is displayed when the THEFTLOCK® system has locked up. Take your vehicle to your GM dealer for service.

If any error occurs repeatedly or if an error cannot be corrected, contact your GM dealer.

XM™ Radio Messages

Radio Display Message	Condition	Action Required
XL (Explicit Language Channels)	XL on the radio display, after the channel name, indicates content with explicit language	These channels, or any others, can be blocked at a customer's request, by calling 1-800-852-XXXM (9696).
Updating	Updating encryption code	The encryption code in the receiver is being updated, and no action is required. This process should take no longer than 30 seconds.
No Signl	Loss of signal	The system is functioning correctly, but the vehicle is in a location that is blocking the XM™ signal. When the vehicle is moved into an open area, the signal should return.
Loading	Acquiring channel audio (after 4 second delay)	The radio system is acquiring and processing audio and text data. No action is needed. This message should disappear shortly.
Off Air	Channel not in service	This channel is not currently in service. Tune to another channel.
CH Unavl	Channel no longer available	This previously assigned channel is no longer assigned. Tune to another station. If this station was one of the presets, choose another station for that preset button.
No Info	Artist Name/Feature not available	No artist information is available at this time on this channel. The system is working properly.
No Info	Song/Program Title not available	No song title information is available at this time on this channel. The system is working properly.

XM™ Radio Messages (cont'd)

Radio Display Message	Condition	Action Required
No Info	Category Name not available	No category information is available at this time on this channel. The system is working properly.
No Info	No Text/Informational message available	No text or informational messages are available at this time on this channel. The system is working properly.
Not Found	No channel available for the chosen category	There are no channels available for the selected category. The system is working properly.
XM Lock	Theft lock active	The XM™ receiver in your vehicle may have previously been in another vehicle. For security purposes, XM™ receivers cannot be swapped between vehicles. If this message is received after having your vehicle serviced, check with your GM dealer.
Radio ID	Radio ID label (channel 0)	If tuned to channel 0, this message will alternate with the XM™ Radio eight-digit radio ID label. This label is needed to activate the service.
Unknown	Radio ID not known (should only be if hardware failure)	If this message is received when tuned to channel 0, there may be a receiver fault. Consult with your GM dealer.
Check XM	Hardware failure	If this message does not clear within a short period of time, the receiver may have a fault. Consult with your GM dealer.

Playing a CD

If the ignition or radio is turned off, with a CD in the player, it will stay in the player. When the ignition or radio is turned on, the CD will start playing where it stopped, if it was the last selected audio source.

When a CD is inserted, the CD symbol will appear on the CD. As each new track starts to play, the track number will appear on the display.

The CD player can play the smaller 3 inch (8 cm) single CDs with an adapter ring. Full-size CDs and the smaller CDs are loaded in the same manner.

If playing a CD-R the sound quality may be reduced due to CD-R quality, the method of recording, the quality of the music that has been recorded, and the way the CD-R has been handled. There may be an increase in skipping, difficulty in finding tracks, and/or difficulty in loading and ejecting. If these problems occur try a known good CD.

Do not add paper labels to CDs, they could get caught in the CD player.

If an error appears on the display, see "CD Messages" later in this section.

LOAD: Press this button to load CDs into the CD player. This CD player will hold up to six CDs.

To insert one CD, do the following:

1. Turn the ignition on.
2. Press and release the LOAD button.
3. Wait for the indicator light, located to the right of the slot, to turn green.
4. Load a CD. Insert the CD partway into the slot, label side up. The player will pull the CD in.

To insert multiple CDs, do the following:

1. Turn the ignition on.
2. Press and hold the LOAD button for two seconds.
You will hear a beep and the indicator light, located to the right of the slot, will begin to flash and MULTI LOAD # will appear on the display.

3. Once the light stops flashing and turns green, INSERT CD # will appear on the display, load a CD. Insert the CD partway into the slot, label side up. The player will pull the CD in. Once the CD is loaded, the indicator light will begin flashing again. Once the light stops flashing and turns green, you can load another CD. The CD player takes up to six CDs. Do not try to load more than six.

To load more than one CD but less than six, complete Steps 1 through 3. When finished loading CDs, press the LOAD button to cancel the loading function. The radio will begin to play the last CD loaded.

If more than one CD has been loaded, a number for each CD will appear on the display.

Playing a Specific Loaded CD

For every CD loaded, a number will appear on the display. To play a specific CD, press the numbered pushbutton that corresponds to the CD. A small bar will appear under the CD number that is playing and the track number will appear on the display.

If an error appears on the display, see “CD Messages” later in this section.

 **(Eject):** Press this button to eject CD(s).

To eject the CD that is currently playing, press and release this button.

To eject multiple CDs, do the following:

1. Press and hold the CD eject button for two seconds. You will hear a beep and the indicator light, located to the right of the slot, will begin to flash and EJECT ALL will appear on the display.
2. Once the light stops flashing, REMOVE CD # will appear on the display. The CD will eject and can be removed.

Once the CD is removed, the indicator light will begin flashing again and another CD will eject.

To stop ejecting the CDs, press the LOAD or the eject button.

If the CD is not removed, after 25 seconds, the CD will be automatically pulled back into the player. If CD is pushed back into the player, before the 25 second time period is complete, the player will sense an error and will try to eject the CD several times before stopping.

Do not repeatedly press the CD eject button to eject a CD after you have tried to push it in manually. The player's 25-second eject timer will reset at each press of eject, causing the player to not eject the CD until the 25-second time period has elapsed.

 **(Reverse):** Press this button to reverse within the current track.

⏩ **(Fast Forward):** Press this button to fast forward within the current track.

🔁 **(Repeat):** With repeat, one track or an entire CD can be repeated.

To use repeat, do the following:

- To repeat the track you are listening to, press and release the repeat button. RPT # will appear on the display. Press this button again to turn off repeat play.
- To repeat the CD you are listening to, press and hold the repeat button for two seconds. REPEAT CD # will appear on the display. Press this button again to turn off repeat play.

RDM (Random): With random, you can listen to the tracks in random, rather than sequential, order, on one CD or on all of the CDs. To use random, do one of the following:

- To play the tracks on the CD you are listening to in random order, press and release the random button. RANDOM ONE will appear on the display. Press this button again to turn off random play.
- To play the tracks on all of the CDs that are loaded in random order, press and hold this button for more than two seconds. You will hear a beep and RANDOM ALL will appear on the display. Press this button again to turn off random play.

◀ **SEEK** ▶ : Press the left arrow to go to the start of the current track, if more than ten seconds have played. Press the right arrow to go to the next track. If either arrow is held or pressed more than once, the player will continue moving backward or forward through the CD.

To scan one CD, press and hold either SEEK arrow for more than two seconds until TRACK SCAN appears on the display and you hear a beep. The radio will go to the next track, play for 10 seconds, then go on to the next track. Press either SEEK arrow again, to stop scanning.

To scan all loaded CDs, press and hold either SEEK arrow for more than four seconds until ALL CD SCAN appears on the display and you hear a beep. Use this feature to listen to 10 seconds of the first track of each loaded CD. Press either SEEK arrow again, to stop scanning.

DISP (Display): Press this knob to see how long the current track has been playing. The elapsed time of the track will appear on the display. To change the default on the display, track or elapsed time, press this knob until you see the display you want, then hold the knob for two seconds. The radio will produce one beep and the selected display will now be the default.

BAND: Press this button to listen to the radio when a CD is playing. The inactive CD(s) will remain safely inside the radio for future listening.

CD: Press this button to play a CD when listening to the radio. The CD symbol will appear on the display when a CD is loaded.

EQ (Equalization): Press EQ to select an equalization setting while playing a CD. The equalization will be set whenever a CD is played. See "EQ" listed previously for more information. If you select an EQ setting for your CD, it will be activated each time you play a CD.

Using List Mode

The six-disc CD changer has a feature called song list. This feature is capable of saving 20 track selections.

To save tracks into the song list feature, perform the following steps:

1. Turn the CD player on and load it with at least one CD. See "LOAD" listed previously in this section for more information.
2. Check to see that the CD changer is not in song list mode. LIST should not appear on the display. If LIST is present, press the LIST button to turn it off.

3. Select the desired CD by pressing the numbered pushbutton and then use the SEEK right arrow to locate the track to be saved. The track will begin to play.
4. Press and hold the LIST button to save the track into memory. When LIST is pressed, one beep will be heard immediately. After two seconds of continuously pressing the LIST button, TRACK ADD will appear on the display and two beeps will sound to confirm the track has been saved.
5. Repeat Steps 3 and 4 for saving other selections.

S-LIST FULL will appear on the display if you try to save more than 20 selections.

To play the song list, press the LIST button. One beep will be heard and S-LIST will appear on the display. The recorded tracks will begin to play in the order they were saved.

Seek through the song list by using the SEEK arrows. Seeking past the last saved track will return to the first saved track.

To delete tracks from the song list, perform the following steps:

1. Turn the CD player on.
2. Press the LIST button to turn song list on. LIST will appear on the display.
3. Press either SEEK arrow to select the desired track to be deleted.
4. Press and hold the LIST button for two seconds. When LIST is pressed, one beep will be heard immediately. After two seconds of continuously pressing the LIST button, TRACK DELETE will appear on the display and two beeps will be heard to confirm that the track has been deleted.

After a track has been deleted, the remaining tracks are moved up the list. When another track is added to the song list, the track will be added to the end of the list.

To delete the entire song list, perform the following steps:

1. Turn the CD player on.
2. Press the LIST button to turn song list on. LIST will appear on the display.
3. Press and hold the LIST button for more than four seconds. One beep will be heard, followed by two beeps after two seconds, and a final beep will be heard after four seconds. LIST EMPTY will appear on the display indicating the song list has been deleted.

If a CD is ejected, and the song list contains saved tracks from that CD, those tracks are automatically deleted from the song list. Any tracks saved to the song list again are added to the bottom of the list.

To end song list mode, press the LIST button. One beep will be heard and LIST will be removed from the display.

CD Messages

CHECK CD: If this message appears on the display and/or the CD comes out, it could be for one of the following reasons:

- It is very hot. When the temperature returns to normal, the CD should play.
- You are driving on a very rough road. When the road becomes smoother, the CD should play.
- The CD is dirty, scratched, wet, or upside down.
- The air is very humid. If so, wait about an hour and try again.
- There may have been a problem while burning the CD.
- The label may be caught in the CD player.

If the CD is not playing correctly, for any other reason, try a known good CD.

If any error occurs repeatedly or if an error cannot be corrected, contact your GM dealer. If the radio displays an error message, write it down and provide it to your GM dealer when reporting the problem.

Theft-Deterrent Feature

THEFTLOCK[®] is designed to discourage theft of your vehicle's radio. The feature works automatically by learning a portion of the Vehicle Identification Number (VIN). If the radio is moved to a different vehicle, it will not operate and LOC or LOCKED will appear on the display.

With THEFTLOCK[®] activated, the radio will not operate if stolen.

Audio Steering Wheel Controls

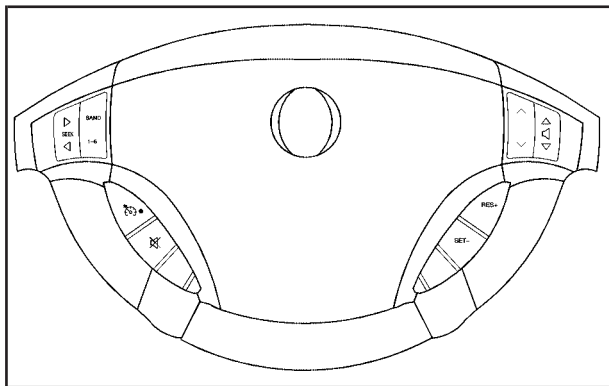

If your vehicle has this feature, some audio functions can be adjusted at the steering wheel. They include the following:

▷ **SEEK** ◁ : Press and release the right or the left arrow to go to the next or to the previous station and stay there.

To scan stations, press and hold either arrow for more than two seconds. SCAN will appear on the display and the radio will produce one beep. The radio will go to a station, play for a few seconds, then go on to the next station. Press either arrow again or one of the pushbuttons to stop scanning presets.

To scan preset stations, press and hold either arrow for more than four seconds. PSCAN will appear on the display and the radio will produce two beeps. The radio will go to a preset station, play for a few seconds, then go on to the next preset station. Press either arrow again or one of the pushbuttons to stop scanning presets.

The radio will only seek and scan stations with a strong signal that are in the selected band.

When a CD is playing, press the right or the left arrow to go to the next or the previous track.



BAND: Press this button to switch between FM1, FM2, or AM, or XM1 or XM2 (if equipped).

When a CD is playing, press this button to listen to the radio. The inactive CD will remain safely inside the radio for future listening.

1 – 6 (Preset Stations): Press this button to go to the next station that is programmed on the radio preset pushbuttons.

 **(OnStar/Mute):** Press and release this button to silence the audio system. Press it again, or any other radio button, to turn on the sound.

If your vehicle has OnStar[®], press and hold this button for two seconds to interact with the OnStar[®] system. See the OnStar[®] manual provided with your vehicle for more information.

  **(Volume):** Press the up or the down arrow to increase or to decrease the volume.

Radio Reception

AM

The range for most AM stations is greater than for FM, especially at night. The longer range, however, can cause stations to interfere with each other. AM can pick up noise from things like storms and power lines. Try reducing the treble to reduce this noise.

FM

FM stereo will give you the best sound, but FM signals will reach only about 10 to 40 miles (16 to 65 km). Tall buildings or hills can interfere with FM signals, causing the sound to come and go.

Care of Your CDs

Handle CDs carefully. Store them in their original cases or other protective cases and away from direct sunlight and dust. If the surface of a CD is soiled, dampen a clean, soft cloth in a mild, neutral detergent solution and clean it, wiping from the center to the edge.

Be sure never to touch the side without writing when handling CDs. Pick up CDs by grasping the outer edges or the edge of the hole and the outer edge.

Care of Your CD Player

The use of CD lens cleaners for CD players is not advised, due to the risk of contaminating the lens of the CD optics with lubricants internal to the CD mechanism.

Backglass Antenna

The AM-FM antenna is integrated with the rear window defogger, located in the rear window. Be sure that the inside surface of the rear window is not scratched and that the lines on the glass are not damaged. If the inside surface is damaged, it could interfere with radio reception. Also, for proper radio reception, the antenna connector at the top-center of the rear window needs to be properly attached to the post on the glass.

Notice: Using a razor blade or sharp object to clear the inside rear window may damage the rear window antenna and/or the rear window defogger. Repairs would not be covered by your warranty. Do not clear the inside rear window with sharp objects.

Notice: Do not apply aftermarket glass tinting with metallic film. The metallic film in some tinting materials will interfere with or distort the incoming radio reception. Any damage caused to your backglass antenna due to metallic tinting materials will not be covered by your warranty.

Because this antenna is built into your rear window, there is a reduced risk of damage caused by car washes and vandals.

If you choose to add a cellular telephone to your vehicle, and the antenna needs to be attached to the glass, be sure that you do not damage the grid lines for the AM-FM antenna. There is enough space between the lines to attach a cellular telephone antenna without interfering with radio reception.

Do not apply aftermarket glass tinting to the back glass. The metallic film in some tinting materials will interfere with or distort the incoming radio reception. Care must be taken when cleaning the rear window because it breaks in the resistive material heating element and will adversely affect radio and defogger performance. See your dealer for details.

Chime Level Adjustment

The radio is the vehicle's chime producer. To change the volume level, press and hold pushbutton 6 with the ignition on and the radio power off. The chime volume level will change from the normal level to loud, and LOUD will appear on the radio display. To change back to the default or normal setting, press and hold pushbutton 6 again. The chime level will change from the loud level to normal, and NORMAL will appear on the radio display. Removing the radio and not replacing it with a factory radio or chime will disable vehicle chimes.

Section 4 Driving Your Vehicle

Your Driving, the Road, and Your Vehicle	4-2	City Driving	4-19
Defensive Driving	4-2	Freeway Driving	4-20
Drunken Driving	4-2	Before Leaving on a Long Trip	4-21
Control of a Vehicle	4-5	Highway Hypnosis	4-21
Braking	4-5	Hill and Mountain Roads	4-22
Anti-Lock Brake System (ABS)	4-6	Winter Driving	4-24
Braking in Emergencies	4-8	If Your Vehicle is Stuck in Sand, Mud, Ice or Snow	4-28
Traction Control System (TCS)	4-8	Rocking Your Vehicle to Get It Out	4-28
StabiliTrak® System	4-9	Loading Your Vehicle	4-29
Steering	4-10	Towing	4-34
Off-Road Recovery	4-12	Towing Your Vehicle	4-34
Passing	4-12	Recreational Vehicle Towing	4-34
Loss of Control	4-13	Towing a Trailer	4-35
Driving at Night	4-15		
Driving in Rain and on Wet Roads	4-16		

Your Driving, the Road, and Your Vehicle

Defensive Driving

The best advice anyone can give about driving is: Drive defensively.

Please start with a very important safety device in your vehicle: Buckle up. See *Safety Belts: They Are for Everyone* on page 1-10.

Defensive driving really means “be ready for anything.” On city streets, rural roads, or freeways, it means “always expect the unexpected.”

Assume that pedestrians or other drivers are going to be careless and make mistakes. Anticipate what they might do. Be ready for their mistakes.

Rear-end collisions are about the most preventable of accidents. Yet they are common. Allow enough following distance. It is the best defensive driving maneuver, in both city and rural driving. You never know when the vehicle in front of you is going to brake or turn suddenly.

Defensive driving requires that a driver concentrate on the driving task. Anything that distracts from the driving task — such as concentrating on a cellular telephone call, reading, or reaching for something on the floor — makes

proper defensive driving more difficult and can even cause a collision, with resulting injury. Ask a passenger to help do things like this, or pull off the road in a safe place to do them yourself. These simple defensive driving techniques could save your life.

Drunken Driving

Death and injury associated with drinking and driving is a national tragedy. It is the number one contributor to the highway death toll, claiming thousands of victims every year.

Alcohol affects four things that anyone needs to drive a vehicle:

- Judgment
- Muscular Coordination
- Vision
- Attentiveness

Police records show that almost half of all motor vehicle-related deaths involve alcohol. In most cases, these deaths are the result of someone who was drinking and driving. In recent years, more than 16,000 annual motor vehicle-related deaths have been associated with the use of alcohol, with more than 300,000 people injured.

Many adults — by some estimates, nearly half the adult population — choose never to drink alcohol, so they never drive after drinking. For persons under 21, it is against the law in every U.S. state to drink alcohol. There are good medical, psychological and developmental reasons for these laws.

The obvious way to eliminate the leading highway safety problem is for people never to drink alcohol and then drive. But what if people do? How much is “too much” if someone plans to drive? It is a lot less than many might think. Although it depends on each person and situation, here is some general information on the problem.

The Blood Alcohol Concentration (BAC) of someone who is drinking depends upon four things:

- The amount of alcohol consumed
- The drinker's body weight
- The amount of food that is consumed before and during drinking
- The length of time it has taken the drinker to consume the alcohol

According to the American Medical Association, a 180 lb (82 kg) person who drinks three 12 ounce (355 ml) bottles of beer in an hour will end up with a BAC of about 0.06 percent. The person would reach the

same BAC by drinking three 4 ounce (120 ml) glasses of wine or three mixed drinks if each had 1-1/2 ounces (45 ml) of liquors like whiskey, gin, or vodka.



It is the amount of alcohol that counts. For example, if the same person drank three double martinis (3 ounces or 90 ml of liquor each) within an hour, the person's BAC would be close to 0.12 percent. A person who consumes food just before or during drinking will have a somewhat lower BAC level.

There is a gender difference, too. Women generally have a lower relative percentage of body water than men. Since alcohol is carried in body water, this means that a woman generally will reach a higher BAC level than a man of her same body weight will when each has the same number of drinks.

The law in most U.S. states, and throughout Canada, sets the legal limit at 0.08 percent. In some other countries, the limit is even lower. For example, it is 0.05 percent in both France and Germany. The BAC limit for all commercial drivers in the United States is 0.04 percent.

The BAC will be over 0.10 percent after three to six drinks (in one hour). Of course, as we have seen, it depends on how much alcohol is in the drinks, and how quickly the person drinks them.

But the ability to drive is affected well below a BAC of 0.10 percent. Research shows that the driving skills of many people are impaired at a BAC approaching 0.05 percent, and that the effects are worse at night. All drivers are impaired at BAC levels above 0.05 percent.

Statistics show that the chance of being in a collision increases sharply for drivers who have a BAC of 0.05 percent or above. A driver with a BAC level of 0.06 percent has doubled his or her chance of having a collision. At a BAC level of 0.10 percent, the chance of this driver having a collision is 12 times greater; at a level of 0.15 percent, the chance is 25 times greater!

The body takes about an hour to rid itself of the alcohol in one drink. No amount of coffee or number of cold showers will speed that up. "I will be careful" is not the right answer. What if there is an emergency, a need to take sudden action, as when a child darts into the street? A person with even a moderate BAC might not be able to react quickly enough to avoid the collision.

There is something else about drinking and driving that many people do not know. Medical research shows that alcohol in a person's system can make crash injuries worse, especially injuries to the brain, spinal cord, or heart. This means that when anyone who has been drinking — driver or passenger — is in a crash, that person's chance of being killed or permanently disabled is higher than if the person had not been drinking.

 **CAUTION:**

Drinking and then driving is very dangerous. Your reflexes, perceptions, attentiveness, and judgment can be affected by even a small amount of alcohol. You can have a serious — or even fatal — collision if you drive after drinking. Please do not drink and drive or ride with a driver who has been drinking. Ride home in a cab; or if you are with a group, designate a driver who will not drink.

Control of a Vehicle

You have three systems that make your vehicle go where you want it to go. They are the brakes, the steering, and the accelerator. All three systems have to do their work at the places where the tires meet the road.

Sometimes, as when you are driving on snow or ice, it is easy to ask more of those control systems than the tires and road can provide. That means you can lose control of your vehicle. See *Traction Control System (TCS)* on page 4-8.

Braking

Braking action involves perception time and reaction time.

First, you have to decide to push on the brake pedal. That is perception time. Then you have to bring up your foot and do it. That is reaction time.

Average reaction time is about three-fourths of a second. But that is only an average. It might be less with one driver and as long as two or three seconds or more with another. Age, physical condition, alertness, coordination and eyesight all play a part. So do alcohol, drugs and frustration. But even in three-fourths of a second, a vehicle moving at 60 mph (100 km/h) travels 66 feet (20 m). That could be a lot of distance in an emergency, so keeping enough space between your vehicle and others is important.

And, of course, actual stopping distances vary greatly with the surface of the road (whether it is pavement or gravel); the condition of the road (wet, dry, icy); tire tread; the condition of your brakes; the weight of the vehicle and the amount of brake force applied.

Avoid needless heavy braking. Some people drive in spurts — heavy acceleration followed by heavy braking — rather than keeping pace with traffic. This is a mistake. Your brakes may not have time to cool between hard stops. Your brakes will wear out much faster if you do a lot of heavy braking. If you keep pace with the traffic and allow realistic following distances, you will eliminate a lot of unnecessary braking. That means better braking and longer brake life.

If your engine ever stops while you are driving, brake normally but do not pump your brakes. If you do, the pedal may get harder to push down. If your engine stops, you will still have some power brake assist. But you will use it when you brake. Once the power assist is used up, it may take longer to stop and the brake pedal will be harder to push.

Anti-Lock Brake System (ABS)

Your vehicle may have anti-lock brakes. ABS is an advanced electronic braking system that will help prevent a braking skid.

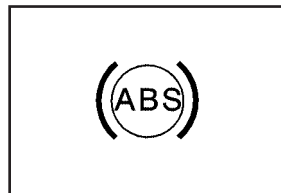

If your vehicle has anti-lock brakes, this warning light on the instrument panel will come on briefly when you start your vehicle.

When you start your engine, or when you begin to drive away, your anti-lock brake system will check itself. You may hear a momentary motor or clicking noise while this test is going on, and you may even notice that your brake pedal moves or pulses a little. This is normal.



Let us say the road is wet and you are driving safely. Suddenly, an animal jumps out in front of you. You slam on the brakes and continue braking. Here is what happens with ABS:

A computer senses that wheels are slowing down. If one of the wheels is about to stop rolling, the computer will separately work the brakes at each wheel.

The anti-lock system can change the brake pressure faster than any driver could. The computer is programmed to make the most of available tire and road conditions. This can help you steer around the obstacle while braking hard.



As you brake, your computer keeps receiving updates on wheel speed and controls braking pressure accordingly.

Remember: Anti-lock does not change the time you need to get your foot up to the brake pedal or always decrease stopping distance. If you get too close to the vehicle in front of you, you will not have time to apply your brakes if that vehicle suddenly slows or stops. Always leave enough room up ahead to stop, even though you have anti-lock brakes.

Using Anti-Lock

Do not pump the brakes. Just hold the brake pedal down firmly and let anti-lock work for you. You may feel a slight brake pedal pulsation or notice some noise, but this is normal.

Braking in Emergencies

At some time, nearly every driver gets into a situation that requires hard braking.

If you have anti-lock brakes, you can steer and brake at the same time. However, if you do not have anti-lock brakes, your first reaction — to hit the brake pedal hard and hold it down — may be the wrong thing to do. Your wheels can stop rolling. Once they do, the vehicle cannot respond to your steering. Momentum will carry it in whatever direction it was headed when the wheels stopped rolling. That could be off the road, into the very thing you were trying to avoid, or into traffic.

If you do not have anti-lock brakes, use a “squeeze” braking technique. This will give you maximum braking while maintaining steering control. You can do this by pushing on the brake pedal with steadily increasing pressure.

In an emergency, you will probably want to squeeze the brakes hard without locking the wheels. If you hear or feel the wheels sliding, ease off the brake pedal.

This will help you retain steering control. If you do have anti-lock brakes, it is different. See *Anti-Lock Brake System (ABS)* on page 4-6.

In many emergencies, steering can help you more than even the very best braking.

Traction Control System (TCS)

Your vehicle may have a Traction Control System (TCS) that limits wheel spin. This is especially useful in slippery road conditions. The system operates only if it senses that one or both of the front wheels are spinning or beginning to lose traction. When this happens, the system reduces engine power and may also upshift the transaxle to limit wheel spin.

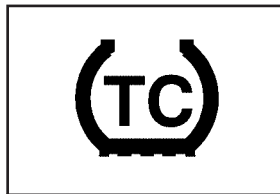

The traction control system active light will come on while the TCS is limiting wheel spin.

If your vehicle has a Driver Information Center (DIC), the TRACTION CONTROL ACTIVE message will come on in the while the TCS is limiting wheel spin.

You may feel or hear the system working, but this is normal.

If the vehicle is in cruise control when the TCS begins to limit wheel spin, the cruise control will automatically disengage. When road conditions allow safe use of the cruise control, it can be used again. See *Cruise Control on page 3-10*.

The TCS operates in all transaxle shift lever positions. But the system can upshift the transaxle only as high as the shift lever position that was chosen, so use the lower gears only when necessary. See *Automatic Transaxle Operation on page 2-24*.

To limit wheel spin, especially in slippery road conditions, you should always leave the TCS on. But you can turn the system off if you ever need to. The TCS should be turned off if the vehicle ever gets stuck in sand, mud or snow and rocking the vehicle is required. See *Rocking Your Vehicle to Get It Out on page 4-28* and *If Your Vehicle is Stuck in Sand, Mud, Ice or Snow on page 4-28*.

To turn the TCS on or off, press the TCS button located directly behind the gear shift lever. If your vehicle has a DIC, the TCS button is located above the radio.

When the TCS is turned off, the TCS warning light will come on. It will disappear when the TCS is turned back on. If the TCS is limiting wheel spin when the TCS button is pressed, the TCS warning light will come on and the TCS will turn off right away.

StabiliTrak[®] System

Your vehicle may be equipped with a vehicle stability enhancement system called StabiliTrak[®]. It is an advanced computer controlled system that assists you with directional control of the vehicle in difficult driving conditions.

StabiliTrak[®] activates when the computer senses a discrepancy between your intended path and the direction the vehicle is actually traveling. StabiliTrak[®] selectively applies braking pressure at any one of the vehicle's brakes to help steer the vehicle in the direction which you are steering.

When the system activates, a STABILITY CONTROL ACTIVE message will be displayed on the Driver Information Center (DIC). See *DIC Warnings and Messages on page 3-53*. You may also hear a noise or feel vibration in the brake pedal. This is normal. Continue to steer the vehicle in the direction you want it to go.

If there is a problem detected with StabiliTrak[®], a SERVICE STABILITY SYSTEM message will be displayed on the Driver Information Center (DIC). See *DIC Warnings and Messages on page 3-53*. When this message is displayed, the system is not operational. Driving should be adjusted accordingly.

If your vehicle is in cruise control when the StabiliTrak[®] activates, the cruise control will automatically disengage. When road conditions allow you to safely use it again, you may reengage the cruise control. See *Cruise Control on page 3-10* for more information.

Steering

Power Steering

If you lose power steering assist because the engine stops or the system is not functioning, you can steer but it will take much more effort.

Steering Tips Driving on Curves

It is important to take curves at a reasonable speed.

A lot of the “driver lost control” accidents mentioned on the news happen on curves. Here is why:

Experienced driver or beginner, each of us is subject to the same laws of physics when driving on curves. The traction of the tires against the road surface makes it possible for the vehicle to change its path when you turn the front wheels. If there is no traction, inertia will keep the vehicle going in the same direction. If you have ever tried to steer a vehicle on wet ice, you will understand this.

The traction you can get in a curve depends on the condition of your tires and the road surface, the angle at which the curve is banked, and your speed. While you are in a curve, speed is the one factor you can control.

Suppose you are steering through a sharp curve. Then you suddenly apply the brakes. Both control systems — steering and braking — have to do their work where the tires meet the road. Unless you have four-wheel anti-lock brakes, adding the hard braking can demand too much of those places. You can lose control.

The same thing can happen if you are steering through a sharp curve and you suddenly accelerate. Those two control systems — steering and acceleration — can overwhelm those places where the tires meet the road and make you lose control. See *Traction Control System (TCS) on page 4-8*.

What should you do if this ever happens? Ease up on the brake or accelerator pedal, steer the vehicle the way you want it to go, and slow down.

Speed limit signs near curves warn that you should adjust your speed. Of course, the posted speeds are based on good weather and road conditions. Under less favorable conditions you will want to go slower.

If you need to reduce your speed as you approach a curve, do it before you enter the curve, while your front wheels are straight ahead.

Try to adjust your speed so you can “drive” through the curve. Maintain a reasonable, steady speed. Wait to accelerate until you are out of the curve, and then accelerate gently into the straightaway.

Steering in Emergencies

There are times when steering can be more effective than braking. For example, you come over a hill and find a truck stopped in your lane, or a car suddenly pulls out from nowhere, or a child darts out from between parked cars and stops right in front of you. You can avoid these problems by braking — if you can stop in time. But sometimes you cannot; there is not room. That is the time for evasive action — steering around the problem.

Your vehicle can perform very well in emergencies like these. First apply your brakes.

See *Braking on page 4-5*. It is better to remove as much speed as you can from a possible collision. Then steer around the problem, to the left or right depending on the space available.

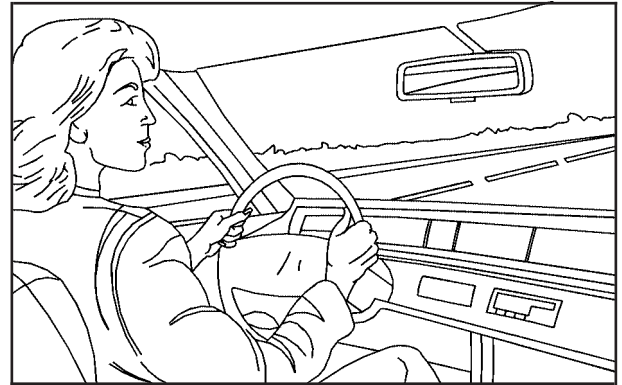

An emergency like this requires close attention and a quick decision. If you are holding the steering wheel at the recommended 9 and 3 o'clock positions, you can turn it a full 180 degrees very quickly without removing either hand. But you have to act fast, steer quickly, and just as quickly straighten the wheel once you have avoided the object.

The fact that such emergency situations are always possible is a good reason to practice defensive driving at all times and wear safety belts properly.

Off-Road Recovery

You may find that your right wheels have dropped off the edge of a road onto the shoulder while you're driving.

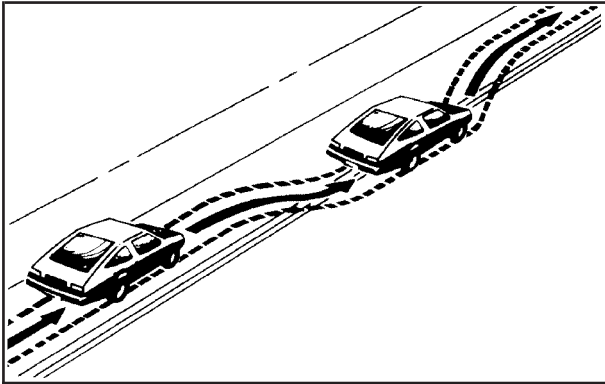

If the level of the shoulder is only slightly below the pavement, recovery should be fairly easy. Ease off the accelerator and then, if there is nothing in the way, steer so that your vehicle straddles the edge of the pavement. You can turn the steering wheel up to one-quarter turn until the right front tire contacts the pavement edge. Then turn your steering wheel to go straight down the roadway.

Passing

The driver of a vehicle about to pass another on a two-lane highway waits for just the right moment, accelerates, moves around the vehicle ahead, then goes back into the right lane again. A simple maneuver?

Not necessarily! Passing another vehicle on a two-lane highway is a potentially dangerous move, since the passing vehicle occupies the same lane as oncoming traffic for several seconds. A miscalculation, an error in judgment, or a brief surrender to frustration or anger can suddenly put the passing driver face to face with the worst of all traffic accidents — the head-on collision.

So here are some tips for passing:

- Drive ahead. Look down the road, to the sides and to crossroads for situations that might affect your passing patterns. If you have any doubt whatsoever about making a successful pass, wait for a better time.
- Watch for traffic signs, pavement markings and lines. If you can see a sign up ahead that might indicate a turn or an intersection, delay your pass. A broken center line usually indicates it is all right to pass, providing the road ahead is clear. Never cross a solid line on your side of the lane or a double solid line, even if the road seems empty of approaching traffic.

- Do not get too close to the vehicle you want to pass while you are awaiting an opportunity. For one thing, following too closely reduces your area of vision, especially if you are following a larger vehicle. Also, you will not have adequate space if the vehicle ahead suddenly slows or stops. Keep back a reasonable distance.
- When it looks like a chance to pass is coming up, start to accelerate but stay in the right lane and do not get too close. Time your move so you will be increasing speed as the time comes to move into the other lane. If the way is clear to pass, you will have a running start that more than makes up for the distance you would lose by dropping back. And if something happens to cause you to cancel your pass, you need only slow down and drop back again and wait for another opportunity.
- If other vehicles are lined up to pass a slow vehicle, wait your turn. But take care that someone is not trying to pass you as you pull out to pass the slow vehicle. Remember to glance over your shoulder and check the blind spot.
- Check your mirrors, glance over your shoulder, and start your left lane change signal before moving out of the right lane to pass. When you are far enough ahead of the passed vehicle to see its front in your

inside mirror, activate your right lane change signal and move back into the right lane. Remember that your right outside mirror is convex. The vehicle you just passed may seem to be farther away from you than it really is.

- Try not to pass more than one vehicle at a time on two-lane roads. Reconsider before passing the next vehicle.
- Do not overtake a slowly moving vehicle too rapidly. Even though the brake lamps are not flashing, it may be slowing down or starting to turn.
- If you are being passed, make it easy for the following driver to get ahead of you. Perhaps you can ease a little to the right.

Loss of Control

Let us review what driving experts say about what happens when the three control systems — brakes, steering, and acceleration — do not have enough friction where the tires meet the road to do what the driver has asked.

In any emergency, do not give up. Keep trying to steer and constantly seek an escape route or area of less danger.

Skidding

In a skid, a driver can lose control of the vehicle. Defensive drivers avoid most skids by taking reasonable care suited to existing conditions, and by not overdriving those conditions. But skids are always possible.

The three types of skids correspond to your vehicle's three control systems. In the braking skid, your wheels are not rolling. In the steering or cornering skid, too much speed or steering in a curve causes tires to slip and lose cornering force. And in the acceleration skid, too much throttle causes the driving wheels to spin.

A cornering skid is best handled by easing your foot off the accelerator pedal.

If you have the Traction Control System (TCS), remember: It helps avoid only the acceleration skid. See *Traction Control System (TCS) on page 4-8*. If you do not have this system, or if the system is off, then an acceleration skid is also best handled by easing your foot off the accelerator pedal.

If your vehicle starts to slide, ease your foot off the accelerator pedal and quickly steer the way you want the vehicle to go. If you start steering quickly enough, your vehicle may straighten out. Always be ready for a second skid if it occurs.

Of course, traction is reduced when water, snow, ice, gravel, or other material is on the road. For safety, you will want to slow down and adjust your driving to these conditions. It is important to slow down on slippery surfaces because stopping distance will be longer and vehicle control more limited.

While driving on a surface with reduced traction, try your best to avoid sudden steering, acceleration, or braking, including engine braking by shifting to a lower gear. Any sudden changes could cause the tires to slide. You may not realize the surface is slippery until your vehicle is skidding. Learn to recognize warning clues — such as enough water, ice, or packed snow on the road to make a mirrored surface — and slow down when you have any doubt.

If you have the anti-lock braking system (ABS), remember: It helps avoid only the braking skid. If you do not have ABS, then in a braking skid, where the wheels are no longer rolling, release enough pressure on the brakes to get the wheels rolling again. This restores steering control. Push the brake pedal down steadily when you have to stop suddenly. As long as the wheels are rolling, you will have steering control.

Driving at Night

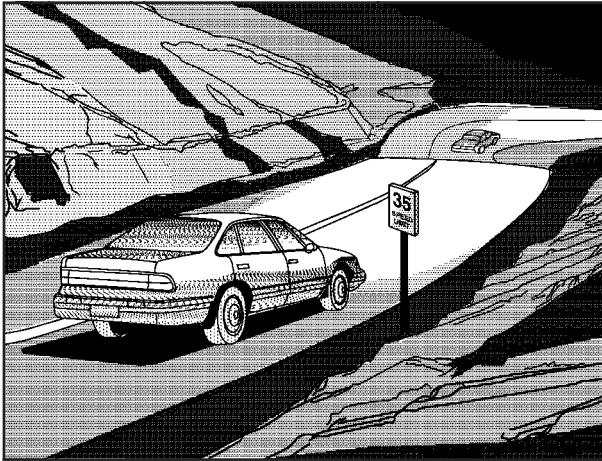

Night driving is more dangerous than day driving. One reason is that some drivers are likely to be impaired — by alcohol or drugs, with night vision problems, or by fatigue.

Here are some tips on night driving.

- Drive defensively.
- Do not drink and drive.
- Adjust your inside rearview mirror to reduce the glare from headlamps behind you.
- Since you cannot see as well, you may need to slow down and keep more space between you and other vehicles.
- Slow down, especially on higher speed roads. Your headlamps can light up only so much road ahead.
- In remote areas, watch for animals.
- If you are tired, pull off the road in a safe place and rest.

No one can see as well at night as in the daytime. But as we get older these differences increase. A 50-year-old driver may require at least twice as much light to see the same thing at night as a 20-year-old.

What you do in the daytime can also affect your night vision. For example, if you spend the day in bright sunshine you are wise to wear sunglasses. Your eyes will have less trouble adjusting to night. But if you are driving, do not wear sunglasses at night. They may cut down on glare from headlamps, but they also make a lot of things invisible.

You can be temporarily blinded by approaching headlamps. It can take a second or two, or even several seconds, for your eyes to re-adjust to the dark. When you are faced with severe glare, as from a driver who does not lower the high beams, or a vehicle with misaimed headlamps, slow down a little. Avoid staring directly into the approaching headlamps.

Keep your windshield and all the glass on your vehicle clean — inside and out. Glare at night is made much worse by dirt on the glass. Even the inside of the glass can build up a film caused by dust. Dirty glass makes lights dazzle and flash more than clean glass would, making the pupils of your eyes contract repeatedly.

Remember that your headlamps light up far less of a roadway when you are in a turn or curve. Keep your eyes moving; that way, it is easier to pick out dimly lighted objects. Just as your headlamps should be checked regularly for proper aim, so should your eyes be examined regularly. Some drivers suffer from night blindness — the inability to see in dim light — and are not even aware of it.

Driving in Rain and on Wet Roads

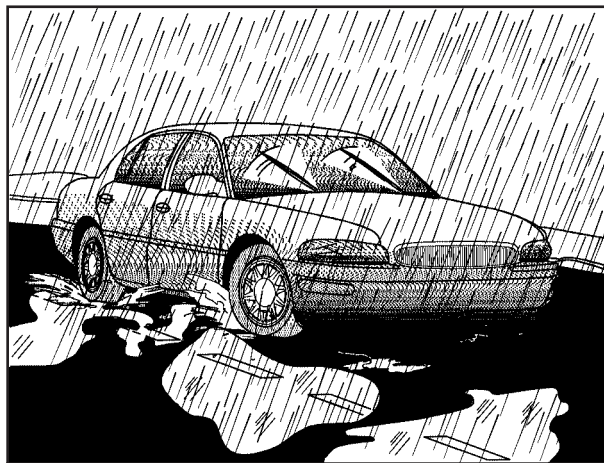

Rain and wet roads can mean driving trouble. On a wet road, you cannot stop, accelerate, or turn as well because your tire-to-road traction is not as good as on dry roads. And, if your tires do not have much tread left, you will get even less traction. It is always wise to go slower and be cautious if rain starts to fall while you are driving. The surface may get wet suddenly when your reflexes are tuned for driving on dry pavement.

The heavier the rain, the harder it is to see. Even if your windshield wiper blades are in good shape, a heavy rain can make it harder to see road signs and traffic signals, pavement markings, the edge of the road, and even people walking.

It is wise to keep your windshield wiping equipment in good shape and keep your windshield washer tank filled with washer fluid. Replace your windshield wiper inserts when they show signs of streaking or missing areas on the windshield, or when strips of rubber start to separate from the inserts.

Driving too fast through large water puddles or even going through some car washes can cause problems, too. The water may affect your brakes. Try to avoid puddles. But if you cannot, try to slow down before you hit them.

 **CAUTION:**

Wet brakes can cause accidents. They will not work as well in a quick stop and may cause pulling to one side. You could lose control of the vehicle.

After driving through a large puddle of water or a car wash, apply your brake pedal lightly until your brakes work normally.

Hydroplaning

Hydroplaning is dangerous. So much water can build up under your tires that they can actually ride on the water. This can happen if the road is wet enough and you are going fast enough. When your vehicle is hydroplaning, it has little or no contact with the road.

Hydroplaning does not happen often. But it can if your tires do not have much tread or if the pressure in one or more is low. It can happen if a lot of water is standing on the road. If you can see reflections from trees, telephone poles, or other vehicles, and raindrops dimple the water's surface, there could be hydroplaning.

Hydroplaning usually happens at higher speeds. There just is not a hard and fast rule about hydroplaning. The best advice is to slow down when it is raining.

Driving Through Deep Standing Water

Notice: If you drive too quickly through deep puddles or standing water, water can come in through your engine's air intake and badly damage your engine. Never drive through water that is slightly lower than the underbody of your vehicle. If you cannot avoid deep puddles or standing water, drive through them very slowly.

Driving Through Flowing Water

CAUTION:

Flowing or rushing water creates strong forces. If you try to drive through flowing water, as you might at a low water crossing, your vehicle can be carried away. As little as six inches of flowing water can carry away a smaller vehicle. If this happens, you and other vehicle occupants could drown. Do not ignore police warning signs, and otherwise be very cautious about trying to drive through flowing water.

Some Other Rainy Weather Tips

- Besides slowing down, allow some extra following distance. And be especially careful when you pass another vehicle. Allow yourself more clear room ahead, and be prepared to have your view restricted by road spray.
- Have good tires with proper tread depth. See *Tires on page 5-52*.

City Driving



One of the biggest problems with city streets is the amount of traffic on them. You will want to watch out for what the other drivers are doing and pay attention to traffic signals.

Here are ways to increase your safety in city driving:

- Know the best way to get to where you are going. Get a city map and plan your trip into an unknown part of the city just as you would for a cross-country trip.
- Try to use the freeways that rim and crisscross most large cities. You will save time and energy. See *Freeway Driving on page 4-20*.
- Treat a green light as a warning signal. A traffic light is there because the corner is busy enough to need it. When a light turns green, and just before you start to move, check both ways for vehicles that have not cleared the intersection or may be running the red light.

Freeway Driving



Mile for mile, freeways — also called thruways, parkways, expressways, turnpikes, or superhighways — are the safest of all roads. But they have their own special rules.

The most important advice on freeway driving is: Keep up with traffic and keep to the right. Drive at the same speed most of the other drivers are driving. Too-fast or too-slow driving breaks a smooth traffic flow. Treat the left lane on a freeway as a passing lane.

At the entrance, there is usually a ramp that leads to the freeway. If you have a clear view of the freeway as you drive along the entrance ramp, you should begin to check traffic. Try to determine where you expect to blend with the flow. Try to merge into the gap at close to the prevailing speed. Switch on your turn signal, check your mirrors, and glance over your shoulder as often as necessary. Try to blend smoothly with the traffic flow.

Once you are on the freeway, adjust your speed to the posted limit or to the prevailing rate if it is slower. Stay in the right lane unless you want to pass.

Before changing lanes, check your mirrors. Then use your turn signal.

Just before you leave the lane, glance quickly over your shoulder to make sure there is not another vehicle in your blind spot.

Once you are moving on the freeway, make certain you allow a reasonable following distance.

Expect to move slightly slower at night.

When you want to leave the freeway, move to the proper lane well in advance. If you miss your exit, do not, under any circumstances, stop and back up. Drive on to the next exit.

The exit ramp can be curved, sometimes quite sharply. The exit speed is usually posted. Reduce your speed according to your speedometer, not to your sense of motion. After driving for any distance at higher speeds, you may tend to think you are going slower than you actually are.

Before Leaving on a Long Trip

Make sure you are ready. Try to be well rested. If you must start when you are not fresh — such as after a day's work — do not plan to make too many miles that first part of the journey. Wear comfortable clothing and shoes you can easily drive in.

Is your vehicle ready for a long trip? If you keep it serviced and maintained, it is ready to go. If it needs service, have it done before starting out. Of course, you will find experienced and able service experts in GM dealerships all across North America. They will be ready and willing to help if you need it.

Here are some things you can check before a trip:

- *Windshield Washer Fluid:* Is the reservoir full? Are all windows clean inside and outside?
- *Wiper Blades:* Are they in good shape?
- *Fuel, Engine Oil, Other Fluids:* Have you checked all levels?
- *Lamps:* Are they all working? Are the lenses clean?
- *Tires:* They are vitally important to a safe, trouble-free trip. Is the tread good enough for long-distance driving? Are the tires all inflated to the recommended pressure?
- *Weather Forecasts:* What is the weather outlook along your route? Should you delay your trip a short time to avoid a major storm system?
- *Maps:* Do you have up-to-date maps?

Highway Hypnosis

Is there actually such a condition as highway hypnosis? Or is it just plain falling asleep at the wheel? Call it highway hypnosis, lack of awareness, or whatever.

There is something about an easy stretch of road with the same scenery, along with the hum of the tires on the road, the drone of the engine, and the rush of the wind against the vehicle that can make you sleepy. Do not let it happen to you! If it does, your vehicle can leave the road in less than a second, and you could crash and be injured.

What can you do about highway hypnosis? First, be aware that it can happen.

Then here are some tips:

- Make sure your vehicle is well ventilated, with a comfortably cool interior.
- Keep your eyes moving. Scan the road ahead and to the sides. Check your rearview mirrors and your instruments frequently.
- If you get sleepy, pull off the road into a rest, service, or parking area and take a nap, get some exercise, or both. For safety, treat drowsiness on the highway as an emergency.

Hill and Mountain Roads



Driving on steep hills or mountains is different from driving in flat or rolling terrain.

If you drive regularly in steep country, or if you are planning to visit there, here are some tips that can make your trips safer and more enjoyable.

- Keep your vehicle in good shape. Check all fluid levels and also the brakes, tires, cooling system, and transaxle. These parts can work hard on mountain roads.
- Know how to go down hills. The most important thing to know is this: let your engine do some of the slowing down. Shift to a lower gear when you go down a steep or long hill.

CAUTION:

If you do not shift down, your brakes could get so hot that they would not work well. You would then have poor braking or even none going down a hill. You could crash. Shift down to let your engine assist your brakes on a steep downhill slope.

 **CAUTION:**

Coasting downhill in NEUTRAL (N) or with the ignition off is dangerous. Your brakes will have to do all the work of slowing down. They could get so hot that they would not work well. You would then have poor braking or even none going down a hill. You could crash. Always have your engine running and your vehicle in gear when you go downhill.

- Know how to go uphill. You may want to shift down to a lower gear. The lower gears help cool your engine and transaxle, and you can climb the hill better.
- Stay in your own lane when driving on two-lane roads in hills or mountains. Do not swing wide or cut across the center of the road. Drive at speeds that let you stay in your own lane.
- As you go over the top of a hill, be alert. There could be something in your lane, like a stalled car or an accident.
- You may see highway signs on mountains that warn of special problems. Examples are long grades, passing or no-passing zones, a falling rocks area, or winding roads. Be alert to these and take appropriate action.

Winter Driving



Here are some tips for winter driving:

- Have your vehicle in good shape for winter.
- You may want to put winter emergency supplies in your trunk.

Also see *Tires* on page 5-52.



Include an ice scraper, a small brush or broom, a supply of windshield washer fluid, a rag, some winter outer clothing, a small shovel, a flashlight, a red cloth, and a couple of reflective warning triangles. And, if you will be driving under severe conditions, include a small bag of sand, a piece of old carpet, or a couple of burlap bags to help provide traction. Be sure you properly secure these items in your vehicle.

Driving on Snow or Ice

Most of the time, those places where your tires meet the road probably have good traction.

However, if there is snow or ice between your tires and the road, you can have a very slippery situation. You will have a lot less traction, or grip, and will need to be very careful.



What is the worst time for this? Wet ice. Very cold snow or ice can be slick and hard to drive on. But wet ice can be even more trouble because it may offer the least

traction of all. You can get wet ice when it is about freezing, 32°F (0°C), and freezing rain begins to fall. Try to avoid driving on wet ice until salt and sand crews can get there.

Whatever the condition — smooth ice, packed, blowing, or loose snow — drive with caution.

If you have the traction control system (TCS), it improves your ability to accelerate when driving on a slippery road. Even though your vehicle has TCS, you will want to slow down and adjust your driving to the road conditions. Under certain conditions, you may want to turn the TCS off, such as when driving through deep snow and loose gravel, to help maintain vehicle motion at lower speeds. See *Traction Control System (TCS) on page 4-8*.

Unless you have the anti-lock braking system (ABS), you will want to brake very gently, too. If you do have ABS, see *Anti-Lock Brake System (ABS) on page 4-6*. ABS improves your vehicle's stability when you make a hard stop on a slippery road. Whether you have ABS or not, you will want to begin stopping sooner than you would on dry pavement. Without ABS, if you feel your vehicle begin to slide, let up on the brakes a little. Push the brake pedal down steadily to get the most traction you can.

Remember, unless you have ABS, if you brake so hard that your wheels stop rolling, you will just slide. Brake so your wheels always keep rolling and you can still steer.

- Whatever your braking system, allow greater following distance on any slippery road.
- Watch for slippery spots. The road might be fine until you hit a spot that is covered with ice. On an otherwise clear road, ice patches may appear in shaded areas where the sun cannot reach, such as around clumps of trees, behind buildings, or under bridges. Sometimes the surface of a curve or an overpass may remain icy when the surrounding roads are clear. If you see a patch of ice ahead of you, brake before you are on it. Try not to brake while you are actually on the ice, and avoid sudden steering maneuvers.

If You Are Caught in a Blizzard

If you are stopped by heavy snow, you could be in a serious situation. You should probably stay with your vehicle unless you know for sure that you are near help and you can hike through the snow. Here are some things to do to summon help and keep yourself and your passengers safe:

- Turn on your hazard flashers.
- Tie a red cloth to your vehicle to alert police that you have been stopped by the snow.

- Put on extra clothing or wrap a blanket around you. If you do not have blankets or extra clothing, make body insulators from newspapers, burlap bags, rags, floor mats — anything you can wrap around yourself or tuck under your clothing to keep warm.

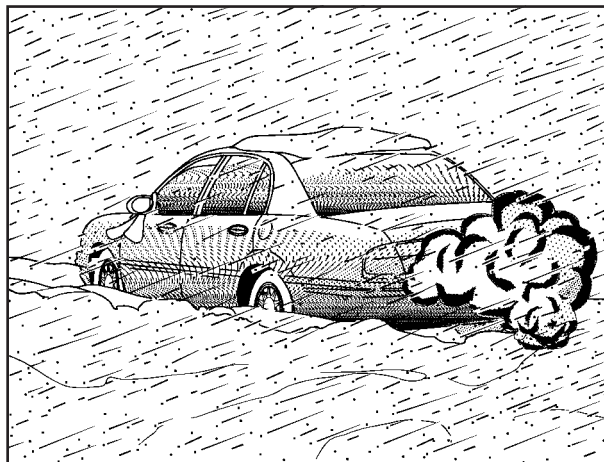

You can run the engine to keep warm, but be careful.

 **CAUTION:**

Snow can trap exhaust gases under your vehicle. This can cause deadly CO (carbon monoxide) gas to get inside. CO could overcome you and kill you. You cannot see it or smell it, so you might not know it is in your vehicle. Clear away snow from around the base of your vehicle, especially any that is blocking your exhaust pipe. And check around again from time to time to be sure snow does not collect there.

Open a window just a little on the side of the vehicle that is away from the wind. This will help keep CO out.

Run your engine only as long as you must. This saves fuel. When you run the engine, make it go a little faster than just idle. That is, push the accelerator slightly. This uses less fuel for the heat that you get and it keeps the battery charged. You will need a well-charged battery to restart the vehicle, and possibly for signaling later on with your headlamps. Let the heater run for a while.

Then, shut the engine off and close the window almost all the way to preserve the heat. Start the engine again and repeat this only when you feel really uncomfortable from the cold. But do it as little as possible. Preserve the fuel as long as you can. To help keep warm, you can get out of the vehicle and do some fairly vigorous exercises every half hour or so until help comes.

If Your Vehicle is Stuck in Sand, Mud, Ice or Snow

In order to free your vehicle when it is stuck, you will need to spin the wheels, but you do not want to spin your wheels too fast. The method known as rocking can help you get out when you are stuck, but you must use caution.

CAUTION:

If you let your tires spin at high speed, they can explode, and you or others could be injured. And, the transaxle or other parts of the vehicle can overheat. That could cause an engine compartment fire or other damage. When you are stuck, spin the wheels as little as possible. Do not spin the wheels above 35 mph (55 km/h) as shown on the speedometer.

Notice: Spinning your wheels can destroy parts of your vehicle as well as the tires. If you spin the wheels too fast while shifting your transaxle back and forth, you can destroy your transaxle. See *Rocking Your Vehicle to Get It Out on page 4-28*.

For information about using tire chains on your vehicle, see *Tire Chains on page 5-66*.

Rocking Your Vehicle to Get It Out

First, turn your steering wheel left and right. That will clear the area around your front wheels. If your vehicle has traction control, you should turn your traction control system off. See *Traction Control System (TCS) on page 4-8*. Then shift back and forth between REVERSE (R) and a forward gear, spinning the wheels as little as possible. Release the accelerator pedal while you shift, and press lightly on the accelerator pedal when the transaxle is in gear. By slowly spinning your wheels in the forward and reverse directions, you will cause a rocking motion that may free your vehicle. If that does not get you out after a few tries, you may need to be towed out. If you do need to be towed out, see *Towing Your Vehicle on page 4-34*.

Loading Your Vehicle

It is very important to know how much weight your vehicle can carry. Two labels on your vehicle show how much weight it may properly carry, the Tire and Loading Information label and the Vehicle Certification label.

CAUTION:

Do not load your vehicle any heavier than the Gross Vehicle Weight Rating (GVWR), or either the maximum front or rear Gross Axle Weight Rating (GAWR). If you do, parts on your vehicle can break, and it can change the way your vehicle handles. These could cause you to lose control and crash. Also, overloading can shorten the life of your vehicle.

Tire and Loading Information Label

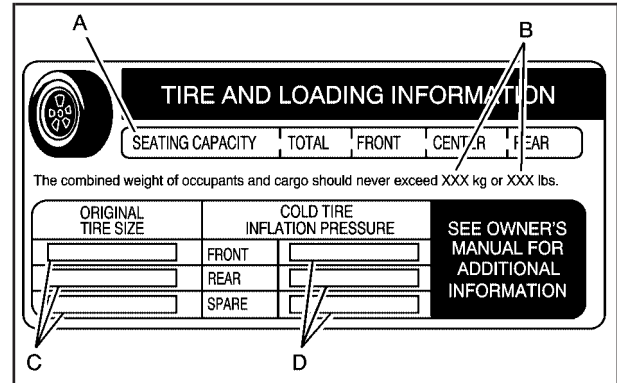

TIRE AND LOADING INFORMATION

SEATING CAPACITY TOTAL FRONT CENTER REAR

The combined weight of occupants and cargo should never exceed XXX kg or XXX lbs.

ORIGINAL TIRE SIZE		COLD TIRE INFLATION PRESSURE	SEE OWNER'S MANUAL FOR ADDITIONAL INFORMATION
	FRONT		
	REAR		
	SPARE		

Label Example

A vehicle specific Tire and Loading Information label is attached to the vehicle's center pillar (B-pillar). With the driver's door open, you will find the label attached below the door lock post (striker). The tire and loading information label lists the number of occupant seating positions (A), and the maximum vehicle capacity weight (B) in kilograms and pounds.

The Tire and Loading Information label also lists the tire size of the original equipment tires (C) and the recommended cold tire inflation pressures (D). For more information on tires and inflation, see *Tires on page 5-52* and *Inflation - Tire Pressure on page 5-58*.

There is also important loading information on the Certification label. It tells you the Gross Vehicle Weight Rating (GVWR) and the Gross Axle Weight Rating (GAWR) for the front and rear axle, see “Certification Label” later in this section.

Steps for Determining Correct Load Limit

1. Locate the statement “The combined weight of occupants and cargo should never exceed XXX kg or XXX pounds” on your vehicle’s placard.
2. Determine the combined weight of the driver and passengers that will be riding in your vehicle.
3. Subtract the combined weight of the driver and passengers from XXX kilograms or XXX pounds.

4. The resulting figure equals the available amount of cargo and luggage load capacity. For example, if the “XXX” amount equals 1400 lbs and there will be five 150 lb passengers in your vehicle, the amount of available cargo and luggage load capacity is 650 lbs (1400 – 750 (5 x 150) = 650 lbs).
5. Determine the combined weight of luggage and cargo being loaded on the vehicle. That weight may not safely exceed the available cargo and luggage load capacity calculated in Step 4.
6. If your vehicle will be towing a trailer, the load from your trailer will be transferred to your vehicle. Consult this manual to determine how this reduces the available cargo and luggage load capacity for your vehicle.

If your vehicle can tow a trailer, see *Towing a Trailer on page 4-35* for important information on towing a trailer, towing safety rules, and trailering tips.

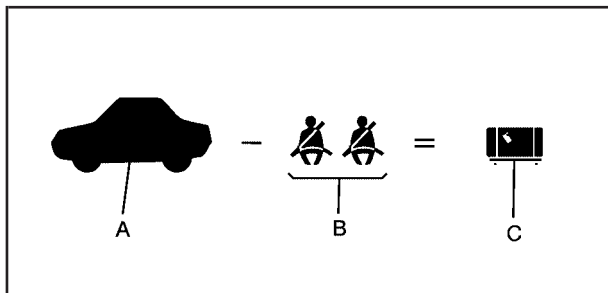

Example 1

Item	Description	Total
A	Maximum Vehicle Capacity Weight for Example 1 =	1,000 lbs (453 kg)
B	Subtract Occupant Weight 150 lbs (68 kg) × 2 =	300 lbs (136 kg)
C	Available Occupant and Cargo Weight =	700 lbs (317 kg)

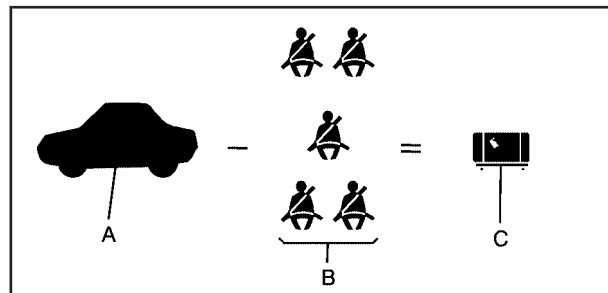

Example 2

Item	Description	Total
A	Maximum Vehicle Capacity Weight for Example 2 =	1,000 lbs (453 kg)
B	Subtract Occupant Weight 150 lbs (68 kg) × 5 =	750 lbs (340 kg)
C	Available Cargo Weight =	250 lbs (113 kg)

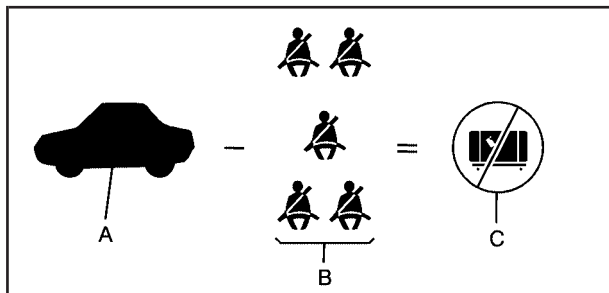

Example 3

Item	Description	Total
A	Maximum Vehicle Capacity Weight for Example 3 =	1,000 lbs (453 kg)
B	Subtract Occupant Weight 200 lbs (91 kg) \times 5 =	1,000 lbs (453 kg)
C	Available Cargo Weight =	0 lbs (0 kg)

Refer to your vehicle's tire and loading information label for specific information about your vehicle's maximum vehicle capacity weight and seating positions. The combined weight of the driver, passengers, and cargo should never exceed your vehicle's maximum vehicle capacity weight.

Certification Label

A vehicle specific Certification label is found on the rear edge of the driver's door.

The label shows the gross weight capacity of your vehicle, called the Gross Vehicle Weight Rating (GVWR). The GVWR includes the weight of the vehicle, all occupants, fuel, and cargo.

Never exceed the GVWR for your vehicle or the Gross Axle Weight Rating (GAWR) for either the front or rear axle.

If the vehicle is going to carry a heavy load, spread it out. Do not carry more than 167 lbs (75 kg) in your trunk.

 **CAUTION:**

Do not load your vehicle any heavier than the Gross Vehicle Weight Rating (GVWR), or either the maximum front or rear Gross Axle Weight Rating (GAWR). If you do, parts on your vehicle can break, and it can change the way your vehicle handles. These could cause you to lose control and crash. Also, overloading can shorten the life of your vehicle.

Notice: Overloading your vehicle may cause damage. Repairs would not be covered by your warranty. Do not overload your vehicle.

If things like suitcases, tools, packages, or anything else are put inside the vehicle, they will go as fast as the vehicle goes. If you have to stop or turn quickly, or if there is a crash, they will keep going.

 **CAUTION:**

Things you put inside your vehicle can strike and injure people in a sudden stop or turn, or in a crash.

- Put things in the trunk of your vehicle. In a trunk, put them as far forward as you can. Try to spread the weight evenly.
- Never stack heavier things, like suitcases, inside the vehicle so that some of them are above the tops of the seats.
- Do not leave an unsecured child restraint in your vehicle.
- When you carry something inside the vehicle, secure it whenever you can.
- Do not leave a seat folded down unless you need to.

Towing

Towing Your Vehicle

Consult your dealer or a professional towing service if you need to have your disabled vehicle towed. See *Roadside Assistance Program on page 7-6*.

If you want to tow your vehicle behind another vehicle for recreational purposes (such as behind a motorhome), see “Recreational Vehicle Towing” following.

Recreational Vehicle Towing

Recreational vehicle towing means towing your vehicle behind another vehicle – such as behind a motorhome. The two most common types of recreational vehicle towing are known as dinghy towing, towing your vehicle with all four wheels on the ground, and dolly towing, towing your vehicle with two wheels on the ground and two wheels up on a device known as a dolly.

With the proper preparation and equipment, many vehicles can be towed in these ways. See “Dinghy Towing” and “Dolly Towing,” following.

Here are some important things to consider before you do recreational vehicle towing:

- What is the towing capacity of the towing vehicle? Be sure you read the tow vehicle manufacturer's recommendations.
- How far will you tow? Some vehicles have restrictions on how far and how long they can tow.
- Do you have the proper towing equipment? See your dealer or trailering professional for additional advice and equipment recommendations.
- Is your vehicle ready to be towed? Just as you would prepare your vehicle for a long trip, you will want to make sure your vehicle is prepared to be towed. See *Before Leaving on a Long Trip on page 4-21*.

Dinghy Towing

Notice: If you tow your vehicle with all four wheels on the ground, the drivetrain components could be damaged. The repairs would not be covered by your warranty. Do not tow your vehicle with all four wheels on the ground.

The vehicle was not designed to be towed with all four wheels on the ground. If your vehicle must be towed, you should use a dolly. See “Dolly Towing” that follows for more information.

Dolly Towing

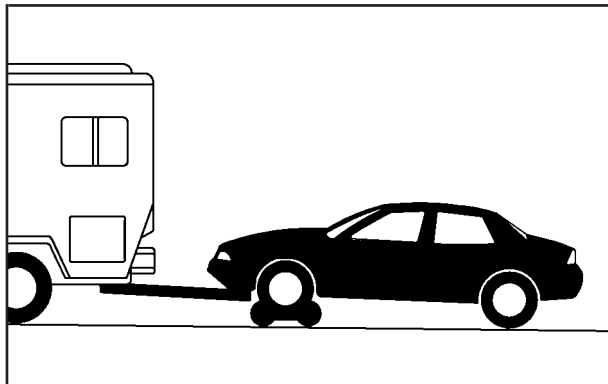

Your vehicle can be towed using a dolly. To tow your vehicle using a dolly, follow these steps:

1. Put the front wheels on a dolly.
2. Put the gear shift lever in PARK (P).
3. Set the parking brake and then remove the ignition key.
4. Clamp the steering wheel in a straight-ahead position.
5. Release the parking brake.

Towing a Trailer

CAUTION:

If you do not use the correct equipment and drive properly, you can lose control when you pull a trailer. For example, if the trailer is too heavy, the brakes may not work well — or even at all. You and your passengers could be seriously injured. You may also damage your vehicle; the resulting repairs would not be covered by your warranty. Pull a trailer only if you have followed all the steps in this section. Ask your dealer for advice and information about towing a trailer with your vehicle.

The vehicle can tow a trailer if it is equipped with the proper trailer towing equipment. To identify what the vehicle trailering capacity is for the vehicle, read the information in “Weight of the Trailer” that appears later in this section. But trailering is different than just driving the vehicle by itself.

Trailer means changes in handling, acceleration, braking, durability, and fuel economy. Successful, safe trailering takes correct equipment, and it has to be used properly.

That is the reason for this part. In it are many time-tested, important trailering tips and safety rules. Many of these are important for your safety and that of your passengers. So please read this section carefully before pulling a trailer.

Load-pulling components such as the engine, transaxle, wheel assembly, and tires are forced to work harder against the drag of the added weight. The engine is required to operate at relatively higher speeds and under greater loads, generating extra heat. What is more, the trailer adds considerably to wind resistance, increasing the pulling requirements.

If You Do Decide To Pull A Trailer

Here are some important points:

- There are many different laws, including speed limit restrictions, having to do with trailering. Make sure your rig will be legal, not only where you live but also where you will be driving. A good source for this information can be state or provincial police.
- Consider using a sway control. Ask a hitch dealer about sway controls.

- Do not tow a trailer at all during the first 1,000 miles (1 600 km) the vehicle is driven. The engine, axle or other parts could be damaged.
- Then, during the first 500 miles (800 km) that the vehicle tows a trailer, do not drive over 50 mph (80 km/h) and do not make starts at full throttle. This helps the engine and other parts of the vehicle wear in at the heavier loads.
- Obey speed limit restrictions when towing a trailer. Do not drive faster than the maximum posted speed for trailers, or no more than 55 mph (90 km/h), to save wear on the vehicle's parts.

There are three important considerations have to do with weight:

- The weight of the trailer
- The weight of the trailer tongue
- The total weight on the vehicle's tires

Weight of the Trailer

How heavy can a trailer safely be?

It should never weigh more than 1,000 lbs (450 kg). But even that can be too heavy.

It depends on how you plan to use your rig. For example, speed, altitude, road grades, outside temperature and how much the vehicle is used to pull a trailer are all important. And, it can also depend on any special equipment that is on the vehicle.

Ask your dealer for our trailering information or advice, or you can write us at:

Buick Customer Assistance Center
P.O. Box 33136
Detroit, MI 48232-5136

In Canada, write to:

General Motors of Canada Limited
Customer Communication Centre, 163-005
1908 Colonel Sam Drive
Oshawa, Ontario L1H 8P7

Weight of the Trailer Tongue

The tongue load (A) of any trailer is an important weight to measure because it affects the total or gross weight of the vehicle. The Gross Vehicle Weight (GVW) includes the curb weight of the vehicle, any cargo in it, and the people who will be riding in the vehicle. If there are a lot of options, equipment, passengers or cargo in the vehicle, it will reduce the tongue weight the

vehicle can carry, which will also reduce the trailer weight the vehicle can tow. And if you tow a trailer, you must add the tongue load to the GVW because the vehicle will be carrying that weight, too. See *Loading Your Vehicle* on page 4-29 for more information about the vehicle's maximum load capacity.

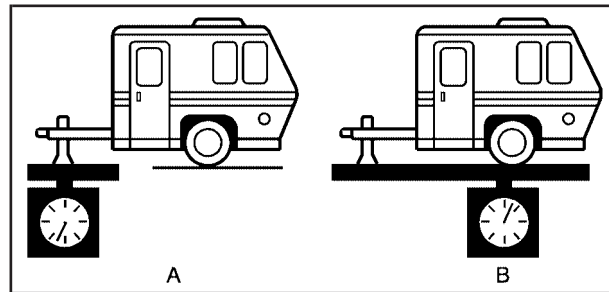

When using a weight-carrying hitch, the trailer tongue (A) should weigh 10 percent to 15 percent of the total loaded trailer weight (B).

After the trailer is loaded, weigh the trailer and the tongue, separately, to see if the weights are proper. The correct weight could be achieved simply by moving some items around in the trailer.

Total Weight on Your Vehicle's Tires

Be sure the vehicle's tires are inflated to the upper limit for cold tires. These numbers can be found on the Tire-Loading Information label. See *Loading Your Vehicle on page 4-29*. Be sure not to go over the GVW limit for the vehicle, or the GAWR, including the weight of the trailer tongue. If a weight distribution hitch is used, make sure not to go over the rear axle limit before applying the weight distribution spring bars.

Hitches

It is important to have the correct hitch equipment. Crosswinds, large trucks going by and rough roads are a few reasons why the right hitch is needed. Here are some rules to follow:

- The rear bumper on the vehicle is not intended for hitches. Do not attach rental hitches or other bumper-type hitches to it. Use only a frame-mounted hitch that does not attach to the bumper.
- If holes need to be made in the body of the vehicle to install a trailer hitch, then be sure to seal the holes later when the hitch is removed. If the holes are not sealed, deadly carbon monoxide (CO) from the exhaust can get into the vehicle. See *Engine Exhaust on page 2-30*. Dirt and water can, too.

Safety Chains

Chains should always be attached between the vehicle and the trailer. Cross the safety chains under the tongue of the trailer so that the tongue will not drop to the road if it becomes separated from the hitch. Instructions about safety chains may be provided by the hitch manufacturer or by the trailer manufacturer. Follow the manufacturer's recommendation for attaching safety chains and do not attach them to the bumper. Always leave just enough slack so the rig can be turned. And, never allow safety chains to drag on the ground.

Trailer Brakes

Because the vehicle has anti-lock brakes, do not try to tap into the vehicle's brake system. If that is done, both brake systems will not work well, or at all.

Driving with a Trailer

Towing a trailer requires a certain amount of experience. Before setting out for the open road, get to know the rig. Acquaint yourself with the feel of handling and braking with the added weight of the trailer. And always keep in mind that the vehicle is now a good deal longer and not nearly as responsive as the vehicle is by itself.

Before starting, check all trailer hitch parts and attachments, safety chains, electrical connector, lamps, tires, and mirror adjustment. If the trailer has electric brakes, start the vehicle and trailer moving and then apply the trailer brake controller by hand to be sure the brakes are working. This lets you check the electrical connection at the same time.

During your trip, check occasionally to be sure that the load is secure, and that the lamps and any trailer brakes are still working.

Following Distance

Stay at least twice as far behind the vehicle ahead as when driving the vehicle without a trailer. This can help avoid situations that require heavy braking and sudden turns.

Passing

More passing distance is needed up ahead when towing a trailer. And, because the vehicle is a good deal longer with the trailer, you will need to go much farther beyond the vehicle you have passed before you can return to the proper lane.

Backing Up

Hold the bottom of the steering wheel with one hand. Then, to move the trailer to the left, move that hand to the left. To move the trailer to the right, move your hand to the right. Always back up slowly and, if possible, have someone guide you.

Making Turns

Notice: Making very sharp turns while trailering could cause the trailer to come in contact with the vehicle. Your vehicle could be damaged. Avoid making very sharp turns while trailering.

When turning with a trailer, make wider turns than normal. Do this so the trailer will not strike soft shoulders, curbs, road signs, trees, or other objects. Avoid jerky or sudden maneuvers. Signal well in advance.

Turn Signals When Towing a Trailer

When towing a trailer, the vehicle may need a different turn signal flasher and/or extra wiring. Check with your dealer. The arrows on the instrument panel will flash whenever signaling a turn or lane change. Properly hooked up, the trailer lamps will also flash, telling other drivers you are about to turn, change lanes or stop.

When towing a trailer, the arrows on the instrument panel will flash for turns even if the bulbs on the trailer are burned out. You may think drivers behind you are seeing your signal when they are not. It is important to check occasionally to be sure the trailer bulbs are still working.

Driving On Grades

Reduce speed and shift to a lower gear *before* starting down a long hill or steep downgrade. If the vehicle is not shifted down, the brakes might have to be used so much that they would get hot and no longer work well.

On a long uphill grade, shift down and reduce the vehicle's speed to around 45 mph (70 km/h) to reduce the possibility of engine and transaxle overheating.

If towing a trailer, you may want to drive in THIRD (3) instead of AUTOMATIC OVERDRIVE (D). Shift to a lower gear as needed.

Parking on Hills

CAUTION:

You really should not park your vehicle, with a trailer attached, on a hill. If something goes wrong, your rig could start to move. People can be injured, and both your vehicle and the trailer can be damaged.

But if the rig ever has to be parked on a hill, here is how to do it:

1. Apply the regular brakes, but do not shift into PARK (P) yet.
2. Have someone place chocks under the trailer's wheels.
3. When the wheel chocks are in place, release the regular brakes until the chocks absorb the load.
4. Reapply the regular brakes. Then apply the parking brake, and shift to PARK (P).
5. Release the regular brakes.

When You Are Ready to Leave After Parking on a Hill

1. Apply the regular brakes and hold the pedal down while you:
 - Start the engine.
 - Shift into a gear.
 - Release the parking brake.
2. Let up on the brake pedal.
3. Drive slowly until the trailer is clear of the chocks.
4. Stop and have someone pick up and store the chocks.

Maintenance When Trailer Towing

The vehicle will need service more often when it pulls a trailer. See *Scheduled Maintenance on page 6-4* for more information. Things that are especially important in trailer operation are automatic transaxle fluid; which should not be overfilled; engine oil, drive belt(s), and cooling and brake systems. Each of these is covered in this manual, and the Index will help you find them quickly. If trailering, it is a good idea to review this information before starting on a trip.

Check periodically to see that all hitch nuts and bolts are tight.

Engine Cooling When Trailer Towing

The cooling system may temporarily overheat during severe operating conditions. See *Engine Overheating on page 5-24*.

 **NOTES**

Section 5 Service and Appearance Care

Service	5-3	Power Steering Fluid	5-33
Doing Your Own Service Work	5-4	Windshield Washer Fluid	5-34
Adding Equipment to the Outside of Your Vehicle	5-5	Brakes	5-35
Fuel	5-5	Battery	5-38
Gasoline Octane	5-5	Jump Starting	5-39
Gasoline Specifications	5-6	Headlamp Aiming	5-43
California Fuel	5-6	Bulb Replacement	5-45
Additives	5-6	Halogen Bulbs	5-45
Fuels in Foreign Countries	5-7	Headlamps and Sidemarkers Lamps	5-46
Filling the Tank	5-8	Front Turn Signal and Parking Lamps	5-47
Filling a Portable Fuel Container	5-10	Fog Lamps	5-48
Checking Things Under the Hood	5-10	Taillamps, Turn Signal, Sidemarkers, Stoplamps and Back-up Lamps	5-48
Hood Release	5-11	Windshield Wiper Blade Replacement	5-51
Engine Compartment Overview	5-12	Tires	5-52
Engine Oil	5-15	Tire Sidewall Labelling	5-53
Engine Oil Life System	5-18	Tire Terminology and Definitions	5-55
Engine Air Cleaner/Filter	5-19	Inflation - Tire Pressure	5-58
Automatic Transmission Fluid	5-21	Tire Inspection and Rotation	5-60
Engine Coolant	5-21	When It Is Time for New Tires	5-61
Radiator Pressure Cap	5-24	Buying New Tires	5-62
Engine Overheating	5-24	Uniform Tire Quality Grading	5-63
Overheated Engine Protection Operating Mode	5-26	Wheel Alignment and Tire Balance	5-64
Cooling System	5-26	Wheel Replacement	5-65

Section 5 Service and Appearance Care

Tire Chains	5-66	Windshield and Wiper Blades	5-82
If a Tire Goes Flat	5-67	Aluminum or Chrome-Plated Wheels	5-83
Changing a Flat Tire	5-68	Tires	5-83
Removing the Spare Tire and Tools	5-69	Sheet Metal Damage	5-84
Removing the Flat Tire and Installing the Spare Tire	5-71	Finish Damage	5-84
Storing a Flat or Spare Tire and Tools	5-76	Underbody Maintenance	5-84
Compact Spare Tire	5-77	Chemical Paint Spotting	5-84
Appearance Care	5-78	Vehicle Care/Appearance Materials	5-85
Fabric/Carpet	5-78	Vehicle Identification	5-86
Vinyl	5-80	Vehicle Identification Number (VIN)	5-86
Leather	5-80	Service Parts Identification Label	5-86
Instrument Panel	5-80	Electrical System	5-87
Interior Plastic Components	5-80	Add-On Electrical Equipment	5-87
Glass Surfaces	5-80	Headlamp Wiring	5-87
Care of Safety Belts	5-81	Windshield Wiper Fuses	5-87
Weatherstrips	5-81	Power Windows and Other Power Options	5-88
Washing Your Vehicle	5-81	Fuses and Circuit Breakers	5-88
Cleaning Exterior Lamps/Lenses	5-81	Instrument Panel Fuse Block	5-88
Finish Care	5-82	Underhood Fuse Block	5-90
		Capacities and Specifications	5-92

Service

Your dealer knows your vehicle best and wants you to be happy with it. We hope you will go to your dealer for all your service needs. You will get genuine GM parts and GM-trained and supported service people.

We hope you will want to keep your GM vehicle all GM. Genuine GM parts have one of these marks:

ACDelco

GM Parts

**GM
Goodwrench**

GM Accessories

California Proposition 65 Warning

Most motor vehicles, including this one, contain and/or emit chemicals known to the State of California to cause cancer and birth defects or other reproductive harm. Engine exhaust, many parts and systems (including some inside the vehicle), many fluids, and some component wear by-products contain and/or emit these chemicals.

Doing Your Own Service Work

If you want to do some of your own service work, you will want to use the proper service manual. It tells you much more about how to service your vehicle than this manual can. To order the proper service manual, see *Service Publications Ordering Information on page 7-11*.

Your vehicle has an airbag system. Before attempting to do your own service work, see *Servicing Your Airbag-Equipped Vehicle on page 1-64*.

You should keep a record with all parts receipts and list the mileage and the date of any service work you perform. See *Maintenance Record on page 6-14*.

CAUTION:

You can be injured and your vehicle could be damaged if you try to do service work on a vehicle without knowing enough about it.

- **Be sure you have sufficient knowledge, experience, the proper replacement parts and tools before you attempt any vehicle maintenance task.**
- **Be sure to use the proper nuts, bolts and other fasteners. English and metric fasteners can be easily confused. If you use the wrong fasteners, parts can later break or fall off. You could be hurt.**

Adding Equipment to the Outside of Your Vehicle

Things you might add to the outside of your vehicle can affect the airflow around it. This may cause wind noise and affect windshield washer performance. Check with your dealer before adding equipment to the outside of your vehicle.

Fuel

The 8th digit of your vehicle identification number (VIN) shows the code letter or number that identifies your engine. You will find the VIN at the top left of the instrument panel. See *Vehicle Identification Number (VIN)* on page 5-86.

Gasoline Octane

If your vehicle has the 3800 V6 engine, use regular unleaded gasoline with a posted octane of 87 or higher. If the octane is less than 87, you may get a heavy knocking noise when you drive. If this occurs, use a gasoline rated at 87 octane or higher as soon as possible. Otherwise, you might damage your engine. A little pinging noise when you accelerate or drive uphill is considered normal. This does not indicate a problem exists or that a higher-octane fuel is necessary. If you are using 87 octane or higher-octane fuel and hear heavy knocking, your engine needs service.

If your vehicle has the 3.6L V6 engine, use regular unleaded gasoline with a posted octane of 87 or higher. However, for best performance and for trailer towing, you may wish to use middle grade or premium unleaded gasoline. If the octane is less than 87, you may get a heavy knocking noise when you drive. If this occurs, use a gasoline rated at 87 octane or higher as soon as possible. Otherwise, you might damage your engine.

Gasoline Specifications

It is recommended that gasoline meet specifications which were developed by automobile manufacturers around the world and contained in the World-Wide Fuel Charter which is available from the Alliance of Automobile Manufacturers at www.autoalliance.org/fuel_charter.htm. Gasoline meeting these specifications could provide improved driveability and emission control system performance compared to other gasoline.

California Fuel

If your vehicle is certified to meet California Emission Standards, it is designed to operate on fuels that meet California specifications. See the underhood emission control label. If this fuel is not available in states adopting California emissions standards, your vehicle will operate satisfactorily on fuels meeting federal specifications, but emission control system performance may be affected. The malfunction indicator lamp may turn on and your vehicle may fail a

smog-check test. See *Malfunction Indicator Lamp* on page 3-39. If this occurs, return to your authorized GM dealer for diagnosis. If it is determined that the condition is caused by the type of fuel used, repairs may not be covered by your warranty.

Additives

To provide cleaner air, all gasolines in the United States are now required to contain additives that will help prevent engine and fuel system deposits from forming, allowing your emission control system to work properly. In most cases, you should not have to add anything to your fuel. However, some gasolines contain only the minimum amount of additive required to meet U.S. Environmental Protection Agency regulations. General Motors recommends that you buy gasolines that are advertised to help keep fuel injectors and intake valves clean. If your vehicle experiences problems due to dirty injectors or valves, try a different brand of gasoline. Also, your GM dealer has additives that will help correct and prevent most deposit-related problems.

Gasolines containing oxygenates, such as ethers and ethanol, and reformulated gasolines may be available in your area to contribute to clean air. General Motors recommends that you use these gasolines, particularly if they comply with the specifications described earlier.

Notice: Your vehicle was not designed for fuel that contains methanol. Do not use fuel containing methanol. It can corrode metal parts in your fuel system and also damage the plastic and rubber parts. That damage would not be covered under your warranty.

Some gasolines that are not reformulated for low emissions may contain an octane-enhancing additive called methylcyclopentadienyl manganese tricarbonyl (MMT); ask the attendant where you buy gasoline whether the fuel contains MMT. General Motors does not recommend the use of such gasolines. Fuels containing MMT can reduce the life of spark plugs and the performance of the emission control system may be affected. The malfunction indicator lamp may turn on. If this occurs, return to your authorized GM dealer for service.

Fuels in Foreign Countries

If you plan on driving in another country outside the United States or Canada, the proper fuel may be hard to find. Never use leaded gasoline or any other fuel not recommended in the previous text on fuel. Costly repairs caused by use of improper fuel would not be covered by your warranty.

To check the fuel availability, ask an auto club, or contact a major oil company that does business in the country where you will be driving.

Filling the Tank

CAUTION:

Fuel vapor burns violently and a fuel fire can cause bad injuries. To help avoid injuries to you and others, read and follow all the instructions on the pump island. Turn off your engine when you are refueling. Do not smoke if you are near fuel or refueling your vehicle. Keep sparks, flames and smoking materials away from fuel. Do not leave the fuel pump unattended when refueling your vehicle — this is against the law in some places. Keep children away from the fuel pump; never let children pump fuel.



The tethered fuel cap is located behind a hinged fuel door on the driver's side of the vehicle.

To remove the fuel cap, turn it slowly to the left (counterclockwise). The fuel cap has a spring in it; if the cap is released too soon, it will spring back to the right.

While refueling, hang the tethered fuel cap from the hook on the fuel door.

 **CAUTION:**

If you spill fuel and then something ignites it, you could be badly burned. Fuel can spray out on you if you open the fuel cap too quickly. This spray can happen if your tank is nearly full, and is more likely in hot weather. Open the fuel cap slowly and wait for any hiss noise to stop. Then unscrew the cap all the way.

Be careful not to spill fuel. Do not top off or overfill the tank and wait a few seconds after you have finished pumping before removing the nozzle. Clean fuel from painted surfaces as soon as possible. See *Washing Your Vehicle on page 5-81*.

When replacing the fuel cap, turn it to the right (clockwise) until it clicks. Make sure the cap is fully installed. The diagnostic system can determine if the fuel cap has been left off or improperly installed. This would allow fuel to evaporate into the atmosphere. See *Malfunction Indicator Lamp on page 3-39*.

Your vehicle may also be equipped with a check gas cap warning light, which will be displayed on the instrument panel cluster if the fuel cap is not properly installed. See *Check Gas Cap Light on page 3-46* for more information.

If your vehicle has a Driver Information Center (DIC), the CHECK GAS CAP message will be displayed if the fuel cap is not properly installed. See *DIC Warnings and Messages on page 3-53* for more information.

 **CAUTION:**

If a fire starts while you are refueling, do not remove the nozzle. Shut off the flow of fuel by shutting off the pump or by notifying the station attendant. Leave the area immediately.

Notice: If you need a new fuel cap, be sure to get the right type. Your dealer can get one for you. If you get the wrong type, it may not fit properly. This may cause your malfunction indicator lamp to light and may damage your fuel tank and emissions system. See *Malfunction Indicator Lamp on page 3-39*.

Filling a Portable Fuel Container

CAUTION:

Never fill a portable fuel container while it is in your vehicle. Static electricity discharge from the container can ignite the gasoline vapor. You can be badly burned and your vehicle damaged if this occurs. To help avoid injury to you and others:

- Dispense gasoline only into approved containers.
- Do not fill a container while it is inside a vehicle, in a vehicle's trunk, pickup bed or on any surface other than the ground.
- Bring the fill nozzle in contact with the inside of the fill opening before operating the nozzle. Contact should be maintained until the filling is complete.
- Do not smoke while pumping gasoline.

Checking Things Under the Hood

CAUTION:

An electric fan under the hood can start up and injure you even when the engine is not running. Keep hands, clothing and tools away from any underhood electric fan.

CAUTION:

Things that burn can get on hot engine parts and start a fire. These include liquids like fuel, oil, coolant, brake fluid, windshield washer and other fluids, and plastic or rubber. You or others could be burned. Be careful not to drop or spill things that will burn onto a hot engine.

Hood Release

To open the hood, do the following:

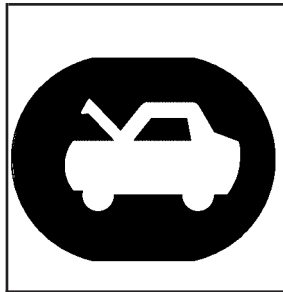

1. Pull the interior hood release handle with this symbol on it. It is located to the left of the steering column below the instrument panel.

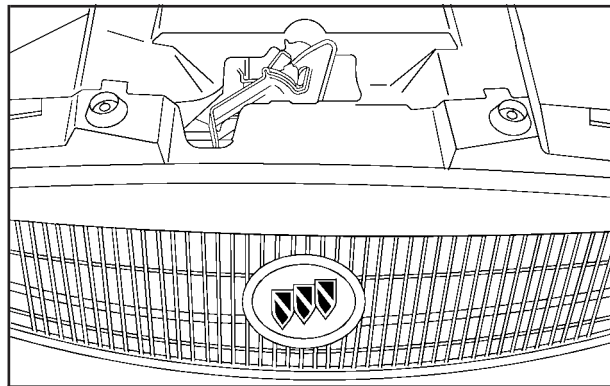

2. Push the secondary hood release lever, located under the center of the hood above the grille, up and to the right to disengage it.
3. Lift the hood.

Before closing the hood, make sure all the filler caps are properly secured. Pull the hood down and close it firmly.

Engine Compartment Overview

When you open the hood on the 3.8L V6 engine, here is what you will see:

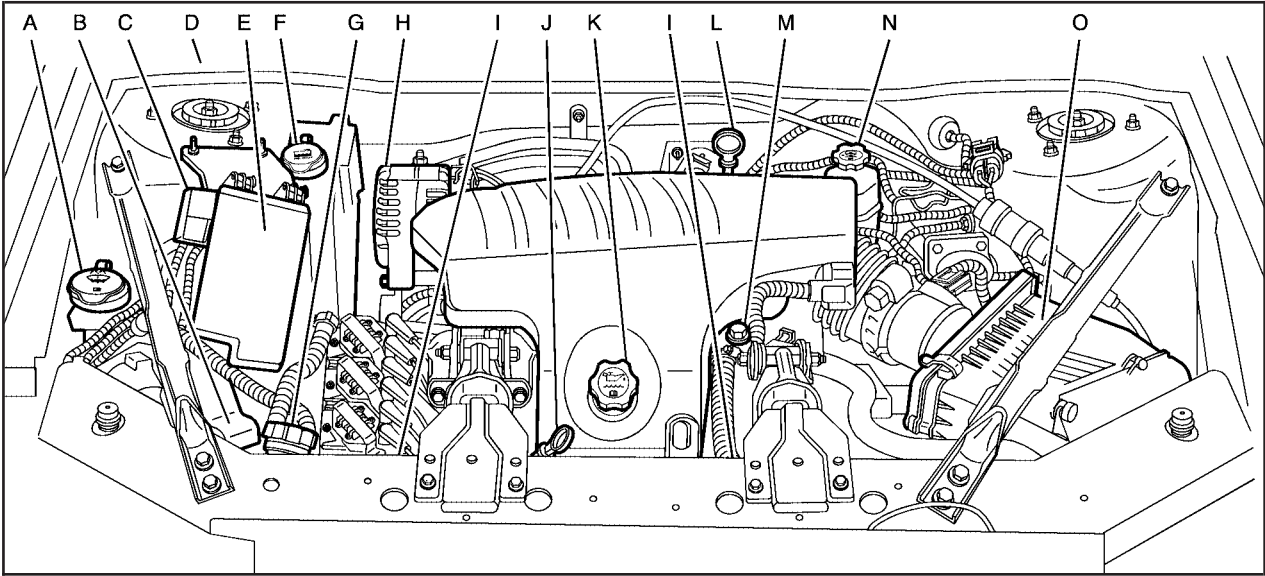

- A. Windshield Washer Fluid Reservoir. See “Adding Washer Fluid” under *Windshield Washer Fluid* on page 5-34.
- B. Battery. See *Battery* on page 5-38.
- C. Remote Positive (+) Terminal. See *Jump Starting* on page 5-39.
- D. Passenger Compartment Air Filter. See *Passenger Compartment Air Filter* on page 3-28.
- E. Underhood Fuse Block. See *Underhood Fuse Block* on page 5-90.
- F. Engine Coolant Surge Tank. See *Cooling System* on page 5-26.
- G. Radiator Pressure Cap. See *Radiator Pressure Cap* on page 5-24.
- H. Power Steering Fluid Reservoir (Below Generator). See *Power Steering Fluid* on page 5-33.
- I. Electric Engine Cooling Fans. See *Cooling System* on page 5-26.
- J. Engine Oil Dipstick. See “Checking Engine Oil” under *Engine Oil* on page 5-15.
- K. Engine Oil Fill Cap. See “When to Add Engine Oil” under *Engine Oil* on page 5-15.
- L. Automatic Transmission Fluid Dipstick. See “Checking the Fluid Level” under *Automatic Transmission Fluid* on page 5-21.
- M. Engine Coolant Bleed Valve. See “How to Add Coolant to the Radiator” under *Cooling System* on page 5-26.
- N. Brake Master Cylinder Reservoir. See “Brake Fluid” under *Brakes* on page 5-35.
- O. Engine Air Cleaner/Filter. See *Engine Air Cleaner/Filter* on page 5-19.

When you open the hood on the 3.6L V6 engine, here is what you will see:

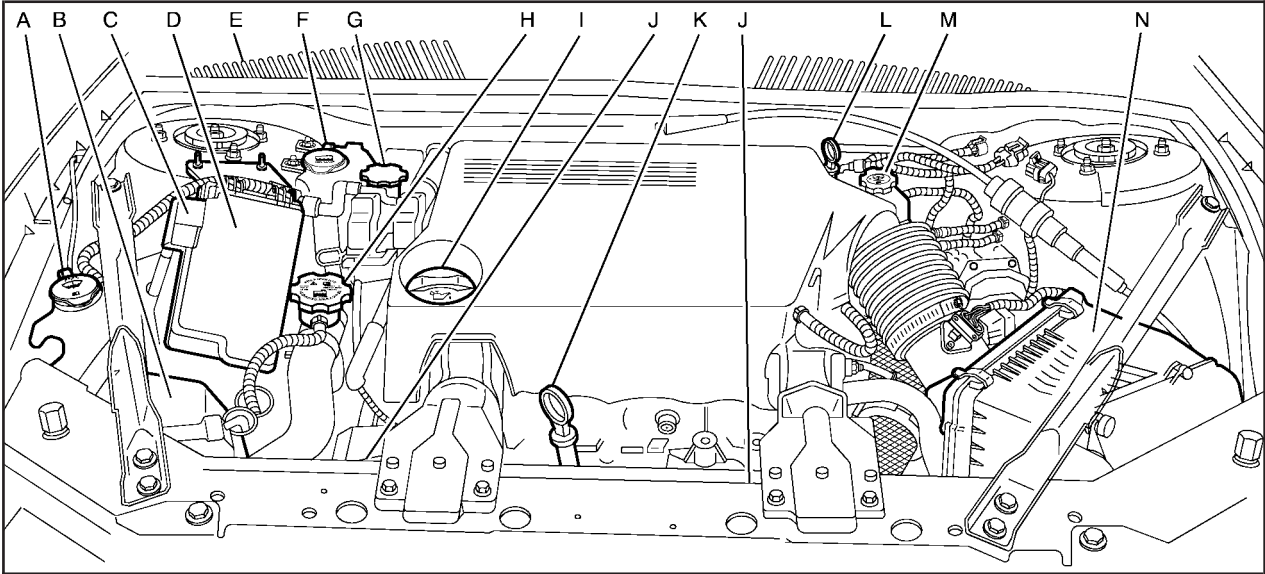

- A. Windshield Washer Fluid Reservoir. See “Adding Washer Fluid” under *Windshield Washer Fluid* on page 5-34.
- B. Battery. See *Battery* on page 5-38.
- C. Remote Positive (+) Terminal. See *Jump Starting* on page 5-39.
- D. Underhood Fuse Block. See *Underhood Fuse Block* on page 5-90.
- E. Passenger Compartment Air Filter. See *Passenger Compartment Air Filter* on page 3-28.
- F. Engine Coolant Surge Tank. See *Cooling System* on page 5-26.
- G. Power Steering Fluid Reservoir. See *Power Steering Fluid* on page 5-33.
- H. Radiator Pressure Cap. See *Radiator Pressure Cap* on page 5-24.
- I. Engine Oil Fill Cap. See “When to Add Engine Oil” under *Engine Oil* on page 5-15.
- J. Electric Engine Cooling Fans. See *Cooling System* on page 5-26.
- K. Engine Oil Dipstick. See “Checking Engine Oil” under *Engine Oil* on page 5-15.

- L. Automatic Transmission Fluid Dipstick. See “Checking the Fluid Level” under *Automatic Transmission Fluid* on page 5-21.
- M. Brake Master Cylinder Reservoir. See “Brake Fluid” under *Brakes* on page 5-35.
- N. Engine Air Cleaner/Filter. See *Engine Air Cleaner/Filter* on page 5-19.

Engine Oil

Checking Engine Oil

It is a good idea to check your engine oil every time you get fuel. In order to get an accurate reading, the oil must be warm and the vehicle must be on level ground.

The engine oil dipstick handle is a yellow loop. See *Engine Compartment Overview* on page 5-12 for the location of the engine oil dipstick.

1. Turn off the engine and give the oil several minutes to drain back into the oil pan. If you do not do this, the oil dipstick might not show the actual level.
2. Pull out the dipstick and clean it with a paper towel or cloth, then push it back in all the way. Remove it again, keeping the tip down, and check the level.

When to Add Engine Oil

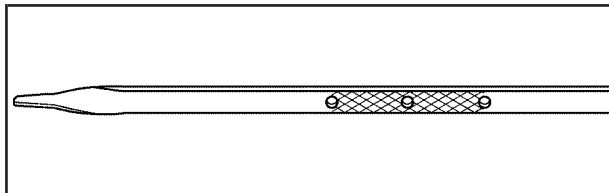

3.6L V6 Engine

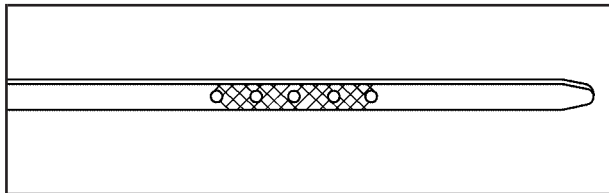

3.8L V6 Engine

If the oil is at or below the cross-hatched area at the tip of the dipstick, then you will need to add at least one quart of oil. But you must use the right kind. This section explains what kind of oil to use. For engine oil crankcase capacity, see *Capacities and Specifications* on page 5-92.

Notice: Do not add too much oil. If the engine has so much oil that the oil level gets above the cross-hatched area that shows the proper operating range, the engine could be damaged.



See *Engine Compartment Overview* on page 5-12 for the location of the engine oil fill cap.

Be sure to add enough oil to put the level somewhere in the proper operating range in the cross-hatched area. Push the dipstick all the way back in when you are through.

What Kind of Engine Oil to Use

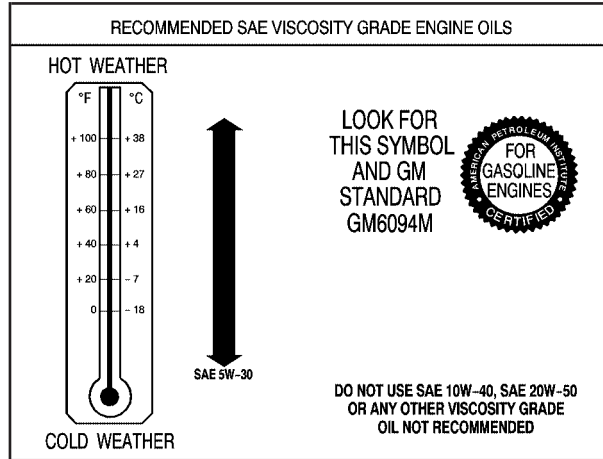

Look for two things:

- GM6094M
Your vehicle's engine requires oil meeting GM Standard GM6094M. You should look for and use only an oil that meets GM Standard GM6094M.
- SAE 5W-30
As shown in the viscosity chart, SAE 5W-30 is best for your vehicle.

These numbers on an oil container show its viscosity, or thickness. Do not use other viscosity oils such as SAE 20W-50.

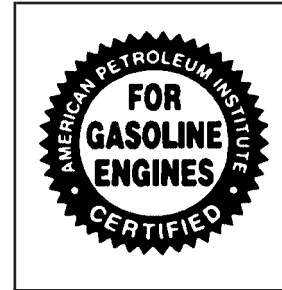

Oils meeting these requirements should also have the starburst symbol on the container. This symbol indicates that the oil has been certified by the American Petroleum Institute (API).

You should look for this information on the oil container, and use *only* those oils that are identified as meeting GM Standard GM6094M and have the starburst symbol on the front of the oil container.

Notice: Use only engine oil identified as meeting GM Standard GM6094M and showing the American Petroleum Institute Certified For Gasoline Engines starburst symbol. Failure to use the recommended oil can result in engine damage not covered by your warranty.

GM Goodwrench[®] oil meets all the requirements for your vehicle.

If you are in an area of extreme cold, where the temperature falls below -20°F (-29°C), it is recommended that you use either an SAE 5W-30 synthetic oil or an SAE 0W-30 oil. Both will provide easier cold starting and better protection for your engine at extremely low temperatures.

Engine Oil Additives

Do not add anything to your oil. The recommended oils with the starburst symbol that meet GM Standard GM6094M are all you will need for good performance and engine protection.

Engine Oil Life System

When to Change Engine Oil

Your vehicle has a computer system that lets you know when to change the engine oil and filter. This is based on engine revolutions and engine temperature, and not on mileage. Based on driving conditions, the mileage at which an oil change will be indicated can vary considerably. For the oil life system to work properly, you must reset the system every time the oil is changed.

When the system has calculated that oil life has been diminished, it will indicate that an oil change is necessary. A change engine oil light or, if your vehicle

has the Driver Information Center (DIC), a CHANGE OIL SOON message will come on. See *Change Engine Oil Light on page 3-43* or *DIC Warnings and Messages on page 3-53*. Change the oil as soon as possible within the next 600 miles (1 000 km). It is possible that, if you are driving under the best conditions, the oil life system may not indicate that an oil change is necessary for over a year. However, the engine oil and filter must be changed at least once a year and at this time the system must be reset. Your dealer has GM-trained service people who will perform this work using genuine GM parts and reset the system. It is also important to check your oil regularly and keep it at the proper level.

If the system is ever reset accidentally, you must change the oil at 3,000 miles (5 000 km) since the last oil change. Remember to reset the oil life system whenever the oil is changed.

How to Reset the Engine Oil Life System

The Engine Oil Life System calculates when to change the engine oil and filter based on vehicle use. Anytime the oil is changed, reset the system so it can calculate when the next oil change is required. If a situation occurs where you change the oil prior to a change engine oil light or CHANGE OIL SOON message being turned on, reset the system.

After changing the engine oil, reset the system by performing the following steps:

1. With the engine off, turn the ignition key to RUN.
2. Fully press and release the accelerator pedal slowly three times within five seconds.
3. Turn the key to OFF, then start the vehicle.

If the light or message comes back on when you start your vehicle, the oil life system has not reset. Repeat the procedure.

What to Do with Used Oil

Used engine oil contains certain elements that may be unhealthy for your skin and could even cause cancer. Do not let used oil stay on your skin for very long. Clean your skin and nails with soap and water, or a good hand cleaner. Wash or properly dispose of clothing or rags containing used engine oil. See the manufacturer's warnings about the use and disposal of oil products.

Used oil can be a threat to the environment. If you change your own oil, be sure to drain all the oil from the filter before disposal. Never dispose of oil by putting it in the trash, pouring it on the ground, into sewers, or into streams or bodies of water. Instead, recycle it by taking it to a place that collects used oil. If you have a problem properly disposing of used oil, ask your dealer, a service station or a local recycling center for help.

Engine Air Cleaner/Filter

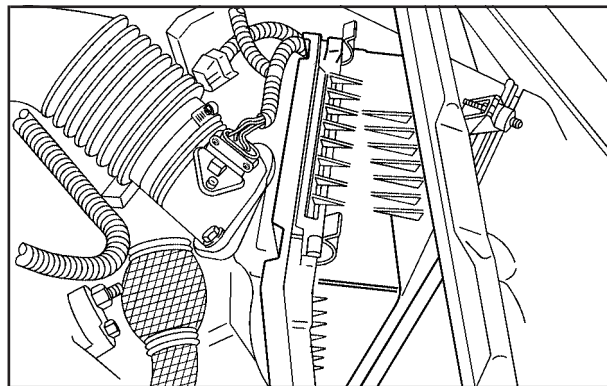

3.6L V6 engine shown, 3.8L V6 engine similar

The engine air cleaner/filter is located in the engine compartment on the driver's side of the vehicle. See *Engine Compartment Overview* on page 5-12 for more information on location.

When to Inspect the Engine Air Cleaner/Filter

Inspect the air cleaner/filter at the Maintenance II intervals and replace at the first oil change after 50,000 miles (83 000 km). See *Scheduled Maintenance on page 6-4* for more information. If you are driving in dusty/dirty conditions, inspect the filter at each engine oil change.

How to Inspect the Engine Air Cleaner/Filter

To inspect the air cleaner/filter, remove the filter from the vehicle and lightly shake the filter to release loose dust and dirt. If the filter remains caked with dirt, a new filter is required.

To inspect or replace the engine air cleaner/filter do the following:

1. Lift the filter cover tabs on top of the engine air cleaner/filter housing.
2. Push the filter cover housing toward the engine.
3. Pull out the filter.
4. Inspect or replace the engine air cleaner/filter. See *Normal Maintenance Replacement Parts on page 6-13*.

5. To reinstall the cover, position the tabs through the slots on the housing. A notch on the sides of the filter cover will indicate the correct engagement.
6. Push the cover tabs on top of the housing to lock the cover in place.

CAUTION:

Operating the engine with the air cleaner/filter off can cause you or others to be burned. The air cleaner not only cleans the air; it helps to stop flame if the engine backfires. If it is not there and the engine backfires, you could be burned. Do not drive with it off, and be careful working on the engine with the air cleaner/filter off.

Notice: If the air cleaner/filter is off, a backfire can cause a damaging engine fire. And, dirt can easily get into your engine, which will damage it. Always have the air cleaner/filter in place when you are driving.

Automatic Transmission Fluid

It is not necessary to check the transmission fluid level. A transmission fluid leak is the only reason for fluid loss. If a leak occurs, take your vehicle to the dealership service department and have it repaired as soon as possible.

Change both the fluid and filter every 50,000 miles (83 000 km) if the vehicle is mainly driven under one or more of these conditions:

- In heavy city traffic where the outside temperature regularly reaches 90°F (32°C) or higher.
- In hilly or mountainous terrain.
- When doing frequent trailer towing.
- Uses such as found in taxi, police or delivery service.

If you do not use your vehicle under any of these conditions, the fluid and filter do not require changing.

Notice: Use of automatic transmission fluid labeled other than DEXRON®-III, Approved for the H-Specification, may damage your vehicle, and the damages may not be covered by your warranty. Always use automatic transmission fluid labeled DEXRON®-III, Approved for the H-Specification.

Engine Coolant

The cooling system in the vehicle is filled with DEX-COOL® engine coolant. This coolant is designed to remain in the vehicle for five years or 150,000 miles (240 000 km), whichever occurs first, if only DEX-COOL® extended life coolant is added.

The following explains the cooling system and how to add coolant when it is low. If there is a problem with engine overheating or if coolant needs to be added to the radiator, see *Engine Overheating on page 5-24*.

A 50/50 mixture of clean, drinkable water and DEX-COOL® engine coolant will:

- Give freezing protection down to -34°F (-37°C).
- Give boiling protection up to 265°F (129°C).
- Protect against rust and corrosion.
- Help keep the proper engine temperature.
- Let the warning lights and gages work as they should.

Notice: Using coolant other than DEX-COOL® may cause premature engine, heater core or radiator corrosion. In addition, the engine coolant may require changing sooner, at 30,000 miles (50 000 km) or 24 months, whichever occurs first. Any repairs would not be covered by your warranty. Always use DEX-COOL® (silicate-free) coolant in your vehicle.

What to Use

Use a mixture of one-half clean, drinkable water and one-half DEX-COOL[®] engine coolant which will not damage aluminum parts. If this coolant mixture is used, nothing else needs to be added.

CAUTION:

Adding only plain water to your cooling system can be dangerous. Plain water, or some other liquid such as alcohol, can boil before the proper coolant mixture will. Your vehicle's coolant warning system is set for the proper coolant mixture. With plain water or the wrong mixture, your engine could get too hot but you would not get the overheat warning. Your engine could catch fire and you or others could be burned. Use a 50/50 mixture of clean, drinkable water and DEX-COOL[®] coolant.

Notice: If you use an improper coolant mixture, your engine could overheat and be badly damaged. The repair cost would not be covered by your warranty. Too much water in the mixture can freeze and crack the engine, radiator, heater core and other parts.

If coolant needs to be added more than four times a year, have your dealer check the cooling system.

Notice: If you use the proper coolant, you do not have to add extra inhibitors or additives which claim to improve the system. These can be harmful.

Checking Coolant



3.8L V6 engine shown,
3.6L V6 engine similar

The coolant recovery tank is located in the engine compartment toward the rear of the engine on the passenger's side of the vehicle. See *Engine Compartment Overview* on page 5-12 for more information on location.

The vehicle must be on a level surface when checking the coolant level.

When the engine is cold, the coolant level should be at the cold fill line or a little higher. The cold fill line is near the bottom of the surge tank and has an arrow pointing down at it.

Adding Coolant

If more coolant is needed, add the proper DEX-COOL® coolant mixture at the coolant recovery tank, but be careful not to spill it.

If the coolant recovery tank is completely empty, add coolant to the radiator. See *Engine Overheating* on page 5-24.

CAUTION:

Turning the radiator pressure cap when the engine and radiator are hot can allow steam and scalding liquids to blow out and burn you badly. With the coolant recovery tank, you will almost never have to add coolant at the radiator. Never turn the radiator pressure cap — even a little — when the engine and radiator are hot.

CAUTION:

You can be burned if you spill coolant on hot engine parts. Coolant contains ethylene glycol, and it will burn if the engine parts are hot enough. Do not spill coolant on a hot engine.

Occasionally check the coolant level in the radiator. For information on how to add coolant to the radiator, see *Cooling System* on page 5-26.

Radiator Pressure Cap

Notice: The radiator cap on your vehicle is a pressure-type cap and must be tightly installed to prevent coolant loss and possible engine damage from overheating. Be sure the arrows on the cap line up with the overflow tube on the radiator filler neck.

The radiator pressure cap is located in the front of the engine compartment on the passenger's side of the vehicle. See *Engine Compartment Overview on page 5-12* for more information on location.

Engine Overheating

There is a coolant temperature gage and a warning light on the instrument panel cluster that indicate an overheated engine condition. See *Engine Coolant Temperature Gage on page 3-38* and *Engine Coolant Temperature Warning Light on page 3-38* for more information.

In addition, if your vehicle is equipped with a Driver Information Center (DIC), you will find an ENGINE COOLANT HOT and a REDUCED POWER STOP WHEN SAFE message displayed on the DIC. See *DIC Warnings and Messages on page 3-53* for more information.

If Steam Is Coming From Your Engine

CAUTION:

Steam from an overheated engine can burn you badly, even if you just open the hood. Stay away from the engine if you see or hear steam coming from it. Just turn it off and get everyone away from the vehicle until it cools down. Wait until there is no sign of steam or coolant before you open the hood.

If you keep driving when your engine is overheated, the liquids in it can catch fire. You or others could be badly burned. Stop your engine if it overheats, and get out of the vehicle until the engine is cool.

See *Overheated Engine Protection Operating Mode on page 5-26* for information on driving to a safe place in an emergency.

Notice: If your engine catches fire because you keep driving with no coolant, your vehicle can be badly damaged. The costly repairs would not be covered by your warranty. See *Overheated Engine Protection Operating Mode on page 5-26* for information on driving to a safe place in an emergency.

If No Steam Is Coming From Your Engine

If you get an engine overheat warning, but see or hear no steam, the problem may not be too serious. Sometimes the engine can get a little too hot when you:

- Climb a long hill on a hot day.
- Stop after high-speed driving.
- Idle for long periods in traffic.
- Tow a trailer.

If you get the overheat warning with no sign of steam, try this for a minute or so:

1. In heavy traffic, let the engine idle in NEUTRAL (N) while stopped. If it is safe to do so, pull off the road, shift to PARK (P) or NEUTRAL (N) and let the engine idle.
2. Set the climate controls to the highest heat setting and fan speed and open the windows as necessary.

If you no longer have the overheat warning, you can drive. Just to be safe, drive slower for about 10 minutes. If the warning does not come back on, you can drive normally.

If the warning continues and you have not stopped, pull over, stop, and park your vehicle right away.

If there is still no sign of steam, you can idle the engine for three minutes while you are parked. If you still have the warning, *turn off the engine and get everyone out of the vehicle* until it cools down. Also, see “Overheated Engine Protection Operating Mode” later in this section.

You may decide not to lift the hood but to get service help right away.

Overheated Engine Protection Operating Mode

This emergency operating mode allows your vehicle to be driven to a safe place in an emergency situation. If an overheated engine condition exists, an overheat protection mode which alternates firing groups of cylinders helps prevent engine damage. In this mode, you will notice a significant loss in power and engine performance. The REDUCED POWER STOP WHEN SAFE message will come on in the Driver Information Center (DIC), along with the engine coolant temperature warning light on the instrument panel, to indicate the vehicle has entered overheated engine protection operating mode. The temperature gage will also indicate an overheat condition exists. Driving extended miles (km) and/or towing a trailer in the overheat protection mode should be avoided.

Notice: After driving in the overheated engine protection operating mode, to avoid engine damage, allow the engine to cool before attempting any repair. The engine oil will be severely degraded. Repair the cause of coolant loss, change the oil and reset the oil life system. See *Engine Oil* on page 5-15.

Cooling System

When you decide it is safe to lift the hood, here is what you will see:

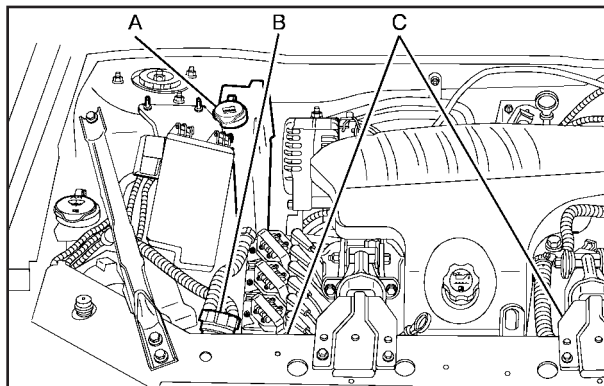

3.8L V6 engine

- A. Coolant Recovery Tank
- B. Radiator Pressure Cap
- C. Electric Engine Cooling Fans

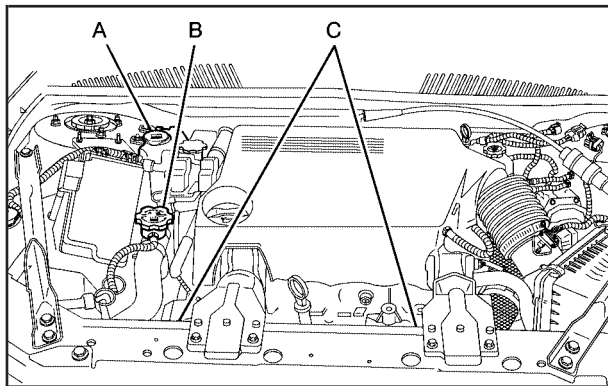

3.6L V6 engine

- A. Coolant Recovery Tank
- B. Radiator Pressure Cap
- C. Electric Engine Cooling Fans

⚠ CAUTION:

An electric engine cooling fan under the hood can start up even when the engine is not running and can injure you. Keep hands, clothing and tools away from any underhood electric fan.

If the coolant inside the coolant recovery tank is boiling, do not do anything else until it cools down. The vehicle should be parked on a level surface.

When the engine is cold, the coolant level should be at or above the cold fill line on the coolant recovery tank. If it is not, there may be a leak at the pressure cap or in the radiator hoses, heater hoses, radiator, water pump, or somewhere else in the cooling system.

 **CAUTION:**

Heater and radiator hoses, and other engine parts, can be very hot. Do not touch them. If you do, you can be burned.

Do not run the engine if there is a leak. If you run the engine, it could lose all coolant. That could cause an engine fire, and you could be burned. Get any leak fixed before you drive the vehicle.

If there seems to be no leak, with the engine on, check to see if the electric engine cooling fans are running. If the engine is overheating, the fans should be running. If the fans are not running, the vehicle needs service.

Notice: Engine damage from running your engine without coolant is not covered by your warranty. See *Overheated Engine Protection Operating Mode* on page 5-26 for information on driving to a safe place in an emergency.

Notice: Using coolant other than DEX-COOL[®] may cause premature engine, heater core or radiator corrosion. In addition, the engine coolant may require changing sooner, at 30,000 miles (50 000 km) or 24 months, whichever occurs first. Any repairs would not be covered by your warranty. Always use DEX-COOL[®] (silicate-free) coolant in your vehicle.

How to Add Coolant to the Coolant Recovery Tank

CAUTION:

Adding only plain water to your cooling system can be dangerous. Plain water, or some other liquid such as alcohol, can boil before the proper coolant mixture will. Your vehicle's coolant warning system is set for the proper coolant mixture. With plain water or the wrong mixture, your engine could get too hot but you would not get the overheat warning. Your engine could catch fire and you or others could be burned. Use a 50/50 mixture of clean, drinkable water and DEX-COOL[®] coolant.

If you have not found a problem yet, but the coolant level is not at the cold fill line, add a 50/50 mixture of *clean, drinkable water* and DEX-COOL[®] engine coolant at the coolant recovery tank. See *Engine Coolant* on page 5-21 for more information.

Notice: In cold weather, water can freeze and crack the engine, radiator, heater core and other parts. Use the recommended coolant and the proper coolant mixture.

CAUTION:

You can be burned if you spill coolant on hot engine parts. Coolant contains ethylene glycol and it will burn if the engine parts are hot enough. Do not spill coolant on a hot engine.

When the coolant level in the coolant recovery tank is at the cold fill line, start the vehicle.

If the overheat warning continues, there is one more thing you can try. You can add the proper coolant mixture directly to the radiator, but be sure the system is cool before you do it.

CAUTION:

Steam and scalding liquids from a hot cooling system can blow out and burn you badly. They are under pressure, and if you turn the radiator pressure cap — even a little — they can come out at high speed. Never turn the cap when the cooling system, including the radiator pressure cap, is hot. Wait for the cooling system and radiator pressure cap to cool if you ever have to turn the pressure cap.

How to Add Coolant to the Radiator

Notice: Your engine has a specific radiator fill procedure. Failure to follow this procedure could cause your engine to overheat and be severely damaged.

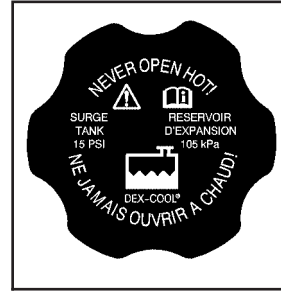

1. You can remove the radiator pressure cap when the cooling system, including the radiator pressure cap and upper radiator hose, is no longer hot. Turn the pressure cap slowly counterclockwise until it first stops.

Do not press down while turning the pressure cap. If you hear a hiss, wait for that to stop. A hiss means there is still some pressure left.

2. Then keep turning the pressure cap, but now push down as you turn it. Remove the pressure cap.



3.8L V6 engine

3. If your vehicle has the 3.8L V6 engine, open the coolant air bleed valve located on the thermostat housing near the heater hose. See *Engine Compartment Overview* on page 5-12 for more information on location.



3.8L V6 engine shown, 3.6L V6 engine similar

4. Fill the radiator with the proper DEX-COOL[®] coolant mixture, up to the base of the filler neck. See *Engine Coolant* on page 5-21 for more information about the proper coolant mixture.
If your vehicle has the 3.8L V6 engine and you see a stream of coolant coming from the air bleed valve, close the valve. Otherwise, close the valve after the radiator is filled.
5. Rinse or wipe any spilled coolant from the engine and the compartment.
6. Then fill the coolant recovery tank to the cold fill line.
7. Put the cap back on the coolant recovery tank, but leave the radiator pressure cap off.



3.8L V6 engine shown, 3.6L V6 engine similar

8. Start the engine and let it run until you can feel the upper radiator hose getting hot. Watch out for the engine cooling fans.
9. By this time, the coolant level inside the radiator filler neck may be lower. If the level is lower, add more of the proper DEX-COOL[®] coolant mixture through the filler neck until the level reaches the base of the filler neck.
10. Then replace the radiator pressure cap. At any time during this procedure if coolant begins to flow out of the filler neck, reinstall the pressure cap. Be sure the pressure cap is hand-tight and fully seated.
11. Check the coolant in the recovery tank. The level in the coolant recovery tank should be at the cold fill line when the engine is cold.

Power Steering Fluid

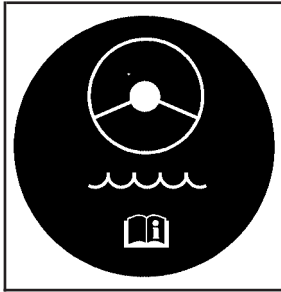

See *Engine Compartment Overview* on page 5-12 for reservoir location.

When to Check Power Steering Fluid

It is not necessary to regularly check power steering fluid unless you suspect there is a leak in the system or you hear an unusual noise. A fluid loss in this system could indicate a problem. Have the system inspected and repaired.

How to Check Power Steering Fluid

To check the power steering fluid, do the following:

1. Turn the key off and let the engine compartment cool down.
2. Wipe the cap and the top of the reservoir clean.

3. Unscrew the cap and wipe the dipstick with a clean rag.
4. Replace the cap and completely tighten it.
5. Remove the cap again and look at the fluid level on the dipstick.

If your vehicle has the 3.8L V6 engine, the fluid level should be between the ADD and HOT marks when the engine is cold, and at the HOT mark when the engine is hot. If the fluid is at the ADD mark when the engine is cold or hot, power steering fluid should be added.

If your vehicle has the 3.6L V6 engine, the fluid level should be between the Min and Max marks when the engine is cold, and at the Max mark when the engine is hot. If the fluid is at the Min mark when the engine is cold or hot, power steering fluid should be added.

What to Use

To determine what kind of fluid to use, see *Recommended Fluids and Lubricants* on page 6-12. Always use the proper fluid. Failure to use the proper fluid can cause leaks and damage hoses and seals.

Windshield Washer Fluid

What to Use

When you need windshield washer fluid, be sure to read the manufacturer's instructions before use. If you will be operating your vehicle in an area where the temperature may fall below freezing, use a fluid that has sufficient protection against freezing.

Adding Washer Fluid

When the windshield washer fluid is low, a low washer fluid light may appear on the instrument panel cluster. See *Low Washer Fluid Warning Light on page 3-45* for more information.

In addition, if your vehicle is equipped with a Driver Information Center (DIC), the LOW WASHER FLUID message will appear when the fluid level is low. See *DIC Warnings and Messages on page 3-53* for more information.

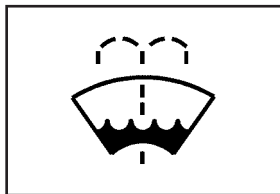

Open the cap with the washer symbol on it. Add washer fluid until the tank is full. See *Engine Compartment Overview on page 5-12* for reservoir location.

Notice:

- **When using concentrated washer fluid, follow the manufacturer's instructions for adding water.**
- **Do not mix water with ready-to-use washer fluid. Water can cause the solution to freeze and damage your washer fluid tank and other parts of the washer system. Also, water does not clean as well as washer fluid.**
- **Fill your washer fluid tank only three-quarters full when it is very cold. This allows for expansion if freezing occurs, which could damage the tank if it is completely full.**
- **Do not use engine coolant (antifreeze) in your windshield washer. It can damage your washer system and paint.**

Brakes

Brake Fluid

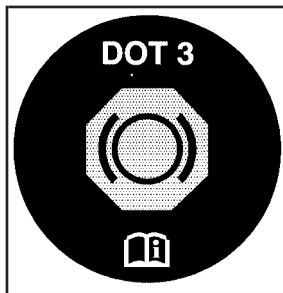

Your brake master cylinder reservoir is filled with DOT-3 brake fluid. See *Engine Compartment Overview* on page 5-12 for the location of the reservoir.

There are only two reasons why the brake fluid level in the reservoir might go down. The first is that the brake fluid goes down to an acceptable level during normal brake lining wear. When new linings are put in, the fluid level goes back up. The other reason is that fluid is leaking out of the brake system. If it is, you should have your brake system fixed, since a leak means that sooner or later your brakes will not work well, or will not work at all.

So, it is not a good idea to top off your brake fluid. Adding brake fluid will not correct a leak. If you add fluid when your linings are worn, then you will have too much fluid when you get new brake linings. You should add or remove brake fluid, as necessary, only when work is done on the brake hydraulic system.

CAUTION:

If you have too much brake fluid, it can spill on the engine. The fluid will burn if the engine is hot enough. You or others could be burned, and your vehicle could be damaged. Add brake fluid only when work is done on the brake hydraulic system.

When your brake fluid falls to a low level, your brake warning light will come on. See *Brake System Warning Light* on page 3-36.

What to Add

When you do need brake fluid, use only DOT-3 brake fluid. Use new brake fluid from a sealed container only. See *Recommended Fluids and Lubricants* on page 6-12.

Always clean the brake fluid reservoir cap and the area around the cap before removing it. This will help keep dirt from entering the reservoir.

CAUTION:

With the wrong kind of fluid in your brake system, your brakes may not work well, or they may not even work at all. This could cause a crash. Always use the proper brake fluid.

Notice:

- **Using the wrong fluid can badly damage brake system parts. For example, just a few drops of mineral-based oil, such as engine oil, in your brake system can damage brake system parts so badly that they will have to be replaced. Do not let someone put in the wrong kind of fluid.**
- **If you spill brake fluid on your vehicle's painted surfaces, the paint finish can be damaged. Be careful not to spill brake fluid on your vehicle. If you do, wash it off immediately. See *Appearance Care* on page 5-78.**

Brake Wear

Your vehicle has four-wheel disc brakes.

Disc brake pads have built-in wear indicators that make a high-pitched warning sound when the brake pads are worn and new pads are needed. The sound may come and go or be heard all the time your vehicle is moving, except when you are pushing on the brake pedal firmly.

 **CAUTION:**

The brake wear warning sound means that soon your brakes will not work well. That could lead to an accident. When you hear the brake wear warning sound, have your vehicle serviced.

Notice: Continuing to drive with worn-out brake pads could result in costly brake repair.

Some driving conditions or climates may cause a brake squeal when the brakes are first applied or lightly applied. This does not mean something is wrong with your brakes.

Properly torqued wheel nuts are necessary to help prevent brake pulsation. When tires are rotated, inspect brake pads for wear and evenly tighten wheel nuts in the proper sequence to GM torque specifications.

Brake linings should always be replaced as complete axle sets.

Brake Pedal Travel

See your dealer if the brake pedal does not return to normal height, or if there is a rapid increase in pedal travel. This could be a sign of brake trouble.

Brake Adjustment

Every time you apply the brakes, with or without the vehicle moving, your brakes adjust for wear.

Replacing Brake System Parts

The braking system on a vehicle is complex. Its many parts have to be of top quality and work well together if the vehicle is to have really good braking. Your vehicle was designed and tested with top-quality GM brake parts. When you replace parts of your braking system — for example, when your brake linings wear down and you need new ones put in — be sure you get new approved GM replacement parts. If you do not, your brakes may no longer work properly. For example, if someone puts in brake linings that are wrong for your vehicle, the balance between your front and rear brakes can change — for the worse. The braking performance you have come to expect can change in many other ways if someone puts in the wrong replacement brake parts.

Battery

Your vehicle has a maintenance free battery. When it is time for a new battery, get one that has the replacement number shown on the original battery's label. We recommend an ACDelco® replacement battery. See *Engine Compartment Overview on page 5-12* for battery location.

Warning: Battery posts, terminals and related accessories contain lead and lead compounds, chemicals known to the State of California to cause cancer and reproductive harm. Wash hands after handling.

If the battery has a very low charge or is dead, you may not be able to remove the ignition key from the ignition switch or shift out of PARK (P). Refer to *Shifting Out of Park (P) on page 2-29*.

Vehicle Storage

If you are not going to drive your vehicle for 25 days or more, remove the black, negative (-) cable from the battery. This will help keep the battery from running down.

CAUTION:

Batteries have acid that can burn you and gas that can explode. You can be badly hurt if you are not careful. See *Jump Starting on page 5-39* for tips on working around a battery without getting hurt.

Jump Starting

If your battery has run down, you may want to use another vehicle and some jumper cables to start your vehicle. Be sure to use the following steps to do it safely.

CAUTION:

Batteries can hurt you. They can be dangerous because:

- They contain acid that can burn you.
- They contain gas that can explode or ignite.
- They contain enough electricity to burn you.

If you do not follow these steps exactly, some or all of these things can hurt you.

Notice: Ignoring these steps could result in costly damage to your vehicle that would not be covered by your warranty.

Trying to start your vehicle by pushing or pulling it will not work, and it could damage your vehicle.

1. Check the other vehicle. It must have a 12-volt battery with a negative ground system.

Notice: If the other vehicles system is not a 12-volt system with a negative ground, both vehicles can be damaged. Only use vehicles with 12-volt systems with negative grounds to jump start your vehicle.

2. Get the vehicles close enough so the jumper cables can reach, but be sure the vehicles are not touching each other. If they are, it could cause a ground connection you do not want. You would not be able to start your vehicle, and the bad grounding could damage the electrical systems.

To avoid the possibility of the vehicles rolling, set the parking brake firmly on both vehicles involved in the jump start procedure. Put an automatic transmission in PARK (P) or a manual transmission in NEUTRAL (N) before setting the parking brake.

Notice: If you leave your radio or other accessories on during the jump starting procedure, they could be damaged. The repairs would not be covered by your warranty. Always turn off your radio and other accessories when jump starting your vehicle.

3. Turn off the ignition on both vehicles. Unplug unnecessary accessories plugged into the cigarette lighter or the accessory power outlets. Turn off the radio and all lamps that are not needed. This will avoid sparks and help save both batteries. And it could save your radio!

4. Open the hood on the other vehicle and locate the positive (+) and negative (-) terminal locations on that vehicle.

You will not use your vehicle's battery for jump starting. It has a remote positive (+) jump starting terminal, located on the underhood fuse block, for that purpose. See *Engine Compartment Overview on page 5-12* for more information on location.



To uncover the remote positive (+) terminal, press the tab at the bottom of the fuse block and lift the cover up.

**3.8L V6 engine shown,
3.6L V6 engine similar**

Always use the remote positive (+) terminal instead of the positive (+) terminal on the battery.

⚠ CAUTION:

An electric fan can start up even when the engine is not running and can injure you. Keep hands, clothing and tools away from any underhood electric fan.

⚠ CAUTION:

Fans or other moving engine parts can injure you badly. Keep your hands away from moving parts once the engine is running.

⚠ CAUTION:

Using a match near a battery can cause battery gas to explode. People have been hurt doing this, and some have been blinded. Use a flashlight if you need more light.

Be sure the battery has enough water. You do not need to add water to the battery installed in your new vehicle. But if a battery has filler caps, be sure the right amount of fluid is there. If it is low, add water to take care of that first. If you do not, explosive gas could be present.

Battery fluid contains acid that can burn you. Do not get it on you. If you accidentally get it in your eyes or on your skin, flush the place with water and get medical help immediately.

5. Check that the jumper cables do not have loose or missing insulation. If they do, you could get a shock. The vehicles could be damaged too.

Before you connect the cables, here are some basic things you should know. Positive (+) will go to positive (+) or to a remote positive (+) terminal if

the vehicle has one. Negative will go to a heavy, unpainted metal engine part or to a remote negative (-) terminal if the vehicle has one.

Do not connect positive (+) to negative (-), or you will get a short that would damage the battery and maybe other parts too. And do not connect the negative (-) cable to the negative (-) terminal on the dead battery because this can cause sparks.



3.8L V6 engine shown, 3.6L V6 engine similar

6. Connect the red positive (+) cable to the positive (+) terminal location on the vehicle with the dead battery. Use a remote positive (+) terminal if the vehicle has one.

- Do not let the other end touch metal. Connect it to the positive (+) terminal location on the vehicle with the good battery. Use a remote positive (+) terminal if the vehicle has one.
- Now connect the black negative (-) cable to the negative (-) terminal location on the vehicle with the good battery. Use a remote negative (-) terminal if the vehicle has one.

Do not let the other end touch anything until the next step. The other end of the negative (-) cable *does not* go to the dead battery. It goes to a heavy, unpainted metal engine part or to a remote negative (-) terminal on the vehicle with the dead battery.

- Connect the other end of the negative (-) cable at least 18 inches (45 cm) away from the dead battery, but not near engine parts that move. The electrical connection is just as good there, and the chance of sparks getting back to the battery is much less.
- Now start the vehicle with the good battery and run the engine for a while.
- Try to start the vehicle that had the dead battery. If it will not start after a few tries, it probably needs service.

Notice: If the jumper cables are connected or removed in the wrong order, electrical shorting may occur and damage the vehicle. The repairs would not be covered by your warranty. Always connect and remove the jumper cables in the correct order, making sure that the cables do not touch each other or other metal.

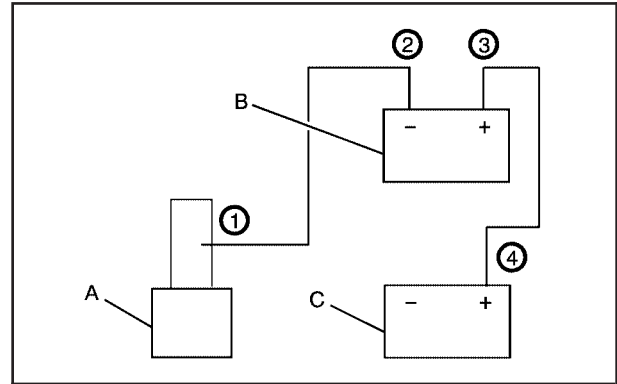

Jumper Cable Removal

- Heavy, Unpainted Metal Engine Part
- Good Battery or Remote Positive (+) Terminal
- Dead Battery or Remote Positive (+) Terminal

To disconnect the jumper cables from both vehicles, do the following:

1. Disconnect the black negative (–) cable from the vehicle that had the dead battery.
2. Disconnect the black negative (–) cable from the vehicle with the good battery.
3. Disconnect the red positive (+) cable from the vehicle with the good battery.
4. Disconnect the red positive (+) cable from the other vehicle.
5. Return the fuse block cover to its original position.

Headlamp Aiming

The vehicle has a visual optical headlamp aiming system. The aim has been preset at the factory and should need no further adjustment

However, If the vehicle is damaged in an accident, the headlamp aim may be affected and adjustment may be necessary.

If oncoming vehicles flash their high beams at you, this may also mean the vertical aim needs to be adjusted.

It is recommended that the vehicle is taken to your dealer for service if the headlamps need to be re-aimed. It is possible however, to re-aim the headlamps as described in the following procedure.

The vehicle should be properly prepared as follows:

- The vehicle should be placed so the headlamps are 25 ft. (7.6 m) from a light colored wall or other flat surface.
- The vehicle must have all four tires on a perfectly level surface which is level all the way to the wall or other flat surface.
- The vehicle should be placed so it is perpendicular to the wall or other flat surface.
- The vehicle should not have any snow, ice or mud on it.
- The vehicle should be fully assembled and all other work stopped while headlamp aiming is being done.
- The vehicle should be normally loaded with a full tank of fuel and one person or 160 lbs (75 kg) on the driver's seat.
- Tires should be properly inflated.

Headlamp aiming is done with the vehicle's low-beam headlamps. The high-beam headlamps will be correctly aimed if the low-beam headlamps are aimed properly.

The vertical headlamp aiming screws are located under the hood near the headlamps.

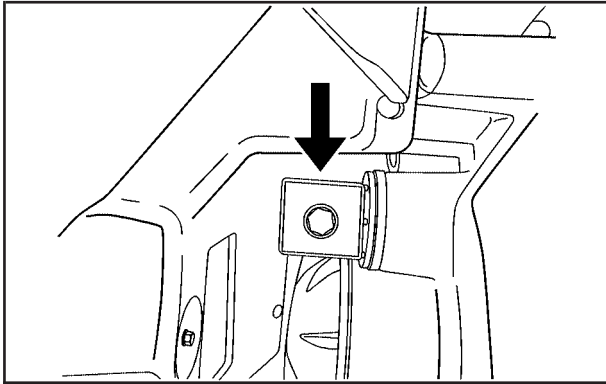

The adjustment screw can be turned with a 6 mm male hex.

To adjust the vertical aim on the headlamps, do the following:

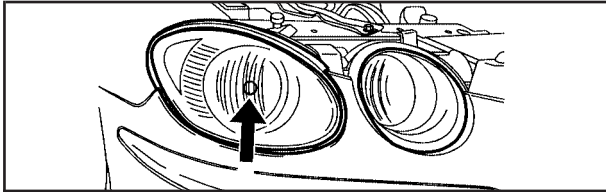

1. Find the aim dot on the lens of the low-beam lamp.

2. Measure the distance from the ground to the aim dot on the lamp. Record the distance.
3. At the wall or other flat surface, measure from the ground upward the recorded distance from Step 2 and draw or tape a horizontal line the width of the vehicle.

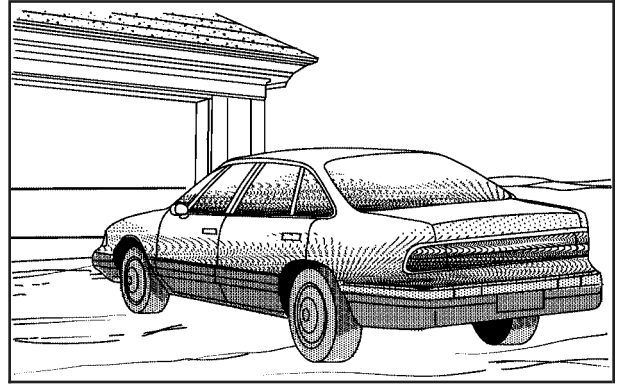

4. Turn on the low-beam headlamps and place a piece of cardboard or equivalent in front of the headlamp not being aimed. This should allow only the beam of light from the headlamp being aimed to be seen on the flat surface.

Notice: Do not cover a headlamp to improve beam cut-off when aiming. Covering a headlamp may cause excessive heat build-up which may cause damage to the headlamp.

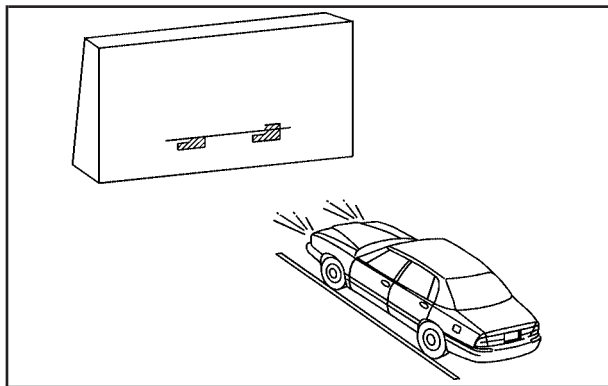

5. Turn the vertical aiming screw until the headlamp beam is aimed to the horizontal tape line. The top edge of the cut-off should be positioned at the bottom edge of the horizontal tape line.
6. Repeat Steps 4 and 5 for the opposite headlamp.

Bulb Replacement

For the proper type of replacement bulbs, see *Replacement Bulbs* on page 5-50.

For any bulb changing procedure not listed in this section, contact your dealer.

Halogen Bulbs

CAUTION:

Halogen bulbs have pressurized gas inside and can burst if you drop or scratch the bulb. You or others could be injured. Be sure to read and follow the instructions on the bulb package.

Headlamps and Sidemarker Lamps

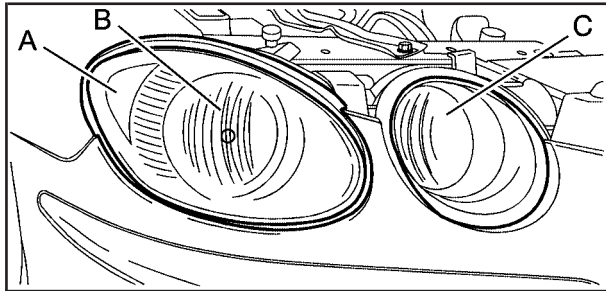

- A. Sidemarker Lamp
- B. Low-Beam Headlamp
- C. High-Beam Headlamp

Low-Beam Headlamp and Sidemarker Bulbs

To replace a low-beam headlamp or sidemarker bulb, do the following:

1. Open the hood. See *Hood Release on page 5-11* for more information.
2. Remove the fastener from the front fascia. The fastener is located inboard of the headlamp assembly, near the high-beam headlamp.

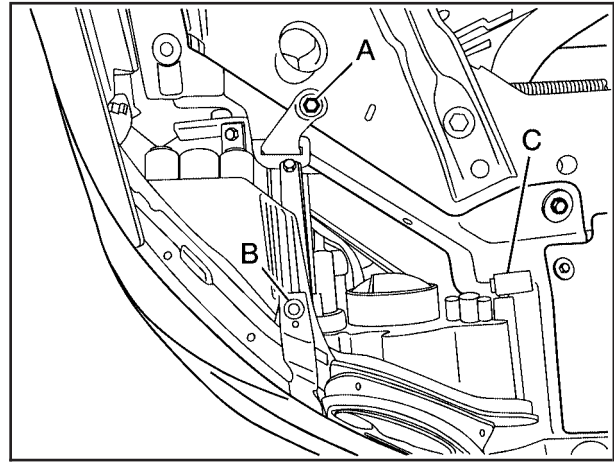

3. Pull up on the plastic retaining clip (C) while pushing rearward on the headlamp. Align the square cut-out on the retaining clip with the notch on the headlamp.
4. Remove the screw (A) from the metal headlamp retainer to pull up and release the headlamp assembly.
5. Remove the push pin (B) retaining the front fascia.

6. Pull back on the front fascia and then pull the headlamp assembly out from the vehicle. Moving the headlamp up and down slightly may help with its removal.
You may have someone assist you with this step.
7. Remove the access cover from behind the bulb being replaced.
8. Turn the bulb socket one-quarter of a turn to remove it from the headlamp assembly.
9. Holding the base of the socket, pull the old bulb from the socket.
10. Replace with a new bulb.
11. Reverse all the steps to reassemble the headlamp assembly.

When replacing the plastic retaining clip, push down on it while pushing rearward on the headlamp, making sure the headlamp assembly is secure.

High-Beam Headlamp Bulbs

To replace the high-beam headlamp bulb, do the following:

1. Open the hood. See *Hood Release on page 5-11* for more information.
2. Locate the high-beam headlamp bulb socket.

3. Remove the access cover from behind the bulb being replaced.
4. Turn the bulb socket counterclockwise and pull it from the headlamp assembly.
5. Holding the base of the socket, pull the old bulb from the socket.
6. Replace with a new bulb.
7. Reverse Steps 2 through 4 to reinstall.

Front Turn Signal and Parking Lamps

To replace a front turn signal/parking lamp bulb in the front fascia, do the following:

1. Locate the front turn signal/parking bulb socket by reaching behind the front bumper.
2. Turn the bulb socket counterclockwise and pull it out of the assembly.
3. Holding the base of the socket, pull the old bulb from the socket.
4. Push the new bulb into the socket.
5. Reverse Steps 1 through 3 to reinstall.

Fog Lamps

Your vehicle may have fog lamps. To replace a fog lamp bulb, do the following:

1. Locate the access door in the splash shield. It is located behind the front fascia. To do this, reach up under and behind the front fascia.
2. Open the access door.
3. Locate the fog lamp bulb socket.
4. Turn the bulb socket counterclockwise one-quarter of a turn while pressing the socket in firmly.
5. Pull the socket rearward until the bulb socket clears the fog lamp housing.

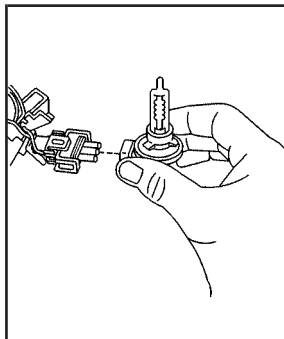

6. Disconnect the wire connector from the bulb by lifting the lock tab and pulling it away from the plastic base.

7. Remove the bulb assembly and replace it with the appropriate bulb.
8. Reverse the steps to reinstall the fog lamp bulb socket.

Taillamps, Turn Signal, Sidemarker, Stoplamps and Back-up Lamps

To replace a taillamp, turn signal, sidemarker, stoplamp or back-up lamp bulb, do the following:

1. Open the trunk. See *Trunk* on page 2-13 for more information.
2. Remove the convenience net if the vehicle has one.

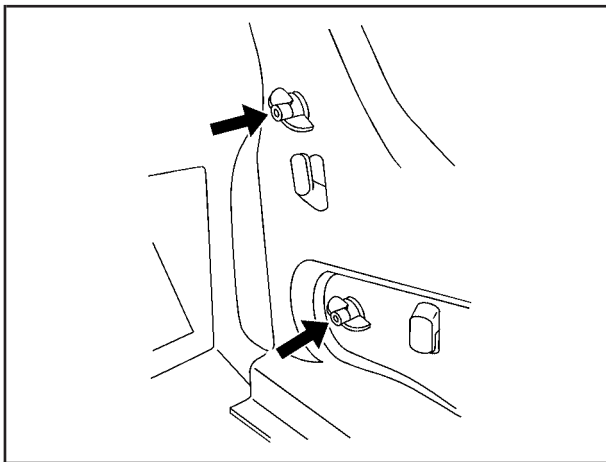

3. Remove the four plastic wing nuts retaining the trunk trim. There are two wing nuts located on the driver's side (shown) and two located on the passenger's side of the vehicle.
4. Pull back the trunk trim.

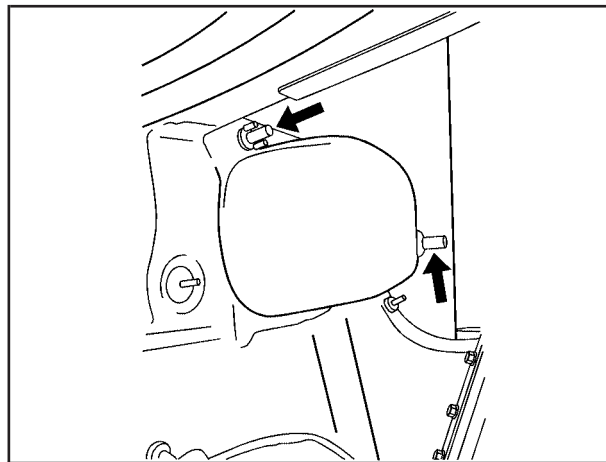

5. Remove the two wing nuts holding the taillamp assembly in place.
6. Pull out the taillamp assembly and disconnect the wiring harness.

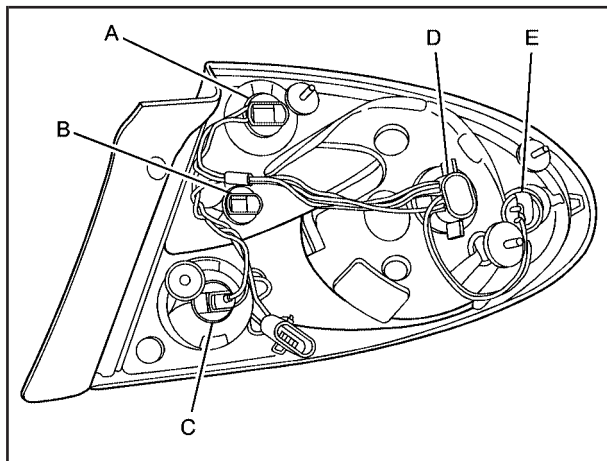

- A. Taillamp
 B. Back-up
 C. Taillamp
 D. Stoplamp/Taillamp/Turn Signal
 E. Sidemarker

7. Turn the bulb socket counterclockwise to remove it.
8. Replace with a new bulb.
9. Turn the bulb socket clockwise to reinstall.
10. Reverse these steps to reinstall the taillamp assembly.

Replacement Bulbs

Exterior Lamps	Bulb Number
Back-Up Lamps	921
Fog Lamp	H11
Front Turn Signal and Parking Lamps	3157NAK
Headlamps	
High-Beam	H9
Low-Beam	H11
Front/Rear Sidemarker and Taillamp	194
Stoplamps and Taillamps	3057

For replacement bulbs not listed here, contact your dealer.

Windshield Wiper Blade Replacement

Windshield wiper blades should be inspected for wear or cracking each time maintenance is performed. See *Scheduled Maintenance on page 6-4*.

1. Lift the wiper arm and turn the blade until it is facing away from the windshield.



2. Push the release lever under the windshield wiper arm, and slide the wiper assembly off of the wiper arm.
3. Slide the new wiper blade securely on the wiper arm until you hear the release clip click into place.

For wiper blade type and length, see *Normal Maintenance Replacement Parts on page 6-13*.

Tires

Your new vehicle comes with high-quality tires made by a leading tire manufacturer. If you ever have questions about your tire warranty and where to obtain service, see your GM Warranty booklet for details. For additional information refer to the tire manufacturer's booklet included with your vehicle's Owner Manual.

CAUTION:

Poorly maintained and improperly used tires are dangerous.

- **Overloading your tires can cause overheating as a result of too much friction. You could have an air-out and a serious accident. See *Loading Your Vehicle on page 4-29.***

CAUTION: (Continued)

CAUTION: (Continued)

- **Underinflated tires pose the same danger as overloaded tires. The resulting accident could cause serious injury. Check all tires frequently to maintain the recommended pressure. Tire pressure should be checked when your tires are cold. See *Inflation - Tire Pressure on page 5-58.***
- **Overinflated tires are more likely to be cut, punctured or broken by a sudden impact — such as when you hit a pothole. Keep tires at the recommended pressure.**
- **Worn, old tires can cause accidents. If your tread is badly worn, or if your tires have been damaged, replace them.**

Tire Sidewall Labelling

Useful information about a tire is molded into its sidewall. The examples below show a typical passenger vehicle tire and a compact spare tire sidewall.

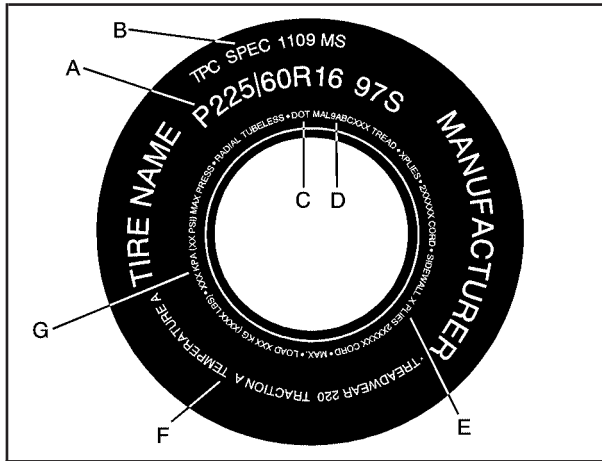

Passenger (P-Metric) Tire Example

(A) Tire Size: The tire size is a combination of letters and numbers used to define a particular tire's width, height, aspect ratio, construction type and service description. See the "Tire Size" illustration later in this section for more detail.

(B) TPC Spec (Tire Performance Criteria Specification): Original equipment tires designed to GM's specific tire performance criteria have a TPC specification code molded onto the sidewall. GM's TPC specifications meet or exceed all federal safety guidelines.

(C) DOT (Department of Transportation): The Department of Transportation (DOT) code indicates that the tire is in compliance with the U.S. Department of Transportation Motor Vehicle Safety Standards.

(D) Tire Identification Number (TIN): The letters and numbers following DOT (Department of Transportation) code is the Tire Identification Number (TIN). The TIN shows the manufacturer and plant code, tire size, and date the tire was manufactured. The TIN is molded onto both sides of the tire, although only one side may have the date of manufacture.

(E) Tire Ply Material: The type of cord and number of plies in the sidewall and under the tread.

(F) Uniform Tire Quality Grading (UTQG): Tire manufacturers are required to grade tires based on three performance factors: treadwear, traction and temperature resistance. For more information see *Uniform Tire Quality Grading* on page 5-63.

(G) Maximum Cold Inflation Load Limit: Maximum load that can be carried and the maximum pressure needed to support that load.

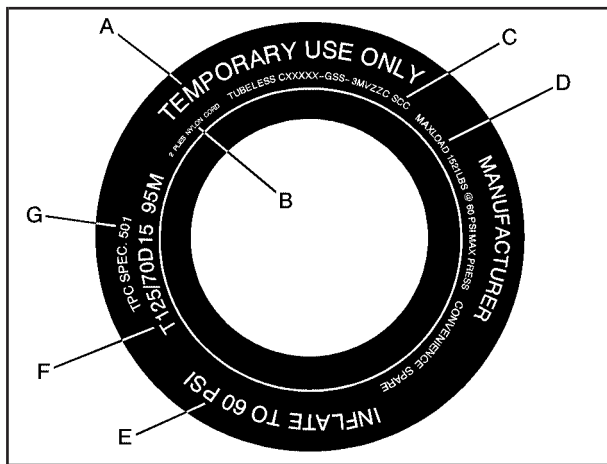

Compact Spare Tire Example

(A) Temporary Use Only: The compact spare tire or temporary use tire has a tread life of approximately 3,000 miles (5 000 km) and should not be driven at speeds over 65 mph (105 km/h). The compact spare tire is for emergency use when a regular road tire has lost air and gone flat. If your vehicle has a compact spare tire, see *Compact Spare Tire on page 5-77* and *If a Tire Goes Flat on page 5-67*.

(B) Tire Ply Material: The type of cord and number of plies in the sidewall and under the tread.

(C) Tire Identification Number (TIN): The letters and numbers following the DOT (Department of Transportation) code is the Tire Identification Number (TIN). The TIN shows the manufacturer and plant code, tire size, and date the tire was manufactured. The TIN is molded onto both sides of the tire, although only one side may have the date of manufacture.

(D) Maximum Cold Inflation Load Limit: Maximum load that can be carried and the maximum pressure needed to support that load.

(E) Tire Inflation: The temporary use tire or compact spare tire should be inflated to 60 psi (420 kPa). For more information on tire pressure and inflation see *Inflation - Tire Pressure on page 5-58*.

(F) Tire Size: A combination of letters and numbers define a tire's width, height, aspect ratio, construction type and service description. The letter T as the first character in the tire size means the tire is for temporary use only.

(G) TPC Spec (Tire Performance Criteria Specification): Original equipment tires designed to GM's specific tire performance criteria have a TPC specification code molded onto the sidewall. GM's TPC specifications meet or exceed all federal safety guidelines.

Tire Size

The following illustration shows an example of a typical passenger vehicle tire size.

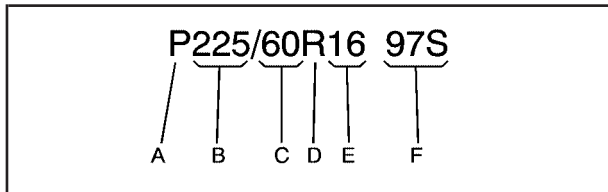

(A) Passenger (P-Metric) Tire: The United States version of a metric tire sizing system. The letter P as the first character in the tire size means a passenger vehicle tire engineered to standards set by the U.S. Tire and Rim Association.

(B) Tire Width: The three-digit number indicates the tire section width in millimeters from sidewall to sidewall.

(C) Aspect Ratio: A two-digit number that indicates the tire height-to-width measurements. For example, if the tire size aspect ratio is 60, as shown in item C of the illustration, it would mean that the tire's sidewall is 60 percent as high as it is wide.

(D) Construction Code: A letter code is used to indicate the type of ply construction in the tire. The letter R means radial ply construction; the letter D means diagonal or bias ply construction; and the letter B means belted-bias ply construction.

(E) Rim Diameter: Diameter of the wheel in inches.

(F) Service Description: These characters represent the load range and speed rating of the tire. The load index represents the load carry capacity a tire is certified to carry. The load index can range from 1 to 279. The speed rating is the maximum speed a tire is certified to carry a load. Speed ratings range from A to Z.

Tire Terminology and Definitions

Air Pressure: The amount of air inside the tire pressing outward on each square inch of the tire. Air pressure is expressed in pounds per square inch (psi) or kiloPascal (kPa).

Accessory Weight: This means the combined weight of optional accessories. Some examples of optional accessories are, automatic transmission, power steering, power brakes, power windows, power seats, and air conditioning.

Aspect Ratio: The relationship of a tire's height to its width.

Belt: A rubber coated layer of cords that is located between the plies and the tread. Cords may be made from steel or other reinforcing materials.

Bead: The tire bead contains steel wires wrapped by steel cords that hold the tire onto the rim.

Bias Ply Tire: A pneumatic tire in which the plies are laid at alternate angles less than 90 degrees to the centerline of the tread.

Cold Inflation Pressure: The amount of air pressure in a tire, measured in pounds per square inch (psi) or kiloPascals (kPa) before a tire has built up heat from driving. See *Inflation - Tire Pressure on page 5-58*.

Curb Weight: This means the weight of a motor vehicle with standard and optional equipment including the maximum capacity of fuel, oil and coolant, but without passengers and cargo.

DOT Markings: A code molded into the sidewall of a tire signifying that the tire is in compliance with the U.S. Department of Transportation (DOT) motor vehicle safety standards. The DOT code includes the Tire Identification Number (TIN), an alphanumeric designator which can also identify the tire manufacturer, production plant, brand and date of production.

GVWR: Gross Vehicle Weight Rating, see *Loading Your Vehicle on page 4-29*.

GAWR FRT: Gross Axle Weight Rating for the front axle, see *Loading Your Vehicle on page 4-29*.

GAWR RR: Gross Axle Weight Rating for the rear axle, see *Loading Your Vehicle on page 4-29*.

Intended Outboard Sidewall: The side of an asymmetrical tire, that must always face outward when mounted on a vehicle.

KiloPascal (kPa): The metric unit for air pressure.

Light Truck (LT-Metric) Tire: A tire used on light duty trucks and some multipurpose passenger vehicles.

Load Index: An assigned number ranging from 1 to 279 that corresponds to the load carrying capacity of a tire.

Maximum Inflation Pressure: The maximum air pressure to which a cold tire may be inflated. The maximum air pressure is molded onto the sidewall.

Maximum Load Rating: The load rating for a tire at the maximum permissible inflation pressure for that tire.

Maximum Loaded Vehicle Weight: The sum of curb weight; accessory weight; vehicle capacity weight; and production options weight.

Normal Occupant Weight: The number of occupants a vehicle is designed to seat multiplied by 150 lbs (68 kg). See *Loading Your Vehicle on page 4-29*.

Occupant Distribution: Designated seating positions.

Outward Facing Sidewall: The side of an asymmetrical tire that has a particular side that faces outward when mounted on a vehicle. The side of the tire that contains a whitewall, bears white lettering or bears manufacturer, brand, and/or model name molding that is higher or deeper than the same moldings on the other sidewall of the tire.

Passenger (P-Metric) Tire: A tire used on passenger cars and some light duty trucks and multipurpose vehicles.

Recommended Inflation Pressure: Vehicle manufacturer's recommended tire inflation pressure and shown on the tire placard. See *Inflation - Tire Pressure on page 5-58* and *Loading Your Vehicle on page 4-29*.

Radial Ply Tire: A pneumatic tire in which the ply cords that extend to the beads are laid at 90 degrees to the centerline of the tread.

Rim: A metal support for a tire and upon which the tire beads are seated.

Sidewall: The portion of a tire between the tread and the bead.

Speed Rating: An alphanumeric code assigned to a tire indicating the maximum speed at which a tire can operate.

Traction: The friction between the tire and the road surface. The amount of grip provided.

Tread: The portion of a tire that comes into contact with the road.

Treadwear Indicators: Narrow bands, sometimes called "wear bars," that show across the tread of a tire when only 1/16 inch (1.6 mm) of tread remains. See *When It Is Time for New Tires on page 5-61*.

UTQGS (Uniform Tire Quality Grading Standards): A tire information system that provides consumers with ratings for a tire's traction, temperature, and treadwear. Ratings are determined by tire manufacturers using government testing procedures. The ratings are molded into the sidewall of the tire. See *Uniform Tire Quality Grading on page 5-63*.

Vehicle Capacity Weight: The number of designated seating positions multiplied by 150 lbs (68 kg) plus the rated cargo load. See *Loading Your Vehicle on page 4-29*.

Vehicle Maximum Load on the Tire: Load on an individual tire due to curb weight, accessory weight, occupant weight, and cargo weight.

Vehicle Placard: A label permanently attached to a vehicle showing the vehicle's capacity weight and the original equipment tire size and recommended inflation pressure. See "Tire and Loading Information Label" under *Loading Your Vehicle on page 4-29*.

Inflation - Tire Pressure

Tires need the correct amount of air pressure to operate effectively.

Notice: Do not let anyone tell you that under-inflation or over-inflation is all right. It is not. If your tires do not have enough air (under-inflation), you can get the following:

- Too much flexing
- Too much heat
- Tire overloading
- Premature or irregular wear
- Poor handling
- Reduced fuel economy

If your tires have too much air (over-inflation), you can get the following:

- Unusual wear
- Poor handling
- Rough ride
- Needless damage from road hazards

A Tire and Loading Information label is attached to the vehicle's center pillar (B-pillar), below the driver's door latch. This label shows your vehicle's original equipment tires and the correct inflation pressures for your tires when they are cold. The recommended cold tire inflation pressure, shown on the label, is the minimum amount of air pressure needed to support your vehicle's maximum load carrying capacity.

For additional information regarding how much weight your vehicle can carry, and an example of the tire and loading information label, see *Loading Your Vehicle on page 4-29*. How you load your vehicle affects vehicle handling and ride comfort, never load your vehicle with more weight than it was designed to carry.

When to Check

Check your tires once a month or more. Do not forget to check the compact spare tire, it should be at 60 psi (420 kPa). For additional information regarding the compact spare tire, see *Compact Spare Tire on page 5-77*.

How to Check

Use a good quality pocket-type gage to check tire pressure. You cannot tell if your tires are properly inflated simply by looking at them. Radial tires may look properly inflated even when they are under-inflated. Check the tire's inflation pressure when the tires are cold. Cold means your vehicle has been sitting for at least three hours or driven no more than 1 mile (1.6 km).

Remove the valve cap from the tire valve stem. Press the tire gage firmly onto the valve to get a pressure measurement. If the cold tire inflation pressure matches the recommended pressure on the Tire and Loading Information label, no further adjustment is necessary. If the inflation pressure is low, add air until you reach the recommended amount.

If you overfill the tire, release air by pushing on the metal stem in the center of the tire valve. Re-check the tire pressure with the tire gage.

Be sure to put the valve caps back on the valve stems. They help prevent leaks by keeping out dirt and moisture.

Tire Inspection and Rotation

Tires should be rotated every 5,000 to 8,000 miles (8 000 to 13 000 km).

Any time you notice unusual wear, rotate your tires as soon as possible and check wheel alignment. Also check for damaged tires or wheels. See *When It Is Time for New Tires on page 5-61* and *Wheel Replacement on page 5-65* for more information.

The purpose of regular rotation is to achieve more uniform wear for all tires on the vehicle. The first rotation is the most important. See *Scheduled Maintenance on page 6-4*.

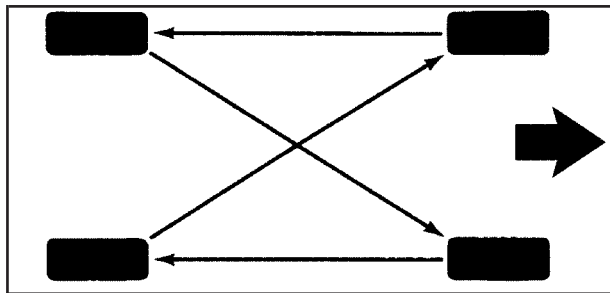

When rotating your tires, always use the correct rotation pattern shown here.

Do not include the compact spare tire in your tire rotation.

After the tires have been rotated, adjust the front and rear inflation pressures as shown on the Tire and Loading Information label.

Make certain that all wheel nuts are properly tightened. See “Wheel Nut Torque” under *Capacities and Specifications on page 5-92*.

CAUTION:

Rust or dirt on a wheel, or on the parts to which it is fastened, can make wheel nuts become loose after a time. The wheel could come off and cause an accident. When you change a wheel, remove any rust or dirt from places where the wheel attaches to the vehicle. In an emergency, you can use a cloth or a paper towel to do this; but be sure to use a scraper or wire brush later, if needed, to get all the rust or dirt off. See *Changing a Flat Tire on page 5-68*.

When It Is Time for New Tires

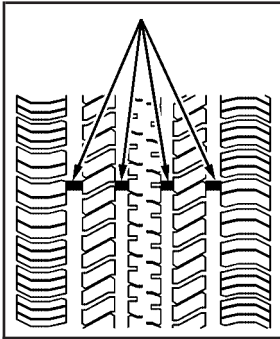

One way to tell when it's time for new tires is to check the treadwear indicators, which will appear when your tires have only 1/16 inch (1.6 mm) or less of tread remaining.

You need a new tire if any of the following statements are true:

- You can see the indicators at three or more places around the tire.
- You can see cord or fabric showing through the tire's rubber.
- The tread or sidewall is cracked, cut or snagged deep enough to show cord or fabric.
- The tire has a bump, bulge or split.
- The tire has a puncture, cut or other damage that can't be repaired well because of the size or location of the damage.

Buying New Tires

To find out what kind and size of tires your vehicle needs, look at the tire and loading information label. For more information about this label and its location on your vehicle, see *Loading Your Vehicle on page 4-29*.

The tires installed on your vehicle when it was new had a Tire Performance Criteria Specification (TPC Spec) number on each tire's sidewall. When you get new tires, GM recommends that you get tires with that same TPC Spec number. That way your vehicle will continue to have tires that are designed to give proper endurance, handling, speed rating, load range, traction, ride and other things during normal service on your vehicle. If your tires have an all-season tread design, the TPC number will be followed by an "MS" (for mud and snow).

If you ever replace your tires with those not having a TPC Spec number, make sure they are the same size, load range, speed rating and construction type (bias, bias-belted or radial) as your original tires.

CAUTION:

Mixing tires could cause you to lose control while driving. If you mix tires of different sizes or types (radial and bias-belted tires), the vehicle may not handle properly, and you could have a crash. Using tires of different sizes may also cause damage to your vehicle. Be sure to use the same size and type tires on all wheels. It's all right to drive with your compact spare temporarily, it was developed for use on your vehicle. See *Compact Spare Tire on page 5-77*.

CAUTION:

If you use bias-ply tires on your vehicle, the wheel rim flanges could develop cracks after many miles of driving. A tire and/or wheel could fail suddenly, causing a crash. Use only radial-ply tires with the wheels on your vehicle.

Uniform Tire Quality Grading

Quality grades can be found where applicable on the tire sidewall between tread shoulder and maximum section width. For example:

Treadwear 200 Traction AA Temperature A

The following information relates to the system developed by the United States National Highway Traffic Safety Administration, which grades tires by treadwear, traction and temperature performance. (This applies only to vehicles sold in the United States.)

The grades are molded on the sidewalls of most passenger car tires. The Uniform Tire Quality Grading system does not apply to deep tread, winter-type snow tires, space-saver or temporary use spare tires, tires with nominal rim diameters of 10 to 12 inches (25 to 30 cm), or to some limited-production tires.

While the tires available on General Motors passenger cars and light trucks may vary with respect to these grades, they must also conform to federal safety requirements and additional General Motors Tire Performance Criteria (TPC) standards.

Treadwear

The treadwear grade is a comparative rating based on the wear rate of the tire when tested under controlled conditions on a specified government test course. For example, a tire graded 150 would wear one and a half (1.5) times as well on the government course as a tire graded 100. The relative performance of tires depends upon the actual conditions of their use, however, and may depart significantly from the norm due to variations in driving habits, service practices and differences in road characteristics and climate.

Traction – AA, A, B, C

The traction grades, from highest to lowest, are AA, A, B, and C. Those grades represent the tire's ability to stop on wet pavement as measured under controlled conditions on specified government test surfaces of asphalt and concrete. A tire marked C may have poor traction performance. Warning: The traction grade assigned to this tire is based on straight-ahead braking traction tests, and does not include acceleration, cornering, hydroplaning, or peak traction characteristics.

Temperature – A, B, C

The temperature grades are A (the highest), B, and C, representing the tire's resistance to the generation of heat and its ability to dissipate heat when tested under controlled conditions on a specified indoor laboratory test wheel. Sustained high temperature can cause the material of the tire to degenerate and reduce tire life, and excessive temperature can lead to sudden tire failure. The grade C corresponds to a level of performance which all passenger car tires must meet under the Federal Motor Vehicle Safety Standard No. 109. Grades B and A represent higher levels of performance on the laboratory test wheel than the minimum required by law.

Warning: The temperature grade for this tire is established for a tire that is properly inflated and not overloaded. Excessive speed, underinflation, or excessive loading, either separately or in combination, can cause heat buildup and possible tire failure.

Wheel Alignment and Tire Balance

The tires and wheels on your vehicle were aligned and balanced carefully at the factory to give you the longest tire life and best overall performance. Adjustments to wheel alignment and tire balancing will not be necessary on a regular basis. However, if you notice unusual tire wear or your vehicle pulling to one side or the other, the alignment may need to be checked. If you notice your vehicle vibrating when driving on a smooth road, your tires and wheels may need to be rebalanced. See your dealer for proper diagnosis.

Wheel Replacement

Replace any wheel that is bent, cracked or badly rusted or corroded. If wheel nuts keep coming loose, the wheel, wheel bolts and wheel nuts should be replaced. If the wheel leaks air, replace it (except some aluminum wheels, which can sometimes be repaired). See your dealer if any of these conditions exist.

Your dealer will know the kind of wheel you need.

Each new wheel should have the same load-carrying capacity, diameter, width, offset and be mounted the same way as the one it replaces.

If you need to replace any of your wheels, wheel bolts or wheel nuts, replace them only with new GM original equipment parts. This way, you will be sure to have the right wheel, wheel bolts and wheel nuts for your vehicle.

CAUTION:

Using the wrong replacement wheels, wheel bolts or wheel nuts on your vehicle can be dangerous. It could affect the braking and handling of your vehicle, make your tires lose air and make you lose control. You could have a collision in which you or others could be injured. Always use the correct wheel, wheel bolts and wheel nuts for replacement.

Notice: The wrong wheel can also cause problems with bearing life, brake cooling, speedometer or odometer calibration, headlamp aim, bumper height, vehicle ground clearance and tire or tire chain clearance to the body and chassis.

See *Changing a Flat Tire* on page 5-68 for more information.

Used Replacement Wheels

CAUTION:

Putting a used wheel on your vehicle is dangerous. You can't know how it's been used or how far it's been driven. It could fail suddenly and cause a crash. If you have to replace a wheel, use a new GM original equipment wheel.

Tire Chains

CAUTION:

If your vehicle has P225/55R17 size tires, do not use tire chains, there is not enough clearance. Tire chains used on a vehicle without the proper amount of clearance can cause damage to the brakes, suspension or other vehicle parts. The area damaged by the tire chains could cause you to lose control of your vehicle and you or others may be injured in a crash.

CAUTION: (Continued)

CAUTION: (Continued)

Use another type of traction device only if its manufacturer recommends it for use on your vehicle and tire size combination and road conditions. Follow that manufacturer's instructions. To help avoid damage to your vehicle, drive slowly, readjust or remove the device if it is contacting your vehicle, and do not spin your wheels.

If you do find traction devices that will fit, install them on the front tires.

Notice: If your vehicle has a tire size other than P225/55R17 size tires, use tire chains only where legal and only when you must. Use only SAE Class "S" type chains that are the proper size for your tires. Install them on the front tires and tighten them as tightly as possible with the ends securely fastened. Drive slowly and follow the chain manufacturer's instructions. If you can hear the chains contacting your vehicle, stop and retighten them. If the contact continues, slow down until it stops. Driving too fast or spinning the wheels with chains on will damage your vehicle.

If a Tire Goes Flat

It is unusual for a tire to blowout while you're driving, especially if you maintain your tires properly. If air goes out of a tire, it is much more likely to leak out slowly. But if you should ever have a blowout, here are a few tips about what to expect and what to do:

If a front tire fails, the flat tire will create a drag that pulls the vehicle toward that side. Take your foot off the accelerator pedal and grip the steering wheel firmly. Steer to maintain lane position, and then gently brake to a stop well out of the traffic lane.

A rear blowout, particularly on a curve, acts much like a skid and may require the same correction you would; use in a skid. In any rear blowout, remove your foot from the accelerator pedal. Get the vehicle under control by steering the way you want the vehicle to go. It may be very bumpy and noisy, but you can still steer. Gently brake to a stop, well off the road if possible.

CAUTION:

Lifting a vehicle and getting under it to do maintenance or repairs is dangerous without the appropriate safety equipment and training. The jack provided with your vehicle is designed only for changing a flat tire. If it is used for anything else, you or others could be badly injured or killed if the vehicle slips off the jack. Use the jack provided with your vehicle only for changing a flat tire.

If a tire goes flat, the next part shows how to use your jacking equipment to change a flat tire safely.

Changing a Flat Tire

If a tire goes flat, avoid further tire and wheel damage by driving slowly to a level place. Turn on your vehicle's hazard warning flashers.

CAUTION:

Changing a tire can be dangerous. The vehicle can slip off the jack and roll over or fall on you or other people. You and they could be badly injured or even killed. Find a level place to change your tire. To help prevent the vehicle from moving:

1. Set the parking brake firmly.
2. Put the shift lever in PARK (P).
3. Turn off the engine and do not restart while the vehicle is raised.
4. Do not allow passengers to remain in the vehicle.

To be even more certain the vehicle will not move, you should put blocks at the front and rear of the tire farthest away from the one being changed. That would be the tire, on the other side, at the opposite end of the vehicle.

When your vehicle has a flat tire, use the following example as a guide to assist you in the placement of wheel blocks.

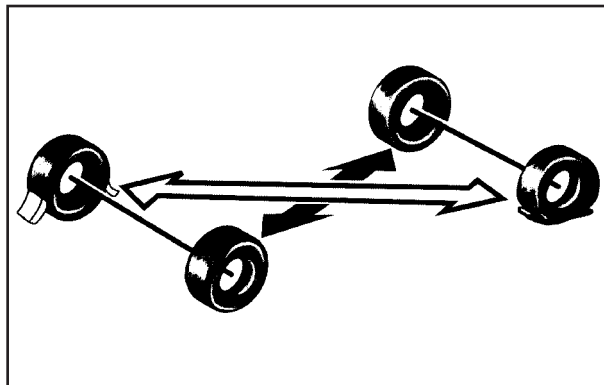

The following information will tell you next how to use the jack and change a tire.

Removing the Spare Tire and Tools

The equipment you will need is located in the trunk.

1. Open the trunk. See *Trunk* on page 2-13 for more information.
2. Remove the convenience net if the vehicle has one.

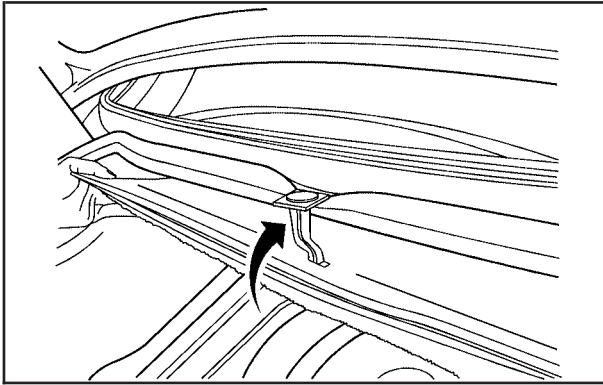

3. Lift the handle on the spare tire cover. The handle may hook on the front edge of the trunk's weatherstrip to hold the cover out of the way.

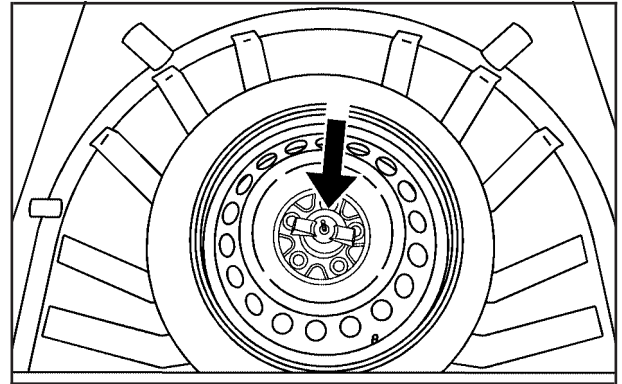

4. Turn the wing nut counterclockwise and remove it.
5. Remove the compact spare tire.

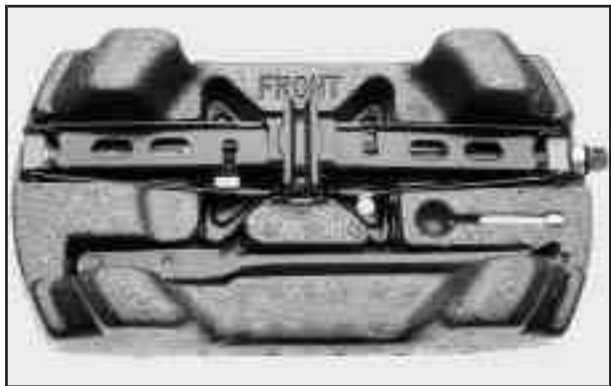

6. Turn the nut holding the jack counterclockwise and remove it. Then remove the jack and wrench.

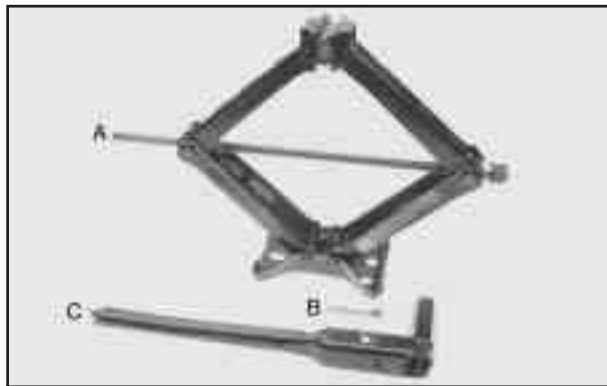

The tools needed to change a tire include the jack (A), extension and protection guide (B), and wheel wrench (C).

Removing the Flat Tire and Installing the Spare Tire

If your vehicle has wheel covers with center caps, the wheel nuts are hidden behind the cap. The center cap must be removed before you can remove the flat tire and install the spare tire.

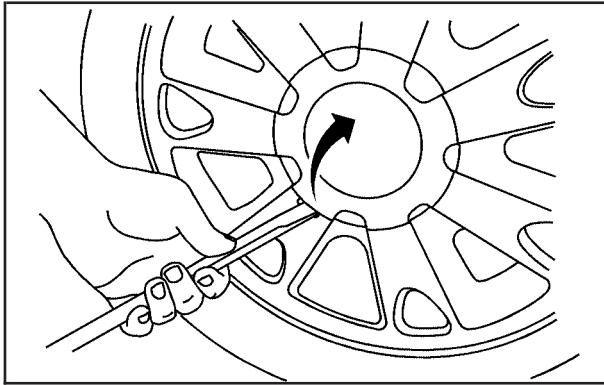

To remove a center cap, use the wrench to pry gently at the notch on the cap. Do not use a tool that is narrower than the wrench to pry at this notch. Then pry off the cap.

Use the wheel wrench to loosen the plastic nut caps in a counterclockwise direction. If needed, finish loosening them by hand. The nut caps will not come off.

Then, using the flat end of the wheel wrench, pry along the edge of the wheel cover until it comes off. Be careful; the edge may be sharp. Do not try to remove the cover with your bare hands.

Once you have removed the center cap or wheel cover, use the following procedure to remove the flat tire and install the spare tire.

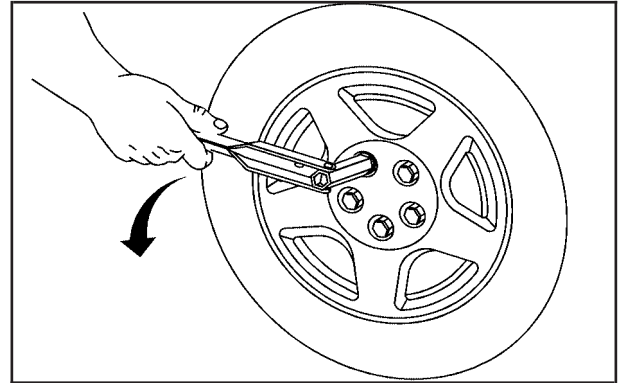

1. Place the wheel wrench securely over the wheel nut. Turn the wheel wrench counterclockwise to loosen all the wheel nuts, but do not remove them yet.

- Turn the jack handle clockwise to raise the jack lift head.

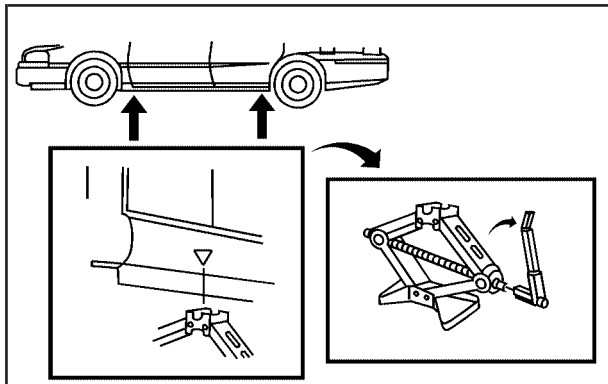

- Find the jacking location using the diagram above and corresponding hoisting notches located on the underside of the vehicle's plastic molding. The notches in the plastic molding are marked with a triangle shape to help you find them.

The front location is about 6.5 inches (16.5 cm) from the rear edge of the front wheel well. The rear location is about 9 inches (22.8 cm) from the front edge of the rear wheel well.

- Put the compact spare tire near you.

⚠ CAUTION:

Getting under a vehicle when it is jacked up is dangerous. If the vehicle slips off the jack you could be badly injured or killed. Never get under a vehicle when it is supported only by a jack.

⚠ CAUTION:

Raising your vehicle with the jack improperly positioned can damage the vehicle and even make the vehicle fall. To help avoid personal injury and vehicle damage, be sure to fit the jack lift head into the proper location before raising the vehicle.

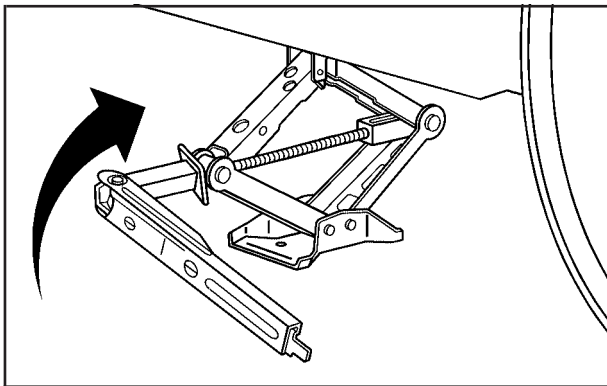

5. Raise the vehicle by turning the jack handle clockwise. Raise the vehicle far enough off the ground for the compact spare tire to fit under the vehicle.
6. Remove all wheel nuts and take off the flat tire.

⚠ CAUTION:

Rust or dirt on the wheel, or on the parts to which it is fastened, can make the wheel nuts become loose after a time. The wheel could come off and cause an accident. When you change a wheel, remove any rust or dirt from the places where the wheel attaches to the vehicle. In an emergency, you can use a cloth or a paper towel to do this; but be sure to use a scraper or wire brush later, if you need to, to get all the rust or dirt off.

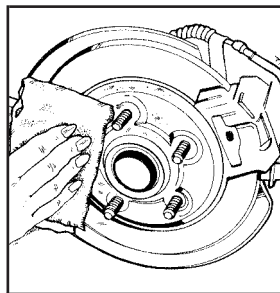

7. Remove any rust or dirt from the wheel bolts, mounting surfaces and spare wheel.

8. Install the compact spare tire.

⚠ CAUTION:

Never use oil or grease on studs or nuts. If you do, the nuts might come loose. Your wheel could fall off, causing a serious accident.

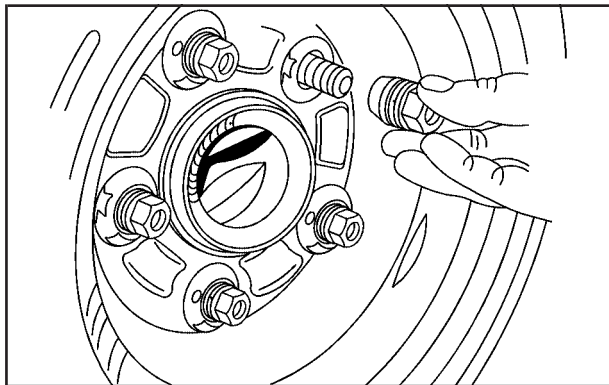

9. Put the wheel nuts back on with the rounded end of the nuts toward the wheel. Tighten each nut by hand until the wheel is held against the hub.

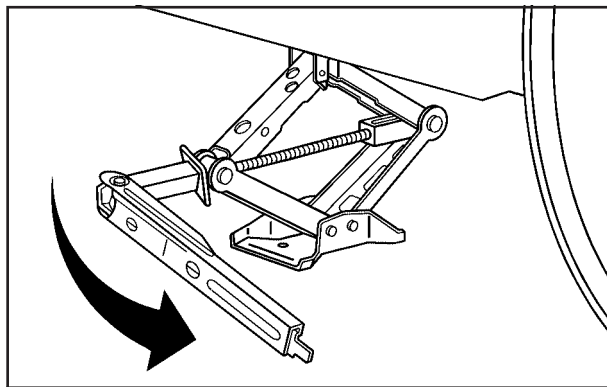

10. Lower the vehicle by turning the jack handle counterclockwise. Lower the jack completely.

⚠ CAUTION:

Incorrect wheel nuts or improperly tightened wheel nuts can cause the wheel to come loose and even come off. This could lead to an accident. Be sure to use the correct wheel nuts. If you have to replace them, be sure to get new GM original equipment wheel nuts. Stop somewhere as soon as you can and have the nuts tightened with a torque wrench to the proper torque specification. See *Capacities and Specifications* on page 5-92 for wheel nut torque specification.

Notice: Improperly tightened wheel nuts can lead to brake pulsation and rotor damage. To avoid expensive brake repairs, evenly tighten the wheel nuts in the proper sequence and to the proper torque specification. See *Capacities and Specifications* on page 5-92 for the wheel nut torque specification.

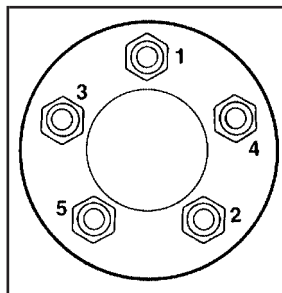

11. Tighten the wheel nuts firmly in a crisscross sequence as shown.

Notice: Wheel covers will not fit on your compact spare. If you try to put a wheel cover on the compact spare, you could damage the cover or the spare.

Do not try to put the wheel cover on the compact spare tire. It will not fit. Store the wheel cover in the trunk until you have the flat tire repaired or replaced.

Storing a Flat or Spare Tire and Tools

CAUTION:

Storing a jack, a tire, or other equipment in the passenger compartment of the vehicle could cause injury. In a sudden stop or collision, loose equipment could strike someone. Store all these in the proper place.

After the compact spare tire has been installed on the vehicle, store the flat tire in the trunk. Use the following procedure to secure the flat tire in the trunk.

When storing a full-size tire, use the extension with the protector, located in the foam holder, to help avoid wheel surface damage. To store a full-size tire, place the tire valve stem facing down, and then remove the protector and attach the retainer securely. Store the cover as far forward as possible.

When storing a compact spare tire in the trunk, put the protector back in the foam holder.

The compact spare is for temporary use only. Replace the compact spare tire with a full-size tire as soon as you can. See *Compact Spare Tire* on page 5-77. See the storage instructions label to return the compact spare to the trunk properly.

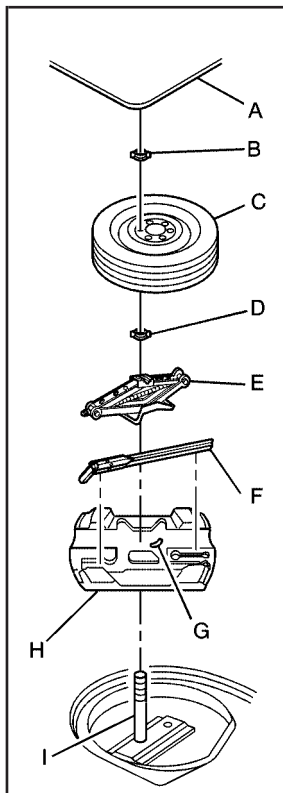

- A. Cover
- B. Wing Nut
- C. Compact Spare Tire
- D. Wing Nut
- E. Jack
- F. Wheel Wrench
- G. Extension Protector
- H. Bolt Screw
- I. Foam Holder

Compact Spare Tire

Although the compact spare tire was fully inflated when the vehicle was new, it can lose air after a time. Check the inflation pressure regularly. It should be 60 psi (420 kPa).

After installing the compact spare on the vehicle, check to make sure it is correctly inflated. The compact spare is made to perform well at speeds up to 65 mph (105 km/h) for distances up to 3,000 miles (5 000 km). However, it is best to replace the compact spare with a full-size tire as soon as possible. The spare will last longer and be in good shape in case it is needed again.

Notice: When the compact spare is installed, do not take your vehicle through an automatic car wash with guide rails. The compact spare can get caught on the rails. That can damage the tire and wheel, and maybe other parts of your vehicle.

Do not use the compact spare on other vehicles.

Do not mix the compact spare tire or wheel with other wheels or tires. They will not fit. Keep the spare tire and its wheel together.

Notice: Tire chains will not fit your compact spare. Using them can damage your vehicle and can damage the chains too. Do not use tire chains on your compact spare.

Appearance Care

Cleaning products can be hazardous. Some are toxic. Other cleaning products can burst into flames if a match is struck near them or if they get on a hot part of the vehicle. Some are dangerous if their fumes are inhaled in an enclosed space. When anything from a container is used to clean the vehicle, be sure to follow the manufacturer's warnings and instructions. Always open the doors or windows of the vehicle when cleaning the inside.

Never use these to clean the vehicle:

- Gasoline
- Benzene
- Naphtha
- Carbon Tetrachloride
- Acetone
- Paint Thinner
- Turpentine
- Lacquer Thinner
- Nail Polish Remover

They can all be hazardous — some more than others — and they can all damage the vehicle, too.

Do not use any of these products unless this manual says you can. In many uses, these will damage the vehicle:

- Alcohol
- Laundry Soap
- Bleach
- Reducing Agents

Fabric/Carpet

Use a vacuum cleaner often to get rid of dust and loose dirt. Wipe vinyl, leather, plastic, and painted surfaces with a clean, damp cloth.

GM-approved cleaning products can be obtained from your dealer.

Here are some cleaning tips:

- Always read the instructions on the cleaner label.
- Clean up stains as soon as you can before they set.
- Carefully scrape off any excess stain.
- Use a clean cloth or sponge, and change to a clean area often. A soft brush may be used if stains are stubborn.
- To avoid forming a ring on the fabric after spot cleaning, clean the entire area immediately or it will set.

Most stains can be removed with club soda water. To clean, use the following instructions:

1. For liquids: blot with a clean, soft, white cloth. For solids: remove as much as possible and then vacuum or brush.
2. Apply club soda water to a clean, soft, white cloth. Do not over-saturate; the cloth should not drip water.
3. Clean the entire area. Avoid getting the fabric too wet.
4. Start cleaning from the seams into the stain to avoid a ring effect.
5. Continue cleaning, using a clean area of the cloth each time it becomes soiled.
6. When the stain is removed, blot the cleaned area with another dry, clean, soft, white cloth.

Using Cleaner on Fabric

1. First, try the cleaner on an area of the fabric that is not easily seen to make sure the cleaner does not affect the color of the fabric.
2. For liquids: blot with a clean, soft, white cloth. For solids: remove as much as possible and then vacuum or brush.
3. Spray a small amount of the cleaner onto a clean soft, white, cloth. Do not apply spray directly to the fabric.

4. Start cleaning from the seams into the stain to avoid a ring effect.
5. Continue cleaning, using a clean area of the cloth each time it becomes soiled.
6. When the stain is removed, blot the cleaned area with another dry, clean, soft, white cloth.
7. If the cleaner leaves a ring effect, follow up with the club soda water instructions given earlier in this section.

Special Fabric Cleaning Problems

Stains caused by such things as catsup, black coffee, egg, fruit, fruit juice, milk, soft drinks, vomit, urine, and blood can be removed using the club soda water instructions given earlier in this section. If an odor lingers after cleaning vomit or urine, treat the area with a water and baking soda solution: 1 teaspoon (5 ml) of baking soda to 1 cup (250 ml) of lukewarm water. Let dry.

Stains caused by oil and grease can be cleaned with an approved GM cleaner and a clean, white cloth.

1. Carefully scrape off excess stain.
2. Clean with cool water and allow to dry completely.
3. If a stain remains, follow the "Using Cleaner on Fabric" instructions described earlier.

Vinyl

Use warm water and a clean cloth.

- Rub with a clean, damp cloth to remove dirt. This may have to be done more than once.
- Things like tar, asphalt, and shoe polish will stain if they are not removed quickly. Use a clean cloth and vinyl cleaner. See your dealer for this product.

Leather

Use a soft cloth with lukewarm water and a mild soap or saddle soap and wipe dry with a soft cloth. Then, let the leather dry naturally. Do not use heat to dry.

- For stubborn stains, use a leather cleaner.
- Never use oils, varnishes, solvent-based or abrasive cleaners, furniture polish, or shoe polish on leather.
- Soiled or stained leather should be cleaned immediately. If dirt is allowed to work into the finish, it can harm the leather.

Instrument Panel

Use only mild soap and water to clean the top surfaces of the instrument panel. Sprays containing silicones or waxes may cause annoying reflections in the windshield and even make it difficult to see through the windshield under certain conditions.

Interior Plastic Components

Use only a mild soap and water solution on a soft cloth or sponge. Commercial cleaners may affect the surface finish.

Glass Surfaces

Notice: If you use abrasive cleaners when cleaning glass surfaces on your vehicle, you could scratch the glass. When cleaning the glass on your vehicle, use only a soft cloth and glass cleaner.

Glass should be cleaned often. Your GM dealer can provide an approved cleaner, or a liquid household glass cleaner will remove normal tobacco smoke and dust films on interior glass. See *Vehicle Care/Appearance Materials on page 5-85*.

Care of Safety Belts

Keep belts clean and dry.

CAUTION:

Do not bleach or dye safety belts. If you do, it may severely weaken them. In a crash, they might not be able to provide adequate protection. Clean safety belts only with mild soap and lukewarm water.

Weatherstrips

Silicone grease on weatherstrips will make them last longer, seal better, and not stick or squeak. Apply silicone grease with a clean cloth. During very cold, damp weather frequent application may be required. See *Recommended Fluids and Lubricants* on page 6-12.

Washing Your Vehicle

The paint finish on the vehicle provides beauty, depth of color, gloss retention, and durability.

The best way to preserve the vehicle's finish is to keep it clean by washing it often with lukewarm or cold water.

Do not wash the vehicle in the direct rays of the sun. Use a car washing soap. Do not use strong soaps or chemical detergents. Be sure to rinse the vehicle well, removing all soap residue completely. GM-approved cleaning products can be obtained from your dealer. See *Vehicle Care/Appearance Materials* on page 5-85. Do not use cleaning agents that are petroleum based, or that contain acid or abrasives. All cleaning agents should be flushed promptly and not allowed to dry on the surface, or they could stain. Dry the finish with a soft, clean chamois or an all-cotton towel to avoid surface scratches and water spotting.

High pressure car washes may cause water to enter the vehicle.

Cleaning Exterior Lamps/Lenses

Use only lukewarm or cold water, a soft cloth and a car washing soap to clean exterior lamps and lenses. Follow instructions under *Washing Your Vehicle* on page 5-81.

Finish Care

Occasional waxing or mild polishing of the vehicle by hand may be necessary to remove residue from the paint finish. GM-approved cleaning products can be obtained from your dealer. See *Vehicle Care/Appearance Materials on page 5-85*.

Notice: Machine compounding or aggressive polishing on a basecoat/clearcoat paint finish may damage it. Use only non-abrasive waxes and polishes that are made for a basecoat/clearcoat paint finish on your vehicle.

The vehicle has a “basecoat/clearcoat” paint finish. The clearcoat gives more depth and gloss to the colored basecoat. Always use waxes and polishes that are non-abrasive and made for a basecoat/clearcoat paint finish.

Foreign materials such as calcium chloride and other salts, ice melting agents, road oil and tar, tree sap, bird droppings, chemicals from industrial chimneys, etc., can damage the vehicle’s finish if they remain on painted surfaces. Wash the vehicle as soon as possible. If necessary, use non-abrasive cleaners that are marked safe for painted surfaces to remove foreign matter.

Exterior painted surfaces are subject to aging, weather, and chemical fallout that can take their toll over a period of years. To help keep the paint finish looking new, keep the vehicle in a garage or covered whenever possible.

Windshield and Wiper Blades

If the windshield is not clear after using the windshield washer, or if the wiper blade chatters when running, wax, sap, or other material may be on the blade or windshield.

Clean the outside of the windshield with a glass cleaning liquid or powder and water solution. The windshield is clean if beads do not form when it is rinsed with water.

Grime from the windshield will stick to the wiper blades and affect their performance. Clean the blade by wiping vigorously with a cloth soaked in full-strength windshield washer solvent. Then rinse the blade with water.

Check the wiper blades and clean them as necessary; replace blades that look worn.

Aluminum or Chrome-Plated Wheels

The vehicle may be equipped with either aluminum or chrome-plated wheels.

Keep the wheels clean using a soft clean cloth with mild soap and water. Rinse with clean water. After rinsing thoroughly, dry with a soft clean towel. A wax may then be applied.

Notice: If you use strong soaps, chemicals, abrasive polishes, cleaners, brushes, or cleaners that contain acid on aluminum or chrome-plated wheels, you could damage the surface of the wheel(s). The repairs would not be covered by your warranty. Use only GM-approved cleaners on aluminum or chrome-plated wheels.

The surface of these wheels is similar to the painted surface of your vehicle. Do not use strong soaps, chemicals, abrasive polishes, abrasive cleaners, cleaners with acid, or abrasive cleaning brushes on them because you could damage the surface. Do not use chrome polish on aluminum wheels.

Notice: Using chrome polish on aluminum wheels could damage the wheels. The repairs would not be covered by your warranty. Use chrome polish on chrome wheels only.

Use chrome polish only on chrome-plated wheels, but avoid any painted surface of the wheel, and buff off immediately after application.

Notice: If you drive your vehicle through an automatic car wash that has silicone carbide tire cleaning brushes, you could damage the aluminum or chrome-plated wheels. The repairs would not be covered by your warranty. Never drive a vehicle equipped with aluminum or chrome-plated wheels through an automatic car wash that uses silicone carbide tire cleaning brushes.

Do not take your vehicle through an automatic car wash that has silicone carbide tire cleaning brushes. These brushes can also damage the surface of these wheels.

Tires

To clean the tires, use a stiff brush with tire cleaner.

Notice: Using petroleum-based tire dressing products on your vehicle may damage the paint finish and/or tires. When applying a tire dressing, always wipe off any overspray from all painted surfaces on your vehicle.

Sheet Metal Damage

If the vehicle is damaged and requires sheet metal repair or replacement, make sure the body repair shop applies anti-corrosion material to parts repaired or replaced to restore corrosion protection.

Original manufacturer replacement parts will provide the corrosion protection while maintaining the warranty.

Finish Damage

Any stone chips, fractures or deep scratches in the finish should be repaired right away. Bare metal will corrode quickly and may develop into major repair expense.

Minor chips and scratches can be repaired with touch-up materials available from your GM dealer. Larger areas of finish damage can be corrected in your GM dealer's body and paint shop.

Underbody Maintenance

Chemicals used for ice and snow removal and dust control can collect on the underbody. If these are not removed, corrosion and rust can develop on the underbody parts such as fuel lines, frame, floor pan, and exhaust system even though they have corrosion protection.

At least every spring, flush these materials from the underbody with plain water. Clean any areas where mud and debris can collect. Dirt packed in close areas of the frame should be loosened before being flushed. Your GM dealer or an underbody car washing system can do this for you.

Chemical Paint Spotting

Some weather and atmospheric conditions can create a chemical fallout. Airborne pollutants can fall upon and attack painted surfaces on the vehicle. This damage can take two forms: blotchy, ring-shaped discolorations, and small, irregular dark spots etched into the paint surface.

Although no defect in the paint job causes this, GM will repair, at no charge to the owner, the surfaces of new vehicles damaged by this fallout condition within 12 months or 12,000 miles (20 000 km) of purchase, whichever occurs first.

Vehicle Care/Appearance Materials

See your GM dealer for more information on purchasing the following products.

Description	Usage
Polishing Cloth Wax-Treated	Interior and exterior polishing cloth.
Tar and Road Oil Remover	Removes tar, road oil, and asphalt.
Chrome Cleaner and Polish	Use on chrome or stainless steel.
White Sidewall Tire Cleaner	Removes soil and black marks from whitewalls.
Vinyl Cleaner	Cleans vinyl.
Glass Cleaner	Removes dirt, grime, smoke and fingerprints.
Chrome and Wire Wheel Cleaner	Removes dirt and grime from chrome wheels and wire wheel covers.
Finish Enhancer	Removes dust, fingerprints, and surface contaminants. Spray on and wipe off.

Description	Usage
Swirl Remover Polish	Removes swirl marks, fine scratches, and other light surface contamination.
Cleaner Wax	Removes light scratches and protects finish.
Foaming Tire Shine Low Gloss	Cleans, shines, and protects in one step. No wiping necessary.
Wash Wax Concentrate	Medium foaming shampoo. Cleans and lightly waxes. Biodegradable and phosphate free.
Spot Lifter	Quickly removes spots and stains from carpets, vinyl, and cloth upholstery.
Odor Eliminator	Odorless spray odor eliminator used on fabrics, vinyl, leather and carpet.
See your General Motors parts department for these products. See <i>Recommended Fluids and Lubricants</i> on page 6-12.	

Vehicle Identification

Vehicle Identification Number (VIN)



This is the legal identifier for your vehicle. It appears on a plate in the front corner of the instrument panel, on the driver's side. You can see it if you look through the windshield from outside your vehicle. The VIN also appears on the Vehicle Certification and Service Parts labels and the certificates of title and registration.

Engine Identification

The eighth character in your VIN is the engine code. This code will help you identify your engine, specifications and replacement parts.

Service Parts Identification Label

You will find this label in the trunk. It is very helpful if you ever need to order parts. On this label, you will find the following:

- VIN
- Model designation
- Paint information
- Production options and special equipment

Be sure that this label is not removed from the vehicle.

Electrical System

Add-On Electrical Equipment

Notice: Don't add anything electrical to your vehicle unless you check with your dealer first. Some electrical equipment can damage your vehicle and the damage wouldn't be covered by your warranty. Some add-on electrical equipment can keep other components from working as they should.

Your vehicle has an airbag system. Before attempting to add anything electrical to your vehicle, see *Servicing Your Airbag-Equipped Vehicle* on page 1-64.

Headlamp Wiring

The headlamp wiring is protected by a circuit breaker in the underhood fuse block. An electrical overload will cause the headlamps to go on and off, or in some cases to remain off. If this happens, have the headlamp system checked right away.

Windshield Wiper Fuses

The windshield wiper motor is protected by a circuit breaker and a fuse. If the motor overheats due to heavy snow, etc., the wiper will stop until the motor cools. If the overload is caused by some electrical problem, have it fixed.

Power Windows and Other Power Options

Circuit breakers in the instrument panel fuse block protect the power windows and other power accessories. When the current load is too heavy, the circuit breaker opens and closes, protecting the circuit until the problem is fixed.

Fuses and Circuit Breakers

The wiring circuits in the vehicle are protected from short circuits by a combination of fuses, circuit breakers and in the fuse block wiring itself. This greatly reduces the chance of fires caused by electrical problems.

Look at the silver-colored band inside the fuse. If the band is broken or melted, replace the fuse. Make sure a bad fuse is replaced with a new one of the identical size and rating.

Instrument Panel Fuse Block



The instrument panel fuse block is located on the passenger's side of the instrument panel. Pull off the cover labeled FUSES to expose the fuse block.

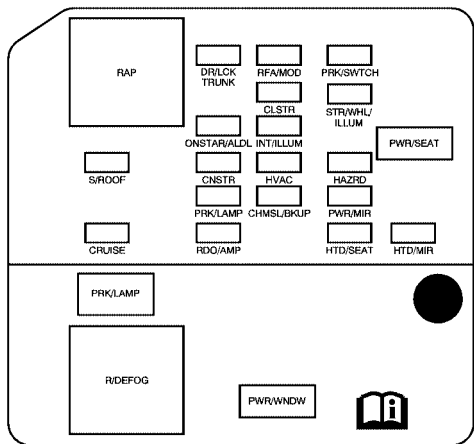

Fuses	Usage
DR/LCK TRUNK	Door Locks, Trunk
RFA/MOD	Remote Keyless Entry
PRK/SWTCH	Ignition Key Lock
CLSTR	Cluster
STR/WHL/ILLUM	Steering Wheel Controls Illumination

Fuses	Usage
ONSTAR/ALDL	OnStar [®] , Data Link
INT/ILLUM	Interior Lamps
PWR/SEAT	Power Seat
S/ROOF	Sunroof
CNSTR	Canister Vent
HVAC	Climate Control System
HAZRD	Turn Signal, Hazard
PRK/LAMP	Park Lamps
CHMSL/BKUP	Center-High-Mounted Stoplamp/Back-up Lamps
PWR/MIR	Power Mirrors
CRUISE	Cruise Control
RDO/AMP	Radio, Amplifier
HTD/SEAT	Heated Seats
HTD/MIR	Heated Mirrors
PWR/WNDW	Power Window

Relays	Usage
RAP	Retained Accessory Power
PRK/LAMP	Park Lamp Relay
R/DEFOG	Rear Defogger Relay

Underhood Fuse Block

Some fuses and relays are located in the underhood fuse block on the passenger's side of the vehicle in the engine compartment. See *Engine Compartment Overview on page 5-12* for more information on location.

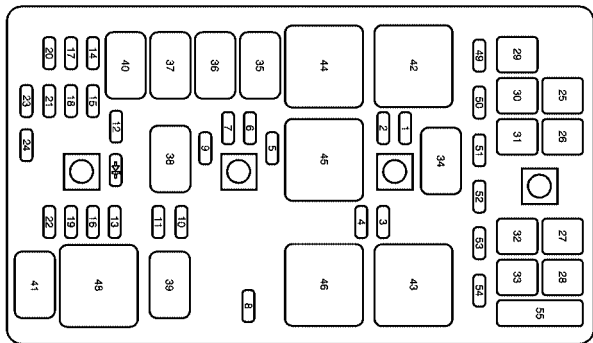

Mini-Fuses	Usage
1	Left High Beam
2	Right High Beam

Mini-Fuses	Usage
3	Left Low Beam
4	Right Low Beam
5	Windshield Wiper
6	Washer/Regulated Voltage Control
7	Fog Lamps
8	Transaxle Control Module
9	Supplemental Inflatable Restraint
10	Auxiliary Power
11	Horn
12	Emission
13	Air Conditioner Clutch
14	Oxygen Sensor
15	Powertrain Control Module
16	Powetrain Control Module, Electronic Throttle Control
17	Electronic Throttle Control
18	Display
19	Anti-lock Brake Solenoid
20	Fuel Injector
21	Transmission Solenoid
22	Fuel Pump
23	Anti-lock Brake System
24	Ignition

J-Style Fuses	Usage
25	Air Pump
26	Battery Main 1
27	Battery Main 2
28	Battery Main 3
29	Fan 1
30	Battery Main 4
31	Anti-lock Brake System Motor
32	Fan 2
33	Starter

Micro-Relays	Usage
34	Headlamp High Beam
35	HDM Module
36	Fog Lamp
37	Ignition 1
38	Air Conditioning Compressor
39	Horn
40	Powertrain
41	Fuel Pump

Mini-Relays	Usage
42	Fan 1
43	Fan 3

Mini-Relays	Usage
44	Windshield Wiper High
45	Windshield Wiper
46	Fan 2
48	Crank

Spare Fuses	Usage
49	Spare
50	Spare
51	Spare
52	Spare
53	Spare
54	Spare

Fuse Puller	Usage
55	Fuse Puller

Diodes	Usage
	Air Conditioner Compressor Clutch Diode

Capacities and Specifications

The following approximate capacities are given in English and metric conversions.

Capacities and Specifications

Application	Capacities	
	English	Metric
Air Conditioning Refrigerant R134a	2.31 lbs	1.05 kg
Automatic Transmission	7.4 qt	7.0 L
Cooling System Including Reservoir		
3.6L V6	11.0 qt	10.4 L
3.8L V6	11.7 qt	11.0 L
Engine Oil with Filter		
3.6L V6	5.5 quarts	5.2 L
3.8L V6	4.5 quarts	4.3 L
Fuel Tank	17.5 gallons	66.0 L
Wheel Nut Torque	100 ft lb	140 N•m

All capacities are approximate. When adding, be sure to fill to the approximate level, as recommended in this manual. See *Scheduled Maintenance on page 6-4*

Engine Specifications

Engine	VIN Code	Transaxle	Spark Plug Gap
3.6L V6	7	Automatic	0.044 inches (1.1 mm)
3.8 V6	2	Automatic	0.060 inches (1.52 mm)

Section 6 Maintenance Schedule

Maintenance Schedule	6-2	Owner Checks and Services	6-8
Introduction	6-2	At Each Fuel Fill	6-8
Maintenance Requirements	6-2	At Least Once a Month	6-9
Your Vehicle and the Environment	6-2	At Least Once a Year	6-9
Using the Maintenance Schedule	6-3	Recommended Fluids and Lubricants	6-12
Scheduled Maintenance	6-4	Normal Maintenance Replacement Parts	6-13
Additional Required Services	6-6	Maintenance Record	6-14
Maintenance Footnotes	6-7		

Maintenance Schedule

Introduction

Important: Keep engine oil at the proper level and change as recommended.



Have you purchased the GM Protection Plan? The Plan supplements your new vehicle warranties. See your Warranty and Owner Assistance booklet or your dealer for details.

Maintenance Requirements

Notice: Maintenance intervals, checks, inspections, replacement parts and recommended fluids and lubricants as prescribed in this manual are necessary to keep your vehicle in good working condition. Any damage caused by failure to follow scheduled maintenance may not be covered by warranty.

Your Vehicle and the Environment

Proper vehicle maintenance not only helps to keep your vehicle in good working condition, but also helps the environment. All recommended maintenance is important. Improper vehicle maintenance can even affect the quality of the air we breathe. Improper fluid levels or the wrong tire inflation can increase the level of emissions from your vehicle. To help protect our environment, and to keep your vehicle in good condition, be sure to maintain your vehicle properly.

Using the Maintenance Schedule

We at General Motors want to help you keep your vehicle in good working condition. But we do not know exactly how you will drive it. You may drive very short distances only a few times a week. Or you may drive long distances all the time in very hot, dusty weather. You may use your vehicle in making deliveries. Or you may drive it to work, to do errands or in many other ways.

Because of all the different ways people use their vehicles, maintenance needs vary. You may need more frequent checks and replacements. So please read the following and note how you drive. If you have any questions on how to keep your vehicle in good condition, see your GM Goodwrench[®] dealer.

This schedule is for vehicles that:

- carry passengers and cargo within recommended limits. You will find these limits on the tire and loading information label. See *Loading Your Vehicle on page 4-29*.
- are driven on reasonable road surfaces within legal driving limits.
- use the recommended fuel. See *Gasoline Octane on page 5-5*.

The services in *Scheduled Maintenance on page 6-4* should be performed when indicated. See *Additional Required Services on page 6-6* and *Maintenance Footnotes on page 6-7* for further information.

CAUTION:

Performing maintenance work on a vehicle can be dangerous. In trying to do some jobs, you can be seriously injured. Do your own maintenance work only if you have the required know-how and the proper tools and equipment for the job. If you have any doubt, see your GM Goodwrench[®] dealer to have a qualified technician do the work.

Some maintenance services can be complex. So, unless you are technically qualified and have the necessary equipment, you should have your GM Goodwrench[®] dealer do these jobs.

When you go to your GM Goodwrench[®] dealer for your service needs, you will know that GM-trained and supported service technicians will perform the work using genuine GM parts.

If you want to purchase service information, see *Service Publications Ordering Information on page 7-11*.

Owner Checks and Services on page 6-8 tells you what should be checked, when to check it and what you can easily do to help keep your vehicle in good condition.

The proper replacement parts, fluids and lubricants to use are listed in *Recommended Fluids and Lubricants on page 6-12* and *Normal Maintenance Replacement Parts on page 6-13*. When your vehicle is serviced, make sure these are used. All parts should be replaced and all necessary repairs done before you or anyone else drives the vehicle. We recommend the use of genuine GM parts.

Scheduled Maintenance

When the change engine oil light or CHANGE OIL SOON DIC message comes on, it means that service is required for your vehicle. Have your vehicle serviced as soon as possible within the next 600 miles (1 000 km). It is possible that, if you are driving under the best conditions, the engine oil life system may not indicate that vehicle service is necessary for over a year. However, the engine oil and filter must be changed at least once a year and at this time the system must be reset. Your GM Goodwrench dealer has GM-trained service technicians who will perform this work using genuine GM parts and reset the system.

If the engine oil life system is ever reset accidentally, you must service your vehicle within 3,000 miles (5 000 km) since the last service. Remember to reset the oil life system whenever the oil is changed. See *Engine Oil Life System on page 5-18* for information on the Engine Oil Life System and resetting the system.

When the light or message appears, certain services, checks, and inspections are required. Required services are described in the following for "Maintenance I" and "Maintenance II." Generally, it is recommended that the first service be Maintenance I, the second service be Maintenance II and that you alternate Maintenance I and Maintenance II thereafter. However, in some cases, Maintenance II may be required more often.

Maintenance I — Use Maintenance I if the light or message comes on within 10 months since the vehicle was purchased or Maintenance II was performed.

Maintenance II — Use Maintenance II if the previous service performed was Maintenance I. Always use Maintenance II whenever the light or message comes on 10 months or more since the last service or if the light or message has not come on at all for one year.

Scheduled Maintenance

Service	Maintenance I	Maintenance II
Change engine oil and filter. See <i>Engine Oil on page 5-15</i> . Reset oil life system. See <i>Engine Oil Life System on page 5-18</i> . An <i>Emission Control Service</i> .	•	•
Visually check for any leaks or damage. See <i>footnote (k)</i> .	•	•
Inspect engine air cleaner filter. If necessary, replace filter. See <i>Engine Air Cleaner/Filter on page 5-19</i> . An <i>Emission Control Service</i> . See <i>footnotes † and (l)</i> .		•
Rotate tires and check inflation pressures and wear. See <i>Tire Inspection and Rotation on page 5-60</i> .	•	•
Inspect brake system. See <i>footnote (a)</i> .	•	•
Check engine coolant and windshield washer fluid levels and add fluid as needed.	•	•
Perform any needed additional services. See “Additional Required Services” in this section.	•	•
Inspect suspension and steering components. See <i>footnote (b)</i> .		•
Inspect engine cooling system. See <i>footnote (c)</i> .		•
Inspect wiper blades. See <i>footnote (d)</i> .		•
Inspect restraint system components. See <i>footnote (e)</i> .		•
Lubricate body components. See <i>footnote (f)</i> .		•
Check transaxle fluid level and add fluid as needed.		•
Replace passenger compartment air filter. See <i>footnote (g)</i> .		•
Inspect throttle system. See <i>footnote (j)</i> .		•

Additional Required Services

The following services should be performed at the first maintenance service (I or II) after the indicated miles (kilometers) shown for each item.

Additional Required Services

Service and Miles (Kilometers)	25,000 (41 500)	50,000 (83 000)	75,000 (125 000)	100,000 (166 000)	125,000 (207 500)	150,000 (240 000)
Inspect fuel system for damage or leaks.	•	•	•	•	•	•
Inspect exhaust system for loose or damaged components.	•	•	•	•	•	•
Replace engine air cleaner filter. See <i>Engine Air Cleaner/Filter on page 5-19. An Emission Control Service.</i>		•		•		•
Change automatic transaxle fluid and filter (severe service). See footnote (h).		•		•		•
Change automatic transaxle fluid and filter (normal service).				•		
Replace spark plugs and inspect spark plug wires. <i>An Emission Control Service.</i>				•		
Engine cooling system service (or every five years, whichever occurs first). <i>An Emission Control Service. See footnote (i).</i>						•
Inspect engine accessory drive belt. <i>An Emission Control Service.</i>						•

Maintenance Footnotes

† *The U.S. Environmental Protection Agency or the California Air Resources Board has determined that the failure to perform this maintenance item will not nullify the emission warranty or limit recall liability prior to the completion of the vehicle's useful life. We, however, urge that all recommended maintenance services be performed at the indicated intervals and the maintenance be recorded.*

(a) *Visually inspect brake lines and hoses for proper hook-up, binding, leaks, cracks, chafing, etc. Inspect disc brake pads for wear and rotors for surface condition. Inspect other brake parts, including calipers, parking brake, etc.*

(b) *Visually inspect front and rear suspension and steering system for damaged, loose or missing parts or signs of wear. Inspect power steering lines and hoses for proper hook-up, binding, leaks, cracks, chafing, etc.*

(c) *Visually inspect hoses and have them replaced if they are cracked, swollen or deteriorated. Inspect all pipes, fittings and clamps; replace with genuine GM parts as needed. To help ensure proper operation, a pressure test of the cooling system and pressure cap and cleaning the outside of the radiator and air conditioning condenser is recommended at least once a year.*

(d) *Visually inspect wiper blades for wear or cracking. Replace blade inserts that appear worn or damaged or that streak or miss areas of the windshield.*

(e) *Make sure the safety belt reminder light and all your belts, buckles, latch plates, retractors and anchorages are working properly. Look for any other loose or damaged safety belt system parts. If you see anything that might keep a safety belt system from doing its job, have it repaired. Have any torn or frayed safety belts replaced. Also look for any opened or broken airbag coverings, and have them repaired or replaced. (The airbag system does not need regular maintenance.)*

(f) *Lubricate all key lock cylinders. Lubricate all hinges and latches, including those for the body doors, hood, secondary latch, pivots, spring anchor, release pawl, rear compartment, glove box door and console door. More frequent lubrication may be required when exposed to a corrosive environment. Applying silicone grease on weatherstrips with a clean cloth will make them last longer, seal better and not stick or squeak.*

(g) *If you drive regularly under dusty conditions, the filter may require replacement more often.*

(h) *Change automatic transaxle fluid and filter if the vehicle is mainly driven under one or more of these conditions:*

- *In heavy city traffic where the outside temperature regularly reaches 90°F (32°C) or higher.*
- *In hilly or mountainous terrain.*
- *When doing frequent trailer towing.*
- *Uses such as found in taxi, police or delivery service.*

(i) *Drain, flush and refill cooling system. This service can be complex; you should have your dealer perform this service. See Engine Coolant on page 5-21 for what to use. Inspect hoses. Clean radiator, condenser, pressure cap and filler neck. Pressure test the cooling system and pressure cap.*

(j) *Check throttle system for interference or binding and for damaged or missing parts. Replace parts as needed. Replace any components that have high effort or excessive wear. Do not lubricate accelerator or cruise control cables.*

(k) *A fluid loss in any vehicle system could indicate a problem. Have the system inspected and repaired and the fluid level checked. Add fluid if needed.*

(l) *If you drive regularly under dusty conditions, inspect the filter at each engine oil change.*

Owner Checks and Services

These owner checks and services should be performed at the intervals specified to help ensure the safety, dependability and emission control performance of your vehicle. Your GM Goodwrench® dealer can assist you with these checks and services.

Be sure any necessary repairs are completed at once. Whenever any fluids or lubricants are added to your vehicle, make sure they are the proper ones, as shown in *Recommended Fluids and Lubricants on page 6-12.*

At Each Fuel Fill

It is important to perform these underhood checks at each fuel fill.

Engine Oil Level Check

Check the engine oil level and add the proper oil if necessary. See *Engine Oil on page 5-15* for further details.

Notice: **It is important to check your oil regularly and keep it at the proper level. Failure to keep your engine oil at the proper level can cause damage to your engine not covered by your warranty.**

Engine Coolant Level Check

Check the engine coolant level and add DEX-COOL[®] coolant mixture if necessary. See *Engine Coolant* on page 5-21 for further details.

Windshield Washer Fluid Level Check

Check the windshield washer fluid level in the windshield washer tank and add the proper fluid if necessary.

At Least Once a Month

Tire Inflation Check

Visually inspect your vehicle's tires and make sure they are inflated to the correct pressures. Do not forget to check the spare tire. See *Tires* on page 5-52 for further details. Check to make sure the spare tire is stored securely. See *Changing a Flat Tire* on page 5-68.

Tire Wear Inspection

Tire rotation may be required for high mileage highway drivers prior to the Engine Oil Life System service notification. Check the tires for wear and, if necessary, rotate the tires. See *Tire Inspection and Rotation* on page 5-60.

At Least Once a Year

Starter Switch Check

CAUTION:

When you are doing this inspection, the vehicle could move suddenly. If the vehicle moves, you or others could be injured.

1. Before you start, be sure you have enough room around the vehicle.
2. Firmly apply both the parking brake and the regular brake. See *Parking Brake* on page 2-27 if necessary.
Do not use the accelerator pedal, and be ready to turn off the engine immediately if it starts.
3. Try to start the engine in each gear. The starter should work only in PARK (P) or NEUTRAL (N). If the starter works in any other position, contact your GM Goodwrench[®] dealer for service.

Automatic Transaxle Shift Lock Control System Check

CAUTION:

When you are doing this inspection, the vehicle could move suddenly. If the vehicle moves, you or others could be injured.

1. Before you start, be sure you have enough room around the vehicle. It should be parked on a level surface.
2. Firmly apply the parking brake. See *Parking Brake* on page 2-27 if necessary.

Be ready to apply the regular brake immediately if the vehicle begins to move.

3. With the engine off, turn the ignition to RUN, but do not start the engine. Without applying the regular brake, try to move the shift lever out of PARK (P) with normal effort. If the shift lever moves out of PARK (P), contact your GM Goodwrench[®] dealer for service.

Ignition Transaxle Lock Check

While parked, and with the parking brake set, try to turn the ignition to LOCK in each shift lever position.

- The ignition should turn to LOCK only when the shift lever is in PARK (P).
- The key should come out only in LOCK.

Contact your GM Goodwrench[®] dealer if service is required.

Parking Brake and Automatic Transaxle Park (P) Mechanism Check

CAUTION:

When you are doing this check, your vehicle could begin to move. You or others could be injured and property could be damaged. Make sure there is room in front of your vehicle in case it begins to roll. Be ready to apply the regular brake at once should the vehicle begin to move.

Park on a fairly steep hill, with the vehicle facing downhill. Keeping your foot on the regular brake, set the parking brake.

- To check the parking brake's holding ability: With the engine running and transaxle in NEUTRAL (N), slowly remove foot pressure from the regular brake pedal. Do this until the vehicle is held by the parking brake only.
- To check the PARK (P) mechanism's holding ability: With the engine running, shift to PARK (P). Then release the parking brake followed by the regular brake.

Contact your GM Goodwrench® dealer if service is required.

Underbody Flushing Service

At least every spring, use plain water to flush any corrosive materials from the underbody. Take care to clean thoroughly any areas where mud and other debris can collect.

Recommended Fluids and Lubricants

Fluids and lubricants identified below by name, part number or specification may be obtained from your dealer.

Usage	Fluid/Lubricant
Engine Oil	Engine oil which meets GM Standard GM6094M and displays the American Petroleum Institute Certified for Gasoline Engines starburst symbol. GM Goodwrench [®] oil meets all the requirements for your vehicle. To determine the proper viscosity for your vehicle's engine, see <i>Engine Oil on page 5-15</i> .
Engine Coolant	50/50 mixture of clean, drinkable water and use only DEX-COOL [®] Coolant. See <i>Engine Coolant on page 5-21</i> .
Hydraulic Brake System	Delco Supreme 11 Brake Fluid or equivalent DOT-3 brake fluid.
Windshield Washer Solvent	GM Optikleen [®] Washer Solvent.

Usage	Fluid/Lubricant
Power Steering System	GM Power Steering Fluid (GM Part No. U.S. 89021184, in Canada 89021186).
Automatic Transaxle	DEXRON [®] -III Automatic Transmission Fluid. Look for "Approved for the H-Specification" on the label.
Key Lock Cylinders	Multi-Purpose Lubricant, Superlube (GM Part No. U.S. 12346241, in Canada 10953474).
Hood Latch Assembly, Secondary Latch, Pivots, Spring Anchor and Release Pawl	Lubriplate Lubricant Aerosol (GM Part No. U.S. 12346293, in Canada 992723) or lubricant meeting requirements of NLGI #2, Category LB or GC-LB.
Hood and Door Hinges	Multi-Purpose Lubricant, Superlube (GM Part No. U.S. 12346241, in Canada 109435474).
Weatherstrip Conditioning	Dielectric Silicone Grease (GM Part No. U.S. 12345579, in Canada 992887).

Normal Maintenance Replacement Parts

Replacement parts identified below by name, part number, or specification can be obtained from your GM dealer.

Normal Maintenance Replacement Parts

Part	GM Part Number	ACDelco® Part Number
Engine Air Cleaner/Filter	24508572	A1614C
Engine Oil Filter 3.6L V6 3.8L V8	12587552 25010792	PF61 PF47
Passenger Compartment Air Filter	10340216	—
Spark Plugs 3.6L V6 Engine 3.8L V8 Engine	12565996 12568387	41-988 41-101
Windshield Wiper Assembly 22.0 inches (56.0 cm)	10350320	—

Maintenance Record

After the scheduled services are performed, record the date, odometer reading, who performed the service and the type of services performed in the boxes provided. See *Maintenance Requirements on page 6-2*. Any additional information from *Owner Checks and Services on page 6-8* can be added on the following record pages. You should retain all maintenance receipts.

Maintenance Record

Date	Odometer Reading	Serviced By	Maintenance I or Maintenance II	Services Performed

Maintenance Record (cont'd)

Date	Odometer Reading	Serviced By	Maintenance I or Maintenance II	Services Performed

Maintenance Record (cont'd)

Date	Odometer Reading	Serviced By	Maintenance I or Maintenance II	Services Performed

Section 7 Customer Assistance and Information

Customer Assistance and Information	7-2	Reporting Safety Defects	7-10
Customer Satisfaction Procedure	7-2	Reporting Safety Defects to the United States	
Online Owner Center	7-3	Government	7-10
Customer Assistance for Text Telephone		Reporting Safety Defects to the Canadian	
(TTY) Users	7-4	Government	7-11
Customer Assistance Offices	7-4	Reporting Safety Defects to General Motors	7-11
GM Mobility Reimbursement Program	7-5	Service Publications Ordering Information	7-11
Roadside Assistance Program	7-6		
Courtesy Transportation	7-7		
Vehicle Data Collection and Event Data			
Recorders	7-9		

Customer Assistance and Information

Customer Satisfaction Procedure

Your satisfaction and goodwill are important to your dealer and to Buick. Normally, any concerns with the sales transaction or the operation of your vehicle will be resolved by your GM dealer's sales or service departments. Sometimes, however, despite the best intentions of all concerned, misunderstandings can occur. If your concern has not been resolved to your satisfaction, the following steps should be taken:

STEP ONE: Discuss your concern with a member of dealership management. Normally, concerns can be quickly resolved at that level. If the matter has already been reviewed with the sales, service, or parts manager, contact the owner of the dealership or the general manager.

STEP TWO: If after contacting a member of dealership management, it appears your concern cannot be resolved by the dealership without further help, contact the Buick Customer Assistance Center by calling 1-800-521-7300. In Canada, contact GM of Canada Customer Communication Centre by calling 1-800-263-3777 (English) or 1-800-263-7854 (French).

We encourage you to call the toll-free number in order to give your inquiry prompt attention. Please have the following information available to give the Customer Assistance Representative:

- Vehicle Identification Number. This is available from the vehicle registration or title, or the plate at the top left of the instrument panel.
- Dealership name and location
- Vehicle delivery date and present mileage

When contacting Buick, please remember that your concern will likely be resolved at a dealer's facility. That is why we suggest you follow Step One first if you have a concern.

STEP THREE: Both General Motors and your dealer are committed to making sure you are completely satisfied with your new vehicle. However, if you continue to remain unsatisfied after following the procedure outlined in Steps One and Two, you should file with the BBB Auto Line Program to enforce any additional rights you may have. Canadian owners refer to your Warranty and Owner Assistance Information booklet for information on the Canadian Motor Vehicle Arbitration Plan (CAMVAP).

The BBB Auto Line Program is an out of court program administered by the Council of Better Business Bureaus to settle automotive disputes regarding vehicle repairs or the interpretation of the New Vehicle Limited Warranty. Although you may be required to resort to this informal dispute resolution program prior to filing a court action, use of the program is free of charge and your case will generally be heard within 40 days. If you do not agree with the decision given in your case, you may reject it and proceed with any other venue for relief available to you.

You may contact the BBB Auto Line Program using the toll-free telephone number or write them at the following address:

BBB Auto Line Program
Council of Better Business Bureaus, Inc.
4200 Wilson Boulevard
Suite 800
Arlington, VA 22203-1838
Telephone: 1-800-955-5100

This program is available in all 50 states and the District of Columbia. Eligibility is limited by vehicle age, mileage and other factors. General Motors reserves the right to change eligibility limitations and/or discontinue its participation in this program.

Online Owner Center

The Owner Center is a resource for your GM ownership needs. Specific vehicle information can be found in one place.

The Online Owner Center allows you to:

- Get e-mail service reminders.
- Access information about your specific vehicle, including tips and videos and an electronic version of this owner's manual (United States only).
- Keep track of your vehicle's service history and maintenance schedule.
- Find GM dealers for service nationwide.
- Receive special promotions and privileges only available to members (United States only).

Refer to the web for updated information.

To register your vehicle, visit www.MyGMLink.com (United States) or My GM Canada within www.gmcanada.com (Canada).

Customer Assistance for Text Telephone (TTY) Users

To assist customers who are deaf, hard of hearing, or speech-impaired and who use Text Telephones (TTYs), Buick has TTY equipment available at its Customer Assistance Center. Any TTY user can communicate with Buick by dialing: 1-800-83-BUICK. TTY users in Canada can dial 1-800-263-3830.

Customer Assistance Offices

Buick encourages customers to call the toll-free number for assistance. If a U.S. customer wishes to write to Buick, the letter should be addressed to Buick's Customer Assistance Center.

United States — Customer Assistance

Buick Customer Assistance Center
P.O. Box 33136
Detroit, MI 48232-5136

1-800-521-7300
1-800-832-8425 (For Text Telephone devices (TTYs))
Roadside Assistance: 1-800-252-1112
Fax Number: 313-381-0022

From Puerto Rico:
1-800-496-9992 (English)
1-800-496-9993 (Spanish)
Fax Number: 313-381-0022

From U.S. Virgin Islands
1-800-496-9994
Fax Number: 313-381-0022

Canada — Customer Assistance

General Motors of Canada Limited
Customer Communication Centre, 163-005
1908 Colonel Sam Drive
Oshawa, Ontario L1H 8P7

1-800-263-3777 (English)
1-800-263-7854 (French)
1-800-263-3830 (For Text Telephone devices (TTYs))
Roadside Assistance: 1-800-268-6800

Overseas — Customer Assistance

Please contact the local General Motors Business Unit.

Mexico, Central America and Caribbean Islands/Countries (Except Puerto Rico and U.S. Virgin Islands) — Customer Assistance

General Motors de Mexico, S. de R.L. de C.V.
Customer Assistance Center
Paseo de la Reforma # 2740
Col. Lomas de Bezares
C.P. 11910, Mexico, D.F.
01-800-508-0000
Long Distance: 011-52-53 29 0 800

GM Mobility Reimbursement Program

This program, available to qualified applicants, can reimburse you up to \$1,000 toward eligible aftermarket driver's or passenger's adaptive equipment you may require for your vehicle, such as hand controls and wheelchair/scooter lifts.

The offer is available for a limited period of time from the date of vehicle purchase/lease. For more details, or to determine your vehicle's eligibility, visit gmmobility.com or call the GM Mobility Assistance Center at 1-800-323-9935. Text telephone (TTY) users, call 1-800-833-9935.

GM of Canada also has a Mobility Program. Call 1-800-GM-DRIVE (463-7483) for details. TTY users call 1-800-263-3830.

Roadside Assistance Program

Call 1-800-252-1112 for Buick Roadside Assistance.

As the proud owner of a new Buick vehicle, you are automatically enrolled in the Buick Roadside Assistance program. This value-added service is intended to provide you with peace of mind as you drive in the city or travel the open road. Call Buick's Roadside Assistance toll-free number at 1-800-252-1112 to speak with a Buick Roadside Assistance representative 24 hours a day, 365 days a year.

We will provide the following services during the Bumper-to-Bumper warranty period, at no expense to you:

- **Fuel Delivery:** Delivery of enough fuel, \$5 maximum, for the customer to get to the nearest service station.
- **Lock-out Service (identification required):** Replacement keys or locksmith service will be covered at no charge if you are unable to gain entry into your vehicle. Delivery of the replacement key will be covered within 10 miles (16 km).
- **Emergency Tow:** Tow to the nearest dealership for warranty service or in the event of a vehicle-disabling accident. Assistance when the vehicle is mired in sand, mud, or snow.

- **Flat Tire Change:** Installation of a spare tire will be covered at no charge. The customer is responsible for the repair or replacement of the tire if not covered by a warrantable failure.
- **Jump Start:** No-start occurrences which require a battery jump start will be covered at no charge.
- **Dealer Locator Service**

In many instances, mechanical failures are covered under Buick's Bumper-to-Bumper warranty. However, when other services are utilized, our Roadside Assistance Representatives will explain any payment obligations you might incur.

For prompt and efficient assistance when calling, please provide the following to the Roadside Assistance Representative:

- Your name, home address, and home telephone number.
- Telephone number of your location.
- Location of the vehicle.
- Model, year, color, and license plate number.
- Mileage, Vehicle Identification Number, and delivery date of the vehicle.
- Description of the problem.

While we hope you never have the occasion to use our service, it is added security while traveling for you and your family. Remember, we are only a phone call away. Buick Roadside Assistance: 1-800-252-1112, text telephone (TTY) users, call 1-888-889-2438.

Buick reserves the right to limit services or reimbursement to an owner or driver when, in Buick's judgement, the claims become excessive in frequency or type of occurrence.

Roadside Assistance is not part of or included in the coverage provided by the New Vehicle Limited Warranty. Buick reserves the right to make any changes or discontinue the Roadside Assistance program at any time without notification.

Canadian Roadside Assistance

Vehicles purchased in Canada have an extensive roadside assistance program accessible from anywhere in Canada or the United States. Please refer to the Warranty and Owner Assistance Information book.

Courtesy Transportation

Buick has always exemplified quality and value in its offering of motor vehicles. To enhance your ownership experience, we and our participating dealers are proud to offer Courtesy Transportation, a customer support program for new vehicles.

The Courtesy Transportation program is offered to retail purchase/lease customers in conjunction with the Bumper-to-Bumper coverage provided by the New Vehicle Limited Warranty. Several transportation options are available when warranty repairs are required. This will reduce your inconvenience during warranty repairs.

Scheduling Service Appointments

When your vehicle requires warranty service, you should contact your dealer and request an appointment. By scheduling a service appointment and advising your service consultant of your transportation needs, your dealer can help minimize your inconvenience.

If your vehicle cannot be scheduled into the service department immediately, keep driving it until it can be scheduled for service, unless, of course, the problem is safety-related. If it is, please call your dealership, let them know this, and ask for instructions.

If the dealer requests that you simply drop the vehicle off for service, you are urged to do so as early in the work day as possible to allow for same day repair.

Transportation Options

Warranty service can generally be completed while you wait. However, if you are unable to wait Buick helps minimize your inconvenience by providing several transportation options. Depending on the circumstances, your dealer can offer you one of the following:

Shuttle Service

Participating dealers can provide you with shuttle service to get to your destination with minimal interruption of your daily schedule. This includes a one way or round trip shuttle ride to a destination up to 10 miles (16 km) from the dealership.

Public Transportation or Fuel Reimbursement

If your vehicle requires overnight warranty repairs, reimbursement of up to a five-day maximum may be available for the use of public transportation such as a taxi or bus. In addition, should you arrange transportation through a friend or relative, reimbursement for reasonable fuel expenses of up to a five-day maximum may be available. Claim amounts should reflect actual costs and be supported by original receipts.

Courtesy Rental Vehicle

Your dealer may arrange to provide you with a courtesy rental vehicle or reimburse you for a rental vehicle that you obtain if your vehicle is kept for a warranty repair. Reimbursement will be limited to a maximum of \$30 a day and must be supported by receipts. This requires that you sign and complete a rental agreement and meet state, local and rental vehicle provider requirements. Requirements vary and may include minimum age requirements, insurance coverage, credit card, etc. You are responsible for taxes, levies, usage fees, excessive mileage, or rental usage beyond the completion of the repair.

Generally it is not possible to provide a like-vehicle as a courtesy rental.

Additional Program Information

Courtesy Transportation is available during the Bumper-to-Bumper warranty coverage period, but it is not part of the New Vehicle Limited Warranty. A separate booklet entitled Warranty and Owner Assistance Information furnished with each new vehicle provides detailed warranty coverage information.

Courtesy Transportation is available only at participating dealers and all program options, such as shuttle service, may not be available at every dealer. Please contact your dealer for specific information about availability. All Courtesy Transportation arrangements will be administered by appropriate dealer personnel.

Canadian Vehicles: For warranty repairs during the Complete Vehicle Coverage period of the General Motors of Canada New Vehicle Limited Warranty, alternative transportation may be available under the Courtesy Transportation Program. Please consult your dealer for details.

General Motors reserves the right to unilaterally modify, change or discontinue Courtesy Transportation at any time and to resolve all questions of claim eligibility pursuant to the terms and conditions described herein at its sole discretion.

Vehicle Data Collection and Event Data Recorders

Your vehicle, like other modern motor vehicles, has a number of sophisticated computer systems that monitor and control several aspects of the vehicle's performance. Your vehicle uses on-board vehicle computers to monitor emission control components to optimize fuel economy, to monitor conditions for airbag deployment and, if so equipped, to provide anti-lock braking and to help the driver control the vehicle in difficult driving situations. Some information may be stored during regular operations to facilitate repair of detected malfunctions; other information is stored only in a crash event by computer systems, such as those commonly called event data recorders (EDR).

In a crash event, computer systems, such as the Airbag Sensing and Diagnostic Module (SDM) in your vehicle may record information about the condition of the vehicle and how it was operated, such as data related to engine speed, brake application, throttle position, vehicle speed, safety belt usage, airbag readiness, airbag performance, and the severity of a collision. This information has been used to improve vehicle crash performance and may be used to improve crash performance of future vehicles and driving safety. Unlike the data recorders on many airplanes, these on-board systems do not record sounds, such as conversation of vehicle occupants.

To read this information, special equipment is needed and access to the vehicle or the device that stores the data is required. GM will not access information about a crash event or share it with others other than:

- with the consent of the vehicle owner or, if the vehicle is leased, with the consent of the lessee,
- in response to an official request of police or similar government office,
- as part of GM's defense of litigation through the discovery process, or
- as required by law.

In addition, once GM collects or receives data, GM may:

- use the data for GM research needs,
- make it available for research where appropriate confidentiality is to be maintained and need is shown, or
- share summary data which is not tied to a specific vehicle with non-GM organizations for research purposes.

Others, such as law enforcement, may have access to the special equipment that can read the information if they have access to the vehicle or the device that stores the data.

If your vehicle is equipped with OnStar[®], please check the OnStar[®] subscription service agreement or manual for information on its operations and data collection.

Reporting Safety Defects

Reporting Safety Defects to the United States Government

If you believe that your vehicle has a defect which could cause a crash or could cause injury or death, you should immediately inform the National Highway Traffic Safety Administration (NHTSA), in addition to notifying General Motors.

If NHTSA receives similar complaints, it may open an investigation, and if it finds that a safety defect exists in a group of vehicles, it may order a recall and remedy campaign. However, NHTSA cannot become involved in individual problems between you, your dealer, or General Motors.

To contact NHTSA, you may either call the Auto Safety Hotline toll-free at 1-800-424-9393 (or 366-0123 in the Washington, D.C. area) or write to:

NHTSA, U.S. Department of Transportation
Washington, D.C. 20590

You can also obtain other information about motor vehicle safety from the hotline.

Reporting Safety Defects to the Canadian Government

If you live in Canada, and you believe that your vehicle has a safety defect, you should immediately notify Transport Canada, in addition to notifying General Motors of Canada Limited. You may write to:

Transport Canada
330 Sparks Street
Tower C
Ottawa, Ontario K1A 0N5

Reporting Safety Defects to General Motors

In addition to notifying NHTSA (or Transport Canada) in a situation like this, we certainly hope you will notify us.

Please call us at 1-800-521-7300, or write:

Buick Customer Assistance Center
P.O. Box 33136
Detroit, MI 48232-5136

In Canada, please call us at 1-800-263-3777 (English) or 1-800-263-7854 (French). Or, write:

General Motors of Canada Limited
Customer Communication Centre, 163-005
1908 Colonel Sam Drive
Oshawa, Ontario L1H 8P7

Service Publications Ordering Information

Service Manuals

Service Manuals have the diagnosis and repair information on engines, transmission, axle suspension, brakes, electrical, steering, body, etc.

Transmission, Transaxle, Transfer Case Unit Repair Manual

This manual provides information on unit repair service procedures, adjustments, and specifications for GM transmissions, transaxles, and transfer cases.

Service Bulletins

Service Bulletins give technical service information needed to knowledgeable service General Motors cars and trucks. Each bulletin contains instructions to assist in the diagnosis and service of your vehicle.

In Canada, information pertaining to Product Service Bulletins can be obtained by contacting your General Motors dealer or by calling 1-800-GM-DRIVE (1-800-463-7483).

Owner's Information

Owner publications are written specifically for owners and intended to provide basic operational information about the vehicle. The owner's manual will include the Maintenance Schedule for all models.

In-Portfolio: Includes a Portfolio, Owner's Manual, and Warranty Booklet.

RETAIL SELL PRICE: \$35.00

Without Portfolio: Owner's Manual only.

RETAIL SELL PRICE: \$25.00

Current and Past Model Order Forms

Service Publications are available for current and past model GM vehicles. To request an order form, please specify year and model name of the vehicle.

ORDER TOLL FREE: 1-800-551-4123 Monday-Friday 8:00 AM - 6:00 PM Eastern Time

For Credit Card Orders Only
(VISA-MasterCard-Discover), visit Helm, Inc. on the
World Wide Web at: www.helminc.com

Or you can write to:

Helm, Incorporated
P.O. Box 07130
Detroit, MI 48207

Prices are subject to change without notice and without incurring obligation. Allow ample time for delivery.

Note to Canadian Customers: All listed prices are quoted in U.S. funds. Canadian residents are to make checks payable in U.S. funds.

A

Accessory Power Outlets	3-20	Appearance Care	5-78
Adding Equipment to Your Airbag-Equipped Vehicle	1-64	Aluminum or Chrome-Plated Wheels	5-83
Additives, Fuel	5-6	Care of Safety Belts	5-81
Add-On Electrical Equipment	5-87	Chemical Paint Spotting	5-84
Air Cleaner/Filter, Engine	5-19	Cleaning Exterior Lamps/Lenses	5-81
Air Conditioning	3-21, 3-24	Fabric/Carpet	5-78
Airbag		Finish Care	5-82
Passenger Status Indicator	3-34	Finish Damage	5-84
Readiness Light	3-33	Glass Surfaces	5-80
Airbag Sensing and Diagnostic Module (SDM)	7-9	Instrument Panel	5-80
Airbag System	1-51	Interior Plastic Components	5-80
Adding Equipment to Your Airbag-Equipped Vehicle	1-64	Leather	5-80
How Does an Airbag Restrain?	1-57	Sheet Metal Damage	5-84
Passenger Sensing System	1-60	Tires	5-83
Servicing Your Airbag-Equipped Vehicle	1-64	Underbody Maintenance	5-84
What Makes an Airbag Inflate?	1-57	Vehicle Care/Appearance Materials	5-85
What Will You See After an Airbag Inflates?	1-58	Vinyl	5-80
When Should an Airbag Inflate?	1-56	Washing Your Vehicle	5-81
Where Are the Airbags?	1-53	Weatherstrips	5-81
Antenna, Backglass	3-120	Windshield and Wiper Blades	5-82
Anti-Lock Brake System (ABS)	4-6	Audio System(s)	3-79
Anti-Lock Brake, System Warning Light	3-37	Audio Steering Wheel Controls	3-118
		Backglass Antenna	3-120
		Care of Your CD Player	3-119
		Care of Your CDs	3-119
		Chime Level Adjustment	3-120

Audio System(s) (cont.)	
Radio with CD	3-79, 3-84, 3-92
Radio with Six-Disc CD	3-105
Setting the Time	3-79
Theft-Deterrent Feature	3-117
Understanding Radio Reception	3-119
Automatic Transaxle	
Operation	2-24
Automatic Transmission	
Fluid	5-21

B

Backglass Antenna	3-120
Battery	5-38
Exterior Lighting Battery Saver	3-15
Run-Down Protection	3-18
Before Leaving on a Long Trip	4-21
Brake	
Anti-Lock Brake System (ABS)	4-6
Emergencies	4-8
Parking	2-27
System Warning Light	3-36
Brakes	5-35
Braking	4-5
Braking in Emergencies	4-8
Break-In, New Vehicle	2-21

Bulb Replacement	5-45
Fog Lamps	5-48
Front Turn Signal and Parking Lamps	5-47
Halogen Bulbs	5-45
Headlamp Aiming	5-43
Replacement Bulbs	5-50
Taillamps, Turn Signal, Sidemarker, Stoptlamps, and Back-Up Lamps	5-48
Buying New Tires	5-62

C

California Fuel	5-6
Canadian Owners	ii
Capacities and Specifications	5-92
Carbon Monoxide	2-13, 2-30, 4-24, 4-35
Care of	
Safety Belts	5-81
Your CD Player	3-119
Your CDs	3-119
Center Console Storage Area	2-41
Center Front Passenger Position, Safety Belts	1-24
Center Seat	1-7
Chains, Tire	5-66
Charging System Light	3-35

Check		Cleaning (cont.)	
Engine Light	3-39	Glass Surfaces	5-80
Check Gas Cap Light	3-46	Instrument Panel	5-80
Checking Things Under the Hood	5-10	Interior Plastic Components	5-80
Chemical Paint Spotting	5-84	Leather	5-80
Child Restraints		Tires	5-83
Child Restraint Systems	1-37	Underbody Maintenance	5-84
Infants and Young Children	1-33	Vinyl	5-80
Lower Anchorages and Top Tethers for		Washing Your Vehicle	5-81
Children (LATCH System)	1-43	Weatherstrips	5-81
Older Children	1-31	Windshield and Wiper Blades	5-82
Securing a Child Restraint Designed for		Climate Control System	3-21
the LATCH System	1-45	Air Filter, Passenger Compartment	3-28
Securing a Child Restraint in a Rear		Dual Automatic	3-24
Seat Position	1-46	Outlet Adjustment	3-28
Securing a Child Restraint in the Center		Steering Wheel Controls	3-30
Front Seat Position	1-48	Comfort Guides, Rear Safety Belt	1-27
Securing a Child Restraint in the Right		Compact Spare Tire	5-77
Front Seat Position	1-48	Content Theft-Deterrent	2-17
Top Strap	1-41	Control of a Vehicle	4-5
Top Strap Anchor Location	1-43	Convenience Net	2-41
Where to Put the Restraint	1-40	Coolant	
Chime Level Adjustment	3-120	Engine Temperature Gage	3-38
Cleaning		Engine Temperature Warning Light	3-38
Aluminum or Chrome-Plated Wheels	5-83	Heater, Engine	2-23
Exterior Lamps/Lenses	5-81	Low Warning Light	3-39
Fabric/Carpet	5-78	Cooling System	5-26
Finish Care	5-82	Courtesy Lamps	3-16

Cruise Control Lever	3-10
Cruise Control Light	3-43
Cupholder(s)	2-40
Customer Assistance Information	
Courtesy Transportation	7-7
Customer Assistance for Text	
Telephone (TTY) Users	7-4
Customer Assistance Offices	7-4
Customer Satisfaction Procedure	7-2
GM Mobility Reimbursement Program	7-5
Reporting Safety Defects to General Motors	7-11
Reporting Safety Defects to the Canadian	
Government	7-11
Reporting Safety Defects to the United States	
Government	7-10
Roadside Assistance Program	7-6
Service Publications Ordering Information	7-11

D

Daytime Running Lamps/Automatic	
Headlamp System	3-14
Defensive Driving	4-2
Delayed Entry Lighting	3-17
Delayed Exit Lighting	3-17
Delayed Locking	2-11
Doing Your Own Service Work	5-4
Door	
Ajar Light	3-45

Door (cont.)	
Delayed Locking	2-11
Locks	2-10
Power Door Locks	2-11
Driver	
Position, Safety Belt	1-15
Driver Information Center (DIC)	3-47
DIC Operation and Displays	3-47
DIC Vehicle Personalization	3-71
DIC Warnings and Messages	3-53
Driving	
At Night	4-15
City	4-19
Defensive	4-2
Drunken	4-2
Freeway	4-20
Hill and Mountain Roads	4-22
In Rain and on Wet Roads	4-16
Rocking Your Vehicle to Get it Out	4-28
Winter	4-24
Dual Automatic Climate Control System	3-24

E

Electrical System	
Add-On Equipment	5-87
Fuses and Circuit Breakers	5-88
Headlamp Wiring	5-87
Instrument Panel Fuse Block	5-88

Electrical System (cont.)	
Power Windows and Other Power Options	5-88
Underhood Fuse Block	5-90
Windshield Wiper Fuses	5-87
Engine	
Air Cleaner/Filter	5-19
Battery	5-38
Change Engine Oil Light	3-43
Check and Service Engine Soon Light	3-39
Coolant	5-21
Coolant Heater	2-23
Coolant Temperature Gage	3-38
Coolant Temperature Warning Light	3-38
Engine Compartment Overview	5-12
Exhaust	2-30
Oil	5-15
Oil Life System	5-18
Overheated Protection Operating Mode	5-26
Overheating	5-24
Reduced Power Light	3-44
Starting	2-22
Entry Lighting	3-16
Event Data Recorders (EDR)	7-9
Extender, Safety Belt	1-30
Exterior Lamps	3-13
Exterior Lighting Battery Saver	3-15

F

Filter	
Engine Air Cleaner	5-19
Finish Damage	5-84
Flash-to-Pass	3-8
Flat Tire	5-67
Flat Tire, Changing	5-68
Flat Tire, Storing	5-76
Fluid	
Automatic Transmission	5-21
Power Steering	5-33
Windshield Washer	5-34
Fog Lamps	3-15, 5-48
Folding Rear Seat	1-8
Fuel	
Additives	5-6
California Fuel	5-6
Check Gas Cap Light	3-46
Filling a Portable Fuel Container	5-10
Filling Your Tank	5-8
Fuels in Foreign Countries	5-7
Gage	3-46
Gasoline Octane	5-5
Gasoline Specifications	5-6
Low Warning Light	3-46

Fuses	
Fuses and Circuit Breakers	5-88
Instrument Panel Fuse Block	5-88
Underhood Fuse Block	5-90
Windshield Wiper	5-87

G

Gage	
Engine Coolant Temperature	3-38
Fuel	3-46
Speedometer	3-32
Tachometer	3-32
Garage Door Opener	2-36
Gasoline	
Octane	5-5
Specifications	5-6
Glove Box	2-40
GM Mobility Reimbursement Program	7-5

H

Hazard Warning Flashers	3-6
Head Restraints	1-7
Headlamp	
Aiming	5-43

Headlamp Wiring	5-87
Headlamps	
Bulb Replacement	5-45
Daytime Running Lamps/Automatic Headlamp System	3-14
Flash-to-Pass	3-8
Front Turn Signal and Parking Lamps	5-47
Halogen Bulbs	5-45
Headlamps and Sidemarkers Lamps	5-46
High/Low Beam Changer	3-8
Suggested Light	3-44
Headlamps and Sidemarkers Lamps	5-46
Heated Seats	1-5
Heater	3-21
Heater	3-24
Highbeam On Light	3-44
Highway Hypnosis	4-21
Hill and Mountain Roads	4-22
HomeLink [®] Transmitter	2-36
HomeLink [®] Transmitter, Programming	2-36
Hood	
Checking Things Under	5-10
Release	5-11
Horn	3-6
How to Use This Manual	ii
How to Wear Safety Belts Properly	1-15

I

Ignition Positions	2-21
Infants and Young Children, Restraints	1-33
Inflation -- Tire Pressure	5-58
Instrument Panel	
Brightness	3-16
Cluster	3-31
Overview	3-4
Interior Lamps	3-16

J

Jump Starting	5-39
---------------------	------

K

Keyless Entry System	2-3
Keys	2-2

L

Labelling, Tire Sidewall	5-53
Lamps	
Battery Run-Down Protection	3-18
Courtesy	3-16
Exterior	3-13

Lamps (cont.)

Exterior Lighting Battery Saver	3-15
Fog	3-15, 5-48
Interior	3-16
Overhead Console Reading	3-18
Rear Assist Handle Reading	3-18
LATCH System	
Child Restraints	1-43
Securing a Child Restraint Designed for the LATCH System	1-45
Light	
Airbag Readiness	3-33
Anti-Lock Brake System Warning	3-37
Brake System Warning	3-36
Change Engine Oil	3-43
Charging System	3-35
Check Gas Cap	3-46
Cruise Control	3-43
Door Ajar	3-45
Engine Coolant Temperature Warning	3-38
Headlamps Suggested	3-44
Highbeam On	3-44
Low Coolant Warning	3-39
Low Fuel Warning	3-46
Low Washer Fluid Warning	3-45
Malfunction Indicator	3-39
Oil Pressure	3-42
Passenger Airbag Status Indicator	3-34

Light (cont.)	
Reduced Engine Power	3-44
Safety Belt Reminder	3-32
Security	3-43
Service Vehicle Soon	3-45
TCS Warning Light	3-37
Traction Control System (TCS) Warning	3-37
Trunk Ajar	3-45
Lighting	
Delayed Entry	3-17
Delayed Exit	3-17
Entry	3-16
Perimeter	3-18
Theater Dimming	3-17
Loading Your Vehicle	4-29
Lockout Protection	2-12
Locks	
Delayed Locking	2-11
Door	2-10
Lockout Protection	2-12
Power Door	2-11
Loss of Control	4-13
Low Coolant Warning Light	3-39
Low Fuel Warning Light	3-46
Low Washer Fluid Warning Light	3-45
Lumbar	
Power Controls	1-4

M

Maintenance Schedule	
Additional Required Services	6-6
At Each Fuel Fill	6-8
At Least Once a Month	6-9
At Least Once a Year	6-9
Introduction	6-2
Maintenance Footnotes	6-7
Maintenance Record	6-14
Maintenance Requirements	6-2
Normal Maintenance Replacement Parts	6-13
Owner Checks and Services	6-8
Recommended Fluids and Lubricants	6-12
Scheduled Maintenance	6-4
Using	6-3
Your Vehicle and the Environment	6-2
Malfunction Indicator Light	3-39
Manual Seats	1-3
Message	
DIC Warnings and Messages	3-53
Mirrors	
Automatic Dimming Rearview	2-32
Automatic Dimming Rearview with OnStar®	2-33
Manual Rearview Mirror	2-32
Manual Rearview Mirror with OnStar®	2-32
Outside Convex Mirror	2-34

Mirrors (cont.)	
Outside Power Heated Mirrors	2-34
Outside Power Mirrors	2-33
MyGMLink.com	7-3

N

New Vehicle Break-In	2-21
Normal Maintenance Replacement Parts	6-13

O

Odometer	3-32
Off-Road Recovery	4-12
Oil	
Change Engine Oil Light	3-43
Engine	5-15
Pressure Light	3-42
Oil, Engine Oil Life System	5-18
Older Children, Restraints	1-31
Online Owner Center	7-3
OnStar [®] System	2-34
Other Warning Devices	3-6
Outlet Adjustment	3-28
Outside	
Convex Mirror	2-34
Power Heated Mirrors	2-34
Power Mirrors	2-33

Overhead Console Reading Lamps	3-18
Overheated Engine Protection	
Operating Mode	5-26
Owner Checks and Services	6-8
Owners, Canadian	ii

P

Park Aid	3-18
Park (P)	
Shifting Into	2-28
Shifting Out of	2-29
Parking	
Assist	3-18
Brake	2-27
Over Things That Burn	2-30
Passenger Airbag Status Indicator	3-34
Passenger Compartment Air Filter	3-28
Passenger Sensing System	1-60
Passing	4-12
PASS-Key [®] III	2-19
PASS-Key [®] III Operation	2-19
Perimeter Lighting	3-18
Power	
Accessory Outlets	3-20
Door Locks	2-11
Electrical System	5-88

Power (cont.)	
Lumbar Controls	1-4
Reduced Engine Light	3-44
Retained Accessory (RAP)	2-22
Six-Way Seats	1-4
Steering Fluid	5-33
Windows	2-16
Pretensioners, Safety Belt	1-30
Programming the HomeLink® Transmitter	2-36

Q

Questions and Answers About Safety Belts	1-14
--	------

R

Radiator Pressure Cap	5-24
Radios	3-79
Care of Your CD Player	3-119
Care of Your CDs	3-119
Radio with CD	3-79, 3-84, 3-92
Radio with Six-Disc CD	3-105
Setting the Time	3-79
Theft-Deterrent	3-117
Understanding Reception	3-119
Rear Assist Handle Reading Lamps	3-18
Rear Safety Belt Comfort Guides	1-27
Rear Seat Passengers, Safety Belts	1-25

Rearview Mirror, Automatic Dimming	2-32
Rearview Mirror, Automatic Dimming with OnStar®	2-33
Rearview Mirror with OnStar®	2-32
Rearview Mirrors	2-32
Reclining Seatbacks	1-5
Recommended Fluids and Lubricants	6-12
Recreational Vehicle Towing	4-34
Reduced Engine Power Light	3-44
Remote Keyless Entry System	2-3
Remote Keyless Entry System, Operation	2-4
Removing the Flat Tire and Installing the Spare Tire	5-71
Removing the Spare Tire and Tools	5-69
Replacement Bulbs	5-50
Reporting Safety Defects	
Canadian Government	7-11
General Motors	7-11
United States Government	7-10
Restraint System Check	
Checking the Restraint Systems	1-65
Replacing Restraint System Parts After a Crash	1-65
Retained Accessory Power (RAP)	2-22
Right Front Passenger Position, Safety Belts	1-23
Roadside	
Assistance Program	7-6
Rocking Your Vehicle to Get it Out	4-28
Running the Engine While Parked	2-31

S

Safety Belt		
Pretensioners	1-30	
Reminder Light	3-32	
Safety Belts		
Care of	5-81	
Center Front Passenger Position	1-24	
Driver Position	1-15	
How to Wear Safety Belts Properly	1-15	
Questions and Answers About Safety Belts	1-14	
Rear Safety Belt Comfort Guides	1-27	
Rear Seat Passengers	1-25	
Right Front Passenger Position	1-23	
Safety Belt Extender	1-30	
Safety Belt Use During Pregnancy	1-23	
Safety Belts Are for Everyone	1-10	
Shoulder Belt Height Adjuster	1-22	
Safety Warnings and Symbols	iii	
Scheduled Maintenance	6-4	
Seats		
Center Seat	1-7	
Head Restraints	1-7	
Heated Seats	1-5	
Manual	1-3	
Seats (cont.)		
Power Lumbar	1-4	
Reclining Seatbacks	1-5	
Six-Way Power Seats	1-4	
Split Folding Rear Seat	1-8	
Securing a Child Restraint		
Center Front Seat Position	1-48	
Designed for the LATCH System	1-45	
Rear Seat Position	1-46	
Right Front Seat Position	1-48	
Security Light	3-43	
Service	5-3	
Adding Equipment to the Outside of Your Vehicle	5-5	
Doing Your Own Work	5-4	
Engine Soon Light	3-39	
Publications Ordering Information	7-11	
Vehicle Soon Light	3-45	
Servicing Your Airbag-Equipped Vehicle	1-64	
Setting the Time	3-79	
Sheet Metal Damage	5-84	
Shifting Into Park (P)	2-28	
Shifting Out of Park (P)	2-29	
Shoulder Belt Height Adjuster	1-22	
Signals, Turn and Lane-Change	3-8	

Spare Tire	
Installing	5-71
Removing	5-69
Storing	5-76
Specifications, Capacities	5-92
Speedometer	3-32
Split Folding Rear Seat	1-8
StabiliTrak [®] System	4-9
Starting Your Engine	2-22
Steering	4-10
Steering Wheel Comfort Controls	3-30
Steering Wheel Controls, Audio	3-118
Steering Wheel, Tilt Wheel	3-6
Storage Areas	
Center Console Storage Area	2-41
Convenience Net	2-41
Cupholder(s)	2-40
Glove Box	2-40
Stuck in Sand, Mud, Ice or Snow	4-28
Sun Visors	2-17
Sunroof	2-42

T

Tachometer	3-32
Taillamps	
Turn Signal, Sidemarker, Stoplamps, and Back-Up Lamps	5-48

TCS Warning Light	3-37
Theater Dimming	3-17
Theft-Deterrent, Radio	3-117
Theft-Deterrent Systems	2-17
Content Theft-Deterrent	2-17
PASS-Key [®] III	2-19
PASS-Key [®] III Operation	2-19
Tilt Wheel	3-6
Tires	5-52
Aluminum or Chrome-Plated Wheels, Cleaning	5-83
Buying New Tires	5-62
Chains	5-66
Changing a Flat Tire	5-68
Cleaning	5-83
Compact Spare Tire	5-77
If a Tire Goes Flat	5-67
Inflation -- Tire Pressure	5-58
Inspection and Rotation	5-60
Installing the Spare Tire	5-71
Removing the Flat Tire	5-71
Removing the Spare Tire and Tools	5-69
Storing a Flat or Spare Tire and Tools	5-76
Tire Sidewall Labelling	5-53
Tire Terminology and Definitions	5-55
Uniform Tire Quality Grading	5-63
Wheel Alignment and Tire Balance	5-64
Wheel Replacement	5-65
When It Is Time for New Tires	5-61

Top Strap	1-41
Top Strap Anchor Location	1-43
Towing	
Recreational Vehicle	4-34
Towing a Trailer	4-35
Your Vehicle	4-34
Traction	
Control System (TCS)	4-8
Control System Warning Light	3-37
StabiliTrak® System	4-9
Transaxle Operation, Automatic	2-24
Transmission	
Fluid, Automatic	5-21
Trunk	2-13
Trunk Ajar Light	3-45
Turn and Lane-Change Signals	3-8
Turn Signal/Multifunction Lever	3-7

U

Ultrasonic Rear Parking Assist (URPA)	3-18
Understanding Radio Reception	3-119
Uniform Tire Quality Grading	5-63

V

Vehicle	
Control	4-5
Damage Warnings	iv

Vehicle (cont.)	
Loading	4-29
Service Soon Light	3-45
Symbols	iv
Vehicle Data Collection and Event Data	
Recorders	7-9
Vehicle Identification	
Number (VIN)	5-86
Service Parts Identification Label	5-86
Vehicle Personalization	
DIC	3-71
Ventilation Adjustment	3-28
Visors	2-17

W

Warning Lights, Gages and Indicators	3-30
Warnings	
DIC Warnings and Messages	3-53
Hazard Warning Flashers	3-6
Other Warning Devices	3-6
Safety and Symbols	iii
Vehicle Damage	iv
Washer Fluid, Low Warning Light	3-45
Wheels	
Alignment and Tire Balance	5-64
Replacement	5-65
Where to Put the Restraint	1-40

Windows	2-15
Power	2-16
Windshield	
Wiper Blades, Cleaning	5-82
Windshield Washer	3-9
Fluid	5-34
Windshield Wiper	
Blade Replacement	5-51

Windshield Wiper (cont.)	
Fuses	5-87
Windshield Wipers	3-9
Winter Driving	4-24

Y

Your Vehicle and the Environment	6-2
--	-----