

2005 Cadillac SRX Owner Manual

Seats and Restraint Systems	1-1	Driving Your Vehicle	4-1
Front Seats	1-2	Your Driving, the Road, and Your Vehicle	4-2
Rear Seats	1-8	Towing	4-50
Safety Belts	1-10	Service and Appearance Care	5-1
Child Restraints	1-28	Service	5-3
Airbag System	1-47	Fuel	5-5
Restraint System Check	1-58	Checking Things Under the Hood	5-10
Features and Controls	2-1	All-Wheel Drive	5-46
Keys	2-3	Rear Axle	5-48
Doors and Locks	2-8	Front Axle	5-49
Windows	2-13	Bulb Replacement	5-50
Theft-Deterrent Systems	2-17	Windshield Wiper Blade Replacement	5-50
Starting and Operating Your Vehicle	2-20	Tires	5-52
Mirrors	2-35	Appearance Care	5-83
OnStar [®] System	2-40	Vehicle Identification	5-92
HomeLink [®] Transmitter	2-42	Electrical System	5-92
Storage Areas	2-47	Capacities and Specifications	5-102
Sunroof	2-50	Maintenance Schedule	6-1
Vehicle Personalization	2-53	Maintenance Schedule	6-2
Instrument Panel	3-1	Customer Assistance and Information	7-1
Instrument Panel Overview	3-4	Customer Assistance and Information	7-2
Climate Controls	3-25	Reporting Safety Defects	7-11
Warning Lights, Gages, and Indicators	3-33	Index	1
Driver Information Center (DIC)	3-48		
Audio System(s)	3-80		



GENERAL MOTORS, GM, the GM Emblem, CADILLAC, the CADILLAC Crest and Wreath, and the name SRX are registered trademarks of General Motors Corporation.

This manual includes the latest information at the time it was printed. We reserve the right to make changes to the product after that time without notice. For vehicles first sold in Canada, substitute the name "General Motors of Canada Limited" for Cadillac Motor Car Division whenever it appears in this manual.

Keep this manual in the vehicle, so it will be there if it is needed while you are on the road. If the vehicle is sold, leave this manual in the vehicle.

Canadian Owners

A French language copy of this manual can be obtained from your dealer or from:

Helm, Incorporated
P.O. Box 07130
Detroit, MI 48207

How to Use This Manual

Many people read the owner manual from beginning to end when they first receive their new vehicle. If this is done, it can help you learn about the features and controls for the vehicle. Pictures and words work together in the owner manual to explain things.

Index

A good place to quickly locate information about the vehicle is the Index in the back of the manual. It is an alphabetical list of what is in the manual and the page number where it can be found.

Safety Warnings and Symbols

There are a number of safety cautions in this book. We use a box and the word CAUTION to tell about things that could hurt you if you were to ignore the warning.

 **CAUTION:**

These mean there is something that could hurt you or other people.

In the caution area, we tell you what the hazard is. Then we tell you what to do to help avoid or reduce the hazard. Please read these cautions. If you do not, you or others could be hurt.

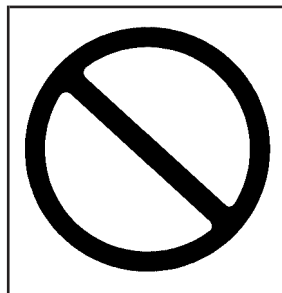

You will also find a circle with a slash through it in this book. This safety symbol means “Do Not,” “Do Not do this” or “Do Not let this happen.”

Vehicle Damage Warnings

Also, in this manual you will find these notices:

Notice: These mean there is something that could damage your vehicle.

A notice tells about something that can damage the vehicle. Many times, this damage would not be covered by your vehicle's warranty, and it could be costly. But the notice will tell what to do to help avoid the damage.

When you read other manuals, you might see CAUTION and NOTICE warnings in different colors or in different words.

There are also warning labels on the vehicle. They use the same words, CAUTION or NOTICE.





























Vehicle Symbols

The vehicle has components and labels that use symbols instead of text. Symbols are shown along with the text describing the operation or information relating to a specific component, control, message, gage, or indicator.

If you need help figuring out a specific name of a component, gage, or indicator, reference the following topics:

- Seats and Restraint Systems in Section 1
- Features and Controls in Section 2
- Instrument Panel Overview in Section 3
- Climate Controls in Section 3
- Warning Lights, Gages, and Indicators in Section 3
- Audio System(s) in Section 3
- Engine Compartment Overview in Section 5

These are some examples of symbols that may be found on the vehicle:

CAUTION POSSIBLE INJURY		LATCH BOTH LAP AND SHOULDER BELTS TO PROTECT OCCUPANT DO NOT TWIST SAFETY BELT WHEN ATTACHING	 	MASTER LIGHTING SWITCH		ENGINE COOLANT TEMP		FUSE BOX ACCESS	
PROTECT EYES BY SHIELDING		FASTEN SEAT BELTS		AIR BAG		BATTERY CHARGING SYSTEM		ENGINE COOLANT FAN	
CAUSTIC BATTERY ACID COULD CAUSE BURNS		MOVE SEAT FULLY REARWARD SECURE CHILD SEAT		DO NOT INSTALL A REAR-FACING CHILD RESTRAINT IN THIS SEATING POSITION		PARKING LAMPS		HAZARD WARNING FLASHER	
AVOID SPARKS OR FLAMES		PULL BELT OUT COMPLETELY THEN SECURE CHILD SEAT		DO NOT INSTALL A FORWARD-FACING CHILD RESTRAINT IN THIS SEATING POSITION		HAZARD WARNING FLASHER		ENGINE OIL PRESSURE	
SPARK OR FLAME COULD EXPLODE BATTERY		POWER WINDOW		DOOR LOCK UNLOCK		ENGINE OIL PRESSURE		OWNER'S MANUAL	
						DAYTIME RUNNING LAMPS		SERVICE MANUAL	
						FOG LAMPS			



NOTES

Section 1 Seats and Restraint Systems

Front Seats	1-2	Child Restraint Systems	1-34
Manual Passenger Seat	1-2	Where to Put the Restraint	1-37
Power Seats	1-2	Top Strap	1-38
Power Lumbar	1-3	Top Strap Anchor Location	1-39
Heated Seats	1-4	Lower Anchorages and Top Tethers for Children (LATCH System)	1-40
Reclining Seatbacks	1-5	Securing a Child Restraint Designed for the LATCH System	1-42
Head Restraints	1-7	Securing a Child Restraint in a Rear Seat Position	1-42
Rear Seats	1-8	Securing a Child Restraint in the Right Front Seat Position	1-45
Rear Seat Operation	1-8	Airbag System	1-47
Stowable Seat	1-8	Where Are the Airbags?	1-50
Safety Belts	1-10	When Should an Airbag Inflate?	1-54
Safety Belts: They Are for Everyone	1-10	What Makes an Airbag Inflate?	1-55
Questions and Answers About Safety Belts	1-14	How Does an Airbag Restrain?	1-55
How to Wear Safety Belts Properly	1-15	What Will You See After an Airbag Inflates?	1-56
Driver Position	1-15	Servicing Your Airbag-Equipped Vehicle	1-58
Safety Belt Use During Pregnancy	1-21	Restraint System Check	1-58
Right Front Passenger Position	1-22	Checking Your Restraint Systems	1-58
Rear Seat Passengers	1-22	Replacing Restraint System Parts After a Crash	1-59
Rear Safety Belt Comfort Guides for Children and Small Adults	1-25		
Safety Belt Pretensioners	1-27		
Safety Belt Extender	1-27		
Child Restraints	1-28		
Older Children	1-28		
Infants and Young Children	1-31		

Front Seats

Manual Passenger Seat



Your vehicle may have a manual passenger seat. To adjust the seat, lift the bar under the front of the seat to unlock it. Slide the seat to where you want it and release the bar. Try to move the seat back and forth with your body to be sure the seat is locked in place.

Power Seats

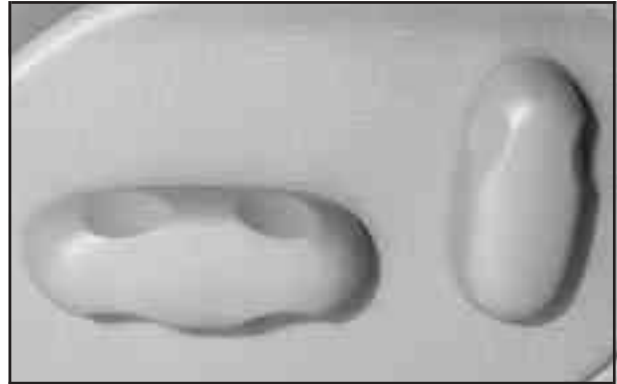

If your vehicle is equipped with power front seats, the controls are located on the outboard sides of the front seat cushions.

- Move the front of the horizontal control up or down to raise or lower the front portion of the cushion.
- Move the rear of the horizontal control up or down to raise or lower the rear portion of the cushion.
- Lift up or push down on the center of the horizontal control to move the entire seat up or down.
- To move the seat forward or rearward, slide the horizontal control forward or rearward.

See *Reclining Seatbacks* on page 1-5 for more information.

Power Lumbar

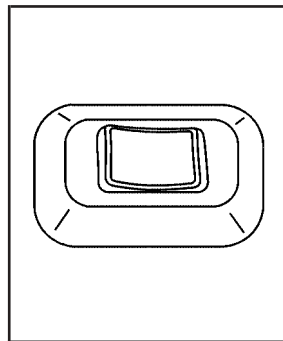

Your vehicle may have this feature. The driver's and passenger's seatback lumbar support can be adjusted by moving the control located on the outboard side of the seat cushions.

To increase or decrease support, hold the control forward or rearward. Keep in mind that as your seating position changes, as it may during long trips, so should the position of your lumbar support. Adjust the seat as needed.

Heated Seats



If your vehicle is equipped with heated front seats, the buttons are located on the climate control panel.

There is one button for the driver and one for the front passenger. Each button has three settings, LO, HI and off. The active setting appears on the climate control panel display. The LO setting warms the seatback and cushion until the seat approximates normal body temperature. The HI setting has a slightly higher temperature.

To turn on the heated seats, press the button once. The seat will heat to the HI setting. Press the button again to switch to the LO setting. Pressing the button a third time turns the system off.

The heated seats can only be used when the ignition is turned on. When the vehicle is turned off, the heated seats automatically turn off. If you wish to have the heated seats on once the vehicle is restarted, press the button again.

Reclining Seatbacks



Manual Recliner

If your vehicle has manual reclining front seatbacks, the levers are located on the outboard sides of the front seats.

Lift the lever to release the seatback, then move the seatback to where you want it. Release the lever to lock the seatback in place. To return the seatback to the upright position, pull up on the lever without pushing on the seatback.

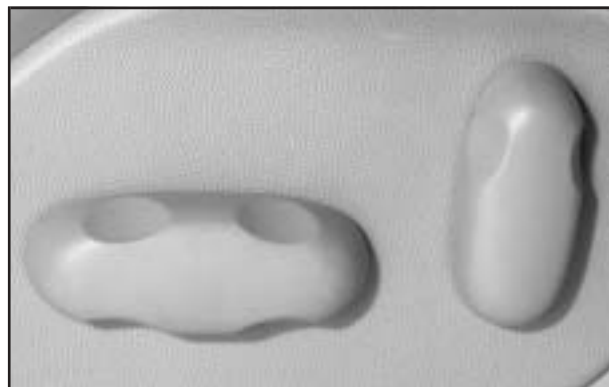

Power Recliner

If your vehicle has power reclining front seatbacks, the control is located on the outboard side of the front seats.

Press the top of the vertical control forward or rearward to adjust the seatback angle.

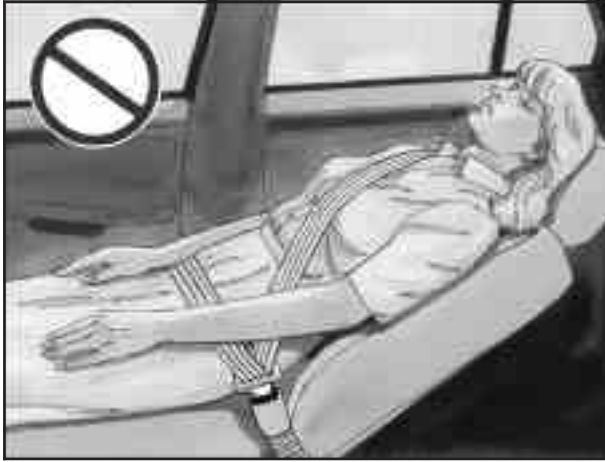

But don't have a seatback reclined if your vehicle is moving.

⚠ CAUTION:

Sitting in a reclined position when your vehicle is in motion can be dangerous. Even if you buckle up, your safety belts can not do their job when you are reclined like this.

The shoulder belt can not do its job. In a crash, you could go into it, receiving neck or other injuries.

The lap belt can not do its job either. In a crash the belt could go up over your abdomen. The belt forces would be there, not at your pelvic bones. This could cause serious internal injuries.

For proper protection when the vehicle is in motion, have the seatback upright. Then sit well back in the seat and wear your safety belt properly.

Head Restraints



Adjust your head restraint so that the top of the restraint is closest to the top of your head. This position reduces the chance of a neck injury in a crash.

The front seat head restraints move up and down. Press the button located at the bottom of the head restraint to raise or lower the head restraint. The head restraints tilt forward and rearward, also.

The second row outboard head restraints work the same as the front seat head restraints except they do not tilt.

The third row head rests are not adjustable. They are removable. They must be removed before the third row seat can be folded. To remove the third row head rests, press the button located on the top of the seatback and pull up on the head rest.

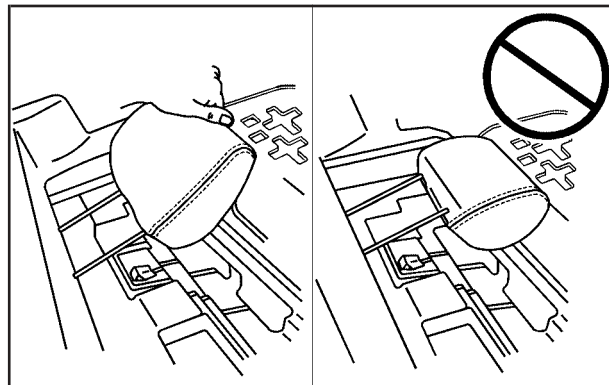

Store the head rests in the storage compartment behind the third row. Open the cover and insert the head rest posts through the slats in the storage area. The head rests must be stored with the front of the rest facing up. Position and snap the head rests in the provided storage tray.

Rear Seats

Rear Seat Operation

Adjusting the Second Row Seat

The second row seat can be adjusted forward or rearward. Pull up on the lever under the seat cushion and slide the seat with your body. Release the lever and try to move the seat forward and rearward to be sure it is locked into place.

Entering or Exiting the Third Row Seat

The passenger's side of the second row seat has an easy entry feature. This makes it easy to get in and out of the third row seat, if your vehicle has one.

To operate the seat, pull the release handle located on the top of the seatback. Fold the seatback down then pull the release handle on the top of the seatback to release the seat to tumble forward.

Be sure to return the seat to the passenger position when finished. Push and pull on the seat to make sure it is locked in place.

Stowable Seat

If your vehicle has a third row seat, it is a power folding seat.

The head rests need to be removed before folding the third row seat. See *Head Restraints on page 1-7* for instructions for removing the third row seat head rests. The seatback will not fold all of the way down if the head rests are not removed.

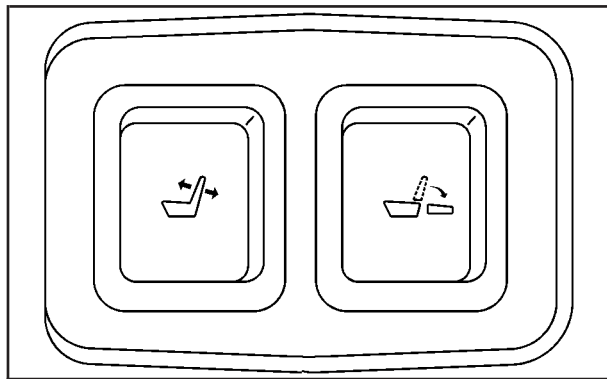

Inside Liftgate

The buttons that are used to operate the power folding third row seat are located inside of the liftgate and behind the second row seat on the passenger's side of the vehicle.

Two buttons are located inside the liftgate. One button is to tilt the seatback forward for added storage space or when storing a flat tire. The other button is the power folding seat button. The button behind the second row seat is also a power folding seat button.

Before folding or unfolding the third row seat, all of the following conditions must be met:

- The liftgate or passenger's side rear door must be open.
- The unlock button on either the remote keyless entry transmitter or the door must be pressed three times to enable the rear seat for two minutes, or the ignition must be in ON or ACCESSORY.
- The vehicle must be in PARK (P).
- The vehicle cannot have a low battery.

After the seat has folded, the panel on the seat must be folded forward to create the flat floor.

If the seat's path is blocked it will stop and back away. Press the button again to return the seat to its previous position.

Before returning the third row seat to the passenger seating position, the panel must be folded back upon itself. Press one of the power folding seat buttons and the seat will unfold into the seating position. If the seat is not unfolded fully into the seating position, a chime will sound when the vehicle is shifted out of PARK (P).

Safety Belts

Safety Belts: They Are for Everyone

This part of the manual tells you how to use safety belts properly. It also tells you some things you should not do with safety belts.

CAUTION:

Do not let anyone ride where he or she can not wear a safety belt properly. If you are in a crash and you are not wearing a safety belt, your injuries can be much worse. You can hit things inside the vehicle or be ejected from it. You can be seriously injured or killed. In the same crash, you might not be, if you are buckled up. Always fasten your safety belt, and check that your passengers' belts are fastened properly too.

CAUTION:

It is extremely dangerous to ride in a cargo area, inside or outside of a vehicle. In a collision, people riding in these areas are more likely to be seriously injured or killed. Do not allow people to ride in any area of your vehicle that is not equipped with seats and safety belts. Be sure everyone in your vehicle is in a seat and using a safety belt properly.



Your vehicle has a light that comes on as a reminder to buckle up. See *Safety Belt Reminder Light* on page 3-36.

In most states and in all Canadian provinces, the law says to wear safety belts. Here is why: *They work.*

You never know if you will be in a crash. If you do have a crash, you do not know if it will be a bad one.

A few crashes are mild, and some crashes can be so serious that even buckled up, a person would not survive. But most crashes are in between. In many of them, people who buckle up can survive and sometimes walk away. Without belts they could have been badly hurt or killed.

After more than 30 years of safety belts in vehicles, the facts are clear. In most crashes buckling up does matter...a lot!

Why Safety Belts Work

When you ride in or on anything, you go as fast as it goes.

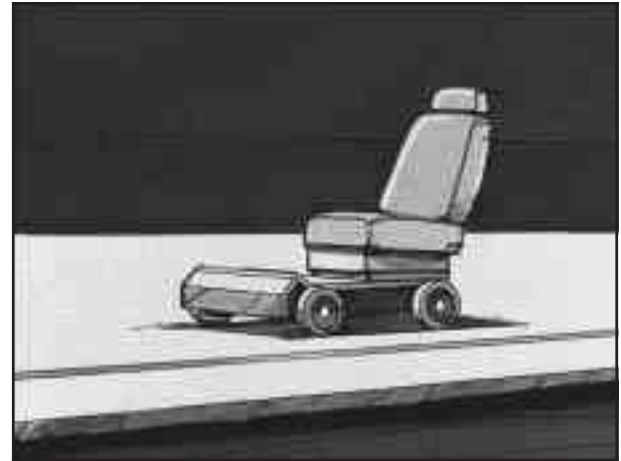

Take the simplest vehicle. Suppose it is just a seat on wheels.



Put someone on it.

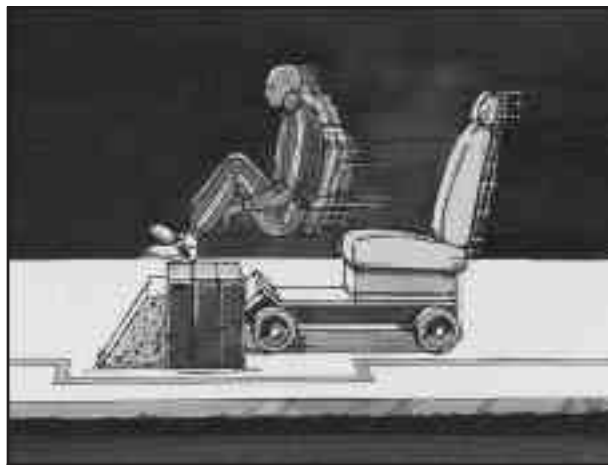

Get it up to speed. Then stop the vehicle. The rider does not stop.



The person keeps going until stopped by something.
In a real vehicle, it could be the windshield...



or the instrument panel...



or the safety belts!

With safety belts, you slow down as the vehicle does. You get more time to stop. You stop over more distance, and your strongest bones take the forces. That is why safety belts make such good sense.

Questions and Answers About Safety Belts

Q: Will I be trapped in the vehicle after an accident if I am wearing a safety belt?

A: You *could* be — whether you are wearing a safety belt or not. But you can unbuckle a safety belt, even if you are upside down. And your chance of being conscious during and after an accident, so you *can* unbuckle and get out, is *much* greater if you are belted.

Q: If my vehicle has airbags, why should I have to wear safety belts?

A: Airbags are in many vehicles today and will be in most of them in the future. But they are supplemental systems only; so they work *with* safety belts — not instead of them. Every airbag system ever offered for sale has required the use of safety belts. Even if you are in a vehicle that has airbags, you still have to buckle up to get the most protection. That is true not only in frontal collisions, but especially in side and other collisions.

Q: If I am a good driver, and I never drive far from home, why should I wear safety belts?

A: You may be an excellent driver, but if you are in an accident — even one that is not your fault — you and your passengers can be hurt. Being a good driver does not protect you from things beyond your control, such as bad drivers.

Most accidents occur within 25 miles (40 km) of home. And the greatest number of serious injuries and deaths occur at speeds of less than 40 mph (65 km/h).

Safety belts are for everyone.

How to Wear Safety Belts Properly

This part is only for people of adult size.

Be aware that there are special things to know about safety belts and children. And there are different rules for smaller children and babies. If a child will be riding in your vehicle, see *Older Children on page 1-28* or *Infants and Young Children on page 1-31*. Follow those rules for everyone's protection.

First, you will want to know which restraint systems your vehicle has.

We will start with the driver position.

Driver Position

Lap-Shoulder Belt

The driver has a lap-shoulder belt. Here is how to wear it properly.

1. Close and lock the door.
2. Adjust the seat so you can sit up straight. To see how, see "Seats" in the Index.

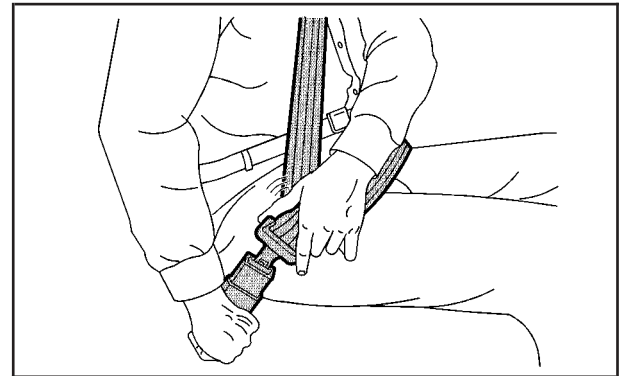

3. Pick up the latch plate and pull the belt across you. Do not let it get twisted.

The shoulder belt may lock if you pull the belt across you very quickly. If this happens, let the belt go back slightly to unlock it. Then pull the belt across you more slowly.

4. Push the latch plate into the buckle until it clicks. Pull up on the latch plate to make sure it is secure. If the belt is not long enough, see *Safety Belt Extender* on page 1-27.

Make sure the release button on the buckle is positioned so you would be able to unbuckle the safety belt quickly if you ever had to.

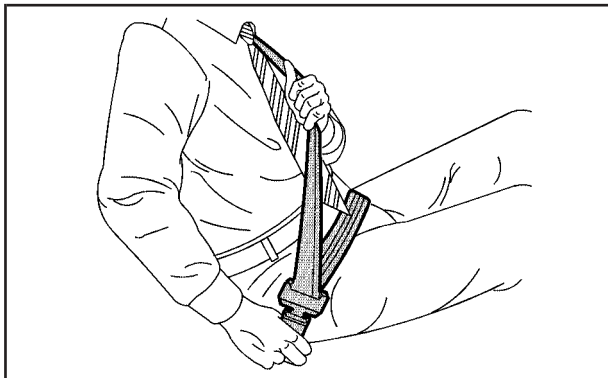

5. To make the lap part tight, pull up on the shoulder belt.

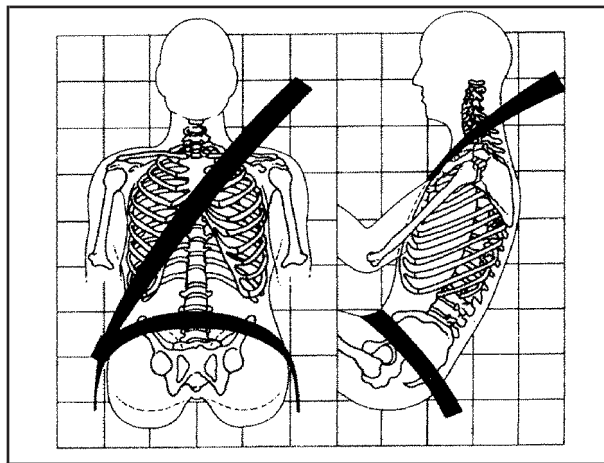

The lap part of the belt should be worn low and snug on the hips, just touching the thighs. In a crash, this applies force to the strong pelvic bones. And you would be less likely to slide under the lap belt. If you slid under it, the belt would apply force at your abdomen. This could cause serious or even fatal injuries. The shoulder belt should go over the shoulder and across the chest. These parts of the body are best able to take belt restraining forces.

The safety belt locks if there is a sudden stop or crash, or if you pull the belt very quickly out of the retractor.

Q: What is wrong with this?

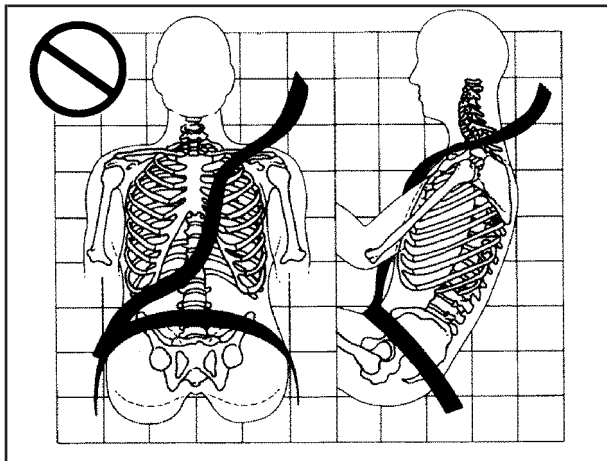

A: The shoulder belt is too loose. It will not give nearly as much protection this way.

⚠ CAUTION:

You can be seriously hurt if your shoulder belt is too loose. In a crash, you would move forward too much, which could increase injury. The shoulder belt should fit against your body.

Q: What is wrong with this?

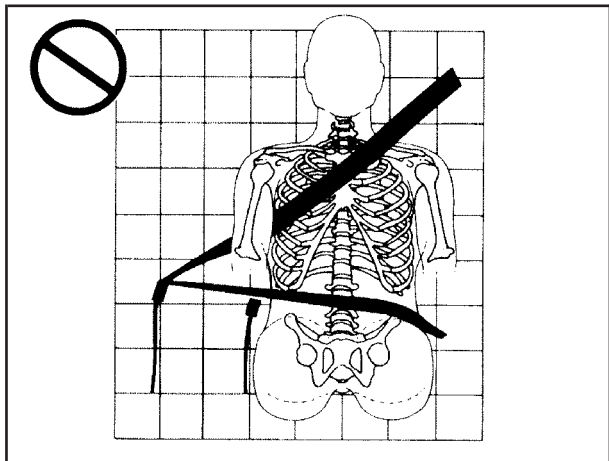

A: The belt is buckled in the wrong place.

⚠ CAUTION:

You can be seriously injured if your belt is buckled in the wrong place like this. In a crash, the belt would go up over your abdomen. The belt forces would be there, not at the pelvic bones. This could cause serious internal injuries. Always buckle your belt into the buckle nearest you.

Q: What is wrong with this?

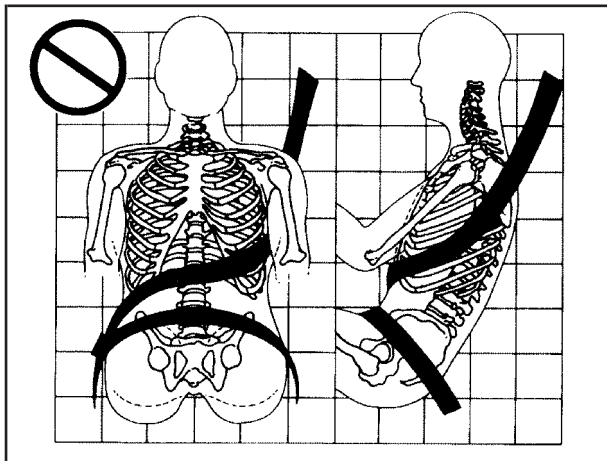

A: The shoulder belt is worn under the arm. It should be worn over the shoulder at all times.

⚠ CAUTION:

You can be seriously injured if you wear the shoulder belt under your arm. In a crash, your body would move too far forward, which would increase the chance of head and neck injury. Also, the belt would apply too much force to the ribs, which are not as strong as shoulder bones. You could also severely injure internal organs like your liver or spleen.

Q: What is wrong with this?

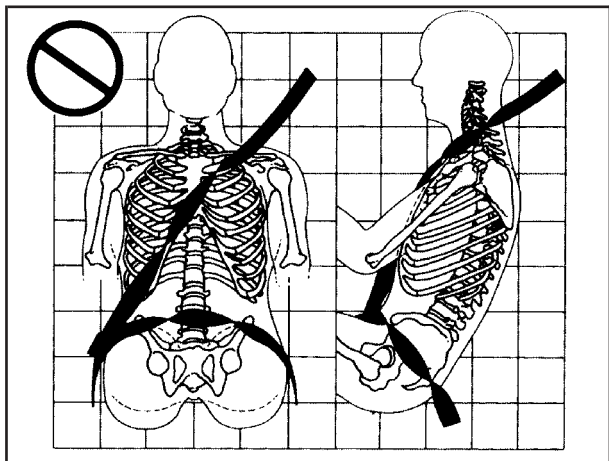

A: The belt is twisted across the body.

⚠ CAUTION:

You can be seriously injured by a twisted belt. In a crash, you would not have the full width of the belt to spread impact forces. If a belt is twisted, make it straight so it can work properly, or ask your dealer to fix it.

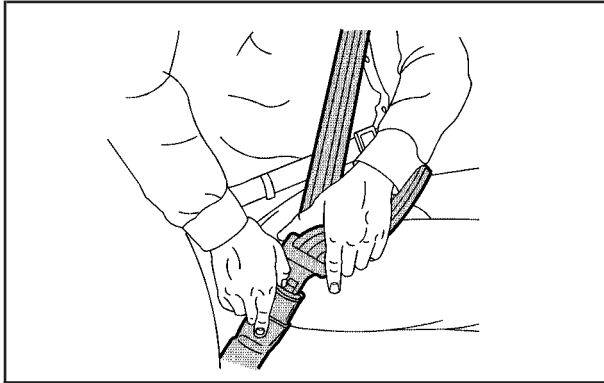

To unclatch the belt, just push the button on the buckle. The belt should go back out of the way.

Before you close the door, be sure the belt is out of the way. If you slam the door on it, you can damage both the belt and your vehicle.

Safety Belt Use During Pregnancy

Safety belts work for everyone, including pregnant women. Like all occupants, they are more likely to be seriously injured if they do not wear safety belts.

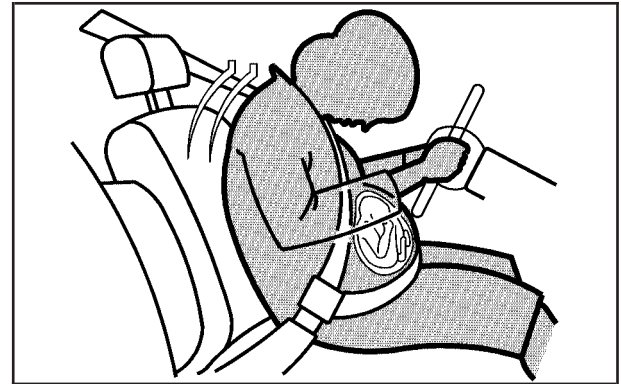

A pregnant woman should wear a lap-shoulder belt, and the lap portion should be worn as low as possible, below the rounding, throughout the pregnancy.

The best way to protect the fetus is to protect the mother. When a safety belt is worn properly, it is more likely that the fetus will not be hurt in a crash. For pregnant women, as for anyone, the key to making safety belts effective is wearing them properly.

Right Front Passenger Position

To learn how to wear the right front passenger's safety belt properly, see *Driver Position on page 1-15*.

The right front passenger's safety belt works the same way as the driver's safety belt — except for the following.

If you ever pull the shoulder portion of the belt out all the way, you will engage the child restraint locking feature. If this happens, just let the belt go back all the way and start again.

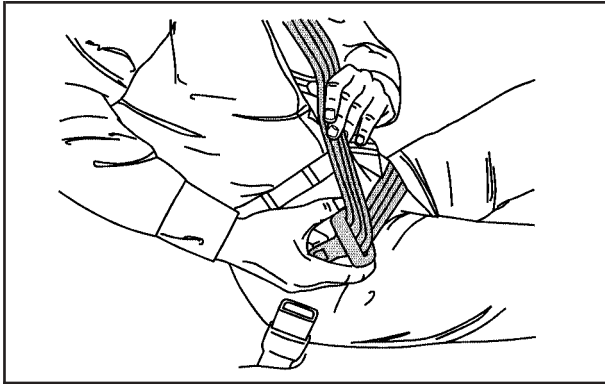

If the belt stops before it reaches the buckle, tilt the latch plate and keep pulling until you can buckle the belt.

Rear Seat Passengers

It is very important for rear seat passengers to buckle up! Accident statistics show that unbelted people in the rear seat are hurt more often in crashes than those who are wearing safety belts.

Rear passengers who are not safety belted can be thrown out of the vehicle in a crash. And they can strike others in the vehicle who are wearing safety belts.

Lap-Shoulder Belt

All rear seating positions have lap-shoulder belts. Here is how to wear one properly.

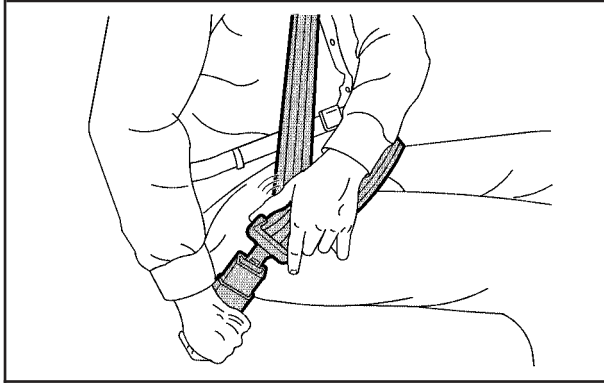

1. Pick up the latch plate and pull the belt across you. Do not let it get twisted.

The shoulder belt may lock if you pull the belt across you very quickly. If this happens, let the belt go back slightly to unlock it. Then pull the belt across you more slowly.

2. Push the latch plate into the buckle until it clicks. Pull up on the latch plate to make sure it is secure. When the shoulder belt is pulled out all the way, it will lock. If it does, let it go back all the way and start again. If the belt is not long enough, see *Safety Belt Extender* on page 1-27. Make sure the release button on the buckle is positioned so you would be able to unbuckle the safety belt quickly if you ever had to.

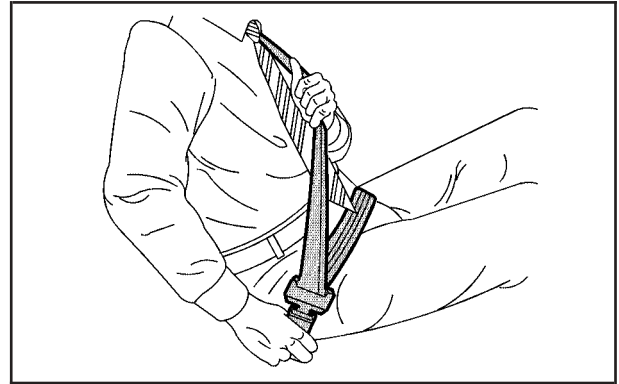

3. To make the lap part tight, pull up on the shoulder part.

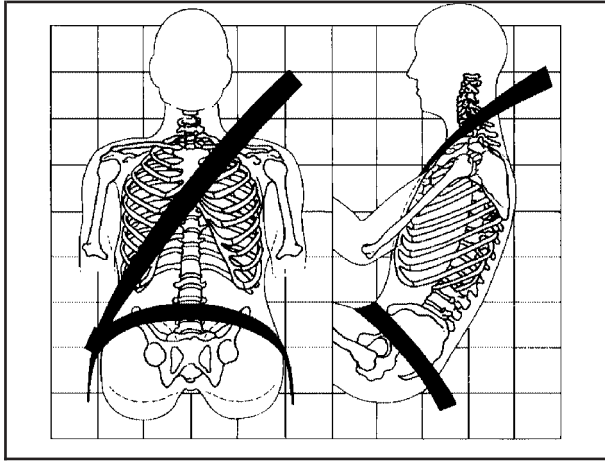

The lap part of the belt should be worn low and snug on the hips, just touching the thighs. In a crash this applies force to the strong pelvic bones. And you would be less likely to slide under the lap belt. If you slid under it, the belt would apply force at your abdomen. This could cause serious or even fatal injuries. The shoulder belt should go over the shoulder and across the chest. These parts of the body are best able to take belt restraining forces.

⚠ CAUTION:

You can be seriously hurt if your shoulder belt is too loose. In a crash, you would move forward too much, which could increase injury. The shoulder belt should fit against your body.

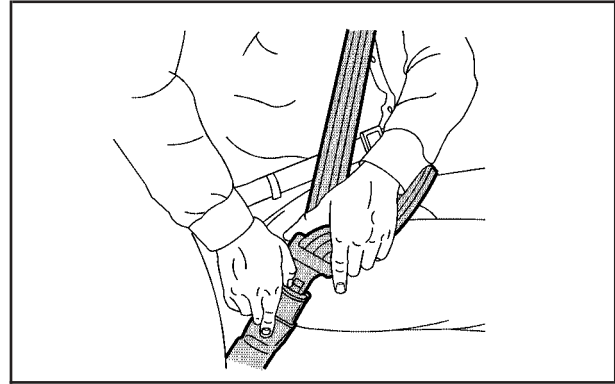

To unlatch the belt, just push the button on the buckle.

Rear Safety Belt Comfort Guides for Children and Small Adults

Your vehicle may have this feature. If not, you can get it from your dealer.

Rear shoulder belt comfort guides provide added safety belt comfort for older children who have outgrown booster seats and for small adults. When attached to a shoulder belt, the comfort guide better positions the belt away from the neck and head.

There is one guide available for each of the rear outside passenger positions in the second row. Here is how to attach the comfort guide to the shoulder belt.

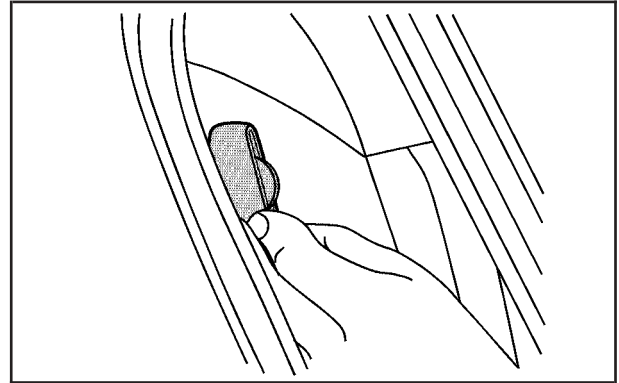

1. Slide the guide off of its storage clip located between the interior body and the seatback.

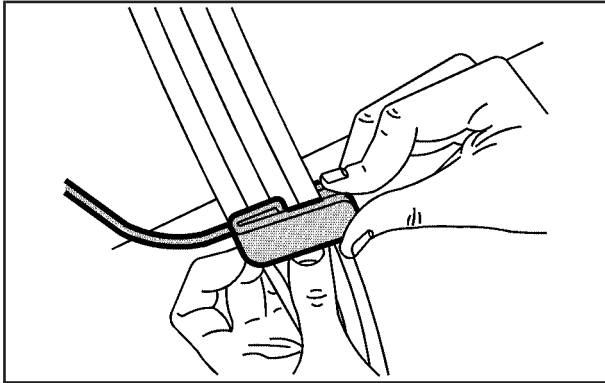

2. Slide the guide under and past the belt. The elastic cord must be under the belt. Then, place the guide over the belt and insert the two edges of the belt into the slots of the guide.

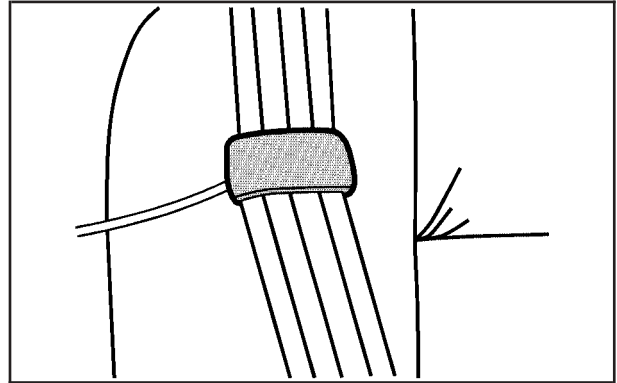

3. Be sure that the belt is not twisted and it lies flat. The elastic cord must be under the belt and the guide on top.

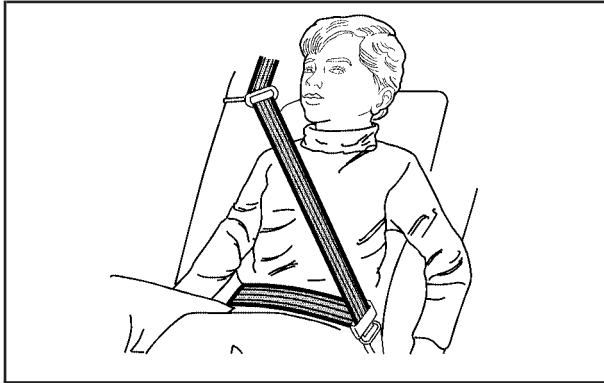

4. Buckle, position and release the safety belt as described in *Rear Seat Passengers* on page 1-22. Make sure that the shoulder belt crosses the shoulder.

To remove and store the comfort guides, squeeze the belt edges together so that you can take them out of the guides. Slide the guide back on its storage clip located between the interior body and the seatback.

Safety Belt Pretensioners

Your vehicle has safety belt pretensioners. You will find them on the buckle end of the safety belts for the driver and right front passenger. They help the safety belts reduce a person's forward movement in a moderate to severe frontal and near frontal crash.

Pretensioners work only once. If they activate in a crash, you will need to get new ones, and probably other new parts for your safety belt system. See *Replacing Restraint System Parts After a Crash* on page 1-59.

Safety Belt Extender

If the vehicle's safety belt will fasten around you, you should use it.

But if a safety belt is not long enough, your dealer will order you an extender. It is free. When you go in to order it, take the heaviest coat you will wear, so the extender will be long enough for you. To help avoid personal injury, do not let someone else use it, and use it only for the seat it is made to fit. The extender has been designed for adults. Never use it for securing child seats. To wear it, just attach it to the regular safety belt. For more information, see the instruction sheet that comes with the extender.

Child Restraints

Older Children

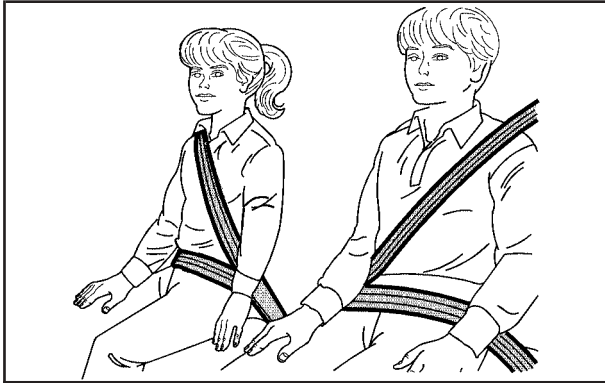

Older children who have outgrown booster seats should wear the vehicle's safety belts.

Q: What is the proper way to wear safety belts?

A: If possible, an older child should wear a lap-shoulder belt and get the additional restraint a shoulder belt can provide. The shoulder belt should not cross the face or neck. The lap belt should fit snugly below the hips, just touching the top of the thighs. It should never be worn over the abdomen, which could cause severe or even fatal internal injuries in a crash.

Accident statistics show that children are safer if they are restrained in the rear seat.

In a crash, children who are not buckled up can strike other people who are buckled up, or can be thrown out of the vehicle. Older children need to use safety belts properly.

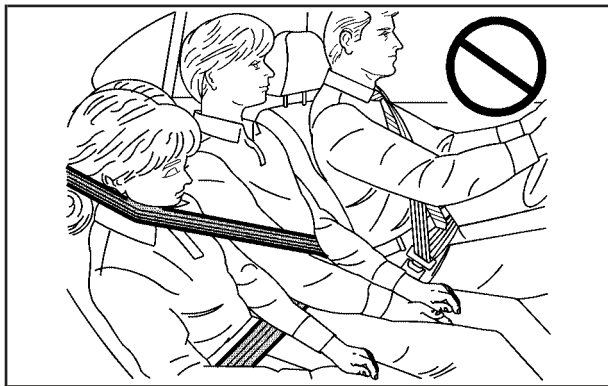

⚠ CAUTION:

Never do this.

Here two children are wearing the same belt. The belt can not properly spread the impact forces. In a crash, the two children can be crushed together and seriously injured. A belt must be used by only one person at a time.

Q: What if a child is wearing a lap-shoulder belt, but the child is so small that the shoulder belt is very close to the child's face or neck?

A: If the child is sitting in a seat next to a window, move the child toward the center of the vehicle. If the child is sitting in the center rear seat passenger position, move the child toward the safety belt buckle. In either case, be sure that the shoulder belt still is on the child's shoulder, so that in a crash the child's upper body would have the restraint the belts provide.

If the child is sitting in a rear seat outside position, see *Rear Safety Belt Comfort Guides for Children and Small Adults* on page 1-25.



⚠ CAUTION:

Never do this.

Here a child is sitting in a seat that has a lap-shoulder belt, but the shoulder part is behind the child. If the child wears the belt in this way, in a crash the child might slide under the belt. The belt's force would then be applied right on the child's abdomen. That could cause serious or fatal injuries.

Wherever the child sits, the lap portion of the belt should be worn low and snug on the hips, just touching the child's thighs. This applies belt force to the child's pelvic bones in a crash.

Infants and Young Children

Everyone in a vehicle needs protection! This includes infants and all other children. Neither the distance traveled nor the age and size of the traveler changes the need, for everyone, to use safety restraints. In fact, the law in every state in the United States and in every Canadian province says children up to some age must be restrained while in a vehicle.

Every time infants and young children ride in vehicles, they should have the protection provided by appropriate restraints. Young children should not use the vehicle's adult safety belts alone, unless there is no other choice. Instead, they need to use a child restraint.

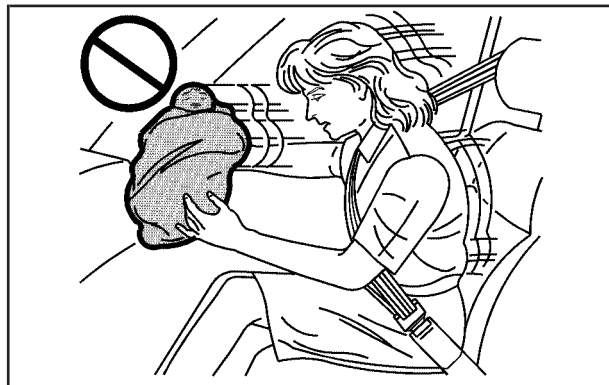

CAUTION:

People should never hold a baby in their arms while riding in a vehicle. A baby does not weigh much — until a crash. During a crash a baby will become so heavy it is not possible to hold it. For example, in a crash at only 25 mph (40 km/h), a 12-lb (5.5 kg) baby will suddenly become a 240-lb (110 kg) force on a person's arms. A baby should be secured in an appropriate restraint.

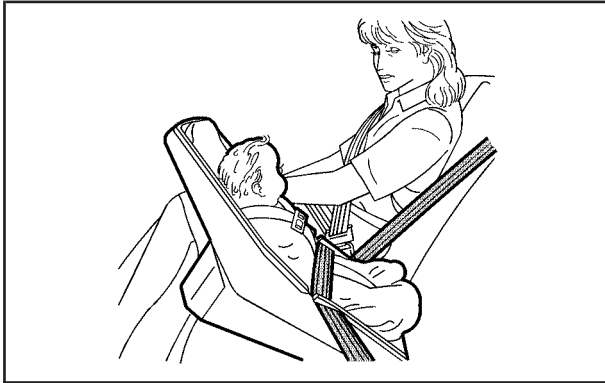

⚠ CAUTION:

Children who are up against, or very close to, any airbag when it inflates can be seriously injured or killed. Airbags plus lap-shoulder belts offer protection for adults and older children, but not for young children and infants. Neither the vehicle's safety belt system nor its airbag system is designed for them. Young children and infants need the protection that a child restraint system can provide.

Q: What are the different types of add-on child restraints?

A: Add-on child restraints, which are purchased by the vehicle's owner, are available in four basic types. Selection of a particular restraint should take into consideration not only the child's weight, height, and age but also whether or not the restraint will be compatible with the motor vehicle in which it will be used.

For most basic types of child restraints, there are many different models available. When purchasing a child restraint, be sure it is designed to be used in a motor vehicle. If it is, the restraint will have a label saying that it meets federal motor vehicle safety standards.

The restraint manufacturer's instructions that come with the restraint state the weight and height limitations for a particular child restraint. In addition, there are many kinds of restraints available for children with special needs.

 **CAUTION:**

Newborn infants need complete support, including support for the head and neck. This is necessary because a newborn infant's neck is weak and its head weighs so much compared with the rest of its body. In a crash, an infant in a rear-facing seat settles into the restraint, so the crash forces can be distributed across the strongest part of an infant's body, the back and shoulders. Infants always should be secured in appropriate infant restraints.

 **CAUTION:**

The body structure of a young child is quite unlike that of an adult or older child, for whom the safety belts are designed. A young child's hip bones are still so small that the vehicle's regular safety belt may not remain low on the hip bones, as it should. Instead, it may settle up around the child's abdomen. In a crash, the belt would apply force on a body area that is unprotected by any bony structure. This alone could cause serious or fatal injuries. Young children always should be secured in appropriate child restraints.

Child Restraint Systems

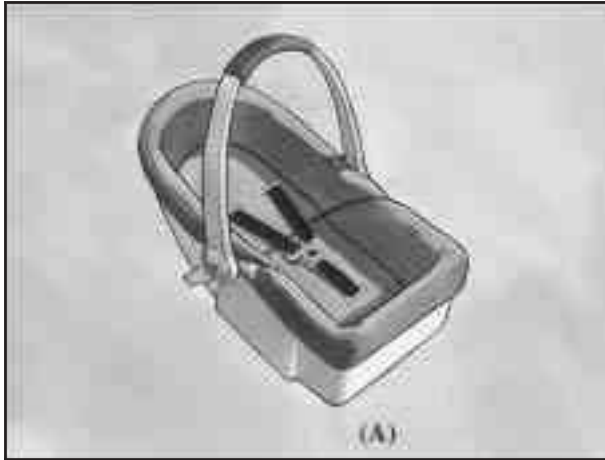

An infant car bed (A), a special bed made for use in a motor vehicle, is an infant restraint system designed to restrain or position a child on a continuous flat surface. Make sure that the infant's head rests toward the center of the vehicle.

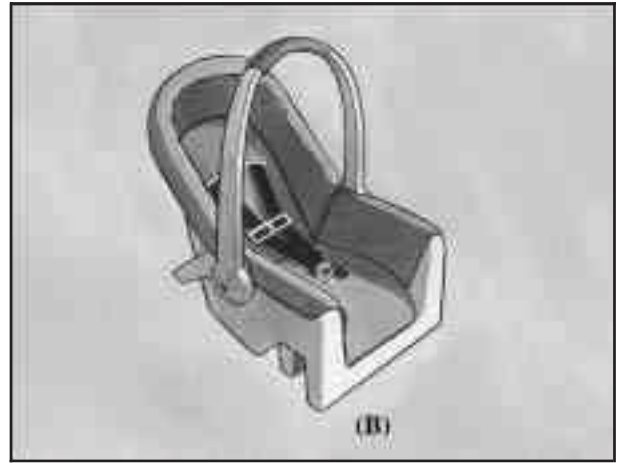

A rear-facing infant seat (B) provides restraint with the seating surface against the back of the infant. The harness system holds the infant in place and, in a crash, acts to keep the infant positioned in the restraint.

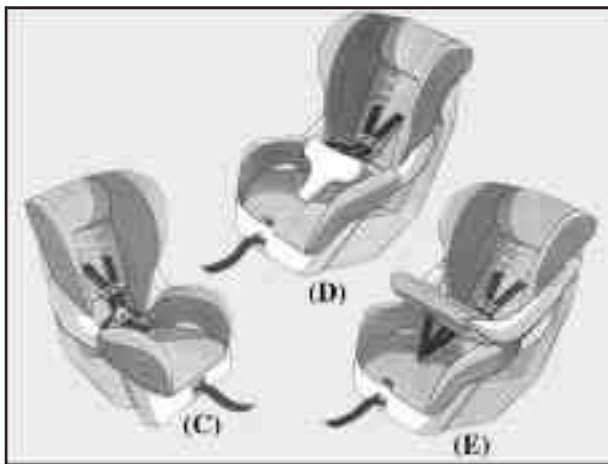

A forward-facing child seat (C-E) provides restraint for the child's body with the harness and also sometimes with surfaces such as T-shaped or shelf-like shields.

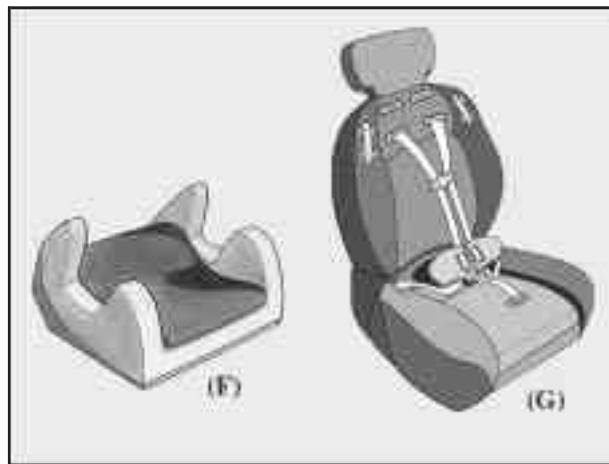

A booster seat (F-G) is a child restraint designed to improve the fit of the vehicle's safety belt system. Some booster seats have a shoulder belt positioner, and some high-back booster seats have a five-point harness. A booster seat can also help a child to see out the window.

Q: How do child restraints work?

A: A child restraint system is any device designed for use in a motor vehicle to restrain, seat, or position children. A built-in child restraint system is a permanent part of the motor vehicle. An add-on child restraint system is a portable one, which is purchased by the vehicle's owner.

For many years, add-on child restraints have used the adult belt system in the vehicle. To help reduce the chance of injury, the child also has to be secured within the restraint. The vehicle's belt system secures the add-on child restraint in the vehicle, and the add-on child restraint's harness system holds the child in place within the restraint.

One system, the three-point harness, has straps that come down over each of the infant's shoulders and buckle together at the crotch. The five-point harness system has two shoulder straps, two hip straps and a crotch strap. A shield may take the place of hip straps. A T-shaped shield has shoulder straps that are attached to a flat pad which rests low against the child's body. A shelf- or armrest-type shield has straps that are attached to a wide, shelf-like shield that swings up or to the side.

When choosing a child restraint, be sure the child restraint is designed to be used in a vehicle. If it is, it will have a label saying that it meets federal motor vehicle safety standards.

Then follow the instructions for the restraint. You may find these instructions on the restraint itself or in a booklet, or both. These restraints use the belt system or the LATCH system in your vehicle, but the child also has to be secured within the restraint to help reduce the chance of personal injury. When securing an add-on child restraint, refer to the instructions that come with the restraint which may be on the restraint itself or in a booklet, or both, and to this manual. The child restraint instructions are important, so if they are not available, obtain a replacement copy from the manufacturer.

Where to Put the Restraint

Accident statistics show that children are safer if they are restrained in the rear rather than the front seat. We, therefore, recommend that child restraints be secured in a rear outside seat position including an infant riding in a rear-facing infant seat, a child riding in a forward-facing child seat and an older child riding in a booster seat. *Never* put a rear-facing child restraint in the front passenger seat. Here is why:

CAUTION:

A child in a rear-facing child restraint can be seriously injured or killed if the right front passenger's airbag inflates. This is because the back of the rear-facing child restraint would be very close to the inflating airbag. Always secure a rear-facing child restraint in a rear seat outside position.

CAUTION: (Continued)

CAUTION: (Continued)

If you need to secure a forward-facing child restraint in the right front seat, always move the front passenger seat as far back as it will go. It is better to secure the child restraint in a rear seat outside position.

Wherever you install it, be sure to secure the child restraint properly.

Keep in mind that an unsecured child restraint can move around in a collision or sudden stop and injure people in the vehicle. Be sure to properly secure any child restraint in your vehicle — even when no child is in it.

Top Strap

Some child restraints have a top strap, or “top tether.” It can help restrain the child restraint during a collision. For it to work, a top strap must be properly anchored to the vehicle. Some top strap-equipped child restraints are designed for use with or without the top strap being anchored. Others require the top strap always to be anchored. Be sure to read and follow the instructions for your child restraint. If yours requires that the top strap be anchored, do not use the restraint unless it is anchored properly.

If the child restraint does not have a top strap, one can be obtained, in kit form, for many child restraints. Ask the child restraint manufacturer whether or not a kit is available.

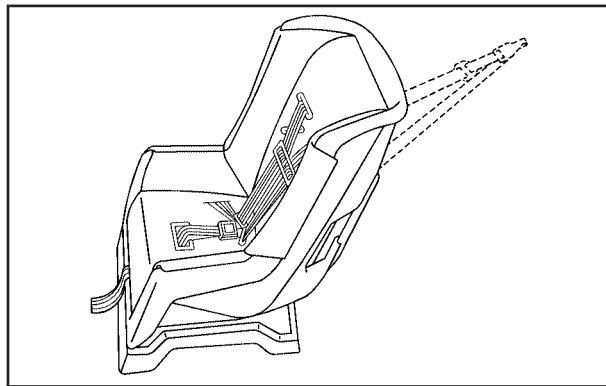

In Canada, the law requires that forward-facing child restraints have a top strap, and that the strap be anchored. In the United States, some child restraints also have a top strap. If your child restraint has a top strap, it should be anchored.



CAUTION:

Each top tether bracket is designed to anchor only one child restraint. Attaching more than one child restraint to a single bracket could cause the anchor to come loose or even break during a crash. A child or others could be injured if this happens. To help prevent injury to people and damage to your vehicle, attach only one child restraint per bracket.

Anchor the top strap to one of the following anchor points. Be sure to use an anchor point located on the same side of the vehicle as the seating position where the child restraint will be placed.

Raise the head restraint and route the top strap under it. See *Head Restraints* on page 1-7.

Once you have the top strap anchored, you will be ready to secure the child restraint itself. Tighten the top strap when and as the child restraint manufacturer's instructions say.

Top Strap Anchor Location

The top strap anchors are located on the floor of the vehicle behind the second row seat. There is one anchor for each second row seat position.

Do not secure a child restraint with a top strap in the right front passenger's position or in the third row if a national or local law requires that the top strap be anchored, or if the instructions that come with the child restraint say that the top strap must be anchored. There is no place to anchor the top strap in these positions.

Lower Anchorages and Top Tethers for Children (LATCH System)

Your vehicle has the LATCH system. You will find anchors for the second row outboard passenger positions.

This system, designed to make installation of child restraints easier, does not use the vehicle's safety belts. Instead, it uses vehicle anchors and child restraint attachments to secure the restraints. Some restraints also use another vehicle anchor to secure a top tether strap.

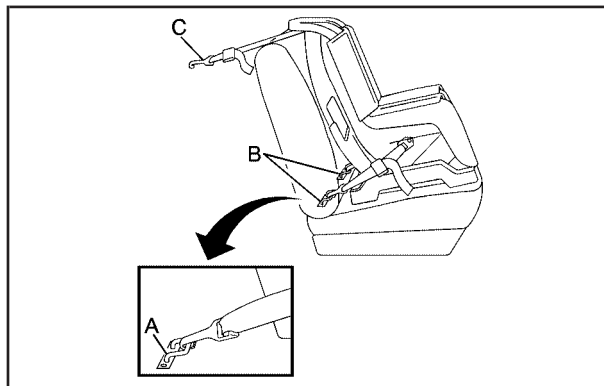

- A. Lower Anchorage
- B. Lower Anchorage
- C. Top Tether

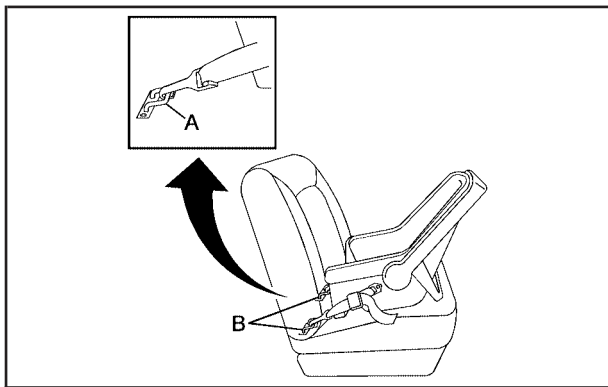

A. Lower Anchorage

B. Lower Anchorage

In order to use the LATCH system in your vehicle, you need a child restraint designed for that system.



To assist you in locating the lower anchors for this child restraint system, each seating position with the LATCH system has a label on the seatback at each lower anchor position.

The labels are located near the base of the second row outboard seating positions.

⚠ CAUTION:

If a LATCH-type child restraint is not attached to its anchorage points, the restraint will not be able to protect the child correctly. In a crash, the child could be seriously injured or killed. Make sure that a LATCH-type child restraint is properly installed using the anchorage points, or use the vehicle's safety belts to secure the restraint, following the instructions that came with that restraint, and also the instructions in this manual.

Securing a Child Restraint Designed for the LATCH System

1. Find the LATCH anchorages for the seating position you want to use, where the bottom of the seatback meets the back of the seat cushion. See *Lower Anchorages and Top Tethers for Children (LATCH System)* on page 1-40.
2. Put the child restraint on the seat.
3. Attach and tighten the LATCH attachments on the child restraint to the LATCH anchorages in the vehicle. The child restraint instructions will show you how.
4. If the child restraint is forward-facing, attach and tighten the top tether to the top tether anchorage. The child restraint instructions will show you how. Also see *Top Strap on page 1-38*.
5. Push and pull the child restraint in different directions to be sure it is secure.

To remove the child restraint, simply unhook the top tether from the top tether anchorage and then disconnect the LATCH attachments from the LATCH anchorages.

Securing a Child Restraint in a Rear Seat Position

If your child restraint is equipped with the LATCH system, see *Lower Anchorages and Top Tethers for Children (LATCH System)* on page 1-40. See *Top Strap on page 1-38* if the child restraint has one.

There are no top strap anchors in the third row seating positions. Do not secure a child restraint in the third row if a national or local law requires that a top strap be anchored or if the instructions that come with the restraint say that the top strap must be anchored.

If your child restraint does not have the LATCH system, you will be using the lap-shoulder belt to secure the child restraint in this position. Be sure to follow the instructions that came with the child restraint. Secure the child in the child restraint when and as the instructions say.

⚠ CAUTION:

In a crash, a child secured in a rear-facing child restraint in the center rear seating position could be injured by the vehicle's armrest. To reduce this risk, the armrest should first be secured with a special armrest retention strap. You can get this from your dealer.



Center Seat Armrest Retention Strap

Install the armrest retention strap following the instructions that come with it.

1. Put the child restraint on the seat.
2. Pick up the latch plate, and run the lap and shoulder portions of the vehicle's safety belt through or around the restraint. The child restraint instructions will show you how.

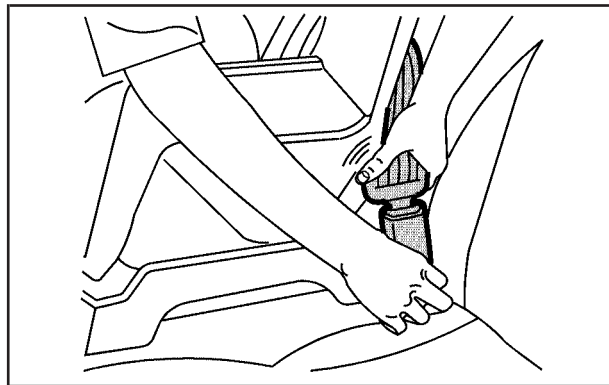

3. Buckle the belt. Make sure the release button is positioned so you would be able to unbuckle the safety belt quickly if you ever had to.

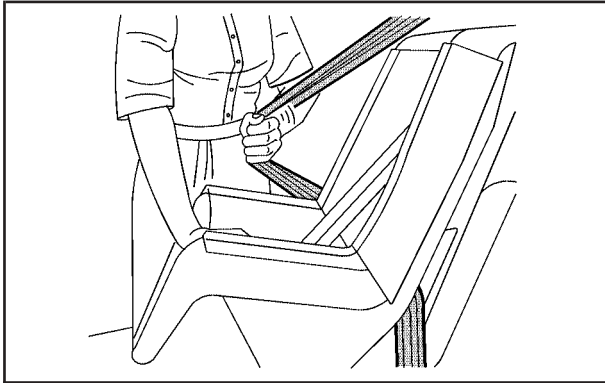

4. Pull the rest of the shoulder belt all the way out of the retractor to set the lock.

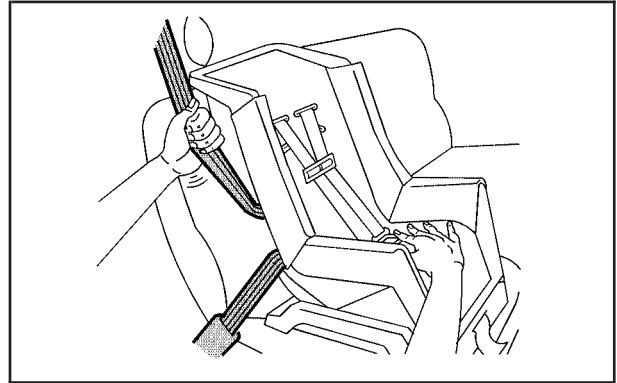

5. To tighten the belt, push down on the child restraint, pull the shoulder portion of the belt to tighten the lap portion of the belt and feed the shoulder belt back into the retractor. If you are using a forward-facing child restraint, you may find it helpful to use your knee to push down on the child restraint as you tighten the belt.
6. Push and pull the child restraint in different directions to be sure it is secure.

To remove the child restraint, just unbuckle the vehicle's safety belt and let it go back all the way. The safety belt will move freely again and be ready to work for an adult or larger child passenger.

Securing a Child Restraint in the Right Front Seat Position

If your child restraint is equipped with the LATCH system, see *Lower Anchorages and Top Tethers for Children (LATCH System)* on page 1-40.

There is no top strap anchor in the right front passenger's position. Do not secure a child seat in this position if a national or local law requires that the top strap be anchored, or if the instructions that come with the child restraint say that the top strap must be anchored. See *Top Strap* on page 1-38 if the child restraint has one.

Your vehicle has a right front passenger airbag. *Never* put a rear facing child restraint in this seat. Here is why:

CAUTION:

A child in a rear-facing child restraint can be seriously injured or killed if the right front passenger's airbag inflates. This is because the back of the rear-facing child restraint would be very close to the inflating airbag. Always secure a rear-facing child restraint in a rear seat.

A rear seat is a safer place to secure a forward-facing child restraint. If you need to secure a forward-facing child restraint in the right front seat, you will be using the lap-shoulder belt to secure the child restraint in this position. Be sure to follow the instructions that came with the child restraint. Secure the child in the child restraint when and as the instructions say.

1. Because your vehicle has a right front passenger's airbag, always move the seat as far back as it will go before securing a forward-facing child restraint. See *Power Seats* on page 1-2 or *Manual Passenger Seat* on page 1-2.
2. Put the child restraint on the seat.
3. Pick up the latch plate, and run the lap and shoulder portions of the vehicle's safety belt through or around the restraint. The child restraint instructions will show you how.

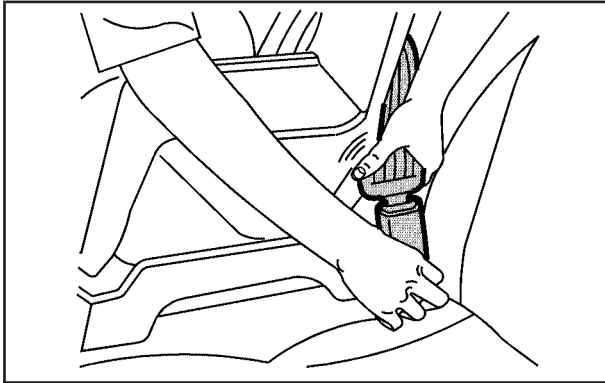

4. Buckle the belt. Make sure the release button is positioned so you would be able to unbuckle the safety belt quickly if you ever had to.

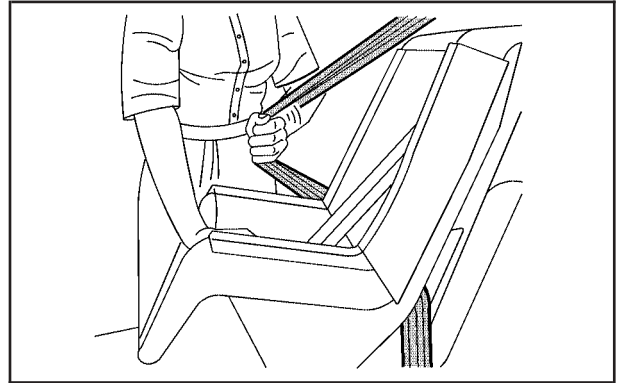

5. Pull the rest of the shoulder belt all the way out of the retractor to set the lock.

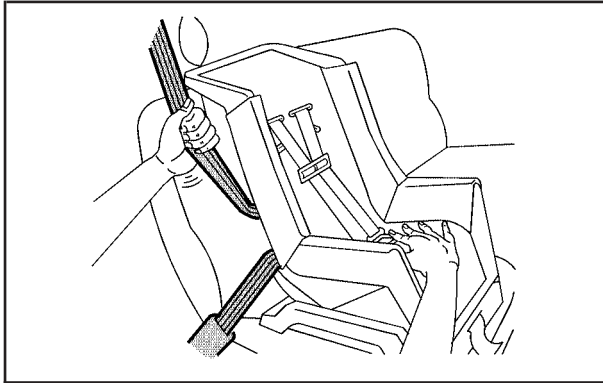

6. To tighten the belt, push down on the child restraint, pull the shoulder portion of the belt to tighten the lap portion of the belt and feed the shoulder belt back into the retractor. You may find it helpful to use your knee to push down on the child restraint as you tighten the belt.
7. Push and pull the child restraint in different directions to be sure it is secure.

To remove the child restraint, just unbuckle the vehicle's safety belt and let it go back all the way. The safety belt will move freely again and be ready to work for an adult or larger child passenger.

Airbag System

Your vehicle has six airbags:

- A frontal airbag for the driver and another frontal airbag for the right front passenger,
- a seat-mounted side impact airbag for the driver and another for the right front passenger,
- a roof-mounted side impact airbag for the driver and passenger directly behind the driver, and
- a roof-mounted side impact airbag for the right front passenger and the person seated directly behind that passenger.

Frontal airbags are designed to help reduce the risk of injury from the force of an inflating airbag. But these airbags must inflate very quickly to do their job and comply with federal regulations.

Here are the most important things to know about the airbag system:

 **CAUTION:**

You can be severely injured or killed in a crash if you are not wearing your safety belt — even if you have airbags. Wearing your safety belt during a crash helps reduce your chance of hitting things inside the vehicle or being ejected from it. Airbags are “supplemental restraints” to the safety belts. All airbags are designed to work with safety belts but do not replace them.

Frontal airbags for the driver and right front passenger are designed to deploy only in moderate to severe frontal and near frontal crashes. They are not designed to inflate in rollover, rear or low-speed frontal crashes, or in many side crashes. And, for some unrestrained occupants, frontal airbags may provide less protection in frontal crashes than more forceful airbags have provided in the past.

The seat-mounted side impact airbags and roof-mounted side impact airbags are designed

CAUTION: (Continued)

CAUTION: (Continued)

to inflate only in moderate to severe crashes where something hits the side of your vehicle. They are not designed to inflate in frontal, in rollover or in rear crashes. Everyone in your vehicle should wear a safety belt properly — whether or not there is an airbag for that person.

 **CAUTION:**

Both frontal and side impact airbags inflate with great force, faster than the blink of an eye. If you are too close to an inflating airbag, as you would be if you were leaning forward, it could seriously injure you. Safety belts help keep you in position for airbag inflation before and during a crash. Always wear your safety belt even with frontal airbags. The driver should sit as far back as possible while still maintaining control of the vehicle. Occupants should not lean on or sleep against the door.

 **CAUTION:**

Anyone who is up against, or very close to, any airbag when it inflates can be seriously injured or killed. Airbags plus lap-shoulder belts offer the best protection for adults, but not for young children and infants. Neither the vehicle's safety belt system nor its airbag system is designed for them. Young children and infants need the protection that a child restraint system can provide. Always secure children properly in your vehicle. To read how, see *Older Children on page 1-28* or *Infants and Young Children on page 1-31*.



There is an airbag readiness light on the instrument panel, which shows the airbag symbol.

The system checks the airbag electrical system for malfunctions. The light tells you if there is an electrical problem. See *Airbag Readiness Light on page 3-37* for more information.

Where Are the Airbags?



The driver's frontal airbag is in the middle of the steering wheel.



The front passenger's frontal airbag is in the instrument panel on the passenger's side.



The driver's side impact airbag is in the side of the driver's seatback closest to the door.



The right front passenger's side impact airbag is in the side of the passenger's seatback closest to the door.



The roof-mounted side impact airbag for the driver and the passenger directly behind the driver is in the ceiling above the side windows.



The roof-mounted side impact airbag for the front passenger and the passenger directly behind the front passenger is in the ceiling above the side windows.

 **CAUTION:**

If something is between an occupant and an airbag, the airbag might not inflate properly or it might force the object into that person causing severe injury or even death. The path of an inflating airbag must be kept clear. Do not put anything between an occupant and an airbag, and do not attach or put anything on the steering wheel hub or on or near any other airbag covering. Do not let seat covers block the inflation path of a side impact airbag.

 **CAUTION:**

If something is between an occupant and an airbag, the bag might not inflate properly or it might force the object into that person causing severe injury or even death. The path of an inflating airbag must be kept clear. Do not put anything between an occupant and an airbag, and do not attach or put anything on the steering wheel hub or on or near any other airbag covering. And, because your vehicle has side impact airbags, never secure anything to the roof of your vehicle by routing the rope or tiedown through any door or window opening. If you do, the path of an inflating side impact airbag will be blocked. The path of an inflating airbag must be kept clear.

When Should an Airbag Inflate?

The driver's and right front passenger's frontal airbags are designed to inflate in moderate to severe frontal or near-frontal crashes. But they are designed to inflate only if the impact exceeds a predetermined deployment threshold. Deployment thresholds take into account a variety of desired deployment and non-deployment events and are used to predict how severe a crash is likely to be in time for the airbags to inflate and help restrain the occupants. Whether your frontal airbags will or should deploy is not based on how fast your vehicle is traveling. It depends largely on what you hit, the direction of the impact and how quickly your vehicle slows down.

In addition, your vehicle has “dual stage” frontal airbags, which adjust the restraint according to crash severity. Your vehicle is equipped with an electronic frontal sensor, which helps the sensing system distinguish between a moderate frontal impact and a more severe frontal impact. For moderate frontal impacts, these airbags inflate at a level less than full deployment. For more severe frontal impacts, full deployment occurs.

If the front of your vehicle goes straight into a wall that does not move or deform, the threshold level for the reduced deployment is about 12 to 16 mph (19 to 26 km/h), and the threshold level for a full deployment is about 18 to 24 mph (29 to 38.5 km/h). (The threshold level can vary, however, with specific vehicle design, so that it can be somewhat above or below this range.)

Airbags may inflate at different crash speeds. For example:

- If the vehicle hits a stationary object, the airbag could inflate at a different crash speed than if the object were moving.
- If the object deforms, the airbag could inflate at a different crash speed than if the object does not deform.
- If the vehicle hits a narrow object (like a pole) the airbag could inflate at a different crash speed than if the vehicle hits a wide object (like a wall).
- If the vehicle goes into an object at an angle the airbag could inflate at a different crash speed than if the vehicle goes straight into the object.

The frontal airbags (driver and right front passenger) are not intended to inflate during vehicle rollovers, rear impacts, or in many side impacts because inflation would not likely help the occupants.

The side impact airbags are designed to inflate in moderate to severe side crashes. A side impact airbag will inflate if the crash severity is above the system's designed "threshold level." The threshold level can vary with specific vehicle design. Side impact airbags are not designed to inflate in frontal or near-frontal impacts, rollovers or rear impacts, because inflation would not likely help the occupant. A side impact airbag will only deploy on the side of the vehicle that is struck.

In any particular crash, no one can say whether an airbag should have inflated simply because of the damage to a vehicle or because of what the repair costs were. For frontal airbags, inflation is determined by the angle of the impact and how quickly the vehicle slows down in frontal and near-frontal impacts. For side impact airbags, inflation is determined by the location and severity of the impact.

What Makes an Airbag Inflate?

In an impact of sufficient severity, the airbag sensing system detects that the vehicle is in a crash. For both frontal and side impact airbags, the sensing system triggers a release of gas from the inflator, which inflates the airbag. The inflator, airbag and related hardware are all part of the airbag modules inside the steering wheel, instrument panel, the side of the front seatbacks closest to the door and the ceiling of the vehicle, near the side windows.

How Does an Airbag Restrain?

In moderate to severe frontal or near frontal collisions, even belted occupants can contact the steering wheel or the instrument panel. In moderate to severe side collisions, even belted occupants can contact the inside of the vehicle. The airbag supplements the protection provided by safety belts. Airbags distribute the force of the impact more evenly over the occupant's upper body, stopping the occupant more gradually. But the frontal airbags would not help you in many types of collisions, including rollovers, rear impacts, and many side impacts, primarily because an occupant's motion is not toward the airbag. Side impact airbags would not help you in many types of collisions, including frontal or near frontal collisions, rollovers, and rear impacts, primarily because an occupant's motion is not toward those airbags. Airbags should never be regarded as anything more than a supplement to safety belts, and then only in moderate to severe frontal or near-frontal collisions for the driver's and right front passenger's frontal airbags, and only in moderate to severe side collisions for the side impact airbags.

What Will You See After an Airbag Inflates?

After the airbag inflates, it quickly deflates, so quickly that some people may not even realize the airbag inflated. Some components of the airbag module — the steering wheel hub for the driver's airbag, the instrument panel for the right front passenger's bag, the side of the seatback closest to the door for the seat-mounted side impact airbags and the area along the ceiling of your vehicle near the side windows — will be hot for a short time. The parts of the bag that come into contact with you may be warm, but not too hot to touch. There will be some smoke and dust coming from the vents in the deflated airbags. Airbag inflation does not prevent the driver from seeing or being able to steer the vehicle, nor does it stop people from leaving the vehicle.

CAUTION:

When an airbag inflates, there is dust in the air. This dust could cause breathing problems for people with a history of asthma or other breathing trouble. To avoid this, everyone in the vehicle should get out as soon as it is safe to do so. If you have breathing problems but can not get out of the vehicle after an airbag inflates, then get fresh air by opening a window or a door. If you experience breathing problems following an airbag deployment, you should seek medical attention.

Your vehicle has a feature that will automatically unlock the doors and turn the interior lamps on when the airbags inflate (if battery power is available). You can lock the doors again and turn the interior lamps off by using the door lock and interior lamp controls. The hazard warning flashers will also come on when the airbags deploy. If you want to turn them off, press the hazard warning flasher button twice.

In many crashes severe enough to inflate the airbag, windshields are broken by vehicle deformation. Additional windshield breakage may also occur from the right front passenger airbag.

- Airbags are designed to inflate only once. After an airbag inflates, you will need some new parts for your airbag system. If you do not get them, the air bag system will not be there to help protect you in another crash. A new system will include airbag modules and possibly other parts. The service manual for your vehicle covers the need to replace other parts.
- Your vehicle is equipped with a crash sensing and diagnostic module which records information after a crash. See *Vehicle Data Collection and Event Data Recorders* on page 7-10.
- Let only qualified technicians work on your airbag systems. Improper service can mean that an airbag system will not work properly. See your dealer for service.

Notice: If you damage the covering for the driver's or the right front passenger's airbag, or the airbag covering on the driver's and right front passenger's seatback, or the side impact airbag covering on the ceiling near the side windows, the bag may not work properly. You may have to replace the airbag module in the steering wheel, both the airbag module and the instrument panel for the right front passenger's airbag, the airbag module and seatback for the driver's and right front passenger's seat-mounted side impact airbags, or side impact airbag module and ceiling covering for the roof-mounted side impact airbag. Do not open or break the airbag coverings.

Servicing Your Airbag-Equipped Vehicle

Airbags affect how your vehicle should be serviced. There are parts of the airbag system in several places around your vehicle. Your dealer and the service manual have information about servicing your vehicle and the airbag system. To purchase a service manual, see *Service Publications Ordering Information on page 7-12*.

CAUTION:

For up to 10 seconds after the ignition key is turned off and the battery is disconnected, an airbag can still inflate during improper service. You can be injured if you are too close to an airbag when it inflates. Avoid wires wrapped with yellow tape, yellow coverings or yellow connectors. They are probably part of the airbag systems. Be sure to follow proper service procedures, and make sure the person performing work for you is qualified to do so.

The airbag system does not need regular maintenance.

Restraint System Check

Checking Your Restraint Systems

Now and then, make sure the safety belt reminder light and all your belts, buckles, latch plates, retractors and anchorages are working properly. Look for any other loose or damaged safety belt system parts. If you see anything that might keep a safety belt system from doing its job, have it repaired.

Torn or frayed safety belts may not protect you in a crash. They can rip apart under impact forces. If a belt is torn or frayed, get a new one right away.

Also look for any opened or broken airbag covers, and have them repaired or replaced. (The airbag system does not need regular maintenance.)

Replacing Restraint System Parts After a Crash

CAUTION:

A crash can damage the restraint systems in your vehicle. A damaged restraint system may not properly protect the person using it, resulting in serious injury or even death in a crash. To help make sure your restraint systems are working properly after a crash, have them inspected and any necessary replacements made as soon as possible.

If you have had a crash, do you need new belts or LATCH system parts?

After a very minor collision, nothing may be necessary. But if the belts were stretched, as they would be if worn during a more severe crash, then you need new parts.

If the LATCH system was being used during a more severe crash, you may need new LATCH system parts.

If belts are cut or damaged, replace them. Collision damage also may mean you will need to have LATCH system, safety belt or seat parts repaired or replaced. New parts and repairs may be necessary even if the belt or LATCH system was not being used at the time of the collision.

If an airbag inflates, you will need to replace airbag system parts. See the part on the airbag system earlier in this section.

If the frontal airbags inflate, you will also need to replace the driver's and right front passenger's safety belt buckle assembly. Be sure to do so. Then the new buckle assembly will be there to help protect you in a collision.

After a crash you may need to replace the driver and front passenger's safety belt buckle assemblies, even if the frontal airbags have not deployed. The driver and front passenger's safety belt buckle assemblies contain the safety belt pretensioners. Have your safety belt pretensioners checked if your vehicle has been in a collision, or if your airbag readiness light stays on after you start your vehicle or while you are driving. See *Airbag Readiness Light on page 3-37*.

Section 2 Features and Controls

Keys	2-3	Starting Your Engine	2-23
Remote Keyless Entry System	2-5	Adjustable Throttle and Brake Pedal	2-23
Remote Keyless Entry System Operation	2-6	Engine Coolant Heater	2-24
Doors and Locks	2-8	Automatic Transmission Operation	2-25
Door Locks	2-8	All-Wheel Drive	2-28
Central Door Unlocking System	2-9	Parking Brake	2-28
Power Door Locks	2-9	Shifting Into Park (P)	2-30
Delayed Locking	2-9	Shifting Out of Park (P)	2-32
Programmable Automatic Door Locks	2-10	Parking Over Things That Burn	2-33
Rear Door Security Locks	2-10	Engine Exhaust	2-33
Lockout Protection	2-11	Running Your Engine While You Are Parked	2-34
Liftgate	2-12	Mirrors	2-35
Windows	2-13	Automatic Dimming Rearview Mirror	
Power Windows	2-14	with OnStar [®]	2-35
Sun Visors	2-16	Automatic Dimming Rearview Mirror	
Theft-Deterrent Systems	2-17	with OnStar [®] and Compass	2-35
Theft-Deterrent System	2-17	Outside Power Heated Mirrors	2-38
Immobilizer	2-18	Outside Automatic Dimming Mirror	2-39
Immobilizer Operation	2-19	Outside Curb View Assist Mirror	2-39
Starting and Operating Your Vehicle	2-20	Outside Convex Mirror	2-39
New Vehicle Break-In	2-20	OnStar[®] System	2-40
Ignition Positions	2-21	HomeLink[®] Transmitter	2-42
Retained Accessory Power (RAP)	2-22	Programming the HomeLink [®] Transmitter	2-43

Section 2 Features and Controls

Storage Areas	2-47	Convenience Net	2-49
Glove Box	2-47	Cargo Cover	2-49
Cupholder(s)	2-47	Cargo Management System	2-49
Cell Phone Storage Area	2-47	Sunroof	2-50
Front Storage Area	2-47	Sunroof (UltraView)	2-50
Center Console Storage Area	2-47	Sunroof (UltraView Plus)	2-51
Map Pocket	2-47	Vehicle Personalization	2-53
Assist Handles	2-47	Memory Seat and Mirrors	2-53
Luggage Carrier	2-48		

Keys

CAUTION:

Leaving children in a vehicle with the ignition key is dangerous for many reasons. They could operate the power windows or other controls or even make the vehicle move. The children or others could be badly injured or even killed. Do not leave the keys in a vehicle with children.



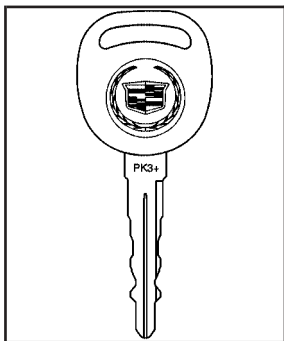

One key works all of the lock cylinders on the vehicle.

Your vehicle has an Immobilizer Vehicle Theft-Deterrent System. The key has a transponder in the key head that matches a decoder in the vehicle's steering column.

If a replacement key or any additional key is needed, you must purchase it from your dealer. The key will have PK3+ stamped on it. Keep the bar code tag that came with the original keys. Give this tag to your dealer if you need a new key made. For more information on Immobilizer see *Immobilizer Operation on page 2-19*.

Notice: If you ever lock your keys in your vehicle, you may have to damage the vehicle to get in. Be sure you have spare keys.

In an emergency, contact Cadillac Roadside Assistance. See *Roadside Service on page 7-6*.

If your vehicle is equipped with the OnStar system with an active subscription and you lock your keys inside the vehicle, OnStar may be able to send a command to unlock your vehicle. See *OnStar® System on page 2-40* for more information.

Remote Keyless Entry System

Your keyless entry system operates on a radio frequency subject to Federal Communications Commission (FCC) Rules and with Industry Canada.

This device complies with Part 15 of the FCC Rules. Operation is subject to the following two conditions:

1. This device may not cause interference, and
2. This device must accept any interference received, including interference that may cause undesired operation of the device.

This device complies with RSS-210 of Industry Canada. Operation is subject to the following two conditions:

1. This device may not cause interference, and
2. This device must accept any interference received, including interference that may cause undesired operation of the device.

Changes or modifications to this system by other than an authorized service facility could void authorization to use this equipment.

At times you may notice a decrease in range. This is normal for any remote keyless entry system. If the transmitter does not work or if you have to stand closer to your vehicle for the transmitter to work, try this:

- Check the distance. You may be too far from your vehicle. You may need to stand closer during rainy or snowy weather.
- Check the location. Other vehicles or objects may be blocking the signal. Take a few steps to the left or right, hold the transmitter higher, and try again.
- Check to determine if battery replacement is necessary. See “Battery Replacement” under *Remote Keyless Entry System Operation on page 2-6*.
- If you are still having trouble, see your dealer or a qualified technician for service.

Remote Keyless Entry System Operation

With this feature, you can lock and unlock the doors or the liftgate and turn on your vehicle's interior lamps from about 10 feet (3 m) away using the remote keyless entry transmitter supplied with your vehicle.

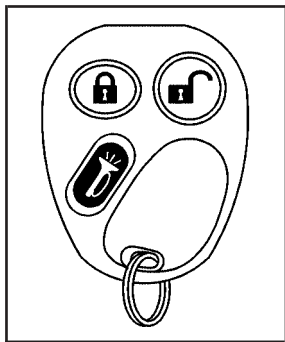

🔒 (Lock): Press this symbol on the remote keyless entry transmitter to lock the doors. This also arms the theft-deterrent system.

You can program your vehicle so that the exterior lamps will flash and/or the horn will sound when you lock the doors with the remote keyless entry transmitter. See *DIC Vehicle Personalization on page 3-66* for more information on programming this feature.

If your vehicle is programmed for remote confirmation, the doors must be closed for this feature to work. If a door is open, remote confirmation will be canceled.

🔓 (Unlock): Press this symbol on the remote keyless entry transmitter to unlock the driver's door. This also disarms the theft-deterrent system. Press the button again to unlock the rest of the doors.

You can program your vehicle so that the exterior lamps will flash when you unlock the doors with the remote keyless entry transmitter. See *DIC Vehicle Personalization on page 3-66* for more information on programming this feature.

If your vehicle is programmed for remote confirmation, the doors must be closed for this feature to work. If a door is open, remote confirmation will be canceled.

🔊 (Panic Alarm): The remote keyless entry transmitter comes equipped with an instant panic alarm. Press the horn symbol when the ignition is turned off. The horn will sound and the exterior lamps will flash for up to 30 seconds. To stop the instant panic alarm, press the symbol again or turn the ignition to ON.

The remote keyless entry transmitter can be used to recall the memory settings for up to two drivers. For more information, see *DIC Vehicle Personalization on page 3-66* and *Memory Seat and Mirrors on page 2-53*.

Matching Transmitter(s) to Your Vehicle

Each remote keyless entry transmitter is coded to prevent another transmitter from unlocking your vehicle. If a transmitter is lost or stolen, a replacement can be purchased through your dealer. Remember to bring any remaining transmitters with you when you go to your dealer. When the dealer matches the replacement transmitter to your vehicle, any remaining transmitters must also be matched. Once your dealer has coded the new transmitter, the lost transmitter will not unlock your vehicle. Each vehicle can have a maximum of four transmitters matched to it.

Battery Replacement

Under normal use, the battery in your remote keyless entry transmitter should last about four years.

You can tell the battery is weak if the transmitter won't work at the normal range in any location. If you have to get close to your vehicle before the transmitter works, it's probably time to change the battery.

Notice: When replacing the battery, use care not to touch any of the circuitry. Static from your body transferred to these surfaces may damage the transmitter.



1. Use a flat thin object to pry open the transmitter.
2. Once the transmitter is separated, use a pencil or similar object to remove the old battery. Do not use a metal object.
3. Insert the new battery as the instructions under the cover indicate.
4. Snap the transmitter back together tightly to be sure no moisture can enter.
5. Press any button on the remote keyless entry transmitter to resynchronize the transmitter.
6. Check the operation of the transmitter.

Doors and Locks

Door Locks

CAUTION:

Unlocked doors can be dangerous.

- Passengers — especially children — can easily open the doors and fall out of a moving vehicle. When a door is locked, the handle will not open it. You increase the chance of being thrown out of the vehicle in a crash if the doors are not locked. So, wear safety belts properly and lock the doors whenever you drive.
- Young children who get into unlocked vehicles may be unable to get out. A child can be overcome by extreme heat and can suffer permanent injuries or even death from heat stroke. Always lock your vehicle whenever you leave it.
- Outsiders can easily enter through an unlocked door when you slow down or stop your vehicle. Locking your doors can help prevent this from happening.

There are several ways to lock and unlock your vehicle.

Because your vehicle has the theft-deterrent system, you must unlock the doors from the outside with the key or remote keyless entry transmitter to avoid setting off the alarm. If the windows are down and the doors are locked, don't reach in to manually unlock the vehicle because you will set off the alarm.



From the inside, use the manual lock levers located on the door panels near the windows.

Push down on the manual lock lever to lock the door. To unlock the door, pull up on the lever.

Central Door Unlocking System

Your vehicle has a central door unlocking feature. When unlocking the driver's door, you can unlock the other doors by holding the key in the turned position for a few seconds or by quickly turning the key twice in the lock cylinder.

Power Door Locks



The power door lock switches are located on the front doors.

Press the bottom part of the power door lock switch to lock or the top of the switch to unlock all the doors at once.

The rear doors do not have power door lock switches. You must use the manual levers to lock and unlock the rear doors when riding in the rear seat.

Delayed Locking

With this feature, you can delay the actual locking of the doors.

When the power door lock switch or the lock button on the remote keyless entry transmitter is pressed when the key is not in the ignition and the driver's door is opened, a chime will sound three times indicating that delayed locking is active.

When all the doors are closed, the doors will lock automatically after five seconds. If a door is reopened before five seconds have elapsed, the five second timer will reset itself once all the doors are closed again.

You can press the door lock switch or the lock button on the remote keyless entry transmitter again to override this feature and lock the doors immediately.

You can turn this feature off using the Driver Information Center (DIC). When delayed locking is off, the doors will lock immediately when you press the power door lock switch or the lock button on the remote keyless entry transmitter. See *DIC Vehicle Personalization on page 3-66* for more information.

Programmable Automatic Door Locks

Your vehicle is programmed so that when the doors are closed, the ignition is on and the shift lever is moved out of PARK (P), all the doors will lock. The front door inside handles will remain active. The doors will unlock every time you stop the vehicle and move the shift lever back into PARK (P).

If someone needs to exit the vehicle once the doors are locked, have that person use the manual lever or power door lock switch for the rear doors. The front doors will remain unlocked from inside the vehicle. When the door is closed again, it will not lock automatically. Use the manual lever or the power door lock switch to lock the door.

The power door locks can be programmed through prompts displayed on the Driver Information Center (DIC). These prompts allow you to choose various lock and unlock settings. For more information on programming, see *DIC Vehicle Personalization* on page 3-66.

Rear Door Security Locks

Your vehicle is equipped with rear door security locks that prevent passengers from opening the rear doors on your vehicle from the inside.

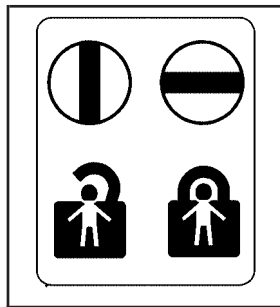

The rear door security locks are located on the inside edge of each rear door. You must open the rear doors to access them.

To use these locks, do the following:

1. Insert your key into the slot next to the rear door security lock label and turn it to engage the lock.
2. Close the door.
3. Repeat the steps for the other rear door.

The rear doors on your vehicle cannot be opened from the inside when this feature is in use.

When you want to open a rear door when the security lock is on, do the following:

1. Unlock the door using the remote keyless entry transmitter, the front door power lock switch or by lifting the rear door manual lock.
2. Then open the door from the outside.

To cancel the rear door security lock, do the following:

1. Unlock the door and open it from the outside.
2. Insert your key into the slot next to the rear door security lock label and turn it to disengage the lock.
3. Repeat the steps for the other lock.

The rear door locks will now work normally.

Lockout Protection

If you press the power door lock switch when the key is in the ignition and any door is open, all the doors will lock and only the driver's door will unlock. If you close the doors, you can lock them using the remote keyless entry transmitter. Be sure to remove the key from the ignition when locking your vehicle.

This feature can be overridden by pressing the lock button on the remote keyless entry transmitter or by pressing the power lock switch a second time.

Liftgate

To unlock the liftgate from the outside, turn the key in the driver's door cylinder counterclockwise or use the remote keyless entry transmitter. To lock the liftgate using the key, turn the key clockwise in the driver's door.

Open the liftgate using the handle located below the license plate. Once slightly opened, the liftgate will rise by itself.

CAUTION:

It can be dangerous to drive with the liftgate open because carbon monoxide (CO) gas can come into your vehicle. You can not see or smell CO. It can cause unconsciousness and even death. If you must drive with the liftgate open or if electrical wiring or other cable connections must pass through the seal between the body and the liftgate:

- **Make sure all other windows are shut.**
- **Turn the fan on your heating or cooling system to its highest speed and select the control setting that will force outside air into your vehicle. See *Dual Climate Control System* on page 3-25.**
- **If you have air outlets on or under the instrument panel, open them all the way. See *Engine Exhaust* on page 2-33.**

To close the liftgate, pull down on the handle, then firmly shut the liftgate. Don't drive with the liftgate open, even slightly. See *Engine Exhaust* on page 2-33.

Windows

CAUTION:

Leaving children, helpless adults, or pets in a vehicle with the windows closed is dangerous. They can be overcome by the extreme heat and suffer permanent injuries or even death from heat stroke. Never leave a child, a helpless adult, or a pet alone in a vehicle, especially with the windows closed in warm or hot weather.



Power Windows



The power window switches are located on the armrest near each window. Press the up or down arrows on the switches to raise or lower the windows.

Your vehicle has Retained Accessory Power (RAP) that allows you to use the power windows once the ignition has been turned off for up to 10 minutes. See *Retained Accessory Power (RAP)* on page 2-22.

Express-Down Window

This feature is on all the power windows. Press the down arrow on the switch to the second position to activate the express-down feature. If you want to stop the window as it is lowering, press the down arrow on the switch again.

Express-Up Window

This feature is on both front power windows. Press the up arrow on the switch to the second position to activate the express-up feature. If you want to stop the window as it is raising, press the up arrow on the switch again.

Programming the Power Windows

If the battery on your vehicle has been recharged, disconnected or is not working, you will need to reprogram each front power window for the express-up feature to work. Before reprogramming, you will need to replace or recharge your vehicle's battery.

To program each front window, follow these steps:

1. With the ignition in ACCESSORY, ON or when Retained Accessory Power (RAP) is active, close all doors.
2. Press and hold the down arrow on the power window switch until the window has fully opened.
3. Press the up arrow on the power window switch until the window is fully closed.
4. Continue holding the up arrow on the switch for approximately two seconds after the window is completely closed.

The window is now reprogrammed. Repeat the process for the other front window.

Anti-Pinch Feature

If any object is in the path of the window when the express-up is active, the window will stop at the obstruction and auto-reverse to a preset factory position. Weather conditions such as severe icing may also cause the window to auto-reverse. The window will return to normal operation once the obstruction or condition is removed.

CAUTION:

If express override is activated, the window will not reverse automatically. You or others could be injured and the window could be damaged. Before you use express override, make sure that all people and obstructions are clear of the window path.

Express Window Override

A condition may exist that causes auto-reversal of the window due to weather or an obstruction. In an emergency, the anti-pinch feature can be overridden in a supervised mode. Hold the window switch all the way down in the express position. The window will rise for as long as the switch is held. Once the switch is released, the express mode is re-activated.

In this mode, the window can still close on an object in its path. Use care when using the override mode.

Window Lockout

This feature allows you to disable the passenger window switches.



The passenger window lockout button is located below the power window switches on the driver's door armrest.

Press the button to disable the passenger window controls. The light on the button will illuminate, indicating that the feature is in use. The passenger windows still can be raised or lowered using the driver's window switches when the lockout feature is active.

To restore power to the passenger windows, press the button again. The light on the button will go out.

You can program this feature to disable all passenger windows or only the rear passenger windows. See *DIC Vehicle Personalization on page 3-66* for more information.

Sun Visors

Swing down the primary visor to block out glare. It can also be detached from the center mount and moved to the side to block glare from that direction.

The driver's sunshade may also have buttons for a built-in garage door opener. See *HomeLink® Transmitter on page 2-42* for more information.

Lighted Visor Vanity Mirror

Pull the visor down and lift the cover. The light will automatically come on. The light will go out when you close the cover.

Theft-Deterrent Systems

Vehicle theft is big business, especially in some cities. Although your vehicle has a number of theft-deterrent features, we know that nothing we put on it can make it impossible to steal.

Theft-Deterrent System

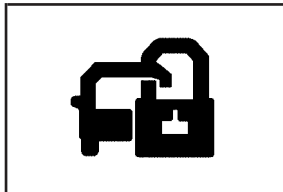

The security light is located on the instrument panel cluster.

If the ignition is off and a door is open, the security light will flash, reminding you to arm the theft-deterrent system.

To arm the system, do the following:

1. Lock the door using the remote keyless entry transmitter or the power door lock switch.
2. Close all the doors. The security light will illuminate. It should go off within approximately 30 seconds.

If a door or a liftgate is opened without a key or a remote keyless entry transmitter, the horn will sound and the lamps will flash for up to 30 seconds.

The theft-deterrent system will not arm if you lock the doors with a key, use the manual door lock or if the liftgate is ajar. It activates only if you use the remote keyless entry transmitter or the power door lock.

To avoid activating the alarm by accident do the following:

- The vehicle should be locked with the door key or the manual door lock after the doors are closed if you don't want to arm the theft-deterrent system.
- Always unlock a door with a key or use the remote keyless entry transmitter. Pressing the unlock button on the remote keyless entry transmitter disarms the theft-deterrent system. Unlocking a door any other way while the system is armed will activate the alarm when a door or the liftgate is opened.

If you activate the alarm by accident, unlock the driver's door with your key. You can also turn off the alarm by using the unlock button on the remote keyless entry transmitter, or by starting the vehicle with a valid key.

Testing the Alarm

1. From inside the vehicle, roll down the window, then get out of the vehicle, keeping the door open.
2. From outside of the vehicle, with the door open, lock the vehicle using the power door lock switch or the remote keyless entry transmitter and close the door. Wait approximately 30 seconds until the security light goes off.
3. Reach in and unlock the door using the manual lock and open the door. The horn will sound and the exterior lamps will flash.

You can turn off the alarm by unlocking the driver's door with your key, using the unlock button on the remote keyless entry transmitter or by starting the car with a valid key.

If the alarm does not sound when it should, check to see if the horn works. The horn fuse may be blown. To replace the fuse, see *Fuses and Circuit Breakers on page 5-93*. If the fuse does not need to be replaced, you may need to have your vehicle serviced.

To reduce the possibility of theft, always arm the theft-deterrent system when leaving your vehicle.

Immobilizer

This device complies with Part 15 of the FCC Rules. Operation is subject to the following two conditions:

1. This device may not cause interference, and
2. This device must accept any interference received, including interference that may cause undesired operation.

This device complies with RSS-210 of Industry Canada. Operation is subject to the following two conditions:

1. This device may not cause interference, and
2. This device must accept any interference received, including interference that may cause undesired operation of the device.

Changes or modifications to this system by other than an authorized service facility could void authorization to use this equipment.

Immobilizer Operation

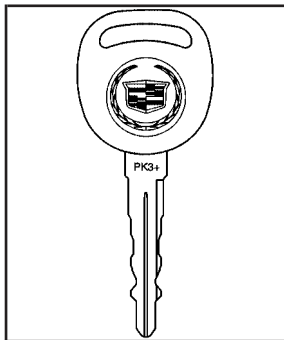

Your vehicle is equipped with a passive theft-deterrent system.

The system works when you turn the key to ON. The key uses a transponder that matches an immobilizer control unit in your vehicle. The correct key will start the vehicle. If the key is ever damaged, you may not be able to start your vehicle.

When trying to start the vehicle, if the engine does not start and the security light comes on, the key may have a damaged transponder. Turn the ignition off and try again.

If the engine still does not start, and the key appears to be undamaged, try another ignition key. At this time, you may also want to check the fuse. See *Fuses and Circuit Breakers on page 5-93*. If the engine still does not start with the other key, your vehicle needs service. If your vehicle does start, the first key may be faulty. See your dealer who can service the theft-deterrent system to have a new key made.

It is possible for the theft-deterrent system decoder to learn the transponder value of a new or replacement key. Up to 10 additional keys may be programmed for the vehicle. This procedure is for learning additional keys only.

Canadian Owners: If you lose or damage your keys, only a GM dealer can service the theft-deterrent system to have new keys made. To program additional keys you will require two current driver's keys. You must add a step to the following procedure. After Step 2, repeat Steps 1 and 2 with the second current driver's key. Then continue with Step 3.

To program a new key do the following:

1. Verify that the new key has PK3+ stamped on it.
2. Insert the current driver's key in the ignition and start the engine. If the engine will not start see your dealer for service.
3. After the engine has started, turn the key to OFF, and remove the key.
4. Insert the key to be programmed and turn it to ON within ten seconds of removing the previous key.
5. The security light will turn off once the key has been programmed. It may not be apparent that the security light went on due to how quickly the key is programmed.
6. Repeat the Steps 1 through 4 if additional keys are to be programmed.

If you are ever driving and the security light comes on and stays on, you will be able to restart your engine if you turn it off. The theft-deterrent system, however, is not working properly and must be serviced by your dealer. Your vehicle is not protected by the theft-deterrent system at this time.

In an emergency, contact Cadillac Roadside Assistance. See *Roadside Service* on page 7-6.

Starting and Operating Your Vehicle

New Vehicle Break-In

Notice: Your vehicle does not need an elaborate “break-in.” But it will perform better in the long run if you follow these guidelines for the first 500 miles (805 km):

- Do not drive at any one speed — fast or slow.
- Do not exceed 70 mph (113 km/h).
- Do not make full-throttle starts; also refrain from using the full throttle while driving.

If these procedures are not followed, your engine, axle or other parts could be damaged.

Avoid making hard stops for the first 200 miles (322 km) or so. During this time your new brake linings are not yet broken in. Hard stops with new linings can mean premature wear and earlier replacement. Follow this break-in guideline every time you get new linings.

Do not tow a trailer during break-in. See *Towing a Trailer* on page 4-52 for more information.

Ignition Positions

With the key in the ignition switch, you can turn the key to four different positions.

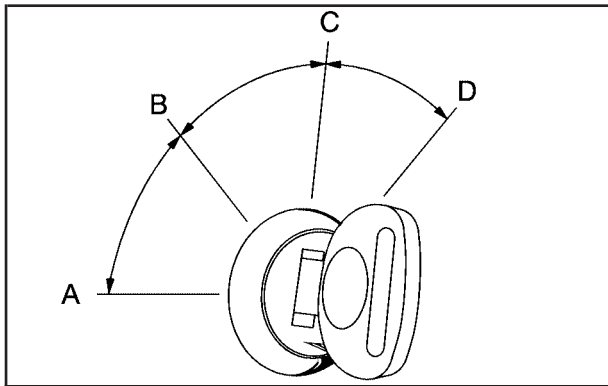

Notice: If your key seems stuck in OFF and you can't turn it, be sure you are using the correct key; if so, is it all the way in? If it is, then turn the steering wheel left and right while you turn the key hard. Turn the key only with your hand. Using a tool to force it could break the key or the ignition switch. If none of these works, then your vehicle needs service.

A (OFF): This is the only position in which you can insert or remove the key. This position locks the ignition, steering wheel and transmission. It is a theft-deterrent feature.

B (ACCESSORY): This position allows you to use things like the radio and the windshield wipers when the engine is off. This position will allow you to turn off the engine, but still turn the steering wheel.

C (ON): This position is for driving. If your vehicle has an automatic transmission and you turn off the engine, the transmission will lock. If you need to shift the transmission out of PARK (P), the ignition key has to be in ON.

D (START): This position starts the engine.

Steering Column Ignition Lock Release

If your vehicle has a dead battery or a battery with low voltage, you can still release the ignition lock and remove the key. Use the following procedure to release the steering column:

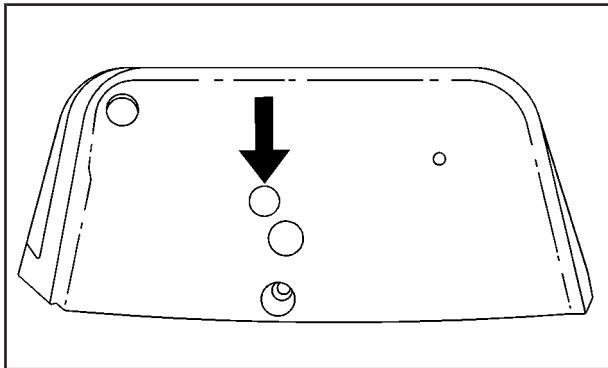

1. Locate the plastic screw head on the underside of the plastic cover for the steering column.
2. Insert a flat, thin object into the slot and turn it until the plastic piece detaches from the steering column cover.

3. Insert a narrow, pointed object into the hole in the steering column cover and press the spring.
4. Then, turn the ignition switch to OFF and remove the key.

Retained Accessory Power (RAP)

The following accessories on your vehicle may be used for up to 10 minutes after the ignition key is turned from ON to OFF:

- Radio
- Power Windows
- Audio Steering Wheel Controls (if programmed)
- Sunroof

Power to these accessories stops after 10 minutes or if a door is opened. If you want power for another 10 minutes, close all the doors and turn the ignition key to ON and then back to OFF.

Starting Your Engine

Move your shift lever to PARK (P) or NEUTRAL (N). Your engine will not start in any other position — that is a safety feature. To restart when you are already moving, use NEUTRAL (N) only.

Notice: Do not try to shift to PARK (P) if your vehicle is moving. If you do, you could damage the transmission. Shift to PARK (P) only when your vehicle is stopped.

1. With your foot off the accelerator pedal, turn your ignition key to START. Then, let go of the key; the engine will start automatically. The idle speed will go down as your engine gets warm.
2. If your engine will not start, or starts but then stops, it could be flooded with too much gasoline. Try pushing your accelerator pedal all the way to the floor and holding it there as you turn the key to START. If the vehicle starts briefly but then stops again, do the same thing.

Notice: Your engine is designed to work with the electronics in your vehicle. If you add electrical parts or accessories, you could change the way the engine operates. Before adding electrical equipment, check with your dealer. If you do not, your engine might not perform properly.

Adjustable Throttle and Brake Pedal

If your vehicle is equipped with this feature, you can change the position of the throttle and brake pedals.

The vehicle must be in PARK (P) for this feature to operate.

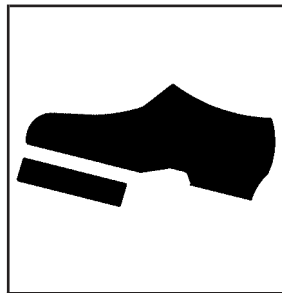

The switch used to adjust the pedals is located on the side of the steering column.

Move the switch rearward to move the pedals closer to your body. Move the switch forward to move the pedals away from your body.

Engine Coolant Heater

Your vehicle may be equipped with an engine coolant heater.

In very cold weather, 0°F (-18°C) or colder, the engine coolant heater can help. You will get easier starting and better fuel economy during engine warm-up. Usually, the coolant heater should be plugged in a minimum of four hours prior to starting your vehicle. At temperatures above 32°F (0°C), use of the coolant heater is not required.

To Use the Engine Coolant Heater

1. Turn off the engine.
2. Open the hood and unwrap the electrical cord. The cord is located in the engine compartment on the driver's side of the vehicle near the engine oil dipstick. See *Engine Compartment Overview* on page 5-12 for more information on location. You must remove the plastic cap to access the plug.

3. Plug it into a normal, grounded 110-volt AC outlet.

CAUTION:

Plugging the cord into an ungrounded outlet could cause an electrical shock. Also, the wrong kind of extension cord could overheat and cause a fire. You could be seriously injured. Plug the cord into a properly grounded three-prong 110-volt AC outlet. If the cord will not reach, use a heavy-duty three-prong extension cord rated for at least 15 amps.

4. Before starting the engine, be sure to unplug and store the cord as it was before to keep it away from moving engine parts. If you do not, it could be damaged.

How long should you keep the coolant heater plugged in? The answer depends on the outside temperature, the kind of oil you have, and some other things. Instead of trying to list everything here, we ask that you contact your dealer in the area where you will be parking your vehicle. The dealer can give you the best advice for that particular area.

Automatic Transmission Operation

The shift lever is located on the center console between the front seats.

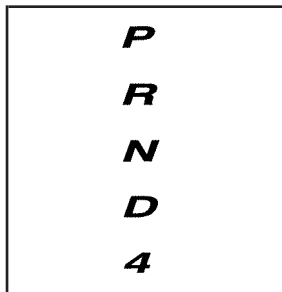

There are several different positions for the shift lever.

PARK (P): This position locks the rear wheels. It is the best position to use when you start the engine because your vehicle cannot move easily.

CAUTION:

It is dangerous to get out of your vehicle if the shift lever is not fully in PARK (P) with the parking brake firmly set. Your vehicle can roll.

Do not leave your vehicle when the engine is running unless you have to. If you have left the engine running, the vehicle can move suddenly. You or others could be injured. To be sure your vehicle will not move, even when you are on fairly level ground, always set your parking brake and move the shift lever to PARK (P). See *Shifting Into Park (P)* on page 2-30. If you are pulling a trailer, see *Towing a Trailer* on page 4-52.

Ensure the shift lever is fully in PARK (P) before starting the engine. Your vehicle has an automatic transmission shift lock control system. You must fully apply your regular brakes before you can shift from PARK (P) when the ignition key is in ON. If you cannot shift out of PARK (P), ease pressure on the shift lever. Push the shift lever all the way into PARK (P) while pressing the button on the shift lever as you maintain brake application. Then move the shift lever into the gear you wish. See *Shifting Out of Park (P)* on page 2-32.

Notice: Shifting to REVERSE (R) while your vehicle is moving forward could damage the transmission. The repairs would not be covered by your warranty. Shift to REVERSE (R) only after your vehicle is stopped.

REVERSE (R): Use this gear to back up.

At low vehicle speeds, you can also use REVERSE (R) to rock your vehicle back and forth to get out of snow, ice or sand without damaging your transmission. See *If You Are Stuck: In Sand, Mud, Ice or Snow* on page 4-44 for additional information.

NEUTRAL (N): In this position, the engine does not connect with the wheels. To restart when you are already moving, use NEUTRAL (N) only. You can also use NEUTRAL (N) when your vehicle is being towed.

 **CAUTION:**

Shifting into a drive gear while your engine is running at high speed is dangerous. Unless your foot is firmly on the brake pedal, your vehicle could move very rapidly. You could lose control and hit people or objects. Do not shift into a drive gear while your engine is running at high speed.

Notice: Shifting out of PARK (P) or NEUTRAL (N) with the engine running at high speed may damage the transmission. The repairs would not be covered by your warranty. Be sure the engine is not running at high speed when shifting your vehicle.

AUTOMATIC OVERDRIVE (D): This position is for normal driving. If you need more power for passing, and you are:

- Going less than 35 mph (55 km/h), push the accelerator pedal about halfway down.
- Going about 35 mph (55 km/h) or more, push the accelerator all the way down.

The transmission will shift down to a lower gear and have more power.

Notice: Spinning the tires or holding the vehicle in one place on a hill using only the accelerator pedal may damage the transmission. If you are stuck, do not spin the tires. When stopping on a hill, use the brakes to hold the vehicle in place.

FOURTH (4): This position is also used for normal driving. However, it offers more power and lower fuel economy than AUTOMATIC OVERDRIVE (D).

Here are examples for using FOURTH (4) instead of AUTOMATIC OVERDRIVE (D).

- When driving on hilly, winding roads.
- When going down a steep hill.

This position may also offer improved trailer towing performance in certain driving conditions.

Driver Shift Control (DSC)

Your automatic transmission has a Driver Shift Control (DSC) feature that allows you to change gears similar to a manual transmission. To use the DSC feature:

1. Slide the shift lever over from AUTOMATIC OVERDRIVE (D) to the right into the DSC area.

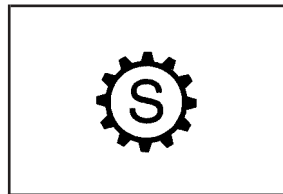

When the transmission is in DSC mode the sport mode light in the instrument panel cluster will come on.

If you do not move the shift lever forward or rearward, the vehicle will be in sport mode. While driving in sport mode, the transmission may remain in a gear longer than it would in normal driving mode based on braking, throttle input and vehicle lateral acceleration.

2. Press the shift lever forward to upshift or rearward to downshift.

The odometer on the instrument panel cluster will change to show the requested gear range when moving the shift lever forward or rearward.

While using the DSC feature the vehicle will have firmer shifting and increased performance. You can use this for sport driving or when climbing hills to stay in gear longer or to down shift for more power or engine braking.

The transmission will only allow you to shift into gears appropriate for the vehicle speed and rpm. The transmission will not automatically shift to the next higher gear if the engine rpm is too high.

All-Wheel Drive

If your vehicle is equipped with this feature, engine power is sent to all four wheels all the time.

This is like four-wheel drive, but it is fully automatic.

Parking Brake



The parking brake pedal is located on the lower portion of the instrument panel to the left of the steering wheel.

To set the parking brake, hold the regular brake pedal down with your right foot and push the parking brake pedal down with your left foot.

If the ignition is on, the brake system warning light on the instrument panel cluster should come on. If it does not, you need to have your vehicle serviced. See *Brake System Warning Light* on page 3-38 for more information.

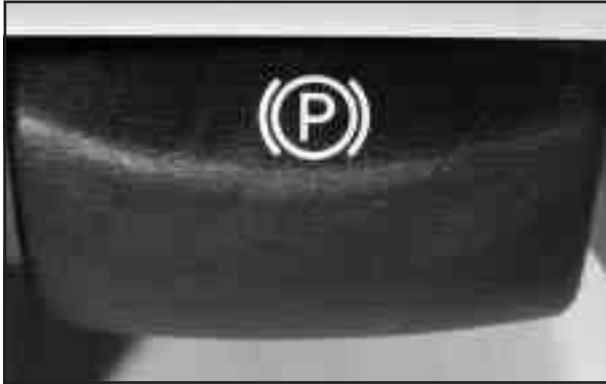

To release the parking brake, pull the release lever located to the left of the steering wheel on the instrument panel.

Notice: Driving with the parking brake on can overheat the brake system and cause premature wear or damage to brake system parts. Verify that the parking brake is fully released and the brake warning light is off before driving.

A warning chime will sound if the parking brake is set, the ignition is on and the vehicle begins to move. To stop the chime, fully release the parking brake.

If you are towing a trailer and parking on a hill, see *Towing a Trailer on page 4-52* for more information.

Shifting Into Park (P)

CAUTION:

It can be dangerous to get out of your vehicle if the shift lever is not fully in PARK (P) with the parking brake firmly set. Your vehicle can roll. If you have left the engine running, the vehicle can move suddenly. You or others could be injured. To be sure your vehicle will not move, even when you are on fairly level ground, use the steps that follow. If you are pulling a trailer, see *Towing a Trailer on page 4-52*.

To shift into PARK (P), use the following steps:

1. Hold the brake pedal down with your right foot.
2. Move the shift lever into PARK (P) by pressing the button on the front of the shift lever while pushing the lever all the way toward the front of the vehicle. Release the button.
3. With your right foot still holding the brake pedal down, set the parking brake with your left foot. See *Parking Brake on page 2-28* for more information.
4. Turn the key to OFF.
5. Remove the key from the ignition switch and take it with you. If you can leave your vehicle with the key in your hand, the vehicle is in PARK (P).

Leaving Your Vehicle With the Engine Running

CAUTION:

It can be dangerous to leave your vehicle with the engine running. Your vehicle could move suddenly if the shift lever is not fully in PARK (P) with the parking brake firmly set. And, if you leave the vehicle with the engine running, it could overheat and even catch fire. You or others could be injured. Do not leave your vehicle with the engine running.

If you have to leave your vehicle with the engine running, be sure your vehicle is in PARK (P) and your parking brake is firmly set before you leave it. After you have moved the shift lever into PARK (P), hold the regular brake pedal down. Then, see if you can move the shift lever away from PARK (P) without first pushing the button on the shift lever. If you can, it means that the shift lever was not fully locked into PARK (P).

Torque Lock

If you are parking on a hill and you do not shift your transmission into PARK (P) properly, the weight of the vehicle may put too much force on the parking pawl in the transmission. You may find it difficult to pull the shift lever out of PARK (P). This is called “torque lock.” To prevent torque lock, set the parking brake and then shift into PARK (P) properly before you leave the driver’s seat. To find out how, see “Shifting Into PARK (P)” listed previously.

If torque lock does occur, you may need to have another vehicle push yours a little uphill to take some of the pressure from the parking pawl in the transmission, so you can pull the shift lever out of PARK (P).

Shifting Out of Park (P)

Your vehicle has an automatic transmission shift lock control system. You have to fully apply your regular brakes before you can shift from PARK (P) when the ignition is in ON. See *Automatic Transmission Operation* on page 2-25 for more information.

If you cannot shift out of PARK (P), ease the pressure on the shift lever. Push the shift lever all the way into PARK (P) while pushing the button on the shift lever as you maintain brake application. Then move the shift lever into the gear you want. If you ever hold the pedal down but still cannot shift out of PARK (P), try the following:

1. Turn the ignition key to ACCESSORY. Open and close the driver's door to turn off the RAP feature.
2. Apply and hold the brake until the end of Step 4.
3. Shift to NEUTRAL (N).
4. Start the vehicle and then shift to the drive gear you want.
5. Have the vehicle fixed as soon as you can.

Shift Lock Release

If your vehicle has a dead battery or a battery with low voltage, you can still shift the vehicle into PARK (P) and remove the ignition key. Use the following procedure to release the shift lever:

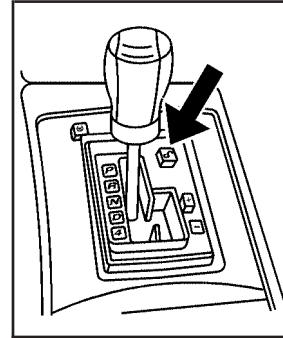

1. Use a tool to remove the cap with the lock symbol located next to the shift lever.

2. Using a narrow, pointed tool, press down on the mechanism under the cap so that you can move the shift lever.

Parking Over Things That Burn

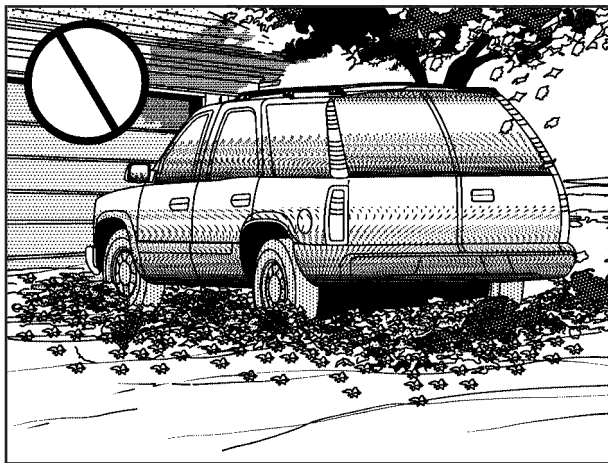

CAUTION:

Things that can burn could touch hot exhaust parts under your vehicle and ignite. Do not park over papers, leaves, dry grass or other things that can burn.

Engine Exhaust

CAUTION:

Engine exhaust can kill. It contains the gas carbon monoxide (CO), which you cannot see or smell. It can cause unconsciousness and death.

You might have exhaust coming in if:

- Your exhaust system sounds strange or different.
- Your vehicle gets rusty underneath.
- Your vehicle was damaged in a collision.
- Your vehicle was damaged when driving over high points on the road or over road debris.
- Repairs were not done correctly.
- Your vehicle or exhaust system had been modified improperly.

If you ever suspect exhaust is coming into your vehicle:

- Drive it only with all the windows down to blow out any CO; and
- Have your vehicle fixed immediately.

Running Your Engine While You Are Parked

It is better not to park with the engine running. But if you ever have to, here are some things to know.

CAUTION:

Idling the engine with the climate control system off could allow dangerous exhaust into your vehicle. See the earlier caution under *Engine Exhaust on page 2-33*.

Also, idling in a closed-in place can let deadly carbon monoxide (CO) into your vehicle even if the climate control fan is at the highest setting. One place this can happen is a garage. Exhaust — with CO — can come in easily. NEVER park in a garage with the engine running.

Another closed-in place can be a blizzard. See *Winter Driving on page 4-40*.

CAUTION:

It can be dangerous to get out of your vehicle if the shift lever is not fully in PARK (P) with the parking brake firmly set. Your vehicle can roll. Do not leave your vehicle when the engine is running unless you have to. If you have left the engine running, the vehicle can move suddenly. You or others could be injured. To be sure your vehicle will not move, even when you are on fairly level ground, always set your parking brake and move the shift lever to PARK (P).

Follow the proper steps to be sure your vehicle will not move. See *Shifting Into Park (P) on page 2-30*.

If you are pulling a trailer, see *Towing a Trailer on page 4-52*.

Mirrors

Automatic Dimming Rearview Mirror with OnStar®

The vehicle may have an automatic dimming inside rearview mirror with OnStar® controls. For more information about OnStar®, see *OnStar® System on page 2-40*.

 **(On/Off):** The on/off button, located on the lower left side of the mirror, is used for the automatic dimming functions of the rearview mirror.

Mirror Operation

The automatic dimming feature comes on each time the vehicle is started. Automatic dimming reduces the glare of lights from behind the vehicle.

To turn the automatic dimming feature on or off, press and release the on/off button. The indicator light will illuminate when this feature is on.

Cleaning the Mirror

When cleaning the mirror, use a paper towel or similar material dampened with glass cleaner. Do not spray glass cleaner directly on the mirror as that may cause the liquid cleaner to enter the mirror housing.

Automatic Dimming Rearview Mirror with OnStar® and Compass

The vehicle may have an automatic dimming inside rearview mirror with a compass and OnStar® controls. For more information about OnStar®, see *OnStar® System on page 2-40*.

The mirror has an eight-point compass display in the upper right corner of the mirror. When on, the compass automatically calibrates, or sets the driving direction, as the vehicle is driven. If the vehicle has the navigation option, the direction the vehicle is facing will be displayed on the navigation screen.

 **(On/Off):** The on/off button is located on the lower left side of the mirror and is used for the automatic dimming and compass functions of the rearview mirror.

Mirror Operation

The automatic dimming feature comes on each time the vehicle is started.

To turn the automatic dimming feature on or off, press the on/off button. The indicator light will illuminate when this feature is on.

Compass Operation

Press the on/off button once to turn the compass on or off.

When the ignition and the compass feature are on, the compass will show two character boxes for approximately two seconds. After two seconds, the mirror will display the current compass direction.

Compass Calibration

If after two seconds the display does not show a compass direction, (N for North for example), there may be a strong magnetic field interfering with the compass. Such interference may be caused by a magnetic antenna mount, note pad holder, or similar object. If the letter C appears in the compass window, the compass may need to be reset or calibrated.

The mirror can be calibrated by driving the vehicle in circles at 5 mph (8 km/h) or less until the display reads a direction.

The compass can be calibrated by pressing and holding the on/off button until a C is shown in the compass display.

Compass Variance

Compass variance is the difference between earth's magnetic north and true geographic north. If the mirror is not adjusted for compass variance, the compass could give false readings.

The mirror is set in zone eight upon leaving the factory. It will be necessary to adjust the compass to compensate for compass variance if the vehicle is driven outside zone eight. Under certain circumstances, such as a long distance, cross-country trip, it will be necessary to adjust the compass variance.

To adjust for compass variance, do the following:

1. Find your current location and variance zone number on the zone map that follows.

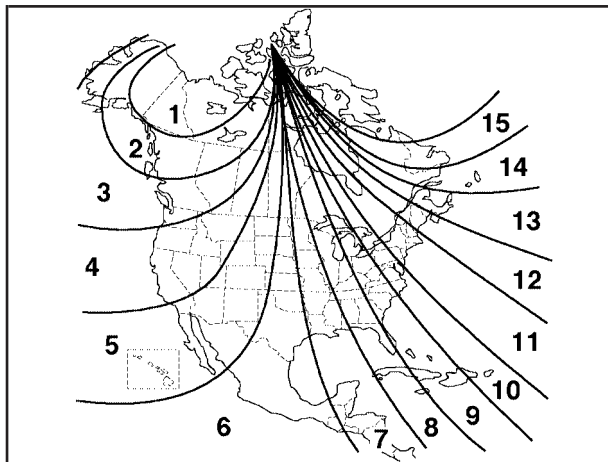

2. Press and hold the on/off button until a zone number appears on the display.
3. Once the zone number appears on the display, press the on/off button quickly until you reach the correct zone number. If C appears in the compass window, the compass may need calibration. See "Compass Calibration" listed previously.

Cleaning the Mirror

When cleaning the mirror, use a paper towel or similar material dampened with glass cleaner. Do not spray glass cleaner directly on the mirror as that may cause the liquid cleaner to enter the mirror housing.

Outside Power Heated Mirrors



The controls on the driver's door armrest operates both outside rearview mirrors.

Press the left or right mirror symbol on the selector control to choose the driver's side or passenger's side mirror. The center position is off and will not move the mirrors if the directional control pad is touched.

Once the mirror to be adjusted is selected, use the arrows on the directional control pad to move the mirror. Adjust each mirror so you can see the side of the vehicle and the area behind it.

The mirrors can be manually folded inward to prevent damage when going through an automatic car wash or a confined space. To fold, push the mirror toward the vehicle. To return the mirror to its original position, push outward. Be sure to return both mirrors to their original unfolded position before driving.

The preferred position can be stored in memory if the vehicle has the memory option. See *Memory Seat and Mirrors* on page 2-53 for more information.

When the rear window defogger is turned on, both outside rearview mirrors are heated to help clear them of ice, snow, and condensation. See "Rear Window Defogger" under *Dual Climate Control System* on page 3-25 for more information.

Outside Automatic Dimming Mirror

The driver's outside mirror may have an automatic dimming feature that helps to reduce glare from other vehicles headlamps. This feature is controlled by the on and off settings on the automatic dimming rearview mirror. See *Automatic Dimming Rearview Mirror with OnStar®* on page 2-35.

Outside Curb View Assist Mirror

If the vehicle has memory seat and mirrors, it will also be capable of adjusting the passenger's mirror to tilt to a preselected position when the vehicle is shifted into REVERSE (R). Use this feature to view the curb when parallel parking.

When the vehicle is shifted out of REVERSE (R) and after a five-second delay, the passenger's mirror will return to its original position.

If further adjustment is needed after the mirror is tilted, the mirror controls can be used. See *Outside Power Heated Mirrors* on page 2-38 for more information.

Outside Convex Mirror

CAUTION:

A convex mirror can make things (like other vehicles) look farther away than they really are. If you cut too sharply into the right lane, you could hit a vehicle on your right. Check your inside mirror or glance over your shoulder before changing lanes.

The passenger's side mirror is convex. A convex mirror's surface is curved so that more can be seen from the driver's seat. The mirror does not have a dimming feature.

OnStar® System

OnStar® uses global positioning system (GPS) satellite technology, wireless communications, and call centers to provide you with a wide range of safety, security, information, and convenience services.

A complete OnStar® user's guide and the terms and conditions of the OnStar® Subscription Service Agreement are included in the vehicle's glove box literature. For more information, visit www.onstar.com or www.onstarcanada.com. Contact OnStar® at 1-888-4-ONSTAR (1-888-466-7827), or press the OnStar® button to speak to an OnStar® advisor 24 hours a day, 7 days a week.

Terms and conditions of the Subscription Service Agreement can be found at www.onstar.com.

OnStar® Services

The Directions and Connections Plan is included on new vehicles for one year from the date of purchase. The OnStar® subscription can be extended for time beyond the first year to meet your needs. For more information, press the OnStar® button to speak with an advisor.

Directions and Connections Plan

- Automatic Notification of Air Bag Deployment
- Emergency Services
- Roadside Assistance
- Stolen Vehicle Tracking
- AccidentAssist
- Remote Door Unlock/Vehicle Alert
- Remote Diagnostics
- Online Concierge
- Driving Directions
- RideAssist
- Information and Convenience Services

OnStar® Personal Calling

As an OnStar® subscriber, the Personal Calling capability is a hands-free wireless phone that is integrated into the vehicle. Calls can be placed nationwide using simple voice commands with no additional contracts and no additional roaming charges. To find out more about OnStar® Personal Calling, refer to the OnStar® user's guide in the vehicle's glove box, visit www.onstar.com or www.onstarcanada.com; or speak with an OnStar® advisor by pressing the OnStar® button or calling 1-888-4-ONSTAR (1-888-466-7827).

OnStar® Virtual Advisor

Virtual Advisor is a feature of OnStar® Personal Calling that uses minutes to access up-to-date weather and traffic reports for your area, news and sports updates, stock quotes, entertainment, and more. You are also able to listen and reply to E-mail through the vehicle's audio system. Customize your information profile at www.myonstar.com. See the OnStar® user's guide for more information.

OnStar® Steering Wheel Controls

A steering wheel control can be used to interact with the OnStar® personal calling feature.

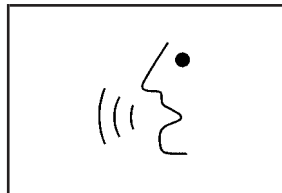

Press the control with this symbol on the steering wheel to place a phone call. When calling into voice mail systems, or to dial directory numbers, press the control, say the number (s), then say "dial".

See the OnStar® user's guide for more information.

HomeLink[®] Transmitter

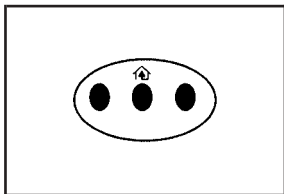

If your vehicle has this feature, the control buttons are located on the driver's sun visor.

HomeLink[®] a combined universal transmitter and receiver, provides a way to replace up to three hand-held transmitters used to activate devices such as gate operators, garage door openers, entry door locks, security systems and home lighting. Additional HomeLink[®] information can be found on the internet at www.homelink.com or by calling 1-800-355-3515.

If your vehicle is equipped with the HomeLink[®] Transmitter, it complies with Part 15 of the FCC Rules. Operation is subject to the following two conditions: (1) this device may not cause harmful interference, and (2) this device must accept any interference received, including interference that may cause undesired operation.

This device complies with RSS-210 of Industry Canada. Operation is subject to the following two conditions: (1) this device may not cause interference, and (2) this device must accept any interference, including interference that may cause undesired operation of the device.

Changes and modifications to this system by other than an authorized service facility could void authorization to use this equipment.

Programming the HomeLink[®] Transmitter

Do not use the HomeLink[®] Transmitter with any garage door opener that does not have the “stop and reverse” feature. This includes any garage door opener model manufactured before April 1, 1982. If you have a newer garage door opener with rolling codes, please be sure to follow steps 6 through 8 to complete the programming of your HomeLink[®] Transmitter.

Read the instructions completely before attempting to program the HomeLink[®] Transmitter. Because of the steps involved, it may be helpful to have another person available to assist you in programming the transmitter.

Keep the original transmitter for use in other vehicles as well as for future HomeLink[®] programming. It is also recommended that upon the sale of the vehicle, the programmed HomeLink[®] buttons should be erased for security purposes. Refer to “Erasing HomeLink[®] Buttons” or, for assistance, contact HomeLink[®] on the internet at: www.homelink.com or by calling 1-800-355-3515.

Be sure that people and objects are clear of the garage door or gate operator you are programming. When programming a garage door, it is advised to park outside of the garage.

It is recommended that a new battery be installed in your hand-held transmitter for quicker and more accurate transmission of the radio frequency.

Programming HomeLink®

Your vehicle's engine should be turned off while programming the transmitter. Follow these steps to program up to three channels:

1. Press and hold down the two outside buttons, releasing only when the indicator light begins to flash, after 20 seconds. Do not hold down the buttons for longer than 30 seconds and do not repeat this step to program a second and/or third transmitter to the remaining two HomeLink® buttons.
2. Position the end of your hand-held transmitter about 1 to 3 inches (3 to 8 cm) away from the HomeLink® buttons while keeping the indicator light in view.
3. Simultaneously press and hold both the desired button on HomeLink® and the hand-held transmitter button. Do not release the buttons until Step 4 has been completed.

Some entry gates and garage door openers may require you to substitute Step 3 with the procedure noted in "Gate Operator and Canadian Programming" later in this section.

4. The indicator light will flash slowly at first and then rapidly after HomeLink® successfully receives the frequency signal from the hand-held transmitter. Release both buttons.
5. Press and hold the newly-trained HomeLink® button and observe the indicator light.

If the indicator light stays on constantly, programming is complete and your device should activate when the HomeLink® button is pressed and released.

To program the remaining two HomeLink® buttons, begin with Step 2 under "Programming HomeLink®." Do not repeat Step 1 as this will erase all of the programmed channels.

If the indicator light blinks rapidly for two seconds and then turns to a constant light, continue with Steps 6 through 8 following to complete the programming of a rolling-code equipped device (most commonly, a garage door opener).

6. Locate in the garage, the garage door opener receiver (motor-head unit). Locate the “Learn” or “Smart” button. This can usually be found where the hanging antenna wire is attached to the motor-head unit.
7. Firmly press and release the “Learn” or “Smart” button. The name and color of the button may vary by manufacturer.

You will have 30 seconds to start Step 8.

8. Return to the vehicle. Firmly press and hold the programmed HomeLink® button for two seconds, then release. Repeat the press/hold/release sequence a second time, and depending on the brand of the garage door opener (or other rolling code device), repeat this sequence a third time to complete the programming.

HomeLink® should now activate your rolling-code equipped device.

To program the remaining two HomeLink® buttons, begin with Step 2 of “Programming HomeLink®.” You do not want to repeat step 1, as this will erase all previous programming.

Gate Operator and Canadian Programming

Canadian radio-frequency laws require transmitter signals to “time out” or quit after several seconds of transmission. This may not be long enough for HomeLink® to pick up the signal during programming. Similarly, some U.S. gate operators are manufactured to “time out” in the same manner.

If you live in Canada, or you are having difficulty programming a gate operator by using the “Programming HomeLink®” procedures (regardless of where you live), replace Step 3 under “Programming HomeLink®” with the following:

Continue to press and hold the HomeLink® button while you press and release every two seconds (cycle) your hand-held transmitter until the frequency signal has been successfully accepted by HomeLink®. The indicator light will flash slowly at first and then rapidly. Proceed with Step 4 under “Programming HomeLink®” to complete.

Using HomeLink®

Press and hold the appropriate HomeLink® button for at least half of a second. The indicator light will come on while the signal is being transmitted.

Erasing HomeLink® Buttons

To erase programming from the three buttons do the following:

1. Press and hold down the two outside buttons until the indicator light begins to flash, after 20 seconds. Do not hold the two outside buttons for longer than 30 seconds.
2. Release both buttons.

HomeLink® is now in the train (learning) mode and can be programmed at any time beginning with Step 2 under “Programming HomeLink®” shown earlier in this section.

Individual buttons cannot be erased, but they can be reprogrammed. See “Reprogramming a Single HomeLink® Button” following this section.

Reprogramming a Single HomeLink® Button

To program a device to HomeLink® using a HomeLink® button previously trained, follow these steps:

1. Press and hold the desired HomeLink® button. Do not release the button.
2. The indicator light will begin to flash after 20 seconds. While still holding the HomeLink® button, proceed with Step 2 under “Programming HomeLink®” shown earlier in this section.

Resetting Defaults

To reset HomeLink® to default settings do the following:

1. Hold down the two outside buttons for about 20 seconds until the indicator light begins to flash.
2. Continue to hold both buttons until the HomeLink® indicator light turns off.
3. Release both buttons.

For questions or comments, contact HomeLink® at 1-800-355-3515, or on the internet at www.homelink.com.

Storage Areas

Glove Box

To open the glove box, lift up on the lever. Use your door key to lock or unlock it.

Cupholder(s)

Your vehicle has cupholders located between the front seats. Slide the cover back to expose them. There are also cupholders in the armrest of the second row seat. Press the panel on the front of the armrest to expose the cupholders. On the outboard sides of the third row there may also be cupholders.

Cell Phone Storage Area

Your vehicle has a closeable cell phone/sunglasses storage area inside both of the front doors. Press the button to open the door.

Front Storage Area

Your vehicle has a closeable storage area inside both of the front doors. Press the button to open the door.

Center Console Storage Area

Your vehicle has a center console storage area located between the front seats. It includes storage areas, and accessory power outlet(s) on the rear of the console.

Map Pocket

There are map pockets located near the bottom of the front doors.

Assist Handles

Your vehicle has assist handles located above the doors.

Luggage Carrier

CAUTION:

If you try to carry something on top of your vehicle that is longer or wider than the luggage carrier — like paneling, plywood, a mattress and so forth — the wind can catch it as you drive along. This can cause you to lose control. What you are carrying could be violently torn off, and this could cause you or other drivers to have a collision, and of course damage your vehicle. You may be able to carry something like this inside. But, never carry something longer or wider than the luggage carrier on top of your vehicle.

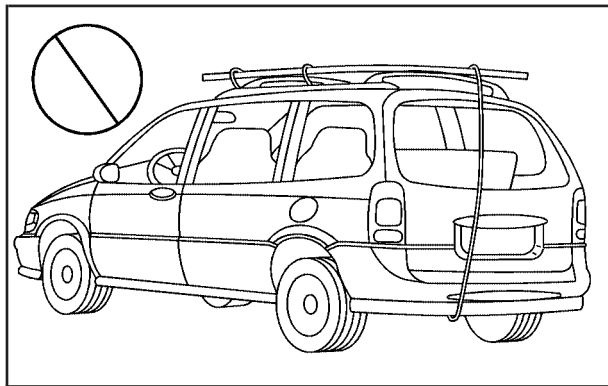

If your vehicle has a luggage carrier, you can load things on top of your vehicle. The luggage carrier has side rails attached to the roof. You can get sliding crossrails through your dealer to use for tying things down. These let you load some things on top of your vehicle, as long as they are not wider or longer than the luggage carrier.

Convenience Net

If your vehicle has a convenience net, the convenience net attaches to the floor or back wall of the rear of the vehicle using six anchor points. The net can be used like a hammock across the rear of the vehicle or hooked on the floor. Put small loads, like grocery bags, behind the net. It can help keep them from falling over during sharp turns or quick starts and stops.

The net is not for larger, heavier loads. Store them in the rear of the vehicle as far forward as you can.

Cargo Cover

If your vehicle has a cargo cover, you can use it to cover items in the rear of the vehicle. Pull the cover from the passenger's side to the driver's side and slide the ends into the slots to secure it. When it is not in use, take the ends out of the slots and allow the cover to roll back up.

Cargo Management System

Your vehicle may have a cargo management system. It provides extra storage space for the rear of the vehicle.

The cargo management system has three compartments. The one closest to the front of the vehicle opens from behind the second row. The center compartment has a divider. The compartment closest to the rear of the vehicle has a removable storage bin.

Sunroof

Sunroof (UltraView)

CAUTION:

People who are in a crash and not wearing a safety belt properly can suffer much worse injuries. They can hit things inside the vehicle or be ejected from it, and be seriously injured or killed. This is true for any vehicle occupant, in any motor vehicle, but if you have the Ultraview roof it is, if anything, even more important. In a rollover or other crash, the Ultraview roof can be damaged or destroyed. People who are unbelted would then be at even greater risk of being ejected from the vehicle. Always fasten your safety belt, and check that your passengers' belts are fastened properly too.

The vehicle may have an ultraview sunroof over the first two rows of seats.

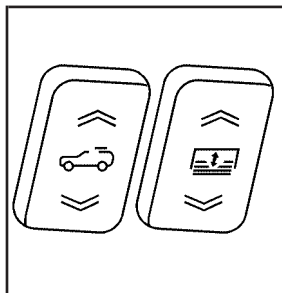

The sunroof/sunshade switches are located in the headliner between the driver and front passenger.

One switch operates the sunroof and the other switch operates the sunshade.

Press the back of the sunroof switch to open the sunroof. When the switch is pressed to the first stop the sunroof will open to a desired position. Press the switch to the second stop to express open the sunroof to a preset comfort position. Press the second stop again to fully express open the sunroof. Press the front of the switch to close the sunroof. The first stop will close the sunroof at a desired position at normal speed, and the second stop will express close the roof.

Press the back of the sunshade switch to open the sunshade. Press the front of the switch to the first stop to close the sunshade to a desired position at a normal speed. Press the switch forward to the second stop to express close the sunshade.

Anti-Pinch Feature

If an object is in the path of the sunroof when it is closing, the anti-pinch feature will detect the object and stop the sunroof from closing at the point of the obstruction. The sunroof will then reverse. To close the sunroof once it has re-opened, remove the obstruction and press the front of the sunroof switch.

Resynchronization

To resynchronize the sunroof and sunshade, do the following.

1. With the engine running, press and hold both the sunroof switch in the open position and the sunshade switch in the closed position for six seconds.
2. Release both buttons.
3. Press the sunshade switch in the closed position until the motor stalls.
4. Press the sunroof switch in the closed position until the motor stalls.

Sunroof (UltraView Plus)

CAUTION:

People who are in a crash and not wearing a safety belt properly can suffer much worse injuries. They can hit things inside the vehicle or be ejected from it, and be seriously injured or killed. This is true for any vehicle occupant, in any motor vehicle, but if you have the Ultraview roof it is, if anything, even more important. In a rollover or other crash, the Ultraview roof can be damaged or destroyed. People who are unbelted would then be at even greater risk of being ejected from the vehicle. Always fasten your safety belt, and check that your passengers' belts are fastened properly too.

The vehicle may have an ultraview sunroof over the first two rows of seats and a smaller sunroof over the third row seat. Both have sunshades, but the back sunroof does not open.

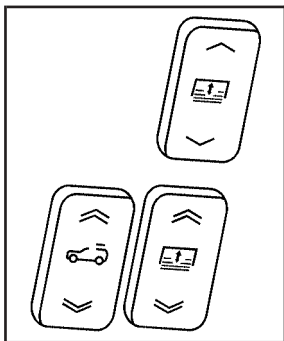

The sunroof/sunshade switches are located in the headliner between the driver and front passenger.

One switch operates the front sunroof and another switch operates the front sunshade. The third switch is for the rear sunshade.

Press the back of the sunroof switch to open the sunroof. Press the switch to the first stop to open the sunroof to a desired position. Press the switch to the second stop to express open the sunroof to a preset comfort stop. Press the switch at the second stop again to express open the sunroof completely. Press the front of the sunroof switch to close the sunroof.

Press the switch to the first stop to close the sunroof to a desired position. Press the front of the switch to the second stop to express close the sunroof.

Press the back of the front sunshade switch to open it. Press it to the first stop to open the front sunshade to a desired position. Press it again to express open the sunshade. Press the front of the front sunshade switch to close it. Press to the first stop to close it to a desired position. Press the switch to the second stop to express close the front sunshade

Press the back of the rear sunshade switch to open the rear sunshade. Press the front of the switch to close the rear sunshade.

Anti-Pinch Feature

If an object is in the path of the sunroof when it is closing, the anti-pinch feature will detect the object and stop the sunroof from closing at the point of the obstruction. The sunroof will then reverse. To close the sunroof once it has re-opened, remove the obstruction and press the front of the sunroof switch.

Resynchronization

To resynchronize the front sunroof and front and rear sunshades, do the following.

1. With the engine running, press and hold the rear sunshade switch in the closed position for about 15 seconds – the shade will move to the stop position.
2. Momentarily release the button, and press the rear sunshade switch in the closed position again. The shade will now move to the fully open position and then return to the fully closed position. Keep the switch pushed in the closed position for the entire open/close cycle of the shade.
3. At the same time, press and hold the front sunroof switch in the open position and the front sunshade switch in the closed position for about six seconds.
4. Release both buttons.
5. Press the front sunshade switch in the closed position until the motor stalls in the closed position.
6. Press the front sunroof switch in the closed position until the motor stalls in the closed position.

Vehicle Personalization

Memory Seat and Mirrors

If your vehicle has the memory feature, you can program and recall memory settings for the driver's seating and outside rearview mirror driving positions for up to two drivers.



The buttons for this feature are located on the driver's door armrest.

Use the following steps to program the buttons:

1. Adjust the driver's seat including the seatback recliner and both outside mirrors.
2. Press and hold button 1 for at least three seconds. Two beeps will sound to confirm that the seat and mirror positions have been saved.
3. Repeat the procedure for a second driver using button 2.

The vehicle must be in PARK (P) to recall the stored driving positions.

Press one of the numbered memory buttons to recall the stored setting. Each time a memory button is pressed, a single beep will sound.

Three chimes will sound and the setting will not be recalled if you press button 1 or 2 when the vehicle is not in PARK (P).

If you would like the stored driving positions to be recalled when unlocking your vehicle with the remote keyless entry transmitter or when you place the key in the ignition, see *DIC Vehicle Personalization on page 3-66*.

To stop recall movement of the memory feature at any time, press one of the power seat or mirror controls.

Two personalized exit positions can also be programmed. Use the following steps to program exit positions:

1. Press memory seat button 1 or the button with the unlock symbol on the remote keyless entry transmitter with the number 1 on the back to recall the driving position.
2. Adjust the driver's seat to the desired exit position.

3. Press and hold the exit button located above buttons 1 and 2 on the driver's door armrest for at least three seconds.

Two beeps will sound to confirm that the exit position has been saved.

4. Repeat the procedure for a second driver using memory seat button 2 or the remote keyless entry transmitter with the number 2 on the back.

To recall the stored exit positions, press and release the exit button. One beep will sound, and the seat will move to the previously stored exit position for the currently identified driver. If an exit position has not been stored for this driver, the seat will move all the way back. The position of the outside mirrors is not stored or recalled for the exit position.

The vehicle must be in PARK (P) to recall the exit positions.

Three chimes will sound and the exit setting will not be recalled if you press the exit button when the vehicle is not in PARK (P).

If you would like your stored exit position to be recalled when unlocking the vehicle with the remote keyless entry transmitter or when the ignition is turned off and the driver's door is opened, see *DIC Vehicle Personalization on page 3-66*.

Section 3 Instrument Panel

Instrument Panel Overview	3-4	Climate Controls	3-25
Hazard Warning Flashers	3-6	Dual Climate Control System	3-25
Other Warning Devices	3-6	Outlet Adjustment	3-30
Horn	3-6	Rear Air Conditioning System	3-31
Tilt Wheel	3-6	Passenger Compartment Air Filter	3-32
Turn Signal/Multifunction Lever	3-7	Warning Lights, Gages, and Indicators	3-33
Turn and Lane-Change Signals	3-8	Instrument Panel Cluster	3-34
Headlamp High/Low-Beam Changer	3-9	Speedometer and Odometer	3-35
Flash-to-Pass	3-9	Trip Odometers	3-35
Windshield Wipers	3-10	Tachometer	3-36
Windshield Washer	3-11	Engine Speed Limiter	3-36
Headlamp Washer	3-12	Safety Belt Reminder Light	3-36
Cruise Control	3-12	Airbag Readiness Light	3-37
Headlamps	3-16	Charging System Light	3-38
Wiper Activated Headlamps	3-16	Brake System Warning Light	3-38
Headlamps on Reminder	3-16	Anti-Lock Brake System Warning Light	3-39
Daytime Running Lamps	3-17	Traction Control System (TCS) Warning Light	3-40
Fog Lamps	3-18	Engine Coolant Temperature Warning Light (CTS)	3-40
Exterior Lighting Battery Saver	3-19	Engine Coolant Temperature Gage	3-41
Instrument Panel Brightness	3-19	Tire Pressure Light	3-41
Entry Lighting	3-19	Malfunction Indicator Lamp	3-42
Parade Dimming	3-20	Oil Pressure Light	3-45
Reading Lamps	3-20	Sport Mode Light	3-45
Ultrasonic Rear Parking Assist (URPA)	3-20		
Accessory Power Outlets	3-23		
Ashtrays and Cigarette Lighter	3-24		

Section 3 Instrument Panel

Security Light	3-46	Audio System(s)	3-80
Fog Lamp Light	3-46	Setting the Time	3-80
Lights On Reminder	3-46	Radio with CD	3-81
Cruise Control Light	3-46	Rear Seat Entertainment System	3-98
Highbeam On Light	3-47	Navigation/Radio System	3-111
Fuel Gage	3-47	Theft-Deterrent Feature	3-111
Driver Information Center (DIC)	3-48	Audio Steering Wheel Controls	3-111
System Controls	3-48	Radio Reception	3-113
Status of Vehicle Systems	3-49	Care of Your CDs and DVDs	3-113
DIC Main Menu	3-53	Care of Your CD and DVD Player	3-113
DIC Warnings and Messages	3-57	Diversity Antenna System	3-114
DIC Vehicle Personalization	3-66	XM™ Satellite Radio Antenna System	3-114



NOTES

Instrument Panel Overview

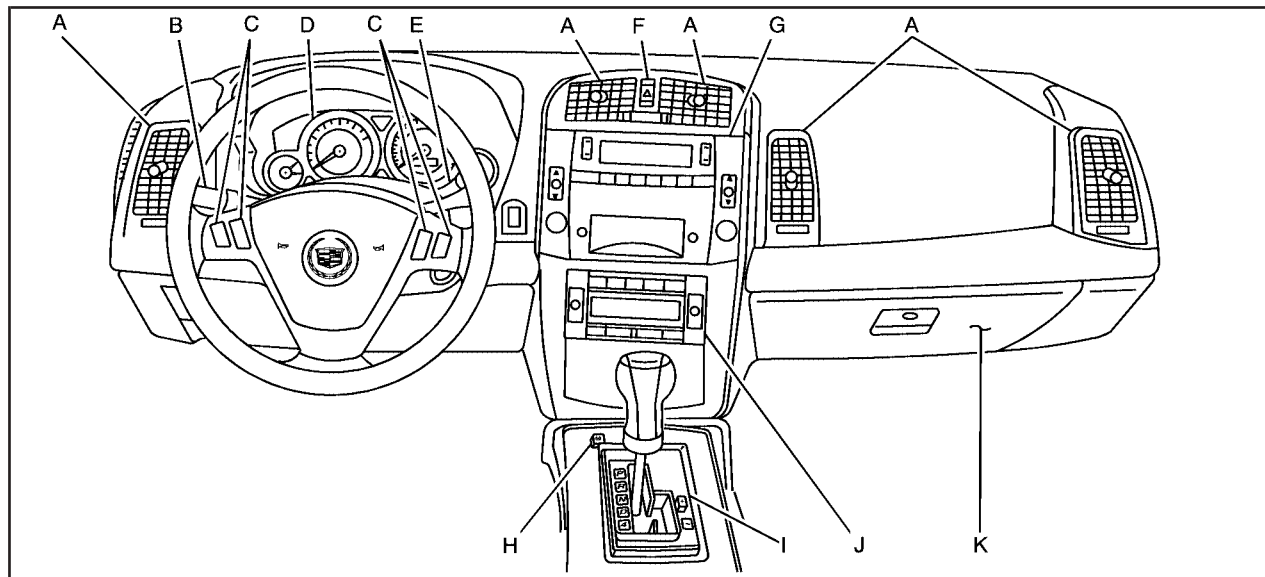

The main components of the instrument panel are the following:

- A. Air Outlets. See *Outlet Adjustment on page 3-30*.
- B. Turn Signal/Multifunction Lever. See *Turn Signal/Multifunction Lever on page 3-7*.
- C. Steering Wheel Controls. See *Audio Steering Wheel Controls on page 3-111*.
- D. Instrument Panel Cluster. See *Instrument Panel Cluster on page 3-34*.
- E. Windshield Wiper Lever. See *Windshield Wipers on page 3-10*.
- F. Hazard Warning Flasher Button. See *Hazard Warning Flashers on page 3-6*.
- G. Audio/Navigation System. See *Audio System(s) on page 3-80*.
- H. Traction Control Button. See *Traction Control System (TCS) on page 4-9*.
- I. Automatic Transmission Shift Lever. See *Automatic Transmission Operation on page 2-25*.
- J. Climate Control System. See *Dual Climate Control System on page 3-25*.
- K. Glove Box. See *Glove Box on page 2-47*.

Hazard Warning Flashers

Your hazard warning flashers let you warn others. They also let police know you have a problem. Your front and rear turn signal lamps will flash on and off.

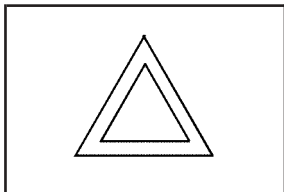

The hazard warning flasher button is located near the center of the instrument panel.

Your hazard warning flashers work no matter what position your key is in, and even if the key is not in.

Press the button to make the front and rear turn signal lamps flash on and off. Press the button again to turn the flashers off.

When the hazard warning flashers are on, your turn signals will not work.

Other Warning Devices

If you carry reflective triangles, you can set them up at the side of the road about 300 feet (100 m) behind your vehicle.

Horn

Press near or on the horn symbols on your steering wheel pad to sound the horn.

Tilt Wheel

A tilt wheel allows you to adjust the steering wheel before you drive. You can raise it to the highest level to give your legs more room when you exit and enter the vehicle.

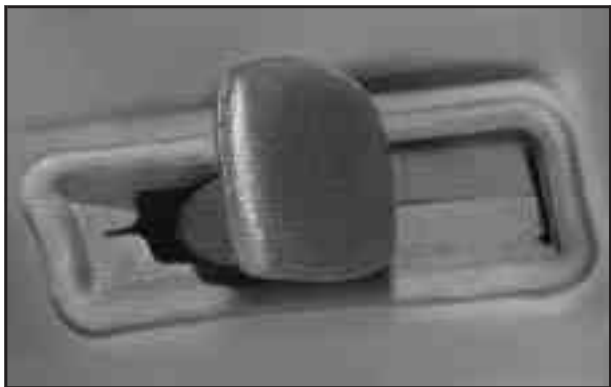



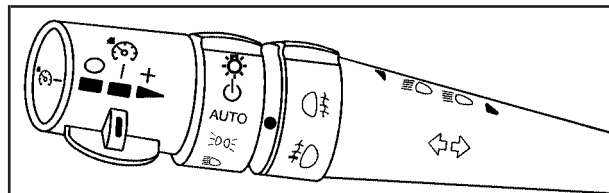

The lever that allows you to tilt the steering wheel is located on the left side of the steering column.

To tilt the wheel, hold the steering wheel and pull the lever. Then move the steering wheel to a comfortable position and release the lever to lock the wheel in place.

Turn Signal/Multifunction Lever



The lever on the left side of the steering column includes the following:

-  Turn and Lane-Change Signals. See *Turn and Lane-Change Signals* on page 3-8.
-  Headlamps. See *Headlamps* on page 3-16.
-  Headlamp High/Low-Beam Changer. See *Headlamp High/Low-Beam Changer* on page 3-9.
- Flash-To-Pass Feature. See *Flash-to-Pass* on page 3-9.
-  Fog Lamps. See *Fog Lamps* on page 3-18.
-  Cruise Control. See *Cruise Control* on page 3-12.

Turn and Lane-Change Signals

To signal a turn, move the lever all the way up or down. The lever returns automatically when the turn is complete.

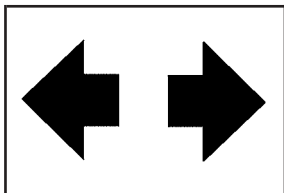

An arrow on the instrument panel cluster will flash in the direction of the turn or lane change.

Raise or lower the lever until the arrow starts to flash to signal a lane change. Hold it there until the lane change is complete. The lever returns to its original position when it's released.

Arrows that flash rapidly when signaling for a turn or lane change may be caused by a burned-out signal bulb. Other driver's won't see the signal.

Replace burned-out bulbs to help avoid possible accidents. Check the fuse and for burned-out bulbs if the arrow fails to work when signaling a turn. See *Fuses and Circuit Breakers* on page 5-93 for more information.

Turn Signal On Chime

If the turn signal is left on for about 1 mile (1.6 km), a warning chime will sound and the Turn Signal On message will appear on the Driver Information Center (DIC) display. See "Turn Signal On" under *DIC Warnings and Messages* on page 3-57 for more information.

Headlamp High/Low-Beam Changer

Push forward on the turn signal/multifunction lever to change the headlamps from low to high beam. Pull the lever back and then release it to change from high to low beam.

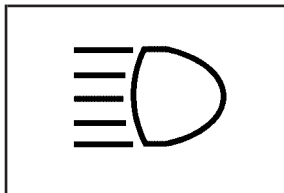

This light on the instrument panel cluster will be on, indicating high-beam usage.

Flash-to-Pass

This feature allows you to use the high-beam headlamps to signal the driver in front of you that you want to pass.

Pull and hold the turn signal/multifunction lever toward you to use this feature. When you do, the following will occur:

- If the headlamps are off, in low-beam or in Daytime Running Lamps (DRL) mode, the high-beam headlamps will turn on. They'll stay on as long as you hold the lever there. Release the lever to turn them off.
- If the headlamps are in high-beam mode, they will switch to low beam. To return to high-beam, push the lever away from you.

Windshield Wipers

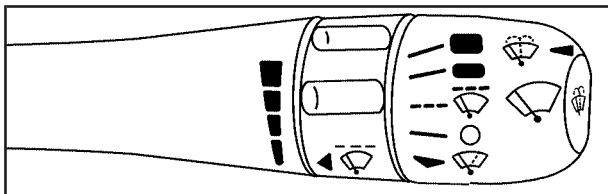

The lever on the right side of the steering column operates the windshield wipers.

▼  **(Mist):** Pull the lever down and release it for a single wiping cycle. The lever will return to its original position. For more cycles, hold the lever down before releasing it.

○ **(Off):** Put the lever in this position to turn off the wipers.

↔  **(Delay):** Put the lever in this position to set a delay between wipes. Turn the delay adjustment band to set the length of the delay.

↔  **(Delay Adjustment):** Use this band to set the length of the delay between wipes when using the delay feature. The closer you move the band toward mist, the longer the delay. The windshield wiper lever must be in delay for this feature to work.

▬ **(Low Speed):** Put the lever in this position for slow, steady wiping cycles.

▬ **(High Speed):** Put the lever in this position for rapid wiping cycles.

If the windshield wipers are in use for about six seconds while you are driving, the exterior lamps will come on automatically if the exterior lamp control is in AUTO. See *Wiper Activated Headlamps* on page 3-16 for more information.

Be sure to clear ice and snow from the wiper blades before using them. If they're frozen to the windshield, gently loosen or thaw them. If the blades do become damaged, install new blades or blade inserts. For more information, see *Windshield Wiper Blade Replacement* on page 5-50.

Heavy snow or ice can overload the wiper motor. A circuit breaker will stop the motor until it cools down. Clear away snow or ice to prevent an overload.

Windshield Washer

CAUTION:

In freezing weather, do not use your washer until the windshield is warmed. Otherwise the washer fluid can form ice on the windshield, blocking your vision.

The windshield washer button is located at the end of the windshield wiper lever.

 (Washer Fluid): Press the button with this symbol located at the end of the windshield washer lever to wash the windshield. Washer fluid will squirt onto the windshield and the wipers will run for a few cycles to clear the windshield. For more wash cycles, press and hold the button.

If your vehicle is low on washer fluid, the Check Washer Fluid message will appear on the Driver Information Center (DIC) display. See *DIC Warnings and Messages* on page 3-57 for more information.

If the headlamps are on when you wash the windshield, the headlamp washer (if equipped) will turn on. Both the windshield and the headlamps will be washed. See *Headlamp Washer* on page 3-12.

Rear Washer/Wiper

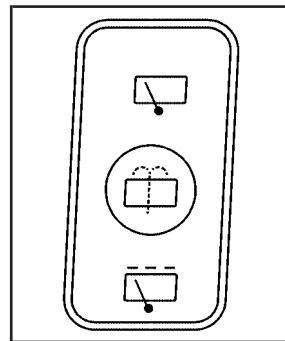

The switch for the rear washer/wiper is located in the overhead console.

Press the top of the switch for regular wipe, press the bottom of the switch for intermittent wipe and press the center of the switch to wash the rear window.

Headlamp Washer

Your vehicle may have headlamp washers. The headlamp washers clear debris from the headlamp lenses.

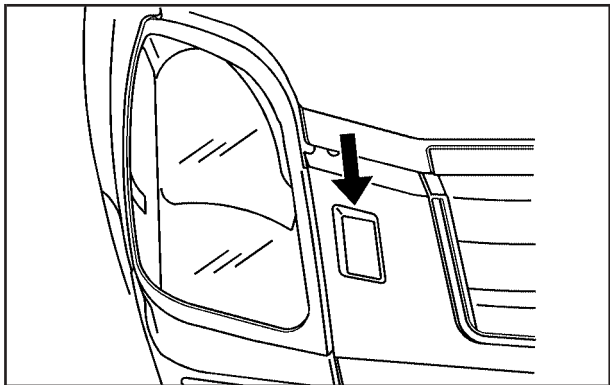

The headlamp washers are located to the inside of the headlamps.

To wash the headlamps, press the washer button located at the end of the windshield wiper lever. Both the headlamps and the windshield will be washed.

The headlamps must be on to be washed. If the headlamps are off, only the windshield will be washed when the washer button is pressed. If the washer fluid is low, the headlamp washers will not work.

See *Windshield Washer* on page 3-11 for additional information.

Cruise Control



These controls are located on the end of the multifunction lever.

○ (Off): This position turns the system off.

| (On): This position activates the system.

+ (Resume/Accelerate): Push the lever to this symbol to make the vehicle resume to a previously set speed or to accelerate when cruise is already active.

 **(Set/Decrease):** Press this button to set the speed or to decrease the speed when cruise is already active.

With cruise control, you can maintain a speed of about 25 mph (40 km/h) or more without keeping your foot on the accelerator. This can really help on long trips. Cruise control does not work at speeds below about 25 mph (40 km/h).

If you apply your brakes, the cruise control will shut off.

CAUTION:

Cruise control can be dangerous where you cannot drive safely at a steady speed. So, do not use your cruise control on winding roads or in heavy traffic.

Cruise control can be dangerous on slippery roads. On such roads, fast changes in tire traction can cause needless wheel spinning, and you could lose control. Do not use cruise control on slippery roads.

If your vehicle is in cruise control when the traction control system begins to limit wheel spin, the cruise control will automatically disengage. See *Traction Control System (TCS)* on page 4-9 and *Stabilitrak® System* on page 4-10. When road conditions allow you to safely use it again, you may turn the cruise control back on.

Setting Cruise Control

CAUTION:

If you leave your cruise control on when you are not using cruise, you might hit a button and go into cruise when you do not want to. You could be startled and even lose control. Keep the cruise control switch off until you want to use cruise control.

1. Move the cruise control switch to on.
2. Get up to the speed you want.
3. Press in the set button at the end of the lever and release it.
4. Take your foot off the accelerator pedal.

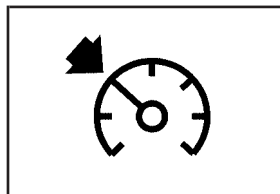

This light on the instrument panel cluster will come on while cruise control is on.

Resuming a Set Speed

Suppose you set your cruise control at a desired speed and then you apply the brake. This, of course, disengages the cruise control. But you don't need to reset it.

Once you're going about 25 mph (40 km/h) or more, you can move the cruise control switch briefly from on to resume/accelerate.

You'll go right back up to your chosen speed and stay there.

If you hold the switch at resume/accelerate the vehicle will keep going faster until you release the switch or apply the brake. So unless you want to go faster, don't hold the switch at resume/accelerate.

Increasing Speed While Using Cruise Control

There are two ways to go to a higher speed:

- Use the accelerator pedal to get to the higher speed. Press the set button at the end of the lever, then release the button and the accelerator pedal. You'll now cruise at the higher speed.
- Move the cruise switch from on to resume/accelerate. Hold it there until you get up to the speed you want, and then release the switch. To increase your speed in very small amounts, move the switch briefly to resume/accelerate. Each time you do this, your vehicle will go about 1 mph (1.6 km/h) faster.

Reducing Speed While Using Cruise Control

There are two ways to reduce your speed while using cruise control:

- Press in the button at the end of the lever until you reach the lower speed you want, then release it.
- To slow down in very small amounts, briefly press the set button. Each time you do this, you'll go about 1 mph (1.6 km/h) slower.

Passing Another Vehicle While Using Cruise Control

Use the accelerator pedal to increase your speed. When you take your foot off the pedal, your vehicle will slow down to the cruise control speed you set earlier.

Using Cruise Control on Hills

How well your cruise control will work on hills depends upon your speed, load and the steepness of the hills. When going up steep hills, you may have to step on the accelerator pedal to maintain your speed. When going downhill, you may have to brake to keep your speed down. Applying the brake will take you out of cruise control. If you need to apply the brake due to the grade of the downhill slope, you may not want to attempt to use your cruise control feature.

Ending Cruise Control

To end a cruise control session, step lightly on the brake pedal.

Stepping on the brake pedal will end the current cruise control session only. Move the cruise control switch to off to turn off the system completely.

Erasing Speed Memory

When you turn off the cruise control or the ignition, your cruise control set speed memory is erased.

Headlamps

The exterior lamp control is located in the middle of the turn signal/multifunction lever.

 **(Exterior Lamp Control):** Turn the control with this symbol on it to operate the exterior lamps.

The exterior lamp control has four positions:

 **(On/Off):** Turn the control to this position to turn off all lamps except the Daytime Running Lamps (DRL).

AUTO (Automatic): Turn the control to this position to put the headlamps in automatic mode. AUTO mode will turn the exterior lamps on and off depending upon how much light is available outside of the vehicle.

 **(Parking Lamps):** Turn the control to this position to turn on the parking lamps together with the following:

- Sidemarkers Lamps
- Taillamps
- License Plate Lamps
- Instrument Panel Lights

 **(Headlamps):** Turn the control to this position to turn on the headlamps, together with the previously listed lamps and lights.

Wiper Activated Headlamps

This feature activates the headlamps and parking lamps after the windshield wipers have been in use for about six seconds. For this feature to work, the exterior lamp control must be in AUTO.

When the exterior lamp control is off or in the parking lamp position and the windshield wiper control is in any position except off, the Headlamps Suggested message will appear on the DIC display. See "Headlamps Suggested Message" under *DIC Warnings and Messages on page 3-57* for more information.

When the ignition is turned to OFF, the wiper-activated headlamps will immediately turn off. They will also turn off if the windshield wiper control is turned off.

Headlamps on Reminder

A warning chime will sound if the exterior lamp control is left on in either the headlamp or parking lamp position and the driver's door is opened with the ignition off. See *Lights On Reminder on page 3-46* for additional information.

Daytime Running Lamps

Daytime Running Lamps (DRL) can make it easier for others to see the front of your vehicle during the day. DRL can be helpful in many different driving conditions, but they can be especially helpful in the short periods after dawn and before sunset. Fully functional daytime running lamps are required on all vehicles first sold in Canada.

The DRL system will make the turn signal lamps come on when the following conditions are met:

- It is still daylight and the ignition is in ON or START,
- the exterior lamp control is in off or AUTO with the headlamps off, and
- an automatic transmission is not in PARK (P) or the parking brake is not set on a manual transmission.

When DRL are on, only your front turn signal lamps will be on. No other exterior lamps will be on when the DRL are being used. Your instrument panel won't be lit up either.

When the exterior lamp control is in AUTO and it's dark enough outside, the DRL will turn off and the low-beam headlamps will turn on. When it's bright enough outside, the low-beam headlamps will go off, and the DRL will turn back on. If you start your vehicle in a dark garage, the automatic headlamp system will come on immediately. Once you leave the garage, it will take

about one minute for the automatic headlamp system to change to DRL if it is light outside. During that delay, your instrument panel cluster may not be as bright as usual. Make sure your instrument panel brightness lever is in the full bright position. See *Instrument Panel Brightness on page 3-19*.

If it's dark enough outside and the exterior lamp control is off, a Headlamps Suggested message will appear on the Driver's Information Center (DIC) display.

This message informs the driver that turning on the exterior lamps is recommended even though the DRL are still illuminated. Turning the exterior lamp control to AUTO or to the low-beam headlamp position will turn off the DRL and cancel the Headlamps Suggested message. If the parking lamps or the fog lamps were turned on instead, the DRL will still turn off and the Headlamps Suggested message will be displayed. You can turn it off by pressing the OK button if you have the Navigation audio system or the CLR button if you have the Base audio system.

To operate your vehicle with the DRL off, turn the exterior lamp control off. Then turn on the fog lamps or parking lamps, and the DRL will turn off. The Headlamps Suggested message will appear on the DIC display. This will work regardless of gear position and whether or not the parking brake is set.

As with any vehicle, you should turn on the regular headlamp system when you need it.

Light Sensor



The light sensor for the DRL and AUTO headlamp feature is located on top of the instrument panel. If you cover the sensor, it will read dark, and the exterior lamps or the Headlamps Suggested message will appear on the DIC whenever the ignition is on.

Fog Lamps

Use the fog lamps for better vision in foggy or misty conditions.

The fog lamp controls are located on the turn signal/multifunction lever.

 : The band with this symbol is used to turn the front fog lamps on and off.

The parking lamps must be on for the fog lamps to work.

To turn the fog lamps on, turn the fog lamp band on the lever up to the dot and release it. The band will return to its original position.

To turn the fog lamps off, turn the fog lamp band up to the dot and release it. The band will return to its original position, and the fog lamps will turn off. If you turn on the high-beam headlamps, the fog lamps will also turn off. They'll turn back on again when you switch back to low-beam headlamps.

Exterior Lighting Battery Saver

If the parking lamps or headlamps have been left on, the exterior lamps will turn off about 10 minutes after the ignition is turned to OFF. This protects against draining the battery in case you have accidentally left the headlamps or parking lamps on. The battery saver does not work if the headlamps are turned on after the ignition is turned to OFF.

If you need to leave the lamps on for more than 10 minutes, use the exterior lamp control to turn the lamps back on.

Instrument Panel Brightness



The lever for this feature is located on the overhead console.

Slide the lever toward the symbol to brighten the lights or away from it to dim them.

If you slide the lever all the way toward the symbol past the resistance point, the interior lamps will come on. To turn them off, slide the lever back toward the minimum brightness setting.

Entry Lighting

The entry lighting system turns on the reading and dome lamps and the backlighting to the exterior lamp control when a door is opened or if you press the remote keyless entry transmitter unlock button. If activated by the transmitter, the lighting will remain active for about 25 seconds. The entry lighting system uses the light sensor; it must be dark outside in order for the lamps to turn on. The lamps turn off about 25 seconds after the last door is closed. They will dim to off if the ignition key is placed in ON, or immediately deactivate if the power locks are activated.

Parade Dimming

This feature prohibits dimming of the instrument panel displays and backlighting during daylight hours when the key is in the ignition and the headlamps are on. This feature operates with the light sensor and is fully automatic. When the light sensor reads darkness outside and the parking lamps are active, the instrument panel displays can be adjusted by sliding the instrument panel brightness lever toward the symbol to brighten or away from the symbol to dim the lighting.

Reading Lamps

The reading lamps are located on the overhead console. These lamps come on automatically when any door is opened.

For manual operation, press the button next to each lamp to turn it on. Press it again to turn the lamp off.

If the reading lamps are left on, they automatically shut off 10 minutes after the ignition has been turned off.

Ultrasonic Rear Parking Assist (URPA)

Your vehicle may have the Ultrasonic Rear Parking Assist (URPA) system. It is designed to help you park while the vehicle is in REVERSE (R). It operates only at very low speeds, less than 3 mph (5 km/h). URPA can help make parking easier and help you avoid colliding with objects such as parked vehicles. The URPA system can detect objects up to 5 feet (1.5 m) behind the vehicle, and tell you how close these objects are from your rear bumper.

⚠ CAUTION:

Even with the Ultrasonic Rear Park Assist system, the driver must check carefully before backing up. The system does not operate above typical backing speeds of 3 mph (5 km/h) while parking. And, the system does not detect objects that are more than 5 feet (1.5 meters) behind the vehicle.

So, unless you check carefully behind you before and when you back up, you could strike children, pedestrians, bicyclists or pets behind you, and they could be injured or killed.

Whether or not you are using rear park assist, always check carefully behind your vehicle before you back up and then watch closely as you do.

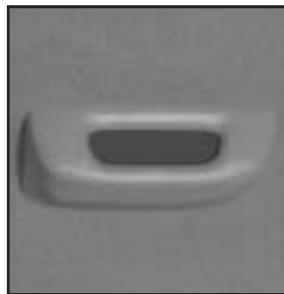

The URPA display is located inside the vehicle, above the liftgate glass. It has three color-coded lights that can be seen through the rearview mirror or by turning around.

How the System Works

URPA comes on automatically when the shift lever is moved into REVERSE (R) and the vehicle speed is less than 3 mph (5 km/h). When the system turns on, the three lights on the display will illuminate for one and a half seconds to let you know that the system is working. If your vehicle is moving in REVERSE (R) at a speed greater than 3 mph (5 km/h), the red light will flash to remind you that the system does not work at a speed greater than 3 mph (5 km/h).

If an object is detected at a REVERSE (R) speed of less than 3 mph (5 km/h), one of the following will occur:

Description	English	Metric
Amber light	5 ft	1.5 m
Amber/amber lights	40 in	1.0 m
Amber/amber/red lights & continuous chime	20 in	0.5 m
Amber/amber/red lights flashing & continuous chime	1 ft	0.3 m

A chime will sound the first time an object is detected between 20 inches (0.5 m) and 5 feet (1.5 m) away.

URPA cannot detect objects that are above liftgate level. In order for the rear sensors to recognize an object, it must be within detection range behind the vehicle.

When the System Does Not Seem to Work Properly

The light may flash red when the vehicle is in REVERSE (R), if the ultrasonic sensors are not kept clean. So be sure to keep your rear bumper free of mud, dirt, snow, ice and slush. Other conditions that may affect system performance include things like the vibrations from a jackhammer or the compression of air brakes on a very large truck. If after cleaning the rear bumper and then driving forward at least 15 mph (25 km/h), the display continues to flash red, see your dealer.

If a trailer was attached to your vehicle, or a bicycle or an object was on the back of, or hanging out of your liftgate during your last drive cycle, the light may also flash red. The light will continue to flash whenever in REVERSE (R) until your vehicle is driven forward at least 15 mph (25 km/h) without any obstructions behind the vehicle.

For cleaning instructions, see *Washing Your Vehicle on page 5-87*.

Accessory Power Outlets

Your vehicle is equipped with accessory power outlets. The outlets can be used to plug in electrical equipment such as a cellular telephone, CB radio, etc.

Your vehicle has one outlet in front of the center console, one in the rear of the center console, one in the rear compartment, and there may be an additional outlet in the rear of the center console.

Your vehicle may have a small cap that must be removed to access the accessory power outlet. If it does, when not using the outlet be sure to cover it with the protective cap.

Notice: Leaving electrical equipment on for extended periods will drain the battery. Always turn off electrical equipment when not in use and do not plug in equipment that exceeds the maximum amperage rating.

Power outlets can be set to work all the time or shut off 10 minutes after the vehicle is turned off. To change your setting, see your dealer for a fuse adjustment.

Certain accessory power plugs may not be compatible to the accessory power outlet and could result in blown vehicle or adapter fuses. If you experience a problem, see your dealer for additional information on the accessory power outlets.

Notice: Adding any electrical equipment to your vehicle may damage it or keep other components from working as they should. The repairs would not be covered by your warranty. Check with your dealer before adding electrical equipment.

Follow the proper installation instructions that are included with any electrical equipment you install.

Notice: Improper use of the power outlet can cause damage not covered by your warranty. Do not hang any type of accessory or accessory bracket from the plug because the power outlets are designed for accessory power plugs only.

Ashtrays and Cigarette Lighter

Your vehicle may have an ashtray and cigarette lighter.

Notice: If you put papers or other flammable items in the ashtray, hot cigarettes or other smoking materials could ignite them and possibly damage your vehicle. Never put flammable items in the ashtray.

Ashtray

The ashtray is located under the climate control panel on the center console. Press on the door to release the ashtray.

To empty the ashtray, remove it from the center console by gripping the edges and pulling straight out. To reinstall, push the tray back into place.

There may also be ashtrays in the rear doors.

Cigarette Lighter

Notice: Holding a cigarette lighter in while it is heating will not allow the lighter to back away from the heating element when it is hot. Damage from overheating may occur to the lighter or heating element, or a fuse could be blown. Do not hold a cigarette lighter in while it is heating. Do not use anything other than the cigarette lighter in the heating element.

The cigarette lighter is located next to the ashtray. The vehicle does not have any cigarette lighters for the rear seat passengers.

Press the lighter all the way in and release it. It will pop back out by itself once the element has heated for use.

Climate Controls

Dual Climate Control System

With this system you can control the heating, cooling and ventilation for your vehicle.



Automatic Operation

AUTO (Automatic): When this button is pressed and the temperature is set, the system will automatically control the inside temperature, the air delivery mode, the air conditioning compressor and the fan speed. AUTO will appear on the display.

1. Press the AUTO button.

2. Adjust the temperature to a comfortable setting between 70°F (21°C) and 80°F (27°C).

Choosing the coldest or warmest temperature setting will not cause the system to heat or cool any faster. If you set the system at the warmest temperature setting, the system will remain in manual mode at that temperature and it will not go into automatic mode.

In cold weather, the system will start at reduced fan speeds to avoid blowing cold air into your vehicle until warmer air is available. The system will start out blowing air at the floor but may change modes automatically as the vehicle warms up to maintain the chosen temperature setting. The length of time needed for warm up will depend on the outside temperature and the length of time that has elapsed since your vehicle was last driven.

3. Wait for the system to regulate. This may take from 10 to 30 minutes. Then adjust the temperature, if necessary.

You can switch from English to metric units through the Driver Information Center (DIC). If you have the Base audio system, see *DIC Main Menu on page 3-53*. If you have the Navigation system, see "Setup Menu" in the Navigation System Manual.

The air-conditioning system removes moisture from the air, so you may sometimes notice a small amount of water dripping underneath your vehicle while idling or after turning off the engine. This is normal.

Do not cover the solar sensor located in the center of the instrument panel, near the windshield. For more information on the solar sensor, see “Sensors” later in this section.

Manual Operation

 **(Mode):** Pressing the mode switch and changing the mode cancels automatic operation and places the system in manual mode. Press AUTO to return to automatic operation.

The outboard air outlets will always receive airflow regardless of the mode selected. See *Outlet Adjustment on page 3-30* to change this airflow from the outboard outlets.

To change the current mode, select one of the following:

 **(Vent):** This mode directs air to the instrument panel outlets.

 **(Bi-Level):** This mode directs approximately half of the air to the instrument panel outlets, and then directs most of the remaining air to the floor outlets. Some air may be directed toward the windshield. In automatic operation, cooler air is directed to the upper outlets and warmer air to the floor outlets.

 **(Floor):** This mode directs most of the air to the floor outlets with some air directed to the outboard outlets (for the side windows), and a little air directed to the windshield.

The mode switch can also be used to select the defog mode. Information on defogging and defrosting can be found later in this section.

 **(Fan):** Press this switch to increase or decrease the fan speed. Pressing this switch cancels automatic operation and places the system in manual mode. Press AUTO to return to automatic operation.

If the airflow seems low when the fan speed is at the highest setting, the passenger compartment air filter may need to be replaced. For more information, see *Passenger Compartment Air Filter* on page 3-32 and *Scheduled Maintenance* on page 6-4.

 **(Recirculation):** This mode keeps outside air from coming in the vehicle. It can be used to prevent outside air and odors from entering your vehicle or to help heat or cool the air inside your vehicle more quickly. Press this button to turn the recirculation mode on or off. The air-conditioning compressor also comes on.

Recirculation is not available in the defrost mode and will automatically turn off after 10 minutes when defog is selected.

Using recirculation for long periods of time may cause the air inside your vehicle to become too dry or stuffy. To prevent this from happening, after the air in your vehicle has cooled, turn the recirculation mode off.

 **(Power/Driver's Temperature):** Press the PWR button located on the driver's side of the climate control panel to turn the entire climate control system on or off. Press the up or down arrow on the switch to increase or decrease the temperature inside your vehicle.

 **(Power/Passenger's Temperature):** Press the PWR button located on the passenger's side of the climate control panel to turn the passenger's climate control system on. Press the up or down arrow on the switch to increase or decrease the temperature for the front passenger.

A/C OFF (Air Conditioning): Press this button to manually turn off the air conditioning compressor. Press AUTO to return to automatic operation or press the A/C OFF button again.

Sensors



There is a solar sensor located on the instrument panel, near the windshield.



There is also an interior temperature sensor located to the right of the steering wheel on the instrument panel.

These sensors monitor the solar radiation and the air inside your vehicle, then use the information to maintain the selected temperature by initiating needed adjustments to the temperature, the fan speed and the air delivery system. The system may also supply cooler air to the side of the vehicle facing the sun. The recirculation mode will also be activated, as necessary. Do not cover the sensors or the automatic climate control system will not work properly.

Defogging and Defrosting

Fog on the inside of windows is a result of high humidity (moisture) condensing on the cool window glass.

This can be minimized if the climate control system is used properly. There are two modes to clear fog from your windshield. Use the defog mode to clear the windows of fog or moisture and warm the passengers. Use the defrost mode to remove fog or frost from the windshield more quickly.

 **(Mode):** Press this button until defog appears on the display.

 **(Defog):** This mode directs the air between the windshield, floor outlets and side windows. When you select this mode, the system turns off recirculation and runs the air-conditioning compressor unless the outside temperature is at or below freezing. The recirculation mode is cancelled when you enter defog mode. If you select recirculation while in defog mode, it will be cancelled after 10 minutes.

If you have fogging on the side windows, turn the thumbwheel on the outboard outlets to the side window defog position. See *Outlet Adjustment on page 3-30* for more information.

 **(Defrost):** Pressing defrost directs most of the air to the windshield, with some air directed to the side windows. In this mode, the system will automatically turn off recirculation and run the air-conditioning compressor, unless the outside temperature is at or below freezing. Recirculation cannot be selected while in the defrost mode.

This mode may also cause the fan speed and air temperature to increase.

If you have fogging on the side windows, turn the thumbwheel on the outboard outlets to the side window defog position. See *Outlet Adjustment on page 3-30* for more information. Do not drive the vehicle until all the windows are clear.

Rear Window Defogger

The rear window defogger uses a warming grid to remove fog or frost from the rear window.

The rear window defogger will only work when the ignition is in ON.

 **(Rear Window Defogger):** Press this button to turn the rear window defogger on or off. Be sure to clear as much snow from the rear window as possible.

The rear window defogger will turn off about 10 minutes after the button is pressed. Or, if the vehicle's speed is above 30 mph (48 km/h), the rear defogger will stay on continuously. If turned on again, the defogger will only run for about five minutes before turning off. The defogger can also be turned off by pressing the button again or by turning off the engine.

The heated outside rearview mirrors will heat to help clear fog or frost from the surface of the mirror when the rear window defogger button is on.

Notice: Using a razor blade or sharp object to clear the inside rear window may damage the rear window defogger. Repairs would not be covered by your warranty. Do not clear the inside of the rear window with sharp objects.

Outlet Adjustment

Use the knobs located in the center of each outlet to change the direction of the airflow. Use the thumbwheels to open or close the outlets.

 **(Side Window Defog):** Turn the thumbwheel to this symbol to use the side window defog setting. The air coming through the outlets will be directed toward the side windows to clear fog.

 **(Open):** Turn the thumbwheel to this symbol to open the outlets completely and allow the maximum amount of air to enter your vehicle. A small amount of air will still be directed to the side windows.

 **(Closed):** Turn the thumbwheel to this symbol to close the outlets and minimize the amount of air entering the vehicle.

Operation Tips

- Clear away any ice, snow or leaves from the air inlets at the base of the windshield that may block the flow of air into your vehicle.
- Use of non-GM approved hood deflectors may adversely affect the performance of the system.
- Keep the path under the front seats clear of objects to help circulate the air inside of your vehicle more effectively.
- If the airflow seems low when the fan speed is at the highest setting, the passenger compartment air filter may need to be replaced. For more information, see *Passenger Compartment Air Filter* on page 3-32.

Rear Air Conditioning System

If your vehicle has the rear air conditioning system it has two fan speed selectors. One fan speed selector is located in the front overhead console and the other is located in the headliner above the second row seats. The rear air conditioning system is designed to provide cooled air only. There is no heating provided with this system.

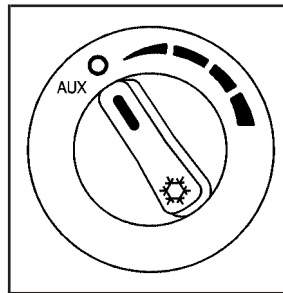

Front Control

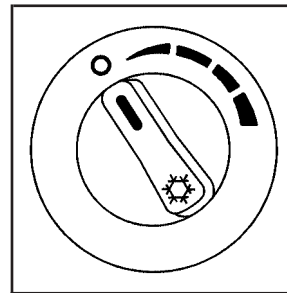

Rear Control

To operate the rear system using the front control, just turn the knob to the fan position you want.

To use the rear control, first turn the front control to the AUX position. Then, the rear control can be used to increase and decrease the airflow.

Passenger Compartment Air Filter

The passenger compartment air filter traps most of the pollen from the air entering your vehicle. Like your vehicle's engine air cleaner/filter, it needs to be changed periodically. For how often to change the passenger compartment air filter, see *Scheduled Maintenance on page 6-4*.

The passenger compartment air filter is located underneath the hood below the windshield wiper arm on the passenger's side of the vehicle. See *Engine Compartment Overview on page 5-12* for more information on location.

Use the procedure listed below to replace the passenger compartment air filter:

1. Open the hood to access the engine compartment. See *Hood Release on page 5-11* for more information. Locate the passenger compartment air filter access panel door.

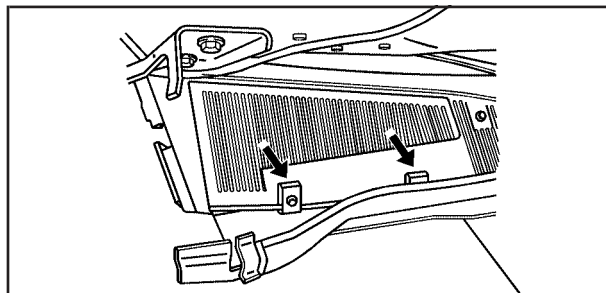

2. Push the two tabs on the access panel door towards the windshield.
3. While pressing forward, lift the access panel out of the clipped position and pull towards the front of the vehicle. This releases the clips and allows the panel door to be removed.
4. Remove the old filter and insert a new one. Make sure the arrow on the filter is pointing toward the passenger compartment.
See Normal Maintenance Replacement Parts on page 6-13 for the correct part number for the filter.
5. Reverse Steps 1 through 3 to reinstall the cover.

Warning Lights, Gages, and Indicators

This part describes the warning lights and gages that may be on your vehicle. The pictures will help you locate them.

Warning lights and gages can signal that something is wrong before it becomes serious enough to cause an expensive repair or replacement. Paying attention to your warning lights and gages could also save you or others from injury.

Warning lights come on when there may be or is a problem with one of your vehicle's functions. As you will see in the details on the next few pages, some warning lights come on briefly when you start the engine just to let you know they're working. If you are familiar with this section, you should not be alarmed when this happens.

Gages can indicate when there may be or is a problem with one of your vehicle's functions. Often gages and warning lights work together to let you know when there's a problem with your vehicle.

When one of the warning lights comes on and stays on when you are driving, or when one of the gages shows there may be a problem, check the section that tells you what to do about it. Follow this manual's advice. Waiting to do repairs can be costly – and even dangerous. So please get to know your warning lights and gages. They're a big help.

Your vehicle also has a Driver Information Center (DIC) that works along with the warning lights and gages. See *Driver Information Center (DIC)* on page 3-48 for more information.

Instrument Panel Cluster

The instrument panel cluster is designed to let you know at a glance how your vehicle is running. You'll know how fast you're going, how much fuel you're using and many of the other things you'll need to know to drive safely and economically.

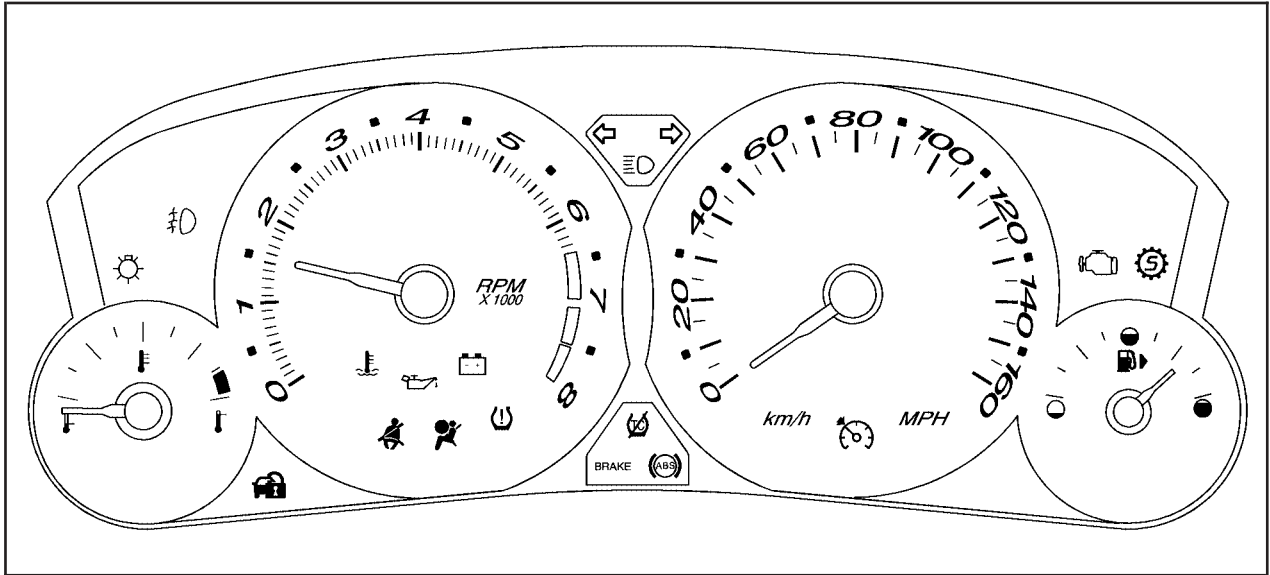

United States version shown, Canada similar

Speedometer and Odometer

The speedometer lets you see your speed in either miles per hour (mph) or kilometers per hour (km/h). The odometer shows how far your vehicle has been driven, in either miles (used in the United States) or kilometers (used in Canada).

If your vehicle has to have a new odometer installed, the new one may read the correct mileage. This is because your vehicle's computer has stored the mileage in memory.

While the Driver Shift Control (DSC) feature is active, the odometer will change to show the gear range. See *Automatic Transmission Operation on page 2-25* for more information.

Trip Odometers

The trip odometer can record the number of miles or kilometers traveled for up to two trips.

The trip odometer is part of the Driver Information Center (DIC). To access the trip odometer, use one of the following procedures:

Using the Base audio system, do the following:

1. Press the INFO (Information) button located to the right of the screen to access the DIC menu.
2. Scroll through the menu using the up or down arrows on the INFO button until you reach Trip Odometer A or Trip Odometer B.

The selected trip odometer (A or B) will be displayed at the top of the screen with the accumulated mileage.

3. Repeat the steps to view the other trip odometer.

You can reset the selected trip odometer by pressing CLR (Clear) button located in the center of the INFO button to the right of the screen. The mileage for that trip odometer will return to zero. Each trip odometer must be reset individually.

Using the Navigation audio system, do the following:

1. Press and hold the vehicle information button in the upper right corner of the screen for three seconds to access the Vehicle Information menu.
2. Use the up and down arrows on the screen to bring TRIP A or TRIP B into view. Then press the button next to the trip you wish to be viewed.

The selected trip odometer (A or B) will be displayed at the top of the screen with the accumulated mileage.

3. Press the RETURN button to return to the previous page.
4. Repeat the steps to view the other trip odometer.

You can reset the selected trip odometer by pressing RESET button on the Vehicle Information menu. The mileage for the selected trip odometer will return to zero. Each trip odometer must be reset individually.

Tachometer

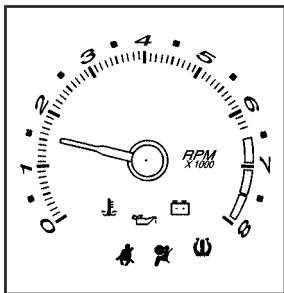

This gage indicates the engine speed in revolutions per minute (rpm).

Notice: If you operate the engine with the tachometer in the shaded warning area, your vehicle could be damaged, and the damages would not be covered by your warranty. Do not operate the engine with the tachometer in the shaded warning area.

Engine Speed Limiter

This feature prevents the engine from operating at too many revolutions per minute (rpm). When the engine's rpms are too high, the throttle is closed to reduce speed. If this is not sufficient, then the fuel supply to the engine will be limited. When the rpms return to normal, the fuel supply will return to normal. This helps prevent damage to the engine.

Safety Belt Reminder Light

When the key is turned to ON or START, a chime will be provided for several seconds to remind people to buckle their safety belts. The driver safety belt light will also be provided and stay on for several seconds, then it will flash for several more. You should buckle your seat belt.



This chime and light will be repeated if the driver remains unbuckled and the vehicle is in motion.

If the driver's belt is buckled, neither the chime nor the light will be provided.

Airbag Readiness Light

There is an airbag readiness light on the instrument panel, which shows the airbag symbol. The system checks the airbag's electrical system for malfunctions. The light tells you if there is an electrical problem. The system check includes the airbag sensors, the airbag modules, the wiring and the diagnostic module. For more information on the airbag system, see *Airbag System* on page 1-47.

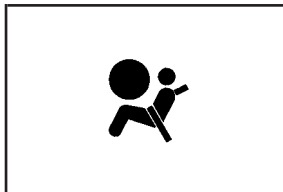

This light will come on when you start your vehicle, and it will flash for a few seconds. Then the light should go out. This means the system is ready.

If the airbag readiness light stays on after you start the vehicle or comes on when you are driving, your airbag system may not work properly. Have your vehicle serviced right away.

CAUTION:

If the airbag readiness light stays on after you start your vehicle, it means the airbag system may not be working properly. The airbags in your vehicle may not inflate in a crash, or they could even inflate without a crash. To help avoid injury to yourself or others, have your vehicle serviced right away if the airbag readiness light stays on after you start your vehicle.

The airbag readiness light should flash for a few seconds when you turn the ignition key to ON. If the light doesn't come on then, have it fixed so it will be ready to warn you if there is a problem.

If there is a problem with the airbag system in your vehicle, the Service airbag message will appear on the DIC display. See *DIC Warnings and Messages* on page 3-57 for more information.

Charging System Light

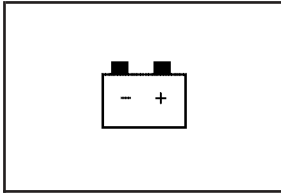

When you turn the key to ON or START, this light will come on briefly to show that the generator and battery charging systems are working properly.

If this light stays on, your vehicle needs service. You should take your vehicle to the dealer at once. To save your battery until you get there, turn off all accessories.

Brake System Warning Light

Your vehicle's hydraulic brake system is divided into two parts. If one part isn't working, the other part can still work and stop you. For good braking, though, you need both parts working well.

If the warning light comes on, there is a brake problem. Have your brake system inspected right away.

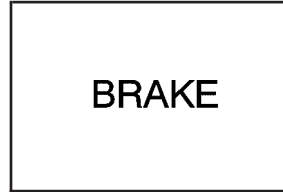

United States

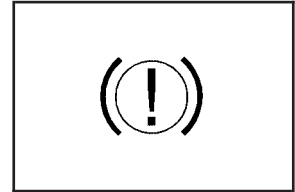

Canada

This light should come on briefly when you turn the ignition key to ON. If it doesn't come on then, have it fixed so it will be ready to warn you if there's a problem.

When the ignition is on, the brake system warning light will also come on when you set your parking brake. The light will stay on if your parking brake doesn't release fully. If it stays on after your parking brake is fully released, it means you have a brake problem.

If the light comes on while you are driving, pull off the road and stop carefully. You may notice that the pedal is harder to push, or the pedal may go closer to the floor. It may take longer to stop. If the light is still on, have the vehicle towed for service. See *Towing Your Vehicle* on page 4-50.

⚠ CAUTION:

Your brake system may not be working properly if the brake system warning light is on. Driving with the brake system warning light on can lead to an accident. If the light is still on after you have pulled off the road and stopped carefully, have the vehicle towed for service.

Anti-Lock Brake System Warning Light

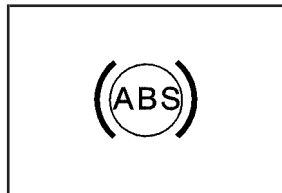

With the anti-lock brake system, the light will come on when your engine is started and may stay on for several seconds. That's normal.

If the ABS warning light comes on and stays on, there may be a problem with the anti-lock portion of the brake system. If the red BRAKE light is not on, you still have brakes, but you don't have anti-lock brakes. See *Brake System Warning Light* on page 3-38.

If the light stays on, turn the ignition to OFF. If the light comes on when you're driving, stop as soon as possible and turn the ignition off. Then start the engine again to reset the system. If the light still stays on, or comes on again while you're driving, your vehicle needs service. If the regular brake system warning light isn't on, you still have brakes, but you don't have anti-lock brakes. If the regular brake system warning light is also on, you don't have anti-lock brakes and there's a problem with your regular brakes. See *Brake System Warning Light* on page 3-38.

Traction Control System (TCS) Warning Light

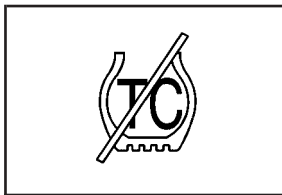

If the TC (traction control) warning light comes on and stays on, there may be a problem with the traction control system.

The TC (traction control) warning light will come on briefly when you turn the ignition to ON. If it doesn't come on then, have it fixed so it will be ready to warn you if there is a problem.

The light will also come on if you turn the traction control system off using the TC (traction control) on/off button located near the shift lever.

If the TC (traction control) warning light stays on or comes on while you are driving, pull off the road as soon as possible and stop carefully. Try resetting the system by turning the ignition off then back on. If the light still stays on or comes back on again while you are driving, your vehicle needs service. Have the traction control system inspected as soon as possible.

See *Traction Control System (TCS)* on page 4-9 for more information.

Engine Coolant Temperature Warning Light (CTS)

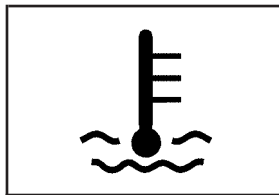

This light tells you that your engine is very hot.

This light will come on when you first start the vehicle as a check to let you know that the light is working. It will go out after a few seconds. If the light does not come on, the bulb may be burned out. See your dealer for assistance in changing the bulb.

If the light does not go out or if the light comes on and stays on while you are driving, your vehicle may have a problem with the cooling system. You should stop the vehicle and turn off the engine as soon as possible to avoid damage to the engine. A warning chime will sound when this light is on, also.

See *Engine Overheating* on page 5-27.

Engine Coolant Temperature Gage

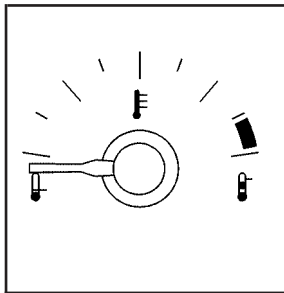

This gage shows the engine coolant temperature. If the gage pointer moves into the shaded area, the engine is too hot.

That reading means the same thing as the warning light – the engine coolant is very hot. See *Engine Overheating* on page 5-27.

Tire Pressure Light

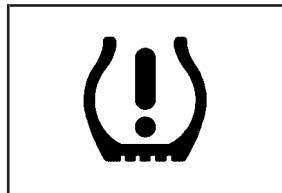

If your vehicle has the Tire Pressure Monitor (TPM) System, this light will come on if the system detects low tire pressure.

This light will also come on for a bulb check when the vehicle is started.

See *Tire Pressure Monitor System* on page 5-61 for more information.

For more information on the proper tire pressure, see *Loading Your Vehicle* on page 4-45. For more information on your tires, see *Tires* on page 5-52.

Malfunction Indicator Lamp

Check Engine Light

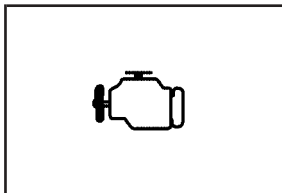

Your vehicle is equipped with a computer which monitors operation of the fuel, ignition, and emission control systems.

This system is called OBD II (On-Board Diagnostics-Second Generation) and is intended to assure that emissions are at acceptable levels for the life of the vehicle, helping to produce a cleaner environment. The check engine light comes on to indicate that there is a problem and service is required. Malfunctions often will be indicated by the system before any problem is apparent. This may prevent more serious damage to your vehicle. This system is also designed to assist your service technician in correctly diagnosing any malfunction.

Notice: If you keep driving your vehicle with this light on, after awhile, your emission controls may not work as well, your fuel economy may not be as good, and your engine may not run as smoothly. This could lead to costly repairs that may not be covered by your warranty.

Notice: Modifications made to the engine, transmission, exhaust, intake, or fuel system of your vehicle or the replacement of the original tires with other than those of the same Tire Performance Criteria (TPC) can affect your vehicle's emission controls and may cause this light to come on. Modifications to these systems could lead to costly repairs not covered by your warranty. This may also result in a failure to pass a required Emission Inspection/Maintenance test.

This light should come on, as a check to show you it is working, when the ignition is on and the engine is not running. If the light does not come on, have it repaired. This light will also come on during a malfunction in one of two ways:

- **Light Flashing** — A misfire condition has been detected. A misfire increases vehicle emissions and may damage the emission control system on your vehicle. Diagnosis and service may be required.
- **Light On Steady** — An emission control system malfunction has been detected on your vehicle. Diagnosis and service may be required.

If the Light is Flashing

The following may prevent more serious damage to your vehicle:

- Reducing vehicle speed
- Avoiding hard accelerations
- Avoiding steep uphill grades
- If you are towing a trailer, reduce the amount of cargo being hauled as soon as it is possible

If the light stops flashing and remains on steady, see “If the Light Is On Steady” following.

If the light continues to flash, when it is safe to do so, stop the vehicle. Find a safe place to park your vehicle. Turn the key off, wait at least 10 seconds and restart the engine. If the light remains on steady, see “If the Light Is On Steady” following. If the light is still flashing, follow the previous steps, and see your dealer for service as soon as possible.

If the Light Is On Steady

You may be able to correct the emission system malfunction by considering the following:

Did you recently put fuel into your vehicle?

If so, reinstall the fuel cap, making sure to fully install the cap. See *Filling Your Tank on page 5-8*. The diagnostic system can determine if the fuel cap has been left off or improperly installed. A loose or missing fuel cap will allow fuel to evaporate into the atmosphere. A few driving trips with the cap properly installed should turn the light off.

Did you just drive through a deep puddle of water?

If so, your electrical system may be wet. The condition will usually be corrected when the electrical system dries out. A few driving trips should turn the light off.

Have you recently changed brands of fuel?

If so, be sure to fuel your vehicle with quality fuel. See *Gasoline Octane on page 5-5*. Poor fuel quality will cause your engine not to run as efficiently as designed. You may notice this as stalling after start-up, stalling when you put the vehicle into gear, misfiring, hesitation on acceleration, or stumbling on acceleration. (These conditions may go away once the engine is warmed up.) This will be detected by the system and cause the light to turn on.

If you experience one or more of these conditions, change the fuel brand you use. It will require at least one full tank of the proper fuel to turn the light off.

If none of the above steps have made the light turn off, your dealer can check the vehicle. Your dealer has the proper test equipment and diagnostic tools to fix any mechanical or electrical problems that may have developed.

Emissions Inspection and Maintenance Programs

Some state/provincial and local governments have or may begin programs to inspect the emission control equipment on your vehicle. Failure to pass this inspection could prevent you from getting a vehicle registration.

Here are some things you need to know to help your vehicle pass an inspection:

Your vehicle will not pass this inspection if the check engine light is on or not working properly.

Your vehicle will not pass this inspection if the OBD (on-board diagnostic) system determines that critical emission control systems have not been completely diagnosed by the system. The vehicle would be considered not ready for inspection. This can happen if you have recently replaced your battery or if your battery has run down. The diagnostic system is designed to evaluate critical emission control systems during normal driving. This may take several days of routine driving. If you have done this and your vehicle still does not pass the inspection for lack of OBD system readiness, your GM dealer can prepare the vehicle for inspection.

Oil Pressure Light

CAUTION:

Do not keep driving if the oil pressure is low. If you do, your engine can become so hot that it catches fire. You or others could be burned. Check your oil as soon as possible and have your vehicle serviced.

Notice: Lack of proper engine oil maintenance may damage the engine. The repairs would not be covered by your warranty. Always follow the maintenance schedule in this manual for changing engine oil.

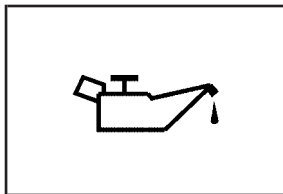

This light tells you if there could be a problem with your engine oil pressure.

The light goes on when you turn your key to ON or START. It goes off once you start your engine. That's a check to be sure the light works. If it doesn't come on, be sure to have it fixed so it will be there to warn you if something goes wrong.

When the light comes on and stays on, it means that oil isn't flowing through your engine properly. You could be low on oil and you might have some other system problem.

Sport Mode Light

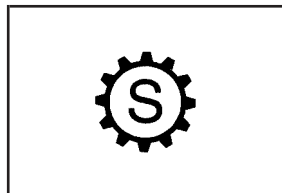

This light will come on while the Driver Shift Control (DSC) feature is in use.

When you stop using the DSC feature, the light will go out. If it stays on, your vehicle may need service. See your dealer. See "Driver Shift Control (DSC)" under *Automatic Transmission Operation* on page 2-25 for more information.

Security Light

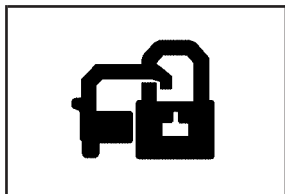

For information regarding this light, see *Theft-Deterrent System* on page 2-17.

Lights On Reminder

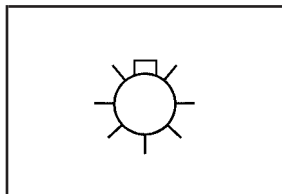

This light comes on whenever the parking lamps are on.

Fog Lamp Light

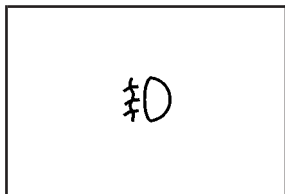

The fog lamps light will come on when the fog lamps are in use.

See *Headlamps on Reminder* on page 3-16 for more information.

Cruise Control Light

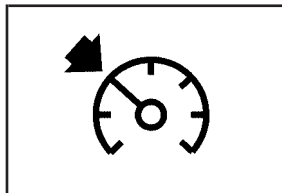

This light comes on whenever you set your cruise control.

The light will go out when the fog lamps are turned off. See *Fog Lamps* on page 3-18 for more information.

The light will go out when the cruise control is turned off. See *Cruise Control* on page 3-12 for more information.

Highbeam On Light

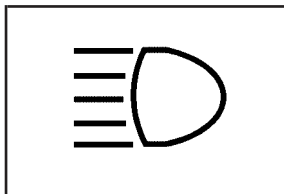

This light comes on whenever the high-beam headlamps are on.

See *Headlamp High/Low-Beam Changer* on page 3-9 for more information.

Fuel Gage

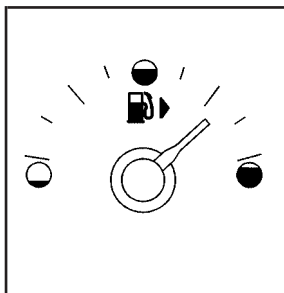

The fuel gage shows approximately how much fuel is in the tank. It works only when the ignition is in ON.

If the fuel supply gets low, the Fuel Level Low message will appear on the DIC and a single chime will sound. See *DIC Warnings and Messages* on page 3-57 for more information.

Here are a few concerns some owners have had about the fuel gage. All of these situations are normal and do not indicate that anything is wrong with the fuel gage:

- At the gas station the gas pump shuts off before the gage reads full.
- The gage may change when you turn, stop quickly or accelerate quickly.
- It takes a little more or less fuel to fill the tank than the gage indicated. For example, the gage may have indicated that the tank was half full, but it actually took a little more or less than half the tank's capacity to fill the tank.

Driver Information Center (DIC)

The DIC gives you the status of many of your vehicle's systems. It is also used to display driver personalization features and warning/status messages.

If your vehicle has the base audio system, use the information contained in this manual for instructions on operating the DIC for your vehicle.

If your vehicle has the Navigation system, see the SRX Navigation System manual for instructions on operating the DIC for your vehicle.

System Controls



Use the following controls located on the audio system to operate the DIC:

INFO (Information): Use the up or down arrows on this switch to scroll through the system status information.

CLR (Clear): Press this button to clear DIC messages and to reset some DIC displays to zero. This button is also used to exit out of a menu. See *DIC Warnings and Messages on page 3-57* and *Status of Vehicle Systems on page 3-49* for more information.

TUNE/SEL (Select) Knob: To scroll through the menu items displayed, turn the knob, located in the lower right corner. Press the knob to select the menu item.

Status of Vehicle Systems

You can view the status of several vehicle systems using the DIC.

Vehicle Information Menu

To access this menu, press the up or down arrow on the INFO switch located to the right of the display.

The following items are available when the ignition is in RUN. These items will not be available when the ignition is in accessory. The tire pressure menu items are only available if your vehicle has the Tire Pressure Monitor (TPM) System:

- OUTSIDE TEMP
- MI TRIP A*
- MI TRIP B*
- MILES RANGE
- MPG AVG*
- MPG INST
- GAL FUEL USED*

- AVG MPH*
- TIMER*
- BATTERY VOLTS
- ENGINE OIL LIFE*
- TRANS FLUID LIFE*
- PSI LF TIRE
- PSI RF TIRE
- PSI RR TIRE
- PSI LR TIRE
- BLANK LINE

*These items can be reset. Each one must be reset individually. For a detailed description of the menu items and how to reset them, see “Vehicle Information Menu Item Descriptions” later in this section.

You can view any of these items at any time, but only one item can be displayed at a time.

Vehicle Information Menu Item Descriptions

The following paragraphs contain a more detailed description of each menu item:

OUTSIDE TEMP: If you select this item, the current outside temperature is displayed at the top of the screen. It will be in either degrees Fahrenheit or degrees Celsius depending upon whether the system is set for English or metric units. If you wish to change the units, see *DIC Main Menu on page 3-53*.

MI TRIP A and B: For information on the trip odometers, see *Trip Odometers on page 3-35*.

MILES RANGE: If you select this item, the approximate number of remaining miles or kilometers you can drive without refueling is displayed. This estimate is based on the current driving conditions and will change if the driving conditions change. For example, if you are driving in traffic making frequent stops, the display may read one number, but if you enter the freeway, the number may change even though you still have the same amount of gas in the gas tank. This is because different driving conditions produce different fuel economies. Generally, freeway driving produces better fuel economy than city driving.

If your vehicle is low on fuel, the Fuel Level Low message will be displayed. See “Fuel Level Low” under *DIC Warnings and Messages on page 3-57* for more information.

MPG AVG: If you select this item, the approximate average miles per gallon (mpg) or Liters per 100 kilometers (L/100km) is displayed. This number is calculated based on the number of mpg (L/100km) recorded since the last time this menu item was reset.

To reset the MPG AVG, press the CLR button located to the right of the screen. The display will return to zero.

MPG INST: If you select this item, the current fuel economy is displayed. This number reflects only the fuel economy that the vehicle has right now and will change frequently as driving conditions change. Unlike average fuel economy, this menu item cannot be reset.

GAL FUEL USED: If you select this item, the number of gallons or liters of fuel used since the last reset of this menu item is displayed.

To reset GAL FUEL USED, press the CLR button located to the right of the screen. The display will return to zero.

AVG MPH: If you select this item, the average speed of the vehicle is displayed in miles per hour (mph) or kilometers per hour (km/h). This average is calculated based on the various vehicle speeds recorded since the last reset of this menu item.

To reset AVG MPH, press the CLR button located to the right of the screen. The display will return to zero.

TIMER: If you select this item, a timing feature is displayed. The timer functions like a stopwatch in that you can record the time it takes to travel from one point to another.

To turn on the timer, press the CLR button located to the right of the screen once. To turn off the timer, press the CLR button again.

When the timer is off, the display will show the timer value and TIMER OFF. The timing feature will stop.

To reset the timer, turn off the timer and then press and hold the CLR button. The display will return to zero.

BATTERY VOLTS: If you select this item, the current battery voltage is displayed. If the voltage is in the normal range, the display will have OK after it. For example, the display may read 13.2 Battery Volts OK.

If there is a problem with the battery charging system, there are four possible DIC messages that may be displayed. See *DIC Warnings and Messages on page 3-57* for more information.

ENGINE OIL LIFE: If you select this item, the percentage of remaining oil life is displayed. If you see 99% Oil Life on the display, that means that 99% of the current oil life remains.

When the oil life is depleted, the Change Engine Oil message will appear on the display. See your GM dealer for service. In addition to the engine oil life system monitoring the oil life, additional maintenance is recommended in the Maintenance Schedule in this manual. See *Scheduled Maintenance on page 6-4* and *Engine Oil on page 5-16* for more information.

When you reset the Change Engine Oil message by clearing it from the display, you still must reset the engine oil life system separately. For more information on resetting the engine oil life system, see “How to Reset the Engine Oil Life System and the Oil Life Indicator” under *Engine Oil Life System on page 5-20*.

TRANS FLUID LIFE: If you select this item, the percentage of remaining transmission fluid life is displayed. If you see 99% Trans Fluid Life on the display, that means that 99% of the current transmission fluid life remains.

When the transmission fluid life is depleted, the Change Transmission Fluid message will appear on the display. You should change the transmission fluid as soon as possible within 200 miles (320 km). Be sure to keep a written record of the mileage and date of the fluid change so you will have it for future reference.

When you reset the Change Transmission Fluid message by clearing it from the display, you still must reset the transmission fluid life monitor separately. For more information on resetting the transmission fluid life monitor, see *Automatic Transmission Fluid on page 5-23*.

LF TIRE: If you select this item, the driver's side front tire pressure will be displayed. If the tire pressure is low, LOW will be displayed with this item. The pressure can be displayed in PSI or KPA. To change the units, see *DIC Main Menu on page 3-53*.

RF TIRE: If you select this item, the passenger's side front tire pressure will be displayed. If the tire pressure is low, LOW will be displayed with this item. The pressure can be displayed in PSI or KPA. To change the units, see *DIC Main Menu on page 3-53*.

RR TIRE: If you select this item, the passenger's side rear tire pressure will be displayed. If the tire pressure is low, LOW will be displayed with this item. The pressure can be displayed in PSI or KPA. To change the units, see *DIC Main Menu on page 3-53*.

LR TIRE: If you select this item, the driver's side rear tire pressure will be displayed. If the tire pressure is low, LOW will be displayed with this item. The pressure can be displayed in PSI or KPA. To change the units, see *DIC Main Menu on page 3-53*.







DIC Main Menu

Accessing the DIC Main Menu

To access the main menu of the DIC, do the following:

1. Press the TUNE/SEL knob once.
2. Turn the TUNE/SEL knob clockwise or counterclockwise to scroll through the menu items.

The DIC main menu consists of the following menu items:

-  BASS - MID - TREBLE
-  EQ
- DSP
- DVD
- AVC
- H/A
- AUTO STORE
- CAT
- TA
- RDS MSG
- AF
- SEEK LOCAL/DISTANT
-  (English/Metric Units)
- TCS
-  (Clock)
-  /  (Clock/Information Display)
- SETUP

DIC Main Menu Item Descriptions

 **BASS - MID (Midrange) - TREBLE:** This menu item allows you to adjust the levels for the bass, midrange, treble, balance, and fade features of the audio system. For more information, see “Setting the Tone (Bass/Treble)” and “Adjusting the Speakers (Balance/Fade)” under *Radio with CD on page 3-81*.

 **EQ (Equalizer):** This menu item allows you to choose among five preset equalizations for the audio system. See “Audio Equalizer” under *Radio with CD on page 3-81* for more information.

DSP (Digital Signal Processing): This menu item allows you to select the DSP type that you want on the audio system. You may choose Normal, Talk, Spacious, Rear Seat or Driver Seat. Press the TUNE/SEL knob to scroll through these choices. Once the desired choice is displayed, turn the knob to set your DSP choice and continue scrolling through the main menu.

See “Using DSP” under *Radio with CD on page 3-81* for more information.

DVD (Digital Versatile Disc): This menu item allows you to turn the DVD on and off. Press the TUNE/SEL knob once to turn DVD on and off. When DVD is on, an X will be in the box next to DVD on the menu. The X disappears when DVD is off.

See *Rear Seat Entertainment System on page 3-98* for more information.

AVC (Automatic Volume Compensation): This menu item allows you to turn the AVC feature on and off. Press the TUNE/SEL knob once to turn AVC on and off. When AVC is on, an X will be in the box next to AVC on the menu. The X disappears when AVC is off.

See “AVC (Automatic Volume Compensation)” under *Radio with CD on page 3-81* for more information.

H/A (Home/Away Preset Stations): This menu item allows you to switch back and forth between your home and away preset radio stations. Press the TUNE/SEL knob to switch between home and away.

See “Setting Preset Stations” under *Radio with CD on page 3-81* for more information.

AUTOSTORE: This menu item allows you to automatically store radio stations with the strongest signals as presets. See “Setting Preset Stations” *Radio with CD on page 3-81* for more information.

CAT (Category): This menu item allows you to select radio stations based on preset categories. To turn the CAT feature on, press the TUNE/SEL knob once. When CAT is on, an X will be in the box next to CAT on the menu. The X disappears when CAT is off.

See *Radio with CD on page 3-81* for more information.

TA (Traffic Announcement): This menu item allows you to turn the TA feature on and off. To turn the TA feature on, press the TUNE/SEL knob once. When TA is on, an X will be in the box next to TA on the menu. The X disappears when TA is off.

See “RDS Messages” under *Radio with CD on page 3-81* for more information.

RDS (Radio Data System) MSG (Message): This menu item allows you to view an RDS radio station message broadcast by a radio station. To view the message, press the TUNE/SEL knob once. The message will appear on the screen.

See “RDS Messages” under *Radio with CD on page 3-81* for more information.

AF (Alternate Frequency): This menu item allows you to turn the AF feature on and off. To turn on AF, press the TUNE/SEL knob once. When AF is on, an X will be in the box next to AF on the menu. The X disappears when AF is off.

See “Radio Data System (RDS)” under *Radio with CD on page 3-81* for more information.

SEEK LOCAL/DISTANT: This feature instructs the audio system to seek only local radio stations with the strongest signal or to seek all radio stations with a strong signal in a large area. Use LOCAL when you are in urban areas where there are several strong radio station signals and you want to limit the number of stations to those with the strongest signals only. Use DISTANT when you are in rural areas where there are fewer radio station signals available.

To switch between LOCAL and DISTANT, press the TUNE/SEL knob. Your choice will be set when you press BACK and return to the main menu.



(English/Metric Units): Use this menu item to adjust the measurement units.

You can choose between ENGLISH UNITS and METRIC UNITS. To switch between the two, press the TUNE/SEL knob. Once your choice is displayed, turn the knob to set your choice and continue scrolling through the main menu.

The measurement units that you choose will be reflected on all the vehicle system displays, not just the DIC information. For example, the climate control panel will display degrees Celsius if you choose METRIC UNITS.

TCS (Traction Control System): You can enable or disable the traction control system using this menu item. Press the TUNE/SEL knob to switch between on and off.

You can also turn the traction control system off using the traction control button located near the shift lever.

When you disable the traction control system, the Traction Suspended message will appear on the DIC and the traction control system warning light on the instrument panel cluster will come on. See *DIC Warnings and Messages on page 3-57* and *Traction Control System (TCS) Warning Light on page 3-40* for more information.



(Clock): Use this menu item to set the time on the vehicle's clock.

See *Setting the Time on page 3-80* for more information.



(Clock/Information Display): Use this menu item to toggle between the clock display and the XM™ Information (Song, Artist, Title), if available.

See *Radio with CD on page 3-81* for more information.

SETUP: When you select this menu item, the following submenu is available:

- Personalization
- Language
- Configure Display Keys

To change the language displayed on the radio, select LANGUAGE by pressing the TUNE/SEL knob. Turn the TUNE/SEL knob to scroll through the available languages and press the knob to make your selection. If you accidentally select a language that you did not want, ENGLISH is always at the top of the language list.

For more information on the other items in the SETUP menu, see *DIC Vehicle Personalization on page 3-66*.

DIC Warnings and Messages

These messages will appear if there is a problem sensed in one of your vehicle's systems.

You must acknowledge a message to clear it from the screen for further use. To clear a message, press the CLR button.

Be sure to take any message that appears on the screen seriously and remember that clearing the message will only make the message disappear, not the problem.

Battery Saver Active

This message appears when the system detects that the battery voltage is dropping beyond a reasonable level. The battery saver system will start reducing certain features of the vehicle that you may not be able to notice. At the point that the features are disabled, this message is displayed. It means that the vehicle is trying to save the charge in the battery.

Turn off all unnecessary accessories to allow the battery to recharge.

The normal battery voltage range is 11.5 to 15.5 volts. You can monitor battery voltage on the DIC by pressing the INFO button until you find BATTERY VOLTS.

Battery Voltage High

This message indicates that the electrical charging system is overcharging the battery. When the system detects that the battery voltage is above approximately 16 volts, this message will be displayed.

To reduce the charging overload, use the vehicle's accessories. Turn on the exterior lamps and radio, set the climate control on AUTO and the fan speed on the highest setting, and turn the rear window defogger on.

The normal battery voltage range is 11.5 to 15.5 volts when the engine is running. You can monitor battery voltage on the DIC by pressing the INFO button until you find BATTERY VOLTS.

Battery Voltage Low

This message will appear when the electrical system is charging less than 10 volts or if the battery has been drained.

If this message appears immediately after starting the engine, it is possible that the generator can still recharge the battery. The battery should recharge while driving but may take a few hours to do so. Consider using an auxiliary charger (be sure to follow the manufacturer's instructions) to boost the battery after returning home or to a final destination.

If this message appears while driving or after starting your vehicle and stays on, have it checked by your GM dealer immediately to determine the cause of this problem.

To help the generator recharge the battery quickly, you can reduce the load on the electrical system by turning off the accessories.

The normal battery voltage range is 11.5 to 15.5 volts. You can monitor battery voltage on the DIC by pressing the INFO button until you find BATTERY VOLTS.

Change Engine Oil

When this message comes on, it means that service is required for your vehicle. See your GM dealer. See *Engine Oil on page 5-16* and *Scheduled Maintenance on page 6-4* for more information.

When you reset the Change Engine Oil message by clearing it from the display, you still must reset the engine oil life system separately. For more information on resetting the engine oil life system, see *Engine Oil Life System on page 5-20*.

Change Trans (Transmission) Fluid

This message indicates that the life of the transmission fluid has expired and it should be changed within 200 miles (320 km). See *Scheduled Maintenance on page 6-4* and *Recommended Fluids and Lubricants on page 6-11* for the proper fluid and change intervals.

When you reset the Change Trans Fluid message by clearing it from the display, you still must reset the transmission fluid life monitor separately. For more information on resetting the transmission fluid life monitor, see *Automatic Transmission Fluid on page 5-23*.

Check Brake Fluid

This message will display if the ignition is in ON to inform the driver that the brake fluid level is low. Have the brake system serviced by your GM dealer as soon as possible. See *Brake System Warning Light on page 3-38* and *Brakes on page 5-37* for more information.

Check Coolant Level

This message will appear when there is a low level of engine coolant. Have the cooling system serviced by your GM dealer as soon as possible. See *Engine Coolant on page 5-24* for more information.

Notice: If your engine catches fire because you keep driving with no coolant, your vehicle can be badly damaged. The costly repairs would not be covered by your warranty. See *Overheated Engine Protection Operating Mode on page 5-29* for information on driving to a safe place in an emergency.

Check Gas Cap

When this message appears on the display, the gas cap has not been fully tightened. You should recheck the gas cap to ensure that it is on and tightened properly. See *Malfunction Indicator Lamp on page 3-42* for more information.

Check Oil Level

This message indicates that the oil level is low. See *Engine Oil on page 5-16* for more information on checking your engine oil.

Check Tire Pressure

This message indicates that one or more of the vehicle's tires are low. See *Status of Vehicle Systems on page 3-49* for information on checking your vehicle's tire pressures. Also, see *Tire Pressure Monitor System on page 5-61* and *Inflation - Tire Pressure on page 5-58* for more information.

Check Washer Fluid

When this message appears on the display, it means that your vehicle is low on windshield washer fluid. You should refill the tank as soon as possible. See *Windshield Washer Fluid on page 5-36* for more information.

Driver Door Ajar

When this message appears on the display, it means that the driver's door was not closed completely. You should make sure that the driver's door is closed completely.

Engine Coolant Hot – AC (Air Conditioning) Off

This message displays when the engine coolant becomes hotter than the normal operating temperature. To avoid added strain on a hot engine, the air conditioning compressor is automatically turned off. When the coolant temperature returns to normal, the air conditioning compressor will turn back on. You can continue to drive your vehicle.

If this message continues to appear, have the system repaired by your GM dealer as soon as possible to avoid compressor damage.

Engine Coolant Hot – Idle Engine

This message will appear when the engine coolant temperature is too hot. Stop and allow the vehicle to idle until it cools down.

Notice: If you drive your vehicle while the engine is overheating, severe engine damage may occur. If an overheat warning appears on the instrument panel cluster and/or DIC, stop the vehicle as soon as possible. Do not increase the engine speed above normal idling speed. See *Engine Overheating on page 5-27* for more information.

Engine Overheated – Stop Engine

This message will appear when the engine has overheated. Stop the vehicle and turn the engine off immediately to avoid severe engine damage. See *Engine Overheating on page 5-27*. A chime will also sound when this message is displayed.

Notice: If you drive your vehicle while the engine is overheating, severe engine damage may occur. If an overheat warning appears on the instrument panel cluster and/or DIC, stop the vehicle as soon as possible. Do not increase the engine speed above normal idling speed. See *Engine Overheating on page 5-27* for more information.

Engine Power Reduced

This message informs you that the vehicle is reducing engine power because the transmission is being placed in gear under conditions that may cause damage to the vehicle's engine or transmission. This also can affect the vehicle's ability to accelerate.

Fuel Level Low

When this message appears on the display, it means that your vehicle is low on fuel. You should refill the tank as soon as possible. A single chime will sound when this message is displayed.

Headlamps Suggested

This message will appear when the amount of available light outside the vehicle is low and the exterior lamp control is off. This message informs the driver that turning on the exterior lamps is recommended even though the daytime running lamps (DRL) are still illuminated and it has become dark enough outside to require the headlamps and/or other exterior lamps.

This message will also appear when the windshield wipers have been on for more than six seconds and the exterior lamp control is off or in the parking lamp position.

Ice Possible

This message appears when the outside temperature is cold enough to create icy road conditions.

Left Rear Door Ajar

When this message appears on the display, it means that the driver's side rear door was not closed completely. You should make sure that the door is closed completely.

Lift Gate Ajar

When this message appears on the display, it means that the liftgate was not closed completely. You should make sure that the liftgate is closed completely.

Oil Pressure Low – Stop Engine

A multiple chime will sound when this message is displayed.

Notice: If you drive your vehicle while the engine oil pressure is low, severe engine damage may occur. If a low oil pressure warning appears on the instrument panel cluster and/or DIC, stop the vehicle as soon as possible. Do not drive the vehicle until the cause of the low oil pressure is corrected. See *Engine Oil on page 5-16* for more information.

Passenger Door Ajar

When this message appears on the display, it means that the passenger's side front door was not closed completely. You should make sure that the door is closed completely.

Right Rear Door Ajar

When this message appears on the display, it means that the passenger's side rear door was not closed completely. You should check to make sure that the door is closed completely.

Service AC (Air Conditioning) System

This message appears when the electronic sensors that control the air conditioning and heating systems are no longer working. Have the climate control system serviced by your GM dealer if you notice a drop in heating and air conditioning efficiency.

Service Air Bag

There is a problem with the air bag system when this message appears. Have your vehicle serviced at your GM dealer immediately. See *Airbag Readiness Light* on page 3-37 for more information.

Service Charging System

This message will display when a problem with the charging system has been detected. Have your vehicle serviced at your GM dealer.

Service Electrical System

This message will display if an electrical problem has occurred within the Powertrain Control Module (PCM) or the ignition switch. Have your vehicle serviced at your GM dealer.

Service Fuel System

The Powertrain Control Module (PCM) has detected a problem within the fuel system when this message appears. Have your vehicle serviced at your GM dealer.

Service Idle Control

A problem with the idle control has occurred when this message displays. Have your vehicle serviced at your GM dealer.

Service Stability System Message

Your vehicle is equipped with a vehicle stability enhancement system called StabiliTrak[®].

See *StabiliTrak[®] System* on page 4-10. The Service Stability System message will be displayed if there has been a problem detected with StabiliTrak[®].

If the Service Stability System message comes on while you are driving, pull off the road as soon as possible and stop carefully. Try resetting the system by turning the ignition off then back on. If the Service Stability System message still stays on or comes back on again while you are driving, your vehicle needs service. Have the StabiliTrak[®] System inspected at your GM dealer as soon as possible.

Service Steering System

Your vehicle may be equipped with a speed variable assist steering system. See *Steering on page 4-12*.

The Service Steering System message will be displayed if a problem is detected with the speed variable assist steering system. When this message is displayed, you may notice that the effort required to steer the vehicle increases or feels “heavier,” but you will still be able to steer the vehicle.

Service Suspension System

This message is displayed to indicate that the suspension system is not operating properly. Have your vehicle serviced at your GM dealer.

Service Theft System

This message means there is a problem with the immobilizer. See *Immobilizer on page 2-18* for more information. A fault has been detected in the system which means that the system is disabled and is not protecting the vehicle. The vehicle usually restarts, however, you may want to take your vehicle to your GM dealer before turning off the engine.

Service Tire Monitor System

This message will appear if the Tire Pressure Monitor (TPM) system is not working properly. Have your vehicle serviced at your GM dealer as soon as possible. See *Tire Pressure Monitor System on page 5-61* for more information.

Service Transmission

There is a problem with the transmission of your vehicle. Have your vehicle serviced at your GM dealer.

Service Vehicle Soon

This message is displayed when a non-emissions related powertrain malfunction occurs. Have your vehicle serviced at your GM dealer as soon as possible.

Speed Limited to XXX

This message indicates that your vehicle speed is limited to XXX (mph in English mode and km/h in Metric mode) because the vehicle detects a problem in the suspension system. Have your vehicle serviced at your GM dealer.

Stability System Engaged Message

The Stability System Engaged message will be displayed any time Stabilitrak[®] is actively assisting you with directional control of the vehicle. Slippery road conditions may exist when this message is displayed, so adjust your driving accordingly. This message may stay on for a few seconds after Stabilitrak[®] stops assisting you with directional control of the vehicle. See *Stabilitrak[®] System on page 4-10* for more information.

Stability System Off Message

The Stability System Off message will be displayed any time you turn off Stabilitrak[®] using the TC (traction control) on/off button. See *Traction Control System (TCS) on page 4-9* for more information. When this message has been displayed, Stabilitrak[®] is no longer available to assist you with directional control of the vehicle. Adjust your driving accordingly.

Stability System Ready Message

The Stability System Ready message will be displayed any time you turn Stabilitrak[®] on again using the TC (traction control) on/off button. See *Traction Control System (TCS) on page 4-9* for more information. When this message has been displayed, Stabilitrak[®] is ready to assist you with directional control of the vehicle if needed.

Starting Disabled – Remove Key

This message will appear when the vehicle theft-deterrent system detects that an improper ignition key is being used to try to start the vehicle. Check the ignition key for damage. If it is damaged, it may need to be replaced. If it is not damaged, remove the key and try to start the vehicle again. If it still does not start, try another ignition key or have your vehicle serviced at your GM dealer.

Starting Disabled – Throttle Problem

This message appears when your vehicle's throttle system is not functioning properly. Have your vehicle serviced at your GM dealer.

Theft Attempted

This message is displayed if the content theft-deterrent system has detected a break-in attempt while you were away from your vehicle.

Top Speed – Fuel Cut Off

This message will appear when the Engine Control Module (ECM) detects that the maximum speed for your vehicle has been reached. Your vehicle's top speed is based on the top speed rating of the tires. This ensures that your vehicle stays in a safe operating range for the tires.

Traction Engaged

This message will appear when the traction control system is actively limiting wheel spin. Slippery road conditions may exist if this message is displayed, so adjust your driving accordingly. The message will stay on for a few seconds after the traction control system stops limiting wheel spin. See *Traction Control System (TCS) on page 4-9* for more information.

Traction Suspended

This message will appear when the traction control system has been temporarily shut off because your vehicle's brakes have overheated. This message does not indicate a problem with your vehicle's traction control system. See *Traction Control System (TCS) on page 4-9* for more information.

Trans (Transmission) Hot – Idle Engine

This message indicates that the transmission fluid in your vehicle is too hot. Stop the vehicle and allow it to idle until the transmission cools down or until this message is removed.

Turn Signal On

If you drive your vehicle for more than about 1 mile (1.6 km) with a turn signal on, this message will appear as a reminder to turn off the turn signal. A multiple chime will sound when this message is displayed.

DIC Vehicle Personalization

Your vehicle is equipped with personalization that allows you to program certain features to a preferred setting for up to two people. The number of programmable features varies depending upon which model of the vehicle is purchased.

On all vehicles, features such as climate control settings, radio preset settings, exterior lighting at unlock, remote lock and unlock confirmation, and automatic door locks have already been programmed for your convenience.

Some vehicles are equipped with additional features that can be programmed including the seat and outside rearview mirror position.

If your vehicle is equipped with the ability to program additional personalization features, the driver's preferences are recalled by pressing the unlock button on the remote keyless entry transmitter, 1 or 2, or by pressing the appropriate memory button, 1 or 2, located on the driver's door. Certain features can be programmed not to recall until the key is placed in the ignition. To change feature preferences, see "Entering the Personalization Menu" following.

Entering the Personalization Menu

To enter the feature programming mode, use the following procedure:

1. Turn the ignition to ON, but do not start the engine. Make sure the vehicle is in PARK (P).
2. If your vehicle has memory settings, press the appropriate memory button, 1 or 2, located on the driver's door armrest. The DIC display will show either Driver 1 or 2 depending on which button was selected.
3. Press the TUNE/SEL knob once to access the main menu of the DIC.
4. Turn the TUNE/SEL knob until SETUP is highlighted.
5. Press the TUNE/SEL knob once to access the SETUP menu.
6. Scroll to the feature you want to change, and press the TUNE/SEL knob to turn the feature on or off. If the feature is turned on, a check mark will appear next to the feature name.

If none of the personalization items are turned on, turn on the personalization menu by pressing the TUNE/SEL knob. The list of features will then appear, and you can repeat Step 6.

Personalization Features

The following choices are available for programming:

Personalization Name

This feature allows you to type in a name that will appear on the DIC display whenever the corresponding remote keyless entry transmitter is used or one of the buttons on the driver's door armrest (1 or 2) is pressed.

If a customized name is not programmed, the system will show Driver 1 or Driver 2 to correspond with the numbers on the back of the remote keyless entry transmitters.

To program a name, use the following procedure:

1. Enter the Personalization menu by following the instructions listed previously.
2. Select the PERSONALIZATION NAME menu item by pressing the TUNE/SEL knob once.

You will see a cursor on the screen.

3. Turn the TUNE/SEL knob until you reach the first letter you want; the letter will be highlighted. There is a complete alphabet with both upper and lower case letters and the numbers zero through nine. Also included are spaces and other non-letter characters such as the ampersand (&).
4. Press the TUNE/SEL knob once to select the letter. The letter will then appear on the display. If you make a mistake, press the TUNE/SEL knob repeatedly to cycle through all the characters until you reach the character you wish to change.
5. Repeat Steps 3 and 4 until the name you want is complete. You can program up to 16 characters.

The name you selected is now set. You can either exit the programming mode by following the instructions later in this section or program the next feature available on your vehicle.

Configure Display Keys

This feature allows you to customize the functions of the four soft keys located to the left and right of the audio display. See "Configurable Radio Display Keys" under *Radio with CD on page 3-81* for programming information.

Remote Recall Memory

If your vehicle has the optional memory package, you will have this feature. When this feature is turned on, you can recall any previously programmed seat, adjustable pedals and mirror controls when the unlock button on the remote keyless entry transmitter is pressed.

Programmable Modes

Mode 1: ON

Mode 2: OFF

Before your vehicle was shipped from the factory, it was programmed to Mode 2. The mode to which the vehicle was programmed may have been changed since it left the factory.

To program the vehicle to a different mode, the following procedure:

1. Enter the personalization portion of the SETUP menu following the instructions listed previously.
2. Scroll to REMOTE RECALL MEMORY to highlight it.
3. Press the TUNE/SEL knob to switch back and forth between on and off.

When the mode is turned on, a check mark will appear next to the feature name.

The mode you selected is now set. You can either exit the programming mode by following the instructions later in this section or program the next feature available on your vehicle.

Remote Exit Recall

If your vehicle has the optional memory package, you will have this feature. When this feature is turned on, you can recall any previously programmed exit position for the driver's seat when the unlock button on the remote keyless entry transmitter is pressed.

Programmable Modes

Mode 1: ON

Mode 2: OFF

Before your vehicle was shipped from the factory, it was programmed to Mode 2. The mode to which the vehicle was programmed may have been changed since it left the factory.

To program the vehicle to a different mode, use the following procedure:

1. Enter the personalization portion of the SETUP menu following the instructions listed previously.
2. Scroll to REMOTE EXIT RECALL to highlight it.
3. Press the TUNE/SEL knob to switch back and forth between on and off.

When the mode is turned on, a check mark will appear next to the feature name.

The mode you selected is now set. You can either exit the programming mode by following the instructions later in this section or program the next feature available on your vehicle.

Key in Recall Memory

If your vehicle has the optional memory package, you will have this feature. When this feature is turned on, you can recall any previously programmed seat and mirror positions when the key is inserted into the ignition.

Programmable Modes

Mode 1: ON

Mode 2: OFF

Before your vehicle was shipped from the factory, it was programmed to Mode 2. The mode to which the vehicle was programmed may have been changed since it left the factory.

To program the vehicle to a different mode, use the following procedure:

1. Enter the personalization portion of the SETUP menu following the instructions listed previously.
2. Scroll to KEY IN RECALL MEMORY to highlight it.
3. Press the TUNE/SEL knob to switch back and forth between on and off.

When the mode is turned on, a check mark will appear next to the feature name.

The mode you selected is now set. You can either exit the programming mode by following the instructions later in this section or program the next feature available on your vehicle.

Auto Exit Seat

If your vehicle has the optional memory package, you will have this feature. When this feature is turned on, you can recall any previously programmed exit position for the driver's seat when the key is removed from the ignition and the driver's door is opened.

Programmable Modes

Mode 1: ON

Mode 2: OFF

Before your vehicle was shipped from the factory, it was programmed to Mode 2. The mode to which the vehicle was programmed may have been changed since it left the factory.

To program the vehicle to a different mode, use the following procedure:

1. Enter the personalization portion of the SETUP menu following the instructions listed previously.
2. Scroll to AUTO EXIT SEAT using the TUNE/SEL knob to highlight it.
3. Press the TUNE/SEL knob to switch back and forth between on and off.

When the mode is turned on, a check mark will appear in the box next to the feature name.

The mode you selected is now set. You can either exit the programming mode by following the instructions later in this section or program the next feature available on your vehicle.

Twilight Delay

This feature allows you to set the amount of time you want the exterior lamps to remain on after you exit the vehicle.

Programmable Modes

Mode 1: 0:00 seconds

Mode 2: 0:15 seconds

Mode 3: 0:30 seconds

Mode 4: 1:00 minute

Mode 5: 1:30 minutes

Mode 6: 2:00 minutes

Mode 7: 2:30 minutes

Mode 8: 3:00 minutes

Before your vehicle was shipped from the factory, it was programmed to Mode 1. The mode to which the vehicle was programmed may have been changed since the vehicle left the factory.

To determine the mode to which the vehicle is programmed or to program the vehicle to a different mode, use the following procedure:

1. Enter the personalization portion of the SETUP menu following the instructions listed previously.
2. Scroll to TWILIGHT DELAY using the TUNE/SEL knob to highlight it.
3. Press the TUNE/SEL knob to scroll through the available delay settings. When the delay time you want is highlighted, press the TUNE/SEL knob once to select it.

When the mode is turned on, an X will appear in the box to the left.

If you choose Mode 1, the exterior lamps will not illuminate when you exit the vehicle. Only one mode can be selected at a time.

The mode you selected is now set. You can either exit the programming mode by following the instructions later in this section or program the next feature available on your vehicle.

Lights Flash at Unlock

This feature flashes the exterior lamps when the remote keyless entry transmitter is used to unlock the vehicle. The lamps will flash for approximately 20 seconds unless a door is opened, the ignition is turned to ACCESSORY, ON or START or the remote keyless entry transmitter is used to lock the vehicle.

Programmable Modes

Mode 1: ON

Mode 2: OFF

Before your vehicle was shipped from the factory, it was programmed to Mode 1. The mode to which the vehicle was programmed may have been changed since it left the factory.

To program the vehicle to a different mode, use the following procedure:

1. Enter the personalization portion of the SETUP menu following the instructions listed previously.
2. Scroll to LIGHTS FLASH AT UNLOCK to highlight it.
3. Press the TUNE/SEL knob to switch back and forth between on and off.

When the mode is turned on, a check mark will appear next to the feature name.

The mode you selected is now set. You can either exit the programming mode by following the instructions later in this section or program the next feature available on your vehicle.

Lights Flash at Lock

This feature allows the exterior lamps to flash once when the remote keyless entry transmitter is used to lock the vehicle. All doors must be closed for this feature to work, and the lamps will not flash if the parking lamps or headlamps are on.

Programmable Modes

Mode 1: ON

Mode 2: OFF

Before your vehicle was shipped from the factory, it was programmed to Mode 1. The mode to which the vehicle was programmed may have been changed since it left the factory.

To program the vehicle to a different mode, use the following procedure:

1. Enter the personalization portion of the SETUP menu following the instructions listed previously.
2. Scroll to LIGHTS FLASH AT LOCK to highlight it.
3. Press the TUNE/SEL knob to switch back and forth between on and off.

When the mode is turned on, a check mark will appear next to the feature name.

You can select this feature by itself, or you can combine it with Horn Sounds At Lock so that both the lights flash and the horn chirps when you lock your vehicle.

The mode you selected is now set. You can either exit the programming mode by following the instructions later in this section or program the next feature available on your vehicle.

Horn Sounds at Lock

This feature sounds the horn once when the remote keyless entry transmitter is used to lock the vehicle. All doors must be closed for this feature to work.

Programmable Modes

Mode 1: ON

Mode 2: OFF

Before your vehicle was shipped from the factory, it was programmed to Mode 2. The mode to which the vehicle was programmed may have been changed since it left the factory.

To program the vehicle to a different mode, use the following procedure:

1. Enter the personalization portion of the SETUP menu following the instructions listed previously.
2. Scroll to HORN SOUNDS AT LOCK to highlight it.
3. Press the TUNE/SEL knob to switch back and forth between on and off.

When the mode is turned on, a check mark will appear next to the feature name.

If you select this feature to be on, Lights Flash At Lock will also be on. You can choose Lights Flash At Lock by itself, but Horn Sounds At Lock will always have Lights Flash At Lock enabled when it is selected.

The mode you selected is now set. You can either exit the programming mode by following the instructions later in this section or program the next feature available on your vehicle.

Exterior Lights at Unlock

This feature turns on the exterior lamps when the remote keyless entry transmitter is used to unlock the vehicle. The lamps will remain on for about 20 seconds unless a door is opened, the ignition is turned to ACCESSORY, ON or START or the remote keyless entry transmitter is used to lock the vehicle.

Programmable Modes

Mode 1: ON

Mode 2: OFF

Before your vehicle was shipped from the factory, it was programmed to Mode 1. The mode to which the vehicle was programmed may have been changed since it left the factory.

To program the vehicle to a different mode, use the following procedure:

1. Enter the personalization portion of the SETUP menu following the instructions listed previously.
2. Scroll to EXT. LIGHT AT UNLOCK to highlight it.
3. Press the TUNE/SEL knob to switch back and forth between on and off.

When the mode is turned on, a check mark will appear next to the feature name.

The mode you selected is now set. You can either exit the programming mode by following the instructions later in this section or program the next feature available on your vehicle.

Driver Unlock in Park

The feature allows the driver's door to automatically unlock when the transmission is shifted into PARK (P).

Programmable Modes

Mode 1: ON

Mode 2: OFF

Before your vehicle was shipped from the factory, it was programmed to Mode 2. The mode to which the vehicle was programmed may have been changed since it left the factory.

To program the vehicle to a different mode, use the following procedure:

1. Enter the personalization portion of the SETUP menu following the instructions listed previously.
2. Scroll to DRIVER UNLOCK IN PARK to highlight it.
3. Press the TUNE/SEL knob to switch back and forth between on and off.

When the mode is turned on, a check mark will appear next to the feature name.

The mode you selected is now set. You can either exit the programming mode by following the instructions later in this section or program the next feature available on your vehicle.

Driver Unlock Key Out

This feature allows the driver's door to automatically unlock when the key is removed from the ignition.

Programmable Modes

Mode 1: ON

Mode 2: OFF

Before your vehicle was shipped from the factory, it was programmed to Mode 2. The mode to which the vehicle was programmed may have been changed since it left the factory.

To program the vehicle to a different mode, use the following procedure:

1. Enter the personalization portion of the SETUP menu following the instructions listed previously.
2. Scroll to DRIVER UNLOCK KEY OUT.
3. Press the TUNE/SEL knob to switch between on and off.

When the mode is turned on, a check mark will appear next to the feature name.

The mode you selected is now set. You can either exit the programming mode by following the instructions later in this section or program the next feature available on your vehicle.

Doors Unlock in Park

The feature allows the doors to automatically unlock when the transmission is shifted into PARK (P).

Programmable Modes

Mode 1: ON

Mode 2: OFF

Before your vehicle was shipped from the factory, it was programmed to Mode 2. The mode to which the vehicle was programmed may have been changed since it left the factory.

To program the vehicle to a different mode, use the following procedure:

1. Enter the personalization portion of the SETUP menu following the instructions listed previously.
2. Scroll to DOORS UNLOCK IN PARK to highlight it.
3. Press the TUNE/SEL knob to switch back and forth between on and off.

When the mode is turned on, a check mark will appear next to the feature name.

The mode you selected is now set. You can either exit the programming mode by following the instructions later in this section or program the next feature available on your vehicle.

Doors Unlock Key Out

This feature allows the doors to automatically unlock when the key is removed from the ignition.

Programmable Modes

Mode 1: ON

Mode 2: OFF

Before your vehicle was shipped from the factory, it was programmed to Mode 2. The mode to which the vehicle was programmed may have been changed since it left the factory.

To program the vehicle to a different mode, use the following procedure:

1. Enter the personalization portion of the SETUP menu following the instructions listed previously.
2. Scroll to DOORS UNLOCK KEY OUT.
3. Press the TUNE/SEL knob to switch between on and off.

When the mode is turned on, a check mark will appear next to the feature name.

The mode you selected is now set. You can either exit the programming mode by following the instructions later in this section or program the next feature available on your vehicle.

Delayed Locking

This feature delays the locking of the vehicle's doors for up to five seconds after a power door lock switch or the lock button on the remote keyless entry transmitter is pressed. The five second delay occurs after the last door is closed.

Programmable Modes

Mode 1: ON

Mode 2: OFF

Before your vehicle was shipped from the factory, it was programmed to Mode 1. The mode to which the vehicle was programmed may have been changed since it left the factory.

To program the vehicle to a different mode, use the following procedure:

1. Enter the personalization portion of the SETUP menu following the instructions listed previously.
2. Scroll to DELAYED LOCKING using the TUNE/SEL knob to highlight it.
3. Press the TUNE/SEL knob to switch back and forth between on and off.

When the mode is turned on, a check mark will appear next to the feature name.

The mode you selected is now set. You can either exit the programming mode by following the instructions later in this section or program the next feature available on your vehicle.

Lock Passenger Window

This feature allows you to disable either all the passenger window switches or the rear passenger window switches only. If this feature is turned on, all passenger window switches will be disabled when the window lockout button is pressed. If the feature is off, only the rear passenger window switches will be disabled. See *Power Windows on page 2-14* for more information.

Programmable Modes

Mode 1: ON

Mode 2: OFF

Before your vehicle was shipped from the factory, it was programmed to Mode 2. The mode to which the vehicle was programmed may have been changed since it left the factory.

To program the vehicle to a different mode, use the following procedure:

1. Enter the personalization portion of the SETUP menu following the instructions listed previously.
2. Scroll to LOCK PASS WINDOW using the TUNE/SEL knob to highlight it.
3. Press the TUNE/SEL knob to switch back and forth between on and off.

When the mode is turned on, a check mark will appear next to the feature name.

The mode you selected is now set. You can either exit the programming mode by following the instructions later in this section or program the next feature available on your vehicle.

Mirror to Curb in Reverse

If your vehicle has the optional memory package, you will have this feature. When this feature is turned on, the passenger's outside rearview mirror will move downward so you can view the curb when the shift lever is shifted into REVERSE (R). The mirror will return to the last known driving position when the shift lever is moved out of REVERSE (R). See *Outside Curb View Assist Mirror on page 2-39* for more information.

Programmable Modes

Mode 1: ON

Mode 2: OFF

Before your vehicle was shipped from the factory, it was programmed to Mode 2. The mode to which the vehicle was programmed may have been changed since it left the factory.

To program the vehicle to a different mode, use the following procedure:

1. Enter the personalization portion of the SETUP menu following the instructions listed previously.
2. Scroll to MIRROR TO CURB IN REV using the TUNE/SEL knob to highlight it.
3. Press the TUNE/SEL knob to switch back and forth between on and off.

When the mode is turned on, a check mark will appear next to the feature name.

The mode you selected is now set. You can either exit the programming mode by following the instructions later in this section or program the next feature available on your vehicle.

Enhanced Chime Volume

This feature allows you to adjust the volume level of the vehicle's warning chimes. The chime volume cannot be turned off, only adjusted.

Programmable Modes

Mode 1: NORMAL

Mode 2: LOUD

Before your vehicle was shipped from the factory, it was programmed to Mode 1. The mode to which the vehicle was programmed may have been changed since it left the factory.

To program the vehicle to a different mode, use the following procedure:

1. Enter the personalization portion of the SETUP menu following the instructions listed previously.
2. Scroll to ENHANCED CHIME VOLUME using the TUNE/SEL knob to highlight it.
3. Press the TUNE/SEL knob to switch back and forth between the normal and loud settings.

The mode you selected is now set. You can either exit the programming mode by following the instructions later in this section or program the next feature available on your vehicle.

Exiting the Personalization Menu

Once you have finished making your selections, you will return to the main audio screen.

Audio System(s)

Notice: Before adding any sound equipment to your vehicle, like a tape player, CB radio, mobile telephone, or two-way radio, make sure that it can be added by checking with your dealer. Also, check federal rules covering mobile radio and telephone units. If sound equipment can be added, it is very important to do it properly. Added sound equipment may interfere with the operation of your vehicle's engine, radio, or other systems, and even damage them. Your vehicle's systems may interfere with the operation of sound equipment that has been added improperly.

Figure out which audio system is in your vehicle, find out what your audio system can do, and how to operate all of its controls.

Your vehicle has a feature called Retained Accessory Power (RAP). With RAP, the audio system can be played even after the ignition is turned off. See *Retained Accessory Power (RAP)* on page 2-22 for more information.

Setting the Time

1. Press the TUNE/SEL knob to enter the main menu.
2. Turn the TUNE/SEL knob until SET CLOCK appears on the display.
3. Press the TUNE/SEL knob to select SET CLOCK.
4. Turn the TUNE/SEL knob to adjust the time.
5. Press the TUNE/SEL knob to update the time. VEHICLE TIME UPDATED will appear on the display.

If the CLOCK/RADIO DISP is configured into one of the configurable keys, pressing the key will switch the display between the radio station frequency and the time. See "Configurable Radio Display Keys" under *Radio with CD on page 3-81* for more information on configuring the keys.

Radio with CD



**Radio with CD shown,
Radio with Six-Disc CD similar**

Radio Data System (RDS)

The audio system has a Radio Data System (RDS). RDS features are available for use only on FM stations that broadcast RDS information.

With RDS, the radio can do the following:

- Seek to stations broadcasting the selected type of programming
- Receive announcements concerning local and national emergencies
- Display messages from radio stations
- Seek to stations with traffic announcements

This system relies upon receiving specific information from these stations and will only work when the information is available. In rare cases, a radio station may broadcast incorrect information that will cause the radio features to work improperly. If this happens, contact the radio station.

While the radio is tuned to an RDS station, the station name or call letters will appear on the display instead of the frequency. RDS stations may also provide the time of day, a program type (PTY) for current programming, and the name of the program being broadcast.

XM™ Satellite Radio Service

XM™ is a satellite radio service that is based in the 48 contiguous United States. XM™ offers 100 coast to coast channels including music, news, sports, talk, and children's programming. XM™ provides digital quality audio and text information, including song title and artist name. A service fee is required in order to receive the XM™ service. For more information, contact XM™ at www.xmradio.com or call 1-800-852-XXXM (9696).

CLOCK/INFO DISP (Clock/Information Display):

Press the CLOCK/INFO DISP button to switch between the clock display, the XM screen, and the XM information display.

Press this button while in XM mode to retrieve three different categories of information related to the current song or channel: Artist, Song Title, and Category.

To view this information, perform the following:

1. Press the TUNE/SEL knob to enter the main menu.
2. Turn the TUNE/SEL knob until CLOCK/INFO DISP appears on the display.
3. Press the TUNE/SEL knob to select CLOCK/INFO DISP. The display will change to show the additional XM information.
4. To return to the original display, press the CLR button or wait for the display to time out.

If the CLOCK/INFO DISP is configured into one of the configurable keys, pressing the key will switch the display between the radio station frequency and the time. See "Configurable Radio Display Keys" later in this section for more information.

Playing the Radio

PWR (Power): Press this knob to turn the system on and off.

VOL (Volume): Turn this knob to increase or to decrease the volume.

AVC (Automatic Volume Compensation): Available only with the premium Bose® audio system, AVC monitors the noise in the vehicle and will adjust the volume level so that it always sounds the same to you. AVC works best when listening at low volume levels. At loud listening levels there will be little or no effect. To turn AVC on and off, perform the following steps:

1. Press the TUNE/SEL knob to enter the main menu.
2. Turn the TUNE/SEL knob until AUTO VOLUME COMP. appears on the display.
3. Press the TUNE/SEL knob to turn AVC on or off. An X will appear in the box when AVC is selected on.
4. Press the CLR button to exit the display. To return to the original display, repeatedly press the CLR button or wait for the display to time out.

SOURCE: Press this button to select a source, either radio or CD. The CD must be loaded to select the source and to play. CD will appear on the display if a CD is loaded. If a CD is not loaded the display will not change from the radio source.

Finding a Station

BAND: Press this button to select FM1, FM2, AM, or XM1 or XM2 (if equipped).

▲ SEEK ▼: Press the up or the down arrow to go to the next or to the previous station and stay there. SEEK will appear on the display. The sound will mute while seeking.

The radio will only seek stations with a strong signal that are in the selected band.

▲ SCAN ▼: Press the SCAN button to enter scan mode. SCAN will appear on the display. Press the up arrow to scan to the next station. The radio will go to a station, play for 5 seconds, then go on to the next station. Press this button again to stop scanning.

To scan preset stations, press and hold SCAN for more than two seconds until you hear a beep and PSCAN appears on the display. The radio will go to the first preset station stored on your pushbuttons, play for 5 seconds, then go on to the next preset station. Press SCAN again to stop scanning presets.

The radio will only scan stations with a strong signal that are in the selected band.

LOCAL/DISTANT Selection: With this feature you can set the radio to search for local stations or stations that are further away for a larger selection. To set this feature to LOCAL or DISTANT, perform the following steps:

1. Press the TUNE/SEL knob to enter the main menu.
2. Turn the TUNE/SEL knob until SEEK LOCAL or SEEK DISTANT appears on the display.
3. Press the TUNE/SEL knob to select either LOCAL or DISTANT.
4. Press the CLR button to exit the display. To return to the original display, repeatedly press the CLR button or wait for the display to time out.

To search for stations, press the SEEK up or down arrows. If the system is set to LOCAL, SEEK will appear in the display and seek to stations with strong signals only. If the system is set to DISTANT, D-SEEK will appear in the display and seek to stations with weak and strong signals.

Setting Preset Stations

Up to 30 stations (six FM1, six FM2, and six AM, six XM1 and six XM2 (if equipped)), can be programmed on the six numbered pushbuttons, by performing the following steps:

1. Turn the radio on.
2. Press BAND to select FM1, FM2, or AM, or XM1 or XM2.
3. Tune in the desired station.
4. Press and hold one of the six numbered pushbuttons for two seconds until you hear a beep. The set preset station number will appear on the display above the pushbutton that it is set to. Whenever that numbered pushbutton is pressed for less than two seconds, the station that was set will return.
5. Repeat the steps for each pushbutton.

To set the preset stations with an equalization setting, DSP setting, or a PTY setting, see each of these features later in this section. When a preset station is selected, once one of these additional settings is selected, the preset station will remember each setting and it will remain active, until the setting is selected off for that preset station.

AUTOSTORE PRESETS: To set the preset stations automatically, perform the following steps:

1. Turn the radio on.
2. Press BAND to select FM1, FM2, or AM.
3. Press the TUNE/SEL knob to enter the main menu.
4. Turn the TUNE/SEL knob until AUTOSTORE PRESETS appears on the display.
5. Press the TUNE/SEL knob to select. AUTOSTORE will appear on the display. The radio will automatically search the band and select and store the six radio stations with the strongest signal. The stations will be stored by signal strength, not sequential order. The set preset station number will appear on the display above the pushbutton that it is set to. Whenever that numbered pushbutton is pressed for less than two seconds, the station that was set will return.
6. Press the CLR button to exit the display. To return to the original display, repeatedly press the CLR button or wait for the display to time out.

When battery power is removed and later applied, you will not have to reset your radio presets.

PRESETS HOME/AWAY: This feature gives you the ability to store two different kinds of station presets. HOME can be used for stations available where you live and AWAY can be for stations available outside of your local broadcasting area. To set preset stations for home and away perform the following steps:

1. Press the TUNE/SEL knob to enter the main menu.
2. Turn the TUNE/SEL knob until PRESETS HOME/AWAY appears on the display.
3. Press the TUNE/SEL knob to select. HOME or AWAY will appear on the display.
4. Press the CLR button to exit the display. To return to the original display, repeatedly press the CLR button or wait for the display to time out.

Follow the manual or automatic steps previously listed for setting the preset pushbuttons for both home and away.

Setting the Tone (Bass/Treble)

To adjust the bass, midrange, and treble, perform the following steps:

1. Press the TUNE/SEL knob to enter the main menu.
2. Turn the TUNE/SEL knob until BASS-MID-TREBLE appears on the display.
3. Press the TUNE/SEL knob to enter the tone settings.
4. Press the TUNE/SEL knob to scroll through the settings.
5. Turn the TUNE/SEL knob to increase or to decrease the bass, midrange, or treble. If a station is weak or noisy, decrease the treble.
6. Press the TUNE/SEL knob to set the adjustment.
7. Press the CLR button to exit the display. To return to the original display repeatedly press the CLR button or wait for the display to time out.

AUDIO EQUALIZER: This feature allows you to select customized equalization settings. To choose an equalization setting (EQ0 through EQ5), perform the following steps:

1. Press the TUNE/SEL knob to enter the main menu.
2. Turn the TUNE/SEL knob until EQUALIZER appears on the display.
3. Press the TUNE/SEL knob to set the equalization setting. The equalization setting will appear on the display.
4. Press the CLR button to exit the display. To return to the original display, repeatedly press the CLR button or wait for the display to time out.

The equalization settings are preset to EQ0 (Normal), EQ1 (Pop), EQ2 (Rock), EQ3 (Jazz), EQ4 (Talk), and EQ5 (Country).

Adjusting the Speakers (Balance/Fade)

To adjust the balance or fade, perform the following steps:

1. Press the TUNE/SEL knob to enter the main menu.
2. Turn the TUNE/SEL knob until BASS-MID-TREBLE appears on the display.
3. Press the TUNE/SEL knob to enter the tone settings.
4. Press the TUNE/SEL knob to scroll to BALANCE or FADER.
5. Turn the TUNE/SEL knob to adjust the BALANCE to the right or the left speakers and the FADER to the front or the rear speakers.
6. Press the TUNE/SEL knob to set the adjustment.
7. Press the CLR button to exit the display.
To return to the original display, repeatedly press the CLR button or wait for the display to time out.

EQ0 will not appear on the display when in this mode.

Using DSP

Available only with the premium Bose® audio system, this feature is used to provide a choice of five different listening experiences: DSP normal, talk, spacious, rear seat, and driver seat. DSP can be used while listening to the radio or the CD player. The radio keeps separate DSP settings for each band, preset, and source. To select a DSP choice, perform the following steps:

1. Press the TUNE/SEL knob to enter the main menu.
2. Turn the TUNE/SEL knob until one of the five settings appears on the display.
3. Press the TUNE/SEL knob to select a DSP setting.
4. Press the CLR button to exit the display. To return to the original display, repeatedly press the CLR button or wait for the display to time out.

DSP NORMAL: This setting provides the best overall audio performance for all passengers. DSP NORMAL will not appear on the display when in this mode.

TALK: This setting should be used when listening to non-musical material such as news, talk shows, sports broadcasts, and books on tape. Talk makes spoken words sound very clear.

SPACIOUS: This setting is used to make the listening space seem larger.

REAR SEAT: This setting adjusts the audio to give the rear seat passenger(s) the best possible sound quality. Sound quality for the front seat passengers may be different when this setting is used.

DRIVER SEAT: This setting adjusts the audio to give the driver the best possible sound quality. Sound quality for the front and rear seat passenger(s) may be different when this setting is used.

RDS Messages

ALERT: Alert warns of local and national emergencies. When, an alert announcement comes on the current radio station or a related network station, ALERT will appear on the display. You will hear the announcement, even if the volume is low or a CD is playing. If a CD is playing, play will stop during the announcement. Alert announcements cannot be turned off. If the radio tunes to a related network station for the announcement, it will return to the original station when the announcement is finished.

ALERT will not be affected by tests of the emergency broadcast system. This feature is not supported by all RDS stations.

MSG (Message): If the current RDS station has a message, MSG will appear on the display. The message may display the artist, song title, call in phone numbers, etc. If the entire message does not appear on the display, parts of the message will appear every three seconds until the message is completed. Once the completed message has been displayed, MSG will disappear from the display until another new message is received.

To display the last message, perform the following steps:

1. Press the TUNE/SEL knob to enter the main menu.
2. Turn the TUNE/SEL knob until RECALL RDS MESSAGE appears on the display.
3. Press the TUNE/SEL knob. The message will appear on the display.

Once the message has been displayed, MSG will disappear from the display until another new message is received.

TP (Traffic Program): TP will appear on the display when the radio detects a signal from an RDS station that has traffic announcement broadcast capability.

TA (Traffic Announcement): If TA appears on the display, the tuned radio station broadcasts traffic announcements and when a traffic announcement comes on the tuned station you will hear it.

If the station does not broadcast traffic announcements, when TA is turned on it will seek to a station that does. When a station that broadcasts traffic announcements is found, the radio will stop seeking and TA will appear on the display. If no station is found that broadcasts traffic announcements, No Traffic will appear on the display.

The radio will play traffic announcements if the volume is low. The radio will interrupt the play of a CD if the last tuned station broadcasts traffic announcements.

To turn TA on or off, perform the following steps:

1. Press the TUNE/SEL knob to enter the main menu.
2. Turn the TUNE/SEL knob until TRAFFIC ANNOUNCE appears on the display.
3. Press the TUNE/SEL knob to select ON or OFF. An X will appear in the box when TA is selected on.
4. Press the CLR button to exit the display. To return to the original display, repeatedly press the CLR button or wait for the display to time out.

Activating Program Type (PTY) Stations (RDS and XM™)

PTY allows you to search for stations with specific types of music. The selectable PTYs are POP, EASY, TALK, CENTRY (Country), CLASS (Classical), and JAZZ.

To activate program types, perform the following steps:

1. Press the TUNE/SEL knob to enter the main menu.
2. Turn the TUNE/SEL knob until PROGRAM TYPE MODE appears on the display.
3. Press the TUNE/SEL knob to select ON or OFF. An X will appear in the box when PTY is selected on.
4. Press the CLR button to exit the display. To return to the original display, repeatedly press the CLR button or wait for the display to time out.

Once program type is activated the PTYs will appear on the display above the pushbuttons, in place of the preset stations (if programmed). Press the pushbutton for the PTY that you would like to listen to. Not all stations support PTYs. The radio may not go to all of the stations with that music type when pressing the pushbutton.

AF (Alternate Frequency): Alternate frequency allows the radio to switch to a stronger station with the same program type.

To turn AF on or off, perform the following steps:

1. Press the TUNE/SEL knob to enter the main menu.
2. Turn the TUNE/SEL knob until ALTERNATE FREQ. appears on the display.
3. Press the TUNE/SEL knob to select AF OFF, AF ON, or AF REG. An X will appear in the box when AF is selected on.
4. Press the CLR button to exit the display. To return to the original display, repeatedly press the CLR button or wait for the display to time out.

Radio Message

THEFTLOCK: This message is displayed when the THEFTLOCK® system has been activated. Take the vehicle to the dealer for service.

XM™ Radio Messages

Radio Display Message	Condition	Action Required
XL (Explicit Language Channels)	XL on the radio display, after the channel name, indicates content with explicit language.	These channels, or any others, can be blocked at a customer's request, by calling 1-800-852-XXMX (9696).
XM Updating	Updating encryption code	The encryption code in the receiver is being updated, and no action is required. This process should take no longer than 30 seconds.
No XM Signal	Loss of signal	The system is functioning correctly, but the vehicle is in a location that is blocking the XM signal. When the vehicle is moved into an open area, the signal should return.
Loading XM	Acquiring channel audio (after 4 second delay)	The audio system is acquiring and processing audio and text data. No action is needed. This message should disappear shortly.
Channel Off Air	Channel not in service	This channel is not currently in service. Tune in to another channel.
Channel Unavail	Channel no longer available	This previously assigned channel is no longer assigned. Tune to another station. If this station was one of the presets, choose another station for that preset button.
No Artist Info	Artist Name/Feature not available	No artist information is available at this time on this channel. The system is working properly.
No Title Info	Song/Program Title not available	No song title information is available at this time on this channel. The system is working properly.

XM™ Radio Messages (cont'd)

Radio Display Message	Condition	Action Required
No CAT Info	Category Name not available	No category information is available at this time on this channel. The system is working properly.
Not Found	No channel available for the chosen category	There are no channels available for the selected category. The system is working properly.
No Information	No Text/Informational message available	No text or informational messages are available at this time on this channel. The system is working properly.
XM Lock	Theft lock active	The XM receiver in your vehicle may have previously been in another vehicle. For security purposes, XM receivers cannot be swapped between vehicles. If this message is received after having your vehicle serviced, check with your GM dealer.
XM Radio ID	Radio ID label (channel 0)	If tuned to channel 0, this message will alternate with the XM Radio 8 digit radio ID label. This label is needed to activate the service.
Unknown	Radio ID not known (should only be if hardware failure)	If this message is received when tuned to channel 0, there may be a receiver fault. Consult with your GM dealer.
Check XM Receiver	Hardware failure	If this message does not clear within a short period of time, the receiver may have a fault. Consult with your GM dealer.

Using the Single CD Player

Insert a CD partway into the slot, label side up. The player will pull it in. If the ignition and the radio are on the CD will begin playing. A CD may be loaded with the radio off but it will not start playing until the radio is on.

If the ignition or radio is turned off with a CD in the player, it will stay in the player. When the ignition or radio is turned on, the CD will start to play where it stopped, if it was the last selected audio source.

When the CD is inserted, CD will appear on the display. As each new track starts to play, the track number will appear on the display.

The CD player can play the smaller 3 inch (8 cm) single CDs with an adapter ring. Full-size CDs and the smaller CDs are loaded in the same manner.

If playing a CD-R the sound quality may be reduced due to CD-R quality, the method of recording, the quality of the music that has been recorded, and the way the CD-R has been handled. There may be an increase in skipping, difficulty in finding tracks, and/or difficulty in loading and ejecting. If these problems occur try a known good CD.

Do not add paper labels to CDs, they could get caught in the CD player.

If an error appears on the display, see "CD Messages" later in this section.

When a CD is inserted the CD functions will appear on the display above the pushbuttons, in place of the preset stations (if programmed).

F1 PREV (Previous): Press this pushbutton to go to the previous track. Press and hold this pushbutton to reverse quickly within a track. Release the pushbutton to play the passage. The elapsed time of the track will appear on the display.

F2 NEXT: Press this pushbutton to go to the next track. Press and hold this pushbutton to advance quickly within a track. Release the pushbutton to play the passage. The elapsed time of the track will appear on the display.

F3 RDM (Random): Press this pushbutton to listen to the tracks in random, rather than sequential, order. RANDOM will appear on the display. Press RDM again to turn off random play. RANDOM will disappear from the display.

F4 RPT (Repeat): Press this pushbutton to hear a track over again. REPEAT will appear on the display. Press RPT again to turn off repeat play. REPEAT will disappear from the display.

F6 DISP (Display): Press this pushbutton to display the time of the track. Press this pushbutton again to remove the time of the track from the display.

▲ SEEK ▼: Press the up or the down arrow to go to the next or to the previous track on the CD.

▲ SCAN ▼: Press this button to listen to each track for 10 seconds. The CD will go to a track, play for 10 seconds, then go on to the next track. Press this button again to stop scanning.

▲ (Eject): Press this button to stop a CD when it is playing or to eject a CD when it is not playing. Eject may be activated with the ignition and the radio off.

Using the Six-Disc CD Changer

The CD player can play the smaller 3 inch (8 cm) single CDs with an adapter ring. Full-size CDs and the smaller CDs are loaded in the same manner.

If playing a CD-R the sound quality may be reduced due to CD-R quality, the method of recording, the quality of the music that has been recorded, and the way the CD-R has been handled. There may be an increase in skipping, difficulty in finding tracks, and/or difficulty in loading and ejecting. If these problems occur try a known good CD.

Do not add paper labels to CDs, they could get caught in the CD player.

If an error appears on the display, see "CD Messages" later in this section.

When a CD is inserted the CD functions will appear on the display above the pushbuttons, in place of the preset stations (if programmed).

LOAD: Press the LOAD button to load CDs into the CD player. This CD player will hold up to six CDs.

To insert one CD, do the following:

1. The ignition and the radio can be on or off.
2. Press and release the LOAD button. Please Wait will appear on the display.
3. Load the CD, when INSERT appears on the display, insert a CD partway into the slot, label side up. The player will pull the CD in.

When a CD is inserted, CD will appear on the display, the number of the CD and the track number will appear on the display if the radio is on.

If the radio is on, the CD will begin to play automatically.

To insert multiple CDs, do the following:

1. The ignition and the radio can be on or off.
2. Press and hold the LOAD button for two seconds. Please Wait will appear on the display and you will hear a beep.

3. Load the CD, when INSERT appears on the display, insert a CD partway into the slot, label side up. The player will pull the CD in.

Do not load a CD until INSERT appears on the display. The CD player will take up to six CDs. Do not try to load more than six. If you want to load less than six CDs, load the desired amount. The CD player will time out when it does not receive any more CDs and the last CD loaded will begin to play.

If the radio is on, the last CD loaded will begin to play automatically.

F1 CD ↓ (Down): Press this pushbutton to go to the previous CD.

F2 CD ↑ (Up): Press this pushbutton to go to the next CD.

CD REV ⏮ (Reverse): Press this pushbutton to go to the previous track. Press and hold this pushbutton to reverse quickly within the track. Release the pushbutton to play the passage. The elapsed time of the track will appear on the display.

CD FWD >> (Forward): Press this pushbutton to go to the next track. Press and hold this pushbutton to advance quickly within the track. Release the pushbutton to play the passage. The elapsed time of the track will appear on the display.

F5 MODE: Press this pushbutton to select from NORMAL, RPT TRCK (Repeat Track), RPT CD (Repeat CD), RDM TRK (Random Track), and RDM ALL (Random All CDs).

- **NORMAL:** Sets the system for normal play of the CD(s). NORMAL will not appear on the display when in this mode.
- **RPT TRCK (Repeat Track):** Repeats the track over again. RPT TRCK will appear on the display. Press the MODE pushbutton again to turn off repeat play. RPT TRCK will disappear from the display.
- **RPT CD (Repeat CD):** Repeats the CD over again. RPT DISC will appear on the display. Press the MODE pushbutton again to turn off repeat play. RPT DISC will disappear from the display.

- **RDM TRK (Random Track):** Plays the tracks on the current CD in random, rather than sequential, order. RDM TRK will appear on the display. Press the MODE pushbutton again to turn off random play. RDM TRK will disappear from the display.
- **RDM ALL (Random All CDs):** Plays all of the CDs loaded in random, rather than sequential, order. RDM ALL will appear on the display. Press the MODE pushbutton again to turn off random play. RDM ALL will disappear from the display.

F6 DISP (Display): Press this pushbutton to display the time of the track. Press this pushbutton again to display CD PLAY and press this pushbutton once more to clear the display.

▲ SEEK ▼: Press the up or the down arrow to go to the next or to the previous track on the CD.

▲ SCAN: Press this button to listen to each track for 10 seconds. The CD will go to a track, play for 10 seconds, then go on to the next track. Press this button again to stop scanning.

▲ (Eject): Press this button to eject the CD that is currently playing, or press and hold this button to eject all of the CDs loaded. You will hear a beep. Eject may be activated with the ignition or radio off.

CD Messages

If the CD comes out, it could be for one of the following reasons:

- If it is very hot. When the temperature returns to normal, the CD should play.
- If you are driving on a very rough road. When the road becomes smoother, the CD should play.
- The CD is dirty, scratched, wet, or upside down.
- The air is very humid. If so, wait about an hour and try again.
- There may have been a problem while burning the CD.
- The label may be caught in the CD player.

If the CD is not playing correctly, for any other reason, try a known good CD.

If any error occurs repeatedly or if an error cannot be corrected, contact your GM dealer. If the radio displays an error message, write it down and provide it to your GM dealer when reporting the problem.

Configurable Radio Display Keys

This feature allows you to customize the four keys that are located on each side of the radio display to make it easier to adjust the radio features and other non-radio related features are also available for customization.

To program the configurable radio display keys, perform the following steps:

1. Press the TUNE/SEL knob to enter the main menu.
2. Turn the TUNE/SEL knob until SETUP appears on the display.
3. Press the TUNE/SEL knob to enter into SETUP.
4. Turn the TUNE/SEL knob until CONFIGURE DISPLAY KEYS appears on the display.
5. Press the TUNE/SEL knob to enter into CONFIGURE DISPLAY KEYS.
6. Turn the TUNE/SEL knob to select which of the four configurable keys you would like to change. The currently assigned feature will be shown.

7. Press the TUNE/SEL knob to select the configurable key to change.
8. Turn the TUNE/SEL knob to find the feature that you would like to store to the key.
9. Press the TUNE/SEL knob when you have found the feature to be stored. The display will update, by showing the symbol of the feature that you selected next to the configurable key.
10. Repeat the previous steps for each configurable key.

Once a feature is programmed to a key, the feature will not appear on the display when programming the remaining configurable keys. The configurable keys can be changed at any time.

Rear Seat Entertainment System

Your vehicle may have the DVD Rear Seat Entertainment (RSE) system. The RSE system includes a DVD player, a video display screen, two sets of wireless headphones, and a remote control.

RSE is available in a base and an uplevel version. The uplevel version is provided with the navigation radio (if equipped). The uplevel RSE system offers the rear seat passengers to have shared control of FM1, FM2, AM, weather, CDC, and XM™ Satellite Radio Service (if equipped).

Before You Drive

The RSE system is for rear seat passengers only. The driver cannot safely view the video screen while driving and should not try to do so.

Headphones

The RSE system includes two sets of wireless headphones.

Each set of headphones has an ON/OFF control. An indicator light will illuminate on the headphones when they are on. If the light does not illuminate, the batteries may need to be replaced. See “Battery Replacement” later in this section for more information. To turn the headphones OFF activate the ON/OFF control.

Each set of headphones has a volume knob. To adjust the volume, adjust this knob.

The transmitters are located below the video display screen. The headphones will shut off to save battery power if they lose the signal from the system after about four minutes. The signal may be lost if the system is turned off or if the headphones are out of range of the signal transmitters.

Notice: Do not store the headphones in heat or direct sunlight. This could damage the headphones and repairs would not be covered by your warranty. Keep the headphones stored in a cool, dry place.

Battery Replacement

To change the batteries, do the following:

1. Loosen the screw on the battery compartment door located on the left side of the headphone earpiece.
2. Replace the two AAA batteries in the compartment. Make sure that they are installed correctly, using the diagram on the inside of the battery compartment.
3. Tighten the screws to close the compartment door.

If the headphones are to be stored for a long period of time, remove the batteries and keep them in a cool, dry place.

Stereo RCA Jacks

The RCA jacks are located on the front of the DVD player faceplate. These jacks allow audio and video signals to be connected from an auxiliary device such as a camcorder or a video game unit to the RSE system. The L jack is for left audio input, the R jack is for right audio input, and the V jack is used for video input. The system requires standard RCA cables, not included, to connect the auxiliary device to the RCA jacks. Refer to the manufacturer's instructions for proper usage.

To use the auxiliary audio and video inputs, connect an external auxiliary device such as a camcorder to the RCA jacks and turn on both the auxiliary device power and the power on the front of the RSE player. To have use of these jacks, select AUX using the MODE button on the DVD player faceplate or the remote control.

How to Change the Video Format when in the Auxiliary Mode

The auxiliary input video format is preset to NTSC. In some countries, the video format may be in PAL system. To change the video format, perform the following:

1. Press the display menu button.
2. Press the down arrow button to highlight the Video Format option.
3. Press the enter button to select Video Format.
4. Press the right or left arrow button to select the video format.
5. Press the enter button to accept the change.

Audio Output

Audio from the DVD player or auxiliary inputs may be heard through the following possible sources:

- Wireless Headphones
- Vehicle Speakers
- Wired Headphones (not included)

The RSE system will always transmit the audio signal by infrared to the wireless headphones, if there is audio available. See “Headphones” previously for more information.

The RSE system is capable of outputting audio to the vehicle speakers by using the radio. The RSE system may be selected as an audio source on the radio if the RSE system power is on. Once the RSE system is selected as an audio source on the radio, adjust the speaker volume on the radio, if necessary. If the RSE system power is not on, the RSE system will not be an available source on the radio. Refer to the radio information for the radio that your vehicle has for more information.

Video Screen

The video screen is located in the floor console. Lift up the screen by the top or the sides into the full open position. Adjust the screen’s position as desired. When the video screen is not in use, close the screen.

The DVD player and display will continue to operate when the screen is in the up or the down position. The video screen contains the transmitters for the wireless headphones and the remote control. If the screen is in the closed position, the signals will not be available for the operation of the headphones and the remote control.

Notice: Directly touching the video screen may damage it. Do not touch the screen. See “Cleaning the Video Screen” later in this section for more information.

DVD Player

The DVD player is located in the floor console under the display. Flip up the display to access the DVD player. The DVD player can be controlled by the buttons on the DVD player and by the buttons on the remote control. See “Remote Control” later in this section for more information.

The DVD player power may be turned on when the ignition is in ON, ACCESSORY, or when Retained Accessory Power (RAP) is active.

The RSE system DVD player is only compatible with DVDs of the appropriate region code for the country that the vehicle was sold in. The DVD region code is printed on the jacket of most DVDs.

The DVD player will also play audio CDs. Not all home recorded CDs, CD-R or CD-RW formats, will play in this DVD player.

If an error message appears on the video screen, see “DVD Messages” later in this section.

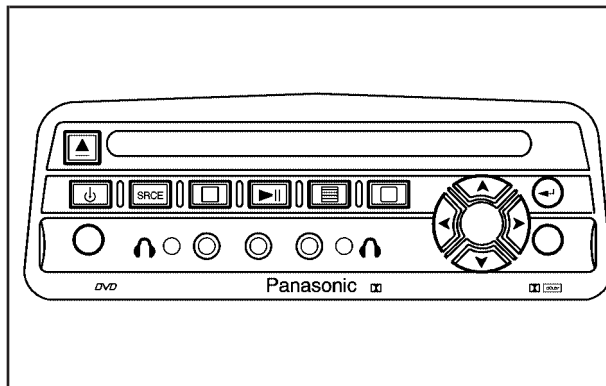

DVD Player Buttons

⏻ (Power): Press this button to turn the RSE system on and off.

⏏ (Eject): Press this button to eject a DVD or CD.

SRCE (Source): Press this button to cycle through the available video modes. Auxiliary is available when an auxiliary device is plugged into the auxiliary jacks on the DVD faceplate.

If your vehicle is equipped with the navigation system, each press of the SRCE button will cycle the rear video between DVD, AUX, TV, and front DVD.

Pressing the enter button when this menu appears on the display will switch the RSE setting between all speaker and rear video. All speaker will not be available if the front passenger has turned on the parental control.

- **All Speaker:** The radio and the RSE unit will share control of what is heard through the vehicle speakers. All audio and video sources are available for selection with the SRCE button when in all speaker.
- **Rear Video:** The RSE unit will only control what is seen on the rear display and what is heard through the headphones.

 **(Stop):** Press this button to stop playing a DVD. Press this button twice to return to the beginning of the DVD.

 **(Play/Pause):** Press this button to turn the DVD player on, to start play of a DVD or CD, and to switch between play and pause of a DVD or CD.

 **(Menu):** Press this button to access the DVD menu. This button only operates with a DVD.

If your vehicle is equipped with the TV option, the menu button will display a TV specific menu.

 **(Display Menu):** Press this button to modify the video screen display characteristics.

 **(Menu Navigation):** Use the arrow keys to navigate through a menu.

 **(Enter):** Press this button to select items within a menu.

If your vehicle is equipped with the navigation system, after pressing the SRCE button, the enter button can select all speaker or rear video. See the SRCE button previously for more information.

Audio/Video Jack: See “Stereo RCA Jacks” earlier in this section for more information.

 **(Headphone Jack):** These jacks allow you to listen to the RSE through wired headphones (not included).

 **(Headphone Volume):** Turn the left knob to increase the volume of the headphone connected to the left headphone jack. Turn the right knob to increase the volume of the headphone connected to the right headphone jack.

Playing a Disc

To play a disc, gently insert the disc with the label side up into the loading slot. The DVD player will continue loading the disc and the player will automatically start if the vehicle is in ON, ACCESSORY, or when RAP is active.

If a disc is already in the player, press the play/pause button on the DVD player faceplate or on the remote control.

Some DVDs will not allow fast forwarding or skipping of the copyright information or the previews. Some DVDs will begin playing after the previews have finished. If the DVD does not begin to play the main title, refer to the on-screen instructions.

Stopping and Resume Playback

To stop playing a disc, press and release the stop button on the DVD player faceplate or the remote control.

To resume playback, press the play/pause button on the DVD player faceplate or the remote control. The movie should resume play from where it was last stopped if the disc has not been ejected and the stop button has not been pressed twice. If the disc has been ejected or if the stop button has been pressed twice, the disc will resume play at the beginning.

Ejecting a Disc

Press the eject button on the DVD player faceplate to eject the disc. There is not an eject button on the remote control.

If a disc is ejected from the player, but is not removed, the DVD player will reload the disc within 25 to 30 seconds. The disc will be stored in the DVD player. The DVD player will not resume play of the disc automatically.

DVD Messages

The following errors may be displayed on the video screen:

- **Disc Format Error:** This message will be displayed if a disc is inserted upside down, if the disc is not readable, or if the disc format is not compatible. The disc will be automatically ejected from the DVD player.
- **Load/Eject Error:** This message will be displayed if the disc is not properly loaded or ejected.
- **Disc Play Error:** This message will be displayed if the DVD player cannot play the disc. Severely scratched or damaged discs will cause this error. The disc will be automatically ejected from the DVD player.

- **Region Code Error:** This message will be displayed if the region code of the DVD is not compatible with the DVD player. The disc will be automatically ejected from the DVD player.
- **No Disc:** This message will be displayed if the PLAY button is pressed and no disc is in the player.

Parental Control Button: This button is located on the navigation system screen. Press this button while a DVD or CD is playing to freeze the video and mute the audio. The video screen will display Parental Control ON and the power indicator light on the DVD player will flash. It will also disable all other button operations from the remote control and the DVD player, with the exception of the eject button. The driver will then be able to gain the attention of the rear seat passengers. Press this button again to restore normal operation of the DVD player.

This button may also be used to turn the DVD player power on and automatically resume play if the vehicle is in an enabled power mode.

Remote Control

To use the remote control, aim it at the transmitter window above the video screen and press the desired button. Direct sunlight or very bright light may affect the ability of the RSE system to receive signals from the remote control. If the remote control does not seem to be working, the batteries may need to be replaced. See "Battery Replacement" later in this section.

Objects blocking the line of sight may also affect the function of the remote control.

Notice: Storing the remote control in a hot area or in direct sunlight may damage it, and the repairs would not be covered by your warranty. Keep the remote control stored in a cool, dry place.

Remote Control Buttons

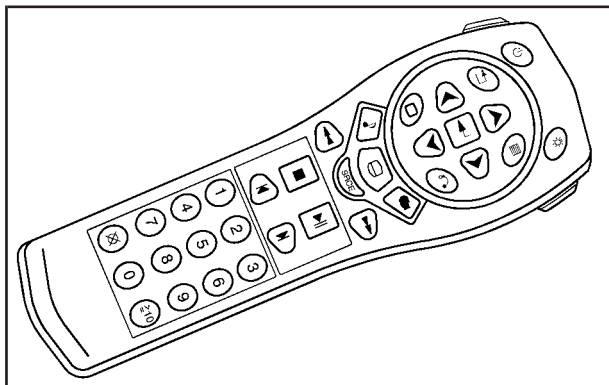



 **(Power):** Press this button to turn the DVD player on and off.

 **(Illumination):** Press this button to turn the remote control backlight on for 8 seconds.

 **(Title):** Press this button to access the multiple titles (if available) of a DVD.

 **(Menu):** Press this button to access the DVD main menu.

 **(Display):** Press this button to switch the video screen display features: color, contrast, brightness, tint, and display mode (normal, full, and zoom). Normal means the horizontal image is not stretched and the borders at the left and right of the picture are blank. Full means the horizontal image is stretched across the display and all of the vertical lines are displayed. No borders are present. Wide means the horizontal image is stretched up and down the display and the image tends to be stretched at the borders instead of at the middle. Borders are not displayed. Press the left or right navigation keys to select the display mode.

 **(Return):** Press this button to exit the current active menu and return to the previous menu. This button will operate only when a DVD is playing and a menu is active.

 **(Up):** Press this button to move up the menu list of a DVD.

 **(Down):** Press this button to move down the menu list of a DVD.

 **(Left):** Press this button to move to the left of the menu list of a DVD.

 **(Right):** Press this button to move to the right of the menu list of a DVD.

 **(Enter):** Press this button to select items within a menu.

 **(Audio):** Press this button to open a menu that will operate only when a DVD is playing. The format and content of this function will vary for each disc.

 **(Subtitle):** Press this button to open a menu that will operate only when a DVD is playing. The format and content of this function will vary for each disc.

 **(Angle):** Press this button to open a menu that will operate only when a DVD is playing. The format and content of this function will vary for each disc.

 **(Next):** Press this button to go to the next chapter or track of a DVD or CD.

 **(Previous):** Press this button to go to the previous chapter or track of a DVD or CD.

 **(Fast Forward):** Press this button to fast forward through the chapter or track of a DVD or CD. This button may not work when the DVD is playing the copyright information or the previews.

 **(Rewind):** Press this button to rewind through the chapter or track of a DVD or CD. This button may not work when the DVD is playing the copyright information or the previews.

 **(Stop):** Press this button to stop the play of a DVD or CD. Press this button twice to return to the beginning of the DVD.

 **(Play/Pause):** Press this button to turn the DVD player on, to start play of a DVD or CD, and to switch between play and pause of a DVD or CD.

1 through 0 (Numeric Keypad): The numeric keypad provides the capability of direct chapter, title, and track number selection.

 **(Double Digit Entries):** Press this button to select chapter, title, and track numbers greater than 9. Press this button before inputting the number.

 **(Clear):** Press this button within three seconds after inputting a numeric selection, to clear all numeric inputs.

Battery Replacement

To change the batteries, do the following:

1. Remove the battery compartment door located on the bottom of the remote control.
2. Replace the two AA batteries in the compartment. Make sure that they are installed correctly, using the diagram on the inside of the battery compartment.
3. Close the battery door securely.

If the remote control is to be stored for a long period of time, remove the batteries and keep them in a cool, dry place.

Problem	Recommended Action
No power.	The ignition might not be in on or accessory. The parental control button might have been turned on. The power indicator light will flash.
Disc will not play.	The system might be off. The parental control button might have been turned on. The power indicator light will flash. The system might be in auxiliary source mode. Press the MODE button to switch between the DVD player and the auxiliary source. The disc is upside down or is not compatible.
The picture does not fill the screen. There are black borders on the top and bottom or on both sides or it looks stretched out.	Press the DISP button on the DVD player or on the remote control. Change the display mode.

Problem	Recommended Action
The disc was ejected, but it was pulled back into the DVD player.	The disc is being stored in the DVD player. Press the eject button again to eject the disc.
In auxiliary mode, the picture moves or scrolls.	Check the signal coming from the auxiliary device and make sure that the connection and the signal is good. Change the Video Format to PAL or NTSC. See "Stereo RCA Jacks" previously for how to change the video format.
The language in the audio or on the screen is wrong.	Press the MENU button on the DVD player or on the remote control and change the audio or language selection on the DVD menu.

Problem	Recommended Action
The remote control does not work.	Point the remote control directly at the infrared window below the video screen while using. Check that the batteries are not dead or put in wrong. The parental control button might have been turned on. The power indicator light will flash.
After stopping the player, I push Play but sometimes the DVD starts where I left off and sometimes at the beginning.	If the stop button was pressed one time, the DVD player will resume playing where the DVD was stopped. If the stop button was pressed two times the DVD player will begin to play from the beginning of the DVD.

Problem	Recommended Action
The auxiliary source is running but there is no picture or sound.	Press the MODE button to change from the DVD player mode to the auxiliary source mode. Check to make sure that the auxiliary source is connected to the inputs properly.
My disc is stuck in the player. The Load/Eject button does not work.	Press the eject/load button on the DVD player. Turn the power off, then on again, then press the eject/load button on the DVD player. Do not attempt to forcibly remove the disc from the DVD player. This could permanently damage the disc and the DVD player.
Sometimes the wireless headphone audio cuts out or buzzes.	This could be caused by interference from cellular telephone towers or by using your cellular telephone in the vehicle.
I lost the remote and/or the headphones.	See your dealer for assistance.

DVD Distortion

There may be an experience with audio distortion in the wireless headphones when operating cellular phones, scanners, CB radios, Global Positioning Systems (GPS)*, two-way radios, mobile fax, or walkie talkies.

It may be necessary to turn off the DVD player when operating one of these devices in or near the vehicle.

* Excludes the OnStar® System.

Cleaning the DVD Player

When cleaning the outside DVD faceplate and buttons, use only a clean cloth dampened with clean water.

Cleaning the Video Screen

Pour some isopropyl or rubbing alcohol on a clean cloth and gently wipe the video screen. Do not spray directly onto the screen and do not press too hard or too long on the video screen.

Navigation/Radio System

Your vehicle may have a navigation radio system that includes Radio Data System (RDS) with Program Type (PTY) selections that will seek out the kind of music you want to listen to and XM™ Satellite Radio Service capabilities (if equipped). The radio can also communicate with the navigation system to broadcast announcements on traffic, weather, and emergency alert communications. For information on how to use this system, see the “Navigation System” manual.

Theft-Deterrent Feature

THEFTLOCK® is designed to discourage theft of your vehicle’s radio. The feature works automatically by learning a portion of the Vehicle Identification Number (VIN). If the radio is moved to a different vehicle, it will not operate. If the radio is removed from your vehicle, the original VIN in the radio can be used to trace the radio back to your vehicle.

With THEFTLOCK® activated, the radio will not operate if stolen.

Audio Steering Wheel Controls

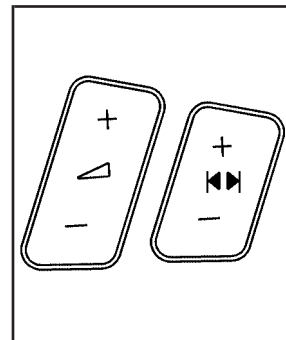
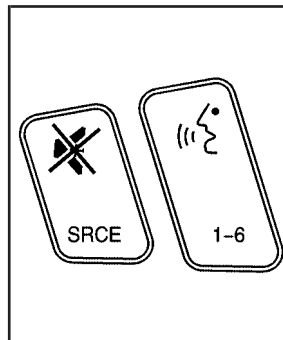

Some audio controls can be adjusted at the steering wheel. They include the following:

 **(Mute):** Press this button to silence the system. Press this button again, or any other radio button, to turn the sound on.

SRCE (Source): Press this button to switch between FM1, FM2, AM, or XM1 or XM2 (if equipped), radio, or CD.

☞ (OnStar/Voice Recognition): If your vehicle has the Radio with CD or Radio with Six-Disc CD audio system, press this button to interact with the OnStar® system. See the OnStar® manual provided with your vehicle for more information.

If your vehicle has the navigation system, press this button to initiate voice recognition. See “Voice Recognition” in the Navigation System manual for more information. You may be able to interact with the OnStar® system using this button. See the OnStar® manual provided with your vehicle for more information.

1–6 (Preset Stations): Press this button to play stations that are programmed on the radio preset pushbuttons. The radio will only seek preset stations with a strong signal that are in the selected band.

When a CD is playing, press this button to go to the next track.

When a CD is playing in the six-disc CD changer, press this button to go to the next available CD, if multiple CDs are loaded.

+ ◀ — (**Volume**): Press this button to increase or to decrease the volume.

+ ◀ ▶ — (**Seek**): Press either arrow to go to the next or the previous radio station and stay there. The radio will only seek stations with a strong signal that are in the selected band.

When a CD is playing, press the minus sign to go to the start of the current track, if more than 10 seconds have played. Press the plus sign to go to the next track. If either the minus or the plus button are pressed more than once, the player will continue moving backward or forward through the CD.

Press and hold the SEEK plus or minus button, until you hear a beep. The CD will fast forward or fast reverse through the CD. Press either button again to play the passage.

If you have the navigation system, some of the audio steering wheel controls work when a DVD is playing in the navigation radio. See the Navigation System manual for more information.

Radio Reception

AM

The range for most AM stations is greater than for FM, especially at night. The longer range can cause station frequencies to interfere with each other. Static can occur on AM stations caused by things like storms and power lines. Try reducing the treble to reduce this noise.

FM Stereo

FM stereo will give the best sound, but FM signals will reach only about 10 to 40 miles (16 to 65 km). Tall buildings or hills can interfere with FM signals, causing the sound to fade in and out.

XM™ Satellite Radio Service

XM™ Satellite Radio Service gives digital radio reception from coast to coast. Just as with FM, tall buildings or hills can interfere with satellite radio signals, causing the sound to fade in and out. The radio may display NO XM SIGNAL to indicate interference.

Cellular Phone Usage

Cellular phone usage may cause interference with your vehicle's radio. This interference may occur when making or receiving phone calls, charging the phone's battery, or simply having the phone on. This interference is an increased level of static while listening to the radio. If static is received while listening to the radio, unplug the cellular phone and turn it off.

Care of Your CDs and DVDs

Handle discs carefully. Store them in their original cases or other protective cases and away from direct sunlight and dust. If the surface of a disc is soiled, dampen a clean, soft cloth in a mild, neutral detergent solution and clean it, wiping from the center to the edge.

Be sure never to touch the side without writing when handling discs. Pick up discs by grasping the outer edges or the edge of the hole and the outer edge.

Care of Your CD and DVD Player

The use of CD lens cleaners for CDs is not advised, due to the risk of contaminating the lens of the CD optics with lubricants internal to the CD mechanism.

Diversity Antenna System

The AM-FM antenna is integrated with the rear quarter glass windows, located in the rear of the vehicle on the driver and passenger sides. Make sure that the inside surface of the rear windows are not scratched and that the grid lines on the glass are not damaged. If the inside surface is damaged, it could interfere with radio reception.

Notice: Do not apply aftermarket glass tinting with metallic film. The metallic film in some tinting materials will interfere with or distort the incoming radio reception. Any damage caused to your backglass antenna due to metallic tinting materials will not be covered by your warranty.

Notice: Do not try to clear frost or other material from the inside of the rear quarter window with a razor blade or anything else that is sharp. This may affect your radio's ability to pick up stations clearly. The repairs wouldn't be covered by your warranty.

If static is heard on the radio, when the rear window defogger is turned on, it could mean that a defogger grid line has been damaged. If this is true, the grid line must be repaired.

If adding an aftermarket cellular telephone to your vehicle, and the antenna needs to be attached to the glass, make sure that the grid lines for the AM-FM antennas are not damaged. Make sure the cellular telephone antenna does not touch a grid line.

XM™ Satellite Radio Antenna System

The XM™ Satellite Radio antenna is located on the roof of your vehicle. Keep this antenna clear of snow and ice build up for clear radio reception.

The performance of the XM™ system may be affected if the sunroof is open.

Loading items onto the roof of your vehicle can interfere with the performance of the XM™ system. Make sure that the XM™ satellite antenna is not obstructed.

Section 4 Driving Your Vehicle

Your Driving, the Road, and Your Vehicle	4-2	Driving in Rain and on Wet Roads	4-32
Defensive Driving	4-2	City Driving	4-35
Drunken Driving	4-3	Freeway Driving	4-36
Control of a Vehicle	4-6	Before Leaving on a Long Trip	4-37
Braking	4-6	Highway Hypnosis	4-38
Anti-Lock Brake System (ABS)	4-7	Hill and Mountain Roads	4-38
Braking in Emergencies	4-8	Winter Driving	4-40
Traction Control System (TCS)	4-9	If You Are Stuck: In Sand, Mud, Ice or Snow	4-44
Magnetic Ride Control	4-10	Rocking Your Vehicle to Get It Out	4-44
Stabilitrak® System	4-10	Recovery Hook	4-45
Panic Brake Assist	4-11	Loading Your Vehicle	4-45
Steering	4-12	Towing	4-50
Off-Road Recovery	4-14	Towing Your Vehicle	4-50
Passing	4-14	Recreational Vehicle Towing	4-50
Loss of Control	4-16	Level Control	4-52
Operating Your All-Wheel-Drive Vehicle		Towing a Trailer	4-52
Off Paved Roads	4-17		
Driving at Night	4-30		

Your Driving, the Road, and Your Vehicle

Defensive Driving

The best advice anyone can give about driving is: Drive defensively.

Please start with a very important safety device in your vehicle: Buckle up. See *Safety Belts: They Are for Everyone* on page 1-10.

Defensive driving really means “be ready for anything.” On city streets, rural roads, or freeways, it means “always expect the unexpected.”

Assume that pedestrians or other drivers are going to be careless and make mistakes. Anticipate what they might do. Be ready for their mistakes.

Rear-end collisions are about the most preventable of accidents. Yet they are common. Allow enough following distance. It is the best defensive driving maneuver, in both city and rural driving. You never know when the vehicle in front of you is going to brake or turn suddenly.

Defensive driving requires that a driver concentrate on the driving task. Anything that distracts from the driving task — such as concentrating on a cellular telephone call, reading, or reaching for something on the floor — makes proper defensive driving more difficult and can even cause a collision, with resulting injury. Ask a passenger to help do things like this, or pull off the road in a safe place to do them yourself. These simple defensive driving techniques could save your life.

Drunken Driving

Death and injury associated with drinking and driving is a national tragedy. It is the number one contributor to the highway death toll, claiming thousands of victims every year.

Alcohol affects four things that anyone needs to drive a vehicle:

- Judgment
- Muscular Coordination
- Vision
- Attentiveness

Police records show that almost half of all motor vehicle-related deaths involve alcohol. In most cases, these deaths are the result of someone who was drinking and driving. In recent years, more than 16,000 annual motor vehicle-related deaths have been associated with the use of alcohol, with more than 300,000 people injured.

Many adults — by some estimates, nearly half the adult population — choose never to drink alcohol, so they never drive after drinking. For persons under 21, it is against the law in every U.S. state to drink alcohol. There are good medical, psychological and developmental reasons for these laws.

The obvious way to eliminate the leading highway safety problem is for people never to drink alcohol and then drive. But what if people do? How much is “too much” if someone plans to drive? It is a lot less than many might think. Although it depends on each person and situation, here is some general information on the problem.

The Blood Alcohol Concentration (BAC) of someone who is drinking depends upon four things:

- The amount of alcohol consumed
- The drinker's body weight
- The amount of food that is consumed before and during drinking
- The length of time it has taken the drinker to consume the alcohol

According to the American Medical Association, a 180 lb (82 kg) person who drinks three 12 ounce (355 ml) bottles of beer in an hour will end up with a BAC of about 0.06 percent. The person would reach the same BAC by drinking three 4 ounce (120 ml) glasses of wine or three mixed drinks if each had 1-1/2 ounces (45 ml) of liquors like whiskey, gin, or vodka.



It is the amount of alcohol that counts. For example, if the same person drank three double martinis (3 ounces or 90 ml of liquor each) within an hour, the person's BAC would be close to 0.12 percent. A person who consumes food just before or during drinking will have a somewhat lower BAC level.

There is a gender difference, too. Women generally have a lower relative percentage of body water than men. Since alcohol is carried in body water, this means that a woman generally will reach a higher BAC level than a man of her same body weight will when each has the same number of drinks.

The law in most U.S. states, and throughout Canada, sets the legal limit at 0.08 percent. In some other countries, the limit is even lower. For example, it is 0.05 percent in both France and Germany. The BAC limit for all commercial drivers in the United States is 0.04 percent.

The BAC will be over 0.10 percent after three to six drinks (in one hour). Of course, as we have seen, it depends on how much alcohol is in the drinks, and how quickly the person drinks them.

But the ability to drive is affected well below a BAC of 0.10 percent. Research shows that the driving skills of many people are impaired at a BAC approaching 0.05 percent, and that the effects are worse at night. All drivers are impaired at BAC levels above 0.05 percent. Statistics show that the chance of being in a collision increases sharply for drivers who have a BAC of 0.05 percent or above. A driver with a BAC level of 0.06 percent has doubled his or her chance of having a collision. At a BAC level of 0.10 percent, the chance of this driver having a collision is 12 times greater; at a level of 0.15 percent, the chance is 25 times greater!

The body takes about an hour to rid itself of the alcohol in one drink. No amount of coffee or number of cold showers will speed that up. “I will be careful” is not the right answer. What if there is an emergency, a need to take sudden action, as when a child darts into the street? A person with even a moderate BAC might not be able to react quickly enough to avoid the collision.

There is something else about drinking and driving that many people do not know. Medical research shows that alcohol in a person’s system can make crash injuries worse, especially injuries to the brain, spinal cord, or heart. This means that when anyone who has been drinking — driver or passenger — is in a crash, that person’s chance of being killed or permanently disabled is higher than if the person had not been drinking.

 **CAUTION:**

Drinking and then driving is very dangerous. Your reflexes, perceptions, attentiveness, and judgment can be affected by even a small amount of alcohol. You can have a serious — or even fatal — collision if you drive after drinking. Please do not drink and drive or ride with a driver who has been drinking. Ride home in a cab; or if you are with a group, designate a driver who will not drink.

Control of a Vehicle

You have three systems that make your vehicle go where you want it to go. They are the brakes, the steering, and the accelerator. All three systems have to do their work at the places where the tires meet the road.

Sometimes, as when you are driving on snow or ice, it is easy to ask more of those control systems than the tires and road can provide. That means you can lose control of your vehicle. See *Stabilitrak[®] System on page 4-10*.

Braking

Braking action involves perception time and reaction time.

First, you have to decide to push on the brake pedal. That is perception time. Then you have to bring up your foot and do it. That is reaction time.

Average reaction time is about three-fourths of a second. But that is only an average. It might be less with one driver and as long as two or three seconds or more with another. Age, physical condition, alertness, coordination and eyesight all play a part. So do alcohol, drugs and frustration. But even in three-fourths of a

second, a vehicle moving at 60 mph (100 km/h) travels 66 feet (20 m). That could be a lot of distance in an emergency, so keeping enough space between your vehicle and others is important.

And, of course, actual stopping distances vary greatly with the surface of the road (whether it is pavement or gravel); the condition of the road (wet, dry, icy); tire tread; the condition of your brakes; the weight of the vehicle and the amount of brake force applied.

Avoid needless heavy braking. Some people drive in spurts — heavy acceleration followed by heavy braking — rather than keeping pace with traffic. This is a mistake. Your brakes may not have time to cool between hard stops. Your brakes will wear out much faster if you do a lot of heavy braking. If you keep pace with the traffic and allow realistic following distances, you will eliminate a lot of unnecessary braking. That means better braking and longer brake life.

If your engine ever stops while you are driving, brake normally but do not pump your brakes. If you do, the pedal may get harder to push down. If your engine stops, you will still have some power brake assist. But you will use it when you brake. Once the power assist is used up, it may take longer to stop and the brake pedal will be harder to push.

Anti-Lock Brake System (ABS)

Your vehicle has anti-lock brakes. ABS is an advanced electronic braking system that will help prevent a braking skid.

When you start your engine and begin to drive away, your anti-lock brake system will check itself. You may hear a momentary motor or clicking noise while this test is going on. This is normal.

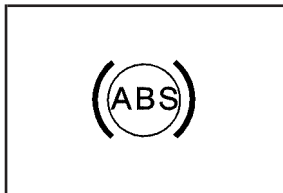

If there is a problem with the anti-lock brake system, this warning light will stay on. See *Anti-Lock Brake System Warning Light* on page 3-39.

Along with ABS, your vehicle has a Dynamic Rear Proportioning (DRP) system. If there is a DRP problem, both the brake and ABS warning lights will come on accompanied by a 10-second chime. The lights and chime will come on each time the ignition is turned on until the problem is repaired. See your dealer for service.



Let us say the road is wet and you are driving safely. Suddenly, an animal jumps out in front of you. You slam on the brakes and continue braking. Here is what happens with ABS:

A computer senses that wheels are slowing down. If one of the wheels is about to stop rolling, the computer will separately work the brakes at each front wheel and at both rear wheels.

The anti-lock system can change the brake pressure faster than any driver could. The computer is programmed to make the most of available tire and road conditions. This can help you steer around the obstacle while braking hard.



As you brake, your computer keeps receiving updates on wheel speed and controls braking pressure accordingly.

Remember: Anti-lock does not change the time you need to get your foot up to the brake pedal or always decrease stopping distance. If you get too close to the vehicle in front of you, you will not have time to apply your brakes if that vehicle suddenly slows or stops. Always leave enough room up ahead to stop, even though you have anti-lock brakes.

Using Anti-Lock

Do not pump the brakes. Just hold the brake pedal down firmly and let anti-lock work for you. You may feel the brakes vibrate, or you may notice some noise, but this is normal.

Braking in Emergencies

With anti-lock, you can steer and brake at the same time. In many emergencies, steering can help you more than even the very best braking.

Traction Control System (TCS)

Your vehicle has a traction control system that limits wheel spin. This is especially useful in slippery road conditions. On a rear-wheel-drive vehicle, the system operates if it senses that one or both of the rear wheels are spinning or beginning to lose traction. On an All-Wheel-Drive (AWD) vehicle the system will operate if it senses that any of the wheels are spinning or beginning to lose traction. When this happens, the system brakes the spinning wheel(s) and/or reduces engine power to limit wheel spin.

You may feel or hear the system working, but this is normal.

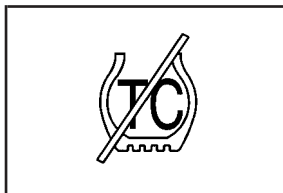

This warning light will come on to let you know if there's a problem with your traction control system.

See *Traction Control System (TCS) Warning Light* on page 3-40. When this warning light is on, the system will not limit wheel spin. Adjust your driving accordingly.

The traction control system automatically comes on whenever you start your vehicle. To limit wheel spin, especially in slippery road conditions, you should always leave the system on. But you can turn the traction control system off if you ever need to.

Notice: Do not repeatedly brake or accelerate heavily when the TCS is off. You could damage your vehicle's driveline.

When the TCS is switched off on AWD vehicles, you may still feel the system working. This is normal and necessary with the AWD hardware on your vehicle.

You should turn the system off if your vehicle ever gets stuck in sand, mud or snow and rocking the vehicle is required. See *Rocking Your Vehicle to Get It Out* on page 4-44 and *If You Are Stuck: In Sand, Mud, Ice or Snow* on page 4-44 for more information. See *Winter Driving* on page 4-40 for information on using TCS when driving in snowy or icy conditions.

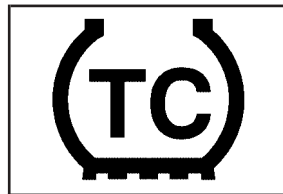

To turn the system off, press the TC (traction control) button located near the shift lever.

If you press the TC button once, the traction control system will turn off and the traction control system warning light will come on. Press the TC button again to turn the system back on. If you press and hold the TC button for five seconds, the Stabilitrak[®] system and the traction control system will turn off. Press the TC button again to turn Stabilitrak[®] back on. For more information, see *Stabilitrak[®] System on page 4-10*.

Magnetic Ride Control

Your vehicle may have Magnetic Ride Control that automatically adjusts the ride of your vehicle. Automatic ride control is achieved through a computer used to control and monitor the suspension system. The controller receives input from various sensors to determine the proper system response. If the controller detects a problem within the system, the DIC will display a Service Suspension System message. See *DIC Warnings and Messages on page 3-57* for more information. See your dealer for service.

Stabilitrak[®] System

Your vehicle is equipped with a vehicle stability enhancement system called Stabilitrak[®]. It is an advanced computer controlled system that assists you with directional control of the vehicle in difficult driving conditions.

Stabilitrak[®] activates when the computer senses a discrepancy between your intended path and the direction the vehicle is actually traveling. Stabilitrak[®] selectively applies braking pressure at any one of the vehicle's brakes to help steer the vehicle in the direction which you are steering.

When the system activates, a Stability System Engaged message will be displayed on the Driver Information Center. See *DIC Warnings and Messages on page 3-57*. You may also hear a noise or feel vibration in the brake pedal. This is normal. Continue to steer the vehicle in the direction you want it to go.

If there is a problem detected with Stabilitrak[®], a Service Stability System message will be displayed on the Driver Information Center. See *DIC Warnings and Messages on page 3-57*. When this message is displayed, the system is not operational. Driving should be adjusted accordingly.

Stabilitrak[®] comes on automatically whenever you start your vehicle. To help assist you with directional control of the vehicle, you should always leave the system on. You can turn Stabilitrak[®] off if you ever need to through the TC (traction control) on/off button. See *Traction Control System (TCS) on page 4-9*.

If your vehicle is in cruise control when the Stabilitrak[®] activates, the cruise control will automatically disengage. When road conditions allow you to safely use it again, you may reengage the cruise control. See "*Cruise Control on page 3-12* for more information.

Panic Brake Assist

Your vehicle has a panic brake assist system that monitors the intention of the driver while braking. If the system senses that the driver has applied hard/fast pressure to the brake pedal, the system will generate additional pressure, making it easier for the driver to maintain brake application. When this happens the brake pedal will feel easier to push. Just hold the brake pedal down firmly and let the system work for you. You may feel the brakes vibrate, or you may notice some noise but this is normal. The brakes will return to normal operation after the brake pedal has been released.

Steering

Power Steering

If you lose power steering assist because the engine stops or the system is not functioning, you can steer but it will take much more effort.

Steering Tips

Driving on Curves

It is important to take curves at a reasonable speed.

A lot of the “driver lost control” accidents mentioned on the news happen on curves. Here is why:

Experienced driver or beginner, each of us is subject to the same laws of physics when driving on curves. The traction of the tires against the road surface makes it possible for the vehicle to change its path when you turn the front wheels. If there is no traction, inertia will keep the vehicle going in the same direction. If you have ever tried to steer a vehicle on wet ice, you will understand this.

The traction you can get in a curve depends on the condition of your tires and the road surface, the angle at which the curve is banked, and your speed. While you are in a curve, speed is the one factor you can control.

Suppose you are steering through a sharp curve. Then you suddenly accelerate. Both control systems — steering and acceleration — have to do their work where the tires meet the road. Adding the sudden acceleration can demand too much of those places. You can lose control. See *Stabilitrak® System on page 4-10*.

What should you do if this ever happens? Ease up on the accelerator pedal, steer the vehicle the way you want it to go, and slow down.

If you have Stabilitrak®, you may see the STABILITY SYSTEM ACTIVE message on the message center. See “Stability System Active Message” under *DIC Warnings and Messages on page 3-57*.

Speed limit signs near curves warn that you should adjust your speed. Of course, the posted speeds are based on good weather and road conditions. Under less favorable conditions you will want to go slower.

If you need to reduce your speed as you approach a curve, do it before you enter the curve, while your front wheels are straight ahead.

Try to adjust your speed so you can “drive” through the curve. Maintain a reasonable, steady speed. Wait to accelerate until you are out of the curve, and then accelerate gently into the straightaway.

Steering in Emergencies

There are times when steering can be more effective than braking. For example, you come over a hill and find a truck stopped in your lane, or a car suddenly pulls out from nowhere, or a child darts out from between parked cars and stops right in front of you. You can avoid these problems by braking — if you can stop in time. But sometimes you cannot; there is not room. That is the time for evasive action — steering around the problem.

Your vehicle can perform very well in emergencies like these. First apply your brakes.

See *Braking on page 4-6*. It is better to remove as much speed as you can from a possible collision. Then steer around the problem, to the left or right depending on the space available.

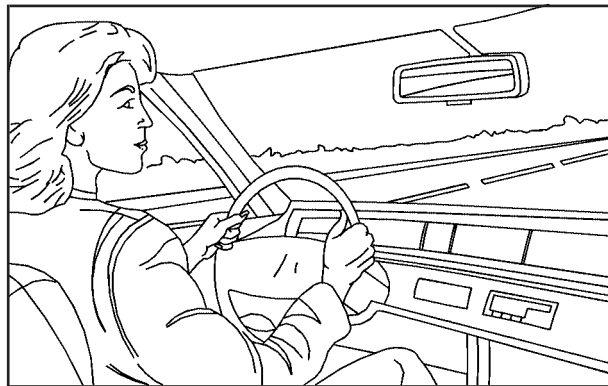

An emergency like this requires close attention and a quick decision. If you are holding the steering wheel at the recommended 9 and 3 o'clock positions, you can turn it a full 180 degrees very quickly without removing either hand. But you have to act fast, steer quickly, and just as quickly straighten the wheel once you have avoided the object.

The fact that such emergency situations are always possible is a good reason to practice defensive driving at all times and wear safety belts properly.

Off-Road Recovery

You may find that your right wheels have dropped off the edge of a road onto the shoulder while you are driving.

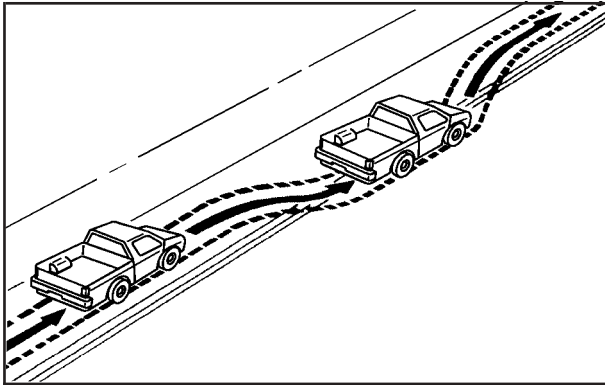

If the level of the shoulder is only slightly below the pavement, recovery should be fairly easy. Ease off the accelerator and then, if there is nothing in the way, steer so that your vehicle straddles the edge of the pavement. You can turn the steering wheel up to one-quarter turn until the right front tire contacts the pavement edge. Then turn your steering wheel to go straight down the roadway.

Passing

The driver of a vehicle about to pass another on a two-lane highway waits for just the right moment, accelerates, moves around the vehicle ahead, then goes back into the right lane again. A simple maneuver?

Not necessarily! Passing another vehicle on a two-lane highway is a potentially dangerous move, since the passing vehicle occupies the same lane as oncoming traffic for several seconds. A miscalculation, an error in judgment, or a brief surrender to frustration or anger can suddenly put the passing driver face to face with the worst of all traffic accidents — the head-on collision.

So here are some tips for passing:

- Drive ahead. Look down the road, to the sides and to crossroads for situations that might affect your passing patterns. If you have any doubt whatsoever about making a successful pass, wait for a better time.
- Watch for traffic signs, pavement markings and lines. If you can see a sign up ahead that might indicate a turn or an intersection, delay your pass. A broken center line usually indicates it is all right to pass, providing the road ahead is clear. Never cross a solid line on your side of the lane or a double solid line, even if the road seems empty of approaching traffic.

- Do not get too close to the vehicle you want to pass while you are awaiting an opportunity. For one thing, following too closely reduces your area of vision, especially if you are following a larger vehicle. Also, you will not have adequate space if the vehicle ahead suddenly slows or stops. Keep back a reasonable distance.
- When it looks like a chance to pass is coming up, start to accelerate but stay in the right lane and do not get too close. Time your move so you will be increasing speed as the time comes to move into the other lane. If the way is clear to pass, you will have a running start that more than makes up for the distance you would lose by dropping back. And if something happens to cause you to cancel your pass, you need only slow down and drop back again and wait for another opportunity.
- If other vehicles are lined up to pass a slow vehicle, wait your turn. But take care that someone is not trying to pass you as you pull out to pass the slow vehicle. Remember to glance over your shoulder and check the blind spot.
- Check your mirrors, glance over your shoulder and start your left lane change signal before moving out of the right lane to pass. When you are far enough ahead of the passed vehicle to see its front in your inside mirror, activate your right lane change signal and move back into the right lane. Remember that if your right outside mirror is convex, the vehicle you just passed may seem to be farther away from you than it really is.
- Try not to pass more than one vehicle at a time on two-lane roads. Reconsider before passing the next vehicle.
- Do not overtake a slowly moving vehicle too rapidly. Even though the brake lamps are not flashing, it may be slowing down or starting to turn.
- If you are being passed, make it easy for the following driver to get ahead of you. Perhaps you can ease a little to the right.

Loss of Control

Let us review what driving experts say about what happens when the three control systems — brakes, steering, and acceleration — do not have enough friction where the tires meet the road to do what the driver has asked.

In any emergency, do not give up. Keep trying to steer and constantly seek an escape route or area of less danger.

Skidding

In a skid, a driver can lose control of the vehicle. Defensive drivers avoid most skids by taking reasonable care suited to existing conditions, and by not overdriving those conditions. But skids are always possible.

The three types of skids correspond to your vehicle's three control systems. In the braking skid, your wheels are not rolling. In the steering or cornering skid, too much speed or steering in a curve causes tires to slip and lose cornering force. And in the acceleration skid, too much throttle causes the driving wheels to spin.

A cornering skid is best handled by easing your foot off the accelerator pedal.

Remember: Any traction control system helps avoid only the acceleration skid. If your traction control system is off, then an acceleration skid is also best handled by easing your foot off the accelerator pedal.

If your vehicle starts to slide, ease your foot off the accelerator pedal and quickly steer the way you want the vehicle to go. If you start steering quickly enough, your vehicle may straighten out. Always be ready for a second skid if it occurs.

Of course, traction is reduced when water, snow, ice, gravel, or other material is on the road. For safety, you will want to slow down and adjust your driving to these conditions. It is important to slow down on slippery surfaces because stopping distance will be longer and vehicle control more limited.

While driving on a surface with reduced traction, try your best to avoid sudden steering, acceleration, or braking, including engine braking by shifting to a lower gear. Any sudden changes could cause the tires to slide. You may not realize the surface is slippery until your vehicle is skidding. Learn to recognize warning clues — such as enough water, ice, or packed snow on the road to make a mirrored surface — and slow down when you have any doubt.

Remember: Any anti-lock brake system (ABS) helps avoid only the braking skid.

Operating Your All-Wheel-Drive Vehicle Off Paved Roads

This off-road guide is for vehicles that have all-wheel drive. If your vehicle does not have all-wheel drive, you should not drive off-road unless you are on a level, solid surface.

Many of the same design features that help make your vehicle responsive on paved roads during poor weather conditions — features like all-wheel drive — help make it much better suited for off-road use. Its higher ground clearance also helps your vehicle step over some off-road obstacles. But your vehicle does not have features like special underbody shielding and a transfer case low gear range, things that are usually thought necessary for extended or severe off-road service.

Also, see *Braking on page 4-6*.

Off-road driving can be great fun. But it does have some definite hazards. The greatest of these is the terrain itself.

“Off-roading” means you have left the North American road system behind. Traffic lanes are not marked. Curves are not banked. There are no road signs. Surfaces can be slippery, rough, uphill or downhill. In short, you have gone right back to nature.

Off-road driving involves some new skills. And that is why it is very important that you read this guide. You will find many driving tips and suggestions. These will help make your off-road driving safer and more enjoyable.

Before You Go Off-Roading

There are some things to do before you go out. For example, be sure to have all necessary maintenance and service work done. Check to make sure all underbody shields (if so equipped) are properly attached. Is there enough fuel? Is the spare tire fully inflated? Are the fluid levels up where they should be? What are the local laws that apply to off-roading where you will be driving? If you do not know, you should check with law enforcement people in the area. Will you be on someone’s private land? If so, be sure to get the necessary permission.

Loading Your Vehicle for Off-Road Driving

There are some important things to remember about how to load your vehicle.

- The heaviest things should be on the load floor and forward of your rear axle. Put heavier items as far forward as you can.
- Be sure the load is secured properly, so driving on the off-road terrain does not toss things around.

CAUTION:

- **Cargo on the load floor piled higher than the seatbacks can be thrown forward during a sudden stop. You or your passengers could be injured. Keep cargo below the top of the seatbacks.**
- **Unsecured cargo on the load floor can be tossed about when driving over rough terrain. You or your passengers can be struck by flying objects. Secure the cargo properly.**
- **Heavy loads on the roof raise the vehicle's center of gravity, making it more likely to roll over. You can be seriously or fatally injured if the vehicle rolls over. Put heavy loads inside the cargo area, not on the roof. Keep cargo in the cargo area as far forward and low as possible.**

You will find other important information in this manual. See *Loading Your Vehicle* on page 4-45, *Luggage Carrier* on page 2-48 and *Tires* on page 5-52.

Environmental Concerns

Off-road driving can provide wholesome and satisfying recreation. However, it also raises environmental concerns. We recognize these concerns and urge every off-roader to follow these basic rules for protecting the environment:

- Always use established trails, roads and areas that have been specially set aside for public off-road recreational driving; obey all posted regulations.
- Avoid any driving practice that could damage the environment — shrubs, flowers, trees, grasses — or disturb wildlife (this includes wheel-spinning, breaking down trees or unnecessary driving through streams or over soft ground).
- Always carry a litter bag — make sure all refuse is removed from any campsite before leaving.
- Take extreme care with open fires (where permitted), camp stoves and lanterns.
- Never park your vehicle over dry grass or other combustible materials that could catch fire from the heat of the vehicle's exhaust system.

Traveling to Remote Areas

It makes sense to plan your trip, especially when going to a remote area. Know the terrain and plan your route. You are much less likely to get bad surprises. Get accurate maps of trails and terrain. Try to learn of any blocked or closed roads.

It is also a good idea to travel with at least one other vehicle. If something happens to one of them, the other can help quickly.

Getting Familiar with Off-Road Driving

It is a good idea to practice in an area that is safe and close to home before you go into the wilderness. Off-road driving does require some new and different driving skills. Here is what we mean.

Tune your senses to different kinds of signals. Your eyes, for example, need to constantly sweep the terrain for unexpected obstacles. Your ears need to listen for unusual tire or engine sounds. With your arms, hands, feet and body, you will need to respond to vibrations and vehicle bounce.

Controlling your vehicle is the key to successful off-road driving. One of the best ways to control your vehicle is to control your speed. Here are some things to keep in mind. At higher speeds:

- you approach things faster and you have less time to scan the terrain for obstacles.
- you have less time to react.
- you have more vehicle bounce when you drive over obstacles.
- you will need more distance for braking, especially since you are on an unpaved surface.

CAUTION:

When you are driving off-road, bouncing and quick changes in direction can easily throw you out of position. This could cause you to lose control and crash. So, whether you're driving on or off the road, you and your passengers should wear safety belts.

Scanning the Terrain

Off-road driving can take you over many different kinds of terrain. You need to be familiar with the terrain and its many different features. Here are some things to consider.

Surface Conditions: Off-roading can take you over hard-packed dirt, gravel, rocks, grass, sand, mud, snow or ice. Each of these surfaces affects the steering, acceleration and braking of your vehicle in different ways. Depending upon the kind of surface you are on, you may experience slipping, sliding, wheel spinning, delayed acceleration, poor traction and longer braking distances.

Surface Obstacles: Unseen or hidden obstacles can be hazardous. A rock, log, hole, rut or bump can startle you if you are not prepared for them. Often these obstacles are hidden by grass, bushes, snow or even the rise and fall of the terrain itself. Here are some things to consider:

- Is the path ahead clear?
- Will the surface texture change abruptly up ahead?
- Does the travel take you uphill or downhill?
(There is more discussion of these subjects later.)
- Will you have to stop suddenly or change direction quickly?

When you drive over obstacles or rough terrain, keep a firm grip on the steering wheel. Ruts, troughs or other surface features can jerk the wheel out of your hands if you are not prepared.

When you drive over bumps, rocks, or other obstacles, your wheels can leave the ground. If this happens, even with one or two wheels, you cannot control the vehicle as well or at all.

Because you will be on an unpaved surface, it is especially important to avoid sudden acceleration, sudden turns or sudden braking.

In a way, off-road driving requires a different kind of alertness from driving on paved roads and highways. There are no road signs, posted speed limits or signal lights. You have to use your own good judgment about what is safe and what is not.

Drinking and driving can be very dangerous on any road. And this is certainly true for off-road driving. At the very time you need special alertness and driving skills, your reflexes, perceptions and judgment can be affected by even a small amount of alcohol. You could have a serious — or even fatal — accident if you drink and drive or ride with a driver who has been drinking. See *Drunken Driving* on page 4-3.

Driving on Off-Road Hills

Off-road driving often takes you up, down or across a hill. Driving safely on hills requires good judgment and understanding of what your vehicle can and cannot do. There are some hills that simply cannot be driven, no matter how well built the vehicle.

CAUTION:

Many hills are simply too steep for any vehicle. If you drive up them, you will stall. If you drive down them, you cannot control your speed. If you drive across them, you will roll over. You could be seriously injured or killed. If you have any doubt about the steepness, do not drive the hill.

Approaching a Hill

When you approach a hill, you need to decide if it is one of those hills that is just too steep to climb, descend or cross. Steepness can be hard to judge. On a very small hill, for example, there may be a smooth, constant incline with only a small change in elevation where you can easily see all the way to the top. On a large hill, the incline may get steeper as you near the top, but you may not see this because the crest of the hill is hidden by bushes, grass or shrubs.

Here are some other things to consider as you approach a hill.

- Is there a constant incline, or does the hill get sharply steeper in places?
- Is there good traction on the hillside, or will the surface cause tire slipping?
- Is there a straight path up or down the hill so you will not have to make turning maneuvers?
- Are there obstructions on the hill that can block your path (boulders, trees, logs or ruts)?
- What is beyond the hill? Is there a cliff, an embankment, a drop-off, a fence? Get out and walk the hill if you do not know. It is the smart way to find out.
- Is the hill simply too rough? Steep hills often have ruts, gullies, troughs and exposed rocks because they are more susceptible to the effects of erosion.

Driving Uphill

Once you decide you can safely drive up the hill, you need to take some special steps.

- Use a low gear and get a firm grip on the steering wheel.
- Get a smooth start up the hill and try to maintain your speed. Do not use more power than you need, because you do not want your wheels to start spinning or sliding.
- Try to drive straight up the hill if at all possible. If the path twists and turns, you might want to find another route.

CAUTION:

Turning or driving across steep hills can be dangerous. You could lose traction, slide sideways, and possibly roll over. You could be seriously injured or killed. When driving up hills, always try to go straight up.

- Ease up on your speed as you approach the top of the hill.
- Attach a flag to the vehicle to make you more visible to approaching traffic on trails or hills.
- Sound the horn as you approach the top of the hill to let opposing traffic know you are there.
- Use your headlamps even during the day. They make you more visible to oncoming traffic.

 **CAUTION:**

Driving to the top (crest) of a hill at full speed can cause an accident. There could be a drop-off, embankment, cliff, or even another vehicle. You could be seriously injured or killed. As you near the top of a hill, slow down and stay alert.

Q: What should I do if my vehicle stalls, or is about to stall, and I cannot make it up the hill?

A: If this happens, there are some things you should do, and there are some things you must not do? First, here is what you *should* do:

- Push the brake pedal to stop the vehicle and keep it from rolling backwards. Also, apply the parking brake.
- If your engine is still running, shift the transmission to REVERSE (R), release the parking brake, and slowly back down the hill in REVERSE (R).
- If your engine has stopped running, you will need to restart it. With the brake pedal pressed and the parking brake still applied, shift the transmission to PARK (P) and restart the engine. Then shift to REVERSE (R), release the parking brake, and slowly back down the hill as straight as possible in REVERSE (R).
- As you are backing down the hill, put your left hand on the steering wheel at the 12 o'clock position. This way you will be able to tell if your wheels are straight and maneuver as you back down. It is best that you back down the hill with your wheels straight rather than in the left or right direction. Turning the wheel too far to the left or right will increase the possibility of a rollover.

Here are some things you *must not* do if you stall, or are about to stall, when going up a hill.

- Never attempt to prevent a stall by shifting into NEUTRAL (N) to rev-up the engine and regain forward momentum. This will not work. Your vehicle will roll backwards very quickly and you could go out of control.

Instead, apply the regular brake to stop the vehicle. Then apply the parking brake. Shift to REVERSE (R), release the parking brake, and slowly back straight down.

- Never attempt to turn around if you are about to stall when going up a hill. If the hill is steep enough to stall your vehicle, it is steep enough to cause you to roll over if you turn around. If you cannot make it up the hill you must back straight down the hill.

Q: Suppose, after stalling, I try to back down the hill and decide I just cannot do it. What should I do?

A: Set the parking brake, put your transmission in PARK (P) and turn off the engine. Leave the vehicle and go get some help. Exit on the uphill side and stay clear of the path the vehicle would take if it rolled downhill.

Driving Downhill

When off-roading takes you downhill, you will want to consider a number of things:

- How steep is the downhill? Will I be able to maintain vehicle control?
- What's the surface like? Smooth? Rough? Slippery? Hard-packed dirt? Gravel?
- Are there hidden surface obstacles? Ruts? Logs? Boulders?
- What is at the bottom of the hill? Is there a hidden creek bank or even a river bottom with large rocks?

If you decide you can go down a hill safely, then try to keep your vehicle headed straight down, and use a low gear. This way, engine drag can help your brakes and they will not have to do all the work. Descend slowly, keeping your vehicle under control at all times.

 **CAUTION:**

Heavy braking when going down a hill can cause your brakes to overheat and fade. This could cause loss of control and a serious accident. Apply the brakes lightly when descending a hill and use a low gear to keep vehicle speed under control.

Q: Are there some things I should not do when driving down a hill?

A: Yes! These are important because if you ignore them you could lose control and have a serious accident.

- When driving downhill, avoid turns that take you across the incline of the hill. A hill that is not too steep to drive down may be too steep to drive across. You could roll over if you do not drive straight down.
- Never go downhill with the transmission in NEUTRAL (N). This is called “free wheeling.” Your brakes will have to do all the work and could overheat and fade.

Q: Am I likely to stall when going downhill?

A: It is much more likely to happen going uphill. But if it happens going downhill, here is what to do.

1. Stop your vehicle by applying the regular brakes. Apply the parking brake.
2. Shift to PARK (P) and, while still braking, restart the engine.
3. Shift back to a low gear, release the parking brake, and drive straight down.
4. If the engine will not start, get out and get help.

Driving Across an Incline

Sooner or later, an off-road trail will probably go across the incline of a hill. If this happens, you have to decide whether to try to drive across the incline.

Here are some things to consider:

- A hill that can be driven straight up or down may be too steep to drive across. When you go straight up or down a hill, the length of the wheel base (the distance from the front wheels to the rear wheels) reduces the likelihood the vehicle will tumble end over end. But when you drive across an incline, the much more narrow track width (the distance between the left and right wheels) may not prevent the vehicle from tilting and rolling over. Also, driving across an incline puts more weight on the downhill wheels. This could cause a downhill slide or a rollover.
- Surface conditions can be a problem when you drive across a hill. Loose gravel, muddy spots, or even wet grass can cause your tires to slip sideways, downhill. If the vehicle slips sideways, it can hit something that will trip it (a rock, a rut, etc.) and roll over.
- Hidden obstacles can make the steepness of the incline even worse. If you drive across a rock with the uphill wheels, or if the downhill wheels drop into a rut or depression, your vehicle can tilt even more.

For reasons like these, you need to decide carefully whether to try to drive across an incline. Just because the trail goes across the incline does not mean you have to drive it. The last vehicle to try it might have rolled over.

CAUTION:

Driving across an incline that is too steep will make your vehicle roll over. You could be seriously injured or killed. If you have any doubt about the steepness of the incline, do not drive across it. Find another route instead.

Q: What if I am driving across an incline that is not too steep, but I hit some loose gravel and start to slide downhill. What should I do?

A: If you feel your vehicle starting to slide sideways, turn downhill. This should help straighten out the vehicle and prevent the side slipping. However, a much better way to prevent this is to get out and “walk the course” so you know what the surface is like before you drive it.

Stalling on an Incline

If your vehicle stalls when you are crossing an incline, be sure you (and your passengers) get out on the uphill side, even if the door there is harder to open. If you get out on the downhill side and the vehicle starts to roll over, you will be right in its path.

If you have to walk down the slope, stay out of the path the vehicle will take if it does roll over.

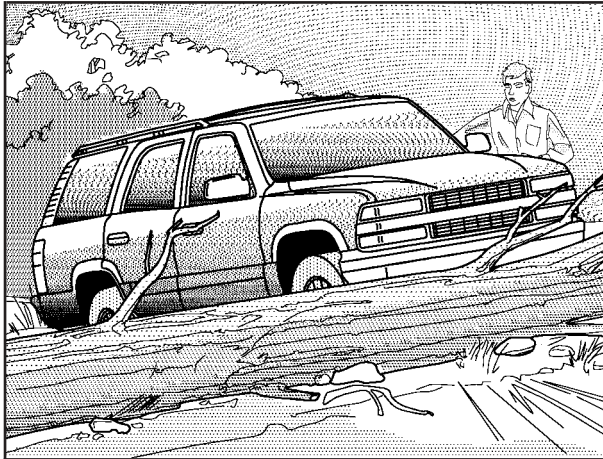

CAUTION:

Getting out on the downhill (low) side of a vehicle stopped across an incline is dangerous. If the vehicle rolls over, you could be crushed or killed. Always get out on the uphill (high) side of the vehicle and stay well clear of the rollover path.

Driving in Mud, Sand, Snow or Ice

When you drive in mud, snow or sand, your wheels will not get good traction. You cannot accelerate as quickly, turning is more difficult, and you will need longer braking distances.

It is best to use a low gear when you are in mud — the deeper the mud, the lower the gear. In really deep mud, the idea is to keep your vehicle moving so you do not get stuck.

When you drive on sand, you will sense a change in wheel traction. But it will depend upon how loosely packed the sand is. On loosely packed sand (as on beaches or sand dunes) your tires will tend to sink into the sand. This has an effect on steering, accelerating and braking. Drive at a reduced speed and avoid sharp turns or abrupt maneuvers.

Hard packed snow and ice offer the worst tire traction. On these surfaces, it is very easy to lose control. On wet ice, for example, the traction is so poor that you will have difficulty accelerating. And, if you do get moving, poor steering and difficult braking can cause you to slide out of control.

CAUTION:

Driving on frozen lakes, ponds or rivers can be dangerous. Underwater springs, currents under the ice, or sudden thaws can weaken the ice. Your vehicle could fall through the ice and you and your passengers could drown. Drive your vehicle on safe surfaces only.

Driving in Water

Heavy rain can mean flash flooding, and flood waters demand extreme caution.

Find out how deep the water is before you drive through it. If it is deep enough to cover your wheel hubs, axles or exhaust pipe, do not try it — you probably will not get through. Also, water that deep can damage your axle and other vehicle parts.

If the water is not too deep, drive slowly through it. At faster speeds, water splashes on your ignition system and your vehicle can stall. Stalling can also occur if you get your tailpipe under water. And, as long as your tailpipe is under water, you will never be able to start your engine. When you go through water, remember that when your brakes get wet, it may take you longer to stop.

CAUTION:

Driving through rushing water can be dangerous. Deep water can sweep your vehicle downstream and you and your passengers could drown. If it is only shallow water, it can still wash away the ground from under your tires, and you could lose traction and roll the vehicle over. Do not drive through rushing water.

See *Driving in Rain and on Wet Roads* on page 4-32 for more information on driving through water.

After Off-Road Driving

Remove any brush or debris that has collected on the underbody, chassis or under the hood. These accumulations can be a fire hazard.

After operation in mud or sand, have the brake linings cleaned and checked. These substances can cause glazing and uneven braking. Check the body structure, steering, suspension, wheels, tires and exhaust system for damage. Also, check the fuel lines and cooling system for any leakage.

Your vehicle will require more frequent service due to off-road use. Refer to the Maintenance Schedule for additional information.

Driving at Night

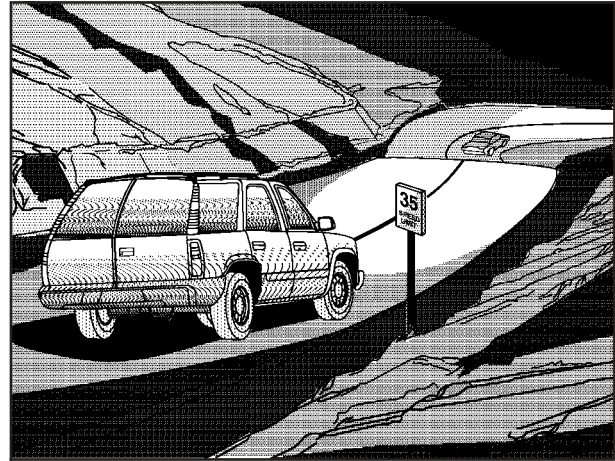

Night driving is more dangerous than day driving. One reason is that some drivers are likely to be impaired — by alcohol or drugs, with night vision problems, or by fatigue.

Here are some tips on night driving.

- Drive defensively.
- Do not drink and drive.
- Since you cannot see as well, you may need to slow down and keep more space between you and other vehicles.
- Slow down, especially on higher speed roads. Your headlamps can light up only so much road ahead.
- In remote areas, watch for animals.
- If you are tired, pull off the road in a safe place and rest.

No one can see as well at night as in the daytime. But as we get older these differences increase. A 50-year-old driver may require at least twice as much light to see the same thing at night as a 20-year-old.

What you do in the daytime can also affect your night vision. For example, if you spend the day in bright sunshine you are wise to wear sunglasses. Your eyes will have less trouble adjusting to night. But if you are driving, do not wear sunglasses at night. They may cut down on glare from headlamps, but they also make a lot of things invisible.

You can be temporarily blinded by approaching headlamps. It can take a second or two, or even several seconds, for your eyes to re-adjust to the dark. When you are faced with severe glare, as from a driver who does not lower the high beams, or a vehicle with misaimed headlamps, slow down a little. Avoid staring directly into the approaching headlamps.

Keep your windshield and all the glass on your vehicle clean — inside and out. Glare at night is made much worse by dirt on the glass. Even the inside of the glass can build up a film caused by dust. Dirty glass makes lights dazzle and flash more than clean glass would, making the pupils of your eyes contract repeatedly.

Remember that your headlamps light up far less of a roadway when you are in a turn or curve. Keep your eyes moving; that way, it is easier to pick out dimly lighted objects. Just as your headlamps should be checked regularly for proper aim, so should your eyes be examined regularly. Some drivers suffer from night blindness — the inability to see in dim light — and are not even aware of it.

Driving in Rain and on Wet Roads

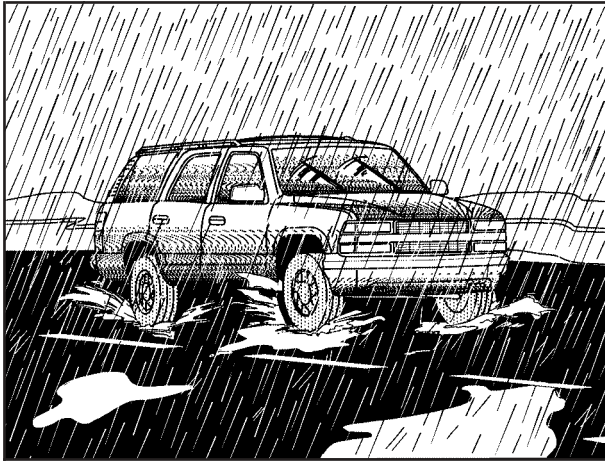

Rain and wet roads can mean driving trouble. On a wet road, you cannot stop, accelerate, or turn as well because your tire-to-road traction is not as good as on dry roads. And, if your tires do not have much tread left,

you will get even less traction. It is always wise to go slower and be cautious if rain starts to fall while you are driving. The surface may get wet suddenly when your reflexes are tuned for driving on dry pavement.

The heavier the rain, the harder it is to see. Even if your windshield wiper blades are in good shape, a heavy rain can make it harder to see road signs and traffic signals, pavement markings, the edge of the road, and even people walking.

It is wise to keep your wiping equipment in good shape and keep your windshield washer tank filled with washer fluid. Replace your windshield wiper inserts when they show signs of streaking or missing areas on the windshield, or when strips of rubber start to separate from the inserts.



Driving too fast through large water puddles or even going through some car washes can cause problems, too. The water may affect your brakes. Try to avoid puddles. But if you cannot, try to slow down before you hit them.

⚠ CAUTION:

Wet brakes can cause accidents. They will not work as well in a quick stop and may cause pulling to one side. You could lose control of the vehicle.

After driving through a large puddle of water or a car wash, apply your brake pedal lightly until your brakes work normally.

Hydroplaning

Hydroplaning is dangerous. So much water can build up under your tires that they can actually ride on the water. This can happen if the road is wet enough and you are going fast enough. When your vehicle is hydroplaning, it has little or no contact with the road.

Hydroplaning does not happen often. But it can if your tires do not have much tread or if the pressure in one or more is low. It can happen if a lot of water is standing on the road. If you can see reflections from trees, telephone poles, or other vehicles, and raindrops dimple the water's surface, there could be hydroplaning.

Hydroplaning usually happens at higher speeds. There just is not a hard and fast rule about hydroplaning. The best advice is to slow down when it is raining.

Driving Through Deep Standing Water

Notice: If you drive too quickly through deep puddles or standing water, water can come in through your engine's air intake and badly damage your engine. Never drive through water that is slightly lower than the underbody of your vehicle. If you cannot avoid deep puddles or standing water, drive through them very slowly.

Driving Through Flowing Water

CAUTION:

Flowing or rushing water creates strong forces. If you try to drive through flowing water, as you might at a low water crossing, your vehicle can be carried away. As little as six inches of flowing water can carry away a smaller vehicle. If this happens, you and other vehicle occupants could drown. Do not ignore police warning signs, and otherwise be very cautious about trying to drive through flowing water.

Some Other Rainy Weather Tips

- Turn on your low-beam headlamps — not just your parking lamps — to help make you more visible to others.
- Besides slowing down, allow some extra following distance. And be especially careful when you pass another vehicle. Allow yourself more clear room ahead, and be prepared to have your view restricted by road spray.
- Have good tires with proper tread depth. See *Tires on page 5-52*.

City Driving



One of the biggest problems with city streets is the amount of traffic on them. You will want to watch out for what the other drivers are doing and pay attention to traffic signals.

Here are ways to increase your safety in city driving:

- Know the best way to get to where you are going. Get a city map and plan your trip into an unknown part of the city just as you would for a cross-country trip.
- Try to use the freeways that rim and crisscross most large cities. You will save time and energy. See *Freeway Driving on page 4-36*.
- Treat a green light as a warning signal. A traffic light is there because the corner is busy enough to need it. When a light turns green, and just before you start to move, check both ways for vehicles that have not cleared the intersection or may be running the red light.

Freeway Driving



Mile for mile, freeways — also called thruways, parkways, expressways, turnpikes, or superhighways — are the safest of all roads. But they have their own special rules.

The most important advice on freeway driving is: Keep up with traffic and keep to the right. Drive at the same speed most of the other drivers are driving. Too-fast or too-slow driving breaks a smooth traffic flow. Treat the left lane on a freeway as a passing lane.

At the entrance, there is usually a ramp that leads to the freeway. If you have a clear view of the freeway as you drive along the entrance ramp, you should begin to check traffic. Try to determine where you expect to blend with the flow. Try to merge into the gap at close to the prevailing speed. Switch on your turn signal, check your mirrors, and glance over your shoulder as often as necessary. Try to blend smoothly with the traffic flow.

Once you are on the freeway, adjust your speed to the posted limit or to the prevailing rate if it is slower. Stay in the right lane unless you want to pass.

Before changing lanes, check your mirrors. Then use your turn signal.

Just before you leave the lane, glance quickly over your shoulder to make sure there is not another vehicle in your blind spot.

Once you are moving on the freeway, make certain you allow a reasonable following distance. Expect to move slightly slower at night.

When you want to leave the freeway, move to the proper lane well in advance. If you miss your exit, do not, under any circumstances, stop and back up. Drive on to the next exit.

The exit ramp can be curved, sometimes quite sharply. The exit speed is usually posted.

Reduce your speed according to your speedometer, not to your sense of motion. After driving for any distance at higher speeds, you may tend to think you are going slower than you actually are.

Before Leaving on a Long Trip

Make sure you are ready. Try to be well rested. If you must start when you are not fresh — such as after a day's work — do not plan to make too many miles that first part of the journey. Wear comfortable clothing and shoes you can easily drive in.

Is your vehicle ready for a long trip? If you keep it serviced and maintained, it is ready to go. If it needs service, have it done before starting out. Of course, you will find experienced and able service experts in GM dealerships all across North America. They will be ready and willing to help if you need it.

Here are some things you can check before a trip:

- *Windshield Washer Fluid:* Is the reservoir full? Are all windows clean inside and outside?
- *Wiper Blades:* Are they in good shape?
- *Fuel, Engine Oil, Other Fluids:* Have you checked all levels?
- *Lamps:* Are they all working? Are the lenses clean?
- *Tires:* They are vitally important to a safe, trouble-free trip. Is the tread good enough for long-distance driving? Are the tires all inflated to the recommended pressure?
- *Weather Forecasts:* What is the weather outlook along your route? Should you delay your trip a short time to avoid a major storm system?
- *Maps:* Do you have up-to-date maps?

Highway Hypnosis

Is there actually such a condition as highway hypnosis? Or is it just plain falling asleep at the wheel? Call it highway hypnosis, lack of awareness, or whatever.

There is something about an easy stretch of road with the same scenery, along with the hum of the tires on the road, the drone of the engine, and the rush of the wind against the vehicle that can make you sleepy. Do not let it happen to you! If it does, your vehicle can leave the road in less than a second, and you could crash and be injured.

What can you do about highway hypnosis? First, be aware that it can happen.

Then here are some tips:

- Make sure your vehicle is well ventilated, with a comfortably cool interior.
- Keep your eyes moving. Scan the road ahead and to the sides. Check your mirrors and your instruments frequently.
- If you get sleepy, pull off the road into a rest, service, or parking area and take a nap, get some exercise, or both. For safety, treat drowsiness on the highway as an emergency.

Hill and Mountain Roads



Driving on steep hills or mountains is different from driving in flat or rolling terrain.

If you drive regularly in steep country, or if you are planning to visit there, here are some tips that can make your trips safer and more enjoyable. See *Operating Your All-Wheel-Drive Vehicle Off Paved Roads on page 4-17* for information about driving off-road.

- Keep your vehicle in good shape. Check all fluid levels and also the brakes, tires, cooling system, and transmission. These parts can work hard on mountain roads.
- Know how to go down hills. The most important thing to know is this: let your engine do some of the slowing down. Shift to a lower gear when you go down a steep or long hill.

 **CAUTION:**

If you do not shift down, your brakes could get so hot that they would not work well. You would then have poor braking or even none going down a hill. You could crash. Shift down to let your engine assist your brakes on a steep downhill slope.

 **CAUTION:**

Coasting downhill in NEUTRAL (N) or with the ignition off is dangerous. Your brakes will have to do all the work of slowing down. They could get so hot that they would not work well. You would then have poor braking or even none going down a hill. You could crash. Always have your engine running and your vehicle in gear when you go downhill.

- Know how to go uphill. You may want to shift down to a lower gear. The lower gears help cool your engine and transmission, and you can climb the hill better.
- Stay in your own lane when driving on two-lane roads in hills or mountains. Do not swing wide or cut across the center of the road. Drive at speeds that let you stay in your own lane.
- As you go over the top of a hill, be alert. There could be something in your lane, like a stalled car or an accident.
- You may see highway signs on mountains that warn of special problems. Examples are long grades, passing or no-passing zones, a falling rocks area, or winding roads. Be alert to these and take appropriate action.

Winter Driving



Here are some tips for winter driving:

- Have your vehicle in good shape for winter.
- You may want to put winter emergency supplies in your vehicle.

Also see *Tires* on page 5-52.

Include an ice scraper, a small brush or broom, a supply of windshield washer fluid, a rag, some winter outer clothing, a small shovel, a flashlight, a red cloth, and a couple of reflective warning triangles. And, if you will be driving under severe conditions, include a small bag of sand, a piece of old carpet, or a couple of burlap bags to help provide traction. Be sure you properly secure these items in your vehicle.

Driving on Snow or Ice

Most of the time, those places where your tires meet the road probably have good traction.

However, if there is snow or ice between your tires and the road, you can have a very slippery situation. You will have a lot less traction, or grip, and will need to be very careful.

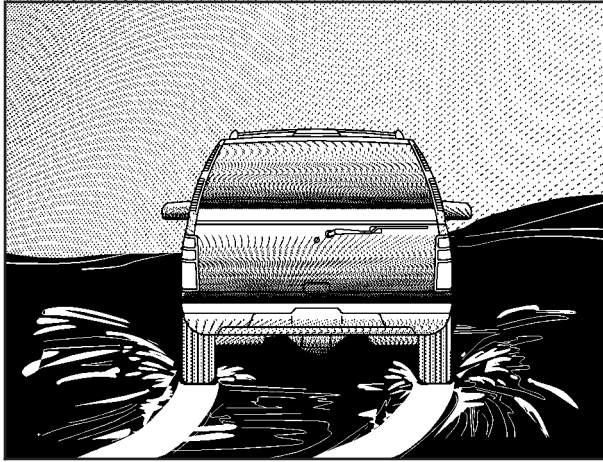

What is the worst time for this? Wet ice. Very cold snow or ice can be slick and hard to drive on. But wet ice can be even more trouble because it may offer the least traction of all. You can get wet ice when it is about freezing (32°F; 0°C) and freezing rain begins to fall. Try to avoid driving on wet ice until salt and sand crews can get there.

Whatever the condition — smooth ice, packed, blowing, or loose snow — drive with caution.

Accelerate gently. Try not to break the fragile traction. If you accelerate too fast, the drive wheels will spin and polish the surface under the tires even more. See *Stabilitrak® System* on page 4-10 and *Rocking Your Vehicle to Get It Out* on page 4-44. Also see “Winter Tires” under *Tires* on page 5-52.

Your anti-lock brakes improve your vehicle’s stability when you make a hard stop on a slippery road. Even though you have an anti-lock braking system, you will want to begin stopping sooner than you would on dry pavement. See *Anti-Lock Brake System (ABS)* on page 4-7.

- Allow greater following distance on any slippery road.
- Watch for slippery spots. The road might be fine until you hit a spot that is covered with ice. On an otherwise clear road, ice patches may appear in shaded areas where the sun cannot reach: around clumps of trees, behind buildings, or under bridges. Sometimes the surface of a curve or an overpass may remain icy when the surrounding roads are clear. If you see a patch of ice ahead of you, brake before you are on it. Try not to brake while you are actually on the ice, and avoid sudden steering maneuvers.

If You Are Caught in a Blizzard



If you are stopped by heavy snow, you could be in a serious situation. You should probably stay with your vehicle unless you know for sure that you are near help and you can hike through the snow. Here are some things to do to summon help and keep yourself and your passengers safe:

- Turn on your hazard flashers.
- Tie a red cloth to your vehicle to alert police that you have been stopped by the snow.

- Put on extra clothing or wrap a blanket around you. If you have no blankets or extra clothing, make body insulators from newspapers, burlap bags, rags, floor mats — anything you can wrap around yourself or tuck under your clothing to keep warm.

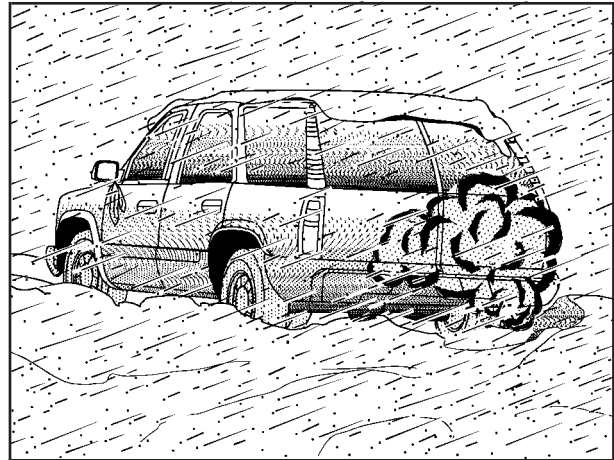

You can run the engine to keep warm, but be careful.

 **CAUTION:**

Snow can trap exhaust gases under your vehicle. This can cause deadly CO (carbon monoxide) gas to get inside. CO could overcome you and kill you. You cannot see it or smell it, so you might not know it is in your vehicle. Clear away snow from around the base of your vehicle, especially any that is blocking your exhaust pipe. And check around again from time to time to be sure snow does not collect there.

Open a window just a little on the side of the vehicle that is away from the wind. This will help keep CO out.

Run your engine only as long as you must. This saves fuel. When you run the engine, make it go a little faster than just idle. That is, push the accelerator slightly. This uses less fuel for the heat that you get and it keeps the battery charged. You will need a well-charged battery to restart the vehicle, and possibly for signaling later on with your headlamps. Let the heater run for a while.

Then, shut the engine off and close the window almost all the way to preserve the heat. Start the engine again and repeat this only when you feel really uncomfortable from the cold. But do it as little as possible. Preserve the fuel as long as you can. To help keep warm, you can get out of the vehicle and do some fairly vigorous exercises every half hour or so until help comes.

If You Are Stuck: In Sand, Mud, Ice or Snow

In order to free your vehicle when it is stuck, you will need to spin the wheels, but you do not want to spin your wheels too fast. The method known as rocking can help you get out when you are stuck, but you must use caution.

CAUTION:

If you let your tires spin at high speed, they can explode, and you or others could be injured. And, the transmission or other parts of the vehicle can overheat. That could cause an engine compartment fire or other damage. When you are stuck, spin the wheels as little as possible. Do not spin the wheels above 35 mph (55 km/h) as shown on the speedometer.

Notice: Spinning your wheels can destroy parts of your vehicle as well as the tires. If you spin the wheels too fast while shifting your transmission back and forth, you can destroy your transmission.

For more information about using tire chains on your vehicle, see *Tire Chains on page 5-68*.

Rocking Your Vehicle to Get It Out

First, turn your steering wheel left and right. That will clear the area around your front wheels. If your vehicle has the Stabilitrak[®] System, turn the system off by pressing and holding the Traction button so that the STABILITY SYS DISABLED message and the traction off light are illuminated on the instrument panel cluster. Then shift back and forth between REVERSE (R) and a forward gear, spinning the wheels as little as possible. Release the accelerator pedal while you shift, and press lightly on the accelerator pedal when the transmission is in gear. By slowly spinning your wheels in the forward and reverse directions, you will cause a rocking motion that may free your vehicle. If that does not get you out after a few tries, you may need to be towed out. Or, you can use your recovery hook if your vehicle has one. If you do need to be towed out, see *Towing Your Vehicle on page 4-50*.

Recovery Hook

Your vehicle may be equipped with a recovery hook. The recovery hook is provided in the jack storage area. The hook can be installed either at the front of the vehicle on the passenger side or at the rear of the vehicle on the driver side. At either location, remove the access cap from the vehicle trim and screw the hook into position. You may need to use the hook if you are stuck off-road and need to be pulled to some place where you can continue driving.

CAUTION:

The recovery hook, when used, is under a lot of force. Always pull the vehicle straight out. Never pull on the hook at a sideways angle. The hook could break off and you or others could be injured from the chain or cable snapping back.

Notice: Never use the recovery hook to tow the vehicle. Your vehicle could be damaged and it would not be covered by warranty.

Loading Your Vehicle

It is very important to know how much weight your vehicle can carry. This weight is called the vehicle capacity weight and includes the weight of all occupants, cargo and all nonfactory-installed options. Two labels on your vehicle show how much weight it may properly carry, the Tire and Loading Information label and the Certification/Tire label.

CAUTION:

Do not load your vehicle any heavier than the GVWR, or either the maximum front or rear GAWR. If you do, parts on your vehicle can break, and it can change the way your vehicle handles. These could cause you to lose control and crash. Also, overloading can shorten the life of your vehicle.

Tire and Loading Information Label

The diagram shows a rectangular label with a black header containing the text "TIRE AND LOADING INFORMATION". To the left of the header is a tire icon with callout 'A' pointing to it. Below the header is a row of five boxes labeled "SEATING CAPACITY", "TOTAL", "FRONT", "CENTER", and "REAR". Below this row is a warning sentence: "The combined weight of occupants and cargo should never exceed XXX kg or XXX lbs." Below the warning is a table with three columns: "ORIGINAL TIRE SIZE", "COLD TIRE INFLATION PRESSURE", and "SEE OWNER'S MANUAL FOR ADDITIONAL INFORMATION". The table has three rows: "FRONT", "REAR", and "SPARE". Callout 'C' points to the "ORIGINAL TIRE SIZE" column, and callout 'D' points to the "COLD TIRE INFLATION PRESSURE" column. Callout 'B' points to the "CENTER" box in the row above the table.

ORIGINAL TIRE SIZE		COLD TIRE INFLATION PRESSURE	SEE OWNER'S MANUAL FOR ADDITIONAL INFORMATION
	FRONT		
	REAR		
	SPARE		

Label Example

A vehicle specific Tire and Loading Information label is attached to the center pillar (B-pillar). With the driver's door open, you will find the label attached below the door lock post (striker). The tire and loading information label shows the number of occupant seating positions (A), and the maximum vehicle capacity weight (B) in kilograms and pounds.

The Tire and Loading Information label also shows the size of the original equipment tires (C) and the recommended cold tire inflation pressures (D). For more information on tires and inflation see *Tires on page 5-52* and *Inflation - Tire Pressure on page 5-58*.

There is also important loading information on the vehicle Certification/Tire label. It tells you the Gross Vehicle Weight Rating (GVWR) and the Gross Axle Weight Rating (GAWR) for the front and rear axle. See "Certification/Tire Label" later in this section.

Steps for Determining Correct Load Limit

1. Locate the statement "The combined weight of occupants and cargo should never exceed XXX kg or XXX pounds" on your vehicle's placard.
2. Determine the combined weight of the driver and passengers that will be riding in your vehicle.
3. Subtract the combined weight of the driver and passengers from XXX kilograms or XXX pounds.

4. The resulting figure equals the available amount of cargo and luggage load capacity. For example, if the “XXX” amount equals 1400 lbs and there will be five 150 lb passengers in your vehicle, the amount of available cargo and luggage load capacity is 650 lbs (1400 – 750 (5 x 150) = 650 lbs).
5. Determine the combined weight of luggage and cargo being loaded on the vehicle. That weight may not safely exceed the available cargo and luggage load capacity calculated in Step 4.
6. If your vehicle will be towing a trailer, the load from your trailer will be transferred to your vehicle. Consult this manual to determine how this reduces the available cargo and luggage load capacity of your vehicle.

If your vehicle can tow a trailer, see *Towing a Trailer on page 4-52* for important information on towing a trailer, towing safety rules, and trailering tips.

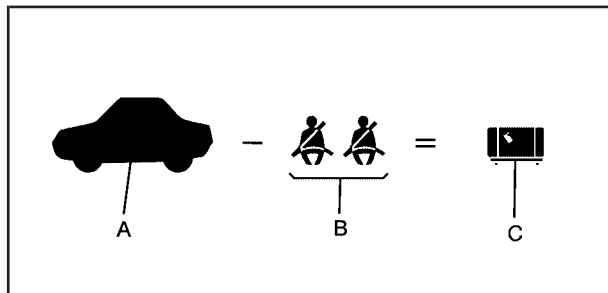

Example 1

Item	Description	Total
A	Vehicle Capacity Weight for Example 1 =	1,000 lbs (453 kg)
B	Subtract Occupant Weight 150 lbs (68 kg) × 2 =	300 lbs (136 kg)
C	Available Occupant and Cargo Weight =	700 lbs (317 kg)

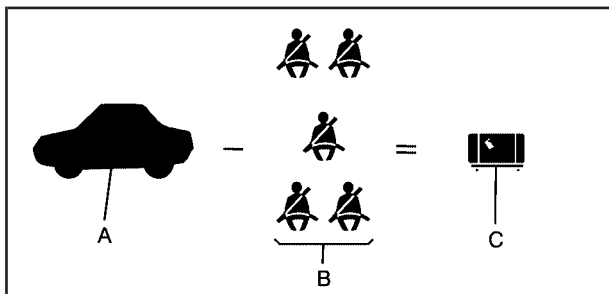

Example 2

Item	Description	Total
A	Vehicle Capacity Weight for Example 2 =	1,000 lbs (453 kg)
B	Subtract Occupant Weight 150 lbs (68 kg) × 5 =	750 lbs (340 kg)
C	Available Cargo Weight =	250 lbs (113 kg)

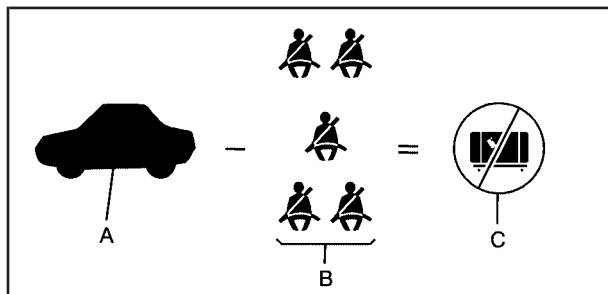

Example 3

Item	Description	Total
A	Vehicle Capacity Weight for Example 3 =	1,000 lbs (453 kg)
B	Subtract Occupant Weight 200 lbs (91 kg) × 5 =	1,000 lbs (453 kg)
C	Available Cargo Weight =	0 lbs (0 kg)

Refer to your vehicle's Tire and Loading Information label for specific information about your vehicle's capacity weight and seating positions. The combined weight of the driver, passengers, and cargo should never exceed your vehicle's capacity weight.

Certification/Tire Label

The diagram shows a rectangular label with several fields for information. At the top, there are three boxes labeled 'GVWR', 'GAWR FRT', and 'GAWR RR'. Below these are three smaller boxes. A large 'EXAMPLE' watermark is overlaid diagonally across the center of the label. At the bottom left, there is a section for 'MODEL:' followed by a box, and 'TIRE SPEED' followed by a box. To the right of this is a section for 'RIM' with two boxes, and 'COLD TIRE PRESSURE' with two boxes. At the bottom, there is a line of text: 'SEE OWNER'S MANUAL FOR ADDITIONAL INFORMATION' followed by a box.

United States version shown, Canada similar

The Certification/Tire label is found on the driver's door edge. This label shows the gross weight capacity of your vehicle and is called the Gross Vehicle Weight Rating (GVWR). The GVWR includes the weight of the vehicle, all occupants, fuel, cargo and trailer tongue weight, if pulling a trailer.

The Certification/Tire label also tells you the maximum weights for the front and rear axles, called Gross Axle Weight Rating (GAWR). To find out the actual loads on your front and rear axles, you need to go to a weigh station and weigh your vehicle. Your dealer can help you with this. Be sure to spread out your load equally on both sides of the centerline.

Never exceed the GVWR for your vehicle, or the GAWR for either the front or rear axle.

And, if you do have a heavy load, you should spread it out.

Similar appearing vehicles may have different GVWRs and payloads. Please note the Certification/Tire label on your truck or consult your dealer for additional details.

CAUTION:

Do not load your vehicle any heavier than the GVWR, or either the maximum front or rear GAWR. If you do, parts on your vehicle can break, and it can change the way your vehicle handles. These could cause you to lose control and crash. Also, overloading can shorten the life of your vehicle.

If you put things inside your vehicle — like suitcases, tools, packages, or anything else — they will go as fast as the vehicle goes. If you have to stop or turn quickly, or if there is a crash, they'll keep going.

 **CAUTION:**

Things you put inside your vehicle can strike and injure people in a sudden stop or turn, or in a crash.

- **Put things in the cargo area of your vehicle. Try to spread the weight evenly.**
- **Never stack heavier things, like suitcases, inside the vehicle so that some of them are above the tops of the seats.**
- **Do not leave an unsecured child restraint in your vehicle.**
- **When you carry something inside the vehicle, secure it whenever you can.**
- **Do not leave a seat folded down unless you need to.**

There's also important loading information for off-road driving in this manual. See *Operating Your All-Wheel-Drive Vehicle Off Paved Roads on page 4-17.*

Towing

Towing Your Vehicle

Consult your dealer or a professional towing service if you need to have your disabled vehicle towed. See *Roadside Service on page 7-6.*

If you want to tow your vehicle behind another vehicle for recreational purposes (such as behind a motorhome), see Recreational Vehicle Towing following.

Recreational Vehicle Towing

Recreational vehicle towing means towing your vehicle behind another vehicle — such as behind a motorhome. The two most common types of recreational vehicle towing are known as “dinghy towing” (towing your vehicle with all four wheels on the ground) and “dolly towing” (towing your vehicle with two wheels on the ground and two wheels up on a device known as a “dolly”).

With the proper preparation and equipment, many vehicles can be towed in these ways. See “Dinghy Towing” and “Dolly Towing,” following.

Here are some important things to consider before you do recreational vehicle towing:

- What's the towing capacity of the towing vehicle? Be sure you read the tow vehicle manufacturer's recommendations.
- How far will you tow? Some vehicles have restrictions on how far and how long they can tow.
- Do you have the proper towing equipment? See your dealer or trailering professional for additional advice and equipment recommendations.
- Is your vehicle ready to be towed? Just as you would prepare your vehicle for a long trip, you'll want to make sure your vehicle is prepared to be towed. See *Before Leaving on a Long Trip on page 4-37*.

Dinghy Towing

Notice: If you tow your vehicle with all four wheels on the ground, the drivetrain components could be damaged. The repairs would not be covered by your warranty. Do not tow your vehicle with all four wheels on the ground.

Your vehicle was not designed to be towed with all four wheels on the ground. If your vehicle must be towed, see "Dolly Towing" following for more information.

Dolly Towing

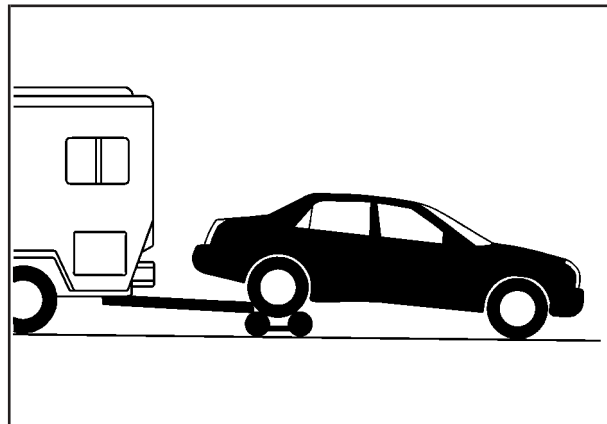

If your vehicle is a rear-wheel drive, it can be towed using a dolly. If you have an All-Wheel-Drive (AWD) vehicle, it can only be towed on a flat-bed trailer. To tow your vehicle using a dolly, follow these steps:

1. Put the rear wheels on the dolly.
2. Put the vehicle in PARK (P).
3. Set the parking brake and then remove the key.
4. Clamp the steering wheel in a straight-ahead position with a clamping device designed for towing.
5. Release the parking brake.

Level Control

This feature keeps the rear of your vehicle level as the load changes. It's automatic — you don't need to adjust anything.

Towing a Trailer

CAUTION:

If you do not use the correct equipment and drive properly, you can lose control when you pull a trailer. For example, if the trailer is too heavy, the brakes may not work well — or even at all. You and your passengers could be seriously injured. You may also damage your vehicle; the resulting repairs would not be covered by your warranty. Pull a trailer only if you have followed all the steps in this section. Ask your dealer for advice and information about towing a trailer with your vehicle.

Your vehicle can tow a trailer if it is equipped with the proper trailer towing equipment. To identify what the vehicle trailering capacity is for your vehicle, you should read the information in “Weight of the Trailer” that appears later in this section. But trailering is different than just driving your vehicle by itself. Trailering means changes in handling, acceleration, braking, durability and fuel economy. Successful, safe trailering takes correct equipment, and it has to be used properly.

That's the reason for this part. In it are many time-tested, important trailering tips and safety rules. Many of these are important for your safety and that of your passengers. So please read this section carefully before you pull a trailer.

Load-pulling components such as the engine, transmission, rear axle, wheel assemblies and tires are forced to work harder against the drag of the added weight. The engine is required to operate at relatively higher speeds and under greater loads, generating extra heat. What's more, the trailer adds considerably to wind resistance, increasing the pulling requirements.

If You Do Decide to Pull a Trailer

If you do, here are some important points:

- There are many different laws, including speed limit restrictions, having to do with trailering. Make sure your rig will be legal, not only where you live but also where you'll be driving. A good source for this information can be state or provincial police.
- Consider using a sway control. You can ask a hitch dealer about sway controls.
- Don't tow a trailer at all during the first 500 miles (805 km) your new vehicle is driven. Your engine, axle or other parts could be damaged.
- Then, during the first 500 miles (805 km) that you tow a trailer, don't drive over 50 mph (80 km/h) and don't make starts at full throttle. This helps your engine and other parts of your vehicle wear in at the heavier loads.
- Obey speed limit restrictions when towing a trailer. Don't drive faster than the maximum posted speed for trailers, or no more than 55 mph (90 km/h), to save wear on your vehicle's parts.

Three important considerations have to do with weight:

- the weight of the trailer
- the weight of the trailer tongue
- and the total weight on your vehicle's tires

Weight of the Trailer

How heavy can a trailer safely be?

It depends on how you plan to use your rig. For example, speed, altitude, road grades, outside temperature and how much your vehicle is used to pull a trailer are all important. And, it can also depend on any special equipment that you have on your vehicle.

Look in the following chart to find the maximum trailer weight for your vehicle.

Vehicle	Trailer Package	Maximum Trailer Weight	*GCWR
V6/V8	Base	2,000 lbs (907 kg)	6,853 lbs (3 808 kg)

*The Gross Combination Weight Rating (GCWR) is the total allowable weight of the completely loaded vehicle and trailer including any passengers, cargo, equipment and conversions. The GCWR for your vehicle should not be exceeded.

You can ask your dealer for our trailering information or advice, or you can write us at:

Cadillac Customer Assistance Center
Cadillac Motor Car Division
P.O. Box 33169
Detroit, MI 48232-5169

In Canada, write to:

General Motors of Canada Limited
Customer Communication Centre, 163-005
1908 Colonel Sam Drive
Oshawa, Ontario L1H 8P7

Weight of the Trailer Tongue

The tongue load (A) of any trailer is an important weight to measure because it affects the total or gross weight of your vehicle. The Gross Vehicle Weight (GVW) includes the curb weight of the vehicle, any cargo you may carry in it, and the people who will be riding in the vehicle. If you have a lot of options, equipment, passengers or cargo in the vehicle, it will reduce the tongue weight your vehicle can carry, which will also reduce the trailer weight your vehicle can tow. And if you tow a trailer, you must add the tongue load to the GVW because your vehicle will be carrying that weight, too. See *Loading Your Vehicle on page 4-45* for more information about your vehicle's maximum load capacity.

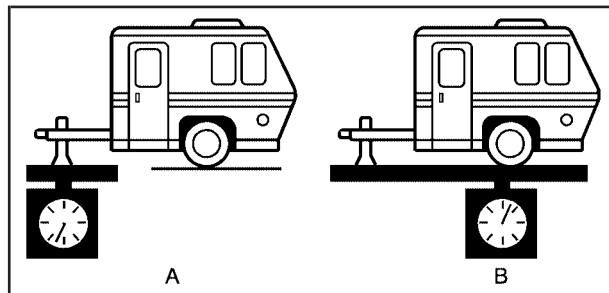

If you're using a weight-carrying hitch or a weight-distributing hitch, the trailer tongue (A) should weigh 10-15 percent of the total loaded trailer weight (B).

After you've loaded your trailer, weigh the trailer and then the tongue, separately, to see if the weights are proper. If they aren't, you may be able to get them right simply by moving some items around in the trailer.

Total Weight on Your Vehicle's Tires

Be sure your vehicle's tires are inflated to the upper limit for cold tires. You'll find these numbers on the Certification/Tire label. See *Loading Your Vehicle on page 4-45*. Then be sure you don't go over the GVW limit for your vehicle, including the weight of the trailer tongue.

Hitches

It's important to have the correct hitch equipment. Crosswinds, large trucks going by and rough roads are a few reasons why you'll need the right hitch.

Here are some rules to follow:

- The rear bumper on your vehicle is not intended for hitches. Do not attach rental hitches or other bumper-type hitches to it. Use only a frame-mounted hitch that does not attach to the bumper.
- Will you have to make any holes in the body of your vehicle when you install a trailer hitch? If you do, then be sure to seal the holes later when you remove the hitch. If you don't seal them, deadly carbon monoxide (CO) from your exhaust can get into your vehicle. See *Engine Exhaust on page 2-33*. Dirt and water can, too.

Safety Chains

You should always attach chains between your vehicle and your trailer. Cross the safety chains under the tongue of the trailer so that the tongue will not drop to the road if it becomes separated from the hitch. Instructions about safety chains may be provided by the hitch manufacturer or by the trailer manufacturer. Follow the manufacturer's recommendation for attaching safety chains and do not attach them to the bumper. Always leave just enough slack so you can turn with your rig. And, never allow safety chains to drag on the ground.

Trailer Brakes

Because your vehicle has anti-lock brakes, don't try to tap into your vehicle's hydraulic brake system. If you do, both brake systems won't work well, or at all. If you tow more than 1,000 lbs (450 kg), use trailer brakes.

Be sure to read and follow the instructions for the trailer brakes so you'll be able to install, adjust and maintain them properly.

Driving with a Trailer

Towing a trailer requires a certain amount of experience. Before setting out for the open road, you'll want to get to know your rig. Acquaint yourself with the feel of handling and braking with the added weight of the trailer. And always keep in mind that the vehicle you are driving is now a good deal longer and not nearly as responsive as your vehicle is by itself.

Before you start, check all trailer hitch parts and attachments, safety chains, electrical connector, lamps, tires and mirror adjustment. If the trailer has electric brakes, start your vehicle and trailer moving and then apply the trailer brake controller by hand to be sure the brakes are working. This lets you check your electrical connection at the same time.

During your trip, check occasionally to be sure that the load is secure, and that the lamps and any trailer brakes are still working.

Following Distance

Stay at least twice as far behind the vehicle ahead as you would when driving your vehicle without a trailer. This can help you avoid situations that require heavy braking and sudden turns.

Passing

You'll need more passing distance up ahead when you're towing a trailer. And, because you're a good deal longer, you'll need to go much farther beyond the passed vehicle before you can return to your lane.

Backing Up

Hold the bottom of the steering wheel with one hand. Then, to move the trailer to the left, just move that hand to the left. To move the trailer to the right, move your hand to the right. Always back up slowly and, if possible, have someone guide you.

Making Turns

Notice: Making very sharp turns while trailering could cause the trailer to come in contact with the vehicle. Your vehicle could be damaged. Avoid making very sharp turns while trailering.

When you're turning with a trailer, make wider turns than normal. Do this so your trailer won't strike soft shoulders, curbs, road signs, trees or other objects. Avoid jerky or sudden maneuvers. Signal well in advance.

Turn Signals When Towing a Trailer

When you tow a trailer, your vehicle may need a different turn signal flasher and/or extra wiring. Check with your dealer. The arrows on your instrument panel will flash whenever you signal a turn or lane change. Properly hooked up, the trailer lamps will also flash, telling other drivers you're about to turn, change lanes or stop.

When towing a trailer, the arrows on your instrument panel will flash for turns even if the bulbs on the trailer are burned out. Thus, you may think drivers behind you are seeing your signal when they are not. It's important to check occasionally to be sure the trailer bulbs are still working.

Driving on Grades

Reduce speed and shift to a lower gear before you start down a long or steep downgrade. If you don't shift down, you might have to use your brakes so much that they would get hot and no longer work well.

On a long uphill grade, shift down and reduce your speed to around 45 mph (70 km/h) to reduce the possibility of the engine and the transmission overheating.

Parking on Hills

CAUTION:

You really should not park your vehicle, with a trailer attached, on a hill. If something goes wrong, your rig could start to move. People can be injured, and both your vehicle and the trailer can be damaged.

But if you ever have to park your rig on a hill, here's how to do it:

1. Apply your regular brakes, but don't shift into PARK (P).
When parking uphill, turn your wheels away from the curb. When parking downhill, turn your wheels into the curb.
2. Have someone place chocks behind the trailer wheels.
3. When the chocks are in place, release the regular brakes until the chocks absorb the load.
4. Reapply the regular brakes. Then apply your parking brake and shift into PARK (P).
5. Release the regular brakes.

When You Are Ready to Leave After Parking on a Hill

1. Apply your regular brakes and hold the pedal down while you:
 - start your engine,
 - shift into a gear, and
 - release the parking brake.
2. Let up on the brake pedal.
3. Drive slowly until the trailer is clear of the chocks.
4. Stop and have someone pick up and store the chocks.

Maintenance When Trailer Towing

Your vehicle will need service more often when you're pulling a trailer. See *Scheduled Maintenance on page 6-4* for more information. Things that are especially important in trailer operation are automatic transmission fluid (don't overfill), engine oil, axle lubricant, drive belt, cooling system and brake system. Each of these is covered in this manual, and the Index will help you find them quickly. If you're trailering, it's a good idea to review this information before you start your trip.

Check periodically to see that all hitch nuts and bolts are tight.

Engine Cooling When Trailer Towing

Your cooling system may temporarily overheat during severe operating conditions. See *Engine Overheating on page 5-27*.

 **NOTES**

Section 5 Service and Appearance Care

Service	5-3	Cooling System	5-30
Doing Your Own Service Work	5-4	Power Steering Fluid	5-35
Adding Equipment to the Outside of Your Vehicle	5-5	Windshield Washer Fluid	5-36
Fuel	5-5	Brakes	5-37
Gasoline Octane	5-5	Battery	5-40
Gasoline Specifications	5-6	Jump Starting	5-41
California Fuel	5-6	All-Wheel Drive	5-46
Additives	5-6	Rear Axle	5-48
Fuels in Foreign Countries	5-7	Front Axle	5-49
Filling Your Tank	5-8	Bulb Replacement	5-50
Filling a Portable Fuel Container	5-10	High Intensity Discharge (HID) Lighting	5-50
Checking Things Under the Hood	5-10	Windshield Wiper Blade Replacement	5-50
Hood Release	5-11	Tires	5-52
Engine Compartment Overview	5-12	Tire Sidewall Labelling	5-53
Engine Oil	5-16	Tire Terminology and Definitions	5-56
Engine Oil Life System	5-20	Inflation - Tire Pressure	5-58
Engine Air Cleaner/Filter	5-22	Tire Pressure Monitor System	5-61
Automatic Transmission Fluid	5-23	Tire Inspection and Rotation	5-63
Engine Coolant	5-24	When It Is Time for New Tires	5-64
Coolant Surge Tank Pressure Cap	5-27	Buying New Tires	5-64
Engine Overheating	5-27	Uniform Tire Quality Grading	5-66
Overheated Engine Protection Operating Mode	5-29	Wheel Alignment and Tire Balance	5-67
		Wheel Replacement	5-67

Section 5 Service and Appearance Care

Tire Chains	5-68	Windshield and Wiper Blades	5-88
If a Tire Goes Flat	5-69	Aluminum or Chrome-Plated Wheels	5-89
Changing a Flat Tire	5-70	Tires	5-90
Removing the Spare Tire and Tools	5-71	Sheet Metal Damage	5-90
Removing the Flat Tire and Installing the Spare Tire	5-73	Finish Damage	5-90
Secondary Latch System	5-77	Underbody Maintenance	5-90
Storing a Flat or Spare Tire and Tools	5-79	Chemical Paint Spotting	5-90
Compact Spare Tire	5-82	Vehicle Care/Appearance Materials	5-91
Appearance Care	5-83	Vehicle Identification	5-92
Fabric/Carpet	5-84	Vehicle Identification Number (VIN)	5-92
Vinyl	5-86	Service Parts Identification Label	5-92
Leather	5-86	Electrical System	5-92
Instrument Panel	5-86	Add-On Electrical Equipment	5-92
Interior Plastic Components	5-86	Windshield Wiper Fuses	5-93
Wood Panels	5-86	Power Windows and Other Power Options	5-93
Speaker Covers	5-86	Fuses and Circuit Breakers	5-93
Glass Surfaces	5-87	Underhood Fuse Block	5-94
Care of Safety Belts	5-87	Rear Underseat Fuse Block (Driver Side)	5-98
Weatherstrips	5-87	Rear Underseat Fuse Block (Passenger Side)	5-100
Washing Your Vehicle	5-87	Capacities and Specifications	5-102
Cleaning Exterior Lamps/Lenses	5-88		
Finish Care	5-88		

Service

Your dealer knows your vehicle best and wants you to be happy with it. We hope you will go to your dealer for all your service needs. You will get genuine GM parts and GM-trained and supported service people.

We hope you will want to keep your GM vehicle all GM. Genuine GM parts have one of these marks:

ACDelco[®]

GM[®] **Parts**

GM[®]
Goodwrench

GM[®] **Accessories**

California Proposition 65 Warning

Most motor vehicles, including this one, contain and/or emit chemicals known to the State of California to cause cancer and birth defects or other reproductive harm. Engine exhaust, many parts and systems (including some inside the vehicle), many fluids, and some component wear by-products contain and/or emit these chemicals.

Doing Your Own Service Work

If you want to do some of your own service work, you will want to use the proper service manual. It tells you much more about how to service your vehicle than this manual can. To order the proper service manual, see *Service Publications Ordering Information on page 7-12*.

Your vehicle has an airbag system. Before attempting to do your own service work, see *Servicing Your Airbag-Equipped Vehicle on page 1-58*.

You should keep a record with all parts receipts and list the mileage and the date of any service work you perform. See *Maintenance Record on page 6-14*.

CAUTION:

You can be injured and your vehicle could be damaged if you try to do service work on a vehicle without knowing enough about it.

- **Be sure you have sufficient knowledge, experience, the proper replacement parts and tools before you attempt any vehicle maintenance task.**
- **Be sure to use the proper nuts, bolts and other fasteners. English and metric fasteners can be easily confused. If you use the wrong fasteners, parts can later break or fall off. You could be hurt.**

Adding Equipment to the Outside of Your Vehicle

Things you might add to the outside of your vehicle can affect the airflow around it. This may cause wind noise and affect windshield washer performance. Check with your dealer before adding equipment to the outside of your vehicle.

Fuel

The 8th digit of your vehicle identification number (VIN) shows the code letter or number that identifies your engine. You will find the VIN at the top left of the instrument panel. See *Vehicle Identification Number (VIN)* on page 5-92.

Gasoline Octane

If your vehicle has the 3.6L V6 engine, use regular unleaded gasoline with a posted octane of 87 or higher. However, for best performance and for trailer towing, you may wish to use middle grade or premium unleaded gasoline. If the octane is less than 87, you may get a heavy knocking noise when you drive. If this occurs, use a gasoline rated at 87 octane or higher as soon as possible. Otherwise, you might damage your engine.

If your vehicle has the 4.6L V8 engine, use premium unleaded gasoline with a posted octane of 91 or higher for best performance. You may also use middle grade or regular unleaded gasoline rated at 87 octane or higher, but your vehicle's acceleration may be slightly reduced. If the octane is less than 87, you may get a heavy knocking noise when you drive. If this occurs, use a gasoline rated at 87 octane or higher as soon as possible. Otherwise, you might damage your engine.

Gasoline Specifications

It is recommended that gasoline meet specifications which were developed by automobile manufacturers around the world and contained in the World-Wide Fuel Charter which is available from the Alliance of Automobile Manufacturers at www.autoalliance.org/fuel_charter.htm. Gasoline meeting these specifications could provide improved driveability and emission control system performance compared to other gasoline.

California Fuel

If your vehicle is certified to meet California Emission Standards (see the underhood emission control label), it is designed to operate on fuels that meet California specifications. If this fuel is not available in states adopting California emissions standards, your vehicle will operate satisfactorily on fuels meeting federal specifications, but emission control system performance may be affected. The malfunction indicator lamp may turn on and your vehicle may fail a smog-check test.

See *Malfunction Indicator Lamp on page 3-42*.

If this occurs, return to your authorized GM dealer for diagnosis. If it is determined that the condition is caused by the type of fuel used, repairs may not be covered by your warranty.

Additives

To provide cleaner air, all gasolines in the United States are now required to contain additives that will help prevent engine and fuel system deposits from forming, allowing your emission control system to work properly. You should not have to add anything to your fuel. However, some gasolines contain only the minimum amount of additive required to meet U.S. Environmental Protection Agency regulations. General Motors recommends that you buy gasolines that are advertised to help keep fuel injectors and intake valves clean. If your vehicle experiences problems due to dirty injectors or valves, try a different brand of gasoline.

Gasolines containing oxygenates, such as ethers and ethanol, and reformulated gasolines may be available in your area to contribute to clean air. General Motors recommends that you use these gasolines, particularly if they comply with the specifications described earlier.

Notice: Your vehicle was not designed for fuel that contains methanol. Do not use fuel containing methanol. It can corrode metal parts in your fuel system and also damage the plastic and rubber parts. That damage would not be covered under your warranty.

Some gasolines that are not reformulated for low emissions may contain an octane-enhancing additive called methylcyclopentadienyl manganese tricarbonyl (MMT); ask the attendant where you buy gasoline whether the fuel contains MMT. General Motors does not recommend the use of such gasolines. Fuels containing MMT can reduce the life of spark plugs and the performance of the emission control system may be affected. The malfunction indicator lamp may turn on. If this occurs, return to your authorized GM dealer for service.

Fuels in Foreign Countries

If you plan on driving in another country outside the United States or Canada, the proper fuel may be hard to find. Never use leaded gasoline or any other fuel not recommended in the previous text on fuel. Costly repairs caused by use of improper fuel would not be covered by your warranty.

To check the fuel availability, ask an auto club, or contact a major oil company that does business in the country where you will be driving.

Filling Your Tank

CAUTION:

Fuel vapor burns violently and a fuel fire can cause bad injuries. To help avoid injuries to you and others, read and follow all the instructions on the pump island. Turn off your engine when you are refueling. Do not smoke if you are near fuel or refueling your vehicle. Keep sparks, flames and smoking materials away from fuel. Do not leave the fuel pump unattended when refueling your vehicle — this is against the law in some places. Keep children away from the fuel pump; never let children pump fuel.

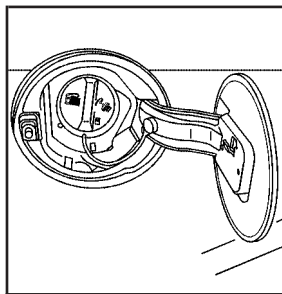

The tethered fuel cap is located behind a hinged fuel door on the passenger's side of the vehicle.

To open the fuel door, press on the rear edge of the fuel door and it will pop open.

To remove the fuel cap, turn it slowly to the left (counterclockwise). The fuel cap has a spring in it; if the cap is released too soon, it will spring back to the right.

While refueling, hang the tethered fuel cap from the hook on the fuel door.

 **CAUTION:**

If you spill fuel and then something ignites it, you could be badly burned. Fuel can spray out on you if you open the fuel cap too quickly. This spray can happen if your tank is nearly full, and is more likely in hot weather. Open the fuel cap slowly and wait for any hiss noise to stop. Then unscrew the cap all the way.

Be careful not to spill fuel. Do not top off or overfill the tank, and wait a few seconds after you have finished pumping before removing the nozzle. Clean fuel from painted surfaces as soon as possible. See *Washing Your Vehicle* on page 5-87.

When replacing the fuel cap, turn it to the right (clockwise) until it clicks. Make sure the cap is fully installed. The diagnostic system can determine if the fuel cap has been left off or improperly installed. This would allow fuel to evaporate into the atmosphere. See *Malfunction Indicator Lamp* on page 3-42.

The Check Gas Cap message will appear on the Driver Information Center (DIC) display if the fuel cap is not reinstalled properly. See *DIC Warnings and Messages* on page 3-57 for more information.

 **CAUTION:**

If a fire starts while you are refueling, do not remove the nozzle. Shut off the flow of fuel by shutting off the pump or by notifying the station attendant. Leave the area immediately.

Notice: If you need a new fuel cap, be sure to get the right type. Your dealer can get one for you. If you get the wrong type, it may not fit properly. This may cause your malfunction indicator lamp to light and may damage your fuel tank and emissions system. See *Malfunction Indicator Lamp* on page 3-42.

Filling a Portable Fuel Container

CAUTION:

Never fill a portable fuel container while it is in your vehicle. Static electricity discharge from the container can ignite the gasoline vapor. You can be badly burned and your vehicle damaged if this occurs. To help avoid injury to you and others:

- Dispense gasoline only into approved containers.
- Do not fill a container while it is inside a vehicle, in a vehicle's trunk, pickup bed or on any surface other than the ground.
- Bring the fill nozzle in contact with the inside of the fill opening before operating the nozzle. Contact should be maintained until the filling is complete.
- Do not smoke while pumping gasoline.

Checking Things Under the Hood

CAUTION:

An electric fan under the hood can start up and injure you even when the engine is not running. Keep hands, clothing and tools away from any underhood electric fan.

CAUTION:

Things that burn can get on hot engine parts and start a fire. These include liquids like fuel, oil, coolant, brake fluid, windshield washer and other fluids, and plastic or rubber. You or others could be burned. Be careful not to drop or spill things that will burn onto a hot engine.

Hood Release

To open the hood, do the following:



1. Pull the hood release lever inside the vehicle. It is located on the lower left side of the instrument panel.



2. Then go to the front of the vehicle and find the secondary hood release lever. The lever is located under the front edge of the grille near the center. Move the release lever to the side and raise the hood.

Before closing the hood, be sure all the filler caps are on properly. Then pull the hood down and close it firmly.

Engine Compartment Overview

When you open the hood on the 3.6L V6 engine, you will see the following:

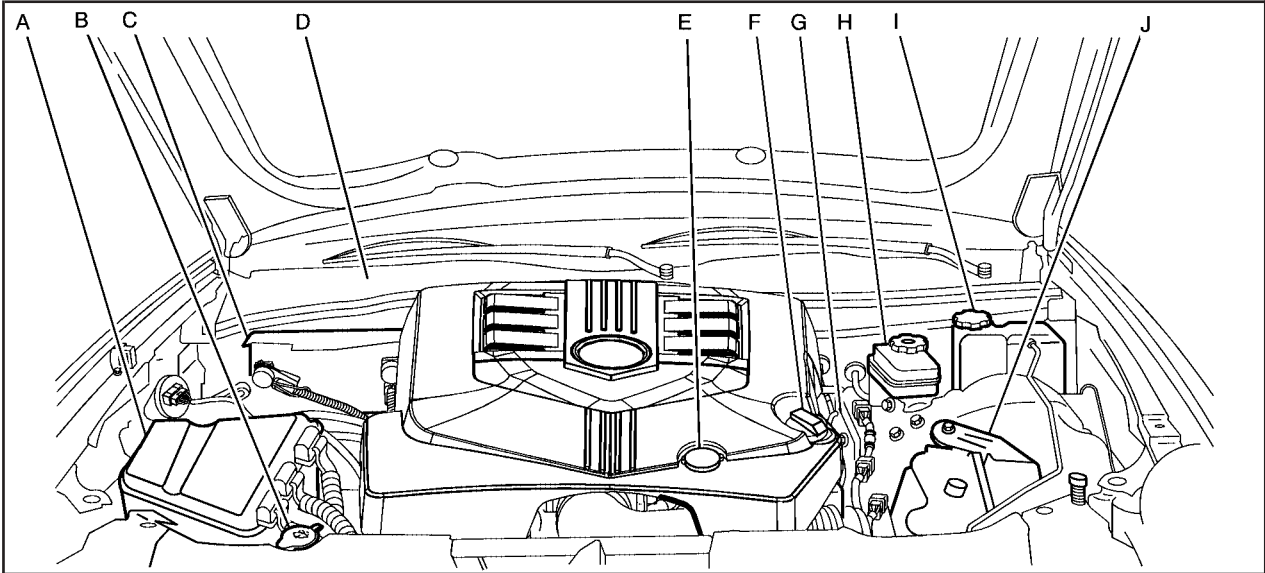

- A. Underhood Fuse Block. See *Underhood Fuse Block on page 5-94*.
- B. Windshield Washer Fluid Reservoir. See “Adding Washer Fluid” under *Windshield Washer Fluid on page 5-36*.
- C. Battery. See *Battery on page 5-40*.
- D. Passenger Compartment Air Filter. See *Passenger Compartment Air Filter on page 3-32*.
- E. Power Steering Fluid Reservoir. See *Power Steering Fluid on page 5-35*.
- F. Engine Oil Fill Cap. See “When to Add Engine Oil” under *Engine Oil on page 5-16*.
- G. Engine Oil Dipstick (Out of View). See “Checking Engine Oil” under *Engine Oil on page 5-16*.
- H. Brake Master Cylinder Reservoir. See “Brake Fluid” under *Brakes on page 5-37*.
- I. Engine Coolant Surge Tank and Pressure Cap. See *Coolant Surge Tank Pressure Cap on page 5-27* and *Cooling System on page 5-30*.
- J. Engine Air Cleaner/Filter. See *Engine Air Cleaner/Filter on page 5-22*.

When you open the hood on the 4.6L V8 engine, you will see the following:

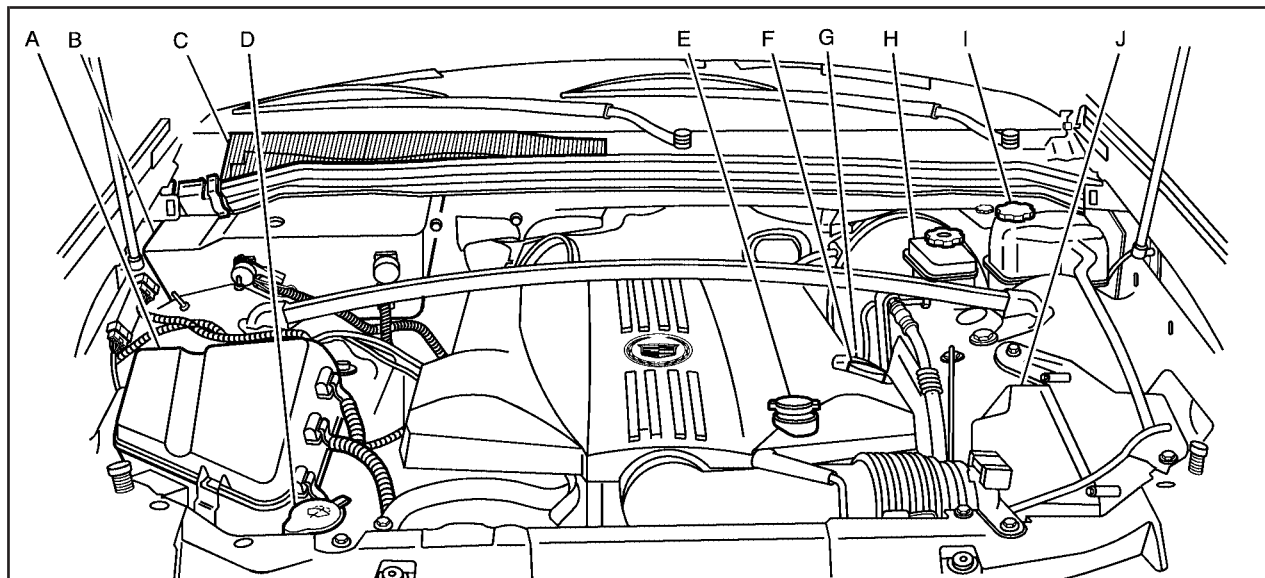

- A. Underhood Fuse Block. See *Underhood Fuse Block on page 5-94*.
- B. Battery. See *Battery on page 5-40*.
- C. Passenger Compartment Air Filter. See *Passenger Compartment Air Filter on page 3-32*.
- D. Windshield Washer Fluid Reservoir. See “Adding Washer Fluid” under *Windshield Washer Fluid on page 5-36*.
- E. Power Steering Fluid Reservoir. See *Power Steering Fluid on page 5-35*.
- F. Engine Oil Fill Cap. See “When to Add Engine Oil” under *Engine Oil on page 5-16*.
- G. Engine Oil Dipstick (Out of View). See “Checking Engine Oil” under *Engine Oil on page 5-16*.
- H. Brake Master Cylinder Reservoir. See “Brake Fluid” under *Brakes on page 5-37*.
- I. Engine Coolant Surge Tank and Pressure Cap. See *Coolant Surge Tank Pressure Cap on page 5-27* and *Cooling System on page 5-30*.
- J. Engine Air Cleaner/Filter. See *Engine Air Cleaner/Filter on page 5-22*.

Engine Oil

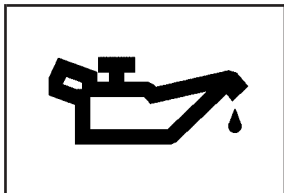

If the oil pressure light and/or the Oil Pressure Low — Stop Engine message on the DIC appears on the instrument cluster, it means you need to check your engine oil level right away.

For more information, see “Oil Pressure Low — Stop Engine” under *DIC Warnings and Messages on page 3-57* and *Oil Pressure Light on page 3-45*.

You should check your engine oil level regularly; this is an added reminder.

Checking Engine Oil

It is a good idea to check your engine oil every time you get fuel. In order to get an accurate reading, the oil must be warm and the vehicle must be on level ground.

The engine oil dipstick handle is a yellow loop. See *Engine Compartment Overview on page 5-12* for the location of the engine oil dipstick.

1. Turn off the engine and give the oil several minutes to drain back into the oil pan. If you do not do this, the oil dipstick might not show the actual level.
2. Pull out the dipstick and clean it with a paper towel or cloth, then push it back in all the way. Remove it again, keeping the tip down, and check the level.

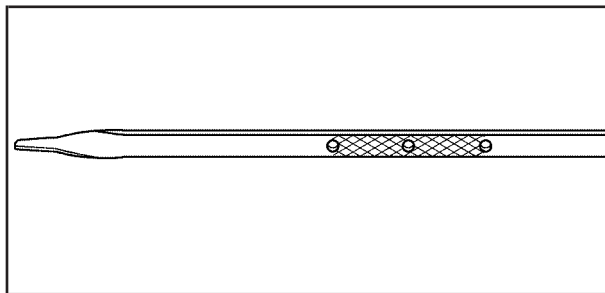

3.6L V6 Engine

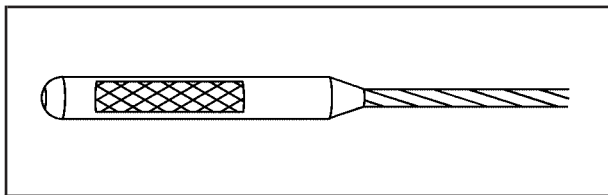

4.6L V8 Engine

When to Add Engine Oil

If the oil is at or below the cross-hatched area at the tip of the dipstick, then you will need to add at least one quart of oil. But you must use the right kind. This section explains what kind of oil to use. For engine oil crankcase capacity, see *Capacities and Specifications on page 5-102*.

Notice: Do not add too much oil. If your engine has so much oil that the oil level gets above the cross-hatched area that shows the proper operating range, your engine could be damaged.

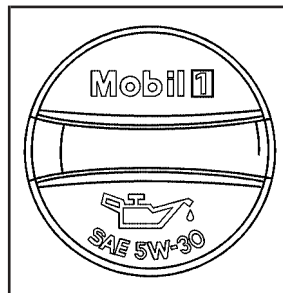

3.6L V6 Engine

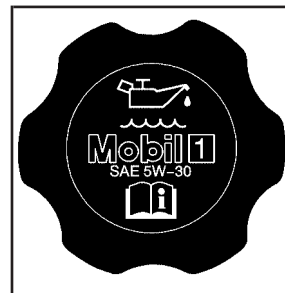

4.6L V8 Engine

See *Engine Compartment Overview on page 5-12* for the location of the engine oil fill cap.

Be sure to add enough oil to put the level somewhere in the proper operating range. Push the dipstick all the way back in when you are through.

What Kind of Engine Oil to Use

Look for two things:

- GM4718M

Your vehicle's engine requires a special oil meeting GM Standard GM4718M. Oils meeting this standard may be identified as synthetic. However, not all *synthetic* oils will meet this GM standard. You should look for and use only an oil that meets GM Standard GM4718M.

Notice: If you use oils that do not have the GM4718M Standard designation, you can cause engine damage not covered by your warranty.

RECOMMENDED SAE VISCOSITY GRADE ENGINE OILS

**HOT
WEATHER**

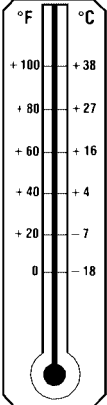

**COLD
WEATHER**

LOOK
FOR THIS
SYMBOL
AND GM STANDARD
GM4718M



SAE 5W-30



DO NOT USE SAE 10W-40, SAE 20W-50 OR ANY OTHER VISCOSITY GRADE OIL NOT RECOMMENDED

- SAE 5W-30

As shown in the viscosity chart, SAE 5W-30 is best for your vehicle.

These numbers on an oil container show its viscosity, or thickness. Do not use other viscosity oils such as SAE 20W-50.



Oils meeting these requirements should also have the starburst symbol on the container. This symbol indicates that the oil has been certified by the American Petroleum Institute (API).

You should look for this on the oil container, and use *only* those oils that are identified as meeting GM Standard GM4718M and have the starburst symbol on the front of the oil container.

Your vehicle's engine is filled at the factory with a Mobil 1[®] synthetic oil, which meets all requirements for your vehicle.

Substitute Engine Oil: When adding oil to maintain engine oil level, oil meeting GM Standard GM4718M may not be available. You can add substitute oil designated SAE 5W-30 with the starburst symbol at all temperatures. If temperatures are above 0°F (-18°C), you may substitute SAE 10W-30 with the starburst symbol. Substitute oil not meeting GM Standard GM4718M should not be used for an oil change.

Engine Oil Additives

Do not add anything to your oil. The recommended oils with the starburst symbol that meet GM Standard GM4718M are all you will need for good performance and engine protection.

Engine Oil Life System

When to Change Engine Oil

Your vehicle has a computer system that lets you know when to change the engine oil and filter. This is based on engine revolutions and engine temperature, and not on mileage. Based on driving conditions, the mileage at which an oil change will be indicated can vary considerably. For the oil life system to work properly, you must reset the system every time the oil is changed.

When the system has calculated that oil life has been diminished, it will indicate that an oil change is necessary. A Change Engine Oil message in the DIC will come on. Change your oil as soon as possible within the next 600 miles (1 000 km). It is possible that, if you are driving under the best conditions, the oil life system may not indicate that an oil change is necessary for over a year. However, your engine oil and filter must be changed at least once a year and at this time the system must be reset. Your dealer has GM-trained service people who will perform this work using genuine GM parts and reset the system. It is also important to check your oil regularly and keep it at the proper level.

If the system is ever reset accidentally, you must change your oil at 3,000 miles (5 000 km) since your last oil change. Remember to reset the oil life system whenever the oil is changed.

After the oil has been changed, the Change Engine Oil message and the oil life indicator must be reset. To reset the message and indicator, use one of the following procedures:

How to Reset the Engine Oil Life System and the Oil Life Indicator

The Engine Oil Life System calculates when to change your engine oil and filter based on vehicle use. Anytime your oil is changed, reset the system so it can calculate when the next oil change is required. If a situation occurs where you change your oil prior to a Change Engine Oil Message in the DIC being turned on, reset the system.

Base Audio System

Press the CLR button located to the right of the DIC display to acknowledge the Change Engine Oil message. This will clear the message from the display and reset it.

To reset the oil life indicator, use the following steps:

1. Press the up or down arrow on the INFO button located to the right of the DIC display to access the DIC menu.
2. Once XXX% ENGINE OIL LIFE menu item is highlighted, press and hold the CLR button. The percentage will return to 100, and the oil life indicator will be reset.
3. Turn the key to OFF.

If the Change Engine Oil message comes back on when you start your vehicle or the percentage does not return to 100, the engine oil life system has not reset. Repeat the procedure.

Navigation System

If you have the navigation system, see "Vehicle Customization" in the SRX Navigation System Owner Supplement for how to reset the oil life indicator.

What to Do with Used Oil

Used engine oil contains certain elements that may be unhealthy for your skin and could even cause cancer. Do not let used oil stay on your skin for very long. Clean your skin and nails with soap and water, or a good hand cleaner. Wash or properly dispose of clothing or rags containing used engine oil. See the manufacturer's warnings about the use and disposal of oil products.

Used oil can be a threat to the environment. If you change your own oil, be sure to drain all the oil from the filter before disposal. Never dispose of oil by putting it in the trash, pouring it on the ground, into sewers, or into streams or bodies of water. Instead, recycle it by taking it to a place that collects used oil. If you have a problem properly disposing of your used oil, ask your dealer, a service station or a local recycling center for help.

Engine Air Cleaner/Filter



4.6L V8 shown, 3.6L V6 similar

The engine air cleaner/filter is in the engine compartment on the driver's side of the vehicle, near the front. See *Engine Compartment Overview on page 5-12* for more information on location.

When to Inspect the Engine Air Cleaner/Filter

Inspect the air cleaner/filter at every oil change and replace it at the first oil change after 25,000 miles (40 000 km).

How to Inspect the Engine Air Cleaner/Filter

To inspect the air cleaner/filter remove the filter from the vehicle and lightly shake the filter to release loose dust and dirt. If the filter remains caked with dirt, a new filter is required.

To inspect or replace the filter, do the following:

1. Remove the two screws located on the top of the cover.
2. Disconnect the coolant recovery hose so that it is not going across the top of the engine air cleaner/filter.
3. Loosen the clamp and remove the duct from the passenger's side of the engine air cleaner/filter.
4. The two sides of the airbox are hinged at the bottom. Open the airbox by pushing the top of the airbox cover toward the engine.

5. Remove the air filter by lifting it straight up through the opening in the airbox.
6. Inspect or replace the engine air cleaner/filter. See *Normal Maintenance Replacement Parts* on page 6-13 for the correct part number for the filter.
7. Reinstall the cover by reversing Steps 1 through 4.

CAUTION:

Operating the engine with the air cleaner/filter off can cause you or others to be burned. The air cleaner not only cleans the air; it helps to stop flame if the engine backfires. If it is not there and the engine backfires, you could be burned. Do not drive with it off, and be careful working on the engine with the air cleaner/filter off.

Notice: If the air cleaner/filter is off, a backfire can cause a damaging engine fire. And, dirt can easily get into your engine, which will damage it. Always have the air cleaner/filter in place when you are driving.

Automatic Transmission Fluid

It is not necessary to check the transmission fluid level. A transmission fluid leak is the only reason for fluid loss. If a leak occurs, take your vehicle to the dealership service department and have it repaired as soon as possible. You may also have your fluid level checked by your dealer or service center when you have your oil changed.

Change both the fluid and filter every 50,000 miles (83 000 km) if the vehicle is mainly driven under one or more of these conditions:

- In heavy city traffic where the outside temperature regularly reaches 90°F (32°C) or higher.
- In hilly or mountainous terrain.
- When doing frequent trailer towing.
- Uses such as found in taxi, police or delivery service.

If you do not use your vehicle under any of these conditions, the fluid and filter do not require changing.

Notice: Use of automatic transmission fluid labeled other than DEXRON®-III, Approved for the H-Specification, may damage your vehicle, and the damages may not be covered by your warranty. Always use automatic transmission fluid labeled DEXRON®-III, Approved for the H-Specification.

How to Reset the Change Transmission Fluid Message and the Transmission Fluid Indicator

After the transmission fluid has been changed, the Change Trans Fluid message and the transmission fluid life indicator must be reset. To reset the message and indicator, use one of the following procedures:

Base Audio System

Press the CLR button located to the right of the DIC display to acknowledge the CHANGE TRANS FLUID message. This will clear the message from the display and reset it.

To reset the transmission fluid life indicator, use the following steps:

1. Press the up or down arrow on the INFO button located to the right of the DIC display to access the DIC menu.
2. Once the XXX% TRANS FLUID LIFE menu item is highlighted, press and hold the CLR button. The percentage will return to 100, and the transmission fluid life indicator will be reset.
3. Repeat the steps if the percentage does not return to 100.

Navigation System

If your vehicle has a navigation system, see your navigation system supplement for instructions on how to reset the transmission fluid life indicator.

Engine Coolant

The cooling system in your vehicle is filled with DEX-COOL[®] engine coolant. This coolant is designed to remain in your vehicle for 5 years or 150,000 miles (240 000 km), whichever occurs first, if you add only DEX-COOL[®] extended life coolant.

The following explains your cooling system and how to add coolant when it is low. If you have a problem with engine overheating, see *Engine Overheating on page 5-27*.

A 50/50 mixture of clean, drinkable water and DEX-COOL[®] coolant will:

- Give freezing protection down to -34°F (-37°C).
- Give boiling protection up to 265°F (129°C).
- Protect against rust and corrosion.
- Help keep the proper engine temperature.
- Let the warning lights and gages work as they should.

Notice: Using coolant other than DEX-COOL[®] may cause premature engine, heater core or radiator corrosion. In addition, the engine coolant may require changing sooner, at 30,000 miles (50 000 km) or 24 months, whichever occurs first. Any repairs would not be covered by your warranty. Always use DEX-COOL[®] (silicate-free) coolant in your vehicle.

What to Use

Use a mixture of one-half *clean, drinkable water* and one-half DEX-COOL[®] coolant which will not damage aluminum parts. If you use this coolant mixture, you do not need to add anything else.

CAUTION:

Adding only plain water to your cooling system can be dangerous. Plain water, or some other liquid such as alcohol, can boil before the proper coolant mixture will. Your vehicle's coolant warning system is set for the proper coolant mixture. With plain water or the wrong mixture, your engine could get too hot but you would not get the overheat warning. Your engine could catch fire and you or others could be burned. Use a 50/50 mixture of clean, drinkable water and DEX-COOL[®] coolant.

Notice: If you use an improper coolant mixture, your engine could overheat and be badly damaged. The repair cost would not be covered by your warranty. Too much water in the mixture can freeze and crack the engine, radiator, heater core and other parts.

If you have to add coolant more than once or twice a year, have your dealer check your cooling system.

Notice: If you use the proper coolant, you do not have to add extra inhibitors or additives which claim to improve the system. These can be harmful.

Checking Coolant



The coolant surge tank and pressure cap are located on the driver's side of the vehicle, toward the rear of the engine compartment. See *Engine Compartment Overview on page 5-12* for more information on location.

CAUTION:

Turning the surge tank pressure cap when the engine and radiator are hot can allow steam and scalding liquids to blow out and burn you badly. Never turn the surge tank pressure cap — even a little — when the engine and radiator are hot.

The vehicle must be on a level surface. When your engine is cold, the coolant level should be at the FULL COLD/FROID line on the side of the surge tank. Follow the arrow from the top of the tank down the side to the horizontal mark.

If the Check Coolant Level message in the Driver Information Center (DIC) comes on and stays on, it means you are low on engine coolant. See *DIC Warnings and Messages on page 3-57* for more information.

Adding Coolant

If you need more coolant, add the proper DEX-COOL[®] coolant mixture at the surge tank, but only when the engine is cool.

CAUTION:

You can be burned if you spill coolant on hot engine parts. Coolant contains ethylene glycol, and it will burn if the engine parts are hot enough. Do not spill coolant on a hot engine.

When replacing the pressure cap, make sure it is hand-tight.

Coolant Surge Tank Pressure Cap

Notice: If the surge tank pressure cap is not tightly installed, coolant loss and possible engine damage may occur. Be sure the cap is properly and tightly secured.

See *Engine Compartment Overview* on page 5-12 for more information on location.

Engine Overheating

There are three engine hot messages that may be displayed in the Driver Information Center (DIC). See *DIC Warnings and Messages* on page 3-57 for more information.

If Steam Is Coming From Your Engine

CAUTION:

Steam from an overheated engine can burn you badly, even if you just open the hood. Stay away from the engine if you see or hear steam coming from it. Just turn it off and get everyone away from the vehicle until it cools down. Wait until there is no sign of steam or coolant before you open the hood.

If you keep driving when your engine is overheated, the liquids in it can catch fire. You or others could be badly burned. Stop your engine if it overheats, and get out of the vehicle until the engine is cool.

See *Overheated Engine Protection Operating Mode on page 5-29* for information on driving to a safe place in an emergency.

Notice: If your engine catches fire because you keep driving with no coolant, your vehicle can be badly damaged. The costly repairs would not be covered by your warranty. See *Overheated Engine Protection Operating Mode on page 5-29* for information on driving to a safe place in an emergency.

If No Steam Is Coming From Your Engine

An overheat warning, along with a Check Coolant Level message, can indicate a serious problem.

If you get an engine overheat warning with no Check Coolant Level message, but see or hear no steam, the problem may not be too serious. Sometimes the engine can get a little too hot when you:

- Climb a long hill on a hot day.
- Stop after high-speed driving.
- Idle for long periods in traffic.
- Tow a trailer.

If you get the overheat warning with no sign of steam, try this for a minute or so:

1. In heavy traffic, let the engine idle in NEUTRAL (N) while stopped. If it is safe to do so, pull off the road, shift to PARK (P) or NEUTRAL (N) and let the engine idle.
2. Set the climate controls to the highest heat setting and fan speed and open the windows, as necessary.

If you no longer have the overheat warning, you can drive. Just to be safe, drive slower for about 10 minutes. If the warning does not come back on, you can drive normally.

If the warning continues and you have not stopped, pull over, stop, and park your vehicle right away.

If there is still no sign of steam, you can idle the engine for three minutes while you are parked. If you still have the warning, *turn off the engine and get everyone out of the vehicle* until it cools down.

You may decide not to lift the hood but to get service help right away.

Overheated Engine Protection Operating Mode

This operating mode allows your vehicle to be driven to a safe place in an emergency. Should an overheated engine condition exist, an overheat protection mode which alternates firing groups of cylinders helps prevent engine damage. In this mode, you will notice a loss in power and engine performance. A low coolant and/or engine overheat warning will indicate that an overheat condition exists. Driving extended miles (km) and/or towing a trailer in the overheat protection mode should be avoided.

Notice: After driving in the overheated engine protection operating mode, to avoid engine damage, allow the engine to cool before attempting any repair. The engine oil will be severely degraded. Repair the cause of coolant loss and change the oil. See *Engine Oil* on page 5-16.

Cooling System

When you decide it is safe to lift the hood, here is what you will see:

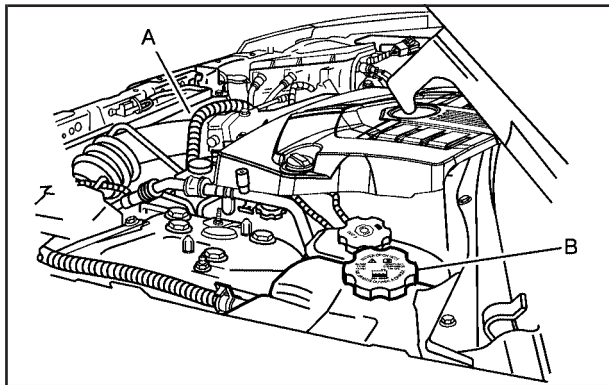

3.6L V6 shown, 4.6L V8 similar

- A. Electric Engine Cooling Fans
- B. Coolant Surge Tank and Pressure Cap

Some vehicles may be equipped with an engine driven fan, as well as the electric pusher fans (A) which are located behind the vehicle's grille.

CAUTION:

An electric engine cooling fan under the hood can start up even when the engine is not running and can injure you. Keep hands, clothing and tools away from any underhood electric fan.

If the coolant inside the coolant surge tank is boiling, do not do anything else until it cools down. The vehicle should be parked on a level surface.

When the engine is cold, the coolant level should be at or slightly above the FULL COLD/FROID line on the side of the coolant surge tank. If it is not, you may have a leak at the pressure cap or in the radiator hoses, heater hoses, radiator, water pump or somewhere else in the cooling system.

 **CAUTION:**

Heater and radiator hoses, and other engine parts, can be very hot. Do not touch them. If you do, you can be burned.

Do not run the engine if there is a leak. If you run the engine, it could lose all coolant. That could cause an engine fire, and you could be burned. Get any leak fixed before you drive the vehicle.

If there seems to be no leak, with the engine on, check to see if the electric engine cooling fans are running. If the engine is overheating, both fans should be running. If they are not, your vehicle needs service.

Notice: Engine damage from running your engine without coolant is not covered by your warranty. See *Overheated Engine Protection Operating Mode on page 5-29* for information on driving to a safe place in an emergency.

Notice: Using coolant other than DEX-COOL[®] may cause premature engine, heater core or radiator corrosion. In addition, the engine coolant may require changing sooner, at 30,000 miles (50 000 km) or 24 months, whichever occurs first. Any repairs would not be covered by your warranty. Always use DEX-COOL[®] (silicate-free) coolant in your vehicle.

How to Add Coolant to the Coolant Surge Tank

If you have not found a problem yet, check to see if coolant is visible in the surge tank. If coolant is visible but the coolant level is not at the FULL COLD/FROID line on the side of the coolant surge tank, add a 50/50 mixture of *clean, drinkable water* and DEX-COOL[®] coolant at the coolant surge tank, but be sure the cooling system, including the coolant surge tank pressure cap, is cool before you do it. See *Engine Coolant* on page 5-24 for more information.

CAUTION:

Steam and scalding liquids from a hot cooling system can blow out and burn you badly. They are under pressure, and if you turn the coolant surge tank pressure cap — even a little — they can come out at high speed. Never turn the cap when the cooling system, including the coolant surge tank pressure cap, is hot. Wait for the cooling system and coolant surge tank pressure cap to cool if you ever have to turn the pressure cap.

CAUTION:

Adding only plain water to your cooling system can be dangerous. Plain water, or some other liquid such as alcohol, can boil before the proper coolant mixture will. Your vehicle's coolant warning system is set for the proper coolant mixture. With plain water or the wrong mixture, your engine could get too hot but you would not get the overheat warning. Your engine could catch fire and you or others could be burned. Use a 50/50 mixture of clean, drinkable water and DEX-COOL[®] coolant.

Notice: In cold weather, water can freeze and crack the engine, radiator, heater core and other parts. Use the recommended coolant and the proper coolant mixture.

⚠ CAUTION:

You can be burned if you spill coolant on hot engine parts. Coolant contains ethylene glycol and it will burn if the engine parts are hot enough. Do not spill coolant on a hot engine.

If no coolant is visible in the surge tank, add coolant as follows:

1. You can remove the coolant surge tank pressure cap when the cooling system, including the coolant surge tank pressure cap and upper radiator hose, is no longer hot. Turn the pressure cap slowly counterclockwise (left) about one-quarter turn and then stop.

If you hear a hiss, wait for that to stop. A hiss means there is still some pressure left.



2. Then keep turning the pressure cap slowly, and remove it.



3. Fill the coolant surge tank with the proper mixture, to slightly above the FULL COLD/FROID line on the side of the coolant surge tank.

4. With the coolant surge tank pressure cap off, start the engine and let it run until you can feel the upper radiator hose getting hot. The upper radiator hose is the largest of the hoses which comes out of the radiator, on the passenger's side of the vehicle. Watch out for the engine cooling fans.

By this time, the coolant level inside the coolant surge tank may be lower. If the level is lower, add more of the proper mixture to the coolant surge tank until the level reaches the FULL COLD/FROID line on the side of the coolant surge tank.

5. Then replace the pressure cap. Be sure the pressure cap is hand-tight and fully seated.

Start the engine and allow it to warm up. If the Check Coolant Level message does not appear on the Driver Information Center, the coolant is at the proper fill level. If a Check Coolant Level message does appear, repeat Steps 1 to 3 then reinstall the pressure cap, or see your GM dealer.

Power Steering Fluid

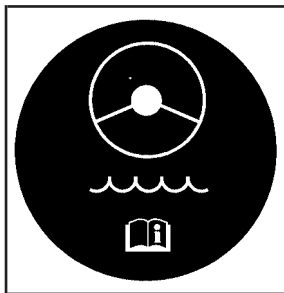

The power steering fluid reservoir is located in the center of the engine compartment, toward the front of the vehicle. See *Engine Compartment Overview on page 5-12* for more information on location.

When to Check Power Steering Fluid

It is not necessary to regularly check power steering fluid unless you suspect there is a leak in the system or you hear an unusual noise. A fluid loss in this system could indicate a problem. Have the system inspected and repaired.

How to Check Power Steering Fluid

To check the power steering fluid, do the following:

1. Turn the key off and let the engine compartment cool down.
2. Wipe the cap and the top of the reservoir clean.
3. Unscrew the cap and wipe the dipstick with a clean rag.
4. Replace the cap and completely tighten it.
5. Remove the cap again and look at the fluid level on the dipstick.

The level should be within the HOT mark. If necessary, add only enough fluid to bring the level within the mark.

What to Use

To determine what kind of fluid to use, see *Recommended Fluids and Lubricants on page 6-11*. Always use the proper fluid. Failure to use the proper fluid can cause leaks and damage hoses and seals.

Windshield Washer Fluid

What to Use

When you need windshield washer fluid, be sure to read the manufacturer's instructions before use. If you will be operating your vehicle in an area where the temperature may fall below freezing, use a fluid that has sufficient protection against freezing.

Adding Washer Fluid

The Check Washer Fluid message will appear on the Driver Information Center (DIC) when the fluid level is low. See *DIC Warnings and Messages on page 3-57* for more information.

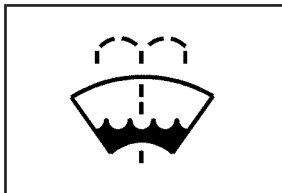

Open the cap with the washer symbol on it. Add washer fluid until the tank is full. See *Engine Compartment Overview on page 5-12* for reservoir location.

Notice:

- **When using concentrated washer fluid, follow the manufacturer's instructions for adding water.**
- **Do not mix water with ready-to-use washer fluid. Water can cause the solution to freeze and damage your washer fluid tank and other parts of the washer system. Also, water does not clean as well as washer fluid.**
- **Fill your washer fluid tank only three-quarters full when it is very cold. This allows for expansion if freezing occurs, which could damage the tank if it is completely full.**
- **Do not use engine coolant (antifreeze) in your windshield washer. It can damage your washer system and paint.**

Brakes

Brake Fluid

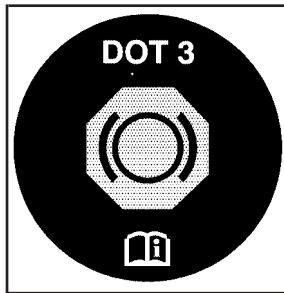

Your brake master cylinder reservoir is filled with DOT-3 brake fluid. See *Engine Compartment Overview* on page 5-12 for the location of the reservoir.

There are only two reasons why the brake fluid level in the reservoir might go down. The first is that the brake fluid goes down to an acceptable level during normal brake lining wear. When new linings are put in, the fluid level goes back up. The other reason is that fluid is leaking out of the brake system. If it is, you should have your brake system fixed, since a leak means that sooner or later your brakes will not work well, or will not work at all.

So, it is not a good idea to top off your brake fluid. Adding brake fluid will not correct a leak. If you add fluid when your linings are worn, then you will have too much fluid when you get new brake linings. You should add or remove brake fluid, as necessary, only when work is done on the brake hydraulic system.

CAUTION:

If you have too much brake fluid, it can spill on the engine. The fluid will burn if the engine is hot enough. You or others could be burned, and your vehicle could be damaged. Add brake fluid only when work is done on the brake hydraulic system. See “Checking Brake Fluid” in this section.

Refer to the Maintenance Schedule to determine when to check your brake fluid. See *Scheduled Maintenance* on page 6-4.

Checking Brake Fluid

You can check the brake fluid without taking off the cap.

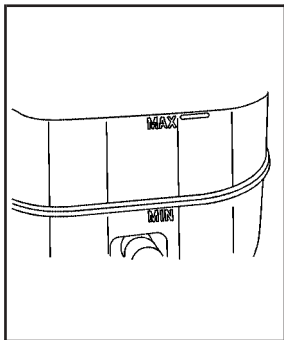

Just look at the brake fluid reservoir. The fluid level should be above MIN. If it is not, have your brake system checked to see if there is a leak.

After work is done on the brake hydraulic system, make sure the level is above the MIN but not over the MAX mark.

What to Add

When you do need brake fluid, use only DOT-3 brake fluid. Use new brake fluid from a sealed container only. See *Recommended Fluids and Lubricants on page 6-11*.

Always clean the brake fluid reservoir cap and the area around the cap before removing it. This will help keep dirt from entering the reservoir.

CAUTION:

With the wrong kind of fluid in your brake system, your brakes may not work well, or they may not even work at all. This could cause a crash. Always use the proper brake fluid.

Notice:

- **Using the wrong fluid can badly damage brake system parts. For example, just a few drops of mineral-based oil, such as engine oil, in your brake system can damage brake system parts so badly that they will have to be replaced. Do not let someone put in the wrong kind of fluid.**
- **If you spill brake fluid on your vehicle's painted surfaces, the paint finish can be damaged. Be careful not to spill brake fluid on your vehicle. If you do, wash it off immediately. See *Appearance Care on page 5-83*.**

Brake Wear

Your vehicle has four-wheel disc brakes.

Disc brake pads have built-in wear indicators that make a high-pitched warning sound when the brake pads are worn and new pads are needed. The sound may come and go or be heard all the time your vehicle is moving, except when you are pushing on the brake pedal firmly.

CAUTION:

The brake wear warning sound means that soon your brakes will not work well. That could lead to an accident. When you hear the brake wear warning sound, have your vehicle serviced.

Notice: Continuing to drive with worn-out brake pads could result in costly brake repair.

Some driving conditions or climates may cause a brake squeal when the brakes are first applied or lightly applied. This does not mean something is wrong with your brakes.

Properly torqued wheel nuts are necessary to help prevent brake pulsation. When tires are rotated, inspect brake pads for wear and evenly tighten wheel nuts in the proper sequence to GM torque specifications.

Brake linings should always be replaced as complete axle sets.

Brake Pedal Travel

See your dealer if the brake pedal does not return to normal height, or if there is a rapid increase in pedal travel. This could be a sign of brake trouble.

Brake Adjustment

Every time you make a brake stop, your disc brakes adjust for wear.

Replacing Brake System Parts

The braking system on a vehicle is complex. Its many parts have to be of top quality and work well together if the vehicle is to have really good braking. Your vehicle was designed and tested with top-quality GM brake parts. When you replace parts of your braking system—for example, when your brake linings wear down and you need new ones put in—be sure you get new approved GM replacement parts. If you do not, your brakes may no longer work properly. For example, if someone puts in brake linings that are wrong for your vehicle, the balance between your front and rear brakes can change—for the worse. The braking performance you have come to expect can change in many other ways if someone puts in the wrong replacement brake parts.

Battery

Your vehicle has a maintenance free battery. When it is time for a new battery, get one that has the replacement number shown on the original battery's label. We recommend an ACDelco® replacement battery. See *Engine Compartment Overview on page 5-12* for battery location.

Warning: Battery posts, terminals and related accessories contain lead and lead compounds, chemicals known to the State of California to cause cancer and reproductive harm. Wash hands after handling.

Vehicle Storage

If you are not going to drive your vehicle for 25 days or more, remove the black, negative (–) cable from the battery. This will help keep your battery from running down.

CAUTION:

Batteries have acid that can burn you and gas that can explode. You can be badly hurt if you are not careful. See *Jump Starting on page 5-41* for tips on working around a battery without getting hurt.

Also, for your audio system, see *Theft-Deterrent Feature on page 3-111*.

Jump Starting

If your battery has run down, you may want to use another vehicle and some jumper cables to start your vehicle. Be sure to use the following steps to do it safely.

CAUTION:

Batteries can hurt you. They can be dangerous because:

- They contain acid that can burn you.
- They contain gas that can explode or ignite.
- They contain enough electricity to burn you.

If you do not follow these steps exactly, some or all of these things can hurt you.

Notice: Ignoring these steps could result in costly damage to your vehicle that would not be covered by your warranty.

Trying to start your vehicle by pushing or pulling it will not work, and it could damage your vehicle.

1. Check the other vehicle. It must have a 12-volt battery with a negative ground system.

Notice: If the other vehicle's system is not a 12-volt system with a negative ground, both vehicles can be damaged. Only use vehicles with 12-volt systems with negative grounds to jump start your vehicle.

2. Get the vehicles close enough so the jumper cables can reach, but be sure the vehicles are not touching each other. If they are, it could cause a ground connection you do not want. You would not be able to start your vehicle and the bad grounding could damage the electrical systems.

To avoid the possibility of the vehicles rolling, set the parking brake firmly on both vehicles involved in the jump start procedure. Put an automatic transmission in PARK (P) or a manual transmission in NEUTRAL before setting the parking brake.

Notice: If you leave your radio or other accessories on during the jump starting procedure, they could be damaged. The repairs would not be covered by your warranty. Always turn off your radio and other accessories when jump starting your vehicle.

3. Turn off the ignition on both vehicles. Unplug unnecessary accessories plugged into the cigarette lighter or the accessory power outlets. Turn off the radio and all lamps that are not needed. This will avoid sparks and help save both batteries. And it could save the radio!

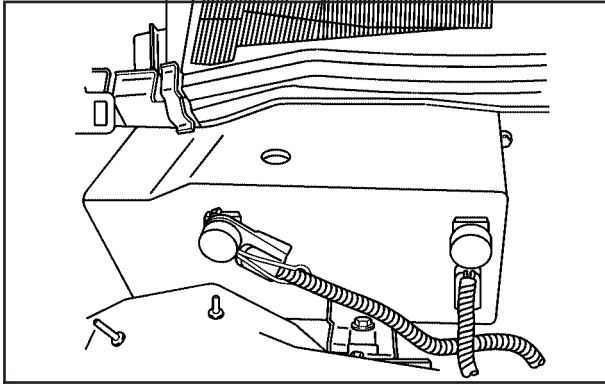

4. Open the hoods and locate the positive (+) and negative (-) terminal locations of the other vehicle, as well as the positive (+) terminal location on your vehicle's battery. See *Engine Compartment Overview* on page 5-12 for more information on the location of the battery.

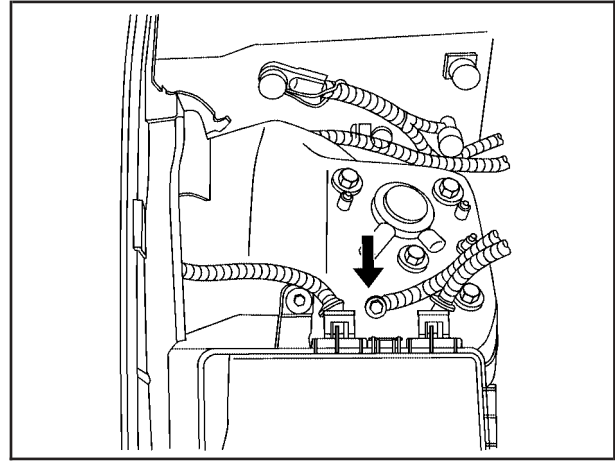

Your vehicle has a remote negative (-) ground location, as shown in the illustration. It is located between the battery and the underhood fuse block. You should always use this remote ground location, instead of the terminal on the battery.

 **CAUTION:**

An electric fan can start up even when the engine is not running and can injure you. Keep hands, clothing and tools away from any underhood electric fan.

 **CAUTION:**

Using a match near a battery can cause battery gas to explode. People have been hurt doing this, and some have been blinded. Use a flashlight if you need more light.

Be sure the battery has enough water. You do not need to add water to the battery installed in your new vehicle. But if a battery has filler caps, be sure the right amount of fluid is there. If it is low, add water to take care of that first. If you do not, explosive gas could be present.

Battery fluid contains acid that can burn you. Do not get it on you. If you accidentally get it in your eyes or on your skin, flush the place with water and get medical help immediately.

⚠ CAUTION:

Fans or other moving engine parts can injure you badly. Keep your hands away from moving parts once the engine is running.

5. Check that the jumper cables do not have loose or missing insulation. If they do, you could get a shock. The vehicles could be damaged too.

Before you connect the cables, here are some basic things you should know. Positive (+) will go to positive (+) or to a remote positive (+) terminal if the vehicle has one. Negative (-) will go to a heavy, unpainted metal engine part or to a remote negative (-) terminal if the vehicle has one.

Do not connect positive (+) to negative (-) or you will get a short that would damage the battery and maybe other parts too. And do not connect the negative (-) cable to the negative (-) terminal on the dead battery because this can cause sparks.

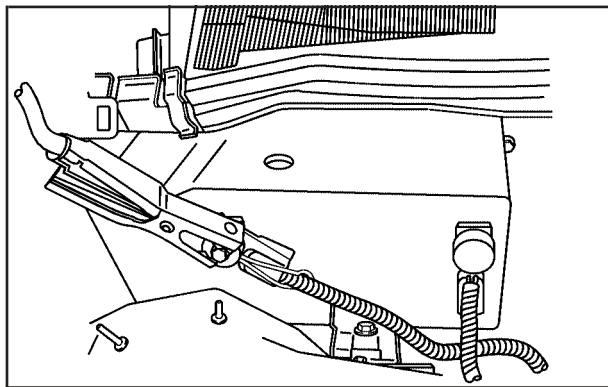

6. Connect the red positive (+) cable to the positive (+) terminal of the dead battery. Use a remote positive (+) terminal if the vehicle has one.

7. Do not let the other end touch metal. Connect it to the positive (+) terminal of the good battery. Use a remote positive (+) terminal if the vehicle has one.
8. Now connect the black negative (-) cable to the negative terminal of the good battery. Use a remote negative (-) terminal if the vehicle has one.

Do not let the other end touch anything until the next step. The other end of the negative (-) cable *does not* go to the dead battery. It goes to a heavy, unpainted metal engine part or to a remote negative (-) terminal on the vehicle with the dead battery.

9. Connect the other end of the negative (-) cable at least 18 inches (45 cm) away from the dead battery, but not near engine parts that move. The electrical connection is just as good there, and the chance of sparks getting back to the battery is much less. Use a remote negative (-) terminal if the vehicle has one. Your vehicle's remote negative (-) ground location is for this purpose.
10. Now start the vehicle with the good battery and run the engine for a while.
11. Try to start the vehicle that had the dead battery. If it will not start after a few tries, it probably needs service.

Notice: If the jumper cables are removed in the wrong order, electrical shorting may occur and damage the vehicle. The repairs would not be covered by your warranty. Remove the jumper cables in the correct order, making sure that the cables do not touch each other or other metal.

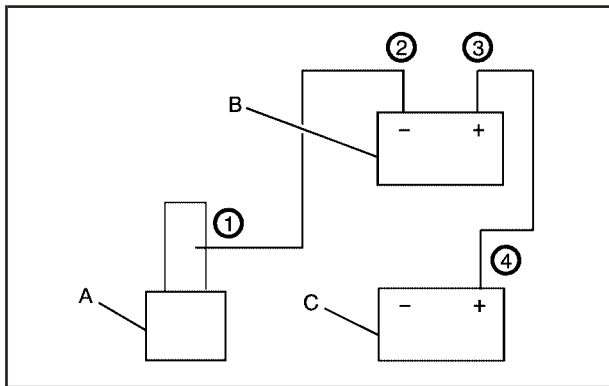

Jumper Cable Removal

- A. Heavy, Unpainted Metal Engine Part or Remote Negative (-) Terminal
- B. Good Battery or Remote Positive (+) Terminal
- C. Dead Battery or Remote Positive (+) Terminal

To disconnect the jumper cables from both vehicles, do the following:

1. Disconnect the black negative (-) cable from the vehicle that had the dead battery.
2. Disconnect the black negative (-) cable from the vehicle with the good battery.
3. Disconnect the red positive (+) cable from the vehicle with the good battery.
4. Disconnect the red positive (+) cable from the other vehicle.

All-Wheel Drive

All of the lubricant checks in this section apply to your vehicle. If you have an all-wheel-drive vehicle, there is an additional system that need lubrication.

Transfer Case

When to Check Lubricant

It is not necessary to regularly check the transfer case fluid unless you suspect there is a leak or you hear an unusual noise. A fluid loss could indicate a problem. Have it inspected and repaired.

How to Check Lubricant

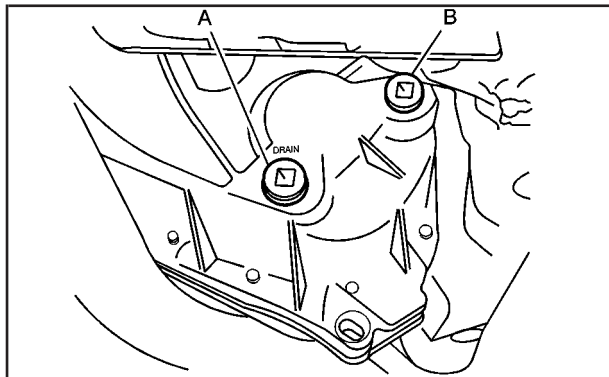

A. Drain Plug

B. Fill Plug

To get an accurate reading, the vehicle should be on a level surface.

If the level is below the bottom of the filler plug hole, located on the transfer case, you'll need to add some lubricant. Add enough lubricant to raise the level to the bottom of the filler plug hole. Use care not to overtighten the plug.

What to Use

Refer to the Maintenance Schedule to determine what kind of lubricant to use. See *Recommended Fluids and Lubricants* on page 6-11.

Rear Axle

When to Check Lubricant

It is not necessary to regularly check rear axle fluid unless you suspect there is a leak or you hear an unusual noise. A fluid loss could indicate a problem. Have it inspected and repaired.

How to Check Lubricant

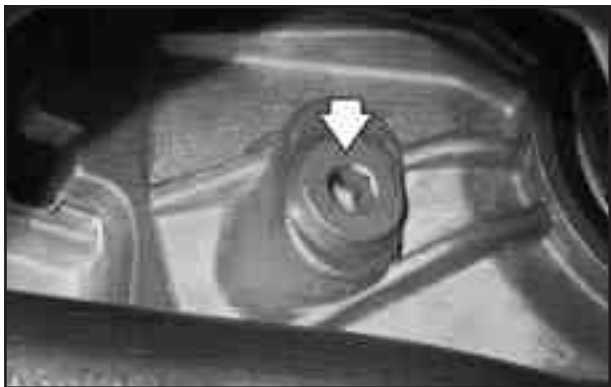

To get an accurate reading, the vehicle should be on a level surface.

If the level is below the bottom of the filler plug hole, located on the rear axle, you'll need to add some lubricant. Add enough lubricant to raise the level to the bottom of the filler plug hole.

What to Use

Refer to the Maintenance Schedule to determine what kind of lubricant to use. See *Recommended Fluids and Lubricants* on page 6-11.

Front Axle

When to Check and Change Lubricant

It is not necessary to regularly check the front axle fluid unless you suspect there is a leak or you hear an unusual noise. A fluid loss could indicate a problem. Have it inspected and repaired.

How to Check Lubricant

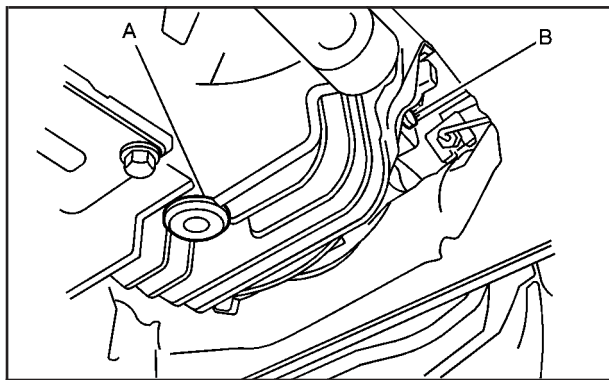

A. Drain Plug

B. Filler Plug

To get an accurate reading, the vehicle should be on a level surface.

If the level is below the bottom of the filler plug hole, located on the front axle, you may need to add some lubricant.

What to Use

Refer to the Maintenance Schedule to determine what kind of lubricant to use. See *Recommended Fluids and Lubricants* on page 6-11.

Bulb Replacement

It is recommended that all bulbs be replaced by your dealer.

High Intensity Discharge (HID) Lighting

CAUTION:

The low beam high intensity discharge lighting system operates at a very high voltage. If you try to service any of the system components, you could be seriously injured. Have your dealer or a qualified technician service them.

Your vehicle may have HID headlamps. After your vehicle's HID headlamp bulb has been replaced, you may notice that the beam is a slightly different shade than it was originally. This is normal.

Windshield Wiper Blade Replacement

Windshield wiper blades should be inspected at least twice a year for wear or cracking. See *Owner Checks and Services on page 6-8*.

It's a good idea to clean or replace the wiper blade assembly on a regular basis or when worn. For proper windshield wiper blade length and type, see *Normal Maintenance Replacement Parts on page 6-13*.

To replace the wiper blade assembly, do the following:

1. Turn the ignition to ON with the engine off.
2. Turn on the windshield wipers and turn them off again when the wipers are in the out-wipe position. The driver's side blade will be straight up and down on the windshield.
3. Pull the windshield wiper assembly away from the windshield.



4. Lift the wiper blade assembly up so it is in a T-shaped position. You should be able to see a tab.

Notice: Allowing the wiper blade arm to touch the windshield when no wiper blade is installed could damage the windshield. Any damage that occurs would not be covered by your warranty. Do not allow the wiper blade arm to touch the windshield.

5. Squeeze the tab together and pull the wiper blade assembly down far enough to release it from the J-hooked end of the wiper arm. Slide the assembly away from the arm.
6. Replace the blade with a new one.



7. Reinstall the wiper blade assembly by sliding it over the wiper arm to engage the J-hooked end. Pull up on the assembly to lock it into place.
8. Repeat the steps for the other wiper.

Tires

Your new vehicle comes with high-quality tires made by a leading tire manufacturer. If you ever have questions about your tire warranty and where to obtain service, see your GM Warranty booklet for details. For additional information refer to the tire manufacturer's booklet included with your vehicle's Owner's Manual.

CAUTION:

- Poorly maintained and improperly used tires are dangerous.
- Overloading your tires can cause overheating as a result of too much friction. You could have an air-out and a serious accident. See *Loading Your Vehicle on page 4-45*.

CAUTION: (Continued)

CAUTION: (Continued)

- Underinflated tires pose the same danger as overloaded tires. The resulting accident could cause serious injury. Check all tires frequently to maintain the recommended pressure. Tire pressure should be checked when your tires are cold.
- Overinflated tires are more likely to be cut, punctured or broken by a sudden impact — such as when you hit a pothole. Keep tires at the recommended pressure.
- Worn, old tires can cause accidents. If your tread is badly worn, or if your tires have been damaged, replace them.

See *Inflation - Tire Pressure on page 5-58*, for inflation pressure adjustment for high speed driving.

Winter Tires

If you expect to drive on snow or ice covered roads often, you may want to get winter tires for your vehicle. All season tires provide good overall performance on most surfaces but they may not offer the traction you would like or the same level of performance as winter tires on snow or ice covered roads.

See your dealer for details regarding winter tire availability and proper tire selection. Also, see *Buying New Tires on page 5-64*

If you choose to use winter tires:

- Use tires of the same brand and tread type on all four wheel positions.
- Use only radial ply tires of the same size, load range, and speed rating as the original equipment tires.

Winter tires with the same speed rating as your original equipment tires may not be available for H, V, W and ZR speed rated tires. If you choose winter tires with a lower speed rating, never exceed the tire's maximum speed capability.

Tire Sidewall Labelling

Useful information about a tire is molded into its sidewall. The examples below show a typical passenger vehicle tire and a compact spare tire sidewall.

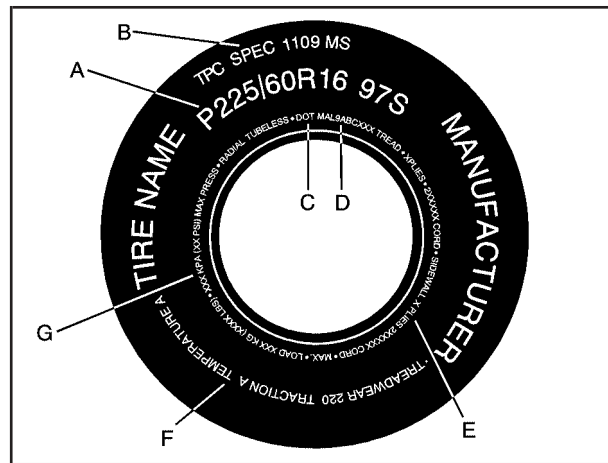

Passenger (P-Metric) Tire Example

(A) Tire Size: The tire size is a combination of letters and numbers used to define a particular tire's width, height, aspect ratio, construction type and service description. See the "Tire Size" illustration later in this section for more detail.

(B) TPC Spec (Tire Performance Criteria

Specification): Original equipment tires designed to GM's specific tire performance criteria have a TPC specification code molded onto the sidewall. GM's TPC specifications meet or exceed all federal safety guidelines.

(C) DOT (Department of Transportation): The Department of Transportation (DOT) code indicates that the tire is in compliance with the U.S. Department of Transportation Motor Vehicle Safety Standards.

(D) Tire Identification Number (TIN): The letters and numbers following DOT (Department of Transportation) code is the Tire Identification Number (TIN). The TIN shows the manufacturer and plant code, tire size, and date the tire was manufactured. The TIN is molded onto both sides of the tire, although only one side may have the date of manufacture.

(E) Tire Ply Material: The type of cord and number of plies in the sidewall and under the tread.

(F) Uniform Tire Quality Grading (UTQG): Tire manufacturers are required to grade tires based on three performance factors: treadwear, traction and temperature resistance. For more information see *Uniform Tire Quality Grading on page 5-66*.

(G) Maximum Cold Inflation Load Limit: Maximum load that can be carried and the maximum pressure needed to support that load.

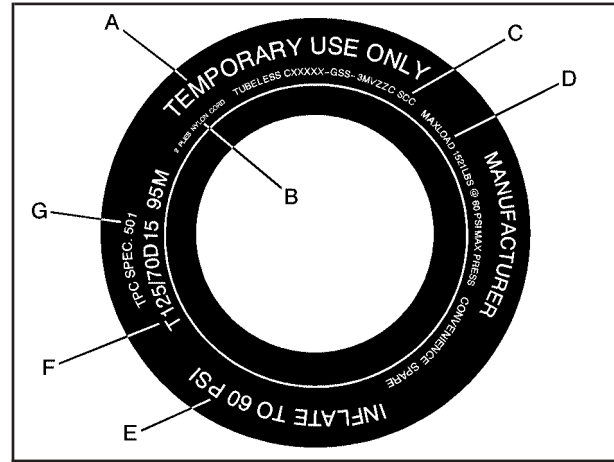

Compact Spare Tire Example

(A) Temporary Use Only: The compact spare tire or temporary use tire has a tread life of approximately 3,000 miles (5 000 km) and should not be driven at speeds over 65 mph (105 km/h). The compact spare tire is for emergency use when a regular road tire has lost air and gone flat. If your vehicle has a compact spare tire, see *Compact Spare Tire on page 5-82* and *If a Tire Goes Flat on page 5-69*.

(B) Tire Ply Material: The type of cord and number of plies in the sidewall and under the tread.

(C) Tire Identification Number (TIN): The letters and numbers following the DOT (Department of Transportation) code is the Tire Identification Number (TIN). The TIN shows the manufacturer and plant code, tire size, and date the tire was manufactured. The TIN is molded onto both sides of the tire, although only one side may have the date of manufacture.

(D) Maximum Cold Inflation Load Limit: Maximum load that can be carried and the maximum pressure needed to support that load.

(E) Tire Inflation: The temporary use tire or compact spare tire should be inflated to 60 psi (420 kPa). For more information on tire pressure and inflation see *Inflation - Tire Pressure on page 5-58*.

(F) Tire Size: A combination of letters and numbers define a tire's width, height, aspect ratio, construction type and service description. The letter T as the first character in the tire size means the tire is for temporary use only.

(G) TPC Spec (Tire Performance Criteria Specification): Original equipment tires designed to GM's specific tire performance criteria have a TPC specification code molded onto the sidewall. GM's TPC specifications meet or exceed all federal safety guidelines.

Tire Size

The following illustration shows an example of a typical passenger vehicle tire size.

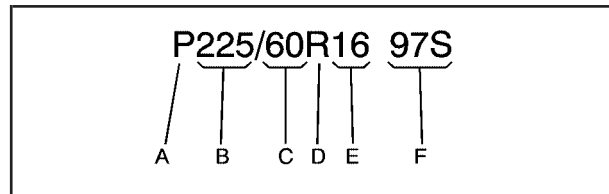

(A) Passenger (P-Metric) Tire: The United States version of a metric tire sizing system. The letter P as the first character in the tire size means a passenger vehicle tire engineered to standards set by the U.S. Tire and Rim Association.

(B) Tire Width: The three-digit number indicates the tire section width in millimeters from sidewall to sidewall.

(C) Aspect Ratio: A two-digit number that indicates the tire height-to-width measurements. For example, if the tire size aspect ratio is 60, as shown in item C of the illustration, it would mean that the tire's sidewall is 60 percent as high as it is wide.

(D) Construction Code: A letter code is used to indicate the type of ply construction in the tire. The letter R means radial ply construction; the letter D means diagonal or bias ply construction; and the letter B means belted-bias ply construction.

(E) Rim Diameter: Diameter of the wheel in inches.

(F) Service Description: These characters represent the load range and speed rating of the tire. The load index represents the load carry capacity a tire is certified to carry. The load index can range from 1 to 279. The speed rating is the maximum speed a tire is certified to carry a load. Speed ratings range from A to Z.

Tire Terminology and Definitions

Air Pressure: The amount of air inside the tire pressing outward on each square inch of the tire. Air pressure is expressed in pounds per square inch (psi) or kilopascal (kPa).

Accessory Weight: This means the combined weight of optional accessories. Some examples of optional accessories are, automatic transmission, power steering, power brakes, power windows, power seats, and air conditioning.

Aspect Ratio: The relationship of a tire's height to its width.

Belt: A rubber coated layer of cords that is located between the plies and the tread. Cords may be made from steel or other reinforcing materials.

Bead: The tire bead contains steel wires wrapped by steel cords that hold the tire onto the rim.

Bias Ply Tire: A pneumatic tire in which the plies are laid at alternate angles less than 90 degrees to the centerline of the tread.

Cold Inflation Pressure: The amount of air pressure in a tire, measured in pounds per square inch (psi) or kilopascals (kPa) before a tire has built up heat from driving. See *Inflation - Tire Pressure on page 5-58*.

Curb Weight: This means the weight of a motor vehicle with standard and optional equipment including the maximum capacity of fuel, oil and coolant, but without passengers and cargo.

DOT Markings: A code molded into the sidewall of a tire signifying that the tire is in compliance with the U.S. Department of Transportation (DOT) motor vehicle safety standards. The DOT code includes the Tire Identification Number (TIN), an alphanumeric designator which can also identify the tire manufacturer, production plant, brand and date of production.

GVWR: Gross Vehicle Weight Rating, see *Loading Your Vehicle on page 4-45*.

GAWR FRT: Gross Axle Weight Rating for the front axle, see *Loading Your Vehicle on page 4-45*.

GAWR RR: Gross Axle Weight Rating for the rear axle, see *Loading Your Vehicle on page 4-45*.

Intended Outboard Sidewall: The side of an asymmetrical tire, that must always face outward when mounted on a vehicle.

KiloPascal (kPa): The metric unit for air pressure.

Light Truck (LT-Metric) Tire: A tire used on light duty trucks and some multipurpose passenger vehicles.

Load Index: An assigned number ranging from 1 to 279 that corresponds to the load carrying capacity of a tire.

Maximum Inflation Pressure: The maximum air pressure to which a cold tire may be inflated. The maximum air pressure is molded onto the sidewall.

Maximum Load Rating: The load rating for a tire at the maximum permissible inflation pressure for that tire.

Maximum Loaded Vehicle Weight: The sum of curb weight; accessory weight; vehicle capacity weight; and production options weight.

Normal Occupant Weight: The number of occupants a vehicle is designed to seat multiplied by 150 lbs (68 kg). See *Loading Your Vehicle on page 4-45*.

Occupant Distribution: Designated seating positions.

Outward Facing Sidewall: The side of an asymmetrical tire that has a particular side that faces outward when mounted on a vehicle. The side of the tire that contains a whitewall, bears white lettering or bears manufacturer, brand, and/or model name molding that is higher or deeper than the same moldings on the other sidewall of the tire.

Passenger (P-Metric) Tire: A tire used on passenger cars and some light duty trucks and multipurpose vehicles.

Recommended Inflation Pressure: Vehicle manufacturer's recommended tire inflation pressure and shown on the tire placard. See *Inflation - Tire Pressure on page 5-58* and *Loading Your Vehicle on page 4-45*.

Radial Ply Tire: A pneumatic tire in which the ply cords that extend to the beads are laid at 90 degrees to the centerline of the tread.

Rim: A metal support for a tire and upon which the tire beads are seated.

Sidewall: The portion of a tire between the tread and the bead.

Speed Rating: An alphanumeric code assigned to a tire indicating the maximum speed at which a tire can operate.

Traction: The friction between the tire and the road surface. The amount of grip provided.

Tread: The portion of a tire that comes into contact with the road.

Treadwear Indicators: Narrow bands, sometimes called “wear bars,” that show across the tread of a tire when only 1/16 inch (1.6 mm) of tread remains. See *When It Is Time for New Tires on page 5-64*.

UTQGS (Uniform Tire Quality Grading Standards):

A tire information system that provides consumers with ratings for a tire’s traction, temperature, and treadwear. Ratings are determined by tire manufacturers using government testing procedures. The ratings are molded into the sidewall of the tire. See *Uniform Tire Quality Grading on page 5-66*.

Vehicle Capacity Weight: The number of designated seating positions multiplied by 150 lbs (68 kg) plus the rated cargo load. See *Loading Your Vehicle on page 4-45*.

Vehicle Maximum Load on the Tire: Load on an individual tire due to curb weight, accessory weight, occupant weight, and cargo weight.

Vehicle Placard: A label permanently attached to a vehicle showing the original equipment tire size and recommended inflation pressure. See *Loading Your Vehicle on page 4-45*.

Inflation - Tire Pressure

Tires need the correct amount of air pressure to operate effectively.

Notice: Do not let anyone tell you that under-inflation or over-inflation is all right. It is not. If your tires do not have enough air (under-inflation), you can get the following:

- Too much flexing
- Too much heat
- Tire overloading
- Premature or irregular wear
- Poor handling
- Reduced fuel economy

If your tires have too much air (over-inflation), you can get the following:

- Unusual wear
- Poor handling
- Rough ride
- Needless damage from road hazards

A Tire and Loading Information label is attached to the vehicle's center pillar, below the driver's door latch. This label lists your vehicle's original equipment tires and shows the correct inflation pressures for your tires when they are cold. The recommended cold tire inflation pressure, shown on the label, is the minimum amount of air pressure needed to support your vehicle's maximum load carrying capacity.

For additional information regarding how much weight your vehicle can carry, and an example of the tire and loading information label, see *Loading Your Vehicle on page 4-45*. How you load your vehicle affects vehicle handling and ride comfort, never load your vehicle with more weight than it was designed to carry.

When to Check

Check your tires once a month or more. Do not forget to check the compact spare tire, it should be at 60 psi (420 kPa). For additional information regarding the compact spare tire, see *Compact Spare Tire on page 5-82*.

How to Check

Use a good quality pocket-type gage to check tire pressure. You cannot tell if your tires are properly inflated simply by looking at them. Radial tires may look properly inflated even when they're under-inflated. Check the tire's inflation pressure when the tires are cold. Cold means your vehicle has been sitting for at least three hours or driven no more than 1 mile (1.6 km).

Remove the valve cap from the tire valve stem. Press the tire gage firmly onto the valve to get a pressure measurement. If the cold tire inflation pressure matches the recommended pressure on the Tire and Loading Information label, no further adjustment is necessary. If the inflation pressure is low, add air until you reach the recommended amount.

If you overfill the tire, release air by pushing on the metal stem in the center of the tire valve. Re-check the tire pressure with the tire gage.

Be sure to put the valve caps back on the valve stems. They help prevent leaks by keeping out dirt and moisture.

High Speed Operation

CAUTION:

Driving at high speeds, 100 mph (160 km/h) or higher, puts an additional strain on tires. Sustained high-speed driving, causes excessive heat build up and can cause sudden tire failure. You could have a crash and you or others could be killed. Some high-speed rated tires require inflation pressure adjustment for high speed operation. When speed limits and road conditions are such, that a vehicle can be driven at high speeds, make sure the tires are rated for high speed operation, in excellent condition and set to the correct cold tire inflation pressure for the vehicle load.

If you will be driving at high speeds, speeds of 100 mph (160 km/h) or higher, where it is legal, set the cold inflation pressure to the maximum inflation pressure shown on the tire sidewall, or 38 psi (265 kPa), whichever is lower. See the example following. When you end this high-speed driving, return the tires to the cold inflation pressure shown on the Tire and Loading Information label. See *Loading Your Vehicle on page 4-45*.

Example:

You will find the maximum load and inflation pressure molded on the tire's sidewall, in small letters, near the rim flange. It will read something like this: Maximum load 690 kg (1521 lbs) 300 kPa (44 psi) Max. Press.

For this example, you would set the inflation pressure for high-speed driving at 38 psi (265 kPa).

Tire Pressure Monitor System

Your vehicle may have this feature. The Tire Pressure Monitor (TPM) system uses radio and sensor technology to check tire pressure levels. If your vehicle has this feature, sensors are mounted on each tire and wheel assembly, except for the compact spare tire and wheel. Tire pressure readings are sent to a receiver located in the vehicle once every 60 seconds while the vehicle is being driven, and once every 60 minutes if the vehicle is stationary for more than 15 minutes.

Using the Driver Information Center (DIC), tire pressure levels can be viewed by the driver. For additional information and details about the DIC operation and displays see *System Controls on page 3-48* and *DIC Warnings and Messages on page 3-57*. When a low tire pressure condition is detected, the TPM system will display the CHECK TIRE PRESSURE warning message on the Driver Information Center (DIC) and, at the same time, illuminate the low tire pressure warning symbol, on the instrument panel cluster.

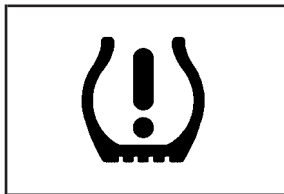

When the tire pressure monitoring system warning light is lit, one or more of your tires is significantly under-inflated.

You should stop and check your tires as soon as possible, and inflate them to the proper pressure as indicated on the vehicle's tire information placard.

Driving on a significantly under-inflated tire causes the tire to overheat and can lead to tire failure. Under-inflation also reduces fuel efficiency and tire tread life, and may affect the vehicle's handling and stopping ability. Each tire, including the spare, should be checked monthly when cold and set to the recommended inflation pressure as specified in the vehicle placard and owner's manual.

The Tire and Loading Information Label (your vehicle's tire information placard) shows the size of your vehicle's original tires and their recommended cold inflation pressures. See *Loading Your Vehicle on page 4-45*, for the location of the tire and loading information label. Also see *Inflation - Tire Pressure on page 5-58*.

Your vehicle's TPM system can alert you about a low tire pressure condition but it does not replace normal tire maintenance. See *Tire Inspection and Rotation on page 5-63* and *Tires on page 5-52*.

Notice: Do not use a tire sealant if your vehicle is equipped with Tire Pressure Monitors. The liquid sealant can damage the tire pressure monitor sensors.

TPM Sensor Identification Codes

Each TPM sensor has a unique identification code. Any time you replace one or more of the TPM sensors, the identification codes will need to be matched to the new tire/wheel position. Each tire/wheel position is matched, to a sensor, by increasing or decreasing the tire's air pressure. The sensors are matched, to the tire/wheel positions, in the following order: left front (LF), right front (RF), right rear (RR), and left rear (LR).

You will have one minute to match the first tire/wheel position, and five minutes overall, to match all four tire/wheel positions. If it takes longer than one minute, to match the first tire and wheel, or more than five minutes to match all four tire and wheel positions the matching process stops and you will need to start over.

The TPM matching process is outlined below:

1. Set the Parking brake.
2. Turn the ignition switch to ON with the engine off.
3. Using the Remote Keyless Entry (RKE) transmitter, lock and unlock the vehicle's doors.
4. Press the lock and unlock buttons, at the same time, on the RKE transmitter. A single horn chirp will sound, indicating that the TPM system is ready, and the sensor matching process can begin.

5. Start with the left (driver's side) front tire.
6. Remove the valve cap from the valve stem. Activate the TPM sensor by increasing or decreasing the tire's air pressure for five seconds, or until a horn chirp sounds. The horn chirp, which may take up to 30 seconds, confirms that the sensor identification code has been matched to this tire position. To decrease the tire's air-pressure use the pointy end of the valve cap, a pencil-style air pressure gage or a key.
7. Proceed to the right (passenger's side) front tire, and repeat the procedure in Step 6.
8. Proceed to the right (passenger's side) rear tire, and repeat the procedure in Step 6.
9. Proceed to the left (driver's side) rear tire, and repeat the procedure in Step 6.
10. After hearing the confirming double horn chirp, for the left rear tire, exit the matching process by turning the ignition switch to OFF.
11. Set all four tires to the recommended air pressure level as indicated on the tire and loading information label.
12. Put the valve caps back on the valve stems.

The spare tire does not have a TPM sensor. If you replace one of the road tires with the spare, the SERVICE TIRE MESSAGE will be displayed on the DIC screen. This message should go off once you re-install the road tire containing the TPM sensor. The Service Tire Monitor message is also displayed when the TPM system is malfunctioning. One or more missing or inoperable TPM sensors will cause the service tire monitor message to be displayed. See your GM dealer for service.

This device complies with Part 15 of the FCC Rules. Operation is subject to the following two conditions:

1. This device may not cause interference.
2. This device must accept any interference received, including interference that may cause undesired operation.

This device complies with RSS-210 of Industry Canada. Operation is subject to the following two conditions:

1. This device may not cause interference, and
2. This device must accept any interference received, including interference that may cause undesired operation of the device.

Changes or modifications to this system by other than an authorized service facility could void authorization to use this equipment.

Tire Inspection and Rotation

The tires on your vehicle are different sizes front to rear. Due to this, your tires should not be rotated. Each tire and wheel should be used only in the position it is in.

Check your tires and wheels regularly for unusual wear and damage. Also see, *Scheduled Maintenance on page 6-4, When It Is Time for New Tires on page 5-64 and Wheel Replacement on page 5-67.*

When It Is Time for New Tires

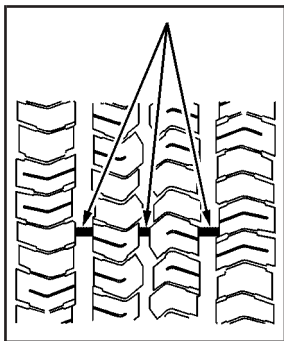

One way to tell when it's time for new tires is to check the treadwear indicators, which will appear when your tires have only 1/16 inch (1.6 mm) or less of tread remaining. Some commercial truck tires may not have treadwear indicators.

You need a new tire if any of the following statements are true:

- You can see the indicators at three or more places around the tire.
- You can see cord or fabric showing through the tire's rubber.
- The tread or sidewall is cracked, cut or snagged deep enough to show cord or fabric.
- The tire has a bump, bulge or split.
- The tire has a puncture, cut or other damage that can't be repaired well because of the size or location of the damage.

Buying New Tires

To find out what kind and size of tires you need, look at the Tire and Loading Information label. See *Loading Your Vehicle* on page 4-45, for an example of the label and where it can be found on your vehicle.

The tires installed on your vehicle when it was new had a Tire Performance Criteria Specification (TPC Spec) number on each tire's sidewall. When you get new tires, GM recommends that you get tires with that same TPC Spec number. That way your vehicle will continue to have tires that are designed to give proper endurance, handling, speed rating, load range, traction, ride, tire pressure monitoring system performance and other things during normal service on your vehicle. If your tires have an all-season tread design, the TPC number will be followed by an "MS" (for mud and snow).

Whenever you replace your tires with those not having a TPC Spec number, make sure they are the same size, load range, speed rating and construction type (bias, bias-belted or radial) as your original tires.

Winter tires with the same speed rating as your original equipment tires may not be available for H, V, W and ZR speed rated tires. If you choose snow tires with a lower speed rating, never exceed the tire's maximum speed capability.

If you replace your vehicle's tires with those not having a TPC Spec number, the tire pressure monitoring system may give an inaccurate low-pressure warning. Non-TPC Spec tires may give a low-pressure warning that is higher or lower than the proper warning level you would get with TPC Spec numbered tires.

 **CAUTION:**

Mixing tires could cause you to lose control while driving. If you mix tires of different sizes (other than those originally installed on your vehicle) or types (radial and bias-belted tires), the vehicle may not handle properly, and you could have a crash. Using tires of different sizes (other than those originally installed on your vehicle) may also cause damage to your vehicle. Be sure to use the correct size and type tires on all wheels. It is all right to drive with your compact spare temporarily, it was developed for use on your vehicle. See *Compact Spare Tire* on page 5-82.

 **CAUTION:**

If you use bias-ply tires on your vehicle, the wheel rim flanges could develop cracks after many miles of driving. A tire and/or wheel could fail suddenly, causing a crash. Use only radial-ply tires with the wheels on your vehicle.

Uniform Tire Quality Grading

Quality grades can be found where applicable on the tire sidewall between tread shoulder and maximum section width. For example:

Treadwear 200 Traction AA Temperature A

The following information relates to the system developed by the United States National Highway Traffic Safety Administration, which grades tires by treadwear, traction and temperature performance. (This applies only to vehicles sold in the United States.)

The grades are molded on the sidewalls of most passenger car tires. The Uniform Tire Quality Grading system does not apply to deep tread, winter-type snow tires, space-saver or temporary use spare tires, tires with nominal rim diameters of 10 to 12 inches (25 to 30 cm), or to some limited-production tires.

While the tires available on General Motors passenger cars and light trucks may vary with respect to these grades, they must also conform to federal safety requirements and additional General Motors Tire Performance Criteria (TPC) standards.

Treadwear

The treadwear grade is a comparative rating based on the wear rate of the tire when tested under controlled conditions on a specified government test course. For example, a tire graded 150 would wear one and a half (1.5) times as well on the government course as a tire graded 100. The relative performance of tires depends upon the actual conditions of their use, however, and may depart significantly from the norm due to variations in driving habits, service practices and differences in road characteristics and climate.

Traction – AA, A, B, C

The traction grades, from highest to lowest, are AA, A, B, and C. Those grades represent the tire's ability to stop on wet pavement as measured under controlled conditions on specified government test surfaces of asphalt and concrete. A tire marked C may have poor traction performance. Warning: The traction grade assigned to this tire is based on straight-ahead braking traction tests, and does not include acceleration, cornering, hydroplaning, or peak traction characteristics.

Temperature – A, B, C

The temperature grades are A (the highest), B, and C, representing the tire's resistance to the generation of heat and its ability to dissipate heat when tested under controlled conditions on a specified indoor laboratory test wheel. Sustained high temperature can cause the material of the tire to degenerate and reduce tire life, and excessive temperature can lead to sudden tire failure. The grade C corresponds to a level of performance which all passenger car tires must meet under the Federal Motor Vehicle Safety Standard No. 109. Grades B and A represent higher levels of performance on the laboratory test wheel than the minimum required by law.

Warning: The temperature grade for this tire is established for a tire that is properly inflated and not overloaded. Excessive speed, underinflation, or excessive loading, either separately or in combination, can cause heat buildup and possible tire failure.

Wheel Alignment and Tire Balance

The wheels on your vehicle were aligned and balanced carefully at the factory to give you the longest tire life and best overall performance.

If you notice unusual tire wear or your vehicle pulling one way or the other, the alignment may need to be reset. If you notice your vehicle vibrating when driving on a smooth road, your wheels may need to be rebalanced.

Wheel Replacement

Replace any wheel that is bent, cracked or badly rusted or corroded. If wheel nuts keep coming loose, the wheel, wheel bolts and wheel nuts should be replaced. If the wheel leaks air, replace it (except some aluminum wheels, which can sometimes be repaired). See your dealer if any of these conditions exist.

Your dealer will know the kind of wheel you need.

Each new wheel should have the same load-carrying capacity, diameter, width, offset and be mounted the same way as the one it replaces.

If you need to replace any of your wheels, wheel bolts or wheel nuts, replace them only with new GM original equipment parts. This way, you will be sure to have the right wheel, wheel bolts and wheel nuts for your vehicle.

CAUTION:

Using the wrong replacement wheels, wheel bolts or wheel nuts on your vehicle can be dangerous. It could affect the braking and handling of your vehicle, make your tires lose air and make you lose control. You could have a collision in which you or others could be injured. Always use the correct wheel, wheel bolts and wheel nuts for replacement.

Notice: The wrong wheel can also cause problems with bearing life, brake cooling, speedometer or odometer calibration, headlamp aim, bumper height, vehicle ground clearance and tire or tire chain clearance to the body and chassis.

See *Changing a Flat Tire* on page 5-70 for more information.

Used Replacement Wheels

CAUTION:

Putting a used wheel on your vehicle is dangerous. You can't know how it's been used or how far it's been driven. It could fail suddenly and cause a crash. If you have to replace a wheel, use a new GM original equipment wheel.

Tire Chains

Notice: Use tire chains only where legal and only when you must. Use only SAE Class "S" type chains that are the proper size for your tires. Install them on the rear axle tires and tighten them as tightly as possible with the ends securely fastened. Drive slowly and follow the chain manufacturer's instructions. If you can hear the chains contacting your vehicle, stop and retighten them. If the contact continues, slow down until it stops. Driving too fast or spinning the wheels with chains on will damage your vehicle.

If a Tire Goes Flat

It's unusual for a tire to "blowout" while you're driving, especially if you maintain your tires properly. If air goes out of a tire, it's much more likely to leak out slowly. But if you should ever have a "blowout," here are a few tips about what to expect and what to do:

If a front tire fails, the flat tire will create a drag that pulls the vehicle toward that side. Take your foot off the accelerator pedal and grip the steering wheel firmly. Steer to maintain lane position, and then gently brake to a stop well out of the traffic lane.

A rear blowout, particularly on a curve, acts much like a skid and may require the same correction you'd use in a skid. In any rear blowout, remove your foot from the accelerator pedal. Get the vehicle under control by steering the way you want the vehicle to go. It may be very bumpy and noisy, but you can still steer. Gently brake to a stop, well off the road if possible.

CAUTION:

Lifting a vehicle and getting under it to do maintenance or repairs is dangerous without the appropriate safety equipment and training. The jack provided with your vehicle is designed only for changing a flat tire. If it is used for anything else, you or others could be badly injured or killed if the vehicle slips off the jack. Use the jack provided with your vehicle only for changing a flat tire.

If a tire goes flat, the next part shows how to use your jacking equipment to change a flat tire safely.

Changing a Flat Tire

If a tire goes flat, avoid further tire and wheel damage by driving slowly to a level place. Turn on your hazard warning flashers.

CAUTION:

Changing a tire can be dangerous. The vehicle can slip off the jack and roll over or fall on you or other people. You and they could be badly injured or even killed. Find a level place to change your tire. To help prevent the vehicle from moving:

1. Set the parking brake firmly.
2. Put the shift lever in PARK (P).
3. Turn off the engine and do not restart while the vehicle is raised.
4. Do not allow passengers to remain in the vehicle.

CAUTION: (Continued)

CAUTION: (Continued)

To be even more certain the vehicle will not move, you should put blocks at the front and rear of the tire farthest away from the one being changed. That would be the tire, on the other side, at the opposite end of the vehicle.

When you have a flat tire, use the following example as a guide to assist you in the placement of wheel blocks.

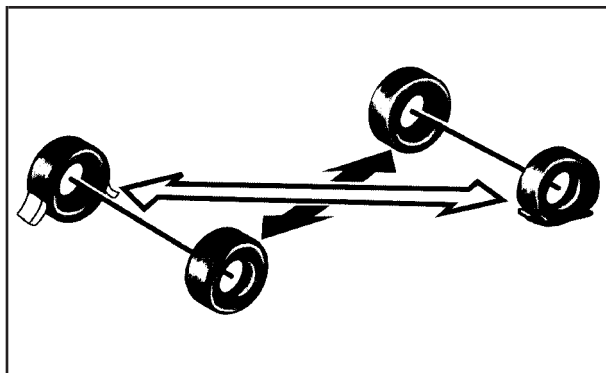

The following information will tell you next how to use the jack and change a tire.

Removing the Spare Tire and Tools

The equipment you'll need is located in the rear of the vehicle.

1. Remove the storage bin to access the jack if your vehicle has the cargo management system.

If your vehicle has the third row seat, remove the head rest storage tray to access the jack.

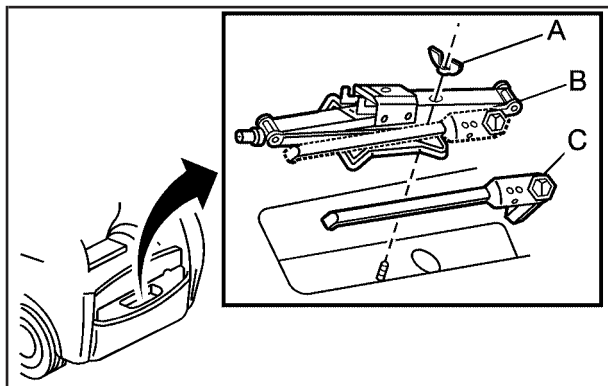

2. Turn the wing nut (A) holding the jack (B) (and storage tray, if applicable) counterclockwise and remove it.
3. Then remove the jack and wheel wrench (C).

Removing the Spare Tire

The compact spare tire is located under the vehicle, ahead of the rear bumper. See *Compact Spare Tire* on page 5-82 for more information about the compact spare.

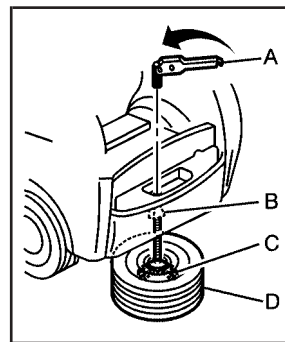

- A. Wheel Wrench
- B. Cable
- C. Retainer
- D. Compact Spare Tire

1. Open the storage compartment door of the cargo management system that is nearest the liftgate and remove the container.
2. Attach the wheel wrench (A) into the hoist shaft.

3. Turn the wheel wrench counterclockwise to lower the spare tire to the ground. Continue turning the wrench until the spare tire can be pulled out from under the vehicle.
4. Tilt the retainer (C) and slip it through the wheel opening to remove the spare tire from the cable (B).
5. Turn the wrench clockwise until you feel two slips or hear two clicks after removing the spare tire to raise the cable back up.

Do not store a full-size or a flat road tire under the vehicle. See *Storing a Flat or Spare Tire and Tools on page 5-79*.

To continue changing the flat tire, see *Removing the Flat Tire and Installing the Spare Tire on page 5-73*.

If the spare tire will not lower, the secondary latch may be engaged causing the tire not to lower. Do the following to check the cable:

1. Check under the vehicle to see if the cable is visible.
2. If it's not visible, see *Secondary Latch System on page 5-77*.

If it is visible, first try to tighten the cable by turning the wheel wrench clockwise until you hear two clicks or feel it skip twice. You cannot over-tighten the cable.

3. Loosen the cable then by turning the wrench counterclockwise three or four turns.
4. Tighten the cable all the way and then loosen it at least two times, if the spare tire has not lowered.

If the spare tire did lower to the ground, continue with Step 4 under *Removing the Spare Tire and Tools on page 5-71*.

If you still cannot lower the spare tire to the ground, see *Secondary Latch System on page 5-77*.

Removing the Flat Tire and Installing the Spare Tire

1. Using the flat end of the wheel wrench, pry off the center cap at the notch. Be careful; the edges may be sharp. Don't try to remove the cover with your bare hands.
2. Loosen the wheel nuts — but do not remove them — using the wheel wrench. (Turn the handle about 180 degrees, then flip the handle back to the starting position. This avoids taking the wrench off the lug nut for each turn.)

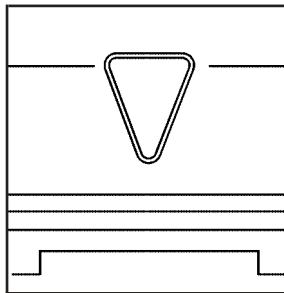

3. Find the jacking location using the hoisting notches located in the plastic molding. The notches in the plastic molding are marked with a triangle shape to help you find them.

CAUTION:

Getting under a vehicle when it is jacked up is dangerous. If the vehicle slips off the jack you could be badly injured or killed. Never get under a vehicle when it is supported only by a jack.

CAUTION:

Raising your vehicle with the jack improperly positioned can damage the vehicle and even make the vehicle fall. To help avoid personal injury and vehicle damage, be sure to fit the jack lift head into the proper location before raising the vehicle.

⚠ CAUTION:

Lifting a vehicle and getting under it to do maintenance or repairs is dangerous without the appropriate safety equipment and training. The jack provided with your vehicle is designed only for changing a flat tire. If it is used for anything else, you or others could be badly injured or killed if the vehicle slips off the jack. Use the jack provided with your vehicle only for changing a flat tire.

4. Attach the wheel wrench to the jack.
5. Turn the wheel wrench clockwise to raise the jack lift head until the jack just fits under the vehicle.

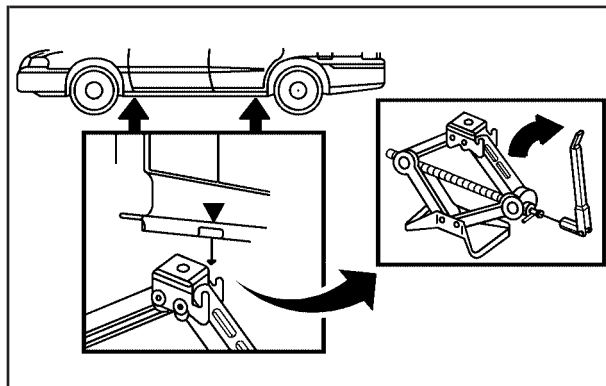

6. Raise the jack by turning the wheel wrench clockwise until the slots in the jack head fit into the metal flange located behind the triangle on the plastic molding as shown.

Notice: Using a jack to raise the vehicle without positioning it correctly could damage your vehicle. When raising your vehicle on a jack, be sure to position it correctly under the frame and avoid contact with the plastic molding.

- Put the compact spare tire near you.
- Raise the vehicle by turning the wheel wrench clockwise. Raise the vehicle far enough off the ground for the compact spare tire to fit under the vehicle.
- Remove all the wheel nuts and take off the flat tire.

⚠ CAUTION:

Rust or dirt on the wheel, or on the parts to which it is fastened, can make the wheel nuts become loose after a time. The wheel could come off and cause an accident. When you change a wheel, remove any rust or dirt from the places where the wheel attaches to the vehicle. In an emergency, you can use a cloth or a paper towel to do this; but be sure to use a scraper or wire brush later, if you need to, to get all the rust or dirt off.

⚠ CAUTION:

Never use oil or grease on studs or nuts. If you do, the nuts might come loose. Your wheel could fall off, causing a serious accident.

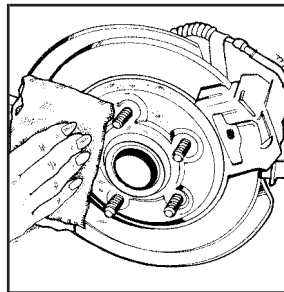

- Remove any rust or dirt from the wheel bolts, mounting surfaces and spare wheel.
- Install the spare tire and put the wheel nuts back on with the rounded end of the nuts toward the wheel.
- Tighten each nut by hand until the wheel is held against the hub.

- Lower the vehicle by attaching the wheel wrench to the jack and turning the wrench counterclockwise. Lower the jack completely.

⚠ CAUTION:

Incorrect wheel nuts or improperly tightened wheel nuts can cause the wheel to come loose and even come off. This could lead to an accident. Be sure to use the correct wheel nuts. If you have to replace them, be sure to get new GM original equipment wheel nuts. Stop somewhere as soon as you can and have the nuts tightened with a torque wrench to the proper torque specification. See *Capacities and Specifications on page 5-102* for wheel nut torque specification.

Notice: Improperly tightened wheel nuts can lead to brake pulsation and rotor damage. To avoid expensive brake repairs, evenly tighten the wheel nuts in the proper sequence and to the proper torque specification.

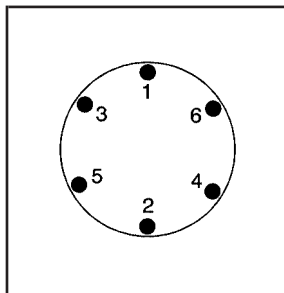

- Tighten the wheel nuts firmly in a crisscross sequence, as shown.

Notice: Wheel covers will not fit on your compact spare. If you try to put a wheel cover on the compact spare, you could damage the cover or the spare.

- Don't try to put a wheel cover on the compact spare tire. It won't fit. Store the wheel cover securely in the rear of the vehicle until you have the flat tire repaired or replaced.

Secondary Latch System

Your vehicle has an underbody mounted tire hoist assembly equipped with a secondary latch system. It is designed to stop the compact spare tire from suddenly falling off your vehicle if the cable holding the spare tire is damaged. For the secondary latch to work, the tire must be stowed with the valve stem pointing down. See *Storing a Flat or Spare Tire and Tools on page 5-79* for instructions on storing the spare tire correctly.

CAUTION:

Before beginning this procedure read all the instructions. Failure to read and follow the instructions could damage the hoist assembly and you and others could get hurt. Read and follow the instructions listed below.

CAUTION:

Someone standing too close during the procedure could be injured by the jack. If the spare tire does not slide off the jack completely, make sure no one is behind you or on either side of you as you pull the jack out from the spare.

To release the spare tire from the secondary latch, do the following:

1. If the cable is not visible, start this procedure at Step 3.
2. If the cable is visible, turn the wrench counterclockwise until approximately 6 inches (15 cm) of cable is exposed.
3. Attach the wheel wrench to the jack and raise the jack at least 10 turns.
4. Place the jack under the vehicle, ahead of the rear bumper. Position the center lift point of the jack under the center of the spare tire.

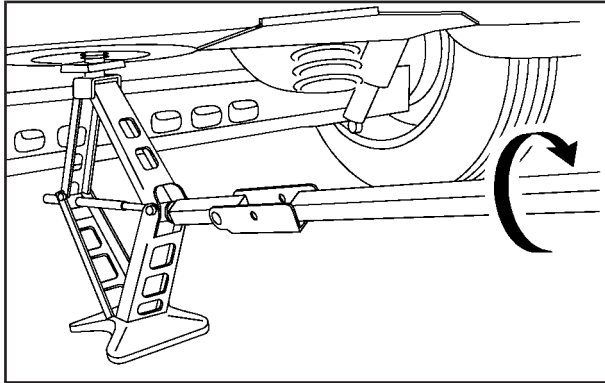

5. Turn the wheel wrench clockwise to raise the jack until it lifts the secondary latch spring.
6. Keep raising the jack until the spare tire stops moving upward and is held firmly in place, this lets you know that the secondary latch has released.
7. Lower the jack by turning the wheel wrench counterclockwise. Keep lowering the jack until the spare tire is resting on the wheel wrench.

8. Grasp the spare tire with both hands and pull it out from under the vehicle.
9. Reach under the vehicle and remove the wheel wrench and jack.
10. Tilt the retainer and slip it through the wheel opening when the spare tire has been completely lowered.
11. Turn the wrench clockwise to raise the cable back up if the cable is hanging.

Have the hoist assembly inspected as soon as you can. You will not be able to store a spare tire using the hoist assembly until it has been repaired or replaced.

Storing a Flat or Spare Tire and Tools

CAUTION:

Storing a jack, a tire, or other equipment in the passenger compartment of the vehicle could cause injury. In a sudden stop or collision, loose equipment could strike someone. Store all these in the proper place.

Storing the Flat Tire with Third Row Passengers

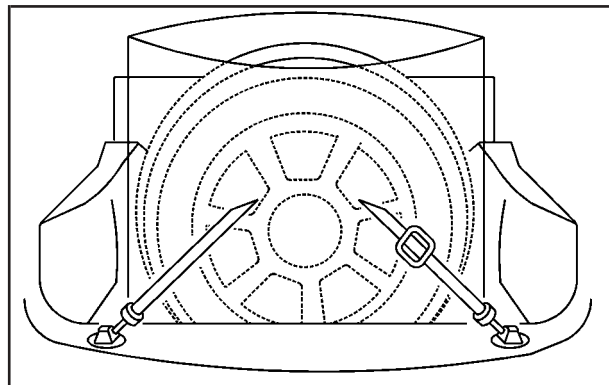

Put back all tools as they were stored in the rear storage compartment and put the compartment cover back on.

1. Use the power third row seat button, near the liftgate, to tilt the third row seatback forward slightly.
2. Place the flat tire in the tire storage bag and put the tire in an upright position against the third row seat.
3. Route the tie-down strap through the tire as shown in the graphic and attach the strap to the cargo tie-downs in the rear of the vehicle.
4. Tighten the tie-down strap.

Storing the Flat Tire with a Flat Load Floor

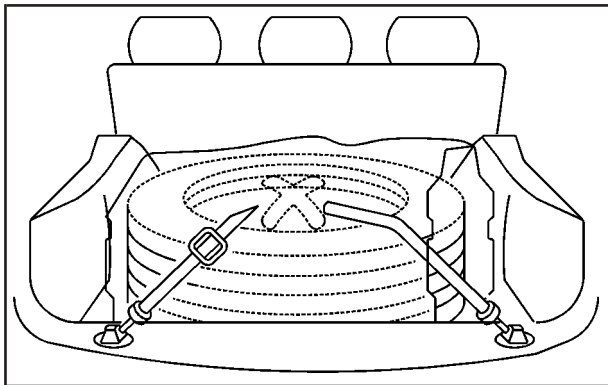

Put back all tools as they were stored in the rear storage compartment and put the compartment cover back on.

1. Place the flat tire in the tire storage bag and put the tire in a horizontal position on the floor in the rear of the vehicle.
2. Route the tie-down strap through the tire as shown in the graphic and attach the strap to the cargo tie-downs in the rear of the vehicle.
3. Tighten the tie-down strap.

Storing the Spare Tire and Tools

⚠ CAUTION:

The underbody-mounted spare tire needs to be stored with the valve stem pointing down. If the spare tire is stored with the valve stem pointing upwards, its secondary latch won't work properly and the spare tire could loosen and suddenly fall from your vehicle. If this happened when your vehicle was being driven, the tire might contact a person or another vehicle, causing injury and, of course, damage to itself as well. Be sure the underbody-mounted spare tire is stored with its valve stem pointing down.

1. Lay the compact spare tire on the ground at the rear of the vehicle. Position the compact spare tire so that the valve stem is pointed down facing the rear of the vehicle.
2. Lower the cable to the ground. See *Removing the Spare Tire and Tools* on page 5-71.

3. Tilt the retainer downward and slip it through the center hole of the spare tire.
Make sure the retainer is fully seated across the underside of the wheel.
4. Attach the wheel wrench to the hoist shaft.
5. Turn the wheel wrench clockwise to lift the spare tire.
6. When the tire is almost in the stored position, turn the tire so that the valve stem is towards the rear of the vehicle.
This will help when you check and maintain tire pressure in the spare.
7. Raise the tire fully against the underside of the vehicle. Continue turning the wheel wrench until you feel more than two clicks. This indicates that the compact spare tire is secure and the cable is tight. The spare tire hoist cannot be overtightened.

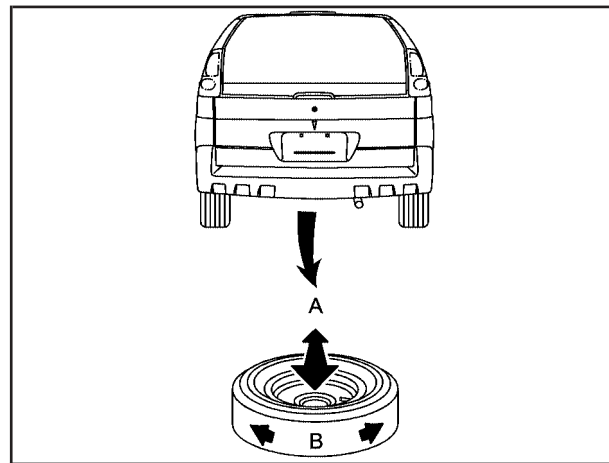

8. Make sure the tire is stored securely. Push, pull (A), and then try to turn the tire (B). If the tire moves, use the wheel wrench to tighten the cable.

Put back all tools as they were stored in the rear storage compartment and put the compartment cover back on.

Compact Spare Tire

Although the compact spare tire was fully inflated when the vehicle was new, it can lose air after a time. Check the inflation pressure regularly. It should be 60 psi (420 kPa).

After installing the compact spare on the vehicle, stop as soon as possible and make sure the spare tire is correctly inflated. The compact spare is made to perform well at speeds up to 65 mph (105 km/h) for distances up to 3,000 miles (5 000 km), so you can finish your trip and have the full-size tire repaired or replaced at your convenience. Of course, it is best to replace the spare with a full-size tire as soon as possible. The spare tire will last longer and be in good shape in case it is needed again.

Notice: When the compact spare is installed, do not take your vehicle through an automatic car wash with guide rails. The compact spare can get caught on the rails. That can damage the tire and wheel, and maybe other parts of your vehicle.

Do not use the compact spare on other vehicles.

And do not mix the compact spare tire or wheel with other wheels or tires. They will not fit. Keep the spare tire and its wheel together.

Notice: Tire chains will not fit your compact spare. Using them can damage your vehicle and can damage the chains too. Do not use tire chains on your compact spare.

Appearance Care

Cleaning products can be hazardous. Some are toxic. Other cleaning products can burst into flames if a match is struck near them or if they get on a hot part of the vehicle. Some are dangerous if their fumes are inhaled in a closed space. When anything from a container is used to clean the vehicle, be sure to follow the manufacturer's warnings and instructions. Always open the doors or windows of the vehicle when cleaning the inside.

Never use these to clean the vehicle:

- Gasoline
- Benzene
- Naphtha
- Carbon Tetrachloride
- Acetone

- Paint Thinner
- Turpentine
- Lacquer Thinner
- Nail Polish Remover

They can all be hazardous — some more than others — and they can all damage the vehicle, too.

Do not use any of these products unless this manual says you can. In many uses, these will damage the vehicle:

- Alcohol
- Laundry Soap
- Bleach
- Reducing Agents

Fabric/Carpet

Use a vacuum cleaner often to get rid of dust and loose dirt. Wipe vinyl, leather, plastic, and painted surfaces with a clean, damp cloth.

GM-approved cleaning products can be obtained from your dealer.

Here are some cleaning tips:

- Always read the instructions on the cleaner label.
- Clean up stains as soon as you can before they set.
- Carefully scrape off any excess stain.
- Use a clean cloth or sponge, and change to a clean area often. A soft brush may be used if stains are stubborn.
- To avoid forming a ring on fabric after spot cleaning, clean the entire area immediately or it will set.

Most stains can be removed with club soda water. To clean, use the following instructions:

1. For liquids: blot with a clean, soft, white cloth. For solids: remove as much as possible and then vacuum or brush.
2. Apply club soda water to a clean, soft, white cloth. Do not over-saturate; the cloth should not drip water.
3. Clean the entire area. Avoid getting the fabric too wet.
4. Start cleaning from the seams into the stain to avoid a ring effect.
5. Continue cleaning, using a clean area of the cloth each time it becomes soiled.
6. When the stain is removed, blot the cleaned area with another dry, clean, soft, white cloth.

Using Cleaner on Fabric

1. First, try the cleaner in an inconspicuous area to make sure the cleaner does not affect the color of the fabric.
2. For liquids: blot with a clean, soft, white cloth.
For solids: remove as much as possible and then vacuum or brush.
3. Spray a small amount of the cleaner onto a clean soft, white, cloth. Do not apply spray directly to the fabric.
4. Start cleaning from the seams into the stain to avoid a ring effect.
5. Continue cleaning, using a clean area of the cloth each time it becomes soiled.
6. When the stain is removed, blot the cleaned area with another dry, clean, soft, white cloth.
7. If the cleaner leaves a ring effect, follow up with the club soda water instructions given earlier in this section.

Special Fabric Cleaning Problems

Stains caused by such things as catsup, black coffee, egg, fruit, fruit juice, milk, soft drinks, vomit, urine, and blood can be removed using the club soda water instructions given earlier in this section. If an odor lingers after cleaning vomit or urine, treat the area with a water and baking soda solution: 1 teaspoon (5 ml) of baking soda to 1 cup (250 ml) of lukewarm water. Let dry.

Stains caused by oil and grease can be cleaned with an approved GM cleaner and a clean, white cloth.

1. Carefully scrape off excess stain.
2. Clean with cool water and allow to dry completely.
3. If a stain remains, follow the cleaner instructions described earlier.

Vinyl

Use warm water and a clean cloth.

- Rub with a clean, damp cloth to remove dirt. This may have to be done more than once.
- Things like tar, asphalt, and shoe polish will stain if they are not removed quickly. Use a clean cloth and vinyl cleaner. See your dealer for this product.

Leather

Use a soft cloth with lukewarm water and a mild soap or saddle soap and wipe dry with a soft cloth. Then, let the leather dry naturally. Do not use heat to dry.

- For stubborn stains, use a leather cleaner.
- Never use oils, varnishes, solvent-based or abrasive cleaners, furniture polish, or shoe polish on leather.
- Soiled or stained leather should be cleaned immediately. If dirt is allowed to work into the finish, it can harm the leather.

Instrument Panel

Use only mild soap and water to clean the top surfaces of the instrument panel. Sprays containing silicones or waxes may cause annoying reflections in the windshield and even make it difficult to see through the windshield under certain conditions.

Interior Plastic Components

Use only a mild soap and water solution on a soft cloth or sponge. Commercial cleaners may affect the surface finish.

Wood Panels

Use a clean cloth moistened in warm, soapy water (use mild dish washing soap). Dry the wood immediately with a clean cloth.

Speaker Covers

Vacuum around a speaker cover gently, so that the speaker will not be damaged. Clean spots with just water and mild soap.

Glass Surfaces

Glass should be cleaned often. GM Glass Cleaner or a liquid household glass cleaner will remove normal tobacco smoke and dust films on interior glass. See *Vehicle Care/Appearance Materials on page 5-91*.

Notice: If you use abrasive cleaners when cleaning glass surfaces on your vehicle, you could scratch the glass and/or cause damage to the rear window defogger and the integrated radio antenna. When cleaning the glass on your vehicle, use only a soft cloth and glass cleaner.

Care of Safety Belts

Keep belts clean and dry.

CAUTION:

Do not bleach or dye safety belts. If you do, it may severely weaken them. In a crash, they might not be able to provide adequate protection. Clean safety belts only with mild soap and lukewarm water.

Weatherstrips

Silicone grease on weatherstrips will make them last longer, seal better, and not stick or squeak. Apply silicone grease with a clean cloth. During very cold, damp weather frequent application may be required. See *Recommended Fluids and Lubricants on page 6-11*.

Washing Your Vehicle

The paint finish on the vehicle provides beauty, depth of color, gloss retention, and durability.

The best way to preserve the vehicle's finish is to keep it clean by washing it often with lukewarm or cold water.

Do not wash the vehicle in the direct rays of the sun. Use a car washing soap. Do not use strong soaps or chemical detergents. Be sure to rinse the vehicle well, removing all soap residue completely. GM-approved cleaning products can be obtained from your dealer. See *Vehicle Care/Appearance Materials on page 5-91*. Do not use cleaning agents that are petroleum based, or that contain acid or abrasives. All cleaning agents should be flushed promptly and not allowed to dry on the surface, or they could stain. Dry the finish with a soft, clean chamois or an all-cotton towel to avoid surface scratches and water spotting.

High pressure car washes may cause water to enter the vehicle.

Cleaning Exterior Lamps/Lenses

Use only lukewarm or cold water, a soft cloth and a car washing soap to clean exterior lamps and lenses. Follow instructions under *Washing Your Vehicle on page 5-87*.

Finish Care

Occasional waxing or mild polishing of the vehicle by hand may be necessary to remove residue from the paint finish. GM-approved cleaning products can be obtained from your dealer. See *Vehicle Care/Appearance Materials on page 5-91*.

The vehicle has a “basecoat/clearcoat” paint finish. The clearcoat gives more depth and gloss to the colored basecoat. Always use waxes and polishes that are non-abrasive and made for a basecoat/clearcoat paint finish.

Notice: Machine compounding or aggressive polishing on a basecoat/clearcoat paint finish may damage it. Use only non-abrasive waxes and polishes that are made for a basecoat/clearcoat paint finish on your vehicle.

Foreign materials such as calcium chloride and other salts, ice melting agents, road oil and tar, tree sap, bird droppings, chemicals from industrial chimneys, etc.,

can damage the vehicle’s finish if they remain on painted surfaces. Wash the vehicle as soon as possible. If necessary, use non-abrasive cleaners that are marked safe for painted surfaces to remove foreign matter.

Exterior painted surfaces are subject to aging, weather, and chemical fallout that can take their toll over a period of years. To help keep the paint finish looking new, keep the vehicle in a garage or covered whenever possible.

Windshield and Wiper Blades

If the windshield is not clear after using the windshield washer, or if the wiper blade chatters when running, wax, sap, or other material may be on the blade or windshield.

Clean the outside of the windshield with a glass cleaning liquid or powder and water solution. The windshield is clean if beads do not form when it is rinsed with water.

Grime from the windshield will stick to the wiper blades and affect their performance. Clean the blade by wiping vigorously with a cloth soaked in full-strength windshield washer solvent. Then rinse the blade with water.

Check the wiper blades and clean them as necessary; replace blades that look worn.

Aluminum or Chrome-Plated Wheels

The vehicle may be equipped with either aluminum or chrome-plated wheels.

Keep the wheels clean using a soft clean cloth with mild soap and water. Rinse with clean water. After rinsing thoroughly, dry with a soft clean towel. A wax may then be applied.

Notice: If you use strong soaps, chemicals, abrasive polishes, cleaners, brushes, or cleaners that contain acid on aluminum or chrome-plated wheels, you could damage the surface of the wheel(s). The repairs would not be covered by your warranty. Use only GM-approved cleaners on aluminum or chrome-plated wheels.

The surface of these wheels is similar to the painted surface of your vehicle. Do not use strong soaps, chemicals, abrasive polishes, abrasive cleaners, cleaners with acid, or abrasive cleaning brushes on them because you could damage the surface. Do not use chrome polish on aluminum wheels.

Notice: Using chrome polish on aluminum wheels could damage the wheels. The repairs would not be covered by your warranty. Use chrome polish on chrome wheels only.

Use chrome polish only on chrome-plated wheels, but avoid any painted surface of the wheel, and buff off immediately after application.

Notice: If you drive your vehicle through an automatic car wash that has silicone carbide tire cleaning brushes, you could damage the aluminum or chrome-plated wheels. The repairs would not be covered by your warranty. Never drive a vehicle equipped with aluminum or chrome-plated wheels through an automatic car wash that uses silicone carbide tire cleaning brushes.

Do not take your vehicle through an automatic car wash that has silicone carbide tire cleaning brushes. These brushes can also damage the surface of these wheels.

Tires

To clean the tires, use a stiff brush with tire cleaner.

Notice: Using petroleum-based tire dressing products on your vehicle may damage the paint finish and/or tires. When applying a tire dressing, always wipe off any overspray from all painted surfaces on your vehicle.

Sheet Metal Damage

If the vehicle is damaged and requires sheet metal repair or replacement, make sure the body repair shop applies anti-corrosion material to parts repaired or replaced to restore corrosion protection.

Original manufacturer replacement parts will provide the corrosion protection while maintaining the warranty.

Finish Damage

Any stone chips, fractures or deep scratches in the finish should be repaired right away. Bare metal will corrode quickly and may develop into major repair expense.

Minor chips and scratches can be repaired with touch-up materials available from your GM dealer. Larger areas of finish damage can be corrected in your GM dealer's body and paint shop.

Underbody Maintenance

Chemicals used for ice and snow removal and dust control can collect on the underbody. If these are not removed, corrosion and rust can develop on the underbody parts such as fuel lines, frame, floor pan, and exhaust system even though they have corrosion protection.

At least every spring, flush these materials from the underbody with plain water. Clean any areas where mud and debris can collect. Dirt packed in close areas of the frame should be loosened before being flushed. Your GM dealer or an underbody car washing system can do this for you.

Chemical Paint Spotting

Some weather and atmospheric conditions can create a chemical fallout. Airborne pollutants can fall upon and attack painted surfaces on the vehicle. This damage can take two forms: blotchy, ring-shaped discolorations, and small, irregular dark spots etched into the paint surface.

Although no defect in the paint job causes this, GM will repair, at no charge to the owner, the surfaces of new vehicles damaged by this fallout condition within 12 months or 12,000 miles (20 000 km) of purchase, whichever occurs first.

Vehicle Care/Appearance Materials

See your GM dealer for more information on purchasing the following products.

Description	Usage
Polishing Cloth Wax-Treated	Interior and exterior polishing cloth.
Tar and Road Oil Remover	Removes tar, road oil, and asphalt.
Chrome Cleaner and Polish	Use on chrome or stainless steel.
White Sidewall Tire Cleaner	Removes soil and black marks from whitewalls.
Vinyl Cleaner	Cleans vinyl tops, upholstery, and convertible tops.
Glass Cleaner	Removes dirt, grime, smoke and fingerprints.
Chrome and Wire Wheel Cleaner	Removes dirt and grime from chrome wheels and wire wheel covers.
Finish Enhancer	Removes dust, fingerprints, and surface contaminants. Spray on and wipe off.

Description	Usage
Swirl Remover Polish	Removes swirl marks, fine scratches, and other light surface contamination.
Cleaner Wax	Removes light scratches and protects finish.
Foaming Tire Shine Low Gloss	Cleans, shines, and protects in one step. No wiping necessary.
Wash Wax Concentrate	Medium foaming shampoo. Cleans and lightly waxes. Biodegradable and phosphate free.
Spot Lifter	Quickly removes spots and stains from carpets, vinyl, and cloth upholstery.
Odor Eliminator	Odorless spray odor eliminator used on fabrics, vinyl, leather and carpet.
See your General Motors parts department for these products. See <i>Recommended Fluids and Lubricants on page 6-11</i> .	

Vehicle Identification

Vehicle Identification Number (VIN)



This is the legal identifier for your vehicle. It appears on a plate in the front corner of the instrument panel, on the driver's side. You can see it if you look through the windshield from outside your vehicle. The VIN also appears on the Vehicle Certification and Service Parts labels and the certificates of title and registration.

Engine Identification

The 8th character in your VIN is the engine code. This code will help you identify your engine, specifications and replacement parts.

Service Parts Identification Label

You will find this label in the passenger side rear storage compartment or at the lower edge of the liftgate. It is very helpful if you ever need to order parts. On this label, you will find the following:

- VIN
- Model designation
- Paint information
- Production options and special equipment

Be sure that this label is not removed from the vehicle.

Electrical System

Add-On Electrical Equipment

Notice: Don't add anything electrical to your vehicle unless you check with your dealer first. Some electrical equipment can damage your vehicle and the damage wouldn't be covered by your warranty. Some add-on electrical equipment can keep other components from working as they should.

Your vehicle has an airbag system. Before attempting to add anything electrical to your vehicle, see *Servicing Your Airbag-Equipped Vehicle* on page 1-58.

Windshield Wiper Fuses

The windshield wiper motor is protected by an internal circuit breaker. If the wiper motor overheats due to heavy snow, the wipers will stop until the motor cools and will then restart.

Power Windows and Other Power Options

Circuit breakers protect the power windows and power seats. When the current load is too heavy, the circuit breaker opens and closes, protecting the circuit until the problem is fixed or goes away.

Fuses and Circuit Breakers

The wiring circuits in your vehicle are protected from short circuits by a combination of fuses and circuit breakers. This greatly reduces the chance of fires caused by electrical problems.

Look at the silver-colored band inside the fuse. If the band is broken or melted, replace the fuse. Be sure you replace a bad fuse with a new one of the identical size and rating. If a fuse blows, see your dealer for service immediately.

If you ever have a problem on the road and don't have a spare fuse, you can "borrow" one that has the same amperage. Pick some feature of your vehicle that you can get along without – like the radio or cigarette lighter – and use its fuse, if it is the correct amperage. Replace it as soon as you can.

The fuses are located in three fuse blocks, one located in the engine compartment on the passenger's side and the other two under the rear seat.

Relays	Usage
HI BEAM RELAY MICRO	High-Beam Headlamps
DRL RELAY MICRO-OPT	Daytime Running Lamps
LO BEAM RELAY/HID MINI-OPT	Low-Beam HID Headlamps (Option)
HDLP WASH RELAY MINI-OPT	Headlamp Washer Motor (Option)
SPARE	Not Used
BLOWER RELAY MINI	Front Blower
FOG LAMP RELAY MICRO	Fog Lamps
MAIN RELAY MICRO	Powertrain/ECM
STARTER RELAY MINI	Starter Solenoid
CMP CLU RELAY MICRO	Compressor Clutch
IGN-1 RELAY MICRO	Ignition Switch (ON)

Wiring Harnesses	Usage
BODY W/H	Wiring Harness Connection
I/P W/H	Wiring Harness Connection
ENG W/H	Engine Wiring Harness Connection
FORWARD LAMP	Forward Lamp Wiring Harness Connection

J Cases	Usage
R REAR	RRPDB (Passenger's Side Rear Power Distribution Box)
R REAR	RRPDB (Passenger's Side Rear Power Distribution Box)
L REAR	LRPDB (Driver's Side Rear Power Distribution Box)
L REAR	LRPDB (Driver's Side Rear Power Distribution Box)
HI FAN	High Cooling Fan Motor
LOW FAN	Low Cooling Fan Motor
BLOWER	PWM Fan Motor Assembly
STARTER	Starter Solenoid
EBCM	Electronic Brake Control Module

Fuses	Usage
RT PARK	Passenger's Side Taillamp Assembly, Front Sidemarker and Front Parking Lamp Assembly
HORN	Dual Horn Assembly
LT HI BEAM	Driver's Side High-Beam Headlamp
LT LOW BEAM	Driver's Side Low-Beam Headlamp
RT LOW BEAM	Passenger's Side Low-Beam Headlamp
RT HI BEAM	Passenger's Side High-Beam Headlamp
HFV6 ECM	High Feature V6 ECM (Electronic Control Module)
REAR WPR	Rear Wiper Motor
THEFT	ECM, TCM (Transmission Control Module), PASS-Key® III+ Module
LT PARK	Driver's Side Taillamp Assembly, Front Sidemarker and Front Parking Lamp Assembly
LIC/DIMMING	Rear License Plate Assembly, DIM (Dash Integration Module)

Fuses	Usage
DIM/ALDL	DIM, ALDL (Assembly Line Data Link)
FLASHER	Turn Signal/Hazard Flasher Module
V8 ECM	V8 ECM, Canister Purge
STRG CTLS	Steering Wheel Control Pad, Headlamp Switch
STARTER RLY	Jumper to Starter Relay
WASH NOZ	Driver's and Passenger's Side Heated Washer Nozzles
ODD COILS	Odd Ignition Coils, Fuel Injectors, Odd Injection Coils
TCM/IPC	TCM, ECM and IPC (Instrument Panel Cluster)
SPARE	Not Used
ABS	Anti-Lock Brake System
VICS	Vehicle Information and Communication System
SPARE	Not Used
SPARE	Not Used

Fuses	Usage
IGN SW	Ignition Switch (Power to IGN-3 and CRANK)
VOLT CHECK	DIM
ECM/TCM	ECM, TCM, IPC, PASS-Key® III+ Module
WPR MOD	Windshield Wiper Module Assembly
POSTO2	Post O2 Sensors
COMP CLUTCH	Compressor Clutch
WPR SW	Windshield Wiper/Washer Switch
FOG LAMP	Fog Lamps
OUTLET	Center Console Accessory Power Outlet
EVEN COILS	Even Injection Coils

Fuses	Usage
I/P OUTLET	Instrument Panel Accessory Power Outlet
CCP	Climate Control
PREO2/CAM	Driver's and Passenger's Side Oxygen Sensors, CAM Phaser
SPARE	Not Used
SPARE	Not Used
SPARE	Not Used

Circuit Breakers	Usage
HDLP WASH C/B-OPT	Headlamp Washer Motor (Optional)

Rear Underseat Fuse Block (Driver Side)

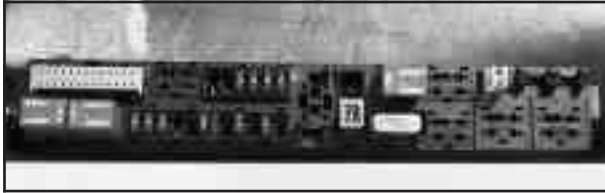

The driver's side rear fuse block is located under the rear seat on the driver's side of the vehicle. The carpet must be lifted up to access the rear fuse block.

To access the fuse block, push in the two tabs located at each end of the fuse block cover. Then lift the cover off.

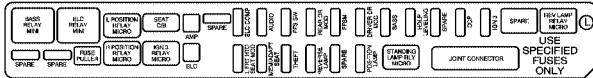

Relays	Usage
BASS RELAY MINI	Brake Apply Sensor
SPARE	Not Used
ELC RELAY MINI	ELC (Electronic Level Control) Compressor Motor
SPARE	Not Used
L POSITION RELAY MICRO	Driver's Side Position Lamp
R POSITION RELAY MICRO	Passenger's Side Position Lamp
IGN 3 RELAY MICRO	Heated Seat Modules, Air Inlet Motor, Shifter Assembly
STANDING LAMP RLY MICRO	Control for Position Lamp Relays
SPARE	Not Used
REV LAMP RELAY MICRO	ISRVM (Inside Rearview Mirror), License Plate Lamp Assembly

Fuses	Usage
L FRT HTD SEAT MOD	Driver's Heated Seat Module
MEM/ADAPT SEAT	Driver's Power Seat Switch, Memory Seat Module
THEFT	Universal Garage Door Opener, Intrusion Sensor, Diversity Antenna Module
REVERSE LAMP	ISRVM (Inside Rearview Mirror), License Plate Lamp Assembly
SPARE	Not Used
POSITION LAMP	Taillamp Assemblies, Front Position Lamp Assemblies
SPARE	Not Used
ELC COMP	ELC Compressor, ELC Solenoid
AUDIO	Radio, OnStar Module
FFS SW	Flip Fold Seat Switch
REAR DR MOD	Rear Door Modules
FFSM	Flip Fold Seat Module
DRIVER DR MOD	Driver's Door Module

Fuses	Usage
BASS	Taillamps, Center High-Mounted Stop Lamp, Flasher Module, ABS Module, Trailer Lamps
HDLP LEVELING	Headlamp Leveling System Chassis Sensors (Export Only)
SPARE	Not Used
CCP	CCP (Climate Control Panel)
IGN 3	Heated Seat Modules, Air Inlet Motor, Shifter Assembly

J Cases	Usage
AMP	Audio Amplifier
ELC	ELC Compressor

Circuit Breakers	Usage
SEAT C/B	Power Seat Switches, Memory Seat Module

Fuses	Usage
INTERIOR LAMP	Hush Panel Lamps, Puddle Lamps, Overhead Courtesy Lamp Assembly
RT FRT DR MOD	Passenger's Door Module
RIM	RIM (Rear Integration Module), Ignition Switch, Key Lock Cylinder
REAR FOG LAMP	Rear Fog Lamps (Export Only)
SUSPNTN	Suspension Module
VICS	TV Tuner Assembly, VICS (Vehicle Information Communication System) Module
SPARE	Not Used
POWER SOUNDER	Power Sounder, Inclination Sensor
AFTERBOIL	Afterboil Heater Pump
CANISTER VENT	Canister Vent Solenoid
FUEL PUMP MTR	Fuel Pump Motor

Fuses	Usage
REAR HVAC	Rear Climate Control System
R FRT HTD SEAT MOD	Passenger's Side Heated Seat Module
REAR HATCH	Rear Hatch Latch
AIR BAG	SDM (Sensing Diagnostic Module)
IGN 1	Shifter, Power Sounder, Rear Parking Aid, Rearview Mirror, RIM
SPARE	Not Used
SPARE	Not Used

J Cases	Usage
SUNROOF MOD	Power Sunroof Module
REAR DEFOG	Rear Window Defogger Element

Circuit Breakers	Usage
DR MOD PWR C/B	Door Modules

Capacities and Specifications

The following approximate capacities are given in English and metric conversions. See *Recommended Fluids and Lubricants* on page 6-11 for more information.

Application	Capacities	
	English	Metric
Air Conditioning Refrigerant R134a Front A/C Front and Rear A/C	1.26 lbs	0.57 kg
	1.76 lbs	0.80 kg
Automatic Transmission	9.0 quarts	8.5 L
Cooling System 3.6L V6 4.6L V8	9.7 quarts	9.2 L
	10.4 quarts	9.8 L
Engine Oil with Filter 3.6L V6 4.6L V8 AWD 4.6L V8 RWD	6.0 quarts	5.7 L
	7.5 quarts	7.1 L
	8.0 quarts	7.6 L
Fuel Tank	20.0 gallons	75.7 L
Wheel Nut Torque	100 ft lb	140 N•m
All capacities are approximate. When adding, be sure to fill to the approximate level, as recommended in this manual. Recheck fluid level after filling.		

Engine Specifications

Engine	VIN Code	Transmission	Spark Plug Gap
3.6L V6 (LY7)	7	Automatic	0.044 inches (1.1 mm)
4.6L V8 (LH2)	A	Automatic	0.040 inches (1.0 mm)

Section 6 Maintenance Schedule

Maintenance Schedule	6-2	Owner Checks and Services	6-8
Introduction	6-2	At Each Fuel Fill	6-8
Maintenance Requirements	6-2	At Least Once a Month	6-9
Your Vehicle and the Environment	6-2	At Least Once a Year	6-9
Using Your Maintenance Schedule	6-2	Recommended Fluids and Lubricants	6-11
Scheduled Maintenance	6-4	Normal Maintenance Replacement Parts	6-13
Additional Required Services	6-6	Maintenance Record	6-14
Maintenance Footnotes	6-7		

Maintenance Schedule

Introduction

Important: Keep engine oil at the proper level and change as recommended.



Have you purchased the GM Protection Plan? The Plan supplements your new vehicle warranties. See your Warranty and Owner Assistance booklet or your dealer for details.

Maintenance Requirements

Notice: Maintenance intervals, checks, inspections, replacement parts and recommended fluids and lubricants as prescribed in this manual are necessary to keep your vehicle in good working condition. Any damage caused by failure to follow scheduled maintenance may not be covered by warranty.

Your Vehicle and the Environment

Proper vehicle maintenance not only helps to keep your vehicle in good working condition, but also helps the environment. All recommended maintenance is important. Improper vehicle maintenance can even affect the quality of the air we breathe. Improper fluid levels or the wrong tire inflation can increase the level of emissions from your vehicle. To help protect our environment, and to keep your vehicle in good condition, be sure to maintain your vehicle properly.

Using Your Maintenance Schedule

We at General Motors want to help you keep your vehicle in good working condition. But we do not know exactly how you will drive it. You may drive very short distances only a few times a week. Or you may drive long distances all the time in very hot, dusty weather. You may use your vehicle in making deliveries. Or you may drive it to work, to do errands or in many other ways.

Because of all the different ways people use their vehicles, maintenance needs vary. You may need more frequent checks and replacements. So please read the following and note how you drive. If you have any questions on how to keep your vehicle in good condition, see your GM Goodwrench dealer.

This schedule is for vehicles that:

- carry passengers and cargo within recommended limits. You will find these limits on the tire and loading information label. See *Loading Your Vehicle* on page 4-45.
- are driven on reasonable road surfaces within legal driving limits.
- are driven off-road in the recommended manner. See *Operating Your All-Wheel-Drive Vehicle Off Paved Roads* on page 4-17.
- use the recommended fuel. See *Gasoline Octane* on page 5-5.

The services in *Scheduled Maintenance* on page 6-4 should be performed when indicated. See *Additional Required Services* on page 6-6 and *Maintenance Footnotes* on page 6-7 for further information.

 **CAUTION:**

Performing maintenance work on a vehicle can be dangerous. In trying to do some jobs, you can be seriously injured. Do your own maintenance work only if you have the required know-how and the proper tools and equipment for the job. If you have any doubt, see your GM Goodwrench dealer to have a qualified technician do the work.

Some maintenance services can be complex. So, unless you are technically qualified and have the necessary equipment, you should have your GM Goodwrench dealer do these jobs.

When you go to your GM Goodwrench dealer for your service needs, you will know that GM-trained and supported service technicians will perform the work using genuine GM parts.

If you want to get service information, see *Service Publications Ordering Information* on page 7-12.

Owner Checks and Services on page 6-8 tells you what should be checked, when to check it and what you can easily do to help keep your vehicle in good condition.

The proper replacement parts, fluids and lubricants to use are listed in *Recommended Fluids and Lubricants on page 6-11* and *Normal Maintenance Replacement Parts on page 6-13*. When your vehicle is serviced, make sure these are used. All parts should be replaced and all necessary repairs done before you or anyone else drives the vehicle. We recommend the use of genuine GM parts.

Scheduled Maintenance

When the CHANGE ENGINE OIL message comes on, it means that service is required for your vehicle. Have your vehicle serviced as soon as possible within the next 600 miles (1 000 km). It is possible that, if you are driving under the best conditions, the engine oil life system may not indicate that vehicle service is necessary for over a year. However, your engine oil and filter must be changed at least once a year and at this time the system must be reset. Your GM Goodwrench dealer has GM-trained service technicians who will perform this work using genuine GM parts and reset the system.

If the engine oil life system is ever reset accidentally, you must service your vehicle within 3,000 miles (5 000 km) since your last service. Remember to reset the oil life system whenever the oil is changed. See *Engine Oil Life System on page 5-20* for information on the Engine Oil Life System and resetting the system.

When the CHANGE ENGINE OIL message appears, certain services, checks and inspections are required. Required services are described in the following for "Maintenance I" and "Maintenance II." Generally, it is recommended that your first service be Maintenance I, your second service be Maintenance II and that you alternate Maintenance I and Maintenance II thereafter. However, in some cases, Maintenance II may be required more often.

Maintenance I — Use Maintenance I if the CHANGE ENGINE OIL message comes on within 10 months since vehicle was purchased or Maintenance II was performed.

Maintenance II — Use Maintenance II if the previous service performed was Maintenance I. Always use Maintenance II whenever the message comes on 10 months or more since the last service or if the message has not come on at all for one year.

Scheduled Maintenance

Service	Maintenance I	Maintenance II
Change engine oil and filter. See <i>Engine Oil</i> on page 5-16. Reset oil life system. See <i>Engine Oil Life System</i> on page 5-20. An Emission Control Service.	•	•
Lubricate chassis components. See footnote #.	•	•
Visually check for any leaks or damage. See footnote (g).	•	•
Inspect engine air cleaner filter. If necessary, replace filter. See <i>Engine Air Cleaner/Filter</i> on page 5-22. An Emission Control Service. See footnote †.	•	•
Check tires for inflation pressures and wear. See <i>Tires</i> on page 5-52.	•	•
Inspect brake system. See footnote (a).	•	•
Check engine coolant and windshield washer fluid levels and add fluid as needed.	•	•
Perform any needed additional services. See “Additional Required Services” in this section.	•	•
Inspect suspension and steering components. See footnote (b).		•
Inspect engine cooling system. See footnote (c).		•
Inspect wiper blades. See footnote (d).		•
Inspect restraint system components. See footnote (e).		•
Lubricate body components. See footnote (f).		•
Check transmission fluid level and add fluid as needed.		•
Replace passenger compartment air filter. See footnote (j).		•

Additional Required Services

The following services should be performed at the first maintenance service (I or II) after the indicated miles (kilometers) shown for each item.

Additional Required Services

Service and Miles (Kilometers)	25,000 (41 500)	50,000 (83 000)	75,000 (125 000)	100,000 (166 000)	125,000 (207 500)	150,000 (240 000)
Inspect fuel system for damage or leaks.	•	•	•	•	•	•
Inspect exhaust system for loose or damaged components.	•	•	•	•	•	•
Replace engine air cleaner filter. <i>See Engine Air Cleaner/Filter on page 5-22. An Emission Control Service.</i>	•	•	•	•	•	•
For vehicles used for trailer towing: Change transfer case fluid.		•		•		•
Change automatic transmission fluid and filter (severe service). <i>See footnote (h).</i>		•		•		•
Change automatic transmission fluid and filter (normal service).				•		
Replace spark plugs. <i>An Emission Control Service.</i>				•		
Engine cooling system service (or every 5 years, whichever occurs first). <i>An Emission Control Service. See footnote (i).</i>						•
Inspect engine accessory drive belt. <i>An Emission Control Service.</i>						•

Maintenance Footnotes

† The U.S. Environmental Protection Agency or the California Air Resources Board has determined that the failure to perform this maintenance item will not nullify the emission warranty or limit recall liability prior to the completion of the vehicle's useful life. We, however, urge that all recommended maintenance services be performed at the indicated intervals and the maintenance be recorded.

Lubricate the front suspension, ball joints, steering linkage, transmission shift linkage and parking brake cable guides. Ball joints should not be lubricated unless their temperature is 10°F (-12°C) or higher, or they could be damaged.

(a) Visually inspect brake lines and hoses for proper hook-up, binding, leaks, cracks, chafing, etc. Inspect disc brake pads for wear and rotors for surface condition. Inspect other brake parts, including calipers, parking brake, etc.

(b) Visually inspect front and rear suspension and steering system for damaged, loose or missing parts, signs of wear or lack of lubrication. Inspect power steering lines and hoses for proper hook-up, binding, leaks, cracks, chafing, etc.

(c) Visually inspect hoses and have them replaced if they are cracked, swollen or deteriorated. Inspect all pipes, fittings and clamps; replace with genuine GM parts as needed. To help ensure proper operation, a pressure test of the cooling system and pressure cap and cleaning the outside of the radiator and air conditioning condenser is recommended at least once a year.

(d) Visually inspect wiper blades for wear or cracking. Replace blade inserts that appear worn or damaged or that streak or miss areas of the windshield.

(e) Make sure the safety belt reminder light and all your belts, buckles, latch plates, retractors and anchorages are working properly. Look for any other loose or damaged safety belt system parts. If you see anything that might keep a safety belt system from doing its job, have it repaired. Have any torn or frayed safety belts replaced. Also look for any opened or broken airbag coverings, and have them repaired or replaced. (The airbag system does not need regular maintenance.)

(f) Lubricate all key lock cylinders, hood latch assemblies, secondary latch, pivots, spring anchor, release pawl, hood hinges, body door hinges, rear compartment hinges and any folding seat hardware. More frequent lubrication may be required when exposed to a corrosive environment. Applying silicone grease on weatherstrips with a clean cloth will make them last longer, seal better and not stick or squeak. See Weatherstrips on page 5-87.

(g) A fluid loss in any vehicle system could indicate a problem. Have the system inspected and repaired and the fluid level checked. Add fluid if needed.

(h) Change automatic transmission fluid and filter if the vehicle is mainly driven under one or more of these conditions:

- In heavy city traffic where the outside temperature regularly reaches 90°F (32°C) or higher.
- In hilly or mountainous terrain.
- When doing frequent trailer towing.
- Uses such as found in taxi, police or delivery service.

(i) Drain, flush and refill cooling system. See *Engine Coolant* on page 5-24 for what to use. Inspect hoses. Clean radiator, condenser, pressure cap and filler neck. Pressure test the cooling system and pressure cap.

(j) If you drive regularly under dusty conditions, the filter may require replacement more often.

Owner Checks and Services

These owner checks and services should be performed at the intervals specified to help ensure the safety, dependability and emission control performance of your vehicle. Your GM Goodwrench dealer can assist you with these checks and services.

Be sure any necessary repairs are completed at once. Whenever any fluids or lubricants are added to your vehicle, make sure they are the proper ones, as shown in *Recommended Fluids and Lubricants* on page 6-11.

At Each Fuel Fill

It is important to perform these underhood checks at each fuel fill.

Engine Oil Level Check

Check the engine oil level and add the proper oil if necessary. See *Engine Oil* on page 5-16 for further details.

Notice: It is important to check your oil regularly and keep it at the proper level. Failure to keep your engine oil at the proper level can cause damage to your engine not covered by your warranty.

Engine Coolant Level Check

Check the engine coolant level and add DEX-COOL® coolant mixture if necessary. See *Engine Coolant* on page 5-24 for further details.

Windshield Washer Fluid Level Check

Check the windshield washer fluid level in the windshield washer tank and add the proper fluid if necessary.

At Least Once a Month

Tire Inflation Check

Visually inspect your tires and make sure tires are inflated to the correct pressures. Do not forget to check your spare tire. See *Tires* on page 5-52 for further details. Check to make sure the spare tire is stored securely. Push, pull and then try to turn the spare tire. If it moves, tighten it. See *Changing a Flat Tire* on page 5-70.

At Least Once a Year

Starter Switch Check

CAUTION:

When you are doing this inspection, the vehicle could move suddenly. If the vehicle moves, you or others could be injured.

1. Before you start, be sure you have enough room around the vehicle.
2. Firmly apply both the parking brake and the regular brake. See *Parking Brake* on page 2-28 if necessary.
Do not use the accelerator pedal, and be ready to turn off the engine immediately if it starts.
3. Try to start the engine in each gear. The starter should work only in PARK (P) or NEUTRAL (N). If the starter works in any other position, contact your GM Goodwrench dealer for service.

Automatic Transmission Shift Lock Control System Check

CAUTION:

When you are doing this inspection, the vehicle could move suddenly. If the vehicle moves, you or others could be injured.

1. Before you start, be sure you have enough room around the vehicle. It should be parked on a level surface.
2. Firmly apply the parking brake. See *Parking Brake* on page 2-28 if necessary.
Be ready to apply the regular brake immediately if the vehicle begins to move.
3. With the engine off, turn the ignition to ON, but do not start the engine. Without applying the regular brake, try to move the shift lever out of PARK (P) with normal effort. If the shift lever moves out of PARK (P), contact your GM Goodwrench dealer for service.

Ignition Transmission Lock Check

While parked, and with the parking brake set, try to turn the ignition to OFF in each shift lever position.

- The ignition should turn to OFF only when the shift lever is in PARK (P).
- The key should come out only in OFF.

Contact your GM Goodwrench dealer if service is required.

Parking Brake and Automatic Transmission Park (P) Mechanism Check

CAUTION:

When you are doing this check, your vehicle could begin to move. You or others could be injured and property could be damaged. Make sure there is room in front of your vehicle in case it begins to roll. Be ready to apply the regular brake at once should the vehicle begin to move.

Park on a fairly steep hill, with the vehicle facing downhill. Keeping your foot on the regular brake, set the parking brake.

- To check the parking brake's holding ability:
With the engine running and transmission in NEUTRAL (N), slowly remove foot pressure from the regular brake pedal. Do this until the vehicle is held by the parking brake only.
- To check the PARK (P) mechanism's holding ability:
With the engine running, shift to PARK (P). Then release the parking brake followed by the regular brake.

Contact your GM Goodwrench dealer if service is required.

Underbody Flushing Service

At least every spring, use plain water to flush any corrosive materials from the underbody. Take care to clean thoroughly any areas where mud and other debris can collect.

Recommended Fluids and Lubricants

Fluids and lubricants identified below by name, part number or specification may be obtained from your dealer.

Usage	Fluid/Lubricant
Engine Oil	The engine requires a special engine oil meeting GM Standard GM4718M. Oils meeting this standard may be identified as synthetic, and should also be identified with the American Petroleum Institute Certified for Gasoline Engines starburst symbol. However, not all synthetic API oils with the starburst symbol will meet this GM standard. You should look for and use only an oil that meets GM Standard GM4718M. GM Goodwrench oil meets all the requirements for your vehicle. For the proper viscosity, see <i>Engine Oil on page 5-16</i> .
Engine Coolant	50/50 mixture of clean, drinkable water and use only DEX-COOL [®] Coolant. See <i>Engine Coolant on page 5-24</i> .

Usage	Fluid/Lubricant
Hydraulic Brake System	Delco Supreme 11 Brake Fluid or equivalent DOT-3 brake fluid.
Windshield Washer Solvent	GM Optikleen® Washer Solvent.
Power Steering System	GM Power Steering Fluid (GM Part No. U.S. 89021184, in Canada 89021186).
Automatic Transmission	DEXRON®-III Automatic Transmission Fluid. Look for "Approved for the H-Specification" on the label.
Key Lock Cylinders	Multi-Purpose Lubricant, Superlube (GM Part No. U.S. 12346241, in Canada 10953474).
Chassis Lubrication	Chassis Lubricant (GM Part No. U.S. 12377985, in Canada 88901242) or lubricant meeting requirements of NLGI #2, Category LB or GC-LB.
Front and Rear Axle	SAE 75W-90 Synthetic Axle Lubricant (GM Part No. U.S. 12378261, in Canada 10953455) meeting GM Specification 9986115.

Usage	Fluid/Lubricant
Transfer Case	DEXRON®-III Automatic Transmission Fluid. Look for "Approved for the H-Specification" on the label.
Hood Hinges	Multi-Purpose Lubricant, Superlube (GM Part No. U.S. 12346241, in Canada 10953474).
Body Door Hinge Pins, Tailgate Hinge and Linkage, Folding Seats and Fuel Door Hinge	Multi-Purpose Lubricant, Superlube (GM Part No. U.S. 12346241, in Canada 10953474).
Outer Tailgate Handle Pivot Points	Multi-Purpose Lubricant, Superlube (GM Part No. U.S. 12346241, in Canada 10953474).
Weatherstrip Conditioning	Dielectric Silicone Grease (GM Part No. U.S. 12345579, in Canada 992887).
Weatherstrip Squeaks	Synthetic Grease with Teflon, Superlube (GM Part No. U.S. 12371287, in Canada 10953437).

Normal Maintenance Replacement Parts

Replacement parts identified below by name, part number, or specification can be obtained from your dealer.

Part	GM Part Numbers	ACDelco® Part Numbers
Engine Air Cleaner/Filter	25728874	A2029C
Engine Oil Filter 3.6L V6 4.6L V8	25177917 89017342	PF2129 PF61
Passenger Compartment Air Filter Element	25740404	—
Spark Plugs 3.6L V6 4.6L V8	12565996 12571533	41-988 41-986
Windshield Wiper Blades (Hook Type) Driver's Side – 22 inches (56.5 cm) Passenger's Side – 21 inches (53.3 cm)	12367281 88892785	8-2221 8-2211

Maintenance Record

After the scheduled services are performed, record the date, odometer reading, who performed the service and the type of services performed in the boxes provided. See *Maintenance Requirements on page 6-2* in this section. Any additional information from *Owner Checks and Services on page 6-8* can be added on the following record pages. Also, you should retain all maintenance receipts.

Maintenance Record

Date	Odometer Reading	Serviced By	Maintenance I or Maintenance II	Services Performed

Maintenance Record (cont'd)

Date	Odometer Reading	Serviced By	Maintenance I or Maintenance II	Services Performed

Maintenance Record (cont'd)

Date	Odometer Reading	Serviced By	Maintenance I or Maintenance II	Services Performed

Section 7 Customer Assistance and Information

Customer Assistance and Information	7-2	Reporting Safety Defects	7-11
Customer Satisfaction Procedure	7-2	Reporting Safety Defects to the	
Online Owner Center	7-4	United States Government	7-11
Customer Assistance for Text Telephone		Reporting Safety Defects to the	
(TTY) Users	7-4	Canadian Government	7-12
Customer Assistance Offices	7-4	Reporting Safety Defects to	
GM Mobility Program for Persons		General Motors	7-12
with Disabilities	7-6	Service Publications Ordering Information	7-12
Roadside Service	7-6		
Courtesy Transportation	7-8		
Vehicle Data Collection and Event			
Data Recorders	7-10		

Customer Assistance and Information

Customer Satisfaction Procedure

Your satisfaction and goodwill are important to your dealer and to Cadillac. Normally, any concerns with the sales transaction or the operation of your vehicle will be resolved by your dealer's sales or service departments. Sometimes, however, despite the best intentions of all concerned, misunderstandings can occur. If your concern has not been resolved to your satisfaction, the following steps should be taken:

STEP ONE: Discuss your concern with a member of dealership management. Normally, concerns can be quickly resolved at that level. If the matter has already been reviewed with the sales, service or parts manager, contact the owner of the dealership or the general manager.

STEP TWO: If after contacting a member of dealership management, it appears your concern cannot be resolved by the dealership without further help, contact the Cadillac Customer Assistance Center, 24 hours a day, by calling 1-800-458-8006. In Canada, contact GM of Canada, Canadian Cadillac Customer Communication Centre by calling 1-888-446-2000.

We encourage you to call the toll-free number in order to give your inquiry prompt attention. Please have the following information available to give the Customer Assistance Representative:

- Vehicle Identification Number (VIN). This is available from the vehicle registration or title, or the plate at the top left of the instrument panel and visible through the windshield.
- Dealership name and location.
- Vehicle delivery date and present mileage.

When contacting Cadillac, please remember that your concern will likely be resolved at a dealer's facility. That is why we suggest you follow Step One first if you have a concern.

STEP THREE: Both General Motors and your dealer are committed to making sure you are completely satisfied with your new vehicle. However, if you continue to remain unsatisfied after following the procedure outlined in Steps One and Two, you should file with the BBB Auto Line Program to enforce any additional rights you may have. Canadian owners refer to your Warranty and Owner Assistance Information booklet for information on the Canadian Motor Vehicle Arbitration Plan (CAMVAP).

The BBB Auto Line Program is an out of court program administered by the Council of Better Business Bureaus to settle automotive disputes regarding vehicle repairs or the interpretation of the New Vehicle Limited Warranty. Although you may be required to resort to this informal dispute resolution program prior to filing a court action, use of the program is free of charge and your case will generally be heard within 40 days. If you do not agree with the decision given in your case, you may reject it and proceed with any other venue for relief available to you.

You may contact the BBB Auto Line Program using the toll-free telephone number or write them at the following address:

BBB Auto Line Program
Council of Better Business Bureaus, Inc.
4200 Wilson Boulevard
Suite 800
Arlington, VA 22203-1838
Telephone: 1-800-955-5100

This program is available in all 50 states and the District of Columbia. Eligibility is limited by vehicle age, mileage and other factors. General Motors reserves the right to change eligibility limitations and/or discontinue its participation in this program.

Online Owner Center

The Owner Center is a resource for your GM ownership needs. Specific vehicle information can be found in one place.

The Online Owner Center allows you to:

- Get e-mail service reminders.
- Access information about your specific vehicle, including tips and videos and an electronic version of this owner's manual (United States only).
- Keep track of your vehicle's service history and maintenance schedule.
- Find GM dealers for service nationwide.
- Receive special promotions and privileges only available to members (United States only).

Refer to the web for updated information.

To register your vehicle, visit www.MyGMLink.com. (United States) or My GM Canada within www.gmcanada.com (Canada).

Customer Assistance for Text Telephone (TTY) Users

To assist customers who are deaf, hard of hearing, or speech-impaired and who use Text Telephones (TTYs), Cadillac has TTY equipment available at its Customer Assistance Center. Any TTY user can communicate with Cadillac by dialing: 1-800-833-CMCC (2622). (TTY users in Canada can dial 1-800-263-3830.)

Customer Assistance Offices

Cadillac encourages customers to call the toll-free number for assistance. If a U.S. customer wishes to write to Cadillac, the letter should be addressed to Cadillac's Customer Assistance Center.

United States — Customer Assistance

Cadillac Customer Assistance Center
Cadillac Motor Car Division
P.O. Box 33169
Detroit, MI 48232-5169

1-800-458-8006
1-800-833-2622 (For Text Telephone devices (TTYs))
Roadside Assistance: 1-800-882-1112
Fax Number: 313-381-0022

From Puerto Rico:

1-800-496-9992 (English)
1-800-496-9993 (Spanish)
Fax Number: 313-381-0022

From U.S. Virgin Islands:

1-800-496-9994
Fax Number: 313-381-0022

Canada — Customer Assistance

General Motors of Canada Limited
Canadian Cadillac Customer Communication
Centre, 163-005
1908 Colonel Sam Drive
Oshawa, Ontario L1H 8P7

1-888-446-2000
1-800-263-3830 (For Text Telephone devices (TTYs))
Roadside Assistance: 1-800-882-1112

Overseas — Customer Assistance

Please contact the local General Motors Business Unit.

Mexico, Central America and Caribbean Islands/Countries (Except Puerto Rico and U.S. Virgin Islands) — Customer Assistance

General Motors de Mexico, S. de R.L. de C.V.
Customer Assistance Center
Paseo de la Reforma # 2740
Col. Lomas de Bezares
C.P. 11910, Mexico, D.F.
01-800-508-0000
Long Distance: 011-52-53 29 0 800

GM Mobility Program for Persons with Disabilities



This program, available to qualified applicants, can reimburse you up to \$1,000 toward eligible aftermarket driver or passenger adaptive equipment that may be required for your vehicle, such as hand controls, wheelchair/scooter lifts, etc.

This program can also provide you with free resource information, such as area driver assessment centers and mobility equipment installers. The offer is available for a limited period of time from the date of vehicle purchase/lease. For more details, or to determine your vehicle's eligibility, see your GM dealer or call the GM Mobility Assistance Center at 1-800-323-9935. Text telephone (TTY) users, call 1-800-833-9935.

GM of Canada also has a Mobility Program. Call 1-800-GM-DRIVE (463-7483) for details. All TTY users call 1-800-263-3830.

Roadside Service

Cadillac's exceptional Roadside Service is more than an auto club or towing service. It provides every Cadillac owner with the advantage of contacting a Cadillac advisor and, where available, a Cadillac trained dealer technician who can provide on-site service.

Each technician travels with a specially equipped service vehicle complete with the necessary Cadillac parts and tools required to handle most roadside repairs.

Cadillac Roadside Service® can be reached by dialing 1-800-882-1112, 24 hours a day, 365 days a year. This service is provided at no charge for any warranty-covered situation and for a nominal charge if the Cadillac is no longer under warranty. Roadside Service is available only in the United States and Canada.

Cadillac Owner Privileges™

Roadside Service provides several Cadillac Owner Privileges™ at “no charge,” throughout your *Cadillac Warranty Period* — 48 months/50,000 miles (80 000 km).

Emergency Road Service is performed on site for the following situations:

- Towing Service
- Battery Jump Starting
- Lock Out Assistance
- Fuel Delivery
- Flat Tire Change (Covers change only)
- Trip Interruption — If your trip is interrupted due to a warranty failure, incidental expenses may be reimbursed during the 48 months/50,000 miles (80 000 km) warranty period. Items covered are hotel, meals, and rental car.

Roadside Service Availability

Wherever you drive in the United States or Canada, an advisor is available to assist you over the phone. A dealer technician, if available, can travel to your location within a 30 mile (50 km) radius of a participating Cadillac dealership. If beyond this radius, we will arrange to have your car towed to the nearest Cadillac dealership.

Reaching Roadside Service

Dial the toll-free Roadside Service number: 1-800-882-1112. A Roadside Service Advisor will assist you and request the following information:

- A description of the problem
- Name, home address, home telephone number
- Location of your Cadillac and number you are calling from
- The model year, Vehicle Identification Number (VIN), mileage, and date of delivery

Roadside Service for the Hearing or Speech Impaired

Roadside Service is prepared to assist owners who have hearing difficulties or are speech impaired. Cadillac has installed special telecommunication devices called Text Telephone (TTY) in the Roadside Service Center.

Any customer who has access to a (TTY) or a conventional teletypewriter can communicate with Cadillac by dialing from the United States or Canada 1-888-889-2438 — daily, 24 hours.

Courtesy Transportation

Cadillac has always exemplified quality and value in its offering of motor vehicles. To enhance your ownership experience, we and our participating dealers are proud to offer Courtesy Transportation, a customer support program for new vehicles.

The Courtesy Transportation program is offered to retail purchase/lease customers in conjunction with the Bumper-to-Bumper coverage provided by the New Vehicle Limited Warranty. Several transportation options are available when warranty repairs are required. This will reduce your inconvenience during warranty repairs.

Scheduling Service Appointments

When your vehicle requires warranty service, you should contact your dealer and request an appointment. By scheduling a service appointment and advising your service consultant of your transportation needs, your dealer can help minimize your inconvenience.

If your vehicle cannot be scheduled into the service department immediately, keep driving it until it can be scheduled for service, unless, of course, the problem is safety-related. If it is, please call your dealership, let them know this, and ask for instructions.

If the dealer requests that you simply drop the vehicle off for service, you are urged to do so as early in the work day as possible to allow for same day repair.

Transportation Options

Warranty service can generally be completed while you wait. However, if you are unable to wait Cadillac helps minimize your inconvenience by providing several transportation options. Depending on the circumstances, your dealer can offer you one of the following:

Shuttle Service

Participating dealers can provide you with shuttle service to get you to your destination with minimal interruption of your daily schedule. This includes a one way or round trip shuttle service to a destination up to 10 miles from the dealership.

Public Transportation or Fuel Reimbursement

If your vehicle requires overnight warranty repairs, reimbursement (five days maximum) may be available for the use of public transportation such as taxi or bus. In addition, should you arrange transportation through a friend or relative, reimbursement for reasonable fuel expenses (five day maximum) may be available. Claim amounts should reflect actual costs and be supported by original receipts.

Courtesy Rental Vehicle

Your dealer may arrange to provide you with a courtesy rental vehicle or reimburse you for a rental vehicle you obtained if your vehicle is kept for a warranty repair. Reimbursement will be limited to a maximum of \$40 a day and must be supported by receipts. This requires that you sign and complete a rental agreement and meet state, local and rental vehicle provider requirements. Requirements vary and may include minimum age requirements, insurance coverage, credit card, etc. You are responsible for fuel usage charges and may also be responsible for taxes, levies, usage fees, excessive mileage, or rental usage beyond the completion of the repair.

Generally it is not possible to provide a like-vehicle as a courtesy rental.

Additional Program Information

Courtesy Transportation is available during the Bumper-to-Bumper warranty coverage period, but it *is not* part of the New Vehicle Limited Warranty. A separate booklet entitled *Warranty and Owner Assistance Information* furnished with each new vehicle provides detailed warranty coverage information.

Courtesy Transportation is available only at participating dealers and all program options, such as shuttle service, may not be available at every dealer. Please contact your dealer for specific information about availability. All Courtesy Transportation arrangements will be administered by appropriate dealer personnel.

Canadian Vehicles: For warranty repairs during the Complete Vehicle Coverage period of the General Motors of Canada New Vehicle Limited Warranty, alternative transportation may be available under the Courtesy Transportation Program. Please consult your dealer for details.

General Motors reserves the right to unilaterally modify, change or discontinue Courtesy Transportation at any time and to resolve all questions of claim eligibility pursuant to the terms and conditions described herein at its sole discretion.

Vehicle Data Collection and Event Data Recorders

Your vehicle, like other modern motor vehicles, has a number of sophisticated computer systems that monitor and control several aspects of the vehicle's performance. Your vehicle uses on-board vehicle computers to monitor emission control components to optimize fuel economy, to monitor conditions for air bag deployment and, if so equipped, to provide anti-lock braking and to help the driver control the vehicle in difficult driving situations. Some information may be stored during regular operations to facilitate repair of detected malfunctions; other information is stored only in a crash event by computer systems, such as those commonly called event data recorders (EDR).

In a crash event, computer systems, such as the Air Bag Sensing and Diagnostic Module (SDM) in your vehicle may record information about the condition of the vehicle and how it was operated, such as data related to engine speed, brake application, throttle position, vehicle speed, safety belt usage, air bag

readiness, air bag performance, and the severity of a collision. This information has been used to improve vehicle crash performance and may be used to improve crash performance of future vehicles and driving safety. Unlike the data recorders on many airplanes, these on-board systems do not record sounds, such as conversation of vehicle occupants.

To read this information, special equipment is needed and access to the vehicle or the device that stores the data is required. GM will not access information about a crash event or share it with others other than:

- with the consent of the vehicle owner or, if the vehicle is leased, with the consent of the lessee,
- in response to an official request of police or similar government office,
- as part of GM's defense of litigation through the discovery process, or
- as required by law.

In addition, once GM collects or receives data, GM may:

- use the data for GM research needs,
- make it available for research where appropriate confidentiality is to be maintained and need is shown, or
- share summary data which is not tied to a specific vehicle with non-GM organizations for research purposes.

Others, such as law enforcement, may have access to the special equipment that can read the information if they have access to the vehicle or the device that stores the data.

If your vehicle is equipped with OnStar[®], please check the OnStar[®] subscription service agreement or manual for information on its operations and data collection.

Reporting Safety Defects

Reporting Safety Defects to the United States Government

If you believe that your vehicle has a defect which could cause a crash or could cause injury or death, you should immediately inform the National Highway Traffic Safety Administration (NHTSA), in addition to notifying General Motors.

If NHTSA receives similar complaints, it may open an investigation, and if it finds that a safety defect exists in a group of vehicles, it may order a recall and remedy campaign. However, NHTSA cannot become involved in individual problems between you, your dealer, or General Motors.

To contact NHTSA, you may either call the Auto Safety Hotline toll-free at 1-800-424-9393 (or 366-0123 in the Washington, D.C. area) or write to:

NHTSA, U.S. Department of Transportation
Washington, D.C. 20590

You can also obtain other information about motor vehicle safety from the hotline.

Reporting Safety Defects to the Canadian Government

If you live in Canada, and you believe that your vehicle has a safety defect, you should immediately notify Transport Canada, in addition to notifying General Motors of Canada Limited. You may write to:

Transport Canada
330 Sparks Street
Tower C
Ottawa, Ontario K1A 0N5

Reporting Safety Defects to General Motors

In addition to notifying NHTSA (or Transport Canada) in a situation like this, we certainly hope you will notify us. Please call us at 1-800-458-8006, or write:

Cadillac Customer Assistance Center
Cadillac Motor Car Division
P.O. Box 33169
Detroit, MI 48232-5169

In Canada, please call us at 1- 888- 446-2000.
Or, write:

Canadian Cadillac Customer Communication
Centre, 163-005
General Motors of Canada Limited
1908 Colonel Sam Drive
Oshawa, Ontario L1H 8P7

Service Publications Ordering Information

Service Manuals

Service Manuals have the diagnosis and repair information on engines, transmission, axle, suspension, brakes, electrical, steering, body, etc.

RETAIL SELL PRICE: \$120.00

Transmission, Transaxle, Transfer Case Unit Repair Manual

This manual provides information on unit repair service procedures, adjustments, and specifications for GM transmissions, transaxles, and transfer cases.

RETAIL SELL PRICE: \$50.00

Service Bulletins

Service Bulletins give technical service information needed to knowledgeably service General Motors cars and trucks. Each bulletin contains instructions to assist in the diagnosis and service of your vehicle.

In Canada, information pertaining to Product Service Bulletins can be obtained by contacting your General Motors dealer or by calling 1-800-GM-DRIVE (1-800-463-7483).

Owner's Information

Owner publications are written specifically for owners and intended to provide basic operational information about the vehicle. The owner's manual will include the Maintenance Schedule for all models.

In-Portfolio: Includes a Portfolio, Owner's Manual, and Warranty Booklet.

RETAIL SELL PRICE: \$35.00

Without Portfolio: Owner's Manual only.

RETAIL SELL PRICE: \$25.00

Current and Past Model Order Forms

Service Publications are available for current and past model GM vehicles. To request an order form, please specify year and model name of the vehicle.

ORDER TOLL FREE: 1-800-551-4123
Monday-Friday 8:00 AM - 6:00 PM
Eastern Time

For Credit Card Orders Only
(VISA-MasterCard-Discover), visit Helm, Inc. on the World Wide Web at: www.helminc.com

Or you can write to:

Helm, Incorporated
P. O. Box 07130
Detroit, MI 48207

Prices are subject to change without notice and without incurring obligation. Allow ample time for delivery.

Note to Canadian Customers: All listed prices are quoted in U.S. funds. Canadian residents are to make checks payable in U.S. funds.

 **NOTES**

A

Accessory Power Outlets	3-23	Anti-Lock Brake, System Warning Light	3-39
Additives, Fuel	5-6	Appearance Care	5-83
Add-On Electrical Equipment	5-92	Aluminum or Chrome-Plated Wheels	5-89
Adjustable Throttle and Brake Pedal	2-23	Care of Safety Belts	5-87
Air Cleaner/Filter, Engine	5-22	Chemical Paint Spotting	5-90
Air Conditioning	3-25	Cleaning Exterior Lamps/Lenses	5-88
Airbag		Fabric/Carpet	5-84
Readiness Light	3-37	Finish Care	5-88
Airbag Sensing and Diagnostic Module (SDM)	7-10	Finish Damage	5-90
Airbag System	1-47	Glass Surfaces	5-87
How Does an Airbag Restrain?	1-55	Instrument Panel	5-86
Servicing Your Airbag-Equipped Vehicle	1-58	Interior Plastic Components	5-86
What Makes an Airbag Inflate?	1-55	Leather	5-86
What Will You See After an		Sheet Metal Damage	5-90
Airbag Inflates?	1-56	Speaker Covers	5-86
When Should an Airbag Inflate?	1-54	Tires	5-90
Where Are the Airbags?	1-50	Underbody Maintenance	5-90
All-Wheel Drive	5-46	Vehicle Care/Appearance Materials	5-91
All-Wheel Drive (AWD) System	2-28	Vinyl	5-86
Antenna, Diversity Antenna System	3-114	Washing Your Vehicle	5-87
Antenna, XM™ Satellite Radio		Weatherstrips	5-87
Antenna System	3-114	Windshield and Wiper Blades	5-88
Anti-Lock Brake System (ABS)	4-7	Wood Panels	5-86
		Ashtrays	3-24
		Assist Handles	2-47

Audio System(s)	3-80
Audio Steering Wheel Controls	3-111
Care of Your CD and DVD Player	3-113
Care of Your CDs and DVDs	3-113
Diversity Antenna System	3-114
Navigation/Radio System	3-111
Radio with CD	3-81
Setting the Time	3-80
Theft-Deterrent Feature	3-111
Understanding Radio Reception	3-113
XM™ Satellite Radio Antenna System	3-114
Automatic Transmission	
Fluid	5-23
Operation	2-25

B

Battery	5-40
Exterior Lighting Battery Saver	3-19
Before Leaving on a Long Trip	4-37
Brake	
Anti-Lock Brake System (ABS)	4-7
Emergencies	4-8
Panic Assist	4-11
Parking	2-28
System Warning Light	3-38

Brake Pedal, Throttle	2-23
Brakes	5-37
Braking	4-6
Braking in Emergencies	4-8
Break-In, New Vehicle	2-20
Bulb Replacement	5-50
High Intensity Discharge (HID) Lighting	5-50
Buying New Tires	5-64

C

California Fuel	5-6
Canadian Owners	ii
Capacities and Specifications	5-102
Carbon Monoxide	2-12, 2-33, 4-40, 4-52
Care of	
Safety Belts	5-87
Your CD and DVD Player	3-113
Your CDs and DVDs	3-113
Cargo Cover	2-49
Cargo Management System	2-49
Cell Phone Storage Area	2-47
Center Console Storage Area	2-47
Chains, Tire	5-68
Charging System Light	3-38

Check		Cleaning (cont.)	
Engine Light	3-42	Instrument Panel	5-86
Checking Things Under the Hood	5-10	Interior Plastic Components	5-86
Chemical Paint Spotting	5-90	Leather	5-86
Child Restraints		Speaker Covers	5-86
Child Restraint Systems	1-34	Tires	5-90
Infants and Young Children	1-31	Underbody Maintenance	5-90
Lower Anchorages and Top Tethers for		Vinyl	5-86
Children (LATCH System)	1-40	Washing Your Vehicle	5-87
Older Children	1-28	Weatherstrips	5-87
Securing a Child Restraint Designed for		Windshield and Wiper Blades	5-88
the LATCH System	1-42	Wood Panels	5-86
Securing a Child Restraint in a		Climate Control System	
Rear Seat Position	1-42	Air Filter, Passenger Compartment	3-32
Securing a Child Restraint in the		Dual	3-25
Right Front Seat Position	1-45	Outlet Adjustment	3-30
Top Strap	1-38	Rear Air Conditioning System	3-31
Top Strap Anchor Location	1-39	Comfort Guides, Rear Safety Belt	1-25
Where to Put the Restraint	1-37	Compact Spare Tire	5-82
Cigarette Lighter	3-24	Control of a Vehicle	4-6
Cleaning		Convenience Net	2-49
Aluminum or Chrome-Plated Wheels	5-89	Coolant	
Exterior Lamps/Lenses	5-88	Engine Temperature Gage	3-41
Fabric/Carpet	5-84	Engine Temperature Warning Light	3-40
Finish Care	5-88	Heater, Engine	2-24
Glass Surfaces	5-87	Surge Tank Pressure Cap	5-27

Cooling System	5-30
Cruise Control Lever	3-12
Cruise Control Light	3-46
Cupholder(s)	2-47
Customer Assistance Information	
Courtesy Transportation	7-8
Customer Assistance for Text Telephone (TTY) Users	7-4
Customer Assistance Offices	7-4
Customer Satisfaction Procedure	7-2
GM Mobility Program for Persons with Disabilities	7-6
Reporting Safety Defects to General Motors	7-12
Reporting Safety Defects to the Canadian Government	7-12
Reporting Safety Defects to the United States Government	7-11
Roadside Service	7-6
Service Publications Ordering Information	7-12

D

Daytime Running Lamps	3-17
Defensive Driving	4-2
Delayed Locking	2-9
Diversity Antenna System	3-114

Doing Your Own Service Work	5-4
Door	
Central Door Unlocking System	2-9
Delayed Locking	2-9
Locks	2-8
Power Door Locks	2-9
Programmable Automatic Door Locks	2-10
Rear Door Security Locks	2-10
Driver	
Position, Safety Belt	1-15
Driver Information Center (DIC)	3-48
DIC Main Menu	3-53
DIC Vehicle Personalization	3-66
DIC Warnings and Messages	3-57
Status of Vehicle Systems	3-49
System Controls	3-48
Driving	
At Night	4-30
City	4-35
Defensive	4-2
Drunken	4-3
Freeway	4-36
Hill and Mountain Roads	4-38
In Rain and on Wet Roads	4-32
Recovery Hook	4-45
Rocking Your Vehicle to Get it Out	4-44
Winter	4-40

Dual Climate Control System	3-25
DVD	
Rear Seat Entertainment System	3-98

E

Electrical System	
Add-On Equipment	5-92
Fuses and Circuit Breakers	5-93
Power Windows and Other	
Power Options	5-93
Rear Underseat Fuse Block	5-98, 5-100
Underhood Fuse Block	5-94
Windshield Wiper Fuses	5-93
Engine	
Air Cleaner/Filter	5-22
Battery	5-40
Check and Service Engine Soon Light	3-42
Coolant	5-24
Coolant Heater	2-24
Coolant Temperature Gage	3-41
Coolant Temperature Warning Light	3-40
Engine Compartment Overview	5-12
Exhaust	2-33
Oil	5-16
Overheated Protection Operating Mode	5-29

Engine (cont.)	
Overheating	5-27
Speed Limiter	3-36
Starting	2-23
Entry Lighting	3-19
Event Data Recorders (EDR)	7-10
Extender, Safety Belt	1-27
Exterior Lighting Battery Saver	3-19

F

Filter	
Engine Air Cleaner	5-22
Finish Damage	5-90
Flash-to-Pass	3-9
Flat Tire	5-69
Flat Tire, Changing	5-70
Flat Tire, Storing	5-79
Fluid	
Automatic Transmission	5-23
Power Steering	5-35
Windshield Washer	5-36
Fog Lamp Light	3-46
Fog Lamps	3-18
Front Axle	5-49
Front Storage Area	2-47

Fuel	5-5
Additives	5-6
California Fuel	5-6
Filling a Portable Fuel Container	5-10
Filling Your Tank	5-8
Fuels in Foreign Countries	5-7
Gage	3-47
Gasoline Octane	5-5
Gasoline Specifications	5-6
Fuses	
Fuses and Circuit Breakers	5-93
Rear Underseat Fuse Block	5-98, 5-100
Underhood Fuse Block	5-94
Windshield Wiper	5-93

G

Gage	
Engine Coolant Temperature	3-41
Fuel	3-47
Speedometer	3-35
Tachometer	3-36
Garage Door Opener	2-42
Gasoline	
Octane	5-5
Specifications	5-6

Glove Box	2-47
GM Mobility Program for Persons with Disabilities	7-6

H

Hazard Warning Flashers	3-6
Head Restraints	1-7
Headlamps	3-16
Bulb Replacement	5-50
Daytime Running Lamps	3-17
Flash-to-Pass	3-9
High Intensity Discharge (HID) Lighting	5-50
High/Low Beam Changer	3-9
On Reminder	3-16
Washer	3-12
Wiper Activated	3-16
Heated Seats	1-4
Heater	3-25
Highbeam On Light	3-47
Highway Hypnosis	4-38
Hill and Mountain Roads	4-38
HomeLink [®] Transmitter	2-42
HomeLink [®] Transmitter, Programming	2-43
Hood	
Checking Things Under	5-10
Release	5-11

Horn	3-6
How to Use This Manual	ii
How to Wear Safety Belts Properly	1-15

I

Ignition Positions	2-21
Immobilizer	2-18
Immobilizer Operation	2-19
Infants and Young Children, Restraints	1-31
Inflation -- Tire Pressure	5-58
Instrument Panel	
Brightness	3-19
Cluster	3-34
Overview	3-4

J

Jump Starting	5-41
---------------------	------

K

Keyless Entry System	2-5
Keys	2-3

L

Labelling, Tire Sidewall	5-53
Lamps	
Exterior Lighting Battery Saver	3-19
Fog	3-18
Reading	3-20
LATCH System	
Child Restraints	1-40
Securing a Child Restraint Designed for the LATCH System	1-42
Level Control	4-52
Liftgate	2-12
Light	
Airbag Readiness	3-37
Anti-Lock Brake System Warning	3-39
Brake System Warning	3-38
Charging System	3-38
Cruise Control	3-46
Engine Coolant Temperature Warning	3-40
Fog Lamp	3-46
Highbeam On	3-47
Lights On Reminder	3-46
Malfunction Indicator	3-42
Oil Pressure	3-45

Light (cont.)	
Safety Belt Reminder	3-36
Security	3-46
Sport Mode	3-45
TCS Warning Light	3-40
Tire Pressure	3-41
Traction Control System (TCS) Warning	3-40
Lighting	
Entry	3-19
Parade Dimming	3-20
Lockout Protection	2-11
Locks	
Central Door Unlocking System	2-9
Delayed Locking	2-9
Door	2-8
Lockout Protection	2-11
Power Door	2-9
Programmable Automatic Door Locks	2-10
Rear Door Security Locks	2-10
Loss of Control	4-16
Luggage Carrier	2-48
Lumbar	
Power Controls	1-3

M

Magnetic Ride Control	4-10
Maintenance Schedule	
Additional Required Services	6-6
At Each Fuel Fill	6-8
At Least Once a Month	6-9
At Least Once a Year	6-9
Introduction	6-2
Maintenance Footnotes	6-7
Maintenance Record	6-14
Maintenance Requirements	6-2
Normal Maintenance Replacement Parts	6-13
Owner Checks and Services	6-8
Recommended Fluids and Lubricants	6-11
Scheduled Maintenance	6-4
Using Your	6-2
Your Vehicle and the Environment	6-2
Malfunction Indicator Light	3-42
Manual Passenger Seat	1-2
Map Pocket	2-47
Memory Mirrors	2-53
Memory Seat	2-53
Message	
DIC Warnings and Messages	3-57

Mirrors	
Automatic Dimming Rearview with OnStar®	2-35
Automatic Dimming Rearview with OnStar® and Compass	2-35
Memory	2-53
Outside Automatic Dimming Mirror	2-39
Outside Convex Mirror	2-39
Outside Curb View Assist Mirror	2-39
Outside Power Heated Mirrors	2-38
MyGMLink.com	7-4

N

Navigation/Radio System	3-111
New Vehicle Break-In	2-20
Normal Maintenance Replacement Parts	6-13

O

Odometer	3-35
Odometers, Trip	3-35
Off-Road Recovery	4-14
Oil	
Engine	5-16
Pressure Light	3-45
Older Children, Restraints	1-28

Online Owner Center	7-4
OnStar® System	2-40
Operating Your All-Wheel-Drive Vehicle Off Paved Roads	4-17
Other Warning Devices	3-6
Outlet Adjustment	3-30
Outside	
Automatic Dimming Mirror	2-39
Convex Mirror	2-39
Curb View Assist Mirror	2-39
Power Heated Mirrors	2-38
Overheated Engine Protection Operating Mode	5-29
Owner Checks and Services	6-8
Owners, Canadian	ii

P

Panic Brake Assist	4-11
Parade Dimming	3-20
Park Aid	3-20
Park (P)	
Shifting Into	2-30
Shifting Out of	2-32
Parking	
Assist	3-20
Brake	2-28
Over Things That Burn	2-33

Passenger Compartment Air Filter	3-32
Passing	4-14
Power	
Accessory Outlets	3-23
Door Locks	2-9
Electrical System	5-93
Lumbar Controls	1-3
Retained Accessory (RAP)	2-22
Seat	1-2
Steering Fluid	5-35
Windows	2-14
Pretensioners, Safety Belt	1-27
Programmable Automatic Door Locks	2-10
Programming the HomeLink® Transmitter	2-43

Q

Questions and Answers About Safety Belts	1-14
--	------

R

Radios	3-80
Care of Your CD and DVD Player	3-113
Care of Your CDs and DVDs	3-113
Navigation/Radio System	3-111

Radios (cont.)	
Radio with CD	3-81
Setting the Time	3-80
Theft-Deterrent	3-111
Understanding Reception	3-113
Reading Lamps	3-20
Rear Air Conditioning System	3-31
Rear Axle	5-48
Rear Door Security Locks	2-10
Rear Safety Belt Comfort Guides	1-25
Rear Seat Entertainment System	3-98
Rear Seat Operation	1-8
Rear Seat Passengers, Safety Belts	1-22
Rearview Mirror, Automatic Dimming with OnStar®	2-35
Rearview Mirror, Automatic Dimming with OnStar® and Compass	2-35
Reclining Seatbacks	1-5
Recommended Fluids and Lubricants	6-11
Recovery Hook	4-45
Recreational Vehicle Towing	4-50
Remote Keyless Entry System	2-5
Remote Keyless Entry System, Operation	2-6
Removing the Flat Tire and Installing the Spare Tire	5-73
Removing the Spare Tire and Tools	5-71

Reporting Safety Defects	
Canadian Government	7-12
General Motors	7-12
United States Government	7-11
Restraint System Check	
Checking Your Restraint Systems	1-58
Replacing Restraint System Parts	
After a Crash	1-59
Restraint Systems	
Checking	1-58
Replacing Parts	1-59
Retained Accessory Power (RAP)	2-22
Right Front Passenger Position,	
Safety Belts	1-22
Roadside	
Service	7-6
Rocking Your Vehicle to Get it Out	4-44
Running Your Engine While You Are Parked	2-34

S

Safety Belt	
Pretensioners	1-27
Reminder Light	3-36
Safety Belts	
Care of	5-87
Driver Position	1-15

Safety Belts (cont.)	
How to Wear Safety Belts Properly	1-15
Questions and Answers About	
Safety Belts	1-14
Rear Safety Belt Comfort Guides for	
Children and Small Adults	1-25
Rear Seat Passengers	1-22
Right Front Passenger Position	1-22
Safety Belt Extender	1-27
Safety Belt Use During Pregnancy	1-21
Safety Belts Are for Everyone	1-10
Safety Warnings and Symbols	iii
Scheduled Maintenance	6-4
Seats	
Head Restraints	1-7
Heated Seats	1-4
Manual Passenger	1-2
Memory	2-53
Power Lumbar	1-3
Power Seats	1-2
Rear Seat Operation	1-8
Reclining Seatbacks	1-5
Stowable Seat	1-8
Secondary Latch System	5-77
Securing a Child Restraint	
Designed for the LATCH System	1-42
Rear Seat Position	1-42
Right Front Seat Position	1-45

Security Light	3-46
Service	5-3
Adding Equipment to the Outside of Your Vehicle	5-5
Doing Your Own Work	5-4
Engine Soon Light	3-42
Publications Ordering Information	7-12
Servicing Your Airbag-Equipped Vehicle	1-58
Setting the Time	3-80
Sheet Metal Damage	5-90
Shifting Into Park (P)	2-30
Shifting Out of Park (P)	2-32
Signals, Turn and Lane-Change	3-8
Spare Tire	
Installing	5-73
Removing	5-71
Storing	5-79
Specifications, Capacities	5-102
Speedometer	3-35
Sport Mode Light	3-45
Stabilitrak® System	4-10
Starting Your Engine	2-23
Status of Vehicle Systems, DIC	3-49
Steering	4-12
Steering Wheel Controls, Audio	3-111
Steering Wheel, Tilt Wheel	3-6

Storage Areas	
Cargo Management System	2-49
Cell Phone Storage Area	2-47
Center Console Storage Area	2-47
Convenience Net	2-49
Cupholder(s)	2-47
Front Storage Area	2-47
Glove Box	2-47
Luggage Carrier	2-48
Map Pocket	2-47
Stowable Seat	1-8
Stuck in Sand, Mud, Ice or Snow	4-44
Sun Visors	2-16
Sunroof	2-50, 2-51
System Controls, DIC	3-48

T

Tachometer	3-36
TCS Warning Light	3-40
Theft-Deterrent, Radio	3-111
Theft-Deterrent System	2-17
Theft-Deterrent Systems	2-17
Immobilizer	2-18
Immobilizer Operation	2-19
Throttle, Adjustable	2-23

Tilt Wheel	3-6	Top Strap	1-38
Tire		Top Strap Anchor Location	1-39
Pressure Light	3-41	Towing	
Tires	5-52	Recreational Vehicle	4-50
Aluminum or Chrome-Plated Wheels,		Towing a Trailer	4-52
Cleaning	5-89	Your Vehicle	4-50
Buying New Tires	5-64	Traction	
Chains	5-68	Control System (TCS)	4-9
Changing a Flat Tire	5-70	Control System Warning Light	3-40
Cleaning	5-90	Magnetic Ride Control	4-10
Compact Spare Tire	5-82	Stabilitrak® System	4-10
If a Tire Goes Flat	5-69	Transmission	
Inflation -- Tire Pressure	5-58	Fluid, Automatic	5-23
Inspection and Rotation	5-63	Transmission Operation, Automatic	2-25
Installing the Spare Tire	5-73	Trip Odometers	3-35
Pressure Monitor System	5-61	Turn and Lane-Change Signals	3-8
Removing the Flat Tire	5-73	Turn Signal/Multifunction Lever	3-7
Removing the Spare Tire and Tools	5-71		
Secondary Latch System	5-77		
Storing a Flat or Spare Tire and Tools	5-79		
Tire Sidewall Labelling	5-53		
Tire Terminology and Definitions	5-56		
Uniform Tire Quality Grading	5-66		
Wheel Alignment and Tire Balance	5-67		
Wheel Replacement	5-67		
When It Is Time for New Tires	5-64		

U

Ultrasonic Rear Parking Assist (URPA)	3-20
Understanding Radio Reception	3-113
Uniform Tire Quality Grading	5-66

V

Vehicle	
Control	4-6
Damage Warnings	iv
Symbols	iv
Vehicle Data Collection and Event	
Data Recorders	7-10
Vehicle Identification	
Number (VIN)	5-92
Service Parts Identification Label	5-92
Vehicle Personalization	
DIC	3-66
Memory Seat and Mirrors	2-53
Ventilation Adjustment	3-30
Visors	2-16

W

Warning Lights, Gages and Indicators	3-33
Warnings	
DIC Warnings and Messages	3-57
Hazard Warning Flashers	3-6
Other Warning Devices	3-6
Safety and Symbols	iii
Vehicle Damage	iv

Wheels	
Alignment and Tire Balance	5-67
Replacement	5-67
Where to Put the Restraint	1-37
Windows	2-13
Power	2-14
Windshield	
Wiper Blades, Cleaning	5-88
Windshield Washer	3-11
Fluid	5-36
Windshield Wiper	
Blade Replacement	5-50
Fuses	5-93
Windshield Wipers	3-10
Winter Driving	4-40
Wiper Activated Headlamps	3-16

X

XM™ Satellite Radio Antenna System	3-114
--	-------

Y

Your Vehicle and the Environment	6-2
--	-----