

2015

Cadillac

ELR

cadillac.com (U.S.)
cadillac.gm.ca (Canada)



2015 Cadillac ELR Owner Manual

In Brief	1-1	Storage	4-1	Driving and Operating	9-1
Instrument Panel	1-2	Storage Compartments	4-1	Driving Information	9-2
Initial Drive Information	1-4	Instruments and Controls	5-1	Starting and Operating	9-16
Vehicle Features	1-16	Controls	5-2	Electric Vehicle Operating	
Battery and Efficiency	1-20	Warning Lights, Gauges, and		Modes	9-21
Performance and		Indicators	5-7	Engine Exhaust	9-27
Maintenance	1-25	Information Displays	5-27	Electric Drive Unit	9-28
Keys, Doors, and		Vehicle Messages	5-41	Brakes	9-29
Windows	2-1	Vehicle Personalization	5-52	Ride Control Systems	9-33
Keys and Locks	2-1	Universal Remote System	5-59	Cruise Control	9-37
Doors	2-13	Lighting	6-1	Driver Assistance Systems	9-47
Vehicle Security	2-15	Exterior Lighting	6-1	Charging	9-58
Exterior Mirrors	2-17	Interior Lighting	6-6	Fuel	9-67
Interior Mirrors	2-18	Lighting Features	6-8	Trailer Towing	9-71
Windows	2-19	Infotainment System	7-1	Conversions and Add-Ons	9-71
Seats and Restraints	3-1	Introduction	7-1	Vehicle Care	10-1
Head Restraints	3-2	Climate Controls	8-1	General Information	10-2
Front Seats	3-3	Climate Control Systems	8-1	Vehicle Checks	10-5
Rear Seats	3-10	Air Vents	8-7	Headlamp Aiming	10-27
Safety Belts	3-11	Maintenance	8-8	Bulb Replacement	10-27
Airbag System	3-19			Electrical System	10-28
Child Restraints	3-32			Wheels and Tires	10-41

2015 Cadillac ELR Owner Manual

Jump Starting	10-69	OnStar	14-1
Towing the Vehicle	10-75	OnStar Overview	14-1
Appearance Care	10-79	OnStar Services	14-2
Service and Maintenance ...	11-1	OnStar Additional Information	14-6
General Information	11-1	Index	i-1
Maintenance Schedule	11-2		
Special Application Services	11-8		
Additional Maintenance and Care	11-9		
Recommended Fluids, Lubricants, and Parts	11-12		
Maintenance Records	11-14		
Technical Data	12-1		
Vehicle Identification	12-1		
Vehicle Data	12-2		
Customer Information	13-1		
Customer Information	13-1		
Reporting Safety Defects	13-13		
Vehicle Data Recording and Privacy	13-14		

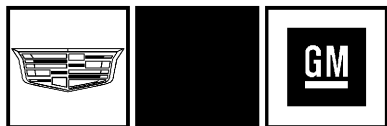

The names, logos, emblems, slogans, vehicle model names, and vehicle body designs appearing in this manual including, but not limited to, GM, the GM logo, CADILLAC, the CADILLAC Emblem, and ELR are trademarks and/or service marks of General Motors LLC, its subsidiaries, affiliates, or licensors.

For vehicles first sold in Canada, substitute the name "General Motors of Canada Limited" for Cadillac Motor Car Division wherever it appears in this manual.

This manual describes features that may or may not be on the vehicle because of optional equipment that was not purchased on the vehicle, model variants, country specifications, features/applications that may not be available in your region, or changes subsequent to the printing of this owner manual.

Refer to the purchase documentation relating to your specific vehicle to confirm the features.

Keep this manual in the vehicle for quick reference.

Canadian Vehicle Owners

Propriétaires Canadiens

A French language manual can be obtained from your dealer, at www.helminc.com, or from:

On peut obtenir un exemplaire de ce guide en français auprès du concessionnaire ou à l'adresse suivante:

Helm, Incorporated
Attention: Customer Service
47911 Halyard Drive
Plymouth, MI 48170

Using this Manual

To quickly locate information about the vehicle, use the Index in the back of the manual. It is an alphabetical list of what is in the manual and the page number where it can be found.

Danger, Warnings, and Cautions

Warning messages found on vehicle labels and in this manual describe hazards and what to do to avoid or reduce them.

Danger

Danger indicates a hazard with a high level of risk which will result in serious injury or death.

Warning

Warning indicates a hazard that could result in injury or death.

Caution

Caution indicates a hazard that could result in property or vehicle damage.



A circle with a slash through it is a safety symbol which means “Do Not,” “Do not do this,” or “Do not let this happen.”

Symbols

The vehicle has components and labels that use symbols instead of text. Symbols are shown along with the text describing the operation or information relating to a specific component, control, message, gauge, or indicator.

 : This symbol is shown when you need to see your owner manual for additional instructions or information.

 : This symbol is shown when you need to see a service manual for additional instructions or information.

Vehicle Symbol Chart

Here are some additional symbols that may be found on the vehicle and what they mean. For more information on the symbol, refer to the Index.

 : Airbag Readiness Light

 : Air Conditioning

 : Antilock Brake System (ABS)

 : Audio Steering Wheel Controls or OnStar®

BRAKE : Brake System Warning Light

 : Charging System (12-Volt Battery)

 : Cruise Control

 : Electric Parking Brake

 : Electronic Stability Control (ESC)

 : Engine Coolant Temperature

 : Exterior Lamps

 : Fault

 : First Responder

 : Fuel Gauge

 : Fuses

 : Headlamp High/Low-Beam Changer

 : Heated Steering Wheel

 : High Voltage

 : LATCH System Child Restraints

 : Malfunction Indicator Lamp

 : Oil Pressure

 : Power

 : Remote Vehicle Start

 : Safety Belt Reminders

 : StabiliTrak® Disable

 : Tire Pressure Monitor

 : Traction Control System (TCS) Disable

 : Vehicle Ready

 : Windshield Washer Fluid

In Brief

Instrument Panel

Instrument Panel Overview 1-2

Initial Drive Information

Initial Drive Information 1-4

Remote Keyless Entry (RKE)
System 1-4

Remote Start 1-5

Door Locks 1-5

Trunk Release 1-6

Windows 1-7

Seat Adjustment 1-7

Memory Features 1-9

Heated Seats 1-9

Head Restraint

Adjustment 1-10

Safety Belts 1-10

Passenger Sensing

System 1-11

Mirror Adjustment 1-11

Steering Wheel

Adjustment 1-12

Interior Lighting 1-12

Exterior Lighting 1-13

Windshield Wiper/Washer 1-14

Climate Controls 1-15

Vehicle Features

Infotainment System 1-16

Steering Wheel Controls 1-16

Cruise Control 1-16

Driver Information

Center (DIC) 1-17

Forward Collision Alert (FCA)

System 1-17

Lane Departure

Warning (LDW) 1-17

Side Blind Zone

Alert (SBZA) 1-18

Rear Vision

Camera (RVC) 1-18

Rear Cross Traffic Alert

(RCTA) System 1-18

Parking Assist 1-18

Rear Automatic Braking (RAB)
System 1-18

Active Emergency Braking
System 1-19

Power Outlets 1-19

Universal Remote System ... 1-19

Battery and Efficiency

High Voltage Safety
Information 1-20

Charging 1-21

Fueling 1-24

Regenerative Braking 1-24

Service 1-25

Performance and Maintenance

Traction Control/Electronic
Stability Control 1-25

Tire Pressure Monitor 1-25

Engine Oil Life System 1-26

Driving for Better Energy
Efficiency 1-26

Roadside Service 1-28

OnStar® 1-28

Instrument Panel

Instrument Panel Overview

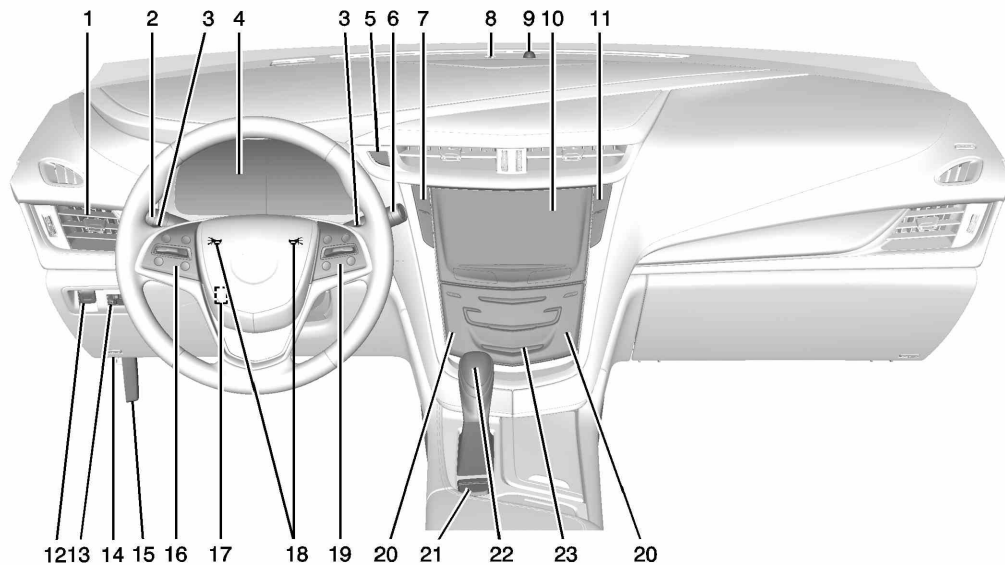

1. *Air Vents on page 8-7.*
2. *Exterior Lamp Controls on page 6-1.*
Turn Signal Lever. See Turn and Lane-Change Signals on page 6-5.
3. *Regen on Demand Paddles. See Regenerative Braking on page 9-32.*
4. *Instrument Cluster on page 5-8.*
Driver Information Center (DIC) Display. See Driver Information Center (DIC) on page 5-38.
5. *Power Button on page 9-16.*
6. *Windshield Wiper/Washer on page 5-3.*
7. *Hazard Warning Flashers on page 6-5.*
Lane Departure Warning (LDW) on page 9-56.
8. *Charging Status Indicator (CSI). See Charging Status Feedback on page 9-60.*
9. *Light Sensor. See Automatic Headlamp System on page 6-4.*
10. *Infotainment on page 7-1.*
11. *Glove Box Button. See Glove Box on page 4-1.*
Parking Assist Button. See Driver Assistance Systems on page 9-47.
12. *Electric Parking Brake on page 9-30.*
13. *Instrument Panel Illumination Control on page 6-6.*
14. *Data Link Connector (DLC) (Out of View). See Malfunction Indicator Lamp on page 5-17.*
15. *Hood Release. See Hood on page 10-6.*
16. *Cruise Control on page 9-37.*
Adaptive Cruise Control on page 9-39 (If Equipped).
Forward Collision Alert (FCA) System on page 9-50 (If Equipped).
17. *Steering Wheel Adjustment on page 5-2.*
18. *Horn on page 5-3.*
19. *Steering Wheel Controls on page 5-2.*
Driver Information Center (DIC) Controls. See Driver Information Center (DIC) on page 5-38.
20. *Heated Front Seats on page 3-8 (If Equipped).*
21. *Traction Control/Electronic Stability Control on page 9-33.*
MODE Button. See Driver Mode Control on page 9-35 (If Equipped).
22. *Shift Lever. See Electric Drive Unit on page 9-28.*
23. *Dual Automatic Climate Control System on page 8-1.*
Heated Steering Wheel on page 5-2.

Initial Drive Information

This section provides a brief overview about some of the important features that may or may not be on your specific vehicle.

For more detailed information, refer to each of the features which can be found later in this owner manual.

Remote Keyless Entry (RKE) System

The Keyless Access system allows for vehicle entry when the transmitter is within range. See *Remote Keyless Entry (RKE) System Operation* on page 2-2

The RKE transmitter may work up to 60 m (197 ft) away from the vehicle.

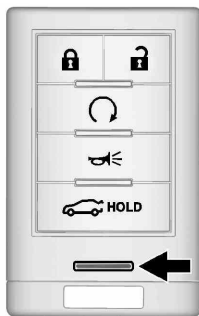





Press the key release button to extend the key. The key can be used for the trunk.

 : Press once to unlock the driver door. Press a second time within five seconds to unlock all doors.

 : Press to lock all doors.

Lock and unlock feedback can be personalized. See *Vehicle Personalization* on page 5-52.

 : Press and release  and then immediately press and hold  for at least four seconds to start the vehicle's heating or air conditioning systems and rear window defogger from outside the vehicle using the RKE transmitter. See *Remote Start* on page 2-8.

 : Press and release to initiate vehicle locator. Press and hold for three seconds to sound the panic alarm. Press again to cancel the panic alarm.



 HOLD : Press and hold to release the trunk.

See *Keys* on page 2-1 and *Remote Keyless Entry (RKE) System Operation* on page 2-2.

Remote Start

Use remote start to heat or cool the interior when the vehicle is plugged in to maximize electric range by utilizing electricity from the electrical outlet. Normal operation of the system will return after the vehicle has been turned on.



Activating Remote Start

1. Aim the transmitter at the vehicle.
2. Press and release  on the RKE transmitter; the doors will lock.
3. Immediately press and hold  until the turn signal lamps flash, or for at least four seconds. Pressing  again during a remote start will turn the feature off.

After entering the vehicle during a remote start, press the POWER  button on the center stack with the brake pedal applied to operate as normal.



Canceling Remote Start

To cancel a remote start, do any of the following:

- Press and hold  until the parking lamps turn off.
- Turn on the hazard warning flashers.
- Press the POWER  button on the center stack, with the brake pedal applied, then press the POWER  button again to turn the vehicle off.

See *Remote Start* on page 2-8.

Door Locks

To lock or unlock the doors from the outside, press  or  on the RKE transmitter. See *Remote Keyless Entry (RKE) System Operation* on page 2-2.

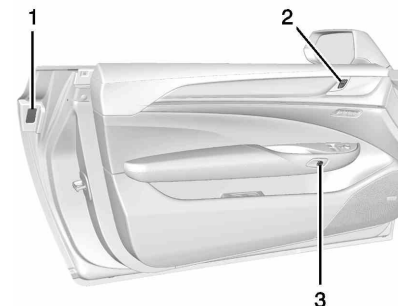

For Keyless Access, the RKE transmitter must be within 1 m (3 ft) of the door handle sensor (1). Grip and press to open.

1-6 In Brief

To lock or unlock the door from the inside, press the power door lock switch (2).

To open the door press the door latch button (3). If the vehicle is stationary, the door latch button unlatches an unlocked door.



See *Door Locks* on page 2-10.

If the vehicle has lost battery power, the doors can be opened manually. See *Power Door Locks* on page 2-11.

Trunk Release



To open the trunk the vehicle must be off or the shift lever must be in P (Park).

- Press  on the driver door.
- Press and hold  HOLD on the Remote Keyless Entry (RKE) transmitter.

- Press the touch pad on the rear of the trunk above the license plate when all doors are unlocked.

For Keyless Access, the trunk can be opened while the vehicle is locked by pressing the touch pad above the license plate when the RKE transmitter is within 1 m (3 ft) of the rear of the vehicle. See *Remote Keyless Entry (RKE) System Operation* on page 2-2.

Close the trunk by pulling on the handle. Do not use the handle as a tie-down. See *Trunk* on page 2-13.

Windows

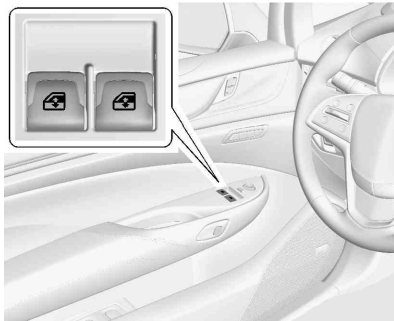

The driver power window switches control all the windows. The passenger switch only controls that window.

Press the switch to lower the window. Pull the switch to raise it. See *Power Windows* on page 2-19.

Seat Adjustment

Power Seats

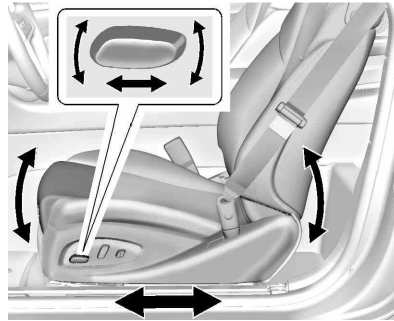

To adjust the seat:

- Move the seat forward or rearward by sliding the control forward or rearward.
- Raise or lower the front part of the seat cushion by moving the front of the control up or down.
- Raise or lower the seat by moving the rear of the control up or down.

See *Power Seat Adjustment* on page 3-4.

Lumbar Adjustment

Lumbar Support

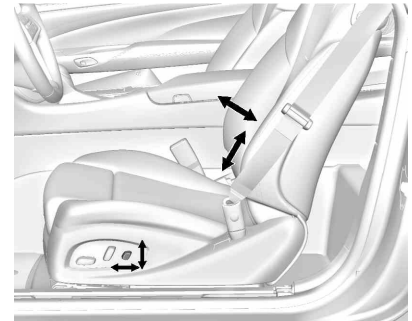

To adjust the lumbar support:

- Press and hold the control forward to increase or rearward to decrease lumbar support.
- Press and hold the control up to raise or down to lower the height of the lumbar support.

Seatback Bolster Support

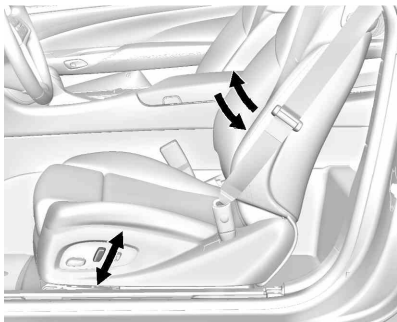

If equipped, to adjust the bolster support:

- Press and hold the control up to increase seatback bolster support.
- Press and hold the control down to decrease seatback bolster support.

See *Lumbar Adjustment* on page 3-4.

Reclining Seatbacks

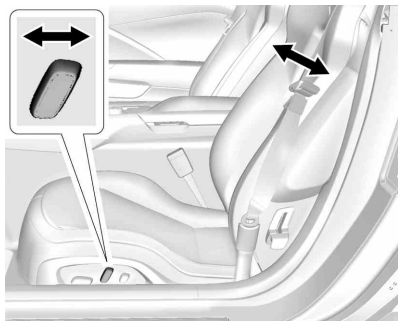

To adjust the seatback:

- Tilt the top of the control rearward to recline.
- Tilt the top of the control forward to raise.

See *Reclining Seatbacks* on page 3-5.

Easy Entry Seat

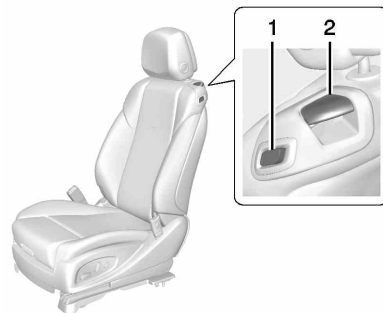

1. Seat Adjustment Switch
2. Folding Seatback Handle

The front seats can be moved out of the way to make it easier to get in and out of the rear seat.

To fold the seatback, lift the handle (2) on top of the seatback. The seatback will fold forward.

To move the seat forward, press and hold the front of the switch (1) on the outboard side of the upper

seatback. To move the seat rearward, press and hold the rear of the switch (1).

See *Easy Entry Seat* on page 3-3.

Memory Features





The SET, "1," "2," and  (Exit) buttons on the driver door are used to manually save and recall memory settings for the driver seat, outside mirrors, and power tilt and telescoping steering column.

See *Memory Seats* on page 3-6 and *Vehicle Personalization* on page 5-52.

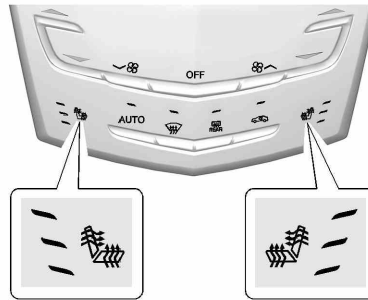
Heated Seats



The buttons are near the climate controls on the center stack. To operate, the ignition must be in ON/RUN/START.



Press  or  to heat the driver or passenger seat cushion and seatback.

Press the button once for the highest setting. With each press of the button, the seat will change to the next lower setting, and then to the off setting. The indicator lights next to the buttons indicate three for the highest setting and one for the lowest. If the heated seats are on high, the level may automatically be lowered after approximately 30 minutes.

See *Heated Front Seats* on page 3-8.

Auto Heated Seats

The controls can be accessed while the vehicle is on by pressing the CLIMATE button on the infotainment home screen.

Press the touch screen  AUTO or  AUTO button. The button color will change to green when this feature is on.

When the vehicle is on, this feature will automatically activate the heated seats at the level required by the vehicle's interior temperature.

The active high, medium, low, or off heated seat level will be indicated by the manual heated seat buttons on the center stack. Use the touch screen button or the manual heated seat buttons on the center stack to turn auto heated seats off.

If the passenger seat is unoccupied, the auto heated seats feature will not activate that seat.

The auto heated seats feature can be programmed to always be enabled when the vehicle is on. See *Vehicle Personalization on page 5-52* and *Climate Controls on page 1-15*.

Head Restraint Adjustment

Do not drive until the head restraints for all occupants are installed and adjusted properly.

To achieve a comfortable seating position, change the seatback recline angle as little as necessary while keeping the seat and the head restraint height in the proper position.

See *Head Restraints on page 3-2* and *Power Seat Adjustment on page 3-4*.

Safety Belts

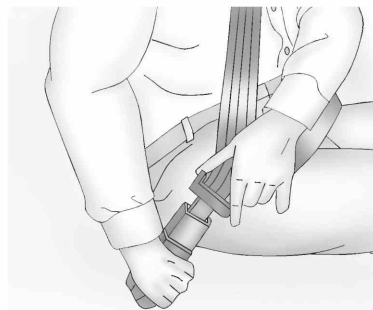

Refer to the following sections for important information on how to use safety belts properly:

- *Safety Belts on page 3-11.*
- *How to Wear Safety Belts Properly on page 3-13.*
- *Lap-Shoulder Belt on page 3-14.*
- *Lower Anchors and Tethers for Children (LATCH System) on page 3-40.*

Passenger Sensing System



United States



Canada

The passenger sensing system will turn off the front outboard passenger frontal airbag and knee airbag under certain conditions. No other airbag is affected by the passenger sensing system. See *Passenger Sensing System* on page 3-25.

The passenger airbag status indicator lights on the overhead console when the vehicle is started. See *Passenger Airbag Status Indicator* on page 5-16.

Mirror Adjustment

Exterior

Mirrors can be folded inward toward the vehicle to prevent damage when going through an automatic car wash. Push the mirror outward to return it to the original position.

See *Folding Mirrors* on page 2-18.

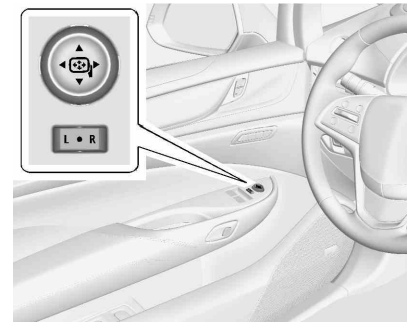

Controls for the outside power mirrors are on the driver door.

To adjust a mirror:

1. Move the selector switch to L (Left) or R (Right) to choose the driver or passenger mirror.
2. Press the arrows on the control pad to move each mirror in the desired direction.
3. Return the selector switch to the center position.

See *Power Mirrors* on page 2-17.

1-12 In Brief

The rear window defogger also heats the outside mirrors. See *Heated Mirrors on page 2-18*.

Interior

Adjust the rearview mirror for a clear view of the area behind the vehicle. The mirror will automatically reduce the glare of headlamps from behind. The dimming feature comes on when the vehicle is started. See *Automatic Dimming Rearview Mirror on page 2-18*.

Steering Wheel Adjustment

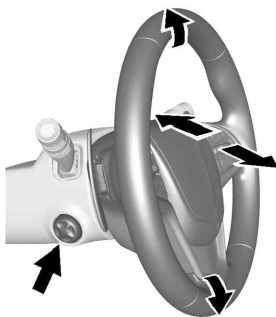

Press the control to move the tilt and telescoping steering wheel up and down or forward and rearward.

Do not adjust the steering wheel while driving.

To set the power tilt wheel memory position, see *Memory Seats on page 3-6*.

Interior Lighting

Dome Lamps

There are front and rear dome lamps in the overhead console and headliner.

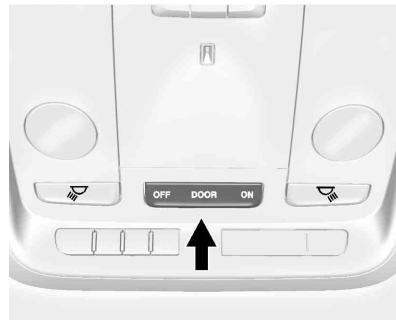

To change the dome lamp settings, press:

OFF: Turns the lamps off, even when a door is open.

DOOR: The lamps come on when a door is opened.

ON: Turns the lamps on.

Reading Lamps

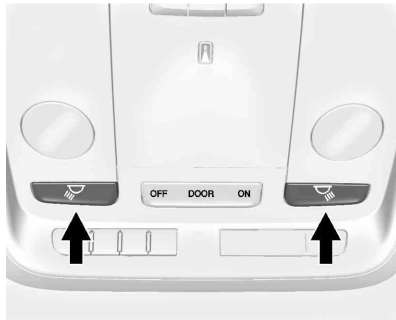

There are front and rear reading lamps on the overhead console and the headliner. These lamps come on when any door is opened. To manually turn the reading lamps on or off:

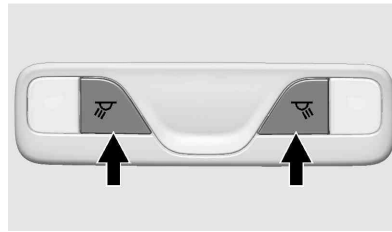

Front Reading Lamps



Rear Reading Lamps

Press  or  next to each reading lamp.



For more information on interior lighting, see *Instrument Panel Illumination Control* on page 6-6.

Exterior Lighting



The exterior lamp control is on the turn signal lever.

Turn the control to the following positions:

 : Turns off the exterior lamps. The knob returns to the AUTO position after it is released. Turn to  again to reactivate the AUTO mode. In Canada, the headlamps will automatically reactivate when the electric drive unit is shifted out of P (Park).

AUTO: Automatically turns the exterior lamps on and off, depending on outside lighting.

1-14 In Brief

 : Turns on the parking lamps including all lamps, except the headlamps.

 : Turns on the headlamps together with the parking lamps and instrument panel lights.

See *Exterior Lamp Controls* on page 6-1 and *Daytime Running Lamps (DRL)* on page 6-4.

Windshield Wiper/Washer





With the ignition in ACC/ACCESSORY or ON/RUN/START, move the lever to select the wiper speed.

HI: Use for fast wipes.

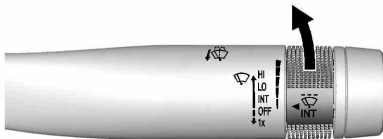
LO: Use for slow wipes.



INT: Move the windshield wiper lever to INT. Turn the  INT band up for more frequent wipes or down for less frequent wipes. If equipped with Rainsense, turn the  INT band to adjust the sensitivity. To turn the Rainsense feature on or off, see "Rain Sense Wipers" under *Vehicle Personalization* on page 5-52.

OFF: Use to turn the wipers off.

1X : For a single wipe, briefly move the lever down. For several wipes, hold the lever down.

↓  : Pull the lever toward you to spray windshield washer fluid and activate the wipers.

See *Windshield Wiper/Washer* on page 5-3.

Climate Controls

The climate control buttons and the touch screen are used to adjust the heating, cooling, and ventilation.

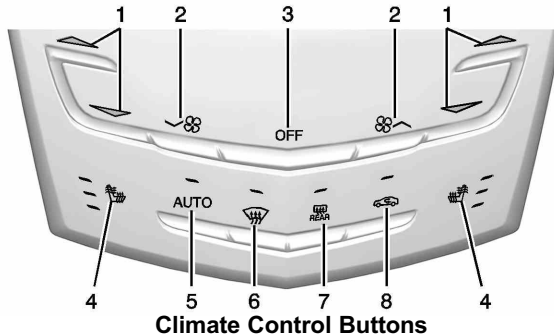

- | | |
|--|--|
| <ol style="list-style-type: none"> 1. Driver and Passenger Temperature Controls 2. Fan Control 3. OFF (Fan) 4. Driver and Passenger Heated Seats | <ol style="list-style-type: none"> 5. AUTO (Automatic Operation) 6. Defrost 7. Rear Window Defogger 8. Recirculation |
|--|--|

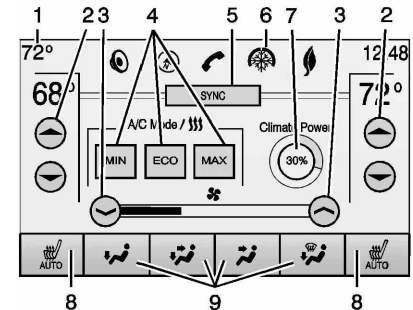

Climate Touch Screen Controls

1. Outside Air Temperature Display
2. Driver and Passenger Temperature Controls
3. Fan Control
4. Climate Modes: MIN, ECO, MAX
5. SYNC (Synchronized Temperature)
6. Climate Control Selection (Application Tray Button)

7. Climate Power Gauge
8. Driver and Passenger Auto Heated Seats
9. Air Delivery Mode Controls

See *Dual Automatic Climate Control System* on page 8-1.

Vehicle Features

Infotainment System

See the infotainment manual for information on the radio, audio players, phone, navigation system, and voice or speech recognition. It also includes information on settings.

Steering Wheel Controls

The infotainment system can be operated by using the steering wheel controls. See "Steering Wheel Controls" in the infotainment manual.

Cruise Control

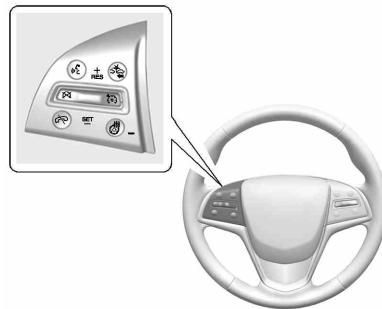

 : Press to turn the system on and off. A white cruise control indicator appears in the instrument cluster when cruise is turned on.

+RES: If there is a set speed in memory, press the control up briefly to resume to that speed or hold to accelerate. If cruise control is already active, use to increase vehicle speed. To increase speed by 1 km/h or 1 mph, press +RES up to the first detent. To increase speed to

the next 5 km/h or 5 mph mark on the speedometer, press +RES up to the second detent.

SET-: Press the control down briefly to set the speed and activate cruise control. If cruise control is already active, use to decrease vehicle speed. To decrease speed by 1 km/h or 1 mph, press SET- down to the first detent. To decrease speed to the next 5 km/h or 5 mph mark on the speedometer, press SET- down to the second detent.



: Press to disengage cruise control without erasing the set speed from memory.



See *Cruise Control on page 9-37* or *Adaptive Cruise Control on page 9-39* (if equipped).

Driver Information Center (DIC)

The DIC display is in the instrument cluster. It shows the status of many vehicle systems.



 or : Move SEL up or down to go to the previous or next selection.

 or : Press to move between the interactive display zones in the cluster. Press  to go back to the previous menu.

SEL: Press to open a menu or select a menu item. Press and hold to reset values on certain screens.

See *Driver Information Center (DIC) on page 5-38*.

Forward Collision Alert (FCA) System

FCA may help avoid or reduce the harm caused by front-end crashes.

FCA provides a green indicator,  when a vehicle is detected ahead. This indicator displays amber if you follow a vehicle much too closely. When approaching a vehicle ahead too quickly, FCA provides a flashing red alert on the windshield and rapidly beeps or pulses the driver seat.

See *Forward Collision Alert (FCA) System on page 9-50*.

Lane Departure Warning (LDW)

LDW may help avoid unintentional lane departures at speeds of 56 km/h (35 mph) or greater. LDW uses a camera sensor to detect the lane markings. The LDW light, , is green if a lane marking is detected. If the vehicle departs the lane, the

light will change to amber and flash. In addition, the driver seat will pulse or beeps will sound.

See *Lane Departure Warning (LDW)* on page 9-56.

Side Blind Zone Alert (SBZA)

If equipped, SBZA will detect vehicles in the next lane over in the vehicle's side blind zone area. When this happens, the SBZA display will light up in the corresponding outside side mirror and will flash if the turn signal is on.

See *Side Blind Zone Alert (SBZA)* on page 9-55.

Rear Vision Camera (RVC)

RVC displays a view of the area behind the vehicle on the center stack display when the vehicle is shifted into R (Reverse).

See *Assistance Systems for Parking or Backing* on page 9-48.

Rear Cross Traffic Alert (RCTA) System

If equipped, when backing, the RCTA system uses a triangle with an arrow displayed on the RVC screen to warn of traffic behind your vehicle that may cross your vehicle's path. In addition, beeps will sound, or the driver seat will pulse.

See *Assistance Systems for Parking or Backing* on page 9-48

Parking Assist

Front and Rear Park Assist (FRPA) uses sensors on the front and rear bumper to assist with parking and avoiding objects. It operates at speeds less than 8 km/h (5 mph). FRPA may display a warning triangle on the Rear Vision Camera

screen and a graphic on the instrument cluster to provide the object distance. In addition, multiple beeps or seat pulses may occur if very close to an object.

See *Driver Assistance Systems* on page 9-47.

Rear Automatic Braking (RAB) System

If the vehicle has Adaptive Cruise Control (ACC) it also has the Rear Automatic Braking (RAB) system, which is designed to help avoid or reduce the harm caused by backing crashes. If the system detects the vehicle is backing too fast to avoid a crash with a detected object behind your vehicle in your path, it may automatically brake hard to a stop.

See *Assistance Systems for Parking or Backing* on page 9-48

Active Emergency Braking System

If the vehicle has Adaptive Cruise Control (ACC) it also has the Active Emergency Braking System, which includes Intelligent Brake Assist (IBA) and the Automatic Collision Preparation (ACP) System. These systems can provide a boost to braking or automatically brake the vehicle to help avoid or lessen the severity of crashes when driving in a forward gear.

See *Active Emergency Braking System* on page 9-53.

Power Outlets

The accessory power outlets can be used to plug in electrical equipment, such as a cell phone or MP3 player.

The vehicle has two accessory power outlets:

- Inside the front center console.
- Inside the center console bin behind the shift lever.

Lift the cover to access the accessory power outlet.

See *Power Outlets* on page 5-7.

Universal Remote System



This system provides a way to replace up to three remote control transmitters used to activate

devices such as garage door openers, security systems, and home automation devices.

Read the instructions completely before attempting to program the Universal Remote system. Because of the steps involved, it may be helpful to have another person available to assist with programming the Universal Remote system.

See *Universal Remote System* on page 5-59.

Battery and Efficiency

High Voltage Safety Information

 **Warning**

Exposure to high voltage can cause shock, burns, and even death. The high voltage components in the vehicle can only be serviced by technicians with special training.

High voltage components are identified by labels. Do not remove, open, take apart, or modify these components. High voltage cable or wiring has orange covering. Do not probe, tamper with, cut, or modify high voltage cable or wiring.

This vehicle has a high voltage battery and a standard 12-volt battery.

If the vehicle is in a crash, the sensing system may shut down the high voltage system. When this occurs, the high voltage battery is disconnected and the vehicle will not start. The SERVICE VEHICLE SOON message in the Driver Information Center (DIC) will be displayed. Before the vehicle can be operated again, it must be serviced at your dealer.

 **Warning**

Damage to the high voltage battery or high voltage system can create a risk of electric shock, overheating, or fire.

If the vehicle is damaged from a moderate to severe crash, flood, fire, or other event, the vehicle should be inspected as soon as possible. Until the vehicle has been inspected, store it outside at least 15 m (50 ft) from any structure or anything that can

(Continued)

Warning (Continued)

burn. Ventilate the vehicle by opening a window or a door. Contact Customer Assistance as soon as possible to determine whether an inspection is needed. See *Customer Assistance Offices on page 13-3*.

See *Battery on page 10-23* for important safety information. If an airbag has inflated, see *What Will You See after an Airbag Inflates? on page 3-24*.

Only a trained service technician with the proper knowledge and tools should inspect, test, or replace the high voltage battery. See your dealer if the high voltage battery needs service.

See *Battery on page 10-23*.

Charging

This section explains the process for charging the high voltage battery. Do not allow the vehicle to remain in temperature extremes for long periods without being driven or plugged in. It is recommended that the vehicle be plugged in when temperatures are below 0°C (32°F) and above 32°C (90°F) to maximize high voltage battery life.

When using a 120-volt AC electrical outlet, it will take approximately 12.5 hours to charge the vehicle with the 12 amp AC current setting or 18 hours using the default 8 amp AC current setting. When using a 240-volt charging station, it will take approximately five hours to charge the vehicle. Charge times will vary with outside temperature. There are three ways to program how the vehicle is charged. See *Programmable Charging on page 5-29*.

The charging system may run fans and pumps that result in sounds from the vehicle while it is turned off. Additional unexpected clicking sounds may be caused by the electrical devices used while charging.

While the charge cord is plugged into the vehicle, the vehicle cannot be driven.

Charging

Start Charge

1. Make sure the vehicle is parked and turned off.
2. Push the rearward edge of the charge port door in and release to open the door.

In cold weather conditions, ice may form around the charge port door. Remove ice from the area before attempting to open or close the charge port door.

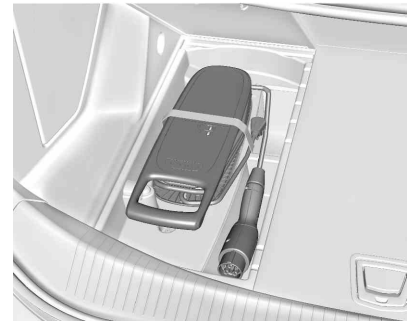

3. Open the rear trunk, lift the left load support floor cover, and remove the charge cord. Pull up on the charge cord handle to release. The vehicle plug is stored as shown.
4. Plug the charge cord into the electrical outlet. See *Electrical Requirements for Battery Charging on page 9-66*. Verify the charge cord status. See the charge cord user guide. See *Charge Cord on page 9-64*.

Select the appropriate charge level using the Select Charge Level Preference screen on the center stack. See "Charge Level Selection" under *Programmable Charging* on page 5-29.



5. Plug in the vehicle plug of the charge cord into the charge port on the vehicle. Verify that the charging status indicator illuminates on top of the instrument panel and a horn chirp occurs. See *Charging Status Feedback* on page 9-60.

Charge Cord Theft Alert

This vehicle has a Charge Cord Theft Alert. To enable this feature, see "Charge Cord Theft Alert" in *Vehicle Personalization* on page 5-52. The system can be armed and disarmed using the door lock function on the RKE transmitter.

End Charge

1. If armed, unlock the vehicle with the RKE transmitter to disarm the charge cord theft alert.



2. Disconnect the vehicle plug of the charge cord from the vehicle.

3. Close the charge port door by pressing firmly on the rearward edge of the door surface.
4. Unplug the charge cord from the electrical outlet.
5. Place the charge cord into the storage compartment.

Charge Cord

See *Radio Frequency Statement* on page 13-12.

A portable charge cord used to charge the vehicle high voltage battery is stored under the load support floor covering in the trunk.

Important Information About Portable Electric Vehicle Charging

- Charging an electric vehicle can stress a building's electrical system more than a typical household appliance.
- Before you plug in to any electrical outlet, have a qualified electrician inspect and verify the electrical system (electrical outlet, wiring, junctions, and

protection devices) for heavy-duty service at a 12 amp continuous load.

- Electrical outlets may wear out with normal usage or be damaged over time, making them unsuitable for electric vehicle charging.
- Check the electrical outlet/plug while charging and discontinue use if the electrical outlet/plug is hot, then have the electrical outlet serviced by a qualified electrician.
- When outdoors, plug into an electrical outlet that is weather-proof while in use.
- Mount the charging cord to reduce strain on the electrical outlet/plug.

Warning

Improper use of portable electric vehicle charge cords may cause a fire, electrical shock, or burns, and may result in damage to property, serious injury, or death.

- Do not use extension cords, multi-outlet power strips, splitters, grounding adaptors, surge protectors, or similar devices.
- Do not use an electrical outlet that is worn or damaged, or one that will not hold the plug firmly in place.
- Do not use an electrical outlet that is not properly grounded.
- Do not use an electrical outlet that is on a circuit with other electrical loads.

See the charge cord user guide.

Charge Cord Status Indicators

See “Charge Cord Status Indicators” in the charge cord user guide.

Charge Level Selection

Charge level selection can be made using the Select Charge Level Preference setting on the center stack. See “Charge Level Selection” under *Programmable Charging* on page 5-29.

Warning

Using a charge level that exceeds the electrical circuit or electrical outlet capacity may start a fire or damage the electrical circuit. Use the lowest charge level until a qualified electrician inspects your electrical circuit capacity. Use the lowest charge level if the electrical circuit or electrical outlet capacity is not known.

Fueling

The fuel system on this vehicle requires a refueling process to control evaporative emissions. To refuel the vehicle:

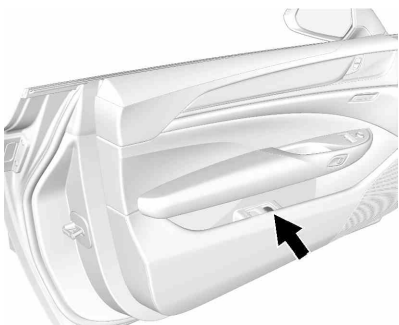

1. Press the fuel door button on the driver door for one second. A WAIT TO REFUEL message displays on the Driver Information Center.

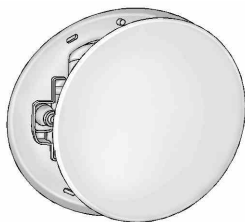

2. When the READY TO REFUEL message displays, the fuel door on the passenger side will unlock. Push the rearward edge of the fuel door in and release to open the door.
3. Turn the fuel cap counterclockwise to remove. While refueling, hang the fuel cap tether from the hook on the inside of the fuel door. Complete refueling within 30 minutes of pressing the fuel door button on the driver door. If refueling more than 30 minutes, press the fuel door button again.

4. After refueling, reinstall the fuel cap by turning it clockwise until it clicks. Close the fuel door.

See *Filling the Tank* on page 9-68.

Regenerative Braking

Regenerative braking takes some of the energy from the moving vehicle and turns it back into electrical energy. This energy is then stored in the high voltage battery system, contributing to increased energy efficiency.

Regen on Demand™

This feature will slow the vehicle by recapturing energy using the steering wheel paddles.

See *Regenerative Braking* on page 9-32.

Service

Warning



Never try to do your own service on high voltage components. You can be injured and the vehicle can be damaged if you try to do your own service work. Service and repair of these high voltage components should only be performed by a trained service technician with the proper knowledge and tools. See *Doing Your Own Service Work on page 10-5*.





Performance and Maintenance

Traction Control/ Electronic Stability Control

The Traction Control System (TCS) limits wheel spin. The system turns on automatically every time the vehicle is started.

StabiliTrak assists with directional control of the vehicle in difficult driving conditions. The system turns on automatically every time the vehicle is started.

- To turn off TCS, press and release the TCS/StabiliTrak button  on the center console.  illuminates in the instrument cluster. The appropriate DIC message is displayed. See *Ride Control System Messages on page 5-49*.

- Press the TCS/StabiliTrak button  again to turn traction control back on.
- To turn off both TCS and StabiliTrak, press and hold the TCS/StabiliTrak button  on the center console until  and  illuminate in the instrument cluster. The appropriate DIC message displays. See *Ride Control System Messages on page 5-49*.
- Press the TCS/StabiliTrak button  again to turn on both systems.

See *Traction Control/Electronic Stability Control on page 9-33*.

Tire Pressure Monitor

This vehicle may have a Tire Pressure Monitor System (TPMS).



The low tire pressure warning light alerts to a significant loss in pressure of one of the vehicle's tires. If the warning light comes on, stop as soon as possible and inflate the tires to the recommended pressure shown on the Tire and Loading Information label. See *Vehicle Load Limits* on page 9-12. The warning light will remain on until the tire pressure is corrected.

The low tire pressure warning light may come on in cool weather when the vehicle is first started, and then turn off as the vehicle is driven. This may be an early indicator that the tire pressures are getting low and the tires need to be inflated to the proper pressure.

The TPMS does not replace normal monthly tire maintenance. Maintain the correct tire pressures.

See *Tire Pressure Monitor System* on page 10-48.

Engine Oil Life System

The engine oil life system calculates engine oil life based on vehicle use and displays the CHANGE ENGINE OIL SOON message when it is time to change the engine oil and filter. The oil life system should be reset to 100% only following an oil change.

Resetting the Oil Life System

1. Display RESET OIL LIFE on the DIC menu. See *Driver Information Center (DIC)* on page 5-38.
2. Press and hold SEL for several seconds while the Oil Life display is active to reset the Oil Life system.

See *Engine Oil Life System* on page 10-12.

Driving for Better Energy Efficiency

Use the following tips to help maximize energy efficiency and range.

In colder temperatures, while these efficiency tips will help, the electric vehicle driving range may be lower due to higher energy usage.

Driving Style

Efficiency Gauge (Instrument Cluster)

The leaf indicator or green ring indicator should be kept green and in the center of the gauge.

Inefficient acceleration is indicated when the ring turns yellow or the leaf turns yellow and travels above the center of the gauge.

Aggressive braking is indicated when the ring turns yellow or the leaf turns yellow and travels below the center of the gauge.

Acceleration/Braking/Coasting

Avoid unnecessary rapid accelerations and decelerations.

Electric range is maximized at 80 km/h (50 mph) and below. Higher speeds use more energy and can significantly reduce electric range.

Use cruise control when appropriate.

Plan ahead for decelerations and coast whenever possible. For example, do not rush to traffic signals.

Do not shift to N (Neutral) to coast. The vehicle recovers energy while coasting and braking in D (Drive) or L (Low).

Drive Mode and PRNDL Selection

Use Tour Mode when possible.

Sport Mode provides more responsive acceleration than Tour Mode, but can reduce efficiency.

Use Mountain Mode prior to climbing long, steep grades in mountainous areas. Be sure to

engage Mountain Mode before starting to climb. Mountain Mode reduces electric range and power, but may be needed to maintain speeds above 96 km/h (60 mph) when climbing grades of 5% or greater.

Use Hold Mode on a trip where all or most of the electric charge will be depleted. Use Hold Mode mainly during highway or high-speed driving to maximize both electric vehicle miles and fuel efficiency.



Use L (Low) in heavy stop-and-go traffic or when traveling downhill. L (Low) requires less brake pedal application and provides a controlled, efficient way to slow the vehicle down.

Climate Setting

Using the heat and air conditioning systems decreases the energy available for electric driving.

Optimal energy efficiency is achieved with the heat, air conditioning, and fan turned off.

Less energy is used at low fan speeds. When using the fan:

- MIN is the most energy efficient climate setting as long as  is not selected.
- ECO is for moderate air conditioning and heater operation and is the next most energy efficient setting as long as  is not selected.
- MAX mode provides the most comfort but is the least energy efficient.

Use the auto heated seat feature instead of climate settings. Heating the seat uses less energy than heating the vehicle interior.

Use remote start to heat or cool the interior when the vehicle is plugged in to maximize the electric range by utilizing electricity from the electrical outlet. Engine Assisted Heating while plugged in can be personalized. See *Remote Start on page 2-8*.

In hot weather, avoid parking in direct sunlight or use sunshades inside the vehicle.

Turn off the front and rear window defog/defrost when they are no longer needed.

Avoid driving with the windows open at highway speeds.

See *Vehicle Personalization* on page 5-52.

Vehicle Charging/Maintenance

Charging

Keep the vehicle plugged in, even when fully charged, to keep the battery temperature ready for the next drive. This is important when outside temperatures are extremely hot or cold.

Maintenance

Always keep the tires properly inflated and the vehicle properly aligned.

The weight of excess cargo in the vehicle affects efficiency and range. Avoid carrying more than is needed.

If fuel is not regularly used, consider keeping the fuel tank only one-third full. Excess fuel weight impacts efficiency and range.

For fuel recommendations, see *Fuel* on page 9-67.

Avoid unnecessary use of electrical accessories. Power used for functions other than propelling the vehicle will reduce electric vehicle range.

Using a rooftop carrier will reduce efficiency due to additional weight and drag.

Roadside Service

U.S.: 1-888-811-1926

Canada: 1-800-882-1112

TTY Users (U.S. Only):
1-888-889-2438

New vehicles are automatically enrolled in the Roadside Service program.

See *Roadside Service* on page 13-5.

OnStar®

This vehicle may be equipped with a comprehensive, in-vehicle system that can connect to a live OnStar Advisor for Emergency, Security, Navigation, Connection, and Diagnostic Services. OnStar services may require a paid subscription. See *OnStar Overview* on page 14-1.

Keys, Doors, and Windows

Keys and Locks

- Keys 2-1
- Remote Keyless Entry (RKE) System 2-2
- Remote Keyless Entry (RKE) System Operation 2-2
- Remote Start 2-8
- Door Locks 2-10
- Power Door Locks 2-11
- Delayed Locking 2-12
- Automatic Door Locks 2-13
- Lockout Protection 2-13

Doors

- Trunk 2-13

Vehicle Security

- Vehicle Security 2-15
- Vehicle Alarm System 2-15
- Immobilizer 2-16
- Immobilizer Operation 2-16

Exterior Mirrors

- Convex Mirrors 2-17
- Power Mirrors 2-17
- Folding Mirrors 2-18
- Heated Mirrors 2-18
- Reverse Tilt Mirrors 2-18

Interior Mirrors

- Interior Rearview Mirrors 2-18
- Automatic Dimming Rearview Mirror 2-18

Windows

- Windows 2-19
- Power Windows 2-19
- Sun Visors 2-21

Keys and Locks

Keys

 **Warning**

Leaving children in a vehicle with a Remote Keyless Entry (RKE) transmitter is dangerous and children or others could be seriously injured or killed. They could operate the power windows or other controls or make the vehicle move. The windows will function with the RKE transmitter in the vehicle, and children or others could be caught in the path of a closing window. Do not leave children in a vehicle with an RKE transmitter.

The key that is part of the RKE transmitter can be used for the trunk.

2-2 Keys, Doors, and Windows

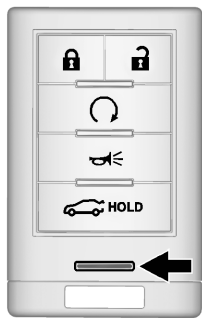

To remove the key, press the button near the bottom of the transmitter, and pull the key out. Never pull the key out without pressing the button.

If it becomes difficult to turn the key, inspect the key blade for debris.

See your dealer if a new key is needed.

Contact Roadside Service if locked out of the vehicle. See *Roadside Service* on page 13-5.

With an active OnStar subscription, an OnStar Advisor may remotely unlock the vehicle. See *OnStar Overview* on page 14-1.

Remote Keyless Entry (RKE) System

See *Radio Frequency Statement* on page 13-12.

If there is a decrease in the RKE operating range:

- Check the distance. The transmitter may be too far from the vehicle.
- Check the location. Other vehicles or objects may be blocking the signal.
- Check the transmitter's battery. See "Battery Replacement" later in this section.
- If the transmitter is still not working correctly, see your dealer or a qualified technician for service.

Remote Keyless Entry (RKE) System Operation

The Keyless Access system allows for vehicle entry when the transmitter is within range. See "Keyless Access Operation" following.

The RKE transmitter functions may work up to 60 m (197 ft) away from the vehicle.

Other conditions, such as those previously stated, can impact the performance of the transmitter.

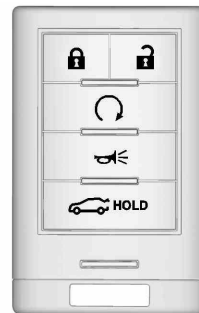

 **(Unlock):** Press once to unlock the driver door. Press a second time within five seconds to unlock all doors.

The hazard warning lamps will flash twice each time the button is pressed and the alarm system will be disarmed. See *Vehicle Alarm System* on page 2-15.

On vehicles with remote operating windows, pressing and holding  will open all of the vehicle's windows. See *Power Windows* on page 2-19. This feature can be disabled by a dealer technician.



 **(Lock):** Press to lock all doors. The hazard warning lamps will flash once and the alarm system will be armed. See *Vehicle Alarm System* on page 2-15.

If the driver door is open when  is pressed, all doors lock and then the driver door will unlock if the Unlocked Door Anti-Lockout feature is enabled through vehicle personalization. See "Unlocked

Door Anti-Lockout" under *Vehicle Personalization* on page 5-52. This may vary based on vehicle personalization.

(Vehicle Locator/Panic

Alarm): Press and release to initiate vehicle locator. The exterior lamps flash and the horn chirps three times. Press and hold for three seconds to sound the panic alarm. The horn sounds and the turn signals flash for 30 seconds. Press again to cancel the panic alarm.

 **(Remote Vehicle Start):** Press and release  and then immediately press and hold  for at least four seconds to start the vehicle from outside using the RKE transmitter. See *Remote Start* on page 2-8.

 **(Remote Trunk Release):** Press and hold to release the trunk.

Keyless Access Operation

To lock and unlock the doors and access the trunk, the RKE transmitter must be within 1 m (3 ft) of the door or trunk.

Keyless Access can be programmed to unlock all doors on the first touch pad press from the driver door. See *Vehicle Personalization* on page 5-52.

Keyless Unlocking from the Driver Door

When the RKE transmitter is within 1 m (3 ft) of the driver door handle, pressing the touch pad button on the driver door handle will unlock and open the driver door. See *Door Locks* on page 2-10.

To customize whether the doors automatically unlock all doors, see "Remote Locking, Unlocking, Starting" under *Vehicle Personalization* on page 5-52.

2-4 Keys, Doors, and Windows

Keyless Unlocking from Passenger Door

Press the door touch pad to unlock all doors and open the passenger door if the RKE transmitter is within 1 m (3 ft).

Passive Locking



This feature will lock the vehicle several seconds after all doors are closed if the vehicle is off and at least one transmitter has been removed or none remain in the vehicle.

To customize whether the doors automatically lock when exiting the vehicle, see “Passive Door Lock” under *Vehicle Personalization* on page 5-52.

If other electronic devices interfere with the RKE transmitter signal, the vehicle may not detect the RKE transmitter inside the vehicle. If passive locking is enabled, the doors may lock with the RKE

transmitter inside the vehicle. Do not leave the RKE transmitter in an unattended vehicle.

Temporarily Disable Passive Locking Feature

Temporarily disable the passive locking by pressing and holding  on the interior door switch with a door open for at least four seconds, or until three chimes are heard. Passive locking will then remain disabled until  on the interior door is pressed, or until the vehicle is turned on.

To customize the doors to automatically lock when exiting the vehicle, see “Remote Lock, Unlock, Start” under *Vehicle Personalization* on page 5-52.

Keyless Trunk Opening

Press the touch pad to open if the RKE transmitter is within 1 m (3 ft) and the doors are locked. If the doors are unlocked, the transmitter is not required to open the trunk.

Programming Transmitters to the Vehicle

Only RKE transmitters programmed to this vehicle will work. If a transmitter is lost or stolen, a replacement can be purchased and programmed through your dealer. The vehicle can be reprogrammed so that lost or stolen transmitters no longer work. Each vehicle can have up to eight transmitters programmed to it.

Programming with a Recognized Transmitter

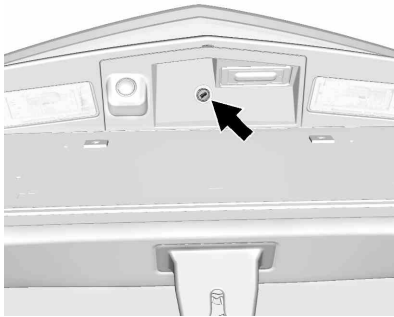

A new transmitter can be programmed to the vehicle when there is one recognized transmitter.

1. The vehicle must be off and both the recognized and new transmitters must be with you.
2. Remove the key base from the recognized RKE transmitter.
3. Place the recognized transmitter in the cupholder.

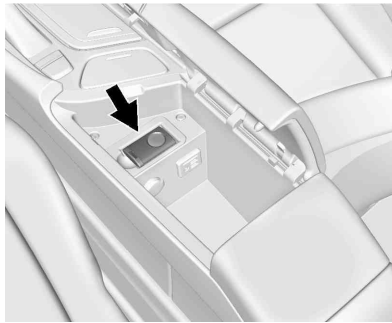

4. Insert the vehicle key into the key cylinder above the license plate.
5. Open the trunk.
6. Turn the key counterclockwise five times within 10 seconds.
7. The DIC displays READY FOR REMOTE KEY 3 or 4, up to 8.



8. Remove the rubber liner to access the pocket. Place the new transmitter, button side down, on the indent in the center console storage area.
9. Press the POWER  button.
10. The DIC displays READY FOR REMOTE KEY 4 or 5, up to 8.
11. Press  or  on each newly programmed transmitter to complete the process.

12. To program additional transmitters, repeat Steps 8–11.

Return the key base back into the RKE transmitter.

13. Press and hold the POWER  button for at least 12 seconds to exit programming.

Programming without a Recognized Transmitter

If there are no currently recognized transmitters available, follow this procedure to program up to eight transmitters. This feature is not available in Canada. This procedure will take approximately 30 minutes to complete. The vehicle must be off and all transmitters to be programmed must be present.

2-6 Keys, Doors, and Windows

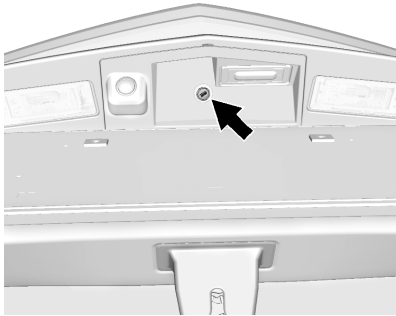





1. Remove the key from the transmitter and insert the vehicle key into the key cylinder above the license plate.
2. Open the trunk.
3. Turn the key counterclockwise five times within 10 seconds.
The DIC message displays REMOTE LEARN PENDING PLEASE WAIT.
4. Return the key base back into the RKE transmitter.

5. Wait for 10 minutes until the DIC displays PRESS ENGINE START BUTTON LEARN, then press the POWER  button.

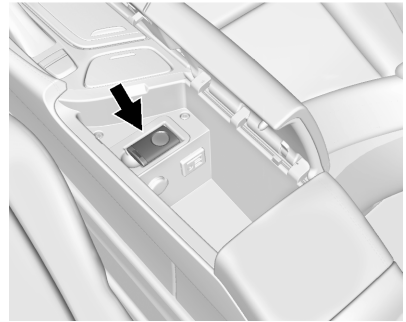
The DIC reads REMOTE LEARN PENDING, PLEASE WAIT.

6. Repeat Step 5 two additional times. After the third time all previously known transmitters will no longer work with the vehicle. Remaining transmitters can be relearned during the next steps. The DIC display should now show READY FOR REMOTE #1.



7. First remove the rubber liner to access the pocket. Place the new transmitter, button side down, on the indent in the center console storage area.
8. Press the POWER  button. When the transmitter is learned, the DIC display will show that it is ready to program the new transmitter.
9. Remove the transmitter from the transmitter pocket and press  or  on the transmitter.

10. To program additional transmitters, repeat Steps 7–9.
11. When all additional transmitters are programmed, press and hold the POWER  button for approximately 12 seconds to exit programming mode.

Starting the Vehicle with a Low Transmitter Battery

When you try to start the vehicle, if the transmitter battery is weak, or if there is interference with the signal, the DIC may display NO REMOTE DETECTED or NO REMOTE KEY WAS DETECTED PLACE KEY IN TRANSMITTER POCKET THEN START YOUR VEHICLE. See *Key and Lock Messages on page 5-45*.

To start the vehicle:

1. Open the center console storage area and the storage tray.

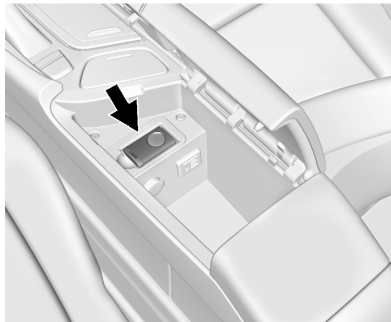

2. Place the transmitter, button side down, into the transmitter indent.
3. With the vehicle in P (Park) or N (Neutral), press the brake pedal and the POWER  button.
Replace the transmitter battery as soon as possible.

Battery Replacement

Caution

When replacing the battery, do not touch any of the circuitry on the transmitter. Static from your body could damage the transmitter.

Replace the battery if the REPLACE BATTERY IN REMOTE KEY message displays in the DIC.

1. Press the button near the bottom of the transmitter and pull the key out.

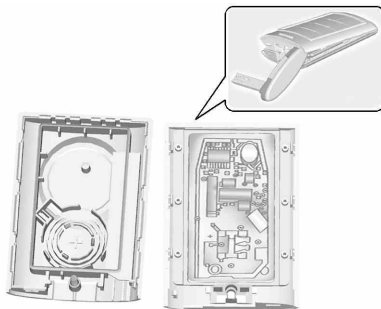



2. Use the oval base of the key blade to separate the two halves of the transmitter.
3. Remove the old battery. Do not use a metal object.
4. Insert the new battery on the back housing, positive side facing down. Replace with a CR2032 or equivalent battery.
5. Align the key release button and snap the transmitter back together.

Remote Start

This feature starts the heating or air conditioning systems and rear window defogger from outside the vehicle. Use remote start to heat or cool the interior when the vehicle is plugged in to maximize the electric range by utilizing electricity from the electrical outlet. Normal operation of the system will return after the vehicle has been turned on.

⏻ (Remote Start): This button is on the RKE transmitter.

During remote start:

- The climate control system will typically default to the last climate setting. If the fan is off or if MIN was selected, the air conditioning or heat will turn on as needed. See *Dual Automatic Climate Control System on page 8-1*.
- If the heated seats have been enabled through vehicle personalization, the heated seats will turn on during colder outside temperatures. See "Remote Start Auto Heat Seats" under *Heated Front Seats on page 3-8* and "Remote Start Auto Heat Seats" under *Vehicle Personalization on page 5-52*.
- The rear defogger will turn on during colder outside temperatures.
- Selecting  during colder outside temperatures before shutting the vehicle off will help windshield clearing.
- Shutting the vehicle off in ECO Mode without  selected will minimize the impact to electric range. Shutting the vehicle off in other modes will maximize heating or air conditioning.

- Use remote start to heat or cool the interior when the vehicle is plugged in to maximize the electric range by utilizing electricity from the electrical outlet. Engine Assisted Heating operation can be personalized.
- Vehicle range may decrease if the vehicle is not plugged into an electrical outlet. If the vehicle is plugged in, much of the energy needed to support this feature will be provided from the electrical outlet, not from the high voltage battery.



Laws in some communities may restrict the use of features that remotely start the engine. For example, some laws may require a person using the remote start feature to have the vehicle in view when doing so. Check local regulations for any requirements on remote starting of vehicles.

The RKE transmitter range may be shorter while the vehicle is running.

Other conditions can affect the performance of the transmitter. See *Remote Keyless Entry (RKE) System on page 2-2*.

Activating Remote Start

To heat or cool the passenger compartment using remote start:

1. Aim the RKE transmitter at the vehicle.
2. Press and release  on the RKE transmitter; the doors will lock.
3. Immediately press and hold  until the turn signal lamps flash, or for at least four seconds. Pressing  again during a remote start will turn the feature off.

Remote start will automatically shut off after 10 minutes unless a time extension is done.

While the remote start is active, the parking lamps will turn on and remain on.

After entering the vehicle during a remote start, press the POWER  button on the center stack with the brake pedal applied to operate as normal.

The remote start can be initiated two separate times between driving. For each remote start, the passenger compartment will be heated or cooled for 10 minutes.

Extending Engine Run Time

The vehicle run time can also be extended by another 10 minutes, if during the first 10 minutes Steps 1–3 are repeated while the engine is still running. This provides a total of 20 minutes.

The remote start can only be extended once.

When the remote start is extended, the second 10-minute period is added on to the first 10 minutes for a total of 20 minutes.



2-10 Keys, Doors, and Windows

A maximum of two remote starts, or a remote start with an extension, are allowed between ignition cycles.

The vehicle's ignition must be changed to ON/RUN/START and then back to OFF before the remote start procedure can be used again.

Canceling Remote Start

To cancel a remote start, do any of the following:

- Press and hold  until the parking lamps turn off.
- Turn on the hazard warning flashers.
- Press the POWER  button on the center stack, with the brake pedal applied, then press the POWER  button again to turn the vehicle off.

Conditions in Which Remote Start May Not Work

Conditions in which a remote start may not occur include:

- An open hood.
- Vehicle propulsion system fault conditions, including an emission control system malfunction.
- High voltage battery fault conditions.

A remote start or extension will not occur if the fuel level is low.

During a remote start, conditions in which a remote start may be canceled include:

- Vehicle propulsion system or high voltage battery fault conditions.
- Low engine oil pressure.
- Engine coolant temperature that is too high.

Door Locks



Warning



Unlocked doors can be dangerous.

- Passengers, especially children, can easily open the doors and fall out of a moving vehicle. The chance of being thrown out of the vehicle in a crash is increased if the doors are not locked. So, all passengers should wear safety belts properly and the doors should be locked whenever the vehicle is driven.
- Young children who get into unlocked vehicles may be unable to get out. A child can be overcome by extreme heat and can suffer permanent injuries or even death from heat stroke. Always lock the vehicle whenever leaving it.

(Continued)



Warning (Continued)

- Outsiders can easily enter through an unlocked door when slowing or stopping the vehicle. Lock the doors to help prevent this from happening.

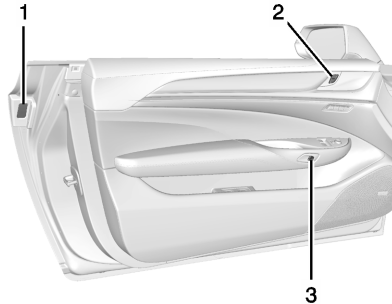
To lock or unlock the doors from the outside press  or  on the RKE transmitter.



For Keyless Access, the RKE transmitter must be within 1 m (3 ft) of the door handle sensor (1). Grip and press to open.

To lock or unlock the doors from the inside, press  or  on the power door lock switch (2).

To open the door, press the door latch button (3). If the vehicle is stationary, the door latch button unlatches an unlocked door.

See “Keyless Access Operation” in *Remote Keyless Entry (RKE) System Operation* on page 2-2.

Power Door Locks

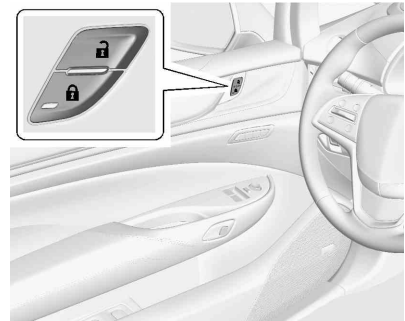

 **(Lock):** Press to lock the doors. The indicator light in the switch will illuminate when activated.

 **(Unlock):** Press to unlock the doors.

2-12 Keys, Doors, and Windows

Loss of Vehicle Electrical Power

If the vehicle has lost battery power, open the doors manually.

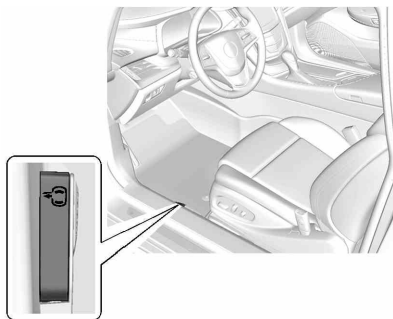

From inside the vehicle, pull the driver door manual release lever.

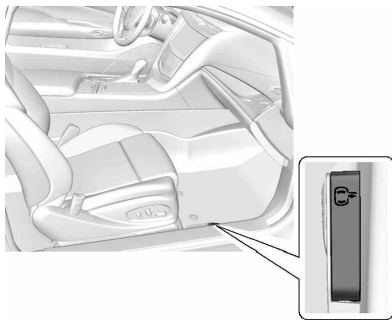

From inside the vehicle, pull the passenger door manual release lever.

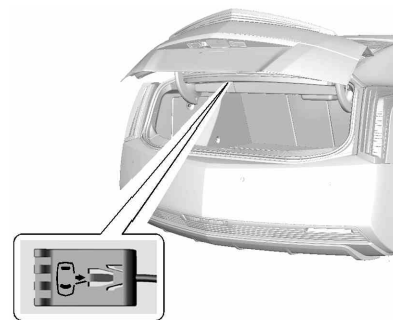



From outside the vehicle, open the trunk and pull the manual door release lever to open the driver door.

Delayed Locking

This feature delays the locking of the doors until five seconds after all doors are closed.

When  is pressed on the power door lock switch while the door is open, a chime will sound three times indicating delayed locking is active.

The doors will lock automatically five seconds after all doors are closed. If a door is reopened before that time, the five-second timer will reset when all doors are closed again.

Press  on the door lock switch or press  on the RKE transmitter to lock the doors immediately.

This feature can also be programmed. See *Vehicle Personalization on page 5-52*.

Automatic Door Locks

The doors will lock automatically when all doors are closed, the ignition is on, and the shift lever is moved out of P (Park).

To unlock the doors:

- Press  on a door.
- Shift the vehicle into P (Park).

Automatic door unlocking can be programmed through the Driver Information Center (DIC). See *Vehicle Personalization on page 5-52*.

Lockout Protection

If the vehicle is in ACC/ACCESSORY or ON/RUN/START and the power door lock switch is pressed with the driver door open, all the doors will lock and only the driver door will unlock.

Lockout Protection can be manually overridden with the driver door open by pressing and holding  on the power door lock switch.

If Unlocked Door Anti-Lockout is turned on and the vehicle is off, the driver door is open, and locking is requested, all the doors will lock and only the driver door will unlock. The Unlocked Door Anti-Lockout feature can be turned on or off using the vehicle personalization menus. See *Vehicle Personalization on page 5-52*.

Doors

Trunk

Warning

Exhaust gases can enter the vehicle if it is driven with the liftgate or trunk/hatch open, or with any objects that pass through the seal between the body and the trunk/hatch or liftgate. Engine exhaust contains carbon monoxide (CO) which cannot be seen or smelled. It can cause unconsciousness and even death.

If the vehicle must be driven with the liftgate or trunk/hatch open:

- Close all of the windows.
- Fully open the air outlets on or under the instrument panel.

(Continued)

2-14 Keys, Doors, and Windows

Warning (Continued)



- Adjust the climate control system to a setting that brings in only outside air and set the fan speed to the highest setting. See “Climate Control Systems” in the Index.
- If the vehicle is equipped with a power liftgate, disable the power liftgate function.

See *Engine Exhaust* on page 9-27.

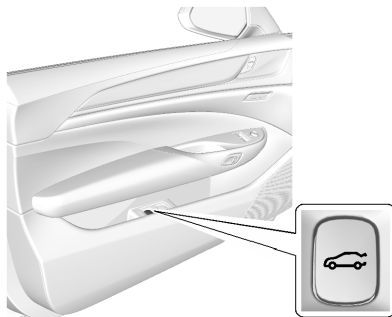
Trunk Release



To open the trunk the shift lever must be in P (Park).

- Press  on the driver door.
- Press and hold  on the Remote Keyless Entry (RKE) transmitter.
- Press the touch pad on the rear of the trunk above the license plate when all doors are unlocked.

The trunk can be opened while the vehicle is locked by pressing the touch pad above the license plate while the RKE transmitter is within 1 m (3 ft) of the rear of the vehicle. See “Keyless Access” in *Remote Keyless Entry (RKE) System Operation* on page 2-2.

Close the trunk by pulling on the handle. Do not use the handle as a tie-down.

Emergency Trunk Release Handle



 **Caution**

Do not use the emergency trunk release handle as a tie-down or anchor point when securing items in the trunk as it could damage the handle.

There is a glow-in-the-dark emergency trunk release handle on the trunk lid. This handle will glow following exposure to light. Pull the release handle to open the trunk from the inside.

After use, return to the stored position.



Vehicle Security

This vehicle has theft-deterrent features; however, they do not make the vehicle impossible to steal.

Vehicle Alarm System

This vehicle has an anti-theft alarm system.

Arming the Alarm System

1. Close the trunk and the hood. Turn off the vehicle.
2. Lock the vehicle in one of three ways:
 - Use the RKE transmitter.
 - Use the Keyless Access system.
 - With a door open, press the inside .
3. After 30 seconds the alarm system will arm. Pressing  on the RKE transmitter a second

time will bypass the 30-second delay and immediately arm the alarm system.

If the driver door is opened without first unlocking with the RKE transmitter, the horn will chirp and the lights will flash to indicate pre-alarm. If the vehicle is not started, or the door is not unlocked by pressing  on the RKE transmitter during the 10-second pre-alarm, the alarm will be activated.

If the charge cord theft alert is enabled, the alarm will also be activated when there is an attempt to remove the charge cord, or if a passenger door, the trunk, or the hood is opened without first disarming the system. When the alarm is activated, the turn signals flash and the horn sounds for about 30 seconds. The alarm system will then re-arm to monitor for the next unauthorized event.

2-16 Keys, Doors, and Windows

The Charge Cord Theft Alert feature may be disabled through the vehicle personalization. See “Charge Cord Theft Alert” under *Vehicle Personalization* on page 5-52.

Disarming the Alarm System

To disarm the alarm system or turn off the alarm if it has been activated:

- Press  on the RKE transmitter.
- Unlock the vehicle using the Keyless Access system.
- Start the vehicle.

To avoid setting off the alarm by accident:

- Lock the vehicle after all occupants have left the vehicle and all doors are closed.
- Always unlock a door with the RKE transmitter or use the Keyless Access system.

How to Detect a Tamper Condition

If  is pressed on the RKE transmitter and the horn chirps and the lights flash three times, a previous alarm occurred while the system was armed.

If the alarm has been activated, a message will appear on the DIC. See *Security Messages* on page 5-49.

Immobilizer

See *Radio Frequency Statement* on page 13-12.

Immobilizer Operation

This vehicle has a passive theft-deterrent system. The system does not have to be manually armed or disarmed.

The vehicle is automatically immobilized when the vehicle is turned off.

The system is automatically disarmed when the vehicle is started with a valid RKE transmitter in the vehicle. The RKE transmitter uses electronic coding that matches an immobilizer control unit in the vehicle and automatically disarms the system. Only a correct transmitter can be used to turn the vehicle on.



The security light comes on if there is a problem with arming or disarming the theft-deterrent system.

This light comes on briefly when the vehicle is turned on. There is a problem if the engine does not start and this light stays on.

Turn the ignition off and try again.

If the engine still does not start, and the RKE transmitter appears undamaged, try the other RKE transmitter for the vehicle, or place the RKE transmitter in the transmitter slot. See *Remote Keyless Entry (RKE) System Operation* on page 2-2. It may be necessary to check the fuse. See *Electrical System Overload* on page 10-29. If the vehicle does start, the first transmitter is bad or if the vehicle still does not start the vehicle needs service. See your dealer.

Do not leave the key or device that disarms or deactivates the vehicle theft system in the vehicle.

Exterior Mirrors

Convex Mirrors

 **Warning**

A convex mirror can make things, like other vehicles, look farther away than they really are. If you cut too sharply into the right lane, you could hit a vehicle on the right. Check the inside mirror or glance over your shoulder before changing lanes.

The passenger side mirror is convex shaped. A convex mirror's surface is curved so more can be seen from the driver seat.

Power Mirrors

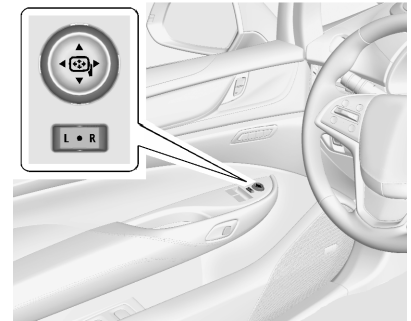

Controls for the outside power mirrors are on the driver door.

To adjust a mirror:

1. Move the selector switch to L (Left) or R (Right) to choose the driver or passenger mirror.
2. Press the arrows on the control pad to move each mirror in the desired direction.
3. Return the selector switch to the center position.

2-18 Keys, Doors, and Windows

If equipped, the vehicle may have memory mirrors. See *Memory Seats* on page 3-6.

Folding Mirrors

Manual Folding Mirrors

The mirrors can be folded inward toward the vehicle to prevent damage when going through an automatic car wash. Push the mirror outward to return it to the original position.

Heated Mirrors

If equipped, the Rear Window Defogger also heats the outside mirrors.

(Rear Window Defogger):

Press to heat the outside mirrors. See “Rear Window Defogger” under *Dual Automatic Climate Control System* on page 8-1.

Reverse Tilt Mirrors

If equipped with the memory package, the passenger and/or driver mirror tilts to a preselected position when the vehicle is in R (Reverse). This feature allows the driver to view the curb when parallel parking. The mirror(s) return to the original position when the vehicle is shifted out of R (Reverse), the ignition is turned off, or if the vehicle is driven in (R) above a predetermined speed.

Turn this feature on or off through vehicle personalization. See *Vehicle Personalization* on page 5-52.

Interior Mirrors

Interior Rearview Mirrors

Adjust the rearview mirror for a clear view of the area behind your vehicle.

Do not spray glass cleaner directly on the mirror. Use a soft towel dampened with water.

Automatic Dimming Rearview Mirror

The rearview mirror automatically dims to reduce the glare of the headlamps from behind. This feature comes on when the vehicle is started.

Windows

Warning

Never leave a child, a helpless adult, or a pet alone in a vehicle, especially with the windows closed in warm or hot weather. They can be overcome by the extreme heat and suffer permanent injuries or even death from heat stroke.



Power Windows

Warning

Leaving children in a vehicle with the Remote Keyless Entry (RKE) transmitter is dangerous for many reasons; children or others could be badly injured or even killed. They could operate the power windows or other controls or even make the vehicle move. The windows will function with the RKE transmitter in the vehicle and they could be seriously injured or killed if caught in the path of a closing window. Do not leave the RKE transmitter in a vehicle with children.

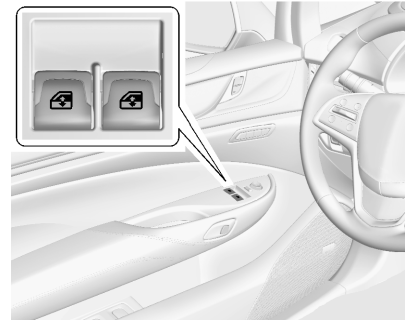

The power window switches are on the driver door. The passenger door also has a window switch for only that window.

Press the switch to open the window. Pull the switch to close it.

The power windows work when the vehicle is on, or when Retained Accessory Power (RAP) is active. See *Retained Accessory Power (RAP)* on page 9-19.

Express-Down/Up Windows

Windows with an express-down or up feature allow the window to be lowered or raised without holding the switch.

Pull a window switch up or press it down all the way, release it, and the window goes up or down automatically. Stop the window by pressing or pulling the switch.

Express Window Anti-Pinch Feature

If any object is in the path of the window when the express-up is active, the window will stop at the obstruction and auto-reverse to a preset factory position. Weather conditions such as severe icing may also cause the window to auto-reverse. The window will return to normal operation once the obstruction or condition is removed.

Express Window Anti-Pinch Override

In an emergency, the anti-pinch feature can be overridden in a supervised mode. Hold the window switch all the way up to the second position. The window will rise for as long as the switch is held. Once the switch is released, the express mode is reactivated.

In this mode, the window can still close on an object in its path. Use care when using the override mode.

Programming the Power Windows

Programming the power windows may be necessary if the 12-volt battery has been disconnected or discharged.

To program the window:

1. Close all doors with the vehicle on, or when Retained Accessory Power (RAP) is active. See *Retained Accessory Power (RAP)* on page 9-19.

2. Pull the window switch to completely close the window. Continue to hold the window switch two seconds after the window is closed.
3. Repeat for each window.

Remote Window Operation

The vehicle may have remote operating windows that will open all the windows from outside the vehicle by pressing and holding  on the Remote Keyless Entry (RKE) transmitter.

This feature can be disabled by a dealer technician.

Sun Visors

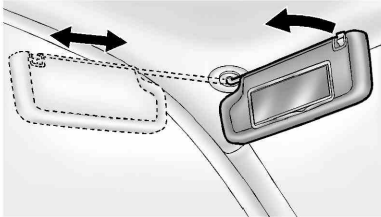

Pull the sun visor down to block glare. Detach the sun visor from the center mount to pivot to the side window or, if equipped, extend along the rod.

Seats and Restraints

Head Restraints

Head Restraints 3-2

Front Seats

Easy Entry Seat 3-3
 Power Seat Adjustment 3-4
 Lumbar Adjustment 3-4
 Thigh Support Adjustment 3-5
 Reclining Seatbacks 3-5
 Memory Seats 3-6
 Heated Front Seats 3-8

Rear Seats

Rear Seats 3-10

Safety Belts

Safety Belts 3-11
 How to Wear Safety Belts Properly 3-13

Lap-Shoulder Belt 3-14
 Safety Belt Use During Pregnancy 3-17
 Safety Belt Extender 3-17
 Safety System Check 3-18
 Safety Belt Care 3-18
 Replacing Safety Belt System Parts after a Crash 3-18

Airbag System

Airbag System 3-19
 Where Are the Airbags? 3-21
 When Should an Airbag Inflate? 3-22
 What Makes an Airbag Inflate? 3-23
 How Does an Airbag Restrain? 3-23
 What Will You See after an Airbag Inflates? 3-24
 Passenger Sensing System 3-25

Servicing the Airbag-Equipped Vehicle 3-30
 Adding Equipment to the Airbag-Equipped Vehicle ... 3-30
 Airbag System Check 3-31
 Replacing Airbag System Parts after a Crash 3-31

Child Restraints

Older Children 3-32
 Infants and Young Children 3-34
 Child Restraint Systems 3-37
 Where to Put the Restraint ... 3-38
 Lower Anchors and Tethers for Children (LATCH System) 3-40
 Replacing LATCH System Parts After a Crash 3-45
 Securing Child Restraints (Rear Seat) 3-45
 Securing Child Restraints (Front Passenger Seat) 3-47

Head Restraints

Warning

With head restraints that are not installed and adjusted properly, there is a greater chance that occupants will suffer a neck/spinal injury in a crash. Do not drive until the head restraints for all occupants are installed and adjusted properly.



Adjust the head restraint so that the top of the restraint is at the same height as the top of the occupant's head. This position reduces the chance of a neck injury in a crash.

Front Seats

The vehicle's front seats have adjustable head restraints in the outboard seating positions.

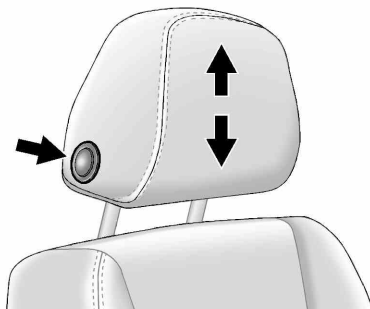

To raise or lower the head restraint, press the button located on the side of the head restraint, and pull up or push the head restraint down and release the button. Pull and push on

the head restraint after the button is released to make sure that it is locked in place.

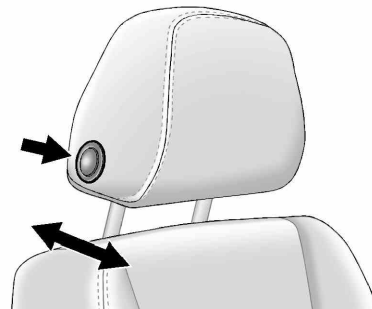

To adjust the head restraint forward and rearward, press the button located on the side facing of the head restraint and move it forward or rearward until the desired locking position is reached. Try to move the head restraint after the button is released to make sure that it is locked in place.

The front seat outboard head restraints are not removable.

Rear Seats

The vehicle's rear seats have headrests in the outboard seating positions that cannot be adjusted.

The rear outboard headrests are not removable.

Front Seats

Easy Entry Seat

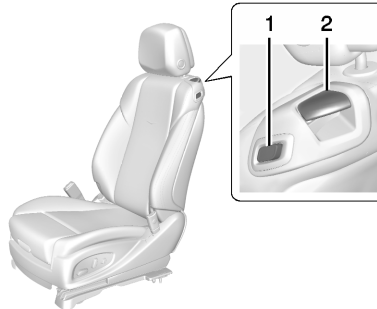

1. Seat Adjustment Switch
2. Folding Seatback Handle

The front seats can be moved out of the way to make it easier to get in and out of the rear seat.

To fold the seatback, lift the handle (2) on top of the seatback. The seatback will fold forward.

To move the seat forward, press and hold the front of the switch (1) on the outboard side of the upper seatback. To move the seat rearward, press and hold the rear of the switch (1). Release the switch (1) when the seat reaches the desired position.

After entering or exiting the rear seat, return the seatback to the upright position. Lift the seatback and push it rearward until it locks into place. Push and pull on the seatback to make sure it is locked.

Warning

If either seatback is not locked, it could move forward in a sudden stop or crash. That could cause injury to the person sitting there. Always push and pull on the seatbacks to be sure they are locked.

3-4 Seats and Restraints

Power Seat Adjustment

Warning

You can lose control of the vehicle if you try to adjust a driver seat while the vehicle is moving. Adjust the driver seat only when the vehicle is not moving.

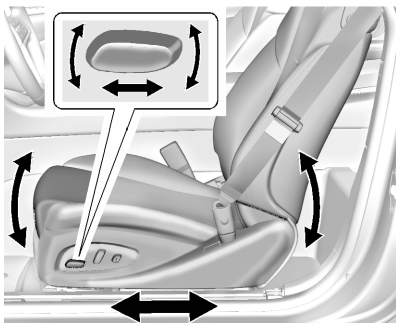

To adjust the seat:

- Move the seat forward or rearward by sliding the control forward or rearward.

The seat can also be adjusted forward or rearward using the switch on the outboard side of the upper seatback. See *Easy Entry Seat* on page 3-3.

- Raise or lower the front part of the seat cushion by moving the front of the control up or down.
- Raise or lower the seat by moving the rear of the control up or down.

To adjust the seatback, see *Reclining Seatbacks* on page 3-5.

To adjust the lumbar support, see *Lumbar Adjustment* on page 3-4.

Some vehicles are equipped with a feature that activates a vibrating pulse alert in the driver seat to help the driver avoid crashes. See *Driver Assistance Systems* on page 9-47.

Lumbar Adjustment

Lumbar Support

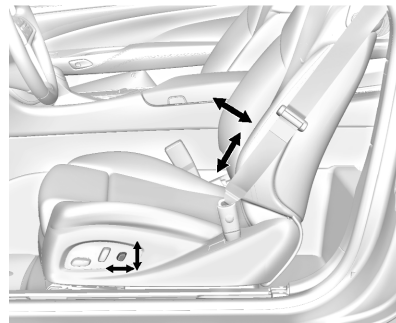

To adjust the lumbar support:

- Press and hold the control forward to increase or rearward to decrease lumbar support.
- Press and hold the control up to raise or down to lower the height of the lumbar support.

Seatback Bolster Support

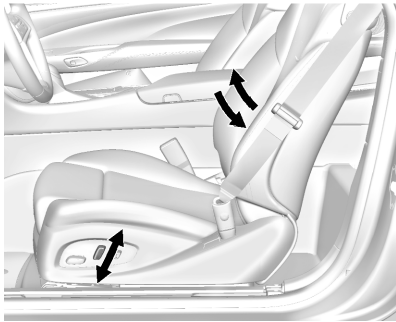

If equipped, to adjust the bolster support:

- Press and hold the control up to increase seatback bolster support.
- Press and hold the control down to decrease seatback bolster support.

The seatback bolster support control is also used to recline and raise the seatback. See *Reclining Seatbacks* on page 3-5.

Thigh Support Adjustment

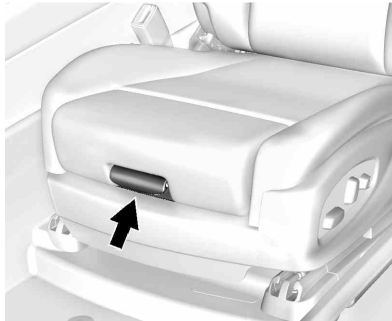

If equipped, adjust the manual leg extension by pulling up on the lever, and then pulling or pushing on the support to lengthen or shorten it. Release the lever to lock it in place.

Reclining Seatbacks

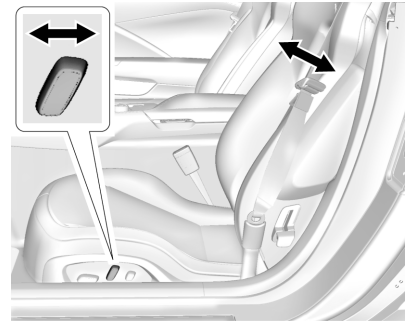

To adjust the seatback:

- Tilt the top of the control rearward to recline.
- Tilt the top of the control forward to raise.

The reclining seatback control is also used to adjust the seatback bolster support. See *Lumbar Adjustment* on page 3-4.

3-6 Seats and Restraints

Warning

Sitting in a reclined position when the vehicle is in motion can be dangerous. Even when buckled up, the safety belts cannot do their job.

The shoulder belt will not be against your body. Instead, it will be in front of you. In a crash, you could go into it, receiving neck or other injuries.

The lap belt could go up over your abdomen. The belt forces would be there, not at your pelvic bones. This could cause serious internal injuries.

For proper protection when the vehicle is in motion, have the seatback upright. Then sit well back in the seat and wear the safety belt properly.



Do not have a seatback reclined if the vehicle is moving.

Memory Seats

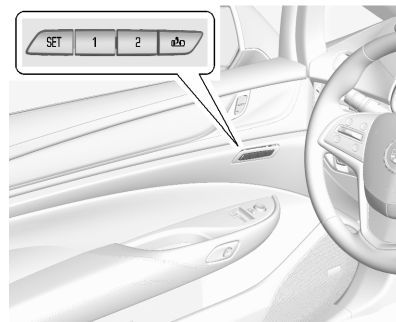



The SET, "1," "2," and  (Exit) buttons on the driver door are used to manually save and recall memory settings for the driver seat, outside mirrors, and power tilt and telescoping steering column.

Storing Memory Positions



To save positions to the “1” and “2” buttons:

1. Adjust the driver seat, outside mirrors, and the power tilt and telescoping steering column to the desired driving positions.
2. Press and release SET. A beep will sound.
3. Immediately press and hold “1” until two beeps sound.
4. Repeat Steps 1 and 2 for a second driver using “2.”

To save positions to the  (Exit) button and easy exit features:

1. Adjust the driver seat, power tilt and telescoping steering column, and the outside mirrors on some vehicles to the desired positions for getting out of the vehicle.
2. Press and release SET. A beep will sound.
3. Immediately press and hold  until two beeps sound.

Manually Recalling Memory Positions

If the vehicle is OFF or not in P (Park), press and hold “1,” “2,” or  to manually recall the previously stored memory positions. Releasing “1,” “2,” or  before the stored positions are reached stops the recall.



If the vehicle is ON and in P (Park), press and release “1,” “2,” or  to manually recall the previously stored memory positions. Placing the ignition in OFF before the stored positions are reached stops the recall.

Automatically Recalling Memory Positions (Auto Memory Recall)

The Auto (Automatic) Memory Recall feature automatically recalls the current driver’s previously stored “1” or “2” position when entering the vehicle.

Depending upon the Auto Memory Recall feature enabled in the vehicle personalization menu, memory “1” or “2” positions are recalled in the following ways:

To activate the recall when On - Driver Door Open is selected in the personalization menu, do one of the following:

- Press  on the RKE transmitter and open the driver door.
- Press  on the RKE transmitter when the driver door is already open.

To activate the recall when On - At Ignition On is selected in the vehicle personalization menu:

- Place the ignition in ON/RUN/START.

See *Vehicle Personalization on page 5-52*.

To stop recall movement, press one of the memory, power mirror, or power seat controls; or press the power tilt and telescoping steering

3-8 Seats and Restraints

column control. If On - At Ignition On is selected in the vehicle personalization menu, placing the ignition in OFF also stops the recall.

Easy Exit Recall

If programmed on in the vehicle personalization menu, the easy exit feature automatically moves the driver seat, power tilt and telescoping steering column, and outside mirrors on some vehicles to the memory positions previously saved to the  (Exit) button. See “Storing Memory Positions” listed previously. See also *Vehicle Personalization on page 5-52*.

Easy exit recall automatically activates when one of the following occurs:

- The vehicle is turned off and the driver door is opened within a short time.
- The vehicle is turned off with the driver door open.

Obstructions

If something has blocked driver seat and/or power tilt and telescoping steering column while recalling a memory position, the recall may stop. Remove the obstruction. Then do one of the following:

- If manually recalling the position, press and hold the appropriate manual control for the memory item that is not recalling for two seconds. Try recalling again by pressing the appropriate memory button.
- If automatically recalling the position, press and hold the appropriate manual control for the memory item that is not recalling for two seconds. Try recalling again by opening the driver door and pressing  on the RKE transmitter.
- If recalling the exit position, press and hold the appropriate manual control for the exit

feature not recalling for two seconds. Then try recalling the exit position again.

If the memory position is still not recalling, see your dealer for service.

Heated Front Seats

Warning

If you cannot feel temperature change or pain to the skin, the seat heater may cause burns. To reduce the risk of burns, people with such a condition should use care when using the seat heater, especially for long periods of time. Do not place anything on the seat that insulates against heat, such as a blanket, cushion, cover, or similar item. This may cause the seat heater to overheat. An overheated seat heater may cause a burn or may damage the seat.

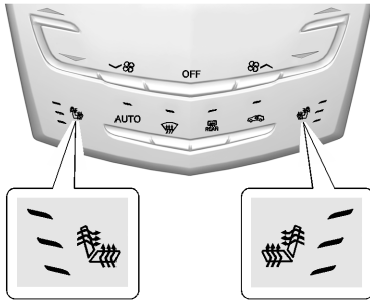

The buttons are near the climate controls on the center stack. To operate, the ignition must be in ON/RUN/START.

Press or to heat the driver or passenger seat cushion and seatback.

Press the button once for the highest setting. With each press of the button, the seat will change to the next lower setting, and then to the off setting. The indicator lights next to the buttons indicate three for

the highest setting and one for the lowest. If the heated seats are on high, the level may automatically be lowered after approximately 30 minutes.

When this feature is off, the heated seat symbol on the button is white. When the heated seat is turned on, the symbol turns red.

The passenger seat may take longer to heat up.

Auto Heated Seats

The controls can be accessed while the vehicle is on by pressing CLIMATE on the infotainment home screen.

Press the touch screen AUTO or AUTO button. The area around the button will change to red when this feature is on.

When the vehicle is on, this feature will automatically activate the heated seats at the level required by the vehicle's interior temperature.

The active high, medium, low, or off heated seat level will be indicated by the manual heated seat buttons on the center stack. Use the touch screen button or the manual heated seat buttons on the center stack to turn auto heated seats off.

If the passenger seat is unoccupied, the auto heated seats feature will not activate that seat.

The auto heated seats feature can be programmed to always be enabled when the vehicle is on. See *Vehicle Personalization on page 5-52*.

Remote Start Auto Heated Seats

When it is cold outside, the heated seats can be turned on automatically during a remote start. They are canceled when the ignition is turned on. Press the button to use the heated seats after the vehicle is started.

The heated seat indicator lights do not turn on during a remote start.

3-10 Seats and Restraints

The temperature performance of an unoccupied seat may be reduced. This is normal.

The heated seats will not turn on during a remote start unless they are enabled in the vehicle personalization menu. See *Vehicle Personalization* on page 5-52 and *Remote Start* on page 2-8.

Rear Seats

Folding the Seatback

Either seatback can be folded for more cargo space. Fold a seatback only when the vehicle is not moving.

 **Caution**

Folding a rear seat with the safety belts still fastened may cause damage to the seat or the safety belts. Always unbuckle the safety belts and return them to their normal stowed position before folding a rear seat.

To fold a seatback:

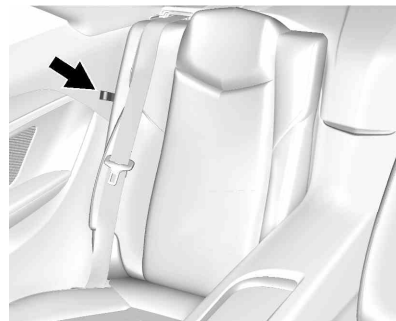

1. Pull the tab on the outboard side of the seatback to release the seatback.
2. Fold the seatback forward.
3. Repeat Steps 1–2 to fold the other seatback, if desired.

Raising the Seatback

 **Warning**

If either seatback is not locked, it could move forward in a sudden stop or crash. That could cause injury to the person sitting there. Always push and pull on the seatbacks to be sure they are locked.

 **Warning**

A safety belt that is improperly routed, not properly attached, or twisted will not provide the protection needed in a crash. The person wearing the belt could be seriously injured. After raising the rear seatback, always check to be sure that the safety belts are properly routed and attached, and are not twisted.

To raise a seatback:

1. Lift the seatback and push it rearward to lock it in place.
2. Push and pull the top of the seatback to be sure it is locked.
3. Repeat the steps to raise the other seatback, if necessary.

When the seat is not in use, it should be kept in the upright, locked position.

Safety Belts

This section of the manual describes how to use safety belts properly. It also describes some things not to do with safety belts.

 **Warning**

Do not let anyone ride where a safety belt cannot be worn properly. In a crash, if you or your passenger(s) are not wearing safety belts, injuries can be much worse than if you are wearing safety belts. You can be seriously injured or killed by hitting things inside the vehicle harder or by being ejected from the vehicle. In addition, anyone who is not buckled up can strike other passengers in the vehicle.

It is extremely dangerous to ride in a cargo area, inside or outside of a vehicle. In a collision, passengers riding in these areas

(Continued)

3-12 Seats and Restraints

Warning (Continued)

are more likely to be seriously injured or killed. Do not allow passengers to ride in any area of the vehicle that is not equipped with seats and safety belts.

Always wear a safety belt, and check that all passenger(s) are restrained properly too.

This vehicle has indicators as a reminder to buckle the safety belts. See *Safety Belt Reminders* on page 5-14.

Why Safety Belts Work



When riding in a vehicle, you travel as fast as the vehicle does. If the vehicle stops suddenly, you keep going until something stops you. It could be the windshield, the instrument panel, or the safety belts!

When you wear a safety belt, you and the vehicle slow down together. There is more time to stop because you stop over a longer distance and, when worn properly, your strongest bones take the forces from the

safety belts. That is why wearing safety belts makes such good sense.

Questions and Answers About Safety Belts

Q: Will I be trapped in the vehicle after a crash if I am wearing a safety belt?

A: You *could* be — whether you are wearing a safety belt or not. Your chance of being conscious during and after a crash, so you *can* unbuckle and get out, is *much* greater if you are belted.

Q: If my vehicle has airbags, why should I have to wear safety belts?

A: Airbags are supplemental systems only; so they work *with* safety belts — not instead of them. Whether or not an airbag is provided, all occupants still have to buckle up to get the most protection.

Also, in nearly all states and in all Canadian provinces, the law requires wearing safety belts.

How to Wear Safety Belts Properly

This section is only for people of adult size.

There are special things to know about safety belts and children. And there are different rules for smaller children and infants. If a child will be riding in the vehicle, see *Older Children* on page 3-32 or *Infants and Young Children* on page 3-34. Follow those rules for everyone's protection.

It is very important for all occupants to buckle up. Statistics show that unbelted people are hurt more often in crashes than those who are wearing safety belts.

There are important things to know about wearing a safety belt properly.

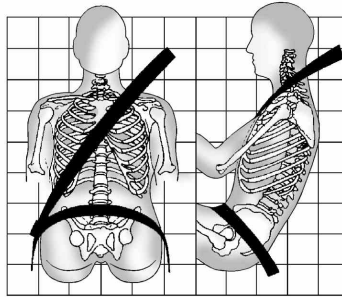

- Sit up straight and always keep your feet on the floor in front of you.
- Always use the correct buckle for your seating position.
- Wear the lap part of the belt low and snug on the hips, just touching the thighs. In a crash, this applies force to the strong pelvic bones and you would be less likely to slide under the lap belt. If you slid under it, the belt

would apply force on your abdomen. This could cause serious or even fatal injuries.

- Wear the shoulder belt over the shoulder and across the chest. These parts of the body are best able to take belt restraining forces. The shoulder belt locks if there is a sudden stop or crash.

Warning

You can be seriously injured, or even killed, by not wearing your safety belt properly.

- Never allow the lap or shoulder belt to become loose or twisted.
- Never wear the shoulder belt under both arms or behind your back.
- Never route the lap or shoulder belt over an armrest.

3-14 Seats and Restraints

Lap-Shoulder Belt

All seating positions in the vehicle have a lap-shoulder belt.

The following instructions explain how to wear a lap-shoulder belt properly.

1. Adjust the seat, if the seat is adjustable, so you can sit up straight. To see how, see "Seats" in the Index.

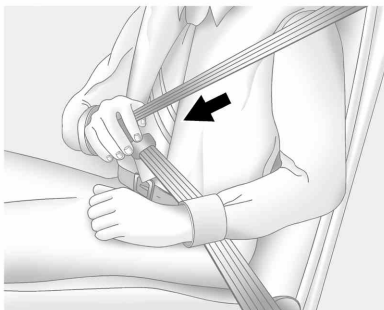

2. Pick up the latch plate and pull the belt across you. Do not let it get twisted.

The lap-shoulder belt may lock if you pull the belt across you very quickly. If this happens, let the belt go back slightly to unlock it. Then pull the belt across you more slowly.

If the shoulder portion of a passenger belt is pulled out all the way, the child restraint locking feature may be engaged. If this happens, let the belt go back all the way and start again.

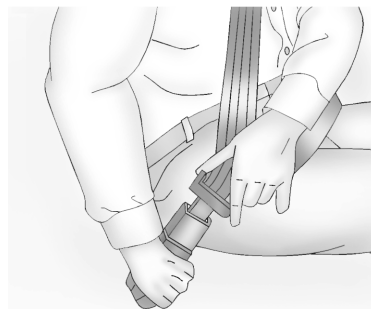

3. Push the latch plate into the buckle until it clicks.

Pull up on the latch plate to make sure it is secure. If the belt is not long enough, see *Safety Belt Extender* on page 3-17.

Position the release button on the buckle so that the safety belt could be quickly unbuckled if necessary.

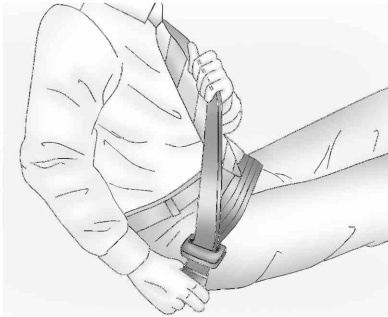

4. To make the lap part tight, pull up on the shoulder belt.

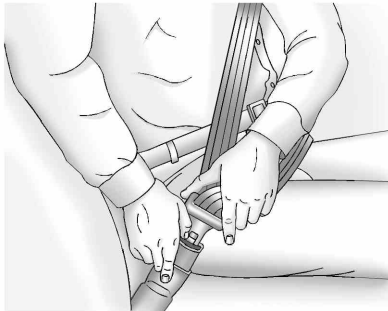

To unlatch the belt, push the button on the buckle. The belt should return to its stowed position.

Before a door is closed, be sure the safety belt is out of the way. If a door is slammed against a safety belt, damage can occur to both the safety belt and the vehicle.

The front passenger safety belt is equipped with an adjustable latch plate stop. The feature allows the user to position the latch plate on the belt to prevent contact with the adjacent door trim and to ensure the safety belt is out of the way when closing the door. If the latch plate contacts the door trim when the belt is returned to its stowed position, slide the adjustable latch plate stop to a higher position.

Safety Belt Pretensioners

This vehicle has safety belt pretensioners for front outboard occupants. Although the safety belt pretensioners cannot be seen, they are part of the safety belt assembly. They can help tighten the safety

belts during the early stages of a moderate to severe frontal, near frontal, or rear crash if the threshold conditions for pretensioner activation are met. Safety belt pretensioners can also help tighten the safety belts in a side crash or a rollover event.

Pretensioners work only once. If the pretensioners activate in a crash, the pretensioners and possibly other parts of the safety belt system will need to be replaced. See *Replacing Safety Belt System Parts after a Crash* on page 3-18.

Rear Safety Belt Comfort Guides

This vehicle may have rear safety belt comfort guides. If not, they are available through your dealer.

Rear safety belt comfort guides may provide added safety belt comfort for older children who have outgrown booster seats and for some adults. When installed on a

3-16 Seats and Restraints

shoulder belt, the comfort guide positions the shoulder belt away from the neck and head.

To install:



1. Remove the guide from its storage pocket on the side of the seat.

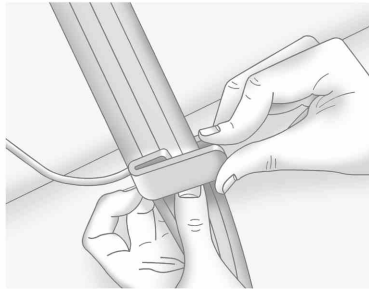

2. Place the guide over the belt, and insert the two edges of the belt into the slots of the guide.

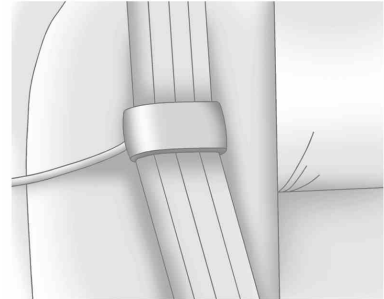

3. Be sure that the belt is not twisted and it lies flat. The elastic cord must be behind the belt with the plastic guide on the front.

Warning

A safety belt that is not properly worn may not provide the protection needed in a crash. The person wearing the belt could be seriously injured. The shoulder belt should go over the shoulder

(Continued)

Warning (Continued)

and across the chest. These parts of the body are best able to take belt restraining forces.

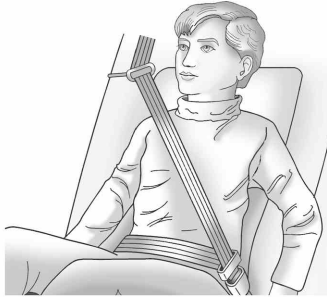

4. Buckle, position, and release the safety belt as described previously in this section. Make sure the shoulder portion of the belt is on the shoulder and not falling off of it. The belt should be close to, but not contacting, the neck.

To remove and store the comfort guide, squeeze the belt edges together so that the safety belt can be removed from the guide. Store the guide in its storage pocket on the side of the seatback.

Safety Belt Use During Pregnancy

Safety belts work for everyone, including pregnant women. Like all occupants, they are more likely to be seriously injured if they do not wear safety belts.



A pregnant woman should wear a lap-shoulder belt, and the lap portion should be worn as low as possible, below the rounding, throughout the pregnancy.

The best way to protect the fetus is to protect the mother. When a safety belt is worn properly, it is more likely that the fetus will not be hurt in a crash. For pregnant women, as for anyone, the key to making safety belts effective is wearing them properly.

Safety Belt Extender

If the vehicle's safety belt will fasten around you, you should use it.

But if a safety belt is not long enough, your dealer will order you an extender. When you go in to order it, take the heaviest coat you will wear, so the extender will be long enough for you. To help avoid personal injury, do not let someone else use it, and use it only for the seat it is made to fit. The extender has been designed for adults.

3-18 Seats and Restraints

Never use it for securing child seats. To wear it, attach it to the regular safety belt. See the instruction sheet that comes with the extender.

Safety System Check

Now and then, check that the safety belt reminder light, safety belts, buckles, latch plates, retractors, and anchorages are all working properly. Look for any other loose or damaged safety belt system parts that might keep a safety belt system from doing its job. See your dealer to have it repaired. Torn or frayed safety belts may not protect you in a crash. They can rip apart under impact forces. If a belt is torn or frayed, get a new one right away.

Make sure the safety belt reminder light is working. See *Safety Belt Reminders on page 5-14*.

Keep safety belts clean and dry. See *Safety Belt Care on page 3-18*.

Safety Belt Care

Keep belts clean and dry.

Warning

Do not bleach or dye safety belts. It may severely weaken them. In a crash, they might not be able to provide adequate protection. Clean safety belts only with mild soap and lukewarm water.

Replacing Safety Belt System Parts after a Crash

Warning

A crash can damage the safety belt system in the vehicle. A damaged safety belt system may not properly protect the person using it, resulting in serious injury or even death in a crash. To help make sure the safety belt systems are working properly after a crash, have them inspected and any necessary replacements made as soon as possible.

After a minor crash, replacement of safety belts may not be necessary. But the safety belt assemblies that were used during any crash may have been stressed or damaged. See your dealer to have the safety belt assemblies inspected or replaced.

New parts and repairs may be necessary even if the safety belt system was not being used at the time of the crash.

Have the safety belt pretensioners checked if the vehicle has been in a crash, or if the airbag readiness light stays on after you start the vehicle or while you are driving. See *Airbag Readiness Light* on page 5-16.

Airbag System

The vehicle has the following airbags:

- A frontal airbag for the driver.
- A frontal airbag for the front outboard passenger.
- A knee airbag for the driver.
- A knee airbag for the front outboard passenger.
- A seat-mounted side impact airbag for the driver.
- A seat-mounted side impact airbag for the front outboard passenger.
- A roof-rail airbag for the driver and the passenger seated directly behind the driver.
- A roof-rail airbag for the front outboard passenger and the passenger seated directly behind the front outboard passenger.

All vehicle airbags have the word AIRBAG on the trim or on a label near the deployment opening.

For frontal airbags, the word AIRBAG is on the center of the steering wheel for the driver and on the instrument panel for the front outboard passenger.

For knee airbags, the word AIRBAG is on the lower part of the instrument panel.

For seat-mounted side impact airbags, the word AIRBAG is on the side of the seatback closest to the door.

For roof-rail airbags, the word AIRBAG is on the ceiling or trim.

Airbags are designed to supplement the protection provided by safety belts. Even though today's airbags are also designed to help reduce the risk of injury from the force of an inflating bag, all airbags must inflate very quickly to do their job.

3-20 Seats and Restraints

Here are the most important things to know about the airbag system:

Warning

You can be severely injured or killed in a crash if you are not wearing your safety belt, even with airbags. Airbags are designed to work with safety belts, not replace them. Also, airbags are not designed to inflate in every crash. In some crashes safety belts are the only restraint. See *When Should an Airbag Inflate?* on page 3-22.

Wearing your safety belt during a crash helps reduce the chance of hitting things inside the vehicle or being ejected from it. Airbags are “supplemental restraints” to the safety belts. Everyone in the vehicle should wear a safety belt properly, whether or not there is an airbag for that person.

Warning

Because airbags inflate with great force and faster than the blink of an eye, anyone who is up against, or very close to any airbag when it inflates can be seriously injured or killed. Do not sit unnecessarily close to any airbag, as you would be if sitting on the edge of the seat or leaning forward. Safety belts help keep you in position before and during a crash. Always wear a safety belt, even with airbags. The driver should sit as far back as possible while still maintaining control of the vehicle.

Occupants should not lean on or sleep against the door or side windows in seating positions with seat-mounted side impact airbags and/or roof-rail airbags.

Warning

Children who are up against, or very close to, any airbag when it inflates can be seriously injured or killed. Always secure children properly in the vehicle. To read how, see *Older Children* on page 3-32 or *Infants and Young Children* on page 3-34.



There is an airbag readiness light on the instrument cluster, which shows the airbag symbol. The system checks the airbag electrical system for malfunctions. The light tells you if there is an electrical problem. See *Airbag Readiness Light* on page 5-16 for more information.

Where Are the Airbags?

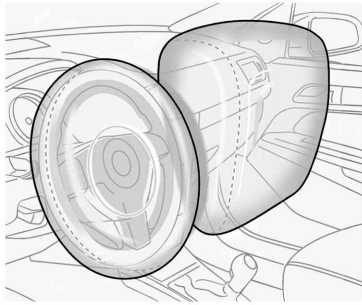

The driver frontal airbag is in the center of the steering wheel.

The front outboard passenger frontal airbag is in the passenger side instrument panel.

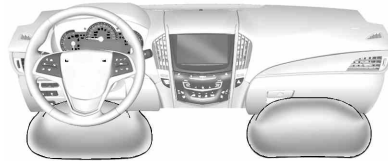

The driver knee airbag is below the steering column. The front outboard passenger knee airbag is below the glove box.

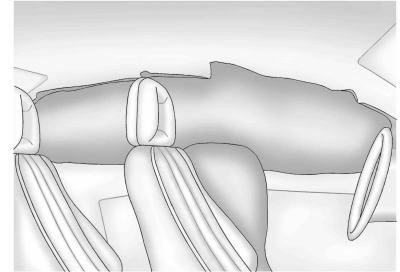

Driver Side Shown, Passenger Side Similar

The seat-mounted side impact airbags for the driver and front outboard passenger are in the side of the seatbacks closest to the door.

The roof-rail airbags for the driver, front outboard passenger, and second row outboard passengers are in the ceiling above the side windows.

Warning

If something is between an occupant and an airbag, the airbag might not inflate properly or it might force the object into that person causing severe injury or even death. The path of an inflating airbag must be kept clear. Do not put anything between an occupant and an airbag, and do not attach or put anything on the steering wheel hub or on or near any other airbag covering.

Do not use seat accessories that block the inflation path of a seat-mounted side impact airbag.

Never secure anything to the roof of a vehicle with roof-rail airbags by routing a rope or tie-down through any door or window opening. If you do, the path of an inflating roof-rail airbag will be blocked.

When Should an Airbag Inflate?

This vehicle is equipped with airbags. See *Airbag System on page 3-19*. Airbags are designed to inflate if the impact exceeds the specific airbag system's deployment threshold. Deployment thresholds are used to predict how severe a crash is likely to be in time for the airbags to inflate and help restrain the occupants. The vehicle has electronic sensors that help the airbag system determine the severity of the impact. Deployment thresholds can vary with specific vehicle design.

Frontal airbags are designed to inflate in moderate to severe frontal or near frontal crashes to help reduce the potential for severe injuries, mainly to the driver's or front outboard passenger's head and chest.

Whether the frontal airbags will or should inflate is not based primarily on how fast the vehicle is traveling.

It depends on what is hit, the direction of the impact, and how quickly the vehicle slows down.

Frontal airbags may inflate at different crash speeds depending on whether the vehicle hits an object straight on or at an angle, and whether the object is fixed or moving, rigid or deformable, narrow or wide.

Frontal airbags are not intended to inflate during vehicle rollovers, in rear impacts, or in many side impacts.

In addition, the vehicle has advanced technology frontal airbags. Advanced technology frontal airbags adjust the restraint according to crash severity.

Knee airbags are designed to inflate in moderate to severe frontal or near frontal impacts. Knee airbags are not designed to inflate during vehicle rollovers, in rear impacts, or in many side impacts.

Seat-mounted side impact airbags are designed to inflate in moderate to severe side crashes depending on the location of the impact.

Seat-mounted side impact airbags are not designed to inflate in frontal impacts, near frontal impacts, rollovers, or rear impacts.

A seat-mounted side impact airbag is designed to inflate on the side of the vehicle that is struck.

Roof-rail airbags are designed to inflate in moderate to severe side crashes depending on the location of the impact. In addition, these roof-rail airbags are designed to inflate during a rollover or in a severe frontal impact. Roof-rail airbags are not designed to inflate in rear impacts. Both roof-rail airbags will inflate when either side of the vehicle is struck, if the sensing system predicts that the vehicle is about to roll over on its side, or in a severe frontal impact.

In any particular crash, no one can say whether an airbag should have inflated simply because of the vehicle damage or repair costs.

What Makes an Airbag Inflate?

In a deployment event, the sensing system sends an electrical signal triggering a release of gas from the inflator. Gas from the inflator fills the airbag causing the bag to break out of the cover. The inflator, the airbag, and related hardware are all part of the airbag module.

For airbag locations, see *Where Are the Airbags?* on page 3-21.

How Does an Airbag Restrain?

In moderate to severe frontal or near frontal collisions, even belted occupants can contact the steering wheel or the instrument panel. In

moderate to severe side collisions, even belted occupants can contact the inside of the vehicle.

Airbags supplement the protection provided by safety belts by distributing the force of the impact more evenly over the occupant's body.

Rollover capable roof-rail airbags are designed to help contain the head and chest of occupants in the outboard seating positions in the first and second rows. The rollover capable roof-rail airbags are designed to help reduce the risk of full or partial ejection in rollover events, although no system can prevent all such ejections.

But airbags would not help in many types of collisions, primarily because the occupant's motion is not toward those airbags. See *When Should an Airbag Inflate?* on page 3-22.

Airbags should never be regarded as anything more than a supplement to safety belts.

What Will You See after an Airbag Inflates?

After the frontal airbags and seat-mounted side impact airbags inflate, they quickly deflate, so quickly that some people may not even realize an airbag inflated. Roof-rail airbags may still be at least partially inflated for some time after they inflate. Some components of the airbag module may be hot for several minutes. For location of the airbags, see *Where Are the Airbags?* on page 3-21.

The parts of the airbag that come into contact with you may be warm, but not too hot to touch. There may be some smoke and dust coming from the vents in the deflated airbags. Airbag inflation does not prevent the driver from seeing out of the windshield or being able to steer the vehicle, nor does it prevent people from leaving the vehicle.

Warning

When an airbag inflates, there may be dust in the air. This dust could cause breathing problems for people with a history of asthma or other breathing trouble. To avoid this, everyone in the vehicle should get out as soon as it is safe to do so. If you have breathing problems but cannot get out of the vehicle after an airbag inflates, then get fresh air by opening a window or a door. If you experience breathing problems following an airbag deployment, you should seek medical attention.

The vehicle has a feature that may automatically unlock the doors, turn on the interior lamps, turn on the hazard warning flashers, and shut off the fuel system after the airbags inflate. The feature may also activate, without airbag inflation, after an event that exceeds a

predetermined threshold. You can lock the doors, turn off the interior lamps, and turn off the hazard warning flashers by using the controls for those features.

Warning

A crash severe enough to inflate the airbags may have also damaged important functions in the vehicle, such as the fuel system, brake and steering systems, etc. Even if the vehicle appears to be drivable after a moderate crash, there may be concealed damage that could make it difficult to safely operate the vehicle.

Use caution if you should attempt to restart the engine after a crash has occurred.

If an airbag inflates or the vehicle has been in a crash, the sensing system may shut down the high voltage system. When this occurs,

the high voltage battery is disconnected and the vehicle will not start. The SERVICE VEHICLE SOON message in the Driver Information Center (DIC) will be displayed. Before the vehicle can be operated again, it must be serviced at your dealer.

In many crashes severe enough to inflate the airbag, windshields are broken by vehicle deformation. Additional windshield breakage may also occur from the front outboard passenger airbag.

- Airbags are designed to inflate only once. After an airbag inflates, you will need some new parts for the airbag system. If you do not get them, the airbag system will not be there to help protect you in another crash. A new system will include airbag modules and possibly other parts. The service manual for the vehicle covers the need to replace other parts.

- The vehicle has a crash sensing and diagnostic module which records information after a crash. See *Vehicle Data Recording and Privacy on page 13-14* and *Event Data Recorders on page 13-14*.
- Let only qualified technicians work on the airbag systems. Improper service can mean that an airbag system will not work properly. See your dealer for service.

Passenger Sensing System

The vehicle has a passenger sensing system for the front outboard passenger position. The passenger airbag status indicator will light on the overhead console when the vehicle is started.



United States



Canada

The words ON and OFF or the symbol for on and off will be visible during the system check. When the system check is complete, either the word ON or OFF, or the symbol for on and off will be visible. See *Passenger Airbag Status Indicator on page 5-16*.

The passenger sensing system turns off the front outboard passenger frontal airbag and passenger knee airbag under

3-26 Seats and Restraints

certain conditions. No other airbag is affected by the passenger sensing system.

The passenger sensing system works with sensors that are part of the front outboard passenger seat. The sensors are designed to detect the presence of a properly seated occupant and determine if the front outboard passenger frontal airbag and passenger knee airbag should be allowed to inflate or not.

According to accident statistics, children are safer when properly secured in a rear seat in a correct child restraint for their weight and size.

Whenever possible, children age 12 and under should be secured in a rear seating position.

Never put a rear-facing child seat in the front. This is because the risk to the rear-facing child is so great, if the airbag inflates.

Warning

A child in a rear-facing child restraint can be seriously injured or killed if the front outboard passenger frontal airbag inflates. This is because the back of the rear-facing child restraint would be very close to the inflating airbag. A child in a forward-facing child restraint can be seriously injured or killed if the front outboard passenger frontal airbag inflates and the passenger seat is in a forward position.

Even if the passenger sensing system has turned off the front outboard passenger airbag(s), no system is fail-safe. No one can guarantee that an airbag will not inflate under some unusual circumstance, even though the airbag(s) are off.

(Continued)

Warning (Continued)

Secure rear-facing child restraints in a rear seat, even if the airbag(s) are off. If you secure a forward-facing child restraint in the front outboard passenger seat, always move the seat as far back as it will go. It is better to secure the child restraint in a rear seat.

The passenger sensing system is designed to turn off the front outboard passenger airbag and passenger knee airbag if:

- The front outboard passenger seat is unoccupied.
- The system determines that an infant is present in a child restraint.
- A front outboard passenger takes his/her weight off of the seat for a period of time.

- There is a critical problem with the airbag system or the passenger sensing system.

When the passenger sensing system has turned off the front outboard passenger frontal airbag and passenger knee airbag, the off indicator will light and stay lit to remind you that the airbags are off. See *Passenger Airbag Status Indicator* on page 5-16.

The passenger sensing system is designed to turn on the front outboard passenger frontal airbag and passenger knee airbag anytime the system senses that a person of adult size is sitting properly in the front outboard passenger seat.

When the passenger sensing system has allowed the airbags to be enabled, the on indicator will light and stay lit as a reminder that the airbags are active.

For some children, including children in child restraints, and for very small adults, the passenger sensing system may or may not turn

off the front outboard passenger frontal airbag and passenger knee airbag, depending upon the person's seating posture and body build. Everyone in the vehicle who has outgrown child restraints should wear a safety belt properly — whether or not there is an airbag for that person.

Warning

If the airbag readiness light ever comes on and stays on, it means that something may be wrong with the airbag system. To help avoid injury to yourself or others, have the vehicle serviced right away. See *Airbag Readiness Light* on page 5-16 for more information, including important safety information.

If the On Indicator Is Lit for a Child Restraint

The passenger sensing system is designed to turn off the front outboard passenger frontal airbag and knee airbag if the system determines that an infant is present in a child restraint. If a child restraint has been installed and the on indicator is lit:

1. Turn the vehicle off.
2. Remove the child restraint from the vehicle.
3. Remove any additional items from the seat such as blankets, cushions, seat covers, seat heaters, or seat massagers.
4. Reinstall the child restraint following the directions provided by the child restraint manufacturer and refer to *Securing Child Restraints (Rear Seat)* on page 3-45 or *Securing Child Restraints (Front Passenger Seat)* on page 3-47.

3-28 Seats and Restraints

5. If, after reinstalling the child restraint and restarting the vehicle, the on indicator is still lit, turn the vehicle off. Then slightly recline the vehicle seatback and adjust the seat cushion, if adjustable, to make sure that the vehicle seatback is not pushing the child restraint into the seat cushion.

Also make sure the child restraint is not trapped under the vehicle head restraint. If this happens, adjust the head restraint. See *Head Restraints on page 3-2*.

6. Restart the vehicle.

The passenger sensing system may or may not turn off the airbags for a child in a child restraint depending upon the child's size. It is better to secure a child restraint in a rear seat.

If the Off Indicator Is Lit for an Adult-Sized Occupant



If a person of adult size is sitting in the front outboard passenger seat, but the off indicator is lit, it could be because that person is not sitting properly in the seat. Use the following steps to allow the system to detect that person and enable the front outboard passenger frontal airbag and passenger knee airbag:

1. Turn the vehicle off.

2. Remove any additional material from the seat, such as blankets, cushions, seat covers, seat heaters, or seat massagers. Also remove laptops, or other electronic devices.
3. Place the seatback in the fully upright position.
4. Have the person sit upright in the seat, centered on the seat cushion, with legs comfortably extended.
5. Restart the vehicle and have the person remain in this position for two to three minutes after the on indicator is lit.

Warning

If the front outboard passenger airbag is turned off for an adult-sized occupant, the airbag will not be able to inflate and help protect that person in a crash, resulting in an increased risk of

(Continued)

Warning (Continued)

serious injury or even death. An adult-sized occupant should not ride in the front outboard passenger seat, if the passenger airbag off indicator is lit.

Additional Factors Affecting System Operation

Safety belts help keep the passenger in position on the seat during vehicle maneuvers and braking, which helps the passenger sensing system maintain the passenger airbag status. See “Safety Belts” and “Child Restraints” in the Index for additional information about the importance of proper restraint use.

A thick layer of additional material, such as a blanket or cushion, or aftermarket equipment such as

seat covers, seat heaters, and seat massagers can affect how well the passenger sensing system operates. We recommend that you not use seat covers or other aftermarket equipment except when approved by GM for your specific vehicle. See *Adding Equipment to the Airbag-Equipped Vehicle on page 3-30* for more information about modifications that can affect how the system operates.

A wet seat can affect the performance of the passenger sensing system. Here is how:

- The passenger sensing system may turn off the passenger frontal airbag and passenger knee airbag when liquid is soaked into the seat. If this happens, the off indicator will be lit, and the airbag readiness light on the instrument panel will also be lit.

- Liquid pooled on the seat that has not soaked in may make it more likely that the passenger sensing system will turn on the passenger frontal airbag and passenger knee airbag while a child restraint or child occupant is on the seat. If the passenger frontal airbag and passenger knee airbag are turned on, the on indicator will be lit.

If the front passenger seat gets wet, dry the seat immediately. If the airbag readiness light is lit, do not install a child restraint or allow anyone to occupy the seat. See *Airbag Readiness Light on page 5-16* for important safety information.

The on indicator may be lit if an object, such as a briefcase, handbag, grocery bag, laptop, or other electronic device, is put on an unoccupied seat. If this is not desired, remove the object from the seat.

Warning

Stowing of articles under the passenger seat or between the passenger seat cushion and seatback may interfere with the proper operation of the passenger sensing system.

Servicing the Airbag-Equipped Vehicle

Airbags affect how the vehicle should be serviced. There are parts of the airbag system in several places around the vehicle. Your dealer and the service manual have information about servicing the vehicle and the airbag system. To purchase a service manual, see *Service Publications Ordering Information* on page 13-11.

Warning

For up to 10 seconds after the vehicle is turned off and the 12-volt battery is disconnected, an airbag can still inflate during improper service. You can be injured if you are close to an airbag when it inflates. Avoid yellow connectors. They are probably part of the airbag system. Be sure to follow proper service procedures, and make sure the person performing work for you is qualified to do so.

Adding Equipment to the Airbag-Equipped Vehicle

Adding accessories that change the vehicle's frame, bumper system, height, front end, or side sheet metal, may keep the airbag system from working properly. The operation of the airbag system can also be affected by changing any parts of the front seats, safety belts,

the airbag sensing and diagnostic module, steering wheel, instrument panel, any of the airbag modules, ceiling or pillar garnish trim, overhead console, front sensors, side impact sensors, or airbag wiring.

Your dealer and the service manual have information about the location of the airbag sensors, sensing and diagnostic module, and airbag wiring.

In addition, the vehicle has a passenger sensing system for the front outboard passenger position, which includes sensors that are part of the passenger seat. The passenger sensing system may not operate properly if the original seat trim is replaced with non-GM covers, upholstery, or trim; or with GM covers, upholstery, or trim designed for a different vehicle. Any object, such as an aftermarket seat heater or a comfort-enhancing pad or device, installed under or on top of the seat fabric, could also interfere with the operation of the

passenger sensing system. This could either prevent proper deployment of the passenger airbag(s) or prevent the passenger sensing system from properly turning off the passenger airbag(s). See *Passenger Sensing System on page 3-25*.

The vehicle has rollover roof-rail airbags. See *Different Size Tires and Wheels on page 10-57*.

If you have to modify your vehicle because you have a disability and you have questions about whether the modifications will affect the vehicle's airbag system, or if you have questions about whether the airbag system will be affected if the vehicle is modified for any other reason, call Customer Assistance. See *Customer Assistance Offices on page 13-3*.

Airbag System Check

The airbag system does not need regularly scheduled maintenance or replacement. Make sure the airbag readiness light is working. See *Airbag Readiness Light on page 5-16*.

 **Caution**

If an airbag covering is damaged, opened, or broken, the airbag may not work properly. Do not open or break the airbag coverings. If there are any opened or broken airbag coverings, have the airbag covering and/or airbag module replaced. For the location of the airbags, see *Where Are the Airbags? on page 3-21*. See your dealer for service.

Replacing Airbag System Parts after a Crash

 **Warning**

A crash can damage the airbag systems in the vehicle. A damaged airbag system may not work properly and may not protect you and your passenger(s) in a crash, resulting in serious injury or even death. To help make sure the airbag systems are working properly after a crash, have them inspected and any necessary replacements made as soon as possible.

3-32 Seats and Restraints

If an airbag inflates, you will need to replace airbag system parts. See your dealer for service.

If the airbag readiness light stays on after the vehicle is started or comes on when you are driving, the airbag system may not work properly. Have the vehicle serviced right away. See *Airbag Readiness Light* on page 5-16.

Child Restraints

Older Children



Older children who have outgrown booster seats should wear the vehicle safety belts.

The manufacturer instructions that come with the booster seat state the weight and height limitations for that booster. Use a booster seat with a lap-shoulder belt until the child passes the fit test below:

- Sit all the way back on the seat. Do the knees bend at the seat edge? If yes, continue. If no, return to the booster seat.
- Buckle the lap-shoulder belt. Does the shoulder belt rest on the shoulder? If yes, continue. If no, try using the rear safety belt comfort guide, if available. See “Rear Safety Belt Comfort Guides” under *Lap-Shoulder Belt* on page 3-14. If a comfort guide is not available, or if the shoulder belt still does not rest on the shoulder, then return to the booster seat.
- Does the lap belt fit low and snug on the hips, touching the thighs? If yes, continue. If no, return to the booster seat.

- Can proper safety belt fit be maintained for the length of the trip? If yes, continue. If no, return to the booster seat.

Q: What is the proper way to wear safety belts?

A: An older child should wear a lap-shoulder belt and get the additional restraint a shoulder belt can provide. The shoulder belt should not cross the face or neck. The lap belt should fit snugly below the hips, just touching the top of the thighs. This applies belt force to the child's pelvic bones in a crash. It should never be worn over the abdomen, which could cause severe or even fatal internal injuries in a crash.

Also see "Rear Safety Belt Comfort Guides" under *Lap-Shoulder Belt* on page 3-14.

According to accident statistics, children are safer when properly restrained in a rear seating position.

In a crash, children who are not buckled up can strike other people who are buckled up, or can be thrown out of the vehicle. Older children need to use safety belts properly.

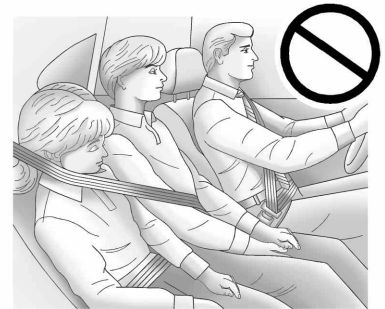

⚠ Warning

Never allow more than one child to wear the same safety belt. The safety belt cannot properly spread the impact forces. In a crash, they can be crushed together and seriously injured. A safety belt must be used by only one person at a time.

⚠ Warning

Never allow a child to wear the safety belt with the shoulder belt behind their back. A child can be seriously injured by not wearing the lap-shoulder belt properly. In a crash, the child would not be restrained by the shoulder belt. The child could move too far forward increasing the chance of head and neck injury. The child might also slide under the lap

(Continued)

Warning (Continued)

belt. The belt force would then be applied right on the abdomen. That could cause serious or fatal injuries. The shoulder belt should go over the shoulder and across the chest.



Infants and Young Children

Everyone in a vehicle needs protection! This includes infants and all other children. Neither the distance traveled nor the age and size of the traveler changes the need, for everyone, to use safety restraints. In fact, the law in every state in the United States and in every Canadian province says children up to some age must be restrained while in a vehicle.

Warning

Children can be seriously injured or strangled if a shoulder belt is wrapped around their neck. The shoulder belt can tighten but cannot be loosened if it is locked. The shoulder belt locks when it is pulled all the way out of the retractor. It unlocks when the shoulder belt is allowed to go all

(Continued)

Warning (Continued)

the way back into the retractor, but it cannot do this if it is wrapped around a child's neck. If the shoulder belt is locked and tightened around a child's neck, the only way to loosen the belt is to cut it.

Never leave children unattended in a vehicle and never allow children to play with the safety belts.

Every time infants and young children ride in vehicles, they should have the protection provided by appropriate child restraints. Neither the vehicle's safety belt system nor its airbag system is designed for them.

Children who are not restrained properly can strike other people, or can be thrown out of the vehicle.

⚠ Warning

Never hold an infant or a child while riding in a vehicle. Due to crash forces, an infant or a child will become so heavy it is not possible to hold it during a crash. For example, in a crash at only 40 km/h (25 mph), a 5.5 kg (12 lb) infant will suddenly become a 110 kg (240 lb) force on a person's arms. An infant should be secured in an appropriate restraint.



⚠ Warning

Children who are up against, or very close to, any airbag when it inflates can be seriously injured or killed. Never put a rear-facing child restraint in the front outboard seat. Secure a rear-facing child restraint in a rear seat. It is also better to secure a forward-facing child restraint in a rear seat. If you must secure a forward-facing child restraint in

(Continued)

Warning (Continued)

the front outboard seat, always move the front passenger seat as far back as it will go.



Q: What are the different types of add-on child restraints?

A: Add-on child restraints, which are purchased by the vehicle owner, are available in four basic types. Selection of a particular restraint should take into consideration not only the child's

3-36 Seats and Restraints

weight, height, and age but also whether or not the restraint will be compatible with the motor vehicle in which it will be used.

For most basic types of child restraints, there are many different models available. When purchasing a child restraint, be sure it is designed to be used in a motor vehicle. If it is, the restraint will have a label saying that it meets federal motor vehicle safety standards.

The restraint manufacturer instructions that come with the restraint state the weight and height limitations for a particular child restraint. In addition, there are many kinds of restraints available for children with special needs.

Warning

To reduce the risk of neck and head injury during a crash, infants need complete support. In a crash, if an infant is in a rear-facing child restraint, the crash forces can be distributed across the strongest part of an infant's body, the back and shoulders. Infants should always be secured in rear-facing child restraints.

Warning

A young child's hip bones are still so small that the vehicle's regular safety belt may not remain low on the hip bones, as it should. Instead, it may settle up around the child's abdomen. In a crash, the belt would apply force on a body area that is unprotected by any bony structure. This alone could cause serious or fatal injuries. To reduce the risk of serious or fatal injuries during a crash, young children should always be secured in appropriate child restraints.

Child Restraint Systems

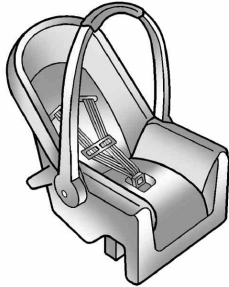

Rear-Facing Infant Seat

A rear-facing infant seat provides restraint with the seating surface against the back of the infant.

The harness system holds the infant in place and, in a crash, acts to keep the infant positioned in the restraint.

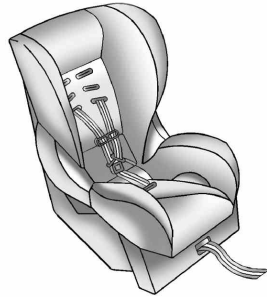

Forward-Facing Child Seat

A forward-facing child seat provides restraint for the child's body with the harness.

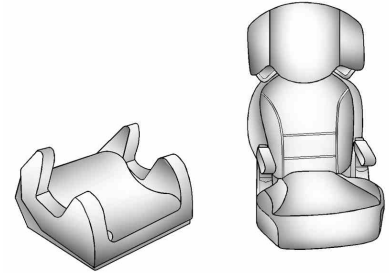

Booster Seats

A booster seat is a child restraint designed to improve the fit of the vehicle's safety belt system. A booster seat can also help a child to see out the window.

Securing an Add-On Child Restraint in the Vehicle

Warning

A child can be seriously injured or killed in a crash if the child restraint is not properly secured in the vehicle. Secure the child restraint properly in the vehicle using the vehicle safety belt or LATCH system, following the instructions that came with that child restraint and the instructions in this manual.

To help reduce the chance of injury, the child restraint must be secured in the vehicle. Child restraint systems must be secured in vehicle seats by lap belts or the lap belt portion of a lap-shoulder belt, or by the LATCH system. See *Lower Anchors and Tethers for Children (LATCH System)* on page 3-40.

Children can be endangered in a crash if the child restraint is not properly secured in the vehicle.

When securing an add-on child restraint, refer to the instructions that come with the restraint which may be on the restraint itself or in a booklet, or both, and to this manual. The child restraint instructions are important, so if they are not available, obtain a replacement copy from the manufacturer.

Keep in mind that an unsecured child restraint can move around in a collision or sudden stop and injure people in the vehicle. Be sure to properly secure any child restraint in the vehicle — even when no child is in it.

In some areas of the United States and Canada, Certified Child Passenger Safety Technicians (CPSTs) are available to inspect and demonstrate how to correctly use and install child restraints. In the U.S., refer to the National Highway Traffic Safety

Administration (NHTSA) website to locate the nearest child safety seat inspection station. For CPST availability in Canada, check with Transport Canada or the Provincial Ministry of Transportation office.

Securing the Child Within the Child Restraint

Warning

A child can be seriously injured or killed in a crash if the child is not properly secured in the child restraint. Secure the child properly following the instructions that came with that child restraint.

Where to Put the Restraint

According to accident statistics, children and infants are safer when properly restrained in a child restraint system or infant restraint system secured in a rear seating position.

Whenever possible, children aged 12 and under should be secured in a rear seating position.

Never put a rear-facing child seat in the front. This is because the risk to the rear-facing child is so great if the airbag deploys.

 **Warning**

A child in a rear-facing child restraint can be seriously injured or killed if the front passenger airbag inflates. This is because the back of the rear-facing child restraint would be very close to the inflating airbag. A child in a forward-facing child restraint can be seriously injured or killed if the front passenger airbag inflates and the passenger seat is in a forward position.

Even if the passenger sensing system has turned off the front passenger frontal airbag, no

(Continued)

Warning (Continued)

system is fail-safe. No one can guarantee that an airbag will not deploy under some unusual circumstance, even though it is turned off.

Secure rear-facing child restraints in a rear seat, even if the airbag is off. If you secure a forward-facing child restraint in the front seat, always move the front passenger seat as far back as it will go. It is better to secure the child restraint in a rear seat.

See *Passenger Sensing System on page 3-25* for additional information.

When securing a child restraint in a rear seating position, study the instructions that came with the child restraint to make sure it is compatible with this vehicle.

Child restraints and booster seats vary considerably in size, and some may fit in certain seating positions better than others. Always make sure the child restraint is properly secured.

Depending on where you place the child restraint and the size of the child restraint, you may not be able to access adjacent safety belt assemblies or LATCH anchors for additional passengers or child restraints. Adjacent seating positions should not be used if the child restraint prevents access to or interferes with the routing of the safety belt.

Wherever a child restraint is installed, be sure to secure the child restraint properly.

Keep in mind that an unsecured child restraint can move around in a collision or sudden stop and injure people in the vehicle. Be sure to properly secure any child restraint in the vehicle — even when no child is in it.

Lower Anchors and Tethers for Children (LATCH System)

The LATCH system secures a child restraint during driving or in a crash. LATCH attachments on the child restraint are used to attach the child restraint to the anchors in the vehicle. The LATCH system is designed to make installation of a child restraint easier.

In order to use the LATCH system in your vehicle, you need a child restraint that has LATCH attachments. LATCH-compatible rear-facing and forward-facing child seats can be properly installed using either the LATCH anchors or the vehicle's safety belts. Do not use both the safety belts and the LATCH anchorage system to secure a rear-facing or forward-facing child seat.

Booster seats use the vehicle's safety belts to secure the child in the booster seat. If the manufacturer

recommends that the booster seat be secured with the LATCH system, this can be done as long as the booster seat can be positioned properly and there is no interference with the proper positioning of the lap-shoulder belt on the child.

Make sure to follow the instructions that came with the child restraint, and also the instructions in this manual.

When installing a child restraint with a top tether, you must also use either the lower anchors or the safety belts to properly secure the child restraint. A child restraint must never be installed using only the top tether and anchor.

The LATCH anchorage system can be used until the combined weight of the child plus the child restraint is 29.5 kg (65 lbs). Use the safety belt alone instead of the LATCH anchorage system once the combined weight is more than 29.5 kg (65 lbs).

The following explains how to attach a child restraint with these attachments in the vehicle.

Not all vehicle seating positions or child restraints have lower anchors and attachments or top tether anchors and attachments.

Lower Anchors

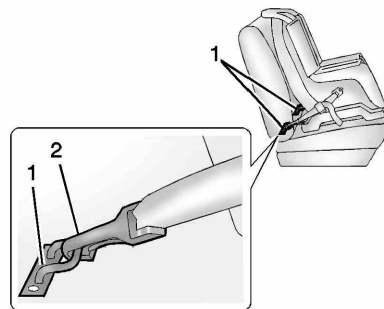

Lower anchors (1) are metal bars built into the vehicle. There are two lower anchors for each LATCH seating position that will accommodate a child restraint with lower attachments (2).

Top Tether Anchor

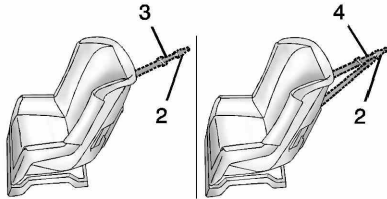

A top tether (3, 4) anchors the top of the child restraint to the vehicle. A top tether anchor is built into the vehicle. The top tether attachment (2) on the child restraint connects to the top tether anchor in the vehicle in order to reduce the forward movement and rotation of the child restraint during driving or in a crash.

The child restraint may have a single tether (3) or a dual tether (4). Either will have a single attachment (2) to secure the top tether to the anchor.

Some child restraints that have a top tether are designed for use with or without the top tether being attached. Others require the top tether always to be attached. Be sure to read and follow the instructions for the child restraint. In Canada, the law requires that forward-facing child restraints have a top tether, and that the tether be attached. Be sure to read and follow the instructions for your child restraint.

Lower Anchor and Top Tether Anchor Locations

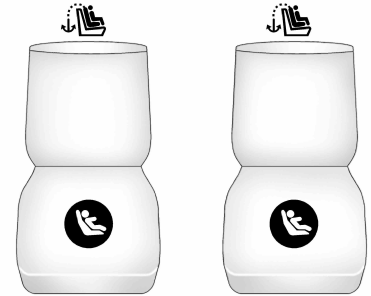

Rear Seat

 **(Top Tether Anchor):** Seating positions with top tether anchors.

 **(Lower Anchor):** Seating positions with two lower anchors.



3-42 Seats and Restraints

To assist in locating the lower anchors, each seating position with lower anchors has two labels, near the crease between the seatback and the seat cushion.

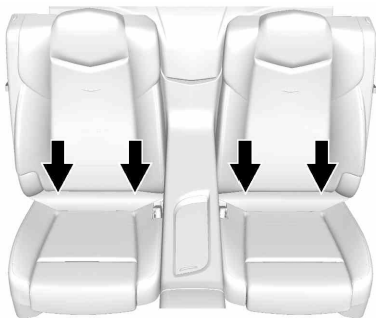

Lift the flap below the label to access the anchors.



To assist in locating the top tether anchors, the top tether anchor symbol is on the cover.



Top Tether Anchors

The top tether anchors for outboard rear seating positions are under the covers, behind the rear seat, on the filler panel. Be sure to use an anchor on the same side of the vehicle as the seating position where the child restraint will be placed.

Do not secure a child restraint in a position without a top tether anchor if a national or local law requires

that the top tether be attached, or if the instructions that come with the child restraint say that the top tether must be attached.

According to accident statistics, children and infants are safer when properly restrained in a child restraint system or infant restraint system secured in a rear seating position. See *Where to Put the Restraint on page 3-38* for additional information.

Securing a Child Restraint Designed for the LATCH System

⚠ Warning

If a LATCH-type child restraint is not attached to anchors or with the safety belt, the child restraint will not be able to protect the child correctly. In a crash, the child could be seriously injured or killed. Install a LATCH-type child

(Continued)

Warning (Continued)

restraint properly using the anchors, or use the vehicle safety belts to secure the restraint, following the instructions that came with the child restraint and the instructions in this manual.

 **Warning**

Do not attach more than one child restraint to a single anchor. Attaching more than one child restraint to a single anchor could cause the anchor or attachment to come loose or even break during a crash. A child or others could be injured. To reduce the risk of serious or fatal injuries during a crash, attach only one child restraint per anchor.

 **Warning**

Children can be seriously injured or strangled if a shoulder belt is wrapped around their neck. The shoulder belt can tighten but cannot be loosened if it is locked. The shoulder belt locks when it is pulled all the way out of the retractor. It unlocks when the shoulder belt is allowed to go all the way back into the retractor, but it cannot do this if it is wrapped around a child's neck. If the shoulder belt is locked and tightened around a child's neck, the only way to loosen the belt is to cut it.

Buckle any unused safety belts behind the child restraint so children cannot reach them. Pull the shoulder belt all the way out of the retractor to set the lock, and tighten the belt behind the child restraint after the child restraint has been installed.

 **Caution**

Do not let the LATCH attachments rub against the vehicle's safety belts. This may damage these parts. If necessary, move buckled safety belts to avoid rubbing the LATCH attachments.

Do not fold the empty rear seat with a safety belt buckled. This could damage the safety belt or the seat. Unbuckle and return the safety belt to its stowed position, before folding the seat.

If you need to secure more than one child restraint in the rear seat, see *Where to Put the Restraint on page 3-38*.

This system is designed to make the installation of child restraints easier. When using lower anchors, do not use the vehicle's safety belts. Instead, use the vehicle's anchors and child restraint attachments to

3-44 Seats and Restraints

secure the restraints. Some restraints also use another vehicle anchor to secure a top tether.

1. Attach and tighten the lower attachments to the lower anchors. If the child restraint does not have lower attachments or the desired seating position does not have lower anchors, secure the child restraint with the top tether and the safety belts. Refer to your child restraint manufacturer instructions and the instructions in this manual.

- 1.1. Find the lower anchors for the desired seating position.
 - 1.2. Put the child restraint on the seat.

When installing a rear-facing child restraint, it may be necessary to move the front seat forward to properly install the child restraint per the child

restraint manufacturer guidelines. See *Power Seat Adjustment* on page 3-4.

- 1.3. Attach and tighten the lower attachments on the child restraint to the lower anchors.
2. If the child restraint manufacturer recommends that the top tether be attached, attach and tighten the top tether to the top tether anchor, if equipped. Refer to the child restraint instructions and the following steps:

- 2.1. Find the top tether anchor.
Open the top tether anchor cover to expose the anchor.

- 2.2. Route, attach, and tighten the top tether according to your child restraint instructions and the following instructions:

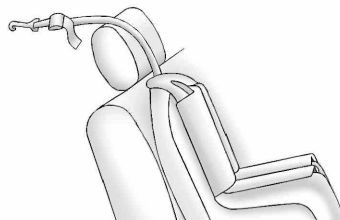

If you are using a single tether in the rear outboard seating position, route the tether over the headrest.

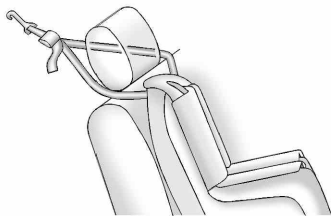

If you are using a dual tether in the rear outboard seating position, route the tether around the headrest.

3. Before placing a child in the child restraint, make sure it is securely held in place. To check, grasp the child restraint at the LATCH path and attempt to move it side to side and back and forth. There should be no more than 2.5 cm (1 in) of movement for proper installation.

Replacing LATCH System Parts After a Crash

Warning

A crash can damage the LATCH system in the vehicle. A damaged LATCH system may not properly secure the child restraint, resulting in serious injury or even death in a crash. To help make sure the LATCH system is working properly after a crash, see your dealer to have the system inspected and any necessary replacements made as soon as possible.

If the vehicle has the LATCH system and it was being used during a crash, new LATCH system parts may be needed.

New parts and repairs may be necessary even if the LATCH system was not being used at the time of the crash.

Securing Child Restraints (Rear Seat)

When securing a child restraint in a rear seating position, study the instructions that came with the child restraint to make sure it is compatible with this vehicle.

If the child restraint has the LATCH system, see *Lower Anchors and Tethers for Children (LATCH System)* on page 3-40 for how and where to install the child restraint using LATCH. If a child restraint is secured in the vehicle using a safety belt and it uses a top tether, see *Lower Anchors and Tethers for Children (LATCH System)* on page 3-40 for top tether anchor locations.

Do not secure a child seat in a position without a top tether anchor if a national or local law requires that the top tether be anchored, or if the instructions that come with the child restraint say that the top strap must be anchored.

3-46 Seats and Restraints

In Canada, the law requires that forward-facing child restraints have a top tether, and that the tether be attached.

If the child restraint or vehicle seat position does not have the LATCH system, you will be using the safety belt to secure the child restraint in this position. Be sure to follow the instructions that came with the child restraint. Secure the child in the child restraint when and as the instructions say.

If more than one child restraint needs to be installed in the rear seat, be sure to read *Where to Put the Restraint on page 3-38*.

1. Put the child restraint on the seat.

When installing a rear-facing child restraint, it may be necessary to move the front seat forward to properly install the child restraint per the child restraint manufacturer instructions. See *Power Seat Adjustment on page 3-4*.

2. Pick up the latch plate, and run the lap and shoulder portions of the vehicle safety belt through or around the restraint. The child restraint instructions will show you how.

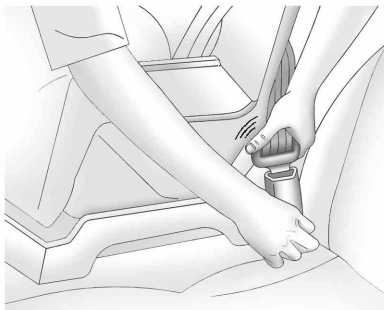

3. Push the latch plate into the buckle until it clicks.
Position the release button on the buckle so that the safety belt could be quickly unbuckled if necessary.

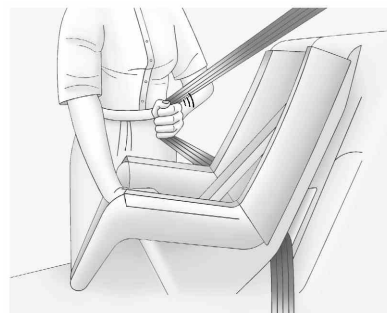

4. Pull the shoulder belt all the way out of the retractor to set the lock. When the retractor lock is set, the belt can be tightened but not pulled out of the retractor.

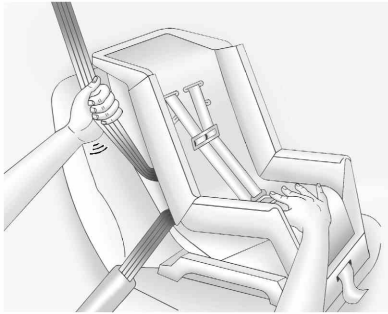

5. To tighten the belt, push down on the child restraint, pull the shoulder portion of the belt to tighten the lap portion of the belt, and feed the shoulder belt back into the retractor. When installing a forward-facing child restraint, it may be helpful to use your knee to push down on the child restraint as you tighten the belt. Try to pull the belt out of the retractor to make sure the retractor is locked. If the retractor is not locked, repeat Steps 4 and 5.
6. If the child restraint has a top tether, follow the child restraint manufacturer's instructions regarding the use of the top tether. See *Lower Anchors and Tethers for Children (LATCH System)* on page 3-40 for more information.
7. Before placing a child in the child restraint, make sure it is securely held in place. To check, grasp the child restraint at the safety belt path and attempt to move it side to side and back and forth. When the child restraint is properly installed, there should be no more than 2.5 cm (1 in) of movement.

To remove the child restraint, unbuckle the vehicle safety belt and let it return to the stowed position. If the top tether is attached to a top tether anchor, disconnect it.

Securing Child Restraints (Front Passenger Seat)

This vehicle has airbags. A rear seat is a safer place to secure a forward-facing child restraint. See *Where to Put the Restraint* on page 3-38.

In addition, the vehicle has a passenger sensing system which is designed to turn off the front outboard passenger frontal airbag and knee airbag under certain conditions. See *Passenger Sensing System* on page 3-25 and *Passenger Airbag Status Indicator* on page 5-16 for more information, including important safety information.

Never put a rear-facing child seat in the front. This is because the risk to the rear-facing child is so great, if the airbag deploys.

Warning

A child in a rear-facing child restraint can be seriously injured or killed if the front outboard passenger frontal airbag inflates. This is because the back of the rear-facing child restraint would be very close to the inflating airbag. A child in a forward-facing child restraint can be seriously injured or killed if the front outboard passenger frontal airbag inflates and the passenger seat is in a forward position.

Even if the passenger sensing system has turned off the front outboard passenger airbag(s), no system is fail-safe. No one can guarantee that an airbag will not inflate under some unusual circumstance, even though the airbag(s) are off.

(Continued)

Warning (Continued)

Secure rear-facing child restraints in a rear seat, even if the airbag(s) are off. If you secure a forward-facing child restraint in the front outboard passenger seat, always move the seat as far back as it will go. It is better to secure the child restraint in a rear seat.

See *Passenger Sensing System on page 3-25* for additional information.

If the child restraint uses a top tether, see *Lower Anchors and Tethers for Children (LATCH System) on page 3-40* for top tether anchor locations.

Do not secure a child seat in a position without a top tether anchor if a national or local law requires that the top tether be anchored, or if

the instructions that come with the child restraint say that the top strap must be anchored.

In Canada, the law requires that forward-facing child restraints have a top tether, and that the tether be attached.

When using the lap-shoulder belt to secure the child restraint in this position, follow the instructions that came with the child restraint and the following instructions:

1. Move the seat rearward as far back as it will go and raise the seat upward as far up as it will go, before securing the forward-facing child restraint. See *Power Seat Adjustment on page 3-4*. Make sure the seatback is in the upright position. See *Reclining Seatbacks on page 3-5*.

When the passenger sensing system has turned off the front outboard passenger frontal airbag and knee airbag, the off indicator on the passenger

airbag status indicator should light and stay lit when you start the vehicle. See *Passenger Airbag Status Indicator* on page 5-16.

2. Put the child restraint on the seat.
3. Pick up the latch plate, and run the lap and shoulder portions of the vehicle's safety belt through or around the restraint. The child restraint instructions will show you how.

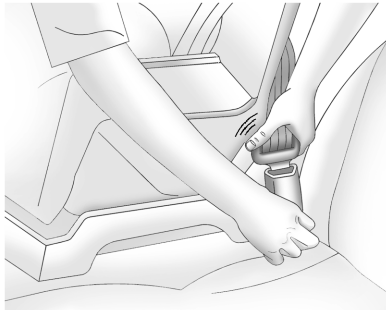

4. Push the latch plate into the buckle until it clicks.
Position the release button on the buckle so that the safety belt could be quickly unbuckled if necessary.

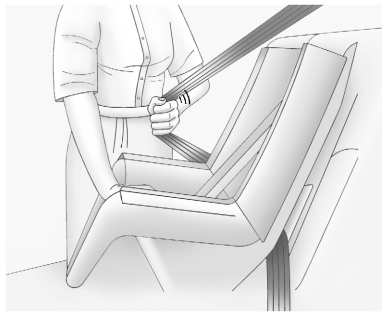

5. Pull the shoulder belt all the way out of the retractor to set the lock. When the retractor lock is set, the belt can be tightened but not pulled out of the retractor.

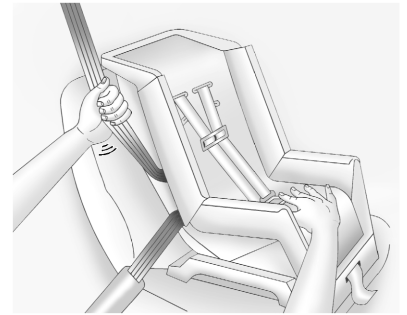

6. To tighten the belt, push down on the child restraint, pull the shoulder portion of the belt to tighten the lap portion of the belt, and feed the shoulder belt back into the retractor. When installing a forward-facing child restraint, it may be helpful to use your knee to push down on the child restraint as you tighten the belt.

Try to pull the belt out of the retractor to make sure the retractor is locked. If the retractor is not locked, repeat Steps 5 and 6.

3-50 Seats and Restraints

7. Before placing a child in the child restraint, make sure it is securely held in place. To check, grasp the child restraint at the safety belt path and attempt to move it side to side and back and forth. When the child restraint is properly installed, there should be no more than 2.5 cm (1 in) of movement.

If the airbags are off, the off indicator in the passenger airbag status indicator will come on and stay on when the vehicle is started.

If a child restraint has been installed and the on indicator is lit, see “If the On Indicator Is Lit for a Child Restraint ” under *Passenger Sensing System* on page 3-25.

To remove the child restraint, unbuckle the vehicle safety belt and let it return to the stowed position. Make sure the adjustable latch plate stop is in a position where it sits above the door trim, when the belt is returned to its stowed position.

Storage

Storage Compartments

- Storage Compartments 4-1
- Instrument Panel Storage 4-1
- Glove Box 4-1
- Cupholders 4-2
- Center Console Storage 4-2

Storage Compartments

 Warning
Do not store heavy or sharp objects in storage compartments. In a crash, these objects may cause the cover to open and could result in injury.

Instrument Panel Storage

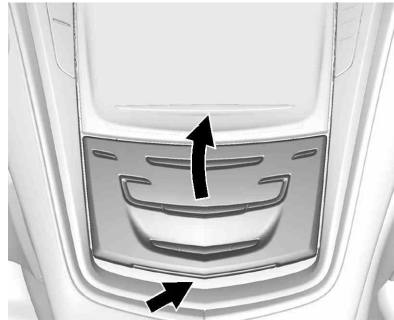

Touch the bottom of the climate control system panel until the door automatically starts to open. There is a USB port inside. See the infotainment manual.

Touch the bottom of the climate control system again until the door automatically starts to close.

Keep the storage area door closed while driving.

Glove Box

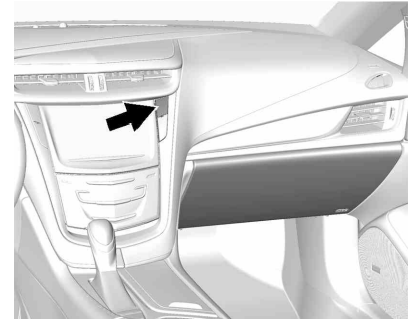

To open, press the button. Close the glove box manually.

4-2 Storage

Cupholders

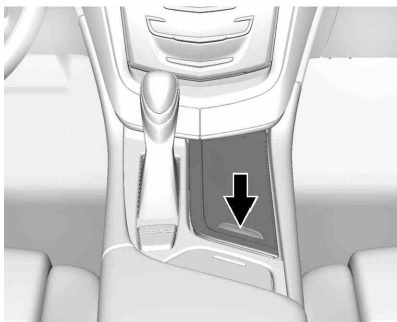

Cupholders in the front center console have a power retractable cover. Push the handle forward to express open. Pull the handle rearward to express close.

The power cover will operate when the vehicle is in ACC, RUN, or Retained Accessory Power (RAP) mode. The cover can be opened or closed manually by pushing or pulling the handle. See *Retained Accessory Power (RAP)* on page 9-19.

If any object is in the path of the power cover when it is active, the cover will stop at the obstruction and auto-reverse to a preset position. The cover will return to normal operation after the obstruction is removed.

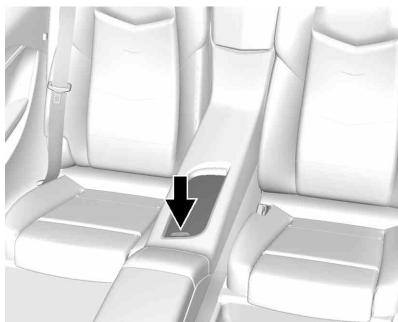

Push the handle to uncover the rear cupholders.

Center Console Storage

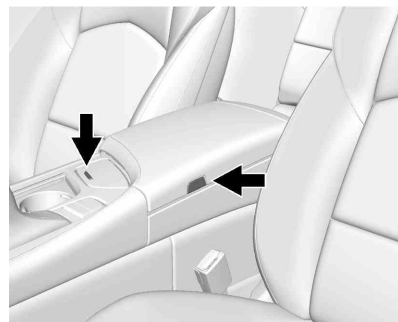

There is a storage area in front of the armrest. Press to release the cover.

Press the button on the driver side of the armrest to access the storage area beneath it. There are two USB ports, an SD card reader, and an auxiliary jack inside.

Instruments and Controls

Controls

Steering Wheel Adjustment ...	5-2
Steering Wheel Controls	5-2
Heated Steering Wheel	5-2
Horn	5-3
Pedestrian Safety Signal	5-3
Windshield Wiper/Washer	5-3
Compass	5-5
Clock	5-5
Power Outlets	5-7

Warning Lights, Gauges, and Indicators

Warning Lights, Gauges, and Indicators	5-7
Instrument Cluster	5-8
Speedometer	5-12
Odometer	5-12
Trip Odometer	5-12
Battery Gauge (High Voltage)	5-12
Fuel Gauge	5-13
Driver Efficiency Gauge	5-13
Power Indicator Gauge	5-14

Safety Belt Reminders	5-14
Airbag Readiness Light	5-16
Passenger Airbag Status Indicator	5-16
Charging System Light (12-Volt Battery)	5-17
Malfunction Indicator Lamp	5-17
Brake System Warning Light	5-20
Electric Parking Brake Light	5-21
Service Electric Parking Brake Light	5-21
Antilock Brake System (ABS) Warning Light	5-21
Lane Departure Warning (LDW) Light	5-22
Vehicle Ahead Indicator	5-22
Traction Off Light	5-22
StabiliTrak [®] OFF Light	5-23
Traction Control System (TCS)/StabiliTrak [®] Light	5-23
Engine Coolant Temperature Warning Light	5-23
Tire Pressure Light	5-24
Engine Oil Pressure Light	5-24
Low Fuel Warning Light	5-25
Security Light	5-25

Vehicle Ready Light	5-26
High-Beam On Light	5-26
Lamps On Reminder	5-26
Cruise Control Light	5-26
Door Ajar Light	5-27

Information Displays

Center Stack Display	5-27
Power Flows	5-27
Programmable Charging	5-29
Energy Information	5-38
Driver Information Center (DIC)	5-38

Vehicle Messages

Vehicle Messages	5-41
Battery and Charging Messages	5-41
Brake System Messages	5-42
Compass Messages	5-42
Cruise Control Messages	5-42
Door Ajar Messages	5-43
Drive Mode Messages	5-44
Electric Drive Unit Messages	5-44
Engine Cooling System Messages	5-44
Engine Oil Messages	5-44
Fuel System Messages	5-45

5-2 Instruments and Controls

Key and Lock Messages	5-45
Lamp Messages	5-46
Object Detection System Messages	5-46
Propulsion Power Messages	5-48
Ride Control System Messages	5-49
Airbag System Messages	5-49
Security Messages	5-49
Service Vehicle Messages ...	5-50
Starting the Vehicle Messages	5-50
Tire Messages	5-50
Vehicle Reminder Messages	5-51
Vehicle Speed Messages	5-51
Washer Fluid Messages	5-51
Window Messages	5-51

Vehicle Personalization

Vehicle Personalization	5-52
-------------------------------	------

Universal Remote System

Universal Remote System ...	5-59
Universal Remote System Programming	5-59
Universal Remote System Operation	5-62

Controls

Steering Wheel Adjustment

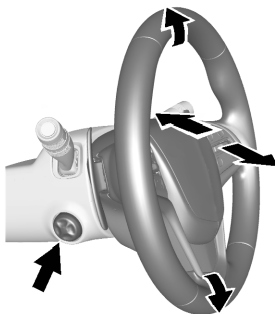

Press the control to move the tilt and telescoping steering wheel up and down or forward and rearward.

Do not adjust the steering wheel while driving.

To set the power tilt wheel memory position, see *Memory Seats on page 3-6*.

Steering Wheel Controls

The infotainment system can be operated by using the steering wheel controls. See "Steering Wheel Controls" in the infotainment manual.

Heated Steering Wheel

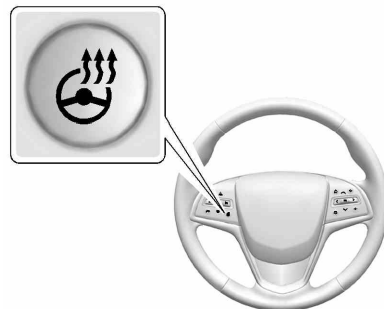

 **(Heated Steering Wheel):** Press to turn the heated steering wheel on or off. A light next to the button displays when the feature is turned on.

The steering wheel takes about three minutes to be fully heated.

Horn

Press  on the steering wheel pad to sound the horn.

The pedestrian safety signal provides a momentary soft-note horn sound. See *Pedestrian Safety Signal* on page 5-3.

Pedestrian Safety Signal

Your vehicle is equipped with an automatic sound generation and a manual alert.

The automatic sound is generated to indicate the vehicle presence to pedestrians. The sound changes if the vehicle is speeding up or slowing down. It is activated when the vehicle is shifted into a forward gear or R (Reverse), up to 30 km/h (19 mph).

An alert can also be sounded manually while driving, such as in parking lots. Use this feature to alert people who may not hear your vehicle approaching.

At speeds less than 64 km/h (40 mph), to manually sound the pedestrian safety signal:

1. Pull the turn signal lever all the way toward you momentarily. See *Exterior Lamp Controls* on page 6-1 and *Headlamp High/Low-Beam Changer* on page 6-3. The high-beam headlamps and indicator light will turn on, and a soft-note alert will momentarily sound. When the turn signal lever is released, the high-beam headlamps and indicator light will turn off.
2. Repeat for additional activations of the pedestrian safety signal.

Windshield Wiper/Washer



With the ignition in ACC/ACCESSORY or ON/RUN/START, move the windshield wiper lever to select the wiper speed.

HI: Use for fast wipes.

LO: Use for slow wipes.

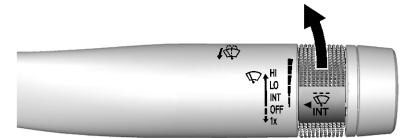

INT (Rainsense Wipe Sensitivity Control): Move the windshield wiper lever to INT. Turn the  INT band on the wiper lever to adjust the

5-4 Instruments and Controls

sensitivity. To turn the Rainsense feature on or off, see “Rainsense Wipers” under *Vehicle Personalization* on page 5-52.

When Rainsense is turned off, move the lever up to INT for intermittent wiper, then turn the  INT band up for more frequent wiper or down for less frequent wiper.

If the windshield wipers are in use for about six seconds while driving, the exterior lamps come on automatically if the exterior lamp control is in AUTO. The transition time for the lamps coming on varies based on wiper speed. See “Lights On with Wipers” under *Automatic Headlamp System* on page 6-4.

OFF: Use to turn the wipers off.

1X (Mist): For a single wipe, briefly move the wiper lever down. For several wiper, hold the wiper lever down.

Clear snow and ice from the wiper blades and windshield before using them. If frozen to the windshield,

carefully loosen or thaw them. Damaged blades should be replaced. See *Wiper Blade Replacement* on page 10-26.

Heavy snow or ice can overload the wiper motor.

Wiper Parking

If the ignition is put in OFF while the wipers are on LO, HI, or INT, they will immediately stop.

If the windshield wiper lever is then moved to OFF before the driver door is opened or within 10 minutes, the wipers will restart and move to the base of the windshield.

If the ignition is put in OFF while the wipers are performing wiper due to windshield washing or Rainsense, the wipers continue to run until they reach the base of the windshield.

The wiper arms can be moved manually when the ignition is off for replacing or cleaning under the blades. The wiper arms will return to their normal position when the ignition is turned on.

Rainsense™

With Rainsense, a sensor near the top center of the windshield detects the amount of water on the windshield and controls the frequency of the windshield wiper.

Keep this area of the windshield clear of debris to allow for best system performance.

INT (Rainsense Wipe Sensitivity Control): Move the windshield wiper lever to INT. Turn the  INT band on the wiper lever to adjust the sensitivity.

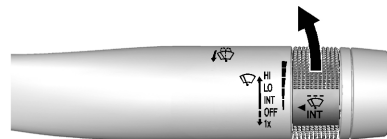

- Turn the band up for more sensitivity to moisture.
- Turn the band down for less sensitivity to moisture.

- Move the windshield wiper lever out of the INT position to deactivate Rainsense.

This feature can be turned on or off, see “Rainsense Wipers” under *Vehicle Personalization on page 5-52*

Wiper Arm Assembly Protection

When using an automatic car wash, move the windshield wiper lever to OFF. This disables the automatic Rainsense windshield wipers.

With Rainsense, if the electric drive unit is in N (Neutral) and the vehicle speed is very slow, the wipers will automatically stop at the base of the windshield.

The wiper operations return to normal when the electric drive unit is no longer in N (Neutral) or the vehicle speed has increased.

↓  **(Windshield Washer):** Pull the windshield wiper lever toward you to spray windshield washer fluid and activate the wipers. The wipers will continue until the lever is

released or the maximum wash time is reached. When the windshield wiper lever is released, additional wipes may occur depending on how long the windshield washer had been activated. See *Washer Fluid on page 10-19* for information on filling the windshield washer fluid reservoir.

Warning

In freezing weather, do not use the washer until the windshield is warmed. Otherwise the washer fluid can form ice on the windshield, blocking your vision.

Compass

The compass displays in the center stack. The compass receives its heading and other information from the Global Positioning System (GPS) antenna, StabiliTrak[®], and vehicle speed information.

The compass system is designed to operate for a certain number of miles or degrees of turn before needing a signal from the GPS satellites. When the compass display shows CAL, drive the vehicle for a short distance in an open area where it can receive a GPS signal. The compass system will automatically determine when a GPS signal is restored and provide a heading again. See *Compass Messages on page 5-42* for the messages that may be displayed for the compass.

Clock

The infotainment system controls are used to access the time and date settings through the menu system. See “Home Page” in the infotainment manual for information about how to use the menu system.

5-6 Instruments and Controls

Setting the Clock

Time

To set the time:

1. From the Home Page, press the SETTINGS screen button, then press Time and Date.
2. Press Set Time, then press + or - to increase or decrease hours or minutes, and change AM or PM.
3. Press 12-24Hr for a 12 or 24 hour clock.
4. Press  Back to go back to the previous menu.

Date

To set the date:

1. Press the SETTINGS screen button and press Time and Date.
2. Press Set Date and press + or - to increase or decrease month, day, or year.

3. Press  Back to go back to the previous menu.

Auto Set

When on, the time and date will automatically update.

To set auto set:

1. Press the SETTINGS screen button, then press Time and Date.
2. Press Set Time or Set Date.
3. Press Auto Set, then select On-Cell Network or Off-Manual to manually set the time and date.
4. Press  Back to go back to the previous menu.

If auto timing is on, the time displayed on the clock may not update immediately when driving into a new time zone.

Clock Display

When on, the digital clock will display on the infotainment screen.

To set the clock display:

1. Press the SETTINGS screen button and press Time and Date.
2. Press Clock Display, then select Off or On.
3. Press  Back to go back to the previous menu.

Power Outlets

The accessory power outlets can be used to plug in electrical equipment, such as a cell phone or MP3 player.

The vehicle has two accessory power outlets:

- Inside the front center console.
- Inside the center console bin behind the shift lever.

Lift the cover to access the accessory power outlet.

Certain accessory power plugs may not be compatible with the accessory power outlet and could overload vehicle or adapter fuses. If a problem is experienced, see your dealer.

When adding electrical equipment, be sure to follow the proper installation instructions included with the equipment. See *Add-On Electrical Equipment* on page 9-71.

 **Caution**

Hanging heavy equipment from the power outlet can cause damage not covered by the vehicle warranty. The power outlets are designed for accessory power plugs only, such as cell phone charge cords.

Always unplug electrical equipment when not in use and do not plug in equipment that exceeds the maximum 15 amps.

Warning Lights, Gauges, and Indicators

Warning lights and gauges can signal that something is wrong before it becomes serious enough to cause an expensive repair or replacement. Paying attention to the warning lights and gauges could prevent injury.

Warning lights come on when there could be a problem with a vehicle function. Some warning lights come on briefly when the propulsion system is started to indicate they are working.

5-8 Instruments and Controls

Gauges can indicate when there could be a problem with a vehicle function. Often gauges and warning lights work together to indicate a problem with the vehicle.

When one of the warning lights comes on and stays on while driving, or when one of the gauges shows there may be a problem, check the section that explains what to do. Waiting to do repairs can be costly and even dangerous.

Instrument Cluster

The instrument cluster displays a preview of information that includes electric range, charging, odometer, and battery status. This happens upon entry when the driver door is opened, and following the welcome animation, before starting the vehicle.

The CHARGING OVERRIDE/ INTERRUPTION OCCURRED message may display on the lower right of the screen to indicate that a charging override or interruption has occurred due to one or more of the following events:

- Override of the charge settings by the owner using OnStar.

- Unintended interruption of AC power at the vehicle's charge port.
- Interruption of charging by the utility company using OnStar as authorized by the vehicle owner.

There are several screens that will display depending on the current charging status.

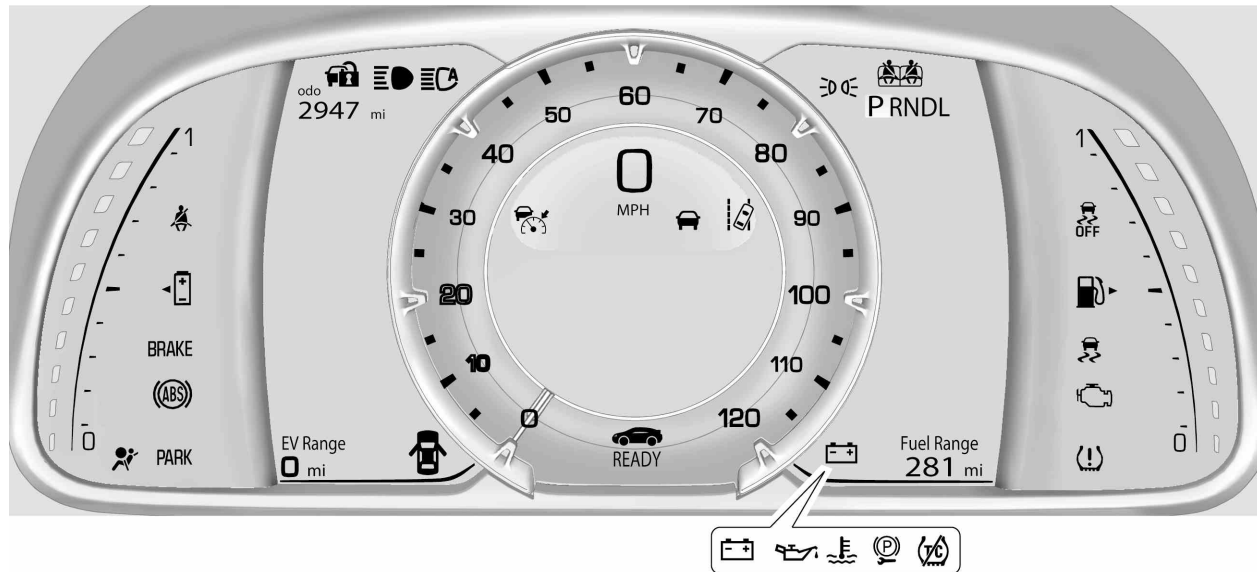

English Cluster Shown, Metric Similar

5-10 Instruments and Controls

Reconfigurable Instrument Cluster

There are four uplevel instrument cluster display configurations to choose from: Classic, Modern, Classic Enhanced, or Modern Enhanced.

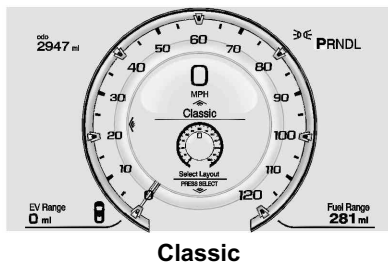

Classic

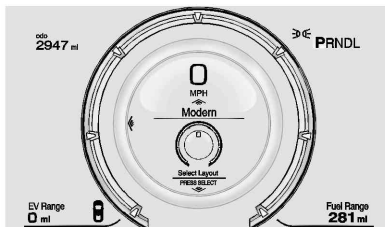

Modern

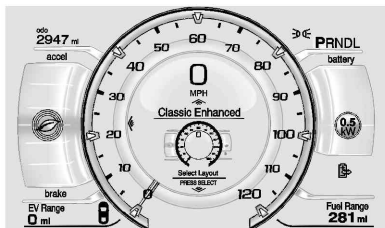

Classic Enhanced

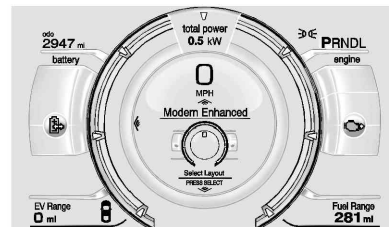

Modern Enhanced

Use the five-way control on the right side of the steering wheel to move between the different display zones and scroll through the different displays.

To change the cluster configuration:

1. Press \leftarrow to access the cluster applications.
2. Use \wedge or \vee to scroll through the list until Display Layout is highlighted. Then press SEL to select it.
3. Each layout in the menu is represented by a small preview image of the display layout. Scroll up or down and highlight

the selection. Press SEL to select the desired cluster configuration.

- Exit the Display Layout menu by pressing \leftarrow .

Cluster Menu

There is an interactive display area in the center of the instrument cluster.

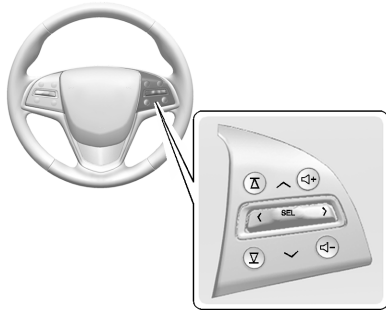

Use the right steering wheel control to open and scroll through the different items and displays.

Press \leftarrow to access the cluster applications. Use \wedge or \vee to scroll through the list of applications.

- Info. This is where you can view the Driver Information Center (DIC) displays. See *Driver Information Center (DIC) on page 5-38*.
- Audio
- Phone
- Navigation
- Display Layout. See “Reconfigurable Instrument Cluster” earlier in this section.
- Settings

Audio

While the Audio application page is displayed, press \triangleright to enter the Audio menu. In the Audio menu, search for music or change the audio source.

Phone

While the Phone application page is displayed, press \triangleright to enter the Phone menu. In the Phone menu, if there is no active phone call, view recent calls or scroll through contacts. If there is an active call, mute the phone or switch to handset operation.

Navigation

If there is no active route, a compass will be displayed. If there is an active route, press \triangleright to end route guidance or turn the voice prompts on or off.

Settings

Press \triangleright to enter the Settings menu. Use \wedge or \vee to scroll through the items in the Settings menu

Units: Press SEL while Units is highlighted to enter the Unit menu. Choose US, Metric, or Imperial units by pressing SEL while the desired

5-12 Instruments and Controls

item is highlighted. A checkmark will be displayed next to the selected item.

Info Pages: Press SEL while Info Pages is highlighted to select the items to be displayed in the DIC info displays. See *Driver Information Center (DIC) on page 5-38*.

Speed Warning: The Speed Warning display allows the driver to set a speed that they do not want to exceed. To set the Speed Warning, press SEL when Speed Warning is displayed. Press \wedge or \vee to adjust the value. Press SEL to set the speed. Once the speed is set, this feature can be turned off by pressing SEL while viewing this page. If the selected speed limit is exceeded, a pop-up warning is displayed with a chime.

Tutorial: Press SEL while Tutorial is highlighted to view the tutorials that explain some of the features of the instrument cluster. The tutorials are only available when the vehicle is in P (Park).

Open Source Software: Press SEL while Open Source Software is highlighted to display open source software information.

Speedometer

The speedometer shows the vehicle's speed in either kilometers per hour (km/h) or miles per hour (mph).

Odometer

The odometer shows how far the vehicle has been driven, in either kilometers or miles.

Trip Odometer

The trip odometer shows how far the vehicle has been driven since the trip odometer was last reset.

The trip odometer is accessed and reset through the Driver Information Center (DIC). See *Driver Information Center (DIC) on page 5-38*.

Battery Gauge (High Voltage)

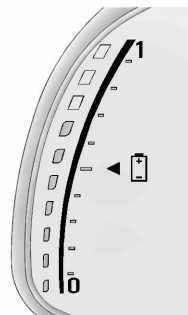

This gauge shows the high voltage battery charge level.

The arrow next to the battery symbol points to the side of the vehicle the charge port is on.

See *Electric Mode on page 9-21*.

Fuel Gauge

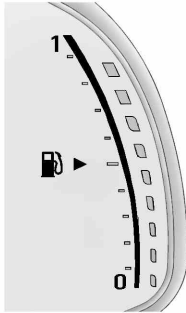

When the ignition is on, the fuel gauge indicates about how much fuel is left in the tank.

There is an arrow near the fuel gauge pointing to the side of the vehicle the fuel door is on.

When the indicator nears empty, the low fuel light comes on. There still is a little fuel left, but the vehicle should be refueled soon.

Here are four things that some owners ask about. None of these show a problem with the fuel gauge:

- At the service station, the fuel pump shuts off before the gauge reads full.
- It takes a little more or less fuel to fill up than the gauge indicated. For example, the gauge may have indicated the tank was half full, but it actually took a little more or less than half the tank's capacity to fill the tank.
- The gauge takes a few seconds to stabilize after the ignition is turned on, and goes back to empty when the ignition is turned off.

Driver Efficiency Gauge



This gauge appears on the left side of the display in the Classic Enhanced configuration.

This gauge is a guide to driving in an efficient manner by keeping the marker green and in the center of the gauge.

See *Driving for Better Energy Efficiency* on page 9-2.

5-14 Instruments and Controls

accel: If the leaf turns yellow and travels above the center of the gauge, acceleration is too aggressive to optimize efficiency.

brake: If the leaf turns yellow and travels below the center of the gauge, braking is too aggressive to optimize efficiency.

In the Modern display configurations, the light ring in the center of the display acts as an efficiency gauge. It is green when driving efficiently and turns yellow when acceleration or braking is too aggressive.

Power Indicator Gauge



Battery Power



Total Power

The power gauge is on the right side of the display in the Classic Enhanced configuration and on both right and left sides in the Modern Enhanced configuration.

The power gauge shows the power coming from the engine and/or battery. When the power indicator is green, battery power is being regenerated. When the indicator is yellow, the vehicle is using power.

Safety Belt Reminders

Driver Safety Belt Reminder Light

There is a driver safety belt reminder light on the instrument cluster.



When the vehicle is started, this light flashes and a chime may come on to remind the driver to fasten their safety belt. Then the light stays on solid until the belt is buckled. This cycle may continue several times if the driver remains or becomes unbuckled while the vehicle is moving.

If the driver safety belt is already buckled, neither the light nor the chime comes on.

Passenger Safety Belt Reminder Light

There is a passenger safety belt reminder light near the passenger airbag status indicator. See *Passenger Sensing System* on page 3-25.



When the vehicle is started, this light flashes and a chime may come on to remind the front passenger to fasten their safety belt. Then the light stays on solid until the belt is buckled. This cycle may continue several times if the front passenger remains or becomes unbuckled while the vehicle is moving.

If the front passenger safety belt is buckled, neither the chime nor the light comes on.

The front passenger safety belt reminder light and chime may turn on if an object is put on the seat such as a briefcase, handbag, grocery bag, laptop, or other electronic device. To turn off the reminder light and/or chime, remove the object from the seat or buckle the safety belt.

Second Row Passenger Safety Belt Reminder Light



Second row seating positions monitored for safety belt use are represented by a colored symbol on the instrument cluster indicating safety belt status.

When the vehicle is started, two safety belt symbols come on and stay on for several seconds to alert the driver that passengers may need to fasten their safety belts. After the passenger safety belt is buckled, the corresponding safety belt symbol in the instrument cluster turns green. If a safety belt is not initially buckled, the instrument cluster displays a gray safety belt symbol.

5-16 Instruments and Controls

While the vehicle is moving, if a second row passenger who was previously buckled becomes unbuckled, the corresponding safety belt symbol will change to flashing red for several seconds and a chime may sound.

Airbag Readiness Light

This light shows if there is an electrical problem with the airbag system. The system check includes the airbag sensor(s), passenger sensing system, the pretensioners, the airbag modules, the wiring, and the crash sensing and diagnostic module. For more information on the airbag system, see *Airbag System* on page 3-19.



The airbag readiness light comes on for several seconds when the vehicle is started. If the light does not come on then, have it fixed immediately.

Warning

If the airbag readiness light stays on after the vehicle is started or comes on while driving, it means the airbag system might not be working properly. The airbags in the vehicle might not inflate in a crash, or they could even inflate without a crash. To help avoid injury, have the vehicle serviced right away.

If there is a problem with the airbag system, a Driver Information Center (DIC) message may also come on. See *Airbag System Messages* on page 5-49.

Passenger Airbag Status Indicator

The vehicle has a passenger sensing system. See *Passenger Sensing System* on page 3-25 for important safety information. The passenger airbag status indicator is in the overhead console.

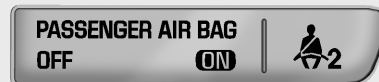

United States



Canada

When the vehicle is started, the passenger airbag status indicator will light ON and OFF, or the symbol for on and off, for several seconds

as a system check. Then, after several more seconds, the status indicator will light either ON or OFF, or the on or off symbol, to let you know the status of the front outboard passenger frontal airbag and knee airbag.

If the word ON or the on symbol is lit on the passenger airbag status indicator, it means that the front outboard passenger frontal airbag and knee airbag are allowed to inflate.

If the word OFF or the off symbol is lit on the airbag status indicator, it means that the passenger sensing system has turned off the front outboard passenger frontal airbag and knee airbag.

If, after several seconds, both status indicator lights remain on, or if there are no lights at all, there may be a problem with the lights or the passenger sensing system. See your dealer for service.

Warning

If the airbag readiness light ever comes on and stays on, it means that something may be wrong with the airbag system. To help avoid injury to yourself or others, have the vehicle serviced right away. See *Airbag Readiness Light on page 5-16* for more information, including important safety information.

Charging System Light (12-Volt Battery)

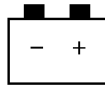

The charging system light comes on briefly when the vehicle is in ON/RUN, as a check to show the light is working.

If the light stays on, or comes on while driving, there could be a problem with the electrical charging system. Have it checked by your dealer. Driving while this light is on could drain the 12-volt battery.

If a short distance must be driven with the light on, be sure to turn off all accessories, such as the radio.

Malfunction Indicator Lamp

A computer system called OBD II (On-Board Diagnostics-Second Generation) monitors operation of the vehicle. It ensures that emissions are at acceptable levels for the life of the vehicle, helping to maintain a clean environment. The malfunction indicator lamp comes on when the vehicle is placed in Service Only Mode, as a check to show it is working. If it does not, have the vehicle serviced by your dealer. See *Power Button on page 9-16* for more information.



If the malfunction indicator lamp comes on, while the engine is in ON/RUN, this indicates that the OBD II system has detected a problem and diagnosis and service might be required.

Malfunctions often are indicated by the system before any problem is apparent. Being aware of the light can prevent more serious damage to the vehicle. This system also assists the dealer technician in correctly diagnosing any malfunction.

⚠ Caution

If the vehicle is continually driven with this light on, the emission controls might not work as well,

(Continued)

Caution (Continued)

the vehicle fuel economy might not be as good, and the engine might not run as smoothly. This could lead to costly repairs that might not be covered by the vehicle warranty.

⚠ Caution

Modifications made to the engine, electric drive unit, exhaust, intake, or fuel system of the vehicle or the replacement of the original tires with other than those of the same Tire Performance Criteria (TPC) can affect the vehicle emission controls and can cause this light to come on.

Modifications to these systems could lead to costly repairs not covered by the vehicle warranty. This could also result in a failure

(Continued)

Caution (Continued)

to pass a required Emission Inspection/Maintenance test. See *Accessories and Modifications on page 10-2*.

This light comes on during a malfunction in one of two ways:

Light Flashing: A misfire condition has been detected. A misfire increases vehicle emissions and could damage the emission control system on the vehicle. Diagnosis and service might be required.

The following can prevent more serious damage to the vehicle:

- Reduce vehicle speed.
- Avoid hard accelerations.
- Avoid steep uphill grades.

If the light continues to flash, find a safe place to stop and park the vehicle. Turn the vehicle off and wait at least 10 seconds before driving the vehicle again. If the light

begins to flash again, follow the previous steps and see your dealer for service as soon as possible.

Light On Steady: An emission control system malfunction has been detected on the vehicle. Diagnosis and service might be required.

The following may correct an emission control system malfunction:

- Check that the fuel cap is fully installed. The diagnostic system can determine if the fuel cap has been left off or improperly installed. A loose or missing fuel cap allows fuel to evaporate into the atmosphere. A few driving trips with the cap properly installed should turn the light off.

- Check that good quality fuel is used. Poor fuel quality causes the engine not to run as efficiently as designed and may cause stalling after start-up or misfiring. These conditions might go away once the engine is warmed up.

If one or more of these conditions occurs, change the fuel brand used. It may require at least one full tank of the proper fuel to turn the light off.

If none of the above have made the light turn off, your dealer can check the vehicle. The dealer has the proper test equipment and diagnostic tools to fix any mechanical or electrical problems that might have developed.

Emissions Inspection and Maintenance Programs

Depending on where you live, your vehicle may be required to participate in an emission control system inspection and maintenance program. For the inspection, the

emission system test equipment will likely connect to the vehicle's Data Link Connector (DLC).

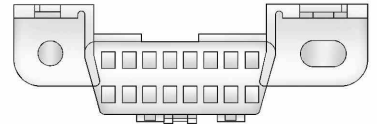

The DLC is under the instrument panel to the left of the steering wheel. See your dealer if assistance is needed.

The vehicle may not pass inspection if:

- The malfunction indicator lamp is on while the vehicle is in ON/RUN, or if the vehicle is placed in Service Only Mode and the malfunction indicator lamp does not come on. See your dealer for assistance in verifying proper operation of the malfunction indicator lamp.

- The OBD II (On-Board Diagnostics) system determines that critical emission control systems have not been completely diagnosed by the system. If this were to occur, the vehicle would be considered not ready for inspection. This can happen if the 12-volt battery has recently been replaced or run down.

The diagnostic system is designed to evaluate critical emission control systems during normal driving. This can take several days of driving. If this has been done and the vehicle still does not pass the inspection for lack of OBD II system readiness, your dealer can prepare the vehicle for inspection.

Brake System Warning Light

The vehicle brake system consists of two hydraulic circuits. If one circuit is not working, the remaining circuit can still work to stop the vehicle. For normal braking performance, both circuits need to be working.

If the warning light comes on, there is a brake problem. Have the brake system inspected right away.



Metric

BRAKE

English

This light comes on briefly when the vehicle is turned on. If it does not come on then, have it fixed so it will be ready to warn if there is a problem.

If the light comes on and stays on, there is a base brake problem.

Warning

The brake system might not be working properly if the brake system warning light is on. Driving with the brake system warning light on can lead to a crash. If the light is still on after the vehicle has been pulled off the road and carefully stopped, have the vehicle towed for service.

Electric Parking Brake Light



PARK

Metric

English

This light comes on when the parking brake is applied. If the light continues flashing after the parking brake is released, or while driving, there is a problem with the Electric Parking Brake system or another system. A message may also display in the Driver Information Center (DIC). See *Brake System Messages on page 5-42*.

If the light does not come on, or remains flashing, see your dealer.

Service Electric Parking Brake Light



If this light comes on and stays on, there is a problem with a system on the vehicle that is causing the parking brake system to work at a reduced level. The vehicle can still be driven, but should be taken to a dealer as soon as possible. See *Electric Parking Brake on page 9-30*. If a message displays in the Driver Information Center (DIC), see *Brake System Messages on page 5-42*.

Antilock Brake System (ABS) Warning Light



This light comes on briefly when the engine is started.

If the light does not come on, have it fixed so it will be ready to warn if there is a problem.

If the light comes on while driving, stop as soon as it is safely possible and turn off the vehicle. Then start the engine again to reset the system. If the ABS light stays on, or comes on again while driving, the vehicle needs service. A chime may also sound when the light comes on steady.

5-22 Instruments and Controls

If the ABS light is the only light on, the vehicle has regular brakes, but the antilock brakes are not functioning.

If both the ABS and the brake system warning light are on, the vehicle's antilock brakes are not functioning and there is a problem with the regular brakes. See your dealer for service.

See *Brake System Warning Light* on page 5-20 and *Brake System Messages* on page 5-42.

Lane Departure Warning (LDW) Light



This light is green if LDW is on and ready to operate.

This light changes to amber and flashes to indicate that the lane marking has been crossed without using a turn signal in that direction.

See *Lane Departure Warning (LDW)* on page 9-56.

Vehicle Ahead Indicator



This indicator will display green when a vehicle is detected ahead and amber when you are following a vehicle ahead much too closely.

See *Forward Collision Alert (FCA) System* on page 9-50.

Traction Off Light



This light comes on briefly while starting the engine. If it does not, have the vehicle serviced by your dealer. If the system is working normally, the indicator light then turns off. For vehicles with a reconfigurable cluster, this light is in the display area and it may not come on when the ignition is turned on.

The traction off light comes on when the Traction Control System (TCS) has been turned off by pressing and releasing the TCS/StabiliTrak button.

This light and the StabiliTrak OFF light come on when StabiliTrak is turned off.

If the TCS is off, wheel spin is not limited. Adjust driving accordingly.

See *Traction Control/Electronic Stability Control on page 9-33*.

StabiliTrak® OFF Light



This light comes on briefly while starting the engine. If it does not, have the vehicle serviced by your dealer.

This light comes on when the StabiliTrak system is turned off. If StabiliTrak is off, the Traction Control System (TCS) is also off.

If the StabiliTrak and TCS are off, the system does not assist in controlling the vehicle. Turn on the TCS and the StabiliTrak systems and the warning light turns off.

See *Traction Control/Electronic Stability Control on page 9-33*.

Traction Control System (TCS)/StabiliTrak® Light



This light comes on briefly when the engine is started.

If the light does not come on, have the vehicle serviced by your dealer. If the system is working normally, the indicator light turns off.

If the light is on and not flashing, the TCS and potentially the StabiliTrak system have been disabled. A DIC message may display. Check the DIC messages to determine which feature(s) is no longer functioning and whether the vehicle requires service.

If the indicator/warning light is on and flashing, the TCS and/or the StabiliTrak system is actively working.

See *Traction Control/Electronic Stability Control on page 9-33*.

Engine Coolant Temperature Warning Light



On some vehicles this light comes on briefly while starting the vehicle. If it does not, have the vehicle serviced by the dealer. If the system is working normally the indicator light goes off. For vehicles with the reconfigurable cluster, this light may not come on when starting the vehicle.

Caution

The engine coolant temperature warning light indicates that the vehicle has overheated. Driving with this light on can damage the engine and it may not be covered by the vehicle warranty. See *Engine Overheating on page 10-19*.

The engine coolant temperature warning light comes on when the engine has overheated.

If this happens pull over and turn off the engine as soon as possible. See *Engine Overheating on page 10-19*.

Tire Pressure Light



For vehicles with the Tire Pressure Monitor System (TPMS), this light comes on briefly when the engine is started. It provides information about tire pressures and the TPMS.

When the Light Is On Steady

This indicates that one or more of the tires are significantly underinflated.

A Driver Information Center (DIC) tire pressure message may also display. See *Tire Messages on page 5-50*. Stop as soon as possible, and inflate the tires to the pressure value shown on the Tire and Loading Information label. See *Tire Pressure on page 10-47*.

When the Light Flashes First and Then Is On Steady

If the light flashes for about a minute and then stays on, there may be a problem with the TPMS. If the problem is not corrected, the light will come on at every ignition cycle. See *Tire Pressure Monitor Operation on page 10-49*.

Engine Oil Pressure Light

Caution

Lack of proper engine oil maintenance can damage the engine. Driving with the engine oil low can also damage the engine. The repairs would not be covered by the vehicle warranty. Check the oil level as soon as possible. Add oil if required, but if the oil level is within the operating range and the oil pressure is still low, have the vehicle serviced. Always follow the maintenance schedule for changing engine oil.



This light should come on briefly as the engine is started. If it does not come on, have the vehicle serviced by your dealer.

If the light comes on and stays on, it means that oil is not flowing through the engine properly. The vehicle could be low on oil and might have some other system problem. See your dealer.

Low Fuel Warning Light



This light is near the fuel gauge and comes on briefly when the ignition is turned on as a check to show it is working.

It also comes on when the fuel tank is low on fuel. The light turns off when fuel is added. If it does not, have the vehicle serviced.

Security Light



On some vehicles the immobilizer light should come on briefly as the engine is started. If it does not come on, have the vehicle serviced by your dealer. If the system is working normally, the indicator light turns off. For vehicles with the reconfigurable cluster, this light may not come on when the engine is started.

If the light stays on and the engine does not start, there could be a problem with the theft-deterrent system. See *Immobilizer Operation* on page 2-16.

Vehicle Ready Light



The vehicle ready light comes on whenever the vehicle is ready to be driven.

High-Beam On Light



This light comes on when the high-beam headlamps are in use.

See *Headlamp High/Low-Beam Changer* on page 6-3.

IntelliBeam® Light



This light comes on when the IntelliBeam system, if equipped, is enabled.

See *Exterior Lamp Controls* on page 6-1.

Lamps On Reminder



This light comes on when the exterior lamps are in use. See *Exterior Lamp Controls* on page 6-1.

Cruise Control Light



The cruise control light is white when the cruise control is on and ready, and turns green when the cruise control is set and active.

See *Cruise Control* on page 9-37.

Adaptive Cruise Control Light



This light is white when the Adaptive Cruise Control (ACC, if equipped) is on and ready, and turns green when

the ACC is set and active. See *Adaptive Cruise Control on page 9-39*.

Door Ajar Light



This light comes on, when a door is open or not securely latched.

Information Displays

Center Stack Display

The center stack screen displays Charging, Power Flow, and Energy Information. See the information that follows.

Climate Control, Infotainment, and Vehicle Personalization information also displays in this screen. For more information on these systems, see:

- *Dual Automatic Climate Control System on page 8-1.*
- The infotainment manual.
- *Vehicle Personalization on page 5-52.*

The center stack controls only need a light touch to operate and work best with bare hands. The controls will work with most gloves although they may take longer to respond. Use the finger pad rather than the

finger tip to minimize response time. If the controls are not responding, remove the gloves.

To view the Power Flow, Charging, and Energy Information, press the  button on the infotainment display.

Power Flows

To view the Power Flow screens, press the  button on the infotainment display and then press the Power Flow button at the bottom of the touch screen. The Power Flow screens indicate the current system operating condition. The screens show the energy flow between the engine, electric drive unit, and high voltage battery. These components will be highlighted when they are active.

5-28 Instruments and Controls

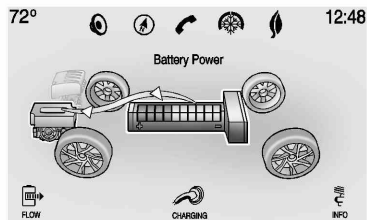

Battery Power - Battery is active with energy flowing to the wheels.

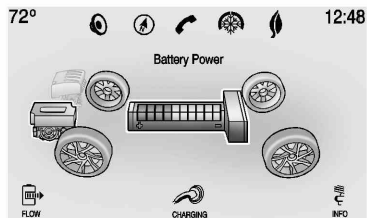

Battery Power - Vehicle is stationary in electric mode and no power is flowing to the wheels.

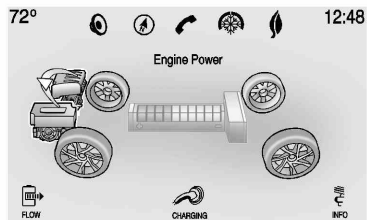

Engine Power - Engine is active with energy flowing to the wheels.

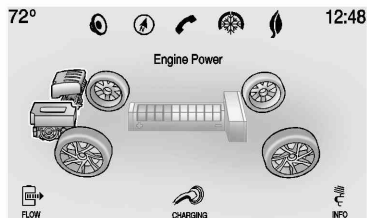

Engine Power - Vehicle is stationary in extended range mode and no power is flowing to the wheels.

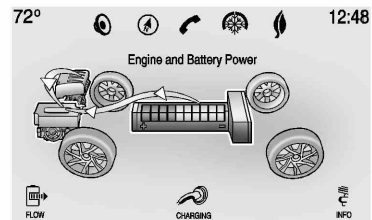

Engine and Battery Power - Both the engine and battery are active with energy flowing to the wheels.

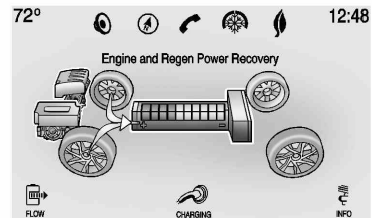

Engine and Regen Power Recovery - Engine is active. Power from the wheels returns to the battery during regenerative braking or coasting.

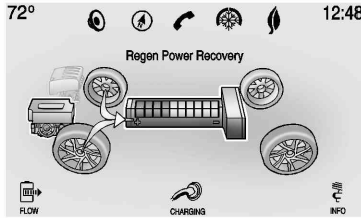

Regen Power Recovery - Power from the wheels returns to the battery during regenerative braking or coasting.

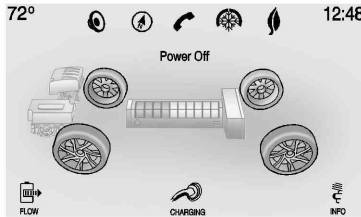

Power Off - No power is flowing to the wheels.

Programmable Charging

Important Information About Portable Electric Vehicle Charging

- Charging an electric vehicle can stress a building's electrical system more than a typical household appliance.
- Before you plug in to any electrical outlet, have a qualified electrician inspect and verify the electrical system (electrical outlet, wiring, junctions, and protection devices) for heavy-duty service at a 12 amp continuous load.
- Electrical outlets may wear out with normal usage or be damaged over time, making them unsuitable for electric vehicle charging.
- Check the electrical outlet/plug while charging and discontinue use if the electrical outlet/plug is hot, then have the electrical outlet serviced by a qualified electrician.

- When outdoors, plug into an electrical outlet that is weather-proof while in use.
- Mount the charging cord to reduce strain on the electrical outlet/plug.

Warning

Improper use of portable electric vehicle charge cords may cause a fire, electrical shock, or burns, and may result in damage to property, serious injury, or death.

- Do not use extension cords, multi-outlet power strips, splitters, grounding adaptors, surge protectors, or similar devices.
- Do not use an electrical outlet that is worn or damaged, or one that will not hold the plug firmly in place.
- Do not use an electrical outlet that is not properly grounded.

(Continued)

5-30 Instruments and Controls

Warning (Continued)

- Do not use an electrical outlet that is on a circuit with other electrical loads.

See the charge cord user guide.

Programmable Charge Modes

This vehicle has three programmable charge modes. To view the current charge mode status in the center stack display, press the  button in the infotainment display and then press the Charging button at the bottom of the touch screen.

The Charge Start and Charge Complete time estimates are also displayed on the screen. These estimates are most accurate when the vehicle is plugged in and in moderate temperature conditions. Also, to get an accurate time estimate, the vehicle uses an

internal clock for programmable charging, not the clock in the center stack.

Charge Mode Status

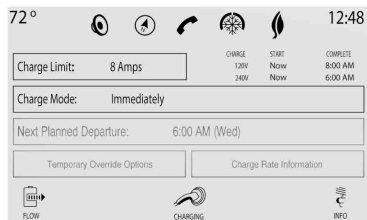

Immediately: The vehicle starts charging as soon as it is connected to an electrical outlet. See *Plug-In Charging* on page 9-58.

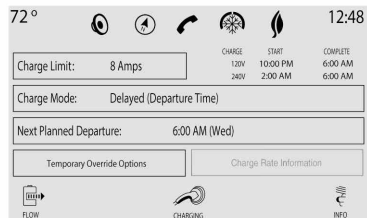

Delayed Departure Time: The vehicle estimates the charging start time considering the programmed departure time for the current day of the week. Charging begins at the start time and is complete by the departure time only if sufficient time is allowed after the charge cord is plugged in.

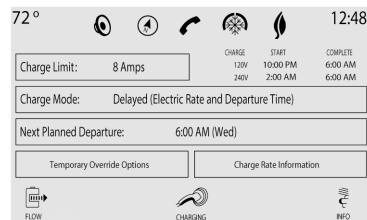

Delayed Rate and Departure Time: The vehicle estimates the charging start time based on the utility rate schedule, utility rate preference, and the programmed departure time for the current day of the week. The vehicle will charge during the least expensive rate periods to achieve a full battery

charge by the departure time. Electrical rate information from the utility company for the charging location is required for this mode.

Also, if the selected electric rate settings result in a very long charge completion time, the vehicle will start charging immediately upon plug-in. For example, if the electric rate table is set up with all “Peak” rates and the rate preference is to charge during “Off-Peak” rates only, then the vehicle will start charging immediately upon plug-in.

Charge Limit Selection

The Charge Limit Preference setting allows the customer to select their vehicle’s charge level so it matches the capability of their charging location. If the vehicle consistently stops charging after plugging in, or if a circuit breaker continues to trip, reducing to a lower Charge Limit Preference may resolve the issue.

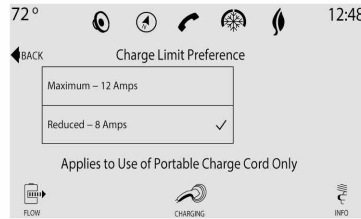

The Charge Limit Preference should be configured to match the electrical current rating for the electrical outlet that the charge cord is connected to. The Charge Limit Preference settings are:

- Maximum: Limits AC current to 12 amps
- Reduced: Limits AC current to 8 amps

Exact current levels may vary from the values shown in this manual. Please check the vehicle for the current available levels.

The Charge Limit Preference setting can be changed at any time while the center stack display is operable.

For some vehicles, the Charge Limit Preference must be updated prior to the vehicle being charged and the Charge Limit Preference will reset to a default value when the vehicle is shifted from P (Park).

Warning

Using a charge level that exceeds the electrical circuit or electrical outlet capacity may start a fire or damage the electrical circuit. Use the lowest charge level until a qualified electrician inspects your electrical circuit capacity. Use the lowest charge level if the electrical circuit or electrical outlet capacity is not known.

Charge Mode Selection

From the Charge Mode Status screen, press Change Charge Mode.

5-32 Instruments and Controls

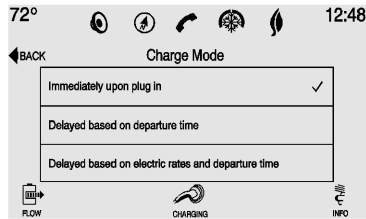

Select one option:

- Immediately upon plug in.
- Delayed based on departure time.
- Delayed based on electric rates and departure time.

Departure Time Entry

From the Delayed Charge Mode Status screen, press Edit to change the departure time for each day of the week to match your personal schedule.

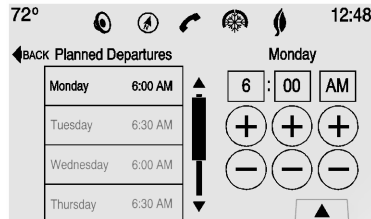

1. Press the day to change.
2. Press + or - to change the hours and minutes.
3. Press + or - to change AM or PM.
4. Press Back to store changes and return to the previous screen.

Charge Rate Information

From the Delayed Rate and Departure Time Charge Mode Status screen, press Charge Rate Information.

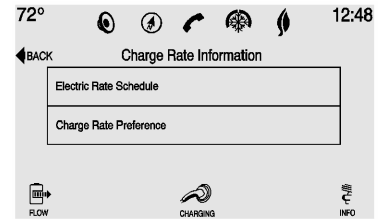

Select one of the following:

- Electric Rate Schedule.
- Charge Rate Preference.

Charge Rate Preference Selection

From the Charge Rate Information screen, press Charge Rate Preference.

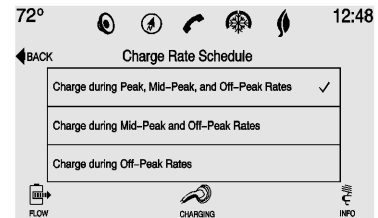

Press one of the following options to select the Charge Rate Preference:

- **Charge during Peak, Mid-Peak, and Off-Peak Rates:** The vehicle can charge during any rate period to satisfy the next planned departure time. However, it will select when to charge to minimize the total cost of the charge.
- **Charge during Mid-Peak and Off-Peak Rates:** The vehicle will charge during Off-Peak and/or Mid-Peak rate periods only and will select when to charge to minimize the total cost of the charge.
- **Charge during Off-Peak Rates:** The vehicle will only charge during Off-Peak rate periods.

Charging begins at the start time and is complete by the departure time only if sufficient time is allowed after the charge cord is plugged in. For example, if the vehicle is plugged in for only one hour prior to the departure time, and the battery

is completely discharged, the vehicle will not be fully charged by the departure time regardless of the rate selection.

Also, if the selected electric rate settings result in a very long charge completion time, the vehicle will start charging immediately upon plug-in. For example, if the electric rate table is set up with all “Peak” rates and the rate preference is to charge during “Off-Peak” rates only, then the vehicle will start charging immediately upon plug-in.

Electric Rate Plan Selection

Electric rates, or cost per unit, may vary based on time, weekday/ weekend, and season. During the day when the demand for electricity is high, the rates are usually higher and called Peak rates. At night when the demand for electricity is low, the rates are usually lower and called Off-Peak rates. In some areas, a Mid-Peak rate is offered.

Contact the utility company to obtain the rate schedule for your area. The summer and winter start dates must be established to use a summer/ winter schedule.

From the Charge Rate Information screen, press Electric Rate Schedule button.

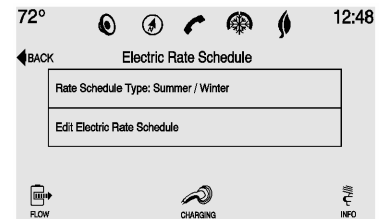

To edit the Summer/Winter Schedule:

1. Select Summer/Winter for the Rate Schedule Type.
2. Press Edit Electric Rate Schedule.

5-34 Instruments and Controls

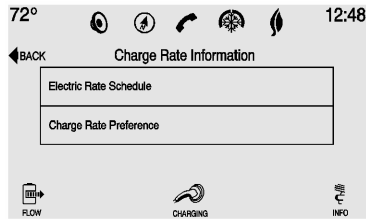

To edit the Yearly Schedule:

1. Select Yearly for the Rate Schedule Type.
2. Press Edit Electric Rate Schedule.

Summer/Winter Schedule Start Date Entering

From the Edit Electric Rate Schedule screen, press Edit Summer/Winter Start Dates.

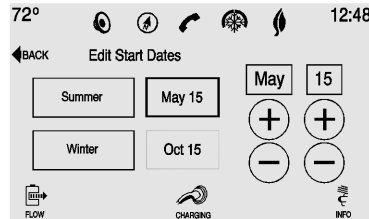

1. Press Summer.
2. Press + or - to set the month and day for the start of summer.
3. Press Winter.
4. Press + or - to set the month and day for the start of winter.
5. Press Edit Summer Schedule or Edit Winter Schedule to edit the daily electric rate schedule.

Electric Rate Schedule Editing

From the Edit Electric Rate Schedule screen, select Weekday Schedule or Weekend Schedule.

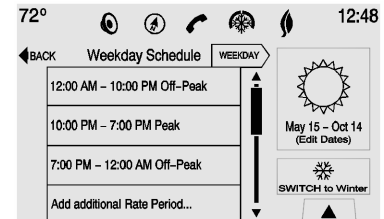

1. Press Weekday or Weekend.
2. Select the row to be changed.
 - Weekdays are Monday through Friday and use the same rate schedule.
 - Weekends are Saturday and Sunday and use the same rate schedule.

Both weekday and weekend schedules must be set. The rate schedule only applies for a 24-hour period, starting at 12:00 AM and ending at 12:00 AM. There can be five rate changes for each day; not all must be used.

The finish times must be consecutive. If a finish time does not follow a start time, the error

message displays “An invalid entry was found in the data entered. Please re-enter data.”

Electric Rate Finish Time Editing

From the Edit (Summer, Winter, or Yearly) Electric Rate Schedule screen, press Edit next to the row to change.

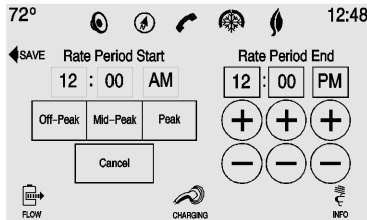

1. Press + or – to adjust the time.
2. Press Off-Peak, Mid-Peak, or Peak to select the electric rate.
3. Press the Save button to store changes.

Only the finish time can be edited. The start time is automatically populated in the rate table.

Electric Rate Schedule Viewing

From the Select Electric Rate Plan screen, press View (Summer, Winter, or Yearly) Schedule.

Temporary Charge Mode Override and Cancel

Programmed Delayed Charge Modes can be temporarily overridden to an Immediate Charge Mode for one charge cycle. Also, the next planned departure time can be temporarily overridden for one charge cycle. In addition to the in-vehicle overrides via the center stack, there are other ways to temporarily override a Delayed Charge Mode. See *Plug-In Charging on page 9-58*.

Temporary Override of a Delayed Charge Mode

To temporarily override a Delayed Charge Mode to Immediate Charge Mode from inside the vehicle:

1. Press Temporary Override Options on the main charging screen.

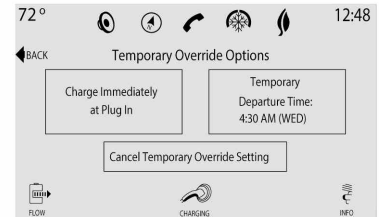

2. Press Charge Immediately at Plug-In to temporarily override to an Immediate Charge Mode.

The Temporary Charge Mode Status screen will automatically display the revised charge complete time.

5-36 Instruments and Controls

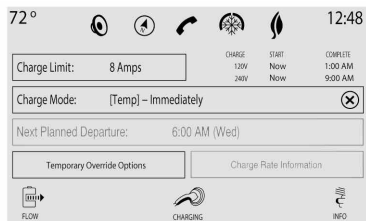

To cancel the temporary override to Immediate, press Cancel Temporary Override Setting on the Temporary Override Setting on the Temporary Override Options screen. Or, from the main charging screen, press the X will be on the far right side of the Charge Mode button.

Temporary Override of the Next Planned Departure Time

To temporarily override the Next Planned Departure Time from inside the vehicle:

1. Press Temporary Override Options on the main charging screen.

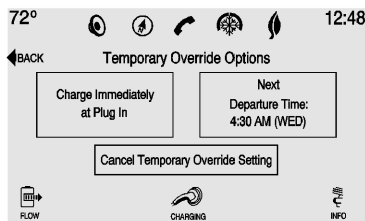

2. Press Next Departure Time.

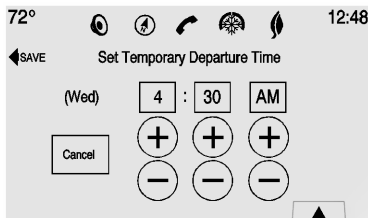

3. Press the + or - button to change the Next Departure Time.

4. Press SAVE to confirm a temporary override of the Next Planned Departure Time.

The Temporary Charge Mode Status screen will automatically display the revised charge complete time.

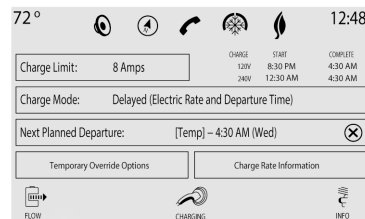

The Temporary Departure Time can only be updated for the same day as the original Next Planned Departure Time. Also, the vehicle will not accept a Temporary Departure Time that is before the present time of day.

To cancel the temporary override of the Next Planned Departure Time:

- From the Temporary Override Options screen, press the Cancel Temporary Override Setting button.
- From the main charging screen, press the X on the right side of the respective override text. When you override to an immediate charge mode, the X will be on the far right side of the Charge Mode button. When you override the departure time of either delayed charge mode, the X will be on the far right side of the Next Planned Departure button.

Charging Override/Interruption Pop-Up

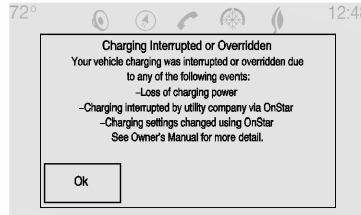

The Charging Override/Interruption pop-up will appear if any of the following conditions occur:

- The charging settings have been modified via OnStar through the website or the Mobile App. For example, the Departure Time Tables, the Rate Tables, or the Charge Mode were updated using the customer website (available in select regions).
- There was an unintended loss of AC power during the plug-in charge event. For example,

there was a power outage or the charge cord was unplugged from the wall.

- The charge process was interrupted by the utility company via OnStar as authorized by the vehicle owner (available in select regions).

See *Utility Interruption of Charging* on page 9-65.

Programmable Charging Disabled

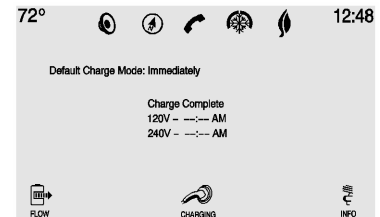

When the Programmable Charging system is disabled, the Default Charge Mode Status screen and the pop-up will display “- :-” for the Charge Complete Time. The

5-38 Instruments and Controls

Programmable Charging system will be disabled if the Charge Complete Time cannot be confidently estimated. If the Programmable Charging system is consistently disabled, see your dealer for details.

Energy Information

To view the Energy Usage and Energy Efficiency, press the  button on the infotainment display and then press the INFO button at the bottom of the touch screen.

Energy Usage

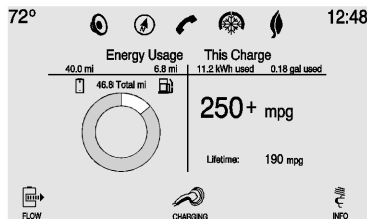

The Energy Usage screen displays information for the total of all drive cycles since the last time the high

voltage battery was fully charged. This includes distance traveled in Electric Mode, distance traveled in Extended Range Mode, total distance traveled, electric energy used from the battery, total fuel used, and average fuel economy. There are maximum limits to some of the values that can be displayed. When these values are replaced with dashes, the value limits have been reached. To reset these values, the high voltage battery will need to be fully recharged. The circle graph also represents the percentage of distance traveled using Electric Mode versus Extended Range Mode. The Lifetime Fuel Economy is a total over the life of the vehicle and can only be reset by the dealer. The Energy Usage information will also appear automatically on power off when Retained Accessory Power is active. This automatic pop-up can be disabled through vehicle personalization. See “Energy Summary Pop-up” under *Vehicle Personalization* on page 5-52.

Driver Information Center (DIC)

The DIC is displayed in the instrument cluster. It shows the status of many vehicle systems.

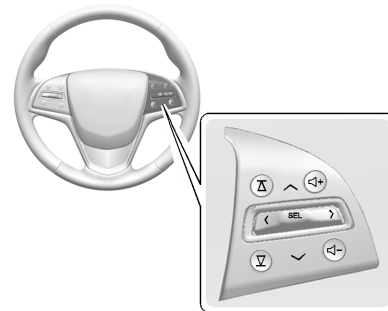

^ or v : Move SEL up or down to go to the previous or next selection.

< or > : Press to move between the interactive display zones in the cluster. Press **<** to go back to the previous menu.

SEL (Select): Press to open a menu or select a menu item. Press and hold to reset values on certain screens.

DIC Information Display Options

The info displays on the DIC can be turned on or off through the Settings menu.

1. Press SEL while viewing the Settings page in one of the interactive display zones on the cluster.
2. Scroll to Info Pages and press SEL.
3. Press \wedge or \vee to move through the list of possible info displays.
4. Press SEL while an item is highlighted to select or deselect that item. When an item is selected, a checkmark will appear next to it.

DIC Information Displays

The following is the list of all possible DIC information displays. Some of the information displays may not be available for your particular vehicle.

Trip A or Trip B and Average Fuel Economy: The Trip display shows the current distance traveled, in either kilometers (km) or miles (mi), since the trip odometer was last reset. The trip odometer can be reset by pressing and holding SEL while this display is active.

The Average Fuel Economy display shows the approximate average liters per 100 kilometers (L/100 km) or miles per gallon (mpg). This number is calculated based on the number of L/100 km (mpg) recorded since the last time this menu item was reset. This number reflects only

the approximate average fuel economy that the vehicle has right now, and will change as driving conditions change. The Average Fuel Economy can be reset along with the trip odometer by pressing and holding SEL while this display is active.

Compass and Speed: Shows the direction the vehicle is driving and the vehicle speed in either kilometers per hour (km/h) or miles per hour (mph).

Total Range: Shows the remaining distance the vehicle can be driven combining the electric range and fuel range.

Oil Life: The Oil Life display shows an estimate of the oil's remaining useful life. If REMAINING OIL LIFE 99% is displayed, that means 99% of the current oil life remains.

5-40 Instruments and Controls

When the remaining oil life is low, the CHANGE ENGINE OIL SOON message will appear on the display. See *Engine Oil Messages on page 5-44*. The oil should be changed as soon as possible. See *Engine Oil on page 10-9*. In addition to the engine oil life system monitoring the oil life, additional maintenance is recommended. See *Maintenance Schedule on page 11-2*.

Remember, the Oil Life display must be reset after each oil change. It will not reset itself. Also, be careful not to reset the Oil Life display accidentally at any time other than when the oil has just been changed. It cannot be reset accurately until the next oil change. To reset the engine oil life system, press and hold SEL for several seconds while the Oil Life display is active. See *Engine Oil Life System on page 10-12*.

Tire Pressure: Shows the approximate pressures of all four tires. Tire pressure is displayed in either kilopascal (kPa) or in pounds per square inch (psi). If the pressure is low, the value for that tire is shown in amber. See *Tire Pressure Monitor System on page 10-48* and *Tire Pressure Monitor Operation on page 10-49*.

Average Speed: Shows the average speed of the vehicle in kilometers per hour (km/h) or miles per hour (mph). This average is calculated based on the various vehicle speeds recorded since the last reset of this value. The average speed can be reset by pressing and holding SEL while this display is active.

Timer: This display can be used as a timer. To start the timer, press SEL while this display is active. The display will show the amount of time that has passed since the timer was last reset. To stop the timer, press SEL briefly while this display is

active and the timer is running. To reset the timer to zero, press and hold SEL while this display is active.

Speed Limit: Shows the current speed limit. The information for this page comes from a roadway database.

Follow Distance Indicator: When Adaptive Cruise Control (ACC) is not engaged, the current follow time to the vehicle ahead is displayed as a time value on this page. When ACC has been engaged, the display switches to the gap setting page. This page shows the current gap setting along with the vehicle ahead telltale.

Coolant Temperature: Shows the engine coolant temperature in either degrees Celsius (°C) or degrees Fahrenheit (°F).

Blank Page: The Blank Page display allows for no information to be displayed in the cluster info display areas.

Vehicle Messages

Messages displayed on the DIC indicate the status of the vehicle or some action that may be needed to correct a condition. Multiple messages may display one after the other.

The messages that do not require immediate action can be acknowledged and cleared by pressing SEL. The messages that require immediate action cannot be cleared until that action is performed. All messages should be taken seriously and clearing the messages does not correct the problem.

The following are some of the vehicle messages that may be displayed depending on the vehicle content.

Battery and Charging Messages

BATTERY SAVER ACTIVE

This message displays when the vehicle has detected that the 12-volt battery voltage has dropped and vehicle features are being disabled. The 12-volt battery saver system starts reducing certain features trying to save the charge of the 12-volt battery. Turn off unnecessary features to allow the battery to recharge.

BATTERY TOO COLD, PLUG IN TO WARM

This message displays during extremely cold temperatures, when the vehicle will not start until the high voltage battery is warm enough.

Plug the vehicle in and make sure the vehicle is off to allow the charging system to warm the high voltage battery, then the vehicle can be started.

CHARGE CORD CONNECTED

This message displays when the charge cord is connected to the vehicle. The vehicle cannot be shifted out of P (Park) with the charge cord connected.

CHARGE DOOR OPEN

This message displays when the charge door is open and the vehicle is shifted out of P (Park). The charge door should be kept fully closed when the vehicle is not charging.

LOW BATTERY

This message displays when the 12-volt battery voltage is low. See *Battery on page 10-23*.

SERVICE BATTERY CHARGING SYSTEM

This message displays when there is a fault in the 12-volt battery charging system. Take the vehicle to your dealer for service.

SERVICE HIGH VOLTAGE CHARGING SYSTEM

This message displays when there is a problem with the high voltage charging system. See your dealer for service.

Brake System Messages

BRAKE FLUID LOW

This message is displayed when the brake fluid level is low. See *Brake Fluid* on page 10-21.

STEP ON BRAKE TO RELEASE PARK BRAKE

This message is displayed if you attempt to release the Electric Parking Brake without the brake pedal applied. See *Electric Parking Brake* on page 9-30.

RELEASE PARKING BRAKE

This message is displayed if the Electric Parking Brake is on while the vehicle is in motion. See *Electric Parking Brake* on page 9-30.

SERVICE BRAKE ASSIST

This message may be displayed when there is a problem with the brake boost assist system. The brake boost assist motor may be heard and brake pedal pulsation may be felt. This is normal under these conditions. Take the vehicle to your dealer for service.

SERVICE PARKING BRAKE

This message is displayed when there is a problem with the parking brake. Take the vehicle to your dealer for service.

Compass Messages

Dashes may be displayed if the vehicle temporarily loses communication with the Global Positioning System (GPS).

Cruise Control Messages

ADAPTIVE CRUISE SET TO XXX

This message displays when the Adaptive Cruise Control (ACC) speed is set. See *Adaptive Cruise Control* on page 9-39.

ADAPTIVE CRUISE TEMPORARILY UNAVAILABLE

This message displays when attempting to activate Adaptive Cruise Control (ACC) when it is temporarily unavailable. The ACC system does not need service.

This can occur under the following conditions:

- Cruise is turned on when the vehicle is stopped.
- The radar cannot see objects well. See next message.

FRONT RADAR BLOCKED, CLEAN FRONT VEHICLE

This message can occur under the following conditions:

- The radar is not clean. Keep the radar sensors free of mud, dirt, snow, ice, and slush. Clean the entire front and/or rear of the vehicle. For cleaning instructions, see *Exterior Care on page 10-79*.
- Heavy rain or snow is interfering with the radar object detection or camera performance.

CRUISE SET TO XXX

This message displays when the cruise control speed is set. See *Cruise Control on page 9-37*.

NO CRUISE BRAKING GAS PEDAL APPLIED

This message displays when Adaptive Cruise Control (ACC) is active and the driver is pressing the

gas pedal. When this occurs, ACC will not brake. See *Adaptive Cruise Control on page 9-39*.

SERVICE ADAPTIVE CRUISE CONTROL

If this message displays, take the vehicle to your dealer to repair the system. Adaptive Cruise Control (ACC), Forward Collision Alert (FCA), and/or the Active Emergency Braking System may not work. Do not use these systems until the vehicle has been repaired.

SHIFT TO PARK BEFORE EXITING

This message may display if Adaptive Cruise Control (ACC) is engaged holding the vehicle at a stop, and the driver attempts to exit the vehicle. Put the vehicle in P (Park) before exiting.

Door Ajar Messages

DOOR OPEN

A door open symbol will be displayed on the DIC showing which door is open. If the vehicle has been shifted out of P (Park), a DOOR OPEN message will also be displayed. The DOOR OPEN message may also be displayed if the vehicle starts to move. Close the door completely.

HOOD OPEN

This message will display along with a hood open symbol when the hood is open. Close the hood completely.

TRUNK OPEN

This message will display along with a symbol when the trunk is open. Close the trunk completely.

Drive Mode Messages

HOLD MODE NOT AVAILABLE

This message displays when in Hold Mode and the mode becomes unavailable. See “Hold Mode” under *Driver Selected Operating Modes* on page 9-22.

MOUNTAIN MODE NOT AVAILABLE

This message displays when in Mountain Mode and the mode becomes unavailable. See “Mountain Mode” under *Driver Selected Operating Modes* on page 9-22.

SPORT MODE NOT AVAILABLE

This message displays when in Sport Mode and the mode becomes unavailable. See “Sport Mode” under *Driver Selected Operating Modes* on page 9-22.

Electric Drive Unit Messages

SHIFT TO PARK

This message displays when the vehicle should be shifted to P (Park). This may appear when attempting to turn off the vehicle when it is not in P (Park).

Engine Cooling System Messages

ENGINE OVERHEATED — REDUCE SPEED

This message displays when the engine coolant temperature or engine oil is too hot. Reduce speed and allow the vehicle to cool down.

ENGINE OVERHEATED — TURN VEHICLE OFF

This message displays and a continuous chime sounds if the engine cooling system reaches unsafe temperatures for operation. Stop and turn off the vehicle as

soon as it is safe to do so to avoid severe damage. This message clears when the engine has cooled to a safe operating temperature.

Engine Oil Messages

CHANGE ENGINE OIL SOON

This message displays when the engine oil needs to be changed. When you change the engine oil, be sure to reset the oil life system. See *Engine Oil Life System* on page 10-12, *Driver Information Center (DIC)* on page 5-38, *Engine Oil* on page 10-9, and *Maintenance Schedule* on page 11-2.

ENGINE OIL HOT, IDLE ENGINE

This message displays when the engine oil temperature is too hot. Stop and allow the vehicle to idle until it cools down.

ENGINE OIL LOW — ADD OIL

On some vehicles, this message displays when the engine oil level may be too low. Check the oil level before filling to the recommended level. If the oil is not low and this message remains on, take the vehicle to your dealer for service. See *Engine Oil* on page 10-9.

OIL PRESSURE LOW — STOP ENGINE

This message displays if low oil pressure levels occur. Stop the vehicle as soon as safely possible and do not operate it until the cause of the low oil pressure has been corrected. Check the oil as soon as possible and have the vehicle serviced by your dealer.

Fuel System Messages**CLOSE FUEL DOOR**

This message displays when the fuel door is open and the vehicle is moving.

**ENGINE NOT AVAILABLE
ADD FUEL**

This message displays when the engine is not available due to running out of fuel. The vehicle can continue to be driven in Electric Mode until the battery is depleted, but will have reduced acceleration. When this message is displayed, refuel the vehicle. See *Out of Fuel/Engine Unavailable* on page 9-24.

FUEL LEVEL LOW

This message displays when the vehicle is low on fuel. Refuel as soon as possible.

READY TO REFUEL

This message displays when the fuel system is depressurized and the vehicle can be refueled.

TIGHTEN GAS CAP

This message displays when the fuel cap is not on tight. Tighten the fuel cap.

WAIT TO REFUEL

This message displays when the fuel system is pressurized and you must to wait to refuel the vehicle.

Key and Lock Messages**NO REMOTE DETECTED**

This message displays when the transmitter battery may be weak. See “Starting the Vehicle with a Low Transmitter Battery” under *Remote Keyless Entry (RKE) System Operation* on page 2-2.

**NO REMOTE KEY WAS
DETECTED PLACE KEY IN
TRANSMITTER POCKET THEN
START YOUR VEHICLE**

This message displays when trying to start the vehicle if an RKE transmitter is not detected. The transmitter battery may be weak. See “Starting the Vehicle with a Low Transmitter Battery” under *Remote Keyless Entry (RKE) System Operation* on page 2-2.

NO REMOTE PRESS BRAKE TO RESTART

This message displays when attempting to turn off the vehicle and the RKE transmitter is no longer detected. Restarting is allowed without the RKE transmitter for five minutes. Press the brake pedal to restart the vehicle.

NUMBER OF KEYS PROGRAMMED

This message displays when programming new keys to the vehicle.

REMOTE LEFT IN VEHICLE

This message displays when leaving the vehicle with the RKE transmitter still inside.

REPLACE BATTERY IN REMOTE KEY

This message displays when the battery in the RKE transmitter needs to be replaced.

Lamp Messages

AUTOMATIC LIGHT CONTROL ON/OFF

This message is displayed when the automatic light control has been turned on or off. See *Automatic Headlamp System* on page 6-4.

XX TURN INDICATOR FAILURE

When one of the turn signals is out, this message displays to show which bulb needs to be replaced. See *Bulb Replacement* on page 10-27 and *Replacement Bulbs* on page 10-28.

TURN SIGNAL ON

This message is displayed if the turn signal has been left on. Turn off the turn signal.

Object Detection System Messages

AUTOMATIC COLLISION PREP OFF

This message displays when the Active Emergency Braking System has been turned off. See *Active Emergency Braking System* on page 9-53.

AUTOMATIC COLLISION PREP REDUCED

This message displays when the Active Emergency Braking System has been set to the Alert setting. This setting disables most automatic braking functions of the Auto Collision Preparation feature. Some last-second automatic braking capability is still provided with the Alert setting, but braking is less likely to occur. See *Active Emergency Braking System* on page 9-53.

AUTOMATIC COLLISION PREP UNAVAILABLE

This message displays when the Active Emergency Braking System has been unavailable for some time. The Active Emergency Braking System does not need service.

This can occur under the following conditions:

- The radar is not clean. Keep the radar sensors free of mud, dirt, snow, ice, and slush. Clean the entire front and/or rear of the vehicle. For cleaning instructions, see *Exterior Care on page 10-79*.
- Heavy rain or snow is interfering with the radar object detection or camera performance.

This message may also be displayed if there is a problem with the StabiliTrak system.

FORWARD COLLISION ALERT OFF

This message displays when the Forward Collision Alert has been turned off.

FRONT CAMERA BLOCKED CLEAN WINDSHIELD

This message displays when the camera is blocked. Cleaning the outside of the windshield behind the rearview mirror may correct the issue. The Lane Departure Warning system will not operate. Adaptive Cruise Control (ACC), Forward Collision Alert (FCA), and the Active Emergency Braking System may not work or may not work as well.

LANE DEPARTURE WARNING UNAVAILABLE

This message displays when attempting to activate the Lane Departure Warning (LDW) system when it is temporarily unavailable. The LDW system does not need service.

This message could be due to the camera being blocked. Cleaning the outside of the windshield behind the rearview mirror may correct the issue.

PARK ASSIST OFF

This message displays when the Parking Assist system has been turned off or when there is a temporary condition causing the system to be disabled.

SERVICE AUTOMATIC COLLISION PREP

If this message displays, take the vehicle to your dealer to repair the system.

SERVICE DRIVER ASSIST SYSTEM

If this message displays, take the vehicle to your dealer to repair the system.

Adaptive Cruise Control (ACC), Forward Collision Alert (FCA), Active Emergency Braking System, Assistance Systems for Parking or

Backing, and/or Lane Departure Warning (LDW) system may not work. Do not use these systems until the vehicle has been repaired.

SERVICE FRONT CAMERA

If this message remains on after continued driving, the vehicle needs service. Do not use the Lane Departure Warning (LDW) and Forward Collision Alert (FCA) features. Take the vehicle to your dealer.

SERVICE PARK ASSIST

This message displays if there is a problem with the Parking Assist system. Do not use this system to help you park. See your dealer for service.

SERVICE SIDE DETECTION SYSTEM

If this message remains on after continued driving, the vehicle needs service. Side Blind Zone Alert

(SBZA) and Rear Cross Traffic Alert (RCTA) features will not work. Take the vehicle to your dealer.

SIDE BLIND ZONE ALERT OFF

This message indicates that the driver has turned the Side Blind Zone Alert (SBZA) system off.

SIDE DETECTION SYSTEM UNAVAILABLE

This message indicates that Side Blind Zone Alert (SBZA) and Rear Cross Traffic Alert (RCTA) are disabled either because the sensor is blocked and cannot detect vehicles in the blind zone, or the vehicle is passing through an open area, such as the desert, where there is insufficient data for operation. This message may also activate during heavy rain or due to road spray. The vehicle does not need service. For cleaning, see "Washing the Vehicle" under *Exterior Care on page 10-79*.

Propulsion Power Messages

PROPULSION POWER IS REDUCED

This message displays when the propulsion power is reduced and can affect the ability to accelerate. If this message is on, but there is no reduction in performance, proceed to your destination. The performance may be reduced the next time the vehicle is driven. The vehicle may be driven at a reduced speed while this message is on, but maximum acceleration and speed may be reduced. If this message stays on when the malfunction indicator lamp is on, the vehicle should be taken to your dealer for service as soon as possible.

This message can display when driving in mountainous terrain without using Mountain Mode or by not entering Mountain Mode soon enough to build a sufficient battery charge reserve before climbing

steep grades. This is normal operation to protect the high voltage battery. Only if both the PROPULSION POWER IS REDUCED message and the malfunction indicator lamp are on should the vehicle be taken to the dealer for service.

While climbing the grade with this message displayed, the vehicle speed may be reduced until the engine can recover the battery state of charge to a normal level. See “Mountain Mode” under *Driver Selected Operating Modes* on page 9-22.

Ride Control System Messages

SERVICE STABILITRAK

This message displays if there is a problem with the StabiliTrak[®] system. If this message appears, try to reset the system. Stop; turn off the engine for at least 15 seconds; then start the engine again. If this message still comes on, it means

there is a problem. See your dealer for service. The vehicle is safe to drive, however, you do not have the benefit of StabiliTrak, so reduce your speed and drive accordingly.

SERVICE TRACTION CONTROL

This message displays when there is a problem with the Traction Control System (TCS). When this message is displayed, the system will not limit wheel spin. Adjust your driving accordingly. See your dealer for service. See *Traction Control/Electronic Stability Control* on page 9-33 for more information.

TRACTION CONTROL OFF

This message displays when the Traction Control System (TCS) is turned off. Adjust your driving accordingly. See *Traction Control/Electronic Stability Control* on page 9-33.

TRACTION CONTROL ON

This message displays when the Traction Control System (TCS) is turned on. See *Traction Control/Electronic Stability Control* on page 9-33. This message clears itself after 10 seconds.

Airbag System Messages

SERVICE AIRBAG

This message displays if there is a problem with the airbag system. Take the vehicle to your dealer for service.

Security Messages

THEFT ATTEMPTED

This message displays if the vehicle detects a tamper condition.

Service Vehicle Messages

ENGINE MAINTENANCE XXX% COMPLETE

This message displays when the Engine Maintenance Mode is running. See "Engine Maintenance Mode" under *Maintenance Modes* on page 9-25.

ENGINE NOT AVAILABLE SERVICE SOON

This message displays when the engine is not available due to a malfunction that will not allow the engine to start. The vehicle can continue to be driven in Electric Mode until the battery is depleted, but will have reduced acceleration. When this message is displayed, the vehicle should be taken to your dealer for service as soon as possible. See *Out of Fuel/Engine Unavailable* on page 9-24.

SERVICE AC SYSTEM

This message displays if there is a problem with the air conditioning system. Take the vehicle to your dealer for service.

SERVICE HEATER SOON

This message displays if there is a problem with the heater system. Take the vehicle to your dealer for service.

SERVICE POWER STEERING

This message displays if there is a problem with the power steering system. Take the vehicle to your dealer for service.

SERVICE VEHICLE SOON

This message displays if there is a problem with the vehicle. Take the vehicle to your dealer for service. Depending on the severity of a crash, this message may come on along with the airbag readiness light.

Starting the Vehicle Messages

PRESS BRAKE TO START VEHICLE

This message is displayed when attempting to start the vehicle without first pressing the brake pedal.

SERVICE KEYLESS START SYSTEM

This message is displayed if there is a problem with the pushbutton start system. Take the vehicle to your dealer for service.

Tire Messages

SERVICE TIRE MONITOR SYSTEM

This message displays if there is a problem with the Tire Pressure Monitor System (TPMS). See *Tire Pressure Monitor Operation* on page 10-49.

TIRE LEARNING ACTIVE

This message displays when the system is learning new tires. See *Tire Pressure Monitor Operation on page 10-49*.

TIRE LOW ADD AIR TO TIRE

This message displays when the pressure in one or more of the tires is low.

This message also displays LEFT FRONT, RIGHT FRONT, LEFT REAR, or RIGHT REAR to indicate the location of the low tire.

The low tire pressure warning light will also come on. See *Tire Pressure Light on page 5-24*.

If a tire pressure message appears on the DIC, stop as soon as you can. Inflate the tires by adding air until the tire pressure is equal to the values shown on the Tire and Loading Information label. See *Tires on page 10-41*, *Vehicle Load Limits on page 9-12*, and *Tire Pressure on page 10-47*.

You can receive more than one tire pressure message at a time. The DIC also shows the tire pressure values. See *Driver Information Center (DIC) on page 5-38*.

Vehicle Reminder Messages**ICE POSSIBLE DRIVE WITH CARE**

This message displays when ice conditions are possible.

Vehicle Speed Messages**SELECTED SPEED LIMIT EXCEEDED**

This message is displayed when the vehicle speed is greater than the set speed. See "Speed Warning" under *Instrument Cluster on page 5-8*.

Washer Fluid Messages**WASHER FLUID LOW ADD FLUID**

This message may display when the washer fluid level is low. Fill the windshield washer reservoir as soon as possible. See *Engine Compartment Overview on page 10-8* for the location of the windshield washer reservoir. Also, see *Washer Fluid on page 10-19*.

Window Messages**OPEN, THEN CLOSE DRIVER/PASSENGER WINDOW**

This message is displayed when the window needs to be reprogrammed. If the vehicle's battery has been recharged or disconnected, you will need to program each front window for the express-up feature to work. See *Power Windows on page 2-19*.

Vehicle Personalization

Use the audio system controls to access the personalization menus for customizing vehicle features.

The following are all possible personalization features. Depending on the vehicle, some may not be available.

Infotainment System Audio System Controls

To access the personalization menus:

1. Press **SETTINGS** on the Home Page on the infotainment system display.
2. Press the desired feature to display a list of available options.
3. Press to select the desired option setting.
4. Press the  Back screen button to return to the previous menu.

Personalization Menus

The following list of menu items may be available:

- Time and Date
- Language (Language)
- Valet Mode
- Radio
- Vehicle
- Bluetooth
- Voice
- Display
- Rear Camera
- Return to Factory Settings
- Software Information

Each menu is detailed in the following information.

Time and Date

Manually set the time and date. See *Clock on page 5-5*.

Language (Language)

Select Language, then select from the available language(s).

Valet Mode

This will lock the infotainment system, infotainment controls, storage area behind the radio, glove box, and trunk.

To turn Valet Mode on and off, enter a four-digit code on the keypad. Press **Enter** to go to the confirmation screen. Re-enter the four-digit code. Press **LOCK** to lock the system. Enter the four-digit code to unlock the system. Press the **Back** screen button to go back to the previous menu.

Radio

Press to display the Radio menu and the following may display:

- Manage Favorites
- Number of Favorites Shown
- Auto Volume

- Maximum Startup Volume
- Audio Cue Volume

Manage Favorites

This allows favorites to be edited. See “Manage Favorites” in “Settings” under “Radio” in the infotainment manual.

Number of Favorites Shown

Press to set the number of favorites to display.

Select the desired number or select Auto and the infotainment system will automatically adjust the number of favorites shown.

Auto Volume

This feature adjusts the volume based on vehicle speed and ambient noise.

Select Off, Low, Medium-Low, Medium, Medium-High, or High.

Maximum Startup Volume

This feature sets the maximum startup volume. If the vehicle is started and the volume is greater

than this level, the volume is adjusted to this level. To set the maximum startup volume, press + or – to increase or decrease.

Audio Cue Volume

This feature sets the volume of audio files played at system startup and shutdown.

Select On, then press + or – to increase or decrease the volume.

Vehicle

Select and the following may display:

- Climate and Air Quality
- Collision/Detection Systems
- Comfort and Convenience
- Energy
- Lighting
- Power Door Locks
- Remote Lock, Unlock, Start

Climate and Air Quality

Select and the following may display:

- Auto Fan Max Speed
- Auto Heated Seats
- Auto Defog
- Engine Assisted Heating Plugged-In

Auto Fan Max Speed

This feature will set the maximum auto fan speed.

Select Low, Medium, or High.

Auto Heated Seats

When enabled, the auto heated seat buttons on the touch screen will be highlighted. This feature will automatically activate heated seats at the level required by the interior temperature. The auto heated seats can be turned off by using the heated seat buttons on the center stack.

Select Off or On.

5-54 Instruments and Controls

Auto Defog

When set to On, the front defog will automatically come on when the vehicle is started.

Select Off or On.

Engine Assisted Heating Plugged-In

During remote start, this feature turns on or off the ability for the engine to run to help heat the vehicle when it is plugged in. A change in setting will not take effect until after the vehicle is first powered down.

Select Off or On.

Collision/Detection Systems

Select and the following may display:

- Alert Type
- Auto Collision Preparation
- Go Notifier
- Side Blind Zone Alert
- Rear Cross Traffic Alert

Alert Type

This feature will set crash alerts to beeps or seat vibrations. This setting affects all crash alerts including Forward Collision, Lane Departure Warning, and Parking Assist alerts.

Select Beeps or Safety Alert Seat.

Auto Collision Preparation

This feature will turn on or off the Forward Collision Alert feature as well as the Automatic Braking capability of the Auto Collision Preparation feature. With the Alert & Brake setting, both Forward Collision Alert as well as the Automatic Braking capability of the Auto Collision Preparation feature are available. The Alert setting disables most automatic braking functions of the Auto Collision Preparation feature. Some last-second automatic braking capability is still provided with the Alert setting, but it is much less likely to be triggered by most driving conditions. Off disables all Forward

Collision Alert and Automatic Braking capabilities of the Auto Collision Preparation feature. See *Active Emergency Braking System* on page 9-53.

Press Auto Collision Preparation. Press to select Off, Alert & Brake, or Alert.

Go Notifier

This feature will give a reminder that Adaptive Cruise Control provides when it has brought the vehicle to a complete stop behind another stopping vehicle, and then that vehicle drives on.

Press Go Notifier. Press to select Off or On. See *Adaptive Cruise Control* on page 9-39.

Side Blind Zone Alert

This allows the Side Blind Zone Alert feature to be turned on or off.

Press Side Blind Zone Alert. Press to select Off or On. See *Side Blind Zone Alert (SBZA)* on page 9-55.

Rear Cross Traffic Alert

This allows the Rear Cross Traffic Alert to be turned on or off.

Select to turn Off or On. See *Assistance Systems for Parking or Backing on page 9-48*.

Comfort and Convenience

Select and the following may display:

- Auto Memory Recall
- Easy Exit Options
- Chime Volume
- Reverse Tilt Mirror
- Rainsense Wipers

Auto Memory Recall

This feature automatically recalls the current driver's previously stored 1 or 2 button positions when entering the vehicle. See *Memory Seats on page 3-6*.

Select Off, On - Driver Door Open, or On - At ignition On.

Easy Exit Options

This feature automatically recalls the current driver's previously stored Exit button position when exiting the vehicle. See *Memory Seats on page 3-6*.

Select Off or On.

Chime Volume

This allows the selection of the chime volume level.

Press + or - to adjust the volume.

Reverse Tilt Mirror

This allows the feature to be turned on or off.

Select Off, On - Driver and Passenger, On - Driver, or On - Passenger.

Rainsense Wipers

This allows the feature to be turned on or off.

Select Off or On.

Energy

Select and the following may display:

- Energy Summary Pop-up
- Charge Status Feedback
- Charge Cord Theft Alert
- Charge Power Loss Alert

Energy Summary Pop-up

This allows the feature to be turned on or off.

Select Off or On.

Charge Status Feedback

This allows the horn chirp and outside rearview mirror charge status feedback to be turned on or off.

Select Off or On.

Charge Cord Theft Alert

This allows the feature to be turned on or off.

Select Off or On.

5-56 Instruments and Controls

Charge Power Loss Alert

This allows the feature to be turned on or off.

Select Off or On.

Lighting

Select and the following may display:

- Vehicle Locator Lights
- Exit Lighting
- Auto High Beam

Vehicle Locator Lights

This feature will flash the exterior lamps when  on the Remote Keyless Entry (RKE) transmitter is pressed to locate the vehicle.

Select Off or On.

Exit Lighting

This allows the selection of how long the exterior lamps stay on when leaving the vehicle when it is dark outside.

Select Off, 30 Seconds, 60 Seconds, or 120 Seconds.

Auto High Beam

This allows the feature to be turned on or off.

Select Off or On.

Power Door Locks

Select and the following may display:

- Unlocked Door Anti-Lockout
- Auto Door Unlock
- Delayed Door Lock

Unlocked Door Anti-Lockout

When on, this feature will keep the driver door from locking when the door is open. If Off is selected, the Delayed Door Lock menu will be available.

Select Off or On.

Auto Door Unlock

This allows selection of which of the doors will automatically unlock when the vehicle is shifted into P (Park).

Select Off, All Doors, or Driver Door.

Delayed Door Lock

When on, this feature will delay the locking of the doors. To override the delay, press the power door lock switch on the door.

Select Off or On.

Remote Lock, Unlock, Start

Select and the following may display:

- Remote Unlock Light Feedback
- Remote Lock Feedback
- Remote Door Unlock
- Remote Start Auto Heat Seats
- Passive Door Unlock
- Passive Door Lock
- Remote Left in Vehicle Alert

Remote Unlock Light Feedback

When on, the exterior lamps will flash when unlocking the vehicle with the RKE transmitter.

Select Off or Flash Lights.

Remote Lock Feedback

This allows selection of what type of feedback is given when locking the vehicle with the RKE transmitter.

Select Off, Lights and Horn, Lights Only, or Horn Only.

Remote Door Unlock

This allows selection of which doors will unlock when pressing  on the RKE transmitter.

Select All Doors or Driver Door.

Remote Start Auto Heat Seats

If equipped and turned on, this feature will turn the heated seats on when using remote start on cold days.

Select Off or On.

Passive Door Unlock

This allows the selection of what doors will unlock when using the door handle touch pad button on the driver door to unlock the vehicle.

Select All Doors or Driver Door.

Passive Door Lock

This allows passive locking to be turned on or off and selects feedback. See “Passive Locking” in *Remote Keyless Entry (RKE) System Operation on page 2-2*.

Select Off, On with Horn Chirp, or On.

Remote Left in Vehicle Alert

This feature sounds an alert when the RKE transmitter is left in the vehicle.

Select Off or On.

Bluetooth

Select and the following may display:

- Pair New Device
- Device Management
- Ringtones
- Voice Mail Numbers

Pair New Device

Select to pair a new device. See “Pairing” in “Infotainment Controls” under “Bluetooth” in the infotainment manual.

Device Management

Select to connect to a different phone source, disconnect a phone, or delete a phone.

Ringtones

Press to change the ring tone for the specific phone. The phone does not need to be connected to change the ring tone.

Voice Mail Numbers

This feature displays the voice mail number for all connected phones. To change the voice mail number, select EDIT or pressing the EDIT button and type in a new number, then select SAVE or press the SAVE button.

Voice

Select and the following may display:

- Confidence Threshold
- Prompt Length
- Audio Feedback Speed

Confidence Threshold

This feature allows the adjustment of the sensitivity of the speech recognition system.

Select Confirm More or Confirm Less.

Prompt Length

This feature adjusts the voice prompt length.

Select Short or Long.

Audio Feedback Speed

This feature adjusts the audio feedback speed.

Select Slow, Medium, or Fast.

Display

Select and the following may display:

- Mode
- Proximity Sensing
- Calibrate Touchscreen
- Turn Display Off

Mode

Select to change the display screen for day or night driving.

Select Auto, Day, or Night.

Proximity Sensing

When on, certain screen buttons and features will become visible when a hand approaches the screen.

Select Off, On, or On - Map Only.

Calibrate Touchscreen

Select to calibrate the touchscreen, then follow the prompts.

Turn Display Off

Select to turn the display off. Press anywhere on the display area or any faceplate button to turn the display on.

Rear Camera

Select and the following may be display:

- Guidance Lines
- Rear Cross Traffic Alert
- Rear Park Assist Symbols

Guidance Lines

Select to turn Off or On. See *Assistance Systems for Parking or Backing on page 9-48*.

Rear Cross Traffic Alert

This allows the Rear Cross Traffic Alert to be turned on or off.

Select to turn Off or On. See *Assistance Systems for Parking or Backing on page 9-48*.

Rear Park Assist Symbols

Select to turn Off or On. See *Assistance Systems for Parking or Backing on page 9-48*.

Return to Factory Settings

Select and the following may display:

- Restore Vehicle Settings
- Clear All Private Data
- Restore Radio Settings

Restore Vehicle Settings

This allows selection of restoring vehicle settings.

Select Restore or Cancel.

Clear All Private Data

This allows selection to clear all private information from the vehicle.

Select Delete or Cancel.

Restore Radio Settings

This allows selection to restore radio settings.

Select Restore or Cancel.

Software Information

Select to view the infotainment system current software information.

Universal Remote System

See *Radio Frequency Statement on page 13-12*.

Universal Remote System Programming

If equipped, these buttons are in the overhead console.

This system can replace up to three remote control transmitters used to activate devices such as garage door openers, security systems, and

home automation devices. These instructions refer to a garage door opener, but can be used for other devices.

Do not use the Universal Remote system with any garage door opener that does not have the stop and reverse feature. This includes any garage door opener model manufactured before April 1, 1982.

Read these instructions completely before programming the Universal Remote system. It may help to have another person assist with the programming process.

Keep the original hand-held transmitter for use in other vehicles as well as for future programming. Erase the programming when vehicle ownership is terminated. See "Erasing Universal Remote System Buttons" later in this section.

To program a garage door opener, park outside directly in line with and facing the garage door opener receiver. Clear all people and objects near the garage door.

Make sure the hand-held transmitter has a new battery for quick and accurate transmission of the radio-frequency signal.

Programming the Universal Remote System

For questions or help programming the Universal Remote system, call 1-800-355-3515 or see www.homelink.com.

Programming involves time-sensitive actions, and may time out causing the procedure to be repeated.

To program up to three devices:

1. Hold the end of the hand-held transmitter about 3 to 8 cm (1 to 3 in) away from the Universal Remote system buttons with the indicator light in view. The

hand-held transmitter was supplied by the manufacturer of the garage door opener receiver.

2. At the same time, press and hold both the hand-held transmitter button and one of the three Universal Remote system buttons to be used to operate the garage door. Do not release either button until the indicator light changes from a slow to a rapid flash. Then release both buttons.

Some garage door openers may require substitution of Step 2 with the procedure under in "Radio Signals for Canada and Some Gate Operators" later in this section.

3. Press and hold the newly programmed Universal Remote system button for five seconds while watching the indicator light and garage door activation.
 - If the indicator light stays on continuously or the garage door moves when the

button is pressed, then programming is complete. There is no need to complete Steps 4–6.

- If the indicator light does not come on or the garage door does not move, a second button press may be required. For a second time, press and hold the newly programmed button for five seconds. If the light stays on or the garage door moves, programming is complete.
- If the indicator light blinks rapidly for two seconds, then changes to a solid light and the garage door does not move, continue with programming Steps 4–6.

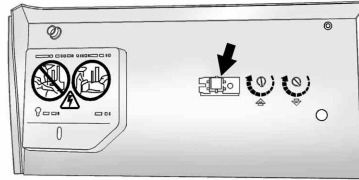

Learn or Smart Button

4. After completing Steps 1–3, locate the Learn or Smart button inside the garage on the garage door opener receiver. The name and color of the button may vary by manufacturer.
5. Press and release the Learn or Smart button. Step 6 must be completed within 30 seconds of pressing this button.
6. Inside the vehicle, press and hold the newly programmed Universal Remote system button for two seconds and then release it. If the garage door does not move or the lamp on the garage door opener receiver

does not flash, press and hold the same button a second time for two seconds, then release it. Again, if the door does not move or the garage door lamp does not flash, press and hold the same button a third time for two seconds, then release it.

The Universal Remote system should now activate the garage door.

Repeat the process for programming the two remaining buttons.

Radio Signals for Canada and Some Gate Operators

For questions or programming help call 1-800-355-3515 or see www.homelink.com.

Canadian radio-frequency laws and some U.S. gate operators require transmitter signals to time out or quit after several seconds of transmission. This may not be long

enough for the Universal Remote system to pick up the signal during programming.

If the programming did not work, replace Step 2 under "Programming the Universal Remote System" with the following:

Press and hold the Universal Remote system button while pressing and releasing the hand-held transmitter button every two seconds until the signal has been successfully accepted by the Universal Remote system. The Universal Remote system indicator light will flash slowly at first and then rapidly. Proceed with Step 3 under "Programming the Universal Remote System" to complete.

Universal Remote System Operation

Using the Universal Remote System

Press and hold the appropriate Universal Remote system button for at least one-half second. The indicator light will come on while the signal is being transmitted.

Erasing Universal Remote System Buttons

Erase all programmed buttons when vehicle ownership is terminated.

To erase:

1. Press and hold the two outside buttons until the indicator light begins to flash. This should take about 10 seconds.
2. Release both buttons.

Reprogramming a Single Universal Remote System Button

To reprogram any of the system buttons:

1. Press and hold any one of the buttons. Do not release the button.
2. The indicator light will begin to flash after 20 seconds. Without releasing the button, proceed with Step 1 under "Programming the Universal Remote System."

Lighting

Exterior Lighting

Exterior Lamp Controls	6-1
Exterior Lamps Off Reminder	6-3
Headlamp High/Low-Beam Changer	6-3
Flash-to-Pass	6-4
Daytime Running Lamps (DRL)	6-4
Automatic Headlamp System	6-4
Hazard Warning Flashers	6-5
Turn and Lane-Change Signals	6-5

Interior Lighting

Instrument Panel Illumination Control	6-6
Courtesy Lamps	6-6
Dome Lamps	6-6
Reading Lamps	6-7

Lighting Features

Entry Lighting	6-8
Exit Lighting	6-8
Battery Power Protection	6-8
Exterior Lighting Battery Saver	6-8

Exterior Lighting

Exterior Lamp Controls



The exterior lamp control is on the turn signal lever.

Turn the control to the following positions:

☰ (Off): Turns off the exterior lamps. The knob returns to the AUTO position after it is released.

Turn to **☰** again to reactivate the AUTO mode.

6-2 Lighting

In Canada, the headlamps will automatically reactivate when the vehicle is shifted out of P (Park).

AUTO (Automatic): Automatically turns the exterior lamps on and off, depending on outside lighting.

☾ (Parking Lamps): Turns on the parking lamps including all lamps, except the headlamps.

☾ (Headlamps): Turns on the headlamps together with the parking lamps and instrument panel lights.

IntelliBeam® System

If equipped, this system turns the vehicle's high-beam headlamps on and off according to surrounding traffic conditions.

The system turns the high-beam headlamps on when it is dark enough and there is no other traffic present.



This light comes on in the instrument cluster when the IntelliBeam system is enabled.

Turning On and Enabling IntelliBeam

To enable the IntelliBeam system, with the turn signal lever in the neutral position, turn the exterior lamp control to AUTO. The blue high-beam on light appears on the instrument cluster when the high beams are on.

Driving with IntelliBeam

The system only activates the high beams when driving over 40 km/h (25 mph).

There is a sensor near the top center of the windshield that automatically controls the system. Keep this area of the windshield clear of debris to allow for best system performance.

The high-beam headlamps remain on, under the automatic control, until one of the following situations occurs:

- The system detects an approaching vehicle's headlamps.
- The system detects a preceding vehicle's taillamps.
- The outside light is bright enough that high-beam headlamps are not required.
- The vehicle's speed drops below 20 km/h (12 mph).

- The IntelliBeam system can be disabled by the High/Low-Beam Changer or the Flash-to-Pass feature. If this happens, the High/Low-Beam Changer must be activated two times within five seconds to reactivate the IntelliBeam system. The instrument cluster light will come on to indicate the IntelliBeam is reactivated. See *Headlamp High/Low-Beam Changer on page 6-3* and *Flash-to-Pass on page 6-4*.

The high beams may not turn off automatically if the system cannot detect another vehicle's lamps because of any of the following:

- The other vehicle's lamps are missing, damaged, obstructed from view, or otherwise undetected.
- The other vehicle's lamps are covered with dirt, snow, and/or road spray.

- The other vehicle's lamps cannot be detected due to dense exhaust, smoke, fog, snow, road spray, mist, or other airborne obstructions.
- The vehicle's windshield is dirty, cracked, or obstructed by something that blocks the view of the light sensor.
- The vehicle is loaded such that the front end points upward, causing the light sensor to aim high and not detect headlamps and taillamps.
- The vehicle is being driven on winding or hilly roads.

The automatic high-beam headlamps may need to be disabled if any of the above conditions exist.

This feature can be turned on or off in vehicle personalization. See *Vehicle Personalization on page 5-52*.

Exterior Lamps Off Reminder

A warning chime will sound if the exterior lamp control is left on in either the headlamp or parking lamp position and the driver door is opened with the ignition off.

Headlamp High/Low-Beam Changer

 **(Headlamp High/Low-Beam Changer):** Push the turn signal lever away from you and release, to turn the high beams on. To return to low beams, push the lever again or pull it toward you and release.



This indicator light turns on in the instrument cluster when the high-beam headlamps are on.

6-4 Lighting

Flash-to-Pass

To flash the high beams, pull the turn signal lever toward you, and release.

Daytime Running Lamps (DRL)

DRL can make it easier for others to see the front of your vehicle during the day. Fully functional DRL are required on all vehicles first sold in Canada.

The DRL will come on when all of the following conditions are met:

- The ignition is on.
- The exterior lamp control is in AUTO.
- The light sensor determines it is daytime.
- The parking brake is released or the vehicle is not in P (Park).

When the DRL are on, the taillamps, instrument panel lights, and other lamps will not be on.

The DRL turn off when the headlamps are turned to  or the ignition is off.

Automatic Headlamp System

When the exterior lamp control is set to AUTO and it is dark enough outside, the headlamps come on automatically.

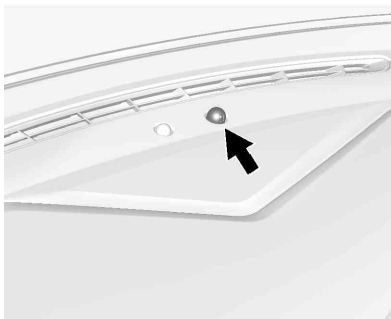

There is a light sensor on top of the instrument panel. Do not cover the sensor.



The system may also turn on the headlamps when driving through a parking garage or tunnel.

When it is bright enough outside, the headlamps will turn off or may change to Daytime Running Lamps (DRL).

The automatic headlamp system turns off when the exterior lamp control is turned to  or the ignition is off.

For vehicles sold in Canada, this control only works when the electric drive unit is in P (Park).

Lights On with Wipers

If the windshield wipers are activated in daylight with the vehicle on, and the exterior lamp control is in AUTO, the headlamps, parking lamps, and other exterior lamps come on. The transition time for the lamps coming on varies based on wiper speed. When the wipers are not operating, these lamps turn off. Move the exterior lamp control to  or  to disable this feature.

Hazard Warning Flashers

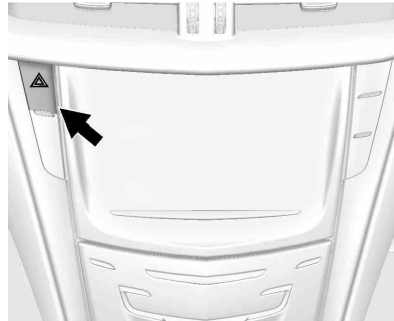

 **(Hazard Warning Flashers):** Press this button to make the front and rear turn signal lamps flash on and off. Press again to turn the flashers off.

The hazard warning flashers turn on automatically if the airbags deploy.

Turn and Lane-Change Signals

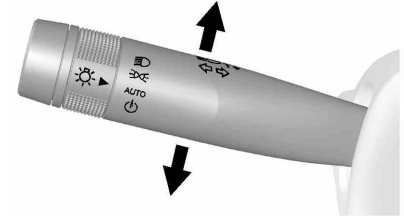

Move the lever all the way up or down to signal a turn.

An arrow on the instrument cluster flashes in the direction of the turn or lane change.

Raise or lower the lever until the arrow starts to flash to signal a lane change. Hold it there until the lane change is completed. If the lever is briefly pressed and released, the turn signal flashes three times.

6-6 Lighting

The turn and lane-change signal can be turned off manually by moving the lever back to its original position.

If after signaling a turn or lane change, the arrow flashes rapidly or does not come on, a signal bulb might be burned out.

Replace any burned out bulbs. If a bulb is not burned out, check the fuse. See *Engine Compartment Fuse Block* on page 10-29.

Interior Lighting

Instrument Panel Illumination Control

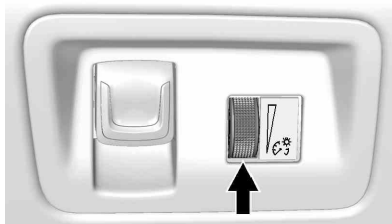

The brightness of the instrument panel lighting and steering wheel controls can be adjusted.

 **(Instrument Panel Illumination):** Move the thumbwheel up or down to brighten or dim the lights.

The brightness of the displays automatically adjusts based on outdoor lighting. The instrument panel illumination control will set the lowest level that the displays will automatically be adjusted.

Courtesy Lamps

The courtesy lamps come on when any door is opened and the dome lamp is in the DOOR position.

Dome Lamps

There are front and rear dome lamps in the overhead console and headliner.

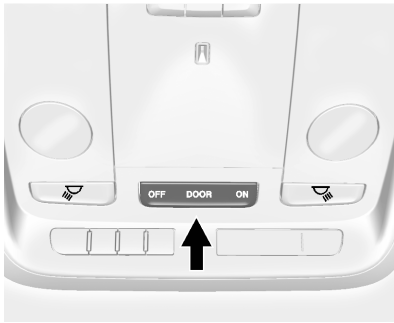

To change the dome lamp settings, press:

OFF: Turns the lamps off, even when a door is open.

DOOR: The lamps come on when a door is opened.

ON: Turns the lamps on.

Reading Lamps

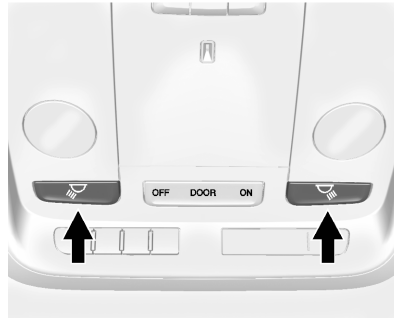

There are front and rear reading lamps on the overhead console and the headliner. These lamps come on when any door is opened. To manually turn the reading lamps on or off:

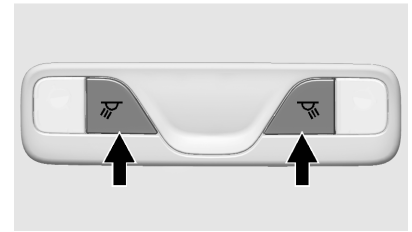

Front Reading Lamps





Rear Reading Lamps

Press  or  next to each reading lamp.

Lighting Features

Entry Lighting

The headlamps, taillamps, back-up lamps, license plate lamps, outside mirror lamps, exterior door handle lamps, dome lamps, and most of the interior lights turn on briefly at night or in areas of limited lighting when  is pressed on the Remote Keyless Entry (RKE) transmitter. See *Remote Keyless Entry (RKE) System Operation on page 2-2*. When the driver door is opened, all control lights, Driver Information Center (DIC) lights, and door pocket lights turn on. After about 30 seconds the exterior lamps turn off, then the dome lamps and remaining interior lights dim to off. Entry lighting can be disabled manually by changing the ignition out of the OFF position, or by pressing  on the RKE transmitter.

This feature can be changed. See “Vehicle Locator Lights” under *Vehicle Personalization on page 5-52*.

Exit Lighting

The headlamps, taillamps, parking lamps, backup lamps, outside mirror lamps, license plate lamps, and exterior door handle lamps come on at night, or in areas with limited lighting, when the driver door is opened after the ignition is turned off. The dome lamps come on after the ignition is changed to the OFF position. The exterior lamps and dome lamps remain on for a set amount of time, then automatically turn off.

The exterior lamps turn off immediately by turning the exterior lamp control off.

This feature can be changed. See *Vehicle Personalization on page 5-52*.

Battery Power Protection

The battery saver feature is designed to protect the vehicle's battery.

If some interior lamps are left on and the ignition is turned off, the battery rundown protection system automatically turns the lamp off after some time.

Exterior Lighting Battery Saver

The exterior lamps turn off about 10 minutes after the ignition is turned off, if the parking lamps or headlamps have been manually left on. This protects against draining the battery. To restart the 10-minute timer, turn the exterior lamp control to the off position and then back to the parking lamp or headlamp position.

To keep the lamps on for more than 10 minutes, the ignition must be in the ACC/ACCESSORY or ON/RUN position.

Infotainment System

Introduction

Infotainment 7-1

Introduction

Infotainment

See the infotainment manual for information on the radio, audio players, phone, navigation system, and voice or speech recognition. It also includes information on settings.

Climate Controls

Climate Control Systems

Dual Automatic Climate Control System 8-1

Air Vents

Air Vents 8-7

Maintenance

Passenger Compartment Air Filter 8-8
 Service 8-8

Climate Control Systems

Dual Automatic Climate Control System

The climate control buttons and the touch screen are used to adjust the heating, cooling, and ventilation.

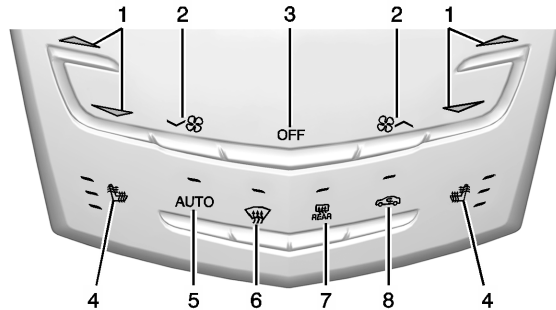

Climate Control Buttons

- | | |
|--|--|
| <ul style="list-style-type: none"> 1. Driver and Passenger Temperature Controls 2. Fan Control 3. OFF (Fan) 4. Driver and Passenger Heated Seats | <ul style="list-style-type: none"> 5. AUTO (Automatic Operation) 6. Defrost 7. Rear Window Defogger 8. Recirculation |
|--|--|

8-2 Climate Controls

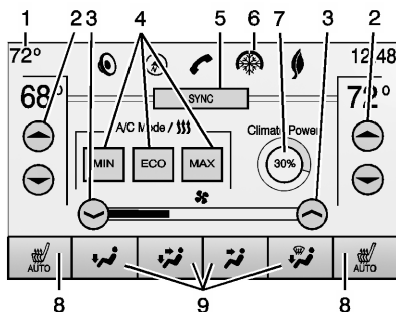

Climate Touch Screen Controls

1. Outside Air Temperature Display
2. Driver and Passenger Temperature Controls
3. Fan Control
4. Climate Modes: MIN, ECO, MAX
5. SYNC (Synchronized Temperature)

6. Climate Control Selection (Application Tray Button)
7. Climate Power Gauge
8. Driver and Passenger Auto Heated Seats
9. Air Delivery Mode Controls

Climate Control Touch Screen

The fan, air delivery mode, driver and passenger temperatures, A/C mode, and SYNC settings can be controlled by pressing CLIMATE on the infotainment home screen or the climate button in the touch screen application tray. A selection can then be made on the front climate control page displayed. See *Infotainment on page 7-1*.

Climate Control Status Screen

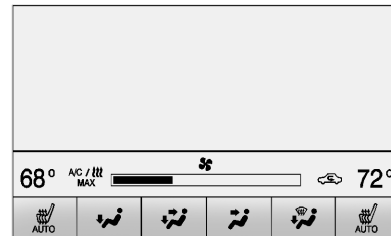

The climate control status screen appears briefly when the climate control buttons on the faceplate are adjusted. The air delivery mode can be adjusted on the climate control status screen.

Climate Mode Operation

There are three climate mode settings: MIN, ECO, and MAX. These settings adjust the impact the climate control system has on the vehicle's electric range or fuel economy.

To select a climate mode:

1. Press CLIMATE on the center stack.
2. Press the climate mode button on the touch screen. The climate mode will be lit.

MIN (Fan Only Mode): The air conditioning and electric heat are turned off. As long as  is not selected, the climate control settings may not have a noticeable effect on the vehicle electric range and fuel economy.

When in MIN mode, the AUTO indicator light will be off. When AUTO is selected in MIN mode, the mode will change to either ECO or MAX.

When in MIN mode, the air conditioning system may turn on automatically if the high voltage battery is being cooled. The climate control system could blow cold air. This is normal. To prevent cold air from blowing into the interior, turn off the fan control and select the vent mode and manual recirculation mode, and close the air vents.

When in MIN mode, if Auto Defog is enabled, the air conditioning and electric heat may turn on when high humidity conditions exist. See "Climate and Air Quality" under *Vehicle Personalization* on page 5-52 for more information on the Auto Defog selection. The air conditioning may also run if  is selected.

ECO (Economy Mode): The air conditioning and electric heat are controlled to balance comfort with fuel economy. As long as  is not selected, the vehicle electric range

or fuel economy will decrease less than in MAX mode, but will result in moderate comfort.

MAX (Comfort Mode): The air conditioning and electric heat are controlled to reach the best comfort level based on the temperature setting selected. In this mode, vehicle electric range or fuel economy will decrease depending on the amount of energy required to reach the best comfort levels.

Climate Power Gauge

When the climate mode is changed, the Climate Power gauge displays the impact that user setting changes have on energy consumption. The higher the reading, the more energy is being used.

Automatic Operation

The system automatically controls the fan speed, air delivery, air conditioning, and recirculation in order to heat or cool the vehicle to the desired temperature.

8-4 Climate Controls

When the indicator light is on or AUTO is displayed on the touch screen, the system is in full automatic operation. If the air delivery mode or fan setting is manually adjusted, the auto indicator turns off and the display will show the selected settings. Auto operation can be turned off individually for climate settings.

For automatic operation:

1. Press AUTO.
2. Set the temperature. Allow the system time to stabilize. Then adjust the temperature as needed for best comfort.

To improve fuel efficiency and to cool the vehicle faster, recirculation may be automatically selected in warm weather. The recirculation light will not come on. Press  to select recirculation; press it again to select outside air.

English units can be changed to metric units through the instrument cluster. See “Settings” under *Instrument Cluster* on page 5-8.

OFF (Fan): Press to turn the fan on or off. The temperature control and air delivery mode can still be adjusted.

△ or ▽ (Driver and Passenger Temperature Controls): The temperature can be adjusted separately for the driver and the passenger. Press to increase or decrease the temperature. Press and hold to rapidly increase or decrease the temperature.

The driver and passenger temperatures can also be adjusted by pressing the controls on the touch screen.

SYNC (Synchronized Temperature): Press SYNC on the touch screen to link all climate zone settings to the driver settings. Adjust the driver side temperature control to change the linked temperature. When the passenger settings are

adjusted, the SYNC button is displayed when the temperatures are unlinked.

Manual Operation

▽  or  ^ (Fan Control):

Press the fan control buttons or the touch screen fan control to increase or decrease the fan speed. Press and hold the buttons or the touch screen control to adjust speed more quickly. The fan speed setting displays. Pressing either button cancels automatic fan control and the fan can be controlled manually. Press AUTO to return to automatic operation. To turn off the fan and climate control system, press and hold the fan down button or touch screen fan control until it is off.

If the fan is manually turned off while in ECO or MAX mode, the display will automatically change to MIN mode. When the fan is turned back on either by manually increasing fan speed or pressing the AUTO button, the climate mode will revert back to ECO or MAX mode.

Air Delivery Mode Control: Press the CLIMATE touch screen button to select climate control. Press the air delivery mode touch screen button to change the direction of the airflow. The selected air delivery mode button is lit. Pressing any of the air delivery buttons cancels automatic air delivery control and the direction of the airflow can be controlled manually. Press AUTO to return to automatic operation.



To change the current mode, select one of the following:

 **(Vent):** Air is directed to the instrument panel outlets.

 **(Bi-Level):** Air is divided between the instrument panel outlets and the floor outlets.

 **(Floor):** Air is directed to the floor outlets, with some air to the windshield and side windows.

 **(Defog):** Clears the windows of fog or moisture. Air is directed to the windshield, side windows, and floor outlets.

 **(Defrost):** Press the  button to turn on or off. This clears the windshield of fog or frost more quickly. Air is directed to the windshield and side windows.

Automatic Air Recirculation: When the AUTO indicator light is on, the air is automatically recirculated as needed to help quickly cool the inside of the vehicle.

 **(Recirculation):** Press to alternate between recirculating air inside the vehicle or pulling in outside air. The indicator light on the button is lit when recirculation mode is active. This helps to quickly cool the air inside the vehicle or prevent outside air and odors from entering.

Pressing this button cancels automatic recirculation. Press AUTO to return to automatic operation; recirculation runs automatically as needed.

Manual recirculation mode is not available when in Defrost mode.

Auto Defog: The climate control system may have a sensor to automatically detect high humidity inside the vehicle. When high humidity is detected, the climate control system may adjust to outside air supply and turn on the air conditioner. If the climate control system does not detect possible window fogging, it returns to normal operation. To turn Auto Defog off or on, see “Climate and Air Quality” under *Vehicle Personalization on page 5-52*.

Rear Window Defogger

 **REAR (Rear Window Defogger):** Press to turn the rear window defogger on or off. An indicator light on the button comes on to show that the rear window defogger is on.



The heated outside mirrors turn on when the rear window defogger button is on. They help to clear fog or frost from the surface of the mirrors.

8-6 Climate Controls

Caution



Do not try to clear frost or other material from the inside of the front windshield and rear window with a razor blade or anything else that is sharp. This may damage the rear window defogger grid and affect the radio's ability to pick up stations clearly. The repairs would not be covered by the vehicle warranty.

or (Manual Heated Seats):

The controls are on the center stack. Press  or  to heat the driver or passenger seat cushion and seatback. See *Heated Front Seats on page 3-8*.

AUTO or AUTO (Auto Heated Seats):

The controls are on the touch screen on the center stack.

Press the touch screen  AUTO or  AUTO button. The area around the button will change to red when this feature is on. When the vehicle

is on, this feature will automatically activate the heated seats at the level required by the vehicle's interior temperature. The active high, medium, low, or off heated seat level will be indicated by the manual heated seat button lights on the center stack. Use the touch screen buttons or the manual heated seat buttons on the center stack to turn auto heated seats off. See *Heated Front Seats on page 3-8*.

Remote Start Climate Control

Operation: The climate control system may run when the vehicle is started remotely. The system uses the driver's previous settings to heat or cool the inside of the vehicle. See *Remote Start on page 2-8*.

The rear window defogger turns on if it is cold outside.

Sensors

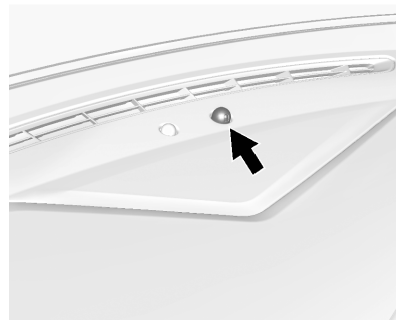

The solar sensor monitors the solar heat.

The climate control system uses the sensor information to adjust the temperature, fan speed, recirculation, and air delivery mode for best comfort.

If the sensor is covered, the automatic climate control system may not work properly.

Air Vents

Adjustable air vents are in the center and on the side of the instrument panel.

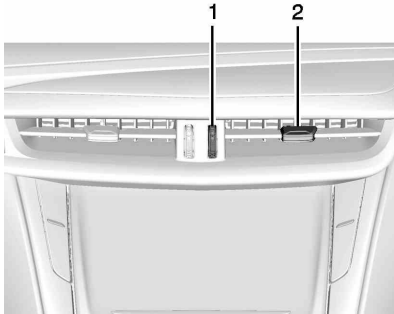

Use the thumbwheels (1) near the air vents to open or close off the airflow.

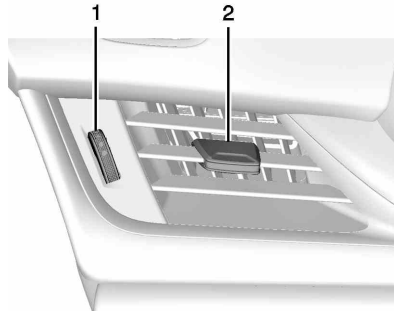

Move the slats (2) to change the direction of the airflow.

Additional air vents are beneath the windshield and the driver side and passenger side door windows. These are fixed and cannot be adjusted.

Operation Tips

- Clear away any ice, snow, or leaves from air inlets at the base of the windshield that could block the flow of air into the vehicle.
- Keep the path under the front seats clear of objects to help circulate the air inside the vehicle more effectively.
- Use of non-GM approved hood deflectors can adversely affect the performance of the system. Check with your dealer before adding equipment to the outside of the vehicle.
- Do not attach any devices to the air vent slats. This restricts airflow and may cause damage to the air vents.

Maintenance

Passenger Compartment Air Filter

The filter removes dust, pollen, and other airborne irritants from outside air that is pulled into the vehicle. The filter should be replaced as part of routine scheduled maintenance. See *Maintenance Schedule on page 11-2*.

See your dealer regarding replacement of the filter.

Service

All vehicles have a label underhood that identifies the refrigerant used in the vehicle. The refrigerant system should only be serviced by trained and certified technicians. The air conditioning evaporator should never be repaired or replaced by one from a salvage vehicle. It should only be replaced by a new evaporator to ensure proper and safe operation.

During service, all refrigerants should be reclaimed with proper equipment. Venting refrigerants directly to the atmosphere is harmful to the environment and may also create unsafe conditions based on inhalation, combustion, frostbite, or other health-based concerns.

Driving and Operating

Driving Information

Driving for Better Energy	
Efficiency	9-2
Distracted Driving	9-4
Defensive Driving	9-5
Drunk Driving	9-5
Control of a Vehicle	9-6
Braking	9-6
Steering	9-6
Off-Road Recovery	9-7
Loss of Control	9-8
Driving on Wet Roads	9-8
Hill and Mountain Roads	9-9
Winter Driving	9-10
If the Vehicle Is Stuck	9-12
Vehicle Load Limits	9-12

Starting and Operating

New Vehicle Break-In	9-16
Power Button	9-16
Starting and Stopping the Vehicle	9-18
Retained Accessory Power (RAP)	9-19
Shifting Into Park	9-19
Shifting out of Park	9-20
Parking over Things That Burn	9-21

Electric Vehicle Operating Modes

System Operation	9-21
Electric Mode	9-21
Extended Range Mode	9-22
Driver Selected Operating Modes	9-22
Out of Fuel/Engine Unavailable	9-24
Maintenance Modes	9-25

Engine Exhaust

Engine Exhaust	9-27
Running the Vehicle While Parked	9-27

Electric Drive Unit

Electric Drive Unit	9-28
---------------------------	------

Brakes

Antilock Brake System (ABS)	9-29
Electric Parking Brake	9-30
Regenerative Braking	9-32

Ride Control Systems

Traction Control/Electronic Stability Control	9-33
Driver Mode Control	9-35
Competitive Driving Mode ...	9-36
Continuous Damping Control (CDC)	9-36

Cruise Control

Cruise Control	9-37
Adaptive Cruise Control	9-39

9-2 Driving and Operating

Driver Assistance Systems

Driver Assistance Systems	9-47
Assistance Systems for Parking or Backing	9-48
Assistance Systems for Driving	9-50
Forward Collision Alert (FCA) System	9-50
Active Emergency Braking System	9-53
Side Blind Zone Alert (SBZA)	9-55
Lane Departure Warning (LDW)	9-56

Charging

Plug-In Charging	9-58
Delayed Charging Override	9-60
Charging Status Feedback	9-60
Charge Cord	9-64
Utility Interruption of Charging	9-65
Electrical Requirements for Battery Charging	9-66

Fuel

Fuel	9-67
California Fuel Requirements	9-68
Fuels in Foreign Countries ...	9-68
Fuel Additives	9-68
Filling the Tank	9-68
Filling a Portable Fuel Container	9-70

Trailer Towing

General Towing Information	9-71
----------------------------------	------

Conversions and Add-Ons

Add-On Electrical Equipment	9-71
-----------------------------------	------

Driving Information

Driving for Better Energy Efficiency

Use the following tips to help maximize energy efficiency and range.

In colder temperatures, while these efficiency tips will help, the electric vehicle driving range may be lower due to higher energy usage.

Driving Style

Efficiency Gauge (Instrument Cluster)

The leaf indicator or green ring indicator should be kept green and in the center of the gauge.

Inefficient acceleration is indicated when the ring turns yellow or the leaf turns yellow and travels above the center of the gauge.

Aggressive braking is indicated when the ring turns yellow or the leaf turns yellow and travels below the center of the gauge.

Acceleration/Braking/Coasting

Avoid unnecessary rapid accelerations and decelerations.

Electric range is maximized at 80 km/h (50 mph) and below. Higher speeds use more energy and can significantly reduce electric range.

Use cruise control when appropriate.

Plan ahead for decelerations and coast whenever possible. For example, do not rush to traffic signals.

Do not shift to N (Neutral) to coast. The vehicle recovers energy while coasting and braking in D (Drive) or L (Low).

Drive Mode and PRNDL Selection

Use Tour Mode when possible.

Sport Mode provides more responsive acceleration than Tour Mode, but can reduce efficiency.

Use Mountain Mode prior to climbing long, steep grades in mountainous areas. Be sure to engage Mountain Mode before starting to climb. Mountain Mode reduces electric range and power, but may be needed to maintain speeds above 96 km/h (60 mph) when climbing grades of 5% or greater.

Use Hold Mode on a trip where all or most of the electric charge will be depleted. Use Hold Mode mainly during highway or high-speed driving to maximize both electric vehicle miles and fuel efficiency.

Use L (Low) in heavy stop-and-go traffic or when traveling downhill. L (Low) requires less brake pedal



application and provides a controlled, efficient way to slow the vehicle down.

Climate Setting

Using the heat and air conditioning systems decreases the energy available for electric driving.

Optimal energy efficiency is achieved with the heat, air conditioning, and fan turned off.

Less energy is used at low fan speeds. When using the fan:

- MIN is the most energy efficient climate setting as long as  is not selected.
- ECO is for moderate air conditioning and heater operation and is the next most energy efficient setting as long as  is not selected.
- MAX mode provides the most comfort but is the least energy efficient.

9-4 Driving and Operating

Use the auto heated seat feature instead of climate settings. Heating the seat uses less energy than heating the vehicle interior.

Use remote start to heat or cool the interior when the vehicle is plugged in to maximize the electric range by utilizing electricity from the electrical outlet. Engine Assisted Heating while plugged in can be personalized. See *Remote Start on page 2-8*.

In hot weather, avoid parking in direct sunlight or use sunshades inside the vehicle.

Turn off the front and rear window defog/defrost when they are no longer needed.

Avoid driving with the windows open at highway speeds.

See *Vehicle Personalization on page 5-52*.

Vehicle Charging/Maintenance Charging

Keep the vehicle plugged in, even when fully charged, to keep the battery temperature ready for the next drive. This is important when outside temperatures are extremely hot or cold.

Maintenance

Always keep the tires properly inflated and the vehicle properly aligned.

The weight of excess cargo in the vehicle affects efficiency and range. Avoid carrying more than is needed.

If fuel is not regularly used, consider keeping the fuel tank only one-third full. Excess fuel weight impacts efficiency and range.

For fuel recommendations, see *Fuel on page 9-67*.

Avoid unnecessary use of electrical accessories. Power used for functions other than propelling the vehicle will reduce electric vehicle range.

Using a rooftop carrier will reduce efficiency due to additional weight and drag.

Distracted Driving

Distraction comes in many forms and can take your focus from the task of driving. Exercise good judgment and do not let other activities divert your attention away from the road. Many local governments have enacted laws regarding driver distraction. Become familiar with the local laws in your area.

To avoid distracted driving, always keep your eyes on the road, hands on the wheel, and mind on the drive.

- Do not use a phone in demanding driving situations. Use a hands-free method to place or receive necessary phone calls.
- Watch the road. Do not read, take notes, or look up information on phones or other electronic devices.
- Designate a front seat passenger to handle potential distractions.
- Become familiar with vehicle features before driving, such as programming favorite radio stations and adjusting climate control and seat settings. Program all trip information into any navigation device prior to driving.

- Wait until the vehicle is parked to retrieve items that have fallen to the floor.
- Stop or park the vehicle to tend to children.
- Keep pets in an appropriate carrier or restraint.
- Avoid stressful conversations while driving, whether with a passenger or on a cell phone.

 **Warning**

Taking your eyes off the road too long or too often could cause a crash resulting in injury or death. Focus your attention on driving.

Refer to the infotainment section for more information on using that system and the navigation system, if equipped, including pairing and using a cell phone.

Defensive Driving

Defensive driving means “always expect the unexpected.” The first step in driving defensively is to wear the safety belt. See *Safety Belts on page 3-11*.

- Assume that other road users (pedestrians, bicyclists, and other drivers) are going to be careless and make mistakes. Anticipate what they might do and be ready.
- Allow enough following distance between you and the driver in front of you.
- Focus on the task of driving.

Drunk Driving

Death and injury associated with drinking and driving is a global tragedy.

Warning

Drinking and then driving is very dangerous. Your reflexes, perceptions, attentiveness, and judgment can be affected by even a small amount of alcohol. You can have a serious — or even fatal — collision if you drive after drinking.

Do not drink and drive or ride with a driver who has been drinking. Ride home in a cab; or if you are with a group, designate a driver who will not drink.

Control of a Vehicle

Braking, steering, and accelerating are important factors in helping to control a vehicle while driving.

Braking

Braking action involves perception time and reaction time. Deciding to push the brake pedal is perception time. Actually doing it is reaction time.

Average driver reaction time is about three-quarters of a second. In that time, a vehicle moving at 100 km/h (60 mph) travels 20 m (66 ft), which could be a lot of distance in an emergency.

Helpful braking tips to keep in mind include:

- Keep enough distance between you and the vehicle in front of you.
- Avoid needless heavy braking.
- Keep pace with traffic.

If propulsion is disabled while the vehicle is being driven, brake normally but do not pump the brakes. If the brakes are pumped, the pedal could get harder to push down. If propulsion stops, there will

still be some power brake assist but it will be used when the brake is applied. Once the power assist is used up, it can take longer to stop and the brake pedal will be harder to push.

Steering

Electric Power Steering

The vehicle has electric power steering. It does not have power steering fluid. Regular maintenance is not required.

If power steering assist is lost due to a system malfunction, the vehicle can be steered, but may require increased effort.

See your dealer if there is a problem.

If the steering wheel is turned until it reaches the end of its travel and is held against that position for an extended period of time, power steering assist may be reduced.

If the steering assist is used for an extended period of time, power assist may be reduced.

Normal use of the power steering assist should return when the system cools down.

See specific vehicle steering messages under *Service Vehicle Messages on page 5-50*. See your dealer if there is a problem.

Curve Tips

- Take curves at a reasonable speed.
- Reduce speed before entering a curve.
- Maintain a reasonable steady speed through the curve.

- Wait until the vehicle is out of the curve before accelerating gently into the straightaway.

Steering in Emergencies

- There are some situations when steering around a problem may be more effective than braking.
- Holding both sides of the steering wheel allows you to turn 180 degrees without removing a hand.
- The Antilock Brake System (ABS) allows steering while braking.

Off-Road Recovery

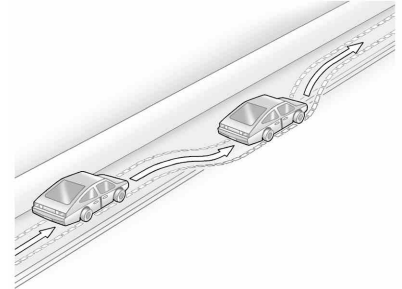

The vehicle's right wheels can drop off the edge of a road onto the shoulder while driving. Follow these tips:

1. Ease off the accelerator and then, if there is nothing in the way, steer the vehicle so that it straddles the edge of the pavement.
2. Turn the steering wheel about one-eighth of a turn, until the right front tire contacts the pavement edge.

9-8 Driving and Operating

3. Turn the steering wheel to go straight down the roadway.

Loss of Control

Skidding

There are three types of skids that correspond to the vehicle's three control systems:

- Braking Skid — wheels are not rolling.
- Steering or Cornering Skid — too much speed or steering in a curve causes tires to slip and lose cornering force.
- Acceleration Skid — too much throttle causes the driving wheels to spin.

Defensive drivers avoid most skids by taking reasonable care suited to existing conditions, and by not overdriving those conditions. But skids are always possible.

If the vehicle starts to slide, follow these suggestions:

- Ease your foot off the accelerator pedal and steer the way you want the vehicle to go. The vehicle may straighten out. Be ready for a second skid if it occurs.
- Slow down and adjust your driving according to weather conditions. Stopping distance can be longer and vehicle control can be affected when traction is reduced by water, snow, ice, gravel, or other material on the road. Learn to recognize warning clues — such as enough water, ice, or packed snow on the road to make a mirrored surface — and slow down when you have any doubt.
- Try to avoid sudden steering, acceleration, or braking, including reducing vehicle speed by shifting to a lower gear. Any sudden changes could cause the tires to slide.

Remember: Antilock brakes help avoid only the braking skid.

Driving on Wet Roads

Rain and wet roads can reduce vehicle traction and affect your ability to stop and accelerate. Always drive slower in these types of driving conditions and avoid driving through large puddles and deep-standing or flowing water.



Warning

Wet brakes can cause crashes. They might not work as well in a quick stop and could cause pulling to one side. You could lose control of the vehicle.

After driving through a large puddle of water or a car/vehicle wash, lightly apply the brake pedal until the brakes work normally.

(Continued)

Warning (Continued)

Flowing or rushing water creates strong forces. Driving through flowing water could cause the vehicle to be carried away. If this happens, you and other vehicle occupants could drown. Do not ignore police warnings and be very cautious about trying to drive through flowing water.

Hydroplaning

Hydroplaning is dangerous. Water can build up under the vehicle's tires so they actually ride on the water. This can happen if the road is wet enough and you are going fast enough. When the vehicle is hydroplaning, it has little or no contact with the road.

There is no hard and fast rule about hydroplaning. The best advice is to slow down when the road is wet.

Other Rainy Weather Tips

Besides slowing down, other wet weather driving tips include:

- Allow extra following distance.
- Pass with caution.
- Keep windshield wiping equipment in good shape.
- Keep the windshield washer fluid reservoir filled.
- Have good tires with proper tread depth. See *Tires on page 10-41*.
- Turn off cruise control.

Hill and Mountain Roads

Driving on steep hills or through mountains is different than driving on flat or rolling terrain. See "Mountain Mode" under *Driver Selected Operating Modes on page 9-22*. Tips for driving in these conditions include:

- Keep the vehicle serviced and in good shape.
- Check all fluid levels and brakes, tires, cooling system, and electric drive unit.
- Keep the vehicle in gear when going down steep or long hills.

Warning

Coasting downhill in N (Neutral) or with the vehicle turned off is dangerous. The brakes will have to do all the work of slowing down the vehicle and could become too hot. Hot brakes may not be able to slow the vehicle enough to maintain speed and control. You could crash. Always have the vehicle running and in gear (preferably LOW range) when going downhill. This will allow the electric drive unit to assist in slowing and maintaining speed.

- Stay in your own lane. Do not swing wide or cut across the center of the road. Drive at speeds that let you stay in your own lane.
- Top of hills: Be alert — something could be in your lane (stalled car, accident).

- Pay attention to special road signs (falling rocks area, winding roads, long grades, passing or no-passing zones) and take appropriate action.

Winter Driving

Driving on Snow or Ice

Drive carefully when there is snow or ice between the tires and the road, creating less traction or grip. Wet ice can occur at about 0°C (32° F) when freezing rain begins to fall, resulting in even less traction. Avoid driving on wet ice or in freezing rain until roads can be treated with salt or sand.

Drive with caution, whatever the condition. Accelerate gently so traction is not lost. Accelerating too quickly causes the wheels to spin and makes the surface under the tires slick, so there is even less traction.

See *Traction Control/Electronic Stability Control* on page 9-33.

The Antilock Brake System (ABS) improves vehicle stability during hard stops on slippery roads, but apply the brakes sooner than when on dry pavement.

Allow greater following distance on any slippery road and watch for slippery spots. Icy patches can occur on otherwise clear roads in shaded areas. The surface of a curve or an overpass can remain icy when the surrounding roads are clear. Avoid sudden steering maneuvers and braking while on ice.

Turn off cruise control on slippery surfaces.

Blizzard Conditions

Being stuck in snow can be a serious situation. Stay with the vehicle unless there is help nearby. If possible, use the Roadside Service Program. To get help and keep everyone in the vehicle safe:

- Turn on the hazard warning flashers.
- Tie a red cloth to an outside mirror.

 **Warning**

Snow can trap engine exhaust under the vehicle. This may cause exhaust gases to get inside. Engine exhaust contains carbon monoxide (CO) which cannot be seen or smelled. It can cause unconsciousness and even death.

(Continued)

Warning (Continued)

If the vehicle is stuck in the snow:

- Clear away snow from around the base of the vehicle, especially any that is blocking the exhaust pipe.
- Check again from time to time to be sure snow does not collect there.
- Open a window about 5 cm (2 in) on the side of the vehicle that is away from the wind to bring in fresh air.
- Fully open the air outlets on or under the instrument panel.
- Adjust the climate control system to a setting that circulates the air inside the vehicle and set the fan speed to the highest setting. See “Climate Control Systems” in the Index.

(Continued)

Warning (Continued)

For more information about carbon monoxide, see *Engine Exhaust on page 9-27*.

To conserve energy, run the vehicle for only short periods as needed to warm the vehicle and then shut the vehicle off and close the window most of the way to save heat. Repeat this until help arrives but only when you feel really uncomfortable from the cold. Moving about to keep warm also helps.

If it takes some time for help to arrive, start the vehicle. The engine may start for cabin comfort and to maintain the high voltage battery state of charge. Turn off unnecessary accessories to conserve energy.

If the Vehicle Is Stuck

Slowly and cautiously spin the wheels to free the vehicle when stuck in sand, mud, ice, or snow.

The Traction Control System (TCS) must be turned off by pressing the TCS/ESC button. Traction control is not completely off, but will only engage if the maneuver can cause damage to the electric drive unit.

Warning

If the vehicle's tires spin at high speed, they can explode, and you or others could be injured. The vehicle can overheat, causing an engine compartment fire or other damage. Spin the wheels as little as possible and avoid going above 56 km/h (35 mph).

Rocking the Vehicle to Get it Out

Turn the steering wheel left and right to clear the area around the front wheels. Shift back and forth between R (Reverse) and a forward gear, spinning the wheels as little as possible. The Traction Control System prevents the tires from spinning at high speeds. To prevent electric drive unit wear, wait until the wheels stop spinning before shifting gears. Release the accelerator pedal while shifting, and press lightly on the accelerator pedal when the electric drive unit is in gear. Slowly spinning the wheels in the forward and reverse directions causes a rocking motion that could free the vehicle. If that does not get the vehicle out after a few tries, it might need to be towed out. If the vehicle does need to be towed out, see *Towing the Vehicle* on page 10-75.

Vehicle Load Limits

It is very important to know how much weight the vehicle can carry. This weight is called the vehicle capacity weight and includes the weight of all occupants, cargo, and all nonfactory-installed options. Two labels on the vehicle show how much weight it was designed to carry, the Tire and Loading Information label and the Certification label.

Warning

Do not load the vehicle any heavier than the Gross Vehicle Weight Rating (GVWR), or either the maximum front or rear Gross Axle Weight Rating (GAWR). This can cause systems to break and change the way the

(Continued)

Warning (Continued)

vehicle handles. This could cause loss of control and a crash. Overloading can also shorten the life of the vehicle.

Tire and Loading Information Label

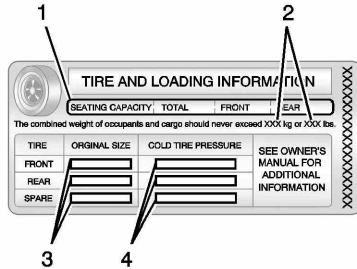

Label Example

A vehicle-specific Tire and Loading Information label is attached to the center pillar

(B-pillar). With the driver door open, the label is attached below the door lock post. The Tire and Loading Information label shows the number of occupant seating positions (1), and the maximum vehicle capacity weight (2) in kilograms and pounds.

The Tire and Loading Information label also shows the tire size of the original equipment tires (3) and the recommended cold tire inflation pressures (4). For more information on tires and inflation see *Tires on page 10-41* and *Tire Pressure on page 10-47*.

There is also important loading information on the Certification label. It tells you the Gross Vehicle Weight Rating (GVWR) and the Gross Axle Weight

Rating (GAWR) for the front and rear axle; see "Certification Label" later in this section.

"Steps for Determining Correct Load Limit–"

1. Locate the statement "The combined weight of occupants and cargo should never exceed XXX kg or XXX lbs." on your vehicle's placard.
2. Determine the combined weight of the driver and passengers that will be riding in your vehicle.
3. Subtract the combined weight of the driver and passengers from XXX kg or XXX lbs.
4. The resulting figure equals the available amount of cargo and luggage load capacity. For example, if the "XXX" amount equals 1400 lbs. and

9-14 Driving and Operating

there will be five 150 lb passengers in your vehicle, the amount of available cargo and luggage load capacity is 650 lbs. (1400-750 (5 x 150) = 650 lbs.)

- Determine the combined weight of luggage and cargo being loaded on the vehicle. That weight may not safely exceed the available cargo and luggage load capacity calculated in Step 4.
- If your vehicle will be towing a trailer, load from your trailer will be transferred to your vehicle. Consult this manual to determine how this reduces the available cargo and luggage load capacity of your vehicle."

The vehicle is neither designed nor intended to tow a trailer.

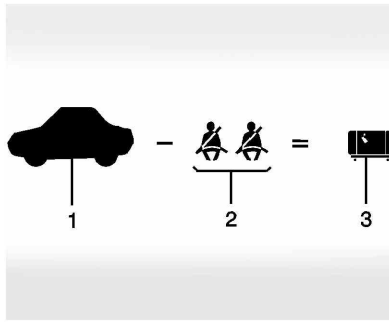

Example 1

- Vehicle Capacity Weight for Example 1 = 453 kg (1,000 lbs).
- Subtract Occupant Weight @ 68 kg (150 lbs) × 2 = 136 kg (300 lbs).
- Available Occupant and Cargo Weight = 317 kg (700 lbs).

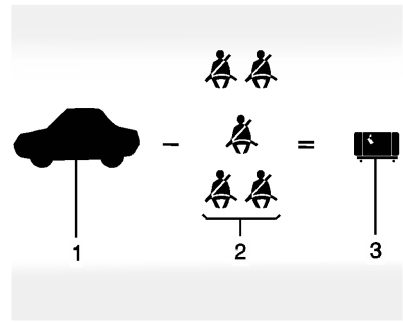

Example 2

- Vehicle Capacity Weight for Example 2 = 453 kg (1,000 lbs).
- Subtract Occupant Weight @ 68 kg (150 lbs) × 5 = 340 kg (750 lbs).
- Available Cargo Weight = 113 kg (250 lbs).

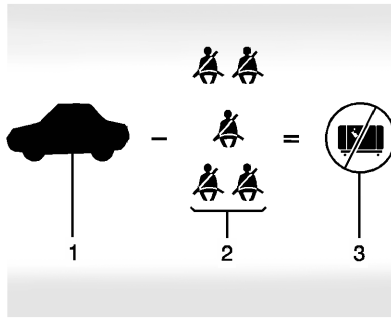

Example 3

1. Vehicle Capacity Weight for Example 3 = 453 kg (1,000 lbs).
2. Subtract Occupant Weight @ 91 kg (200 lbs) × 5 = 453 kg (1,000 lbs).
3. Available Cargo Weight = 0 kg (0 lbs).

Refer to the vehicle's Tire and Loading Information label for specific information about the vehicle's capacity weight and

seating positions. The combined weight of the driver, passengers, and cargo should never exceed the vehicle's capacity weight.

Certification Label

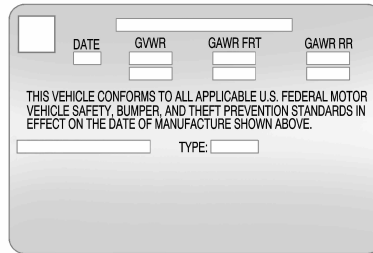

Label Example

A vehicle-specific Certification label is found on the center pillar (B-pillar). The label shows the gross weight capacity of the vehicle. This is the Gross Vehicle Weight Rating (GVWR) and includes the weight of the vehicle, all occupants, fuel, and

cargo. Never exceed the GVWR for the vehicle, or the Gross Axle Weight Rating (GAWR) for either the front or rear axle.

Spread out heavy loads equally on both sides of the vehicle. See "Steps for Determining Correct Load Limit" earlier in this section.

Warning

Do not load the vehicle any heavier than the Gross Vehicle Weight Rating (GVWR), or either the maximum front or rear Gross Axle Weight Rating (GAWR). This can cause systems to break and change the way the vehicle handles. This could cause loss of control and a crash. Overloading can also shorten the life of the vehicle.

9-16 Driving and Operating

If you put things inside the vehicle — like suitcases, tools, packages, or anything else — they will go as fast as the vehicle goes. If you have to stop or turn quickly, or if there is a crash, they will keep going.

Warning

Things inside the vehicle can strike and injure people in a sudden stop or turn, or in a crash.

- Put things in the cargo area of the vehicle. In the cargo area, put them as far forward as possible. Try to spread the weight evenly.

(Continued)

Warning (Continued)

- Never stack heavier things, like suitcases, inside the vehicle so that some of them are above the tops of the seats.
- Do not leave an unsecured child restraint in the vehicle.
- Secure loose items in the vehicle.
- Do not leave a seat folded down unless needed.

Starting and Operating

New Vehicle Break-In

The vehicle does not require a break-in period. Vehicle break-in is performed during manufacturing.

Power Button

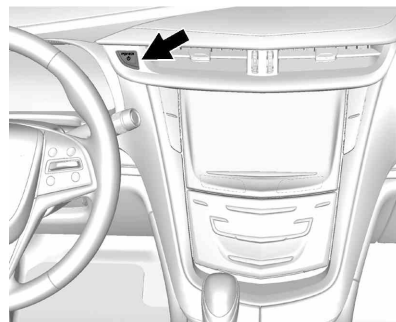

The vehicle has an electronic pushbutton start. The POWER  button light is on steady when in

ON/RUN power mode. When the vehicle is turned off, the POWER  button light will turn off.

The Remote Keyless Entry (RKE) transmitter must be in the vehicle for the system to operate. If the vehicle will not start, place the RKE transmitter in the transmitter slot. See *Remote Keyless Entry (RKE) System Operation on page 2-2*.

ON/RUN: This position is for starting and driving. With the vehicle off, and the brake pedal applied, pressing the POWER  button once will place the vehicle in ON/RUN. When the READY light is on in the instrument cluster, the vehicle is ready to be driven. This could take up to 15 seconds at extremely cold temperatures. See *Vehicle Ready Light on page 5-26*. The engine will only start if needed. If the vehicle did not start, the instrument cluster will display a screen with inactive fuel and battery gauges. See *Starting and Stopping the Vehicle on page 9-18*.

Service Only Mode

This power mode is available for service and diagnostics, and to verify the proper operation of the malfunction indicator lamp as may be required for emission inspection purposes. With the vehicle off, and the brake pedal not applied, pressing and holding the POWER  button for more than five seconds will place the vehicle in Service Only Mode. The instruments and audio systems will operate as they do in ON/RUN, but the vehicle will not be able to be driven. The propulsion system will not start in Service Only Mode. Press the button again to turn the vehicle off.

Caution

Service Only Mode will discharge the 12-volt battery. Do not use Service Only Mode for an extended period, or the vehicle may not start.

STOPPING THE VEHICLE/OFF:

To turn the vehicle off, press the POWER  button with the vehicle in P (Park). Retained Accessory Power (RAP) will remain active until the driver door is opened. See *Retained Accessory Power (RAP) on page 9-19*. When turning off the vehicle, if the vehicle is not in P (Park), the vehicle will go to ACC/ACCESSORY and display the message SHIFT TO PARK in the Driver Information Center (DIC). See *Electric Drive Unit Messages on page 5-44*.

If the vehicle must be shut off in an emergency:

1. Brake using a firm and steady pressure. Do not pump the brakes repeatedly. This may deplete power assist, requiring increased brake pedal force.
2. Shift the vehicle to N (Neutral). This can be done while the vehicle is moving. After shifting

9-18 Driving and Operating

to N (Neutral), firmly apply the brakes and steer the vehicle to a safe location.

3. Come to a complete stop, shift to P (Park), and turn the vehicle off by pressing the POWER ⏻ button.
4. Set the parking brake. See *Electric Parking Brake on page 9-30*.

Warning

Turning off the vehicle while moving may disable the airbags. While driving, only shut the propulsion system off in an emergency.

If the vehicle cannot be pulled over, and must be shut off while driving, press and hold the POWER ⏻ button for longer than two seconds, or press twice in five seconds.

Starting and Stopping the Vehicle

The engine may start, if required, when the propulsion system is on.

Caution

Do not try to shift to P (Park) if the vehicle is moving or the electric drive unit could be damaged. Shift to P (Park) only when the vehicle is stopped.

Caution

If you add electrical parts or accessories, you could change the way the vehicle operates. Any resulting damage would not be covered by the vehicle warranty. See *Add-On Electrical Equipment on page 9-71*.

Starting Procedure

1. Move the shift lever to P (Park) or N (Neutral). The propulsion system will not start in any other position.
2. The Remote Keyless Entry (RKE) transmitter must be in the vehicle.
3. Press the brake pedal and press and release the POWER ⏻ button.

If the RKE transmitter is not in the vehicle or something is interfering with the transmitter, a message displays in the Driver Information Center (DIC). See *Key and Lock Messages on page 5-45*.

If the vehicle will not start due to a low RKE transmitter battery, the vehicle can still be driven. See “Starting the Vehicle with a Low Transmitter Battery” in *Remote Keyless Entry (RKE) System Operation on page 2-2*.

Welcome, powering up, and powering down audio messages are heard as well as displayed on the instrument cluster. This happens when opening the driver door upon entry, and when pressing the POWER  button.

The instrument cluster displays an active fuel or battery gauge, along with an audio startup cue, when the vehicle is ready to be driven. This could take up to 15 seconds at extremely cold temperatures. The engine will only start if needed. If the vehicle did not start, the instrument cluster will display a screen with inactive fuel and battery gauges. See *Starting and Stopping the Vehicle* on page 9-18.

Restarting Procedure

If the vehicle must be restarted while it is still moving, move the shift lever to N (Neutral) and press the POWER  button twice without pressing the brake pedal. The propulsion system will not restart in any other position.

Computers determine when the engine needs to run. The engine may start, if required, when the propulsion system is on. Some vehicle conditions that force the engine to run:

- There are cold ambient temperatures.
- The hood is open or not completely latched.
- The high voltage battery has a low charge.
- The engine needs to run for maintenance.

See *Maintenance Modes* on page 9-25.

A chime will sound if the driver door is opened while the vehicle is in ON/RUN. Always press the POWER  button to turn the vehicle off before exiting.

Stopping Procedure

For information on how to turn the vehicle off, see *Power Button* on page 9-16.

Retained Accessory Power (RAP)

The following features will operate for up to 10 minutes or until the driver door is opened:

- Audio System
- Accessory Power Outlets

Power windows will operate for up to 10 minutes or until any door is opened.

Shifting Into Park

1. Hold the brake pedal down and set the parking brake. See *Electric Parking Brake* on page 9-30.
2. Move the shift lever into P (Park) by pushing the lever all the way toward the front of the vehicle.
3. Turn the vehicle off.

Leaving the Vehicle with the Propulsion System On

Warning

It can be dangerous to leave the vehicle with the propulsion system running. It could overheat and catch fire.

It is dangerous to get out of the vehicle if the shift lever is not fully in P (Park) with the parking brake firmly set. The vehicle can roll.

Do not leave the vehicle when the propulsion system is running. If you have left the propulsion system running, the vehicle can move suddenly. You or others could be injured. To be sure the vehicle will not move, even when you are on fairly level ground, always set the parking brake and move the shift lever to P (Park). See *Shifting Into Park* on page 9-19.

If you have to leave the vehicle with the propulsion system on, be sure the vehicle is in P (Park) and the parking brake is firmly set before you leave it. After you have moved the shift lever into P (Park), hold down the regular brake pedal. See if you can move the shift lever away from P (Park) without first pulling it toward you. If you can, it means that the shift lever was not fully locked into P (Park).

Torque Lock

Torque lock is when the weight of the vehicle puts too much force on the parking pawl in the electric drive unit. This happens when parking on a hill and shifting the electric drive unit into P (Park) is not done properly and then it is difficult to shift out of P (Park). To prevent torque lock, set the parking brake and then shift into P (Park).

If torque lock does occur, your vehicle may need to be pushed uphill by another vehicle to relieve the parking pawl pressure, so you can shift out of P (Park).

Shifting out of Park

To shift out of P (Park), the vehicle must be in ON/RUN, the brake pedal must be applied, and the charge cord must be unplugged.

The vehicle has an electronic shift lock release system. The shift lock release is designed to:

- Prevent the vehicle from turning off unless the shift lever is in P (Park).
- Prevent moving the shift lever out of P (Park), unless the vehicle is in ON/RUN, the brake pedal is applied, and the charge cord is unplugged.

Parking the vehicle in extreme cold for several days without the charge cord connected may cause the

electric drive unit to be locked in P (Park) until the propulsion system has warmed sufficiently.

The shift lock is always functional except in the case of an uncharged or low charged 12-volt battery (less than 9 volts).

If the vehicle has an uncharged 12-volt battery or a 12-volt battery with low voltage, try charging or jump starting the 12-volt battery. See *Battery on page 10-23* or *Jump Starting on page 10-69*.

If the console shift lever cannot be moved out of P (Park):

1. Apply and maintain the regular brakes.
2. Turn the vehicle on using the POWER  button. See *Power Button on page 9-16*.
3. Let up on the shift lever and make sure the shift lever is pushed all the way into P (Park).
4. Press the shift lever button.

5. Move the shift lever into the desired gear.

If you still cannot move the shift lever from P (Park), see your dealer or a professional towing service.

Parking over Things That Burn

Warning

Things that can burn could touch hot exhaust parts under the vehicle and ignite. Do not park over papers, leaves, dry grass, or other things that can burn.

Electric Vehicle Operating Modes

System Operation

This vehicle is an Extended Range Electric Vehicle (EREV). It uses an electric propulsion system to drive the vehicle at all times. Electricity is the vehicle's primary source of energy, while gasoline is the secondary source.

The vehicle has two modes of operation: Electric and Extended Range. In both modes, the vehicle is propelled by its electric drive unit. It converts electrical energy into mechanical energy to drive the wheels. See *Driving for Better Energy Efficiency on page 9-2*.

Electric Mode

In Electric Mode, the vehicle does not use fuel or produce tailpipe emissions. During this primary mode, the vehicle is powered by electrical energy stored in the high

9-22 Driving and Operating

voltage battery. The vehicle can operate in this mode until the battery has reached a low charge.

There are some conditions when the battery charge is high enough to provide Electric Mode operation, but the engine still runs. They are:

- Cold ambient temperatures.
- Hot or cold high voltage battery temperatures.
- The hood being open or not completely closed and latched.
- Certain high voltage battery fault conditions.
- Engine Maintenance Mode or Fuel Maintenance Mode being run.

Extended Range Mode

When the vehicle reaches the end of its electric range, it switches to Extended Range Mode (ERM). In this secondary mode, electricity is produced by the fuel-powered engine. This secondary source of

electric power extends the vehicle range. Operation will continue in ERM until the vehicle can be plugged in to recharge the high voltage battery and restore Electric Mode.

The high voltage battery will continue to provide some power and work together with the engine to provide peak performance when it is required, such as driving up a steep incline or for high acceleration maneuvers. The battery will not be charged nor will electric vehicle range be restored by the engine.

In either Electric Mode or Extended Range Mode, when the hood is open, the engine will run without turning off if the vehicle is on. The high voltage battery is neither charged nor discharged when this occurs.

In either Electric Mode or Extended Range Mode, if there is a high voltage battery fault, the engine may run without turning off to generate needed electricity. The malfunction

indicator lamp will turn on. See *Malfunction Indicator Lamp* on page 5-17.

Driver Selected Operating Modes

While driving in Electric or Extended Range Mode, additional operating modes can be selected.

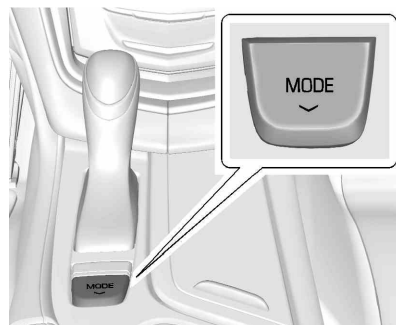

Press the MODE switch to display selectable drive modes in the Driver Information Center (DIC). Continue pressing to scroll through the modes.

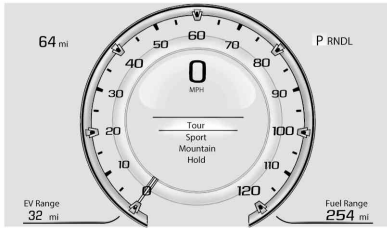

Highlight either the Mountain, Sport, or Hold Mode, then release the MODE switch. After three seconds, the new drive mode will become active.

Pressing the MODE switch again will return to Tour Mode, and become active after three seconds.

At next start, the vehicle will default to Tour Mode. Drive modes can then be selected again as desired.

During some conditions, certain drive modes may be unavailable. The unavailable mode is grayed out in the DIC menu and cannot be selected.

If in Sport, Mountain, or Hold Mode, the mode may become unavailable and the vehicle will return to Tour Mode. The indicator light goes off and a DIC message displays. See *Propulsion Power Messages* on page 5-48.

Sport Mode

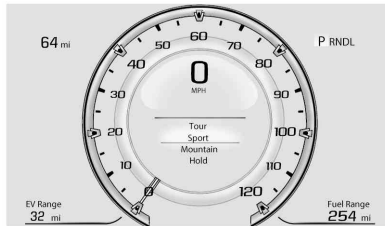

Sport Mode provides more responsive acceleration, steering, and suspension than Tour Mode, but can reduce efficiency. Use Tour Mode whenever possible.

Press the MODE switch button to select Sport Mode.

Press the MODE switch again to return to Tour Mode and it becomes active after three seconds.

Each time the vehicle is started, it will return to Tour Mode.

Mountain Mode

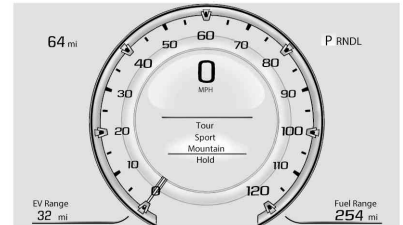

Mountain Mode should be selected in advance of climbing steep, uphill grades and when expecting to drive in very hilly or mountainous terrain. This mode maintains a reserve electrical charge of the high voltage battery to provide better grade climbing performance. While driving in Mountain Mode, the vehicle will have less responsive acceleration.

9-24 Driving and Operating

Mountain Mode will not change normal vehicle braking performance for steep downhill grades. See *Hill and Mountain Roads* on page 9-9 and *Electric Drive Unit* on page 9-28.

Press the MODE switch to select Mountain Mode. If steep hill driving is expected, it is recommended to select Mountain Mode at least 20 minutes before driving on steep grades. This will allow the vehicle time to build a sufficient battery charge reserve.

If Mountain Mode is not selected for these conditions, propulsion power may be reduced and the engine speed may increase. See *Propulsion Power Messages* on page 5-48.

The engine may run when Mountain Mode is selected, depending on the high voltage battery charge, to build reserve battery charge for uphill climbs. The high voltage battery charge reserved for Mountain Mode

will be displayed on the battery gauge, but will not be depleted until it is required for uphill driving.

Press the MODE switch again to return to Tour Mode and it becomes active after three seconds.

Each time the vehicle is started, it will return to Tour Mode to maintain a smaller battery charge reserve for normal driving.

Hold Mode

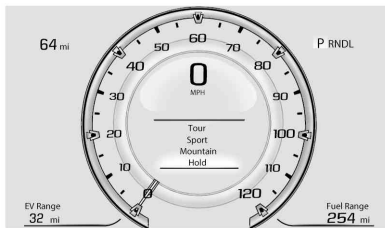

Hold Mode is only available when the vehicle is in Electric Mode. This mode places the remaining battery charge into a reserve for the driver to use as desired. Selecting this

mode transitions the vehicle to Extended Range Mode to maintain the battery charge reserve.

Upon exiting Hold Mode, the reserved battery charge becomes available again and the vehicle returns to Electric Mode. If the transition is from Hold Mode directly to Mountain Mode, the electric range displayed adjusts for the Mountain Mode charge reserve.

Press the MODE switch and scroll to Hold Mode to select it.

Press the MODE switch again to return to Tour Mode and it becomes active after three seconds.

Each time the vehicle is started, it will return to Tour Mode.

Out of Fuel/Engine Unavailable

If the vehicle runs out of fuel, or the engine will not start due to a malfunction, the vehicle can continue to be driven in Electric Mode. The vehicle will have less

responsive acceleration. DIC messages indicate reduced propulsion power, that the engine is not available, and the need for fuel or service.

Once the vehicle is refueled, or the malfunction is corrected, the engine will start the next time the vehicle is turned on to perform a self test, and DIC messages will not be displayed. Once the engine starts successfully, normal operation will continue in either Electric or Extended Range Mode. The engine may stop running after the self test is completed based on the current mode of operation. See *Fuel System Messages on page 5-45* and *Service Vehicle Messages on page 5-50*.

Maintenance Modes

Engine Maintenance Mode (EMM)

EMM runs the engine to keep it in good working condition after approximately six weeks of no or very limited engine operation. EMM

will force the engine to run, even if there is a charge to power the vehicle. When EMM is needed, the EMM Request screen appears on the center stack display at vehicle start.

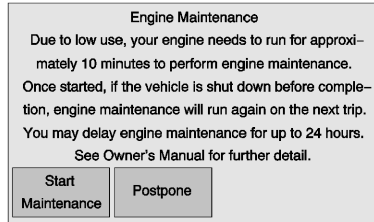

If Start Maintenance is selected, EMM will begin. The engine will run for a set amount of time without turning off. During EMM, a DIC message displays to show the EMM percentage complete.

If Postpone is selected, the EMM Request screen will appear when the vehicle is next started. The EMM request can be delayed for only one day.

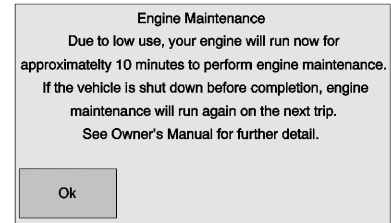

If the EMM request was delayed for one day, EMM will automatically start the engine at the next vehicle start. An EMM Notification screen will appear in the center stack display.

If the vehicle shuts off during EMM, it will restart the next time the vehicle is driven. A message displays to indicate that EMM is active.

If EMM is required and the fuel level is low, EMM may eventually empty the fuel tank if fuel is not added. This will result in reduced, or no power. An adequate fuel level must be maintained in the vehicle to keep it operational. See *Propulsion Power Messages on page 5-48*.

9-26 Driving and Operating

Fuel Maintenance Mode (FMM)

FMM tracks average fuel age. Old fuel can cause engine problems. If low engine usage causes average fuel age to exceed approximately one year, FMM will run the engine to use up the old fuel. The engine will run until enough fresh fuel is added to bring the average fuel age into an acceptable range. Allowing more old fuel to be used up by FMM and adding a larger amount of fresh fuel will maximize the length of time before another FMM is needed. During FMM the engine may turn on and off.

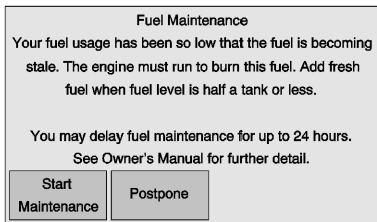

When FMM is needed, the FMM Request screen appears on the center stack display at vehicle start.

If Start Maintenance is selected, FMM will begin. FMM will automatically continue at each vehicle start until fresh fuel is added.

If Postpone is selected, the FMM Request screen will appear when the vehicle is next started. The FMM request can be delayed for only one day.

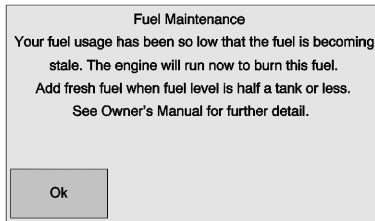

If the FMM request was delayed for one day, FMM will start at the next vehicle start and display the FMM Notification screen on the center stack display.

If FMM is required and the fuel level is low, FMM may eventually empty the fuel tank if fuel is not added. This will result in reduced, or no power. An adequate fuel level must be maintained in the vehicle to keep it operational. See *Propulsion Power Messages on page 5-48*.

Engine Exhaust

Warning

Engine exhaust contains carbon monoxide (CO) which cannot be seen or smelled. Exposure to CO can cause unconsciousness and even death.

Exhaust may enter the vehicle if:

- The engine is running in Extended Range Mode in areas with poor ventilation (parking garages, tunnels, or deep snow that may block underbody airflow or tail pipes).
- The exhaust smells or sounds strange or different.
- The exhaust system leaks due to corrosion or damage.
- The vehicle exhaust system has been modified, damaged, or improperly repaired.

(Continued)

Warning (Continued)

- There are holes or openings in the vehicle body from damage or aftermarket modifications that are not completely sealed.

If unusual fumes are detected or if it is suspected that exhaust is coming into the vehicle:

- Drive it only with the windows completely down.
- Have the vehicle repaired immediately.

Never park with the engine running in Extended Range Mode in an enclosed area such as a garage or a building that has no fresh air ventilation.

Running the Vehicle While Parked

It is better not to park with the propulsion system running.

If the vehicle is left with the propulsion system running, follow the proper steps to be sure the vehicle will not move. See *Shifting Into Park* on page 9-19 and *Engine Exhaust* on page 9-27.

Electric Drive Unit

The vehicle uses an electric drive unit.



P (Park): This position locks the front wheels. It is the best position to use when starting the propulsion system because the vehicle cannot move easily.

Warning

It is dangerous to get out of the vehicle if the shift lever is not fully in P (Park) with the parking brake firmly set. The vehicle can roll.

Do not leave the vehicle when the propulsion system is running. If you have left the propulsion system running, the vehicle can move suddenly. You or others could be injured. To be sure the vehicle will not move, even when you are on fairly level ground, always set the parking brake and move the shift lever to P (Park). See *Shifting Into Park* on page 9-19.

Make sure the shift lever is fully in P (Park) before starting the propulsion system. The vehicle has an electric drive unit shift lock control system. The regular brake must be fully applied first and then the shift lever button pressed before

shifting from P (Park) when the vehicle is in ON/RUN. If you cannot shift out of P (Park), ease pressure on the shift lever, then push the shift lever all the way into P (Park) as you maintain brake application. Then press the shift lever button and move the shift lever into another gear. See *Shifting out of Park* on page 9-20.

R (Reverse): Use this gear to back up.

Caution

Shifting to R (Reverse) while the vehicle is moving forward could damage the electric drive unit. The repairs would not be covered by the vehicle warranty. Shift to R (Reverse) only after the vehicle is stopped.

To rock the vehicle back and forth to get out of snow, ice, or sand without damaging the electric drive unit, see *If the Vehicle Is Stuck* on page 9-12.

N (Neutral): In this position, the propulsion system does not connect with the wheels.

D (Drive): This position is for normal driving. It provides the best fuel economy. If more power is needed for passing, and the vehicle is:

- Going less than 56 km/h (35 mph), push the accelerator pedal about halfway down.
- Going about 56 km/h (35 mph) or more, push the accelerator all the way down.

 **Caution**

If the vehicle seems to accelerate slowly or not respond when you go faster, and you continue to drive the vehicle that way, you could damage the electric drive unit. Have the vehicle serviced right away.

L (Low): This position reduces vehicle speed without using the brakes. You can use L (Low) on hills. It can help control vehicle speed going down steep mountain roads along with using the brakes off and on. You can use L (Low) on very steep hills, in deep snow, or in mud.

The brake lamps may come on when the vehicle is in L (Low) and the accelerator is not pressed to indicate the vehicle is slowing down.

 **Caution**

Spinning the tires or holding the vehicle in one place on a hill using only the accelerator pedal may damage the electric drive unit. The repair will not be covered by the vehicle warranty. If you are stuck, do not spin the tires. When stopping on a hill, use the brakes to hold the vehicle in place.

Brakes

Antilock Brake System (ABS)

This vehicle has ABS, an advanced electronic braking system that helps prevent a braking skid.

When propulsion is active and the vehicle begins to drive away, ABS checks itself. A momentary motor or clicking noise might be heard while this test is going on, and it might even be noticed that the brake pedal moves a little. This is normal.



If there is a problem with ABS, this warning light stays on. See *Antilock Brake System (ABS) Warning Light* on page 5-21.

9-30 Driving and Operating

If driving safely on a wet road and it becomes necessary to slam on the brakes and continue braking to avoid a sudden obstacle, a computer senses that the wheels are slowing down. If one of the wheels is about to stop rolling, the computer will separately work the brakes at each wheel.

ABS can change the brake pressure to each wheel, as required, faster than any driver could. This can help the driver steer around the obstacle while braking hard.

As the brakes are applied, the computer keeps receiving updates on wheel speed and controls braking pressure accordingly.

Remember: ABS does not change the time needed to get a foot up to the brake pedal or always decrease stopping distance. If you get too close to the vehicle in front of you, there will not be enough time to apply the brakes if that vehicle

suddenly slows or stops. Always leave enough room up ahead to stop, even with ABS.

Using ABS

Do not pump the brakes. Just hold the brake pedal down firmly and let ABS work. You might hear the ABS pump or motor operating and feel the brake pedal pulsate, but this is normal.

Braking in Emergencies

ABS allows the driver to steer and brake at the same time. In many emergencies, steering can help more than even the very best braking.

Electric Parking Brake

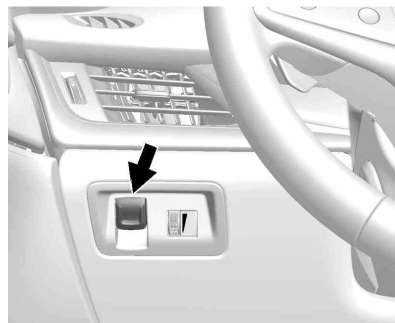

The vehicle has an Electric Parking Brake (EPB). The switch is to the left of the steering wheel. The EPB can always be activated, even if the vehicle is off. To prevent draining the 12-volt battery, avoid repeated cycles of the EPB system when the vehicle is off.

The system has a red parking brake status light and an amber parking brake warning light. See *Electric Parking Brake Light* on page 5-21 and *Service Electric Parking Brake Light* on page 5-21. There are also parking brake-related Driver Information Center (DIC) messages. See *Brake System Messages* on page 5-42. In case of insufficient electrical power, the EPB cannot be applied or released.

Before leaving the vehicle, check the red parking brake status light to ensure that the parking brake is applied.

EPB Apply

To apply the EPB:

1. Be sure the vehicle is at a complete stop.
2. Lift up the EPB switch momentarily.

The red parking brake status light will flash and then stay on once the EPB is fully applied. If the red parking brake status light flashes

continuously, then the EPB is only partially applied or there is a problem with the EPB. A DIC message will display. Release the EPB and try to apply it again. If the light does not come on, or keeps flashing, have the vehicle serviced. Do not drive the vehicle if the red parking brake status light is flashing. See your dealer. See *Electric Parking Brake Light* on page 5-21.

If the amber parking brake warning light is on, lift up on the EPB switch and hold it up. Continue to hold the switch until the red parking brake status light remains on. If the amber parking brake warning light is on, see your dealer.

If the EPB is applied while the vehicle is moving, the vehicle will decelerate as long as the switch is held up. If the switch is held up until the vehicle comes to a stop, the EPB will remain applied.

The vehicle may automatically apply the EPB in some situations when the vehicle is not moving. This is

normal, and is done to periodically check the correct operation of the EPB system.

If the EPB fails to apply, the rear wheels should be blocked to prevent vehicle movement.

EPB Release

To release the EPB:

1. Place the ignition in the ACC/ACCESSORY or ON/RUN position.
2. Apply and hold the brake pedal.
3. Push down momentarily on the EPB switch.

The EPB is released when the red parking brake status light is off.

If the amber parking brake warning light is on, release the EPB by pushing down on the EPB switch and holding it down. Continue to hold the switch until the red parking brake status light is off. If either light stays on after release is attempted, see your dealer.

Caution

Driving with the parking brake on can overheat the brake system and cause premature wear or damage to brake system parts. Make sure that the parking brake is fully released and the brake warning light is off before driving.

Automatic EPB Release

The EPB will automatically release if the vehicle is running, placed into gear, and an attempt is made to drive away. Avoid rapid acceleration when the EPB is applied, to preserve parking brake lining life.

Regenerative Braking

Regenerative braking takes some of the energy from the moving vehicle and turns it back into electrical energy. This energy is then stored back into the high voltage battery system, contributing to increased energy efficiency.

The hydraulic disc brakes work with the regenerative braking to ensure effective braking, such as when a high braking demand is requested.

The braking system is computer controlled and blends the regenerative braking with the conventional hydraulic disc brakes to meet any requirements for deceleration. The controller interprets the braking request and uses regenerative braking, conventional hydraulic braking, or a combination of both as necessary. Because the controller applies the hydraulic brakes through its high pressure accumulator, you may occasionally hear the motor-driven pump when it recharges the system. This is normal.

See *Warning Lights, Gauges, and Indicators* on page 5-7 and *Driver Information Center (DIC)* on page 5-38. In the event of a controller problem, the brake pedal may be harder to push and the stopping distance may be longer.

Regen on Demand™

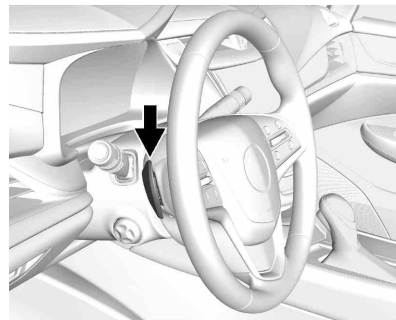

Regen on Demand allows increased deceleration by pressing and holding either of the steering wheel paddle switches. It works in D (Drive) and L (Low). The accelerator pedal must be fully released for it to work.

The brake pedal must be applied at low speed, because it will not stop the car.

Cruise control will turn off, and the brake lights may come on, when this feature is activated.

Ride Control Systems

Traction Control/ Electronic Stability Control

The vehicle has a Traction Control System (TCS) and StabiliTrak[®], an electronic stability control system. These systems help limit wheel slip and assist the driver in maintaining control, especially on slippery road conditions.

TCS activates if it senses that any of the drive wheels are spinning or beginning to lose traction. When this happens, the system brakes the spinning wheel(s) and/or reduces engine power to limit wheel spin.

StabiliTrak activates when the computer senses a difference between the intended path and the direction the vehicle is actually traveling. StabiliTrak selectively applies braking pressure at any one of the vehicle's brakes to help steer the vehicle in the intended direction.

If cruise control is being used and traction control or StabiliTrak begins to limit wheel spin, cruise control will disengage. Cruise control may be turned back on when road conditions allow.

Both systems come on automatically when the vehicle is started and begins to move. The systems may be heard or felt while they are operating or while performing diagnostic checks. This is normal and does not mean there is a problem with the vehicle.

It is recommended to leave both systems on for normal driving conditions, but it may be necessary to turn TCS off if the vehicle gets stuck in sand, mud, ice, or snow. See *If the Vehicle Is Stuck on page 9-12* and "Turning the Systems Off and On" later in this section.



The indicator light for both systems is in the instrument cluster. This light will:

- Flash when TCS is limiting wheel spin.
- Flash when StabiliTrak is activated.
- Turn on and stay on when either system is not working.

If either system fails to turn on or to activate, a message displays in the Driver Information Center (DIC), and  comes on and stays on to indicate that the system is inactive and is not assisting the driver in maintaining control. The vehicle is safe to drive, but driving should be adjusted accordingly.

9-34 Driving and Operating

If  comes on and stays on:

1. Stop the vehicle.
2. Turn the engine off and wait 15 seconds.
3. Start the engine.

Drive the vehicle. If  comes on and stays on, the vehicle may need more time to diagnose the problem. If the condition persists, see your dealer.

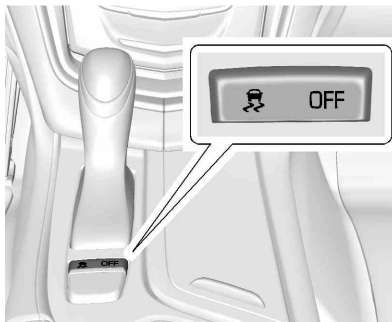

Turning the Systems Off and On





The button for TCS and StabiliTrak is on the center console, behind the shift lever.



Caution



Do not repeatedly brake or accelerate heavily when TCS is off. The vehicle driveline could be damaged.

To turn off only TCS, press and release the  button. The traction off light  displays in the instrument cluster. The appropriate DIC message is displayed. See *Ride Control System Messages on page 5-49*.

To turn TCS on again, press and release the  button. The traction off light  displayed in the instrument cluster will turn off.

If TCS is limiting wheel spin when the  button is pressed, the system will not turn off until the wheels stop spinning.

To turn off both TCS and StabiliTrak, press and hold the  button until the traction off light  and StabiliTrak OFF light  come on and stay on in the instrument cluster. The appropriate DIC message is displayed. See *Ride Control System Messages on page 5-49*.

To turn TCS and StabiliTrak on again, press and release the  button. The traction off light  and StabiliTrak OFF light  in the instrument cluster turn off.

Adding accessories can affect the vehicle's performance. See *Accessories and Modifications* on page 10-2.

Driver Mode Control

Driver Mode Control attempts to add a sportier feel, provide a more comfortable ride, or assist in very hilly or mountainous terrain. This system simultaneously changes the software calibration of various sub-systems. Depending on the option package, available features, and mode selected, the suspension, steering, and powertrain will change calibrations to achieve the desired mode characteristics. The vehicle is equipped with Continuous Damping Control (CDC). Selecting the various Driver Modes adjusts the ride of the

vehicle to enhance the ride performance for the road conditions and the selected mode.

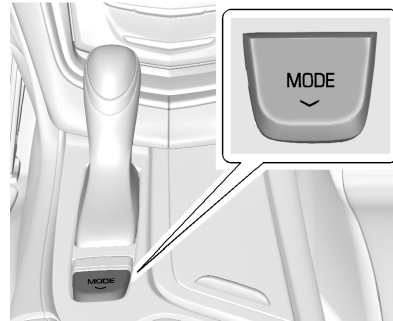

Driver Mode Control Switch

The Driver Mode Control has four modes: Tour, Sport, Mountain, and Hold. Press  on the MODE switch on the center console to make a mode selection. The first press of the switch will always show the Tour Mode. Subsequent presses will scroll through the available modes. The Tour and Sport Modes will feel similar on a smooth road. Select a new setting whenever driving

conditions change. For additional information on these Modes, see *Driver Selected Operating Modes* on page 9-22.

Tour Mode

Use for normal city and highway driving to provide a smooth, soft ride. Each time the vehicle is started, it will return to Tour Mode.

Sport Mode

Use where road conditions or personal preference demand a more controlled response.

When selected, the Sport Mode indicator will display in the DIC.

When in Sport Mode, the vehicle will still shift automatically. The electric drive unit may remain in gear longer than it would in the normal driving mode based on braking, throttle input, and vehicle lateral acceleration. The steering will change to provide more precise control. The suspension will change to provide better body control and handling performance.

Mountain Mode

Use when driving in very hilly or mountainous terrain.

When selected, the Mountain Mode indicator will display in the DIC.

This feature is intended to maintain a reserve electrical charge of the high voltage battery to provide better grade climbing performance. While driving in Mountain Mode, the vehicle will have less responsive acceleration.

Hold Mode



The Hold Mode is only available when the vehicle is in the Electric Mode. Use when wanting to change to Extended Range Mode to maintain the battery charge reserve. See *Extended Range Mode on page 9-22*.

When selected, the Hold Mode indicator will display in the DIC.

This feature is intended to place the remaining battery charge into a reserve for the driver to use as



desired. Hold Mode will not change normal vehicle acceleration or braking performance.

Competitive Driving Mode

If equipped, the Competitive Driving Mode is selected by pressing the TCS/StabiliTrak[®] button  on the center console twice within five seconds. The StabiliTrak OFF Light  will come on in the instrument cluster.

The Competitive Driving Mode allows the driver to have control of the power applied to the wheels, while the StabiliTrak system helps steer the vehicle by selective brake application.

In the Competitive Driving Mode, the levels at which StabiliTrak is engaged have been modified to better suit a performance driving environment. When the StabiliTrak OFF Light  is on, TCS will not be operating. Driving should be adjusted accordingly.

When the TCS/StabiliTrak button  is pressed again, TCS will be turned back on and the StabiliTrak OFF Light  in the instrument cluster will turn off.

Continuous Damping Control (CDC)

The CDC feature provides superior vehicle ride and handling under a variety of passenger and loading conditions.

The system is fully automatic and uses a computer controller to continuously monitor vehicle speed, wheel to body position, lift/dive, and steering position of the vehicle. The controller then sends signals to each shock absorber to independently adjust the damping level to provide the optimum vehicle ride.

Cruise Control

With cruise control, a speed of about 40 km/h (25 mph) or more can be maintained without keeping your foot on the accelerator. Cruise control does not work at speeds below about 40 km/h (25 mph).

Warning

Cruise control can be dangerous where you cannot drive safely at a steady speed. Do not use the cruise control on winding roads or in heavy traffic.

Cruise control can be dangerous on slippery roads. On such roads, fast changes in tire traction can cause excessive wheel slip, and you could lose control. Do not use cruise control on slippery roads.

If the StabiliTrak[®] system begins to limit wheel spin while using cruise control, the cruise control automatically disengages. See *Traction Control/Electronic Stability Control* on page 9-33. If a collision alert occurs when cruise control is activated, cruise control is disengaged. See *Forward Collision Alert (FCA) System* on page 9-50. When road conditions allow you to safely use it again, cruise control can be turned back on.

If the brakes are applied, cruise control disengages.

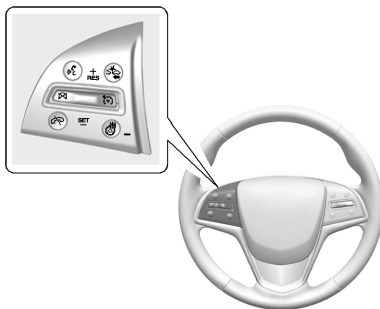

On/Off: Press to turn the system on and off. A white cruise control indicator appears in the instrument cluster when cruise is turned on.



+RES (Resume/Accelerate): If there is a set speed in memory, press the control up briefly to resume that speed or hold to accelerate. If cruise control is already active, use to increase vehicle speed. To increase speed by 1 km/h or 1 mph, press +RES up to the first detent. To increase speed to the next 5 km/h or 5 mph mark on the speedometer, press +RES up to the second detent.

SET- (Set/Coast): Press the control down briefly to set the speed and activate cruise control. If cruise control is already active, use to decrease vehicle speed. To decrease speed by 1 km/h or 1 mph, press SET- down to the first detent.

To decrease speed to the next 5 km/h or 5 mph mark on the speedometer, press SET- down to the second detent.

 **(Cancel):** Press to disengage cruise control without erasing the set speed from memory.

Setting Cruise Control

If  is on when not in use, SET- or +RES could get bumped and go into cruise when not desired. Keep  off when cruise is not being used.

1. Press .
2. Get up to the desired speed.
3. Press and release SET- .
4. Remove your foot from the accelerator.

When the cruise control has been set to the desired speed, the cruise control indicator appears green on the instrument cluster.

Resuming a Set Speed

If the cruise control is set at a desired speed and then the brakes or  is applied, the cruise control is disengaged without erasing the set speed from memory.

Once the vehicle speed reaches about 40 km/h (25 mph) or more, press +RES up to the first detent briefly on the steering wheel. The vehicle returns to the previous set speed.

Increasing Speed While Cruise Control is at a Set Speed

If the cruise control system is already activated:

- Press and hold +RES up until the desired speed is reached, then release it.
- To increase vehicle speed in small increments, briefly press +RES up to the first detent. For each press, the vehicle goes about 1 km/h or 1 mph faster.

- To increase vehicle speed in larger increments, briefly press +RES up to the second detent. For each press, the vehicle speed increases to the next 5 km/h or 5 mph mark on the speedometer.

The speedometer reading can be displayed in either English or metric units. See *Instrument Cluster on page 5-8*. The increment value used depends on the units displayed.

Reducing Speed While Cruise Control is at a Set Speed

If the cruise control system is already activated:

- Press and hold SET- down until the desired lower speed is reached, then release it.
- To decrease the vehicle speed in small increments, briefly press SET- down to the first detent. For each press, the vehicle goes about 1 km/h or 1 mph slower.

- To decrease the vehicle speed in larger increments, briefly press SET- down to the second detent. For each press, the vehicle speed decreases to the next 5 km/h or 5 mph mark on the speedometer.

The speedometer reading can be displayed in either English or metric units. See *Instrument Cluster on page 5-8*. The increment value used depends on the units displayed.

Passing Another Vehicle While Using Cruise Control



Use the accelerator pedal to increase the vehicle speed. When you take your foot off the pedal, the vehicle will slow down to the previously set cruise speed. While pressing the accelerator pedal or shortly following the release to override cruise control, briefly applying the SET- control will result in cruise control set to the current vehicle speed.

Using Cruise Control on Hills

How well cruise control will work on hills depends upon the vehicle speed, load, and the steepness of the hills. When going up steep hills, you might have to step on the accelerator pedal to maintain the vehicle speed. Also, you may have to brake or shift to a lower gear to keep the vehicle speed down. If the brake pedal is applied, cruise control will disengage.

Ending Cruise Control

To disengage cruise control, do one of the following:

- Step lightly on the brake pedal.
- Press .
- Press .
- Press a Regen on Demand paddle.

Erasing Speed Memory

The cruise control set speed is erased from memory if  is pressed or if the ignition is turned off.

Adaptive Cruise Control

If equipped with Adaptive Cruise Control (ACC), it allows the driver to select the cruise control set speed and following gap. Read this entire section before using this system. The following gap is the following time between your vehicle and a vehicle detected directly ahead in your path moving in the same direction. If no vehicle is detected in your path, ACC works like regular cruise control. ACC uses a radar sensor. See *Radio Frequency Statement on page 13-12*.

If a vehicle is detected in your path, ACC can apply acceleration or limited, moderate braking to maintain the selected following gap. To disengage ACC, apply the brake. If ACC is controlling your vehicle

9-40 Driving and Operating

speed when the Traction Control System (TCS) activates, the ACC may automatically disengage. See *Traction Control/Electronic Stability Control* on page 9-33. When road conditions allow ACC to be safely used, the ACC can be turned back on.

ACC will not engage if the TCS or StabiliTrak electronic stability control system is disabled.

Warning

ACC has limited braking ability and may not have time to slow the vehicle down enough to avoid a collision with another vehicle you are following. This can occur when vehicles suddenly slow or stop ahead, or enter your lane. Also see “Alerting the Driver” in this section. Complete attention is always required while driving and you should be ready to take action and apply the brakes. See *Defensive Driving* on page 9-5.

Warning

Adaptive Cruise Control will not detect or brake for children, pedestrians, animals, or other objects.

Do not use Adaptive Cruise Control when:

- On winding and hilly roads or when the sensors are blocked by snow, ice, or dirt. The system may not detect a vehicle ahead. Keep the entire front of the vehicle clean.
- Visibility is low, such as in fog, rain, or snow conditions. Adaptive Cruise Control performance is limited under these conditions.
- On slippery roads where fast changes in tire traction can cause excessive wheel slip.

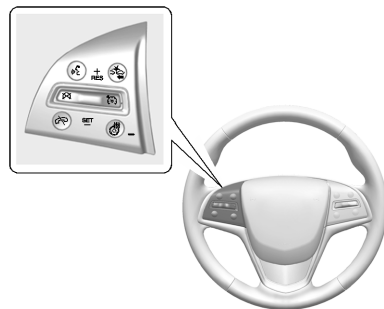

 **(On/Off):** Press to turn the system on or off. A white adaptive cruise control indicator comes on.

+RES (Resume/Accelerate): Press the control up briefly to resume the previous set speed or hold to accelerate. If ACC is already activated, use to increase vehicle speed.

SET- (Set/Coast): Press the control down briefly to set the speed and activate ACC. If cruise control is already active, use to decrease vehicle speed.

 **(Cancel):** Press to disengage ACC without erasing the selected speed.

 **(Follow Distance Gap):** Press to select a following gap time (or distance) setting for ACC of Far, Medium, or Near.

Setting Adaptive Cruise Control

If the cruise button is on when not in use, the cruise on/off control could get pressed and cruise control could become active when not desired. Keep the cruise control off when cruise is not being used.

Select the set speed desired for cruise. This is the vehicle speed when no vehicle is detected in its path.

ACC will not set at a speed less than 24 km/h (15 mph), although it can be resumed when driving at lower speeds.

To set ACC:

1. Press .
2. Get up to the desired speed.
3. Press and release the SET- control on the steering wheel.
4. Remove foot from the accelerator.

After ACC is set, it may immediately apply the brakes if a vehicle ahead is detected closer than the selected following gap.



The ACC indicator displays in the instrument cluster. When the ACC is active, the indicator will be lit green.

Be mindful of speed limits, surrounding traffic speeds, and weather conditions when selecting the set speed.

Resuming a Set Speed

If the ACC is set at a desired speed and then the brakes are applied, the ACC is disengaged without erasing the set speed from memory.

To begin using ACC again, press +RES up briefly on the steering wheel. The vehicle returns to the previous set speed.

Increasing Speed While ACC is at a Set Speed

If ACC is already activated, do one of the following:

- Use the accelerator to get to the higher speed. Press SET- down. Release the control and the accelerator pedal. The vehicle will now cruise at the higher speed.

When the accelerator pedal is pressed, ACC will not brake because it is overridden. A warning message will appear on the Driver Information Center (DIC). See *Cruise Control Messages on page 5-42*.

9-42 Driving and Operating

- Press and hold +RES up until the desired set speed appears on the display, then release it.
- To increase vehicle speed in small increments, briefly press +RES . For each press, the vehicle goes to the next 1km/h or 1 mph faster mark on the speedometer.
- To increase vehicle speed in larger increments, press +RES up to the second detent. For each press, the vehicle speed increases to the next 5 km/h or 5 mph mark on the speedometer.

When it is determined that there is no vehicle ahead inside the selected following gap, then the vehicle speed will increase to the set speed.

The speedometer reading can be displayed in either English or metric units. See *Instrument Cluster on page 5-8*. The increment value used depends on the units displayed.

Reducing Speed While ACC is at a Set Speed

If ACC is already activated, do one of the following:

- Use the brake to get to the desired lower speed. Press SET- down and release the accelerator pedal. The vehicle will now cruise at the lower speed.
- Press and hold SET- down until the desired lower speed is reached, then release it.
- To decrease the vehicle speed in smaller increments, press SET-. For each press, the vehicle goes to the next 1 km/h or 1 mph slower mark on the speedometer.
- To decrease the vehicle speed in larger increments, press SET- down to the second detent. For each press, the vehicle speed decreases to the next 5 km/h or 5 mph mark on the speedometer.

The speedometer reading can be displayed in either English or metric units. See *Instrument Cluster on page 5-8*. The increment value used depends on the units displayed.

Selecting the Follow Distance

When a slower moving vehicle is detected ahead within the selected following gap, ACC will adjust the vehicle's speed and attempt to maintain the follow distance gap selected.

Press  on the steering wheel to adjust the following gap. When pressed, the current gap setting displays briefly on the instrument cluster.

Subsequent presses cycle the gap button through three settings: Far, Medium, or Near. The gap setting will be maintained until it is changed.

Since each gap setting corresponds to a following time (Far, Medium, or Near), the following distance will vary based on vehicle speed. The

faster the vehicle speed, the further back your vehicle will follow a vehicle detected ahead. Consider traffic and weather conditions when selecting the following gap. The range of selectable gaps may not be appropriate for all drivers and driving conditions.

Changing the gap setting automatically changes the alert timing sensitivity (Far, Medium, or Near) for the Forward Collision Alert (FCA) feature. See *Forward Collision Alert (FCA) System* on page 9-50.

Alerting the Driver

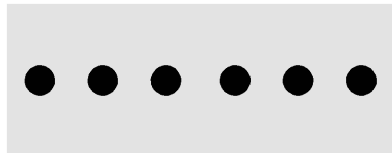

If ACC is engaged, driver action may be required when ACC cannot apply sufficient braking because of approaching a vehicle too rapidly.

When this condition occurs, six red lights will flash on the windshield and either eight beeps will sound from the front, or both sides of the Safety Alert Seat will pulse five times. See *Collision/Detection systems* under *Vehicle Personalization* on page 5-52.

See *Defensive Driving* on page 9-5.

Approaching and Following a Vehicle



The vehicle ahead symbol is in the DIC.

The vehicle ahead symbol only displays when a vehicle is detected in your vehicle's path moving in the same direction.

If this symbol is not displaying, ACC will not respond to or brake to vehicles ahead.

ACC automatically slows the vehicle down and adjusts vehicle speed to follow the vehicle in front at the selected follow gap. The vehicle speed increases or decreases to follow the vehicle in front of you, but will not exceed the set speed. It may apply limited braking, if necessary. When braking is active, the brake lamps will come on. The automatic braking may feel or sound different than if the brakes were applied manually. This is normal.

Stationary or Very Slow-Moving Objects



Warning

Adaptive Cruise Control (ACC) may not detect and react to stopped or slow-moving vehicles ahead of you. For example, the system may not brake for a

(Continued)

Warning (Continued)

vehicle it has never detected moving. This can occur in stop-and-go traffic or when a vehicle suddenly appears due to a vehicle ahead changing lanes. Your vehicle may not stop and could cause a crash. Use caution when using ACC. Your complete attention is always required while driving and you should be ready to take action and apply the brakes.

ACC Automatically Disengages

ACC may automatically disengage and the driver will need to manually apply the brakes to slow the vehicle when:

- The sensors are blocked.
- The Traction Control System (TCS) or electronic stability control system has activated or been disabled.

- No traffic or other objects are being detected.
- There is a fault in the system.
- Regen on Demand is engaged.

A message indicating that the cruise is disengaging will appear on the DIC and the ACC active symbol will not be displayed when ACC is no longer active.

Notification to Resume ACC

ACC will maintain a follow gap behind a detected vehicle and slow your vehicle to a stop behind that vehicle.

If the stopped vehicle ahead has driven away and ACC has not been resumed, the vehicle ahead symbol will flash as a reminder to check traffic ahead before proceeding. In addition, the left and right sides of the Safety Alert Seat will pulse three times, or three beeps will sound. See “Alert Type” and “Go Notifier” under Collision/Detection systems in *Vehicle Personalization on page 5-52*.

When the vehicle ahead drives away, press +RES or the accelerator pedal to resume ACC. If stopped for more than two minutes or if the driver door is opened and the safety belt is unbuckled, the ACC automatically applies the electric parking brake to hold the vehicle. The electric parking brake status light will turn on. See *Electric Parking Brake on page 9-30*. To resume ACC and release the electric parking brake, press the accelerator pedal.

A DIC warning message may display indicating to shift to P (Park) before exiting the vehicle. See *Vehicle Messages on page 5-41*.

Warning

If ACC has stopped the vehicle, and if ACC is disengaged, turned off, or canceled, the vehicle will no longer be held at a stop. The vehicle can move. When ACC is

(Continued)

Warning (Continued)

holding the vehicle at a stop, always be prepared to manually apply the brakes.

 **Warning**

Leaving the vehicle without placing it in P (Park) can be dangerous. Do not leave the vehicle while it is being held at a stop by ACC. Always place the vehicle in P (Park) and turn off the ignition before leaving the vehicle.

ACC Override

If using the accelerator pedal while ACC is active, a DIC warning message will indicate that automatic braking will not occur. See *Vehicle Messages on page 5-41*. ACC will

resume operation when the accelerator pedal is not being pressed.

 **Warning**

The ACC will not automatically apply the brakes if your foot is resting on the accelerator pedal or if Regen on Demand paddles are engaged. You could crash into a vehicle ahead of you.

Curves in the Road

 **Warning**

On curves, ACC may not detect a vehicle ahead in your lane. You could be startled if the vehicle accelerates up to the set speed, especially when following a vehicle exiting or entering exit ramps. You could lose control of the vehicle or crash. Do not use

(Continued)

Warning (Continued)

ACC while driving on an entrance or exit ramp. Always be ready to use the brakes if necessary.

 **Warning**

On curves, ACC may respond to a vehicle in another lane, or may not have time to react to a vehicle in your lane. You could crash into a vehicle ahead of you, or lose control of your vehicle. Give extra attention in curves and be ready to use the brakes if necessary. Select an appropriate speed while driving in curves.

ACC may operate differently in a sharp curve. It may reduce the vehicle speed if the curve is too sharp.

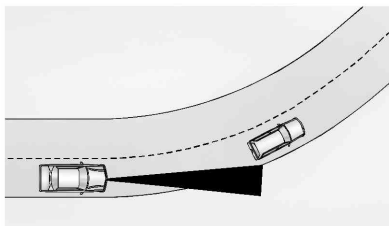

When following a vehicle and entering a curve, ACC may not detect the vehicle ahead and accelerate to the set speed. When this happens the vehicle ahead symbol will not appear.

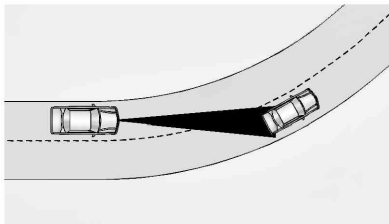

ACC may detect a vehicle that is not in your lane and apply the brakes.

ACC may occasionally provide an alert and/or braking that is considered unnecessary. It could respond to vehicles in different lanes, signs, guardrails, and other stationary objects when entering or exiting a curve. This is normal operation. The vehicle does not need service.

Other Vehicle Lane Changes

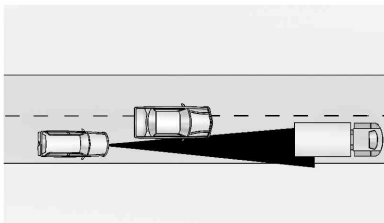

ACC will not detect a vehicle ahead until it is completely in the lane. The brake may need to be manually applied.

Do Not Use ACC on Hills and When Towing a Trailer

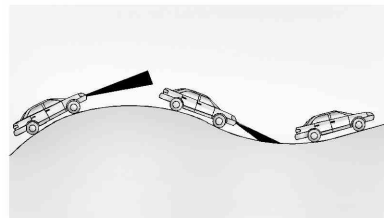

Do not use ACC when driving on steep hills or when towing a trailer. ACC will not detect a vehicle in the lane while driving on steep hills. The driver will often need to take over acceleration and braking on steep hills, especially when towing a trailer. If the brakes are applied, the ACC disengages.

Ending ACC

To disengage ACC, do one of the following:

- Step lightly on the brake pedal.
- Press .

- Press .
- Press a Regen on Demand paddle.

Erasing Speed Memory

The cruise control set speed is erased from memory if  is pressed or if the ignition is turned off.

Cleaning the Sensing System

The radar sensor on the front of the vehicle can become blocked by snow, ice, dirt, or mud. These areas need to be cleaned for ACC to operate properly.

For cleaning instructions, see “Washing the Vehicle” under *Exterior Care* on page 10-79.

System operation may also be limited under snow, heavy rain, or road spray conditions.

Driver Assistance Systems

This vehicle may have features that work together to help avoid crashes or reduce crash damage while driving, backing, and parking. Read this entire section before using these systems.

Warning

Do not rely on the Driver Assistance Systems. These systems do not replace the need for paying attention and driving safely. You may not hear or feel alerts or warnings provided by these systems. Failure to use proper care when driving may result in injury, death, or vehicle damage. See *Defensive Driving* on page 9-5.

(Continued)

Warning (Continued)

Under many conditions, these systems will not:

- Detect children, pedestrians, bicyclists, or animals.
- Detect vehicles or objects outside the area monitored by the system.
- Work at all driving speeds.
- Warn you or provide you with enough time to avoid a crash.
- Work under poor visibility or bad weather conditions.
- Work if the detection sensor is not cleaned or is covered by ice, snow, mud, or dirt.

Complete attention is always required while driving, and you should be ready to take action and apply the brakes and/or steer the vehicle to avoid crashes.

9-48 Driving and Operating

Audible or Safety Alert Seat

Some driver assistance features alert the driver of obstacles by beeping. To change the volume of the warning chime, see “Comfort and Convenience” under *Vehicle Personalization on page 5-52*.

With the Safety Alert Seat, the driver seat cushion may provide a vibrating pulse alert instead of beeping. To change this, see “Collision/Detection Systems” under *Vehicle Personalization on page 5-52*.

Assistance Systems for Parking or Backing

The Rear Vision Camera (RVC) and Front and Rear Parking Assist (FRPA) may help the driver to avoid a crash or to reduce crash damage while backing and parking. Some models may also have Rear Cross Traffic Alert (RCTA).

When the vehicle is shifted into R (Reverse), the RVC displays an image of the area behind the vehicle in the center stack display.

Warning

The RVC system does not display children, pedestrians, bicyclists, crossing traffic, animals, or any other object located outside the camera's field of view, below the bumper, or under the vehicle. Perceived distances may be different from actual distances. Do not back the vehicle using only the RVC screen. Failure to use proper care before backing may result in injury, death, or vehicle damage. Always check behind and around the vehicle before backing.

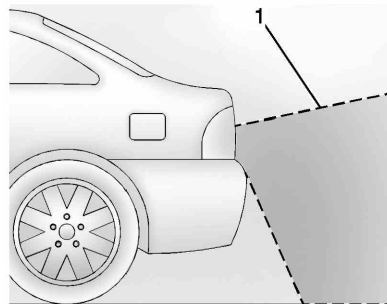

1. View Displayed by the Camera

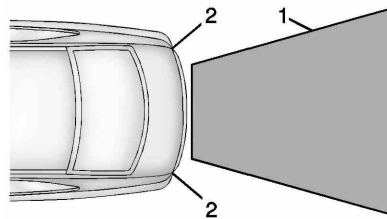

1. View Displayed by the Camera
2. Corners of the Rear Bumper

Displayed images may be farther or closer than they appear. The area displayed is limited and objects that are close to either corner of the bumper or under the bumper do not display.

A warning triangle may display on the RVC screen to show where the Rear Parking Assist (RPA) has detected an object. This triangle changes from amber to red and increases in size the closer the object.

On vehicles with the Rear Cross Traffic Alert (RCTA), a triangle with an arrow may also display on the RVC screen to warn of traffic coming from either direction. When backing, this system detects objects coming from up to 20 m (65 ft) from the left or right side, behind the vehicle. When an object is detected, either three beeps sound or three Safety Alert Seat pulses occur on the left or right side, depending on the direction of the detected vehicle.

Front and Rear Park Assist (FRPA) operates at speeds of less than 8 km/h (5 mph) and detects nearby objects within a zone 25 cm (10 in) high off the ground and below bumper level. FRPA detects objects up to 2.5 m (8 ft) behind the vehicle, and detects objects up to 1.2 m (4 ft) in front of the vehicle. These detection distances may be shorter during warmer or humid weather. Blocked sensors will not detect objects and can also cause false detections. Keep the sensors clean of mud, dirt, snow, ice, and slush; and clean sensors after a car wash in freezing temperatures.

Warning

The parking assist system does not detect children, pedestrians, bicyclists, animals, or objects located below the bumper or that are too close or too far from the vehicle. It is not available at

(Continued)

Warning (Continued)

speeds greater than 8 km/h (5 mph). To prevent injury, death, or vehicle damage, even with parking assist, always check the area around the vehicle and check all mirrors before moving forward or backing.

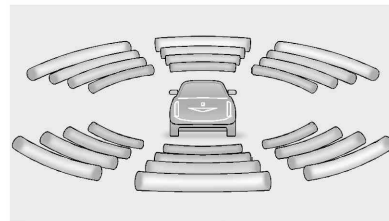

The instrument cluster parking assist display may have bars that show “distance to object” and object location information for FRPA. As the object gets closer, more bars light up. When an object is first detected in the rear, one beep will

be heard from the rear, or both sides of the Safety Alert Seat will pulse two times. When an object is very close (<0.6 m (2 ft) in the vehicle rear, or <0.3 m (1 ft) in the vehicle front), five beeps will sound from the rear or front, or both sides of the Safety Alert Seat will pulse five times. Beeps for Front Parking Assist are higher pitched than for Rear Parking Assist.

Turning the Features On or Off



The  button in the center stack is used to turn on or off the Front and Rear Parking Assist. The indicator light next to the button comes on when the features are on and turns off when the features have been disabled.

The parking assist symbols and guidance lines can be turned on or off through the Settings menu on the infotainment system. To turn the symbols or guidance lines on or off:

1. On the infotainment system, press the SETTINGS screen button, or turn the MENU knob to highlight Settings and press MENU.
2. Select Rear Camera.
3. Press Rear Park Assist Symbols or Guidance Lines and then select OFF or ON.

The Rear Cross Traffic Alert (RCTA) can be turned on and off through Vehicle Personalization. See “Collision/Detection Systems” under *Vehicle Personalization on page 5-52*.

Assistance Systems for Driving

If equipped, when driving the vehicle forward, Forward Collision Alert (FCA), Lane Departure Warning (LDW), Side Blind Zone Alert (SBZA), and/or the Active Emergency Braking System can help to avoid a crash or reduce crash damage.

Forward Collision Alert (FCA) System

The FCA system may help to avoid or reduce the harm caused by front-end crashes. When approaching a vehicle ahead too quickly, FCA provides a red flashing alert on the windshield and rapidly beeps or pulses the driver seat. FCA also lights an amber visual alert if following another vehicle much too closely.

FCA detects vehicles within a distance of approximately 60 m (197 ft) and operates at speeds above 40 km/h (25 mph). If the vehicle has Adaptive Cruise Control (ACC), it can detect vehicles to distances of approximately 110 m (360 ft) and operates at all speeds. See *Adaptive Cruise Control* on page 9-39.

Warning

FCA is a warning system and does not apply the brakes. When approaching a slower-moving or stopped vehicle ahead too rapidly, or when following a vehicle too closely, FCA may not provide a warning with enough time to help avoid a crash. FCA does not warn of pedestrians, animals, signs, guardrails, bridges, construction barrels, or other objects. Be ready to take action and apply the brakes. For more information, see *Defensive Driving* on page 9-5.

FCA can be disabled with the FCA steering wheel control, or if your vehicle is equipped with Adaptive Cruise Control (ACC), through vehicle personalization. See the “Auto Collision Preparation” portion of “Collision/Detection Systems” under *Vehicle Personalization* on page 5-52.

Detecting the Vehicle Ahead



FCA warnings will not occur unless the FCA system detects a vehicle ahead. When a vehicle is detected, the vehicle-ahead indicator will display green. Vehicles may not be detected on curves, highway exit ramps, or hills; or due to poor visibility. FCA will not detect another vehicle ahead until it is completely in the driving lane.

Warning

FCA does not provide a warning to help avoid a crash, unless it detects a vehicle. FCA may not detect a vehicle ahead if the FCA sensor is blocked by dirt, snow, or ice, or if the windshield is damaged. It may also not detect a vehicle on winding or hilly roads, or in conditions that can limit visibility such as fog, rain, or snow, or if the headlamps or windshield are not cleaned or in proper condition. Keep the windshield, headlamps, and FCA sensors clean and in good repair.

Collision Alert

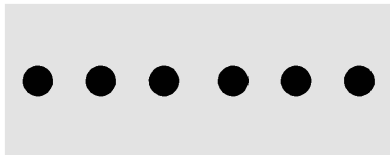

When your vehicle approaches another detected vehicle too rapidly, the red FCA display will flash on the windshield. Also, eight rapid high-pitched beeps will sound from the front, or both sides of the Safety Alert Seat will pulse five times. When this Collision Alert occurs, the brake system may prepare for driver braking to occur more rapidly which can cause a brief, mild deceleration. Continue to apply the brake pedal as the driving situation dictates. Cruise control may be disengaged when the Collision Alert occurs.

Tailgating Alert



The vehicle-ahead indicator will display amber when you are following a vehicle ahead much too closely.

Selecting the Alert Timing

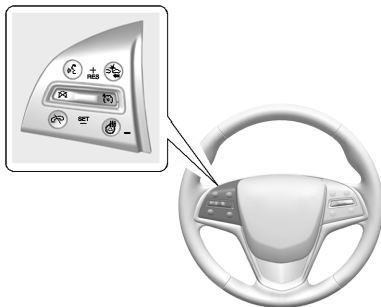

The Collision Alert control is on the steering wheel. Press  to set the FCA timing to far, medium, near, or on some vehicles, off. The first button press shows the current setting on the DIC. Additional button presses will change this setting. The chosen setting will remain until it is changed and will affect the timing of both the Collision Alert and the Tailgating Alert features. The timing of both alerts will vary based on vehicle speed. The faster the vehicle speed, the farther away the alert will occur. Consider traffic and weather conditions when selecting the alert timing. The range of selectable alert timing may not be appropriate for all drivers and driving conditions.

If your vehicle is equipped with Adaptive Cruise Control (ACC), changing the FCA timing setting automatically changes the following gap setting (Far, Medium, or Near).

Following Distance Indication

The following distance to a moving vehicle you are following is indicated in following time in seconds on the Driver Information Center (DIC). See *Driver Information Center (DIC)* on page 5-38. The minimum following time is 0.5 seconds away. If there is no vehicle detected ahead, or the vehicle ahead is out of sensor range, dashes will be displayed.

Unnecessary Alerts

FCA may provide unnecessary alerts for turning vehicles, vehicles in other lanes, objects that are not vehicles, or shadows. These alerts are normal operation and the vehicle does not need service.

Cleaning the System

If the FCA system does not seem to operate properly, cleaning the outside of the windshield in front of the rearview mirror, and cleaning the

front of the vehicle where radar sensors are located, may correct the issue.

Active Emergency Braking System

If the vehicle has Adaptive Cruise Control (ACC) it also has the Active Emergency Braking System, which includes Intelligent Brake Assist (IBA) and the Automatic Collision Preparation (ACP) System. These systems can provide a boost to braking or automatically brake the vehicle to help avoid or lessen the severity of crashes when driving in a forward gear.

Intelligent Brake Assist (IBA)

IBA may activate when the brake pedal is applied quickly by providing a boost to braking based on the speed of approach and distance to a vehicle ahead.

Minor brake pedal pulsations or pedal movement during this time is normal and the brake pedal should

continue to be applied as needed. IBA will automatically disengage only when the brake pedal is released.

Warning

IBA may increase vehicle braking in situations when it may not be necessary. You could block the flow of traffic. If this occurs, take your foot off the brake pedal and then apply the brakes as needed.

Automatic Collision Preparation (ACP) System

When driving in a forward gear above 9 km/h (5 mph), ACP may help reduce crash damage by applying the brakes. It has a detection range of approximately 60 m (197 ft). This front automatic braking can only occur if a vehicle is detected. This is shown by the FCA vehicle-ahead indicator being lit. See *Forward Collision Alert (FCA) System* on page 9-50.

Warning

ACP is an emergency crash preparation feature and is not designed to avoid crashes. Do not rely on ACP to brake the vehicle.

ACP may not:

- Respond to stopped vehicles, pedestrians, or animals.
- Detect a vehicle ahead on winding or hilly roads.
- Detect a stopped or slow-moving vehicle or other object ahead.
- Detect a vehicle when weather limits visibility, such as in fog, rain, or snow. In these situations, ACP sensor performance is limited.

(Continued)

Warning (Continued)

Complete attention is always required while driving, and you should be ready to take action and apply the brakes and/or steer the vehicle to avoid crashes.

Brake Preparation

When quickly approaching a vehicle ahead, Brake Preparation reduces brake response time by having the brake system prepared for driver braking to occur more rapidly.

Automatic Braking

If ACP detects it is about to crash with the vehicle you are following that is moving or has come to a stop, and the brakes have not been applied, it may automatically brake hard. This can help to reduce crash damage and it may even help to avoid some very low speed crashes.

Automatic Braking may slow the vehicle to a complete stop to try to avoid a potential crash. The vehicle will only hold at a stop briefly. A firm press of the accelerator pedal will also release Automatic Braking.

Warning

Automatic Braking may automatically brake the vehicle suddenly in situations where it is unexpected and undesired. It could respond to a turning vehicle ahead, guardrails, signs, and other non-moving objects. To override Automatic Braking, firmly press the accelerator pedal, if it is safe to do so.

Automatic Braking can be disabled or reduced through vehicle personalization. See the “Auto Collision Preparation” portion of “Collision/Detection Systems” under *Vehicle Personalization on page 5-52.*

Side Blind Zone Alert (SBZA)

If equipped, the Side Blind Zone Alert system is a lane-changing aid that assists drivers with avoiding crashes that occur with vehicles in the side blind zone (or spot) areas. The SBZA warning display will light up in the corresponding outside side mirror and will flash if the turn signal is on.

Warning

SBZA does not alert the driver to vehicles rapidly approaching outside of the side blind zones, pedestrians, bicyclists, or animals. It may not provide alerts when changing lanes under all driving conditions. Failure to use proper care when changing lanes may result in injury, death, or vehicle damage. Before making a lane change, always

(Continued)

Warning (Continued)

check mirrors, glance over your shoulder, and use the turn signals.

SBZA Detection Zones

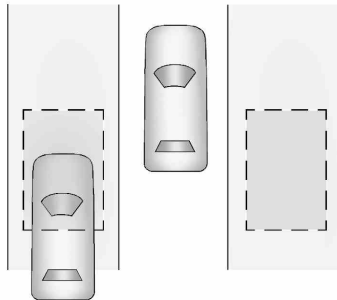

The SBZA sensor covers a zone of approximately one lane over from both sides of the vehicle, or 3.5 m (11 ft). The height of the zone is approximately between 0.5 m (1.5 ft) and 2 m (6 ft) off the ground. This

zone starts at approximately the middle of the vehicle and goes back 5 m (16 ft).

How the System Works

The SBZA symbol lights up in the side mirrors when the system detects a vehicle in the next lane over that is in the side blind zone. This indicates it may be unsafe to change lanes. Before making a lane change, check the SBZA display, check mirrors, glance over your shoulder, and use the turn signals.

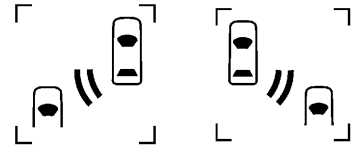

Left Side Mirror Display Right Side Mirror Display

When the vehicle is started, both outside mirror SBZA displays will briefly come on to indicate the system is operating. When the vehicle is moving forward, the

left- or right-side mirror display will light up if a vehicle is detected in that blind zone. If the turn signal is activated in the same direction of a detected vehicle, this display will flash as an extra warning not to change lanes.

SBZA can be disabled through vehicle personalization. See "Collision/Detection Systems" under *Vehicle Personalization on page 5-52*. If SBZA is disabled by the driver, the SBZA mirror displays will not light up.

When the System Does Not Seem to Work Properly

SBZA may alert to objects attached to the vehicle, such as a bicycle, or object extending out to either side of the vehicle. This is normal system operation; the vehicle does not need service.

SBZA may not always alert the driver to vehicles in the side blind zone, especially in wet conditions. The system does not need to be serviced. The system may light up due to guardrails, signs, trees, shrubs, and other non-moving objects. This is normal system operation; the vehicle does not need service.

SBZA may not operate when the SBZA sensors in the left or right corners of the rear bumper are covered with mud, dirt, snow, ice, or slush, or in heavy rainstorms. For cleaning instructions, see "Washing the Vehicle" under *Exterior Care on page 10-79*. If the DIC still displays the system unavailable message after cleaning both sides of the vehicle toward the rear corners of the vehicle, see your dealer.

If the SBZA displays do not light up when vehicles are in the blind zone and the system is clean, the system may need service. Take the vehicle to your dealer.

When SBZA is disabled for any reason other than the driver turning it off, the Side Blind Zone Alert On option will not be available on the personalization menu.

Radio Frequency Information

See *Radio Frequency Statement on page 13-12*.

Lane Departure Warning (LDW)

LDW may help avoid crashes due to unintentional lane departures. It may provide an alert if the vehicle is crossing a lane marker without using a turn signal in that direction. LDW uses a camera sensor to detect the lane markings at speeds of 56 km/h (35 mph) or greater.

Warning

The LDW system does not steer the vehicle. The LDW system may not:

- Provide enough time to avoid a crash.
- Detect lane markings under poor weather or visibility conditions. This can occur if the windshield or headlamps are blocked by dirt, snow, or ice; if they are not in proper condition; or if the sun shines directly into the camera.
- Detect road edges.
- Detect lanes on winding or hilly roads.

If LDW only detects lane markings on one side of the road, it will only warn you when departing the lane on the side where it has detected a lane

(Continued)

Warning (Continued)



marking. Always keep your attention on the road and maintain proper vehicle position within the lane, or vehicle damage, injury, or death could occur. Always keep the windshield, headlamps, and camera sensors clean and in good repair. Do not use LDW in bad weather conditions.

How the System Works

The LDW camera sensor is on the windshield ahead of the rearview mirror.

To turn LDW on and off, press  on the center stack. The control indicator will light when LDW is on.



When LDW is on,  is green if LDW is available to warn of a lane departure. If the vehicle crosses a detected lane marking without using the turn signal in that direction,  changes to amber and flashes. Additionally, there will be three beeps, or the driver seat will pulse three times, on the right or left, depending on the lane departure direction.

When the System Does Not Seem to Work Properly

The system may not detect lanes as well when there are:

- Close vehicles ahead.
- Sudden lighting changes, such as when driving through tunnels.
- Banked roads.

If the LDW system is not functioning properly when lane markings are clearly visible, cleaning the windshield may help.

LDW alerts may occur due to tar marks, shadows, cracks in the road, temporary or construction lane markings, or other road imperfections. This is normal system operation; the vehicle does not need service. Turn LDW off if these conditions continue.

Charging

Plug-In Charging

This section explains the process for charging the vehicle's high voltage battery. Do not allow the vehicle to remain in temperature extremes for long periods without being driven or plugged in. It is recommended that the vehicle be plugged in when temperatures are below 0°C (32°F) and above 32°C (90°F) to maximize high voltage battery life.

When using a 120-volt AC electrical outlet, it will take approximately 12.5 hours to charge the vehicle with the 12 amp AC current setting or 18 hours using the default 8 amp AC current setting. When using a 240-volt charging station, it will take approximately five hours to charge the vehicle. Charge times will vary with outside temperature.

There are three ways to program how the vehicle is charged. See *Programmable Charging on page 5-29*.

The charging system may run fans and pumps that result in sounds from the vehicle while it is turned off. Additional unexpected clicking sounds may be caused by the electrical devices used while charging.

While the charge cord is plugged into the vehicle, the vehicle cannot be driven.

Charging

Start Charge

1. Make sure the vehicle is parked and turned off.
2. Push the rearward edge of the charge port door in and release to open the door.

In cold weather conditions, ice may form around the charge port door. Remove ice from the area before attempting to open or close the charge port door.

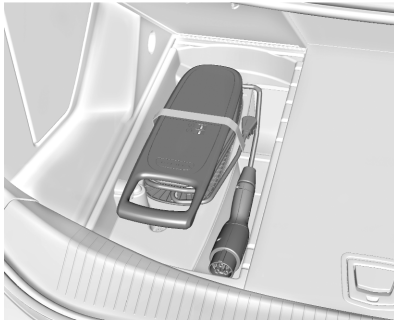

3. Open the rear trunk, lift the left load support floor cover, and remove the charge cord. Pull up on the charge cord handle to release. The vehicle plug is stored as shown.

4. Plug the charge cord into the electrical outlet. See *Electrical Requirements for Battery Charging* on page 9-66. Verify the charge cord status. See the charge cord user guide. See *Charge Cord* on page 9-64. Select the appropriate charge level using the Select Charge Level Preference screen on the center stack. See "Charge Level Selection" under *Programmable Charging* on page 5-29.



5. Plug in the vehicle plug of the charge cord into the charge port on the vehicle. Verify that the charging status indicator illuminates on top of the instrument panel and a horn chirp occurs. See *Charging Status Feedback* on page 9-60.

Charge Cord Theft Alert

This vehicle has a Charge Cord Theft Alert. To enable this feature, see "Charge Cord Theft Alert" in *Vehicle Personalization* on page 5-52. The system can be armed and disarmed using the door lock function on the RKE transmitter.

End Charge

1. If armed, unlock the vehicle with the RKE transmitter to disarm the charge cord theft alert.

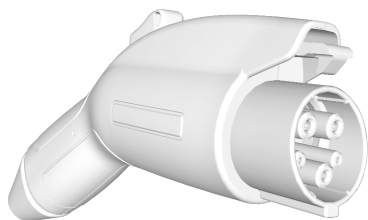

2. Disconnect the vehicle plug of the charge cord from the vehicle.
3. Close the charge port door by pressing firmly on the rearward edge of the door surface.
4. Unplug the charge cord from the electrical outlet.
5. Place the charge cord into the storage compartment.

Delayed Charging Override

To temporarily override a delayed charge event, unplug the charge cord from the charge port and then plug it back in within five seconds. A single horn chirp will sound and charging will begin immediately.

To cancel a temporary override, unplug the charge cord, wait for 10 seconds, and then plug the charge cord back in. A double horn chirp will sound and charging will be delayed.

See *Programmable Charging on page 5-29* for advanced charge scheduling options.

Charging Status Feedback

The vehicle has two ways of monitoring the charging status of the high voltage battery. The Instrument Panel Charging Status Indicator (CSI) is at the center of the instrument panel near the windshield. The LEDs in the Outside Rearview Mirrors (OSRVM) are also used to monitor charging status.

Some local laws restricting the use of colored lights on public roads may apply to the outside rearview mirrors charging status feedback. To turn the OSRVM charge indicator off, see “Charge Status Feedback” in *Vehicle Personalization on page 5-52*.

Instrument Panel Charging Status Indicator (CSI)

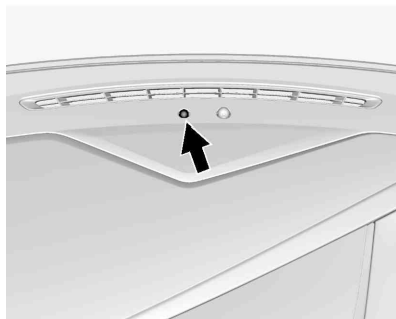

When the vehicle is plugged in and the vehicle power is off, the CSI indicates the following:

- Solid Green – Vehicle is plugged in. Battery is not fully charged. Battery is charging.
- Long Flashing Green – Vehicle is plugged in. Battery is not fully charged. Battery charging is delayed.

- Short Flashing Green – Vehicle is plugged in. Battery is fully charged.
- Solid Yellow – Vehicle is plugged in. It is normal for the CSI to turn yellow for a few seconds after plugging in a compatible charge cord. The solid yellow may be extended depending on the vehicle temperature or if there is a total utility interruption via OnStar. See *Utility Interruption of Charging* on page 9-65. This may also indicate that the charging system has detected a fault and will not charge the battery. See “Charge Cord Status Indicators” in the charge cord user guide.

The system may be thermally conditioning the battery during any of the states above, requiring electrical energy to be transferred to the vehicle.



If the vehicle is plugged in and vehicle power is on, the CSI will be on solid green. The same is true during a remote start if the vehicle is plugged in.

If the vehicle is plugged in and the CSI is off, a total utility interruption using OnStar or a charging fault has been detected. See *Utility Interruption of Charging* on page 9-65 or “Charge Cord Status Indicators” in the charge cord user guide.

This chart indicates vehicle feedback when the charge cord is plugged in.

9-62 Driving and Operating

Charging Status Indicator	Sound	Action/Reason
Solid Green	One horn chirp	Charging has begun.
Long Flashing Green	Two horn chirps	Charging is delayed by Programmable Charging or, if the vehicle is equipped accordingly, by a total utility interruption via OnStar. Charging will begin later. See <i>Utility Interruption of Charging</i> on page 9-65.
Short Flashing Green	None	Charging is complete.
Yellow (Upon Plug-in)	None	Charge cord is OK and the vehicle is not yet charging.
Yellow (For Extended Time Period after Plug-in)	None	Charge cord is OK, but the vehicle is not charging. This may be due to vehicle temperature or a total utility interruption via Onstar and charging will begin later. See <i>Utility Interruption of Charging</i> on page 9-65 or <i>Malfunction Indicator Lamp</i> on page 5-17.
Solid Green	Two horn chirps	Vehicle is charging but will delay at least once before the charge is complete.
Solid Green or Long Flashing Green	Four horn chirps	Insufficient time to fully charge by departure time due to rate preference.
None (Upon Plug-in)	None	Charge cord connection should be checked.

Charging Status Indicator	Sound	Action/Reason
None (After Green or Yellow CSI Indication Observed)	None	Charge cord connection should be checked. If connection is good, this may be due to a total utility interruption via OnStar and charging will begin later. See <i>Utility Interruption of Charging on page 9-65</i> or <i>Malfunction Indicator Lamp on page 5-17</i> .
None	<p>Repeated horn chirps</p> <p>To disable this feature, see “Charge Power Loss Alert” in <i>Vehicle Personalization on page 5-52</i>.</p> <p>To stop this alert, do one of the following:</p> <ul style="list-style-type: none"> • Unplug the charge cord. • Press  on the RKE transmitter. • Press and hold  on the RKE transmitter, then press again to stop the panic alarm. • Press the horn pad. 	Electricity was interrupted before charging was complete.

Outside Rearview Mirror (OSRVM) Charging Status Indicator



The outside rearview mirrors are equipped with green indicator lights used to indicate high voltage battery system charging status. The OSRVM CSI indicates the following:

- Solid green - Battery is charging and is less than half complete.
- Fast flashing - Battery is charging. Battery is more than half complete.

- Slow flashing - Battery is charging. Battery is nearly complete.
- Off - Not charging.

Charge Cord

See *Radio Frequency Statement on page 13-12*.

A portable charge cord used to charge the vehicle high voltage battery is stored under the load support floor covering in the trunk.

Important Information About Portable Electric Vehicle Charging

- Charging an electric vehicle can stress a building's electrical system more than a typical household appliance.
- Before you plug in to any electrical outlet, have a qualified electrician inspect and verify the electrical system (electrical outlet, wiring, junctions, and protection devices) for heavy-duty service at a 12 amp continuous load.

- Electrical outlets may wear out with normal usage or be damaged over time, making them unsuitable for electric vehicle charging.
- Check the electrical outlet/plug while charging and discontinue use if the electrical outlet/plug is hot, then have the electrical outlet serviced by a qualified electrician.
- When outdoors, plug into an electrical outlet that is weather-proof while in use.
- Mount the charging cord to reduce strain on the electrical outlet/plug.

⚠ Warning

Improper use of portable electric vehicle charge cords may cause a fire, electrical shock, or burns, and may result in damage to property, serious injury, or death.

- Do not use extension cords, multi-outlet power strips, splitters, grounding adaptors, surge protectors, or similar devices.
- Do not use an electrical outlet that is worn or damaged, or one that will not hold the plug firmly in place.
- Do not use an electrical outlet that is not properly grounded.
- Do not use an electrical outlet that is on a circuit with other electrical loads.

See the charge cord user guide.

Charge Cord Status Indicators

See “Charge Cord Status Indicators” in the charge cord user guide.

Charge Level Selection

Charge level selection can be made using the Charge Level Preference setting on the center stack. See “Charge Level Selection” under *Programmable Charging on page 5-29*.

⚠ Warning

Using a charge level that exceeds the electrical circuit or electrical outlet capacity may start a fire or damage the electrical circuit. Use the lowest charge level until a qualified electrician inspects your electrical circuit capacity. Use the lowest charge level if the electrical circuit or electrical outlet capacity is not known.

Utility Interruption of Charging

For participating customers using AC charging, this vehicle will respond to remote requests via OnStar to limit or completely block electrical power grid usage for brief time periods. A utility interruption of charging may increase AC vehicle charge times, but will not affect DC charge times.

When electrical grid power is completely blocked, the vehicle will delay charging until the utility interruption has expired. The vehicle should be left plugged in so that, when the utility interruption expires, the vehicle can automatically begin charging.

Changing the charge mode to Immediate or performing a delayed charging override will not disable a utility interruption.

9-66 Driving and Operating

A pop-up will appear in the center stack display during the key cycle following any utility interruption. See “Charging Override/Interruption Pop-up” under *Programmable Charging on page 5-29*.

Text will be displayed on the instrument cluster indicating that a utility interruption has occurred. See *Instrument Cluster on page 5-8*.

Electrical Requirements for Battery Charging

This vehicle is capable of being charged with most standard vehicle charging equipment complying to one or more of the following:

- SAE J1772
- SAE J2847-2
- IEC 61851-1
- IEC 61851-22
- IEC 61851-23
- IEC 61851-24
- IEC 62196-1

- IEC 62196-2
- IEC 62196-3
- ISO 15118

The following are the minimum requirements for circuits used to charge this vehicle:

- 120 volts/15 amps
- 240 volts/20 amps

Charging equipment with a rating of at least 240 volts/20 amps will provide the fastest charging time and best charging efficiency to recharge the high voltage battery. 240 volt/40 amp circuits provide flexibility for future vehicle charging needs. Always follow the charging equipment installation instructions. Contact your dealer for more information.

Caution

Do not use portable or stationary backup generating equipment to charge the vehicle. This may cause damage to the vehicle's charging system. Only charge the vehicle from utility supplied power.

Fuel

Use of the recommended fuel is an important part of the proper maintenance of this vehicle. When driving in the U.S. and Canada, to help keep the engine clean and maintain optimum vehicle performance, we recommend TOP TIER Detergent Gasolines. See www.topTiergas.com for a list of TOP TIER Detergent Gasolines.



Use premium unleaded gasoline meeting ASTM specification D4814 with a posted octane rating of 91 or

higher. If the octane is less than 91, damage to the engine may occur and may void the vehicle warranty. If heavy knocking is heard when using gasoline rated at 91 octane or higher, the engine needs service.

Use of Seasonal Fuels

Use summer and winter fuels in the appropriate season. The fuels industry automatically modifies the fuel for the appropriate season. If fuel is left in the vehicle tank for long periods of time, driving or starting could be affected. Drive the vehicle until the fuel is at one-half tank or less, then refuel with the current seasonal fuel.

Prohibited Fuels

Gasolines containing oxygenates such as ethers and ethanol, as well as reformulated gasolines, are available in some cities. If these gasolines comply with the previously described specification, then they are acceptable to use. However, E85 (85% ethanol) and

other fuels containing more than 15% ethanol must be used only in FlexFuel vehicles.

Caution

Do not use fuel containing methanol. It can corrode metal parts in the fuel system and also damage plastic and rubber parts. That damage would not be covered under the vehicle warranty.

Some gasolines, mainly high octane racing gasolines, can contain an octane-enhancing additive called methylcyclopentadienyl manganese tricarbonyl (MMT). Do not use gasolines and/or fuel additives with MMT as they can reduce spark plug life and affect emission control system performance. The malfunction indicator lamp may turn on. If this occurs, see your dealer for service.

California Fuel Requirements

If the vehicle is certified to meet California Emissions Standards, it is designed to operate on fuels that meet California specifications. See the underhood emission control label. If this fuel is not available in states adopting California Emissions Standards, the vehicle will operate satisfactorily on fuels meeting federal specifications, but emission control system performance might be affected. The malfunction indicator lamp could turn on and the vehicle may not pass a smog-check test. See *Malfunction Indicator Lamp* on page 5-17. If this occurs, return to your authorized dealer for diagnosis. If it is determined that the condition is caused by the type of fuel used, repairs may not be covered by the vehicle warranty.

Fuels in Foreign Countries

If planning to drive in countries outside the U.S. or Canada, the proper fuel might be hard to find. Check regional auto club or fuel retail brand websites for availability in the country where driving. Never use leaded gasoline, fuel containing methanol, manganese, or any other fuel not recommended. Costly repairs caused by use of improper fuel would not be covered by the vehicle warranty.

Fuel Additives

To keep fuel systems clean, TOP TIER Detergent Gasoline is recommended. See *Fuel* on page 9-67.

If TOP TIER Detergent Gasoline is not available, one bottle of Fuel System Treatment PLUS added to the fuel tank at every engine oil change, can help. Fuel System Treatment PLUS is the only

gasoline additive recommended by General Motors. It is available at your dealer.

Filling the Tank

Warning

Fuel vapors and fuel fires burn violently and can cause injury or death.

- To help avoid injuries to you and others, read and follow all the instructions on the fuel pump island.
- Turn off the engine when refueling.
- Keep sparks, flames, and smoking materials away from fuel.
- Do not leave the fuel pump unattended.
- Do not reenter the vehicle while pumping fuel.

(Continued)

Warning (Continued)

- Keep children away from the fuel pump and never let children pump fuel.
- Fuel can spray out if the fuel cap is opened too quickly. This spray can happen if the tank is nearly full, and is more likely in hot weather. Open the fuel cap slowly and wait for any hiss noise to stop then unscrew the cap all the way.

The fuel system on this vehicle requires a refueling process to control evaporative emissions. To refuel the vehicle:

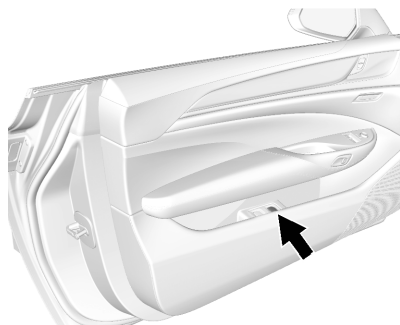

1. Press the fuel door button on the driver door for one second. A WAIT TO REFUEL message displays on the Driver Information Center.

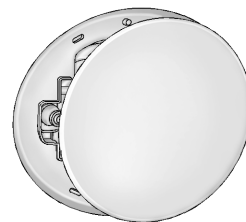

2. When the READY TO REFUEL message displays, the fuel door on the passenger side will unlock. To open the fuel door, push and release the rearward center edge of the door.
3. Turn the fuel cap counterclockwise to remove. While refueling, hang the fuel cap tether from the hook on the inside of the fuel door. Complete refueling within 30 minutes of pressing the fuel door button on the driver door. If refueling more than 30 minutes, press the fuel door button again.
4. After refueling, reinstall the fuel cap by turning it clockwise until it clicks. Close the fuel door.

9-70 Driving and Operating

Do not top off or overfill the tank and wait a few seconds before removing the nozzle. Clean fuel from painted surfaces as soon as possible. See *Exterior Care* on page 10-79.

Warning

If a fire starts while you are refueling, do not remove the nozzle. Shut off the flow of fuel by shutting off the pump or by notifying the station attendant. Leave the area immediately.

Caution

If a new fuel cap is needed, be sure to get the right type of cap from your dealer. The wrong type of fuel cap may not fit properly, may cause the malfunction indicator lamp to light, and could damage the fuel tank and

(Continued)

Caution (Continued)

emissions system. See *Malfunction Indicator Lamp* on page 5-17.

Filling a Portable Fuel Container

Warning

Filling a portable fuel container while it is in the vehicle can cause fuel vapors that can ignite either by static electricity or other means. You or others could be badly burned and the vehicle could be damaged. Always:

- Use approved fuel containers.
- Remove the container from the vehicle, trunk, or pickup bed before filling.

(Continued)

Warning (Continued)

- Place the container on the ground.
- Place the nozzle inside the fill opening of the container before dispensing fuel, and keep it in contact with the fill opening until filling is complete.
- Fill the container no more than 95% full to allow for expansion.
- Do not smoke, light matches, or use lighters while pumping fuel.
- Avoid using cell phones or other electronic devices.

Trailer Towing

General Towing Information

The vehicle is neither designed nor intended to tow a trailer or another vehicle.

For information on towing a disabled vehicle, see *Towing the Vehicle on page 10-75*. For information on towing the vehicle behind another vehicle such as a motor home, see *Recreational Vehicle Towing on page 10-77*.

Conversions and Add-Ons

Add-On Electrical Equipment

 **Caution**

Some electrical equipment can damage the vehicle or cause components to not work and would not be covered by the warranty. Always check with your dealer before adding electrical equipment.

Add-on equipment can drain the vehicle's 12-volt battery, even if the vehicle is not operating.

When adding electrical equipment, it should only be connected using the accessory power outlets. The maximum power that can be supplied by one accessory power outlet, or spread across all power outlets, is 200 watts or 15 amps. Exceeding 200 watts or 15 amps may cause erratic vehicle operation. See *Power Outlets on page 5-7*.

Vehicle Care

General Information

General Information	10-2
California Proposition 65 Warning	10-2
California Perchlorate Materials Requirements	10-2
Accessories and Modifications	10-2
Lifting the Vehicle	10-3

Vehicle Checks

Doing Your Own Service Work	10-5
Hood	10-6
Engine Compartment Overview	10-8
Engine Oil	10-9
Engine Oil Life System	10-12
Engine Air Cleaner/Filter	10-13
Cooling System (Engine) ...	10-14
Cooling System (High Voltage Battery)	10-15
Cooling System (Power Electronics and Charger Modules)	10-16
Engine Coolant	10-16

Engine Overheating	10-19
Washer Fluid	10-19
Brakes	10-20
Brake Fluid	10-21
Battery	10-23
Electric Drive Unit Shift Lock Control Function Check ...	10-25
Park Brake and P (Park) Mechanism Check	10-25
Wiper Blade Replacement	10-26

Headlamp Aiming

Headlamp Aiming	10-27
-----------------------	-------

Bulb Replacement

Bulb Replacement	10-27
LED Lighting	10-27
License Plate Lamp	10-27
Replacement Bulbs	10-28

Electrical System

High Voltage Devices and Wiring	10-28
Electrical System Overload	10-29
Engine Compartment Fuse Block	10-29

Instrument Panel Fuse Block (Left Side)	10-33
Instrument Panel Fuse Block (Right Side)	10-35
Rear Compartment Fuse Block	10-38

Wheels and Tires

Tires	10-41
All-Season Tires	10-42
Winter Tires	10-42
Summer Tires	10-42
Tire Sidewall Labeling	10-43
Tire Designations	10-44
Tire Terminology and Definitions	10-44
Tire Pressure	10-47
Tire Pressure Monitor System	10-48
Tire Pressure Monitor Operation	10-49
Tire Inspection	10-53
Tire Rotation	10-53
When It Is Time for New Tires	10-54
Buying New Tires	10-55
Different Size Tires and Wheels	10-57

10-2 Vehicle Care

Uniform Tire Quality Grading	10-57
Wheel Alignment and Tire Balance	10-59
Wheel Replacement	10-59
Tire Chains	10-60
If a Tire Goes Flat	10-61
Tire Sealant and Compressor Kit	10-62
Storing the Tire Sealant and Compressor Kit	10-69
Jump Starting	
Jump Starting	10-69
Towing the Vehicle	
Towing the Vehicle	10-75
Recreational Vehicle Towing	10-77
Appearance Care	
Exterior Care	10-79
Interior Care	10-84
Floor Mats	10-87

General Information

For service and parts needs, visit your dealer. You will receive genuine GM parts and GM-trained and supported service people.

Genuine GM parts have one of these marks:

ACDelco[®]

Genuine **GM** | Parts

GM Accessories

California Proposition 65 Warning

Most motor vehicles, including this one, contain and/or emit chemicals known to the State of California to

cause cancer and birth defects or other reproductive harm. Engine exhaust, many parts and systems, many fluids, and some component wear by-products contain and/or emit these chemicals.

California Perchlorate Materials Requirements

Certain types of automotive applications, such as airbag initiators, safety belt pretensioners, and lithium batteries contained in Remote Keyless Entry transmitters, may contain perchlorate materials. Special handling may be necessary. For additional information, see www.dtsc.ca.gov/hazardouswaste/perchlorate.

Accessories and Modifications

Adding non-dealer accessories or making modifications to the vehicle can affect vehicle performance and safety, including such things as airbags, braking, stability, ride and

handling, emissions systems, aerodynamics, durability, and electronic systems like antilock brakes, traction control, and stability control. These accessories or modifications could even cause malfunction or damage not covered by the vehicle warranty.

Damage to vehicle components resulting from modifications or the installation or use of non-GM certified parts, including control module or software modifications, is not covered under the terms of the vehicle warranty and may affect remaining warranty coverage for affected parts.

GM Accessories are designed to complement and function with other systems on the vehicle. See your dealer to accessorize the vehicle using genuine GM Accessories installed by a dealer technician.

Also, see *Adding Equipment to the Airbag-Equipped Vehicle* on page 3-30.

Lifting the Vehicle

Lift the vehicle using a three-stage front arm hoist with 3-inch adapters only. A service jack can also be used.

Caution

Lifting the vehicle improperly can damage the vehicle and result in costly repairs not covered by the warranty.

Lifting the Vehicle with a Hoist

Lift the vehicle with a three-stage front arm hoist, using the four lifting points at the same time. See your dealer and service manual.

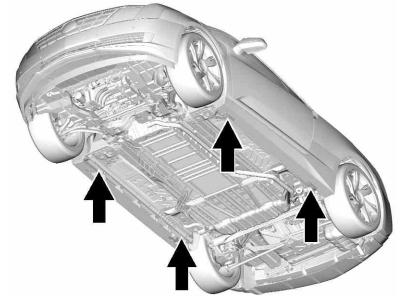

The front lifting points can be accessed from either side of the vehicle, behind the front tires.

The rear lifting points can be accessed from either side of the vehicle, in front of the rear tires.

10-4 Vehicle Care

Lifting the Vehicle with a Service Jack

Warning

Lifting a vehicle can cause an injury. The vehicle can slip off the jack and roll over you or other people. You and they could be badly injured. Find a level place to lift your vehicle. To help prevent the vehicle from moving:

1. Set the parking brake firmly.
2. Put the shift lever in P (Park).
3. Turn off the vehicle.

To be even more certain the vehicle will not move, put blocks in front of and behind the wheels.

Warning

Getting under a vehicle when it is lifted on a jack is dangerous. If the vehicle slips off the jack, you could be badly injured or killed. Never get under a vehicle when it is supported only by a jack.

Warning

Raising the vehicle with the jack improperly positioned can damage the vehicle or the vehicle may fall and cause injury to you or others.

When using a jack to lift the vehicle, follow the instructions that came with the jack and be sure to use the correct lifting points to avoid damaging the vehicle.

Caution

Lifting the vehicle improperly can cause damage and result in costly repairs not covered by the warranty. To lift the vehicle properly, use this procedure. For additional information, see your dealer and the service manual.

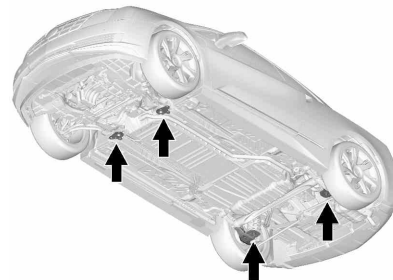

There are four points where the vehicle can be lifted with a service jack.

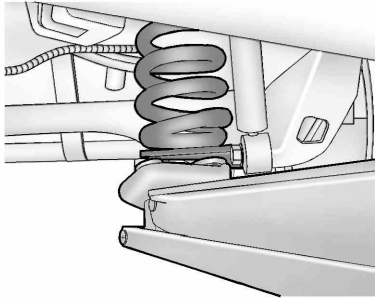

When lifting the vehicle from the rear, place the service jack directly under one of the spring seats.

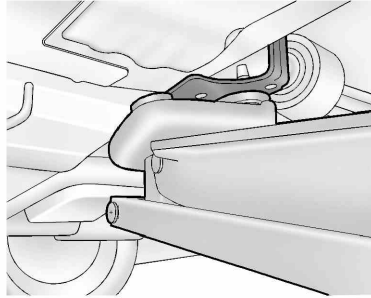

When lifting the vehicle from the front, place the service jack directly under one of the cradle mounts.

Ramps may be needed under the front tires to provide the necessary clearance for certain service jacks in this location.

For more information, see *Doing Your Own Service Work* on page 10-5.

Vehicle Checks

Doing Your Own Service Work

Warning

Never try to do your own service on high voltage battery components. You can be injured and the vehicle can be damaged if you try to do your own service work. Service and repair of these high voltage battery components should only be performed by a trained dealer technician with the proper knowledge and tools.

Exposure to high voltage can cause shock, burns, and even death. The high voltage components in the vehicle can only be serviced by technicians with special training.

(Continued)

10-6 Vehicle Care

Warning (Continued)

High voltage components are identified by labels. Do not remove, open, take apart, or modify these components. High voltage cable or wiring has orange covering. Do not probe, tamper with, cut, or modify high voltage cable or wiring.

Warning

It can be dangerous to work on your vehicle if you do not have the proper knowledge, service manual, tools, or parts. Always follow owner manual procedures and consult the service manual for your vehicle before doing any service work.

If doing some of your own service work, use the proper service manual. It tells you much more

about how to service the vehicle than this manual can. To order the proper service manual, see *Service Publications Ordering Information on page 13-11*.

This vehicle has an airbag system. Before attempting to do your own service work, see *Airbag System Check on page 3-31*.

Keep a record with all parts receipts and list the mileage and the date of any service work performed. See *Maintenance Records on page 11-14*.

Caution

Even small amounts of contamination can cause damage to vehicle systems. Do not allow contaminants to contact the fluids, reservoir caps, or dipsticks.

Hood

To open the hood:

1. Turn the vehicle off before opening the hood. If the vehicle is on, the engine will start when the hood is opened. See *Electric Mode on page 9-21* and *Extended Range Mode on page 9-22*.



2. Pull the release handle with this symbol. It is below the instrument panel outboard of the steering wheel.

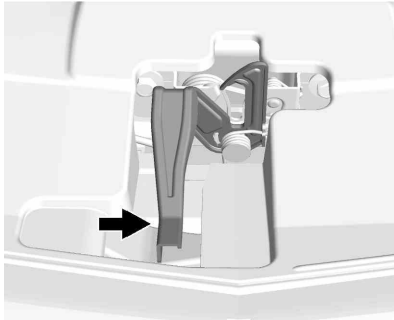

3. Go to the front of the vehicle and locate the secondary release lever under the front center of the hood. Push the secondary hood release lever to the right to disengage.

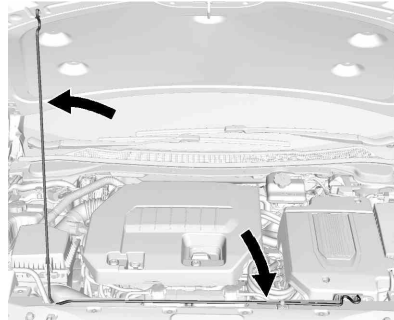

4. Lift the hood and release the hood prop rod from its retainer above the radiator support. Place the prop rod securely into the slotted retainer in the hood.

To close the hood:

1. Before closing the hood, check that all filler caps are properly installed. Then, lift the hood to relieve pressure on the hood prop.
2. Remove the hood prop from the slotted retainer in the hood and return it to its retainer above the radiator support. The prop rod must lock into place when returning it to the retainer to prevent hood damage.
3. Lower the hood 20 cm (8 in) above the vehicle and release it so it fully latches. Check to make sure the hood is firmly closed. Repeat the process if necessary.

Engine Compartment Overview

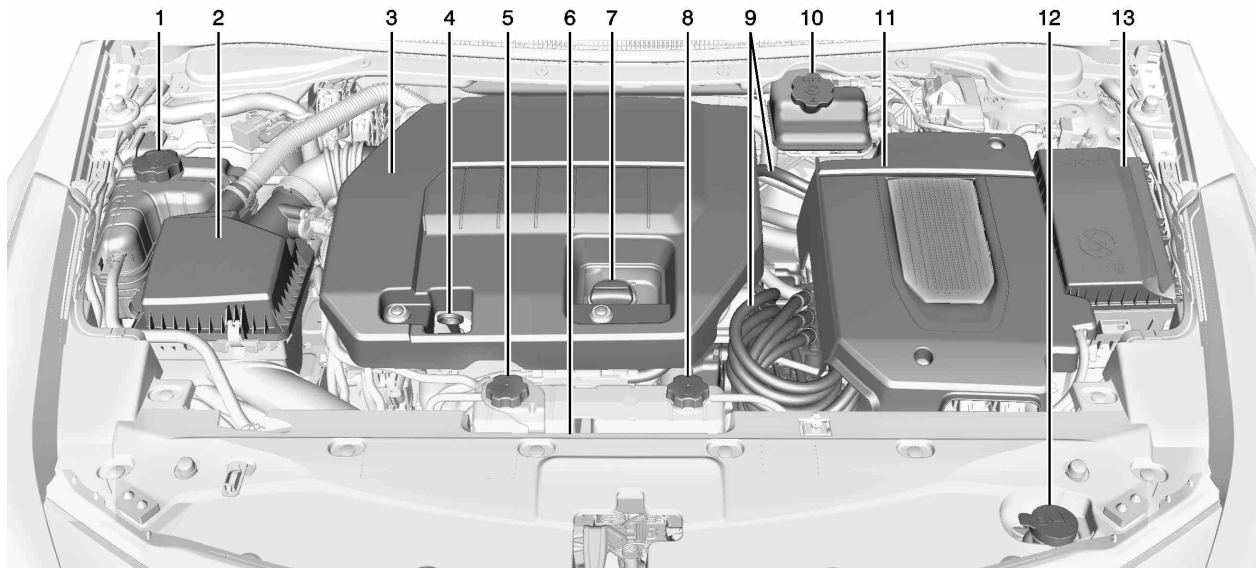

1. Engine Coolant Surge Tank and Pressure Cap. See *Engine Coolant* on page 10-16.
2. *Engine Air Cleaner/Filter* on page 10-13.
3. Engine Cover.
4. Engine Oil Dipstick. See *Engine Oil* on page 10-9.
5. High Voltage Battery Coolant Reservoir and Pressure Cap. See *Cooling System (Engine)* on page 10-14 or *Cooling System (High Voltage Battery)* on page 10-15 or *Cooling System (Power Electronics and Charger Modules)* on page 10-16.
6. Engine Cooling Fans. See *Cooling System (Engine)* on page 10-14 or *Cooling System (High Voltage Battery)* on page 10-15 or *Cooling System (Power Electronics and Charger Modules)* on page 10-16.
7. Engine Oil Fill Cap. See *Engine Oil* on page 10-9.
8. Power Electronics Coolant Reservoir and Pressure Cap. See *Cooling System (Engine)* on page 10-14 or *Cooling System (High Voltage Battery)* on page 10-15 or *Cooling System (Power Electronics and Charger Modules)* on page 10-16.
9. High Voltage Cables (Orange Color).
10. Brake Fluid Reservoir. See “Brake Fluid” under *Brakes* on page 10-20.
11. Power Electronics Module.
12. Windshield Washer Fluid Reservoir. See “Adding Washer Fluid” under *Washer Fluid* on page 10-19.
13. *Engine Compartment Fuse Block* on page 10-29.

Engine Oil

To ensure proper engine performance and long life, careful attention must be paid to engine oil. Following these simple, but important steps will help protect your investment:

- Always use engine oil approved to the proper specification and of the proper viscosity grade. See “Selecting the Right Engine Oil” in this section.
- Check the engine oil level regularly and maintain the proper oil level. See “Checking Engine Oil” and “When to Add Engine Oil” in this section.
- Change the engine oil at the appropriate time. See *Engine Oil Life System* on page 10-12.
- Always dispose of engine oil properly. See “What to Do with Used Oil” in this section.

Checking Engine Oil

It is a good idea to check the engine oil level at each fuel fill. In order to get an accurate reading, the vehicle must be on level ground. The engine oil dipstick handle is a loop. See *Engine Compartment Overview* on page 10-8 for the location of the engine oil dipstick.

Obtaining an accurate oil level reading is essential:

1. If the engine has been running recently, turn off the engine and allow several minutes for the oil to drain back into the oil pan. Checking the oil level too soon after engine shutoff will not provide an accurate oil level reading.

Warning

The engine oil dipstick handle may be hot; it could burn you. Use a towel or glove to touch the dipstick handle.

2. Pull out the dipstick and wipe it with a clean paper towel or cloth, then push it back in all the way. Remove it again, keeping the tip down, and check the level.

When to Add Engine Oil

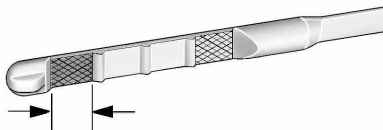

If the oil is below the cross-hatched area at the tip of the dipstick, add 1 L (1 qt) of the recommended oil and then recheck the level. See "Selecting the Right Engine Oil" in this section for an explanation of what kind of oil to use. For engine oil crankcase capacity, see *Capacities and Specifications* on page 12-2.

Caution

Do not add too much oil. Oil levels above or below the acceptable operating range shown on the dipstick are harmful to the engine. If you find that you have an oil level above the operating range, i.e., the engine has so much oil that the oil level gets above the cross-hatched area that shows the proper operating range, the engine could be damaged. You should drain out the excess oil or limit driving of the vehicle and seek a service professional to remove the excess amount of oil.

See *Engine Compartment Overview* on page 10-8 for the location of the engine oil fill cap.

Add enough oil to put the level somewhere in the proper operating range. Push the dipstick all the way back in when through.

Selecting the Right Engine Oil

Selecting the right engine oil depends on both the proper oil specification and viscosity grade. See *Recommended Fluids and Lubricants* on page 11-12.

Specification

Use and ask for licensed engine oils with the dexos1[®] approved certification mark. Engine oils meeting the requirements for the vehicle should have the dexos1 approved certification mark. This certification mark indicates that the oil has been approved to the dexos1 specification. See www.gmdexos.com.



⚠ Caution

Failure to use the recommended engine oil can result in engine damage not covered by the vehicle warranty. Check with your dealer or service provider on whether the oil is approved to the dexos1 specification.

Viscosity Grade

Use SAE 5W-30 viscosity grade engine oil.

Cold Temperature Operation: In an area of extreme cold, where the temperature falls below -29°C (-20°F), an SAE 0W-30 oil may be used. An oil of this viscosity grade will provide easier cold starting for the engine at extremely low temperatures. When selecting an oil of the appropriate viscosity grade, always select an oil of the correct specification. See "Specification" earlier in this section for more information.

Engine Oil Additives/Engine Oil Flushes

Do not add anything to the oil. The recommended oils with the dexos specification and displaying the dexos certification mark are all that is needed for good performance and engine protection.

Engine oil system flushes are not recommended and could cause engine damage not covered by the vehicle warranty.

What to Do with Used Oil

Used engine oil contains certain elements that can be unhealthy for your skin and could even cause cancer. Do not let used oil stay on your skin for very long. Clean your skin and nails with soap and water, or a good hand cleaner. Wash or properly dispose of clothing or rags containing used engine oil. See the manufacturer's warnings about the use and disposal of oil products.

Used oil can be a threat to the environment. If you change your own oil, be sure to drain all the oil from the filter before disposal. Never dispose of oil by putting it in the trash or pouring it on the ground, into sewers, or into streams or bodies of water. Recycle it by taking it to a place that collects used oil.

Engine Oil Life System

When to Change Engine Oil

This vehicle has a computer system that indicates when to change the engine oil and filter. This is based on a combination of factors which include engine revolutions, engine temperature, and miles driven. Based on driving conditions, the mileage at which an oil change is indicated can vary considerably. For the oil life system to work properly, the system must be reset every time the oil is changed.

When the system has calculated that oil life has been diminished, it indicates that an oil change is

necessary. A CHANGE ENGINE OIL SOON message comes on. Change the oil as soon as possible within the next 1 000 km (600 mi). It is possible that, if driving under the best conditions, the oil life system might indicate that an oil change is not necessary for up to two years. The engine oil and filter must be changed at least once every two years and, at this time, the system must be reset. Your dealer has trained service people who will perform this work and reset the system. It is also important to check the oil regularly over the course of an oil drain interval and keep it at the proper level.

If the system is ever reset accidentally, the oil must be changed at 5 000 km (3,000 mi) since the last oil change. Remember to reset the oil life system whenever the oil is changed.

How to Reset the Engine Oil Life System

Reset the system whenever the engine oil is changed so that the system can calculate the next engine oil change. To reset the system:

1. Display RESET OIL LIFE on the DIC menu. See *Driver Information Center (DIC)* on page 5-38.
2. Press and hold SEL for several seconds while the Oil Life display is active to reset the Oil Life system.

100% OIL LIFE will be displayed when OIL LIFE is successfully reset.

If the CHANGE ENGINE OIL SOON message comes back on when the vehicle is started, the engine oil life system has not reset. Repeat the procedure.

Engine Air Cleaner/Filter

See *Engine Compartment Overview on page 10-8* for the location of the engine air cleaner/filter.

When to Inspect the Engine Air Filter

Inspect or replace the air filter at the scheduled maintenance intervals. See *Maintenance Schedule on page 11-2*. If driving in dusty/dirty conditions, inspect the air filter at each engine oil change.

How to Inspect the Engine Air Filter

To inspect the air filter, remove it from the engine air cleaner/filter assembly and lightly shake to release loose dust and dirt. If the air filter remains covered with dirt, a new air filter is required.

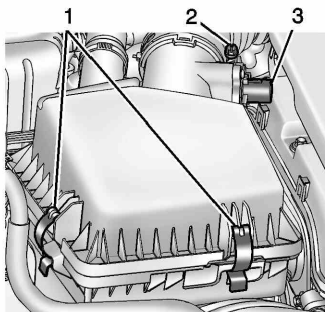

1. Retaining Clips
2. Air Duct Clamp
3. Electrical Connector

To inspect or replace the air filter:

1. Open the hood. See *Hood on page 10-6*.
2. Locate the engine air cleaner/filter assembly on the passenger side of the engine compartment. See *Engine Compartment Overview on page 10-8*.
3. Disconnect the air duct by loosening the air duct clamp (2).

4. Disconnect the electrical connector (3).
5. Lift the retaining clips (1) from the engine air cleaner/filter assembly.
6. Turn and tilt the air cleaner cover slightly upward and slide it out. Remove the air filter.

How to Reinstall the Engine Air Filter

1. Install the air filter into the engine air cleaner/filter assembly. The outer air filter seal must be fitted properly in the engine air cleaner/filter assembly.
2. Replace the air cleaner cover by lowering it to meet the bottom of the engine air cleaner/filter assembly. Place the retaining clips (1) on the engine air cleaner/filter assembly and secure. The rear tabs must be secured into the lower portion of the air cleaner.

10-14 Vehicle Care

3. Reconnect the air duct and tighten the air duct clamp (2).
4. Reconnect the electrical connector (3).

Warning

Operating the engine with the air cleaner/filter off can cause you or others to be burned. The air cleaner not only cleans the air; it helps to stop flames if the engine backfires. Use caution when working on the engine and do not drive with the air cleaner/filter off.

Caution

If the air cleaner/filter is off, dirt can easily get into the engine, which could damage it. Always have the air cleaner/filter in place when you are driving.

Cooling System (Engine)

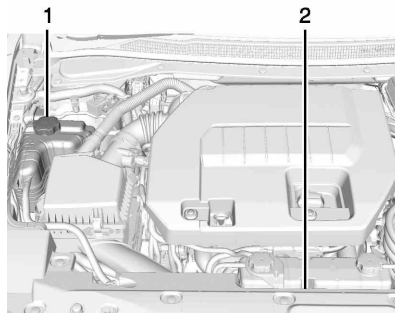

1. Engine Coolant Surge Tank and Pressure Cap
2. Engine Cooling Fans (Out of View)

Warning

The electric fans under the hood can start up even when the engine is not running and can

(Continued)

Warning (Continued)

cause injury. Keep hands, clothing, and tools away from any underhood electric fan.

If the coolant inside the coolant surge tank is boiling, do not do anything else until it cools down. The vehicle should be parked on a level surface.

The coolant level should be up to the cold fill line. If it is not, there might be a leak at the radiator hoses, heater hoses, radiator, water pump, or somewhere else in the cooling system.

Warning

Heater and radiator hoses, and other engine parts, can be very hot. Do not touch them. If you do, you can be burned.

(Continued)

Warning (Continued)

Do not run the vehicle if there is a leak. If you run the engine, it could lose all coolant. That could cause an engine fire, and you could be burned. Get any leak fixed before you drive the vehicle.

If there seems to be no leak, with the engine on, check to see if the cooling fans are running. If the engine is overheating, the fans should be running. If it is not, the vehicle needs service. Turn off the vehicle.

Cooling System (High Voltage Battery)

During vehicle operation and also during charging, the high voltage battery cells in the vehicle are kept within a normal operating temperature range. If the temperature rises above this temperature, the battery cooling

system turns on the air conditioning compressor and cools the coolant until the correct temperature is reached. If the temperature falls below this temperature, a high voltage heater, located in the battery, heats the coolant until the correct temperature is reached.

What to Use

The high voltage battery coolant reservoir in the vehicle is filled with a 50/50 mixture of DEX-COOL[®] engine coolant and deionized water. If using this mixture, nothing else needs to be added.

The coolant needs to be replaced at the appropriate interval. See *Maintenance Schedule* on page 11-2.

Checking Coolant

The vehicle must be on a level surface when checking the coolant level.

The high voltage battery coolant reservoir is in the engine compartment. See *Engine Compartment Overview* on page 10-8.

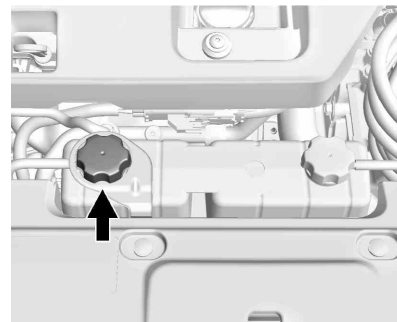

Check to see if coolant is visible in the high voltage battery coolant reservoir. If coolant is visible but the coolant level is below the cold fill line, there could be a leak in the cooling system.

The high voltage battery coolant should only be serviced by a qualified technician.

Cooling System (Power Electronics and Charger Modules)

The power electronics and charger modules are cooled using the same coolant loop.

The power electronics and charger modules in the vehicle are kept below a maximum temperature. If the temperature rises above this temperature, the electric cooling fans will turn on and cool the coolant until the correct temperature is reached.

What to Use

The power electronics and charger modules coolant reservoir in the vehicle is filled with a 50/50 mixture of DEX-COOL engine coolant and deionized water. If using this mixture, nothing else needs to be added.

The coolant needs to be replaced at the appropriate interval. See *Maintenance Schedule on page 11-2*.

Checking Coolant

The vehicle must be on a level surface when checking the coolant level.

The power electronics and charger modules coolant reservoir is in the engine compartment. See *Engine Compartment Overview on page 10-8*.

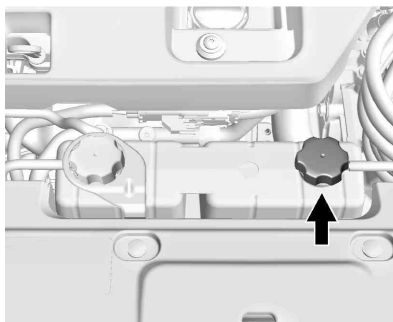

Check to see if coolant is visible in the power electronics and charger modules coolant reservoir. If coolant is visible but the coolant level is below the cold fill line, there could be a leak in the cooling system.

The power electronics and charger modules coolant should only be serviced by a qualified technician.

Engine Coolant

The engine cooling system in the vehicle is filled with DEX-COOL engine coolant. The coolant needs to be replaced every 5 years or 240 000 km (150,000 mi), whichever occurs first.

The following explains the cooling system and how to check and add coolant when it is low. If there is a problem with engine overheating, see *Engine Overheating on page 10-19*.

What to Use

Warning

Adding only plain water or some other liquid to the cooling system can be dangerous. Plain water and other liquids, can boil before the proper coolant mixture will. The coolant warning system is set for the proper coolant mixture. With plain water or the wrong mixture, the engine could get too hot but you would not get the overheat warning. The engine could catch fire and you or others could be burned. Use a 50/50 mixture of deionized water and DEX-COOL coolant.

Use a 50/50 mixture of deionized water and DEX-COOL coolant. If using this mixture, nothing else needs to be added. This mixture:

- Gives freezing protection down to -37°C (-34°F), outside temperature.

- Gives boiling protection up to 129°C (265°F), engine temperature.
- Protects against rust and corrosion.
- Will not damage aluminum parts.
- Helps keep the proper engine temperature.

Caution

If improper coolant mixture, inhibitors, or additives are used in the vehicle cooling system, the engine could overheat and be damaged. Too much deionized water or clean drinkable water can freeze and crack engine cooling parts. The repairs would not be covered by the vehicle warranty. Use only the proper mixture of engine coolant for the cooling system. See *Recommended Fluids and Lubricants on page 11-12*.

Never dispose of engine coolant by putting it in the trash, pouring it on the ground, or into sewers, streams, or bodies of water. Have the coolant changed by an authorized service center, familiar with legal requirements regarding used coolant disposal. This will help protect the environment and your health.

Checking Coolant

The vehicle must be on a level surface when checking the coolant level.

Check to see if coolant is visible in the coolant surge tank. If the coolant inside the coolant surge tank is boiling, do not do anything else until it cools down. If coolant is visible but the coolant level is not at or above the cold fill mark, add a 50/50 mixture of deionized water and DEX-COOL coolant at the coolant surge tank, but be sure the cooling system is cool before this is done. See *Engine Overheating on page 10-19*

10-18 Vehicle Care

The coolant reservoir is located on the passenger side of the engine compartment. See *Engine Compartment Overview on page 10-8*.

The coolant level should be at or above the cold fill line on the coolant surge tank. If it is not, there could be a leak in the cooling system.

How to Add Coolant to the Coolant Surge Tank

Warning

You can be burned if you spill coolant on hot engine parts. Coolant contains ethylene glycol and it will burn if the engine parts are hot enough. Do not spill coolant on a hot engine.

Caution

This vehicle has a specific coolant fill procedure. Failure to follow this procedure could cause the engine to overheat and be severely damaged.

Warning

The electric fans under the hood can start up even when the engine is not running and can cause injury. Keep hands, clothing, and tools away from any underhood electric fan.

Warning

Steam and scalding liquids from a hot cooling system can blow out and burn you badly. They are

(Continued)

Warning (Continued)

under pressure, and if you turn the surge tank pressure cap — even a little — they can come out at high speed. Never turn the cap when the cooling system, including the surge tank pressure cap, is hot. Wait for the cooling system and surge tank pressure cap to cool if you ever have to turn the pressure cap.

If coolant is needed, add the proper DEX-COOL coolant mixture at the coolant surge tank.



The coolant surge tank pressure cap can be removed when the cooling system, including the surge tank pressure cap and upper radiator hose, is no longer hot.

1. Turn the pressure cap slowly counterclockwise. If a hiss is heard, wait for that to stop. A hiss means there is still some pressure left.
2. Keep turning the cap and remove it.

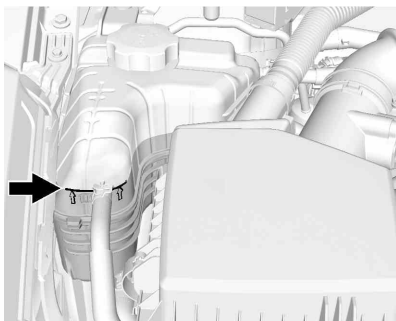

3. Fill the coolant surge tank with the proper mixture to the cold fill line.
4. Replace the pressure cap. Be sure the pressure cap is hand-tight and fully seated.

⚠ Caution

If the pressure cap is not tightly installed, coolant loss and possible engine damage may occur. Be sure the cap is properly and tightly secured.

Engine Overheating

The vehicle has an indicator to warn of engine overheating.

If the decision is made not to lift the hood when this warning appears, get service help right away. See *Roadside Service* on page 13-5.

If the decision is made to lift the hood, make sure the vehicle is parked on a level surface.

Then check to see if the engine cooling fans are running. If the engine is overheating, the fans should be running. If they are not, do not continue to run the vehicle and have the vehicle serviced.

⚠ Caution

Running the engine without coolant may cause damage or a fire. Vehicle damage would not be covered by the vehicle warranty.

Washer Fluid

What to Use

When adding windshield washer fluid to the vehicle, be sure to read the manufacturer's instructions before use. If operating the vehicle in an area where the temperature may fall below freezing, use a fluid that has sufficient protection against freezing.

Adding Washer Fluid

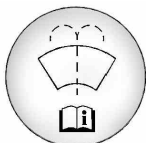

Open the cap with the washer symbol on it. Add washer fluid until the tank is full. See *Engine Compartment Overview* on page 10-8 for reservoir location.

Caution

- Do not use engine coolant (antifreeze) in the windshield washer. It can damage the windshield washer system and paint.
- Do not mix water with ready-to-use washer fluid. Water can cause the solution

(Continued)

Caution (Continued)

to freeze and damage the washer fluid tank and other parts of the washer system.

- When using concentrated washer fluid, follow the manufacturer instructions for adding water.
- Fill the washer fluid tank only three-quarters full when it is very cold. This allows for fluid expansion if freezing occurs, which could damage the tank if it is completely full.

Brakes

This vehicle has disc brakes. Disc brake pads have built-in wear indicators that make a high-pitched warning sound when the brake pads are worn and new pads are needed. The sound can come and go or be heard all the time when the vehicle is moving, except when applying the brake pedal firmly.

Warning

The brake wear warning sound means that soon the brakes will not work well. That could lead to a crash. When the brake wear warning sound is heard, have the vehicle serviced.

Caution

Continuing to drive with worn-out brake pads could result in costly brake repair.

Some driving conditions or climates can cause a brake squeal when the brakes are first applied or lightly applied. This does not mean something is wrong with the brakes.

Properly torqued wheel nuts are necessary to help prevent brake pulsation. When tires are rotated, inspect brake pads for wear and evenly tighten wheel nuts in the

proper sequence to torque specifications. See *Capacities and Specifications on page 12-2*.

Brake pads should be replaced as complete sets.

Brake Pedal Travel

See your dealer if the brake pedal does not return to normal height, or if there is a rapid increase in pedal travel. This could be a sign that brake service might be required.

Brake Adjustment

Every time the brakes are applied, with or without the vehicle moving, the brakes adjust for wear.

Replacing Brake System Parts

The braking system on a vehicle is complex. Its many parts have to be of top quality and work well together if the vehicle is to have really good braking. The vehicle was designed and tested with top-quality brake parts. When parts of the braking system are replaced, be sure to get

new, approved replacement parts. If this is not done, the brakes might not work properly. For example, installing disc brake pads that are wrong for the vehicle, can change the balance between the front and rear brakes — for the worse. The braking performance expected can change in many other ways if the wrong replacement brake parts are installed.

Brake Fluid

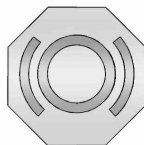

The brake master cylinder reservoir is filled with DOT 3 brake fluid as indicated on the reservoir cap. See *Engine Compartment Overview on page 10-8* for the location of the reservoir.

There are only two reasons why the brake fluid level in the reservoir might go down:

- The brake fluid level goes down because of normal brake lining wear. When new linings are installed, the fluid level goes back up.
- A fluid leak in the brake hydraulic system can also cause a low fluid level. Have the brake hydraulic system fixed, since a leak means that sooner or later the brakes will not work well.

Do not top off the brake fluid. Adding fluid does not correct a leak. If fluid is added when the linings are worn, there will be too much fluid when new brake linings are installed. Add or remove brake fluid, as necessary, only when work is done on the brake hydraulic system.

Warning

If too much brake fluid is added, it can spill on the engine and burn, if the engine is hot enough. You or others could be burned, and the vehicle could be damaged. Add brake fluid only when work is done on the brake hydraulic system.

When the brake fluid falls to a low level, the brake warning light comes on. See *Brake System Warning Light* on page 5-20.

Checking Brake Fluid

Check brake fluid by looking at the brake fluid reservoir. See *Engine Compartment Overview* on page 10-8.

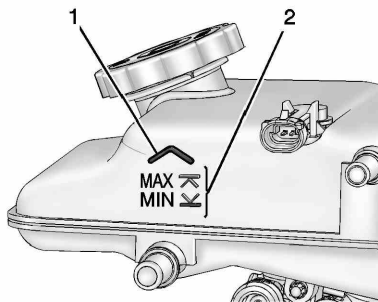

With the vehicle not running for at least one minute, the maximum fluid level (1) is at the top of the reservoir body. With the vehicle running, the fluid level should be in the proper operating range (2) between the MIN and MAX marks. If it is not, have the brake hydraulic system checked to see if there is a leak.

After work is done on the brake hydraulic system, make sure the level, with the vehicle running, is in the proper operating range (2) between the MIN and MAX marks.

What to Add

Use only new DOT 3 brake fluid from a sealed container. See *Recommended Fluids and Lubricants* on page 11-12.

Always clean the brake fluid reservoir cap and the area around the cap before removing it. This helps keep dirt from entering the reservoir.

Warning

With the wrong kind of fluid in the brake hydraulic system, the brakes might not work well. This could cause a crash. Always use the proper brake fluid.

 **Caution**

- Using the wrong fluid can badly damage brake hydraulic system parts. For example, just a few drops of mineral-based oil, such as engine oil, in the brake hydraulic system can damage brake hydraulic system parts so badly that they will have to be replaced. Do not let someone put in the wrong kind of fluid.
- If brake fluid is spilled on the vehicle's painted surfaces, the paint finish can be damaged. Be careful not to spill brake fluid on the vehicle. If you do, wash it off immediately.

Battery

This vehicle has a high voltage battery and a standard 12-volt battery.

High Voltage Battery

If the vehicle is in a crash, the sensing system may shut down the high voltage system. When this occurs, the high voltage battery is disconnected and the vehicle will not start. The SERVICE VEHICLE SOON message in the Driver Information Center (DIC) will be displayed. Before the vehicle can be operated again, it must be serviced at your dealer.

See "If a Crash Occurs" under *Collision Damage Repair* on page 13-9 and *High Voltage Safety Information* on page 1-20. If an airbag has inflated, see *What Will You See after an Airbag Inflates?* on page 3-24.

Only a trained service technician with the proper knowledge and tools should inspect, test, or replace the high voltage battery. See your dealer if the high voltage battery needs service. The dealer has information on how to recycle the high voltage battery. There is also information available at <http://www.recyclemybattery.com>.

Keep the vehicle plugged in, even when fully charged, to keep the high voltage battery temperature ready for the next drive. This is important when outside temperatures are extremely hot or cold.

A vehicle cover, which can reduce sun loading on the vehicle and improve high voltage battery life, is available from your dealer.

12-Volt Battery

The 12-volt battery is in the trunk, under the center compartment cover. Refer to the replacement number shown on the original battery label when a new 12-volt battery is needed. The vehicle has an Absorbed Glass Mat (AGM) 12-volt battery. Installation of a standard 12-volt battery will result in reduced 12-volt battery life.

When using a 12-volt battery charger on the 12-volt AGM battery, some chargers have an AGM battery setting on the charger. If available, use the AGM setting on the charger, to limit charge voltage to 14.8 volts. Follow the charger manufacturer's instructions.

Warning

Battery posts, terminals, and related accessories contain lead and lead compounds, chemicals known to the State of California to cause cancer and reproductive harm. Wash hands after handling.

Vehicle Storage

Warning

12-volt batteries have acid that can burn you and gas that can explode. You can be badly hurt if you are not careful. See *Jump Starting on page 10-69* for tips on working around a battery without getting hurt.

Up to four weeks

- Plug in the high voltage battery charge cord if temperatures will exceed 35°C (95°F) and keep the 12-volt battery cables connected.

Four weeks to 12 months

- Discharge the high voltage battery until two or three bars remain on the battery range indicator (Battery symbol) on the instrument cluster.
- Do not plug in the high voltage battery charge cord.
- Remove the black negative (-) cable from the 12-volt battery and attach a trickle charger to the battery terminals or keep the 12-volt battery cables connected and trickle charge from the underhood remote positive (+) and negative (-) terminals. See *Jump Starting on page 10-69* for the location of these terminals.

⚠ Caution

The vehicle is equipped with an AGM/VRLA 12-volt battery, which can be damaged by using the incorrect type of trickle charger. An AGM/VRLA-compatible charger must be used, with the appropriate setting selected. Follow the trickle charger manufacturer instructions.

After the battery cable is reconnected, it is possible that the vehicle may not operate in Electric Mode. If this happens, the high voltage battery may need to be charged.

Electric Drive Unit Shift Lock Control Function Check**⚠ Warning**

When you are doing this inspection, the vehicle could move suddenly. If the vehicle moves, you or others could be injured.

1. Before starting this check, be sure there is enough room around the vehicle. It should be parked on a level surface.
2. Firmly apply the parking brake. See *Electric Parking Brake on page 9-30*.
Be ready to apply the regular brake immediately if the vehicle begins to move.
3. With the vehicle off and the brake not applied, press and hold the POWER  button for

more than five seconds to place the vehicle in Service Only Mode. See *Power Button on page 9-16*. Without applying the regular brake, try to move the shift lever out of P (Park) with normal effort. If the shift lever moves out of P (Park), contact your dealer for service.

Park Brake and P (Park) Mechanism Check**⚠ Warning**

When you are doing this check, the vehicle could begin to move. You or others could be injured and property could be damaged. Make sure there is room in front of the vehicle in case it begins to roll. Be ready to apply the regular brake at once should the vehicle begin to move.

Park on a fairly steep hill, with the vehicle facing downhill. Keeping your foot on the regular brake, set the electric parking brake.

- To check the electric parking brake's holding ability: With the propulsion system active and the electric drive unit in N (Neutral), slowly remove foot pressure from the regular brake pedal. Do this until the vehicle is held by the electric parking brake only.
- To check the P (Park) mechanism's holding ability: With the propulsion system active, shift to P (Park). Then release the electric parking brake followed by the regular brake.

Contact your dealer if service is required.

Wiper Blade Replacement

Windshield wiper blades should be inspected for wear and cracking. See the *Maintenance Schedule* on page 11-2.

Replacement blades come in different types and are removed in different ways. For proper type and length, see *Maintenance Replacement Parts* on page 11-13.

Caution

Allowing the wiper arm to touch the windshield when no wiper blade is installed could damage the windshield. Any damage that occurs would not be covered by your warranty. Do not allow the wiper arm to touch the windshield.

To replace the windshield wiper blade:

1. Pull the windshield wiper assembly away from the windshield.

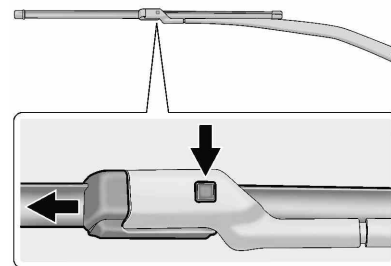

2. Press the button in the middle of the wiper arm connector, and pull the wiper blade away from the arm connector.
3. Remove the wiper blade.
4. Reverse Steps 1–3 for wiper blade replacement.

Headlamp Aiming

Headlamp aim has been preset and should need no further adjustment.

If the vehicle is damaged in a crash, the headlamp aim may be affected. If adjustment to the headlamps is necessary, see your dealer.

Bulb Replacement

For the proper type of replacement bulbs, see *Replacement Bulbs* on page 10-28.

For any bulb-changing procedure not listed in this section, contact your dealer.

LED Lighting

This vehicle has several LED lamps. For replacement of any LED lighting assembly, contact your dealer.

License Plate Lamp

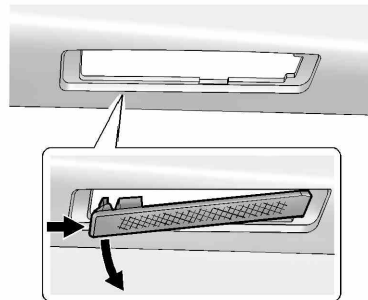

Lamp Assembly

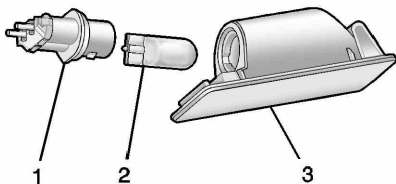

Bulb Assembly

1. Bulb Socket
2. Bulb
3. Lamp Assembly

To replace one of these bulbs:

1. Push the lamp assembly (3) toward the right.
2. Pull the lamp assembly down to remove.
3. Turn the bulb socket (1) counterclockwise to remove it from the lamp assembly (3).

4. Pull the bulb (2) straight out of the bulb socket (1).
5. Push the replacement bulb straight into the bulb socket and turn the bulb socket clockwise to install it into the lamp assembly.
6. Push the lamp assembly back into position until the release tab locks into place.

Replacement Bulbs

Exterior Lamp	Bulb Number
License Plate Lamp	W5W LL

For replacement bulbs not listed here, contact your dealer.

Electrical System

High Voltage Devices and Wiring

Warning

Exposure to high voltage can cause shock, burns, and even death. The high voltage components in the vehicle can only be serviced by technicians with special training.

High voltage components are identified by labels. Do not remove, open, take apart, or modify these components. High voltage cable or wiring has orange covering. Do not probe, tamper with, cut, or modify high voltage cable or wiring.

Electrical System Overload

The vehicle has fuses and circuit breakers to protect against an electrical system overload.

When the current electrical load is too heavy, the circuit breaker opens and closes, protecting the circuit until the current load returns to normal or the problem is fixed. This greatly reduces the chance of circuit overload and fire caused by electrical problems.

Fuses and circuit breakers protect the following in the vehicle:

- Headlamp Wiring
- Windshield Wiper Motor
- Power Windows and other Power Accessories

Replace a bad fuse with a new one of the identical size and rating.

If there is a problem on the road and a fuse needs to be replaced, the same amperage fuse can be

borrowed. Choose some feature of the vehicle that is not needed to use and replace it as soon as possible.

Headlamp Wiring

An electrical overload may cause the lamps to go on and off, or in some cases to remain off. Have the headlamp wiring checked right away if the lamps go on and off or remain off.

Windshield Wipers

If the wiper motor overheats due to heavy snow or ice, the windshield wipers will stop until the motor cools and the wiper control is turned off. After removal of the blockage, the wiper motor will restart when the control is then moved to the desired operating position.

Although the circuit is protected from electrical overload, overload due to heavy snow or ice, may cause wiper damage. Always clear ice and heavy snow from the windshield before using the windshield wipers.

If the overload is caused by an electrical problem and not snow or ice, be sure to get it fixed.

Engine Compartment Fuse Block

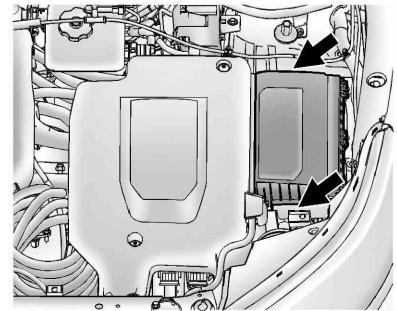

To open the fuse block cover, press the clips at the front and back and rotate the cover up to the side.

10-30 Vehicle Care

Caution

Spilling liquid on any electrical component on the vehicle may damage it. Always keep the covers on any electrical component.

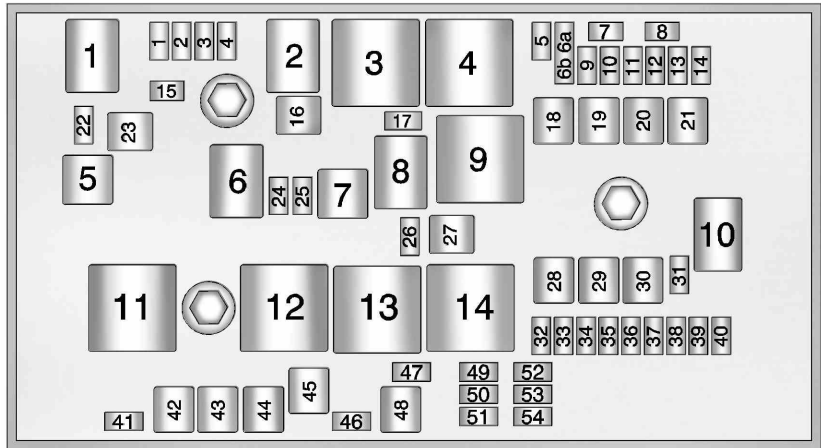

Engine Compartment Fuse Block

A fuse puller is in the engine compartment fuse block.

The vehicle may not be equipped with all of the fuses, relays, and features shown.

Mini Fuses	Amps	Usage
1	15A	Engine Control Module – Switched Power
2	7.5A	Emissions
3	–	Not Used

Mini Fuses	Amps	Usage
4	15A	Ignition Coils/ Injectors
5	10A	Column Lock
6a	–	Empty
6b	–	Empty
7	–	Empty
8	–	Empty
9	7.5A	Heated Mirrors
10	5A	Air Conditioning Control Module
11	7.5A	Traction Power Inverter Module – Battery
12	–	Not Used
13	10A	Cabin Heater Pump and Valve
14	–	Not Used

Mini Fuses	Amps	Usage
15	15A	Traction Power Inverter Module and Transmission Control Module – Battery
17	5A	Engine Control Module – Battery
22	10A	Left High-Beam Headlamp
24	–	Empty
25	–	Empty
26	–	Not Used
31	5A	Adaptive Cruise Control/Auto Headlamp
32	5A	Vehicle Integration Control Module
33	10A	Run/Crank for Heated Steering Wheel

Mini Fuses	Amps	Usage
34	10A	Vehicle Integration Control Module – Battery
35	–	Not Used
36	10A	Power Electronics Coolant Pump
37	5A	Cabin Heater Control Module
38	10A	Rechargeable Energy Storage System (High Voltage Battery) Coolant Pump
39	10A	Rechargeable Energy Storage System (High Voltage Battery) Control Module
40	10A	Front Windshield Washer

10-32 Vehicle Care

Mini Fuses	Amps	Usage
41	10A	Right High-Beam Headlamp
46	–	Empty
47	–	Empty
49	–	Empty
50	10A	Run/Crank – Rear Vision Camera, Accessory Power Module
51	7.5A	Run/Crank for ABS, Aero Shutter, VITM
52	5A	Engine Control Module/ Transmission Control Module – Run/Crank
53	7.5A	Traction Power Inverter Module – Run/Crank

Mini Fuses	Amps	Usage
54	7.5A	Run/Crank – Fuel System Control Module, Air Conditioning Control Module, On Board Charger, Instrument Cluster, Automatic Occupant Sensing, Mirrors

J-Case Fuses	Amps	Usage
16	20A	AIR Solenoid (PZEV Only)
18	30A	Rear Defogger Lower Grid
19	30A	Power Window – Front
20	–	Empty

J-Case Fuses	Amps	Usage
21	30A	Antilock Brake System Electronic Control Unit
23	–	Empty
27	40A	AIR Pump (PZEV Only)
28	–	Empty
29	30A	Front Wipers
30	60A	Antilock Brake System Motor
42	30A	Cooling Fan – Right
43	30A	Front Wipers
44	40A	Charger
45	–	Empty
48	30A	Cooling Fan – Left

Mini Relays	Usage
3	Powertrain
4	Heated Mirrors
7	Empty
9	AIR Pump (PZEV Only)
11	Empty
12	Empty
13	Empty
14	Run/Crank

Micro Relays	Usage
1	Empty
2	AIR Solenoid (PZEV Only)
6	Empty
8	Empty
10	Empty

Ultra Micro Relays	Usage
5	Empty

Instrument Panel Fuse Block (Left Side)

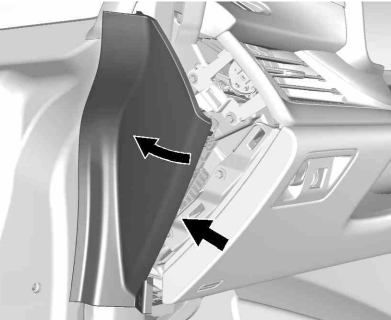

The left instrument panel fuse block is on the left side end of the instrument panel, behind the end

cap. To access the fuses, insert a plastic tool between the end panel and the instrument panel, and carefully release the end cap retaining clips. When all clips are released, remove the panel.

To reinstall the door, insert the forward edge hook feature, and press around the edges of the end cap to reengage all of the clips.

10-34 Vehicle Care

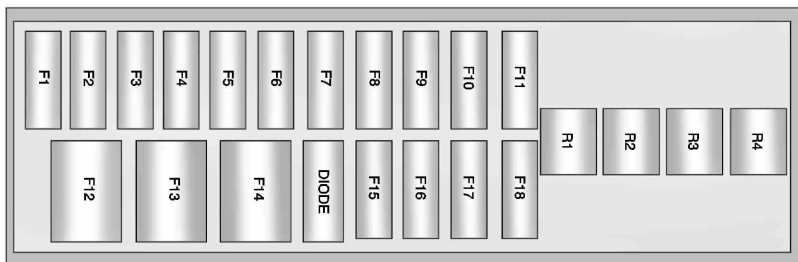

A fuse puller is in the engine compartment fuse block.

The vehicle may not be equipped with all of the fuses, relays, and features shown.

Fuses	Amps	Usage
F1	20A	Power Outlet/ Cigarette Lighter – Top of IP Storage Bin
F2	15A	Infotainment (HMI, CD)

Fuses	Amps	Usage
F3	10A	Instrument Cluster
F4	10A	Infotainment Display, Steering Wheel Control Switches
F5	10A	Heating, Ventilation, & Air Conditioning

Fuses	Amps	Usage
F6	10A	Airbag (Sensing Diagnostic Module/ Passenger Sensing Module)
F7	15A	Data Link Connector, Left (Primary)
F8	10A	Column Lock
F9	10A	OnStar
F10	15A	Body Control Module 1/Body Control Module Electronics/ Keyless Entry/ Power Moding/ Center High Mounted Stoplamp/License Plate Lamps/Left Daytime Running Lamp/Left Parking Lamps/ Trunk Release

Fuses	Amps	Usage
		Relay Control/ Washer Pump Relay Control/ Switch Indicator Lights
F11	15A	Body Control Module 4/Left Headlamp
F12	–	Empty
F13	–	Empty
F14	–	Empty
F15	20A	Power Outlet (Inside Console Bin)
F16	5A	Wireless Charger
F17	–	Empty
F18	–	Empty

Relays	Usage
R1	Retained Accessory Power Relay for Power Outlets

Relays	Usage
R2	Empty
R3	Empty
R4	Empty

Diodes	Usage
Diode	Empty

Instrument Panel Fuse Block (Right Side)

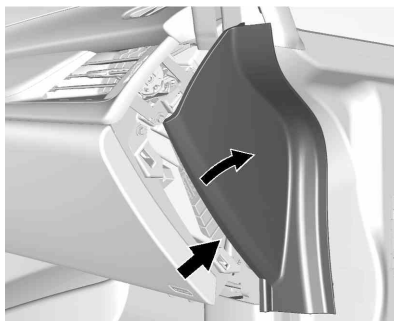

The right instrument panel fuse block is on the right side end of the instrument panel, behind the end cap. To access the fuses, insert a plastic tool between the end panel and the instrument panel, and carefully release the end cap retaining clips. When all clips are released, remove the panel.

To reinstall the door, insert the forward edge hook feature, and press around the edges of the end cap to reengage all of the clips.

10-36 Vehicle Care

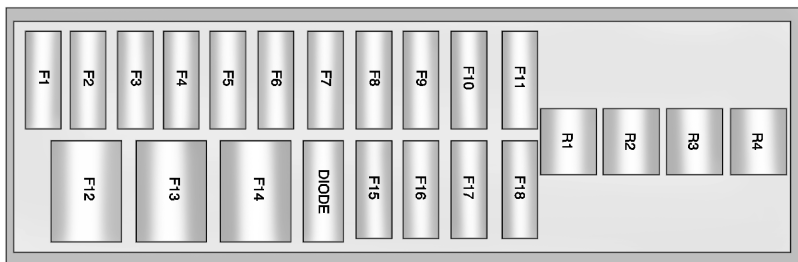

A fuse puller is in the engine compartment fuse block.

The vehicle may not be equipped with all of the fuses, relays, and features shown.

Fuses	Amps	Usage
F1	2A	Steering Wheel Switch
F2	10A	Auto Headlamp Leveling

Fuses	Amps	Usage
F3	10A	Motorized Cup Holder
F4	15A	Body Control Module 3/ Right Headlamp

Fuses	Amps	Usage
F5	7.5A	Body Control Module 2/ Body Control Module Electronics/ Trunk Lamp/ Right Daytime Running Lamp/ Shifter Lock/Switch Backlighting
F6	15A	Tilt/Telescope Column
F7	7.5A	Body Control Module 6/ Map Lights/ Courtesy Lights/ Back-up Lamp

Fuses	Amps	Usage
F8	15A	Body Control Module 7/Left Front Turn Signal/Right Rear Stop and Turn Signal Lamp
F9	–	Empty
F10	15A	Data Link Connector, Right (Secondary)
F11	7.5A	Universal Garage Door Opener, Rain Sensor, Front Camera

Fuses	Amps	Usage
F12	30A	Blower Motor
F13	–	Empty
F14	–	Empty
F15	–	Empty
F16	10A	Glove Box
F17	–	Empty
F18	–	Empty

Relays	Usage
R1	Empty
R2	Glove Box Door
R3	Empty
R4	Empty

Diodes	Usage
DIODE	Empty

Rear Compartment Fuse Block

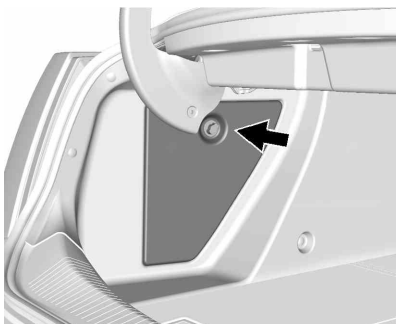

There are two rear compartment fuse blocks, located on the left side of the trunk behind a cover.



The vehicle may not be equipped with all of the fuses, relays, and features shown.

Fuses	Amps	Usage
F1	–	Empty
F2	15A	Fuel System Control Module

Fuses	Amps	Usage
F3	5A	Passive Entry/Passive Start
F4	15A	Heated Seats

Fuses	Amps	Usage
F5	2A	Regulated Voltage Control, Current Sensor
F6	10A	Fuel (Diurnal Valve and Evap. Leak Check Module)
F7	15A	Accessory Power Module Cooling Fan
F8	30A	Amplifier
F9	–	Empty
F10	5A	Regulated Voltage Control/Front and Rear Parking Assist, Side Blind Zone

Fuses	Amps	Usage
F11	15A	Horn
F12	–	Empty
F13	30A	Electric Parking Brake
F14	30A	Rear Defog (Upper Grid)
F15	–	Empty
F16	10A	Trunk Release
F17	–	Empty
F18	–	Empty

Relays	Usage
R1	Rear Defog (Upper Grid)
R2	Trunk Release
R3	Empty
R4	Empty
R5	Empty
R6	Empty
R7/R8	Horn

Diodes	Usage
DIODE	Empty

10-40 Vehicle Care

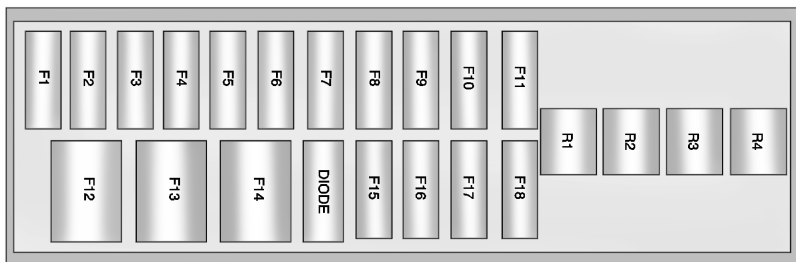

Fuses	Amps	Usage
F1	–	Empty
F2	15A	Radio
F3	10A	Pedestrian Protection
F4	10A	CDC
F5	10A	Memory Seat Module
F6	–	Empty

Fuses	Amps	Usage
F7	10A	Mirror/Window/Seat Switch
F8	20A	Passive Entry/Passive Start 2
F9	15A	Heated Seat 2
F10	–	Empty
F11	–	Empty

Fuses	Amps	Usage
F12	30A	Driver Power Seat
F13	30A	Passenger Power Seat
F14	–	Empty
F15	–	Empty
F16	–	Empty
F17	–	Empty
F18	–	Empty

Relays	Usage
R1	Empty
R2	Empty
R3	Empty
R4	Empty

Diodes	Usage
DIODE	Empty

Wheels and Tires

Tires

Every new GM vehicle has high-quality tires made by a leading tire manufacturer. See the warranty manual for information regarding the tire warranty and where to get service. For additional information refer to the tire manufacturer.

 **Warning**

- Poorly maintained and improperly used tires are dangerous.
- Overloading the tires can cause overheating as a result of too much flexing. There could be a blowout

(Continued)

Warning (Continued)

and a serious crash. See *Vehicle Load Limits on page 9-12*.

- Underinflated tires pose the same danger as overloaded tires. The resulting crash could cause serious injury. Check all tires frequently to maintain the recommended pressure. Tire pressure should be checked when the tires are cold.
- Overinflated tires are more likely to be cut, punctured, or broken by a sudden impact — such as when hitting a pothole. Keep tires at the recommended pressure.

(Continued)

Warning (Continued)

- Worn or old tires can cause a crash. If the tread is badly worn, replace them.
- Replace any tires that have been damaged by impacts with potholes, curbs, etc.
- Improperly repaired tires can cause a crash. Only the dealer or an authorized tire service center should repair, replace, dismount, and mount the tires.
- Do not spin the tires in excess of 56 km/h (35 mph) on slippery surfaces such as snow, mud, ice, etc. Excessive spinning may cause the tires to explode.

All-Season Tires

This vehicle may come with all-season tires. These tires are designed to provide good overall performance on most road surfaces and weather conditions. Original equipment tires designed to GM's specific tire performance criteria have a TPC specification code molded onto the sidewall. Original equipment all-season tires can be identified by the last two characters of this TPC code, which will be "MS."

Consider installing winter tires on the vehicle if frequent driving on snow or ice-covered roads is expected. All-season tires provide adequate performance for most winter driving conditions, but they may not offer the same level of traction or performance as winter tires on snow or ice-covered roads. See *Winter Tires on page 10-42*.

Winter Tires

This vehicle was not originally equipped with winter tires. Winter tires are designed for increased traction on snow and ice-covered roads. Consider installing winter tires on the vehicle if frequent driving on ice or snow covered roads is expected. See your dealer for details regarding winter tire availability and proper tire selection. Also, see *Buying New Tires on page 10-55*.

With winter tires, there may be decreased dry road traction, increased road noise, and shorter tread life. After changing to winter tires, be alert for changes in vehicle handling and braking.

If using winter tires:

- Use tires of the same brand and tread type on all four wheel positions.

- Use only radial ply tires of the same size, load range, and speed rating as the original equipment tires.

Winter tires with the same speed rating as the original equipment tires may not be available for H, V, W, Y, and ZR speed rated tires. If winter tires with a lower speed rating are chosen, never exceed the tire's maximum speed capability.

Summer Tires

This vehicle may come with high performance summer tires. These tires have a special tread and compound that are optimized for maximum dry and wet road performance. This special tread and compound will have decreased performance in cold climates, and on ice and snow. We recommend installing winter tires on the vehicle if frequent driving at temperatures below approximately 5°C (40°F) or on ice or snow covered roads is expected. See *Winter Tires on page 10-42*.

Tire Sidewall Labeling

Useful information about a tire is molded into its sidewall. The examples show a typical passenger tire sidewall.

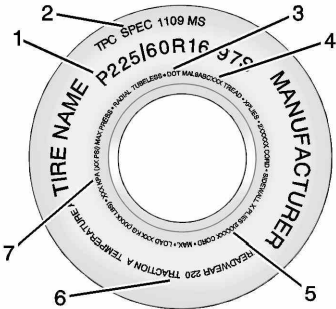

Passenger (P-Metric) Tire Example

(1) Tire Size: The tire size is a combination of letters and numbers used to define a particular tire's width, height, aspect ratio, construction type, and service description. See the "Tire Size" illustration later in this section for more detail.

(2) TPC Spec (Tire Performance Criteria Specification): Original equipment tires designed to GM's specific tire performance criteria have a TPC specification code molded onto the sidewall. GM's TPC specifications meet or exceed all federal safety guidelines.

(3) DOT (Department of Transportation): The Department of Transportation (DOT) code indicates that the tire is in compliance with the U.S. Department of Transportation Motor Vehicle Safety Standards.

DOT Tire Date of Manufacture: The last four digits of the TIN indicate the tire manufactured date. The first two digits represent the week (01-52) and the last two digits, the year. For example, the third

week of the year 2010 would have a four-digit DOT date of 0310.

(4) Tire Identification Number (TIN): The letters and numbers following the DOT code are the Tire Identification Number (TIN). The TIN shows the manufacturer and plant code, tire size, and date the tire was manufactured. The TIN is molded onto both sides of the tire, although only one side may have the date of manufacture.

(5) Tire Ply Material: The type of cord and number of plies in the sidewall and under the tread.

(6) Uniform Tire Quality Grading (UTQG): Tire manufacturers are required to grade tires based on three performance factors: treadwear, traction, and temperature

resistance. For more information see *Uniform Tire Quality Grading on page 10-57*.

(7) Maximum Cold Inflation

Load Limit: Maximum load that can be carried and the maximum pressure needed to support that load.

Tire Designations

Tire Size

The following is an example of a typical passenger vehicle tire size.

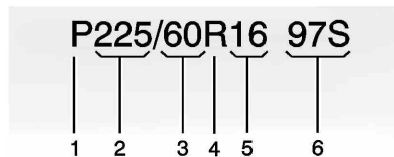

(1) Passenger (P-Metric) Tire:

The United States version of a metric tire sizing system. The letter P as the first character in

the tire size means a passenger vehicle tire engineered to standards set by the U.S. Tire and Rim Association.

(2) Tire Width: The three-digit number indicates the tire section width in millimeters from sidewall to sidewall.

(3) Aspect Ratio: A two-digit number that indicates the tire height-to-width measurements. For example, if the tire size aspect ratio is 60, as shown in item 3 of the illustration, it would mean that the tire's sidewall is 60 percent as high as it is wide.

(4) Construction Code: A letter code is used to indicate the type of ply construction in the tire. The letter R means radial ply construction; the letter D means diagonal or bias ply construction; and the letter B means belted-bias ply construction.

(5) Rim Diameter: Diameter of the wheel in inches.

(6) Service Description: These characters represent the load index and speed rating of the tire. The load index represents the load carrying capacity a tire is certified to carry. The speed rating is the maximum speed a tire is certified to carry a load.

Tire Terminology and Definitions

Air Pressure: The amount of air inside the tire pressing outward on each square inch of the tire. Air pressure is expressed in kPa (kilopascal) or psi (pounds per square inch).

Accessory Weight: The combined weight of optional accessories. Some examples of optional accessories are, electric

drive unit, power windows, power seats, and air conditioning.

Aspect Ratio: The relationship of a tire's height to its width.

Belt: A rubber coated layer of cords that is located between the plies and the tread. Cords may be made from steel or other reinforcing materials.

Bead: The tire bead contains steel wires wrapped by steel cords that hold the tire onto the rim.

Bias Ply Tire: A pneumatic tire in which the plies are laid at alternate angles less than 90 degrees to the centerline of the tread.

Cold Tire Pressure: The amount of air pressure in a tire, measured in kPa (kilopascal) or psi (pounds per square inch)

before a tire has built up heat from driving. See *Tire Pressure on page 10-47*.

Curb Weight: The weight of a motor vehicle with standard and optional equipment including the maximum capacity of fuel, oil, and coolant, but without passengers and cargo.

DOT Markings: A code molded into the sidewall of a tire signifying that the tire is in compliance with the U.S. Department of Transportation (DOT) Motor Vehicle Safety Standards. The DOT code includes the Tire Identification Number (TIN), an alphanumeric designator which can also identify the tire manufacturer, production plant, brand, and date of production.

GVWR: Gross Vehicle Weight Rating. See *Vehicle Load Limits on page 9-12*.

GAWR FRT: Gross Axle Weight Rating for the front axle. See *Vehicle Load Limits on page 9-12*.

GAWR RR: Gross Axle Weight Rating for the rear axle. See *Vehicle Load Limits on page 9-12*.

Intended Outboard Sidewall: The side of an asymmetrical tire, that must always face outward when mounted on a vehicle.

Kilopascal (kPa): The metric unit for air pressure.

Light Truck (LT-Metric) Tire: A tire used on light duty trucks and some multipurpose passenger vehicles.

Load Index: An assigned number ranging from 1 to 279 that corresponds to the load carrying capacity of a tire.

Maximum Inflation Pressure:

The maximum air pressure to which a cold tire can be inflated. The maximum air pressure is molded onto the sidewall.

Maximum Load Rating: The load rating for a tire at the maximum permissible inflation pressure for that tire.

Maximum Loaded Vehicle

Weight: The sum of curb weight, accessory weight, vehicle capacity weight, and production options weight.

Normal Occupant Weight: The number of occupants a vehicle is designed to seat multiplied by 68 kg (150 lbs). See *Vehicle Load Limits* on page 9-12.

Occupant Distribution:

Designated seating positions.

Outward Facing Sidewall: The side of an asymmetrical tire that has a particular side that faces outward when mounted on a vehicle. The side of the tire that contains a whitewall, bears white lettering, or bears manufacturer, brand, and/or model name molding that is higher or deeper than the same moldings on the other sidewall of the tire.

Passenger (P-Metric) Tire: A tire used on passenger cars and some light duty trucks and multipurpose vehicles.

Recommended Inflation

Pressure: Vehicle manufacturer's recommended tire inflation pressure as shown on the tire placard. See *Tire Pressure* on page 10-47 and *Vehicle Load Limits* on page 9-12.

Radial Ply Tire: A pneumatic tire in which the ply cords that extend to the beads are laid at 90 degrees to the centerline of the tread.

Rim: A metal support for a tire and upon which the tire beads are seated.

Sidewall: The portion of a tire between the tread and the bead.

Speed Rating: An alphanumeric code assigned to a tire indicating the maximum speed at which a tire can operate.

Traction: The friction between the tire and the road surface. The amount of grip provided.

Tread: The portion of a tire that comes into contact with the road.

Treadwear Indicators: Narrow bands, sometimes called wear bars, that show across the tread of a tire when only 1.6 mm (1/16 in) of tread remains. See *When It Is Time for New Tires on page 10-54.*

UTQGS (Uniform Tire Quality Grading Standards): A tire information system that provides consumers with ratings for a tire's traction, temperature, and treadwear. Ratings are determined by tire manufacturers using government testing procedures. The ratings are molded into the sidewall of the tire. See *Uniform Tire Quality Grading on page 10-57.*

Vehicle Capacity Weight: The number of designated seating positions multiplied by 68 kg (150 lbs) plus the rated cargo load. See *Vehicle Load Limits on page 9-12.*

Vehicle Maximum Load on the Tire: Load on an individual tire due to curb weight, accessory weight, occupant weight, and cargo weight.

Vehicle Placard: A label permanently attached to a vehicle showing the vehicle's capacity weight and the original equipment tire size and recommended inflation pressure. See "Tire and Loading Information Label" under *Vehicle Load Limits on page 9-12.*

Tire Pressure

Tires need the correct amount of air pressure to operate effectively.

 Caution
<p>Neither tire underinflation nor overinflation is good. Underinflated tires, or tires that do not have enough air, can result in:</p> <ul style="list-style-type: none"> • Tire overloading and overheating which could lead to a blowout. • Premature or irregular wear. • Poor handling. • Reduced fuel economy. <p>Overinflated tires, or tires that have too much air, can result in:</p> <ul style="list-style-type: none"> • Unusual wear. • Poor handling. • Rough ride. • Needless damage from road hazards.

The Tire and Loading Information label on the vehicle indicates the original equipment tires and the correct cold tire inflation pressures. The recommended pressure is the minimum air pressure needed to support the vehicle's maximum load carrying capacity.

For additional information regarding how much weight the vehicle can carry, and an example of the Tire and Loading Information label, see *Vehicle Load Limits on page 9-12*. How the vehicle is loaded affects vehicle handling and ride comfort. Never load the vehicle with more weight than it was designed to carry.

When to Check

Check the tires once a month or more.

How to Check

Use a good quality pocket-type gauge to check the tire pressure. Proper tire inflation cannot be determined by looking at the tire. Check the tire inflation pressure when the tires are cold, meaning the vehicle has not been driven for at least three hours or no more than 1.6 km (1 mi).

Remove the valve cap from the tire valve stem. Press the tire gauge firmly onto the valve to get the pressure measurement. If the cold tire inflation pressure matches the recommended pressure on the Tire and Loading Information label, no further adjustment is necessary.

If the inflation pressure is low, add air until the recommended pressure is reached. If the inflation pressure is high, press on the metal stem in the center

of the tire valve to release air. Re-check the tire pressure with the tire gauge.

Return the valve caps on the valve stems to keep out dirt and moisture and prevent leaks.

Tire Pressure Monitor System

The Tire Pressure Monitor System (TPMS) uses radio and sensor technology to check tire pressure levels. The TPMS sensors monitor the air pressure in your tires and transmit tire pressure readings to a receiver located in the vehicle.

Each tire, including the spare (if provided), should be checked monthly when cold and inflated to the inflation pressure recommended by the vehicle manufacturer on the vehicle placard or tire inflation pressure label. (If your vehicle has tires of a different size than the size indicated on the vehicle placard or

tire inflation pressure label, you should determine the proper tire inflation pressure for those tires.)

As an added safety feature, your vehicle has been equipped with a tire pressure monitoring system (TPMS) that illuminates a low tire pressure telltale when one or more of your tires is significantly under-inflated.

Accordingly, when the low tire pressure telltale illuminates, you should stop and check your tires as soon as possible, and inflate them to the proper pressure. Driving on a significantly under-inflated tire causes the tire to overheat and can lead to tire failure. Under-inflation also reduces fuel efficiency and tire tread life, and may affect the vehicle's handling and stopping ability.

Please note that the TPMS is not a substitute for proper tire maintenance, and it is the driver's responsibility to maintain correct tire pressure, even if under-inflation has

not reached the level to trigger illumination of the TPMS low tire pressure telltale.

Your vehicle has also been equipped with a TPMS malfunction indicator to indicate when the system is not operating properly. The TPMS malfunction indicator is combined with the low tire pressure telltale. When the system detects a malfunction, the telltale will flash for approximately one minute and then remain continuously illuminated. This sequence will continue upon subsequent vehicle start-ups as long as the malfunction exists.

When the malfunction indicator is illuminated, the system may not be able to detect or signal low tire pressure as intended. TPMS malfunctions may occur for a variety of reasons, including the installation of replacement or alternate tires or wheels on the vehicle that prevent the TPMS from functioning properly. Always check the TPMS malfunction telltale after replacing one or more tires or wheels on your vehicle to

ensure that the replacement or alternate tires and wheels allow the TPMS to continue to function properly.

See *Tire Pressure Monitor Operation* on page 10-49.

See *Radio Frequency Statement* on page 13-12.

Tire Pressure Monitor Operation

This vehicle may have a Tire Pressure Monitor System (TPMS). The TPMS is designed to warn the driver when a low tire pressure condition exists. TPMS sensors are mounted onto each tire and wheel assembly, excluding the spare tire and wheel assembly. The TPMS sensors monitor the air pressure in the tires and transmit the tire pressure readings to a receiver located in the vehicle.



When a low tire pressure condition is detected, the TPMS illuminates the low tire pressure warning light on the instrument cluster. If the warning light comes on, stop as soon as possible and inflate the tires to the recommended pressure shown on the Tire and Loading Information label. See *Vehicle Load Limits* on page 9-12.

A message to check the pressure in a specific tire displays in the Driver Information Center (DIC). The low tire pressure warning light and the DIC warning message come on at each ignition cycle until the tires are inflated to the correct inflation pressure. Using the DIC, tire

pressure levels can be viewed. For additional information and details about the DIC operation and displays see *Driver Information Center (DIC)* on page 5-38.

The low tire pressure warning light may come on in cool weather when the vehicle is first started, and then turn off as the vehicle is driven. This could be an early indicator that the air pressure is getting low and needs to be inflated to the proper pressure.

A Tire and Loading Information label, attached to your vehicle, shows the size of the original equipment tires and the correct inflation pressure for the tires when they are cold. See *Vehicle Load Limits* on page 9-12, for an example of the Tire and Loading Information label and its location. Also see *Tire Pressure* on page 10-47.

The TPMS can warn about a low tire pressure condition but it does not replace normal tire maintenance. See *Tire Inspection* on page 10-53, *Tire Rotation* on page 10-53 and *Tires* on page 10-41.

Caution

Tire sealant materials are not all the same. A non-approved tire sealant could damage the TPMS sensors. TPMS sensor damage caused by using an incorrect tire sealant is not covered by the vehicle warranty. Always use only the GM approved tire sealant available through your dealer or included in the vehicle.

Factory-installed Tire Inflator Kits use a GM approved liquid tire sealant. Using non-approved tire sealants could damage the TPMS sensors. See *Tire Sealant and Compressor Kit on page 10-62* for information regarding the inflator kit materials and instructions.

TPMS Malfunction Light and Message

The TPMS will not function properly if one or more of the TPMS sensors are missing or inoperable. When the system detects a malfunction, the low tire warning light flashes for about one minute and then stays on for the remainder of the ignition cycle. A DIC warning message also displays. The malfunction light and DIC warning message come on at each ignition cycle until the problem is corrected. Some of the conditions that can cause these to come on are:

- One of the road tires has been replaced with the spare tire, if equipped. The spare tire does

not have a TPMS sensor. The malfunction light and DIC message should go off after the road tire is replaced and the sensor matching process is performed successfully. See "TPMS Sensor Matching Process" later in this section.

- The TPMS sensor matching process was not done or not completed successfully after rotating the tires. The malfunction light and the DIC message should go off after successfully completing the sensor matching process. See "TPMS Sensor Matching Process" later in this section.
- One or more TPMS sensors are missing or damaged. The malfunction light and the DIC message should go off when the TPMS sensors are installed and the sensor matching process is performed successfully. See your dealer for service.

- Replacement tires or wheels do not match the original equipment tires or wheels. Tires and wheels other than those recommended could prevent the TPMS from functioning properly. See *Buying New Tires on page 10-55*.
- Operating electronic devices or being near facilities using radio wave frequencies similar to the TPMS could cause the TPMS sensors to malfunction.

If the TPMS is not functioning properly it cannot detect or signal a low tire condition. See your dealer for service if the TPMS malfunction light and DIC message come on and stay on.

TPMS Sensor Matching Process

Each TPMS sensor has a unique identification code. The identification code needs to be matched to a new tire/wheel position after rotating the vehicle's tires or replacing one or more of the TPMS sensors. The TPMS sensor matching process

should also be performed after replacing a spare tire with a road tire containing the TPMS sensor. The malfunction light and the DIC message should go off at the next ignition cycle. The sensors are matched to the tire/wheel positions, using a TPMS relearn tool, in the following order: driver side front tire, passenger side front tire, passenger side rear tire, and driver side rear. See your dealer for service or to purchase a relearn tool. A TPMS relearn tool can also be purchased. See Tire Pressure Monitor Sensor Activation Tool at www.gmtoolsandequipment.com or call 1-800-GM TOOLS (1-800-468-6657).

There are two minutes to match the first tire/wheel position, and five minutes overall to match all four tire/wheel positions. If it takes longer, the matching process stops and must be restarted.

The TPMS sensor matching process is:

1. Set the parking brake.
2. Place the vehicle power mode in ON/RUN. See *Power Button* on page 9-16.
3. Make sure the Tire Pressure info display option is turned on. The info displays on the DIC can be turned on and off through the Settings menu. See *Driver Information Center (DIC)* on page 5-38.
4. Use the five-way DIC control on the right side of the steering wheel to scroll to the Tire Pressure screen under the DIC info page. See *Driver Information Center (DIC)* on page 5-38.
5. Press and hold the SEL button in the center of the five-way DIC control.

The horn sounds twice to signal the receiver is in relearn mode and the TIRE LEARNING ACTIVE message displays on the DIC screen.

6. Start with the driver side front tire.
7. Place the relearn tool against the tire sidewall, near the valve stem. Then press the button to activate the TPMS sensor. A horn chirp confirms that the sensor identification code has been matched to this tire and wheel position.
8. Proceed to the passenger side front tire, and repeat Step 7.
9. Proceed to the passenger side rear tire, and repeat Step 7.

10. Proceed to the driver side rear tire, and repeat Step 7. The horn sounds two times to indicate the sensor identification code has been matched to the driver side rear tire, and the TPMS sensor matching process is no longer active. The TIRE LEARNING ACTIVE message on the DIC display screen goes off.
11. Shut the ignition off.
12. Set all four tires to the recommended air pressure level as indicated on the Tire and Loading Information label.

Tire Inspection

We recommend that the tires, including the spare tire, if the vehicle has one, be inspected for signs of wear or damage at least once a month.

Replace the tire if:

- The indicators at three or more places around the tire can be seen.
- There is cord or fabric showing through the tire's rubber.
- The tread or sidewall is cracked, cut, or snagged deep enough to show cord or fabric.
- The tire has a bump, bulge, or split.
- The tire has a puncture, cut, or other damage that cannot be repaired well because of the size or location of the damage.

Tire Rotation

Tires should be rotated every 12 000 km (7,500 mi). The first rotation is the most important. See *Maintenance Schedule on page 11-2*.

Tires are rotated to achieve a more uniform wear for all tires.

Anytime unusual wear is noticed, rotate the tires as soon as possible, check for proper tire inflation pressure, and check for damaged tires or wheels. If the unusual wear continues after the rotation, check the wheel alignment. See *When It Is Time for New Tires on page 10-54* and *Wheel Replacement on page 10-59*.

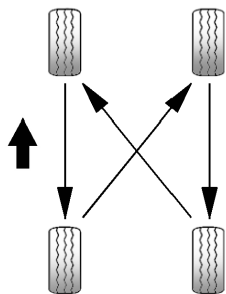

Use this rotation pattern when rotating the tires.

Adjust the front and rear tires to the recommended inflation pressure on the Tire and Loading Information label after the tires have been rotated. See *Tire Pressure* on page 10-47 and *Vehicle Load Limits* on page 9-12.

Reset the Tire Pressure Monitor System. See *Tire Pressure Monitor Operation* on page 10-49.

Check that all wheel nuts are properly tightened. See “Wheel Nut Torque” under *Capacities and Specifications* on page 12-2.

Warning

Rust or dirt on a wheel, or on the parts to which it is fastened, can make wheel nuts become loose after a time. The wheel could come off and cause a crash. When changing a wheel, remove any rust or dirt from places where the wheel attaches to the vehicle. In an emergency, a cloth or a paper towel can be used, however, use a scraper or wire brush to remove all rust or dirt.

Lightly coat the center of the wheel hub with wheel bearing grease after a wheel change or

tire rotation to prevent corrosion or rust build-up. Do not get grease on the flat wheel mounting surface or on the wheel nuts or bolts.

When It Is Time for New Tires

Factors such as maintenance, temperatures, driving speeds, vehicle loading, and road conditions affect the wear rate of the tires.

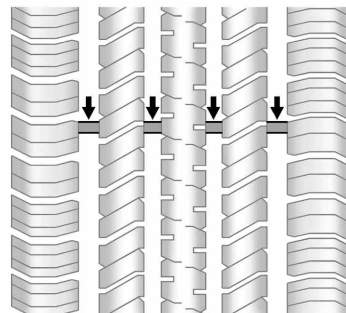

Treadwear indicators are one way to tell when it is time for new tires.

Treadwear indicators appear when the tires have only 1.6 mm (1/16 in) or less of tread remaining. See *Tire Inspection on page 10-53* and *Tire Rotation on page 10-53*.

The rubber in tires ages over time. This also applies to the spare tire, if the vehicle has one, even if it is never used. Multiple factors including temperatures, loading conditions, and inflation pressure maintenance affect how fast aging takes place. GM recommends that tires, including the spare if equipped, be replaced after six years, regardless of tread wear. The tire manufacture date is the last four digits of the DOT Tire Identification Number (TIN) which is molded into one side of the tire sidewall. The first two digits represent the week (01–52) and the last two digits, the year. For example, the third week of the year 2010 would have a four-digit DOT date of 0310.

Vehicle Storage

Tires age when stored normally mounted on a parked vehicle. Park a vehicle that will be stored for at least a month in a cool, dry, clean area away from direct sunlight to slow aging. This area should be free of grease, gasoline, or other substances that can deteriorate rubber.

Parking for an extended period can cause flat spots on the tires that may result in vibrations while driving. When storing a vehicle for at least a month, remove the tires or raise the vehicle to reduce the weight from the tires.

Buying New Tires

GM has developed and matched specific tires for the vehicle. The original equipment tires installed were designed to meet General Motors Tire Performance Criteria Specification (TPC Spec) system rating. When

replacement tires are needed, GM strongly recommends buying tires with the same TPC Spec rating.

GM's exclusive TPC Spec system considers over a dozen critical specifications that impact the overall performance of the vehicle, including brake system performance, ride and handling, traction control, and tire pressure monitoring performance. GM's TPC Spec number is molded onto the tire's sidewall near the tire size. If the tires have an all-season tread design, the TPC spec number will be followed by MS, for mud and snow. See *Tire Sidewall Labeling on page 10-43*.

GM recommends replacing worn tires in complete sets of four. Uniform tread depth on all tires will help to maintain the performance of the vehicle.

Braking and handling performance may be adversely affected if all the tires are not replaced at the same time.

If proper rotation and maintenance have been done, all four tires should wear out at about the same time. See *Tire Rotation* on page 10-53.

However, if it is necessary to replace only one axle set of worn tires, place the new tires on the rear axle.

Winter tires with the same speed rating as the original equipment tires may not be available for H, V, W, Y, and ZR speed rated tires. Never exceed the winter tires' maximum speed capability when using winter tires with a lower speed rating.

Warning

Tires could explode during improper service. Attempting to mount or dismount a tire could cause injury or death. Only your dealer or authorized tire service center should mount or dismount the tires.

Warning

Mixing tires of different sizes, brands, or types may cause loss of control of the vehicle, resulting in a crash or other vehicle damage. Use the correct size, brand, and type of tire on all wheels.

Warning

Using bias-ply tires on the vehicle may cause the wheel rim flanges to develop cracks after many miles of driving. A tire and/or wheel could fail suddenly and cause a crash. Use only radial-ply tires with the wheels on the vehicle.

If the vehicle tires must be replaced with a tire that does not have a TPC Spec number, make sure they are the same size, load range, speed rating, and construction (radial) as the original tires.

Vehicles that have a tire pressure monitoring system could give an inaccurate low-pressure warning if non-TPC Spec rated tires are installed. See *Tire Pressure Monitor System* on page 10-48.

The Tire and Loading Information Label indicates the original equipment tires on the vehicle. See *Vehicle Load Limits on page 9-12*, for the label location and more information about the Tire and Loading Information label.

Different Size Tires and Wheels

If wheels or tires are installed that are a different size than the original equipment wheels and tires, vehicle performance, including its braking, ride and handling characteristics, stability, and resistance to rollover may be affected. If the vehicle has electronic systems such as antilock brakes, rollover airbags, traction control, electronic stability control, or All-Wheel Drive, the performance of these systems can also be affected.

Warning

If different sized wheels are used, there may not be an acceptable level of performance and safety if tires not recommended for those wheels are selected. This increases the chance of a crash and serious injury. Only use GM specific wheel and tire systems developed for the vehicle, and have them properly installed by a GM certified technician.

See *Buying New Tires on page 10-55* and *Accessories and Modifications on page 10-2*.

Uniform Tire Quality Grading

Quality grades can be found where applicable on the tire sidewall between tread shoulder and maximum section width. For example:

Treadwear 200 Traction AA Temperature A

The following information relates to the system developed by the United States National Highway Traffic Safety Administration (NHTSA), which grades tires by treadwear, traction, and temperature performance. This applies only to vehicles sold in the United States. The grades are molded on the sidewalls of most passenger car tires. The Uniform Tire Quality Grading (UTQG) system does not apply to deep tread, winter tires, compact spare tires, tires with nominal rim diameters of 10 to 12 inches (25 to 30 cm), or to some limited-production tires.

While the tires available on General Motors passenger cars and light trucks may vary with respect to these grades, they

must also conform to federal safety requirements and additional General Motors Tire Performance Criteria (TPC) standards.

All Passenger Car Tires Must Conform to Federal Safety Requirements In Addition To These Grades.

Treadwear

The treadwear grade is a comparative rating based on the wear rate of the tire when tested under controlled conditions on a specified government test course. For example, a tire graded 150 would wear one and one-half (1½) times as well on the government course as a tire graded 100. The relative performance of tires depends upon the actual conditions of their use, however, and may depart significantly from the norm due to variations in driving

habits, service practices and differences in road characteristics and climate.

Traction

The traction grades, from highest to lowest, are AA, A, B, and C. Those grades represent the tire's ability to stop on wet pavement as measured under controlled conditions on specified government test surfaces of asphalt and concrete. A tire marked C may have poor traction performance. **Warning:** The traction grade assigned to this tire is based on straight-ahead braking traction tests, and does not include acceleration, cornering, hydroplaning, or peak traction characteristics.

Temperature

The temperature grades are A (the highest), B, and C, representing the tire's resistance to the generation of heat and its ability to dissipate heat when tested under controlled conditions on a specified indoor laboratory test wheel. Sustained high temperature can cause the material of the tire to degenerate and reduce tire life, and excessive temperature can lead to sudden tire failure. The grade C corresponds to a level of performance which all passenger car tires must meet under the Federal Motor Safety Standard No. 109. Grades B and A represent higher levels of performance on the laboratory test wheel than the minimum required by law. **Warning:** The temperature grade for this tire is established for a tire that is properly inflated and not

overloaded. Excessive speed, underinflation, or excessive loading, either separately or in combination, can cause heat buildup and possible tire failure.

Wheel Alignment and Tire Balance

The tires and wheels were aligned and balanced at the factory to provide the longest tire life and best overall performance. Adjustments to wheel alignment and tire balancing are not necessary on a regular basis. Consider an alignment check if there is unusual tire wear or the vehicle is significantly pulling to one side or the other. Some slight pull to the left or right, depending on the crown of the road and/or other road surface variations such as troughs or ruts, is normal. If the vehicle is vibrating when driving on a smooth road, the tires and wheels may need to be rebalanced. See your dealer for proper diagnosis.

Wheel Replacement

Replace any wheel that is bent, cracked, or badly rusted or corroded. If wheel nuts keep coming loose, the wheel, wheel bolts, and wheel nuts should be replaced. If the wheel leaks air, replace it. Some aluminum wheels can be repaired. See your dealer if any of these conditions exist.

Your dealer will know the kind of wheel that is needed.

Each new wheel should have the same load-carrying capacity, diameter, width, and offset, and should be mounted the same way as the one it replaces.

Replace wheels, wheel bolts, wheel nuts, or Tire Pressure Monitor System (TPMS) sensors with new GM original equipment parts.

Warning

Using the wrong replacement wheels, wheel bolts, or wheel nuts can be dangerous. It could affect the braking and handling of the vehicle. Tires can lose air, and cause loss of control, causing a crash. Always use the correct wheel, wheel bolts, and wheel nuts for replacement.

Caution

The wrong wheel can also cause problems with bearing life, brake cooling, speedometer or odometer calibration, headlamp aim, bumper height, vehicle ground clearance, and tire clearance to the body and chassis.

Warning

Never use oil or grease on studs or the threads of the wheel nuts. The wheel nuts might come loose and the wheel could fall off, causing a crash.

Warning

Incorrect wheel nuts or improperly tightened wheel nuts can cause the wheel to become loose and even come off. This could lead to a crash. Be sure to use the correct wheel nuts. If you have to replace them, be sure to get new GM original equipment wheel nuts.

Caution

Improperly tightened wheel nuts can lead to brake pulsation and rotor damage. To avoid expensive brake repairs, evenly tighten the wheel nuts in the proper sequence and to the proper torque specification.

Used Replacement Wheels

Warning

Replacing a wheel with a used one is dangerous. How it has been used or how far it has been driven may be unknown. It could fail suddenly and cause a crash. When replacing wheels, use a new GM original equipment wheel.

Tire Chains

Warning

Do not use tire chains. There is not enough clearance. Tire chains used on a vehicle without the proper amount of clearance can cause damage to the brakes, suspension, or other vehicle parts. The area damaged by the tire chains could cause loss of control and a crash.

Use another type of traction device only if its manufacturer recommends it for the vehicle's tire size combination and road conditions. Follow that manufacturer's instructions. To avoid vehicle damage, drive slow and readjust or remove the traction device if it contacts the vehicle. Do not spin the wheels. If traction devices are used, install them on the front tires.

If a Tire Goes Flat

This vehicle has a tire sealant and compressor kit. See *Tire Sealant and Compressor Kit on page 10-62*. There is no spare tire, no tire changing equipment, and no place to store a tire.

To properly lift this vehicle, see *Lifting the Vehicle on page 10-3*.

It is unusual for a tire to blowout while driving, especially if the tires are maintained properly. See *Tires on page 10-41*. If air goes out of a tire, it is much more likely to leak out slowly. But if there ever is a blowout, here are a few tips about what to expect and what to do:

If a front tire fails, the flat tire will create a drag that pulls the vehicle toward that side. Take your foot off the accelerator pedal and grip the steering wheel firmly. Steer to maintain lane position, and then gently brake to a stop, well off the road, if possible.

A rear blowout, particularly on a curve, acts much like a skid and may require the same correction as used in a skid. Stop pressing the accelerator pedal and steer to straighten the vehicle. It may be very bumpy and noisy. Gently brake to a stop, well off the road, if possible.

Warning

Driving on a flat tire will cause permanent damage to the tire. Re-inflating a tire after it has been driven on while severely underinflated or flat may cause a blowout and a serious crash. Never attempt to re-inflate a tire that has been driven on while severely underinflated or flat. Have your dealer or an authorized tire service center repair or replace the flat tire as soon as possible.

If a tire goes flat, avoid further tire and wheel damage by driving slowly to a level place and stopping, well off the road, if possible.

1. Turn on the hazard warning flashers. See *Hazard Warning Flashers on page 6-5*.
2. Set the parking brake firmly.
3. Put the shift lever in P (Park). See *Shifting Into Park on page 9-19*.
4. Turn off the engine.
5. Inspect the flat tire.

If the tire has been separated from the wheel, has damaged sidewalls, or has a puncture larger than 6 mm (0.25 in), the tire is too severely damaged for the tire sealant and compressor kit to be effective. See *Roadside Service on page 13-5*.

If the tire has a puncture less than 6 mm (0.25 in) in the tread area of the tire, see *Tire Sealant and Compressor Kit on page 10-62*.

Tire Sealant and Compressor Kit

Warning

Running the engine in Extended Range Mode in an enclosed area with poor ventilation is dangerous. Engine exhaust may enter the vehicle. Engine exhaust contains carbon monoxide (CO) which cannot be seen or smelled. It can cause unconsciousness and even death. Never run the engine in Extended Range Mode in an enclosed area that has no fresh air ventilation. For more information, see *Engine Exhaust* on page 9-27.

Warning

Overinflating a tire could cause the tire to rupture and you or others could be injured. Be sure to read and follow the tire sealant and compressor kit instructions and inflate the tire to its recommended pressure. Do not exceed the recommended pressure.

Warning

Storing the tire sealant and compressor kit or other equipment in the passenger compartment of the vehicle could cause injury. In a sudden stop or collision, loose equipment could strike someone. Store the tire sealant and compressor kit in its original location.

If this vehicle has a tire sealant and compressor kit, there may not be a spare tire, tire changing equipment, and on some vehicles there may not be a place to store a tire.

The tire sealant and compressor can be used to temporarily seal punctures up to 6 mm (0.25 in) in the tread area of the tire. It can also be used to inflate an underinflated tire.

If the tire has been separated from the wheel, has damaged sidewalls, or has a large puncture, the tire is too severely damaged for the tire sealant and compressor kit to be effective. See *Roadside Service* on page 13-5.

Read and follow all of the tire sealant and compressor kit instructions.

The kit includes:

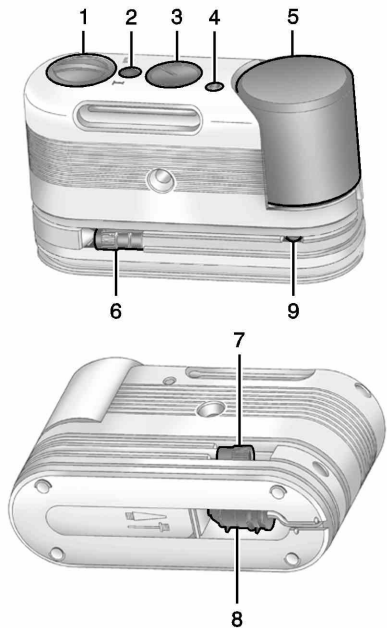

1. Selector Switch (Sealant/Air or Air Only)
2. On/Off Button
3. Pressure Gauge
4. Pressure Deflation Button (If equipped)
5. Tire Sealant Canister
6. Sealant/Air Hose (Clear)
7. Air Only Hose (Black)
8. Power Plug
9. Canister Release Button (Under Sealant/Air Hose)

Tire Sealant

Read and follow the safe handling instructions on the label adhered to the sealant canister.

Check the tire sealant expiration date on the sealant canister. The sealant canister should be replaced before its expiration date.

Replacement sealant canisters are available at your local dealer. See “Removal and Installation of the Sealant Canister” following.

There is only enough sealant to seal one tire. After usage, the sealant canister and sealant/air hose assembly must be replaced. See “Removal and Installation of the Sealant Canister” following.

Using the Tire Sealant and Compressor Kit to Temporarily Seal and Inflate a Punctured Tire

Follow the directions closely for correct sealant usage.

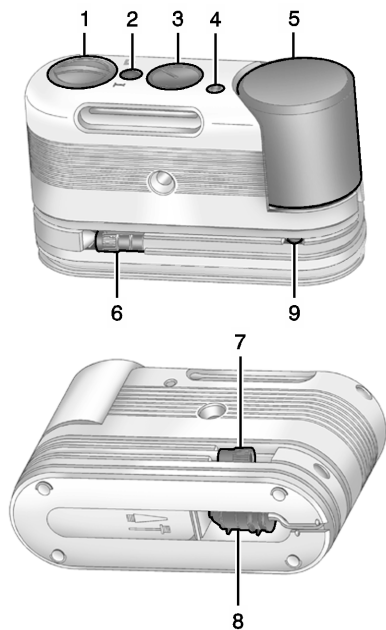

When using the tire sealant and compressor kit during cold temperatures, warm the kit in a

heated environment for five minutes. This will help to inflate the tire faster.

If a tire goes flat, avoid further tire and wheel damage by driving slowly to a level place. Turn on the hazard warning flashers. See *Hazard Warning Flashers* on page 6-5.

See *If a Tire Goes Flat* on page 10-61 for other important safety warnings.

Do not remove any objects that have penetrated the tire.

1. Remove the tire sealant and compressor kit from its storage location. See *Storing the Tire Sealant and Compressor Kit* on page 10-69.
2. Unwrap the sealant/air hose (6) and the power plug (8).
3. Place the kit on the ground.

Make sure the tire valve stem is positioned close to the ground so the hose will reach it.

4. Remove the valve stem cap from the flat tire by turning it counterclockwise.
5. Attach the sealant/air hose (6) onto the tire valve stem. Turn it clockwise until it is tight.
6. Plug the power plug (8) into the accessory power outlet in the vehicle. Unplug all items from other accessory power outlets. See *Power Outlets* on page 5-7.

If the vehicle has an accessory power outlet, do not use the cigarette lighter.

If the vehicle only has a cigarette lighter, use the cigarette lighter.

Do not pinch the power plug cord in the door or window.

7. Start the vehicle. The vehicle must be running while using the air compressor.
8. Press and turn the selector switch (1) counterclockwise to the Sealant + Air position.

9. Press the on/off button (2) to turn the tire sealant and compressor kit on.

The compressor will inject sealant and air into the tire.

The pressure gauge (3) will initially show a high pressure while the compressor pushes the sealant into the tire. Once the sealant is completely dispersed into the tire, the pressure will quickly drop and start to rise again as the tire inflates with air only.

10. Inflate the tire to the recommended inflation pressure using the pressure gauge (3). The recommended inflation pressure can be found on the Tire and Loading Information label. See *Tire Pressure* on page 10-47.

The pressure gauge (3) may read higher than the actual tire pressure while the compressor is on. Turn the compressor off to get an accurate pressure

reading. The compressor may be turned on/off until the correct pressure is reached.

⚠ Caution

If the recommended pressure cannot be reached after approximately 25 minutes, the vehicle should not be driven farther. The tire is too severely damaged and the tire sealant and compressor kit cannot inflate the tire. Remove the power plug from the accessory power outlet and unscrew the inflating hose from the tire valve. See *Roadside Service* on page 13-5.

11. Press the on/off button (2) to turn the tire sealant and compressor kit off.

The tire is not sealed and will continue to leak air until the vehicle is driven and the sealant is distributed in the tire; therefore, Steps 12–18 must be done immediately after Step 11.

Be careful while handling the tire sealant and compressor kit as it could be warm after usage.

12. Unplug the power plug (8) from the accessory power outlet in the vehicle.
13. Turn the sealant/air hose (6) counterclockwise to remove it from the tire valve stem.
14. Replace the tire valve stem cap.
15. Replace the sealant/air hose (6), and the power plug (8) back in their original location.



16. If the flat tire was able to inflate to the recommended inflation pressure, remove the maximum speed label from the sealant canister (5) and place it in a highly visible location.

Do not exceed the speed on this label until the damaged tire is repaired or replaced.

17. Return the equipment to its original storage location in the vehicle.
18. Immediately drive the vehicle 8 km (5 mi) to distribute the sealant in the tire.

19. Stop at a safe location and check the tire pressure. Refer to Steps 1–11 under “Using the Tire Sealant and Compressor Kit without Sealant to Inflate a Tire (Not Punctured).”

If the tire pressure has fallen more than 68 kPa (10 psi) below the recommended inflation pressure, stop driving the vehicle. The tire is too severely damaged and the tire sealant cannot seal the tire. See *Roadside Service on page 13-5*.

If the tire pressure has not dropped more than 68 kPa (10 psi) from the recommended inflation pressure, inflate the tire to the recommended inflation pressure.

20. Wipe off any sealant from the wheel, tire, and vehicle.

21. Dispose of the used sealant canister (5) and sealant/air hose (6) assembly at a local dealer or in accordance with local state codes and practices.
22. Replace it with a new canister available from your dealer.
23. After temporarily sealing a tire using the tire sealant and compressor kit, take the vehicle to an authorized dealer within a 161 km (100 mi) of driving to have the tire repaired or replaced.

Using the Tire Sealant and Compressor Kit without Sealant to Inflate a Tire (Not Punctured)

To use the air compressor to inflate a tire with air only and not sealant:

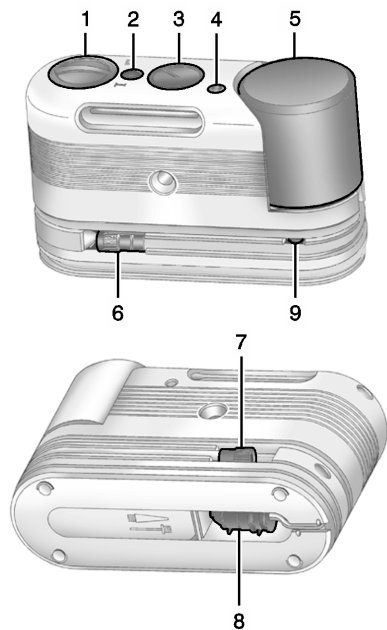

If a tire goes flat, avoid further tire and wheel damage by driving slowly to a level place. Turn on the hazard warning flashers. See *Hazard Warning Flashers* on page 6-5.

See *If a Tire Goes Flat* on page 10-61 for other important safety warnings.

1. Remove the tire sealant and compressor kit from its storage location. See *Storing the Tire Sealant and Compressor Kit* on page 10-69.
2. Unwrap the air only hose (7) and the power plug (8).
3. Place the kit on the ground.
Make sure the tire valve stem is positioned close to the ground so the hose will reach it.
4. Remove the tire valve stem cap from the flat tire by turning it counterclockwise.
5. Attach the air only hose (7) onto the tire valve stem by turning it clockwise until it is tight.

6. Plug the power plug (8) into the accessory power outlet in the vehicle. Unplug all items from other accessory power outlets. See *Power Outlets* on page 5-7.

If the vehicle has an accessory power outlet, do not use the cigarette lighter.

If the vehicle only has a cigarette lighter, use the cigarette lighter.

Do not pinch the power plug cord in the door or window.

7. Start the vehicle. The vehicle must be running while using the air compressor.
8. Press and turn the selector switch (1) clockwise to the Air Only position.
9. Press the on/off button (2) to turn the compressor on.
The compressor will inflate the tire with air only.

10-68 Vehicle Care

- Inflate the tire to the recommended inflation pressure using the pressure gauge (3). The recommended inflation pressure can be found on the Tire and Loading Information label. See *Tire Pressure* on page 10-47.

The pressure gauge (3) may read higher than the actual tire pressure while the compressor is on. Turn the compressor off to get an accurate reading. The compressor may be turned on/off until the correct pressure is reached.

If you inflate the tire higher than the recommended pressure you can adjust the excess pressure by pressing the pressure deflation button (4), if equipped, until the proper pressure reading is reached. This option is only functional when using the air only hose (7).

- Press the on/off button (2) to turn the tire sealant and compressor kit off.

Be careful while handling the tire sealant and compressor kit as it could be warm after usage.

- Unplug the power plug (8) from the accessory power outlet in the vehicle.
- Disconnect the air only hose (7) from the tire valve stem by turning it counterclockwise, and replace the tire valve stem cap.
- Replace the air only hose (7) and the power plug (8) and cord back in their original locations.
- Place the equipment in the original storage location in the vehicle.

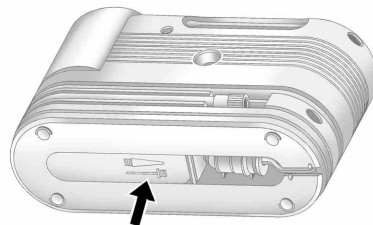

The tire sealant and compressor kit has an accessory adapter located in a compartment on the bottom of its housing that may be used to inflate air mattresses, balls, etc.

Removal and Installation of the Sealant Canister

To remove the sealant canister:

- Unwrap the sealant hose.
- Press the canister release button (9).
- Pull up and remove the canister.

4. Replace with a new canister which is available from your dealer.
5. Push the new canister into place.

Storing the Tire Sealant and Compressor Kit

To access the tire sealant and compressor kit:

1. Open the trunk. See *Trunk* on page 2-13.
2. Lift and remove the cover.

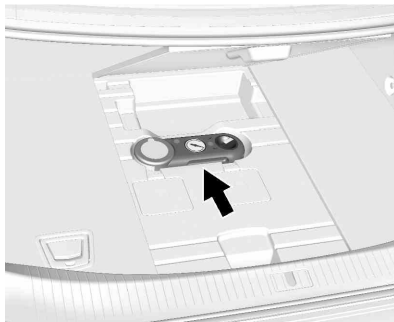

3. Remove the tire sealant and compressor kit.

To store the tire sealant and compressor kit, reverse the steps.

Jump Starting

Jump starting is connecting jumper cables between the two vehicles to enable vehicle starting. If the ELR or another vehicle has a run-down 12-volt battery, it can be jump started using good condition jumper cables.

Warning

The high voltage battery cannot be jump started either with another vehicle or battery charger. Personal injury, death, or damage to the vehicle could result.

Warning

Batteries are dangerous and can cause injury. Batteries contain acid and can explode or ignite.

(Continued)

Warning (Continued)

They contain electricity that can burn. Follow the exact steps provided or injuries could occur.

Using an open flame near a battery can cause battery gas to explode; you or others could be hurt. Battery acid can cause blindness.

Be sure the battery in the other vehicle has enough water. Add water if the level is low. A low water level could cause explosive gas to be present.

Battery fluid contains acid that can burn. If battery fluid gets in eyes or on skin; flush with water and get medical help immediately.

Warning

Electric fans can start up even when the engine is not running and can cause injury. Keep hands, clothing, and tools away from any underhood electric fans.

Caution

Ignoring these steps could result in costly damage to the vehicle that would not be covered by the vehicle warranty. Trying to start the vehicle by pushing or pulling it will not work, and it could damage the vehicle.

Jump Starting the ELR

If the ELR will not start, the 12-volt battery may be run down. To jump start the ELR jumper cables are connected directly to the positive (+)

and negative (-) terminals on the 12-volt battery in the rear cargo area.

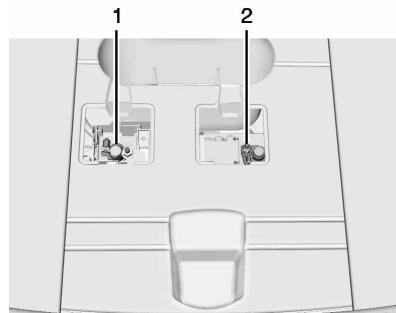

1. Positive (+) Terminal
2. Negative (-) Terminal

1. The other vehicle used to jump start the ELR must have a 12-volt battery with a negative ground system.

 **Caution**

If the other vehicle does not have a 12-volt system with a negative ground, both vehicles can be damaged. Only use a vehicle that has a 12-volt system with a negative ground for jump starting.

2. Park both vehicles close enough so that the jumper cables can reach both vehicles' positive (+) and negative (-) terminals. The vehicles must not touch each other. It could cause an unwanted ground connection that could damage both vehicles' electrical systems.

Put both vehicles in P (Park) for an automatic transmission or electric drive unit. For a manual transmission, place the vehicle in Neutral and set the parking brake.

 **Caution**

If any accessories are left on or plugged in during the jump starting procedure, they could be damaged. The repairs would not be covered by the vehicle warranty. Whenever possible, turn off or unplug all accessories on either vehicle when jump starting.

3. Turn off the ignition on the other vehicle. Turn off the radio, all lamps, and accessories that are not needed in both vehicles. Unplug accessories from the cigarette lighter or the accessory power outlets. This avoids sparks and helps save both batteries and accessories.
4. Locate the positive (+) and negative (-) terminals on the other vehicle.
5. Locate the positive (+) and negative (-) battery terminals on the ELR. The access cover is

under the load floor access cover in the rear cargo area. Open the access covers for the positive (+) terminal (1) and the negative (-) terminal (2).

6. Check that the jumper cables do not have loose or missing insulation or a shock could result and the vehicles could be damaged.

Before connecting the jumper cables, here are some basic things to know. Positive (+) jumper cable goes to positive (+) battery terminal or a remote positive (+) terminal if available. Negative (-) jumper cable goes to negative (-) battery terminal or a remote negative (-) terminal if available. Do not connect positive (+) to negative (-) or there will be a short that may damage the battery and other parts of the vehicle.

Caution

If the jumper cables are connected or removed in the wrong order, electrical shorting may occur and damage the vehicle. The repairs would not be covered by the vehicle warranty. Always connect and remove the jumper cables in the correct order, making sure that the cables do not touch each other or other metal.

Connecting the Jumper Cables

1. Connect the red positive (+) jumper cable to the positive (+) terminal (1) of the ELR. Do not let the other end of the cable touch metal.
2. Connect the other end of the red positive (+) jumper cable to the positive (+) terminal of the other vehicle.

3. Connect the black negative (-) jumper cable to the negative (-) battery terminal of the other vehicle battery. Do not let the other end touch anything until the next step.
4. Connect the other end of the black negative (-) jumper cable to the negative (-) terminal (2) of the ELR.
5. Press the POWER  button to start. This will wake up the electronics on the ELR. After the instrument cluster initializes, the ELR will use power from the high voltage battery to charge the 12-volt battery. The jumper cables can then be disconnected. If the ELR does not start, call your dealer or Roadside Service. See *Roadside Service on page 13-5*.

Disconnecting the Jumper Cables

1. Disconnect the black negative (-) jumper cable from the ELR. Do not let the other end of the cable touch anything until after the next step.
2. Disconnect the black negative (-) jumper cable from the other vehicle with the good battery.
3. Disconnect the red positive (+) jumper cable from the other vehicle. Do not let the other end of the cable touch anything until after the next step.
4. Disconnect the red positive (+) jumper cable from the ELR.

Jump Starting Another Vehicle

When using the ELR to jump start another vehicle with a run-down battery, jumper cables are connected directly to the positive (+) and negative (-) terminals on the 12-volt battery in the rear cargo area.

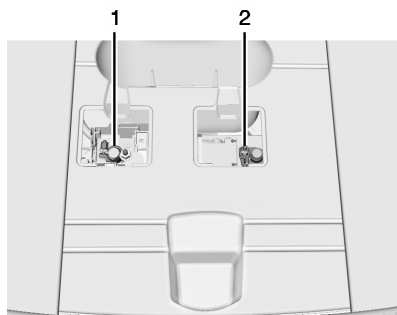

- 1. Positive (+) Terminal
- 2. Negative (-) Terminal

1. Check the other vehicle. It must have a 12-volt battery with a negative ground system.

⚠ Caution

If the other vehicle does not have a 12-volt system with a negative ground, both vehicles can be damaged. Only use a vehicle that has a 12-volt system with a negative ground for jump starting.

2. Park both vehicles close enough so that the jumper cables can reach both vehicles' positive (+) and negative (-) terminals. The vehicles must not touch each other. It could cause an unwanted ground connection that could damage both vehicles' electrical systems.

Put both vehicles in P (Park) for an automatic transmission or electric drive unit. For a manual transmission, place the vehicle in Neutral and set the parking brake.

⚠ Caution

If any accessories are left on or plugged in during the jump starting procedure, they could be damaged. The repairs would not be covered by the vehicle warranty. Whenever possible, turn off or unplug all accessories on either vehicle when jump starting.

3. Turn off both vehicles. Turn off the radio, all lamps, and accessories that are not needed in both vehicles. Unplug accessories from the cigarette lighter or the accessory power outlets. This avoids sparks and helps save both batteries and accessories.
4. Locate the positive (+) and negative (-) terminals on the vehicle with the run-down battery.
5. Locate the positive (+) and negative (-) battery terminals on the ELR. The access cover is under the load floor access cover in the rear cargo area. Open the access covers for the positive (+) terminal (1) and the negative (-) terminal (2).

6. Check that the jumper cables do not have loose or missing insulation or a shock could result and the vehicles could be damaged.

Before connecting the jumper cables, here are some basic things to know. Positive (+) jumper cable goes to positive (+) battery terminal or a remote positive (+) terminal if available. Negative (-) jumper cable goes to remote negative (-) terminal if available, or a heavy, unpainted metal engine part or a solid engine ground on the vehicle with the run-down battery.

Do not connect positive (+) to negative (-) or there will be a short that may damage the battery or other parts of the vehicle. Do not connect the negative (-) cable to the negative (-) terminal on the run-down battery because this can cause sparks.

Caution

If the jumper cables are connected or removed in the wrong order, electrical shorting may occur and damage the vehicle. The repairs would not be covered by the vehicle warranty. Always connect and remove the jumper cables in the correct order, making sure that the cables do not touch each other or other metal.

Connecting the Jumper Cables

1. Connect the red positive (+) jumper cable to the positive (+) terminal of the other vehicle with the run-down battery. Use a remote positive (+) terminal if available. Do not let the other end touch metal.
2. Connect the other end of the red positive (+) jumper cable to the positive (+) battery terminal of the ELR.

3. Connect the black negative (-) jumper cable to the negative (-) battery terminal of the ELR. Do not let the other end touch anything until the next step.
4. Make the final connection to a heavy, unpainted metal engine part or to the remote negative (-) terminal on the other vehicle with the run-down battery.
5. Press the POWER  button to start the ELR. This will wake up the electronics on the ELR. The engine will only start if it is needed.
6. Try to start the other vehicle that had the run-down battery. If it will not start after a few tries, it probably needs service.

Disconnecting the Jumper Cables

1. Disconnect the black negative (-) jumper cable from the other vehicle that had the run-down battery. Do not let the other end of the cable touch anything until after the next step.

2. Disconnect the black negative (-) jumper cable from the ELR.
3. Disconnect the red positive (+) jumper cable from the ELR. Do not let the other end of the cable touch anything until after the next step.
4. Disconnect the red positive (+) jumper cable from the other vehicle.
5. Return the positive (+) and negative (-) terminal covers to their original positions.

Towing the Vehicle

⚠ Caution

Incorrectly towing a disabled vehicle may cause damage to the vehicle. The disabled vehicle should be towed on a flatbed car carrier. Use care when there is low ground clearance and/or special equipment. Attempting to pull the vehicle onto a flatbed without following the proper steps could damage the vehicle.

Consult your dealer or a professional towing service if the disabled vehicle must be towed.

To load a vehicle onto a flatbed carrier:

1. The vehicle must be on a flat surface.

2. The front tires must be properly inflated. If necessary, move a rear tire to the front to replace a flat or damaged tire.

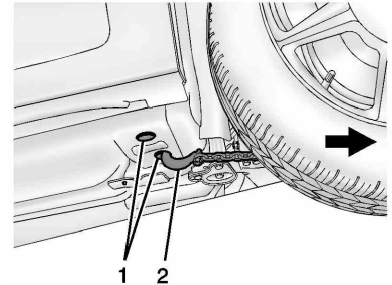

3. Place the tow chain hooks (2) into one of the torque box openings (1) behind the front wheels.

10-76 Vehicle Care

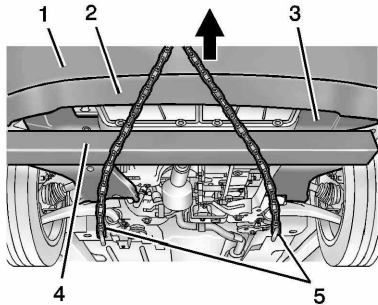

4. Place a 1.2 m (4 ft) X 102 mm (4 in) X 102 mm (4 in) wood beam (4) under the front cradle crossmember (3), and on top of both tow chains (5) to ensure the tow chains do not come into contact with the front fascia (1).

Try to minimize the contact of the chains with the flexible air dam (2).

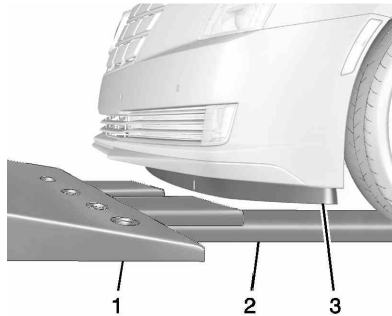

5. Ramps (2) are required for the front fascia (3) to clear the flatbed (1). The ramp height should be approximately 102 mm (4 in). Lower the flatbed onto the set of ramps.

Caution

If ramps are not used, the front fascia will come into contact with the flatbed and may cause damage. Always use ramps.

6. After the front tires are on the flatbed adjust the flatbed upward to provide additional clearance between the air dam, fascia, and flatbed.
7. When the fascia has enough clearance to clear the flatbed, lower the flatbed, and finish pulling the vehicle onto the flatbed.
8. Use the proper nylon strap harnesses around the tires to secure them to the flatbed car carrier.

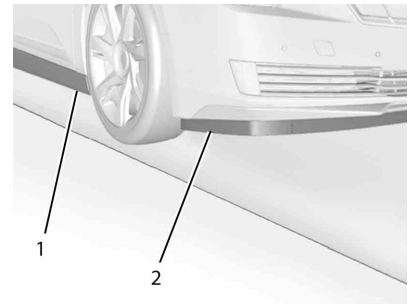

If the vehicle is parked off the shoulder of the road, at an angle that it cannot be pulled onto a flatbed, a hook/chain can be placed into either of the front torque box openings to pull the vehicle onto a flat surface. Make sure that the chains do not come in contact with the rocker panel (1) or the front fascia (2).

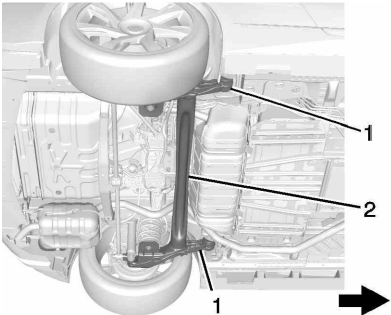

⚠ Caution
When using tow straps to move the vehicle, damage may occur if the tow straps contact the rear fascia. Do not let the tow straps contact the rear fascia.

If you cannot access the front torque box openings, wrap a tow strap through one, or both of the rear trailing arms (1) between the bushing and torque tube, and pull the vehicle onto a flat surface. Do not wrap the tow strap around the rear torque tube (2).

Recreational Vehicle Towing

Recreational vehicle towing refers to towing the vehicle behind another vehicle such as a motor home. The two most common types of recreational vehicle towing are known as dinghy towing and dolly towing. Dinghy towing is towing the

vehicle with all four wheels on the ground. Dolly towing is towing the vehicle with two wheels on the ground and two wheels up on a device known as a dolly.

Here are some important things to consider before recreational vehicle towing:

- The towing capacity of the towing vehicle. Read the tow vehicle manufacturer's recommendations.
- How far the vehicle can be towed. Some vehicles have restrictions on how far and how long they can tow.
- Whether the vehicle has the proper towing equipment. See your dealer or trailering professional for additional advice and equipment recommendations.
- Is the vehicle ready to be towed. Just as preparing the vehicle for a long trip, make sure the vehicle is prepared to be towed.

Dinghy Towing

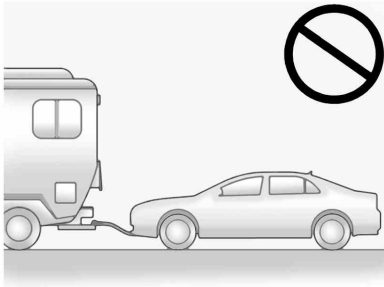

Caution

If the vehicle is towed with all four wheels on the ground, the drive unit could be damaged. Repairs would not be covered by the vehicle warranty. Do not tow the vehicle with all four wheels on the ground.

The vehicle was not designed to be towed with all four wheels on the ground. If the vehicle must be towed, a dolly should be used. See the information on dolly towing following.

Dolly Towing from the Front

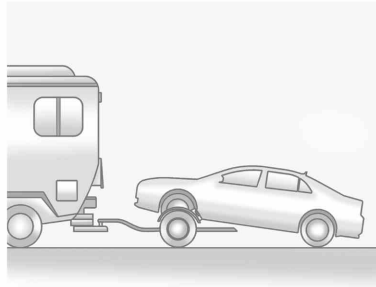

The vehicle can be towed from the front using a dolly. To tow the vehicle using a dolly:

1. Attach the dolly to the tow vehicle following the dolly manufacturer's instructions.

2. Drive the front wheels onto the dolly.
3. Put the shift lever in P (Park).
4. Set the parking brake and remove the key.
5. Clamp the steering wheel in a straight-ahead position with a clamping device designed for towing.
6. Secure the vehicle to the dolly.
7. Release the parking brake.
8. Check for adequate rear fascia to ground clearance.

Dolly Towing from the Rear

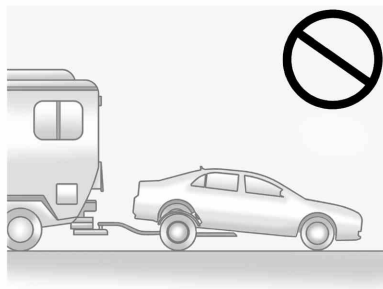

⚠ Caution

Towing the vehicle from the rear, with the front wheels on the ground, could damage the drive unit, and front fascia. Do not tow the vehicle from the rear with the front wheels on the ground.

Appearance Care

Exterior Care

Locks

Locks are lubricated at the factory. Use a de-icing agent only when absolutely necessary, and have the locks greased after using. See *Recommended Fluids and Lubricants on page 11-12.*

Washing the Vehicle

To preserve the vehicle's finish, wash it often and out of direct sunlight.

⚠ Caution

Do not use petroleum-based, acidic, or abrasive cleaning agents as they can damage the vehicle's paint, metal, or plastic parts. If damage occurs, it would not be covered by the vehicle warranty. Approved cleaning

(Continued)

Caution (Continued)

products can be obtained from your dealer. Follow all manufacturer directions regarding correct product usage, necessary safety precautions, and appropriate disposal of any vehicle care product.

⚠ Caution

Avoid using high-pressure washes closer than 30 cm (12 in) to the surface of the vehicle. Use of power washers exceeding 8,274 kPa (1,200 psi) can result in damage or removal of paint and decals.

This symbol  is on any underhood compartment electrical center that should not be power

10-80 Vehicle Care

washed. This could cause damage that would not be covered by the vehicle warranty.

If using an automatic car wash, follow the car wash instructions. The windshield wiper must be off.

Remove any accessories that may be damaged or interfere with the car wash equipment.

Rinse the vehicle well, before washing and after, to remove all cleaning agents completely. If they are allowed to dry on the surface, they could stain.

Dry the finish with a soft, clean chamois or an all-cotton towel to avoid surface scratches and water spotting.

Finish Care

Application of aftermarket clearcoat sealant/wax materials is not recommended. If painted surfaces are damaged, see your dealer to have the damage assessed and repaired. Foreign materials such as calcium chloride and other salts, ice

melting agents, road oil and tar, tree sap, bird droppings, chemicals from industrial chimneys, etc., can damage the vehicle's finish if they remain on painted surfaces. Wash the vehicle as soon as possible. If necessary, use non-abrasive cleaners that are marked safe for painted surfaces to remove foreign matter.

Occasional hand waxing or mild polishing should be done to remove residue from the paint finish. See your dealer for approved cleaning products.

Do not apply waxes or polishes to uncoated plastic, vinyl, rubber, decals, simulated wood, or flat paint as damage can occur.

Caution

Machine compounding or aggressive polishing on a basecoat/clearcoat paint finish may damage it. Use only

(Continued)

Caution (Continued)

non-abrasive waxes and polishes that are made for a basecoat/clearcoat paint finish on the vehicle.

To keep the paint finish looking new, keep the vehicle garaged or covered whenever possible.

Protecting Exterior Bright Metal Moldings

Caution

Failure to clean and protect the bright metal moldings can result in a hazy white finish or pitting. This damage would not be covered by the vehicle warranty.

The bright metal moldings on the vehicle are aluminum. To prevent damage always follow these cleaning instructions:

- Be sure the molding is cool to the touch before applying any cleaning solution.
- Use a cleaning solution approved for aluminum. Some cleaners are highly acidic or contain alkaline substances and can damage the moldings.
- Always dilute a concentrated cleaner according to the manufacturer's instructions.
- Do not use chrome cleaners.
- Do not use cleaners that are not intended for automotive use.
- Use a nonabrasive wax on the vehicle after washing to protect and extend the molding finish.

Front Air Deflector

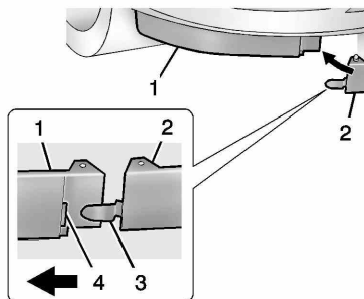

1. Outer Air Deflector
2. Inner Air Deflector
3. Tab
4. Slot

The front air deflector directs the airflow under the vehicle.

If it becomes detached, insert the tab into the slot. Repeat for the other side.

Cleaning Exterior Lamps/ Lenses, Emblems, Decals and Stripes

Use only lukewarm or cold water, a soft cloth, and a car washing soap to clean exterior lamps, lenses, emblems, decals and stripes. Follow instructions under "Washing the Vehicle" previously in this section.

Lamp covers are made of plastic, and some have a UV protective coating. Do not clean or wipe them while they are dry.

Do not use any of the following on lamp covers:

- Abrasive or caustic agents.
- Washer fluids and other cleaning agents in higher concentrations than suggested by the manufacturer.
- Solvents, alcohols, fuels, or other harsh cleaners.
- Ice scrapers or other hard items.

10-82 Vehicle Care

- Aftermarket appearance caps or covers while the lamps are illuminated, due to excessive heat generated.

Caution

Failure to clean lamps properly can cause damage to the lamp cover that would not be covered by the vehicle warranty.

Caution

Using wax on low gloss black finish stripes can increase the gloss level and create a non-uniform finish. Clean low gloss stripes with soap and water only.

Air Intakes

Clear debris from the air intakes, between the hood and windshield, when washing the vehicle.

Windshield and Wiper Blades

Clean the outside of the windshield with glass cleaner.

Clean rubber blades using lint-free cloth or paper towel soaked with windshield washer fluid or a mild detergent. Wash the windshield thoroughly when cleaning the blades. Bugs, road grime, sap, and a buildup of vehicle wash/wax treatments may cause wiper streaking.

Replace the wiper blades if they are worn or damaged. Damage can be caused by extreme dusty conditions, sand, salt, heat, sun, snow, and ice.

Weatherstrips

Apply Dielectric silicone grease on weatherstrips to make them last longer, seal better, and not stick or squeak. Lubricate weatherstrips at least once a year. Hot, dry climates may require more frequent application. Black marks from rubber material on painted surfaces

can be removed by rubbing with a clean cloth. See *Recommended Fluids and Lubricants on page 11-12*.

Tires

Use a stiff brush with tire cleaner to clean the tires.

Caution

Using petroleum-based tire dressing products on the vehicle may damage the paint finish and/or tires. When applying a tire dressing, always wipe off any overspray from all painted surfaces on the vehicle.

Wheels and Trim — Aluminum or Chrome

Use a soft, clean cloth with mild soap and water to clean the wheels. After rinsing thoroughly with clean water, dry with a soft, clean towel. A wax may then be applied.

 **Caution**

Chrome wheels and other chrome trim may be damaged if the vehicle is not washed after driving on roads that have been sprayed with magnesium, calcium, or sodium chloride. These chlorides are used on roads for conditions such as ice and dust. Always wash the chrome with soap and water after exposure.

 **Caution**

To avoid surface damage, do not use strong soaps, chemicals, abrasive polishes, cleaners, brushes, or cleaners that contain acid on aluminum or chrome-plated wheels. Use only approved cleaners. Also, never drive a vehicle with aluminum or chrome-plated wheels through an

(Continued)

Caution (Continued)

automatic car wash that uses silicone carbide tire cleaning brushes. Damage could occur and the repairs would not be covered by the vehicle warranty.

Steering, Suspension, and Chassis Components

Visually inspect steering, suspension, and chassis components for damaged, loose, or missing parts or signs of wear at least once a year.

Inspect power steering for proper hook-up, binding, leaks, cracks, chafing, etc.

Visually check constant velocity joint boots and axle seals for leaks.

Body Component Lubrication

Lubricate all key lock cylinders, hood hinges, liftgate hinges, and the steel fuel door hinge unless the components are plastic. Applying

silicone grease on weatherstrips with a clean cloth will make them last longer, seal better, and not stick or squeak.

Underbody Maintenance

At least twice a year, spring and fall, use plain water to flush dirt and debris from the vehicle's underbody. Your dealer or an underbody car washing system can do this. If not removed, rust and corrosion can develop.

Sheet Metal Damage

If the vehicle is damaged and requires sheet metal repair or replacement, make sure the body repair shop applies anti-corrosion material to parts repaired or replaced to restore corrosion protection.

Original manufacturer replacement parts will provide the corrosion protection while maintaining the vehicle warranty.

Finish Damage

Quickly repair minor chips and scratches with touch-up materials available from your dealer to avoid corrosion. Larger areas of finish damage can be corrected in your dealer's body and paint shop.

Chemical Paint Spotting

Airborne pollutants can fall upon and attack painted vehicle surfaces causing blotchy, ring-shaped discolorations, and small, irregular dark spots etched into the paint surface. Refer to "Finish Care" previously in this section.

Interior Care

To prevent dirt particle abrasions, regularly clean the vehicle's interior. Immediately remove any soils. Note that newspapers or dark garments that can transfer color to home furnishings can also permanently transfer color to the vehicle's interior.

Use a soft bristle brush to remove dust from knobs and crevices on the instrument cluster. Using a mild soap solution, immediately remove hand lotions, sunscreen, and insect repellent from all interior surfaces or permanent damage may result.

Your dealer may have products for cleaning the interior. Use cleaners specifically designed for the surfaces being cleaned to prevent permanent damage. Apply all cleaners directly to the cleaning cloth. Do not spray cleaners directly on any switches or controls. Cleaners should be removed quickly. Never allow cleaners to remain on the surface being cleaned for extended periods of time.

Cleaners may contain solvents that can become concentrated in the interior. Before using cleaners, read and adhere to all safety instructions on the label. While cleaning the interior, maintain adequate ventilation by opening the doors and windows.

To prevent damage, do not clean the interior using the following cleaners or techniques:

- Never use a razor or any other sharp object to remove a soil from any interior surface.
- Never use a brush with stiff bristles.
- Never rub any surface aggressively or with excessive pressure.
- Do not use laundry detergents or dishwashing soaps with degreasers. For liquid cleaners, use approximately 20 drops per 3.8 L (1 gal) of water. A concentrated soap solution will leave a residue that creates streaks and attracts dirt. Do not use solutions that contain strong or caustic soap.
- Do not heavily saturate the upholstery when cleaning.
- Do not use solvents or cleaners containing solvents.

Interior Glass

To clean, use a terry cloth fabric dampened with water. Wipe droplets left behind with a clean dry cloth. Commercial glass cleaners may be used, if necessary, after cleaning the interior glass with plain water.

 Caution
<p>To prevent scratching, never use abrasive cleaners on automotive glass. Abrasive cleaners or aggressive cleaning may damage the rear window defogger.</p>

To prevent scratching, never use abrasive cleaners on automotive glass. Abrasive cleaners or aggressive cleaning may damage the rear window defogger.

Cleaning the windshield with water during the first three to six months of ownership will reduce tendency to fog.

Speaker Covers

Vacuum around a speaker cover gently, so that the speaker will not be damaged. Clean spots with just water and mild soap.

Coated Moldings

Coated moldings should be cleaned.

- When lightly soiled, wipe with a sponge or soft lint-free cloth dampened with water.
- When heavily soiled, use warm soapy water.

Fabric/Carpet/Suede

Start by vacuuming the surface using a soft brush attachment. If a rotating brush attachment is being used during vacuuming, only use it on the floor carpet. Before cleaning, gently remove as much of the soil as possible using one of the following techniques:

- Gently blot liquids with a paper towel. Continue blotting until no more soil can be removed.
- For solid soils, remove as much as possible prior to vacuuming.

To clean:

1. Saturate a clean lint-free colorfast cloth with water. Microfiber cloth is recommended to prevent lint transfer to the fabric or carpet.
2. Remove excess moisture by gently wringing until water does not drip from the cleaning cloth.
3. Start on the outside edge of the soil and gently rub toward the center. Fold the cleaning cloth to a clean area frequently to prevent forcing the soil in to the fabric.
4. Continue gently rubbing the soiled area until there is no longer any color transfer from the soil to the cleaning cloth.
5. If the soil is not completely removed, use a mild soap solution followed only by plain water.

If the soil is not completely removed, it may be necessary to use a commercial upholstery

cleaner or spot lifter. Test a small hidden area for colorfastness before using a commercial upholstery cleaner or spot lifter. If ring formation occurs, clean the entire fabric or carpet.

Following the cleaning process, a paper towel can be used to blot excess moisture.

Cleaning High Gloss Surfaces and Vehicle Information and Radio Displays

For vehicles with high gloss surfaces or vehicle displays, use a microfiber cloth to wipe surfaces. Before wiping the surface with the microfiber cloth, use a soft bristle brush to remove dirt that could scratch the surface. Then use the microfiber cloth by gently rubbing to clean. Never use window cleaners or solvents. Periodically hand wash the microfiber cloth separately, using mild soap. Do not use bleach or fabric softener. Rinse thoroughly and air dry before next use.

Caution

Do not attach a device with a suction cup to the display. This may cause damage and would not be covered by the warranty.

Instrument Panel, Leather, Vinyl, Other Plastic Surfaces, Low Gloss Paint Surfaces and Natural Open Pore Wood Surfaces

Use a soft microfiber cloth dampened with water to remove dust and loose dirt. For a more thorough cleaning, use a soft microfiber cloth dampened with a mild soap solution.

Caution

Soaking or saturating leather, especially perforated leather, as well as other interior surfaces,
(Continued)

Caution (Continued)

may cause permanent damage. Wipe excess moisture from these surfaces after cleaning and allow them to dry naturally. Never use heat, steam, spot lifters, or spot removers. Do not use cleaners that contain silicone or wax-based products. Cleaners containing these solvents can permanently change the appearance and feel of leather or soft trim and are not recommended.

Do not use cleaners that increase gloss, especially on the instrument panel. Reflected glare can decrease visibility through the windshield under certain conditions.

 **Caution**

Use of air fresheners may cause permanent damage to plastics and painted surfaces. If an air freshener comes in contact with any plastic or painted surface in the vehicle, blot immediately and clean with a soft cloth dampened with a mild soap solution. Damage caused by air fresheners would not be covered by the vehicle warranty.

Cargo Cover and Convenience Net

Wash with warm water and mild detergent. Do not use chlorine bleach. Rinse with cold water, and then dry completely.

Care of Safety Belts

Keep belts clean and dry.

 **Warning**

Do not bleach or dye safety belts. It may severely weaken them. In a crash, they might not be able to provide adequate protection. Clean safety belts only with mild soap and lukewarm water.

Floor Mats

 **Warning**

If a floor mat is the wrong size or is not properly installed, it can interfere with the pedals. Interference with the pedals can cause unintended acceleration and/or increased stopping distance which can cause a crash and injury. Make sure the floor mat does not interfere with the pedals.

Use the following guidelines for proper floor mat usage:

- The original equipment floor mats were designed for your vehicle. If the floor mats need replacing, it is recommended that GM certified floor mats be purchased. Non-GM floor mats may not fit properly and may interfere with the pedals. Always check that the floor mats do not interfere with the pedals.
- Use the floor mat with the correct side up. Do not turn it over.
- Do not place anything on top of the driver side floor mat.
- Use only a single floor mat on the driver side.
- Do not place one floor mat on top of another.

Removing and Replacing the Floor Mats

Pull up on the rear of the floor mat to unlock each retainer and remove.

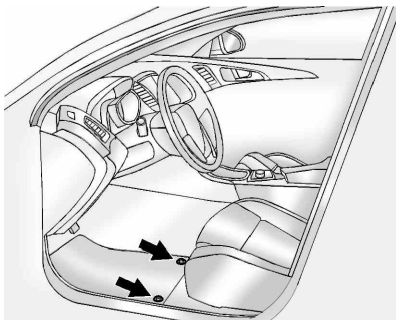

Reinstall by lining up the floor mat retainer openings over the carpet retainers and snap into position.

Make sure the floor mat is properly secured in place.

Verify the floor mat does not interfere with the pedals.

Service and Maintenance

General Information

General Information 11-1

Maintenance Schedule

Maintenance Schedule 11-2

Special Application Services

Special Application
Services 11-8

Additional Maintenance and Care

Additional Maintenance
and Care 11-9

Recommended Fluids, Lubricants, and Parts

Recommended Fluids and
Lubricants 11-12
Maintenance Replacement
Parts 11-13

Maintenance Records

Maintenance Records 11-14

General Information

Your vehicle is an important investment. This section describes the required maintenance for the vehicle. Follow this schedule to help protect against major repair expenses resulting from neglect or inadequate maintenance. It may also help to maintain the value of the vehicle if it is sold. It is the responsibility of the owner to have all required maintenance performed.

Your dealer has trained technicians who can perform required maintenance using genuine replacement parts. They have up-to-date tools and equipment for fast and accurate diagnostics. Many dealers have extended evening and Saturday hours, courtesy transportation, and online scheduling to assist with service needs.

Your dealer recognizes the importance of providing competitively priced maintenance and repair services. With trained

technicians, the dealer is the place for routine maintenance such as oil changes and tire rotations and additional maintenance items like tires, brakes, batteries, and wiper blades.

Caution

Damage caused by improper maintenance can lead to costly repairs and may not be covered by the vehicle warranty.

Maintenance intervals, checks, inspections, recommended fluids, and lubricants are important to keep the vehicle in good working condition.

The Tire Rotation and Required Services are the responsibility of the vehicle owner. It is recommended to have your dealer perform these services every 12 000 km/7,500 mi. Proper vehicle maintenance helps to keep the vehicle in good working condition, improves fuel economy, and reduces vehicle emissions.

11-2 Service and Maintenance

Because of the way people use vehicles, maintenance needs vary. There may need to be more frequent checks and services. The Additional Required Services - Normal are for vehicles that:

- Carry passengers and cargo within recommended limits on the Tire and Loading Information label. See *Vehicle Load Limits on page 9-12*.
- Are driven on reasonable road surfaces within legal driving limits.
- Use the recommended fuel. See *Fuel on page 9-67*.

Refer to the information in the Maintenance Schedule Additional Required Services - Normal chart.

The Additional Required Services - Severe are for vehicles that are:

- Mainly driven in heavy city traffic in hot weather.
- Mainly driven in hilly or mountainous terrain.

- Frequently towing a trailer.
- Used for high speed or competitive driving.
- Used for taxi, police, or delivery service.

Refer to the information in the Maintenance Schedule Additional Required Services - Severe chart.

Warning

Performing maintenance work can be dangerous and can cause serious injury. Perform maintenance work only if the required information, proper tools, and equipment are available. If they are not, see your dealer to have a trained technician do the work. See *Doing Your Own Service Work on page 10-5*.

Maintenance Schedule

Owner Checks and Services

At Each Fuel Stop

- Check the engine oil level. See *Engine Oil on page 10-9*.

Once a Month

- Check the tire inflation pressures. See *Tire Pressure on page 10-47*.
- Inspect the tires for wear. See *Tire Inspection on page 10-53*.
- Check the windshield washer fluid level. See *Washer Fluid on page 10-19*.
- Engine, power electronics, and high voltage battery pack coolant level checks. See *Cooling System (Engine) on page 10-14* or *Cooling System (High Voltage Battery) on page 10-15* or *Cooling System (Power Electronics and Charger Modules) on page 10-16*.

Engine Oil Change

Every 24 months or when the CHANGE ENGINE OIL SOON message displays, change the engine oil and filter as soon as possible, within the next 1 000 km/ 600 mi. The engine oil and filter must be changed at least once every 24 months. After each oil and filter change, the oil life system must be reset. See *Engine Oil Life System on page 10-12*. More frequent changes may be required when the vehicle is exposed to a corrosive environment, such as areas of high humidity, along an ocean coast, and/or areas that apply road salt during winter.

Your trained dealer technician can perform this work. If the engine oil life system is reset accidentally, service the vehicle within 5 000 km/ 3,000 mi since the last service. Reset the oil life system when the oil is changed.

Tire Rotation and Required Services Every 12 000 km/ 7,500 mi

Rotate the tires, if recommended for the vehicle, and perform the following services. See *Tire Rotation on page 10-53*.

- Check engine oil level and oil life percentage. If needed, change engine oil and filter, and reset oil life system. See *Engine Oil on page 10-9* and *Engine Oil Life System on page 10-12*.
- Check engine coolant level. See *Engine Coolant on page 10-16*.
- Check windshield washer fluid level. See *Washer Fluid on page 10-19*.
- Visually inspect windshield wiper blades for wear, cracking, or contamination. See *Exterior Care on page 10-79*. Replace worn or damaged wiper blades. See *Wiper Blade Replacement on page 10-26*.
- Check tire inflation pressures. See *Tire Pressure on page 10-47*.
- Inspect tire wear. See *Tire Inspection on page 10-53*.
- Visually check for fluid leaks.
- Inspect engine air cleaner filter. See *Engine Air Cleaner/Filter on page 10-13*.
- Inspect brake system.

11-4 Service and Maintenance

- Visually inspect steering, suspension, and chassis components for damaged, loose, or missing parts or signs of wear. See *Exterior Care* on page 10-79.
- Check restraint system components. See *Safety System Check* on page 3-18.
- Visually inspect fuel system for damage or leaks.
- Visually inspect exhaust system and nearby heat shields for loose or damaged parts.
- Lubricate body components. See *Exterior Care* on page 10-79.
- Check electric drive unit shift lock control function. See *Electric Drive Unit Shift Lock Control Function Check* on page 10-25.
- Check parking brake and electric drive unit mechanism. See *Park Brake and P (Park) Mechanism Check* on page 10-25.
- Check accelerator pedal for damage, high effort, or binding. Replace if needed.
- Visually inspect gas strut for signs of wear, cracks, or other damage. Check the hold open ability of the strut. See your dealer if service is required.
- Check tire sealant expiration date, if equipped. See *Tire Sealant and Compressor Kit* on page 10-62.

11-6 Service and Maintenance

Footnotes — Maintenance Schedule Additional Required Services - Normal

(1) Or every two years, whichever comes first. More frequent replacement may be needed if the vehicle is driven in areas with heavy traffic, areas with poor air quality, or areas with high dust levels. Replacement may also be needed if there is a reduction in air flow, excessive window fogging, or odors.

(2) Check all fuel and vapor lines and hoses for proper hook-up, routing, and condition.

(3) Or every four years, whichever comes first.

(4) Or every five years, whichever comes first. See *Cooling System (Engine)* on page 10-14 or *Cooling System (High Voltage Battery)* on page 10-15 or *Cooling System (Power Electronics and Charger Modules)* on page 10-16.

(5) Or every 10 years, whichever comes first. Inspect for fraying, excessive cracking, or damage; replace, if needed.

(6) Or every 10 years, whichever comes first.

11-8 Service and Maintenance

Footnotes — Maintenance Schedule Additional Required Services - Severe

(1) Or every two years, whichever comes first. More frequent replacement may be needed if the vehicle is driven in areas with heavy traffic, areas with poor air quality, or areas with high dust levels.

Replacement may also be needed if there is a reduction in air flow, excessive window fogging, or odors.

(2) Check all fuel and vapor lines and hoses for proper hook-up, routing, and condition.

(3) Or every four years, whichever comes first.

(4) Or every five years, whichever comes first. See *Cooling System (Engine)* on page 10-14 or *Cooling System (High Voltage Battery)* on page 10-15 or *Cooling System (Power Electronics and Charger Modules)* on page 10-16.

(5) Or every 10 years, whichever comes first. Inspect for fraying, excessive cracking, or damage; replace, if needed.

(6) Or every 10 years, whichever comes first.

Special Application Services

- Severe Commercial Use Vehicles Only: Lubricate chassis components every 5 000 km/ 3,000 mi.
- Have underbody flushing service performed. See "Underbody Maintenance" in *Exterior Care* on page 10-79.
- Have the air conditioning system flushed and refilled and desiccant replaced every 10 years.

Additional Maintenance and Care

Your vehicle is an important investment and caring for it properly may help to avoid future costly repairs. To maintain vehicle performance, additional maintenance services may be required.

It is recommended that your dealer perform these services — their trained dealer technicians know your vehicle best. Your dealer can also perform a thorough assessment with a multi-point inspection to recommend when your vehicle may need attention.

The following list is intended to explain the services and conditions to look for that may indicate services are required.

Battery

The battery supplies power to start the engine and operate any additional electrical accessories.

- To avoid break-down or failure to start the vehicle, maintain a battery with full cranking power.
- Trained dealer technicians have the diagnostic equipment to test the battery and ensure that the connections and cables are corrosion-free.

Belts

- Belts may need replacing if they squeak or show signs of cracking or splitting.
- Trained dealer technicians have access to tools and equipment to inspect the belts and recommend adjustment or replacement when necessary.

Brakes

Brakes stop the vehicle and are crucial to safe driving.

- Signs of brake wear may include chirping, grinding, or squealing noises, or difficulty stopping.
- Trained dealer technicians have access to tools and equipment to inspect the brakes and recommend quality parts engineered for the vehicle.

Fluids

Proper fluid levels and approved fluids protect the vehicle's systems and components. See *Recommended Fluids and Lubricants on page 11-12* for GM approved fluids.

- Engine oil and windshield washer fluid levels should be checked at every fuel fill.

11-10 Service and Maintenance

- Instrument cluster lights may come on to indicate that fluids may be low and need to be filled.

Hoses

Hoses transport fluids and should be regularly inspected to ensure that there are no cracks or leaks. With a multi-point inspection, your dealer can inspect the hoses and advise if replacement is needed.

Lamps

Properly working headlamps, taillamps, and brake lamps are important to see and be seen on the road.

- Signs that the headlamps need attention include dimming, failure to light, cracking, or damage. The brake lamps need to be checked periodically to ensure that they light when braking.

- With a multi-point inspection, your dealer can check the lamps and note any concerns.

Shocks and Struts

Shocks and struts help aid in control for a smoother ride.

- Signs of wear may include steering wheel vibration, bounce/sway while braking, longer stopping distance, or uneven tire wear.
- As part of the multi-point inspection, trained dealer technicians can visually inspect the shocks and struts for signs of leaking, blown seals, or damage, and can advise when service is needed.

Tires

Tires need to be properly inflated, rotated, and balanced. Maintaining the tires can save money and fuel, and can reduce the risk of tire failure.

- Signs that the tires need to be replaced include three or more visible treadwear indicators; cord or fabric showing through the rubber; cracks or cuts in the tread or sidewall; or a bulge or split in the tire.
- Trained dealer technicians can inspect and recommend the right tires. Your dealer can also provide tire/wheel balancing services to ensure smooth vehicle operation at all speeds. Your dealer sells and services name brand tires.

Vehicle Care

To help keep the vehicle looking like new, vehicle care products are available from your dealer. For information on how to clean and protect the vehicle's interior and exterior, see *Interior Care on page 10-84* and *Exterior Care on page 10-79*.

Wheel Alignment

Wheel alignment is critical for ensuring that the tires deliver optimal wear and performance.

- Signs that the alignment may need to be adjusted include pulling, improper vehicle handling, or unusual tire wear.

- Your dealer has the required equipment to ensure proper wheel alignment.

Windshield

For safety, appearance, and the best viewing, keep the windshield clean and clear.

- Signs of damage include scratches, cracks, and chips.
- Trained dealer technicians can inspect the windshield and recommend proper replacement if needed.

Wiper Blades

Wiper blades need to be cleaned and kept in good condition to provide a clear view.

- Signs of wear include streaking, skipping across the windshield, and worn or split rubber.
- Trained dealer technicians can check the wiper blades and replace them when needed.

Recommended Fluids, Lubricants, and Parts

Recommended Fluids and Lubricants

Usage	Fluid/Lubricant
Engine Oil	Use only engine oil licensed to the dexos1 [®] specification of the proper SAE viscosity grade. ACDelco dexos1 Synthetic Blend is recommended. See <i>Engine Oil on page 10-9</i> .
Engine Cooling System	Premix DEX-COOL [®] (GM Part No. 12378390, in Canada 10953456). See <i>Engine Coolant on page 10-16</i> .
High Voltage Battery Cooling System	Premix DEX-COOL (GM Part No. 12378390, in Canada 10953456).
Power Electronics Cooling System	Premix DEX-COOL (GM Part No. 12378390, in Canada 10953456).
Hydraulic Brake System	DOT 3 Hydraulic Brake Fluid (GM Part No. 19299818, in Canada 19299819).
Windshield Washer	Automotive windshield washer fluid that meets regional freeze protection requirements.
Parking Brake Cable Guides	Chassis Lubricant (GM Part No. 12377985, in Canada 88901242) or lubricant meeting requirements of NLGI #2, Category LB or GC-LB.
Electric Drive Unit	DEXRON [®] -VI Automatic Transmission Fluid.
Key Lock Cylinders	Multi-Purpose Lubricant, Superlube (GM Part No. 12346241, in Canada 10953474).

Usage	Fluid/Lubricant
Hood and Trunk Hinges	Multi-Purpose Lubricant, Superlube (GM Part No. 12346241, in Canada 10953474).
Weatherstrip Conditioning	Weatherstrip Lubricant (GM Part No. 3634770, in Canada 10953518) or Dielectric Silicone Grease (GM Part No. 12345579, in Canada 10953481).

Maintenance Replacement Parts

Replacement parts identified below by name, part number, or specification can be obtained from your dealer.

Part	GM Part Number	ACDelco Part Number
Engine Air Cleaner/Filter	20871244	A3148C
Engine Oil Filter	55352643	PF65
Spark Plugs	55585534	41-122
Wiper Blades		
Driver – 65 cm (25.6 in)	23184313	—
Passenger – 65 cm (25.6 in)	23184314	—

11-14 Service and Maintenance

Maintenance Records

After the scheduled services are performed, record the date, odometer reading, who performed the service, and the type of services performed in the boxes provided. Retain all maintenance receipts.

Date	Odometer Reading	Serviced By	Services Performed

Technical Data

Vehicle Identification

Vehicle Identification Number (VIN)	12-1
Service Parts Identification Label	12-1

Vehicle Data

Capacities and Specifications	12-2
Engine Drive Belt Routing ...	12-4

Vehicle Identification

Vehicle Identification Number (VIN)



This legal identifier is in the front corner of the instrument panel, on the left side of the vehicle. It can be seen through the windshield from outside. The VIN also appears on the Vehicle Certification and Service Parts labels and certificates of title and registration.

Engine Identification

The eighth character in the VIN is the engine code. This code identifies the vehicle's engine, specifications, and replacement parts. See "Engine Specifications" under *Capacities and Specifications* on page 12-2 for the vehicle's engine code.

Service Parts Identification Label

The label is on the rear compartment storage floor and has the following information:

- Vehicle Identification Number (VIN).
- Model designation.
- Paint information.
- Production options and special equipment.

Do not remove this label from the vehicle.

Vehicle Data

Capacities and Specifications

The following approximate capacities are given in metric and English conversions. Refer to *Recommended Fluids and Lubricants on page 11-12* for more information.

Application	Capacities	
	Metric	English
Air Conditioning Refrigerant	For the air conditioning system refrigerant charge type and amount, see the refrigerant label under the hood. See your dealer for more information.	
Cooling Systems		
Engine	7.3 L	7.7 qt
High Voltage Battery	6.0 L	6.4 qt
Power Electronics	2.8 L	3.0 qt
Engine Oil with Filter	3.5 L	3.7 qt
Fuel Tank	35.2 L	9.3 gal
Electric Drive Unit	8.45 L	8.93 qt
Wheel Nut Torque	140 N•m	100 lb ft
All capacities are approximate. When adding, be sure to fill to the approximate level, as recommended in this manual.		

Engine Specifications

Engine	VIN Code	Electric Drive Unit	Spark Plug Gap
1.4L L4	4	Automatic	0.60–0.70 mm (0.024–0.027 in)

12-4 Technical Data

Engine Drive Belt Routing

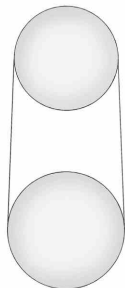

Customer Information

Customer Information

Customer Satisfaction Procedure	13-1
Customer Assistance Offices	13-3
Customer Assistance for Text Telephone (TTY) Users	13-4
Online Owner Center	13-4
Roadside Service	13-5
Scheduling Service	
Appointments	13-7
Courtesy Transportation Program	13-8
Collision Damage Repair	13-9
Service Publications	
Ordering Information	13-11
Radio Frequency Identification (RFID)	13-12
Radio Frequency Statement	13-12

Reporting Safety Defects

Reporting Safety Defects to the United States Government	13-13
Reporting Safety Defects to the Canadian Government	13-13
Reporting Safety Defects to General Motors	13-14

Vehicle Data Recording and Privacy

Vehicle Data Recording and Privacy	13-14
Event Data Recorders	13-14
OnStar®	13-15
Infotainment System	13-15

Customer Information

Customer Satisfaction Procedure

Your satisfaction and goodwill are important to your dealer and to Cadillac. Normally, any concerns with the sales transaction or the operation of the vehicle will be resolved by your dealer's sales or service departments. Sometimes, however, despite the best intentions of all concerned, misunderstandings can occur. If your concern has not been resolved to your satisfaction, the following steps should be taken:

STEP ONE: Discuss your concern with a member of dealership management. Normally, concerns can be quickly resolved at that level. If the matter has already been reviewed with the sales, service or parts manager, contact the owner of your dealership or the general manager.

13-2 Customer Information

STEP TWO: If after contacting a member of dealership management, it appears your concern cannot be resolved by your dealership without further help, in the U.S., call the Cadillac Customer Assistance Center at 855-422-3357 (855 4 CAD ELR). In Canada, call the Canadian Cadillac Customer Care Centre at 1-888-446-2000.

We encourage you to call the toll-free number in order to give your inquiry prompt attention. Have the following information available to give the Customer Assistance representative:

- Vehicle Identification Number (VIN). This is available from the vehicle registration or title, or the plate at the top left of the instrument panel and visible through the windshield.
- Dealership name and location.
- Vehicle delivery date and present mileage.

When contacting Cadillac, remember that your concern will likely be resolved at a dealer's facility. That is why we suggest following Step One first.

STEP THREE — U.S. Owners:

Both General Motors and your dealer are committed to making sure you are completely satisfied with the new vehicle. However, if you continue to remain unsatisfied after following the procedure outlined in Steps One and Two, you can file with the Better Business Bureau (BBB) Auto Line® Program to enforce your rights.

The BBB Auto Line Program is an out-of-court program administered by the Council of Better Business Bureaus to settle automotive disputes regarding vehicle repairs or the interpretation of the New Vehicle Limited Warranty. Although you may be required to resort to this informal dispute resolution program prior to filing a court action, use of the program is free of charge and your case will generally be heard within

40 days. If you do not agree with the decision given in your case, you may reject it and proceed with any other venue for relief available to you.

You may contact the BBB Auto Line Program using the toll-free telephone number or write them at the following address:

BBB Auto Line Program
Council of Better Business Bureaus, Inc.
4200 Wilson Boulevard
Suite 800
Arlington, VA 22203-1838

Telephone: 1-800-955-5100
www.dr.bbb.org/goauto

This program is available in all 50 states and the District of Columbia. Eligibility is limited by vehicle age, mileage, and other factors. General Motors reserves the right to change eligibility limitations and/or discontinue its participation in this program.

STEP THREE — Canadian

Owners: In the event that you do not feel your concerns have been addressed after following the procedure outlined in Steps One and Two, General Motors of Canada Limited wants you to be aware of its participation in a no-charge mediation/arbitration program. General Motors of Canada Limited has committed to binding arbitration of owner disputes involving factory-related vehicle service claims. The program provides for the review of the facts involved by an impartial third party arbiter, and may include an informal hearing before the arbiter. The program is designed so that the entire dispute settlement process, from the time you file your complaint to the final decision, should be completed in approximately 70 days. We believe our impartial program offers advantages over courts in most jurisdictions because it is informal, quick, and free of charge.

For further information concerning eligibility in the Canadian Motor Vehicle Arbitration Plan (CAMVAP), call toll-free 1-800-207-0685, or call the General Motors Customer Care Centre, 1-888-446-2000 (English), 1-800-263-7854 (French), or write to:

Mediation/Arbitration Program
c/o Customer Care Centre
General Motors of Canada Limited
Mail Code: CA1-163-005
1908 Colonel Sam Drive
Oshawa, Ontario L1H 8P7

The inquiry should be accompanied by the Vehicle Identification Number (VIN).

Customer Assistance Offices

Cadillac encourages customers to call the toll-free number for assistance. However, if a customer wishes to write or e-mail Cadillac, the letter should be addressed to:

United States and Puerto Rico

Cadillac Customer Assistance Center
Cadillac Motor Car Division
P.O. Box 33169
Detroit, MI 48232-5169
www.Cadillac.com

1-855-422-3357 (855 4 CAD ELR)
1-800-833-2622 (For Text Telephone devices (TTYs))
Roadside Service: 1-888-811-1926

From U.S. Virgin Islands:
1-800-496-9994

13-4 Customer Information

Canada

General Motors of Canada Limited
Canadian Cadillac Customer Care
Centre, Mail Code: CA1-163-005
1908 Colonel Sam Drive
Oshawa, Ontario L1H 8P7
www.gm.ca

1-888-446-2000 (English)
1-800-263-7854 (French)
Roadside Service: 1-800-882-1112

Overseas

Contact the local General Motors
Business Unit.

Customer Assistance for Text Telephone (TTY) Users

To assist customers who are deaf,
hard of hearing, or speech-impaired
and who use Text Telephones
(TTYs), Cadillac has TTY equipment
available at its Customer Assistance
Center. Any TTY user can

communicate with Cadillac by
dialing: 1-800-833-2622. TTY users
in Canada can dial 1-800-263-3830.

Online Owner Center

Online Owner Experience (U.S.) my.cadillac.com

The Cadillac online owner
experience is a one-stop resource
that allows interaction with Cadillac
and keeps important vehicle-specific
information in one place.

Membership Benefits

 **(Vehicle Information):**
Download owner manuals and view
vehicle-specific how-to videos.

 **(Maintenance Information):**
View maintenance schedules,
required alerts, OnStar onboard
vehicle diagnostic information, and
schedule service appointments.

 **(Service History):** View
printable dealer-recorded service
records and self-recorded service
records.

 **(Preferred Dealer
Information):** Select a preferred
dealer and view dealer location,
maps, phone numbers, and hours.

 **(Warranty Tracking
Information):** Track the vehicle's
warranty information.

 **(Recall Information):** View
active recalls or search by Vehicle
Identification Number (VIN). See
Vehicle Identification Number (VIN)
on page 12-1.

 **(Other Account Information):**
View GM Card, SiriusXM Satellite
radio, and OnStar account
information.

 **(Live Chat Support):** Chat live
with online help representatives.

 **(Charging and Efficiency):**
View the battery status, charging
information, and mileage history.

 **(Remote Commands):**
Remotely start/stop the vehicle,
activate the horn and lights alert,

and lock/unlock the vehicle. Requires an Android™ or iPhone® and an active OnStar subscription.

See my.cadillac.com to register the vehicle.

Cadillac Owner Centre (Canada) cadillacowner.ca

Take a trip to the Cadillac Owner Centre:

- Chat live with online help representatives.
- Locate owner resources such as lease-end, financing, and warranty information.
- Retrieve favorite articles, quizzes, tips, and multimedia galleries organized into the Features and Auto Care Sections.
- Download owner manuals.
- Find Cadillac-recommended maintenance services.

Roadside Service

U.S.: 1-888-811-1926.

Canada: 1-800-882-1112.

Text Telephone (TTY) Users (U.S. Only): 1-888-889-2438.

Service is available 24 hours a day, 365 days a year.

Calling for Service

When calling Roadside Service, have the following information ready:

- Your name, home address, and home telephone number.
- Telephone number of your location.
- Location of the vehicle.
- Model, year, color, and license plate number of the vehicle.
- Odometer reading, Vehicle Identification Number (VIN), and delivery date of the vehicle.
- Description of the problem.

Coverage

Services are provided up to 6 years/110 000 km (70,000 mi), whichever comes first.

In the U.S., anyone driving the vehicle is covered. In Canada, a person driving the vehicle without permission from the owner is not covered.

Roadside Service is not a part of the New Vehicle Limited Warranty. General Motors North America and Cadillac reserve the right to make any changes or discontinue the Roadside Service program at any time without notification.

General Motors North America and Cadillac reserve the right to limit services or payment to an owner or driver if they decide the claims are made too often, or the same type of claim is made many times.

13-6 Customer Information

Cadillac Owner Privileges™

- **Emergency Fuel Delivery:** Delivery of enough fuel for the vehicle to get to the nearest service station.
- **Lock-Out Service:** Service to unlock the vehicle if you are locked out. A remote unlock may be available if you have OnStar. For security reasons, the driver must present identification before this service is given.
- **Emergency Tow from a Public Road or Highway:** Tow to the nearest certified ELR or Volt dealer for warranty service, or if the vehicle was in a crash and cannot be driven. Assistance is not given when the vehicle is stuck in the sand, mud, or snow.

Emergency towing may be covered for the duration of the Extended Range Electric Vehicle (EREV) component warranty.

- **Flat Tire Change:** Service to change a flat tire with the tire sealant and compressor kit. If the tire has been separated from the wheel, has damaged sidewalls, or has a large puncture, the tire is too severely damaged for the tire sealant and compressor kit to be effective and the vehicle will have to be towed. It is the owner's responsibility for the repair or replacement of the tire if it is not covered by the warranty.
- **Battery Jump Start:** Service to jump start a dead battery.
- **Trip Interruption Benefits and Service:** If your trip is interrupted due to a warranty failure, incidental expenses may be reimbursed during the Powertrain warranty period. Items considered are hotel, meals and rental car.

Cadillac Technician Roadside Service (U.S. Only)

Cadillac's exceptional Roadside Service is more than an auto club or towing service. It provides every Cadillac owner in the United States with the advantage of contacting a Cadillac advisor and, where available, a Cadillac trained dealer technician who can provide on-site service.

A dealer technician will travel to your location within a 30-mile radius of a participating Cadillac dealership. If beyond this radius, we will arrange to have your car towed to the nearest Cadillac dealership. Each technician travels with a specially equipped service vehicle complete with the necessary Cadillac parts and tools required to handle most roadside repairs.

Services Not Included in Roadside Service

- Impound towing caused by violation of any laws.
- Legal fines.
- Mounting, dismounting, or changing of snow tires, chains, or other traction devices.

Service is not provided if a vehicle is in an area that is not accessible to the service vehicle or is not a regularly traveled or maintained public road, which includes ice and winter roads. Off-road use is not covered.

Services Specific to Canadian-Purchased Vehicles

- **Fuel delivery:** Reimbursement is up to 7 liters. Diesel fuel delivery may be restricted. Propane and other fuels are not provided through this service.
- **Lock-Out Service:** Vehicle registration is required.

- **Trip Interruption Benefits and Service:** Pre-authorization, original detailed receipts, and a copy of the repair orders are required. Once authorization has been received, the Roadside Service advisor will help you make arrangements and explain how to receive payment.
- **Alternative Service:** If assistance cannot be provided right away, the Roadside Service advisor may give you permission to get local emergency road service. You will receive payment, up to \$100, after sending the original receipt to Roadside Service. Mechanical failures may be covered, however any cost for parts and labor for repairs not covered by the warranty are the owner responsibility.

Scheduling Service Appointments

When the vehicle requires warranty service, contact your dealer and request an appointment. By scheduling a service appointment and advising the service consultant of your transportation needs, your dealer can help minimize your inconvenience.

If the vehicle cannot be scheduled into the service department immediately, keep driving it until it can be scheduled for service, unless, of course, the problem is safety related. If it is, please call your dealership, let them know this, and ask for instructions.

If your dealer requests you to bring the vehicle for service, you are urged to do so as early in the work day as possible to allow for same-day repair.

Courtesy Transportation Program

To enhance your ownership experience, we and our participating dealers are proud to offer Courtesy Transportation, a customer support program for vehicles with the Bumper-to-Bumper (Base Warranty Coverage period in Canada), and extended powertrain in both the U.S. and Canada.

Several Courtesy Transportation options are available to assist in reducing inconvenience when warranty repairs are required.

Courtesy Transportation is not a part of the New Vehicle Limited Warranty. A separate booklet entitled "Limited Warranty and Owner Assistance Information" furnished with each new vehicle provides detailed warranty coverage information.

Transportation Options

Warranty service can generally be completed while you wait. However, if you are unable to do so, your dealer may offer the following transportation options:

Shuttle Service

This includes one-way or round-trip shuttle service within reasonable time and distance parameters of your dealer's area.

Public Transportation or Fuel Reimbursement

If overnight warranty repairs are needed, and public transportation is used, the expense must be supported by original receipts and within the maximum amount allowed by GM for shuttle service. If U.S. customers arrange their own transportation, limited reimbursement for reasonable fuel expenses may be available. Claim amounts should reflect actual costs

and be supported by original receipts. See your dealer for information.

Courtesy Rental Vehicle

For an overnight warranty repair, the dealer may provide an available courtesy rental vehicle or provide for reimbursement of a rental vehicle. Reimbursement is limited and must be supported by original receipts as well as a signed and completed rental agreement and meet state/provincial, local, and rental vehicle provider requirements.

Requirements vary and may include minimum age requirements, insurance coverage, credit card, etc. Additional fees such as fuel usage charges, taxes, levies, usage fees, excessive mileage, or rental usage beyond the completion of the repair are also your responsibility.

It may not be possible to provide a like vehicle as a courtesy rental.

Additional Program Information

All program options, such as shuttle service, may not be available at every dealer. Contact your dealer for specific availability.

General Motors reserves the right to unilaterally modify, change, or discontinue Courtesy Transportation at any time and to resolve all questions of claim eligibility pursuant to the terms and conditions described herein at its sole discretion.

Collision Damage Repair

If the vehicle is involved in a collision and it is damaged, have the damage repaired by a qualified technician using the proper equipment and quality replacement parts. Poorly performed collision repairs diminish the vehicle resale value, and safety performance can be compromised in subsequent collisions.

Collision Parts

Genuine GM Collision parts are new parts made with the same materials and construction methods as the parts with which the vehicle was originally built. Genuine GM Collision parts are the best choice to ensure that the vehicle's designed appearance, durability, and safety are preserved. The use of Genuine GM parts can help maintain the GM New Vehicle Limited Warranty.

Recycled original equipment parts may also be used for repair. These parts are typically removed from vehicles that were total losses in prior crashes. In most cases, the parts being recycled are from undamaged sections of the vehicle. A recycled original equipment GM part may be an acceptable choice to maintain the vehicle's originally designed appearance and safety performance; however, the history of these parts is not known. Such parts are not covered by the GM New

Vehicle Limited Warranty, and any related failures are not covered by that warranty.

Aftermarket collision parts are also available. These are made by companies other than GM and may not have been tested for the vehicle. As a result, these parts may fit poorly, exhibit premature durability/corrosion problems, and may not perform properly in subsequent collisions. Aftermarket parts are not covered by the GM New Vehicle Limited Warranty, and any vehicle failure related to such parts is not covered by that warranty.

Repair Facility

GM also recommends that you choose a collision repair facility that meets your needs before you ever need collision repairs. Your dealer may have a collision repair center with GM-trained technicians and state-of-the-art equipment, or be able to recommend a collision repair

13-10 Customer Information

center that has GM-trained technicians and comparable equipment.

Insuring the Vehicle

Protect your investment in the GM vehicle with comprehensive and collision insurance coverage. There are significant differences in the quality of coverage afforded by various insurance policy terms. Many insurance policies provide reduced protection to the GM vehicle by limiting compensation for damage repairs by using aftermarket collision parts. Some insurance companies will not specify aftermarket collision parts. When purchasing insurance, we recommend that you ensure that the vehicle will be repaired with GM original equipment collision parts. If such insurance coverage is not available from your current insurance carrier, consider switching to another insurance carrier.

If the vehicle is leased, the leasing company may require you to have insurance that ensures repairs with Genuine GM Original Equipment Manufacturer (OEM) parts or Genuine Manufacturer replacement parts. Read the lease carefully, as you may be charged at the end of the lease for poor quality repairs.

If a Crash Occurs

If there has been an injury, call emergency services for help. Do not leave the scene of a crash until all matters have been taken care of. Move the vehicle only if its position puts you in danger, or you are instructed to move it by a police officer.

Give only the necessary information to police and other parties involved in the crash.

For emergency towing see *Roadside Service on page 13-5*.

Gather the following information:

- Driver name, address, and telephone number.

- Driver license number.
- Owner name, address, and telephone number.
- Vehicle license plate number.
- Vehicle make, model, and model year.
- Vehicle Identification Number (VIN).
- Insurance company and policy number.
- General description of the damage to the other vehicle.

Choose a reputable repair facility that uses quality replacement parts. See "Collision Parts" earlier in this section.

In a crash, the sensing system may shut down the high voltage system. See *Battery on page 10-23* for important safety information. If an airbag has inflated, see *What Will You See after an Airbag Inflates? on page 3-24*.

If the vehicle is damaged from a crash, flood, fire, or other event it may be necessary to have the vehicle inspected. See *Battery on page 10-23* and *High Voltage Safety Information on page 1-20* for important safety information.

Managing the Vehicle Damage Repair Process

In the event that the vehicle requires damage repairs, GM recommends that you take an active role in its repair. If you have a pre-determined repair facility of choice, take the vehicle there, or have it towed there. Specify to the facility that any required replacement collision parts be original equipment parts, either new Genuine GM parts or recycled original GM parts. Remember, recycled parts will not be covered by the GM vehicle warranty.

Insurance pays the bill for the repair, but you must live with the repair. Depending on your policy limits, your insurance company may initially value the repair using

aftermarket parts. Discuss this with the repair professional, and insist on Genuine GM parts. Remember, if the vehicle is leased, you may be obligated to have the vehicle repaired with Genuine GM parts, even if your insurance coverage does not pay the full cost.

If another party's insurance company is paying for the repairs, you are not obligated to accept a repair valuation based on that insurance company's collision policy repair limits, as you have no contractual limits with that company. In such cases, you can have control of the repair and parts choices as long as the cost stays within reasonable limits.

Service Publications Ordering Information

Service Manuals

Service Manuals have the diagnosis and repair information on the engine, electric drive unit, axle, suspension, brakes, electrical, steering, body, etc.

Service Bulletins

Service Bulletins give additional technical service information needed to knowledgeably service General Motors cars and trucks. Each bulletin contains instructions to assist in the diagnosis and service of the vehicle.

Owner Information

Owner publications are written specifically for owners and intended to provide basic operational information about the vehicle. The Owner Manual includes the Maintenance Schedule for all models.

13-12 Customer Information

In-Portfolio: Includes a Portfolio, Owner Manual, and Warranty Booklet.

RETAIL SELL PRICE: \$35.00 to \$40.00 (U.S.) plus handling and shipping fees.

Without Pouch: Owner Manual only.

RETAIL SELL PRICE:
\$25.00 (U.S.) plus handling and shipping fees.

Current and Past Models

Technical Service Bulletins and Manuals are available for current and past model GM vehicles.

**ORDER TOLL FREE:
1-800-551-4123 Monday - Friday
8:00 AM - 6:00 PM Eastern Time**

For Credit Card Orders Only
(VISA-MasterCard-Discover), visit
Helm, Inc. at: www.helminc.com

Or write to:

Helm, Incorporated
Attention: Customer Service
47911 Halyard Drive
Plymouth, MI 48170

Prices are subject to change without notice and without incurring obligation. Allow ample time for delivery.

All listed prices are quoted in U.S. funds. Make checks payable in U.S. funds.

Radio Frequency Identification (RFID)

RFID technology is used in some vehicles for functions such as tire pressure monitoring and ignition system security, as well as in connection with conveniences such as Remote Keyless Entry (RKE) transmitters for remote door locking/unlocking and starting, and in-vehicle transmitters for garage door openers. RFID technology in GM vehicles does not use or record

personal information or link with any other GM system containing personal information.

Radio Frequency Statement

This vehicle has systems that operate on a radio frequency that complies with Part 15/Part 18 of the Federal Communications Commission (FCC) rules and with Industry Canada Standards RSS-GEN/210/220/310.

Operation is subject to the following two conditions:

1. The device may not cause harmful interference.
2. The device must accept any interference received, including interference that may cause undesired operation of the device.

Changes or modifications to any of these systems by other than an authorized service facility could void authorization to use this equipment.

Reporting Safety Defects

Reporting Safety Defects to the United States Government

If you believe that your vehicle has a defect which could cause a crash or could cause injury or death, you should immediately inform the National Highway Traffic Safety Administration (NHTSA) in addition to notifying General Motors.

If NHTSA receives similar complaints, it may open an investigation, and if it finds that a safety defect exists in a group of vehicles, it may order a recall and remedy campaign.

However, NHTSA cannot become involved in individual problems between you, your dealer, or General Motors.

To contact NHTSA, you may call the Vehicle Safety Hotline toll-free at 1-888-327-4236 (TTY: 1-800-424-9153); go to <http://www.safercar.gov>; or write to:

Administrator, NHTSA
1200 New Jersey Avenue, S.E.
Washington, D.C. 20590

You can also obtain other information about motor vehicle safety from <http://www.safercar.gov>.

Reporting Safety Defects to the Canadian Government

If you live in Canada, and you believe that the vehicle has a safety defect, notify Transport Canada immediately, and notify General Motors of Canada Limited. Call Transport Canada at 1-800-333-0510 or write to:

Transport Canada
Road Safety Branch
80 rue Noel
Gatineau , QC J8Z 0A1

Reporting Safety Defects to General Motors

In addition to notifying NHTSA (or Transport Canada) in a situation like this, notify General Motors.

Call 1-800-458-8006, or write:

Cadillac Customer Assistance
Center
Cadillac Motor Car Division
P.O. Box 33169
Detroit , MI 48232-5169

In Canada, call 1-888-446-2000,
or write:

Canadian Cadillac Customer Care
Centre, Mail Code: CA1-163-005
General Motors of Canada Limited
1908 Colonel Sam Drive
Oshawa , Ontario L1H 8P7

Vehicle Data Recording and Privacy

The vehicle has a number of computers that record information about the vehicle's performance and how it is driven. For example, the vehicle uses computer modules to monitor and control engine and electric drive unit performance, to monitor the conditions for airbag deployment and to deploy them in a crash, and, if equipped, to provide antilock braking to help the driver control the vehicle. These modules may store data to help the dealer technician service the vehicle. Some modules may also store data about how the vehicle is operated, such as rate of fuel consumption or average speed. These modules may retain personal preferences, such as radio presets, seat positions, and temperature settings.

Event Data Recorders

This vehicle is equipped with an event data recorder (EDR). The main purpose of an EDR is to record, in certain crash or near crash-like situations, such as an air bag deployment or hitting a road obstacle, data that will assist in understanding how a vehicle's systems performed. The EDR is designed to record data related to vehicle dynamics and safety systems for a short period of time, typically 30 seconds or less. The EDR in this vehicle is designed to record such data as:

- How various systems in your vehicle were operating;
- Whether or not the driver and passenger safety belts were buckled/fastened;
- How far (if at all) the driver was depressing the accelerator and/or brake pedal; and,
- How fast the vehicle was traveling.

These data can help provide a better understanding of the circumstances in which crashes and injuries occur. NOTE: EDR data are recorded by your vehicle only if a non-trivial crash situation occurs; no data are recorded by the EDR under normal driving conditions and no personal data (e.g., name, gender, age, and crash location) are recorded. However, other parties, such as law enforcement, could combine the EDR data with the type of personally identifying data routinely acquired during a crash investigation.

To read data recorded by an EDR, special equipment is required, and access to the vehicle or the EDR is needed. In addition to the vehicle manufacturer, other parties, such as law enforcement, that have the special equipment, can read the information if they have access to the vehicle or the EDR.

GM will not access this data or share it with others except: with the consent of the vehicle owner or, if the vehicle is leased, with the consent of the lessee; in response to an official request by police or similar government office; as part of GM's defense of litigation through the discovery process; or, as required by law. Data that GM collects or receives may also be used for GM research needs or may be made available to others for research purposes, where a need is shown and the data is not tied to a specific vehicle or vehicle owner.

OnStar®

If the vehicle is equipped with OnStar® and has an active subscription, additional data may be collected through the OnStar system. This includes information about the vehicle's operation; collisions involving the vehicle; the

use of the vehicle and its features; and, in certain situations, the location and approximate GPS speed of the vehicle. Refer to the OnStar Terms and Conditions and Privacy Statement on the OnStar website.

Infotainment System

Using the navigation system may result in the storage of destinations, addresses, telephone numbers, and other trip information. See the infotainment manual for information on stored data and for deletion instructions.

OnStar

OnStar Overview

OnStar Overview 14-1

OnStar Services

Emergency 14-2

Security 14-3

Navigation 14-3

Connections 14-4

Vehicle Diagnostics 14-6

OnStar Additional Information

OnStar Additional
Information 14-6

OnStar Overview



 Voice Command Button



 Blue OnStar Button



 Emergency Button

This vehicle may be equipped with a comprehensive, in-vehicle system that can connect to a live OnStar Advisor for Emergency, Security, Navigation, Connection, and Diagnostic Services. OnStar services may require a paid subscription. OnStar requires the vehicle battery and electrical system, cellular service, and GPS satellite signals to be available and operating. OnStar acts as a link to

existing public emergency service providers. OnStar may collect information about you and your vehicle, including location information. See OnStar's Terms and Conditions and Privacy Statement for more details including system limitations at www.onstar.com (U.S.) or www.onstar.ca (Canada).

The OnStar system status light is next to the OnStar buttons. If the status light is:

- Solid Green: System is on.
- Flashing Green: On a call.
- Red: Indicates a problem.
- Off: System is off. Press the blue OnStar button twice to speak with an OnStar Advisor.

Press  or call 1-888-4-ONSTAR (1-888-466-7827) to speak to an Advisor.

Press  to:

- Make a call, end a call, or answer an incoming call.
- Give OnStar Hands-Free Calling voice commands.
- Give OnStar Turn-by-Turn Navigation voice commands. Requires a specific OnStar subscription plan.
- Obtain the WiFi network name, or Service Set Identifier or SSID, and passphrase (if equipped).

Press  to connect to a live Advisor to:

- Verify account information or update contact information.
- Get driving directions. Requires a specific OnStar subscription plan..

- Receive On-Demand Diagnostics for a check of the vehicle's key operating systems.
- Receive Roadside Assistance.
- Manage WiFi Settings (if equipped).

Press  to get a priority connection to an OnStar Emergency Advisor available 24/7 to:

- Get help for an emergency.
- Be a Good Samaritan or respond to an AMBER Alert.
- Get assistance in severe weather or other crisis and evacuation routes.

OnStar Services

Emergency

With Automatic Crash Response, the OnStar system can automatically connect to an OnStar Emergency Advisor. The built-in system can automatically connect to help in certain crashes.

Press  to connect to an OnStar Emergency Advisor. GPS technology is used to identify the vehicle location and can provide important information to emergency personnel. OnStar Emergency Advisors are trained to provide assistance and link to existing public emergency service providers in emergency situations.

With OnStar Crisis Assist, specially trained Crisis Advisors are available 24 hours a day, 7 days a week, to provide a central point of contact, assistance, and information if a crisis occurs.

Security

OnStar provides services including Stolen Vehicle Assistance, Remote Ignition Block, and Roadside Assistance, if equipped. OnStar can unlock the vehicle doors remotely, if equipped with automatic door locks, and can help police locate the vehicle if it is stolen.

Navigation

OnStar navigation requires a specific OnStar subscription plan.

Press  to receive directions or have them sent to the vehicle navigation screen, if equipped. Destinations can also be forwarded to the vehicle from MapQuest.com.

Turn-by-Turn Navigation

1. Press  to connect to a live Advisor.
2. Request directions.
3. Directions are downloaded to the vehicle.

4. Follow the voice-guided commands.

Using Voice Commands During a Planned Route

Cancel Route

1. Press . System responds: "OnStar ready," then a tone. Say "Cancel route." System responds: "Do you want to cancel directions?"
2. Say "Yes." System responds: "OK, request completed, thank you, goodbye."

Route Preview

1. Press . System responds: "OnStar ready," then a tone.
2. Say "Route preview." System responds with the next three maneuvers.

Repeat

1. Press . System responds: "OnStar ready," then a tone.

2. Say "Repeat." System responds with the last direction given, then responds with "OnStar ready," then a tone.

Get My Destination

1. Press . System responds: "OnStar ready," then a tone.
2. Say "Get my destination." System responds with the address and the distance to the destination, then responds with "OnStar ready," then a tone.

Other Navigation Services Available from OnStar

OnStar eNav: Subscribers can send destinations from MapQuest.com to the vehicle Turn-by-Turn Navigation or screen-based navigation system (if equipped). When ready, the directions will be downloaded to the vehicle.

Destination Download: Press , then request the Advisor to download directions to the navigation system in the vehicle (if equipped). After the call ends, press the "Go" button on the navigation screen to begin driving directions.

If directions are downloaded to the navigation system, the route can only be canceled through the navigation system.

Destinations can also be downloaded on the go. For information about eNav or Destination Download, see www.onstar.com (U.S.) or www.onstar.ca (Canada).



Connections

The required specific Onstar subscription plan includes the services that follow to help customers stay connected.

For coverage maps, see www.onstar.com (U.S.) or www.onstar.ca (Canada).

WiFi Connectivity (If Equipped)

The vehicle has a WiFi hotspot that provides a high-speed, wireless Internet connection to connect multiple mobile devices (data plan required).

1. To retrieve WiFi hotspot information, press  and select or say "WiFi settings."
2. The WiFi settings will display the WiFi network name/SSID, passphrase, and level of encryption.
3. To change the SSID or passphrase, press  or call 1-888-4-ONSTAR to connect with an Advisor.

OnStar RemoteLink[®] Mobile App (If Equipped)

Download the OnStar RemoteLink mobile app to select Apple[®], Android[™], and BlackBerry[®] or Windows 7 or 8 mobile devices. From the mobile device, check the vehicle's fuel level, oil life, or tire

pressure (if the vehicle is equipped with the tire pressure monitoring system); or activate remote horn and lights. Also remote start the vehicle (if factory equipped) or unlock the doors from anywhere with a wireless connection (if equipped with automatic locks). With a required specific OnStar subscription plan, a destination can be sent to the vehicle. For OnStar RemoteLink information and compatibility, see www.onstar.com (U.S.) or www.onstar.ca (Canada).

OnStar RemoteLink[®] Key Fob Services

This feature is included for five years and allows for remote door lock/unlock (if equipped with automatic locks), remote start (if factory equipped), or activation of horn and lights from anywhere with a wireless signal. Download the app and start using it any time during the trial period to get started.

OnStar Hands-Free Calling

This service allows calls to be made and received from the vehicle.

To Make a Call

1. Press . System responds: "OnStar ready."
2. Say "Call." System responds: "Call. Please say the name or number to call."
3. Say the entire number without pausing, including a "1" and the area code. System responds: "OK calling."

Calling 911 Emergency

1. Press . System responds: "OnStar Ready," followed by a tone.
2. Say "Call." System responds: "Call. Please say the name or number to call."
3. Say "911" without pausing. System responds: "911."

4. Say "Call." System responds: "OK, dialing 911."

Retrieve My Number

1. Press . System responds: "OnStar ready."
2. Say "My number." System responds: "Your OnStar Hands-Free Calling number is," then says the number.

End a Call

Press . System responds: "Call ended."

Store a Name Tag for Speed Dialing

1. Press . System responds: "OnStar ready."
2. Say "Store." System responds: "Please say the number you would like to store."

3. Say the entire number without pausing. System responds: "Please say the name tag."
4. Pick a name tag. System responds: "About to store <name tag>. Does that sound OK?"
5. Say "Yes" or say "No" to try again. System responds: "OK, storing <name tag>."

Place a Call Using a Stored Number

1. Press . System responds: "OnStar ready."
2. Say "Call <name tag>." System responds: "OK, calling <name tag>."

Verify Minutes and Expiration

Press  and say "Minutes" then "Verify" to check how many minutes remain and their expiration date.

Vehicle Diagnostics

OnStar Vehicle Diagnostics can perform a vehicle check every month. It will check the electric drive unit, antilock brakes, and major vehicle systems. It also checks the tire pressures, if the vehicle is equipped with the Tire Pressure Monitoring System. If an On-Demand Diagnostics check is needed, press **On**, and an Advisor can run a check.

OnStar Additional Information

Transferring Service

Press **On** to request account transfer eligibility information. The Advisor can assist in canceling or removing account information.

Selling/Transferring the Vehicle

Call 1-888-4-ONSTAR immediately to terminate your OnStar services if the vehicle is disposed of, sold, transferred, or if the lease ends.

Reactivation for Subsequent Owners

Press **On** and follow the prompts to speak to an Advisor as soon as possible. The Advisor will update vehicle records and explain the OnStar service options available.

How OnStar Service Works

Automatic Crash Response, Emergency Services, Crisis Assist, Stolen Vehicle Assistance, Vehicle Diagnostics, Remote Door Unlock, Roadside Assistance, Turn-by-Turn Navigation, and Hands-Free Calling are available on most vehicles. Not all OnStar services are available everywhere or on all vehicles. For more information, a full description of OnStar services, system limitations, and OnStar terms and conditions:

- Call 1-888-4-ONSTAR (1-888-466-7827).
- See www.onstar.com (U.S.).
- See www.onstar.ca (Canada).
- Call TTY 1-877-248-2080.
- Press **On** to speak with an Advisor.

OnStar services cannot work unless the vehicle is in a place where OnStar has an agreement with a wireless service provider for service in that area. The wireless service provider must also have coverage, network capacity, reception, and technology compatible with OnStar services. Service involving location information about the vehicle cannot work unless GPS signals are available, unobstructed, and compatible with the OnStar hardware. OnStar services may not work if the OnStar equipment is not properly installed or it has not been properly maintained. If equipment or software is added, connected, or modified, OnStar services may not work. Other problems beyond the control of OnStar may prevent service such as hills, tall buildings, tunnels, weather, electrical system design and architecture of the vehicle, damage to the vehicle in a crash, or wireless phone network congestion or jamming.

See *Radio Frequency Statement on page 13-12*.

Services for People with Disabilities

Advisors provide services to help subscribers with physical disabilities and medical conditions.

Press  for help with:

- Locating a gas station with an attendant to pump gas.
- Finding a hotel, restaurant, etc., that meets accessibility needs.
- Providing directions to the closest hospital or pharmacy in urgent situations.

TTY Users

OnStar has the ability to communicate to deaf, hard-of-hearing, or speech-impaired customers while in the vehicle. The available dealer-installed TTY system can provide in-vehicle

access to all of the OnStar services, except Virtual Advisor and OnStar Turn-by-Turn Navigation.

OnStar Personal Identification Number (PIN)

A PIN is needed to access some of the OnStar services, like Remote Door Unlock and Stolen Vehicle Assistance. The PIN will need to be changed the first time when speaking with an Advisor. To change the OnStar PIN, contact an OnStar Advisor by pressing  or calling 1-888-4-ONSTAR.

Warranty

OnStar equipment may be warranted as part of the vehicle warranty.

Languages

The vehicle can be programmed to respond in multiple languages.

Press  and ask for an Advisor. Advisors are available in English, Spanish, and French. Available languages may vary by country.

Potential Issues

OnStar cannot perform Remote Door Unlock or Stolen Vehicle Assistance after the vehicle has been off continuously for five days. After five days, OnStar can contact Roadside Assistance and a locksmith to help gain access to the vehicle.

Global Positioning System (GPS)

- Obstruction of the GPS can occur in a large city with tall buildings; in parking garages; around airports; in tunnels, underpasses; or in an area with very dense trees. If GPS signals are not available, the OnStar system should still operate to call OnStar. However, OnStar could have difficulty identifying the exact location.
- In emergency situations, OnStar can use the last stored GPS location to send to emergency responders.

A temporary loss of GPS can cause loss of the ability to send a Turn-by-Turn Navigation route. The Advisor may give a verbal route or may ask for a call back after the vehicle is driven into an open area.

Cellular and GPS Antennas

Do not place items over or near the antenna to prevent blocking cellular and GPS signal reception. Cellular reception is required for OnStar to send remote signals to the vehicle.

Unable to Connect to OnStar Message

If there is limited cellular coverage or the cellular network has reached maximum capacity, this message may come on. Press  to try the call again or try again after driving a few miles into another cellular area.

Vehicle and Power Issues

OnStar services require a vehicle electrical system, wireless service, and GPS satellite technologies to be available and operating for features

to function properly. These systems may not operate if the battery is discharged or disconnected.

Add-on Electrical Equipment

The OnStar system is integrated into the electrical architecture of the vehicle. Do not add any electrical equipment. See *Add-On Electrical Equipment on page 9-71*. Added electrical equipment may interfere with the operation of the OnStar system and cause it to not operate.

Privacy

The complete OnStar Privacy Statement may be found at www.onstar.com (U.S.), or www.onstar.ca (Canada). We recommend that you review it. If you have any questions, call 1-888-4-ONSTAR (1-888-466-7827) or press  to speak with an Advisor. Users of wireless communications are cautioned that the privacy of any information sent via wireless cellular communications cannot be assured. Third parties

may unlawfully intercept or access transmissions and private communications without consent.

OnStar - software acknowledgements

Certain OnStar components include libcurl and unzip software and other third party software. Below are the notices and licenses associated with libcurl and unzip and for other third party software please see <http://www.lg.com/global/support/opensource/index> and <https://www.onstar.com/web/portal/getdocuments>

libcurl:

COPYRIGHT AND PERMISSION NOTICE

Copyright (c) 1996 - 2010, Daniel Stenberg, <daniel@haxx.se>.

All rights reserved.

Permission to use, copy, modify, and distribute this software for any purpose with or without fee is hereby granted, provided that the

above copyright notice and this permission notice appear in all copies.

THE SOFTWARE IS PROVIDED "AS IS," WITHOUT WARRANTY OF ANY KIND, EXPRESS OR IMPLIED, INCLUDING BUT NOT LIMITED TO THE WARRANTIES OF MERCHANTABILITY, FITNESS FOR A PARTICULAR PURPOSE AND NONINFRINGEMENT OF THIRD PARTY RIGHTS. IN NO EVENT SHALL THE AUTHORS OR COPYRIGHT HOLDERS BE LIABLE FOR ANY CLAIM, DAMAGES OR OTHER LIABILITY, WHETHER IN AN ACTION OF CONTRACT, TORT OR OTHERWISE, ARISING FROM, OUT OF OR IN CONNECTION WITH THE SOFTWARE OR THE USE OR OTHER DEALINGS IN THE SOFTWARE.

Except as contained in this notice, the name of a copyright holder shall not be used in advertising or otherwise to promote the sale, use

or other dealings in this Software without prior written authorization of the copyright holder.

unzip:

This is version 2005-Feb-10 of the Info-ZIP copyright and license. The definitive version of this document should be available at <ftp://ftp.info-zip.org/pub/infozip/license.html> indefinitely.

Copyright (c) 1990-2005 Info-ZIP. All rights reserved.

For the purposes of this copyright and license, "Info-ZIP" is defined as the following set of individuals:

Mark Adler, John Bush, Karl Davis, Harald Denker, Jean-Michel Dubois, Jean-loup Gailly, Hunter Goatley, Ed Gordon, Ian Gorman, Chris Herborth, Dirk Haase, Greg Hartwig, Robert Heath, Jonathan Hudson, Paul Kienitz, David Kirschbaum, Johnny Lee, Onno van der Linden, Igor Mandrichenko, Steve P. Miller, Sergio Monesi, Keith Owens, George Petrov, Greg Roelofs, Kai

Uwe Rommel, Steve Salisbury, Dave Smith, Steven M. Schweda, Christian Spieler, Cosmin Truta, Antoine Verheijen, Paul von Behren, Rich Wales, Mike White.

This software is provided “as is,” without warranty of any kind, express or implied. In no event shall Info-ZIP or its contributors be held liable for any direct, indirect, incidental, special or consequential damages arising out of the use of or inability to use this software.

Permission is granted to anyone to use this software for any purpose, including commercial applications, and to alter it and redistribute it freely, subject to the following restrictions:

1. Redistributions of source code must retain the above copyright notice, definition, disclaimer, and this list of conditions.
2. Redistributions in binary form (compiled executables) must reproduce the above copyright notice, definition, disclaimer, and

this list of conditions in documentation and/or other materials provided with the distribution. The sole exception to this condition is redistribution of a standard UnZipSFX binary (including SFXWiz) as part of a self-extracting archive; that is permitted without inclusion of this license, as long as the normal SFX banner has not been removed from the binary or disabled.

3. Altered versions—including, but not limited to, ports to new operating systems, existing ports with new graphical interfaces, and dynamic, shared, or static library versions—must be plainly marked as such and must not be misrepresented as being the original source. Such altered versions also must not be misrepresented as being Info-ZIP releases—including, but not limited to, labeling of the altered versions with the names “Info-ZIP” (or any variation

thereof, including, but not limited to, different capitalizations), “Pocket UnZip,” “WiZ” or “MacZip” without the explicit permission of Info-ZIP. Such altered versions are further prohibited from misrepresentative use of the Zip-Bugs or Info-ZIP e-mail addresses or of the Info-ZIP URL(s).

4. Info-ZIP retains the right to use the names “Info-ZIP,” “Zip,” “UnZip,” “UnZipSFX,” “WiZ,” “Pocket UnZip,” “Pocket Zip,” and “MacZip” for its own source and binary releases.

A

Accessories and
Modifications 10-2

Accessory Power 9-19

Active Emergency
Braking System 1-19, 9-53

Adaptive Cruise Control 9-39

Add-On Electrical
Equipment 9-71

Additional Information
OnStar® 14-6

Additional Maintenance
and Care 11-9

Adjustments
Lumbar, Front Seats 3-4
Thigh Support 3-5

Air Cleaner/Filter, Engine 10-13

Air Filter, Passenger
Compartment 8-8

Air Vents 8-7

Airbag System
Check 3-31
How Does an Airbag
Restrain? 3-23
Passenger Sensing
System 3-25

Airbag System (cont'd)
What Makes an Airbag
Inflate? 3-23

What Will You See after an
Airbag Inflates? 3-24

When Should an Airbag
Inflate? 3-22

Where Are the Airbags? 3-21

Airbags
Adding Equipment to the
Vehicle 3-30
Passenger Status Indicator 5-16
Readiness Light 5-16
Servicing Airbag-Equipped
Vehicles 3-30
System Check 3-19

Alarm
Vehicle Security 2-15

Alert
Side Blind Zone (SBZA) 9-55

All-Season Tires 10-42

Antilock Brake
System (ABS) 9-29
Warning Light 5-21

Appearance Care
Exterior 10-79
Interior 10-84

Assistance Systems for
Driving 9-50

Assistance Systems for
Parking and Backing 9-48

Automatic
Door Locks 2-13
Headlamp System 6-4

B

Battery 10-23
Exterior Lighting Battery
Saver 6-8
Gauge 5-12
High Voltage 5-12
Jump Starting 10-69
Power Protection 6-8

Battery and Charging
Messages 5-41

Blade Replacement, Wiper 10-26

Brake
Parking, Electric 9-30
System Warning Light 5-20

Brakes 10-20
Antilock 9-29
Fluid 10-21

Brakes (cont'd)		Child Restraints (cont'd)	
Regenerative Braking	9-32	Older Children	3-32
System Messages	5-42	Securing	3-45, 3-47
Braking	9-6	Systems	3-37
Braking System		Cleaning	
Active Emergency	1-19	Exterior Care	10-79
Break-In, New Vehicle	9-16	Interior Care	10-84
Bulb Replacement	10-28	Climate Control Systems	
Headlamp Aiming	10-27	Dual Automatic	8-1
Headlamps	10-27	Clock	5-5
License Plate Lamps	10-27	Cluster, Instrument	5-8
Buying New Tires	10-55	Collision Damage Repair	13-9
		Compartments	
C		Storage	4-1
Calibration	5-5	Compass	5-5
California		Messages	5-42
Fuel Requirements	9-68	Competitive Driving Mode	9-36
Perchlorate Materials		Compressor Kit, Tire	
Requirements	10-2	Sealant	10-62
Warning	10-2	Connections	
Canadian Vehicle Owners	iii	OnStar®	14-4
Capacities and		Continuous Damping	
Specifications	12-2	Control (CDC)	9-36
		Control	
Carbon Monoxide		Traction and Electronic	
Engine Exhaust	9-27	Stability	9-33
Trunk	2-13	Control of a Vehicle	9-6
Winter Driving	9-10		
Cautions, Danger, and			
Warnings	iv		
Center Console Storage	4-2		
Center Stack Display	5-27		
Chains, Tire	10-60		
Charge Cord	9-64		
Charging			
Delay Override	9-60		
Electrical Requirements	9-66		
Plug-In	9-58		
Programmable	5-29		
Utility Interruption	9-65		
Charging Status Screens	9-60		
Charging System Light	5-17		
Check			
Engine Light	5-17		
Child Restraints			
Infants and Young			
Children	3-34		
Lower Anchors and			
Tethers for Children	3-40		

Convex Mirrors 2-17

Coolant

 Engine 10-16

 Engine Temperature

 Warning Light 5-23

Cooling System 10-14–10-16

 Engine Messages 5-44

Courtesy Lamps 6-6

Courtesy Transportation

 Program 13-8

Cruise Control 9-37

 Light 5-26

 Messages 5-42

Cruise Control, Active 9-39

Cupholders 4-2

Customer Assistance 13-4

 Offices 13-3

 Text Telephone (TTY)

 Users 13-4

Customer Information

 Service Publications

 Ordering Information 13-11

Customer Satisfaction

 Procedure 13-1

D

Damage Repair, Collision 13-9

Danger, Warnings, and

 Cautions iv

Data Recorders, Event 13-14

Daytime Running

 Lamps (DRL) 6-4

Defensive Driving 9-5

Delayed Charging Override 9-60

Delayed Locking 2-12

Display

 Center Stack 5-27

 Distracted Driving 9-4

Dome Lamps 6-6

Door

 Ajari Light 5-27

 Ajari Messages 5-43

 Delayed Locking 2-12

 Locks 2-10

 Power Locks 2-11

Drive Belt Routing, Engine 12-4

Drive Mode Messages 5-44

Drive Unit

 Electric 9-28

Driver Assistance Systems 9-47

Driver Efficiency Gauge 5-13

Driver Information

 Center (DIC) 5-38

Driver Mode Control 9-35

Driver Selected Operating

 Modes 9-22

Driving

 Assistance Systems 9-50

 Defensive 9-5

 Drunk 9-5

 Hill and Mountain Roads 9-9

 If the Vehicle is Stuck 9-12

 Loss of Control 9-8

 Off-Road Recovery 9-7

 Vehicle Load Limits 9-12

 Wet Roads 9-8

 Winter 9-10

Driving for Better

 Energy Efficiency 1-26, 9-2

Driving Mode

 Competitive 9-36

Dual Automatic Climate

 Control System 8-1

E

Easy Entry Seat	3-3
Electric Drive Unit	9-28
Electric Drive Unit Messages	5-44
Electric Drive Unit Shift Lock Control Function Check	10-25
Electric Mode	9-21
Electric Parking Brake	9-30
Electric Parking Brake Light ...	5-21
Electrical Equipment, Add-On	9-71
Electrical Requirements for Battery Charging	9-66
Electrical System Engine Compartment Fuse Block	10-29
Instrument Panel Fuse Block	10-33, 10-35
Overload	10-29
Rear Compartment Fuse Block	10-38
Emergency OnStar®	14-2

Energy Efficiency Driving	1-26, 9-2
Energy Information	5-38
Engine Air Cleaner/Filter	10-13
Check and Service Engine Soon Light	5-17
Compartment Overview	10-8
Coolant	10-16
Coolant Temperature Warning Light	5-23
Cooling System	10-14–10-16
Cooling System Messages ...	5-44
Drive Belt Routing	12-4
Exhaust	9-27
Oil Life System	10-12
Oil Messages	5-44
Overheating	10-19
Pressure Light	5-24
Running While Parked	9-27
Engine Unavailable Out of Fuel	9-24
Entry Lighting	6-8
Event Data Recorders	13-14
Exit Lighting	6-8

Extended Range Mode	9-22
Extender, Safety Belt	3-17
Exterior Lamp Controls	6-1
Exterior Lamps Off Reminder ...	6-3
Exterior Lighting Battery Saver	6-8

F

Features Memory	1-9
Filter, Engine Air Cleaner	10-13
Flash-to-Pass	6-4
Flashers, Hazard Warning	6-5
Flat Tire	10-61
Floor Mats	10-87
Fluid Brakes	10-21
Washer	10-19
Folding Mirrors	2-18
Forward Collision Alert (FCA) System	9-50
Frequency Statement Radio	13-12

Front Seats
 Heated 3-8
 Fuel 9-67
 Additives 9-68
 Filling a Portable Fuel
 Container 9-70
 Filling the Tank 9-68
 Foreign Countries 9-68
 Gauge 5-13
 Low Fuel Warning Light 5-25
 Requirements, California 9-68
 System Messages 5-45
 Function Check
 Electric Drive Unit Shift
 Lock Control 10-25
 Fuses
 Engine Compartment
 Fuse Block 10-29
 Instrument Panel
 Fuse Block 10-33, 10-35
 Rear Compartment Fuse
 Block 10-38

G

Garage Door Opener 5-59
 Programming 5-59
 Gauges
 Battery 5-12
 Driver Efficiency 5-13
 Fuel 5-13
 Odometer 5-12
 Power Indicator 5-14
 Speedometer 5-12
 Trip Odometer 5-12
 Warning Lights and
 Indicators 5-7
 General Information
 Service and Maintenance 11-1
 Towing 9-71
 Vehicle Care 10-2
 Glove Box 4-1

H

Hazard Warning Flashers 6-5
 Head Restraints 3-2

Headlamps
 Aiming 10-27
 Automatic 6-4
 Bulb Replacement 10-27
 Daytime Running
 Lamps (DRL) 6-4
 Flash-to-Pass 6-4
 High-Beam On Light 5-26
 High/Low Beam Changer 6-3
 Lamps On Reminder 5-26
 Heated
 Steering Wheel 5-2
 Heated Front Seats 3-8
 Heated Mirrors 2-18
 High Voltage Battery Gauge 5-12
 High Voltage Devices and
 Wiring 10-28
 High-Beam On Light 5-26
 Hill and Mountain Roads 9-9
 Hood 10-6
 Horn 5-3
 How to Wear Safety Belts
 Properly 3-13

I

Immobilizer	2-16
Indicator	
Vehicle Ahead	5-22
Infants and Young Children,	
Restraints	3-34
Information	
Energy	5-38
Infotainment	7-1
Infotainment System	13-15
Instrument Cluster	5-8
Instrument Panel	
Storage Area	4-1
Instrument Panel Overview	1-2
Interior Rearview Mirrors	2-18
Introduction	iii

J

Jump Starting	10-69
---------------------	-------

K

Key and Lock Messages	5-45
Keyless Entry	
Remote (RKE) System	2-2
Keys	2-1

L

Labeling, Tire Sidewall	10-43
Lamps	
Courtesy	6-6
Daytime Running (DRL)	6-4
Dome	6-6
Exterior Controls	6-1
Exterior Lamps Off	
Reminder	6-3
Exterior Lighting Battery	
Saver	6-8
License Plate	10-27
Malfunction Indicator	5-17
Messages	5-46
On Reminder	5-26
Reading	6-7
Lane Departure	
Warning (LDW)	9-56
Lane Departure Warning	
Light	5-22
Lap-Shoulder Belt	3-14
LATCH System	
Replacing Parts after a	
Crash	3-45
LATCH, Lower Anchors and	
Tethers for Children	3-40

LED Lighting	10-27
Lifting the Vehicle, Tires	10-3
Light	
Ready Indicator	5-26
Vehicle Ready	5-26
Lighting	
Entry	6-8
Exit	6-8
Illumination Control	6-6
LED	10-27
Lights	
Airbag Readiness	5-16
Antilock Brake System	
(ABS) Warning	5-21
Brake System Warning	5-20
Charging System	5-17
Cruise Control	5-26
Door Ajar	5-27
Electric Parking Brake	5-21
Engine Coolant	
Temperature Warning	5-23
Engine Oil Pressure	5-24
Flash-to-Pass	6-4
High-Beam On	5-26
High/Low Beam Changer	6-3
Lane Departure Warning	5-22

Lights (cont'd)

- Low Fuel Warning 5-25
- Safety Belt Reminders 5-14
- Security 5-25
- Service Electric Parking
 - Brake 5-21
- StabiliTrak® OFF 5-23
- Tire Pressure 5-24
- Traction Control System
(TCS)/StabiliTrak® 5-23
- Traction Off 5-22
- Locks
 - Automatic Door 2-13
 - Delayed Locking 2-12
 - Door 2-10
 - Lockout Protection 2-13
 - Power Door 2-11
- Loss of Control 9-8
- Low Fuel Warning Light 5-25
- Lower Anchors and Tethers
for Children (LATCH
System) 3-40
- Lumbar Adjustment 3-4
 - Front Seats 3-4

M

- Maintenance
 - Records 11-14
- Maintenance and Care
 - Additional 11-9
- Maintenance Modes 9-25
- Maintenance Schedule 11-2
 - Recommended Fluids
and Lubricants 11-12
- Malfunction Indicator Lamp 5-17
- Memory Features 1-9
- Memory Seats 3-6
- Messages
 - Airbag System 5-49
 - Brake System 5-42
 - Compass 5-42
 - Door Ajar 5-43
 - Drive Mode 5-44
 - Electric Drive Unit 5-44
 - Engine Cooling System 5-44
 - Engine Oil 5-44
 - Fuel System 5-45
 - Key and Lock 5-45
 - Lamp 5-46
 - Object Detection System 5-46
 - Propulsion Power 5-48

- Messages (cont'd)
 - Ride Control System 5-49
 - Security 5-49
 - Service Vehicle 5-50
 - Starting the Vehicle 5-50
 - Tire 5-50
 - Vehicle 5-41
 - Vehicle Reminder 5-51
 - Vehicle Speed 5-51
 - Washer Fluid 5-51
 - Window 5-51
- Mirrors
 - Automatic Dimming
 - Rearview 2-18
 - Convex 2-17
 - Folding 2-18
 - Heated 2-18
 - Power 2-17
 - Tilt in Reverse 2-18
- Mirrors, Interior Rearview 2-18
- Mode
 - Driver Control 9-35
 - Electric 9-21
 - Extended Range 9-22
- Modes
 - Driver Selected 9-22
 - Maintenance 9-25

Monitor System, Tire
Pressure 10-48

N

Navigation
OnStar® 14-3
New Vehicle Break-In 9-16

O

Object Detection System
Messages 5-46
Odometer 5-12
Trip 5-12
Off-Road
Recovery 9-7
Oil
Engine 10-9
Engine Oil Life System 10-12
Messages 5-44
Pressure Light 5-24
Older Children, Restraints 3-32
Online Owner Center 13-4
OnStar 13-15
OnStar®
System, In Brief 1-28

OnStar® Additional
Information 14-6
OnStar® Connections 14-4
OnStar® Emergency 14-2
OnStar® Navigation 14-3
OnStar® Overview 14-1
OnStar® Security 14-3
OnStar® Vehicle
Diagnostics 14-6
Ordering
Service Publications 13-11
Out of Fuel/Engine
Unavailable 9-24
Outlets
Power 5-7
Overheating, Engine 10-19

P

Park
Shifting Into 9-19
Shifting Out of 9-20
Parking
Brake and P (Park)
Mechanism Check 10-25
Over Things That Burn 9-21

Parking or Backing
Assistance Systems 9-48
Passenger Airbag Status
Indicator 5-16
Passenger Compartment Air
Filter 8-8
Passenger Sensing System 3-25
Pedestrian Safety Signal 5-3
Perchlorate Materials
Requirements, California 10-2
Personalization
Vehicle 5-52
Plug-In Charging 9-58
Power
Button 9-16
Door Locks 2-11
Flows 5-27
Indicator Gauge 5-14
Mirrors 2-17
Outlets 5-7
Protection, Battery 6-8
Retained Accessory (RAP) 9-19
Seat Adjustment 3-4
Windows 2-19
Pregnancy, Using Safety
Belts 3-17

Privacy
 Vehicle Data Recording 13-14
 Program
 Courtesy Transportation 13-8
 Programmable Charging 5-29
 Proposition 65 Warning,
 California 10-2
 Propulsion Power
 Messages 5-48

R

Radio Frequency
 Identification (RFID) 13-12
 Radio Frequency
 Statement 13-12
 Reading Lamps 6-7
 Ready Indicator 5-26
 Rear Seats 3-10
 Rearview Mirrors
 Automatic Dimming 2-18
 Reclining Seatbacks 3-5
 Recommended Fluids and
 Lubricants 11-12
 Records
 Maintenance 11-14

Recreational Vehicle
 Towing 10-77
 Regenerative Braking 9-32
 Remote Keyless Entry (RKE)
 System 2-2
 Remote Start 2-8
 Replacement Bulbs 10-28
 Replacement Parts
 Airbags 3-31
 Maintenance 11-13
 Replacing Airbag System 3-31
 Replacing LATCH System
 Parts after a Crash 3-45
 Replacing Safety Belt
 System Parts after a Crash... 3-18
 Reporting Safety Defects
 Canadian Government 13-13
 General Motors 13-14
 U.S. Government 13-13
 Requirements
 Electrical Battery Charging ... 9-66
 Restraints
 Where to Put 3-38
 Retained Accessory
 Power (RAP) 9-19
 Reverse Tilt Mirrors 2-18

Ride Control Systems
 Messages 5-49
 Roads
 Driving, Wet 9-8
 Roadside Service 13-5
 Rotation, Tires 10-53
 Routing, Engine Drive Belt 12-4
 Running the Vehicle While
 Parked 9-27

S

Safety Belts 3-11
 Care 3-18
 Extender 3-17
 How to Wear Safety Belts
 Properly 3-13
 Lap-Shoulder Belt 3-14
 Reminders 5-14
 Replacing after a Crash 3-18
 Use During Pregnancy 3-17
 Safety Defects Reporting
 Canadian Government 13-13
 General Motors 13-14
 U.S. Government 13-13

Safety Signal			
Pedestrian	5-3		
Safety System Check	3-18		
Scheduling Appointments	13-7		
Sealant Kit, Tire	10-62		
Seats			
Easy Entry Seat	3-3		
Head Restraints	3-2		
Heated Front	3-8		
Lumbar Adjustment, Front	3-4		
Memory	3-6		
Power Adjustment, Front	3-4		
Rear	3-10		
Reclining Seatbacks	3-5		
Securing Child			
Restraints	3-45, 3-47		
Security			
Light	5-25		
Messages	5-49		
OnStar®	14-3		
Vehicle	2-15		
Vehicle Alarm	2-15		
Service	8-8		
Accessories and			
Modifications	10-2		
Doing Your Own Work	10-5		
Engine Soon Light	5-17		
Maintenance Records	11-14		
Maintenance, General			
Information	11-1		
Parts Identification Label	12-1		
Publications Ordering			
Information	13-11		
Scheduling Appointments	13-7		
Vehicle Messages	5-50		
Service Electric Parking			
Brake Light	5-21		
Services			
Special Application	11-8		
Servicing the Airbag	3-30		
Shifting			
Into Park	9-19		
Out of Park	9-20		
Side Blind Zone			
Alert (SBZA)	9-55		
Signals, Turn and			
Lane-Change	6-5		
Special Application Services ..	11-8		
Specifications and			
Capacities	12-2		
Speedometer	5-12		
StabiliTrak			
OFF Light	5-23		
Start			
Remote	2-8		
Starting and Stopping the			
Vehicle	9-18		
Starting the Vehicle			
Messages	5-50		
Status Screens			
Charging	9-60		
Steering	9-6		
Heated Wheel	5-2		
Wheel Adjustment	5-2		
Wheel Controls	5-2		
Storage Areas			
Center Console	4-2		
Glove Box	4-1		
Instrument Panel	4-1		
Storage Compartments	4-1		
Storing the Tire Sealant			
and Compressor Kit	10-69		
Stuck Vehicle	9-12		
Summer Tires	10-42		

Sun Visors 2-21
 Symbols iv
 System
 Active Emergency Braking 9-53
 Forward Collision
 Alert (FCA) 9-50
 Infotainment 7-1, 13-15
 System Operation 9-21
 Systems
 Driver Assistance 9-47

T

Text Telephone (TTY) Users ... 13-4
 Theft-Deterrent Systems 2-16
 Immobilizer 2-16
 Thigh Support Adjustment 3-5
 Time 5-5
 Tires 10-41
 All-Season 10-42
 Buying New Tires 10-55
 Chains 10-60
 Designations 10-44
 Different Size 10-57
 If a Tire Goes Flat 10-61
 Inflation Monitor System 10-49
 Inspection 10-53

Tires (cont'd)
 Lifting the Vehicle 10-3
 Messages 5-50
 Pressure Light 5-24
 Pressure Monitor System ... 10-48
 Rotation 10-53
 Sealant and
 Compressor Kit 10-62
 Sealant and Compressor
 Kit, Storing 10-69
 Sidewall Labeling 10-43
 Terminology and
 Definitions 10-44
 Uniform Tire Quality
 Grading 10-57
 Wheel Alignment and Tire
 Balance 10-59
 Wheel Replacement 10-59
 When It Is Time for New
 Tires 10-54
 Winter 10-42
 Towing
 General Information 9-71
 Recreational Vehicle 10-77
 Vehicle 10-75

Traction
 Control System (TCS)/
 StabiliTrak® Light 5-23
 Off Light 5-22
 Traction Control/Electronic
 Stability Control 9-33
 Transportation Program,
 Courtesy 13-8
 Trip Odometer 5-12
 Trunk 2-13
 Turn and Lane-Change
 Signals 6-5

U

Uniform Tire Quality
 Grading 10-57
 Universal Remote System 5-59
 Operation 5-62
 Programming 5-59
 Using This Manual iii
 Utility Interruption of
 Charging 9-65

V

Vehicle	
Alarm System	2-15
Canadian Owners	iii
Control	9-6
Identification	
Number (VIN)	12-1
Load Limits	9-12
Messages	5-41
Personalization	5-52
Reminder Messages	5-51
Security	2-15
Speed Messages	5-51
Starting and Stopping	9-18
Towing	10-75
Vehicle Ahead Indicator	5-22
Vehicle Care	
Storing the Tire Sealant and Compressor Kit	10-69
Tire Pressure	10-47
Vehicle Data Recording and Privacy	13-14
Vehicle Diagnostics	
OnStar®	14-6
Vehicle Ready Light	5-26
Ventilation, Air	8-7

Visors	2-21
Voltage Devices and Wiring	10-28

W

Warning	
Brake System Light	5-20
Lane Departure (LDW)	9-56
Warning Lights, Gauges, and Indicators	5-7
Warnings	iv
Cautions and Danger	iv
Hazard Flashers	6-5
Washer Fluid	10-19
Messages	5-51
Wheels	
Alignment and Tire Balance	10-59
Different Size	10-57
Replacement	10-59
When It Is Time for New Tires	10-54
Where to Put the Restraint	3-38
Windows	2-19
Messages	5-51
Power	2-19

Windshield	
Wiper/Washer	5-3
Winter	
Driving	9-10
Winter Tires	10-42
Wiper Blade Replacement	10-26
Wiring, High Voltage Devices	10-28