

1996

TRACKER

GEO 

owner's manual

Geo The 1996 Geo Tracker Owner's Manual

Seats and Restraint Systems	1-1
This section tells you how to use your seats and safety belts properly. It also explains the air bag system.	
Features and Controls	2-1
This section explains how to start and operate your Geo.	
Comfort Controls and Audio Systems	3-1
This section tells you how to adjust the ventilation and comfort controls and how to operate your audio system.	
Your Driving and the Road	4-1
Here you'll find helpful information and tips about the road and how to drive under different conditions.	
Problems on the Road	5-1
This section tells you what to do if you have a problem while driving, such as a flat tire or overheated engine, etc.	
Service and Appearance Care	6-1
Here the manual tells you how to keep your Geo running properly and looking good.	
Maintenance Schedule	7-1
This section tells you when to perform vehicle maintenance and what fluids and lubricants to use.	
Customer Assistance Information	8-1
This section tells you how to contact Chevrolet/Geo for assistance and how to get service and owner publications. It also gives you information on "Reporting Safety Defects" on page 8-8.	
Index	9-1
Here's an alphabetical listing of almost every subject in this manual. You can use it to quickly find something you want to read.	



GENERAL MOTORS, GM, the GM Emblem, CHEVROLET, the CHEVROLET Emblem, GEO, the GEO Emblem and the name TRACKER are registered trademarks of General Motors Corporation.

This manual includes the latest information at the time it was printed. We reserve the right to make changes in the product after that time without further notice. For vehicles first sold in Canada, substitute the name "General Motors of Canada Limited" for Chevrolet/Geo whenever it appears in this manual.

Please keep this manual in your Geo, so it will be there if you ever need it when you're on the road. If you sell the vehicle, please leave this manual in it so the new owner can use it.

Litho in U.S.A.
Part No. 10277493 B • First Edition

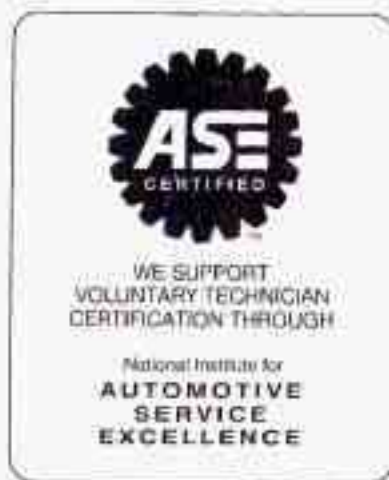

We support voluntary technician certification.

For Canadian Owners Who Prefer a French Language Manual:

Aux propriétaires canadiens: Vous pouvez vous procurer un exemplaire de ce guide en français chez votre concessionnaire ou au:

DGN Marketing Services Ltd.
1500 Bonhill Rd.
Mississauga, Ontario L5T 1C7

© Copyright General Motors Corporation 1995
All Rights Reserved

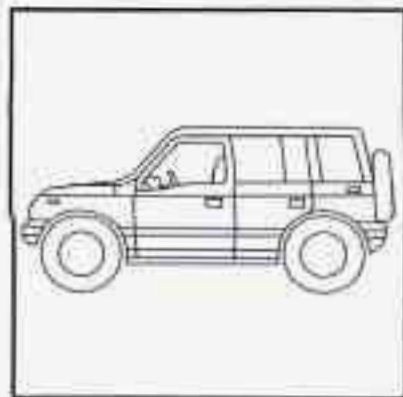

4-Door Hardtop

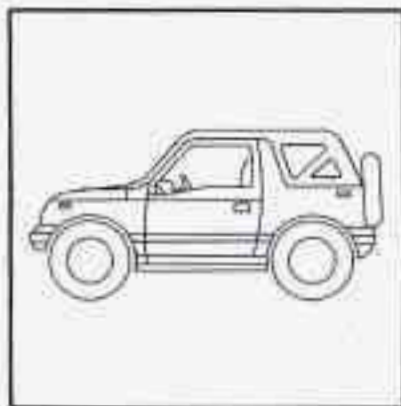

2-Door Convertible

About Driving Your Geo

As with other vehicles of this type, failure to operate this vehicle correctly may result in loss of control or an accident. Be sure to read the “on-pavement” and “off-road” driving guidelines in this manual. (See “Driving Guidelines” and “Off-Road Driving with your Four-Wheel-Drive Vehicle” in the Index.)

How to Use This Manual

Many people read their owner’s manual from beginning to end when they first receive their new vehicle. If you do this, it will help you learn about the features and controls for your vehicle. In this manual, you’ll find that pictures and words work together to explain things quickly.

Index

A good place to look for what you need is the Index in the back of the manual. It’s an alphabetical list of all that’s in the manual, and the page number where you’ll find it.

Safety Warnings and Symbols

You will find a number of safety cautions in this book. We use a box and the word CAUTION to tell you about things that could hurt you if you were to ignore the warning.

 **CAUTION:**

These mean there is something that could hurt you or other people.

In the caution area, we tell you what the hazard is. Then we tell you what to do to help avoid or reduce the hazard. Please read these cautions. If you don't, you or others could be hurt.

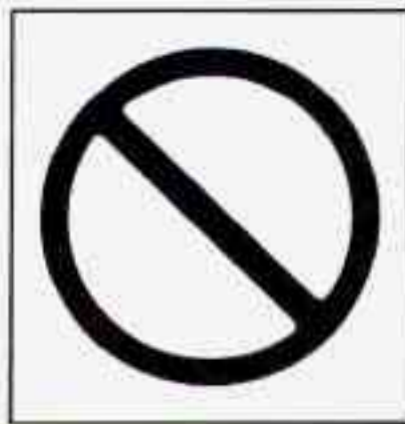

You will also find a circle with a slash through it in this book. This safety symbol means "Don't," "Don't do this," or "Don't let this happen."

Vehicle Damage Warnings

Also, in this book you will find these notices:

NOTICE:

These mean there is something that could damage your vehicle.

In the notice area, we tell you about something that can damage your vehicle. Many times, this damage would not be covered by your warranty, and it could be costly. But the notice will tell you what to do to help avoid the damage.

When you read other manuals, you might see CAUTION and NOTICE warnings in different colors or in different words.

You'll also see warning labels on your vehicle. They use the same words, CAUTION or NOTICE.

Vehicle Symbols

These are some of the symbols you may find on your vehicle.

For example, these symbols are used on an original battery:

CAUTION
POSSIBLE
INJURY



PROTECT
EYES BY
SHIELDING



CAUSTIC
BATTERY
ACID COULD
CAUSE
BURNS



AVOID
SPARKS OR
FLAMES



SPARK OR
FLAME
COULD
EXPLODE
BATTERY



These symbols are important for you and your passengers whenever your vehicle is driven:

DOOR LOCK
UNLOCK



FASTEN
SEAT
BELTS



POWER
WINDOW



AIR BAG



These symbols have to do with your lights:

MASTER
LIGHTING
SWITCH



TURN
SIGNALS

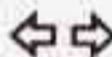

PARKING
LAMPS



HAZARD
WARNING
FLASHER



DAYTIME
RUNNING
LAMPS



FOG LAMPS

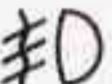

These symbols are on some of your controls:

WINDSHIELD
WIPER



WINDSHIELD
WASHER



WINDSHIELD
DEFROSTER



REAR
WINDOW
DEFOGGER



VENTILATING
FAN



These symbols are used on warning and indicator lights:

ENGINE
COOLANT
TEMP



BATTERY
CHARGING
SYSTEM

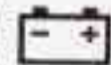

BRAKE



COOLANT



ENGINE OIL
PRESSURE



ANTI-LOCK
BRAKES



Here are some other symbols you may see:

FUSE



LIGHTER



HORN



SPEAKER



FUEL



Geo Section 1 Seats and Restraint Systems

Here you'll find information about the seats in your Geo and how to use your safety belts properly. You can also learn about some things you should *not* do with air bags and safety belts.

Seats and Seat Controls

This part tells you about the seats -- how to adjust them, and also about reclining front seatbacks, head restraints, easy entry seats and the folding rear seatback.

Manual Front Seat

⚠ CAUTION:

You can lose control of the vehicle if you try to adjust a manual driver's seat while the vehicle is moving. The sudden movement could startle and confuse you, or make you push a pedal when you don't want to. Adjust the driver's seat only when the vehicle is not moving.



Lift the lever under the front seat to unlock it. Slide the seat to where you want it. Release the lever and try to move the seat with your body, to make sure the seat is locked into place.

Reclining Front Seatbacks

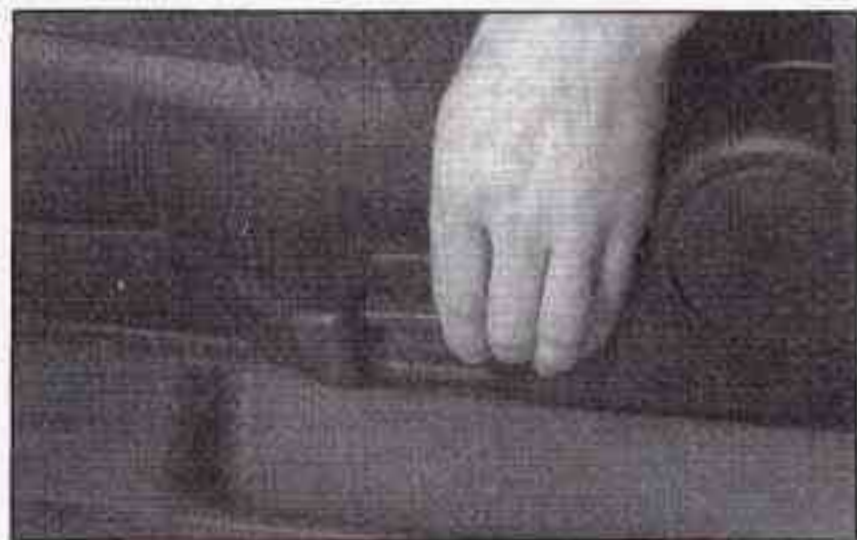

To adjust the seatback, lift the lever on the outer side of the seat. Release the lever to lock the seatback where you want it. Pull up on the lever, and the seat will go to its original upright position.

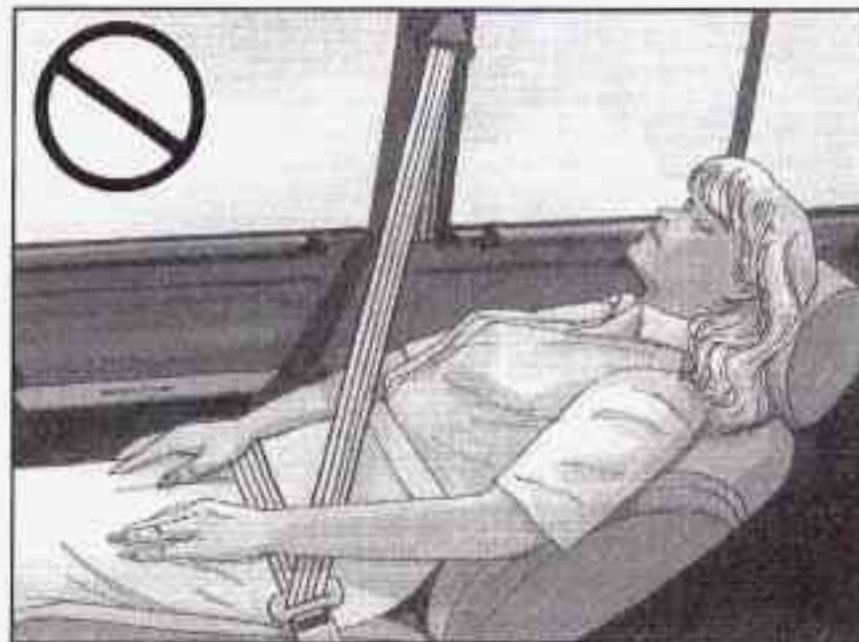

But don't have a seatback reclined if your vehicle is moving.

 **CAUTION:**

Sitting in a reclined position when your vehicle is in motion can be dangerous. Even if you buckle up, your safety belts can't do their job when you're reclined like this.

The shoulder belt can't do its job because it won't be against your body. Instead, it will be in front of you. In a crash you could go into it, receiving neck or other injuries.

The lap belt can't do its job either. In a crash the belt could go up over your abdomen. The belt forces would be there, not at your pelvic bones. This could cause serious internal injuries.

For proper protection when the vehicle is in motion, have the seatback upright. Then sit well back in the seat and wear your safety belt properly.

Head Restraints

Head restraints are fixed on some models and adjustable on others. Slide an adjustable head restraint up or down so that the top of the restraint is closest to the top of your ears. This position reduces the chance of a neck injury in a crash.

To raise or lower the restraint, push in the release while you pull up or push down on the restraint.

Easy Entry Seats (2-Door)

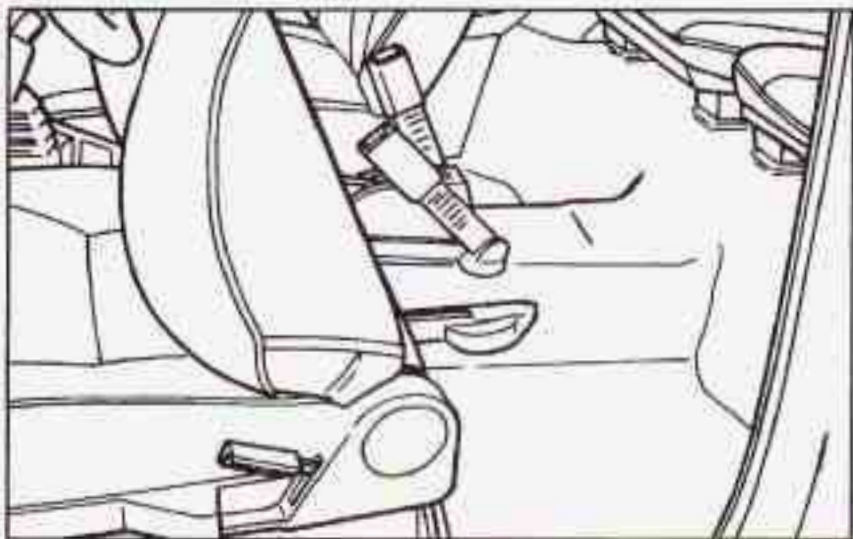

The front seats of your vehicle make it easy to get in and out of the rear seat.

- When you pull up on the recliner release lever, the seatback will tilt forward and the whole seat can slide forward by hand.
- After someone gets into the rear seat area, move the seatback to its original position. Then move the seat rearward until it locks.



CAUTION:

If any easy entry seat isn't locked, it can move. In a sudden stop or crash, the person sitting there could be injured. And, even if there is no crash or sudden stop, a driver sitting in an unlocked easy entry seat could be startled by the sudden movement and hit the wrong control or pedal, causing an accident. After you've used it, be sure to push rearward on any easy entry seat to be sure it is locked.

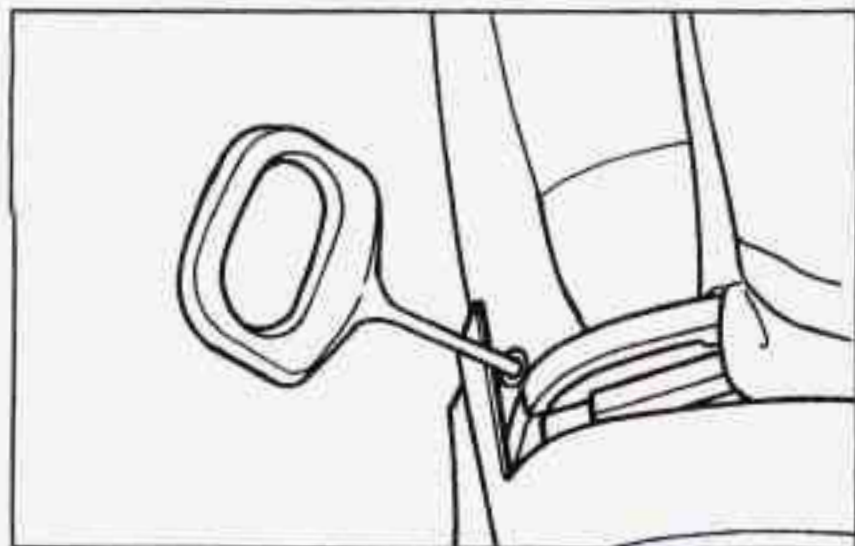

- To get out, pull the release handle on the rear of the passenger's side front seat.

Folding the Rear Seatback (2-Door Models)

The rear seat in your Geo folds to provide more cargo space.

To fold the rear seat, lower the rear seatback and then flip the whole rear seat up against the front seats.

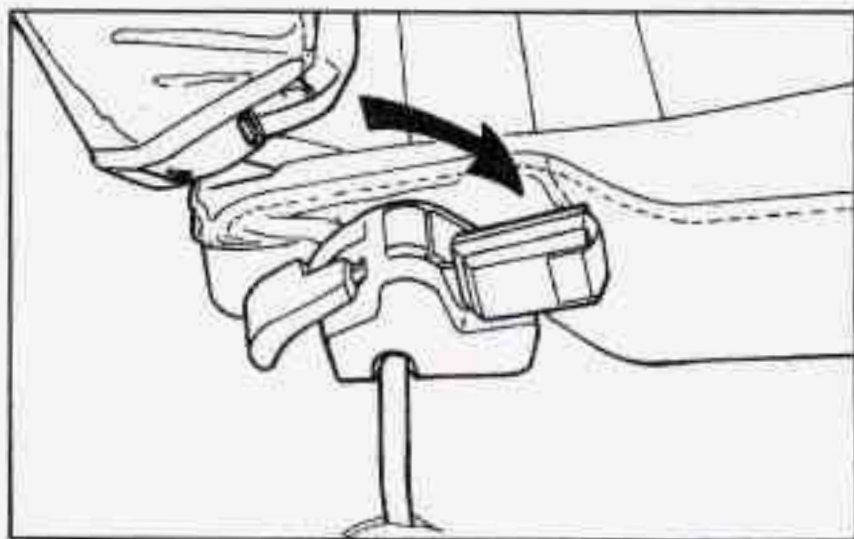

1. Swing the safety belt buckles forward and down.

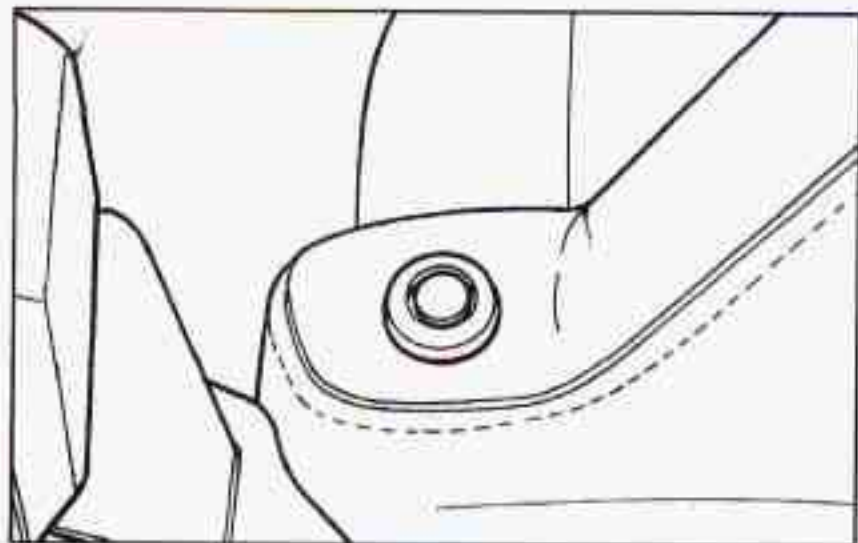

2. Pull the knobs on both sides of the seatback. If you have the split rear seat, you can fold half of the seat by pulling only the knob on the side you wish to fold.

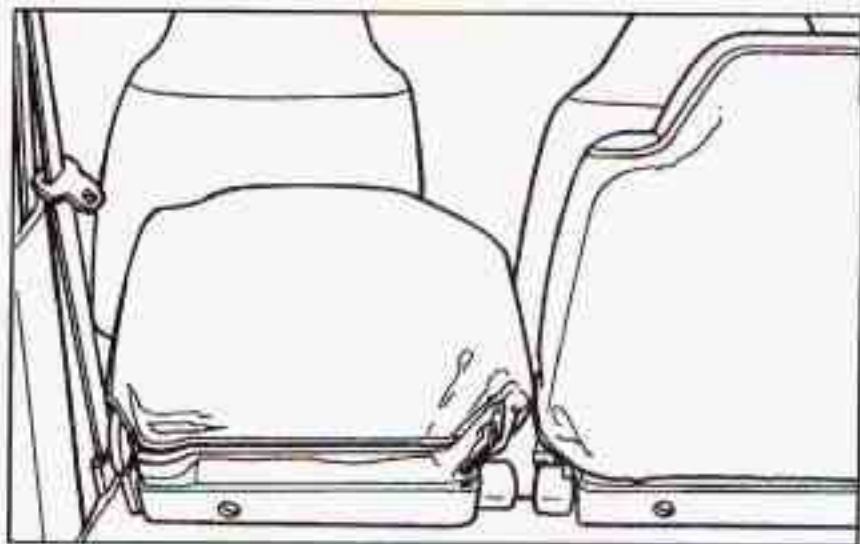

3. Fold the seatback down.



4. Unlock the bottom part of the seat:
 - On the one-piece rear seat, pull out the release ring.
 - On the split rear seat, lift the release lever on either seat.
5. Lift the bottom of the seat up and push it toward the front of the vehicle.

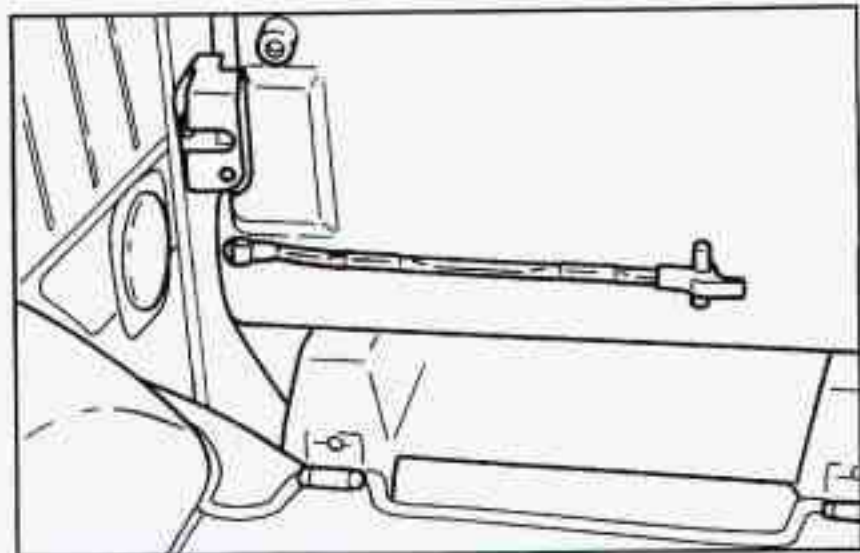

6. Find the support bar on the bottom of the seat. This bar keeps the rear seat from unfolding.
7. Pull the inner end of the support off of the seat bracket and swing it down.

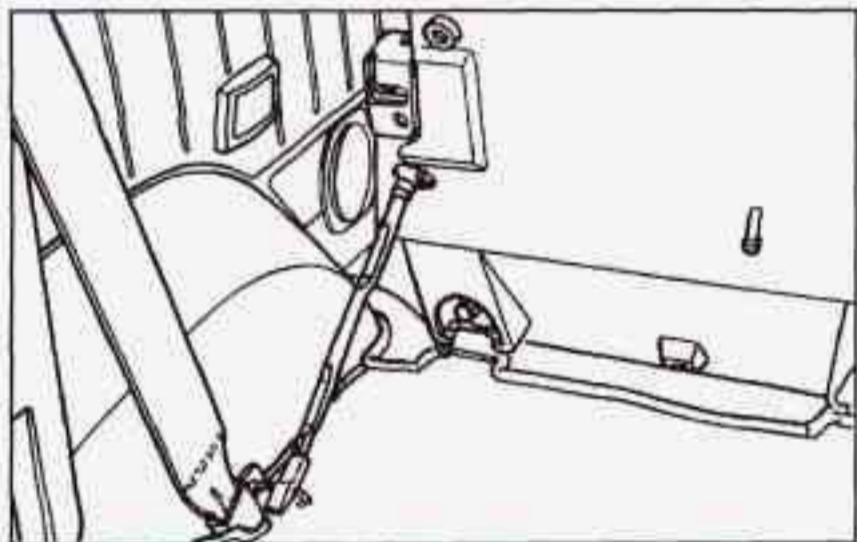

8. Attach support bar to the floor bracket.

To unfold the seat:

Keep your hands, safety belts and other objects away from where the seat will rest.

1. Pull the support bar out of the floor bracket and swing it up and toward the bottom of the seat.
2. Push and secure the support bar into the bracket on the bottom of the seat.
3. Slowly pull the seat down to the floor. The seat should latch into place. Pull up on the bottom of the seat to be sure it is locked in position.
4. Pull the seatback up and push it back to lock it into place. Push and pull the top of the seatback to be sure the seatback is locked in position.

Folding the Rear Seatback (4-Door Models)

The rear seat in your Geo folds forward to provide more cargo space.

To fold the rear seat forward:

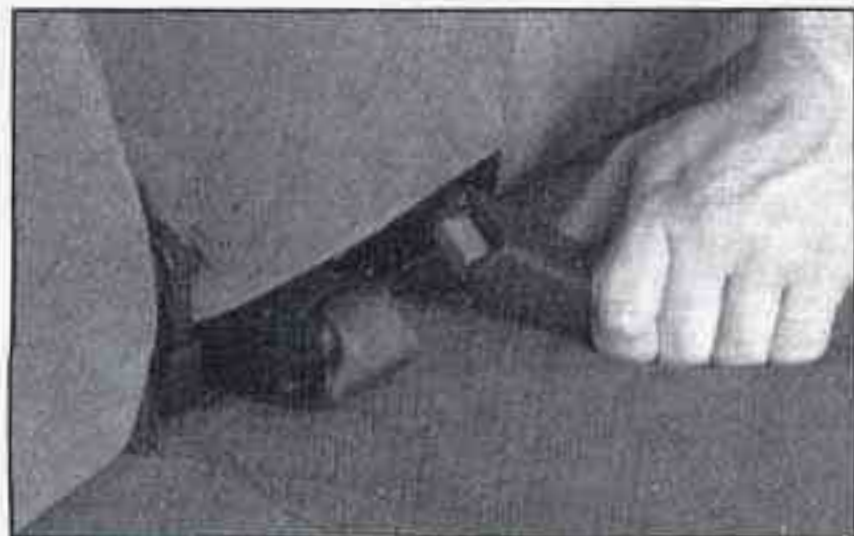

1. Tuck the seatbelts into the storage groove between the seatbacks.



2. Pull up on the lock knob on the top of each seatback.

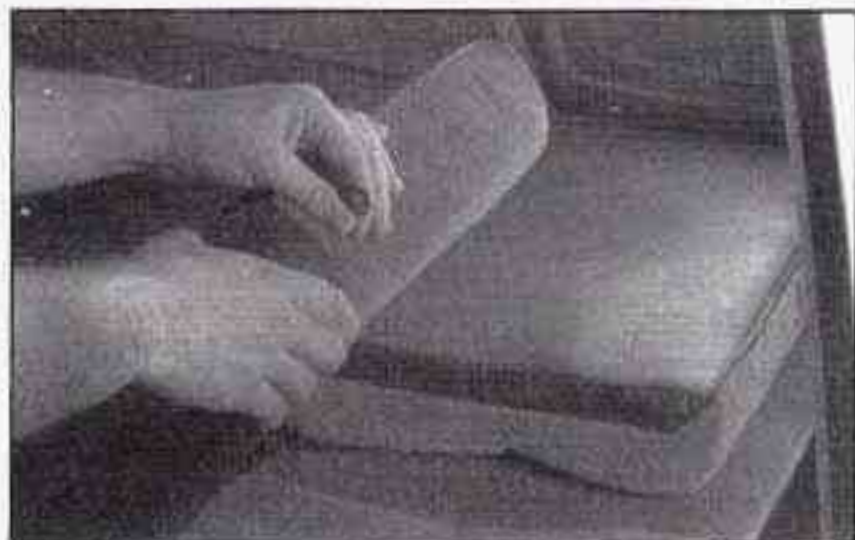

3. While pulling up on the lock knob, fold each rear seatback down. Both rear seatbacks must be folded down in order to move the seat forward.

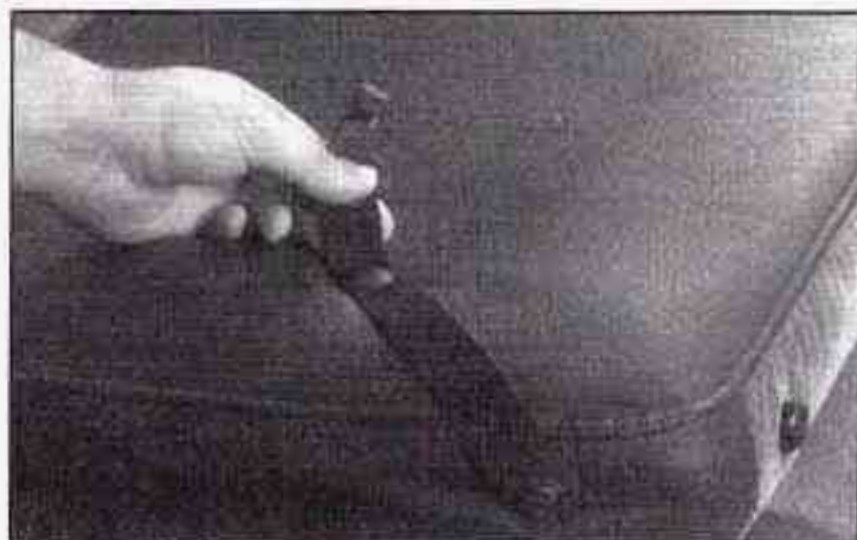

4. Unsnap the strap located on the back of the passenger's side rear seatback.



5. Pull the release ring out to unlock the bottom of the seat.

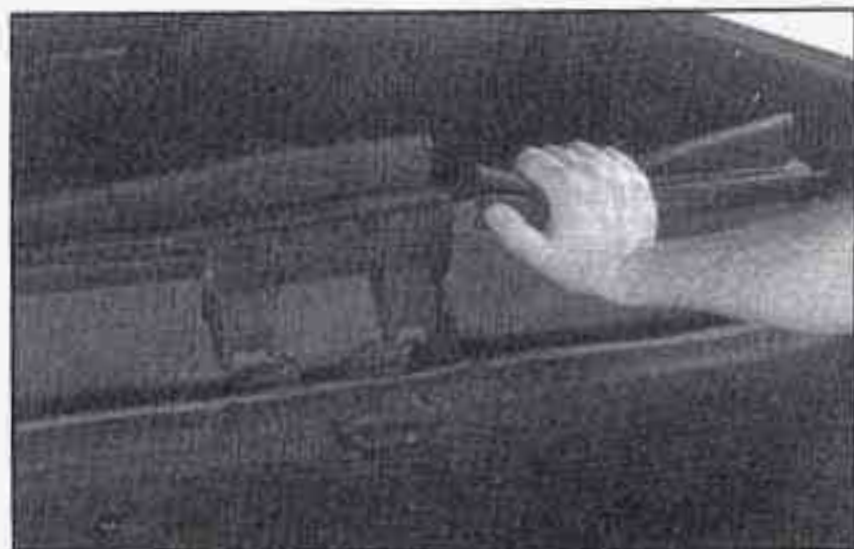

6. Lift the bottom of the seat up and push it toward the front of the vehicle.

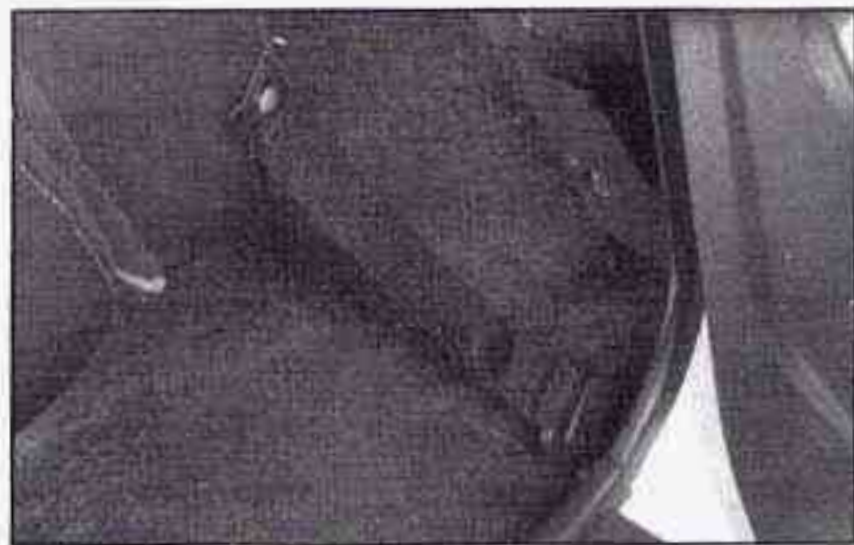

7. Hook the strap to the floor loop to secure the folded rear seat.

To raise the rear seat:

1. Unhook the strap from the floor loop and snap it on the back of the passenger's side rear seatback.
2. Slowly pull the seat down to the floor until it latches into place. Pull up on the bottom of the seat to be sure it is locked into position.
3. While pulling the lock knob up on each rear seatback, pull each seatback up and push it into place. Push and pull the top of the seatback to be sure it is locked into position.

Safety Belts: They're for Everyone

This part of the manual tells you how to use safety belts properly. It also tells you some things you should not do with safety belts.

And it explains the air bag system.

CAUTION:

Don't let anyone ride where he or she can't wear a safety belt properly. If you are in a crash and you're not wearing a safety belt, your injuries can be much worse. You can hit things inside the vehicle or be ejected from it. You can be seriously injured or killed. In the same crash, you might not be if you are buckled up. Always fasten your safety belt, and check that your passengers' belts are fastened properly too.



Your vehicle has a light that comes on as a reminder to buckle up. (See "Safety Belt Reminder Light" in the Index.)

In most states and Canadian provinces, the law says to wear safety belts. Here's why: *They work.*

You never know if you'll be in a crash. If you do have a crash, you don't know if it will be a bad one.

A few crashes are mild, and some crashes can be so serious that even buckled up a person wouldn't survive. But most crashes are in between. In many of them, people who buckle up can survive and sometimes walk away. Without belts they could have been badly hurt or killed.

After more than 25 years of safety belts in vehicles, the facts are clear. In most crashes buckling up does matter ... a lot!

Why Safety Belts Work

When you ride in or on anything, you go as fast as it goes.

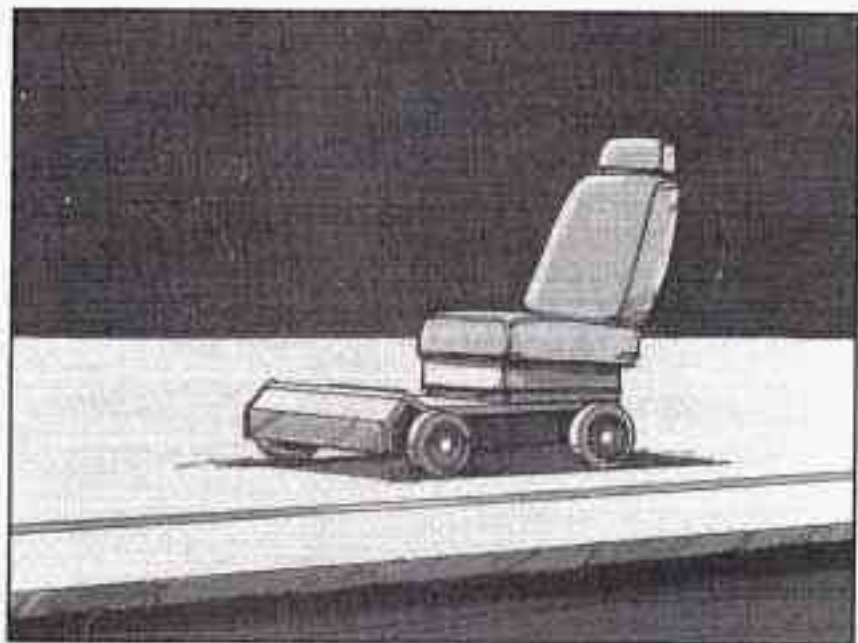

Take the simplest vehicle. Suppose it's just a seat on wheels.

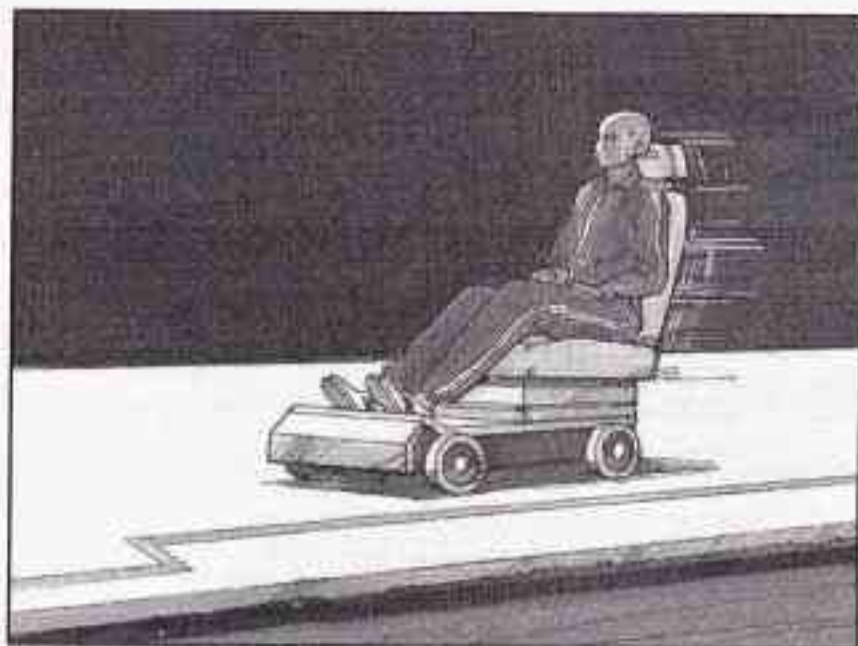

Put someone on it.

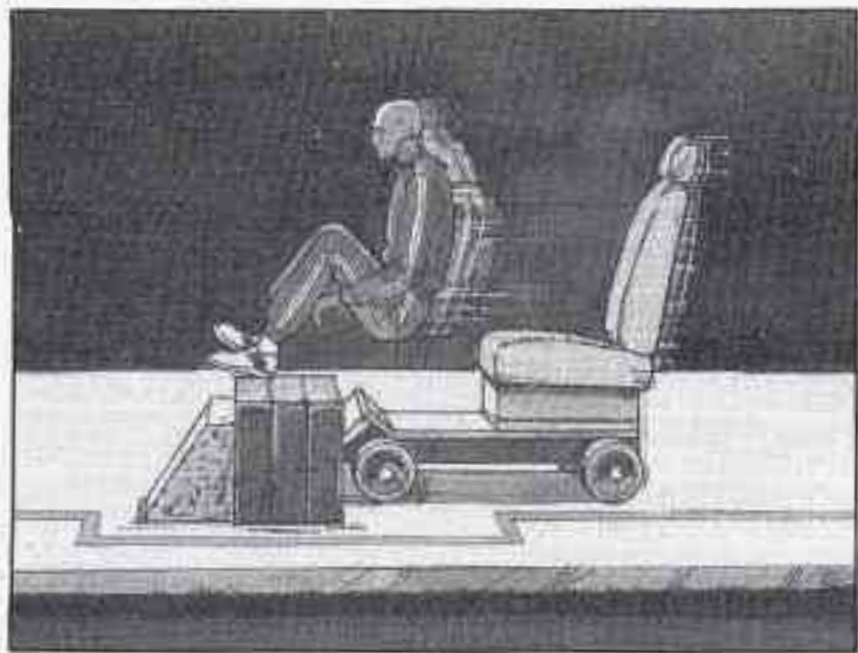

Get it up to speed. Then stop the vehicle. The rider doesn't stop.



The person keeps going until stopped by something. In a real vehicle, it could be the windshield ...

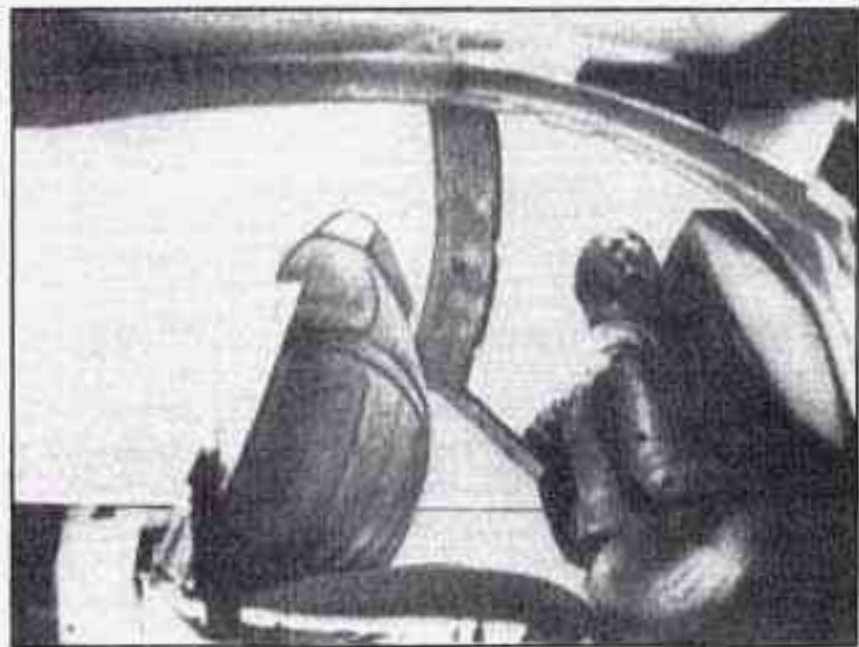

or the instrument panel ...



or the safety belts!

With safety belts, you slow down as the vehicle does. You get more time to stop. You stop over more distance, and your strongest bones take the forces. That's why safety belts make such good sense.

Here Are Questions Many People Ask About Safety Belts -- and the Answers

Q: Won't I be trapped in the vehicle after an accident if I'm wearing a safety belt?

A: You *could* be -- whether you're wearing a safety belt or not. But you can unbuckle a safety belt, even if you're upside down. And your chance of being conscious during and after an accident, so you *can* unbuckle and get out, is *much* greater if you are belted.

Q: If my vehicle has air bags, why should I have to wear safety belts?

A: Air bags are in many vehicles today and will be in most of them in the future. But they are supplemental systems only; so they work *with* safety belts -- not instead of them. Every air bag system ever offered for sale has required the use of safety belts. Even if you're in a vehicle that has air bags, you still have to buckle up to get the most protection. That's true not only in frontal collisions, but especially in side and other collisions.

Q: If I'm a good driver, and I never drive far from home, why should I wear safety belts?

A: You may be an excellent driver, but if you're in an accident -- even one that isn't your fault -- you and your passengers can be hurt. Being a good driver doesn't protect you from things beyond your control, such as bad drivers.

Most accidents occur within 25 miles (40 km) of home. And the greatest number of serious injuries and deaths occur at speeds of less than 40 mph (65 km/h).

Safety belts are for everyone.

How to Wear Safety Belts Properly

Adults

This part is only for people of adult size.

Be aware that there are special things to know about safety belts and children. And there are different rules for smaller children and babies. If a child will be riding in your Geo, see the part of this manual called "Children." Follow those rules for everyone's protection.

First, you'll want to know which restraint systems your vehicle has.

We'll start with the driver position.

Driver Position

This part describes the driver's restraint system.

Lap-Shoulder Belt

The driver has a lap-shoulder belt. Here's how to wear it properly.

1. Close and lock the door.
2. Adjust the seat (to see how, see "Seats" in the Index) so you can sit up straight.



3. Pick up the latch plate and pull the belt across you. Don't let it get twisted.

The shoulder belt may lock if you pull the belt across you very quickly. If this happens, let the belt go back slightly to unlock it. Then pull the belt across you more slowly.

4. Push the latch plate into the buckle until it clicks.

Pull up on the latch plate to make sure it is secure. If the belt isn't long enough, see "Safety Belt Extender" at the end of this section.

Make sure the release button on the buckle is positioned so you would be able to unbuckle the safety belt quickly if you ever had to.



5. To make the lap part tight, pull down on the buckle end of the belt as you pull up on the shoulder belt.

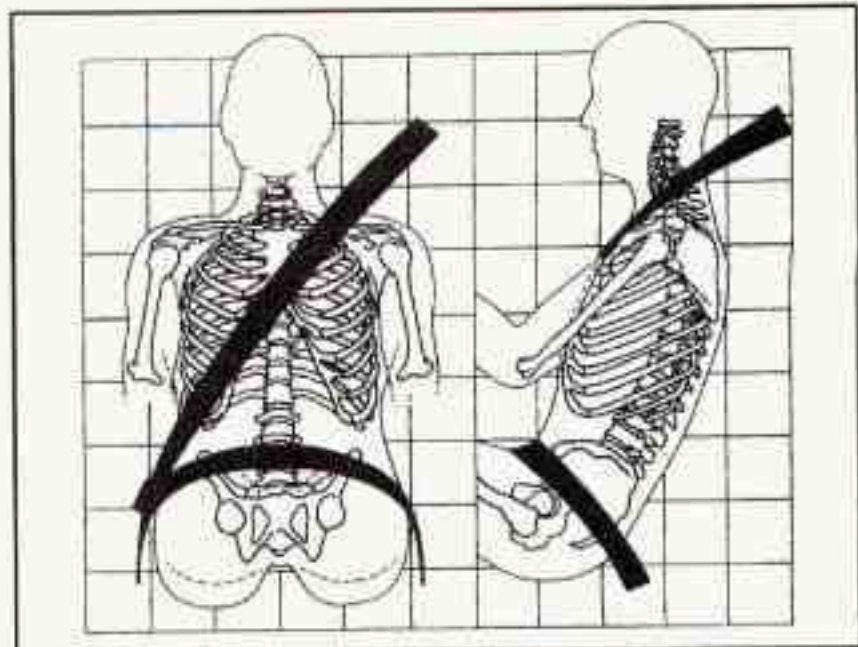

The lap part of the belt should be worn low and snug on the hips, just touching the thighs. In a crash, this applies force to the strong pelvic bones. And you'd be less likely to slide under the lap belt. If you slid under it, the belt would apply force at your abdomen. This could cause serious or even fatal injuries. The shoulder belt should go over the shoulder and across the chest. These parts of the body are best able to take belt restraining forces.

The safety belt locks if there's a sudden stop or crash, or if you pull the belt very quickly out of the retractor.

Q: What's wrong with this?

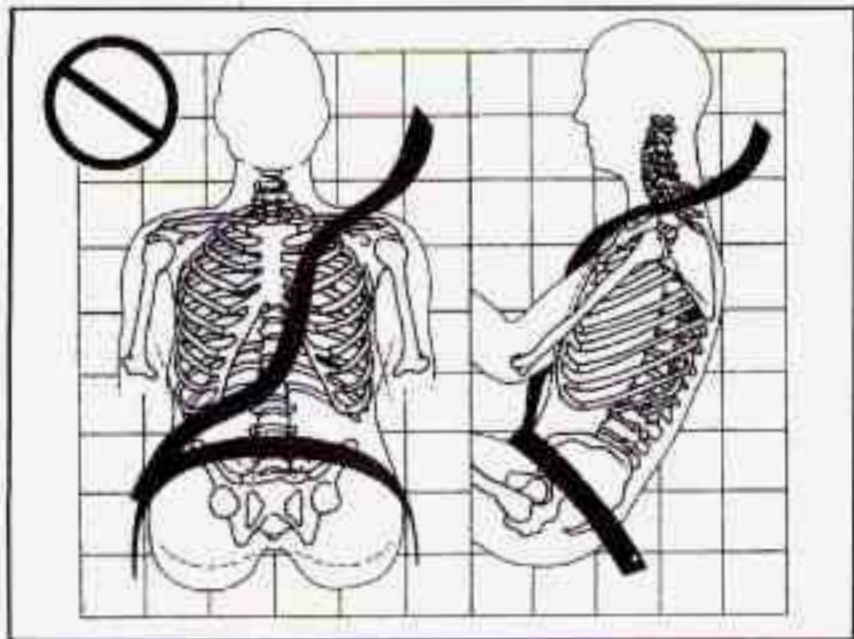

A: The shoulder belt is too loose. It won't give nearly as much protection this way.

⚠ CAUTION:

You can be seriously hurt if your shoulder belt is too loose. In a crash, you would move forward too much, which could increase injury. The shoulder belt should fit against your body.

Q: What's wrong with this?

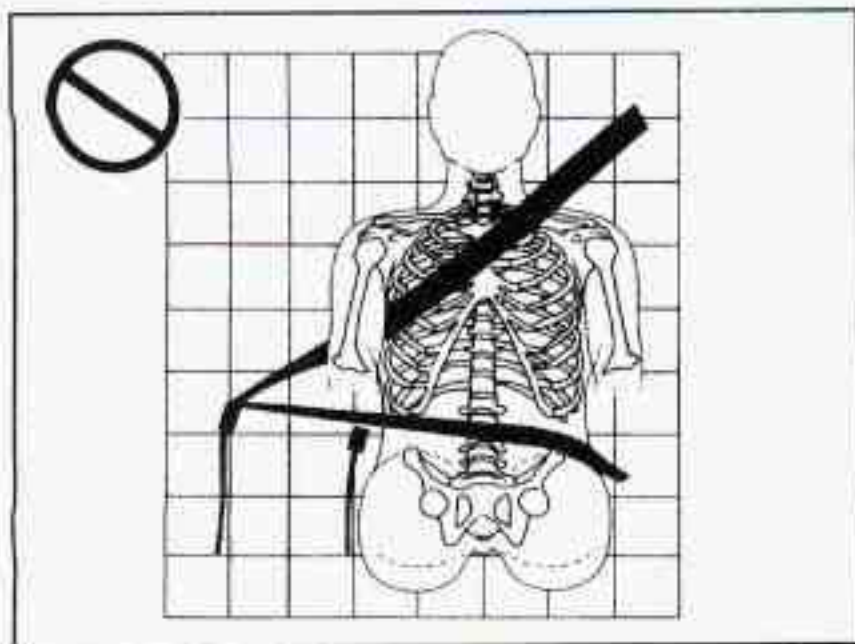

A: The belt is buckled in the wrong place.

⚠ CAUTION:

You can be seriously injured if your belt is buckled in the wrong place like this. In a crash, the belt would go up over your abdomen. The belt forces would be there, not at the pelvic bones. This could cause serious internal injuries. Always buckle your belt into the buckle nearest you.

Q: What's wrong with this?

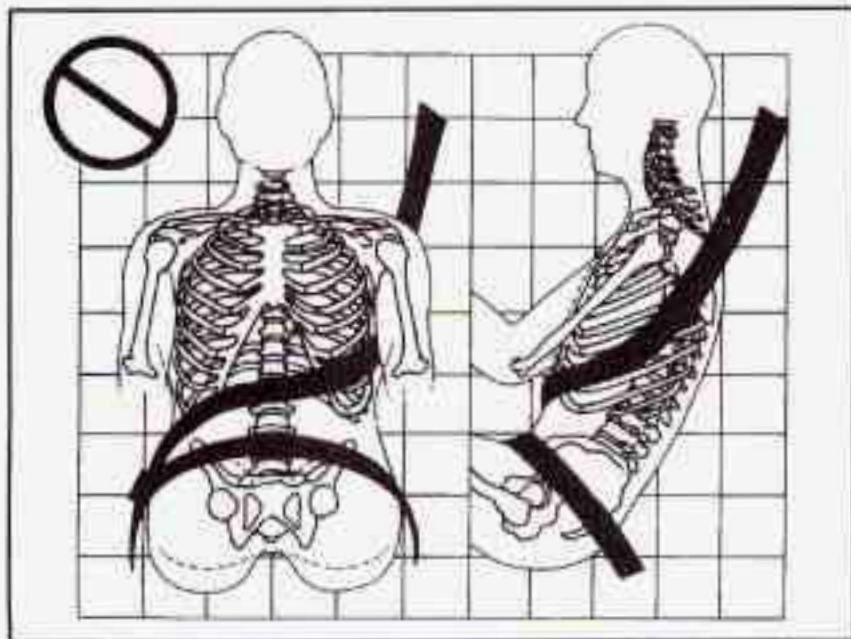

A: The shoulder belt is worn under the arm. It should be worn over the shoulder at all times.

⚠ CAUTION:

You can be seriously injured if you wear the shoulder belt under your arm. In a crash, your body would move too far forward, which would increase the chance of head and neck injury. Also, the belt would apply too much force to the ribs, which aren't as strong as shoulder bones. You could also severely injure internal organs like your liver or spleen.

Q: What's wrong with this?

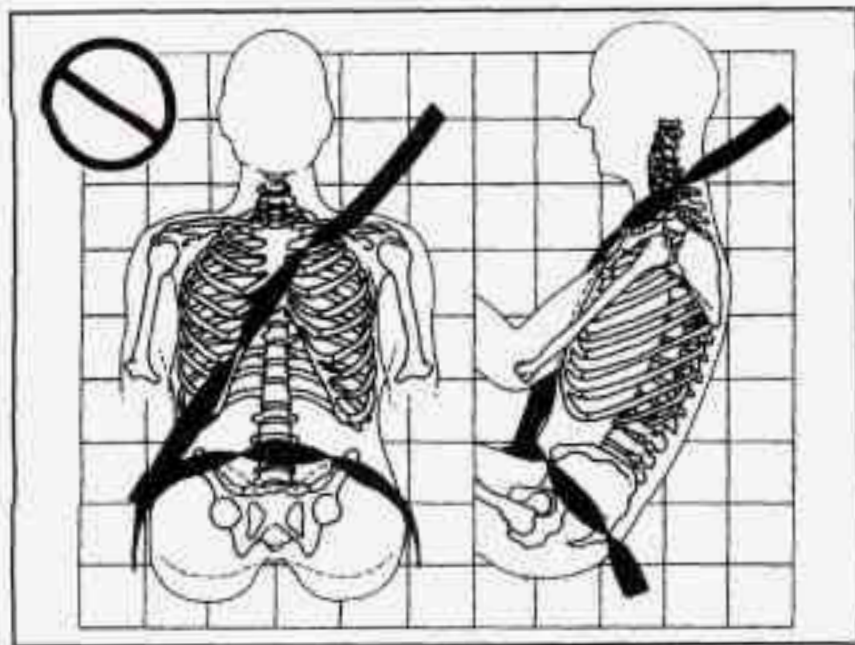

A: The belt is twisted across the body.

⚠ CAUTION:

You can be seriously injured by a twisted belt. In a crash, you wouldn't have the full width of the belt to spread impact forces. If a belt is twisted, make it straight so it can work properly, or ask your dealer to fix it.



To unlatch the belt, just push the button on the buckle. The belt should go back out of the way.

Before you close the door, be sure the belt is out of the way. If you slam the door on it, you can damage both the belt and your vehicle.

Air Bag System

This part explains the air bag system.

Your Geo has two air bags -- one air bag for the driver and another air bag for the right front passenger.

Here are the most important things to know about the air bag system:

CAUTION:

You can be severely injured or killed in a crash if you aren't wearing your safety belt -- even if you have an air bag. Wearing your safety belt during a crash helps reduce your chance of hitting things inside the vehicle or being ejected from it. The air bag is only a "supplemental restraint." That is, it works with safety belts but doesn't replace them.

CAUTION: (Continued)

CAUTION: (Continued)

Air bags are designed to work only in moderate to severe crashes where the front of your vehicle hits something. They aren't designed to inflate at all in rollover, rear, side or low-speed frontal crashes. Everyone in your vehicle, including the driver, should wear a safety belt properly -- whether or not there's an air bag for that person.

 **CAUTION:**

Air bags inflate with great force, faster than the blink of an eye. If you're too close to an inflating air bag, it could seriously injure you. Safety belts help keep you in position for an air bag inflation in a crash. Always wear your safety belt, even with an air bag. The driver should sit as far back as possible while still maintaining control of the vehicle.

 **CAUTION:**

An inflating air bag can seriously injure small children. Always secure children properly in your vehicle. To read how, see the part of this manual called "Children" and the caution label on the right front passenger's safety belt.

AIR
BAG

There is an air bag readiness light on the instrument panel, which shows AIR BAG.

The system checks the air bag's electrical system for malfunctions. The light tells you if there is an electrical problem. See "Air Bag Readiness Light" in the Index for more information.

How the Air Bag System Works



Where is the air bag?

The driver's air bag is in the middle of the steering wheel.



The right front passenger's air bag is in the instrument panel on the passenger's side.

 **CAUTION:**

Don't put anything on, or attach anything to, the steering wheel or instrument panel. Also, don't put anything (such as pets or objects) between any occupant and the steering wheel or instrument panel. If something is between an occupant and an air bag, it could affect the performance of the air bag -- or worse, it could cause injury.

When should an air bag inflate?

The air bag is designed to inflate in moderate to severe frontal or near-frontal crashes. The air bag will inflate only if the impact speed is above the system's designed "threshold level." If your vehicle goes straight into a wall that doesn't move or deform, the threshold level is about 9 to 15 mph (14 to 24 km/h). The threshold level can vary, however, with specific vehicle design, so that it can be somewhat above or below this range. If your vehicle strikes something that will move or deform, such as a parked car, the threshold level will be higher.

The air bag is not designed to inflate in rollovers, side impacts or rear impacts, because inflation would not help the occupant.

In any particular crash, no one can say whether an air bag should have inflated simply because of the damage to a vehicle or because of what the repair costs were. Inflation is determined by the angle of the impact and the vehicle's deceleration. Vehicle damage is only one indication of this.

The air bag system is designed to work properly under a wide range of conditions, including off-road usage. Observe safe driving speeds, especially on rough terrain. As always, wear your safety belt. See "Off-Road Driving" in the Index for more tips on off-road driving.

What makes an air bag inflate?

In a frontal or near-frontal impact of sufficient severity, the air bag sensing system detects that the vehicle is suddenly stopping as a result of a crash. The sensing system signals the inflator to produce a gas that inflates the air bags. The inflator, air bag and related hardware are all part of the air bag modules packed inside the steering wheel and in the instrument panel in front of the right front passenger.

How does an air bag restrain?

In moderate to severe frontal or near-frontal collisions, even *belted* occupants can contact the steering wheel or the instrument panel. The air bag supplements the protection provided by safety belts. Air bags distribute the force of the impact more evenly over the occupant's upper body, stopping the occupant more gradually. But air bags would not help you in many types of collisions, including rollovers, rear impacts and side impacts, primarily because an occupant's motion is not toward the air bag. Air bags should never be regarded as anything more than a supplement to safety belts, and then only in moderate to severe frontal or near-frontal collisions.

What will you see after an air bag inflates?

After the air bag inflates, it quickly deflates. This occurs so quickly that some people may not even realize the air bag inflated. Some components of the air bag module in the steering wheel hub for the driver's air bag, or the instrument panel for the right front passenger's bag, will be hot for a short time. The part of the bag that comes into contact with you may be warm, but it will never be too hot to touch. There will be some smoke and dust coming from vents in the deflated air bags. Air bag inflation will not prevent the driver from seeing or from being able to steer the vehicle, nor will it stop people from leaving the vehicle.



CAUTION:

When an air bag inflates, there is dust in the air. This dust could cause breathing problems for people with a history of asthma or other breathing trouble. To avoid this, everyone in the vehicle should get out as soon as it is safe to do so. If you have breathing problems but can't get out of the vehicle after an air bag inflates, then get fresh air by opening a window or door.

In many crashes severe enough to inflate an air bag, windshields are broken by vehicle deformation. Additional windshield breakage may also occur from the right front passenger air bag.

- The air bags are designed to inflate only once. After they inflate, you'll need some new parts for your air bag system. If you don't get them, the air bag system won't be there to help protect you in another crash. A new system will include air bag modules and possibly other parts. The service manual for your vehicle covers the need to replace other parts.

- Your vehicle is equipped with a crash sensing and diagnostic module, which records information about the air bag system. The module records information about the readiness of the system, when the sensors are activated and driver's safety belt usage at deployment.
- Let only qualified technicians work on your air bag system. Improper service can mean that your air bag system won't work properly. See your dealer for service.

NOTICE:

If you damage the cover for the driver's or the right front passenger's air bag, they may not work properly. You may have to replace the air bag module in the steering wheel or both the air bag module and the instrument panel for the right front passenger's air bag. Do not open or break the air bag covers.

Servicing Your Air Bag-Equipped Geo

Air bags affect how your Geo should be serviced. There are parts of the air bag system in several places around your vehicle. You don't want the system to inflate while someone is working on your vehicle. Your Geo dealer and the Tracker Service Manual have information about servicing your vehicle and the air bag system. To purchase a service manual, see "Service and Owner Publications" in the Index.



CAUTION:

For up to 10 seconds after the ignition key is turned off and the battery is disconnected, an air bag can still inflate during improper service. You can be injured if you are close to an air bag when it inflates. Avoid wires wrapped with yellow tape or yellow connectors. They are probably part of the air bag system. Be sure to follow proper service procedures, and make sure the person performing work for you is qualified to do so.

The air bag system does not need regular maintenance.

Adding Equipment to Your Air Bag-Equipped Geo

Q: If I add a push bumper or a bicycle rack to the front of my vehicle, will it keep the air bags from working properly?

A: As long as the push bumper or bicycle rack is attached to your vehicle so that the vehicle's basic structure isn't changed, it's not likely to keep the air bags from working properly in a crash.

Q: Is there anything I might add to the front of the vehicle that could keep the air bags from working properly?

A: Yes. If you add things that change your vehicle's frame, bumper system, front end sheet metal or height, they may keep the air bag system from working properly. Also, the air bag system may not work properly if you relocate any of the air bag sensors. If you have any questions about this, you should contact Customer Assistance before you modify your vehicle. (The phone numbers and addresses for Customer Assistance are in Step Two of the Customer Satisfaction Procedure in this manual. See "Customer Satisfaction Procedure" in the Index.)

Safety Belt Use During Pregnancy

Safety belts work for everyone, including pregnant women. Like all occupants, they are more likely to be seriously injured if they don't wear safety belts.

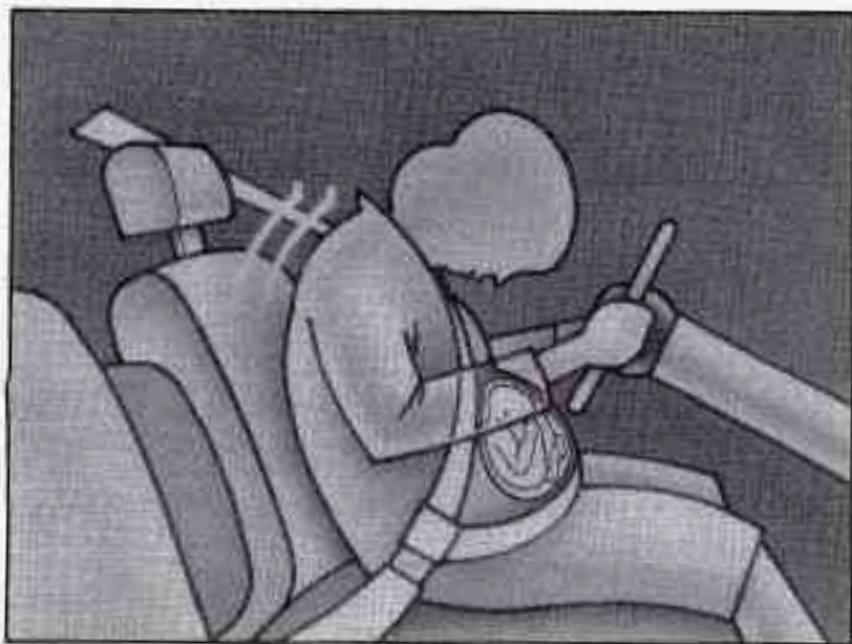

A pregnant woman should wear a lap-shoulder belt, and the lap portion should be worn as low as possible, below the rounding, throughout the pregnancy.

The best way to protect the fetus is to protect the mother. When a safety belt is worn properly, it's more likely that the fetus won't be hurt in a crash. For pregnant women, as for anyone, the key to making safety belts effective is wearing them properly.

Right Front Passenger Position

The right front passenger's safety belt works the same way as the driver's safety belt. See "Driver Position" earlier in this section.

When the shoulder belt is pulled out all the way, it will lock. If it does, let it go back all the way and start again.

Rear Seat Passengers

It's very important for rear seat passengers to buckle up! Accident statistics show that unbelted people in the rear seat are hurt more often in crashes than those who are wearing safety belts.

Rear passengers who aren't safety belted can be thrown out of the vehicle in a crash. And they can strike others in the vehicle who are wearing safety belts.

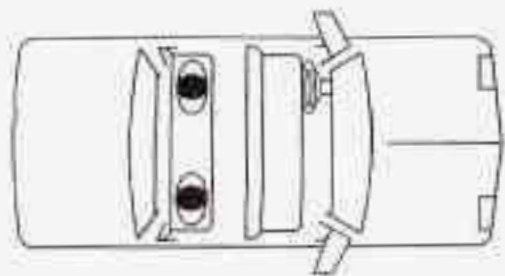

Lap-Shoulder Belt

The rear seats have lap-shoulder belts. Here's how to wear one properly.



1. Pick up the latch plate and pull the belt across you. Don't let it get twisted.

The shoulder belt may lock if you pull the belt across you very quickly. If this happens, let the belt go back slightly to unlock it. Then pull the belt across you more slowly.

2. Push the latch plate into the buckle until it clicks.

Pull up on the latch plate to make sure it is secure.

When the shoulder belt is pulled out all the way, it will lock. If it does, let it go back all the way and start again. If the belt is not long enough, see "Safety Belt Extender" at the end of this section. Make sure the release button on the buckle is positioned so you would be able to unbuckle the safety belt quickly if you ever had to.



3. To make the lap part tight, pull down on the buckle end of the belt as you pull up on the shoulder part.

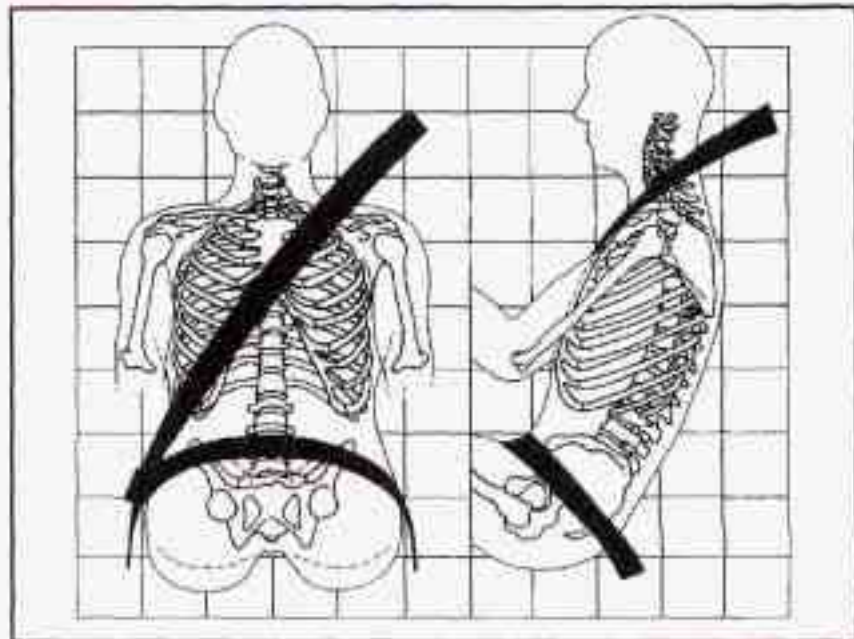

The lap part of the belt should be worn low and snug on the hips, just touching the thighs. In a crash, this applies force to the strong pelvic bones. And you'd be less likely to slide under the lap belt. If you slid under it, the belt would apply force at your abdomen. This could cause serious or even fatal injuries. The shoulder belt should go over the shoulder and across the chest. These parts of the body are best able to take belt restraining forces.

The safety belt locks if there's a sudden stop or a crash, or if you pull the belt very quickly out of the retractor.

⚠ CAUTION:

You can be seriously hurt if your shoulder belt is too loose. In a crash, you would move forward too much, which could increase injury. The shoulder belt should fit against your body.



To unlatch the belt, just push the button on the buckle.

Children

Everyone in a vehicle needs protection! That includes infants and all children smaller than adult size. In fact, the law in every state in the United States and in every Canadian province says children up to some age must be restrained while in a vehicle.

Smaller Children and Babies

CAUTION:

Smaller children and babies should always be restrained in a child or infant restraint. The instructions for the restraint will say whether it is the right type and size for your child. A very young child's hip bones are so small that a regular belt might not stay low on the hips, as it should. Instead, the belt will likely be over the child's abdomen. In a crash, the belt would apply force right on the child's abdomen, which could cause serious or fatal injuries. So, be sure that any child small enough for one is always properly restrained in a child or infant restraint.



CAUTION: (Continued)

at only 25 mph (40 km/h), a 12-lb. (5.5 kg) baby will suddenly become a 240-lb. (110 kg) force on your arms. The baby would be almost impossible to hold.

Secure the baby in an infant restraint.

⚠ CAUTION:

Never hold a baby in your arms while riding in a vehicle. A baby doesn't weigh much -- until a crash. During a crash a baby will become so heavy you can't hold it. For example, in a crash

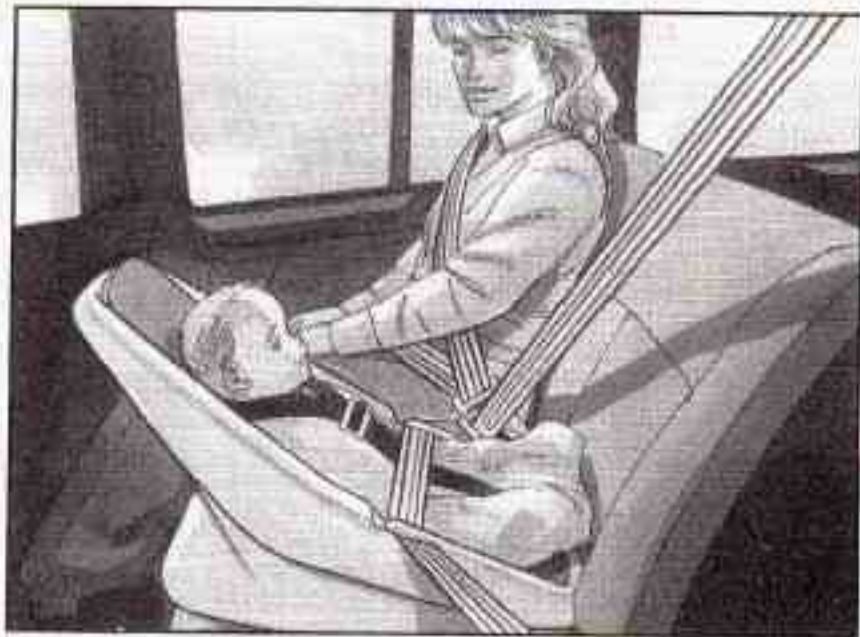

Child Restraints

Be sure the child restraint is designed to be used in a vehicle. If it is, it will have a label saying that it meets Federal Motor Vehicle Safety Standards.

Then follow the instructions for the restraint. You may find these instructions on the restraint itself or in a booklet, or both. These restraints use the belt system in your vehicle, but the child also has to be secured within the restraint to help reduce the chance of personal injury. The instructions that come with the infant or child restraint will show you how to do that.

Where to Put the Restraint

Accident statistics show that children are safer if they are restrained in the rear rather than the front seat. We at General Motors therefore recommend that you put your child restraint in the rear seat. *Never* put a rear-facing child restraint in the front passenger seat. Here's why:



CAUTION:

A child in a rear-facing child restraint can be seriously injured if the right front passenger's air bag inflates. This is because the back of a rear-facing child restraint would be very close to the inflating air bag. Always secure a rear-facing child restraint in the rear seat.

You may, however, secure a forward-facing child restraint in the right front seat. Before you secure a forward-facing child restraint, always move the front passenger seat as far back as it will go. Or, secure the child restraint in the rear seat.

Wherever you install it, be sure to secure the child restraint properly.

Keep in mind that an unsecured child restraint can move around in a collision or sudden stop and injure people in the vehicle. Be sure to properly secure any child restraint in your vehicle -- even when no child is in it.

Top Strap

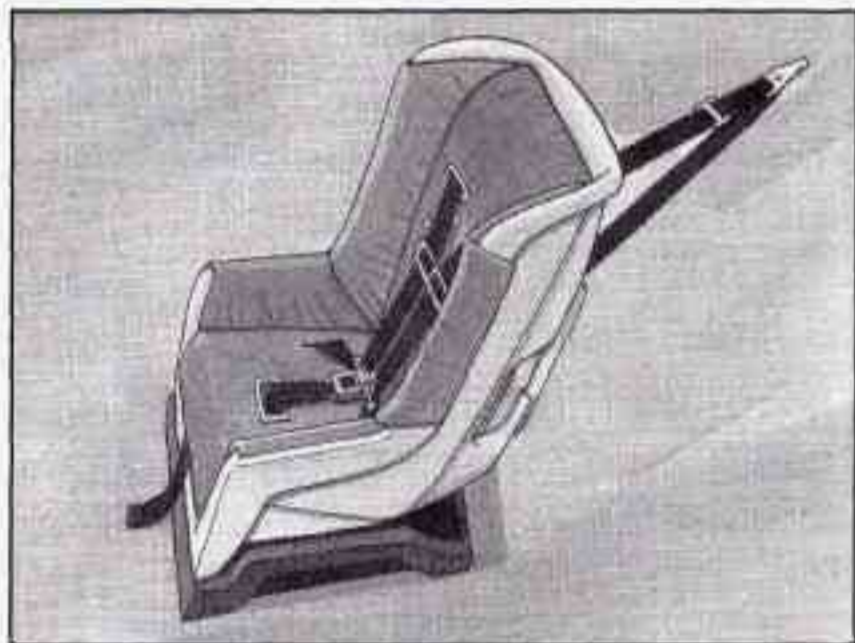

If your child restraint has a top strap, it should be anchored. If you have a two-door model, don't use a restraint like that in your vehicle because the top strap anchor cannot be installed properly. You shouldn't use this type of restraint without anchoring the top strap.

If your vehicle is a four-door model and you need to have an anchor installed, you can ask your Geo dealer to put one in for you. If you want to install an anchor yourself, your dealer can tell you how to do it.

Securing a Child Restraint in a Rear Seat Position

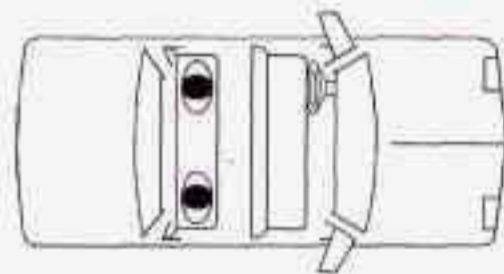

You'll be using the lap-shoulder belt. See the earlier part about the top strap if the child restraint has one.

1. Put the restraint on the seat. Follow the instructions for the child restraint.
2. Secure the child in the child restraint as the instructions say.
3. Pick up the latch plate, and run the lap and shoulder portions of the vehicle's safety belt through or around the restraint. The child restraint instructions will show you how.

If the shoulder belt goes in front of the child's face or neck, put it behind the child restraint.



4. Buckle the belt. Make sure the release button is positioned so you would be able to unbuckle the safety belt quickly if you ever had to.

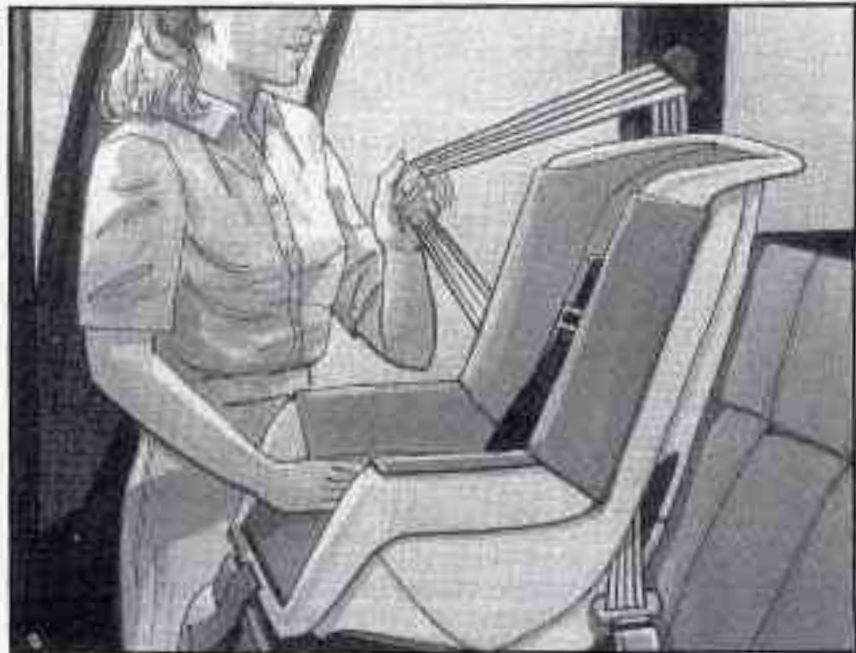

5. Pull the rest of the shoulder belt all the way out of the retractor to set the lock.

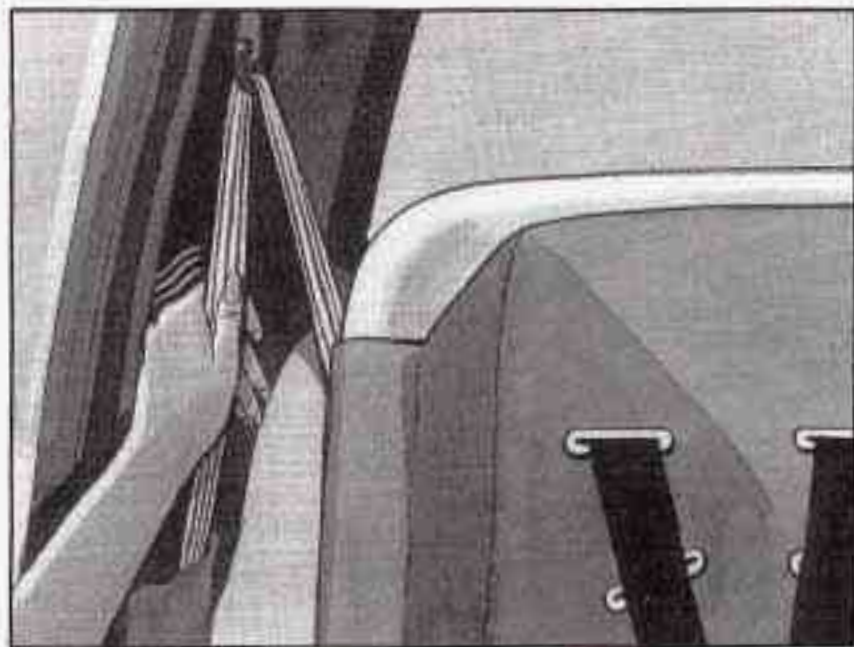

6. To tighten the belt, feed the shoulder belt back into the retractor while you push down on the child restraint.
7. Push and pull the child restraint in different directions to be sure it is secure.

To remove the child restraint, just unbuckle the vehicle's safety belt and let it go back all the way. The safety belt will move freely again and be ready to work for an adult or larger child passenger.

Securing a Child Restraint in the Right Front Seat Position

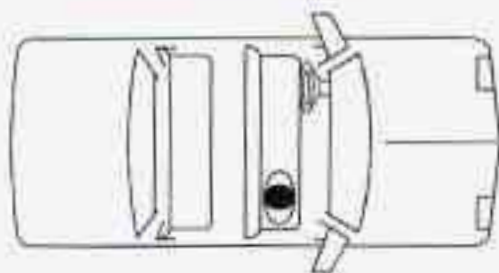

Your vehicle has a right front passenger air bag. *Never* put a rear-facing child restraint in this seat. Here's why:

CAUTION:

A child in a rear-facing child restraint can be seriously injured if the right front passenger's air bag inflates. This is because the back of a rear-facing child restraint would be very close to the inflating air bag. Always secure a rear-facing child restraint in the rear seat.

You'll be using the lap-shoulder belt. See the earlier part about the top strap if the child restraint has one.

1. Because your vehicle has a right front passenger air bag, always move the seat as far back as it will go before securing a forward-facing child restraint. (See "Seats" in the Index.)
2. Put the restraint on the seat. Follow the instructions for the child restraint.
3. Secure the child in the child restraint as the instructions say.
4. Pick up the latch plate, and run the lap and shoulder portions of the vehicle's safety belt through or around the restraint. The child restraint instructions will show you how.

If the shoulder belt goes in front of the child's face or neck, put it behind the child restraint.



5. Buckle the belt. Make sure the release button is positioned so you would be able to unbuckle the safety belt quickly if you ever had to.



6. Pull the rest of the shoulder belt all the way out of the retractor to set the lock.

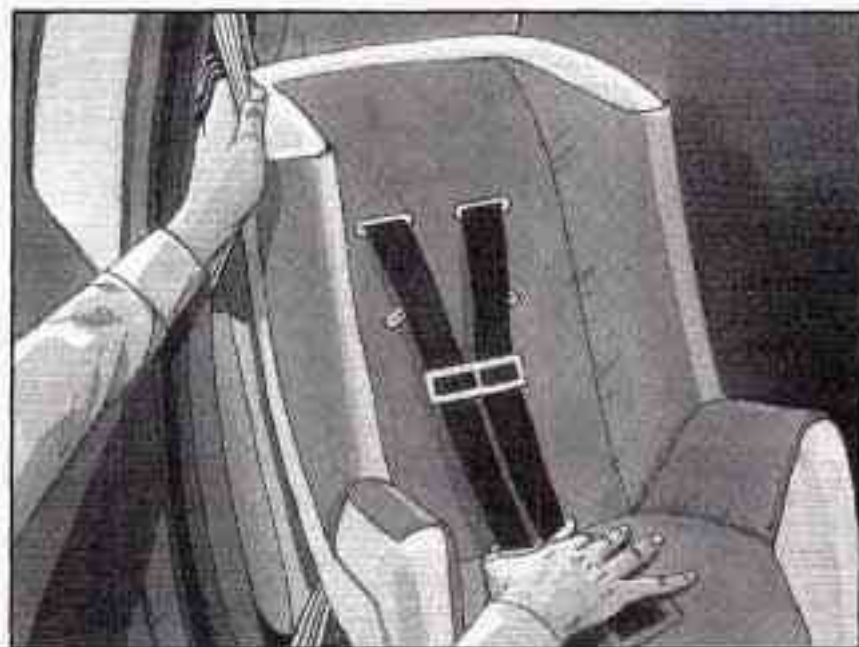

7. To tighten the belt, feed the shoulder belt back into the retractor while you push down on the child restraint.
8. Push and pull the child restraint in different directions to be sure it is secure.

To remove the child restraint, just unbuckle the vehicle's safety belt and let it go back all the way. The safety belt will move freely again and be ready to work for an adult or larger child passenger.

Larger Children

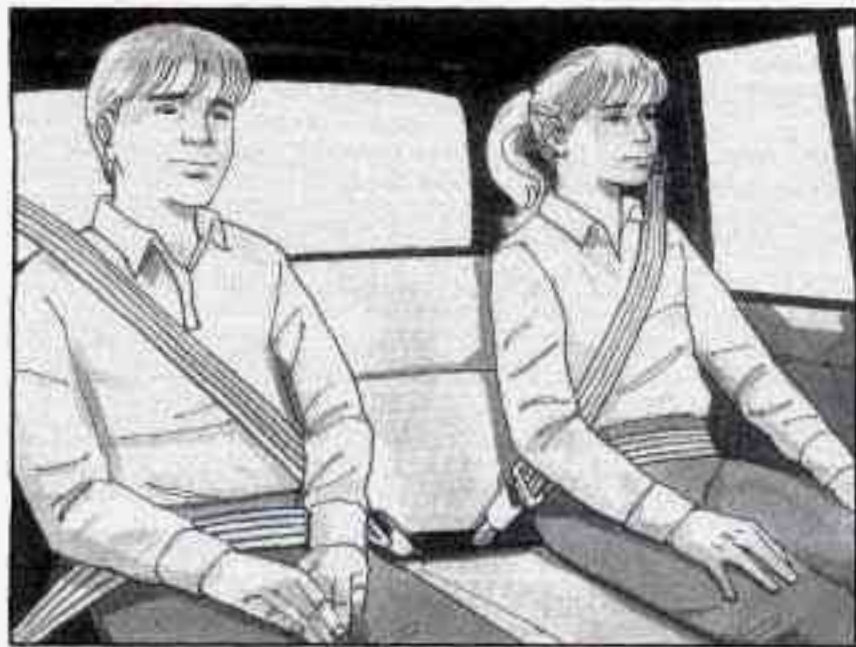

Children who have outgrown child restraints should wear the vehicle's safety belts.

Accident statistics show that children are safer if they are restrained in the rear seat. But they need to use the safety belts properly.

- Children who aren't buckled up can be thrown out in a crash.
- Children who aren't buckled up can strike other people who are.



⚠ CAUTION:

Never do this.

Here two children are wearing the same belt. The belt can't properly spread the impact forces. In a crash, the two children can be crushed together and seriously injured. A belt must be used by only one person at a time.

- Q:** What if a child is wearing a lap-shoulder belt, but the child is so small that the shoulder belt is very close to the child's face or neck?
- A:** Move the child toward the center of the vehicle, but be sure that the shoulder belt still is on the child's shoulder, so that in a crash the child's upper body would have the restraint that belts provide.



⚠ CAUTION:

Never do this.

Here a child is sitting in a seat that has a lap-shoulder belt, but the shoulder part is behind the child. If the child wears the belt in this way, in a crash the child might slide under the belt. The belt's force would then be applied right on the child's abdomen. That could cause serious or fatal injuries.

Wherever the child sits, the lap portion of the belt should be worn low and snug on the hips, just touching the child's thighs. This applies belt force to the child's pelvic bones in a crash.

Safety Belt Extender

If the vehicle's safety belt will fasten around you, you should use it.

But if a safety belt isn't long enough to fasten, your dealer will order you an extender. It's free. When you go in to order it, take the heaviest coat you will wear, so the extender will be long enough for you. The extender will be just for you, and just for the seat in your vehicle that you choose. Don't let someone else use it, and use it only for the seat it is made to fit. To wear it, just attach it to the regular safety belt.

Checking Your Restraint Systems

Now and then, make sure the safety belt reminder light and all your belts, buckles, latch plates, retractors and anchorages are working properly. Look for any other loose or damaged safety belt system parts. If you see anything that might keep a safety belt system from doing its job, have it repaired.

Torn or frayed safety belts may not protect you in a crash. They can rip apart under impact forces. If a belt is torn or frayed, get a new one right away.

Also look for any opened or broken air bag covers, and have them repaired or replaced. (The air bag system does not need regular maintenance.)

Replacing Restraint System Parts After a Crash

If you've had a crash, do you need new belts?

After a very minor collision, nothing may be necessary. But if the belts were stretched, as they would be if worn during a more severe crash, then you need new belts.

If belts are cut or damaged, replace them. Collision damage also may mean you will need to have safety belt or seat parts repaired or replaced. New parts and repairs may be necessary even if the belt wasn't being used at the time of the collision.

If an air bag inflates, you'll need to replace air bag system parts. See the part on the air bag system earlier in this section.

Geo Section 2 Features and Controls

Here you can learn about the many standard and optional features on your Geo, and information on starting, shifting and braking. Also explained are the instrument panel and the warning systems that tell you if everything is working properly -- and what to do if you have a problem.

Keys

CAUTION:

Leaving young children in a vehicle with the ignition key is dangerous for many reasons. A child or others could be badly injured or even killed.

They could operate power windows or other controls or even make the vehicle move. Don't leave the keys in a vehicle with young children.

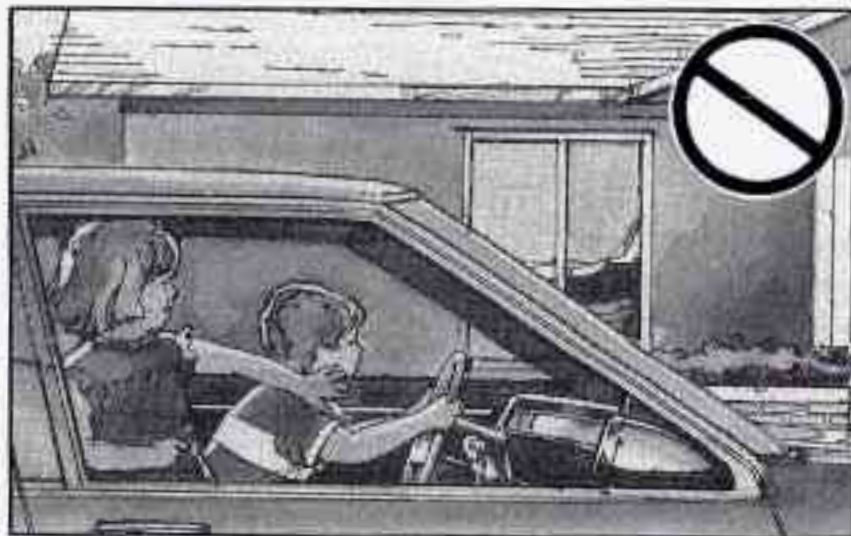

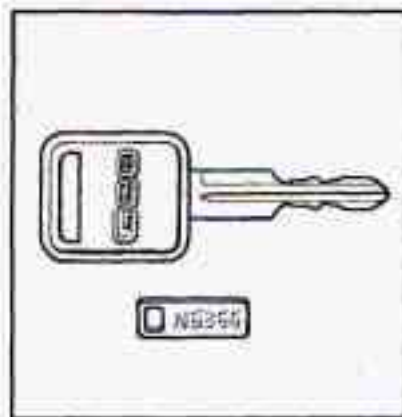

One key is used for the ignition, the doors and all other locks.

When a new Tracker is delivered, the dealer removes the metal plate from the key ring and gives it to the first owner.

The metal plate has a code on it that tells your dealer or a qualified locksmith how to make extra keys. Keep the code in a safe place. If you lose your keys, you'll be able to have new ones made easily using this code.

NOTICE:

Your Geo has a number of features that can help prevent theft. However, you can have a lot of trouble getting into your vehicle if you ever lock your keys inside. You may even have to damage your vehicle to get in. So be sure you have an extra key.

Door Locks

CAUTION:

Unlocked doors can be dangerous.

Passengers -- especially children -- can easily open the doors and fall out. When a door is locked, the inside handle won't open it.

Outsiders can easily enter through an unlocked door when you slow down or stop your vehicle.

This may not be so obvious: You increase the chance of being thrown out of the vehicle in a crash if the doors aren't locked. Wear safety belts properly, lock your doors, and you will be far better off whenever you drive your vehicle.

There are several ways to lock and unlock your vehicle.

From the outside, use your key. To lock the door, turn the key toward the front of the vehicle. To unlock the door, turn the key toward the rear.

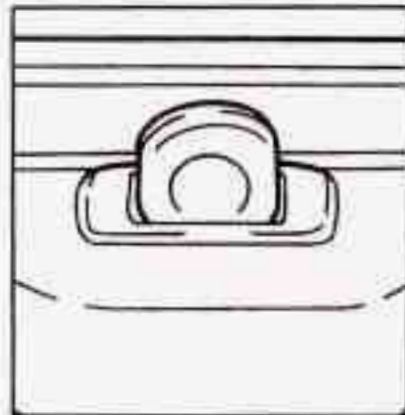

To lock the door from the inside, push down the button on the door. To unlock it, pull up on the button.

Power Door Locks (Option)



Push the front of the power door lock switch to lock all the doors and the tailgate.

To unlock the doors and tailgate, push the rear of the power door lock switch.

Rear Door Security Locks (4-Door Models)



Your Geo is equipped with rear security door locks that help prevent passengers from opening the rear doors of your vehicle from the inside.

To use one of these locks:

1. Move the lever down to engage the lock.
2. Close the door.
3. Do the same to the other rear door lock.

The rear doors of your vehicle cannot be opened from the inside when this feature is in use.

If you want to open a rear door when the security lock is on, unlock the door from the inside, then open the door from the outside.

If you don't cancel the security lock feature, adults or older children who ride in the rear won't be able to open the rear door from the inside. You should let adults and older children know how these security locks work, and how to cancel the locks.

To cancel the rear door lock:

1. Unlock the door from the inside and open the door from the outside.
2. Move the lever up to disengage the lock.
3. Do the same for the other rear door.

The rear door locks will now work normally.

Leaving Your Vehicle

If you are leaving the vehicle, take your key, open your door and set the locks from inside. Then get out and close the door.

Tailgate

CAUTION:

It can be dangerous to drive with the tailgate window open because carbon monoxide (CO) gas can come into your vehicle. You can't see or smell CO. It can cause unconsciousness and even death.

If you must drive with the tailgate window open or if electrical wiring or other cable connections must pass through the seal between the body and the tailgate window:

- Make sure all windows are shut.
- Turn the fan on your heating or cooling system to its highest speed with the setting on CIRCULATE. That will force outside air into your vehicle. See "Comfort Controls" in the Index.
- If you have air outlets on or under the instrument panel, open them all the way. See "Engine Exhaust" in the Index.

Tailgate Lock Release

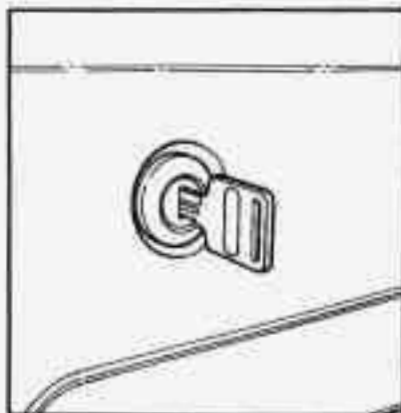

Use your key to lock or unlock your tailgate.

If you have a convertible, you can still open or close the tailgate with the rear window closed.

Theft

Vehicle theft is big business, especially in some cities. Although your Geo has a number of theft-deterrent features, we know that nothing we put on it can make it impossible to steal. However, there are ways you can help.

Key in the Ignition

If you leave your vehicle with the keys inside, it's an easy target for joy riders or professional thieves -- so don't do it.

When you park your Geo and open the driver's door, you'll hear a chime reminding you to remove your key from the ignition and take it with you. Always do this. Your steering wheel will be locked, and so will your ignition. If you have an automatic transmission, taking your key out also locks your transmission. And remember to lock the doors.

Parking at Night

Park in a lighted spot, close all windows and lock your vehicle. Remember to keep your valuables out of sight. Put them in a storage area, or take them with you.

New Vehicle "Break-In"

NOTICE:

Your modern Geo doesn't need an elaborate "break-in." But it will perform better in the long run if you follow these guidelines:

- Keep your speed at 55 mph (88 km/h) or less for the first 500 miles (804 km).
- Don't drive at any one speed -- fast or slow -- for the first 500 miles (804 km). Don't make full-throttle starts.
- Avoid making hard stops for the first 200 miles (322 km) or so. During this time your new brake linings aren't yet broken in. Hard stops with new linings can mean premature wear and earlier replacement. Follow this breaking-in guideline every time you get new brake linings.
- Don't tow a trailer during break-in. See "Towing a Trailer" in the Index for more information.

Ignition Positions

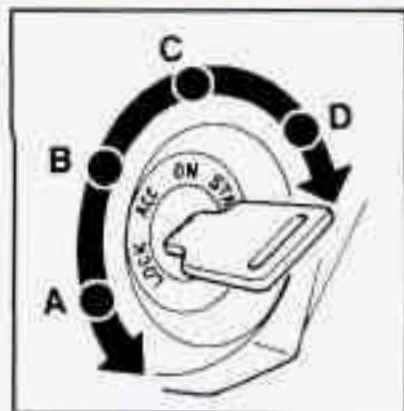

With the key in the ignition switch, you can turn the switch to four positions.

LOCK (A): The only position in which you can remove the key. This locks your steering wheel, ignition and automatic transmission.

If you have an automatic transmission, the ignition switch can't be turned to LOCK unless the shift lever is in the PARK (P) position.

ACC (B): The position that you can operate your electrical power accessories. It unlocks the steering wheel and ignition. Use this position if your vehicle must be pushed or towed.

ON (C): The position in which the switch returns to after you start your engine and release the switch. The switch stays in the ON position when the engine is running. But even when the engine is not running, you can use ON to operate your electrical power accessories and to display some instrument panel warning and indicator lights.

START (D): The position in which the engine starts. When the engine starts, release the key. The ignition switch will return to ON for normal driving.

When the engine is not running, ACC and ON allow you to operate your electrical accessories, such as the radio and ventilation fan.

A warning chime will sound if you open the driver's door when the ignition is in ACC or LOCK and the key is in the ignition.

CAUTION:

On manual transmission vehicles, turning the key to **LOCK** will lock the steering column and result in a loss of ability to steer the vehicle. This could cause a collision. If you need to turn the engine off while the vehicle is moving, turn the key only to **ACC**. Don't push the key in while the vehicle is moving.

NOTICE:

If your key seems stuck in **LOCK** and you can't turn it, be sure it is all the way in. If it is, then turn the steering wheel left and right while you turn the key hard. But turn the key only with your hand. Using a tool to force it could break the key or the ignition switch. If none of this works, then your vehicle needs service.

Starting Your Engine

Automatic transmission

Move your shift lever to **PARK (P)** or **NEUTRAL (N)**. Your engine won't start in any other position -- that's a safety feature. To restart when you're already moving, use **NEUTRAL (N)** only.

NOTICE:

Don't try to shift to **PARK (P)** if your Geo is moving. If you do, you could damage the transmission. Shift to **PARK (P)** only when your vehicle is stopped.

Manual transmission

The gear selector should be in **NEUTRAL (N)**. Hold the clutch pedal to the floor and start the engine. Your vehicle won't start if the clutch pedal is not all the way down -- that's a safety feature.

Starting Your 1.6 Liter Engine

1. Without pushing the accelerator pedal, turn your ignition key to START. When the engine starts, let go of the key.

NOTICE:

Holding your key in START for longer than 15 seconds at a time will cause your battery to be drained much sooner. And the excessive heat can damage your starter motor.

2. If it doesn't start right away, hold your key in START for about three seconds at a time until your engine starts. Wait about 15 seconds between each try to help avoid draining your battery.

If your engine still won't start, call your dealer for help.

NOTICE:

Your engine is designed to work with the electronics in your vehicle. If you add electrical parts or accessories, you could change the way the engine operates. Before adding electrical equipment, check with your dealer. If you don't, your engine might not perform properly.

If you ever have to have your vehicle towed, see the part of this manual that tells how to do it without damaging your vehicle. See "Towing Your Vehicle" in the Index.

Automatic Transmission Operation

There are several different positions for your shift lever.



PARK (P): This locks your rear wheels. It's the best position to use when you start your engine because your vehicle can't move easily.



CAUTION:

It is dangerous to get out of your vehicle if the shift lever is not fully in PARK (P) with the parking brake firmly set. Your vehicle can roll. Don't leave your vehicle when the engine is running unless you have to. If you have left the engine running, the vehicle can move suddenly. You or others could be injured. To be sure your vehicle won't move, even when you're on fairly level ground, always set your parking brake and move the shift lever to PARK (P).

If you have four-wheel drive, your vehicle will be free to roll -- even if your shift lever is in PARK (P) -- if your transfer case is in NEUTRAL (N). So, be sure the transfer case is in a drive gear, two-wheel high (2H), four-wheel high (4H) or four-wheel low (4L) -- not in NEUTRAL (N). See "Shifting Into PARK (P)" in the Index. If you're pulling a trailer, see "Towing a Trailer" in the Index.

Ensure the shift lever is fully in PARK (P) range before starting the engine. Your Geo has a brake-transmission shift interlock. You have to fully apply your regular brakes before you can shift from PARK (P) when the ignition key is in the ON position. If you cannot shift out of PARK (P), ease pressure on the shift lever -- push the shift lever all the way into PARK (P) and release the shift lever button as you maintain brake application. Then press the shift lever button and move the shift lever into the gear you wish. See "Shifting Out of PARK (P)" in the Index.

REVERSE (R): Use this gear to back up.

NOTICE:

Shifting to REVERSE (R) while your vehicle is moving forward could damage your transmission. Shift to REVERSE (R) only after your vehicle is stopped.

To rock your vehicle back and forth to get out of snow, ice or sand without damaging your transmission, see "Stuck: In Sand, Mud, Ice or Snow" in the Index.

NEUTRAL (N): In this position, your engine doesn't connect with the wheels. To restart when you're already moving, use NEUTRAL (N) only. Also, use NEUTRAL (N) when your vehicle is being towed.



CAUTION:

Shifting out of PARK (P) or NEUTRAL (N) while your engine is "racing" (running at high speed) is dangerous. Unless your foot is firmly on the brake pedal, your vehicle could move very rapidly. You could lose control and hit people or objects. Don't shift out of PARK (P) or NEUTRAL (N) while your engine is racing.

NOTICE:

Damage to your transmission caused by shifting out of PARK (P) or NEUTRAL (N) with the engine racing isn't covered by your warranty.

DRIVE (D): This position is for normal driving.

If you need more power for passing, and you're:

- Going less than about 15 mph (25 km/h), push your accelerator pedal about halfway down.
- Going about 15 mph (25 km/h) or more, push your accelerator pedal all the way down.

You'll shift down to the next gear and have more power.

SECOND (2): This position gives you more power but lower fuel economy. You can use SECOND (2) on hills. It can help control your speed as you go down steep mountain roads, but then you would also want to use your brakes off and on.

NOTICE:

Don't shift into SECOND (2) unless you are going slower than 65 mph (105 km/h) with the transfer case in FOUR HIGH (4H), or 35 mph (55 km/h) with the transfer case in FOUR LOW (4L) or you can damage your transmission.

LOW (L): This position gives you even more power (but lower fuel economy) than SECOND (2). You can use it on very steep hills, or in deep snow or mud. If the selector lever is put in LOW (L), the transmission won't shift into low gear until the vehicle is going slowly enough.

NOTICE:

Don't shift into LOW (L) at speeds above 40 mph (65 km/h) with the transfer case in FOUR-WHEEL LOW (4L), or you can damage your transmission.

NOTICE:

If your rear wheels can't rotate, don't try to drive. This might happen if you were stuck in very deep sand or mud or were up against a solid object. You could damage your transmission.

Also, if you stop when going uphill, don't hold your vehicle there with only the accelerator pedal. This could overheat and damage the transmission. Use your brakes to hold your vehicle in position on a hill.

Power Mode Selector Switch



A power mode selector switch is included. When you need more power for climbing hills or quicker acceleration, press the P (POWER) switch.

The POWER indicator light on the instrument panel comes on. For normal driving, press the N (NORMAL) switch. The POWER indicator light goes off.

Overdrive Off Switch (Option)

The overdrive off switch is located on the left side of the shifter. By operating the overdrive off switch, the four-speed automatic transmission (three-speed plus overdrive) can be converted to a three-speed automatic transmission. While in the three-speed mode, the transmission will not shift into the overdrive position.

To convert the transmission to the three-speed mode, push in the overdrive off switch and release it. The switch comes out and the O/D OFF indicator light on the instrument panel comes on.

To return the transmission to the four-speed mode, push in the overdrive off switch again. The switch will remain in and the O/D OFF indicator light goes off.

Please note that if the transfer lever is in the 4L position, the four-speed automatic transmission will remain in the three-speed mode.

Manual Transmission

5-Speed

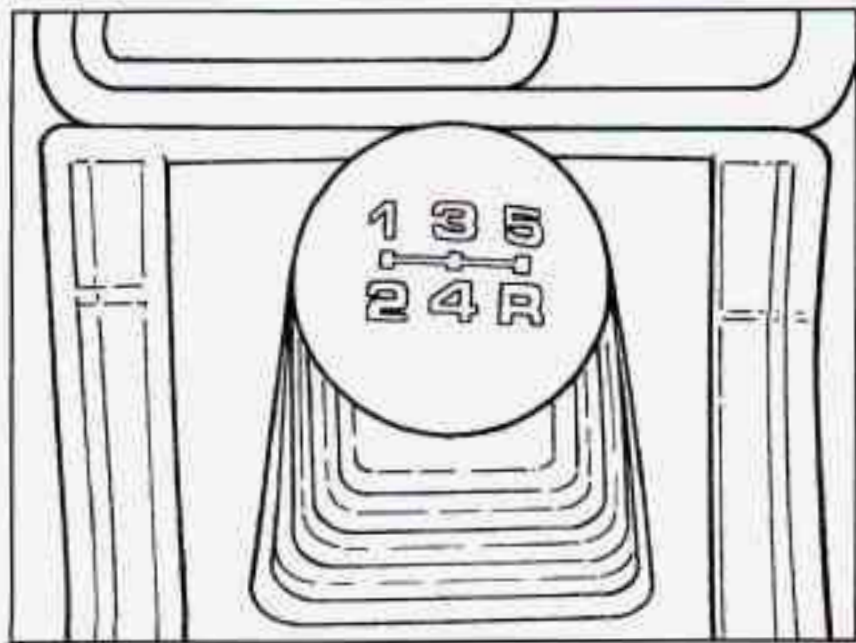

This is your shift pattern.

Here's how to operate your transmission:

FIRST (1): Press the clutch pedal and shift into FIRST (1). Then, slowly let up on the clutch pedal as you press the accelerator pedal.

You can shift into FIRST (1) when you're going less than 20 mph (32 km/h). If you've come to a complete stop and it's hard to shift into FIRST (1), put the shift lever in NEUTRAL (N) and let up on the clutch. Press the clutch pedal back down. Then shift into FIRST (1).

SECOND (2): Press the clutch pedal as you let up on the accelerator pedal and shift into SECOND (2). Then, slowly let up on the clutch pedal as you press the accelerator pedal.

THIRD (3), FOURTH (4), FIFTH (5): Shift into THIRD (3), FOURTH (4) and FIFTH (5) the same way you do for SECOND (2). Slowly let up on the clutch pedal as you press the accelerator pedal.

To stop, let up on the accelerator pedal and press the brake pedal. Just before the vehicle stops, press the clutch pedal and the brake pedal, and shift to NEUTRAL (N).

NEUTRAL (N): Use this position when you start or idle your engine.

REVERSE (R): To back up, press down the clutch pedal and shift into REVERSE (R). Let up on the clutch pedal slowly while pressing the accelerator pedal.

You cannot go from FIFTH (5) into REVERSE (R). If you try, you will be locked out. You must first shift into NEUTRAL (N), move the lever to the left, back to the right, and then shift into REVERSE (R). This is a safety feature.

NOTICE:

Shift to REVERSE (R) only after your vehicle is stopped. Shifting to REVERSE (R) while your vehicle is moving could damage your transmission.

Also, use REVERSE (R) along with the parking brake for parking your vehicle.

Shift Speeds

CAUTION:

If you skip more than one gear when you downshift, you could lose control of your vehicle. And you could injure yourself or others. Don't shift from FIFTH (5) to SECOND (2) or from FOURTH (4) to FIRST (1).

This chart shows when to shift to the next higher gear for best fuel economy.

	Acceleration Shift Speed				Cruise Shift Speed		
	1 to 2	2 to 3	3 to 4	4 to 5	2 to 3	3 to 4	4 to 5
mph	15	25	40	45	20 to 26	30 to 35	39 to 45
km/h	24	40	64	72	32 to 42	48 to 56	63 to 72

If your speed drops below 20 mph (32 km/h), or if the engine is not running smoothly, you should downshift to the next lower gear. You may have to downshift two or more gears to keep the engine running smoothly or for good performance.

NOTICE:

If you skip more than one gear when you downshift, or if you race the engine when you downshift, you can damage the clutch or transmission.

Four-Wheel Drive (Option)

If your vehicle has four-wheel drive, you can send your engine's driving power to all four wheels for extra traction. To shift out of two-wheel drive and into four-wheel drive, lock the freewheeling hubs (manual hubs only) and move the transfer case shift lever to **FOUR-WHEEL HIGH (4H)** or **FOUR-WHEEL LOW (4L)** (see the following). You should use **TWO-WHEEL HIGH (2H)** for most normal driving.

NOTICE:

Driving in FOUR-WHEEL HIGH (4H) or FOUR-WHEEL LOW (4L) positions for a long time on dry or wet pavement could shorten the life of your vehicle's drivetrain.

Freewheeling Hubs

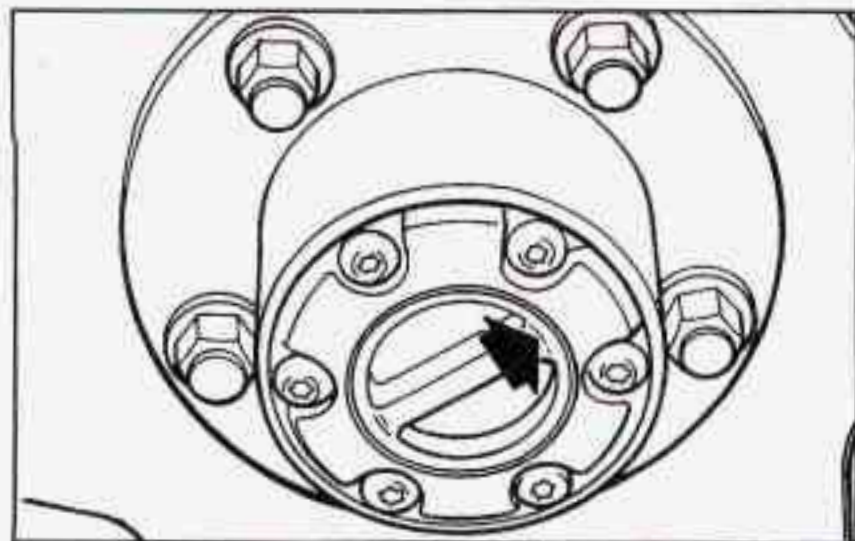

Your vehicle may have either manual or automatic freewheeling hubs. You must lock the hubs before you use **FOUR-WHEEL HIGH (4H)** or **FOUR-WHEEL LOW (4L)**.

Manual

To lock or unlock the hubs, you must park your vehicle (see "Shifting into **PARK (P)**" or "Parking Your Vehicle" in the Index) and get out. To lock the hubs, turn the hub dials to **LOCK**.

NOTICE:

Don't drive in **TWO-WHEEL HIGH (2H)** with the manual locking hubs in **LOCK**. If you do, you could damage your front driveshaft parts.

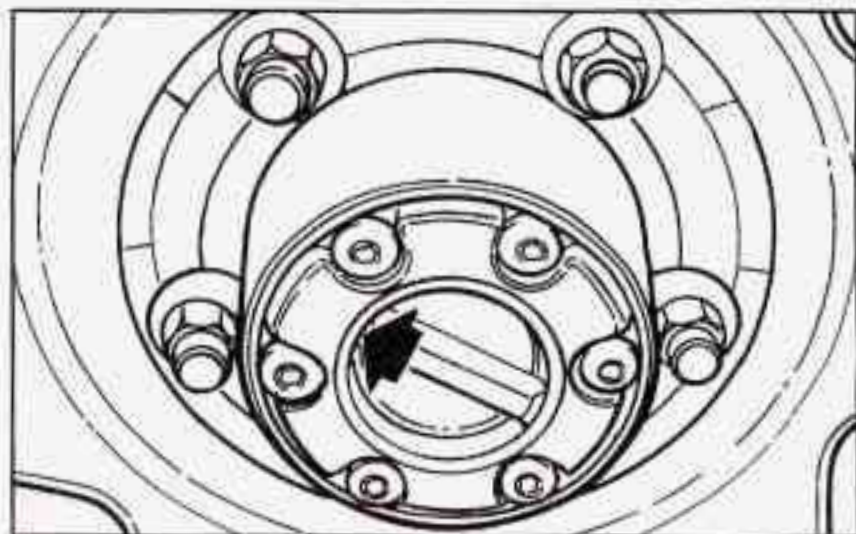

To unlock the hubs, turn the hub dials to **FREE**.

Automatic

With automatic freewheeling hubs, you don't have to get out of the vehicle to lock or unlock the hubs.

Locking the Hubs

1. Stop your vehicle.
2. Shift the transfer case to FOUR-WHEEL HIGH (4H) or FOUR-WHEEL LOW (4L).
3. Drive slowly forward and the hubs will lock.

Unlocking the Hubs

1. Stop your vehicle.
2. Drive 7 feet (2 m) in the direction opposite to the direction you were driving before you stopped.
3. Then, press the clutch if you have a manual transmission, and shift the transfer case to TWO-WHEEL HIGH (2H). The hubs will unlock.

Transfer Case

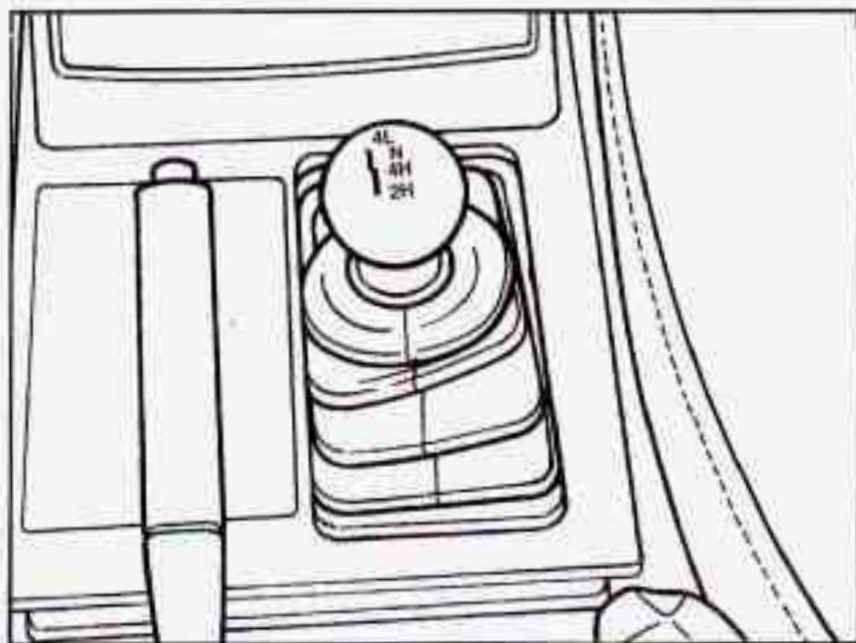

The transfer case shift lever is on the floor to the right of the driver. Use this lever to shift into and out of four-wheel drive. An indicator light comes on when the transfer case is in FOUR-WHEEL HIGH (4H) or FOUR-WHEEL LOW (4L).

TWO-WHEEL HIGH (2H): This setting is for driving in most street and highway situations. Your front axle is not engaged in two-wheel drive.

FOUR-WHEEL HIGH (4H): This setting engages your front axle to help drive your vehicle. Use **FOUR-WHEEL HIGH (4H)** when you need extra traction, such as on wet or icy roads, or in most off-road situations.

NEUTRAL (N): Shift to this setting only when your vehicle needs to be towed.

FOUR-WHEEL LOW (4L): This setting also engages your front axle to give you extra traction and can be used for driving downhill, uphill or on rocky terrain when you're driving slower than 35 mph (55 km/h).

Remember that driving in **FOUR-WHEEL HIGH (4H)** or **FOUR-WHEEL LOW (4L)** may reduce fuel economy. Also, driving in four-wheel drive on dry pavement could cause your tires to wear faster and make your transfer case harder to shift.

You can shift from **TWO-WHEEL HIGH (2H)** to **FOUR-WHEEL HIGH (4H)** or from **FOUR-WHEEL HIGH (4H)** to **TWO-WHEEL HIGH (2H)** at any speed if your hubs are locked and your wheels are straight ahead. Your front axle will engage faster if you take your foot off the accelerator pedal for a few seconds as you shift.

Shifting Into or Out of FOUR-WHEEL LOW (4L)

1. Stop your vehicle and shift your transmission to **NEUTRAL (N)**.
2. Shift the transfer case in one continuous motion.

Don't pause in **NEUTRAL (N)** as you shift into **FOUR-WHEEL HIGH (4H)**, or your gears could clash.

Parking Brake

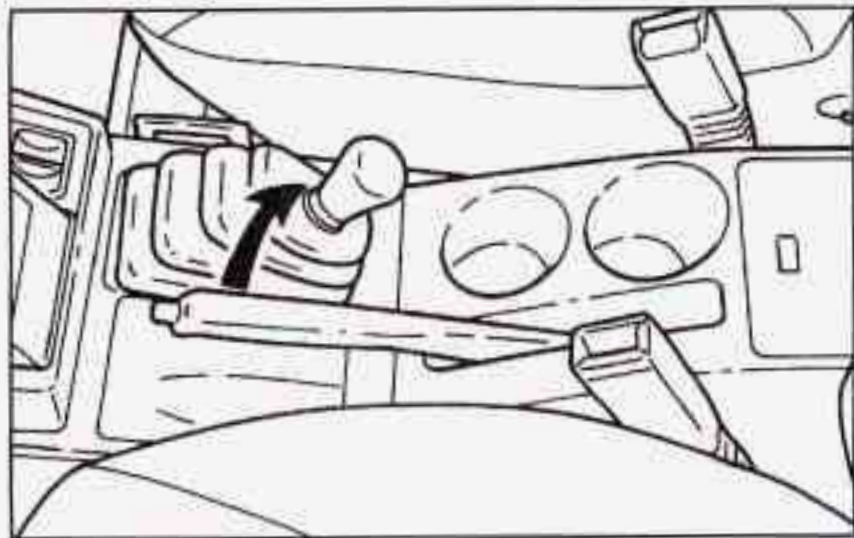

To set the parking brake, hold the brake pedal down and pull up on the parking brake lever. If the ignition is on, the brake system warning light will come on.

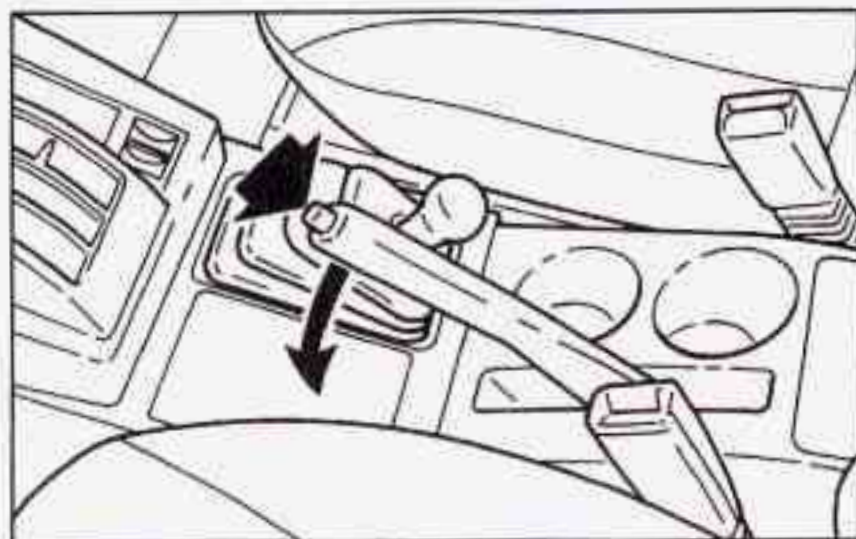

To release the parking brake, hold the brake pedal down. Pull the parking brake lever up until you can push in the release button. Hold the release button in as you move the lever all the way down.

NOTICE:

Driving with the parking brake on can cause your rear brakes to overheat. You may have to replace them, and you could also damage other parts of your vehicle.

If you are towing a trailer, see "Towing a Trailer" in the Index.

Shifting Into PARK (P) (Automatic Transmission Models Only)

CAUTION:

It can be dangerous to get out of your vehicle if the shift lever is not fully in **PARK (P)** with the parking brake firmly set. Your vehicle can roll.

If you have left the engine running, the vehicle can move suddenly. You or others could be injured. To be sure your vehicle won't move, even when you're on fairly level ground, use the steps that follow. If you have four-wheel drive and your transfer case is in **NEUTRAL (N)**, your vehicle will be free to roll, even if your shift lever is in **PARK (P)**. So, be sure the transfer case is in a drive gear -- not in **NEUTRAL (N)**. If you're pulling a trailer, see "Towing a Trailer" in the Index.

1. Hold the brake pedal down with your right foot and set the parking brake.
2. Move the shift lever into PARK (P) by holding in the button on the lever and pushing the lever all the way toward the front of your vehicle.
3. If you have four-wheel drive, be sure the transfer case is in a drive gear -- not in NEUTRAL (N).
4. Move the key to LOCK.
5. Remove the key and take it with you. If you can leave your vehicle with the key in your hand, your vehicle is in PARK (P).

Leaving Your Vehicle With the Engine Running (Automatic Transmission Models Only)

 **CAUTION:**

It can be dangerous to leave your vehicle with the engine running. Your vehicle could move suddenly if the shift lever is not fully in PARK (P) with the parking brake firmly set. If you have four-wheel drive and your transfer case is in NEUTRAL (N), your vehicle will be free to roll, even if your shift lever is in PARK (P). So be sure the transfer case is in a drive gear -- not in NEUTRAL (N). And, if you leave the vehicle with the engine running, it could overheat and even catch fire. You or others could be injured. Don't leave your vehicle with the engine running unless you have to.

Torque Lock (Automatic Transmission)

If you are parking on a hill and you don't shift your transmission into PARK (P) properly, the weight of the vehicle may put too much force on the parking pawl in the transmission. You may find it difficult to pull the shift lever out of PARK (P). This is called "torque lock." To prevent torque lock, set the parking brake and then shift into PARK (P) properly before you leave the driver's seat. To find out how, see "Shifting Into PARK (P)" in the Index.

When you are ready to drive, move the shift lever out of PARK (P) *before* you release the parking brake.

If torque lock does occur, you may need to have another vehicle push yours a little uphill to take some of the pressure from the transmission, so you can pull the shift lever out of PARK (P).

Shifting Out of PARK (P) (Automatic Transmission)

Your Geo has a brake-transmission shift interlock. You have to fully apply your regular brakes before you can shift from PARK (P) when the ignition is in the ON position. See "Automatic Transmission" in the Index.

If you cannot shift out of PARK (P), ease pressure on the shift lever -- push the shift lever all the way into PARK (P) and release the shift lever button as you maintain brake application. Then press the shift lever button and move the shift lever into the gear you wish.

If you ever hold the brake pedal down but still can't shift out of PARK (P), try this:

1. Apply and hold the brake until the end of Step 6.
2. If the engine is running, shut it off. Turn the key to ON or ACC.
3. Find the access hole cover on the driver's side of the console, near the shift lever.
4. Remove the screw and cover.
5. Inside you'll see the return plate. Using your finger, move the return plate toward the rear of the vehicle until it stops.
6. Move the shift lever into the gear you want.
7. Have the vehicle fixed as soon as possible.

Parking Your Vehicle (Manual Transmission)

Before you get out of your vehicle, put your manual transmission in REVERSE (R) and firmly apply the parking brake.

If you have four-wheel drive, be sure your transfer case is in a drive gear. Your vehicle could roll if it isn't.

If you are towing a trailer, see "Towing a Trailer" in the Index.

Parking Over Things That Burn

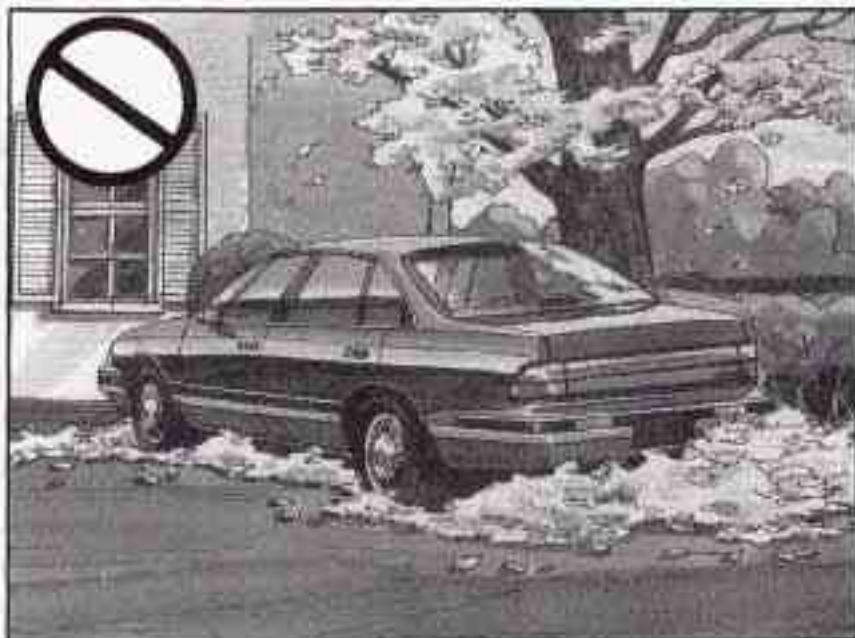

CAUTION:

Things that can burn could touch hot exhaust parts under your vehicle and ignite. Don't park over papers, leaves, dry grass or other things that can burn.

Engine Exhaust

CAUTION:

Engine exhaust can kill. It contains the gas carbon monoxide (CO), which you can't see or smell. It can cause unconsciousness and death.

You might have exhaust coming in if:

- Your exhaust system sounds strange or different.
- Your vehicle gets rusty underneath.
- Your vehicle was damaged in a collision.
- Your vehicle was damaged when driving over high points on the road or over road debris.
- Repairs weren't done correctly.
- Your vehicle or exhaust system had been modified improperly.

If you ever suspect exhaust is coming into your vehicle:

- Drive it only with all the windows down to blow out any CO; and
- Have your vehicle fixed immediately.

Running Your Engine While You're Parked (Automatic Transmission)

It's better not to park with the engine running. But if you ever have to, here are some things to know.

CAUTION:

Idling the engine with the air system control off could allow dangerous exhaust into your vehicle (see the earlier Caution under "Engine Exhaust").

Also, idling in a closed-in place can let deadly carbon monoxide (CO) into your vehicle even if the fan switch is at the highest setting. One place this can happen is a garage. Exhaust -- with CO -- can come in easily. NEVER park in a garage with the engine running.

Another closed-in place can be a blizzard. (See "Blizzard" in the Index.)

 **CAUTION:**

It can be dangerous to get out of your vehicle if the shift lever is not fully in PARK (P) with the parking brake firmly set. Your vehicle can roll. Don't leave your vehicle when the engine is running unless you have to. If you've left the engine running, the vehicle can move suddenly. You or others could be injured. To be sure your vehicle won't move, even when you're on fairly level ground, always set your parking brake and move the shift lever to PARK (P).

If you have four-wheel drive and your transfer case is in NEUTRAL (N), your vehicle will be free to roll, even if your shift lever is in PARK (P). So, be sure the transfer case is in a drive gear -- not in NEUTRAL (N). Always set your parking brake. Follow the proper steps to be sure your vehicle won't move. See "Shifting Into PARK (P)" in the Index.

If you're pulling a trailer, see "Towing a Trailer" in the Index.

Windows

Manual Windows

Use the window crank to open and close each door window.

Power Windows (Option)



With power windows, switches on the driver's door control each of the front side windows when the ignition is on.



The driver-controlled switches for the rear windows are located on the center console.

There are individual controls near each window.

The driver's door also has a lock button for the passenger window(s). When you push LOCK, the passenger window(s) can't be raised or lowered. Push LOCK again to unlock the window(s).

Horn

To sound the horn, press one of the horn symbols on your steering wheel.

Turn Signal/Multifunction Lever

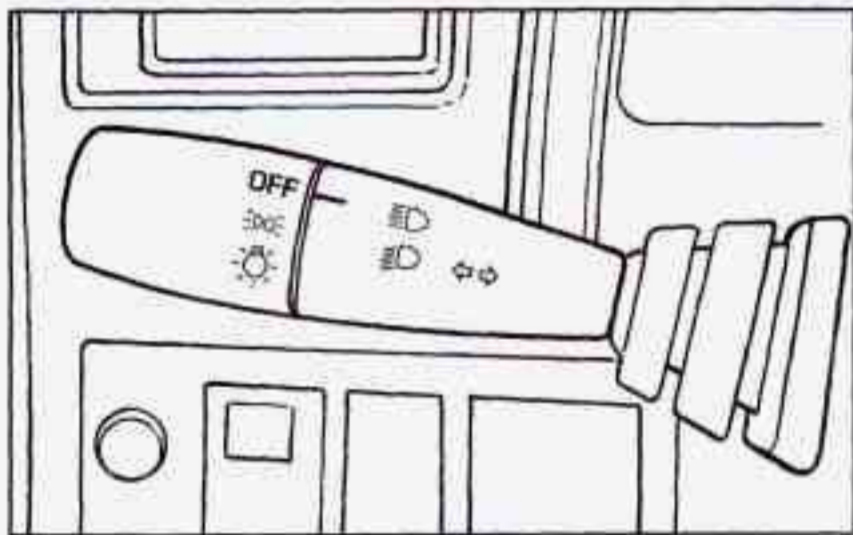

The lever on the left side of the steering column includes your:

- Turn Signal and Lane Change Indicator
- Headlamp High/Low Beam Changer and Passing Signal
- Lighting Operation

Turn Signal and Lane Change Indicator

The turn signal has two upward (for right) and two downward (for left) positions. These positions allow you to signal a turn or a lane change.

To signal a turn, move the lever all the way up or down. When the turn is finished, the lever will return automatically.

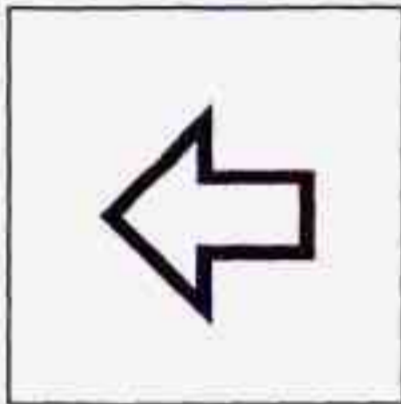

An arrow on the instrument panel will flash in the direction of the turn or lane change.

To signal a lane change, just raise or lower the lever until the arrow starts to flash. Hold it there until you complete your lane change. The lever will return by itself when you release it.

As you signal a turn or a lane change, if the arrows don't flash but just stay on, a signal bulb may be burned out and other drivers won't see your turn signal.

If a bulb is burned out, replace it to help avoid an accident. If the arrows don't go on at all when you signal a turn, check the fuse (see "Fuses and Circuit Breakers" in the Index) and for burned-out bulbs.

Lamps Control

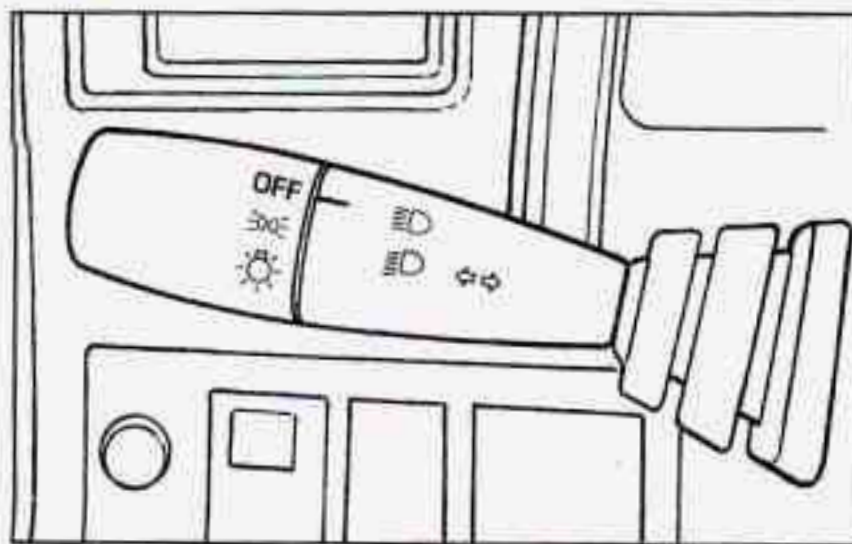

Turn the outside part of the lever to control the lamps. There are three positions for the lamp switch.

OFF: All lamps are off.

 : The parking lamps, taillamps, license plate lamp and the instrument panel lights come on. The headlamps are off.

 : The headlamps and all other operating lamps come on.

Lamps On Reminder

If you turn the ignition off, remove the key, open the door and leave the lamps on, a chime will remind you to turn off your lamps.

Headlamp High/Low Beam Changer

First, you must have the headlamps on. For high beams, push the turn signal lever away from you.

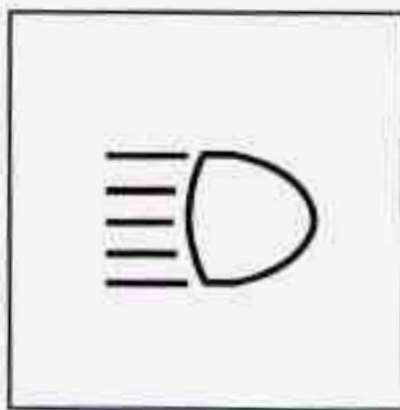

When the high beams are on, a light on the instrument panel also will be on. It will go off when you switch to low beam.

To switch back to low beams, pull the lever toward you.

Flash-to-Pass

With the lever in the low-beam position, pull the lever toward you to momentarily switch to high beam (to signal that you are going to pass). When you release the lever, the headlamps will return to low-beam operation.

Windshield Wiper/Washer Lever



The lever on the right side of the steering column controls the windshield wipers and washers.

Move the wiper switch to the position you want:

OFF: The wipers are off.

INT: Intermittent wiper operation. In light rain or snow, you might want to use this position rather than continuous wiping.

LO: The wipers will run continuously at low speed.

HI: The wipers will run continuously at high speed.

For a single wiping cycle, pull the lever toward you. Hold it there until the wipers start, then let go. The wipers will stop after one cycle. If you want more cycles, hold the lever longer.

Be sure to clear ice and snow from the wiper blades before using them. If they're frozen to the windshield, carefully loosen or thaw them. If your blades do become damaged, get new blades or blade inserts.

Heavy snow or ice can overload your wipers. A circuit breaker will stop them until the motor cools. Clear away snow or ice to prevent an overload.

Windshield Washer

Pull the wiper/washer lever toward you to spray washer fluid on the windshield. The spray will continue until you release the lever. This will also turn on the low speed wipers. See “Windshield Washer Fluid” in the Index.

CAUTION:

In freezing weather, don't use your washer until the windshield is warmed. Otherwise the washer fluid can form ice on the windshield, blocking your vision.

Rear Window Wiper/Washer (Option)

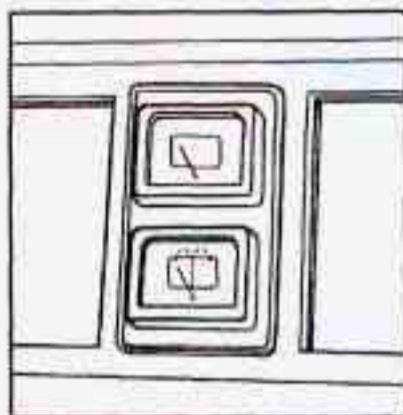

To turn on your rear wiper, push the upper button. Push the same button again to turn it off.

To spray washer fluid on the rear window, push the lower button about halfway down. Washer fluid will spray as long as you hold this button. To wash and wipe at the same time, push the button all the way in.

The washer and wiper will run as long as you hold this button. To add washer fluid, see “Windshield Washer Fluid” in the Index.

Cruise Control (Option)

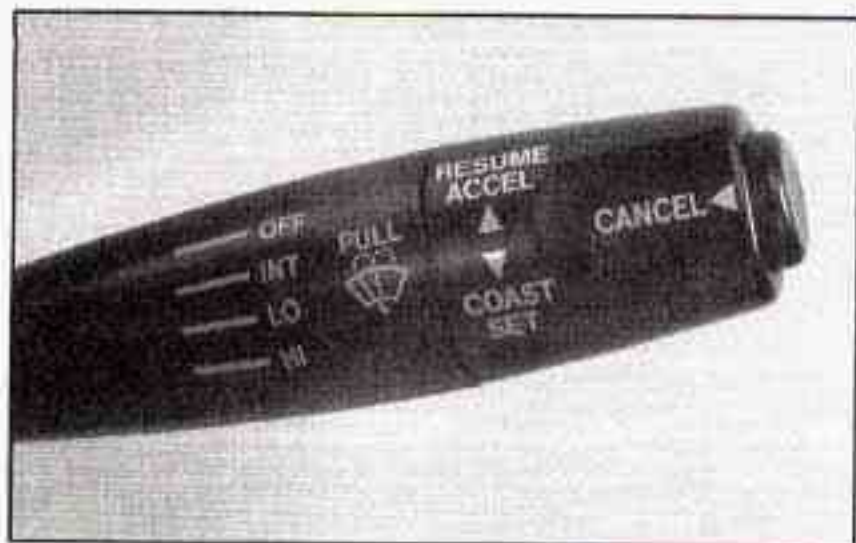

With cruise control, you can maintain a speed of about 25 mph (40 km/h) or more without keeping your foot on the accelerator. This can really help on long trips. Cruise control does not work at speeds below about 25 mph (40 km/h).

When you apply your brakes, or push the clutch pedal if you have a manual transmission, the cruise control shuts off.

CAUTION:

- Cruise control can be dangerous where you can't drive safely at a steady speed. So, don't use your cruise control on winding roads or in heavy traffic.
- Cruise control can be dangerous on slippery roads. On such roads, fast changes in tire traction can cause needless wheel spinning, and you could lose control. Don't use cruise control on slippery roads.

Setting Cruise Control

CAUTION:

If you leave your cruise control switch on when you're not using cruise, you might hit a button and go into cruise when you don't want to. You could be startled and even lose control. Keep the cruise control switch OFF until you want to use it.



1. Press the **CRUISE CTRL** switch on the instrument panel to turn the system on. The indicator light on the switch will come on.

2. Get up to the speed you want.



3. Once you're going 25 mph (40 km/h) or more, turn the lever to **COAST/SET** and release. Your cruise will set.
4. Take your foot off the accelerator pedal.

Resuming a Set Speed

Suppose you set your cruise control at a desired speed and then you apply the brake. This, of course, shuts off the cruise control. But you don't need to reset it.



Once you're going about 25 mph (40 km/h) or more, you can turn the lever to RESUME/ACCEL for about one second.

You'll go right back to your chosen speed and stay there.

Increasing Speed While Using Cruise Control

There are two ways to go to a higher speed. Here's the first:

1. Use the accelerator pedal to get to the higher speed.
2. Turn the lever to COAST/SET and release. Take your foot off the accelerator pedal. You'll now cruise at the higher speed.

Here's the second way to go to a higher speed:

1. Turn the lever to RESUME/ACCEL.
2. Hold the lever at RESUME/ACCEL until you get up to the speed you want, then release the lever.

Reducing Speed While Using Cruise Control

To reduce your speed, turn and hold the lever in the COAST/SET position until you reach the lower speed you want, then release the lever.

Passing Another Vehicle While Using Cruise Control

Use the accelerator pedal to increase your speed. When you take your foot off the pedal, your vehicle will slow down to the cruise control speed you set earlier.

Using Cruise Control on Hills

How well your cruise control will work on hills depends upon your speed, load and the steepness of the hills. When going up steep hills, you may have to step on the accelerator pedal to maintain your speed. When going downhill, you may have to brake or shift to a lower gear to keep your speed down. Of course, applying the brake takes you out of cruise control. Many drivers find this to be too much trouble and don't use cruise control on steep hills.

Getting Out of Cruise Control

There are three ways to turn off cruise control:

- Step lightly on the brake pedal, or push the clutch pedal if you have a manual transmission.
- Push in the CANCEL button on the end of the cruise control lever.
- Press OFF on the cruise control switch.

Erasing Speed Memory

When you turn off the cruise control or the ignition, your cruise control set speed memory is erased.

Lamps

Daytime Running Lamps

Daytime Running Lamps (DRL) can make it easier for others to see the front of your vehicle during the day. DRL can be helpful in many different driving conditions, but they can be especially helpful in the short periods after dawn and before sunset.

The DRL system will make your low-beam headlamps come on at a reduced brightness when:

- The ignition is on,
- The headlamp switch is off, and
- The parking brake is released.

When you turn on the headlamp switch, your DRL will go out, and your headlamps will come on.

The other lamps that come on with your headlamps will also come on.

When you turn off the headlamp switch, the regular lamps will go off, and your low-beam headlamps come on at the reduced brightness of DRL.

To idle your vehicle with the DRL off, set the parking brake. The DRL will stay off until you release the parking brake.

As with any vehicle, you should turn on the regular headlamp system when you need it.

Interior Lamps

Instrument Panel Brightness Control



This knob controls the brightness of your instrument panel lights. Turn the knob to the right to brighten the lights or to the left to dim them.

Dome Lamp

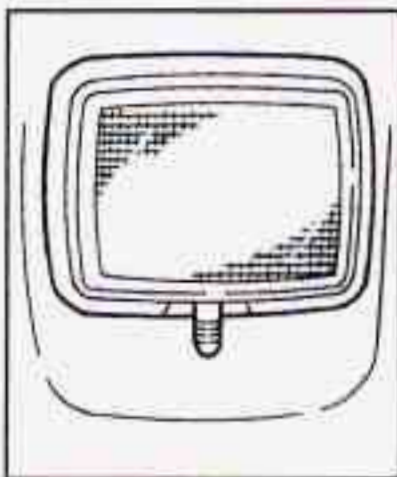

The dome lamp has a three-position switch.

- 1:** This position is to the left when sitting in the driver's seat. The dome lamp turns on and stays on whether or not a door is open.
- 2:** This is the center position. The lamp comes on when a door is opened.
- 3:** This position is to the right when sitting in the driver's seat. The lamp stays off even when a door is open.

Mirrors

Inside Day/Night Rearview Mirror



An inside rearview mirror is attached above your windshield. The mirror has pivots so that you can adjust it up and down or side to side.

You can adjust the mirror for day or night driving. Pull the tab for night driving to reduce glare. Push the tab for daytime driving.

Outside Manual Adjust Mirrors

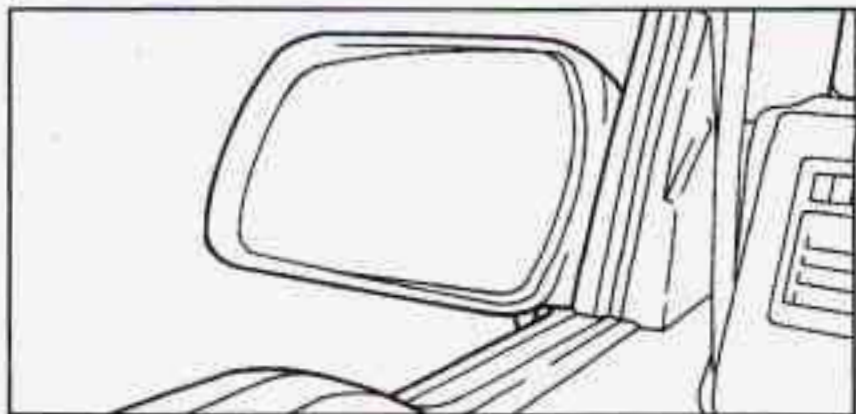

Adjust these mirrors by hand so that you can just see the side of your vehicle when you are sitting in a comfortable driving position.

Power Remote Control Mirrors (Option)



The switch to control the power mirrors is located on the instrument panel. You can only adjust the mirrors when the ignition switch is in the ON position.

To adjust the mirrors:

1. Move the selector switch to the left or right to select the mirror you wish to adjust.
2. Press the outer part of the switch that matches the direction you want to move the mirror.
3. Return the selector switch to the center position to help prevent moving the mirror accidentally.

Convex Outside Mirror

Your passenger's side mirror is convex. A convex mirror's surface is curved so you can see more from the driver's seat.

CAUTION:

A convex mirror can make things (like other vehicles) look farther away than they really are. If you cut too sharply into the right lane, you could hit a vehicle on your right. Check your inside mirror or glance over your shoulder before changing lanes.

Storage Compartments

Glove Box

To open the glove box, pull the latch toward you. Use your key to lock and unlock the glove box.

Door Storage

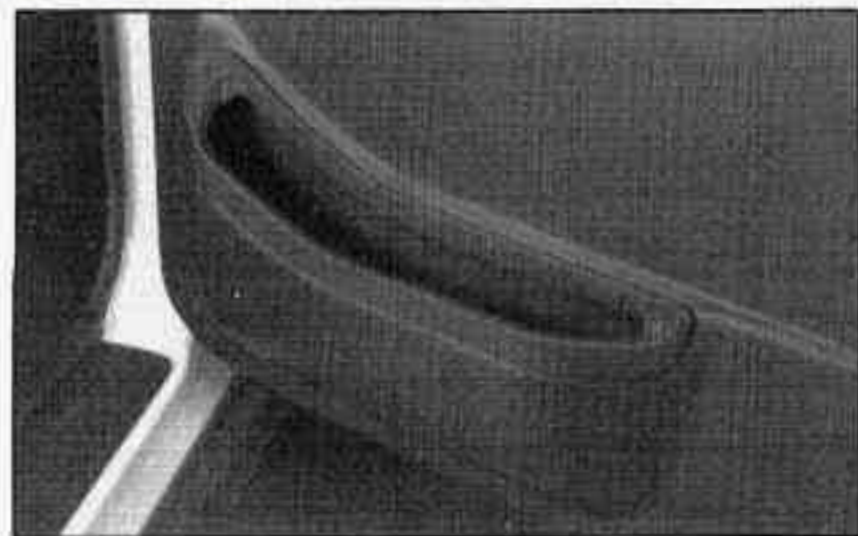

Each door has a storage compartment.

Front Seat Side Pockets

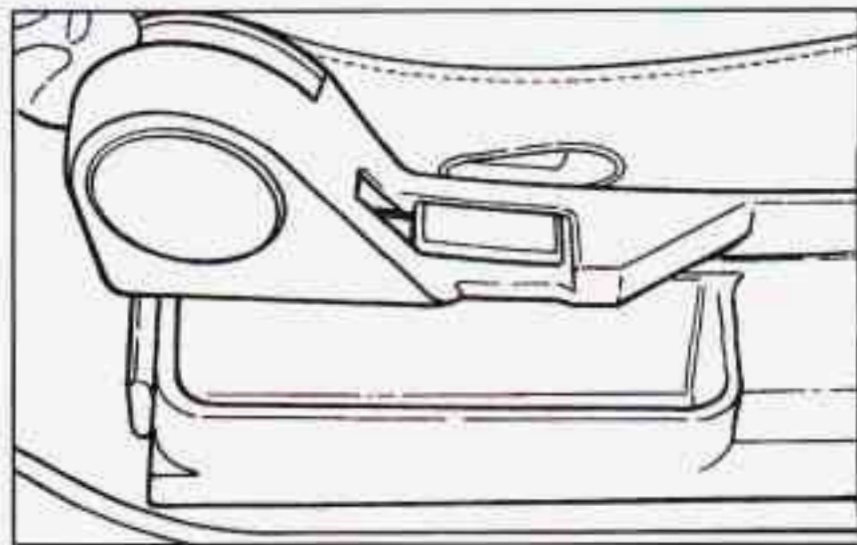

On the outside of each front seat is a storage pocket.

Coinholder and Bin



Your console has a coinholder and a small storage bin.

Cupholder

Two cupholders are on the center console next to the parking brake lever.

Ashtrays and Lighter

To use the lighter, push the lighter in all the way and let go. When it's ready, it will pop back by itself.

NOTICE:

Don't hold a cigarette lighter in with your hand while it is heating. If you do, it won't be able to back away from the heating element when it's ready. That can make it overheat, damaging the lighter and the heating element.

Pull the door to open the ashtray. To remove it, press down on the silver tab and pull the ashtray out.

The rear ashtray is on the back of the center console. Pull on the top of the door to open it. To remove the ashtray, press down on the tab and pull it out.

NOTICE:

Don't put papers and other things that burn into your ashtray. If you do, cigarettes or other smoking materials could set them on fire, causing damage.

Sun Visors

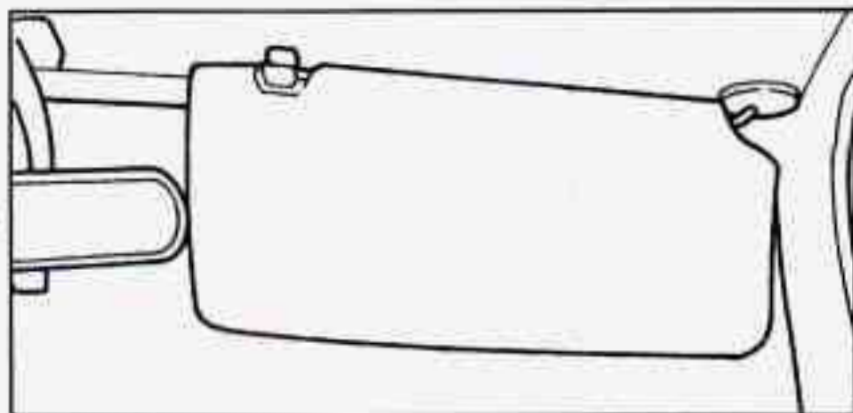

To block out glare, you can swing down the visors.

You can also swing them to the side. If the visors swing too easily, tighten the screw on the roof rail.

Convertible Top (Option)

Your convertible top features a sunroof, a removable rear window, removable side windows and a removable canvas top.

NOTICE:

- Never raise or lower the top while the vehicle is moving, or drive with any part of the top unfastened or partially removed. The wind could get under it and cause damage.
- Do not take your vehicle through an automatic car wash. It could damage your convertible top.
- Don't try to lower or raise the convertible top or tap or beat on the plastic windows if your vehicle is out in cold weather, 41° F (5° C) or below. The cold can cause cracks and other damage to the windows and to the top as it is being lowered or raised.

(Continued)

NOTICE: (Continued)

- Don't lower the top if it is damp or wet. After the top is down, the trapped water can cause stains, mildew and damage to the inside of your car. Be sure to dry off the top before you lower it.
- Don't lower the convertible top if the rear flap or side windows are dirty. Dirt could scratch the side windows.
- The convertible top isn't designed to carry weight. Never let anyone sit on the top, and don't put anything on top of it when it is up, or it could be damaged.

Opening and Closing Your Sunroof

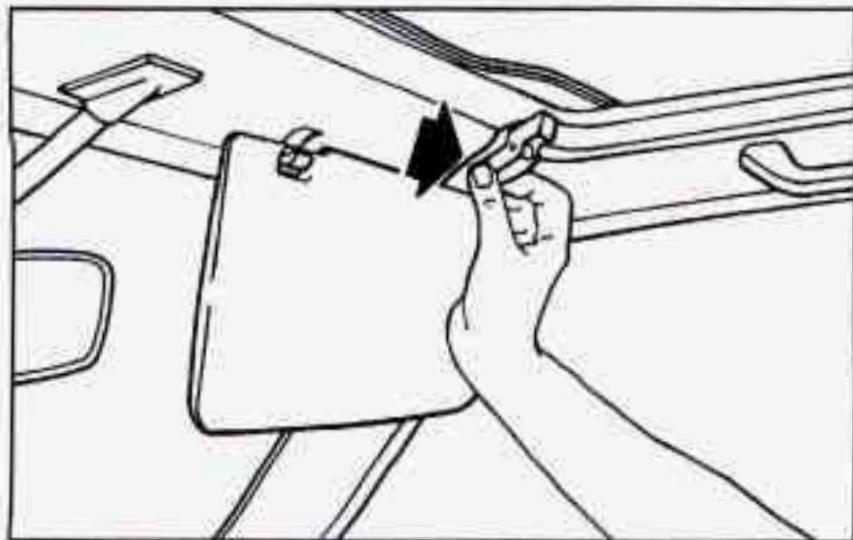

1. Lower your antenna and swing your sun visors down.
2. Squeeze the front top bow latch buttons and pull the latch back.

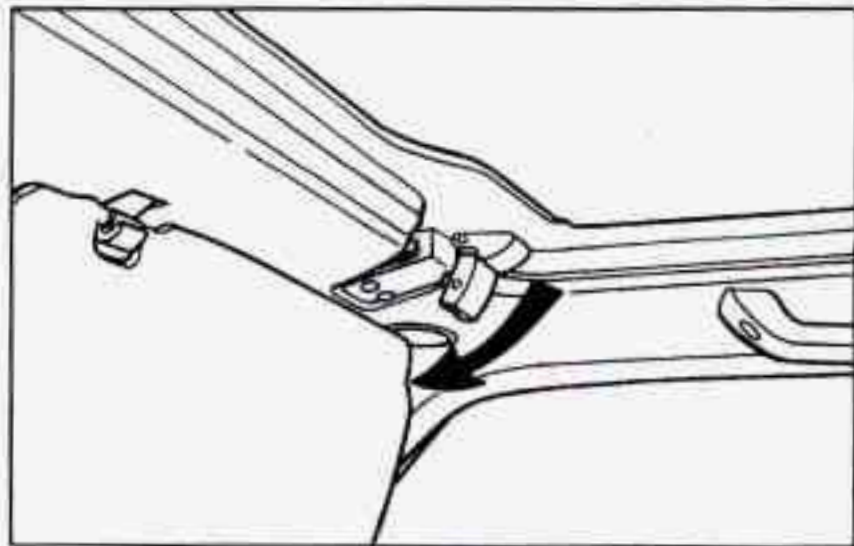

3. Unhook the latch from the front top bow.

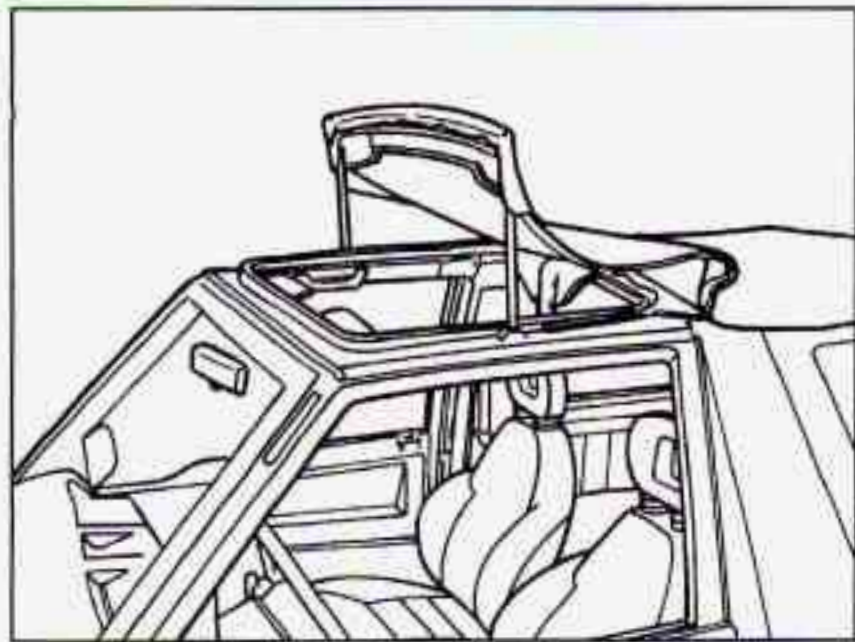

4. Swing the front top bow up and back while folding the canvas top out from between the top bow and the roof support. Be sure that you don't pinch the canvas top between the front top bow arms and the roof rails.



5. Unfasten the holding strap near the dome lamp and pull it through the slot in the front top bow.
6. Fasten the holding strap to itself.
7. Push the front top bow latches down until they "click."
8. Swing your sun visors up and raise your antenna.

Reverse the steps to close your sunroof. Be sure your front top bow is latched securely.

Removing and Installing Your Rear Window

The rear window of your vehicle is removable. This allows you to open the back opening all the way or to replace the window if it becomes deteriorated. To remove the rear window:

1. Open the rear gate all the way.
2. Unfasten the canvas flaps at the lower corners of the rear window to uncover the zipper pull.
3. Unzip the rear window.

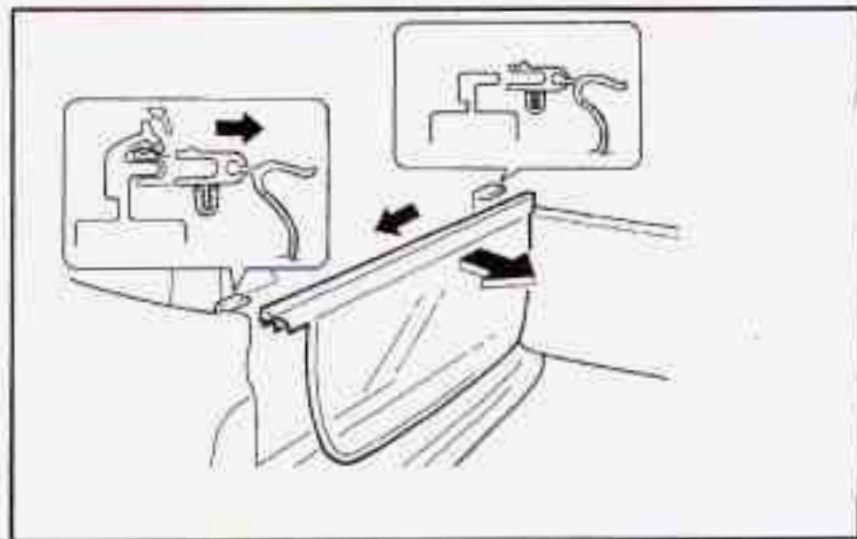

4. Hang the rear window down so it hangs outside of the vehicle.
5. Push the clip on the driver's side of the rear window frame (see illustration above) and pull the bar rearward. Then slide the bar to the left to release the passenger's side.

Reverse the steps to install the rear window. Make sure that the window is completely closed before driving.

Removing and Installing the Side Window

To remove the side window:

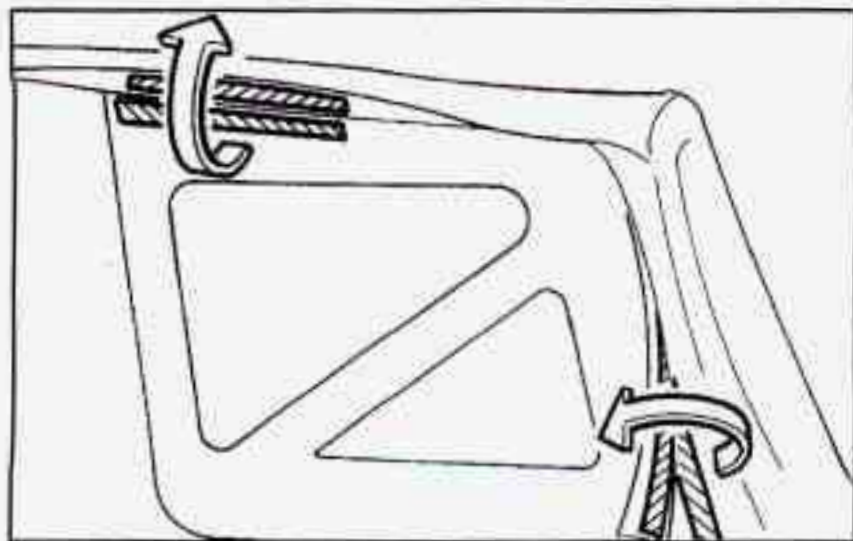

1. Unfasten the Velcro[®] on the top and rear quarter of the side window.
2. Unzip the zipper almost all the way, leaving about 3 inches (8 cm) of it still zipped and unfasten the Velcro on the inside of the window.
3. Release the plastic strip sewn along the bottom edge of the window by gently pulling down and out then release the plastic along the front edge of the window by pulling it forward and out.

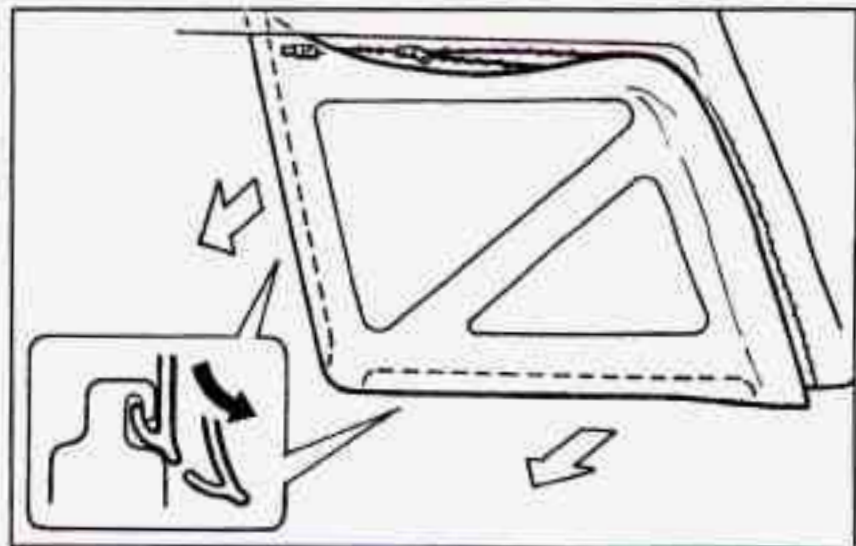

4. Unzip the zipper the rest of the way and remove the side window.

Reverse the steps to install the side window.

Please note that during installation:

You may want to start by zipping the zipper about 3 inches (8 cm), to hold the window in place. When zipping, place the rear bottom corner of the window inside the rear part of the vehicle body to help you engage the zipper end.

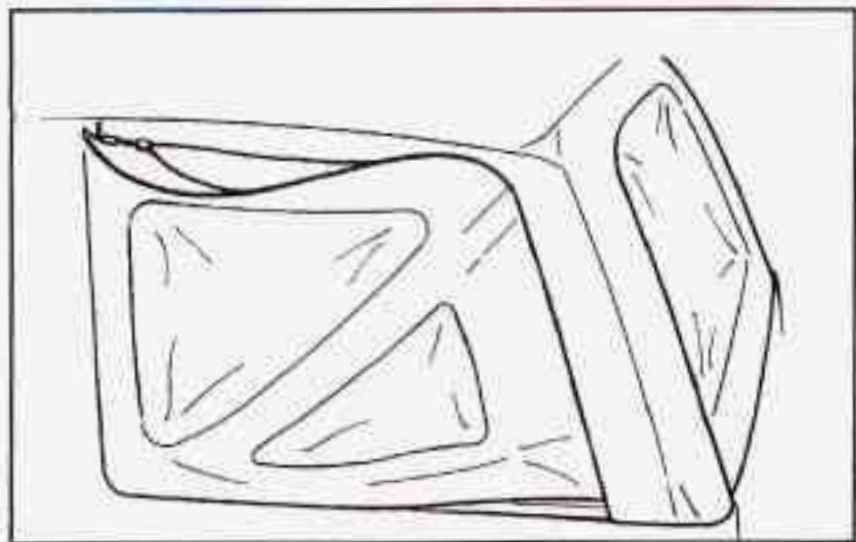

Be sure to:

- Fit the side and rear part of the window into the frame before completely zipping the window.
- Push the inner lip of the canvas top all the way in while zipping.

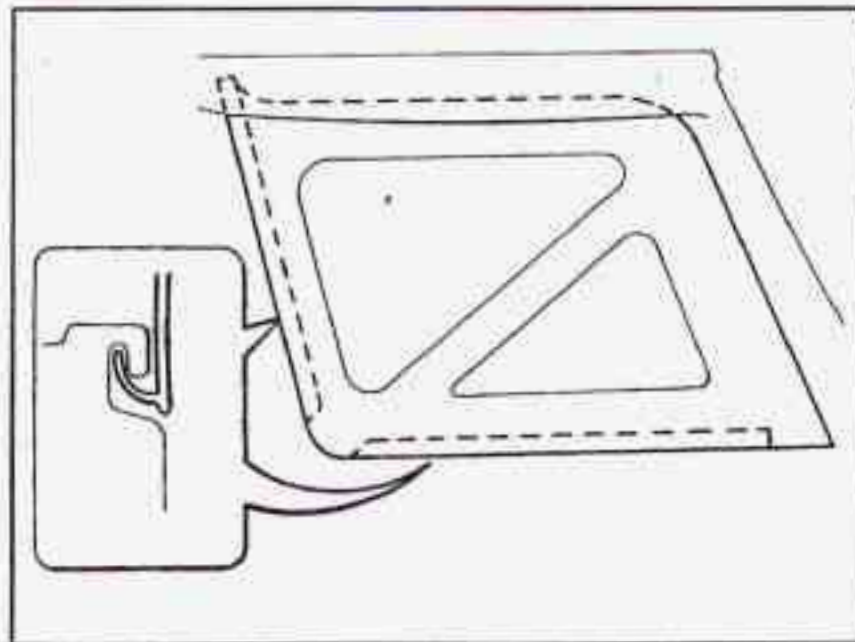

After completing installation, make sure that the front and bottom ends are securely hooked and the rear top end of the window is under the canvas top.

Lowering and Raising the Canvas Top

1. Remove the side windows of the canvas top as shown previously.
2. Open the rear window and hang it down inside the luggage compartment.

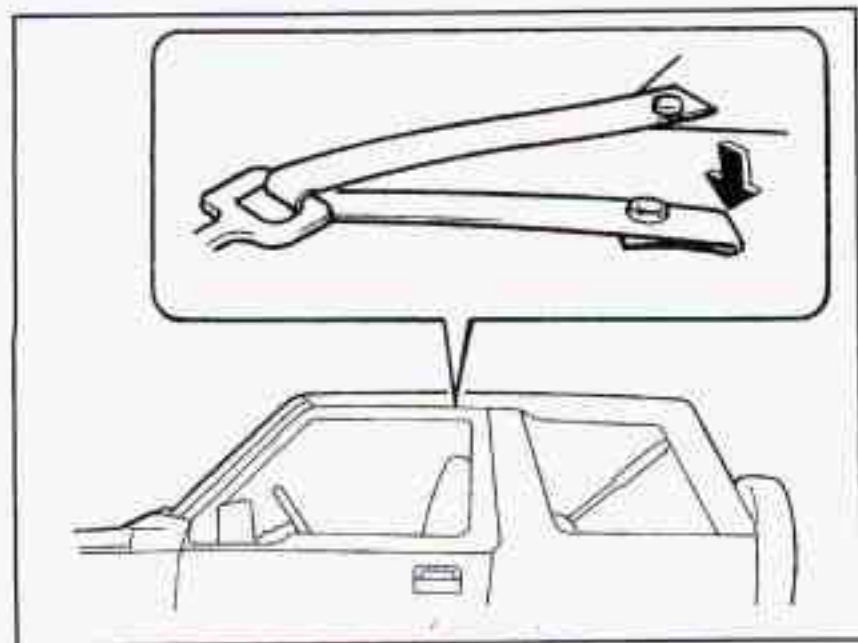

3. Unfasten the snaps on the driver's and passenger's sides of the roof side tension belts, located above the doors on the outside of the vehicle, underneath the canvas top.

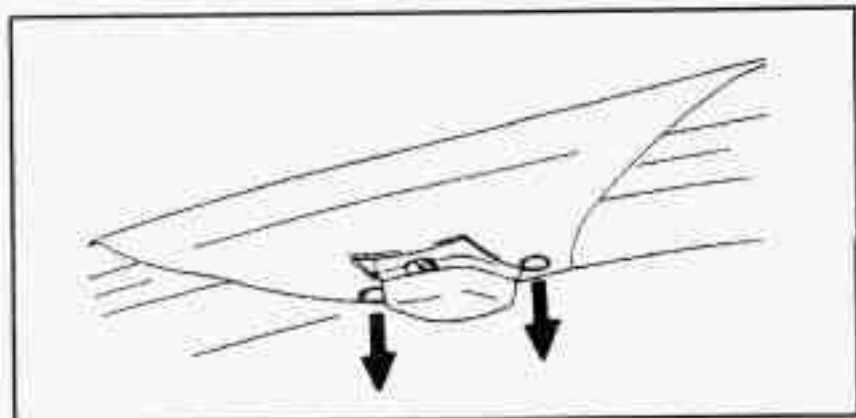

4. Unfasten the snaps that secure the canvas top to the roof piece. The snaps are located on either side of the dome lamp.

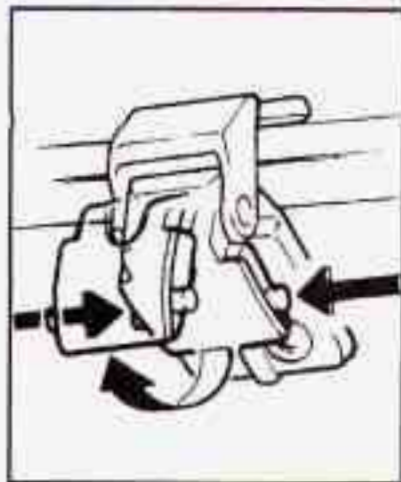

5. Lower the sun visors and push both sides of the lock buttons on the front latches.

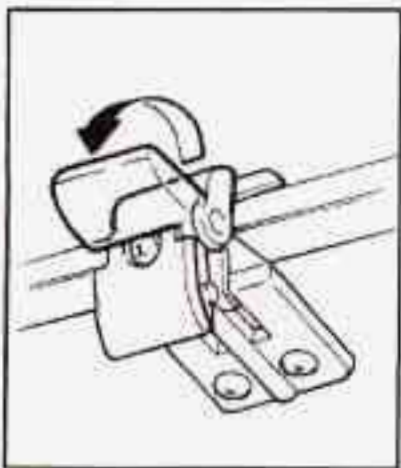

6. Unhook the latches.

7. Pull back the swing arm, unfasten the five snaps that secure the canvas to the swing arm and remove the canvas from the swing arm.

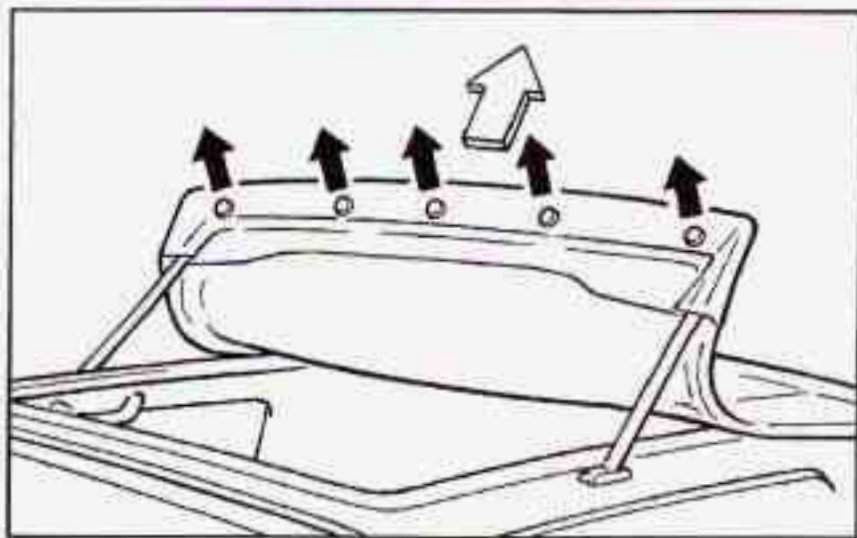

8. Return the swing arm forward and hook it securely with the latches.
9. Pull the tension belts located above the door frame out through their rings.

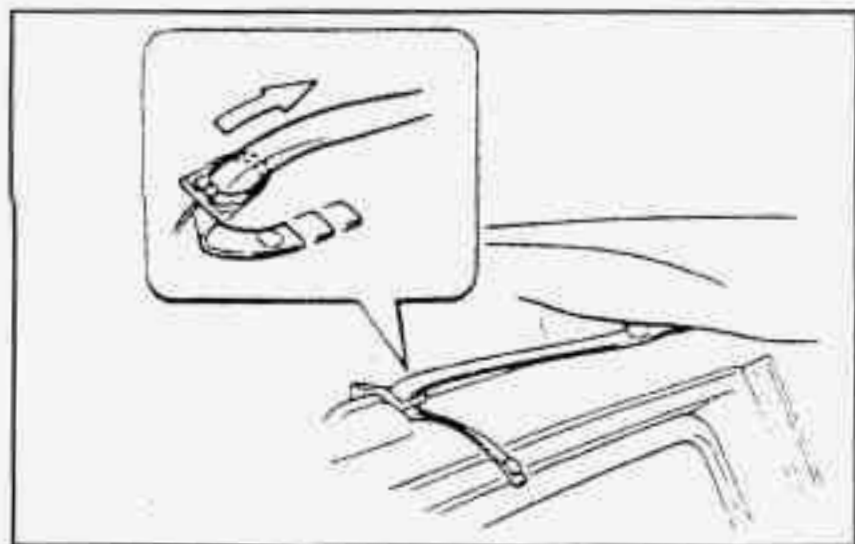

10. Lay the front half part of the canvas top onto the rear half of the top. Then, fold it forward so it is in "half."
11. Put the rear bottom corners of the canvas top into the luggage compartment.

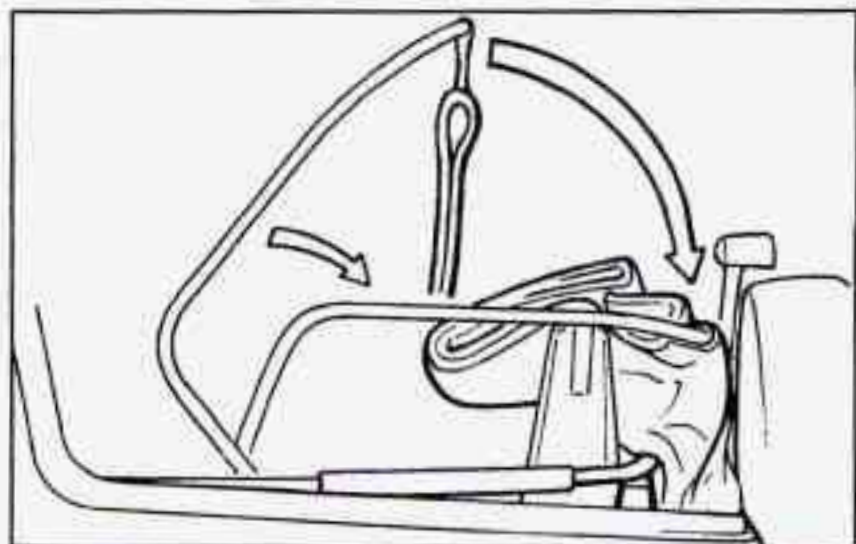

12. Lower the top bows.
Make sure that the lower top bow rests on the rubber support without pinching any part of the canvas top.



13. Lower the folded canvas behind the rear seatback(s). Make sure that the rear seat belts around the shoulder anchor are clear from the folded top.

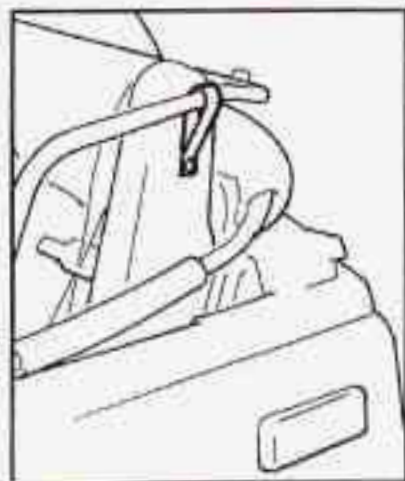

14. Fasten the upper top bow with the belt on the driver's side seat belt shoulder anchor bracket.

Reverse the steps to raise your canvas top.

After raising the canvas top, make sure that the canvas extension is located outside the roof rail.

Removing and Installing the Canvas Top

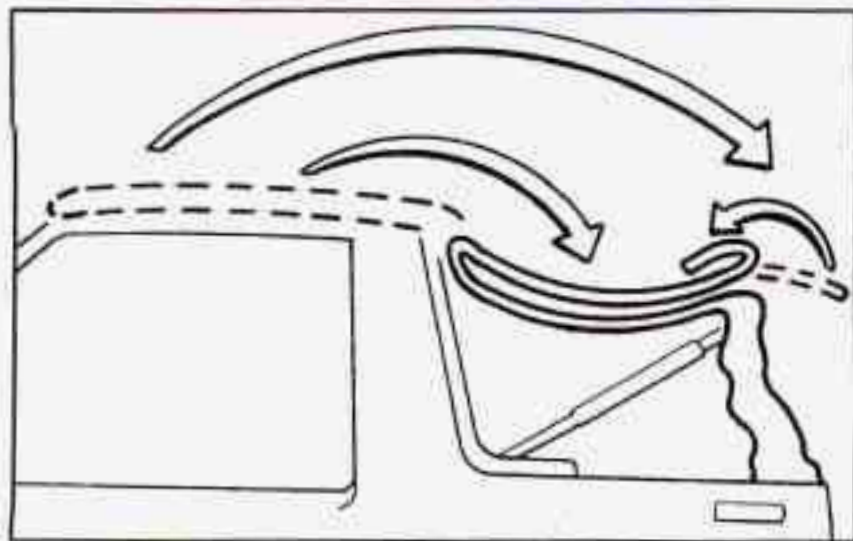

1. Complete the steps listed previously for lowering the canvas top.
2. Detach the rear bottom corners of the canvas top.

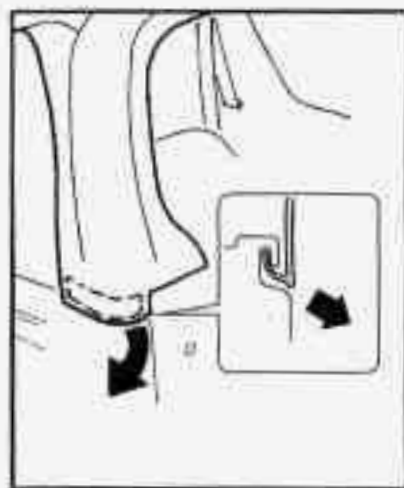

3. Unfasten the Velcro[®] fastener.

4. Unsnap the canvas top to remove it all the way.
See "Preparing Your Canvas Top for Storage" in this section for the correct storage procedure.

Preparing the Canvas Top for Storage

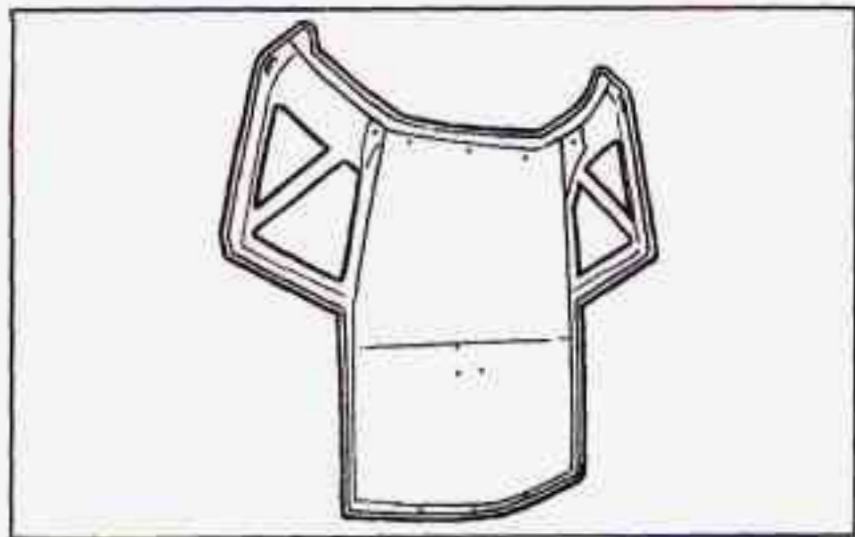

1. Lay the canvas top inside-up on a clean, dry, flat surface.

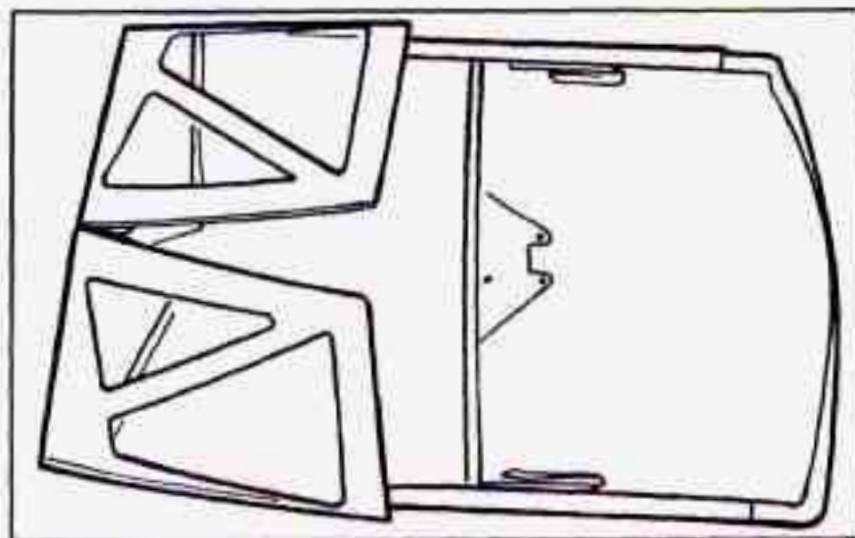

2. Fold the side windows onto the top.

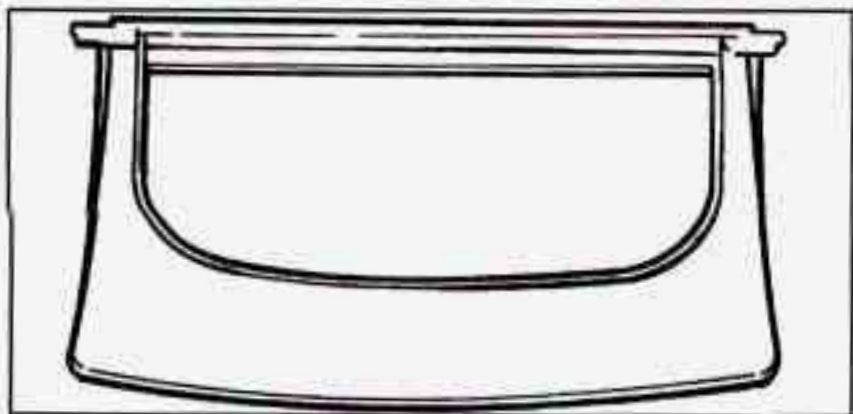

3. Fold the front part of the canvas top over the windows.
4. Lay the rear window on top of the folded canvas top.

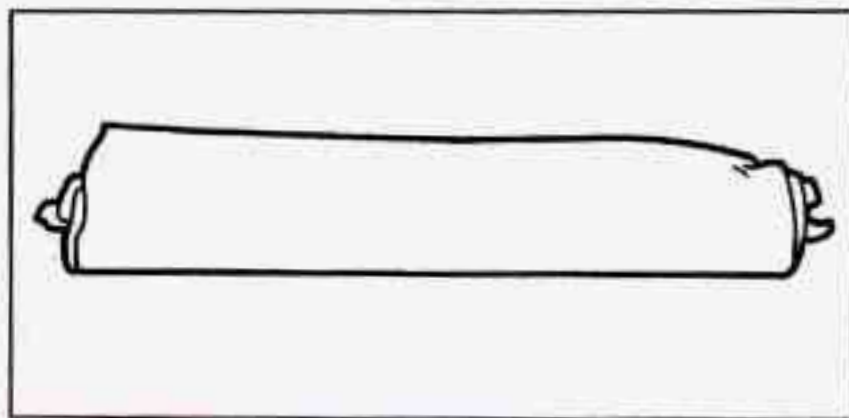

5. Roll the canvas top around the rear window.
6. Store in a clean, dry location.

Instrument Panel -- Your Information System

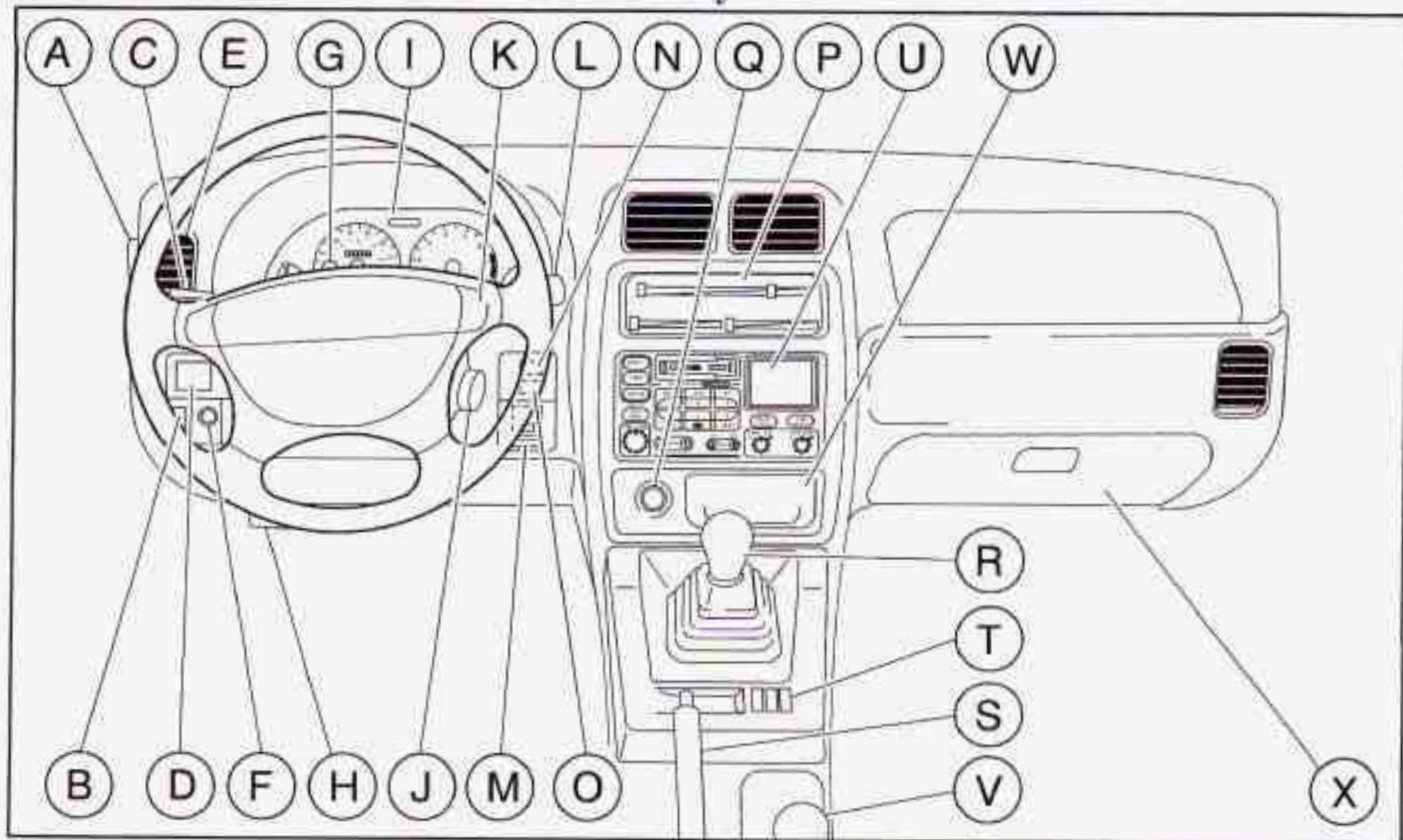

- A. Defroster
- B. Rear Defogger (Option)
- C. Turn Signal/Multifunction Lever
- D. Power Mirror Control (Option)
- E. Air Vent
- F. Instrument Panel Brightness Control
- G. Hazard Switch
- H. Fuse Block
- I. Instrument Cluster
- J. Ignition Switch
- K. Horn
- L. Windshield Wiper/Washer Lever
- M. Cruise Control ON/OFF Button (Option)
- N. Rear Window Wiper Button (Option)
- O. Rear Window Washer Button (Option)
- P. Comfort Controls
- Q. Cigarette Lighter
- R. Shift Lever
- S. Parking Brake Lever
- T. Coinholder/Bin
- U. Audio System
- V. Transfer Case Shift Lever
- W. Ashtray
- X. Glove Box

Instrument Panel Cluster

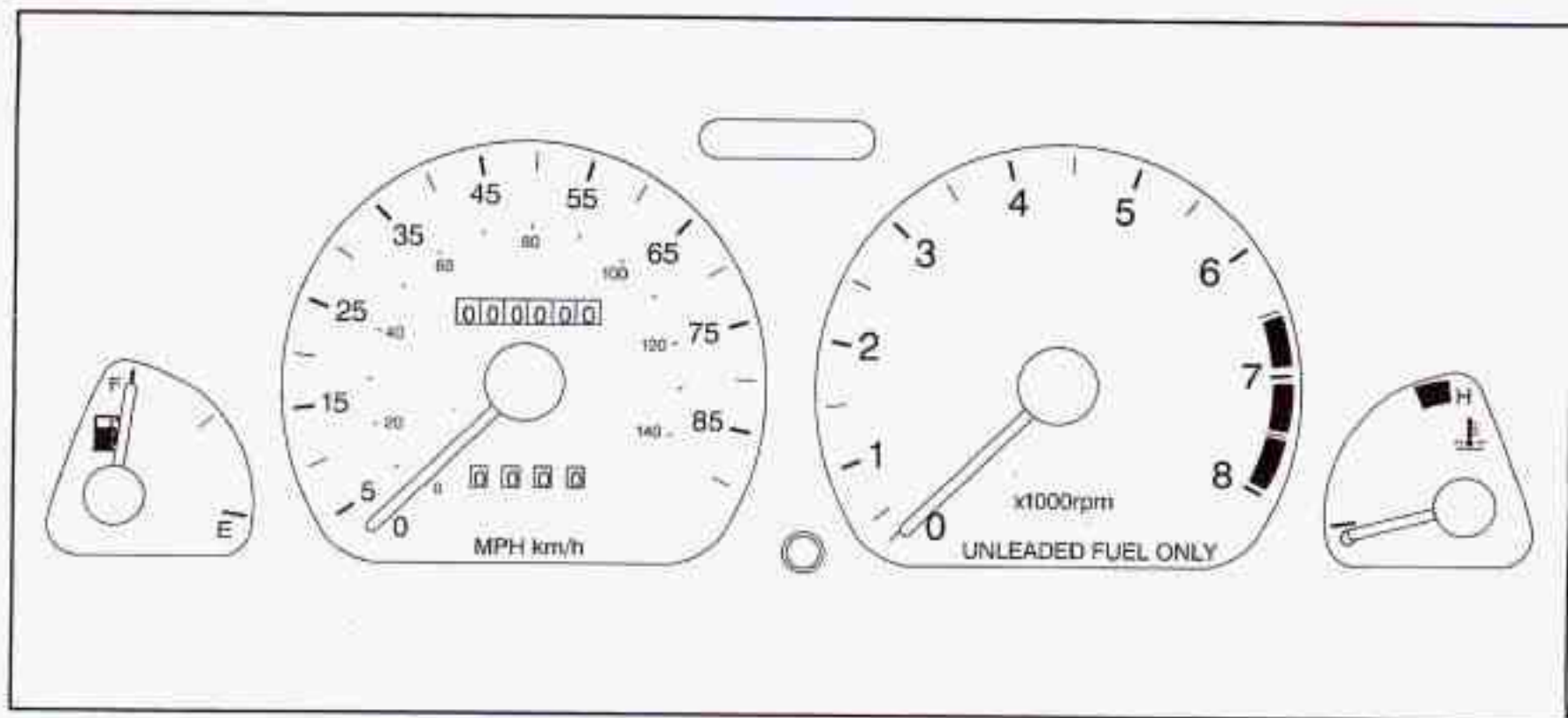

Your instrument cluster is designed to let you know at a glance how your vehicle is running. You'll know how fast you're going, about how much fuel you have left, and many other things you'll need to know to drive safely and economically.

Speedometer and Odometer

Your speedometer lets you see your speed in both miles per hour (mph) and kilometers per hour (km/h). Your odometer shows how far your vehicle has been driven, in either miles (used in the United States) or kilometers (used in Canada).

Your Geo's odometer is tamper-resistant. If you can see silver lines between the numbers, someone probably has tried to turn it back. The numbers may not be true.

You may wonder what happens if your vehicle needs a new odometer installed. If possible, the new one is to be set to the same reading as the old one. If it can't be, then it's set at zero. Then a label is attached on the driver's door to show the old reading and when the new one was installed.

Trip Odometer

The trip odometer can tell you how far your vehicle has been driven since you last set the trip odometer to zero.

To set the trip odometer to zero, press the knob.

Tachometer



The tachometer shows engine speed in thousands of revolutions per minute (rpm). You can use it while driving to select correct shift points. The tachometer may not return to zero when the engine is not running.

NOTICE:

Do not operate the engine with the tachometer in the red area, or engine damage may occur.

Warning Lights, Gages and Indicators

This part describes the warning lights and gages that may be on your vehicle. The pictures will help you locate them.

Warning lights and gages can signal that something is wrong before it becomes serious enough to cause an expensive repair or replacement. Paying attention to your warning lights and gages could also save you or others from injury.

Warning lights come on when there may be or is a problem with one of your vehicle's functions. As you will see in the details on the next few pages, some warning lights come on briefly when you start the engine just to let you know they're working. If you are familiar with this section, you should not be alarmed when this happens.

Gages can indicate when there may be or is a problem with one of your vehicle's functions. Often gages and warning lights work together to let you know when there's a problem with your vehicle.

When one of the warning lights comes on and stays on when you are driving, or when one of the gages shows there may be a problem, check the section that tells you what to do about it. Please follow this manual's advice. Waiting to do repairs can be costly -- and even dangerous. So please get to know your warning lights and gages. They're a big help.

Safety Belt Reminder Light



When the key is turned to ON or START, a light will come on for about eight seconds to remind people to fasten their safety belts. Unless the driver's safety belt is already buckled, a chime will also sound.

Air Bag Readiness Light

There is an air bag readiness light on the instrument panel, which shows AIR BAG. The system checks the air bag's electrical system for malfunctions. The light tells you if there is an electrical problem. The system check includes the air bag sensors, the air bag modules, the wiring and the crash sensing and diagnostic module. For more information on the air bag system, see "Air Bag" in the Index.



You will see this light flash for a few seconds when you turn your ignition to ON or START. Then the light should go out. This means the system is ready.

If the air bag readiness light doesn't come on when you start your vehicle, or stays on, or comes on when you are driving, your air bag system may not work properly. Have your vehicle serviced right away.

Charging System Light

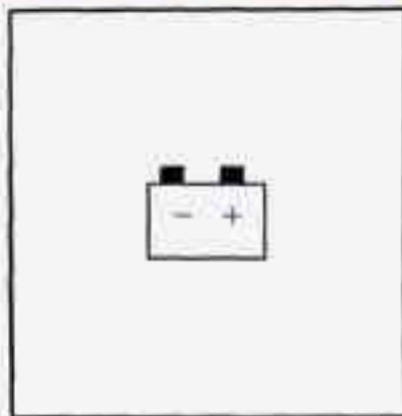

This light will come on briefly when you turn on the ignition, but the engine is not running, as a check to show you it is working. Then it should go out when the engine starts.

If the light stays on or comes on while you are driving, you may have a problem with the electrical charging system. It could indicate that you have a loose generator drive belt or another electrical problem. Have it checked right away. Driving while this light is on could drain your battery.

If you must drive a short distance with this light on, be certain to turn off all your accessories, such as the radio and air conditioner.

Brake System Warning Light

Your Geo's hydraulic brake system is divided into two parts. If one part isn't working, the other part can still work and stop you. For good braking, though, you need both parts working well.

If the warning light comes on, there could be a brake problem. Have your brake system inspected right away.

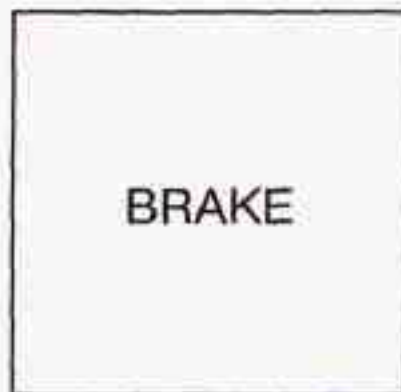

United States

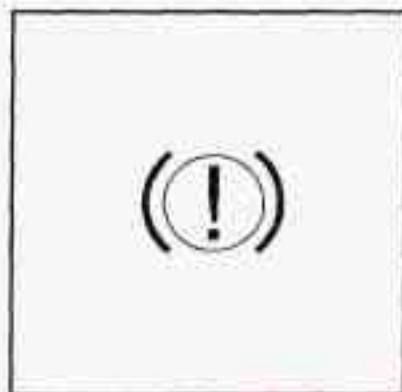

Canada

This light should come on when you turn the ignition key to START. If it doesn't come on then, have it fixed so it will be ready to warn you if there's a problem.

If the light comes on while you are driving, pull off the road and stop carefully. You may notice that the pedal is harder to push. Or, the pedal may go closer to the floor. It may take longer to stop. If the light is still on, or if the anti-lock brake system warning light is flashing, have the vehicle towed for service. (See "Anti-Lock Brake System Warning Light" and "Towing Your Vehicle" in the Index.)

CAUTION:

Your brake system may not be working properly if the brake system warning light is on. Driving with the brake system warning light on can lead to an accident. If the light is still on or if the anti-lock brake system warning light is flashing after you've pulled off the road and stopped carefully, have the vehicle towed for service.

When the ignition is on, the brake system warning light will also come on when you set your parking brake. The light will stay on if your parking brake doesn't release fully. If it stays on after your parking brake is fully released, it means you have a brake problem.

Anti-Lock Brake System Warning Light (Option)

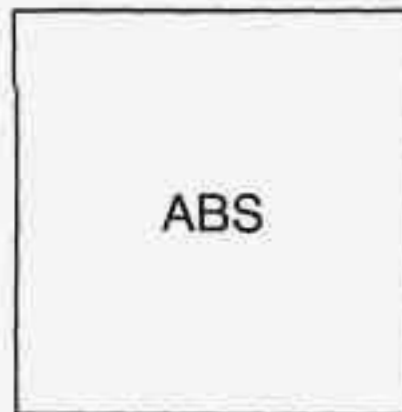

With the anti-lock brake system, this light will come on when you start your engine and it will stay on for three seconds. That's normal.

If the light flashes when you're driving, you don't have anti-lock brakes and there could be a problem with your regular brakes. Pull off the road and stop carefully. You may notice that the pedal is harder to push. Or, the pedal may go closer to the floor. It may take longer to stop. Have the vehicle towed for service. (See "Towing Your Vehicle" in the Index.)



CAUTION:

Your regular brake system may not be working properly if the anti-lock brake system warning light is flashing. Driving with the anti-lock brake system warning light flashing can lead to an accident. After you've pulled off the road and stopped carefully, have the vehicle towed for service.

If the anti-lock brake system warning light stays on longer than normal after you've started your engine, turn the ignition off. Or, if the light comes on and stays on when you're driving, stop as soon as possible and turn the ignition off. Then start the engine again to reset the system. If the light still stays on, or comes on again while you're driving, your Geo needs service. If the light is on but not flashing and the regular brake system warning light isn't on, you still have brakes, but you don't have anti-lock brakes.

The anti-lock brake system warning light should come on briefly when you turn the ignition key to *ON*. If the light doesn't come on then, have it fixed so it will be ready to warn you if there is a problem.

Anti-Lock Brake System Active Light (Option)



When your anti-lock system is adjusting brake pressure to help avoid a braking skid, the anti-lock brake system active light will come on.

Slippery road conditions may exist if this light comes on, so adjust your driving accordingly. The light will stay on for a few seconds after the system stops adjusting brake pressure.

The anti-lock brake system active light also comes on briefly when you turn the ignition key to ON. If the light doesn't come on then, have it fixed so it will be there to tell you when the system is active.

Engine Coolant Temperature Gage

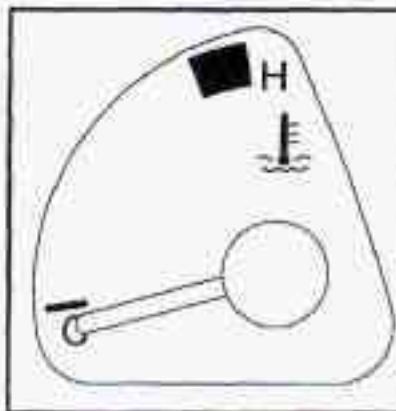

This gage shows the engine coolant temperature. If the gage pointer moves to the H (red) side, your engine is too hot!

It means that your engine coolant has overheated and you should stop your vehicle and turn off the engine as soon as possible.

In "Problems on the Road," this manual shows what to do. See "Engine Overheating" in the Index.

Malfunction Indicator Lamp (Service Engine Soon Light)



SERVICE
ENGINE
SOON

Your Geo is equipped with a computer which monitors operation of the fuel, ignition and emission control systems.

This system is called OBD II (On-Board Diagnostics-Second Generation) and is intended to assure that emissions are at acceptable levels for the life of the vehicle, helping to produce a cleaner environment. (In Canada, OBD II is replaced by Enhanced Diagnostics.) The SERVICE ENGINE SOON light comes on to indicate that there is a problem and service is required. Malfunctions often will be indicated by the system before any problem is apparent, which may prevent more serious damage to your vehicle. This system is also designed to assist your service technician in correctly diagnosing any malfunction.

NOTICE:

If you keep driving your vehicle with this light on, after a while, your emission controls may not work as well, your fuel economy may not be as good and your engine may not run as smoothly. This could lead to costly repairs that may not be covered by your warranty.

This light should come on, as a check to show you it is working, when the ignition is on and the engine is not running. If the light doesn't come on, have it repaired. This light will also come on during a malfunction in one of two ways:

- **Light Flashing** -- A misfire condition has been detected. A misfire increases vehicle emissions and may damage the emission control system on your vehicle. Dealer or qualified service center diagnosis and service is required.
- **Light On Steady** -- An emission control system malfunction has been detected on your vehicle. Dealer or qualified service center diagnosis and service may be required.

If the Light Is Flashing

The following may prevent more serious damage to your vehicle:

- Reduce vehicle speed.
- Avoid hard accelerations.
- Avoid steep uphill grades.
- If towing a trailer, reduce the amount of cargo being hauled as soon as it is possible.

If the light stops flashing and remains on steady, see “If the Light Is On Steady” following.

If the light continues to flash, when it is safe to do so, *stop the vehicle*. Put your vehicle in PARK (P). Turn the key off, wait at least 10 seconds and restart the engine.

If the light remains on steady, see “If the Light Is On Steady” following. If the light is still flashing follow the previous steps, and drive the vehicle to your dealer or qualified service center for service.

If the Light Is On Steady

You may be able to correct the emission system malfunction by considering the following:

Did you just put fuel into your vehicle?

If so, reinstall the fuel cap, making sure to fully install the cap. The diagnostic system can determine if the fuel cap has been left off or improperly installed. This will allow fuel to evaporate into the atmosphere. A few driving trips should turn the light off.

Did you just drive through a deep puddle of water?

If so, your electrical system may be wet. The condition will usually be corrected when the electrical system dries out. A few driving trips should turn the light off.

Are you low on fuel?

As your engine starts to run out of fuel, your engine may not run as efficiently as designed since small amounts of air are sucked into the fuel line causing a misfire. The system can detect this. Adding fuel should correct this condition. Make sure to install the fuel cap properly. It will take a few driving trips to turn the light off.

Have you recently changed brands of fuel?

If so, be sure to fuel your vehicle with quality fuel (see "Fuel" in the Index). Poor fuel quality will cause your engine not to run as efficiently as designed. You may notice this as stalling after start-up, stalling when you put the vehicle into gear, misfiring, hesitation on acceleration or stumbling on acceleration. (These conditions may go away once the engine is warmed up.) This will be detected by the system and cause the light to turn on.

If you experience this condition, change the fuel brand you use. It will require at least one full tank of the proper fuel to turn the light off.

If none of the above steps have made the light turn off, have your dealer or qualified service center check the vehicle. Your dealer has the proper test equipment and diagnostic tools to fix any mechanical or electrical problems that may have developed.

Oil Pressure Light

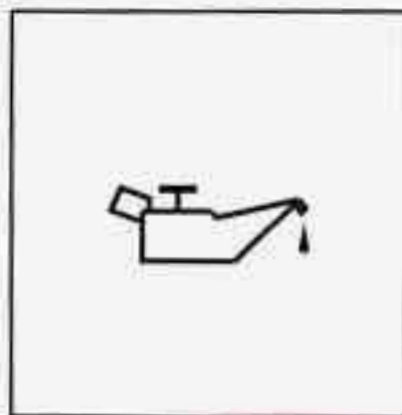

If you have a problem with your oil, this light may stay on after you start your engine, or come on when you are driving.

This indicates that there is not enough pressure to keep your engine properly lubricated and cool. The engine could be low on oil, or have some other oil related problem. Have it fixed right away.

The oil light could also come on in three other situations.

- When the ignition is on but the engine is not running, the light will come on as a test to show you it is working, but the light will go out when you turn the engine to START. If it doesn't come on with the ignition on, you may have a problem with the fuse or bulb. Have it fixed right away.
- Sometimes when the engine is idling at a stop, the light may blink on and off. This is normal.
- If you make a hard stop, the light may come on for a moment. This is normal.

 **CAUTION:**

Don't keep driving if the oil pressure is low. If you do, your engine can become so hot that it catches fire. You or others could be burned. Check your oil as soon as possible and have your vehicle serviced.

NOTICE:

Damage to your engine from neglected oil problems can be costly and is not covered by your warranty.

Power Indicator Light (Option)

POWER

This light comes on when the power mode selector switch is turned to P (power) with the ignition switch in the ON position.

Overdrive Off Light (Option)

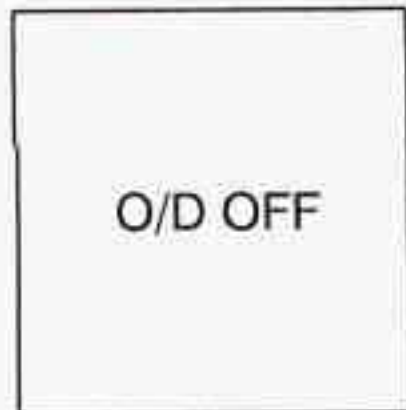

This light comes on when the automatic four-speed transmission has been converted to the three-speed mode and overdrive is turned off.

Daytime Running Lamps (DRL) Indicator Light

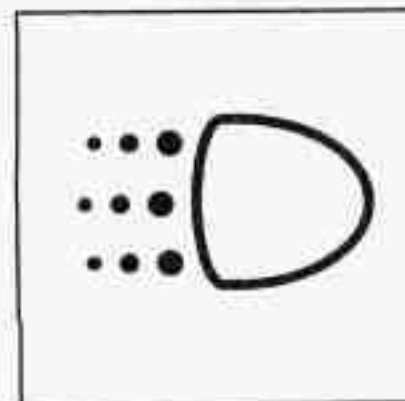

This light goes on whenever the daytime running lamps are on.

Fuel Gage

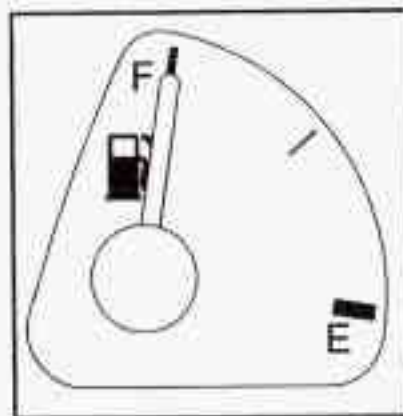

Your fuel gage shows about how much fuel is in your tank. When the gage first indicates EMPTY (E), you still have a little fuel left (about one or two gallons) (4 to 8 L), but you need to get more right away.

Here are four concerns some owners have had about the fuel gage. All these situations are normal and do not indicate that anything is wrong with the fuel gage.

- At the gas station, the fuel pump shuts off before the gage reads FULL (F).
- It takes more (or less) fuel to fill up than the gage reads. For example, the gage reads half full, but it took more (or less) than half of the tank's capacity to fill it.
- The gage moves a little when you turn, stop or speed up.
- When you turn the engine off, the gage doesn't go back to EMPTY (E).

NOTES

Geo Section 3 Comfort Controls and Audio Systems

In this section you'll find out how to operate the comfort control and audio systems offered with your Geo. Be sure to read about the particular systems supplied with your vehicle.

Comfort Controls



With this system, you can control the heating and ventilation in your Geo. If you have the air conditioning option, you can also control cooling.

Your vehicle also has the flow-through ventilation system described later in this section.

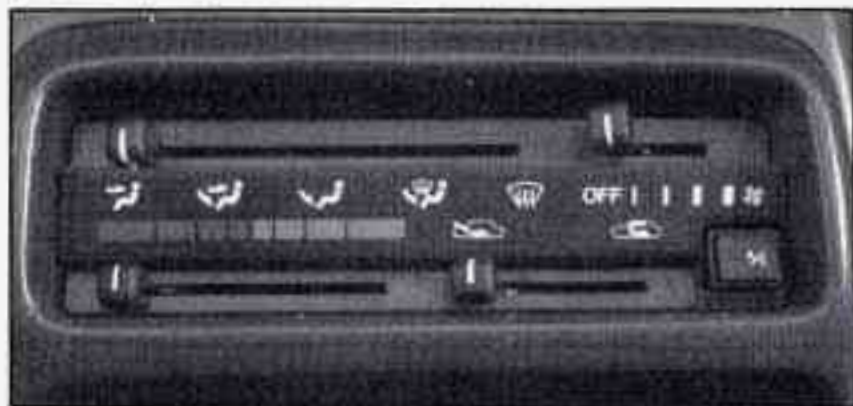
Climate Control System



Airflow Lever

-  **VENT:** This position directs the airflow through the instrument panel vents.
-  **BI-LEVEL:** This position directs air through the instrument panel vents and toward the floor.

 **FLOOR:** This position directs air toward the floor.

 **DEFOG:** This position directs air toward the floor, the windshield and side windows.

 **DEFROST:** This position directs air to the windshield and side windows.

Fan Control Lever

Slide the lever away from OFF to turn the system on. Move the lever toward the fan symbol to increase the fan's speed.

Temperature Control Lever

Slide the lever to change the temperature of the air flowing from the system. Move it to the right for warmer air and to the left for cooler air. Without optional air conditioning, the air temperature cannot be less than the outside air temperature.

Air Intake Lever

RECIRCULATE: Choose this position to recirculate the inside air through the comfort control system.

CIRCULATE: Choose this position to circulate outside air through the comfort control system.

Air Conditioner Controls (Option)



The air conditioning system uses the same controls as described previously. The function of each lever is explained under "Climate Control System" in this part. The incoming air is cooled and dehumidified instead of being heated.

Push the A/C button to change your comfort control system from heating to air conditioning. A light will come on when the air conditioning is on. The A/C button can also control the humidity in your vehicle.

The air conditioner works best if you keep your windows closed. On very hot days, open the windows just long enough for the hot air to escape.

For normal cooling, push the A/C button and move the air intake lever to **CIRCULATE**. For faster cooling, move the lever to **RECIRCULATE**. Then move the airflow lever to **VENT**, the temperature control lever toward the left and the fan control lever toward the fan symbol.

On days when it is raining or the humidity is high, follow these dehumidifying steps to help clean windows that are cloudy with moisture. Push the A/C button. Move the air intake lever to **CIRCULATE**. Move the airflow lever to **DEFROST** and the fan control lever toward the fan symbol. Adjust the temperature control lever to a comfortable setting.

Heating

For the quickest results, move the air intake lever to **RECIRCULATE**. Move the airflow lever to **FLOOR**, the temperature control lever toward the right for warmer air and the fan control lever toward the fan symbol. You should switch to **CIRCULATE** once in a while to avoid stale air and cloudy windows.

Ventilation System

For mild outside temperatures, when little heating or cooling is needed, you can still direct outside air through your vehicle.

Move the air intake lever to **CIRCULATE** and the airflow lever to **BI-LEVEL**. Adjust the temperature control lever to a comfortable setting and move the fan control lever toward the fan symbol.

Your Geo's flow-through ventilation system supplies outside air into the vehicle when it is moving. Outside air will also enter the vehicle when the fan is running and the air intake lever is at **CIRCULATE**.



Your vehicle has air outlets that allow you to adjust the direction and amount of airflow inside the vehicle. Push the outlet up or down to direct airflow to your preference. Increase or reduce the amount of airflow by opening and closing the louvers.

Ventilation Tips

- Keep the hood and front air inlet free of ice, snow or any other obstruction (such as leaves). The heater and defroster will work far better, reducing the chance of fogging the inside of your windows.
- When you enter a vehicle in cold weather, move the fan control lever toward the fan symbol for a few moments before driving off. This helps clear the intake ducts of snow and moisture, and reduces the chance of fogging the inside of your windows.
- Keep the air path under the front seats clear of objects. This helps air to circulate throughout your vehicle.

Defogging and Defrosting

Slide the air intake lever to **CIRCULATE** and the airflow lever to **DEFROST** to direct air to the windshield vents. Then slide the temperature control lever toward the right and the fan lever toward the fan symbol. When the windshield is clear, turn down the fan speed.

Rear Window Defogger (Option)



The rear window defogger uses a warming grid to remove fog from the rear window.

Press the switch to turn on the defogger. An indicator light will come on below the switch to remind you that the defogger is on. Press the switch again to turn the defogger off. The rear window defogger will also turn off if you turn the ignition switch to ACC or LOCK, but will turn back on when the ignition is turned back on.

Do not attach anything like a temporary vehicle license or a decal across the defogger grid on the rear window.

NOTICE:

Don't use a razor blade or something else sharp on the inside of the rear window. If you do, you could cut or damage the warming grid, and the repairs wouldn't be covered by your warranty.

Audio Systems

Your Delco[®] audio system has been designed to operate easily and give years of listening pleasure. You will get the most enjoyment out of it if you acquaint yourself with it first. Find out what your Delco system can do and how to operate all its controls, to be sure you're getting the most out of the advanced engineering that went into it.

Setting the Clock for AM-FM Stereo

Press and hold RCL (TIME SET) to set the correct hour. At the same time, press and hold the TUNE left arrow (HR) until the correct hour appears.

Press and hold RCL (TIME SET) to set the correct minute. At the same time, press and hold the TUNE right arrow (MIN) until the correct minute appears.

Setting the Clock for AM-FM Stereo with Cassette Tape Player

Press and hold RCL-PROG (TIME SET) to set the correct hour. At the same time, press and hold the TUNE left arrow (HR) until the correct hour appears.

Press and hold RCL-PROG (TIME SET) to set the correct minute. At the same time, press and hold the TUNE right arrow (MIN) until the correct minute appears.

Setting the Clock for AM-FM Stereo with Cassette Tape and Compact Disc Players

Press and hold the RCL up and down arrow (TIME SET). At the same time, press and hold the TUNE left arrow (HR) until the correct hour appears.

Press and hold the RCL up and down arrow (TIME SET). At the same time press and hold TUNE right arrow (MIN) until the correct minute appears.

AM-FM Stereo (Option)



To Play the Radio

Turn the ON-VOL knob to turn the system on or off.

VOL: Turn this knob to adjust the volume.

RCL: Press this button to see the station being played for a moment. Or, press it if you want to see the time when the ignition is off.

Finding a Station

AM-FM: Press this button to get AM or FM. The lighted display shows your selection.

TUNE: Press the right or left arrow to go to a higher or lower station. Press and hold to continue tuning and release when you find your station. The display will show the frequency of each station tuned.

SEEK: Press the right or left arrow and the radio will tune to the next higher or lower station and stay there.

PUSHBUTTONS: The six numbered pushbuttons let you return to your previously played stations. You can set up to 12 stations (six AM and six FM).

1. Tune in the desired station.
2. Press one of the six pushbuttons, for at least two seconds.
3. The sound will mute and then return when the station is stored. Whenever you press that numbered button, the station you set will return.
4. Repeat the steps for each pushbutton.

Setting the Tone

TREB: Turn this knob to the right to hear more treble.

BASS: Turn this control behind the TREB knob to the right to hear more bass.

Adjusting the Speakers

FADE: Turn this knob to move the sound between the front and rear speakers.

BAL: Turn this control behind the FADE knob to move the sound between the left and right speakers.

AM-FM Stereo with Cassette Tape Player (Option)



To Play the Radio

Turn the ON-VOL knob to turn the system on or off.

VOL: Turn this knob to adjust the volume.

RCL: Press this button to see the station being played for a moment. Or, press it if you want to see the time when the ignition is off.

Finding a Station

AM-FM: Press this button to get AM, FM1 or FM2. The lighted display shows your selection.

TUNE: Press the TUNE right or left arrow to go to a higher or lower station. Press and hold to continue tuning and release when you find your station. The display will show the frequency of each station tuned.

SEEK: Press the SEEK right or left arrow and the radio will tune to the next higher or lower station and stay there.

PUSHBUTTONS: The six numbered pushbuttons let you return to your previously played stations. You can set up to 18 stations (six AM, six FM1 and six FM2).

1. Tune in the desired station.
2. Press one of the six pushbuttons, for at least two seconds.
3. The sound will mute and then return when the station is stored. Whenever you press that numbered button, the station you set will return.
4. Repeat the steps for each pushbutton.

PRESET SCAN: Press this button to hear each of your favorite stations stored on your pushbuttons for a few seconds. When you want to stop at a chosen station, press PRESET SCAN again.

Setting the Tone

TREB: Turn this knob to the right to hear more treble.

BASS: Turn this control behind the TREB knob to the right to hear more bass.

Treble and bass cannot be adjusted manually when TONE SELECT is on.

TONE SELECT: Press this button to choose preset treble and bass equalization settings designed for ROCK, NEWS, POP, JAZZ and CLASSICAL.

ROCK will appear when you first press TONE SELECT. Each time you press it, another setting will appear on the display. If you press it one more time, after CLASSICAL appears on the display, tone control will be back to the treble and bass knob.

Adjusting the Speakers

FADE: Turn this knob to move the sound between the front and rear speakers.

BAL: Turn this control behind the FADE knob to move the sound between the right and left speakers.

Playing a Cassette Tape

Your tape player is built to work best with tapes that are 30 to 45 minutes long on each side. Tapes longer than that are so thin they may not work well in this player.

The longer side with the tape visible should face to the right. If you hear nothing or hear just a garbled sound, it may not be in squarely. Press EJECT to remove the tape and start over.

Once the tape is playing, use the knobs for VOL, FADE and BAL, just as you do for the radio. The lighted arrows show which side of the tape is playing.

MTL: Your bias is set automatically. MTL will appear on your display when a metal or chrome tape is inserted.

FF: Press this button to advance rapidly to another part of the tape. Press FF, RCL/PROG or EJECT to return to playing speed.

REW: Press this button to reverse the tape rapidly. Press REW or RCL/PROG to return to playing speed. If you press RCL/PROG, the tape will also change sides.

NEXT: Press this button to go forward to the beginning of the next selection. Press the button again or press RCL/PROG or EJECT to cancel this function.

For NEXT to work properly, your tape must have at least three or four seconds of silence between each selection. If you press RCL/PROG, the tape will also change sides.

PREV: Press this button to go back to the beginning of the last selection. Press PREV again or press RCL/PROG or EJECT to cancel this function.

RCL/PROG: Press this button to switch from one side of the tape to the other. Your cassette tape player can play continuously because the player has an auto-reverse feature.

Noise Reduction: Press the button with the double-D symbol to remove noise from tapes encoded with Dolby NR.

Dolby Noise Reduction is manufactured under a license from Dolby Laboratories Licensing Corporation. Dolby and the double-D symbol are trademarks of Dolby Laboratories Licensing Corporation.

EJECT: Press the button with this symbol to remove the tape and switch to radio.

TAPE: Press this button when the radio is playing to switch to tape play. To switch from the tape to the radio when the tape is playing, press the AM-FM button.

R-M: Press this button to hear the radio when you are fast forwarding or reversing a cassette tape. You can use the TUNE, SEEK and PRESET SCAN buttons while in the radio monitor mode.

CLN: This message may appear on the display. If it does, your cassette tape player needs to be cleaned. It will still play tapes, but you should clean it as soon as possible to prevent damage to your tapes and player. See "Care of Your Cassette Tape Player" in the Index. After you clean the player, press and hold EJECT for five seconds to reset the CLN indicator. The radio will display --- to show the indicator was reset.

AM-FM Stereo with Cassette Tape and Compact Disc Player (Option)



To Play the Radio

Turn the ON-VOL knob to turn the system on or off.

VOL: Turn this knob to adjust the volume.

RCL: Press this button to see the station being played for a moment. Or, press it if you want to see the time when the ignition is off.

Finding a Station

AM-FM: Press this button to get AM, FM1 or FM2. The *lighted display* shows your selection.

TUNE: Press the TUNE right or left arrow to go to a higher or lower station. Press and hold to continue tuning and release when you find your station. The display will show the frequency of each station tuned.

SEEK: Press the SEEK right or left arrow and the radio will tune to the next higher or lower station and stay there.

PUSHBUTTONS: The six numbered pushbuttons let you return to your previously played stations. You can set up to 18 stations (six AM, six FM1 and six FM2).

1. Tune in the desired station.
2. Press one of the six pushbuttons, for at least two seconds.
3. The sound will mute and then return when the station is stored. Whenever you press that numbered button, the station you set will return.
4. Repeat the steps for each pushbutton.

PSCAN: Press this button to hear each of your favorite stations stored on your pushbuttons for a few seconds. When you want to stop at a chosen station, press PSCAN again.

Setting the Tone

TREB: Turn this knob to the right to hear more treble.

BASS: Turn this control behind the TREB knob to the right to hear more bass.

Treble and bass cannot be adjusted manually when TONE SELECT is on.

TONE SELECT: Press this button to choose preset treble and bass equalization settings designed for ROCK, NEWS, POP, JAZZ and CLASSICAL.

ROCK will appear when you first press TONE SELECT. Each time you press it, another setting will appear on the display. If you press it one more time, after CLASSICAL appears on the display, tone control will be back to the treble and bass knob.

Adjusting the Speakers

FADE: Turn this knob to move the sound between the front and rear speakers.

BAL: Turn this control behind the FADE knob to move the sound between the right and left speakers.

Playing a Cassette Tape

Your tape player is built to work best with tapes that are 30 to 45 minutes long on each side. Tapes longer than that are so thin they may not work well in this player.

The longer side with the tape visible should face to the right. If you hear nothing or hear just a garbled sound, it may not be in squarely. Press **STOP** or **EJECT** to remove the tape and start over.

Once the tape is playing, use the knobs for **VOL**, **FADE** and **BAL**, just as you do for the radio. The lighted arrows show which side of the tape is playing.

MTL: Your bias is set automatically. **MTL** will appear on the display when a metal or chrome tape is inserted.

FF: Press this button to advance rapidly to another part of the tape. Press **FF**, **RCL** or **STOP** to return to playing speed. If you press **RCL**, the tape will also change sides.

REW: Press this button to reverse the tape rapidly. Press **REW**, **RCL** or **STOP** to return to playing speed. If you press **RCL**, the tape will also change sides.

NXT: Press this button to go forward to the beginning of the next selection. Press **NXT** again or press **RCL**, or **STOP** to cancel this function. If you press **RCL**, the tape will also change sides.

PRV: Press this button to go back to the beginning of the last selection. Press the button again or press **RCL**, or **STOP** to cancel this function.

For **NXT** and **PRV** to work properly, your tape must have at least three or four seconds of silence between each selection. If you press **RCL**, the tape will also change sides.

RPT: Press this button to go to the beginning of the selection and play it again. Press **RPT** again to cancel this function.

Noise Reduction: Press the button with the double-D symbol to remove noise from tapes encoded with Dolby NR.

Dolby Noise Reduction is manufactured under a license from Dolby Laboratories Licensing Corporation. Dolby and the double-D symbol are trademarks of Dolby Laboratories Licensing Corporation.

RDM: When playing a tape, press this button during FF or REW to hear the radio. Press it again to turn the radio off. During this operation, only TUNE, SEEK and PSCAN will work.

RCL: Press this button to switch from one side of the tape to the other.

STOP: Press this button to stop the tape and switch to the radio.

EJECT: Press this button to remove the tape and switch to the radio.

CLN: This message may appear on the display. If it does, your cassette tape player needs to be cleaned. It will still play tapes, but you should clean it as soon as possible to prevent damage to your tapes and player. See "Care of Your Cassette Tape Player" in the Index. After you clean the player, press and hold EJECT for five seconds to reset the CLN indicator. The radio will display --- to show the indicator was reset.

Playing a Compact Disc

Don't use mini-discs (three-inch singles). They won't eject. Use full-size compact discs.

Insert your disc into the CD slot on your audio system.

If the disc comes back out, it could be that the road is rough, (the disc should play when the road is smoother); the disc is upside down; dirty, scratched or wet; or there is too much moisture in the air. (If there's too much moisture in the air, wait about one hour and try again.)

If you see ERR on the display, the disc player is too hot to play the disc. Press RCL to take ERR off the display.

RCL: Press this button to see which track is playing. Press RCL again, within five seconds, to see how long it has been playing.

The track number also appears when the disc is inserted or you change the volume.

PRV: Press this button to hear a track again. If you hold this button, or press it more than once, the disc will return to previous tracks.

NXT: Press this button to hear the next track now (instead of waiting until the present track is finished).

If you hold this button, or press it more than once, the disc will advance further.

REW: Press and hold this button to return rapidly to a favorite passage. Release it to play the passage.

FF: Press and hold this button to fast forward or advance quickly within a track. Release it to resume playing.

COMP: Press this button to make soft and loud passages more nearly equal in volume.

RPT: Press this button once to hear a selection over again.

RDM: Pressing this button will cause the CD player to play the tracks back in random order. To cancel the random feature, press RDM or RPT.

STOP: Press this button or AM-FM to stop playing the disc and switch to radio. Press STOP again to restart the disc at the point where it stopped.

CD-TP: Press this button to switch between playing a tape and a CD when both are inserted.

EJECT: Press this button to eject the disc and the radio will play. The disc will start playing at track one when you reinsert it.

Theft-Deterrent Feature

The theft-deterrent feature for the AM-FM stereo with cassette tape or compact disc players can be used or ignored. If ignored, the system plays normally. If it is used, your system won't be usable if it's ever stolen because it will go into LOC mode.

If your vehicle loses battery power for any reason, you must enter your secret code again before the system will turn on.

Activating the Theft-Deterrent Feature

The following instructions will tell you how to enter a security code into the system.

NOTE: If you allow more than 15 seconds to elapse between any steps, the radio automatically reverts to time and you must start the procedure over at Step 4.

1. Write down any four-digit number and keep it in a safe place.
2. Turn the ignition switch to the ACC or ON position.
3. Turn the radio off.

4. Press the 1 and 4 buttons together. Hold them down until ---- shows on the display.
5. Press the left or right SEEK arrow, or the left or right TUNE arrow and 0000 will appear on the display.
6. Press the SEEK left arrow and hold it until the first digit of your code appears. Release the button.
7. Press the SEEK right arrow and hold it until the second digit of your code appears. Release the button.
8. Press the TUNE left arrow and hold it until the third digit of your code appears. Release the button.
9. Press TUNE right arrow and hold it until the fourth digit of your code appears. Release the button.
10. Press AM-FM after you have checked that the code you entered is the one you wrote down. Then, REP will appear on the display which means you need to repeat Steps 5 through 9.
11. Press AM-FM again and the display will now show SEC.

Disabling the Theft-Deterrent Feature

If your radio is secured (SEC shows on the display) and you wish to disable it, enter your security code as follows, pausing no more than 15 seconds between steps.

1. Press the 1 and 4 buttons together. Hold them down until SEC shows on the display. You are now ready to enter your security code.
2. Press the SEEK left arrow and hold it until the first digit of your code appears.
3. Press the SEEK right arrow and hold it until the second digit of your code appears.
4. Press the TUNE left arrow and hold it until the third digit of your code appears.
5. Press the TUNE right arrow and hold it until the fourth digit of your code appears.
6. Press AM-FM after you have checked that the code you entered matches the one you wrote down and 0000 should now appear on the display. You will need to repeat the above procedure.
7. If the code is correct, the radio will now operate. If the code is wrong, ERR will appear on the display.

Unlocking the Theft-Deterrent Feature After a Power Loss

If power is disrupted to the radio while in the SEC mode, the unit will not work and LOC will show on the display whenever the ignition is on. To unlock the unit, press the left or right SEEK arrows, or the left or right TUNE arrows and 0000 will appear on the display.

1. Press the SEEK left arrow and hold it until the first digit of your code appears.
2. Press the SEEK right arrow and hold it until the second digit of your code appears.
3. Press the TUNE left arrow and hold it until the third digit of your code appears.
4. Press the TUNE right arrow and hold it until the fourth digit of your code appears.
5. Press AM-FM after you have checked that the code matches the one you wrote down. Now the time of day will appear on the display. (Please note that if an incorrect code is entered, ERR will appear on the display and the above steps need to be repeated.)

Understanding Radio Reception

FM Stereo

FM stereo will give you the best sound. But FM signals will reach only about 10 to 40 miles (16 to 65 km). Tall buildings or hills can interfere with FM signals, causing the sound to come and go.

AM

The range for most AM stations is greater than for FM, especially at night. The longer range, however, can cause stations to interfere with each other. AM can pick up noise from things like storms and power lines. Try reducing the treble to reduce this noise if you ever get it.

Tips About Your Audio System

Hearing damage from loud noise is almost undetectable until it is too late. Your hearing can adapt to higher volumes of sound. Sound that seems normal can be loud and harmful to your hearing. Take precautions by adjusting the volume control on your radio to a safe sound level before your hearing adapts to it.

To help avoid hearing loss or damage:

- Adjust the volume control to the lowest setting.
- Increase volume slowly until you hear comfortably and clearly.

NOTICE:

Before you add any sound equipment to your vehicle -- like a tape player, CB radio, mobile telephone or two-way radio -- be sure you can add what you want. If you can, it's very important to do it properly. Added sound equipment may interfere with the operation of your vehicle's engine, Delco radio or other systems, and even damage them. Your vehicle's systems may interfere with the operation of sound equipment that has been added improperly.

So, before adding sound equipment, check with your dealer and be sure to check Federal rules covering mobile radio and telephone units.

Care of Your Cassette Tape Player

A tape player that is not cleaned regularly can cause reduced sound quality, ruined cassettes or a damaged mechanism. Cassette tapes should be stored in their cases away from contaminants, direct sunlight and extreme heat. If they aren't, they may not operate properly or may cause failure of the tape player.

Your tape player should be cleaned regularly after every 50 hours of use. Your radio may display CLN to indicate that you have used your tape player for 50 hours without resetting the tape clean timer. If you notice a reduction in sound quality, try a known good cassette to see if the tape or the tape player is at fault. If this other cassette has no improvement in sound quality, clean the tape player.

Cleaning may be done with a scrubbing action, non-abrasive cleaning cassette with pads which scrub the tape head as the hubs of the cleaner cassette turn. It is normal for the cassette to eject while cleaning. Insert the cassette at least three times to ensure thorough cleaning. A scrubbing action cleaning cassette is available through your Geo dealer.

You may also choose a non-scrubbing action, wet-type cleaner which uses a cassette with a fabric belt to clean the tape head. This type of cleaning cassette will not eject. It may not clean as thoroughly as the scrubbing type cleaner.

Cassettes are subject to wear and the sound quality may degrade over time. Always make sure that the cassette tape is in good condition before you have your tape player serviced.

Care of Your Compact Discs

Handle discs carefully. Store them in their original cases or other protective cases and away from direct sunlight and dust. If the surface of a disc is soiled, dampen a clean, soft cloth in a mild, neutral detergent solution and clean it, wiping from the center to the edge.

Be sure never to touch the signal surface when handling discs. Pick up discs by grasping the outer edges or the edge of the hole and the outer edge.

Antenna

Use the knob on the end of the antenna to raise the antenna. To lower it, hold the antenna mast near the roof and feed it into the holder. Do not try to lower the antenna using the knob. Keep the antenna mast clean for good performance.

Always lower the antenna before entering a car wash. If you have the convertible top, also lower the antenna before removing or installing the top.

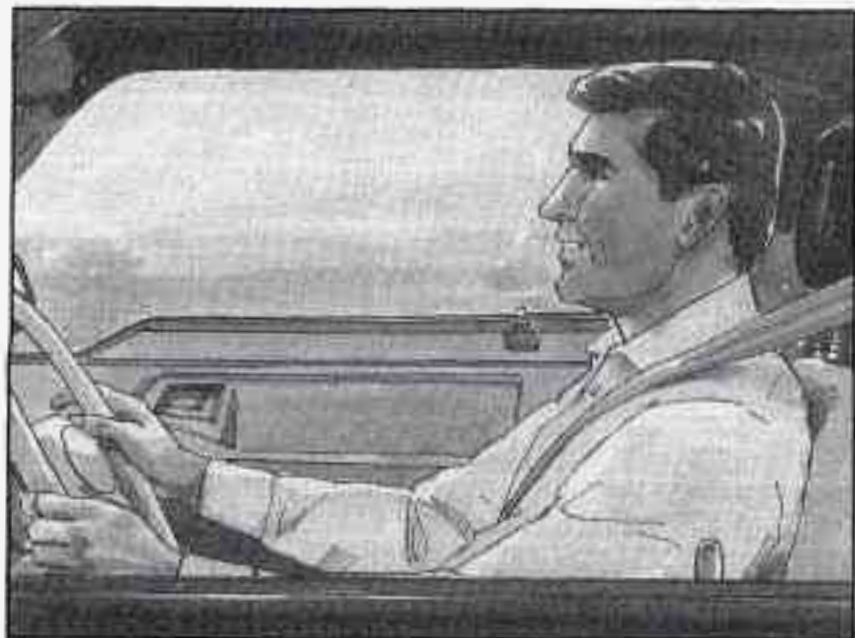

Here you'll find information about driving on different kinds of roads and in varying weather conditions. We've also included many other useful tips on driving.

Defensive Driving

The best advice anyone can give about driving is: Drive defensively.

Please start with a very important safety device in your Geo: Buckle up. (See "Safety Belts" in the Index.)

Defensive driving really means "be ready for anything." On city streets, rural roads or freeways, it means "always expect the unexpected."

Assume that pedestrians or other drivers are going to be careless and make mistakes. Anticipate what they might do. Be ready for their mistakes.

Rear-end collisions are about the most preventable of accidents. Yet they are common. Allow enough following distance. It's the best defensive driving maneuver, in both city and rural driving. You never know when the vehicle in front of you is going to brake or turn suddenly.

Drunken Driving

Death and injury associated with drinking and driving is a national tragedy. It's the number one contributor to the highway death toll, claiming thousands of victims every year.

Alcohol affects four things that anyone needs to drive a vehicle:

- Judgment
- Muscular Coordination
- Vision
- Attentiveness.

Police records show that almost half of all motor vehicle-related deaths involve alcohol. In most cases, these deaths are the result of someone who was drinking and driving. In recent years, some 18,000 annual motor vehicle-related deaths have been associated with the use of alcohol, with more than 300,000 people injured.

Many adults -- by some estimates, nearly half the adult population -- choose never to drink alcohol, so they never drive after drinking. For persons under 21, it's against the law in every U.S. state to drink alcohol. There are good medical, psychological and developmental reasons for these laws.

The obvious way to solve this highway safety problem is for people never to drink alcohol and then drive. But what if people do? How much is "too much" if the driver plans to drive? It's a lot less than many might think. Although it depends on each person and situation, here is some general information on the problem.

The Blood Alcohol Concentration (BAC) of someone who is drinking depends upon four things:

- The amount of alcohol consumed
- The drinker's body weight
- The amount of food that is consumed before and during drinking
- The length of time it has taken the drinker to consume the alcohol.

According to the American Medical Association, a 180-lb. (82 kg) person who drinks three 12-ounce (355 ml) bottles of beer in an hour will end up with a BAC of about 0.06 percent. The person would reach the same BAC by drinking three 4-ounce (120 ml) glasses of wine or three mixed drinks if each had 1-1/2 ounces (45 ml) of a liquor like whiskey, gin or vodka.

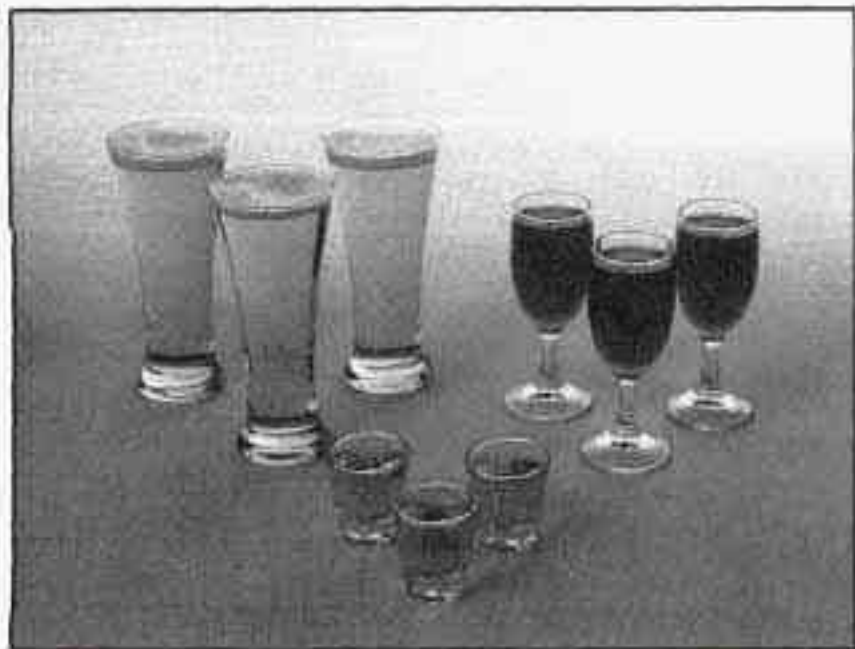

It's the amount of alcohol that counts. For example, if the same person drank three double martinis (3 ounces or 90 ml of liquor each) within an hour, the person's BAC would be close to 0.12 percent. A person who consumes food just before or during drinking will have a somewhat lower BAC level.

There is a gender difference, too. Women generally have a lower relative percentage of body water than men.

Since alcohol is carried in body water, this means that a woman generally will reach a higher BAC level than a man of her same body weight when each has the same number of drinks.

The law in many U.S. states sets the legal limit at a BAC of 0.10 percent. In a growing number of U.S. states, and throughout Canada, the limit is 0.08 percent. In some other countries, it's even lower. The BAC limit for all commercial drivers in the United States is 0.04 percent.

The BAC will be over 0.10 percent after three to six drinks (in one hour). Of course, as we've seen, it depends on how much alcohol is in the drinks, and how quickly the person drinks them.

But the ability to drive is affected well below a BAC of 0.10 percent. Research shows that the driving skills of many people are impaired at a BAC approaching 0.05 percent, and that the effects are worse at night. All drivers are impaired at BAC levels above 0.05 percent. Statistics show that the chance of being in a collision increases sharply for drivers who have a BAC of 0.05 percent or above. A driver with a BAC level of 0.06 percent has doubled his or her chance of having a collision. At a BAC level of 0.10 percent, the chance of this driver having a collision is 12 times greater; at a level of 0.15 percent, the chance is 25 times greater!

The body takes about an hour to rid itself of the alcohol in one drink. No amount of coffee or number of cold showers will speed that up. "I'll be careful" isn't the right answer. What if there's an emergency, a need to take sudden action, as when a child darts into the street? A person with even a moderate BAC might not be able to react quickly enough to avoid the collision.

There's something else about drinking and driving that many people don't know. Medical research shows that alcohol in a person's system can make crash injuries worse, especially injuries to the brain, spinal cord or heart. This means that when anyone who has been drinking -- driver or passenger -- is in a crash, that person's chance of being killed or permanently disabled is higher than if the person had not been drinking.



CAUTION:

Drinking and then driving is very dangerous. Your reflexes, perceptions, attentiveness and judgment can be affected by even a small amount of alcohol. You can have a serious -- or even fatal -- collision if you drive after drinking. Please don't drink and drive or ride with a driver who has been drinking. Ride home in a cab; or if you're with a group, designate a driver who will not drink.

Control of a Vehicle

You have three systems that make your vehicle go where you want it to go. They are the brakes, the steering and the accelerator. All three systems have to do their work at the places where the tires meet the road.

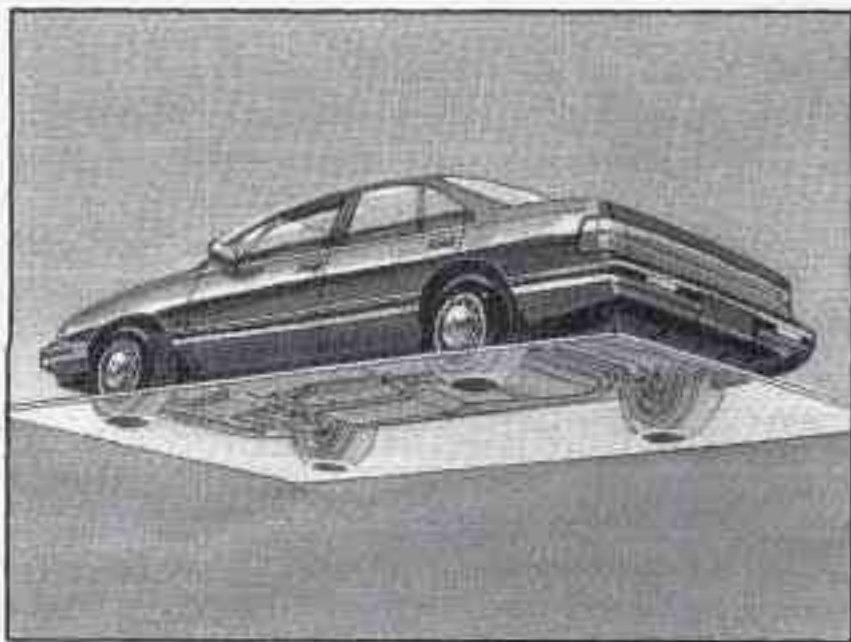

Sometimes, as when you're driving on snow or ice, it's easy to ask more of those control systems than the tires and road can provide. That means you can lose control of your vehicle.

Braking

Braking action involves *perception time* and *reaction time*.

First, you have to decide to push on the brake pedal. That's *perception time*. Then you have to bring up your foot and do it. That's *reaction time*.

Average *reaction time* is about $3/4$ of a second. But that's only an average. It might be less with one driver and as long as two or three seconds or more with another. Age, physical condition, alertness, coordination and eyesight all play a part. So do alcohol, drugs and frustration. But even in $3/4$ of a second, a vehicle moving at 60 mph (100 km/h) travels 66 feet (20 m). That could be a lot of distance in an emergency, so keeping enough space between your vehicle and others is important.

And, of course, actual stopping distances vary greatly with the surface of the road (whether it's pavement or gravel); the condition of the road (wet, dry, icy); tire tread; and the condition of your brakes.

Avoid needless heavy braking. Some people drive in spurts — heavy acceleration followed by heavy braking — rather than keeping pace with traffic. This is a mistake. Your brakes may not have time to cool between hard stops. Your brakes will wear out much faster if you do a lot of heavy braking. If you keep pace with the traffic and allow realistic following distances, you will eliminate a lot of unnecessary braking. That means better braking and longer brake life.

If your engine ever stops while you're driving, brake normally but don't pump your brakes. If you do, the pedal may get harder to push down. If your engine stops, you will still have some power brake assist. But you will use it when you brake. Once the power assist is used up, it may take longer to stop and the brake pedal will be harder to push.

Anti-Lock Brakes (Option)

Your vehicle may have anti-lock brakes (ABS). ABS is an advanced electronic braking system that will help prevent a braking skid.

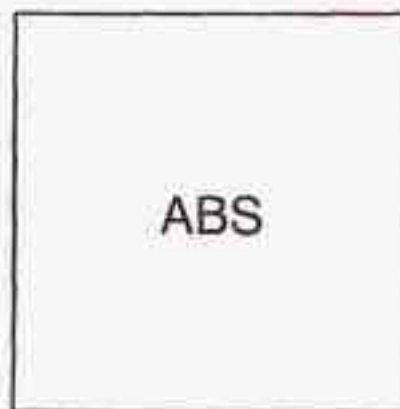

If your vehicle has anti-lock brakes, this warning light on the instrument panel will come on briefly when you start your vehicle.

When you start your engine, or when you begin to drive away, your anti-lock brake system will check itself. You may hear a momentary motor or clicking noise while this test is going on, and you may even notice that your brake pedal moves a little. This is normal.

If there's a problem with the anti-lock brake system, the anti-lock brake system warning light will stay on or flash. See "Anti-Lock Brake System Warning Light" in the Index.



Here's how anti-lock works. Let's say the road is wet. You're driving safely. Suddenly an animal jumps out in front of you.

You slam on the brakes. Here's what happens with ABS. A computer senses that wheels are slowing down. If one of the wheels is about to stop rolling, the computer will separately work the brakes at each front wheel and at the rear wheels.

The anti-lock system can change the brake pressure faster than any driver could. The computer is programmed to make the most of available tire and road conditions.



You can steer around the obstacle while braking hard.

As you brake, your computer keeps receiving updates on wheel speed and controls braking pressure accordingly.

Remember: Anti-lock doesn't change the time you need to get your foot up to the brake pedal or always decrease stopping distance. If you get too close to the vehicle in front of you, you won't have time to apply your brakes if that vehicle suddenly slows or stops. Always leave enough room up ahead to stop, even though you have anti-lock brakes.

Using Anti-Lock

Don't pump the brakes. Just hold the brake pedal down and let anti-lock work for you. You may feel the system working, or you may notice some noise, but this is normal.

A rectangular box containing the text "ABS ACTIVE" in a bold, sans-serif font, representing a dashboard warning light.

**ABS
ACTIVE**

When your anti-lock system is adjusting brake pressure to help avoid a braking skid, this light will come on. See "Anti-Lock Brake System Active Light" in the Index.

Braking in Emergencies

At some time, nearly every driver gets into a situation that requires hard braking.

If you have anti-lock, you can steer and brake at the same time. However, if you don't have anti-lock, your first reaction -- to hit the brake pedal hard and hold it down -- may be the wrong thing to do. Your wheels can stop rolling. Once they do, the vehicle can't respond to your steering. Momentum will carry it in whatever direction it was headed when the wheels stopped rolling. That could be off the road, into the very thing you were trying to avoid, or into traffic.

If you don't have anti-lock, use a "squeeze" braking technique. This will give you maximum braking while maintaining steering control. You do this by pushing on the brake pedal with steadily increasing pressure.

In an emergency, you will probably want to squeeze the brakes hard without locking the wheels. If you hear or feel the wheels sliding, ease off the brake pedal. This will help you retain steering control. (If you *do* have anti-lock, it's different: see "Anti-Lock Brakes" in the Index.)

In many emergencies, steering can help you more than even the very best braking.

Steering

Power Steering

If you lose power steering assist because the engine stops or the system is not functioning, you can steer but it will take much more effort.

Steering Tips

Driving on Curves

It's important to take curves at a reasonable speed.

A lot of the "driver lost control" accidents mentioned on the news happen on curves. Here's why:

Experienced driver or beginner, each of us is subject to the same laws of physics when driving on curves. The traction of the tires against the road surface makes it possible for the vehicle to change its path when you turn the front wheels. If there's no traction, inertia will keep the vehicle going in the same direction. If you've ever tried to steer a vehicle on wet ice, you'll understand this.

The traction you can get in a curve depends on the condition of your tires and the road surface, the angle at which the curve is banked, and your speed. While you're in a curve, speed is the one factor you can control.

Suppose you're steering through a sharp curve. Then you suddenly apply the brakes. Both control systems -- steering and braking -- have to do their work where the tires meet the road. Unless you have four-wheel anti-lock brakes, adding the hard braking can demand too much of those places. You can lose control.

The same thing can happen if you're steering through a sharp curve and you suddenly accelerate. Those two control systems -- steering and acceleration -- can overwhelm those places where the tires meet the road and make you lose control.

What should you do if this ever happens? Ease up on the brake or accelerator pedal, steer the vehicle the way you want it to go, and slow down.

Speed limit signs near curves warn that you should adjust your speed. Of course, the posted speeds are based on good weather and road conditions. Under less favorable conditions you'll want to go slower.

If you need to reduce your speed as you approach a curve, do it before you enter the curve, while your front wheels are straight ahead.

Try to adjust your speed so you can "drive" through the curve. Maintain a reasonable, steady speed. Wait to accelerate until you are out of the curve, and then accelerate gently into the straightaway.

Steering in Emergencies

There are times when steering can be more effective than braking. For example, you come over a hill and find a truck stopped in your lane, or a car suddenly pulls out from nowhere, or a child darts out from between parked cars and stops right in front of you. You can avoid these problems by braking -- if you can stop in time. But sometimes you can't; there isn't room. That's the time for evasive action -- steering around the problem.

Your Geo can perform very well in emergencies like these. First apply your brakes -- but, unless you have anti-lock, not enough to lock your wheels. (See "Braking in Emergencies" earlier in this section.) It is better to remove as much speed as you can from a possible collision. Then steer around the problem, to the left or right depending on the space available.



An emergency like this requires close attention and a quick decision. If you are holding the steering wheel at the recommended 9 and 3 o'clock positions, you can turn it a full 180 degrees very quickly without removing either hand. But you have to act fast, steer quickly, and just as quickly straighten the wheel once you have avoided the object.

The fact that such emergency situations are always possible is a good reason to practice defensive driving at all times and wear safety belts properly.

Off-Road Recovery

You may find sometime that your right wheels have dropped off the edge of a road onto the shoulder while you're driving.

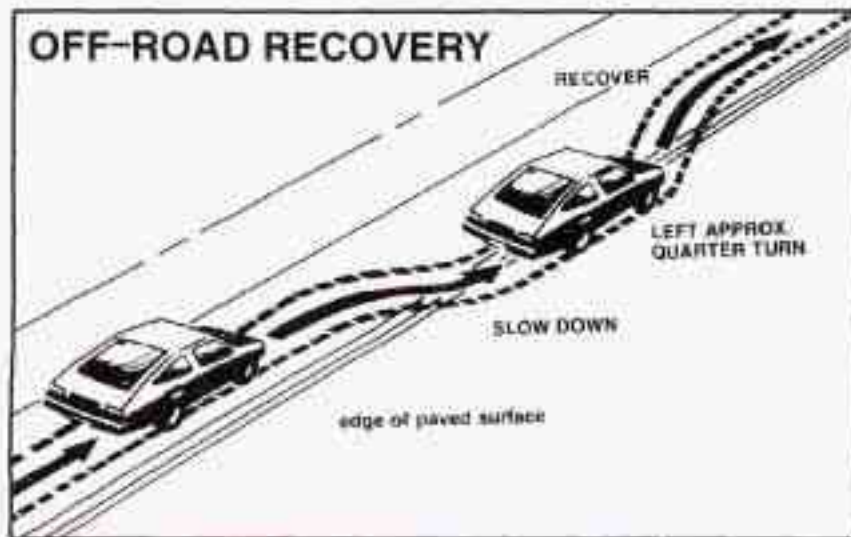

If the level of the shoulder is only slightly below the pavement, recovery should be fairly easy. Ease off the accelerator and then, if there is nothing in the way, steer so that your vehicle straddles the edge of the pavement. You can turn the steering wheel up to one-quarter turn until the right front tire contacts the pavement edge. Then turn your steering wheel to go straight down the roadway.

Passing

The driver of a vehicle about to pass another on a two-lane highway waits for just the right moment, accelerates, moves around the vehicle ahead, then goes back into the right lane again. A simple maneuver?

Not necessarily! Passing another vehicle on a two-lane highway is a potentially dangerous move, since the passing vehicle occupies the same lane as oncoming traffic for several seconds. A miscalculation, an error in judgment, or a brief surrender to frustration or anger can suddenly put the passing driver face to face with the worst of all traffic accidents -- the head-on collision.

So here are some tips for passing:

- "Drive ahead." Look down the road, to the sides and to crossroads for situations that might affect your passing patterns. If you have any doubt whatsoever about making a successful pass, wait for a better time.
- Watch for traffic signs, pavement markings and lines. If you can see a sign up ahead that might indicate a turn or an intersection, delay your pass. A broken center line usually indicates it's all right to pass (providing the road ahead is clear). Never cross a solid line on your side of the lane or a double solid line, even if the road seems empty of approaching traffic.

- Do not get too close to the vehicle you want to pass while you're awaiting an opportunity. For one thing, following too closely reduces your area of vision, especially if you're following a larger vehicle. Also, you won't have adequate space if the vehicle ahead suddenly slows or stops. Keep back a reasonable distance.
- When it looks like a chance to pass is coming up, start to accelerate but stay in the right lane and don't get too close. Time your move so you will be increasing speed as the time comes to move into the other lane. If the way is clear to pass, you will have a "running start" that more than makes up for the distance you would lose by dropping back. And if something happens to cause you to cancel your pass, you need only slow down and drop back again and wait for another opportunity.
- If other cars are lined up to pass a slow vehicle, wait your turn. But take care that someone isn't trying to pass you as you pull out to pass the slow vehicle. Remember to glance over your shoulder and check the blind spot.
- Check your mirrors, glance over your shoulder and start your left lane change signal before moving out

of the right lane to pass. When you are far enough ahead of the passed vehicle to see its front in your inside mirror, activate your right lane change signal and move back into the right lane. (Remember that your right outside mirror is convex. The vehicle you just passed may seem to be farther away from you than it really is.)

- Try not to pass more than one vehicle at a time on two-lane roads. Reconsider before passing the next vehicle.
- Don't overtake a slowly moving vehicle too rapidly. Even though the brake lamps are not flashing, it may be slowing down or starting to turn.
- If you're being passed, make it easy for the following driver to get ahead of you. Perhaps you can ease a little to the right.

Loss of Control

Let's review what driving experts say about what happens when the three control systems (brakes, steering and acceleration) don't have enough friction where the tires meet the road to do what the driver has asked.

In any emergency, don't give up. Keep trying to steer and constantly seek an escape route or area of less danger.

Skidding

In a skid, a driver can lose control of the vehicle. Defensive drivers avoid most skids by taking reasonable care suited to existing conditions, and by not “overdriving” those conditions. But skids are always possible.

The three types of skids correspond to your Geo’s three control systems. In the braking skid, your wheels aren’t rolling. In the steering or cornering skid, too much speed or steering in a curve causes tires to slip and lose cornering force. And in the acceleration skid, too much throttle causes the driving wheels to spin.

A cornering skid and an acceleration skid are best handled by easing your foot off the accelerator pedal.

If your vehicle starts to slide, ease your foot off the accelerator pedal and quickly steer the way you want the vehicle to go. If you start steering quickly enough, your vehicle may straighten out. Always be ready for a second skid if it occurs.

Of course, traction is reduced when water, snow, ice, gravel or other material is on the road. For safety, you’ll want to slow down and adjust your driving to these conditions. It is important to slow down on slippery surfaces because stopping distance will be longer and vehicle control more limited.

While driving on a surface with reduced traction, try your best to avoid sudden steering, acceleration or braking (including engine braking by shifting to a lower gear). Any sudden changes could cause the tires to slide. You may not realize the surface is slippery until your vehicle is skidding. Learn to recognize warning clues -- such as enough water, ice or packed snow on the road to make a “mirrored surface” -- and slow down when you have any doubt.

If you have the anti-lock braking system, remember: It helps avoid only the braking skid. If you do not have anti-lock, then in a braking skid (where the wheels are no longer rolling), release enough pressure on the brakes to get the wheels rolling again. This restores steering control. Push the brake pedal down steadily when you have to stop suddenly. As long as the wheels are rolling, you will have steering control.

Driving Guidelines

This multipurpose passenger vehicle is defined as a utility vehicle in Consumer Information Regulations issued by the National Highway Traffic Safety Administration (NHTSA) of the United States Department of Transportation. Utility vehicles have higher ground clearance and a narrower track to make them capable of performing in a wide variety of off-road applications. Specific design characteristics give them a higher center of gravity than ordinary cars. An advantage of the higher ground clearance is a better view of the road allowing you to anticipate problems. They are not designed for cornering at the same speeds as conventional two-wheel-drive vehicles any more than low-slung sports cars are designed to perform satisfactorily under off-road conditions. If at all possible, avoid sharp turns or abrupt maneuvers. As with other vehicles of this type, failure to operate this vehicle correctly may result in loss of control or vehicle rollover.

Off-Road Driving with Your Geo Four-Wheel-Drive Vehicle

This off-road guide is for vehicles that have four-wheel drive.

Also, see "Anti-Lock Brakes" in the Index.

If your vehicle doesn't have four-wheel drive, you shouldn't drive off-road unless you're on a level, solid surface.

Off-road driving can be great fun. But it does have some definite hazards. The greatest of these is the terrain itself.

"Off-roading" means you've left the great North American road system behind. Traffic lanes aren't marked. Curves aren't banked. There are no road signs. Surfaces can be slippery, rough, uphill or downhill. In short, you've gone right back to nature.

Off-road driving involves some new skills. And that's why it's very important that you read this guide. You'll find many driving tips and suggestions. These will help make your off-road driving safer and more enjoyable.

Before You Go Off-Road

There are some things to do before you go out. For example, be sure to have all necessary maintenance and service work done. Check to make sure all underbody shields (if so equipped) are properly attached. Be sure you read all the information about your four-wheel-drive vehicle in this manual. Is there enough fuel? Is the spare tire fully inflated? Are the fluid levels up where they should be? What are the local laws that apply to off-roading where you'll be driving? If you don't know, you should check with law enforcement people in the area. Will you be on someone's private land? If so, be sure to get the necessary permission.

Loading Your Vehicle for Off-Road Driving

There are some important things to remember about how to load your vehicle.

- The heaviest things should be on the load floor and forward of your rear axle. Put heavier items as far forward as you can.
- Be sure the load is secured properly, so driving on the off-road terrain doesn't toss things around.



CAUTION:

- **Cargo on the load floor piled higher than the seatbacks can be thrown forward during a sudden stop. You or your passengers could be injured. Keep cargo below the top of the seatbacks.**
- **Unsecured cargo on the load floor can be tossed about when driving over rough terrain. You or your passengers can be struck by flying objects. Secure the cargo properly.**
- **Heavy loads on the roof raise the vehicle's center of gravity, making it more likely to roll over. You can be seriously or fatally injured if the vehicle rolls over. Put heavy loads inside the cargo area, not on the roof. Keep cargo in the cargo area as far forward and low as possible.**

You'll find other important information in this manual. See "Vehicle Loading," "Luggage Carrier" and "Tires" in the Index.

Environmental Concerns

Off-road driving can provide wholesome and satisfying recreation. However, it also raises environmental concerns. Geo recognizes these concerns and urges every off-roader to follow these basic rules for protecting the environment:

- Always use established trails, roads and areas that have been specially set aside for public off-road recreational driving; obey all posted regulations.
- Avoid any driving practice that could damage the environment -- shrubs, flowers, trees, grasses -- or disturb wildlife (this includes wheel-spinning, breaking down trees or unnecessary driving through streams or over soft ground).
- Always carry a litter bag . . . make sure all refuse is removed from any campsite before leaving.
- Take extreme care with open fires (where permitted), camp stoves and lanterns.
- Never park your vehicle over dry grass or other combustible materials that could catch fire from the heat of the vehicle's exhaust system.

Traveling to Remote Areas

It makes sense to plan your trip, especially when going to a remote area. Know the terrain and plan your route. You are much less likely to get bad surprises. Get accurate maps of trails and terrain. Try to learn of any blocked or closed roads.

It's also a good idea to travel with at least one other vehicle. If something happens to one of them, the other can help quickly.

Does your vehicle have a winch? If so, be sure to read the winch instructions. In a remote area, a winch can be handy if you get stuck. But you'll want to know how to use it properly.

Getting Familiar with Off-Road Driving

It's a good idea to practice in an area that's safe and close to home before you go into the wilderness. Off-road driving does require some new and different driving skills. Here's what we mean.

Tune your senses to different kinds of signals. Your eyes, for example, need to constantly sweep the terrain for unexpected obstacles. Your ears need to listen for unusual tire or engine sounds. With your arms, hands, feet and body, you'll need to respond to vibrations and vehicle bounce.

Controlling your vehicle is the key to successful off-road driving. One of the best ways to control your vehicle is to control your speed. Here are some things to keep in mind. At higher speeds:

- you approach things faster and you have less time to scan the terrain for obstacles.
- you have less time to react.
- you have more vehicle bounce when you drive over obstacles.
- you'll need more distance for braking, especially since you're on an unpaved surface.

CAUTION:

When you're driving off-road, bouncing and quick changes in direction can easily throw you out of position. This could cause you to lose control and crash. So, whether you're driving on or off the road, you and your passengers should wear safety belts.

Scanning the Terrain

Off-road driving can take you over many different kinds of terrain. You need to be familiar with the terrain and its many different features. Here are some things to consider.

Surface Conditions. Off-roading can take you over hard-packed dirt, gravel, rocks, grass, sand, mud, snow or ice. Each of these surfaces affects the steering, acceleration and braking of your vehicle in different ways. Depending upon the kind of surface you are on, you may experience slipping, sliding, wheel spinning, delayed acceleration, poor traction and longer braking distances.

Surface Obstacles. Unseen or hidden obstacles can be hazardous. A rock, log, hole, rut or bump can startle you if you're not prepared for them. Often these obstacles are hidden by grass, bushes, snow or even the rise and fall of the terrain itself. Here are some things to consider:

- Is the path ahead clear?
- Will the surface texture change abruptly up ahead?
- Does the travel take you uphill or downhill? (There's more discussion of these subjects later.)

- Will you have to stop suddenly or change direction quickly?

When you drive over obstacles or rough terrain, keep a firm grip on the steering wheel. Ruts, troughs or other surface features can jerk the wheel out of your hands if you're not prepared.

When you drive over bumps, rocks, or other obstacles, your wheels can leave the ground. If this happens, even with one or two wheels, you can't control the vehicle as well or at all.

Because you will be on an unpaved surface, it's especially important to avoid sudden acceleration, sudden turns or sudden braking.

In a way, off-road driving requires a different kind of alertness from driving on paved roads and highways. There are no road signs, posted speed limits or signal lights. You have to use your own good judgment about what is safe and what isn't.

Drinking and driving can be very dangerous on any road. And this is certainly true for off-road driving. At the very time you need special alertness and driving skills, your reflexes, perceptions and judgment can be affected by even a small amount of alcohol. You could have a serious -- or even fatal -- accident if you drink and drive or ride with a driver who has been drinking. See "Drunken Driving" in the Index.

Driving on Off-Road Hills

Off-road driving often takes you up, down or across a hill. Driving safely on hills requires good judgment and an understanding of what your vehicle can and can't do. There are some hills that simply can't be driven, no matter how well built the vehicle.

CAUTION:

Many hills are simply too steep for any vehicle. If you drive up them, you will stall. If you drive down them, you can't control your speed. If you drive across them, you will roll over. You could be seriously injured or killed. If you have any doubt about the steepness, don't drive the hill.

Approaching a Hill

When you approach a hill, you need to decide if it's one of those hills that's just too steep to climb, descend or cross. Steepness can be hard to judge. On a very small hill, for example, there may be a smooth, constant incline with only a small change in elevation where you

can easily see all the way to the top. On a large hill, the incline may get steeper as you near the top, but you may not see this because the crest of the hill is hidden by bushes, grass or shrubs.

Here are some other things to consider as you approach a hill.

- Is there a constant incline, or does the hill get sharply steeper in places?
- Is there good traction on the hillside, or will the surface cause tire slipping?
- Is there a straight path up or down the hill so you won't have to make turning maneuvers?
- Are there obstructions on the hill that can block your path (boulders, trees, logs or ruts)?
- What's beyond the hill? Is there a cliff, an embankment, a drop-off, a fence? Get out and walk the hill if you don't know. It's the smart way to find out.
- Is the hill simply too rough? Steep hills often have ruts, gullies, troughs and exposed rocks because they are more susceptible to the effects of erosion.

Driving Uphill

Once you decide you can safely drive up the hill, you need to take some special steps.

- Use a low gear and get a firm grip on the steering wheel.
- Get a smooth start up the hill and try to maintain your speed. Don't use more power than you need, because you don't want your wheels to start spinning or sliding.
- Try to drive straight up the hill if at all possible. If the path twists and turns, you might want to find another route.

CAUTION:

Turning or driving across steep hills can be dangerous. You could lose traction, slide sideways, and possibly roll over. You could be seriously injured or killed. When driving up hills, always try to go straight up.

- Ease up on your speed as you approach the top of the hill.
- Attach a flag to the vehicle to make you more visible to approaching traffic on trails or hills.
- Sound the horn as you approach the top of the hill to let opposing traffic know you're there.
- Use your headlamps even during the day. They make you more visible to oncoming traffic.

CAUTION:

Driving to the top (crest) of a hill at full speed can cause an accident. There could be a drop-off, embankment, cliff, or even another vehicle. You could be seriously injured or killed. As you near the top of a hill, slow down and stay alert.

Q: What should I do if my vehicle stalls, or is about to stall, and I can't make it up the hill?

A: If this happens, there are some things you should do, and there are some things you must not do.

First, here's what you *should* do:

- Push the brake pedal to stop the vehicle and keep it from rolling backwards. Also, apply the parking brake.
- If your engine is still running, shift the transmission to REVERSE (R), release the parking brake, and slowly back down the hill in REVERSE (R).
- If your engine has stopped running, you'll need to restart it. With the brake pedal depressed and the parking brake still applied, shift the transmission to PARK (P) (or, shift to NEUTRAL (N) if your vehicle has a manual transmission) and restart the engine. Then, shift to REVERSE (R), release the parking brake, and slowly back down the hill as straight as possible in REVERSE (R).
- As you are backing down the hill, put your left hand on the steering wheel at the 12 o'clock position. This way, you'll be able to tell if your wheels are straight

and maneuver as you back down. It's best that you back down the hill with your wheels straight rather than in the left or right direction. Turning the wheel too far to the left or right will increase the possibility of a rollover.

Here are some things you *must not* do if you stall, or are about to stall, when going up a hill.

- Never attempt to prevent a stall by shifting into NEUTRAL (N) (or depressing the clutch, if you have a manual transmission) to "rev-up" the engine and regain forward momentum. This won't work. Your vehicle will roll backwards very quickly and you could go out of control.

Instead, apply the regular brake to stop the vehicle. Then apply the parking brake. Shift to REVERSE (R), release the parking brake, and slowly back straight down.

- Never attempt to turn around if you are about to stall when going up a hill. If the hill is steep enough to stall your vehicle, it's steep enough to cause you to roll over if you turn around. If you can't make it up the hill, you must back straight down the hill.

Q: Suppose, after stalling, I try to back down the hill and decide I just can't do it. What should I do?

A: Set the parking brake, put your transmission in PARK (P) (or the manual transmission in FIRST (1)) and turn off the engine. Leave the vehicle and go get some help. Exit on the uphill side and stay clear of the path the vehicle would take if it rolled downhill. Do not shift the transfer case to NEUTRAL (N) when you leave the vehicle. Leave it in some gear.



CAUTION:

Shifting the transfer case to NEUTRAL (N) can cause your vehicle to roll even if the transmission is in PARK (P) (or, if you have the manual transmission, even if you're in gear). This is because the NEUTRAL (N) position on the transfer case overrides the transmission. If you are going to leave your vehicle, set the parking brake and shift the transmission to PARK (P) (or, put your manual transmission in FIRST (1)). But do not shift the transfer case to the NEUTRAL (N) position. Leave the transfer case in the 2H, 4H or 4L position.

Driving Downhill

When off-roading takes you downhill, you'll want to consider a number of things:

- How steep is the downhill? Will I be able to maintain vehicle control?
- What's the surface like? Smooth? Rough? Slippery? Hard-packed dirt? Gravel?
- Are there hidden surface obstacles? Ruts? Logs? Boulders?
- What's at the bottom of the hill? Is there a hidden creek bank or even a river bottom with large rocks?

If you decide you can go down a hill safely, then try to keep your vehicle headed straight down, and use a low gear. This way, engine drag can help your brakes and they won't have to do all the work. Descend slowly, keeping your vehicle under control at all times.



CAUTION:

Heavy braking when going down a hill can cause your brakes to overheat and fade. This could cause loss of control and a serious accident. Apply the brakes lightly when descending a hill and use a low gear to keep vehicle speed under control.

Q: Are there some things I should not do when driving down a hill?

A: Yes! These are important because if you ignore them you could lose control and have a serious accident.

- When driving downhill, avoid turns that take you across the incline of the hill. A hill that's not too steep to drive down may be too steep to drive across. You could roll over if you don't drive straight down.
- Never go downhill with the transmission in NEUTRAL (N), or with the clutch pedal depressed in a manual shift. This is called "free-wheeling." Your brakes will have to do all the work and could overheat and fade.
- Unless you have anti-lock: Avoid braking so hard that you lock the wheels when going downhill. If your wheels are locked, you can't steer your vehicle. If your wheels lock up during downhill braking, you may feel the vehicle starting to slide sideways. To regain your *direction*, just ease off the brakes and steer to keep the front of the vehicle pointing straight downhill.

Q: Am I likely to stall when going downhill?

A: It's much more likely to happen going uphill. But if it happens going downhill, here's what to do.

- Stop your vehicle by applying the regular brakes. Apply the parking brake.
- Shift to PARK (P) (or to NEUTRAL (N) with the manual transmission) and, while still braking, restart the engine.
- Shift back to a low gear, release the parking brake, and drive straight down.
- If the engine won't start, get out and get help.

Driving Across an Incline

Sooner or later, an off-road trail will probably go across the incline of a hill. If this happens, you have to decide whether to try to drive across the incline. Here are some things to consider:

- A hill that can be driven straight up or down may be too steep to drive across. When you go straight up or down a hill, the length of the wheel base (the distance from the front wheels to the rear wheels) reduces the likelihood the vehicle will tumble end over end. But when you drive across an incline, the much more narrow track width (the distance between the left and right wheels) may not prevent the vehicle from tilting and rolling over. Also, driving across an incline puts more weight on the downhill wheels. This could cause a downhill slide or a rollover.
- Surface conditions can be a problem when you drive across a hill. Loose gravel, muddy spots, or even wet grass can cause your tires to slip sideways, downhill. If the vehicle slips sideways, it can hit something that will trip it (a rock, a rut, etc.) and roll over.
- Hidden obstacles can make the steepness of the incline even worse. If you drive across a rock with the uphill wheels, or if the downhill wheels drop into a rut or depression, your vehicle can tilt even more.

For reasons like these, you need to decide carefully whether to try to drive across an incline. Just because the trail goes across the incline doesn't mean you have to drive it. The last vehicle to try it might have rolled over.



CAUTION:

Driving across an incline that's too steep will make your vehicle roll over. You could be seriously injured or killed. If you have any doubt about the steepness of the incline, don't drive across it. Find another route instead.

Q: What if I'm driving across an incline that's not too steep, but I hit some loose gravel and start to slide downhill. What should I do?

A: If you feel your vehicle starting to slide sideways, turn downhill. This should help straighten out the vehicle and prevent the side slipping. However, a much better way to prevent this is to get out and "walk the course" so you know what the surface is like before you drive it.

Stalling on an Incline

If your vehicle stalls when you're crossing an incline, be sure you (and your passengers) get out on the uphill side, even if the door there is harder to open. If you get out on the downhill side and the vehicle starts to roll over, you'll be right in its path.

If you have to walk down the slope, stay out of the path the vehicle will take if it does roll over.

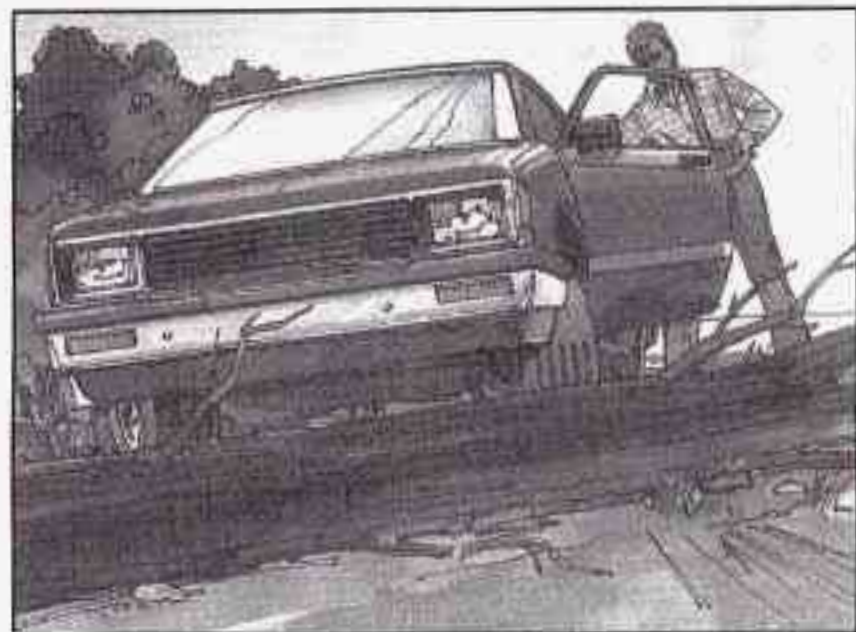

CAUTION:

Getting out on the downhill (low) side of a vehicle stopped across an incline is dangerous. If the vehicle rolls over, you could be crushed or killed. Always get out on the uphill (high) side of the vehicle and stay well clear of the rollover path.

Driving in Mud, Sand, Snow or Ice

When you drive in mud, snow or sand, your wheels won't get good traction. You can't accelerate as quickly, turning is more difficult, and you'll need longer braking distances.

It's best to use a low gear when you're in mud -- the deeper the mud, the lower the gear. In really deep mud, the idea is to keep your vehicle moving so you don't get stuck.

When you drive on sand, you'll sense a change in wheel traction. But it will depend upon how loosely packed the sand is. On loosely packed sand (as on beaches or sand dunes) your tires will tend to sink into the sand. This has an effect on steering, accelerating and braking. You may want to reduce the air pressure in your tires slightly when driving on sand. This will improve traction.

Hard packed snow and ice offer the worst tire traction. On these surfaces, it's very easy to lose control. On wet ice, for example, the traction is so poor that you will have difficulty accelerating. And if you do get moving, poor steering and difficult braking can cause you to slide out of control.



CAUTION:

Driving on frozen lakes, ponds or rivers can be dangerous. Underwater springs, currents under the ice, or sudden thaws can weaken the ice. Your vehicle could fall through the ice and you and your passengers could drown. Drive your vehicle on safe surfaces only.

Driving in Water

Light rain causes no special off-road driving problems. But heavy rain can mean flash flooding, and flood waters demand extreme caution.

Find out how deep the water is before you drive through it. If it's deep enough to cover your wheel hubs, axles or exhaust pipe, don't try it -- you probably won't get through. Also, water that deep can damage your axle and other vehicle parts.

If the water isn't too deep, then drive through it slowly. At fast speeds, water splashes on your ignition system and your vehicle can stall. Stalling can also occur if you get your tailpipe under water. And, as long as your tailpipe is under water, you'll never be able to start your engine. When you go through water, remember that when your brakes get wet, it may take you longer to stop.

CAUTION:

Driving through rushing water can be dangerous. Deep water can sweep your vehicle downstream and you and your passengers could drown. If it's only inches deep, it can still wash away the ground from under your tires, and you could lose traction and roll the vehicle over. Don't drive through rushing water.

After Off-Road Driving

Remove any brush or debris that has collected on the underbody, chassis or under the hood. These accumulations can be a fire hazard.

After operation in mud or sand, have the brake linings cleaned and checked. These substances can cause glazing and uneven braking. Check the body structure, steering, suspension, wheels, tires and exhaust system for damage. Also, check the fuel lines and cooling system for any leakage.

Your vehicle will require more frequent service due to off-road use. Refer to the Maintenance Schedule for additional information.

Driving at Night



Night driving is more dangerous than day driving. One reason is that some drivers are likely to be impaired -- by alcohol or drugs, with night vision problems, or by fatigue.

Here are some tips on night driving.

- Drive defensively.
- Don't drink and drive.
- Adjust your inside rearview mirror to reduce the glare from headlamps behind you.
- Since you can't see as well, you may need to slow down and keep more space between you and other vehicles.
- Slow down, especially on higher speed roads. Your headlamps can light up only so much road ahead.
- In remote areas, watch for animals.
- If you're tired, pull off the road in a safe place and rest.

Night Vision

No one can see as well at night as in the daytime. But as we get older these differences increase. A 50-year-old driver may require at least twice as much light to see the same thing at night as a 20-year-old.

What you do in the daytime can also affect your night vision. For example, if you spend the day in bright sunshine you are wise to wear sunglasses. Your eyes will have less trouble adjusting to night. But if you're driving, don't wear sunglasses at night. They may cut down on glare from headlamps, but they also make a lot of things invisible.

You can be temporarily blinded by approaching lights. It can take a second or two, or even several seconds, for your eyes to readjust to the dark. When you are faced with severe glare (as from a driver who doesn't lower the high beams, or a vehicle with misaimed headlamps), slow down a little. Avoid staring directly into the approaching headlamps.

Keep your windshield and all the glass on your vehicle clean -- inside and out. Glare at night is made much worse by dirt on the glass. Even the inside of the glass can build up a film caused by dust. Dirty glass makes lights dazzle and flash more than clean glass would, making the pupils of your eyes contract repeatedly.

Remember that your headlamps light up far less of a roadway when you are in a turn or curve. Keep your eyes moving; that way, it's easier to pick out dimly lighted objects. Just as your headlamps should be checked regularly for proper aim, so should your eyes be examined regularly. Some drivers suffer from night blindness -- the inability to see in dim light -- and aren't even aware of it.

Driving in Rain and on Wet Roads



Rain and wet roads can mean driving trouble. On a wet road, you can't stop, accelerate or turn as well because your tire-to-road traction isn't as good as on dry roads. And, if your tires don't have much tread left, you'll get even less traction. It's always wise to go slower and be cautious if rain starts to fall while you are driving. The surface may get wet suddenly when your reflexes are tuned for driving on dry pavement.

The heavier the rain, the harder it is to see. Even if your windshield wiper blades are in good shape, a heavy rain can make it harder to see road signs and traffic signals, pavement markings, the edge of the road and even people walking.

It's wise to keep your wiping equipment in good shape and keep your windshield washer tank filled with washer fluid. Replace your windshield wiper inserts when they show signs of streaking or missing areas on the windshield, or when strips of rubber start to separate from the inserts.



⚠ CAUTION:

Wet brakes can cause accidents. They won't work well in a quick stop and may cause pulling to one side. You could lose control of the vehicle.

After driving through a large puddle of water or a car wash, apply your brake pedal lightly until your brakes work normally.

Driving too fast through large water puddles or even going through some car washes can cause problems, too. The water may affect your brakes. Try to avoid puddles. But if you can't, try to slow down before you hit them.

Hydroplaning

Hydroplaning is dangerous. So much water can build up under your tires that they can actually ride on the water. This can happen if the road is wet enough and you're going fast enough. When your vehicle is hydroplaning, it has little or no contact with the road.

Hydroplaning doesn't happen often. But it can if your tires haven't much tread or if the pressure in one or more is low. It can happen if a lot of water is standing on the road. If you can see reflections from trees, telephone poles or other vehicles, and raindrops "dimple" the water's surface, there could be hydroplaning.

Hydroplaning usually happens at higher speeds. There just isn't a hard and fast rule about hydroplaning. The best advice is to slow down when it is raining.

Driving Through Deep Standing Water

NOTICE:

If you drive too quickly through deep puddles or standing water, water can come in through your engine's air intake and badly damage your engine. Never drive through water that is slightly lower than the underbody of your vehicle. If you can't avoid deep puddles or standing water, drive through them very slowly.

Some Other Rainy Weather Tips

- Besides slowing down, allow some extra following distance. And be especially careful when you pass another vehicle. Allow yourself more clear room ahead, and be prepared to have your view restricted by road spray.
- Have good tires with proper tread depth. (See "Tires" in the Index.)

City Driving



One of the biggest problems with city streets is the amount of traffic on them. You'll want to watch out for what the other drivers are doing and pay attention to traffic signals.

Here are ways to increase your safety in city driving:

- Know the best way to get to where you are going. Get a city map and plan your trip into an unknown part of the city just as you would for a cross-country trip.
- Try to use the freeways that rim and crisscross most large cities. You'll save time and energy. (See the next part, "Freeway Driving.")
- Treat a green light as a warning signal. A traffic light is there because the corner is busy enough to need it. When a light turns green, and just before you start to move, check both ways for vehicles that have not cleared the intersection or may be running the red light.

Freeway Driving

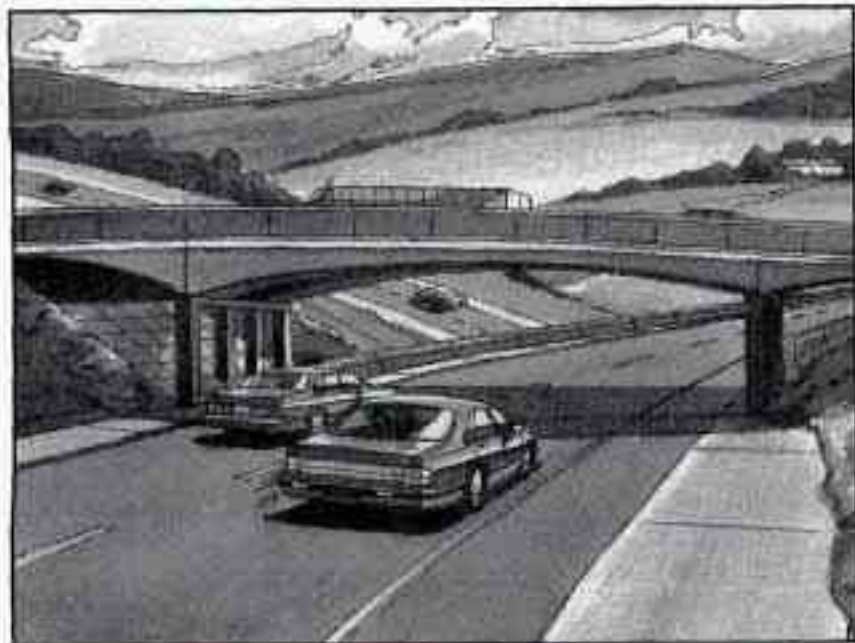

Mile for mile, freeways (also called thruways, parkways, expressways, turnpikes or superhighways) are the safest of all roads. But they have their own special rules.

The most important advice on freeway driving is: Keep up with traffic and keep to the right. Drive at the same speed most of the other drivers are driving. Too-fast or too-slow driving breaks a smooth traffic flow. Treat the left lane on a freeway as a passing lane.

At the entrance, there is usually a ramp that leads to the freeway. If you have a clear view of the freeway as you drive along the entrance ramp, you should begin to check traffic. Try to determine where you expect to blend with the flow. Try to merge into the gap at close to the prevailing speed. Switch on your turn signal, check your mirrors and glance over your shoulder as often as necessary. Try to blend smoothly with the traffic flow.

Once you are on the freeway, adjust your speed to the posted limit or to the prevailing rate if it's slower. Stay in the right lane unless you want to pass.

Before changing lanes, check your mirrors. Then use your turn signal. Just before you leave the lane, glance quickly over your shoulder to make sure there isn't another vehicle in your "blind" spot.

Once you are moving on the freeway, make certain you allow a reasonable following distance. Expect to move slightly slower at night.

When you want to leave the freeway, move to the proper lane well in advance. If you miss your exit, do not, under any circumstances, stop and back up. Drive on to the next exit.

The exit ramp can be curved, sometimes quite sharply. The exit speed is usually posted.

Reduce your speed according to your speedometer, not to your sense of motion. After driving for any distance at higher speeds, you may tend to think you are going slower than you actually are.

Before Leaving on a Long Trip

Make sure you're ready. Try to be well rested. If you must start when you're not fresh -- such as after a day's work -- don't plan to make too many miles that first part of the journey. Wear comfortable clothing and shoes you can easily drive in.

Is your vehicle ready for a long trip? If you keep it serviced and maintained, it's ready to go. If it needs service, have it done before starting out. Of course, you'll find experienced and able service experts in Geo dealerships all across North America. They'll be ready and willing to help if you need it.

Here are some things you can check before a trip:

- *Windshield Washer Fluid:* Is the reservoir full? Are all windows clean inside and outside?
- *Wiper Blades:* Are they in good shape?
- *Fuel, Engine Oil, Other Fluids:* Have you checked all levels?
- *Lamps:* Are they all working? Are the lenses clean?
- *Tires:* They are vitally important to a safe, trouble-free trip. Is the tread good enough for long-distance driving? Are the tires all inflated to the recommended pressure?
- *Weather Forecasts:* What's the weather outlook along your route? Should you delay your trip a short time to avoid a major storm system?
- *Maps:* Do you have up-to-date maps?

Highway Hypnosis

Is there actually such a condition as “highway hypnosis”? Or is it just plain falling asleep at the wheel? Call it highway hypnosis, lack of awareness, or whatever.

There is something about an easy stretch of road with the same scenery, along with the hum of the tires on the road, the drone of the engine, and the rush of the wind against the vehicle that can make you sleepy. Don't let it happen to you! If it does, your vehicle can leave the road in *less than a second*, and you could crash and be injured.

What can you do about highway hypnosis? First, be aware that it can happen.

Then here are some tips:

- Make sure your vehicle is well ventilated, with a comfortably cool interior.
- Keep your eyes moving. Scan the road ahead and to the sides. Check your mirrors and your instruments frequently.
- If you get sleepy, pull off the road into a rest, service or parking area and take a nap, get some exercise, or both. For safety, treat drowsiness on the highway as an emergency.

Hill and Mountain Roads



Driving on steep hills or mountains is different from driving in flat or rolling terrain.

If you drive regularly in steep country, or if you're planning to visit there, here are some tips that can make your trips safer and more enjoyable. (See "Off-Road Driving" in the Index for information about driving off-road.)

- Keep your vehicle in good shape. Check all fluid levels and also the brakes, tires, cooling system and transmission. These parts can work hard on mountain roads.
- Know how to go down hills. The most important thing to know is this: let your engine do some of the slowing down. Shift to a lower gear when you go down a steep or long hill.

 **CAUTION:**

If you don't shift down, your brakes could get so hot that they wouldn't work well. You would then have poor braking or even none going down a hill. You could crash. Shift down to let your engine assist your brakes on a steep downhill slope.

 **CAUTION:**

Coasting downhill in NEUTRAL (N) or with the ignition off is dangerous. Your brakes will have to do all the work of slowing down. They could get so hot that they wouldn't work well. You would then have poor braking or even none going down a hill. You could crash. Always have your engine running and your vehicle in gear when you go downhill.

- Know how to go uphill. You may want to shift down to a lower gear. The lower gears help cool your engine and transmission, and you can climb the hill better.
- Stay in your own lane when driving on two-lane roads in hills or mountains. Don't swing wide or cut across the center of the road. Drive at speeds that let you stay in your own lane.
- As you go over the top of a hill, be alert. There could be something in your lane, like a stalled car or an accident.
- You may see highway signs on mountains that warn of special problems. Examples are long grades, passing or no-passing zones, a falling rocks area or winding roads. Be alert to these and take appropriate action.

Winter Driving

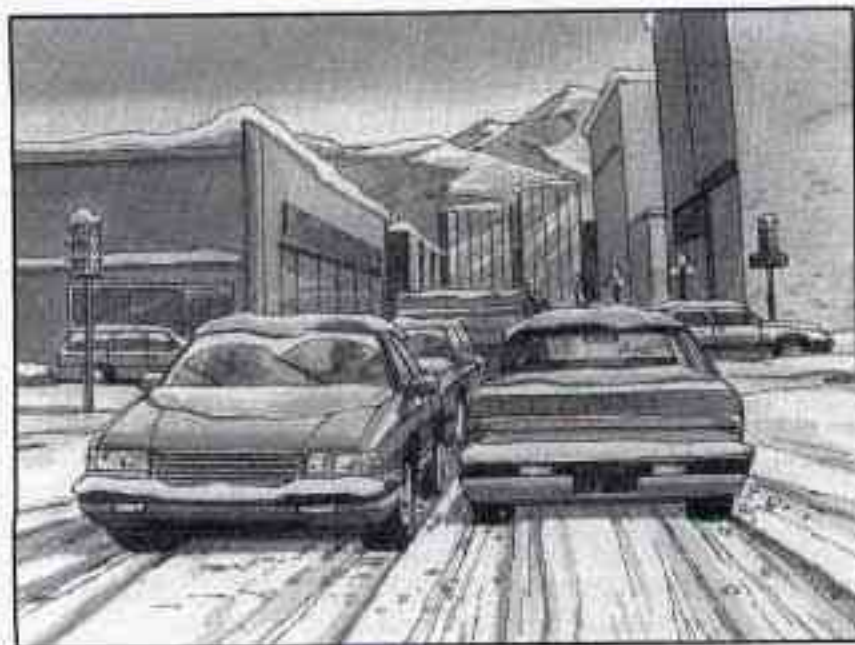

Here are some tips for winter driving:

- Have your Geo in good shape for winter.
- You may want to put winter emergency supplies in your vehicle.

Include an ice scraper, a small brush or broom, a supply of windshield washer fluid, a rag, some winter outer clothing, a small shovel, a flashlight, a red cloth and a couple of reflective warning triangles. And, if you will be driving under severe conditions, include a small bag of sand, a piece of old carpet or a couple of burlap bags to help provide traction. Be sure you properly secure these items in your vehicle.

Driving on Snow or Ice

Most of the time, those places where your tires meet the road probably have good traction.

However, if there is snow or ice between your tires and the road, you can have a very slippery situation. You'll have a lot less traction or "grip" and will need to be very careful.



What's the worst time for this? "Wet ice." Very cold snow or ice can be slick and hard to drive on. But wet ice can be even more trouble because it may offer the least traction of all. You can get wet ice when it's about freezing (32°F; 0°C) and freezing rain begins to fall. Try to avoid driving on wet ice until salt and sand crews can get there.

Whatever the condition -- smooth ice, packed, blowing or loose snow -- drive with caution. Accelerate gently. Try not to break the fragile traction. If you accelerate too fast, the drive wheels will spin and polish the surface under the tires even more.

Unless you have the anti-lock braking system, you'll want to brake very gently, too. (If you do have anti-lock, see "Anti-Lock" in the Index. This system improves your vehicle's stability when you make a hard stop on a slippery road.) Whether you have the anti-lock braking system or not, you'll want to begin stopping sooner than you would on dry pavement. Without anti-lock brakes, if you feel your vehicle begin to slide, let up on the brakes a little. Push the brake pedal down steadily to get the most traction you can.

Remember, unless you have anti-lock, if you brake so hard that your wheels stop rolling, you'll just slide. Brake so your wheels always keep rolling and you can still steer.

- Whatever your braking system, allow greater following distance on any slippery road.
- Watch for slippery spots. The road might be fine until you hit a spot that's covered with ice. On an otherwise clear road, ice patches may appear in shaded areas where the sun can't reach: around clumps of trees, behind buildings or under bridges. Sometimes the surface of a curve or an overpass may remain icy when the surrounding roads are clear. If you see a patch of ice ahead of you, brake before you are on it. Try not to brake while you're actually on the ice, and avoid sudden steering maneuvers.

If You're Caught in a Blizzard



If you are stopped by heavy snow, you could be in a serious situation. You should probably stay with your vehicle unless you know for sure that you are near help and you can hike through the snow. Here are some things to do to summon help and keep yourself and your passengers safe:

- Turn on your hazard flashers.

- Tie a red cloth to your vehicle to alert police that you've been stopped by the snow.
- Put on extra clothing or wrap a blanket around you. If you have no blankets or extra clothing, make body insulators from newspapers, burlap bags, rags, floor mats -- anything you can wrap around yourself or tuck under your clothing to keep warm.

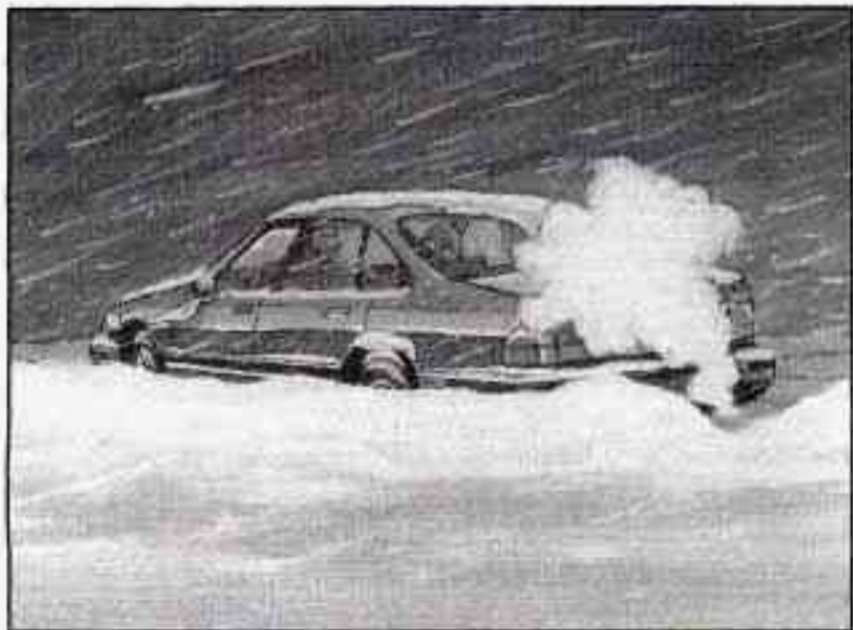

You can run the engine to keep warm, but be careful.



CAUTION:

Snow can trap exhaust gases under your vehicle. This can cause deadly CO (carbon monoxide) gas to get inside. CO could overcome you and kill you. You can't see it or smell it, so you might not know it is in your vehicle. Clear away snow from around the base of your vehicle, especially any that is blocking your exhaust pipe. And check around again from time to time to be sure snow doesn't collect there.

Open a window just a little on the side of the vehicle that's away from the wind. This will help keep CO out.

Run your engine only as long as you must. This saves fuel. When you run the engine, make it go a little faster than just idle. That is, push the accelerator slightly. This uses less fuel for the heat that you get and it keeps the battery charged. You will need a well-charged battery to restart the vehicle, and possibly for signaling later on with your headlamps. Let the heater run for awhile.

Then, shut the engine off and close the window almost all the way to preserve the heat. Start the engine again and repeat this only when you feel really uncomfortable from the cold. But do it as little as possible. Preserve the fuel as long as you can. To help keep warm, you can get out of the vehicle and do some fairly vigorous exercises every half hour or so until help comes.

Recreational Vehicle Towing

There may be times when you want to tow your Geo behind another vehicle for use at your destination. Be sure to use the proper towing equipment designed for recreational towing. Follow the instructions for the towing equipment.

Towing Your Vehicle from the Rear

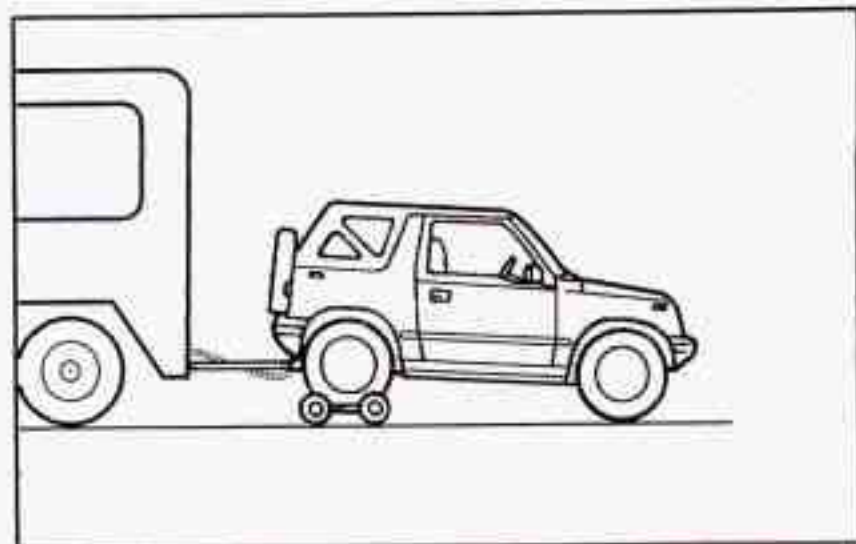

The best way to tow your Geo is from the rear. Follow these steps:

1. Put the rear wheels on a dolly.

NOTICE:

Do not tow your Geo with the rear wheels in contact with the ground, or the transmission could be damaged.

2. Set the parking brake.
3. If your Geo is a four-wheel-drive vehicle, set your manual free-wheeling hubs to FREE or unlock your automatic freewheeling hubs. See "Four-Wheel Drive" in the Index.
4. Turn the ignition key to ACC to unlock the steering wheel.
5. Clamp the steering wheel in a straight-ahead position, with a clamping device designed for towing.
6. Release the parking brake.

NOTICE:

Make sure that the towing speed does not exceed 55 mph (90 km/h), or your Geo could be badly damaged.

Towing Your Vehicle from the Front

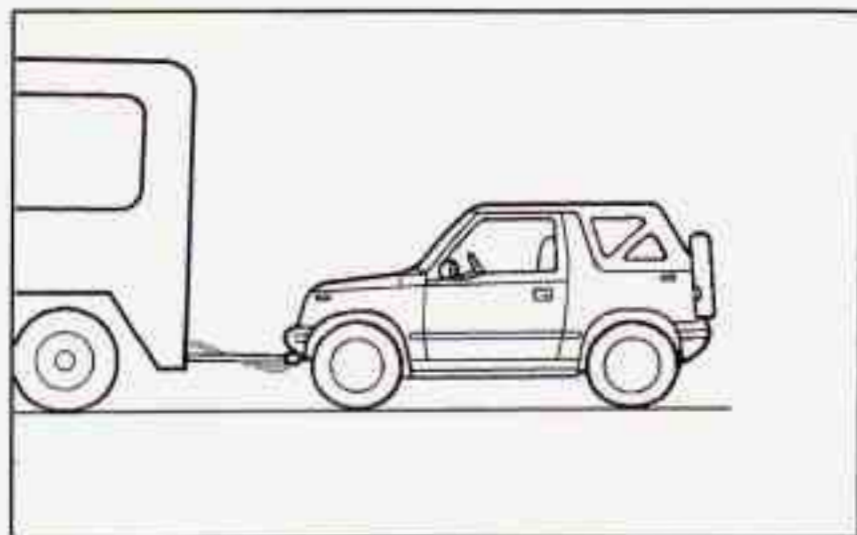

NOTICE:

If your vehicle has automatic freewheeling hubs or two-wheel drive, do not tow it on all four wheels. If you do, your transmission could be damaged.

If you have a four-wheel-drive vehicle with manual freewheeling hubs, it can be towed from the front with all four wheels on the ground. Follow these steps:

1. Set the parking brake.
2. Turn the ignition key to ACC to unlock the steering wheel.
3. Shift your automatic transmission into PARK (P), or your manual transmission into SECOND (2).
4. Shift the transfer case to NEUTRAL (N).
5. Set the hubs to FREE. See "Four-Wheel Drive" in the Index.
6. Release the parking brake.

Stop towing every 200 miles (300 km) and start the engine. Leave the transfer case shift lever in NEUTRAL (N). Shift your automatic transmission to DRIVE (D); leave a manual transmission in SECOND (2) with the clutch engaged. Run the engine at medium speed for one minute to circulate the oil in the transfer case. Turn the ignition key to ACC. Now you can continue towing your Geo.

NOTICE:

The front wheels transmit shocks during towing. The steering column may not be strong enough to withstand the shocks. Always unlock the steering wheel before towing.

NOTICE:

Make sure that the towing speed does not exceed 50 mph (80 km/h), or your Geo could be badly damaged.

Loading Your Vehicle

TIRE PLACARD			
	GVWR	GVWR FRT	GAWR RR
LB/Kg			
TIRES			
RIMS			
INFLATION PRESSURE COLD PSI/KPa			

Two labels on your vehicle show how much weight it may properly carry. The Tire-Loading Information label found on the driver's door lock pillar tells you the proper size, speed rating and recommended inflation pressures for the tires on your vehicle. It also gives you important information about the number of people that can be in your vehicle and the total weight that you can carry. This weight is called the vehicle capacity weight and includes the weight of all occupants, cargo and all nonfactory-installed options.



The other label is the Certification label, also found on the driver's door lock pillar. It tells you the gross weight capacity of your vehicle, called the GVWR (Gross Vehicle Weight Rating). The GVWR includes the weight of the vehicle, all occupants, fuel and cargo. Never exceed the GVWR for your vehicle, or the Gross Axle Weight Rating (GAWR) for either the front or rear axle.

And, if you do have a heavy load, you should spread it out. Don't carry more than 400 lbs. (181 kg) in your rear area when four people are in your two-wheel-drive vehicle. If you have a four-wheel-drive vehicle, don't carry more than 200 lbs. (91 kg) in your rear area when four people are in your vehicle.

 **CAUTION:**

Do not load your vehicle any heavier than the GVWR, or either the maximum front or rear GAWR. If you do, parts on your vehicle can break, or it can change the way your vehicle handles. These could cause you to lose control. Also, overloading can shorten the life of your vehicle.

NOTICE:

Your warranty does not cover parts or components that fail because of overloading.

If you put things inside your vehicle -- like suitcases, tools, packages or anything else -- they will go as fast as the vehicle goes. If you have to stop or turn quickly, or if there is a crash, they'll keep going.

 **CAUTION:**

Things you put inside your vehicle can strike and injure people in a sudden stop or turn, or in a crash.

- Put things in the cargo area of your vehicle. Try to spread the weight evenly.
- Never stack heavier things, like suitcases, inside the vehicle so that some of them are above the tops of the seats.
- Don't leave an unsecured child restraint in your vehicle.
- When you carry something inside the vehicle, secure it whenever you can.
- Don't leave a seat folded down unless you need to.

There's also important loading information for off-road driving in this manual. See "Loading Your Vehicle" in the Index.

Towing a Trailer

CAUTION:

If you don't use the correct equipment and drive properly, you can lose control when you pull a trailer. For example, if the trailer is too heavy, the brakes may not work well -- or even at all. You and your passengers could be seriously injured. Pull a trailer only if you have followed all the steps in this section. Ask your Geo dealer for advice and information about towing a trailer with your vehicle.

NOTICE:

Pulling a trailer improperly can damage your vehicle and result in costly repairs not covered by your warranty. To pull a trailer correctly, follow the advice in this part, and see your Geo dealer for important information about towing a trailer with your vehicle.

Your vehicle can tow a trailer. To identify what the vehicle trailering capacity is for your vehicle, you should read the information in "Weight of the Trailer" that appears later in this section. But trailering is different than just driving your vehicle by itself. Trailering means changes in handling, durability and fuel economy. Successful, safe trailering takes correct equipment, and it has to be used properly.

That's the reason for this section. In it are many time-tested, important trailering tips and safety rules. Many of these are important for your safety and that of your passengers. So please read this section carefully before you pull a trailer.

Load-pulling components such as the engine, transmission, wheel assemblies and tires are forced to work harder against the drag of the added weight. The engine is required to operate at relatively higher speeds and under greater loads, generating extra heat. What's more, the trailer adds considerably to wind resistance, increasing the pulling requirements.

If You Do Decide To Pull A Trailer

If you do, here are some important points:

- There are many different laws, including speed limit restrictions, having to do with trailering. Make sure your rig will be legal, not only where you live but also where you'll be driving. A good source for this information can be state or provincial police.
- Consider using a sway control. You can ask a hitch dealer about sway controls.
- Don't tow a trailer at all during the first 500 miles (800 km) your new vehicle is driven. Your engine, axle or other parts could be damaged.
- Then, during the first 500 miles (800 km) that you tow a trailer, don't drive over 50 mph (80 km/h) and don't make starts at full throttle. This helps your engine and other parts of your vehicle wear in at the heavier loads.
- If you have an automatic transmission, you should use DRIVE (D) (or, as you need to, a lower gear) when towing a trailer. Operating your vehicle in DRIVE (D) when towing a trailer will minimize heat buildup and extend the life of your transmission. If you have a manual transmission and you are towing a trailer, it's better not to use FIFTH (5) gear. Just drive in FOURTH (4) gear (or, as you need to, a lower gear).

Three important considerations have to do with weight: the weight of the trailer, the weight of the trailer tongue and the weight on your vehicle's tires.

Weight of the Trailer

How heavy can a trailer safely be?

It should never weigh more than 1,000 lbs. (450 kg). But even that can be too heavy.

It depends on how you plan to use your rig. For example, speed, altitude, road grades, outside temperature and how much your vehicle is used to pull a trailer are all important. And, it can also depend on any special equipment that you have on your vehicle.

You can ask your dealer for our trailering information or advice, or you can write us at:

Customer Assistance Department
Chevrolet/Geo
P.O. Box 7047
Troy, MI 48007-7047

In Canada, write to:

General Motors of Canada Limited
Customer Assistance Center
1908 Colonel Sam Drive
Oshawa, Ontario L1H 8P7

Weight of the Trailer Tongue

The tongue load (A) of any trailer is an important weight to measure because it affects the total or gross weight of your vehicle. The Gross Vehicle Weight (GVW) includes the curb weight of the vehicle, any cargo you may carry in it, and the people who will be riding in the vehicle. And if you will tow a trailer, you must add the tongue load to the GVW because your vehicle will be carrying that weight, too. See "Loading Your Vehicle" in the Index for more information about your vehicle's maximum load capacity.

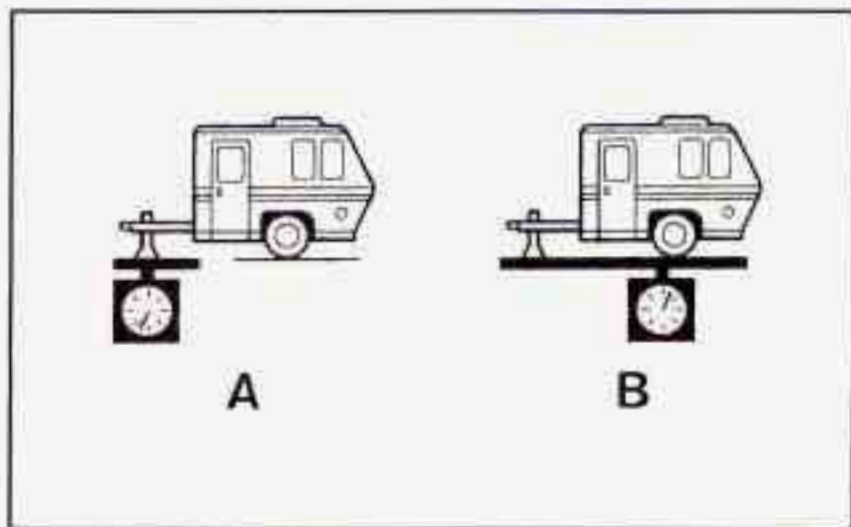

If you're using a weight-carrying hitch, the trailer tongue (A) should weigh 10 percent of the total loaded trailer weight (B). If you have a weight-distributing hitch, the trailer tongue (A) should weigh 12 percent of the total loaded trailer weight (B).

After you've loaded your trailer, weigh the trailer and then the tongue, separately, to see if the weights are proper. If they aren't, you may be able to get them right simply by moving some items around in the trailer.

Total Weight on Your Vehicle's Tires

Be sure your vehicle's tires are inflated to the limit for cold tires. You'll find these numbers on the Certification label at the rear edge of the driver's door lock pillar or see "Tire Loading" in the Index. Then be sure you don't go over the GVW limit for your vehicle, including the weight of the trailer tongue.

Hitches

It's important to have the correct hitch equipment. Crosswinds, large trucks going by and rough roads are a few reasons why you'll need the right hitch. Here are some rules to follow:

- If you use a step-bumper hitch, your bumper could be damaged in sharp turns. Make sure you have ample room when turning to avoid contact between the trailer and the bumper.

Safety Chains

You should always attach chains between your vehicle and your trailer. Cross the safety chains under the tongue of the trailer so that the tongue will not drop to the road if it becomes separated from the hitch. Instructions about safety chains may be provided by the hitch manufacturer or by the trailer manufacturer. Follow the manufacturer's recommendation for attaching safety chains and do not attach them to the bumper. Always leave just enough slack so you can turn with your rig. And, never allow safety chains to drag on the ground.

Trailer Brakes

If your trailer weighs more than 1,000 lbs. (450 kg) loaded, then it needs its own brakes -- and they must be adequate. Be sure to read and follow the instructions for the trailer brakes so you'll be able to install, adjust and maintain them properly.

- Don't tap into your vehicle's brake system if the trailer's brake system will use more than 0.02 cubic inch (0.3 cc) of fluid from your vehicle's master cylinder. If it does, both systems won't work well. You could even lose your brakes.
- Will the trailer brake parts take 3,000 psi (20 650 kPa) of pressure? If not, the trailer brake system must not be used with your vehicle.
- If everything checks out this far, then make the brake fluid tap at the port on the master cylinder that sends fluid to the rear brakes. But don't use copper tubing for this. If you do, it will bend and finally break off. Use steel brake tubing.

Driving with a Trailer

Towing a trailer requires a certain amount of experience. Before setting out for the open road, you'll want to get to know your rig. Acquaint yourself with the feel of handling and braking with the added weight of the trailer. And always keep in mind that the vehicle you are driving is now a good deal longer and not nearly as responsive as your vehicle is by itself.

Before you start, check the trailer hitch and platform (and attachments), safety chains, electrical connector, lamps, tires and mirror adjustment. If the trailer has electric brakes, start your vehicle and trailer moving and then apply the trailer brake controller by hand to be sure the brakes are working. This lets you check your electrical connection at the same time.

During your trip, check occasionally to be sure that the load is secure, and that the lamps and any trailer brakes are still working.

Following Distance

Stay at least twice as far behind the vehicle ahead as you would when driving your vehicle without a trailer. This can help you avoid situations that require heavy braking and sudden turns.

Passing

You'll need more passing distance up ahead when you're towing a trailer. And, because you're a good deal longer, you'll need to go much farther beyond the passed vehicle before you can return to your lane.

Backing Up

Hold the bottom of the steering wheel with one hand. Then, to move the trailer to the left, just move that hand to the left. To move the trailer to the right, move your hand to the right. Always back up slowly and, if possible, have someone guide you.

Making Turns

NOTICE:

Making very sharp turns while trailering could cause the trailer to come in contact with the vehicle. Your vehicle could be damaged. Avoid making very sharp turns while trailering.

When you're turning with a trailer, make wider turns than normal. Do this so your trailer won't strike soft shoulders, curbs, road signs, trees or other objects. Avoid jerky or sudden maneuvers. Signal well in advance.

Turn Signals When Towing a Trailer

When you tow a trailer, your vehicle has to have extra wiring (included in the optional trailering package).

The green arrows on your instrument panel will flash whenever you signal a turn or lane change. Properly hooked up, the trailer lamps will also flash, telling other drivers you're about to turn, change lanes or stop.

When towing a trailer, the green arrows on your instrument panel will flash for turns even if the bulbs on the trailer are burned out. Thus, you may think drivers behind you are seeing your signal when they are not. It's important to check occasionally to be sure the trailer bulbs are still working.

Driving On Grades

Reduce speed and shift to a lower gear *before* you start down a long or steep downgrade. If you don't shift down, you might have to use your brakes so much that they would get hot and no longer work well.

On a long uphill grade, shift down and reduce your speed to around 45 mph (70 km/h) to reduce the possibility of engine and transmission overheating.

If you are towing a trailer and you have a manual transmission with FIFTH (5) gear, you may prefer not to use FIFTH (5). Just drive in FOURTH (4) (or, as you need to, a lower gear).

Parking on Hills

You really should not park your vehicle, with a trailer attached, on a hill. If something goes wrong, your rig could start to move. People can be injured, and both your vehicle and the trailer can be damaged.

But if you ever have to park your rig on a hill, here's how to do it:

1. Apply your regular brakes, but don't shift into PARK (P) yet, or into gear for a manual transmission.
2. Have someone place chocks under the trailer wheels.
3. When the wheel chocks are in place, release the regular brakes until the chocks absorb the load.
4. Reapply the regular brakes. Then apply your parking brake, and then shift to PARK (P), or REVERSE (R) for a manual transmission.
5. If you have a four-wheel-drive vehicle, be sure the transfer case is in a drive gear -- not in NEUTRAL (N).
6. Release the regular brakes.



CAUTION:

It can be dangerous to get out of your vehicle if the shift lever is not fully in PARK (P) with the parking brake firmly set. Your vehicle can roll. If you have left the engine running, the vehicle can move suddenly. You or others could be injured. To be sure your vehicle won't move, even when you're on fairly level ground, use the steps that follow.

If you have four-wheel drive and your transfer case is in NEUTRAL (N), your vehicle will be free to roll, even if your shift lever is in PARK (P). So, be sure the transfer case is in a drive gear -- not in NEUTRAL (N).

When You Are Ready to Leave After Parking on a Hill

1. Apply your regular brakes and hold the pedal down while you:
 - Start your engine;
 - Shift into a gear; and
 - Release the parking brake.
2. Let up on the brake pedal.
3. Drive slowly until the trailer is clear of the chocks.
4. Stop and have someone pick up and store the chocks.

Maintenance When Trailer Towing

Your vehicle will need service more often when you're pulling a trailer. See the Maintenance Schedule for more on this. Things that are especially important in trailer operation are automatic transmission fluid (don't overfill), engine oil, axle lubricant, belts, cooling system and brake adjustment. Each of these is covered in this manual, and the Index will help you find them quickly. If you're trailering, it's a good idea to review these sections before you start your trip.

Check periodically to see that all hitch nuts and bolts are tight.

Here you'll find what to do about some problems that can occur on the road.

Hazard Warning Flashers

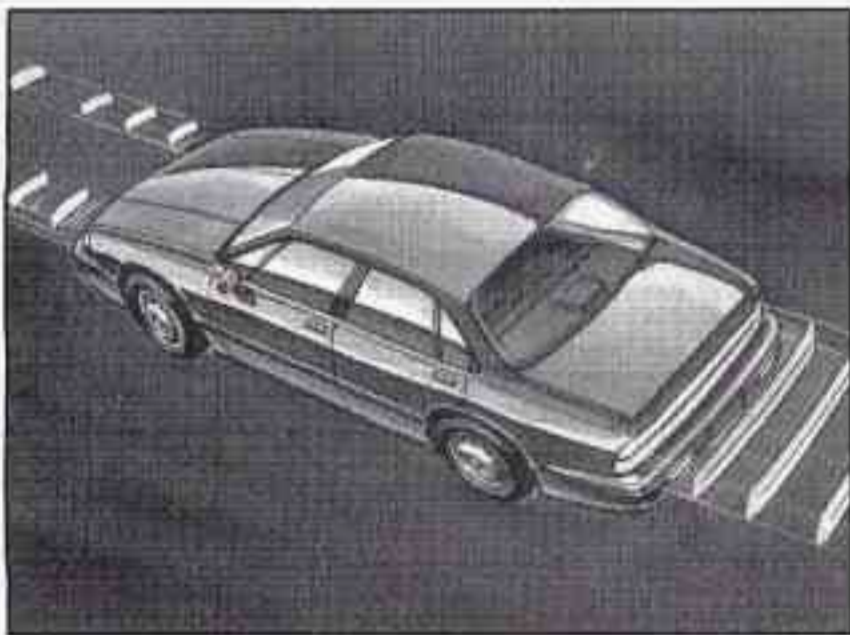

Your hazard warning flashers let you warn others. They also let police know you have a problem. Your front and rear turn signal lamps will flash on and off.



Press the button on top of the steering column to make your front and rear turn signal lamps flash on and off.

Your hazard warning flashers work no matter what position your key is in, and even if the key isn't in.

To turn off the flashers, push the button again.

When the hazard warning flashers are on, your turn signals won't work.

Other Warning Devices

If you carry reflective triangles, you can set one up at the side of the road about 300 feet (100 m) behind your vehicle.

Jump Starting

If your battery has run down, you may want to use another vehicle and some jumper cables to start your Geo. But please use the following steps to do it safely.



CAUTION:

Batteries can hurt you. They can be dangerous because:

- They contain acid that can burn you.
- They contain gas that can explode or ignite.
- They contain enough electricity to burn you.

If you don't follow these steps exactly, some or all of these things can hurt you.

NOTICE:

Ignoring these steps could result in costly damage to your vehicle that wouldn't be covered by your warranty.

Trying to start your Geo by pushing or pulling it could damage your vehicle, even if you have a manual transmission. And if you have an automatic transmission, it won't start that way.

1. Check the other vehicle. It must have a 12-volt battery with a negative ground system.

NOTICE:

If the other system isn't a 12-volt system with a negative ground, both vehicles can be damaged.

2. Get the vehicles close enough so the jumper cables can reach, but be sure the vehicles aren't touching each other. If they are, it could cause a ground connection you don't want. You wouldn't be able to start your Geo, and the bad grounding could damage the electrical systems.
3. Turn off the ignition on both vehicles. Unplug unnecessary accessories plugged into the cigarette lighter. Turn off all lamps that aren't needed as well as radios. This will avoid sparks and help save both batteries. In addition, it could save your radio!

NOTICE:

If you leave your radio on, it could be badly damaged. The repairs wouldn't be covered by your warranty.

4. Open the hoods and locate the batteries. Find the positive (+) and negative (-) terminals on each battery.

CAUTION:

An electric fan can start up even when the engine is not running and can injure you. Keep hands, clothing and tools away from any underhood electric fan.

 **CAUTION:**

Using a match near a battery can cause battery gas to explode. People have been hurt doing this, and some have been blinded. Use a flashlight if you need more light.

Be sure the battery has enough water. You don't need to add water to the Delco Freedom[®] battery installed in every new GM vehicle. But if a battery has filler caps, be sure the right amount of fluid is there. If it is low, add water to take care of that first. If you don't, explosive gas could be present.

Battery fluid contains acid that can burn you. Don't get it on you. If you accidentally get it in your eyes or on your skin, flush the place with water and get medical help immediately.

5. Check that the jumper cables don't have loose or missing insulation. If they do, you could get a shock. The vehicles could be damaged, too.

 **CAUTION:**

Fans or other moving engine parts can injure you badly. Keep your hands away from moving parts once the engines are running.



6. Positive (+) goes to positive (+) and negative (-) goes to negative (-) or a metal engine part. Don't connect positive (+) to negative (-) or you'll get a short that would damage the battery and maybe other parts, too. Connect the red positive (+) cable to the positive (+) terminal of the vehicle with the dead battery. Use a remote positive (+) terminal if the vehicle has one.



7. Don't let the other end touch metal. Connect it to the positive (+) terminal of the good battery. Use a remote positive (+) terminal if the vehicle has one.



8. Now connect the black negative (-) cable to the good battery's negative (-) terminal. Don't let the other end touch anything until the next step.

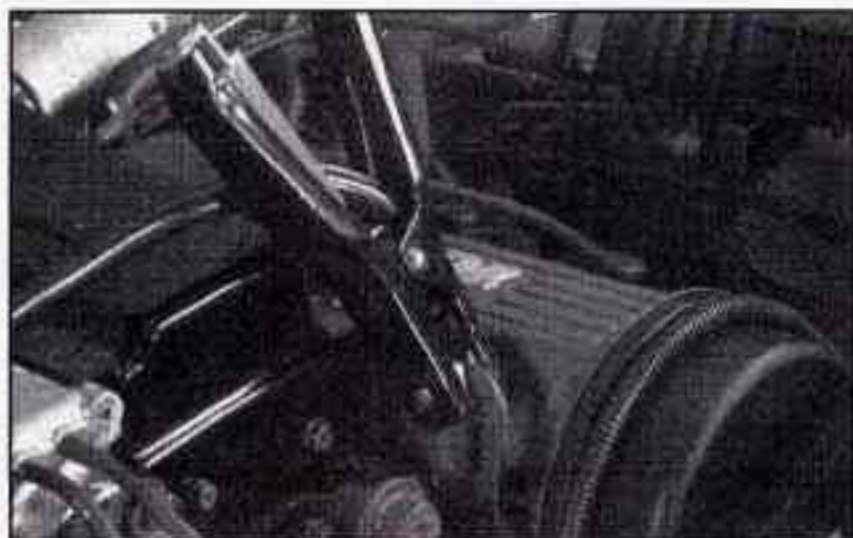

- The other end of the negative (-) cable doesn't go to the dead battery. It goes to a heavy unpainted metal part on the engine of the vehicle with the dead battery. Attach the cable at least 18 inches (45 cm) away from the dead battery, but not near engine parts that move. The electrical connection is just as good there, but the chance of sparks getting back to the battery is much less.
- Now start the vehicle with the good battery and run the engine for a while.
- Try to start the vehicle with the dead battery. If it won't start after a few tries, it probably needs service.

- Remove the cables in reverse order to prevent electrical shorting. Take care that they don't touch each other or any other metal.

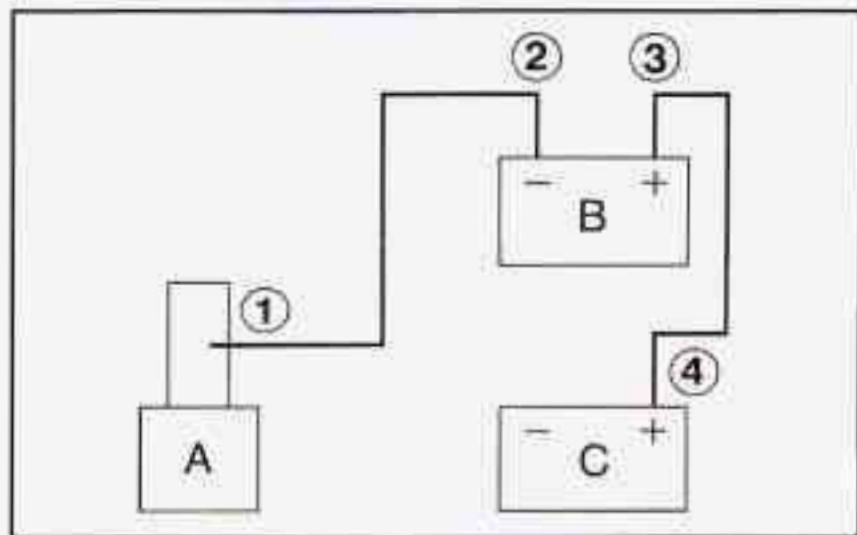

- A. Heavy Metal Engine Part
B. Good Battery
C. Dead Battery

Towing Your Vehicle

Try to have a Chevrolet/Geo dealer or a professional towing service tow your Geo. See "Roadside Assistance" in the Index.

If your vehicle has been changed or modified since it was factory-new by adding aftermarket items like fog lamps, aero skirting, or special tires and wheels, these instructions may not be correct.

Before you do anything, turn on the hazard warning flashers.

When you call, tell the towing service:

- That your vehicle has rear-wheel drive, or that it has the four-wheel-drive option.
- The make, model and year of your vehicle.
- Whether you can still move the shift lever for the transmission and transfer case, if you have one.
- If there was an accident, what was damaged.

When the towing service arrives, let the tow operator know that this manual contains detailed towing instructions and illustrations. The operator may want to see them.

CAUTION:

To help avoid injury to you or others:

- Never let passengers ride in a vehicle that is being towed.
- Never tow faster than safe or posted speeds.
- Never tow with damaged parts not fully secured.
- Never get under your vehicle after it has been lifted by the tow truck.
- Always use separate safety chains on each side when towing a vehicle.
- Never use T-hooks. Use J-hooks instead.

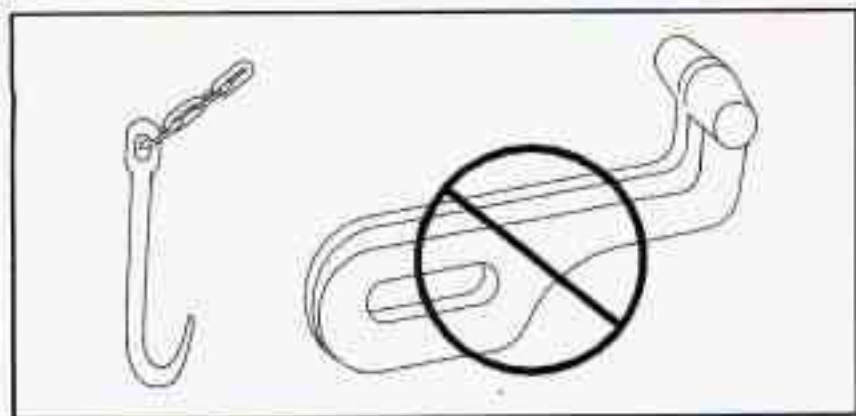

When your vehicle is being towed, have the ignition key turned to the OFF position. The steering wheel should be clamped in a straight-ahead position, with a clamping device designed for towing service. Do not use the vehicle's steering column lock for this. The transmission and transfer case, if you have one, should be in NEUTRAL (N) and the parking brake released.

Don't have your vehicle towed on the drive wheels unless you must. If the vehicle must be towed on the drive wheels, be sure to follow any speed and distance restrictions later in this section, or your transmission will be damaged. If these limitations must be exceeded, then the drive wheels have to be supported on a dolly.

⚠ CAUTION:

A vehicle can fall from a car carrier if it isn't adequately secured. This can cause a collision, serious personal injury and vehicle damage. The vehicle should be tightly secured with chains or steel cables before it is transported.

Don't use substitutes (ropes, leather straps, canvas webbing, etc.) that can be cut by sharp edges underneath the towed vehicle.

Front Towing

A towing dolly must be used under the drive wheels when towing from the front.

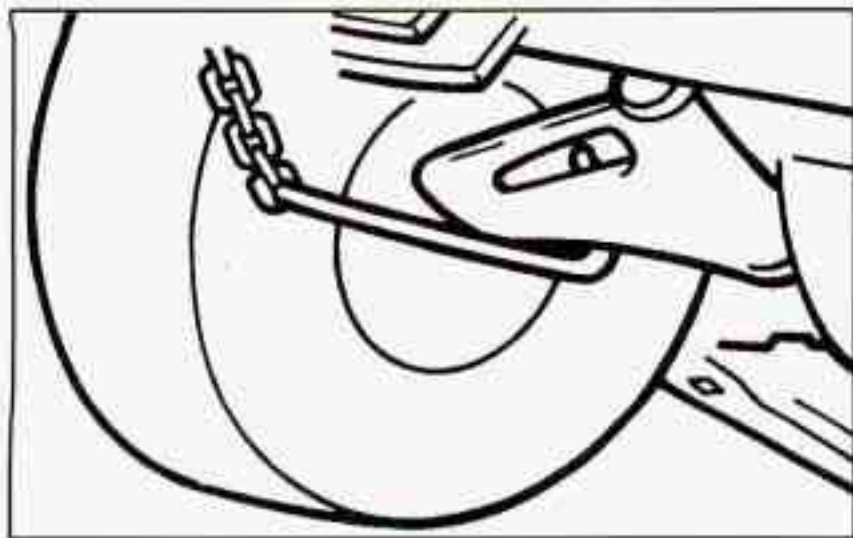

Attach J-hook chains on both sides to the rear of lower control arms inboard of the spring.

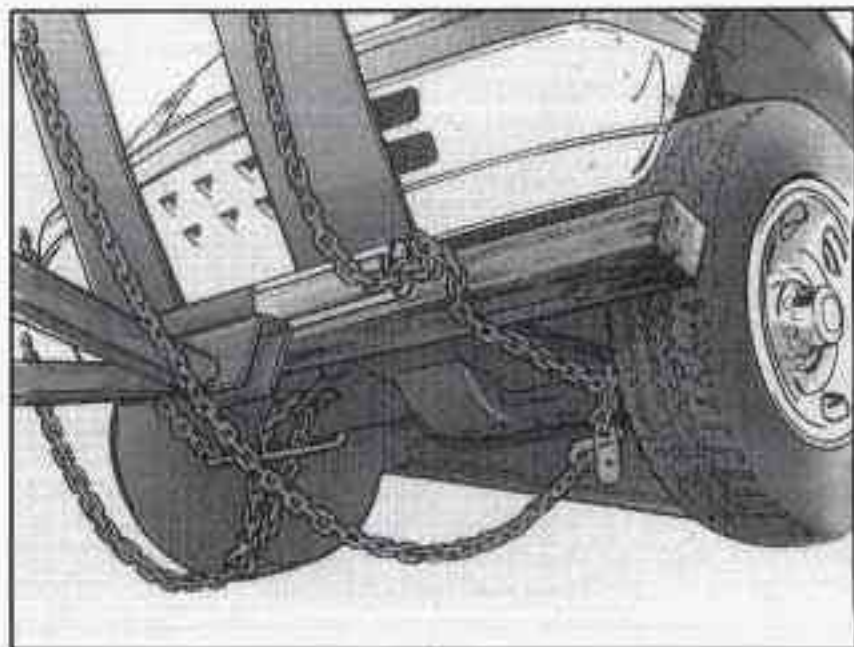

Position a 4" x 4" wood beam across the sling chains and against the lower control arm front attachment brackets. Position the lower sling crossbar in front and against the 4" x 4" wood beam.

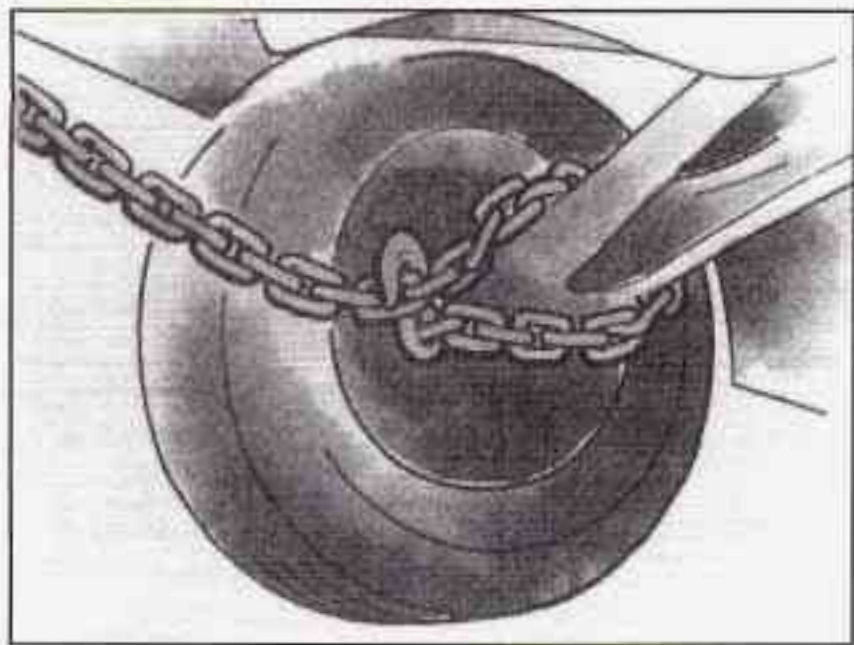

Attach a separate safety chain around the outboard end of each lower control arm.

Rear Towing

If your vehicle has four-wheel drive, don't have it towed on the front wheels unless you must. If a vehicle with four-wheel drive must be towed on the front wheels, set your manual, freewheeling hubs to FREE or unlock your automatic freewheeling hubs, and set your transfer case to two-wheel drive. If your vehicle must be towed on the front wheels, don't go more than 55 mph (90 km/h).

A towing dolly must be used under the front wheels when towing from the rear.

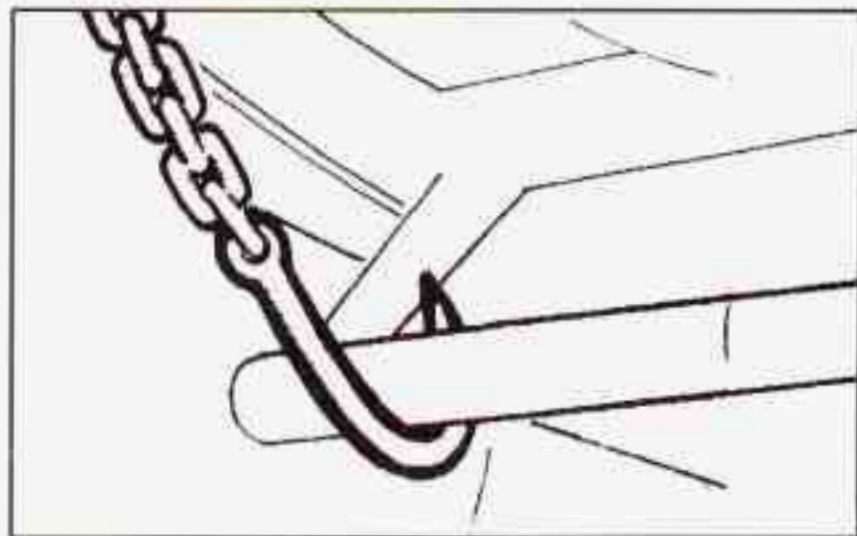

Attach J-hooks around the axle tube.

NOTICE:

Take care not to damage the brake pipes on the axle tubes.

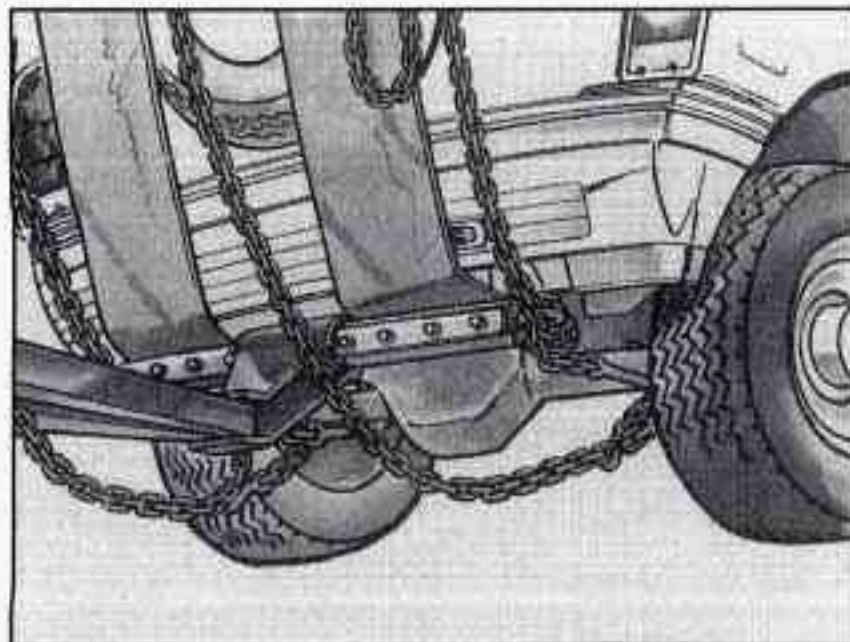

Position the sling crossbar under and forward of the rear bumper.

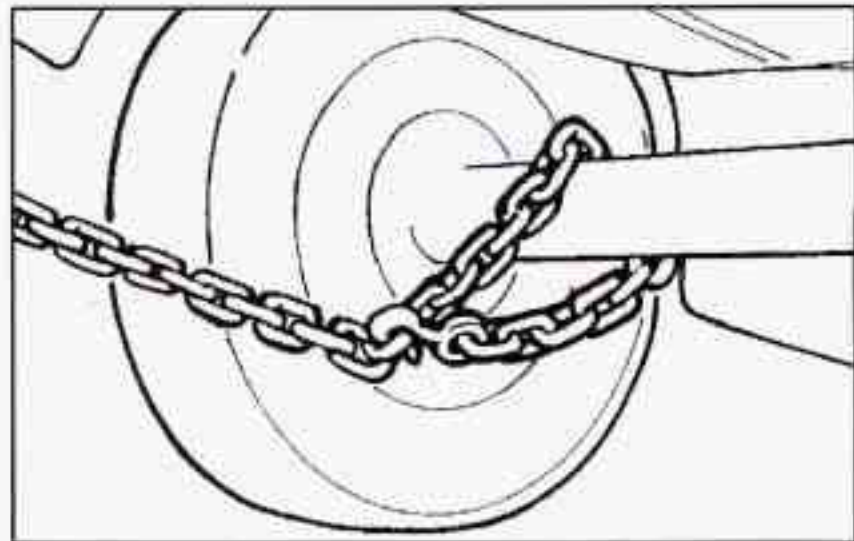

Attach a separate safety chain around the end of each axle, inboard of the spring.

Engine Overheating

You will find a coolant temperature gage on your Geo instrument panel.

If Steam Is Coming From Your Engine



CAUTION:

Steam from an overheated engine can burn you badly, even if you just open the hood. Stay away from the engine if you see or hear steam coming from it. Just turn it off and get everyone away from the vehicle until it cools down. Wait until there is no sign of steam or coolant before opening the hood.

If you keep driving when your engine is overheated, the liquids in it can catch fire. You or others could be badly burned. Stop your engine if it overheats, and get out of the vehicle until the engine is cool.

NOTICE:

If your engine catches fire because you keep driving with no coolant, your vehicle can be badly damaged. The costly repairs would not be covered by your warranty.

If No Steam Is Coming From Your Engine

If you get the overheat warning but see or hear no steam, the problem may not be too serious. Sometimes the engine can get a little too hot when you:

- Climb a long hill on a hot day.
- Stop after high-speed driving.
- Idle for long periods in traffic.
- Tow a trailer.

If you get the overheat warning with no sign of steam, try this for a minute or so:

1. If you have an air conditioner, turn it off.
2. Turn on your heater to full hot at the highest fan speed and open the window as necessary.
3. If you're in a traffic jam, shift to NEUTRAL (N); otherwise, shift to the highest gear while driving -- AUTOMATIC OVERDRIVE @ or DRIVE (D) for automatic transmissions.

If you no longer have the overheat warning, you can drive. Just to be safe, drive slower for about 10 minutes. If the warning doesn't come back on, you can drive normally.

If the warning continues, pull over, stop, and park your vehicle right away.

If there's still no sign of steam, you can idle the engine for two or three minutes while you're parked, to see if the warning stops. But then, if you still have the warning, *turn off the engine and get everyone out of the vehicle* until it cools down.

You may decide not to lift the hood but to get service help right away.

When you decide it's safe to lift the hood, here's what you'll see:

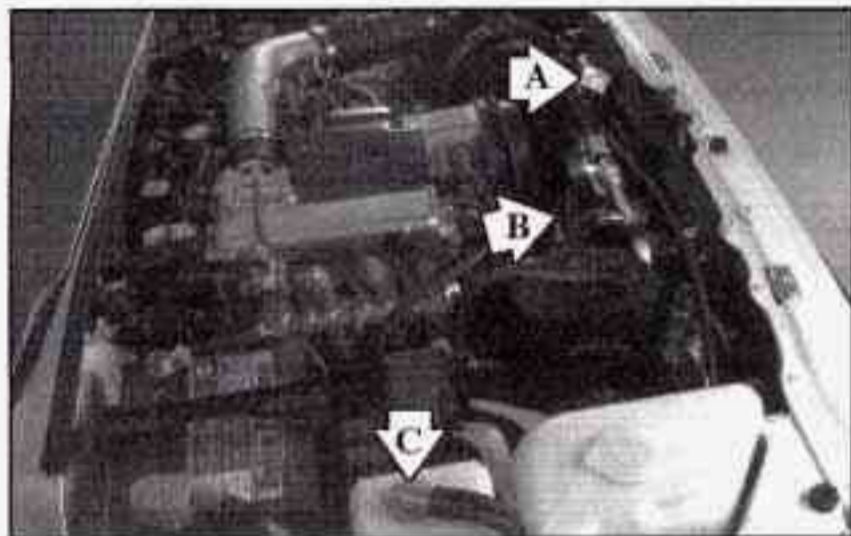

- A. Radiator Pressure Cap
- B. Electric Engine Fan
- C. Coolant Recovery Tank



CAUTION:

An electric fan under the hood can start up even when the engine is not running and can injure you. Keep hands, clothing and tools away from any underhood electric fan. Don't reach through the grille to release the underhood lever.

If the coolant inside the coolant recovery tank is boiling, don't do anything else until it cools down.

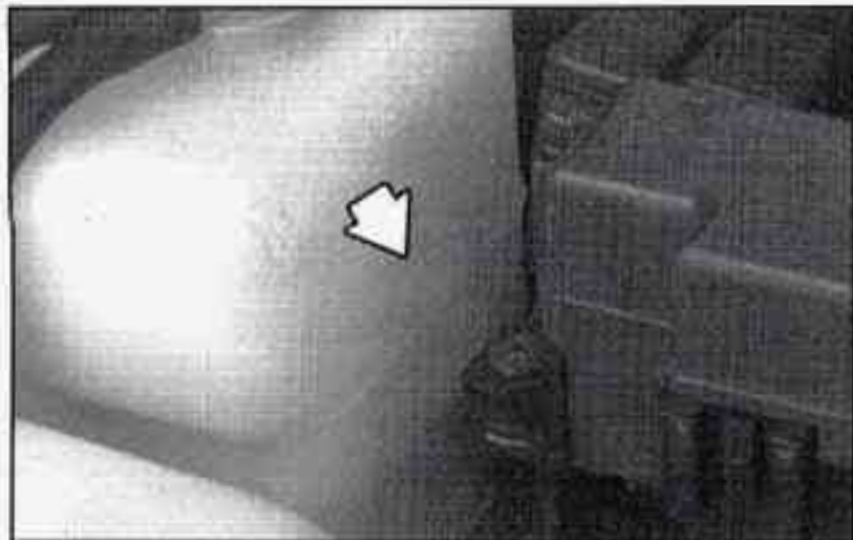

The coolant level should be at or above FULL. If it isn't, you may have a leak in the radiator hoses, heater hoses, radiator, water pump or somewhere else in the cooling system.

⚠ CAUTION:

Heater and radiator hoses, and other engine parts, can be very hot. Don't touch them. If you do, you can be burned.

Don't run the engine if there is a leak. If you run the engine, it could lose all coolant. That could cause an engine fire, and you could be burned. Get any leak fixed before you drive the vehicle.

NOTICE:

Engine damage from running your engine without coolant isn't covered by your warranty.

If there seems to be no leak, with the engine on, check to see if the electric engine fan is running. If the engine is overheating, the fan should be running. If it isn't, your vehicle needs service.

How to Add Coolant to the Coolant Recovery Tank

If you haven't found a problem yet, but the coolant level isn't at or above the FULL mark, add a 50/50 mixture of *clean water* (preferably distilled) and a proper antifreeze at the coolant recovery tank. (See "Engine Coolant" in the Index for more information about the proper coolant mix.)

CAUTION:

Adding only plain water to your cooling system can be dangerous. Plain water, or some other liquid like alcohol, can boil before the proper coolant mix will. Your vehicle's coolant warning system is set for the proper coolant mix. With plain water or the wrong mix, your engine could get too hot but you wouldn't get the overheat warning. Your engine could catch fire and you or others could be burned. Use a 50/50 mix of clean water and a proper antifreeze.

NOTICE:

In cold weather, water can freeze and crack the engine, radiator, heater core and other parts. Use the recommended coolant and the proper coolant mix.



⚠ CAUTION:

You can be burned if you spill coolant on hot engine parts. Coolant contains ethylene glycol and it will burn if the engine parts are hot enough. Don't spill coolant on a hot engine.

When the coolant in the coolant recovery tank is at or above the FULL mark start your vehicle.

If the overheat warning continues, there's one more thing you can try. You can add the proper coolant mix directly to the radiator, but be sure the cooling system is cool before you do it.

⚠ CAUTION:

Steam and scalding liquids from a hot cooling system can blow out and burn you badly. They are under pressure, and if you turn the radiator pressure cap -- even a little -- they can come out at high speed. Never turn the cap when the cooling system, including the radiator pressure cap, is hot. Wait for the cooling system and radiator pressure cap to cool if you ever have to turn the pressure cap.



How to Add Coolant to the Radiator



1. You can remove the radiator pressure cap when the cooling system, including the radiator pressure cap and upper radiator hose, is no longer hot. Turn the pressure cap slowly counterclockwise until it first stops. (Don't press down while turning the pressure cap.)

If you hear a hiss, wait for that to stop. A hiss means there is still some pressure left.



2. Then keep turning the pressure cap, but now push down as you turn it. Remove the pressure cap.



3. Fill the radiator with the proper mix, up to the base of the filler neck.



4. Then fill the coolant recovery tank to the FULL mark.
5. Put the cap back on the coolant recovery tank, but leave the radiator pressure cap off.

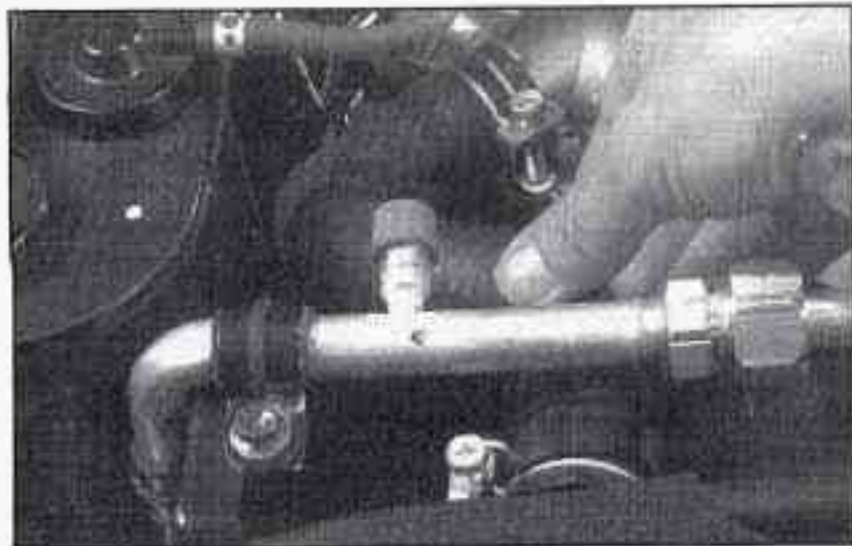

6. Start the engine and let it run until you can feel the upper radiator hose getting hot. Watch out for the engine fan.
7. By this time the coolant level inside the radiator filler neck may be lower. If the level is lower, add more of the proper mix through the filler neck until the level reaches the base of the filler neck.



8. Then replace the pressure cap. At any time during this procedure if coolant begins to flow out of the filler neck, reinstall the pressure cap. Be sure the arrows on the pressure cap line up like this.

If a Tire Goes Flat

It's unusual for a tire to "blow out" while you're driving, especially if you maintain your tires properly. If air goes out of a tire, it's much more likely to leak out slowly. But if you should ever have a "blowout," here are a few tips about what to expect and what to do:

If a front tire fails, the flat tire will create a drag that pulls the vehicle toward that side. Take your foot off the accelerator pedal and grip the steering wheel firmly. Steer to maintain lane position, and then gently brake to a stop well out of the traffic lane.

A rear blowout, particularly on a curve, acts much like a skid and may require the same correction you'd use in a skid. In any rear blowout, remove your foot from the accelerator pedal. Get the vehicle under control by steering the way you want the vehicle to go. It may be very bumpy and noisy, but you can still steer. Gently brake to a stop -- well off the road if possible.

If a tire goes flat, the next part shows how to use your jacking equipment to change a flat tire safely.

Changing a Flat Tire

If a tire goes flat, avoid further tire and wheel damage by driving slowly to a level place. Turn on your hazard warning flashers.



CAUTION:

Changing a tire can cause an injury. The vehicle can slip off the jack and roll over you or other people. You and they could be badly injured. Find a level place to change your tire. To help prevent the vehicle from moving:

- 1. Set the parking brake firmly.**
- 2. Put an automatic transmission shift lever in PARK (P) or shift a manual transmission to FIRST (1) or REVERSE (R).**
- 3. If you have a four-wheel-drive vehicle, be sure the transfer case is in a drive gear -- not in NEUTRAL (N).**
- 4. Turn off the engine.**

To be even more certain the vehicle won't move, you can put blocks at the front and rear of the tire farthest away from the one being changed. That would be the tire on the other side of the vehicle, at the opposite end.



The following steps will tell you how to use the jack and change a tire.

Removing the Spare Tire and Tools



The jack and wheel wrench are under the front passenger's seat.

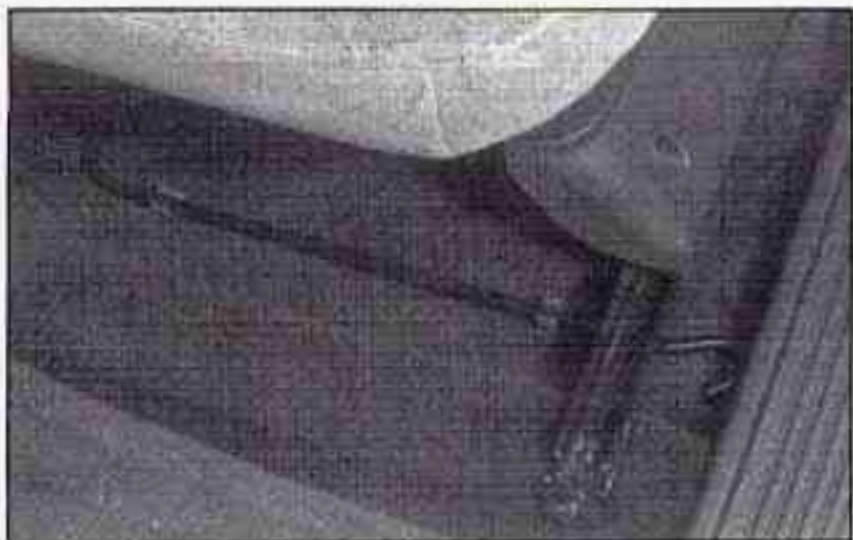

The jack handle is under the driver's seat.

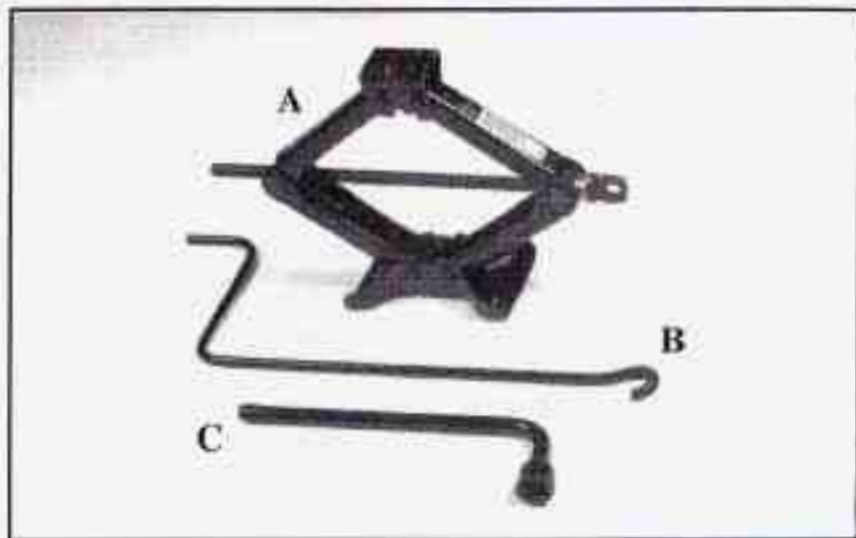

The tools you'll be using include the jack (A), jack handle (B) and wheel wrench (C).

Attach the jack handle to the jack. Turn the jack handle to the right to raise the lift head.



The spare tire is mounted on your tailgate. Pull the cover off of the spare tire.



Insert your key into the wheel lock on the spare tire and pull the wheel lock off.



Remove wheel nuts with the wheel wrench.

Remove the spare tire from the mounting bracket and place it near your flat tire.

Attach the jack handle to the jack bolt. Turn the jack handle clockwise. That will raise the lift head a little.

Removing the Flat Tire and Installing the Spare Tire



1. Using the wheel wrench, loosen all the wheel nuts. Don't remove them yet.

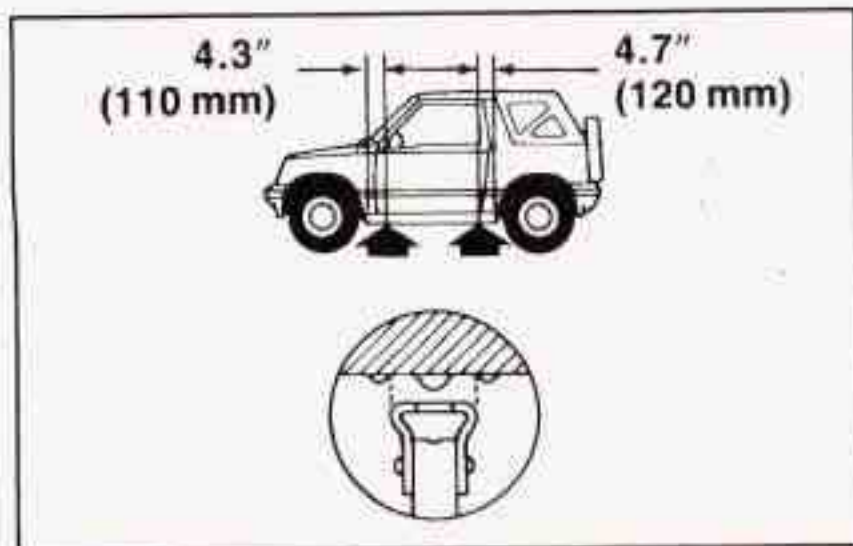

2. Position the jack and raise the jack lift head until it fits firmly onto the bosses nearest the flat tire.
(Under the vehicle near each wheel, there are bosses in the vehicle's rocker flange.)

⚠ CAUTION:

Getting under a vehicle when it is jacked up is dangerous. If the vehicle slips off the jack, you could be badly injured or killed. Never get under a vehicle when it is supported only by a jack.

NOTICE:

Raising your vehicle with the jack improperly positioned will damage the vehicle or may allow the vehicle to fall off the jack. Be sure to fit the jack lift head into the proper location before raising your vehicle.

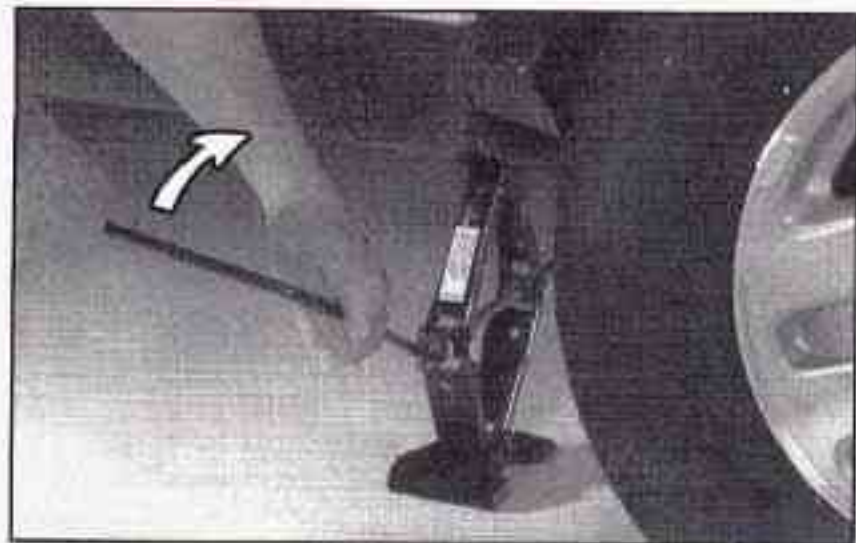

3. Raise the vehicle by turning the jack handle clockwise. Raise the vehicle far enough off the ground so there is enough room for the spare tire to fit.



4. Remove all the wheel nuts and take off the flat tire.

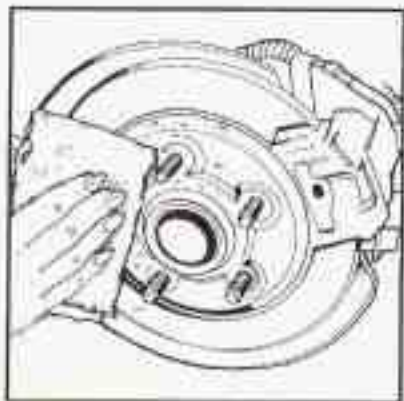

5. Remove any rust or dirt from the wheel bolts, mounting surfaces and spare wheel.

⚠ CAUTION:

Rust or dirt on the wheel, or on the parts to which it is fastened, can make the wheel nuts become loose after a time. The wheel could come off and cause an accident. When you change a wheel, remove any rust or dirt from the places where the wheel attaches to the vehicle. In an emergency, you can use a cloth or a paper towel to do this; but be sure to use a scraper or wire brush later, if you need to, to get all the rust or dirt off.

⚠ CAUTION:

Never use oil or grease on studs or nuts. If you do, the nuts might come loose. Your wheel could fall off, causing a serious accident.



6. Replace the wheel nuts with the rounded end of the nuts toward the wheel. Tighten each nut by hand until the wheel is held against the hub.

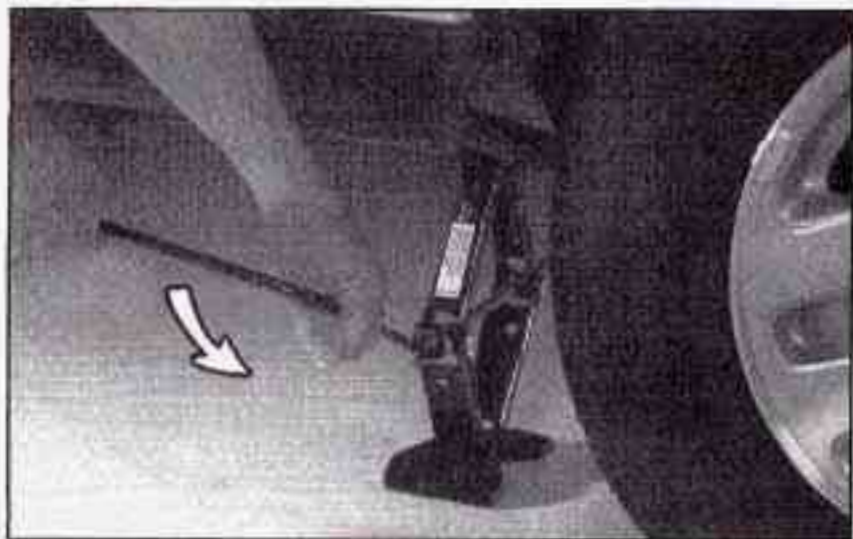

7. Lower the vehicle by turning the jack handle counterclockwise. Lower the jack completely.

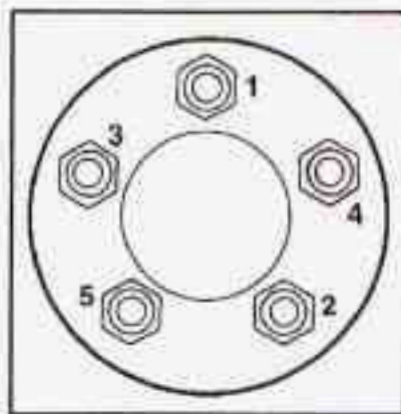

8. Tighten the wheel nuts firmly in a criss-cross sequence as shown.

⚠ CAUTION:

Incorrect wheel nuts or improperly tightened wheel nuts can cause the wheel to become loose and even come off. This could lead to an accident. Be sure to use the correct wheel nuts. If you have to replace them, be sure to get new GM original equipment wheel nuts.

Stop somewhere as soon as you can and have the nuts tightened with a torque wrench to 60 lb-ft (80 N·m).

NOTICE:

Improperly tightened wheel nuts can lead to brake pulsation and rotor damage. To avoid expensive brake repairs, evenly tighten the wheel nuts in the proper sequence and to the proper torque specification.

Storing a Flat or Spare Tire and Tools

⚠ CAUTION:

Storing a jack, a tire or other equipment in the passenger compartment of the vehicle could cause injury. In a sudden stop or collision, loose equipment could strike someone. Store all these in the proper place.



Store your vehicle's flat tire or spare by mounting it on the tailgate and cover.

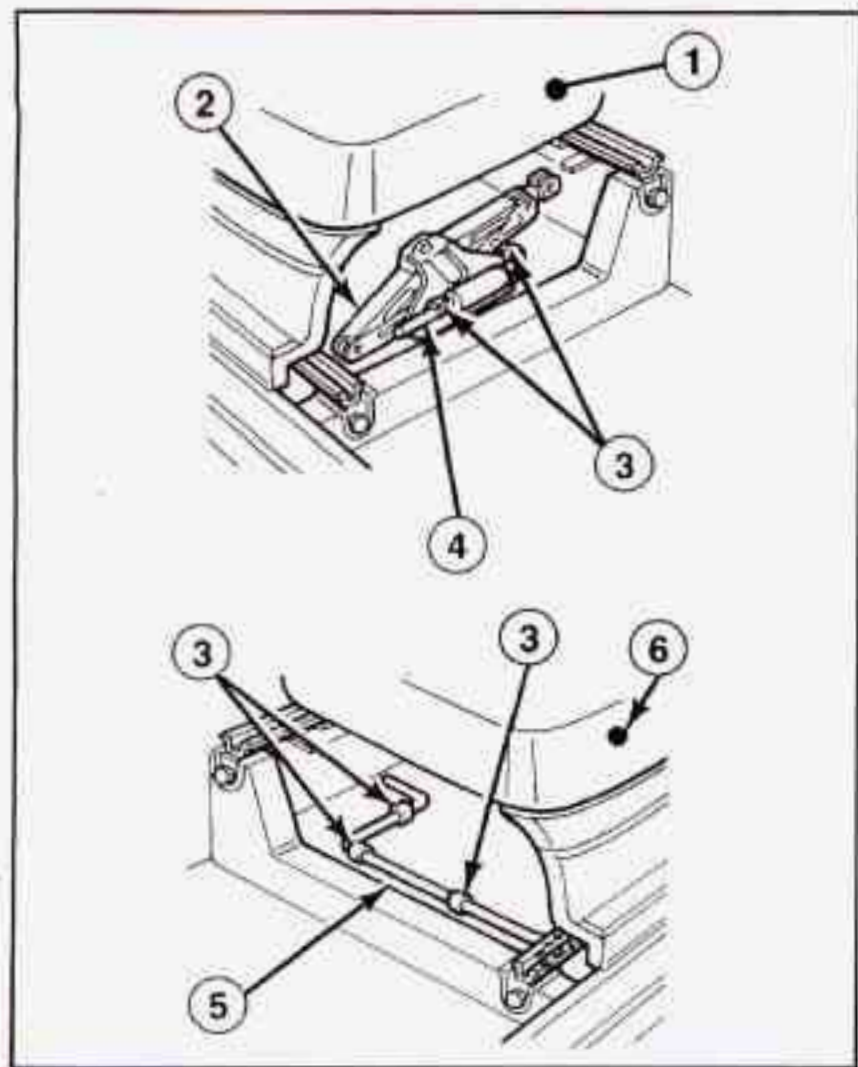

Replace the jack, jack handle and wheel wrench.

1. Front Passenger's Seat

2. Jack

3. Clamp

4. Wrench

5. Jack Handle

6. Driver's Seat

If You're Stuck: In Sand, Mud, Ice or Snow

What you don't want to do when your vehicle is stuck is to spin your wheels too fast. The method known as "rocking" can help you get out when you're stuck, but you must use caution.

CAUTION:

If you let your tires spin at high speed, they can explode, and you or others could be injured. And, the transmission or other parts of the vehicle can overheat. That could cause an engine compartment fire or other damage. When you're stuck, spin the wheels as little as possible. Don't spin the wheels above 35 mph (55 km/h) as shown on the speedometer.

NOTICE:

Spinning your wheels can destroy parts of your vehicle as well as the tires. If you spin the wheels too fast while shifting your transmission back and forth, you can destroy your transmission.

For information about using tire chains on your vehicle, see "Tire Chains" in the Index.

Rocking your vehicle to get it out:

First, turn your steering wheel left and right. That will clear the area around your front wheels. Then shift back and forth between REVERSE (R) and a forward gear (or with a manual transmission, between FIRST (1) or SECOND (2) and REVERSE(R)), spinning the wheels as little as possible. Release the accelerator pedal while you shift, and press lightly on the accelerator pedal when the transmission is in gear. If that doesn't get you out after a few tries, you may need to be towed out. Or, you can use your recovery hooks if your vehicle has them. If you do need to be towed out, see "Towing Your Vehicle" in the Index.

Using the Recovery Hooks

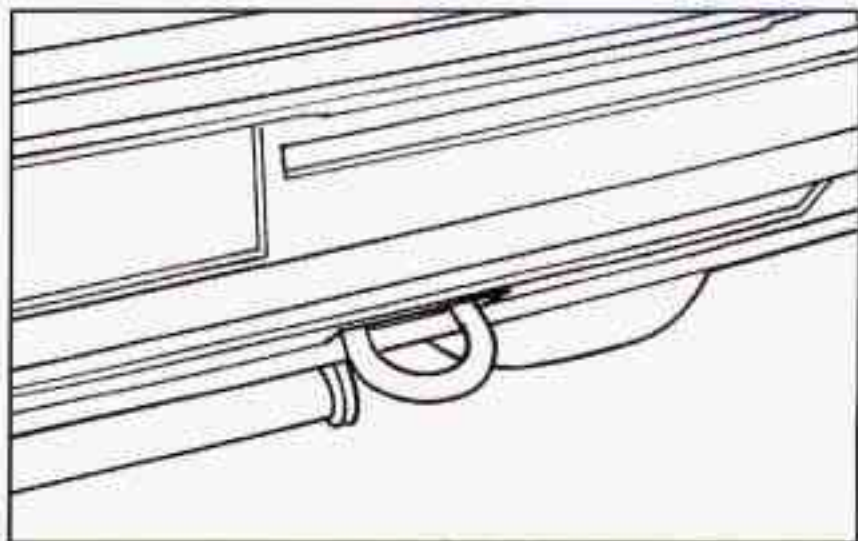

Your vehicle is equipped with recovery hooks. The recovery hooks are provided at the front and rear of your vehicle. You may need to use them if you're stuck off-road and need to be pulled to some place where you can continue driving.

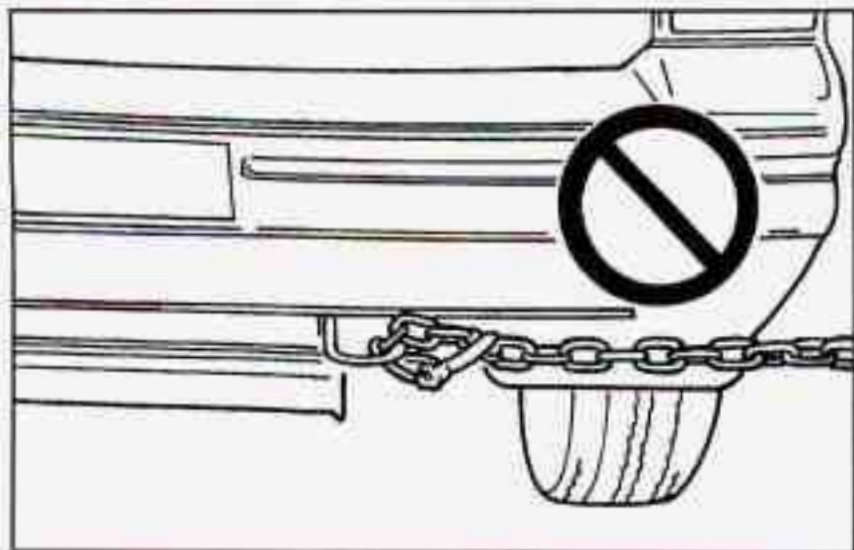

⚠ CAUTION:

The recovery hooks, when used, are under a lot of force. Always pull the vehicle straight out. Never pull on the hooks at a sideways angle. The hooks could break off and you or others could be injured from the chain or cable snapping back.

NOTICE:

Never use the recovery hooks to tow the vehicle. Your vehicle could be damaged and it would not be covered by warranty.

Geo Section 6 Service and Appearance Care

Here you will find information about the care of your Geo. This section begins with service and fuel information, and then it shows how to check important fluid and lubricant levels. There is also technical information about your vehicle, and a part devoted to its appearance care.

Service

Your Geo dealer knows your vehicle best and wants you to be happy with it. We hope you'll go to your dealer for all your service needs. You'll get genuine GM parts and GM-trained and supported service people.

We hope you'll want to keep your GM vehicle all GM. Genuine GM parts have one of these marks:



Doing Your Own Service Work

If you want to do some of your own service work, you'll want to get the proper Geo Service Manual. It tells you much more about how to service your Geo than this manual can. To order the proper service manual, see "Service and Owner Publications" in the Index.

Your vehicle has an air bag system. Before attempting to do your own service work, see "Servicing Your Air Bag-Equipped Geo" in the Index.

You should keep a record with all parts receipts and list the mileage and the date of any service work you perform. See "Maintenance Record" in the Index.

CAUTION:

You can be injured and your vehicle could be damaged if you try to do service work on a vehicle without knowing enough about it.

- **Be sure you have sufficient knowledge, experience, and the proper replacement parts and tools before you attempt any vehicle maintenance task.**
- **Be sure to use the proper nuts, bolts and other fasteners. “English” and “metric” fasteners can be easily confused. If you use the wrong fasteners, parts can later break or fall off. You could be hurt.**

Fuel

Use regular unleaded gasoline rated at 87 octane or higher. At a minimum, it should meet specifications ASTM D4814 in the United States and CGSB 3.5-M93 in Canada. Improved gasoline specifications have been developed by the American Automobile Manufacturers Association (AAMA) for better vehicle performance and engine protection. Gasolines meeting the AAMA specification could provide improved driveability and emission control system protection compared to other gasolines.

Be sure the posted octane is at least 87. If the octane is less than 87, you may get a heavy knocking noise when you drive. If it's bad enough, it can damage your engine.

If you're using fuel rated at 87 octane or higher and you still hear heavy knocking, your engine needs service. But don't worry if you hear a little pinging noise when you're accelerating or driving up a hill. That's normal, and you don't have to buy a higher octane fuel to get rid of pinging. It's the heavy, constant knock that means you have a problem.

If your vehicle is certified to meet California Emission Standards (indicated on the underhood tune-up label), it is designed to operate on fuels that meet California specifications. If such fuels are not available in states adopting California emissions standards, your vehicle will operate satisfactorily on fuels meeting federal specifications, but emission control system performance may be affected. The malfunction indicator lamp on your instrument panel may turn on and/or your vehicle may fail a smog-check test. If this occurs, return to your authorized Geo dealer for diagnosis to determine the cause of failure. In the event it is determined that the cause of the condition is the type of fuels used, repairs may not be covered by your warranty.

In Canada, some gasolines contain an octane-enhancing additive called MMT. If you use such fuels, your emission control system performance may deteriorate and the malfunction indicator lamp on your instrument panel may turn on. If this happens, return to your authorized Chevrolet/Geo dealer for service.

To provide cleaner air, all gasolines are now required to contain additives that will help prevent deposits from forming in your engine and fuel system, allowing your emission control system to function properly. Therefore, you should not have to add anything to the fuel. In addition, gasolines containing oxygenates, such as ethers and ethanol, and reformulated gasolines may be available in your area to help clean the air. General Motors recommends that you use these gasolines if they comply with the specifications described earlier.

NOTICE:

Your vehicle was not designed for fuel that contains methanol. Don't use it. It can corrode metal parts in your fuel system and also damage plastic and rubber parts. That damage wouldn't be covered under your warranty.

Fuels in Foreign Countries

If you plan on driving in another country outside the United States or Canada, the proper fuel may be hard to find. Never use leaded gasoline or any other fuel not recommended in the previous text on fuel. Costly repairs caused by use of improper fuel wouldn't be covered by your warranty.

To check on fuel availability, ask an auto club, or contact a major oil company that does business in the country where you'll be driving.

You can also write us at the following address for advice. Just tell us where you're going and give your Vehicle Identification Number (VIN).

General Motors Overseas Distribution Corporation,
North American Export Sales (NAES)
1908 Colonel Sam Drive
Oshawa, Ontario L1H 8P7

Filling Your Tank

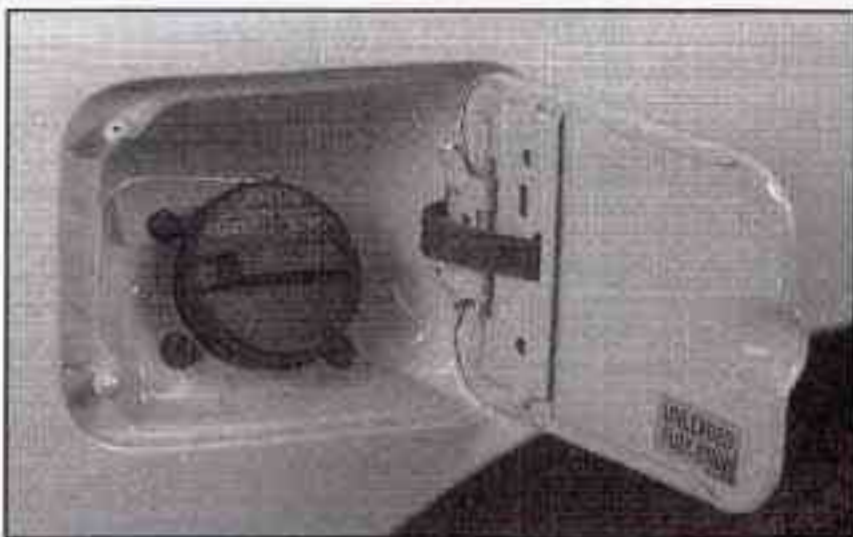

CAUTION:

Gasoline vapor is highly flammable. It burns violently, and that can cause very bad injuries. Don't smoke if you're near gasoline or refueling your vehicle. Keep sparks, flames and smoking materials away from gasoline.

The cap is behind a hinged door on the passenger's side of your vehicle. On four-door models, use the key to the vehicle to unlock the fuel door.

To take off the cap, turn it slowly to the left (counterclockwise).

 **CAUTION:**

If you get gasoline on yourself and then something ignites it, you could be badly burned. Gasoline can spray out on you if you open the fuel filler cap too quickly. This spray can happen if your tank is nearly full, and is more likely in hot weather. Open the fuel filler cap slowly and wait for any "hiss" noise to stop. Then unscrew the cap all the way.

Be careful not to spill gasoline. Clean gasoline from painted surfaces as soon as possible. See "Cleaning the Outside of Your Geo" in the Index.

When you put the cap back on, turn it to the right until you hear at least three clicks. Make sure you fully install the cap. The diagnostic system can determine if the fuel cap has been left off or improperly installed. This would allow fuel to evaporate into the atmosphere. See "Malfunction Indicator Lamp" in the Index.

NOTICE:

If you need a new cap, be sure to get the right type. Your dealer can get one for you. If you get the wrong type, it may not fit or have proper venting, and your fuel tank and emissions system might be damaged.

Checking Things Under the Hood

CAUTION:

An electric fan under the hood can start up and injure you even when the engine is not running. Keep hands, clothing and tools away from any underhood electric fan. Don't reach through the grille to release the underhood lever.

CAUTION:

Things that burn can get on hot engine parts and start a fire. These include liquids like gasoline, oil, coolant, brake fluid, windshield washer and other fluids, and plastic or rubber. You or others could be burned. Be careful not to drop or spill things that will burn onto a hot engine.



To open the hood, first pull the release handle inside the glove box.

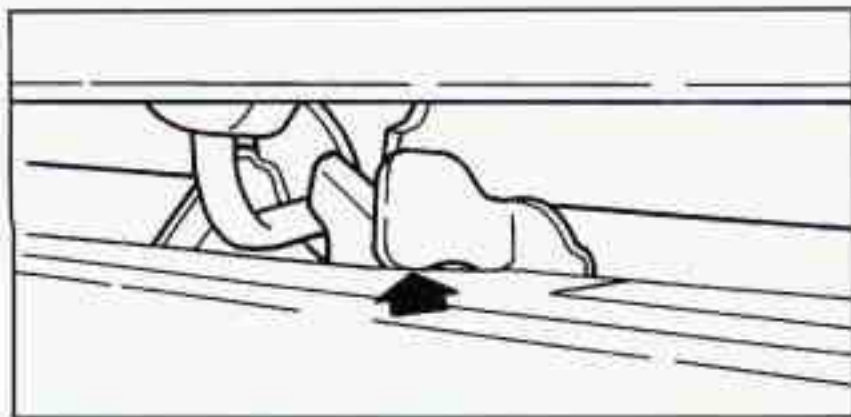

Then go to the front of the vehicle, pull up on the hood, and push the hood release lever to your left.

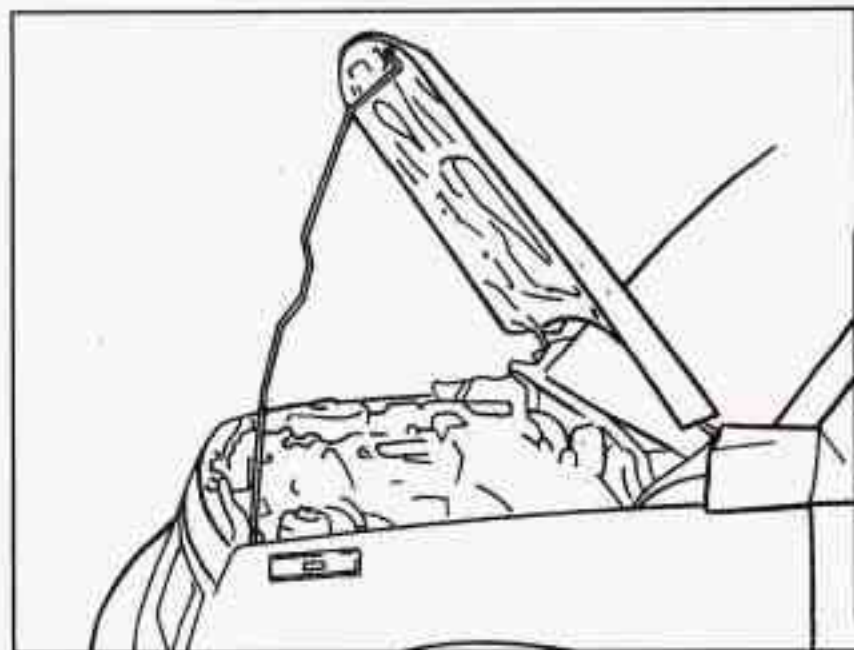

Lift the hood, release the hood prop from its retainer and put the hood prop into the slot in the hood.

When you open the hood, you'll see the following:

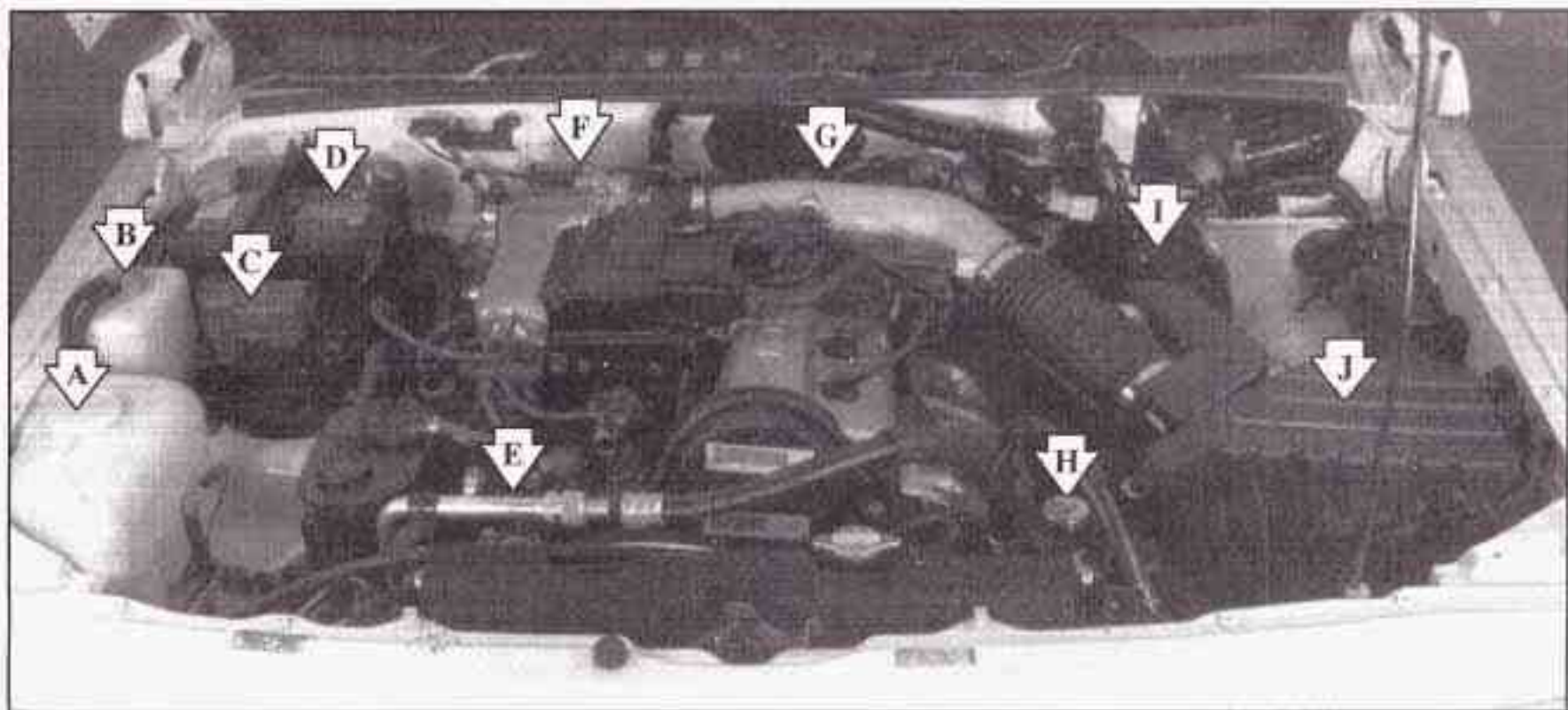

- A. Windshield Washer Reservoir
- B. Engine Coolant Reservoir
- C. Main Fuse Box
- D. Battery
- E. Engine Oil Dipstick

- F. Automatic Transmission Dipstick (if equipped)
- G. Oil Fill Cap
- H. Power Steering Fluid Reservoir
- I. Brake Fluid Reservoir
- J. Air Cleaner

Before closing the hood, be sure all the filler caps are on.

Then lift the hood to relieve pressure on the hood prop. Remove the hood prop from the slot in the hood and return the prop to its retainer. Then let the hood down and close it firmly.

Engine Oil



If the engine oil pressure light on the instrument panel comes on, it means you need to check your engine oil level right away.

For more information, see "Engine Oil Pressure Light" in the Index. You should check your engine oil level regularly; this is an added reminder.

It's a good idea to check your engine oil every time you get fuel. In order to get an accurate reading, the oil must be warm and the vehicle must be on level ground.

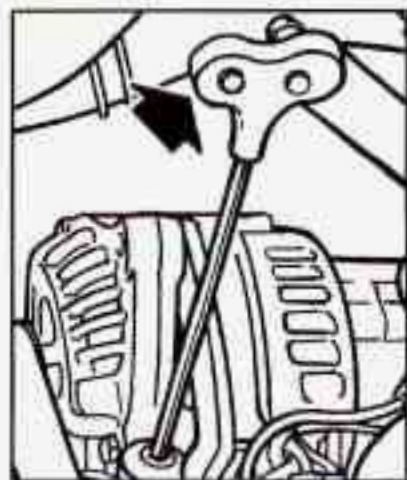

Turn off the engine and give the oil a few minutes to drain back into the oil pan. If you don't, the oil dipstick might not show the actual level.

Checking Engine Oil

Pull out the dipstick and clean it with a paper towel or cloth, then push it back in all the way. Remove it again, keeping the tip down, and check the level.

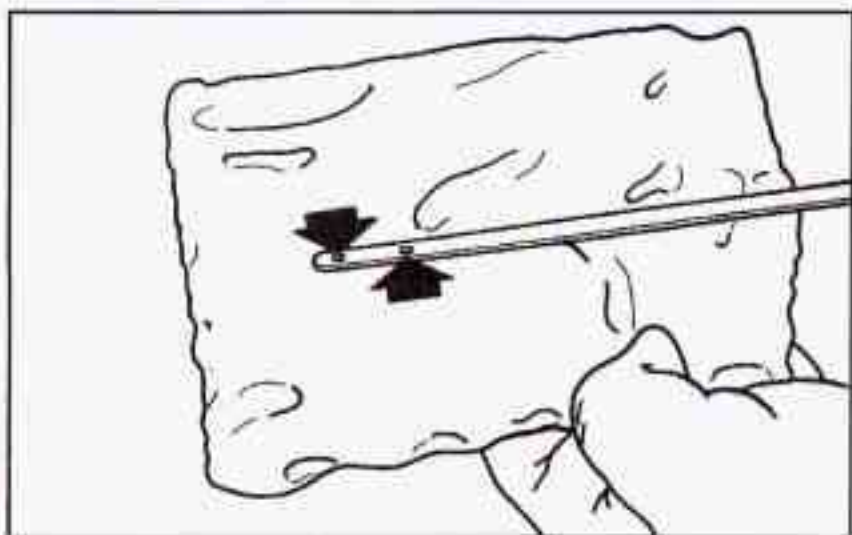

When to Add Oil

If the oil is at or below the ADD mark, then you'll need to add some oil. But you must use the right kind. This part explains what kind of oil to use. For crankcase capacity, see "Capacities and Specifications" in the Index.

NOTICE:

Don't add too much oil. If your engine has so much oil that the oil level gets above the upper mark that shows the proper operating range, your engine could be damaged.

Just fill it enough to put the level somewhere in the proper operating range. Push the dipstick all the way back in when you're through.

What Kind of Oil to Use

Oils recommended for your vehicle can be identified by looking for the "Starburst" symbol. This symbol indicates that the oil has been certified by the American Petroleum Institute (API). Do not use any oil which does not carry this Starburst symbol.



If you change your own oil, be sure you use oil that has the Starburst symbol on the front of the oil container. If you have your oil changed for you, be sure the oil put into your engine is American Petroleum Institute certified for gasoline engines.

You should also use the proper viscosity oil for your vehicle, as shown in the following chart:

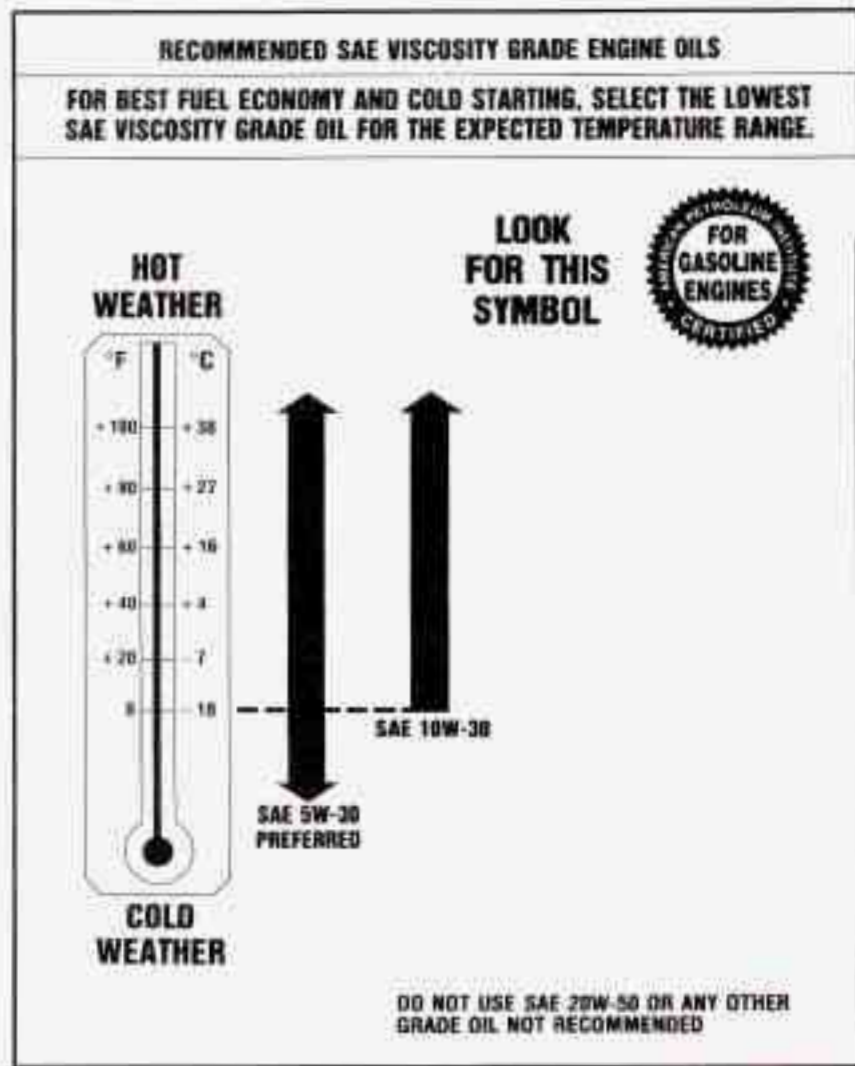

As shown in the chart, SAE 5W-30 is best for your vehicle. However, you can use SAE 10W-30 if it's going to be 0°F (-18°C) or above. These numbers on an oil container show its viscosity, or thickness. Do not use other viscosity oils, such as SAE 20W-50.

NOTICE:

Use only engine oil with the American Petroleum Institute Certified For Gasoline Engines "Starburst" symbol. Failure to use the recommended oil can result in engine damage not covered by your warranty.

GM Goodwrench[®] oil meets all the requirements for your vehicle.

Engine Oil Additives

Don't add anything to your oil. Your Geo dealer is ready to advise if you think something should be added.

When to Change Engine Oil

See if any one of these is true for you:

- Most trips are less than 5 to 10 miles (8 to 16 km). This is particularly important when outside temperatures are below freezing.
- Most trips include extensive idling (such as frequent driving in stop-and-go traffic).
- You operate your vehicle in dusty areas or off-road frequently.
- You frequently tow a trailer or use a carrier on top of your vehicle.
- The vehicle is used for delivery service, police, taxi or other commercial application.

Driving under these conditions causes engine oil to break down sooner. If any one of these is true for your vehicle, then you need to change your oil and filter every 3,000 miles (5 000 km) or 3 months -- whichever occurs first.

If none of them is true, change oil and filter every 7,500 miles (12 500 km) or 7.5 months -- whichever occurs first. Driving a vehicle with a fully warmed engine under highway conditions causes engine oil to break down slower.

What to Do with Used Oil

Did you know that used engine oil contains certain elements that may be unhealthy for your skin and could even cause cancer? Don't let used oil stay on your skin for very long. Clean your skin and nails with soap and water, or a good hand cleaner. Wash or properly throw away clothing or rags containing used engine oil. (See the manufacturer's warnings about the use and disposal of oil products.)

Used oil can be a real threat to the environment. If you change your own oil, be sure to drain all free-flowing oil from the filter before disposal. Don't ever dispose of oil by putting it in the trash, pouring it on the ground, into sewers, or into streams or bodies of water. Instead, recycle it by taking it to a place that collects used oil. If you have a problem properly disposing of your used oil, ask your dealer, a service station or a local recycling center for help.

Air Cleaner

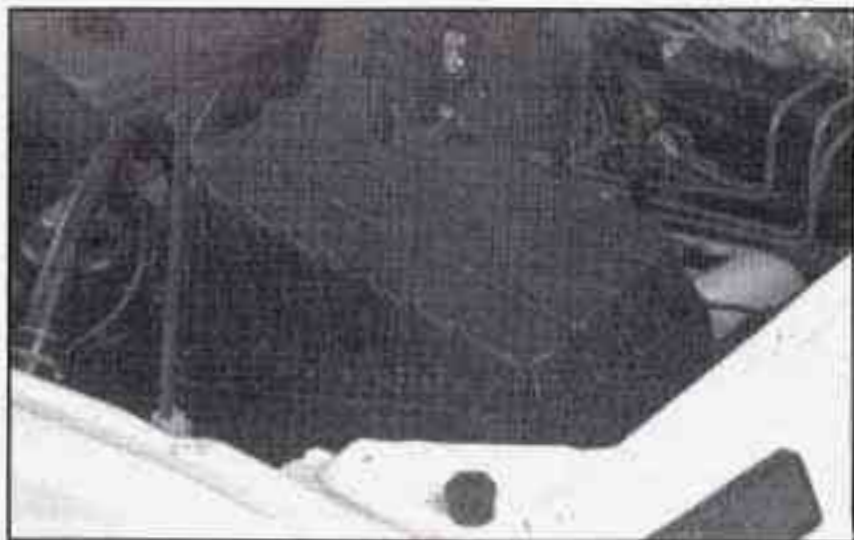

Refer to the Maintenance Schedule to determine when to replace the air filter and the crankcase ventilation filter.

See "Scheduled Maintenance Services" in the Index.

CAUTION:

Operating the engine with the air cleaner off can cause you or others to be burned. The air cleaner not only cleans the air, it stops flame if the engine backfires. If it isn't there, and the engine backfires, you could be burned. Don't drive with it off, and be careful working on the engine with the air cleaner off.

NOTICE:

If the air cleaner is off, a backfire can cause a damaging engine fire. And, dirt can easily get into your engine, which will damage it. Always have the air cleaner in place when you're driving.

Air Filter Replacement

To check or replace the filter:



1. Remove the screws on the cover.
2. Lift the cover up.

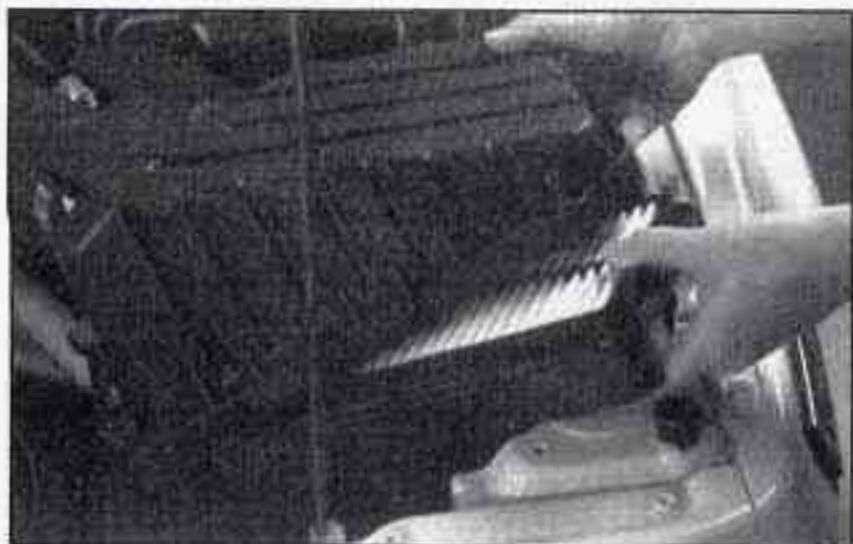

3. Pull out the filter.

Automatic Transmission Fluid

When to Check and Change

A good time to check your automatic transmission fluid level is when the engine oil is changed.

Change both the fluid and filter every 50,000 miles (83 000 km) if the vehicle is mainly driven under one or more of these conditions:

- In heavy city traffic where the outside temperature regularly reaches 90°F (32°C) or higher.
- In hilly or mountainous terrain.
- When doing frequent trailer towing.
- Uses such as found in taxi, police or delivery service.

If you do not use your vehicle under any of these conditions, the fluid and filter do not require changing.

See "Scheduled Maintenance Services" in the Index.

How to Check

Because this operation can be a little difficult, you may choose to have this done at your Geo dealership Service Department.

If you do it yourself, be sure to follow all the instructions here, or you could get a false reading on the dipstick.

NOTICE:

Too much or too little fluid can damage your transmission. Too much can mean that some of the fluid could come out and fall on hot engine parts or exhaust system parts, starting a fire. Be sure to get an accurate reading if you check your transmission fluid.

Wait at least 30 minutes before checking the transmission fluid level if you have been driving:

- When outside temperatures are above 90°F (32°C).
- At high speed for quite a while.
- In heavy traffic -- especially in hot weather.
- While pulling a trailer.

To get the right reading, the fluid should be at normal operating temperature, which is 180°F to 200°F (82°C to 93°C).

Checking Transmission Fluid Hot

Get the vehicle warmed up by driving about 15 miles (24 km) when outside temperatures are above 50°F (10°C). If it's colder than 50°F (10°C), drive the vehicle in DRIVE (D) until the engine temperature gage moves and then remains steady for 10 minutes. Then follow the hot check procedures.

Checking Transmission Fluid Cold

A cold check is made after the vehicle has been sitting for eight hours or more with the engine off and is used only as a reference. Let the engine run at idle for five minutes if outside temperatures are 50°F (10°C) or more. If it's colder than 50°F (10°C), you may have to idle the engine longer. Should the fluid level be low during a cold check, you *must* perform a hot check before adding fluid. This will give you a more accurate reading of the fluid level.

Checking the Fluid Hot or Cold

- Park your vehicle on a level place. Keep the engine running.
- With the parking brake applied, place the shift lever in PARK (P).
- With your foot on the brake pedal, move the shift lever through each gear range, pausing for about three seconds in each range. Then, position the shift lever in PARK (P).
- Let the engine run at idle for three minutes or more.

Then, without shutting off the engine, follow these steps:

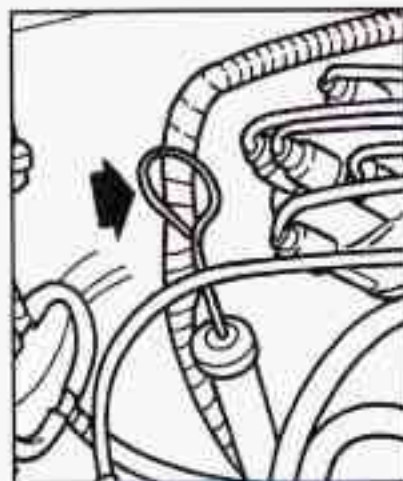

1. Pull out the dipstick and wipe it with a clean rag or paper towel.
2. Push it back in all the way, wait three seconds and then pull it back out again.

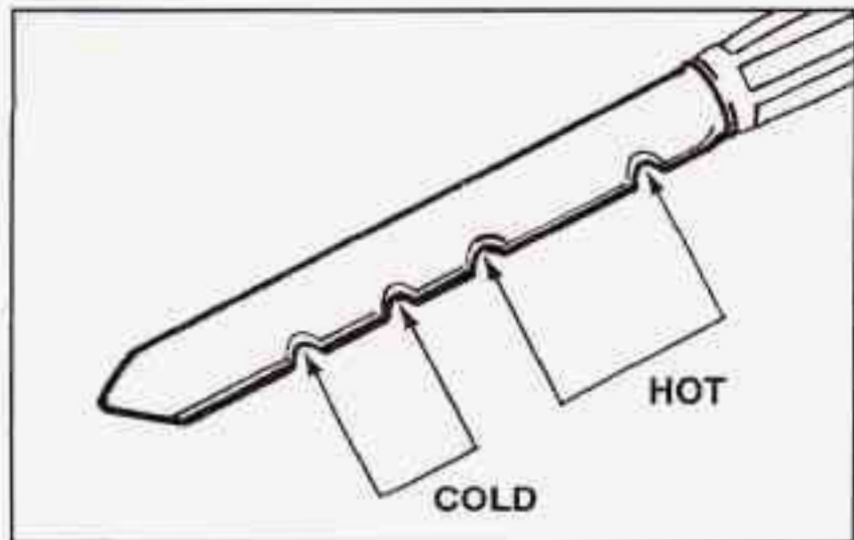

3. Check both sides of the dipstick, and read the lower level. The fluid level must be in the COLD area for a cold check or in the HOT area or cross-hatched area for a hot check.
4. If the fluid level is in the acceptable range, push the dipstick back in all the way.

How to Add Fluid

Refer to the Maintenance Schedule to determine what kind of transmission fluid to use. See "Recommended Fluids and Lubricants" in the Index.

Add fluid only after checking the transmission fluid HOT. (A COLD check is used only as a reference.) If the fluid level is low, add only enough of the proper fluid to bring the level up to the HOT area for a hot check. It doesn't take much fluid, generally less than a pint (0.5 L). *Don't overfill.* We recommend you use only fluid labeled DEXRON[®]-III, because fluid with that label is made especially for your automatic transmission. Damage caused by fluid other than DEXRON-III is not covered by your new vehicle warranty.

- After adding fluid, recheck the fluid level as described under "How to Check."
- When the correct fluid level is obtained, push the dipstick back in all the way.

Manual Transmission Fluid

When to Check and Change

A good time to have it checked is when the engine oil is changed. Refer to the Maintenance Schedule to determine when to change your transmission fluid. See "Scheduled Maintenance Services" in the Index.

How to Check

Because this operation can be a little difficult, you may choose to have this done at your Geo dealership Service Department.

If you do it yourself, be sure to follow all the instructions here, or you could get a false reading.

NOTICE:

Too much or too little fluid can damage your transmission. Too much can mean that some of the fluid could come out and fall on hot engine parts or exhaust system parts, starting a fire. Be sure to get an accurate reading if you check your transmission fluid.

Check the fluid level only when your engine is off, the vehicle is parked on a level place and the transmission is cool enough for you to rest your fingers on the transmission case.

Then, follow these steps:



1. Remove the filler plug.
2. Check that the lubricant level is up to the bottom of the filler plug hole.
3. If the fluid level is good, install the plug and be sure it is fully seated. If the fluid level is low, add more fluid as described in the next steps.

How to Add Fluid

Here's how to add fluid. Refer to the Maintenance Schedule to determine what kind of fluid to use. See "Recommended Fluids and Lubricants" in the Index.

1. Remove the filler plug.
2. Add fluid at the filler plug hole. Add only enough fluid to bring the fluid level up to the bottom of the filler plug hole.
3. Install the filler plug. Be sure the plug is fully seated.

Clutch Adjustment

The clutch linkage in your vehicle should be checked as recommended in your Maintenance Schedule. To check, push the clutch pedal down with your hand until you feel some resistance to movement of the pedal. If the pedal moves freely up to 1 inch (25 mm) or so before you feel resistance to the travel, adjustment isn't needed.

If there is no free travel or very little (less than 5/8 of an inch (16 mm)), see your dealer for adjustment.

Rear Axle

When to Check and Change Lubricant

Refer to the Maintenance Schedule to determine how often to check the lubricant and when to change it. See "Periodic Maintenance Inspections" and "Scheduled Maintenance Services" in the Index.

How to Check Lubricant



If the level is below the bottom of the filler plug hole, you'll need to add some lubricant. Add enough lubricant to raise the level to the bottom of the filler plug hole.

What to Use

Refer to the Maintenance Schedule to determine what kind of lubricant to use. See "Recommended Fluids and Lubricants" in the Index.

Four-Wheel Drive

Most lubricant checks in this section also apply to four-wheel-drive vehicles. However, they have two additional systems that need lubrication.

Transfer Case

When to Check and Change Lubricant

Refer to the Maintenance Schedule to determine how often to check the lubricant and when to change it. See "Scheduled Maintenance Services" in the Index.

How to Check Lubricant



If the level is below the bottom of the filler plug hole, you'll need to add some lubricant. Add enough lubricant to raise the level to the bottom of the filler plug hole.

What to Use

Refer to the Maintenance Schedule to determine what kind of lubricant to use. See "Recommended Fluids and Lubricants" in the Index.

Front Axle

When to Check and Change Lubricant

Refer to the Maintenance Schedule to determine how often to check the lubricant and when to change it. See "Periodic Maintenance Inspections" and "Scheduled Maintenance Services" in the Index.

How to Check Lubricant

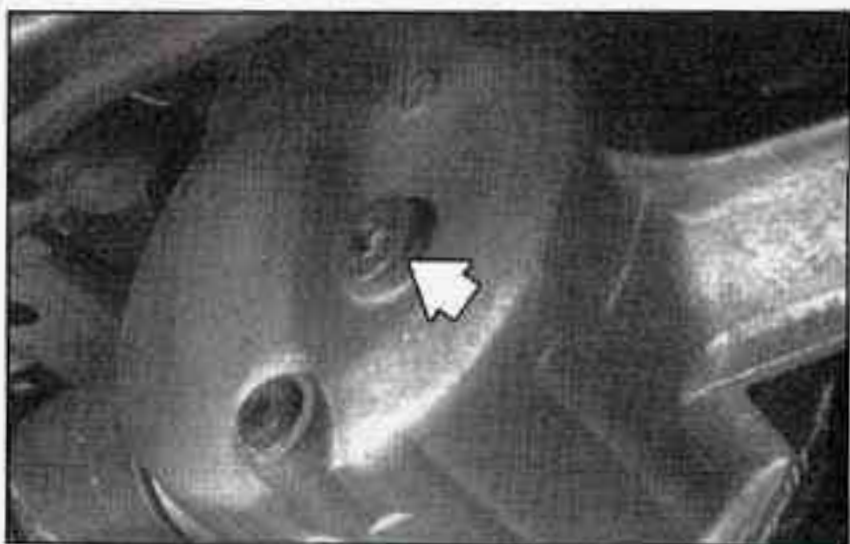

If the level is below the bottom of the filler plug hole, you'll need to add some lubricant.

If the differential is at operating temperature (warm), add enough lubricant to raise the level to the bottom of the filler plug hole.

If the differential is cold, add enough lubricant to raise the level to 1/2 inch (12 mm) below the filler plug hole.

What to Use

Refer to the Maintenance Schedule to determine what *kind of lubricant* to use. See "Recommended Fluids and Lubricants" in the Index.

Engine Coolant

The following explains your cooling system and how to add coolant when it is low. If you have a problem with engine overheating, see "Engine Overheating" in the Index.

A 50/50 mixture of water and the proper coolant for your Geo will:

- Give freezing protection down to -33°F (-36°C).
- Give boiling protection up to 258°F (125°C).
- Protect against rust and corrosion.
- Help keep the proper engine temperature.
- Let the warning lights and gages work as they should.

What to Use

Use a mixture of one-half *clean water* (preferably distilled) and one-half antifreeze that meets GM Specification 1825-M, which won't damage aluminum parts. You can also use a recycled coolant conforming to GM Specification 1825-M with a complete coolant flush and refill. If you use this mixture, you don't need to add anything else.



CAUTION:

Adding only plain water to your cooling system can be dangerous. Plain water, or some other liquid like alcohol, can boil before the proper coolant mix will. Your vehicle's coolant warning system is set for the proper coolant mix. With plain water or the wrong mix, your engine could get too hot but you wouldn't get the overheat warning. Your engine could catch fire and you or others could be burned. Use a 50/50 mix of clean water and the proper antifreeze.

NOTICE:

If you use an improper coolant mix, your engine could overheat and be badly damaged. The repair cost wouldn't be covered by your warranty. Too much water in the mix can freeze and crack the engine, radiator, heater core and other parts.

If you have to add coolant more than four times a year, have your dealer check your cooling system.

NOTICE:

If you use the proper coolant, you don't have to add extra inhibitors or additives which claim to improve the system. These can be harmful.

Checking Coolant



When your engine is cold, the coolant level should be at **LOW**, or a little higher. When your engine is warm, the level should be up to **FULL**, or a little higher.

Adding Coolant

If you need more coolant, add the proper mix *at the coolant recovery tank*.

 **CAUTION:**

Turning the radiator pressure cap when the engine and radiator are hot can allow steam and scalding liquids to blow out and burn you badly. With the coolant recovery tank, you will almost never have to add coolant at the radiator. Never turn the radiator pressure cap -- even a little -- when the engine and radiator are hot.

Add coolant mix at the recovery tank, but be careful not to spill it.

 **CAUTION:**

You can be burned if you spill coolant on hot engine parts. Coolant contains ethylene glycol, and it will burn if the engine parts are hot enough. Don't spill coolant on a hot engine.

Radiator Pressure Cap

NOTICE:

Your radiator cap is a 13 psi (90 kPa) pressure-type cap and must be tightly installed to prevent coolant loss and possible engine damage from overheating. Be sure the arrows on the cap line up with the overflow tube on the radiator filler neck.

When you replace your radiator pressure cap, an AC[®] cap is recommended.

Thermostat

Engine coolant temperature is controlled by a thermostat in the engine coolant system. The thermostat stops the flow of coolant through the radiator until the coolant reaches a preset temperature.

When you replace your thermostat, an AC[®] thermostat is recommended.

Power Steering Fluid



When to Check Power Steering Fluid

It is not necessary to regularly check power steering fluid unless you suspect there is a leak in the system or you hear an unusual noise. A fluid loss in this system could indicate a problem. Have the system inspected and repaired.

How To Check Power Steering Fluid

When the engine compartment is cool, unscrew the cap and wipe the dipstick with a clean rag. Replace the cap and completely tighten it. Then remove the cap again and look at the fluid level on the dipstick.

- When the engine compartment is hot, the level should be at the MAX mark.
- When the engine compartment is cool, the level should be at the MIN mark.



What to Use

Refer to the Maintenance Schedule to determine what kind of fluid to use. See "Recommended Fluids and Lubricants" in the Index. Always use the proper fluid. Failure to use the proper fluid can cause leaks and damage hoses and seals.

Windshield Washer Fluid

What to Use

When you need windshield washer fluid, be sure to read the manufacturer's instructions before use. If you will be operating your vehicle in an area where the temperature may fall below freezing, use a fluid that has sufficient protection against freezing.

Adding Washer Fluid



Open the cap with the washer symbol on it. Add washer fluid until the tank is full.

NOTICE:

- When using concentrated washer fluid, follow the manufacturer's instructions for adding water.
- Don't mix water with ready-to-use washer fluid. Water can cause the solution to freeze and damage your washer fluid tank and other parts of the washer system. Also, water doesn't clean as well as washer fluid.
- Fill your washer fluid tank only three-quarters full when it's very cold. This allows for expansion, which could damage the tank if it is completely full.
- Don't use radiator antifreeze in your windshield washer. It can damage your washer system and paint.

Brakes

Brake Fluid



Your brake master cylinder reservoir is here. It is filled with DOT-3 brake fluid.

There are only two reasons why the brake fluid level in the reservoir might go down. The first is that the brake fluid goes down to an acceptable level during normal brake lining wear. When new linings are put in, the fluid level goes back up. The other reason is that fluid is leaking out of the brake system. If it is, you should have your brake

system fixed, since a leak means that sooner or later your brakes won't work well, or won't work at all.

So, it isn't a good idea to "top off" your brake fluid. Adding brake fluid won't correct a leak. If you add fluid when your linings are worn, then you'll have too much fluid when you get new brake linings. You should add (or remove) brake fluid, as necessary, only when work is done on the brake hydraulic system.

CAUTION:

If you have too much brake fluid, it can spill on the engine. The fluid will burn if the engine is hot enough. You or others could be burned, and your vehicle could be damaged. Add brake fluid only when work is done on the brake hydraulic system.

Refer to the Maintenance Schedule to determine when to check your brake fluid. See "Periodic Maintenance Inspections" in the Index.

Checking Brake Fluid

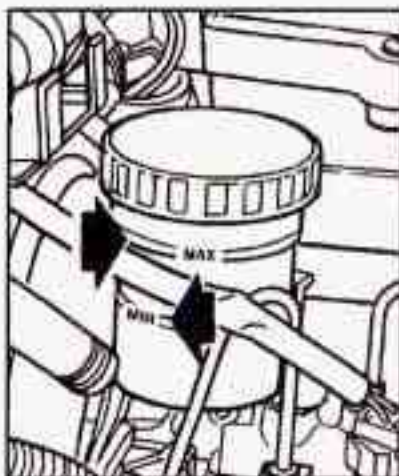

You can check the brake fluid without taking off the cap.

Just look at the windows on the brake fluid reservoir. The fluid levels should be above MIN. If they aren't, have your brake system checked to see if there is a leak.

After work is done on the brake hydraulic system, make sure the levels are above MIN and below the top of each window.

What to Add

When you do need brake fluid, use only DOT-3 brake fluid -- such as Delco Supreme 11[®] (GM Part No. 1052535). Use new brake fluid from a sealed container only, and always clean the brake fluid reservoir cap before removing it.

CAUTION:

With the wrong kind of fluid in your brake system, your brakes may not work well, or they may not even work at all. This could cause a crash. Always use the proper brake fluid.

NOTICE:

- Using the wrong fluid can badly damage brake system parts. For example, just a few drops of mineral-based oil, such as engine oil, in your brake system can damage brake system parts so badly that they'll have to be replaced. Don't let someone put in the wrong kind of fluid.
- If you spill brake fluid on your vehicle's painted surfaces, the paint finish can be damaged. Be careful not to spill brake fluid on your vehicle. If you do, wash it off immediately. See "Appearance Care" in the Index.

Brake Wear

Your Geo has front disc brakes and rear drum brakes.

Disc brake pads have built-in wear indicators that make a high-pitched warning sound when the brake pads are worn and new pads are needed. The sound may come and go or be heard all the time your vehicle is moving (except when you are pushing on the brake pedal firmly).

CAUTION:

The brake wear warning sound means that sooner or later your brakes won't work well. That could lead to an accident. When you hear the brake wear warning sound, have your vehicle serviced.

NOTICE:

Continuing to drive with worn-out brake pads could result in costly brake repair.

Some driving conditions or climates may cause a brake squeal when the brakes are first applied or lightly applied. This does not mean something is wrong with your brakes.

Free movement of brake calipers and properly torqued wheel nuts are necessary to help prevent brake pulsation. When tires are rotated, inspect brake calipers for movement, brake pads for wear, and evenly torque wheel nuts in the proper sequence to GM specifications.

Your rear drum brakes don't have wear indicators, but if you ever hear a rear brake rubbing noise, have the rear brake linings inspected. Also, the rear brake drums should be removed and inspected each time the tires are removed for rotation or changing. When you have the front brakes replaced, have the rear brakes inspected, too.

Brake linings should always be replaced as complete axle sets.

Brake Pedal Travel

See your dealer if the brake pedal does not return to normal height, or if there is a rapid increase in pedal travel. This could be a sign of brake trouble.

Brake Adjustment

Every time you make a brake stop, your disc brakes adjust for wear.

Replacing Brake System Parts

The braking system on a modern vehicle is complex. Its many parts have to be of top quality and work well together if the vehicle is to have really good braking. Vehicles we design and test have top-quality GM brake parts in them, as your Geo does when it is new. When you replace parts of your braking system -- for example, when your brake linings wear down and you have to have new ones put in -- be sure you get new genuine GM replacement parts. If you don't, your brakes may no longer work properly. For example, if someone puts in brake linings that are wrong for your vehicle, the balance between your front and rear brakes can change -- for the worse. The braking performance you've come to expect can change in many other ways if someone puts in the wrong replacement brake parts.

Battery

Every new Geo has a Delco Freedom[®] battery. You never have to add water to one of these. When it's time for a new battery, we recommend a Delco Freedom battery. Get one that has the replacement number shown on the original battery's label.

Vehicle Storage

If you're not going to drive your vehicle for 25 days or more, take off the black, negative (-) cable from the battery. This will help keep your battery from running down.

CAUTION:

Batteries have acid that can burn you and gas that can explode. You can be badly hurt if you aren't careful. See "Jump Starting" in the Index for tips on working around a battery without getting hurt.

Contact your dealer to learn how to prepare your vehicle for longer storage periods.

Also, for your audio system, see "Theft-Deterrent Feature" in the Index.

Bulb Replacement

See "Replacement Bulbs" in the Index to check the size and type of bulb you need to use.

Halogen Bulbs

CAUTION:

Halogen bulbs have pressurized gas inside and can burst if you drop or scratch the bulb. You or others could be injured. Be sure to read and follow the instructions on the bulb package.

Headlamps

To replace the headlamp bulb:

1. Open the hood.
2. Push in on both sides of the electrical connector. Then pull up and rearward, to disconnect it from the bulb. The plastic clip on the electrical connector may need to be lifted gently with a screwdriver.

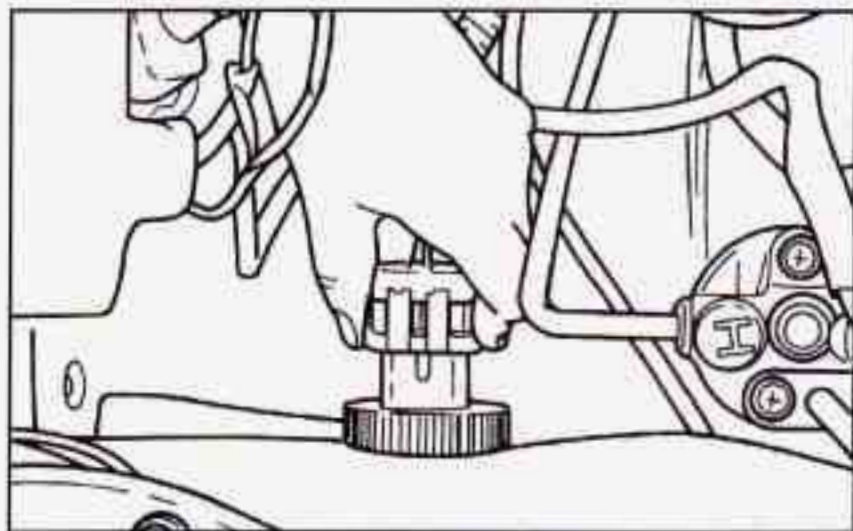

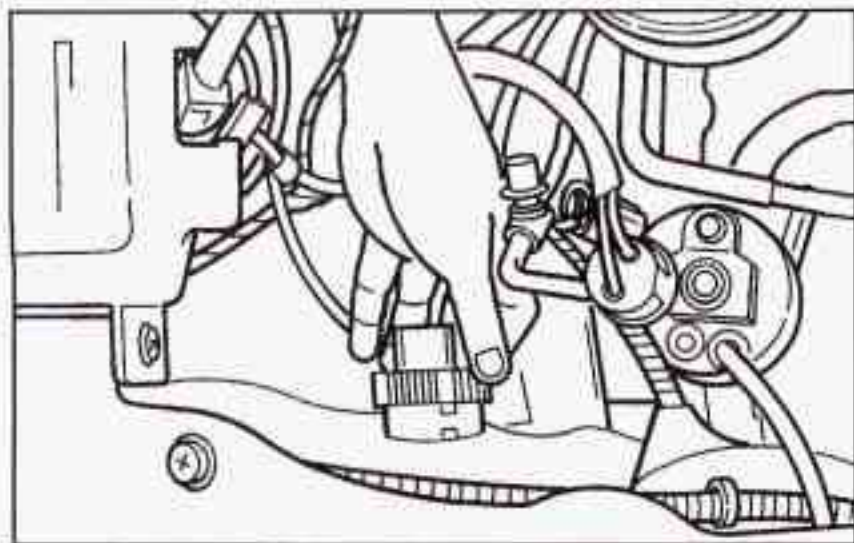

3. Turn the lock ring counterclockwise to release the bulb.

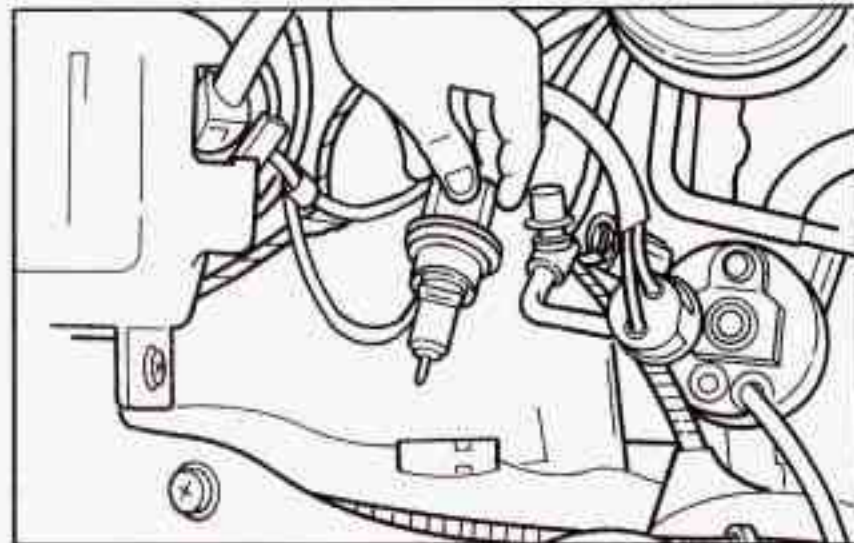

4. Pull the lock ring and the headlamp straight out. Save the lock ring and use with the new bulb.
5. Reverse the steps with a new bulb.

Front Parking and Turn Signal Lamps

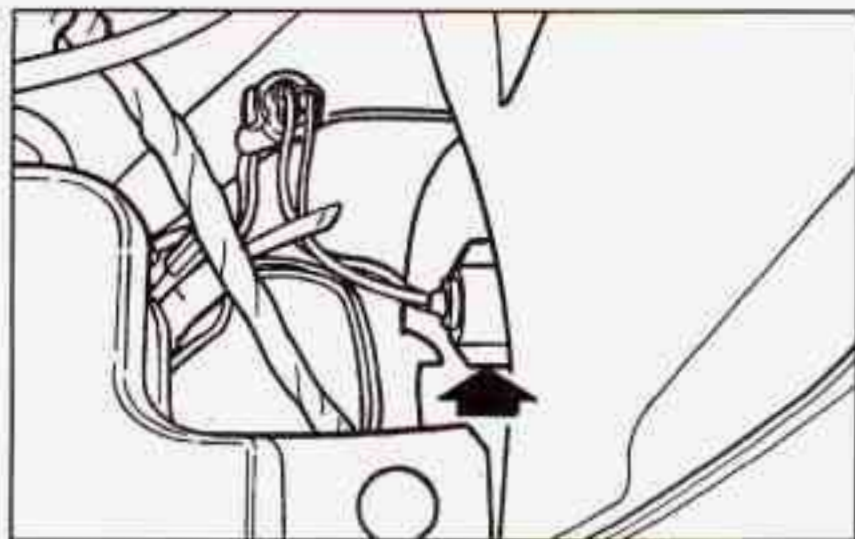

To replace the parking and turn signal bulb:

1. Open the hood.
2. Turn the bulb socket counterclockwise and pull it out of the lamp housing.

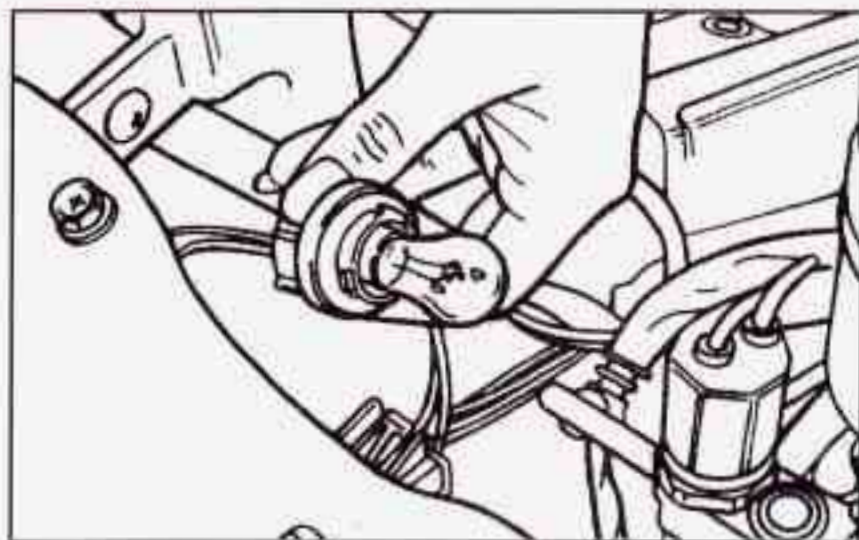

3. Push the bulb in, turn it to counterclockwise and pull it out.
4. Reverse the steps with a new bulb.

Sidemarker Lamps

To replace the sidemarker bulb:

1. Push the sidemarker housing toward the back of the vehicle to release the clip and pull out the front edge. The housing should pull away from the vehicle.

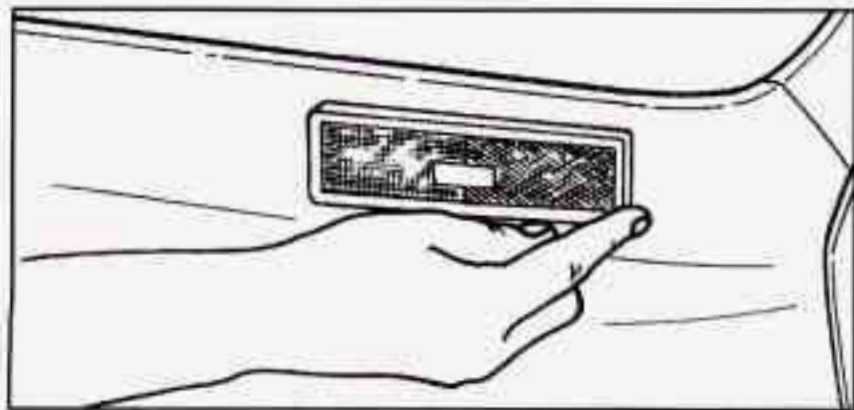

2. Turn the socket counterclockwise and pull it out of the housing.

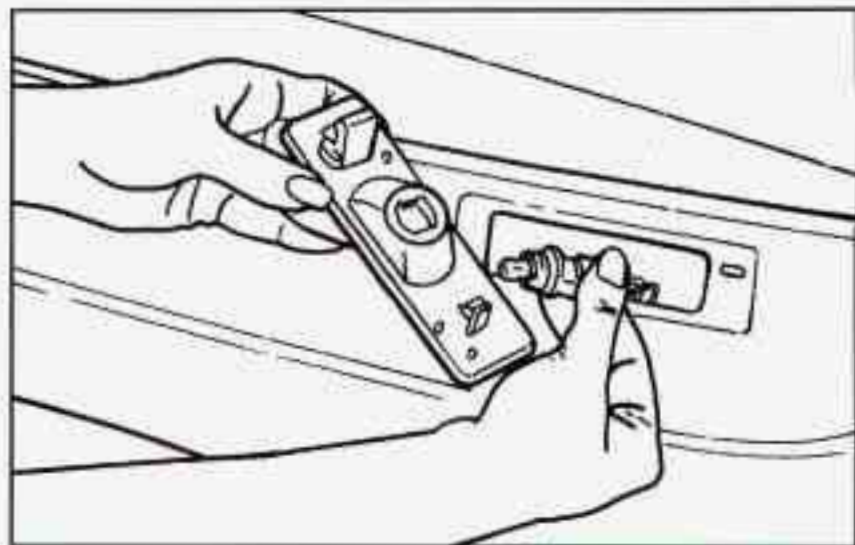

3. Pull the bulb out of the socket.
4. Reverse the steps with a new bulb.

Rear Sidemarker Lamps

To replace the rear sidemarker bulb:

1. Remove the screw (hardtop only).
2. Pull the sidemarker lamp housing out at the back edge.
3. Turn the socket toward the rear of the vehicle and pull it out.
4. Pull the bulb out of the socket.
5. Reverse the steps with a new bulb.

Rear Combination Lamps

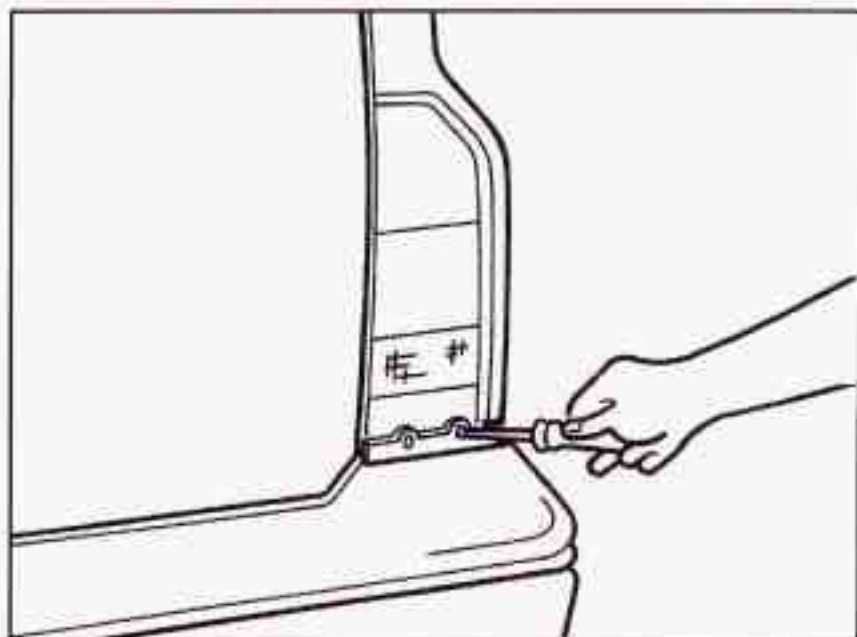

To remove the rear combination bulbs:

1. Remove the two screws from the combination lamps.

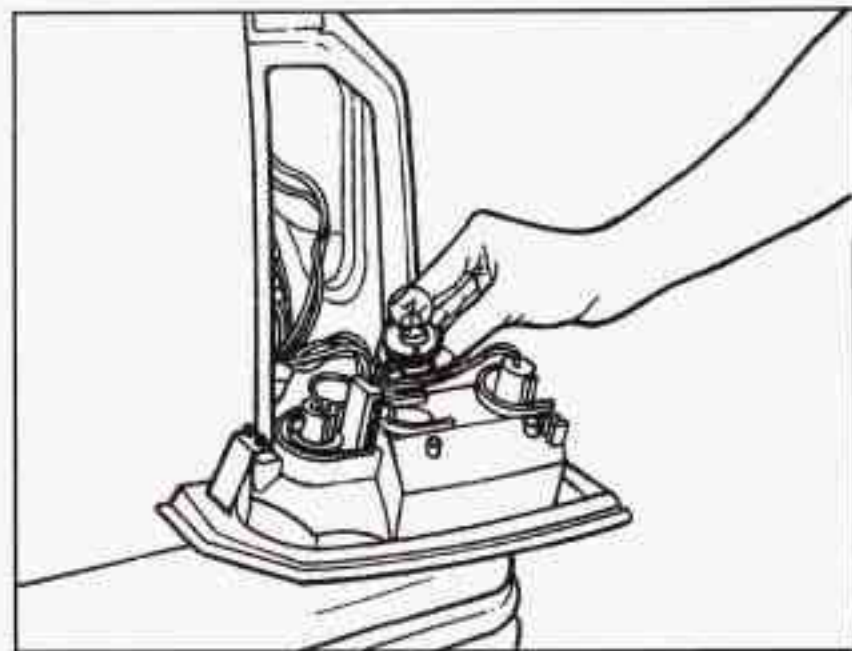
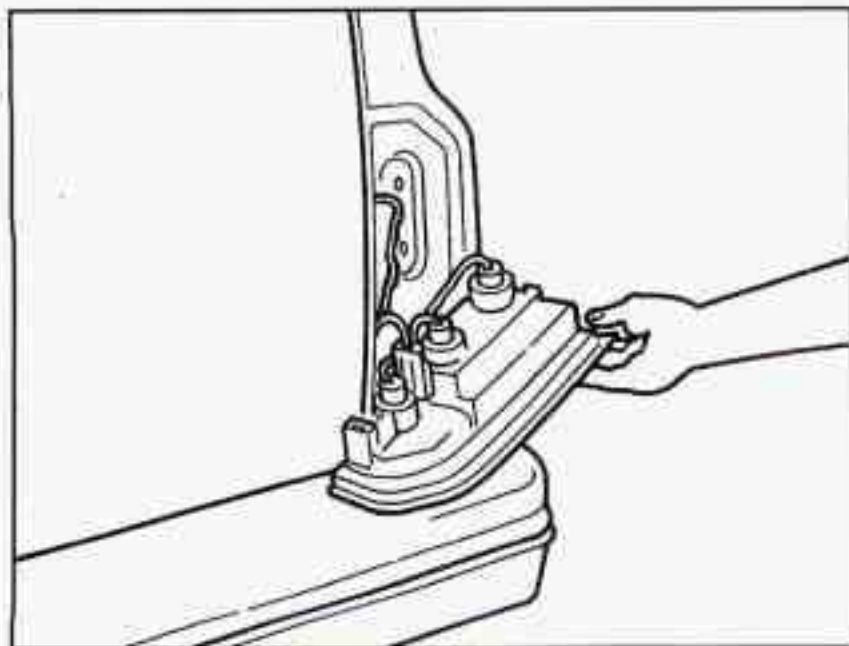

2. Disconnect the bulb from its socket by twisting and then pulling the bulb out.
3. Reverse the steps with a new bulb.

Tires

We don't make tires. Your new Geo comes with high-quality tires made by a leading tire manufacturer. If you ever have questions about your tire warranty and where to obtain service, see your Geo Warranty booklet for details.



CAUTION:

Poorly maintained and improperly used tires are dangerous.

- **Overloading your tires can cause overheating as a result of too much friction. You could have an air-out and a serious accident. See "Loading Your Vehicle" in the Index.**
- **Underinflated tires pose the same danger as overloaded tires. The resulting accident could cause serious injury. Check all tires frequently to maintain the recommended pressure. Tire pressure should be checked when your tires are cold.**
- **Overinflated tires are more likely to be cut, punctured or broken by a sudden impact -- such as when you hit a pothole. Keep tires at the recommended pressure.**
- **Worn, old tires can cause accidents. If your tread is badly worn, or if your tires have been damaged, replace them.**

Inflation -- Tire Pressure

The Tire-Loading Information label, which is on the driver's door lock pillar, shows the correct inflation pressures for your tires when they're cold. "Cold" means your vehicle has been sitting for at least three hours or driven no more than 1 mile (1.6 km).

NOTICE:

Don't let anyone tell you that underinflation or overinflation is all right. It's not. If your tires don't have enough air (underinflation), you can get the following:

- Too much flexing
- Too much heat
- Tire overloading
- Bad wear
- Bad handling
- Bad fuel economy.

NOTICE: (Continued)

NOTICE: (Continued)

If your tires have too much air (overinflation), you can get the following:

- Unusual wear
- Bad handling
- Rough ride
- Needless damage from road hazards.

When to Check

Check your tires once a month or more. Also, check the tire pressure of the spare tire.

How to Check

Use a good quality pocket-type gage to check tire pressure. You can't tell if your tires are properly inflated simply by looking at them. Radial tires may look properly inflated even when they're underinflated.

Be sure to put the valve caps back on the valve stems. They help prevent leaks by keeping out dirt and moisture.

Tire Inspection and Rotation

Tires should be inspected every 6,000 to 8,000 miles (10 000 to 13 000 km) for any signs of unusual wear. If unusual wear is present, rotate your tires as soon as possible and check wheel alignment. Also check for damaged tires or wheels. See "When It's Time for New Tires" and "Wheel Replacement" later in this section for more information.

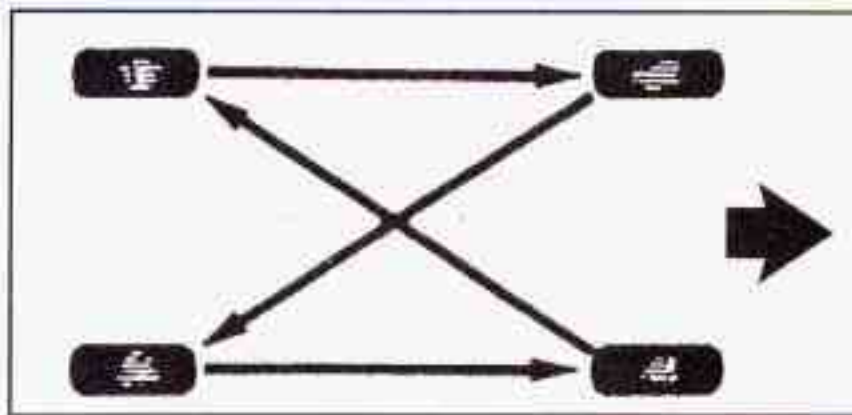
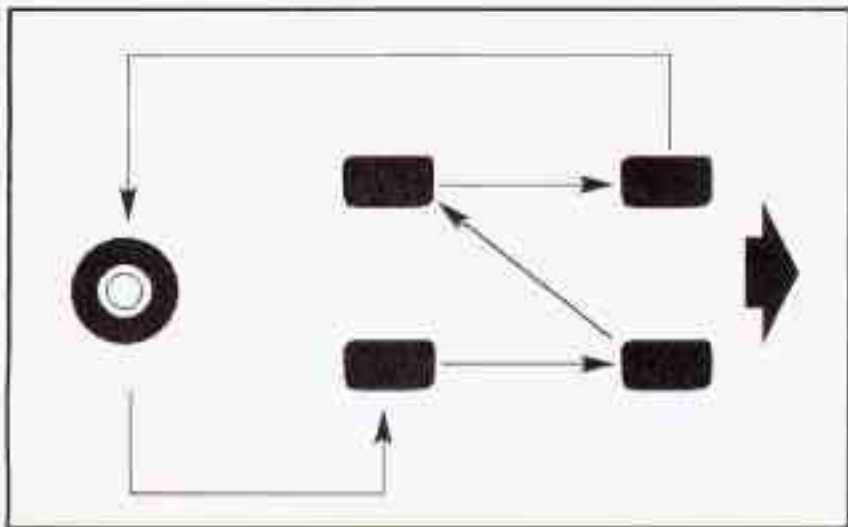

The purpose of regular rotation is to achieve more uniform wear for all tires on the vehicle. The first rotation is the most important. See "Scheduled Maintenance Services" in the Index for scheduled rotation intervals.

When rotating your tires, always use one of the correct rotation patterns shown here.

After the tires have been rotated, adjust the front and rear inflation pressures as shown on the Tire-Loading Information label. Make certain that all wheel nuts are properly tightened. See "Wheel Nut Torque" in the Index.

CAUTION:

Rust or dirt on a wheel, or on the parts to which it is fastened, can make wheel nuts become loose after a time. The wheel could come off and cause an accident. When you change a wheel, remove any rust or dirt from places where the wheel attaches to the vehicle. In an emergency, you can use a cloth or a paper towel to do this; but be sure to use a scraper or wire brush later, if you need to, to get all the rust or dirt off. (See "Changing a Flat Tire" in the Index.)

When It's Time for New Tires

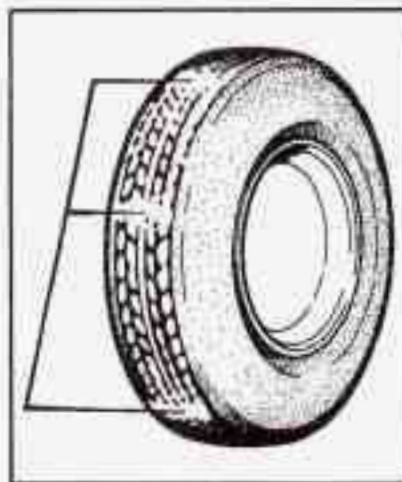

One way to tell when it's time for new tires is to check the treadwear indicators, which will appear when your tires have only 1/16 inch (1.6 mm) or less of tread remaining.

You need a new tire if any of the following statements are true:

- You can see the indicators at three or more places around the tire.
- You can see cord or fabric showing through the tire's rubber.
- The tread or sidewall is cracked, cut or snagged deep enough to show cord or fabric.
- The tire has a bump, bulge or split.
- The tire has a puncture, cut or other damage that can't be repaired well because of the size or location of the damage.

Buying New Tires

To find out what kind and size of tires you need, look at the *Tire-Loading Information* label.

The tires installed on your vehicle when it was new had a Tire Performance Criteria Specification (TPC Spec) number on each tire's sidewall. When you get new tires, get ones with that same TPC Spec number. That way your vehicle will continue to have tires that are designed to give proper endurance, handling, speed rating, traction, ride and other things during normal service on your vehicle. If your tires have an all-season tread design, the TPC number will be followed by an "MS" (for mud and snow).

If you ever replace your tires with those not having a TPC Spec number, make sure they are the same size, load range, speed rating and construction type (bias, bias-belted or radial) as your original tires.



CAUTION:

Mixing tires could cause you to lose control while driving. If you mix tires of different sizes or types (radial and bias-belted tires), the vehicle may not handle properly, and you could have a crash. Using tires of different sizes may also cause damage to your vehicle. Be sure to use the same size and type tires on all wheels.

Uniform Tire Quality Grading

The following information relates to the system developed by the United States National Highway Traffic Safety Administration, which grades tires by treadwear, traction and temperature performance. (This applies only to vehicles sold in the United States.) The grades are molded on the sidewalls of most passenger car tires. The Uniform Tire Quality Grading system does not apply to deep tread, winter-type snow tires, space-saver or temporary use spare tires, tires with nominal rim diameters of 10 to 12 inches (25 to 30 cm), or to some limited-production tires.

While the tires available on General Motors passenger cars and light trucks may vary with respect to these grades, they must also conform to Federal safety requirements and additional General Motors Tire Performance Criteria (TPC) standards.

Treadwear

The treadwear grade is a comparative rating based on the wear rate of the tire when tested under controlled conditions on a specified government test course. For example, a tire graded 150 would wear one and a half (1 1/2) times as well on the government course as a tire graded 100. The relative performance of tires depends upon the actual conditions of their use, however, and may depart significantly from the norm due to variations in driving habits, service practices and differences in road characteristics and climate.

Traction -- A, B, C

The traction grades, from highest to lowest, are A, B, and C, and they represent the tire's ability to stop on wet pavement as measured under controlled conditions on specified government test surfaces of asphalt and concrete. A tire marked C may have poor traction performance.

Warning: The traction grade assigned to this tire is based on braking (straightahead) traction tests and does not include cornering (turning) traction.

Temperature -- A, B, C

The temperature grades are A (the highest), B, and C, representing the tire's resistance to the generation of heat and its ability to dissipate heat when tested under controlled conditions on a specified indoor laboratory test wheel. Sustained high temperature can cause the material of the tire to degenerate and reduce tire life, and excessive temperature can lead to sudden tire failure. The grade C corresponds to a level of performance which all passenger car tires must meet under the Federal Motor Vehicle Safety Standard No. 109. Grades B and A represent higher levels of performance on the laboratory test wheel than the minimum required by law.

Warning: The temperature grade for this tire is established for a tire that is properly inflated and not overloaded. Excessive speed, underinflation, or excessive loading, either separately or in combination, can cause heat buildup and possible tire failure.

Wheel Alignment and Tire Balance

The wheels on your vehicle were aligned and balanced carefully at the factory to give you the longest tire life and best overall performance.

In most cases, you will not need to have your wheels aligned again. However, if you notice unusual tire wear or your vehicle pulling one way or the other, the alignment may need to be reset. If you notice your vehicle vibrating when driving on a smooth road, your wheels may need to be rebalanced.

Wheel Replacement

Replace any wheel that is bent, cracked, or badly rusted or corroded. If wheel nuts keep coming loose, the wheel, wheel bolts and wheel nuts should be replaced. If the wheel leaks air, replace it (except some aluminum wheels, which can sometimes be repaired). See your Geo dealer if any of these conditions exist.

Your dealer will know the kind of wheel you need.

Each new wheel should have the same load-carrying capacity, diameter, width, offset and be mounted the same way as the one it replaces.

If you need to replace any of your wheels, wheel bolts or wheel nuts, replace them only with new GM original equipment parts. This way, you will be sure to have

the right wheel, wheel bolts and wheel nuts for your Geo model.

CAUTION:

Using the wrong replacement wheels, wheel bolts or wheel nuts on your vehicle can be dangerous. It could affect the braking and handling of your vehicle, make your tires lose air and make you lose control. You could have a collision in which you or others could be injured. Always use the correct wheel, wheel bolts and wheel nuts for replacement.

NOTICE:

The wrong wheel can also cause problems with bearing life, brake cooling, speedometer or odometer calibration, headlamp aim, bumper height, vehicle ground clearance and tire or tire chain clearance to the body and chassis.

See "Changing a Flat Tire" in the Index for more information.

Used Replacement Wheels

CAUTION:

Putting a used wheel on your vehicle is dangerous. You can't know how it's been used or how many miles it's been driven. It could fail suddenly and cause an accident. If you have to replace a wheel, use a new GM original equipment wheel.

Tire Chains

NOTICE:

Use tire chains only where legal and only when you must. Use only SAE Class "S" type chains that are the proper size for your tires. Install them on the tires of the drive axle (four-wheel-drive vehicles can use chains on both axles).

Tighten them as tightly as possible with the ends securely fastened. Drive slowly and follow the chain manufacturer's instructions. If you can hear the chains contacting your vehicle, stop and retighten them. If the contact continues, slow down until it stops. Driving too fast or spinning the wheels with chains on will damage your vehicle.

Appearance Care

Remember, cleaning products can be hazardous. Some are toxic. Others can burst into flame if you strike a match or get them on a hot part of the vehicle. Some are dangerous if you breathe their fumes in a closed space. *When you use anything from a container to clean your Geo, be sure to follow the manufacturer's warnings and instructions. And always open your doors or windows when you're cleaning the inside.*

Never use these to clean your vehicle:

- Gasoline
- Benzene
- Naphtha
- Carbon Tetrachloride
- Acetone
- Paint Thinner
- Turpentine
- Lacquer Thinner
- Nail Polish Remover

They can all be hazardous -- some more than others -- and they can all damage your vehicle, too.

Don't use any of these unless this manual says you can. In many uses, these will damage your vehicle:

- Alcohol
- Laundry Soap
- Bleach
- Reducing Agents

Cleaning the Inside of Your Geo

Use a vacuum cleaner often to get rid of dust and loose dirt. Wipe vinyl or leather with a clean, damp cloth.

Your Geo dealer has two GM cleaners, a solvent-type spot lifter and a foam-type powdered cleaner. They will clean normal spots and stains very well. Do not use them on vinyl or leather.

Here are some cleaning tips:

- Always read the instructions on the cleaner label.
- Clean up stains as soon as you can -- before they set.
- Use a clean cloth or sponge, and change to a clean area often. A soft brush may be used if stains are stubborn.
- Use solvent-type cleaners in a well-ventilated area only. If you use them, don't saturate the stained area.
- If a ring forms after spot cleaning, clean the entire area immediately or it will set.

Using Foam-Type Cleaner on Fabric

1. Vacuum and brush the area to remove any loose dirt.
2. Always clean a whole trim panel or section. Mask surrounding trim along stitch or welt lines.
3. Mix Multi-Purpose Powdered Cleaner following the directions on the container label.
4. Use suds only and apply with a clean sponge.
5. Don't saturate the material.
6. Don't rub it roughly.
7. As soon as you've cleaned the section, use a sponge to remove the suds.
8. Rinse the section with a clean, wet sponge.
9. Wipe off what's left with a slightly damp paper towel or cloth.
10. Then dry it immediately with a blow dryer.
11. Wipe with a clean cloth.

Using Solvent-Type Cleaner on Fabric

First, see if you have to use solvent-type cleaner at all. Some spots and stains will clean off better with just water and mild soap.

If you need to use a solvent:

- Gently scrape excess soil from the trim material with a clean, dull knife or scraper. Use very little cleaner, light pressure and clean cloths (preferably cheesecloth). Cleaning should start at the outside of the stain, "feathering" toward the center. Keep changing to a clean section of the cloth.
- When you clean a stain from fabric, immediately dry the area with a blow dryer to help prevent a cleaning ring.

Fabric Protection

Your Geo has upholstery that has been treated with Scotchgard™ Fabric Protector, a 3M product. It protects fabrics by repelling oil and water, which are the carriers of most stains. Even with this protection, you still need to clean your upholstery often to keep it looking new.

Further information on cleaning is available by calling 1-800-433-3296 (in Minnesota, 1-800-642-6167).

Special Cleaning Problems

Greasy or Oily Stains

Stains caused by grease, oil, butter, margarine, shoe polish, coffee with cream, chewing gum, cosmetic creams, vegetable oils, wax crayon, tar and asphalt can be removed as follows:

1. Carefully scrape off excess stain.
2. Follow the solvent-type instructions described earlier.
3. Shoe polish, wax crayon, tar and asphalt will stain if left on a vehicle's seat fabric. They should be removed as soon as possible. Be careful, because the cleaner will dissolve them and may cause them to spread.

Non-Greasy Stains

Stains caused by catsup, coffee (black), egg, fruit, fruit juice, milk, soft drinks, wine, vomit, urine and blood can be removed as follows:

1. Carefully scrape off excess stain, then sponge the soiled area with cool water.
2. If a stain remains, follow the foam-type instructions described earlier.

3. If an odor lingers after cleaning vomit or urine, treat the area with a water/baking soda solution: 1 teaspoon (5 ml) of baking soda to 1 cup (250 ml) of lukewarm water.
4. If needed, clean lightly with solvent-type cleaner.

Combination Stains

Stains caused by candy, ice cream, mayonnaise, chili sauce and unknown stains can be removed as follows:

- Carefully scrape off excess stain, then clean with cool water and allow to dry.
- If a stain remains, clean it with solvent-type cleaner.

Cleaning Vinyl

Use warm water and a clean cloth.

- Rub with a clean, damp cloth to remove dirt. You may have to do it more than once.
- Things like tar, asphalt and shoe polish will stain if you don't get them off quickly. Use a clean cloth and a GM Vinyl/Leather Cleaner or equivalent product.

Cleaning the Top of the Instrument Panel

Use only mild soap and water to clean the top surfaces of the instrument panel. Sprays containing silicones or waxes may cause annoying reflections in the windshield and even make it difficult to see through the windshield under certain conditions.

Care of Safety Belts

Keep belts clean and dry.



CAUTION:

Do not bleach or dye safety belts. If you do, it may severely weaken them. In a crash, they might not be able to provide adequate protection. Clean safety belts only with mild soap and lukewarm water.

Glass

Glass should be cleaned often. GM Glass Cleaner (GM Part No. 1050427) or a liquid household glass cleaner will remove normal tobacco smoke and dust films.

Don't use abrasive cleaners on glass, because they may cause scratches. Avoid placing decals on the inside rear window, since they may have to be scraped off later. If abrasive cleaners are used on the inside of the rear window, an electric defogger element may be damaged. Any temporary license should not be attached across the defogger grid.

Cleaning the Outside of the Windshield, Backglass and Wiper Blades

If the windshield is not clear after using the windshield washer, or if the wiper blade chatters when running, wax or other material may be on the blade or windshield.

Clean the outside of the windshield with GM Windshield Cleaner, Bon-Ami Powder[®] (GM Part No. 1050011). The windshield is clean if beads do not form when you rinse it with water.

Clean the blade by wiping vigorously with a cloth soaked in full-strength windshield washer solvent. Then rinse the blade with water.

Wiper blades should be checked on a regular basis and replaced when worn.

Weatherstrips

Silicone grease on weatherstrips will make them last longer, seal better, and not stick or squeak. Apply silicone grease with a clean cloth at least every six months. During very cold, damp weather more frequent application may be required. (See "Recommended Fluids and Lubricants" in the Index.)

Cleaning the Outside of Your Geo

The paint finish on your vehicle provides beauty, depth of color, gloss retention and durability.

Washing Your Vehicle

The best way to preserve your vehicle's finish is to keep it clean by washing it often with lukewarm or cold water.

Don't wash your vehicle in the direct rays of the sun. Don't use strong soaps or chemical detergents. Use liquid hand, dish or car washing (mild detergent) soaps. Don't use cleaning agents that are petroleum based, or

that contain acid or abrasives. All cleaning agents should be flushed promptly and not allowed to dry on the surface, or they could stain. Dry the finish with a soft, clean chamois or a 100% cotton towel to avoid surface scratches and water spotting.

High pressure vehicle washes may cause water to enter your vehicle.

Finish Care

Occasional waxing or mild polishing of your Geo by hand may be necessary to remove residue from the paint finish. You can get GM-approved cleaning products from your dealer. (See "Appearance Care and Materials" in the Index.)

Your Geo has a "basecoat/clearcoat" paint finish. The clearcoat gives more depth and gloss to the colored basecoat. Always use waxes and polishes that are non-abrasive and made for a basecoat/clearcoat paint finish.

NOTICE:

Machine compounding or aggressive polishing on a basecoat/clearcoat paint finish may dull the finish or leave swirl marks.

Foreign materials such as calcium chloride and other salts, ice melting agents, road oil and tar, tree sap, bird droppings, chemicals from industrial chimneys, etc., can damage your vehicle's finish if they remain on painted surfaces. Wash the vehicle as soon as possible. If necessary, use non-abrasive cleaners that are marked safe for painted surfaces to remove foreign matter.

Exterior painted surfaces are subject to aging, weather and chemical fallout that can take their toll over a period of years. You can help to keep the paint finish looking new by keeping your Geo garaged or covered whenever possible.

Protecting Exterior Bright Metal Parts

Bright metal parts should be cleaned regularly to keep their luster. Washing with water is all that is usually needed. However, you may use GM Chrome Polish on chrome or stainless steel trim, if necessary.

Use special care with aluminum trim. To avoid damaging protective trim, never use auto or chrome polish, steam or caustic soap to clean aluminum. A coating of wax, rubbed to high polish, is recommended for all bright metal parts.

Special Care for Canvas Top and Plastic Windows

To protect the canvas top:

- After you wash the vehicle, make sure the top is completely dry before you open or remove it.
- Don't get any vinyl cleaner on the vehicle's painted finish; it could leave streaks.
- Don't go through automatic car washes; the canvas top could be damaged.

The plastic windows are pliable and can be scratched if you don't take these precautions when you clean them:

- Wipe off dust with a soft cotton cloth moistened with clean, cool or lukewarm water. Don't use a "dry" cloth. Wipe in one direction only, not back and forth.
- To remove frost, snow or ice, use lukewarm water. Don't use a scraper or any de-icing fluids.
- Wash the windows with a soft cloth and clean, cool or lukewarm water. Never use a dry cloth, hot water, strong soap or detergent, solvents or harsh cleaning agents. Rinse thoroughly and wipe with a slightly moist soft, clean cloth.

- Don't put any labels, stickers or tape on windows. It's hard to remove adhesives left on the window when such items are removed. If a sticker or label must be removed, remove any adhesive left on the window while the adhesive is still soft and sticky. Press on a new sticker or piece of tape and then lift it off again; keep doing this until all the adhesive lifts off with the sticker or tape.

Aluminum Wheels (If So Equipped)

Keep your wheels clean using a soft clean cloth with mild soap and water. Rinse with clean water. After rinsing thoroughly, dry with a soft clean towel. A wax may then be applied.

The surface of these wheels is similar to the painted surface of your vehicle. Don't use strong soaps, chemicals, abrasive polishes, abrasive cleaners or abrasive cleaning brushes on them because you could damage the surface.

Don't take your vehicle through an automatic vehicle wash that has silicon carbide tire cleaning brushes. These brushes can also damage the surface of these wheels.

Tires

To clean your tires, use a stiff brush with a tire cleaner.

NOTICE:

When applying a tire dressing always take care to wipe off any overspray or splash from all painted surfaces on the body or wheels of the vehicle. Petroleum-based products may damage the paint finish.

Sheet Metal Damage

If your vehicle is damaged and requires sheet metal repair or replacement, make sure the body repair shop applies anti-corrosion material to the parts repaired or replaced to restore corrosion protection.

Finish Damage

Any stone chips, fractures or deep scratches in the finish should be repaired right away. Bare metal will corrode quickly and may develop into a major repair expense.

Minor chips and scratches can be repaired with touch-up materials available from your dealer or other service outlets. Larger areas of finish damage can be corrected in your dealer's body and paint shop.

Underbody Maintenance

Chemicals used for ice and snow removal and dust control can collect on the underbody. If these are not removed, accelerated corrosion (rust) can occur on the underbody parts such as fuel lines, frame, floor pan and exhaust system even though they have corrosion protection.

At least every spring, flush these materials from the underbody with plain water. Clean any areas where mud and other debris can collect. Dirt packed in closed areas of the frame should be loosened before being flushed. Your dealer or an underbody vehicle washing system can do this for you.

Chemical Paint Spotting

Some weather and atmospheric conditions can create a chemical fallout. Airborne pollutants can fall upon and attack painted surfaces on your vehicle. This damage can take two forms: blotchy, ringlet-shaped discolorations, and small irregular dark spots etched into the paint surface.

Although no defect in the paint job causes this, Geo will repair, at no charge to the owner, the surfaces of new vehicles damaged by this fallout condition within 12 months or 12,000 miles (20 000 km) of purchase, whichever occurs first.

Appearance Care Materials Chart

PART NUMBER	SIZE	DESCRIPTION	USAGE
1050004	2.75 sq. ft.	Chamois	Shines vehicle without scratching
1050172	16 oz. (0.473 L)	Tar and Road Oil Remover	Also removes old waxes and polishes
1050173	16 oz. (0.473 L)	Chrome Cleaner and Polish	Removes rust and corrosion
1050174	16 oz. (0.473 L)	White Sidewall Tire Cleaner	Removes soil and black marks
1050201	16 oz. (0.473 L)	Magic Mirror Cleaner Polish	Exterior cleaner and polish
1050214	32 oz. (0.946 L)	Vinyl and Leather Cleaner	Spot and stain removal
1050427	23 oz. (0.680 L)	Glass Cleaner	Cleans grease, grime and smoke film
1050429	6 lbs. (2.72 kg)	Multi-Purpose Powdered Cleaner	Cleans vinyl, cloth, tires and mats
1051398*	8 oz. (0.237 L)	Spot Lifter	For cloth
1051515	32 oz. (0.946 L)	Optikleen	Windshield washer solvent and antifreeze
1052870	16 oz. (0.473 L)	Wash and Wax Concentrate	Exterior wash
1052918**	8 oz. (0.237 L)	Armor All™ Protector	Protects vinyl, leather and rubber
1052929	16 oz. (0.473 L)	Wheel Cleaner	Spray on wheel cleaner
1052930	8 oz. (0.237 L)	Capture Dry Spot Remover	Attracts and absorbs soils
12345002**	16 oz. (0.473 L)	Armor All™ Cleaner	Cleans vinyl, leather and rubber
12345725	12 oz. (0.354 L)	Silicone Tire Shine	Shines tires
See your General Motors Parts Department for these products. See "Fluids and Lubricants" in the Index.		* Not recommended for pigskin suede leather. ** Not recommended for use on instrument panel vinyl.	

Vehicle Identification Number (VIN)

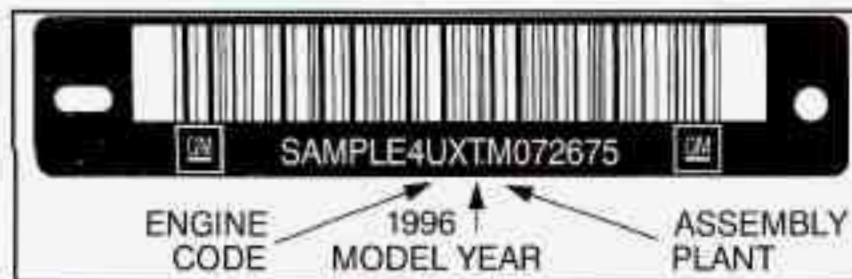

This is the legal identifier for your Geo. It appears on a plate in the front corner of the instrument panel, on the driver's side. You can see it if you look through the windshield from outside your vehicle. The VIN also appears on the Vehicle Certification and Service Parts labels and the certificates of title and registration.

Engine Identification

The eighth character in your VIN is the engine code. This code will help you identify your engine, specifications and replacement parts.

Service Parts Identification Label

You'll find this label inside the glove box on the door. It's very helpful if you ever need to order parts. On this label is:

- your VIN,
- the model designation,
- paint information, and
- a list of all production options and special equipment.

Be sure that this label is not removed from the vehicle.

Electrical System

Add-On Electrical Equipment

NOTICE:

Don't add anything electrical to your Geo unless you check with your dealer first. Some electrical equipment can damage your vehicle and the damage wouldn't be covered by your warranty. Some add-on electrical equipment can keep other components from working as they should.

Your vehicle has an air bag system. Before attempting to add anything electrical to your Geo, see "Servicing Your Air Bag-Equipped Geo" in the Index.

Fuses and Circuit Breakers

The *wiring circuits* in your vehicle are protected from short circuits by fuses, circuit breakers and thermal links in the wiring itself. This greatly reduces the chance of fires caused by electrical problems.

Look at the silver-colored band inside the fuse. If the band is broken or melted, replace the fuse. Be sure you replace a bad fuse with a new one of the correct size.

If you ever have a problem on the road and don't have a spare fuse, you can borrow one. Just pick some feature of your vehicle that you can get along without -- like the radio or cigarette lighter -- and use its fuse, if it is the size you need. Replace it as soon as you can.

Before replacing a fuse, turn every vehicle electrical switch off.

There are two fuse blocks in your vehicle: the instrument panel fuse block and the engine compartment fuse block.

Instrument Panel Fuse Block



This fuse box is under the left side of the instrument panel. The fuses here protect each separate circuit including headlamps. If you have electrical failure, check here first.

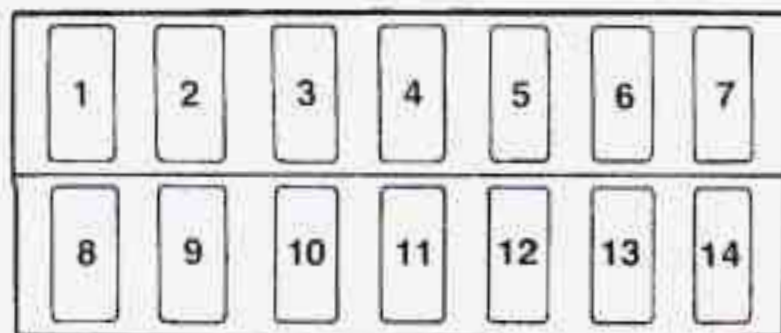

Fuse	Usage
1	Empty
2	Empty
3	Dome Lamp, Sidemarker Lamps, Parking Lamps, License Plate Lamp, Instrument Panel Illumination
4	Stoplamps, Horn
5	Hazard Lamps
6	Door Lock (Option)
7	Lighter, Radio
8	Ignition System, Warning and Indicator Lights, Gages, Four-Wheel Drive System (Option)
9	Turn Signal Flasher, Back-up Lamps
10	Wiper/Washer
11	Rear Defogger
12	Heater
13	Empty
14	Empty

Please note, fuses for the air bags are located next to the instrument panel fuse block.

Main Fuse Block

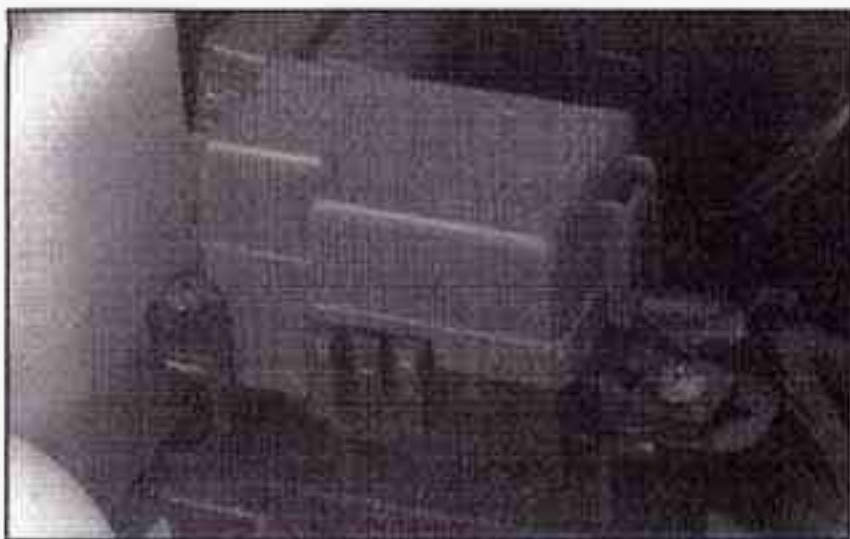

The main fuse box in your engine compartment protects all electrical loads.

For access to the main fuses, pull off the cover. A spare fuse is also inside the fuse box.

	BATT	USE THE DESIGNATED FUSES ONLY
	ABS	
H/L,L	IG	
H/L,R	LAMP	
FI		
A/C		

Fuse	Usage
BATT	All Electrical Load
ABS	Anti-Lock Brake System
IG	Ignition, Lighter, Radio, Wiper/Washer, Rear Defogger, Turn Signals, Backup Lamps, Heater
LAMP	Taillamps, Dome Lamps, Stop Lamps, Horn, Hazard Lamps
H/L, R	Right Side Headlamp
H/L, L	Left Side Headlamp
FI	Fuel Injection System
A/C	Air Conditioning

Replacement Bulbs

Bulb	Number	Bulb	Number
Back-up	1156	License Plate	194
Center High-Mounted Stop	921	GM Part No. 96053203	
Dome	GM Part No. 96051559	or equivalent	
Front Parking and Turn Signal	1157 NA	Rear Hazard and Turn Signal	1156
Headlamp (Halogen)	9004	GM Part No. 96051557	
GM Part No. 9441731		or equivalent	
or equivalent		Rear Parking and Stop	1157
Headlamp, High-Beam	GM Part No. 9433184	GM Part No. 96051558	
or equivalent		or equivalent	
Turn Signal	GM Part No. 9433184	Sidemarkers	194
or equivalent		GM Part No. 96053293	
		or equivalent	

Capacities and Specifications

Engine

Type	L4
Compression Ratio	9.5:1
Firing Order	1-3-4-2
Horsepower	95
Fuel Delivery	Fuel Injection
Piston Displacement	97 CID (1.6L)
Valve Arrangement	In-Head "V" Type
AC Belt Tension	Deflect Belt 0.24-0.3 inch (6-9 mm) @ 22 lbs. (10 kg) Pressure
Fan Belt Tension	
Inspection	Deflect Belt 0.24-0.32 inch (6-8 mm) @ 22 lbs. (10 kg) Pressure
Replacement	Deflect Belt 0.20-0.28 inch (5-7 mm) @ 22 lbs. (10 kg) Pressure
Thermostat Temperature	
Specification	180°F (82°C)

Replacement Parts

Air Cleaner Filter	13780-58B20 GM Part No. 96068629 or equivalent
Battery	26R-50S
Engine Oil Filter	GM Part No. 25014441
Fuel Filter	AC Type GF571 GM Part No. 96058022 or equivalent
PCV Valve	GM Part No. 96058079 or equivalent
Radiator Pressure Cap	13 psi (90 kPa)
Spark Plug	AC Type R43XLS 0.028-0.032 inch gap (0.7 to 0.8 mm)

Capacities (Approximate)

The following approximate capacities are given in English and metric conversions.

Air Conditioning† . . . See the refrigerant information label under the hood and "Air Conditioning Refrigerants" at the end of this section.

Please refer to "Fluids and Lubricants" in the Index for more information.

Automatic Transmission

Drain and Refill 3.0 quarts (2.8 L)**

Overhaul

Two-Door Convertible 5.4 quarts (5.1 L)

Four-Door Hardtop 7.3 quarts (6.9 L)

Cooling System

Automatic Transmission 5.5 quarts (5.2 L)

Manual Transmission 5.6 quarts (5.3 L)

Crankcase

With Filter Change 4.5 quarts (4.2 L)*

Front Differential 1.1 quarts (1.0 L)

Fuel Tank

Two-Door Convertible 11.1 gallons (42 L)

Four-Door Hardtop 14.5 gallons (55 L)

Manual Transmission

Four-Wheel Drive 1.6 quarts (1.5 L)**

Two-Wheel Drive 2.0 quarts (1.9 L)**

Rear Differential 2.3 quarts (2.2 L)

Transfer Case 1.8 quarts (1.7 L)

* When changing the oil filter, additional oil may be needed. Recheck the oil level after filling. See "Engine Oil" in the Index.

** Recheck fluid level after filling. See "Automatic Transmission Fluid" or "Manual Transmission Fluid" in the Index.

Wheel Nuts

Wheel Nut Torque 60 lb-ft (80 N·m)

Vehicle Dimensions

Wheelbase

Two-Door Convertible . . . 86.6 inches (2 200 mm)

Four-Door Hardtop 97.6 inches (2 480 mm)

Tread

Front 54.9 inches (1 395 mm)

Rear 55.1 inches (1 400 mm)

Length

Two-Door Convertible . . 143.7 inches (3 650 mm)

Four-Door Hardtop 158.7 inches (4 030 mm)

Width

Two-Door Convertible . . . 64.2 inches (1 630 mm)

Four-Door Hardtop 64.4 inches (1 635 mm)

Height

Two-Door Convertible

Two-Wheel Drive 64.3 inches (1 633 mm)

Four-Wheel Drive 65.1 inches (1 654 mm)

Four-Door Hardtop

Two-Wheel Drive 65.7 inches (1 669 mm)

Four-Wheel Drive 66.5 inches (1 689 mm)

Air Conditioning Refrigerants

Not all air conditioning refrigerants are the same. If the air conditioning system in your vehicle needs refrigerant, be sure the proper refrigerant is used. If you're not sure, ask your Geo dealer.

**IMPORTANT:
KEEP ENGINE OIL
AT THE PROPER
LEVEL AND CHANGE AS
RECOMMENDED**

This section covers the maintenance required for your Geo. Your vehicle needs these services to retain its safety, dependability and emission control performance.



Have you purchased the GM Protection Plan? The Plan supplements your new vehicle warranties. See your Warranty and Owner Assistance booklet, or your Geo dealer for details.

Introduction

Your Vehicle and the Environment

Proper vehicle maintenance not only helps to keep your vehicle in good working condition, but also helps the environment. All recommended maintenance procedures are important. Improper vehicle maintenance can even affect the quality of the air we breathe. Improper fluid levels or the wrong tire inflation can increase the level of emissions from your vehicle. To help protect our environment, and to keep your vehicle in good condition, please maintain your vehicle properly.

How This Section is Organized

The remainder of this section is divided into five parts:

“Part A: Scheduled Maintenance Services”

shows what to have done and how often. Some of these services can be complex, so unless you are technically qualified and have the necessary equipment, you should let your dealer’s service department or another qualified service center do these jobs.

CAUTION:

Performing maintenance work on a vehicle can be dangerous. In trying to do some jobs, you can be seriously injured. Do your own maintenance work only if you have the required know-how and the proper tools and equipment for the job. If you have any doubt, have a qualified technician do the work.

If you are skilled enough to do some work on your vehicle, you will probably want to get the service information GM publishes. See “Service and Owner Publications” in the Index.

“Part B: Owner Checks and Services” tells you what should be checked whenever you stop for fuel. It also explains what you can easily do to help keep your vehicle in good condition.

“Part C: Periodic Maintenance Inspections”

explains important inspections that your Geo dealer’s service department or another qualified service center should perform.

“Part D: Recommended Fluids and Lubricants”

lists some products GM recommends to help keep your vehicle properly maintained. These products, or their equivalents, should be used whether you do the work yourself or have it done.

“Part E: Maintenance Record” provides a place for you to record the maintenance performed on your vehicle. Whenever any maintenance is performed, be sure to write it down in this part. This will help you determine when your next maintenance should be done. In addition, it is a good idea to keep your maintenance receipts. They may be needed to qualify your vehicle for warranty repairs.

Part A: Scheduled Maintenance Services

Using Your Maintenance Schedule

We at General Motors want to help you keep your vehicle in good working condition. But we don't know exactly how you'll drive it. You may drive very short distances only a few times a week. Or you may drive long distances all the time in very hot, dusty weather. You may use your vehicle in making deliveries. Or you may drive it to work, to do errands or in many other ways.

Because of all the different ways people use their GM vehicles, maintenance needs vary. You may even need more frequent checks and replacements than you'll find in the schedules in this section. So please read this section and note how you drive. If you have any questions on how to keep your vehicle in good condition, see your Geo dealer.

This part tells you the maintenance services you should have done and when you should schedule them. If you go to your dealer for your service needs, you'll know that GM-trained and supported service people will perform the work using genuine GM parts.

The proper fluids and lubricants to use are listed in Part D. Make sure whoever services your vehicle uses these. All parts should be replaced and all necessary repairs done before you or anyone else drives the vehicle.

These schedules are for vehicles that:

- carry passengers and cargo within recommended limits. You will find these limits on your vehicle's Tire-Loading Information label. See "Loading Your Vehicle" in the Index.
- are driven on reasonable road surfaces within legal driving limits.
- use the recommended fuel. See "Fuel" in the Index.

Selecting the Right Schedule

First you'll need to decide which of the two schedules is right for your vehicle. Here's how to decide which schedule to follow:

Maintenance Schedule

Short Trip/City Definition

Follow the Short Trip/City Maintenance Schedule if any one of these conditions is true for your vehicle:

- Most trips are less than 5 to 10 miles (8 to 16 km). This is particularly important when outside temperatures are below freezing.
- Most trips include extensive idling (such as frequent driving in stop-and-go traffic).
- You frequently tow a trailer or use a carrier on top of your vehicle.
- If the vehicle is used for delivery service, police, taxi or other commercial application.

One of the reasons you should follow this schedule if you operate your vehicle under any of these conditions is that these conditions cause engine oil to break down sooner.

Short Trip/City Intervals

Every 3,000 Miles (5 000 km): Engine Oil and Filter Change (or 3 months, whichever occurs first). Free-Wheeling Hubs Inspection (if equipped) (or 3 months, whichever occurs first).

Every 6,000 Miles (10 000 km): Tire Rotation.

Every 15,000 Miles (25 000 km): Air Cleaner Filter Inspection, if driving in dusty conditions. Front Wheel Bearing Repack (or at each brake relining, whichever occurs first). Manual Transmission Fluid Change (or every 15 months, whichever occurs first). Engine Idle Speed Check. Valve Lash (Clearance) Adjustment. Propeller Shafts and U-Joints Inspection (or every 15 months, whichever occurs first).

Every 30,000 Miles (50 000 km): Air Cleaner Filter Replacement. Spark Plug Replacement. Engine Accessory Drive Belt Inspection (or every 24 months, whichever occurs first). Cooling System Service (or every 30 months, whichever occurs first). Fuel Filter Replacement (or every 30 months, whichever occurs first).

Maintenance Schedule

Short Trip/City Intervals

Every 50,000 Miles (83 000 km): Automatic Transmission Service (severe conditions only). Positive Crankcase Ventilation (PCV) Valve Replacement.

Every 60,000 Miles (100 000 km): Engine Timing and Distributor Check. Fuel Tank Cap Gasket Replacement. Emission System Hoses Inspection. Camshaft Timing Belt Replacement. Brake Fluid Service. Spark Plug Wire Replacement (or every 60 months, whichever occurs first). Wiring Harness and Connectors Inspection (or every 60 months, whichever occurs first).

Short Trip/City Intervals

At 90,000 Miles (150 000 km): Camshaft Timing Belt Inspection.

Every 100,000 Miles (166 000 km): Fuel Injector Inspection. Evaporative Emissions Canister Replacement.

These intervals only summarize maintenance services. Be sure to follow the complete maintenance schedule on the following pages.

Maintenance Schedule

Long Trip/Highway Definition

Follow this maintenance schedule *only* if none of the conditions from the Short Trip/City Maintenance Schedule is true.

Driving a vehicle with a fully warmed engine under highway conditions causes engine oil to break down slower.

Long Trip/Highway Intervals

Every 7,500 Miles (12 500 km): Engine Oil and Filter Change (or every 7.5 months, whichever occurs first). Free-Wheeling Hubs Inspection (if equipped) (or every 3 months, whichever occurs first). Tire Rotation.

Every 15,000 Miles (25 000 km): Engine Idle Speed Check. Valve Lash (Clearance) Adjustment. Propeller Shafts and U-Joints Inspection (or every 15 months, whichever occurs first).

Every 30,000 Miles (50 000 km): Engine Accessory Drive Belt Inspection (or every 24 months, whichever occurs first). Cooling System Service (or every 30 months, whichever occurs first). Spark Plug Replacement. Air Cleaner Filter Replacement. Fuel Tank, Cap and Lines Inspection. Manual Transmission Fluid Change (or every 30 months, whichever occurs first). Fuel Filter Replacement (or every 30 months, whichever occurs first).

Maintenance Schedule

Long Trip/Highway Intervals

Every 50,000 Miles (83 000 km): Automatic Transmission Service (severe conditions only). Positive Crankcase Ventilation (PCV) Valve Replacement.

Every 60,000 Miles (100 000 km): Engine Timing and Distributor Check. Fuel Tank Cap Gasket Replacement. Emission System Hoses Inspection. Camshaft Timing Belt Replacement. Spark Plug Wire Replacement (or every 60 months, whichever occurs first). Wiring Harness and Connectors Inspection (or every 60 months, whichever occurs first). Brake Fluid Service.

Long Trip/Highway Intervals

At 90,000 Miles (150 000 km): Camshaft Timing Belt Inspection.

Every 100,000 Miles (166 000 km): Fuel Injector Inspection. Evaporative Emissions Canister Replacement.

These intervals only summarize maintenance services. Be sure to follow the complete maintenance schedule on the following pages.

Short Trip/City Maintenance Schedule

The services shown in this schedule up to 100,000 miles (166 000 km) should be performed after 100,000 miles (166 000 km) at the same intervals.

Footnotes

† The U.S. Environmental Protection Agency or the California Air Resources Board has determined that the failure to perform this maintenance item will not nullify the emission warranty or limit recall liability prior to the completion of the vehicle's useful life. We, however, urge that all recommended maintenance services be performed at the indicated intervals and the maintenance be recorded.

3,000 Miles (5 000 km)

- Change engine oil and filter (or every 3 months, whichever occurs first).
An Emission Control Service.
- Inspect the locking front hubs (if equipped) for correct operation (or every 3 months, whichever occurs first). Repair or replace if necessary.

DATE	ACTUAL MILEAGE	SERVICED BY:

Short Trip/City Maintenance Schedule

6,000 Miles (10 000 km)

- Change engine oil and filter (or every 3 months, whichever occurs first).
An Emission Control Service.
- Rotate tires. See "Tire Inspection and Rotation" in the Index for proper rotation pattern and additional information. During tire rotation, check brake calipers for freedom of movement. Refer to the appropriate GM service manual for proper caliper service procedures.
- Inspect the locking front hubs (if equipped) for correct operation (or every 3 months, whichever occurs first). Repair or replace if necessary.

DATE	ACTUAL MILEAGE	SERVICED BY:

9,000 Miles (15 000 km)

- Change engine oil and filter (or every 3 months, whichever occurs first).
An Emission Control Service.
- Inspect the locking front hubs (if equipped) for correct operation (or every 3 months, whichever occurs first). Repair or replace if necessary.

DATE	ACTUAL MILEAGE	SERVICED BY:

Short Trip/City Maintenance Schedule

12,000 Miles (20 000 km)

- Change engine oil and filter (or every 3 months, whichever occurs first).
An Emission Control Service.
- Rotate tires. See "Tire Inspection and Rotation" in the Index for proper rotation pattern and additional information. During tire rotation, check brake calipers for freedom of movement. Refer to the appropriate GM service manual for proper caliper service procedures.
- Inspect the locking front hubs (if equipped) for correct operation (or every 3 months, whichever occurs first). Repair or replace if necessary.

DATE	ACTUAL MILEAGE	SERVICED BY:

15,000 Miles (25 000 km)

- Change engine oil and filter (or every 3 months, whichever occurs first).
An Emission Control Service.
- Inspect air cleaner filter if you are driving in dusty conditions. Replace filter if necessary. *An Emission Control Service.* †
- Clean and repack the front wheel bearings (or at each brake relining, whichever occurs first).
- Change manual transmission fluid (or every 15 months, whichever occurs first).
- Inspect the valve lash and adjust if necessary.
An Emission Control Service.
- Check engine idle speed and adjust it to underhood label specifications.
An Emission Control Service. †

Short Trip/City Maintenance Schedule

- Inspect the locking front hubs (if equipped) for correct operation (or every 3 months, whichever occurs first). Repair or replace as necessary.
- Inspect propeller shafts and u-joints for looseness and damage (or every 15 months, whichever occurs first). Inspect more frequently if used off-road or for pulling a trailer. Tighten u-joint flange bolts if necessary.

DATE	ACTUAL MILEAGE	SERVICED BY:

18,000 Miles (30 000 km)

- Change engine oil and filter (or every 3 months, whichever occurs first).
An Emission Control Service.
- Rotate tires. See "Tire Inspection and Rotation" in the Index for proper rotation pattern and additional information. During tire rotation, check brake calipers for freedom of movement. Refer to the appropriate GM service manual for proper caliper service procedures.
- Inspect the locking front hubs (if equipped) for correct operation (or every 3 months, whichever occurs first). Repair or replace if necessary.

DATE	ACTUAL MILEAGE	SERVICED BY:

Short Trip/City Maintenance Schedule

21,000 Miles (35 000 km)

- Change engine oil and filter (or every 3 months, whichever occurs first).
An Emission Control Service.
- Inspect the locking front hubs (if equipped) for correct operation (or every 3 months, whichever occurs first). Repair or replace if necessary.

DATE	ACTUAL MILEAGE	SERVICED BY:

24,000 Miles (40 000 km)

- Change engine oil and filter (or every 3 months, whichever occurs first).
An Emission Control Service.
- Rotate tires. See "Tire Inspection and Rotation" in the Index for proper rotation pattern and additional information. During tire rotation, check brake calipers for freedom of movement. Refer to the appropriate GM service manual for proper caliper service procedures.
- Inspect the locking front hubs (if equipped) for correct operation (or every 3 months, whichever occurs first). Repair or replace if necessary.

DATE	ACTUAL MILEAGE	SERVICED BY:

Short Trip/City Maintenance Schedule

27,000 Miles (45 000 km)

- Change engine oil and filter (or every 3 months, whichever occurs first).
An Emission Control Service.
- Inspect the locking front hubs (if equipped) for correct operation (or every 3 months, whichever occurs first). Repair or replace if necessary.

DATE	ACTUAL MILEAGE	SERVICED BY:

30,000 Miles (50 000 km)

- Change engine oil and filter (or every 3 months, whichever occurs first).
An Emission Control Service.
- Inspect engine accessory drive belts (or every 24 months, whichever occurs first).
An Emission Control Service.
- Drain, flush and refill cooling system (or every 30 months, whichever occurs first). See "Engine Coolant" in the Index for what to use. Inspect hoses. Clean radiator, condenser, pressure cap and neck. Pressure test the cooling system and pressure cap.
An Emission Control Service. †
- Clean and repack the front wheel bearings (or at each brake relining, whichever occurs first).

(Continued)

Short Trip/City Maintenance Schedule

30,000 Miles (50 000 km) (Continued)

- Replace spark plugs.
An Emission Control Service.
- Replace air cleaner filter.
An Emission Control Service.
- Inspect fuel tank, cap and lines for damage or leaks. Inspect fuel cap gasket for any damage. Replace parts as needed.
An Emission Control Service. †
- Rotate tires. See "Tire Inspection and Rotation" in the Index for proper rotation pattern and additional information. During tire rotation, check brake calipers for freedom of movement. Refer to the appropriate GM service manual for proper caliper service procedures.
- Change manual transmission fluid (or every 15 months, whichever occurs first).
- Inspect the valve lash and adjust if necessary.
An Emission Control Service.
- Replace fuel filter (or every 30 months, whichever occurs first, or sooner if filter is clogged). *An Emission Control Service. †*
- Check engine idle speed and adjust it to underhood label specifications.
An Emission Control Service. †
- Inspect the locking front hubs (if equipped) for correct operation (or every 3 months, whichever occurs first). Repair or replace as necessary.
- Inspect propeller shafts and u-joints for looseness and damage (or every 15 months, whichever occurs first). Inspect more frequently if used off-road or for pulling a trailer. Tighten u-joint flange bolts if necessary.

DATE	ACTUAL MILEAGE	SERVICED BY:

Short Trip/City Maintenance Schedule

33,000 Miles (55 000 km)

- Change engine oil and filter (or every 3 months, whichever occurs first).
An Emission Control Service.
- Inspect the locking front hubs (if equipped) for correct operation (or every 3 months, whichever occurs first). Repair or replace if necessary.

DATE	ACTUAL MILEAGE	SERVICED BY:

36,000 Miles (60 000 km)

- Change engine oil and filter (or every 3 months, whichever occurs first).
An Emission Control Service.
- Rotate tires. See "Tire Inspection and Rotation" in the Index for proper rotation pattern and additional information. During tire rotation, check brake calipers for freedom of movement. Refer to the appropriate GM service manual for proper caliper service procedures.
- Inspect the locking front hubs (if equipped) for correct operation (or every 3 months, whichever occurs first). Repair or replace if necessary.

DATE	ACTUAL MILEAGE	SERVICED BY:

Short Trip/City Maintenance Schedule

39,000 Miles (65 000 km)

- Change engine oil and filter (or every 3 months, whichever occurs first).
An Emission Control Service.
- Inspect the locking front hubs (if equipped) for correct operation (or every 3 months, whichever occurs first). Repair or replace if necessary.

DATE	ACTUAL MILEAGE	SERVICED BY:

42,000 Miles (70 000 km)

- Change engine oil and filter (or every 3 months, whichever occurs first).
An Emission Control Service.
- Rotate tires. See "Tire Inspection and Rotation" in the Index for proper rotation pattern and additional information. During tire rotation, check brake calipers for freedom of movement. Refer to the appropriate GM service manual for proper caliper service procedures.
- Inspect the locking front hubs (if equipped) for correct operation (or every 3 months, whichever occurs first). Repair or replace if necessary.

DATE	ACTUAL MILEAGE	SERVICED BY:

Short Trip/City Maintenance Schedule

45,000 Miles (75 000 km)

- Change engine oil and filter (or every 3 months, whichever occurs first).
An Emission Control Service.
- Clean and repack the front wheel bearings (or at each brake relining, whichever occurs first).
- Inspect air cleaner filter if you are driving in dusty conditions. Replace filter if necessary. *An Emission Control Service. †*
- Change manual transmission fluid (or every 15 months, whichever occurs first).
- Inspect the valve lash and adjust if necessary. *An Emission Control Service.*
- Check engine idle speed and adjust it to underhood label specifications.
An Emission Control Service. †
- Inspect the locking front hubs (if equipped) for correct operation (or every 3 months, whichever occurs first). Repair or replace as necessary.
- Inspect propeller shafts and u-joints for looseness and damage (or every 15 months, whichever occurs first). Inspect more frequently if used off-road or for pulling a trailer. Tighten u-joint flange bolts if necessary.

DATE	ACTUAL MILEAGE	SERVICED BY:

Short Trip/City Maintenance Schedule

48,000 Miles (80 000 km)

- Change engine oil and filter (or every 3 months, whichever occurs first).
An Emission Control Service.
- Rotate tires. See "Tire Inspection and Rotation" in the Index for proper rotation pattern and additional information. During tire rotation, check brake calipers for freedom of movement. Refer to the appropriate GM service manual for proper caliper service procedures.
- Inspect the locking front hubs (if equipped) for correct operation (or every 3 months, whichever occurs first). Repair or replace if necessary.

DATE	ACTUAL MILEAGE	SERVICED BY:

50,000 Miles (83 000 km)

- Replace Positive Crankcase Ventilation (PCV) valve. Replace any worn, plugged or collapsed hoses. *An Emission Control Service.*

DATE	ACTUAL MILEAGE	SERVICED BY:

Short Trip/City Maintenance Schedule

51,000 Miles (85 000 km)

- Change engine oil and filter (or every 3 months, whichever occurs first).
An Emission Control Service.
- Inspect the locking front hubs (if equipped) for correct operation (or every 3 months, whichever occurs first). Repair or replace if necessary.

DATE	ACTUAL MILEAGE	SERVICED BY:

54,000 Miles (90 000 km)

- Change engine oil and filter (or every 3 months, whichever occurs first).
An Emission Control Service.
- Rotate tires. See "Tire Inspection and Rotation" in the Index for proper rotation pattern and additional information. During tire rotation, check brake calipers for freedom of movement. Refer to the appropriate GM service manual for proper caliper service procedures.
- Inspect the locking front hubs (if equipped) for correct operation (or every 3 months, whichever occurs first). Repair or replace if necessary.

DATE	ACTUAL MILEAGE	SERVICED BY:

Short Trip/City Maintenance Schedule

57,000 Miles (95 000 km)

- Change engine oil and filter (or every 3 months, whichever occurs first).
An Emission Control Service.
- Inspect the locking front hubs (if equipped) for correct operation (or every 3 months, whichever occurs first). Repair or replace if necessary.

60,000 Miles (100 000 km)

- Change engine oil and filter (or every 3 months, whichever occurs first).
An Emission Control Service.
- Clean and repack the front wheel bearings (or at each brake relining, whichever occurs first).
- Replace spark plugs.
An Emission Control Service.
- Inspect engine accessory drive belts (or every 24 months, whichever occurs first).
An Emission Control Service.
- Drain, flush and refill cooling system (or every 30 months, whichever occurs first). See "Engine Coolant" in the Index for what to use. Inspect hoses. Clean radiator, condenser, pressure cap and neck. Pressure test the cooling system and pressure cap.
An Emission Control Service. †

DATE	ACTUAL MILEAGE	SERVICED BY:

Short Trip/City Maintenance Schedule

- Replace spark plug wires (or every 60 months, whichever occurs first).
An Emission Control Service.
- Inspect the underhood wiring harness for loose connections, chafed wires and damage (or every 60 months, whichever occurs first). *An Emission Control Service. †*
- Drain, refill and bleed the brake system.
- Replace the camshaft timing belt.
An Emission Control Service. †
- Replace air cleaner filter.
An Emission Control Service.
- Inspect fuel tank, cap and lines for damage or leaks. Inspect fuel cap gasket for any damage. Replace parts as needed.
An Emission Control Service. †
- Rotate tires. See "Tire Inspection and Rotation" in the Index for proper rotation pattern and additional information. During tire rotation, check brake calipers for freedom of movement. Refer to the appropriate GM service manual for proper caliper service procedures.
- Replace fuel filter (or every 30 months, whichever occurs first).
An Emission Control Service. †
- Change manual transmission fluid (or every 15 months, whichever occurs first).
- Inspect the valve lash and adjust if necessary.
An Emission Control Service.
- Check engine idle speed and adjust it to underhood label specifications.
An Emission Control Service. †
- Inspect the locking front hubs (if equipped) for correct operation (or every 3 months, whichever occurs first). Repair or replace as necessary.

(Continued)

Short Trip/City Maintenance Schedule

60,000 Miles (100 000 km) (Continued)

- Adjust engine timing to underhood label specifications. Inspect the inside and outside of the distributor cap and rotor for cracks, carbon tracking and corrosion. Clean or replace as needed. *An Emission Control Service.*
- Inspect emission system hoses and replace as necessary. *An Emission Control Service.* †
- Inspect propeller shafts and u-joints for looseness and damage (or every 15 months, whichever occurs first). Inspect more frequently if used off-road or for pulling a trailer. Tighten u-joint flange bolts if necessary.

DATE	ACTUAL MILEAGE	SERVICED BY:

63,000 Miles (105 000 km)

- Change engine oil and filter (or every 3 months, whichever occurs first).
An Emission Control Service.
- Inspect the locking front hubs (if equipped) for correct operation (or every 3 months, whichever occurs first). Repair or replace if necessary.

DATE	ACTUAL MILEAGE	SERVICED BY:

Short Trip/City Maintenance Schedule

66,000 Miles (110 000 km)

- Change engine oil and filter (or every 3 months, whichever occurs first).
An Emission Control Service.
- Rotate tires. See "Tire Inspection and Rotation" in the Index for proper rotation pattern and additional information. During tire rotation, check brake calipers for freedom of movement. Refer to the appropriate GM service manual for proper caliper service procedures.
- Inspect the locking front hubs (if equipped) for correct operation (or every 3 months, whichever occurs first). Repair or replace if necessary.

DATE	ACTUAL MILEAGE	SERVICED BY:

69,000 Miles (115 000 km)

- Change engine oil and filter (or every 3 months, whichever occurs first).
An Emission Control Service.
- Inspect the locking front hubs (if equipped) for correct operation (or every 3 months, whichever occurs first). Repair or replace if necessary.

DATE	ACTUAL MILEAGE	SERVICED BY:

Short Trip/City Maintenance Schedule

72,000 Miles (120 000 km)

- Change engine oil and filter (or every 3 months, whichever occurs first).
An Emission Control Service.
- Rotate tires. See "Tire Inspection and Rotation" in the Index for proper rotation pattern and additional information. During tire rotation, check brake calipers for freedom of movement. Refer to the appropriate GM service manual for proper caliper service procedures.
- Inspect the locking front hubs (if equipped) for correct operation (or every 3 months, whichever occurs first). Repair or replace if necessary.

DATE	ACTUAL MILEAGE	SERVICED BY:

75,000 Miles (125 000 km)

- Change engine oil and filter (or every 3 months, whichever occurs first).
An Emission Control Service.
- Clean and repack the front wheel bearings (or at each brake relining, whichever occurs first).
- Inspect air cleaner filter if you are driving in dusty conditions. Replace filter if necessary. *An Emission Control Service.* †
- Change manual transmission fluid (or every 15 months, whichever occurs first).
- Inspect the valve lash and adjust if necessary.
An Emission Control Service.
- Check engine idle speed and adjust it to underhood label specifications.
An Emission Control Service. †

Short Trip/City Maintenance Schedule

- Inspect the locking front hubs (if equipped) for correct operation (or every 3 months, whichever occurs first). Repair or replace as necessary.
- Inspect propeller shafts and u-joints for looseness and damage (or every 15 months, whichever occurs first). Inspect more frequently if used off-road or for pulling a trailer. Tighten u-joint flange bolts if necessary.

DATE	ACTUAL MILEAGE	SERVICED BY:

78,000 Miles (130 000 km)

- Change engine oil and filter (or every 3 months, whichever occurs first).
An Emission Control Service.
- Rotate tires. See "Tire Inspection and Rotation" in the Index for proper rotation pattern and additional information. During tire rotation, check brake calipers for freedom of movement. Refer to the appropriate GM service manual for proper caliper service procedures.
- Inspect the locking front hubs (if equipped) for correct operation (or every 3 months, whichever occurs first). Repair or replace if necessary.

DATE	ACTUAL MILEAGE	SERVICED BY:

Short Trip/City Maintenance Schedule

81,000 Miles (135 000 km)

- Change engine oil and filter (or every 3 months, whichever occurs first).
An Emission Control Service.
- Inspect the locking front hubs (if equipped) for correct operation (or every 3 months, whichever occurs first). Repair or replace if necessary.

DATE	ACTUAL MILEAGE	SERVICED BY:

84,000 Miles (140 000 km)

- Change engine oil and filter (or every 3 months, whichever occurs first).
An Emission Control Service.
- Rotate tires. See "Tire Inspection and Rotation" in the Index for proper rotation pattern and additional information. During tire rotation, check brake calipers for freedom of movement. Refer to the appropriate GM service manual for proper caliper service procedures.
- Inspect the locking front hubs (if equipped) for correct operation (or every 3 months, whichever occurs first). Repair or replace if necessary.

DATE	ACTUAL MILEAGE	SERVICED BY:

Short Trip/City Maintenance Schedule

87,000 Miles (145 000 km)

- Change engine oil and filter (or every 3 months, whichever occurs first).
An Emission Control Service.
- Inspect the locking front hubs (if equipped) for correct operation (or every 3 months, whichever occurs first). Repair or replace if necessary.

90,000 Miles (150 000 km)

- Change engine oil and filter (or every 3 months, whichever occurs first).
An Emission Control Service.
- Clean and repack the front wheel bearings (or at each brake relining, whichever occurs first).
- Inspect engine accessory drive belts (or every 24 months, whichever occurs first).
An Emission Control Service.
- Inspect camshaft timing belt.
An Emission Control Service. †

DATE	ACTUAL MILEAGE	SERVICED BY:

(Continued)

Short Trip/City Maintenance Schedule

90,000 Miles (150 000 km) (Continued)

- Drain, flush and refill cooling system (or every 30 months, whichever occurs first). See "Engine Coolant" in the Index for what to use. Inspect hoses. Clean radiator, condenser, pressure cap and neck. Pressure test the cooling system and pressure cap.
An Emission Control Service. †
- Replace spark plugs.
An Emission Control Service.
- Replace air cleaner filter.
An Emission Control Service.
- Inspect fuel tank, cap and lines for damage or leaks. Inspect fuel cap gasket for any damage. Replace parts as needed.
An Emission Control Service. †
- Rotate tires. See "Tire Inspection and Rotation" in the Index for proper rotation pattern and additional information. During tire rotation, check brake calipers for freedom of movement. Refer to the appropriate GM service manual for proper caliper service procedures.
- Change manual transmission fluid (or every 15 months, whichever occurs first).
- Inspect the valve lash and adjust if necessary.
An Emission Control Service.
- Replace fuel filter (or every 30 months, whichever occurs first).
An Emission Control Service. †
- Check engine idle speed and adjust it to underhood label specifications.
An Emission Control Service. †
- Inspect the locking front hubs (if equipped) for correct operation (or every 3 months, whichever occurs first). Repair or replace as necessary.

Short Trip/City Maintenance Schedule

- Inspect propeller shafts and u-joints for looseness and damage (or every 15 months, whichever occurs first). Inspect more frequently if used off-road or for pulling a trailer. Tighten u-joint flange bolts if necessary.

DATE	ACTUAL MILEAGE	SERVICED BY:

93,000 Miles (155 000 km)

- Change engine oil and filter (or every 3 months, whichever occurs first).
An Emission Control Service.
- Inspect the locking front hubs (if equipped) for correct operation (or every 3 months, whichever occurs first). Repair or replace if necessary.

DATE	ACTUAL MILEAGE	SERVICED BY:

Short Trip/City Maintenance Schedule

96,000 Miles (160 000 km)

- Change engine oil and filter (or every 3 months, whichever occurs first).
An Emission Control Service.
- Rotate tires. See "Tire Inspection and Rotation" in the Index for proper rotation pattern and additional information. During tire rotation, check brake calipers for freedom of movement. Refer to the appropriate GM service manual for proper caliper service procedures.
- Inspect the locking front hubs (if equipped) for correct operation (or every 3 months, whichever occurs first). Repair or replace if necessary.

DATE	ACTUAL MILEAGE	SERVICED BY:

99,000 Miles (165 000 km)

- Change engine oil and filter (or every 3 months, whichever occurs first).
An Emission Control Service.
- Inspect the locking front hubs (if equipped) for correct operation (or every 3 months, whichever occurs first). Repair or replace if necessary.

DATE	ACTUAL MILEAGE	SERVICED BY:

Short Trip/City Maintenance Schedule

100,000 Miles (166 000 km)

- Change automatic transmission fluid and filter if the vehicle is mainly driven under one or more of these conditions:
 - In heavy city traffic where the outside temperature regularly reaches 90°F (32°C) or higher.
 - In hilly or mountainous terrain.
 - When doing frequent trailer towing.
 - Uses such as found in taxi, police or delivery service.

If you do not use your vehicle under any of these conditions, the fluid and filter do not require changing.

- Replace Positive Crankcase Ventilation (PCV) valve. Replace any worn, plugged or collapsed hoses. *An Emission Control Service.*
- Inspect Exhaust Gas Recirculation (EGR) system. *An Emission Control Service.*
- Inspect fuel injector. *An Emission Control Service.*
- Replace evaporative emissions canister. *An Emission Control Service.*

DATE	ACTUAL MILEAGE	SERVICED BY:

Long Trip/Highway Maintenance Schedule

The services shown in this schedule up to 100,000 miles (166 000 km) should be performed after 100,000 miles (166 000 km) at the same intervals.

Footnotes

† The U.S. Environmental Protection Agency or the California Air Resources Board has determined that the failure to perform this maintenance item will not nullify the emission warranty or limit recall liability prior to the completion of the vehicle's useful life. We, however, urge that all recommended maintenance services be performed at the indicated intervals and the maintenance be recorded.

7,500 Miles (12 500 km)

- Change engine oil and filter (or every 7.5 months, whichever occurs first).
An Emission Control Service.
- Rotate tires. See "Tire Inspection and Rotation" in the Index for proper rotation pattern and additional information. During tire rotation, check brake calipers for freedom of movement. Refer to the appropriate GM service manual for proper caliper service procedures.
- Inspect the locking front hubs (if equipped) for correct operation (or every 3 months, whichever occurs first). Repair or replace if necessary.

DATE	ACTUAL MILEAGE	SERVICED BY:

Long Trip/Highway Maintenance Schedule

15,000 Miles (25 000 km)

- Change engine oil and filter (or every 7.5 months, whichever occurs first).
An Emission Control Service.
- Rotate tires. See "Tire Inspection and Rotation" in the Index for proper rotation pattern and additional information. During tire rotation, check brake calipers for freedom of movement. Refer to the appropriate GM service manual for proper caliper service procedures.
- Inspect the locking front hubs (if equipped) for correct operation (or every 3 months, whichever occurs first). Repair or replace if necessary.
- Inspect the valve lash and adjust if necessary. *An Emission Control Service.*
- Check engine idle speed and adjust it to underhood label specifications.
An Emission Control Service.†
- Inspect propeller shafts and u-joints for looseness and damage (or every 15 months, whichever occurs first). Inspect more frequently if used off-road or for pulling a trailer. Tighten u-joint flange bolts if necessary.

DATE	ACTUAL MILEAGE	SERVICED BY:

Long Trip/Highway Maintenance Schedule

22,500 Miles (37 500 km)

- Change engine oil and filter (or every 7.5 months, whichever occurs first).
An Emission Control Service.
- Rotate tires. See "Tire Inspection and Rotation" in the Index for proper rotation pattern and additional information. During tire rotation, check brake calipers for freedom of movement. Refer to the appropriate GM service manual for proper caliper service procedures.
- Inspect the locking front hubs (if equipped) for correct operation (or every 3 months, whichever occurs first). Repair or replace if necessary.

DATE	ACTUAL MILEAGE	SERVICED BY:

30,000 Miles (50 000 km)

- Change engine oil and filter (or every 7.5 months, whichever occurs first).
An Emission Control Service.
- Clean and repack the front wheel bearings (or at each brake relining, whichever occurs first).
- Rotate tires. See "Tire Inspection and Rotation" in the Index for proper rotation pattern and additional information. During tire rotation, check brake calipers for freedom of movement. Refer to the appropriate GM service manual for proper caliper service procedures.
- Inspect engine accessory drive belts (or every 24 months, whichever occurs first).
An Emission Control Service.

Long Trip/Highway Maintenance Schedule

- Drain, flush and refill cooling system (or every 30 months, whichever occurs first). See "Engine Coolant" in the Index for what to use. Inspect hoses. Clean radiator, condenser, pressure cap and neck. Pressure test the cooling system and pressure cap.
An Emission Control Service. †
- Replace spark plugs.
An Emission Control Service.
- Replace air cleaner filter.
An Emission Control Service.
- Inspect fuel tank, cap and lines for damage or leaks. Inspect fuel cap gasket for any damage. Replace parts as needed.
An Emission Control Service. †
- Change manual transmission fluid (or every 30 months, whichever occurs first).
- Replace fuel filter (or every 30 months, whichever occurs first, or sooner if filter is clogged). *An Emission Control Service. †*
- Inspect the locking front hubs (if equipped) for correct operation (or every 3 months, whichever occurs first). Repair or replace if necessary.
- Inspect the valve lash and adjust if necessary. *An Emission Control Service.*

(Continued)

Long Trip/Highway Maintenance Schedule

30,000 Miles (50 000 km) (Continued)

- Check engine idle speed and adjust it to underhood label specifications.
An Emission Control Service.†
- Inspect propeller shafts and u-joints for looseness and damage (or every 15 months, whichever occurs first). Inspect more frequently if used off-road or for pulling a trailer. Tighten u-joint flange bolts if necessary.

DATE	ACTUAL MILEAGE	SERVICED BY:

37,500 Miles (62 500 km)

- Change engine oil and filter (or every 7.5 months, whichever occurs first).
An Emission Control Service.
- Rotate tires. See "Tire Inspection and Rotation" in the Index for proper rotation pattern and additional information. During tire rotation, check brake calipers for freedom of movement. Refer to the appropriate GM service manual for proper caliper service procedures.
- Inspect the locking front hubs (if equipped) for correct operation (or every 3 months, whichever occurs first). Repair or replace if necessary.

DATE	ACTUAL MILEAGE	SERVICED BY:

Long Trip/Highway Maintenance Schedule

45,000 Miles (75 000 km)

- Change engine oil and filter (or every 7.5 months, whichever occurs first).

An Emission Control Service.

- Rotate tires. See "Tire Inspection and Rotation" in the Index for proper rotation pattern and additional information. During tire rotation, check brake calipers for freedom of movement. Refer to the appropriate GM service manual for proper caliper service procedures.
- Inspect the locking front hubs (if equipped) for correct operation (or every 3 months, whichever occurs first). Repair or replace if necessary.
- Inspect the valve lash and adjust if necessary. *An Emission Control Service.*

- Check engine idle speed and adjust it to underhood label specifications.

An Emission Control Service.†

- Inspect propeller shafts and u-joints for looseness and damage (or every 15 months, whichever occurs first). Inspect more frequently if used off-road or for pulling a trailer. Tighten u-joint flange bolts if necessary.

DATE	ACTUAL MILEAGE	SERVICED BY:

Long Trip/Highway Maintenance Schedule

50,000 Miles (83 000 km)

- Change automatic transmission fluid and filter if the vehicle is mainly driven under one or more of these conditions:
 - In heavy city traffic where the outside temperature regularly reaches 90°F (32°C) or higher.
 - In hilly or mountainous terrain.
 - When doing frequent trailer towing.
 - Uses such as found in taxi, police or delivery service.

If you do not use your vehicle under any of these conditions, the fluid and filter do not require changing.

- Replace Positive Crankcase Ventilation (PCV) valve. Replace any worn, plugged or collapsed hoses. *An Emission Control Service.*

DATE	ACTUAL MILEAGE	SERVICED BY:

Long Trip/Highway Maintenance Schedule

52,500 Miles (87 500 km)

- Change engine oil and filter (or every 7.5 months, whichever occurs first).
An Emission Control Service.
- Rotate tires. See "Tire Inspection and Rotation" in the Index for proper rotation pattern and additional information. During tire rotation, check brake calipers for freedom of movement. Refer to the appropriate GM service manual for proper caliper service procedures.
- Inspect the locking front hubs (if equipped) for correct operation (or every 3 months, whichever occurs first). Repair or replace if necessary.

DATE	ACTUAL MILEAGE	SERVICED BY:

60,000 Miles (100 000 km)

- Change engine oil and filter (or every 7.5 months, whichever occurs first).
An Emission Control Service.
- Clean and repack the front wheel bearings (or at each brake relining, whichever occurs first).
- Rotate tires. See "Tire Inspection and Rotation" in the Index for proper rotation pattern and additional information. During tire rotation, check brake calipers for freedom of movement. Refer to the appropriate GM service manual for proper caliper service procedures.
- Inspect engine accessory drive belts (or every 24 months, whichever occurs first).
An Emission Control Service.

(Continued)

Long Trip/Highway Maintenance Schedule

60,000 Miles (100 000 km) (Continued)

- Drain, flush and refill cooling system (or every 30 months, whichever occurs first). See "Engine Coolant" in the Index for what to use. Inspect hoses. Clean radiator, condenser, pressure cap and neck. Pressure test the cooling system and pressure cap. *An Emission Control Service.* †
- Replace spark plugs. *An Emission Control Service.*
- Replace air cleaner filter. *An Emission Control Service.*
- Inspect fuel tank, cap and lines and any hoses for damage. Replace fuel tank cap gasket. *An Emission Control Service.* †
- Change manual transmission fluid (or every 30 months, whichever occurs first).
- Replace fuel filter (or every 30 months, whichever occurs first). *An Emission Control Service.* †
- Inspect the locking front hubs (if equipped) for correct operation (or every 3 months, whichever occurs first). Repair or replace as necessary.
- Inspect the valve lash and adjust if necessary. *An Emission Control Service.*
- Check engine idle speed and adjust it to underhood label specifications. *An Emission Control Service.* †

Long Trip/Highway Maintenance Schedule

- Adjust engine timing to underhood label specifications. Inspect the inside and outside of the distributor cap and rotor for cracks, carbon tracking and corrosion. Clean or replace as needed.
An Emission Control Service. †
- Inspect emission system hoses and replace as necessary. *An Emission Control Service. †*
- Inspect propeller shafts and u-joints for looseness and damage (or every 15 months, whichever occurs first). Inspect more frequently if used off-road or for pulling a trailer. Tighten u-joint flange bolts if necessary.
- Inspect the underhood wiring harness for loose connections, chafed wires and damage (or every 60 months, whichever occurs first). *An Emission Control Service. †*
- Replace the camshaft timing belt.
An Emission Control Service. †
- Replace spark plug wires (or every 60 months, whichever occurs first).
An Emission Control Service.
- Drain, refill and bleed the brake system.

DATE	ACTUAL MILEAGE	SERVICED BY:

Long Trip/Highway Maintenance Schedule

67,500 Miles (112 500 km)

- Change engine oil and filter (or every 7.5 months, whichever occurs first).
An Emission Control Service.
- Rotate tires. See "Tire Inspection and Rotation" in the Index for proper rotation pattern and additional information. During tire rotation, check brake calipers for freedom of movement. Refer to the appropriate GM service manual for proper caliper service procedures.
- Inspect the locking front hubs (if equipped) for correct operation (or every 3 months, whichever occurs first). Repair or replace if necessary.

DATE	ACTUAL MILEAGE	SERVICED BY:

75,000 Miles (125 000 km)

- Change engine oil and filter (or every 7.5 months, whichever occurs first).
An Emission Control Service.
- Rotate tires. See "Tire Inspection and Rotation" in the Index for proper rotation pattern and additional information. During tire rotation, check brake calipers for freedom of movement. Refer to the appropriate GM service manual for proper caliper service procedures.
- Inspect the locking front hubs (if equipped) for correct operation (or every 3 months, whichever occurs first). Repair or replace if necessary.
- Inspect the valve lash and adjust if necessary. *An Emission Control Service.*

Long Trip/Highway Maintenance Schedule

- Check engine idle speed and adjust it to underhood label specifications.
An Emission Control Service.†
- Inspect propeller shafts and u-joints for looseness and damage (or every 15 months, whichever occurs first). Inspect more frequently if used off-road or for pulling a trailer. Tighten u-joint flange bolts if necessary.

DATE	ACTUAL MILEAGE	SERVICED BY:

82,500 Miles (137 500 km)

- Change engine oil and filter (or every 7.5 months, whichever occurs first).
An Emission Control Service.
- Rotate tires. See "Tire Inspection and Rotation" in the Index for proper rotation pattern and additional information. During tire rotation, check brake calipers for freedom of movement. Refer to the appropriate GM service manual for proper caliper service procedures.
- Inspect the locking front hubs (if equipped) for correct operation (or every 3 months, whichever occurs first). Repair or replace if necessary.

DATE	ACTUAL MILEAGE	SERVICED BY:

Long Trip/Highway Maintenance Schedule

90,000 Miles (150 000 km)

- Change engine oil and filter (or every 7.5 months, whichever occurs first).
An Emission Control Service.
- Clean and repack the front wheel bearings (or at each brake relining, whichever occurs first).
- Inspect engine accessory drive belts (or every 24 months, whichever occurs first).
An Emission Control Service.
- Inspect camshaft timing belt.
An Emission Control Service. †
- Drain, flush and refill cooling system (or every 30 months, whichever occurs first). See "Engine Coolant" in the Index for what to use. Inspect hoses. Clean radiator, condenser, pressure cap and neck. Pressure test the cooling system and pressure cap.
An Emission Control Service. †
- Replace spark plugs.
An Emission Control Service.
- Replace air cleaner filter.
An Emission Control Service.
- Inspect fuel tank, cap and lines and any hoses for damage. Replace fuel tank cap gasket. *An Emission Control Service. †*
- Change manual transmission fluid (or every 30 months, whichever occurs first).
- Replace fuel filter (or every 30 months, whichever occurs first).
An Emission Control Service. †
- Inspect the locking front hubs (if equipped) for correct operation (or every 3 months, whichever occurs first). Repair or replace if necessary.
- Inspect the valve lash and adjust if necessary. *An Emission Control Service.*

Long Trip/Highway Maintenance Schedule

- Check engine idle speed and adjust it to underhood label specifications.
An Emission Control Service.†
- Inspect propeller shafts and u-joints for looseness and damage (or every 15 months, whichever occurs first). Inspect more frequently if used off-road or for pulling a trailer. Tighten u-joint flange bolts if necessary.
- Rotate tires. See "Tire Inspection and Rotation" in the Index for proper rotation pattern and additional information. During tire rotation, check brake calipers for freedom of movement. Refer to the appropriate GM service manual for proper caliper service procedures.

DATE	ACTUAL MILEAGE	SERVICED BY:

97,500 Miles (162 500 km)

- Change engine oil and filter (or every 7.5 months, whichever occurs first).
An Emission Control Service.
- Rotate tires. See "Tire Inspection and Rotation" in the Index for proper rotation pattern and additional information. During tire rotation, check brake calipers for freedom of movement. Refer to the appropriate GM service manual for proper caliper service procedures.
- Inspect the locking front hubs (if equipped) for correct operation (or every 3 months, whichever occurs first). Repair or replace if necessary.

DATE	ACTUAL MILEAGE	SERVICED BY:

Long Trip/Highway Maintenance Schedule

100,000 Miles (166 000 km)

- Change automatic transmission fluid and filter if the vehicle is mainly driven under one or more of these conditions:
 - In heavy city traffic where the outside temperature regularly reaches 90°F (32°C) or higher.
 - In hilly or mountainous terrain.
 - When doing frequent trailer towing.
 - Uses such as found in taxi, police or delivery service.

If you do not use your vehicle under any of these conditions, the fluid and filter do not require changing.

- Replace Positive Crankcase Ventilation (PCV) valve. Replace any worn, plugged or collapsed hoses. *An Emission Control Service.*
- Inspect Exhaust Gas Recirculation (EGR) system. *An Emission Control Service.*
- Inspect fuel injector. *An Emission Control Service.*
- Replace evaporative emissions canister. *An Emission Control Service.*

DATE	ACTUAL MILEAGE	SERVICED BY:

Part B: Owner Checks and Services

Listed below are owner checks and services which should be performed at the intervals specified to help ensure the safety, dependability and emission control performance of your vehicle.

Be sure any necessary repairs are completed at once. Whenever any fluids or lubricants are added to your vehicle, make sure they are the proper ones, as shown in Part D.

At Each Fuel Fill

It is important for you or a service station attendant to perform these underhood checks at each fuel fill.

Engine Oil Level Check

Check the engine oil level and add the proper oil if necessary. See "Engine Oil" in the Index for further details.

Engine Coolant Level Check

Check the engine coolant level and add the proper coolant mix if necessary. See "Engine Coolant" in the Index for further details.

Windshield Washer Fluid Level Check

Check the windshield washer fluid level in the windshield washer tank and add the proper fluid if necessary. See "Windshield Washer Fluid" in the Index for further details.

Hood Latch Operation Check

Pull the primary hood latch release handle inside the vehicle. The secondary latch should keep the hood from opening all the way when the primary latch is released. Make sure the hood closes firmly. See "Hood Release" in the Index for further details.

At Least Once a Month

Tire Inflation Check

Make sure tires are inflated to the correct pressures. See "Tires" in the Index for further details.

Cassette Deck Service

Clean cassette deck. Cleaning should be done every 50 hours of tape play. See "Audio Systems" in the Index for further details.

At Least Twice a Year

Restraint System Check

Make sure the safety belt reminder light and all your belts, buckles, latch plates, retractors and anchorages are working properly. Look for any other loose or damaged safety belt system parts. If you see anything that might keep a safety belt system from doing its job, have it repaired. Have any torn or frayed safety belts replaced.

Also look for any opened or broken air bag covers, and have them repaired or replaced. (The air bag system does not need regular maintenance.)

Fluid Level Check

Check the transfer case, axle differential(s) and automatic or manual transmission fluid levels and add as needed. See "Transfer Case," "Axle, Rear," "Axle, Front" and "Automatic Transmission" or "Manual Transmission" in the Index. A fluid loss in these systems could indicate a problem. Have the system inspected and repaired at once.

Automatic Transmission Check

Check the transmission fluid level; add if needed. See "Automatic Transmission" in the Index. A fluid loss may indicate a problem. Check the system and repair if needed.

At Least Once a Year

Key Lock Cylinders Service

Lubricate the key lock cylinders with the lubricant specified in Part D.

Body Lubrication Service

Lubricate all body door hinges. Also lubricate all hinges and latches, including those for the hood, rear compartment, glove box door, console door and any folding seat hardware. Part D tells you what to use. More frequent lubrication may be required when exposed to a corrosive environment.

Starter Switch Check

CAUTION:

When you are doing this check, the vehicle could move suddenly. If it does, you or others could be injured. Follow the steps below.

1. Before you start, be sure you have enough room around the vehicle.
2. Firmly apply both the parking brake (see “Parking Brake” in the Index if necessary) and the regular brake.

NOTE: Do not use the accelerator pedal, and be ready to turn off the engine immediately if it starts.

3. On automatic transmission vehicles, try to start the engine in each gear. The starter should work only in PARK (P) or NEUTRAL (N). If the starter works in any other position, your vehicle needs service.

On manual transmission vehicles, put the shift lever in NEUTRAL (N), push the clutch down halfway and try to start the engine. The starter should work only when the clutch is pushed down all the way to the floor. If the starter works when the clutch isn't pushed all the way down, your vehicle needs service.

Brake-Transmission Shift Interlock (BTSI) Check (Automatic Transmission)

CAUTION:

When you are doing this check, the vehicle could move suddenly. If it does, you or others could be injured. Follow the steps below.

1. Before you start, be sure you have enough room around the vehicle. It should be parked on a level surface.
2. Firmly apply the parking brake (see “Parking Brake” in the Index if necessary).

NOTE: Be ready to apply the regular brake immediately if the vehicle begins to move.

3. With the engine off, turn the key to the ON position, but don't start the engine. Without applying the regular brake, try to move the shift lever out of PARK (P) with normal effort. If the shift lever moves out of PARK (P), your vehicle's BTSI needs service.

Steering Column Lock Check

While parked, and with the parking brake set, try to turn the key to LOCK in each shift lever position.

- With an automatic transmission, the key should turn to LOCK only when the shift lever is in PARK (P).
- With a manual transmission, the key should turn to LOCK only if you push the key in farther, while turning it towards LOCK.

On vehicles with a key release lever, try to turn the key to LOCK without pressing the lever. The key should turn to LOCK only when you press the key lever.

On all vehicles, the key should come out only in LOCK.

Parking Brake and Automatic Transmission PARK (P) Mechanism Check

CAUTION:

When you are doing this check, your vehicle could begin to move. You or others could be injured and property could be damaged. Make sure there is room in front of your vehicle in case it begins to roll. Be ready to apply the regular brake at once should the vehicle begin to move.

Park on a fairly steep hill, with the vehicle facing downhill. Keeping your foot on the regular brake, set the parking brake.

- To check the parking brake: With the engine running and transmission in NEUTRAL (N), slowly remove foot pressure from the regular brake pedal. Do this until the vehicle is held by the parking brake only.
- To check the PARK (P) mechanism's holding ability: Shift to PARK (P). Then release all brakes. If your vehicle is four-wheel drive, be sure the transfer case is not in NEUTRAL (N).

Underbody Flushing Service

At least every spring, use plain water to flush any corrosive materials from the underbody. Take care to clean thoroughly any areas where mud and other debris can collect.

Part C: Periodic Maintenance Inspections

Listed below are inspections and services which should be performed at least twice a year (for instance, each spring and fall). You should let your GM dealer's service department or other qualified service center do these jobs. Make sure any necessary repairs are completed at once.

Proper procedures to perform these services may be found in a Geo service manual. See "Service and Owner Publications" in the Index.

Steering, Suspension and Front-Wheel-Drive Axle Boot and Seal Inspection

Inspect the front and rear suspension and steering system for damaged, loose or missing parts, signs of wear, or lack of lubrication. Inspect the power steering lines and hoses for proper hook-up, binding, leaks, cracks, chafing, etc. Clean and then inspect the drive axle boot seals for damage, tears or leakage. Replace seals if necessary.

Exhaust System Inspection

Inspect the complete exhaust system. Inspect the body near the exhaust system. Look for broken, damaged, missing or out-of-position parts as well as open seams, holes, loose connections, or other conditions which could cause a heat build-up in the floor pan or could let exhaust fumes into the vehicle. See "Engine Exhaust" in the Index.

Radiator and Heater Hose Inspection

Inspect the hoses and have them replaced if they are cracked, swollen or deteriorated. Inspect all pipes, fittings and clamps; replace as needed.

Throttle Linkage Inspection

Inspect the throttle linkage for interference or binding, and for damage or missing parts. Replace parts as needed. Replace any cables that have high effort or excessive wear. Do not lubricate accelerator and cruise control cables.

Rear Axle (All) and Front Axle (Four-Wheel Drive) Service

Check the gear lubricant level and add if needed. See "Rear Axle" and "Four-Wheel Drive" in the Index. A fluid loss may indicate a problem. Check the system(s), and repair the system(s) if needed. Refer to "Scheduled Maintenance Services," earlier in this section, to determine when to change the lubricant.

Brake System Inspection

Inspect the complete system. Inspect brake lines and hoses for proper hook-up, binding, leaks, cracks, chafing, etc. Inspect disc brake pads for wear and rotors for surface condition. Also inspect drum brake linings for wear and cracks. Inspect other brake parts, including drums, wheel cylinders, calipers, parking brake, etc. Check parking brake adjustment. You may need to have your brakes inspected more often if your driving habits or conditions result in frequent braking.

Clutch System Service

Check clutch pedal free travel and adjust as necessary. See "Clutch Adjustment" in the Index.

Part D: Recommended Fluids and Lubricants

NOTE: Fluids and lubricants identified below by name, part number or specification may be obtained from your GM dealer.

USAGE	FLUID/LUBRICANT
Engine Oil	Engine oil with the American Petroleum Institute Certified For Gasoline Engines "Starburst" symbol of the proper viscosity. To determine the preferred viscosity for your vehicle's engine, see "Engine Oil" in the Index.
Engine Coolant	50/50 mixture of clean water (preferably distilled) and good quality ethylene glycol base antifreeze (GM Part No. 1052753 or equivalent) conforming to GM Specification 1825M or approved recycled coolant conforming to GM Specification 1825M. See "Engine Coolant" in the Index.

USAGE	FLUID/LUBRICANT
Hydraulic Brake System	Delco Supreme 11 [®] Brake Fluid (GM Part No. 1052535 or equivalent DOT-3 brake fluid).
Parking Brake Cable Guides	Chassis lubricant (GM Part No. 1052497 or equivalent) or lubricant meeting requirements of NLGI Grade 2, Category LB or GC-LB.
Power Steering System	DEXRON [®] -III Automatic Transmission Fluid.
Manual Transmission (All) and Transfer Case (4-Wheel-Drive)	GM Goodwrench Synthetic Manual Transmission Gear Oil (GM Part No. 12346190 - 1 qt.), Castrol Syntorq [®] LT or equivalent SAE 75W-90 GL-4 gear oil.
Automatic Transmission	DEXRON [®] -III Automatic Transmission Fluid.
Key Lock Cylinders	Multi-Purpose Lubricant, Superlube [®] (GM Part No. 12346241 or equivalent).

USAGE	FLUID/LUBRICANT
Manual Transmission Shift Linkage	Chassis lubricant (GM Part No. 1052497 or equivalent) or lubricant meeting requirements of NLGI Grade 2, Category LB or GC-LB.
Clutch Linkage Pivot Points	Lithium base grease.
Floor Shift Linkage	Lubriplate Lubricant aerosol (GM Part No. 12346293 or equivalent) or lubricant meeting requirements of NLGI Grade 2 Category LB or GC-LB.
Chassis Lubrication	Chassis lubricant (GM Part No. 1052497 or equivalent) or lubricant meeting requirements of NLGI Grade 2, Category LB or GC-LB.
Rear Axle (All) and Front Axle (Four-Wheel Drive)	Axle Lubricant (GM Part No. 12345977) or SAE 80W-90 GL-5 Gear Lubricant.

USAGE	FLUID/LUBRICANT
Windshield Washer Solvent	GM Optikleen [®] Washer Solvent (GM Part No. 1051515) or equivalent.
Hood Latch Assembly Pivots, Spring Anchor and Release Pawl	Lubriplate lubricant aerosol (GM Part No. 12346293 or equivalent) or lubricant meeting requirements of NLGI Grade 2, Category LB or GC-LB.
Hood and Door Hinges	Multi-purpose lubricant, Superlube [®] (GM Part No. 12346241 or equivalent).
Weatherstrip Conditioning	Dielectric Silicone Grease (GM Part No. 12345579 or equivalent).

See "Replacement Parts" in the Index for recommended replacement filters, valves and spark plugs.

Part E: Maintenance Record

After the scheduled services are performed, record the date, odometer reading and who performed the service in the boxes provided after the maintenance interval. Any additional information from "Owner Checks and

Services" or "Periodic Maintenance" can be added on the following record pages. Also, you should retain all maintenance receipts. Your owner information portfolio is a convenient place to store them.

Maintenance Record			
DATE	ODOMETER READING	SERVICED BY	MAINTENANCE PERFORMED

Here you will find out how to contact Chevrolet/Geo if you need assistance. This section also tells you how to obtain service publications and how to report any safety defects.

This section includes information on:

- The Customer Satisfaction Procedure
- Customer Assistance for Text Telephone (TTY) Users
- Roadside Assistance
- Courtesy Transportation
- BBB Auto Line -- Alternative Dispute Resolution Program
- Reporting Safety Defects
- Service and Owner Publications

Customer Satisfaction Procedure



Your satisfaction and goodwill are important to your dealer and Chevrolet/Geo. Normally, any concern you

may have with your vehicle can be handled by your selling or servicing dealer. Your dealer has the facility, trained technicians, special tools and up-to-date information to promptly address any issue which may arise. Chevrolet/Geo has empowered its dealers to make any decisions and repair vehicles, and they are eager to resolve your concern to your complete satisfaction. If your concern has not been resolved to your satisfaction, take the following steps:

STEP ONE -- Discuss your concern with a member of dealer management. Normally, concerns can be quickly resolved at that level. If the matter has already been reviewed with the Sales, Service, or Parts Manager, contact the owner of the dealership or the General Manager.

STEP TWO -- If after contacting a member of dealership management, it appears your concern cannot be resolved by the dealership without further help, contact the Chevrolet/Geo Customer Assistance Center by calling 1-800-222-1020. In Canada, contact GM of Canada Customer Assistance Center in Oshawa by calling 1-800-263-3777 (English) or 1-800-263-7854 (French).

For help outside of the United States and Canada, call the following numbers as appropriate:

- In Mexico: (525) 625-3256
- In Puerto Rico: 1-800-496-9992 (English) or 1-800-496-9993 (Spanish)
- In the U.S. Virgin Islands: 1-800-496-9994
- In the Dominican Republic: 1-800-751-4135 (English) or 1-800-751-4136 (Spanish)
- In the Bahamas: 1-800-389-0009
- In Bermuda, Barbados, Antigua and the British Virgin Islands: 1-800-534-0122
- In all other Caribbean countries: 1-809-763-1315
- In other overseas locations, call GM North American Export Sales in Canada at 1-905-644-4112

For prompt assistance, please have the following information available to give the Customer Assistance Representative:

- Your name, address, home and business telephone numbers
- Vehicle Identification Number (This is available from the vehicle registration or title, or the plate at the top left of the instrument panel and visible through the windshield.)
- Dealership name and location
- Vehicle delivery date and present mileage
- Nature of concern

We encourage you to call us so we can give your inquiry prompt attention. However, if you wish to write Chevrolet/Geo, write to:

Chevrolet/Geo
Customer Assistance Center
P.O. Box 7047
Troy, MI 48007-7047

Refer to your Warranty and Owner Assistance Information booklet for addresses of Canadian and GM Overseas offices.

When contacting Chevrolet/Geo, please remember that your concern will likely be resolved by the dealer, using the dealer's facilities, equipment and personnel. That is why we suggest you follow Step One first if you have a concern.

Customer Assistance for Text Telephone (TTY) Users

To assist customers who are deaf, hard of hearing, or speech-impaired and who use Text Telephones (TTYs), Chevrolet/Geo has TTY equipment available at its Customer Assistance Center. Any TTY user can communicate with Chevrolet/Geo by dialing: 1-800-833-CHEV. (TTY users in Canada can dial 1-800-263-3830.)

Chevrolet/Geo Roadside Assistance Program

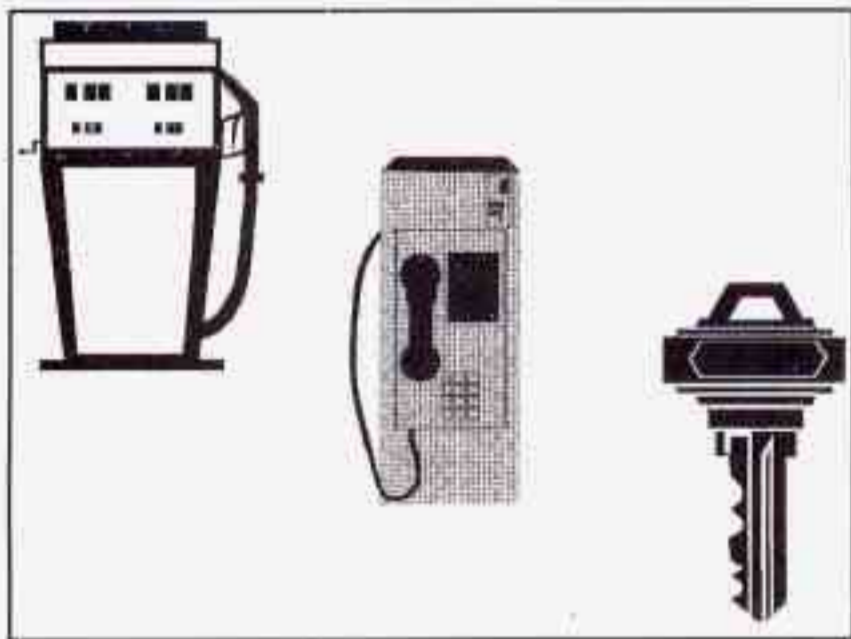

To enhance Chevrolet/Geo's strong commitment to customer satisfaction, Chevrolet/Geo is excited to announce the establishment of the Chevrolet/Geo Roadside Assistance Center. As the owner of a 1996 Chevrolet/Geo, membership in Roadside Assistance is free.

Roadside Assistance is available 24 hours a day, 365 days a year, by calling 1-800-CHEV-USA (1-800-243-8872). This toll-free number will provide you over-the-phone roadside assistance with minor mechanical problems. If your problem cannot be resolved over the phone, our advisors have access to a nationwide network of dealer recommended service providers. Roadside membership is free, however some services may incur costs.

Roadside offers two levels of service to the customer, *Basic Care* and *Courtesy™ Care*:

- Toll-free number, 1-800-CHEV-USA
- Free towing for warranty repairs
- Basic over-the-phone technical advice
- Available dealer services at reasonable costs (ie., wrecker services, locksmith/key service, glass repair, etc.)

ROADSIDE *Courtesy™ Care* PROVIDES:

- Roadside *Basic Care* services (as outlined above)
Plus:
- FREE Non-Warranty Towing (to the closest dealer from a legal roadway)
- FREE Locksmith/Key Service (when keys are lost on the road or locked inside)

- FREE Flat Tire Service (spare installed on the road)
- FREE Jump Start (at home or on the road)
- FREE Fuel Delivery (\$5 of fuel delivered on the road)

Chevrolet/Geo offers Courtesy Transportation for customers needing warranty service. Courtesy Transportation will be offered in conjunction with the coverage provided by the BUMPER-TO-BUMPER New Vehicle Limited Warranty to eligible purchasers of 1996 Chevrolet/Geo passenger car and light duty trucks. (Please see your selling dealer for details.)

Note: *Courtesy Care* is available to Retail and Retail Lease Customers operating 1996 and newer Chevrolet/Geo vehicles for a period of 36 months/36,000 miles. All *Courtesy Care* services must be pre-arranged by Chevrolet/Geo Roadside or dealer Service Management.

Basic Care and *Courtesy Care* are not part of or included in the coverage provided by the New Vehicle Limited Warranty. Chevrolet/Geo reserves the right to modify or discontinue *Basic Care* and *Courtesy Care* at any time.

For complete program details, see your Chevrolet/Geo dealer to obtain a Roadside Assistance Center brochure.

The Roadside Assistance Center uses companies that will provide you with quality and priority service. When roadside services are required, our advisors will explain any payment obligations that may be incurred for utilizing outside services.

For prompt assistance when calling, please have the following available to give to the advisor:

- Vehicle Identification Number
- License plate number
- Vehicle color
- Vehicle location
- Telephone number where you can be reached
- Vehicle mileage
- Description of problem

Please refer to the Roadside Assistance brochure inside your owner information portfolio for full program details.

Canadian Roadside Assistance

Vehicles purchased in Canada have an extensive Roadside Assistance program accessible from anywhere in Canada or the United States. Please refer to the separate brochure provided by the dealer or call 1-800-268-6800 for emergency services.

Courtesy Transportation

Chevrolet/Geo offers Courtesy Transportation for customers needing warranty service. Courtesy Transportation will be offered in conjunction with the coverage provided by the BUMPER-TO-BUMPER New Vehicle Limited Warranty to retail purchasers of 1996 Chevrolet/Geo passenger cars and light duty trucks (please see your selling dealer for details).

Courtesy Transportation includes:

- One way shuttle ride for any warranty repair completed during the same day.
- Up to \$30 maximum daily vehicle rental allowance for any overnight warranty repair up to five days, OR
- Up to \$30 maximum daily cab, bus, or other transportation allowance in lieu of rental for any overnight warranty repair up to five days, OR
- Up to \$10 daily fuel allowance for rides provided by another person (i.e., friend, neighbor, etc.) in lieu of rental for any overnight warranty repair up to five days.

Note: All Courtesy Transportation arrangements will be administered by your Chevrolet/Geo dealer service management. Claim amounts should reflect all actual costs.

- Chevrolet/Geo Courtesy Transportation is not part of the BUMPER-TO-BUMPER New Vehicle Limited Warranty. Chevrolet/Geo reserves the right to make any changes or discontinue Courtesy Transportation at any time without notification.
- For additional program details contact your Chevrolet/Geo dealer.

In Canada, please consult your GM dealer for information on Courtesy Transportation.

Some state insurance regulations make it impractical to rent vehicles to people under 21 years of age. If you are under 21 and have difficulty renting a vehicle, Chevrolet/Geo will reimburse up to \$30/day for documented transportation you receive.

For warranty repairs during the Complete Vehicle Coverage period in the New Vehicle Limited Warranty, interim transportation may be available under the Courtesy Transportation Program. Please consult your dealer for details. The Roadside Assistance program is available only in the United States and Canada.

GM Participation in BBB AUTO LINE -- Alternative Dispute Resolution Program*

*This program may not be available in all states, depending on state law. Canadian owners refer to your Warranty and Owner Assistance Information booklet. General Motors reserves the right to change eligibility limitations and/or to discontinue its participation in this program.

Both Chevrolet/Geo and your Chevrolet/Geo dealer are committed to making sure you are completely satisfied with your new vehicle. Our experience has shown that, if a situation arises where you feel your concern has not been adequately addressed, the Customer Satisfaction Procedure described earlier in this section is very successful.

There may be instances where an impartial third party can assist in arriving at a solution to a disagreement regarding vehicle repairs or interpretation of the New Vehicle Limited Warranty. To assist in resolving these disagreements, Chevrolet/Geo voluntarily participates in BBB AUTO LINE.

BBB AUTO LINE is an out-of-court program administered by the Better Business Bureau system to settle disputes between customers and automobile manufacturers. This program is available free of charge to customers who currently own or lease a GM vehicle.

If you are not satisfied after following the Customer Satisfaction Procedure, you may contact the BBB using the toll-free telephone number, or write them at the following address:

BBB AUTO LINE
Council of Better Business Bureaus
4200 Wilson Boulevard
Suite 800
Arlington, VA 22203
Telephone: 1-800-955-5100

To file a claim, you will be asked to provide your name and address, your Vehicle Identification Number (VIN) and a statement of the nature of your complaint. Eligibility is limited by vehicle age and mileage, and other factors.

We prefer you utilize the Customer Satisfaction Procedure before you resort to AUTO LINE, but you may contact the BBB at any time. The BBB will attempt to resolve the complaint serving as an intermediary between you and Chevrolet/Geo. If this mediation is unsuccessful, an informal hearing will be scheduled where eligible customers may present their case to an impartial third-party arbitrator.

The arbitrator will make a decision which you may accept or reject. If you accept the decision, GM will be bound by that decision. The entire dispute resolution procedure should ordinarily take about 40 days from the time you file a claim until a decision is made.

Some state laws may require you to use this program before filing a claim with a state-run arbitration program or in the courts. For further information, contact the BBB at 1-800-955-5100 or the Chevrolet/Geo Customer Assistance Center at 1-800-222-1020.

REPORTING SAFETY DEFECTS TO THE UNITED STATES GOVERNMENT

If you believe that your vehicle has a defect which could cause a crash or could cause injury or death, you should immediately inform the National Highway Traffic Safety Administration (NHTSA), in addition to notifying General Motors.

If NHTSA receives similar complaints, it may open an investigation, and if it finds that a safety defect exists in a group of vehicles, it may order a recall and remedy campaign. However, NHTSA cannot become involved in individual problems between you, your dealer or General Motors.

To contact NHTSA, you may either call the Auto Safety Hotline toll-free at 1-800-424-9393 (or 366-0123 in the Washington, D.C. area) or write to:

NHTSA, U.S. Department of Transportation
Washington, D.C. 20590

You can also obtain other information about motor vehicle safety from the Hotline.

REPORTING SAFETY DEFECTS TO THE CANADIAN GOVERNMENT

If you live in Canada, and you believe that your vehicle has a safety defect, you should immediately notify Transport Canada, in addition to notifying General Motors of Canada Limited. You may write to:

Transport Canada
Box 8880
Ottawa, Ontario K1G 3J2

REPORTING SAFETY DEFECTS TO GENERAL MOTORS

In addition to notifying NHTSA (or Transport Canada) in a situation like this, we certainly hope you'll notify us. Please call us at 1-800-222-1020, or write:

Chevrolet/Geo
Customer Assistance Center
P.O. Box 7047
Troy, Michigan 48007-7047

In Canada, please call us at 1-800-263-3777 (English) or 1-800-263-7854 (French), or write:

General Motors of Canada Limited
Customer Assistance Center
1908 Colonel Sam Drive
Oshawa, Ontario L1H 8P7

Service and Owner Publications



Service manuals, service bulletins, owner's manuals and other service literature are available for purchase for all current and many past model General Motors vehicles.

Toll-free telephone numbers for ordering information:

United States 1-800-551-4123
Canada 1-800-668-5539

Service Manuals

Service manuals contain diagnostic and repair information for all chassis and body systems. They may be useful for owners who wish to get a greater understanding of their vehicle. They are also useful for owners with the appropriate skill level or training who wish to perform "do-it-yourself" service. These are authentic General Motors service manuals meant for professional, qualified technicians.

Service Bulletins

Service bulletins covering various subjects are regularly sent to all General Motors dealerships. GM monitors product performance in the field. When service methods are found which promote better service on GM vehicles, bulletins are created to help the technician perform better service. Service bulletins may involve any

number of vehicles. Some will describe inexpensive service; others will describe expensive service. Some will advise of new or unexpected conditions, and others may help avoid future costly repairs. Service bulletins are meant for qualified technicians. In some cases, bulletins refer to service manuals, specialized tools, equipment and safety procedures necessary to service the vehicle. Since these bulletins are issued throughout the model year and beyond, an index is required and published quarterly to help identify specific bulletins. Subscriptions are available. You can order an index at the toll-free numbers listed previously, or ask a GM dealer to see an index or individual bulletin.

Owner Publications

Owner's manuals, warranty folders and various owner assistance booklets provide owners with general operation and maintenance information.

Geo Section 9 Index

A ir Bag	1-24	Appearance Care Materials	6-56
Adding Equipment	1-30	Arbitration Program	8-7
How Does it Restrain	1-28	Ashtrays	2-40
How it Works	1-26	Audio Systems	3-6
Location	1-26	Automatic	
Readiness Light	1-25, 2-61	Overdrive	2-13
Servicing	1-29	Overdrive Off Switch	2-13
What Makes it Inflate	1-27	Shifting	2-10
What Will You See After it Inflates	1-28	Starting Your Engine	2-8
When Should it Inflate	1-27	Transmission	2-8, 2-10
Air Cleaner	6-13	Transmission Check	7-48
Air Conditioning	3-2	Transmission Fluid	6-15
Air Conditioning Refrigerants	6-64	Transmission Operation	2-10
Alignment and Balance, Tire	6-46	Transmission Park Mechanism Check	7-50
Aluminum Wheels, Cleaning	6-54	Axle, Front	6-23
Antenna	3-19	Axle, Rear	6-21
Antifreeze	6-24	B attery	6-33
Anti-Lock		Jump Starting	5-2
Brake System Active Light	2-64, 4-8	Warnings	5-2
Brake System Warning Light	2-63, 4-6	BBB Auto Line	8-7
Brakes	4-6	Better Business Bureau Mediation	8-7
Appearance Care	6-48		

Brake	
Adjustment	6-33
Fluid	6-29
Master Cylinder	6-29
Parking	2-20
Pedal Travel	6-32
Replacing System Parts	6-33
System Warning Light	2-62
Trailer	4-51
Transmission Shift Interlock	2-23
Transmission Shift Interlock Check	7-49
Wear	6-32
Brakes, Anti-Lock	4-6
Braking	4-5
Braking in Emergencies	4-8
Break-In, New Vehicle	2-6
Brightness Control	2-36
BTSI	2-23
BTSI Check	7-49
Bulb Replacement	6-34
C anadian Roadside Assistance	8-6
Canvas Top	
And Plastic Window Care	6-53
Lowering and Raising	2-49
Preparing for Storage	2-54
Removing and Installing	2-53
Capacities and Specifications	6-62
Carbon Monoxide	2-25, 4-42
Cassette Deck Service	7-47
Cassette Tape Player	3-8, 3-11
Cassette Tape Player Care	3-18
CD Player Theft-Deterrent Feature	3-15
Certification Label	4-46
Certification/Tire Label	4-46
Chains, Safety	4-51
Chains, Tire	6-47
Changing a Flat Tire	5-22
Charging System Light	2-61
Checking Your Restraint Systems	1-46
Chemical Paint Spotting	6-55
Child Restraints	1-37
Securing in a Rear Seat Position	1-38
Securing in the Right Front Seat Position	1-40
Top Strap	1-38
Where to Put	1-37
Cigarette Lighter	2-40
Circuit Breakers and Fuses	6-58
Cleaner, Air	6-13
Cleaning	
Aluminum Wheels	6-54
Canvas Top and Plastic Window	6-53
Fabric	6-49
Glass	6-51
Inside of Your Geo	6-48

Instrument Panel	6-51	Cruise Control	2-32
Outside of Your Geo	6-52	Cruise Light	2-33
Special Problems	6-50	Cupholders	2-40
Stains	6-50	Customer Assistance for Text Telephone Users	8-3
Tires	6-54	Customer Assistance Information	8-1
Vinyl	6-50	Customer Satisfaction Procedure	8-1
Wheels	6-54		
Windshield and Wiper Blades	6-51	D amage, Finish	6-55
Climate Control System	3-1	Damage, Sheet Metal	6-54
Clock, Setting the	3-6	Daytime Running Lamps	2-35
Clutch Adjustment	6-21	Daytime Running Lamps Indicator Light	2-69
Coinholder	2-40	Dead Battery	5-2
Comfort Controls	3-1	Defects, Reporting Safety	8-8
Compact Disc Care	3-19	Defensive Driving	4-1
Compact Disc Player	3-11	Defogger, Rear Window	3-5
Control of a Vehicle	4-5	Defogging	3-4
Convertible Top	2-42	Defrosting	3-4
Convex Outside Mirror	2-38	Dimensions, Vehicle	6-64
Coolant	6-24	Dome Lamps	2-36
Level Check	5-15	Door	
Recovery Tank	5-16	Locks	2-3
Radiator	5-19	Storage	2-39
Temperature Gage	2-64	Downshifting	2-15, 2-16
Cooling System	5-14	Drive Position, Automatic Transmission	2-12
Courtesy Transportation	8-6	Driver Position	1-18

Driving		Coolant Temperature Gage	2-64
City	4-34	Exhaust	2-25
Defensive	4-1	Identification	6-57
Drunken	4-2	Main Fuse Block	6-60
Freeway	4-35	Oil Level Check	7-47
Guidelines	4-14	Overheating	5-12
In a Blizzard	4-41	Running While Parked	2-25
In Foreign Countries	6-4	Specifications	6-62
In the Rain	4-31	Starting Your	2-8, 2-9
Night	4-29	Engine Compartment Main Fuse Block	6-60
Off-Road	4-14	Engine Oil	6-9
On Curves	4-9	Adding	6-10
On Grades While Towing a Trailer	4-53	Additives	6-12
On Hill and Mountain Roads	4-37	Checking	6-10
On Snow and Ice	4-40	Used	6-13
Through Water	4-33	When to Change	6-12
Wet Roads	4-31	Ethanol	6-3
Winter	4-39	Exhaust, Engine	2-25
With a Trailer	4-52	F abric Cleaning	6-49
Drunken Driving	4-2	Fifth Gear, Manual Transmission	2-14
E asy Entry Seat	1-4	Filling Your Tank	6-4
Electrical Equipment, Adding	2-9, 6-57	Filter, Air	6-14
Electrical System	6-57	Finish Care	6-52
Engine	6-8	Finish Damage	6-55
Coolant	6-24	First Gear, Manual Transmission	2-14
Coolant Level Check	7-47	Flashers, Hazard Warning	5-1

Flash-to-Pass Feature	2-30	Gear Positions, Manual Transmission	2-14
Flat Tire, Changing	5-22	Glove Box	2-39
Fluid Capacities	6-63	Gross Axle Weight Rating	4-46
Fluids and Lubricants	7-53	Gross Vehicle Weight Rating	4-46
Foreign Countries, Fuel	6-4	Guide en Français	ii
Fourth Gear, Manual Transmission	2-14	GVWR	4-46
Four-Wheel Drive	2-16, 6-22	H alogen Bulbs	6-34
French Language Manual	ii	Hazard Warning Flashers	5-1
Front Axle	6-23	Head Restraints	1-3
Front Seat Side Pockets	2-39	Headlamps	2-29
Front Sidemarker Lamp Bulb Replacement	6-37	Bulb Replacement	6-34
Front Towing	5-9	High/Low Beam Changer	2-29
Front Turn Signal Lamp Bulb Replacement	6-36	Hearing Impaired, Customer Assistance	8-3
Fuel	6-2	Heating	3-3
Canada	6-3	Highway Hypnosis	4-37
Door Lock	6-5	Hill and Mountain Roads	4-37
Filling Your Tank	6-4	Hitches, Trailer	4-51
Gage	2-69	Hood	
In Foreign Countries	6-4	Checking Things Under	6-6
Fuses and Circuit Breakers	6-58	Prop	6-7
G ages		Release	6-6
Engine Coolant Temperature	2-64	Horn	2-28
Fuel	2-69	Hubs, Freewheeling	2-17
GAWR	4-46	Hydroplaning	4-33
Gear Positions, Automatic Transmission	2-10		

I gnition Positions	2-7
Inflation, Tire	6-41
Inside Day/Night Rearview Mirror	2-37
Inspections	7-51
Brake System	7-52
Exhaust Systems	7-51
Front-Wheel-Drive Axle Boot	7-51
Front-Wheel-Drive Axle Seal	7-51
Radiator and Heater Hose	7-51
Rear Axle	7-52
Steering	7-51
Suspension	7-51
Throttle Linkage	7-52
Instrument Panel	2-56
Brightness Control	2-36
Cleaning	6-51
Cluster	2-58
Fuse Block	6-58
Interior Lamps	2-36
J ack, Tire	5-23
Jump Starting	5-2
K ey Lock Cylinders Service	7-48
Keys	2-1

L abels	
Certification	4-46
Certification/Tire	4-46
Service Parts Identification	6-57
Tire-Loading Information	4-46
Vehicle Identification Number	6-57
Lamps	2-35
Dome	2-36
Interior	2-36
On Reminder	2-29
Lamps Control	2-29
Leaving Your Vehicle	2-4
Leaving Your Vehicle with the Engine Running	2-22
Lighter	2-40
Lights	
Air Bag Readiness	1-25, 2-6, 2-61
Anti-Lock Brake System Active	2-64, 4-8
Anti-Lock Brake System Warning	2-63, 4-6
Brake System Warning	2-62
Charging System	2-61
Cruise	2-33
Daytime Running Lamps Indicator	2-69
Oil Pressure	2-67
Overdrive Off	2-69
Rear Window Defogger	3-5

Safety Belt Reminder	1-13, 2-60	Short Trip/City Definition	7-4
Service Engine Soon	2-65	Short Trip/City Intervals	7-4, 7-7-8
Loading Your Vehicle	4-46	Maintenance, Underbody	6-55
Locks	2-3	Maintenance When Trailer Towing	4-55
Cylinders	7-48	Malfunction Indicator Lamp	2-65
Door	2-3	Manual Adjust Mirror	2-37
Fuel Door	6-5	Manual Front Seat	1-1
Key Lock Cylinder Service	7-48	Manual Transmission	2-8, 2-14
Power Door	2-3	Shifting	2-14
Rear Door Security	2-4	Starting Your Engine	2-8
Steering Column Lock Check	7-50	Fluid	6-19
Window	2-27	Methanol	6-3
Low, Automatic Transmission	2-12	Mirrors	2-37
Lowering and Raising the Canvas Top	2-49	Convex Outside	2-38
Lubricants and Fluids	7-53	Inside Day/Night Rearview	2-37
Lubrication Service, Body	7-48	Manual Adjust	2-37
M aintenance, Normal Replacement Parts	6-62	Power Remote Control	2-38
Maintenance Record	7-55	MMT	6-3
Maintenance Schedule	7-1	Model Reference	iii
Long Trip/Highway Definition	7-6	Mountain Roads	4-37
Long Trip/Highway Intervals	7-6, 7-32	Multifunction Lever	2-28
Owner Checks and Services	7-47	N eutral, Automatic Transmission	2-11
Periodic Maintenance Inspections	7-51	Neutral, Manual Transmission	2-15
Recommended Fluids and Lubricants	7-53	New Vehicle Break-In	2-6
Scheduled Maintenance Services	7-3	Night Vision	4-30

O dometer	2-59	Passing	4-11
Odometer, Trip	2-59	Periodic Maintenance Inspections	7-51
Off-Road Driving	4-14	Power	
Off-Road Recovery	4-11	Door Locks	2-3
Oil, Engine	6-9	Remote Control Mirror	2-38
Oil Pressure Light	2-67	Steering	4-9
Overdrive, Automatic Transmission	2-13	Steering Fluid	6-27
Overdrive Off Light	2-69	Windows	2-27
Overheating Engine	5-12	Power Mode Selector Switch	2-13
Owner Checks and Services	7-47	Pregnancy, Use of Safety Belts	1-31
Owner Publications, Ordering	8-9	Preparing Your Canvas Top for Storage	2-54
P aint Spotting, Chemical	6-55	Problems on the Road	5-1
Park		Publications, Service and Owner	8-9
Automatic Transmission	2-10	R adiator, Coolant	5-19
Shifting Into	2-21	Radiator Pressure Cap	6-26
Shifting Out of	2-23	Radio Reception	3-17
Parking		Radios	3-6
At Night	2-6	Rain, Driving In	4-31
Brake	2-20	Rear	
Brake Mechanism Check	7-50	Axle	6-21
Over Things That Burn	2-24	Combination Lamp Bulb Replacement	6-38
With a Trailer	4-54	Door Security Locks	2-4
Your Vehicle, Manual Transmission	2-24	Seat Passengers	1-31
Parking Lamp Bulb Replacement	6-36	Sidemarker Lamp Bulb Replacement	6-38
Passenger Position	1-31	Towing	5-10

Turn Signal Lamp Bulb Replacement	6-38	Restraints	
Window Defogger	3-5	Checking	1-46
Window Defogger Light	3-5	Child	1-37
Windshield Washer	2-31	Head	1-3
Rear Window		Replacing Parts After a Crash	1-46
Removing and Installing	2-46	System Check	7-48
Reclining Front Seatbacks	1-2	Reverse, Automatic Transmission	2-11
Rearview Mirrors	2-37	Reverse, Manual Transmission	2-15
Convex Outside	2-38	Right Front Passenger Position	1-31
Inside Day/Night	2-37	Roadside Assistance	8-4
Manual Adjust	2-37	Roadside Assistance, Canadian	8-6
Power Remote Control	2-38	Rocking Your Vehicle	5-34
Recovery Hooks	5-34	Rotation, Tires	6-42
Recovery Tank, Coolant	5-16		
Recreational Vehicle Towing	4-43	S afety Belt Extender	1-46
Refrigerants, Air Conditioning	6-64	Safety Belts	1-13
the Rear Window	2-46	Adults	1-18
Replacement		Care	6-51
Bulbs	6-61	Children	1-35
Parts	6-62	Driver Position	1-18
Wheel	6-46	Extender	1-46
Replacing Safety Belts	1-46	How to Wear Properly	1-18
Reporting Safety Defects	8-8	Incorrect Usage	1-20, 1-44, 1-45
		Lap-Shoulder	1-18, 1-32

Larger Children	1-43	Service	6-1
Passenger Position	1-31	Bulletins, Ordering	8-9
Questions and Answers	1-17	Engine Soon Light	2-65
Rear Seat Passengers	1-31	Manuals, Ordering	8-9
Reminder Light	1-13, 2-60	Parts Identification Label	6-57
Replacing After a Crash	1-46	Publications, Ordering	8-9
Right Front Passenger Position	1-31	Work, Doing Your Own	6-1
Smaller Children and Babies	1-35	Service and Appearance Care	6-1
Use During Pregnancy	1-31	Service and Owner Publications	8-9
Why They Work	1-14	Service Publications	8-9
Safety Chains	4-51	Service Publications	8-9
Safety Defects, Reporting	8-8	Servicing Your Air Bag-Equipped Geo	1-29
Safety Warnings and Symbols	iv	Sheet Metal Damage	6-54
Scheduled Maintenance Services	7-3	Shift Lever	2-10, 2-14
Seatback, Reclining Front	1-2	Shift Speeds	2-15
Seats		Shifting	
Easy Entry	1-4	Automatic Transmission	2-10
Manual Front	1-1	Into Park (P)	2-21
Rear	1-5, 1-9	Manual Transmission	2-14
Restraint Systems	1-1	Out of Park	2-23
Seat Controls	1-1	Side Window, Removing and Installing the	2-47
Securing a Child Restraint	1-37	Signaling Turns	2-28
Second Gear, Automatic Transmission	2-12	Skidding	4-13
Second Gear, Manual Transmission	2-14	Sound Equipment, Adding	3-18
		Specifications and Capacities	6-62

Specifications, Engine	6-62	Tire Chains	6-47
Speech Impaired, Customer Assistance	8-3	Tire Loading	4-46
Speedometer	2-59	Tire-Loading Information Label	4-46
Stains, Cleaning	6-50	Tires	6-40
Starter Switch Check	7-49	Alignment and Balance	6-46
Steam	5-12	Buying New	6-44
Steering	4-9	Chains	6-47
Column Lock Check	7-50	Changing a Flat	5-22
In Emergencies	4-10	Cleaning	6-54
Power	4-9	Inflation	6-41
Tips	4-9	Inflation Check	7-47
Storage Areas	2-39	Inspection and Rotation	6-42
Storage, Vehicle	6-33	Loading	4-46
Stuck: In Sand, Mud, Ice or Snow	5-33	Pressure	6-41
Sun Visors	2-41	Temperature	6-45
Sunroof	2-43	Traction	6-45
Symbols, Vehicle	vi	Treadwear	6-45
T achometer	2-59	Uniform Quality Grading	6-44
Tailgate	2-5	Wear Indicators	6-43
Tailgate Lock Release	2-5	Wheel Replacement	6-46
Tape Player Care	3-18	When It's Time for New	6-43
Theft	2-5	Top Strap	1-38
Theft-Deterrent Feature, CD Player	3-15	Torque Lock	2-23
Thermostat	6-26	Torque, Wheel Nut	5-31, 6-63
Third Gear, Manual Transmission	2-14	Towing a Trailer	4-48
		Towing, Recreational Vehicle	4-43
		Towing Your Vehicle	5-7

Trailer	
Brakes	4-51
Driving on Grades	4-53
Driving with	4-52
Hitches	4-51
Maintenance When Towing	4-55
Parking on Hills	4-54
Safety Chains	4-51
Tongue Weight	4-50
Total Weight on Tires	4-50
Turn Signals	4-53
Weight	4-49
Transfer Case, Manual Shift	2-18, 6-22
Transmission Fluid	
Automatic	6-15
Manual	6-19
Transportation, Courtesy	8-6
Trip Odometer	2-59
TTY Users	8-3
Turn Signal and Lane Change Signals	2-28
Turn Signal/Multifunction Lever	2-28
Turn Signals When Towing a Trailer	4-53
U nderbody Flushing Service	7-50
Underbody Maintenance	6-55
V ehicle	
Control	4-5
Damage Warnings	v
Dimensions	6-64
Identification Number	6-57
Loading	4-46
Storage	6-33
Ventilation System	3-3
Visors, Sun	2-41
W arning Devices	5-2
Warning Lights, Gages and Indicators	2-60
Washer Fluid, Windshield	6-28
Washing Your Vehicle	6-52
Weatherstrips	6-52
Wheel	
Alignment	6-46
Lock Key	5-23
Nut Torque	5-31, 6-63
Replacement	6-46
Wrench	5-23
Window Lock	2-27
Windows, Power	2-27
Windshield Washer	2-31
Fluid	6-28, 2-31
Fluid Level Check	7-47
Rear	2-31
Windshield Wiper	2-30
Rear	2-31
Winter Driving	4-39
Wrench, Wheel	5-23

