

TABLE OF CONTENTS

SECTION		PAGE
1	INTRODUCTION	3
2	THINGS TO KNOW BEFORE STARTING YOUR VEHICLE	7
3	UNDERSTANDING THE FEATURES OF YOUR VEHICLE	45
4	UNDERSTANDING YOUR INSTRUMENT PANEL	79
5	STARTING AND OPERATING	129
6	WHAT TO DO IN EMERGENCIES	173
7	MAINTAINING YOUR VEHICLE	187
8	MAINTENANCE SCHEDULES	235
9	IF YOU NEED CONSUMER ASSISTANCE	251
10	INDEX	259

INTRODUCTION

CONTENTS

■ Introduction	4	■ Vehicle Identification Number	6
■ How To Use This Manual	4	■ Vehicle Modifications / Alterations	6
■ Warnings And Cautions	6		

INTRODUCTION

This manual has been prepared with the assistance of service and engineering specialists to acquaint you with the operation and maintenance of your new vehicle. It is supplemented by a Warranty Information Booklet and various customer oriented documents. You are urged to read these publications carefully. Following the instructions and recommendations in this manual will help assure safe and enjoyable operation of your vehicle.

NOTE: After you read the manual, it should be stored in the vehicle for convenient reference and remain with the vehicle when sold so that the new owner will be aware of all safety warnings.

When it comes to service, remember that your manufacturer's dealer knows your vehicle best, has the factory-trained technicians and genuine Mopar® parts, and is interested in your satisfaction.

WARNING!

Engine exhaust, some of its constituents, and certain vehicle components contain or emit chemicals known to the State of California to cause cancer and birth defects or other reproductive harm. In addition, certain fluids contained in vehicles and certain products of component wear contain or emit chemicals known to the State of California to cause cancer and birth defects or other reproductive harm.

HOW TO USE THIS MANUAL

Consult the table of contents to determine which section contains the information you desire.

The detailed index, at the rear of this manual, contains a complete listing of all subjects.

Consult the following table for a description of the symbols that may be used throughout this owner's manual:

									
TURN SIGNALS	REAR WINDOW WIPER	WINDSHIELD WIPER INTERMITTENT	BRAKE SYSTEM WARNING PARKING BRAKE	HIGH BEAM	HORN	UPPER AIR OUTLET	HEATED SEAT LOW	DOOR LOCK	ADJUSTABLE PEDALS
									
FUEL	REAR WINDOW INTERMITTENT WIPER	WINDSHIELD WASHER	FAILURE OF ANTI-LOCK BRAKING SYSTEM	LOW BEAM	KEY ACTIVATE (POWER OUTLET)	UPPER AND LOWER AIR OUTLET	HEATED SEAT HIGH	WINDOW LIFT	TIRE PRESSURE MONITOR
									
FUEL FILL SIDE	REAR WINDOW WASHER	WINDSHIELD WASHER FLUID LEVEL	SEAT BELT	FRONT FOG LIGHT	HOOD RELEASE	LOWER AIR OUTLET	RECIRCULATION	CONVERTIBLE 4 WINDOW DOWN	VOICE RECOGNITION BUTTON
									
ENGINE OIL	REAR WINDOW DEFROST	WINDSHIELD, ELECTRICALLY HEATED	AIRBAG	EXTERIOR BULB FAILURE	LIFTGATE RELEASE AND LIFTGATE OPEN	DEFROST AND LOWER AIR OUTLET	VENTILATING FAN	POWER STEERING FLUID	UCONNECT™ BUTTON
									
BATTERY CHARGING	HEATED MIRROR	WINDSHIELD DEFROST	SIDE AIRBAG	DOME LIGHT	SLIDING DOOR	TRUNK / DECK RELEASE	AIR CONDITIONING	SEE OWNER'S MANUAL ISO	TRACTION CONTROL
									
ENGINE COOLANT TEMPERATURE	CHILD SEAT TETHER ANCHOR	WINDSHIELD WIPER AND WASHER	HAZARD	PARK LIGHTS	SLIDING DOOR	CONVERTIBLE TOP UP	EMERGENCY RELEASE HANDLE	INSTRUMENT PANEL ILLUMINATION	WARNING
									
ENGINE	LOWER ANCHORS AND TETHER FOR CHILDREN (LATCH)	SRS AIRBAG SUPPLEMENTAL RESTRAINT SYSTEM	WINDOW LOCK	LIGHTER	DOOR AJAR	CONVERTIBLE TOP DOWN	PASSENGER AIRBAG OFF	MASTER LIGHTING SWITCH	

WARNINGS AND CAUTIONS

This manual contains **WARNINGS** against operating procedures which could result in an accident or bodily injury. It also contains **CAUTIONS** against procedures which could result in damage to your vehicle. If you do not read this entire manual you may miss important information. Observe all Warnings and Cautions.

VEHICLE IDENTIFICATION NUMBER

The vehicle identification number (VIN) is on a stamped plate on the left front corner on the body of the vehicle, visible through the windshield. This number also appears on the Automobile Information Disclosure Label affixed to a window on your vehicle. Save this label as a convenient record of your vehicle identification number and optional equipment.

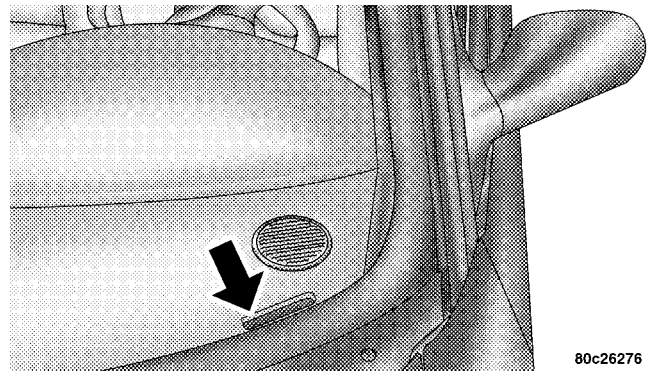

80c26276

VEHICLE MODIFICATIONS / ALTERATIONS

<p>WARNING!</p> <p>Any modifications or alterations to this vehicle could seriously affect its roadworthiness and safety and may lead to an accident resulting in serious injury or death.</p>

THINGS TO KNOW BEFORE STARTING YOUR VEHICLE

CONTENTS

■ A Word About Your Keys	9	□ Central Locking—If Equipped	13
□ Ignition Key Removal	9	□ Door Ajar Warning	14
□ Automatic Transaxle Ignition Interlock System	10	□ Automatic (Rolling) Door Locks	14
□ Key-In-Ignition Reminder	10	□ Automatic Unlock On Exit—Only Available If Automatic Door Locks Are Enabled	15
■ Sentry Key — If Equipped	10	■ Remote Keyless Entry — If Equipped	15
□ Replacement Keys	11	□ To Unlock The Doors	16
□ Customer Key Programming	11	□ To Lock The Doors	16
□ General Information	12	□ To Unlock The Trunk	17
■ Illuminated Entry System	12	□ Panic Alarm	17
■ Door Locks	12	□ To Use The Panic Alarm	17
□ Power Door Locks	13	□ To Program Additional Transmitters	17

8 THINGS TO KNOW BEFORE STARTING YOUR VEHICLE

□ General Information18	□ Enhanced Driver Seat Belt Reminder System (BeltAlert)27
□ Transmitter Battery Service18	□ Seat Belts And Pregnant Women28
■ Vehicle Theft Alarm19	□ Seat Belt Extender28
□ Tamper Alert19	□ Driver And Right Front Passenger Supplemental Restraint System (SRS) - Airbag29
□ Security System Manual Override20	□ Child Restraint34
■ Trunk Lock And Release20	■ Engine Break-In Recommendations42
■ Trunk Safety Warning20	■ Safety Tips42
□ Trunk Internal Emergency Release21	□ Exhaust Gas42
■ Power Windows21	□ Safety Checks You Should Make Inside The Vehicle43
□ Wind Buffeting22	□ Periodic Safety Checks You Should Make Outside The Vehicle43
■ Occupant Restraints22		
□ Lap/Shoulder Belts23		
□ Pretensioners26		

A WORD ABOUT YOUR KEYS

CAUTION!

An unlocked car is an invitation to thieves. Always remove the key from the ignition, lock the doors, and close the windows when leaving the vehicle unattended.

Ignition Key Removal

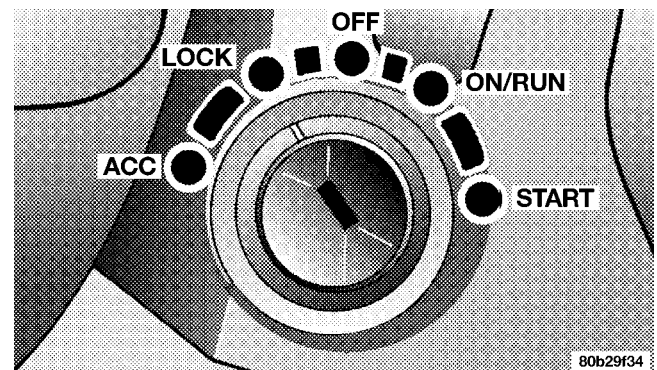

2

Place the shift lever in PARK and make sure that the gearshift knob push button has returned to the out position. Turn the key to the Lock position and remove the key.

NOTE: If you try to remove the key before you place the lever in PARK, the key may become trapped temporarily in the key cylinder. If this occurs, rotate the key clockwise slightly, then remove the key as described. If a malfunction occurs, the system may trap the key in the ignition cylinder to warn you that this safety feature is

inoperable. The engine can be started and stopped but the key cannot be removed until you obtain service.

Automatic Transaxle Ignition Interlock System

This system prevents the key from being removed unless the shift lever is in PARK. It also prevents shifting out of PARK unless the key is in the OFF or RUN positions.

Key-In-Ignition Reminder

Opening the driver's door when the key is in the ignition and is in the OFF, LOCK, or ACC position, sounds a signal to remind you to remove the key.

SENTRY KEY — IF EQUIPPED

With this system, an electronically coded ignition key sends a signal to the vehicle electronics. If the electronics recognizes the signal, the vehicle will start and continue to run. If the system does not recognize the signal the vehicle will start and run for 2 seconds then shut off. The system will allow the engine to be started and run (for 2 seconds) up to six times after which the starter motor will be disabled and the engine will not crank.

NOTE:

- The Sentry Key Immobilizer System is not compatible with remote starting systems. Use of these systems may result in vehicle starting problems and loss of security protection.
- Additional Sentry Keys or Mobil Speed Pass™ devices held too close to the ignition key when starting the vehicle may cause problems when attempting to start the vehicle. These devices cannot damage the Sentry Key System, but can cause a momentary problem when attempting to start the engine. If a problem occurs, remove the Sentry Key from the key ring and restart the vehicle. Pagers, cell phones, walkmans, etc., have no effect on this system.

The Theft Alarm Light, located on the instrument cluster to the right of the fuel gauge, will illuminate for about 3 seconds when the ignition switch is first turned to the On position. If the vehicle electronics do not receive a valid signal from the ignition key, the theft alarm light will flash continuously to signal that the vehicle has been

immobilized. If the Theft Alarm Light remains On during vehicle operation, it indicates a fault in the system electronics.

All of the keys provided with your new vehicle have been programmed to the vehicle electronics.

Replacement Keys

NOTE: Only keys that have been programmed to the vehicle electronics can be used to start the vehicle. Once a Sentry Key has been programmed to a vehicle, it can not be programmed to any other vehicle.

At the time of purchase, the original owner is provided with a four digit PIN number. This number is required for dealer replacement of keys. Duplication of keys may be performed at an authorized dealer or by using the Customer Key Programming procedure. This procedure consists of programming a blank key to the vehicle electronics. A blank key is one which has never been programmed.

NOTE: When having the Sentry Key System serviced, bring all vehicle keys to the dealer.

Customer Key Programming

You can program new keys to the system if you have two valid keys by doing the following:

1. Insert the first valid key into the ignition and turn the ignition On for at least 3 seconds but no longer than 15 seconds.

Turn the ignition Off and remove the first key.

2. Insert the second valid key and switch the ignition On within 15 seconds. After ten seconds a chime will sound and the Theft Alarm Light will begin to flash.

Turn the ignition Off and remove the second key.

3. Insert a blank Sentry Key into the ignition and switch the ignition On within 60 seconds. After 10 seconds a single chime will sound. The Theft Alarm Light will stop flashing, turn on for 3 seconds; then turn off.

The new Sentry Key has been programmed. Repeat this process to program up to a total of 8 keys.

General Information

The Sentry Key system complies with FCC rules part 15. Operation is subject to the following two conditions:

1. this device may not cause harmful interference
2. this device must accept any interference that may be received, including interference that may cause undesired operation

ILLUMINATED ENTRY SYSTEM

The interior lights will come on when you open either door, unlock the vehicle with the remote keyless entry or central unlock from the driver's side (if so equipped). They will remain on for about 30 seconds after all doors are closed then fade to off.

The lights also will turn off if you turn on the ignition after you close all doors.

DOOR LOCKS

WARNING!

For personal security and safety in the event of an accident, lock the vehicle doors as you drive and when you park and leave the vehicle.

WARNING!

When leaving the vehicle always remove the key from the ignition lock, and lock your vehicle. Do not leave children unattended in the vehicle, or with access to an unlocked vehicle. Unsupervised use of vehicle equipment may cause severe personal injuries and death.

Power Door Locks

There is a door lock switch on each front door located to the front of each door handle. Press this switch to lock or unlock the doors.

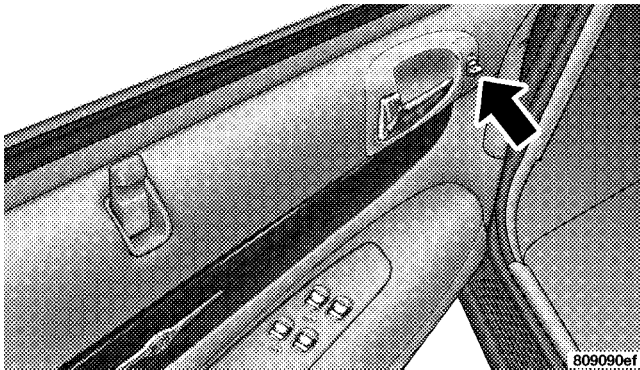

If you press the door lock switch while the keys are in the ignition switch, and the driver's door is open, the doors will not lock.

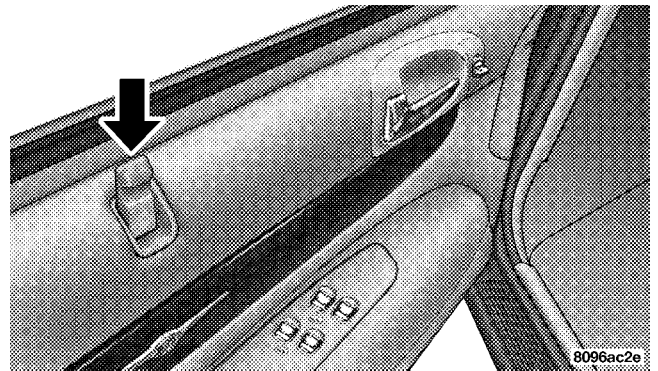

If the door lock plunger is down when you shut the door, the door will lock. Therefore, make sure that the keys are not inside the vehicle before closing the door.

Central Locking—If Equipped

Turning the driver's door lock to the unlock position twice within five seconds will unlock both doors. Turning the key in the driver's door to the unlock position once will unlock only the driver's door.

Locking the driver's door with the key will lock both doors.

Door Ajar Warning

If you move the vehicle and a door is not completely closed, the word DOOR will replace the odometer display and a chime will sound once. The odometer display will reappear once the door is closed.

Automatic (Rolling) Door Locks

The doors will lock automatically, as programmed from the factory, if:

1. The transaxle is in gear,
2. All doors are closed,
3. Vehicle speed is above 15 mph (24 km/h),
4. The accelerator pedal is depressed.

The Automatic Door Locks can be disabled or re-enabled by performing the following procedure:

1. Close all doors and place the key in the ignition.
2. Cycle the ignition switch between OFF and ON/RUN and back to OFF 4 times ending up in the OFF position.

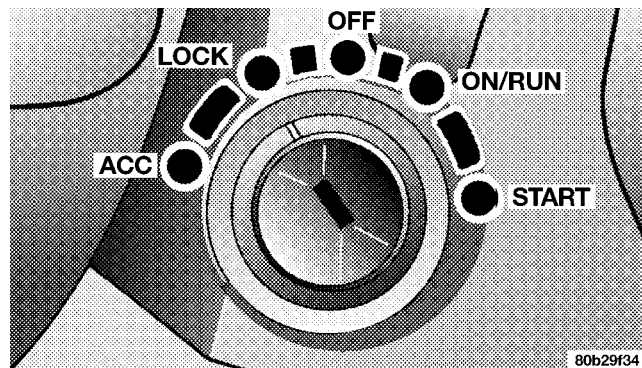

3. Depress the power door lock switch to lock the doors.

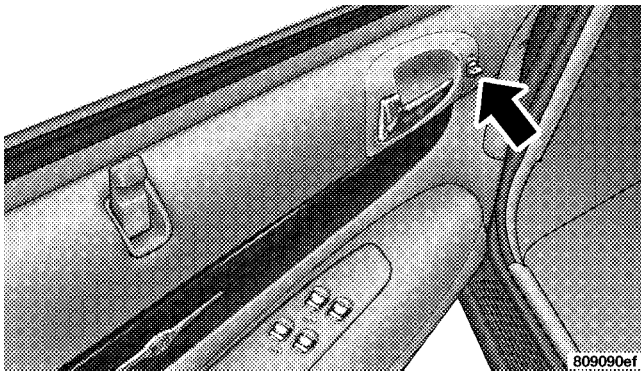

4. A single chime will indicate the completion of the programming.

Automatic Unlock on Exit—Only Available if Automatic Door Locks are Enabled

This feature will unlock all the doors when the driver's door is opened and the ignition switch is in the LOCK position. This function is disabled as delivered from the factory. Automatic Unlock on Exit can be enabled or disabled by performing the following procedure:

1. Close all doors and place the key in the ignition.
2. Cycle the ignition switch between OFF and ON/RUN and back to OFF 4 times ending up in the OFF position.
3. Depress the power door lock switch to unlock the doors.
4. A single chime will indicate the completion of the programming.

2

REMOTE KEYLESS ENTRY — IF EQUIPPED

This system allows you to lock or unlock the doors or open the trunk from distances up to 23 feet (7 meters) using a transmitter. You don't have to point the transmitter at the vehicle to activate the system.

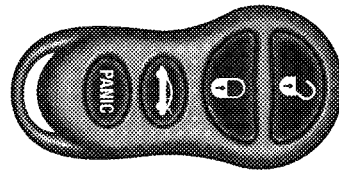

8091f2a0

To unlock the doors:

Press and release the UNLOCK button once to unlock the driver's door. Press the button twice within 5 seconds to unlock all doors. If your vehicle is equipped with Illuminated Entry, the interior lights also come on and remain on for about 30 seconds, when you unlock the doors.

NOTE: The system may be programmed to unlock all the doors upon the first press of the Unlock button. To toggle between the first press unlock of the driver's door to unlock of all doors, perform the following procedure:

1. Press and hold the Unlock button on the transmitter.
2. Continue to hold the Unlock button, wait at least 4 but no longer than 10 seconds, then press the LOCK button.
3. Release both buttons.

The headlights will flash twice to acknowledge the unlock signal.

NOTE: The Lamp Flash can be enabled or disabled by performing the following procedure:

1. Press and hold the Lock button on the transmitter.
2. Continue to hold the Lock button, wait at least 4 but no longer than 10 seconds, then press the Trunk button.
3. Release both buttons.

To lock the doors:

The horn will chirp and the headlamps will flash once to acknowledge the lock signal.

NOTE: To enable or disable the Lamp Flash, see the Note just prior to the sub-section "To lock the doors". The horn chirp can be enabled or disabled by the following procedure:

1. Press and hold the Lock button on the transmitter.
2. Continue to hold the Lock button, wait at least 4 but no longer than 10 seconds, then press the Unlock button.
3. Release both buttons.

To unlock the trunk:

Press and hold the Trunk button on the transmitter to unlatch the trunk.

NOTE: The transmitter can be programmed to unlatch the trunk immediately upon activation of the Trunk button (without pressing and holding) by performing the following procedure:

1. Press and hold the Unlock button on the transmitter.
2. Continue to hold the Unlock button, wait at least 4 but no longer than 10 seconds, then press the Trunk button.
3. Release both buttons.

Panic Alarm

The panic mode unlocks the driver's door, turns on the interior lights, flashes the headlights, and sounds the horn for about 3 minutes or until the alarm is turned off.

To use the Panic Alarm:

Press and hold the Panic Button for at least 1 second to activate the panic alarm. Press and hold the panic button a second time or unlock the door with the key (if equipped with central locking) to deactivate the alarm. The alarm will also shut itself off after 3 minutes, or when the vehicle speed reaches 15 MPH (24 km/h).

To Program Additional Transmitters:

Up to 4 transmitters can be programmed to your vehicle. To program a transmitter, perform the following procedure:

1. With the vehicle in Park, turn the ignition switch to the ON/RUN position.
2. Using a currently programmed transmitter, press the Unlock button on the transmitter. Continue to hold the Unlock button, wait at least 4 but no longer than 10 seconds, then press and hold the Panic button for at least one second. Release both buttons simultaneously. You will hear a chime to signal that you can proceed with programming the new transmitter.

18 THINGS TO KNOW BEFORE STARTING YOUR VEHICLE

3. Press and release the Lock and Unlock buttons simultaneously, followed by a press and release of ANY button on each new transmitter to be programmed as well as the original transmitter. You will hear a chime when a transmitter has been successfully programmed. You will have 30 seconds to finish programming all new transmitters. A chime will sound when the 30 seconds is over or the ignition switch is turned to the LOCK position.

General Information

This transmitter complies with FCC rules part 15 and with RS-210 of Industry Canada. Operation is subject to the following two conditions:

1. This device may not cause harmful interference
2. This device must accept any interference that may be received, including interference that may cause undesired operation

If your Remote Lock Control fails to operate from a normal distance, check for these two conditions:

1. Weak batteries in transmitter. The expected life of batteries is from one to two years

2. Closeness to a radio transmitter such as a radio station tower, airport transmitter, and some mobile or CB radios.

Transmitter Battery Service

The recommended replacement batteries are CR2016.

1. Pry the transmitter halves apart with a dime or similar object. Make sure not to damage the rubber gasket material during removal.

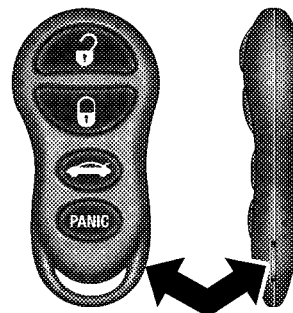

8091f2a8

2. Remove and replace the batteries. Avoid touching the new batteries with your fingers. Skin oils may cause battery deterioration. If you touch the battery, clean it with rubbing alcohol.
3. Reassemble the transmitter case. Snap the halves together and test transmitter operation.

VEHICLE THEFT ALARM

The system monitors the doors, trunk, and ignition for unauthorized operation.

If something triggers the alarm, the system will signal for up to 18 minutes. For the first three minutes the horn will sound and the headlights and interior lights will flash. Then the horn will stop and if the source of the trigger is still present, the lights will continue to flash for another 15 minutes.

NOTE: The engine will not start until you disarm the system.

To set the alarm:

1. Remove the keys from the ignition switch and get out of the vehicle.
2. Lock the door using either the power door lock switch, the key, or the Keyless Entry Transmitter and close all doors.
3. The light in the instrument cluster will flash rapidly for 15 seconds. This shows that the system is arming. If the light comes on but does not flash, the system is still armed, but there is a problem in the trunk circuit. After 15 seconds the light will continue to flash slowly. This shows that the system is fully armed.

To disarm the system:

Unlock a front door using either the key or the Keyless Entry Transmitter.

Tamper Alert

If the horn sounds 3 times when you unlock a front door using either a key or the Keyless Entry Transmitter, the alarm had been triggered. Check the vehicle for tampering.

Security System Manual Override

The system will not arm if you lock the doors using the manual lock control.

TRUNK LOCK AND RELEASE

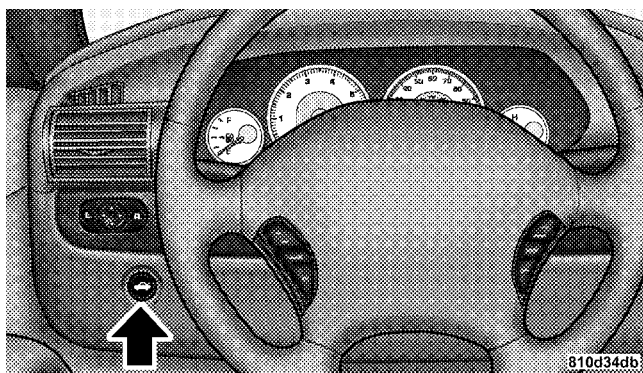

Use the key or the Remote Keyless Entry Transmitter to open the trunk from outside the vehicle. From inside the car the trunk lid can be released by turning the ignition ON and depressing the Trunk Release Button located on the instrument panel to the left of the steering wheel. The transmission must be in Park before the switch will

operate. Vehicles with manual transmissions must have the ignition ON and be at 0 mph for the switch to work.

With the ignition ON, the word “deck” will be displayed in place of the odometer display indicating that the trunk is open. The odometer display will reappear once the trunk is closed or if the trip button is depressed.

With the key in lock position or key out, the “deck” will be displayed until the trunk is closed.

TRUNK SAFETY WARNING

WARNING!

Do not allow children to have access to the trunk, either by climbing into the trunk from outside, or through the inside of the vehicle. Always close the trunk lid when your vehicle is unattended. Once in the trunk, young children may not be able to escape, even if they entered through the rear seat. If trapped in the trunk, children can die from suffocation or heat stroke.

Trunk Internal Emergency Release

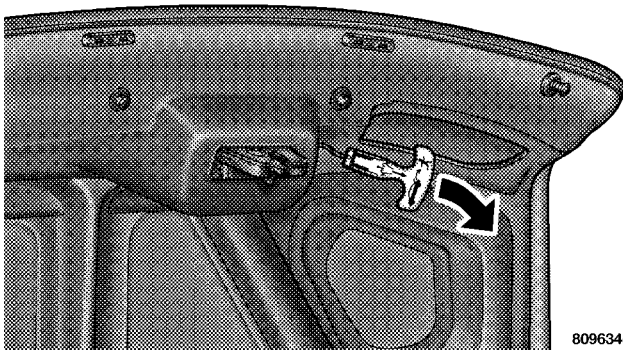

809634cd

NOTE: As a security measure, a Trunk Internal Emergency Release lever is built into the trunk latching mechanism. In the event of an individual being locked inside the trunk, the trunk can be simply opened by pulling on the glow-in-the-dark handle attached to the trunk latching mechanism. See picture.

POWER WINDOWS

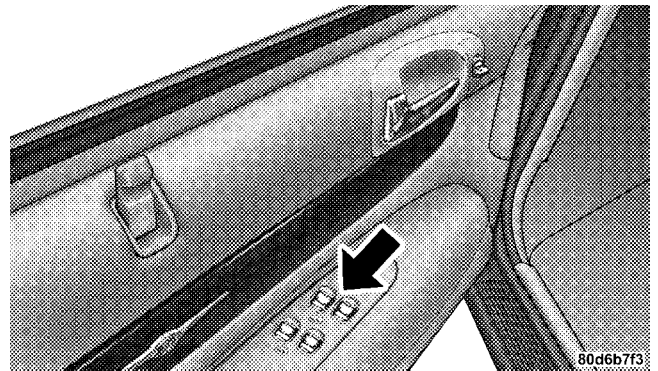

80d6b7f3

The window controls on the driver's door operate all windows.

The driver's window switch has an Auto Down feature. Press the window switch past the detent, release, and the window will go down automatically.

To open the window part way, pull the window switch part way and release it when you want the window to stop.

Wind Buffeting

Wind buffeting can be described as the perception of pressure on the ears or a helicopter type sound in the ears. Your vehicle may exhibit wind buffeting with the windows down, or in certain open or partially open positions. This is a normal occurrence and can be minimized. If the buffeting occurs with the rear windows open, open the front and rear windows together to minimize the buffeting.

OCCUPANT RESTRAINTS

Some of the most important safety features in your vehicle are the restraint systems. These include the front and rear seat belts for the driver and all passengers, and front airbags for both the driver and front passenger. If you will be carrying children too small for adult-size belts, your seat belts also can be used to hold infant and child restraint systems.

Please pay close attention to the information in this section. It tells you how to use your restraint system properly to keep you and your passengers as safe as possible.

WARNING!

In a collision, you and your passengers can suffer much greater injuries if you are not properly buckled up. You can strike the interior of your vehicle or other passengers, or you can be thrown out of the vehicle. Always be sure you and others in your vehicle are buckled up properly.

Buckle up even though you are an excellent driver, even on short trips. Someone on the road may be a poor driver and cause a collision which includes you. This can happen far away from home or on your own street.

Research has shown that seat belts save lives, and they can reduce the seriousness of injuries in a collision. Some of the worst injuries happen when people are thrown from the vehicle. Seat belts reduce the possibility of ejection and the risk of injury caused by striking the inside of the vehicle. **Everyone** in a motor vehicle should be belted at all times.

Lap/Shoulder Belts

All seating positions in your vehicle are equipped with Lap/Shoulder Belts.

The belt webbing retractor is designed to lock during very sudden stops or impacts. This feature allows the shoulder part of the belt to move freely with you under normal conditions. But in a collision, the belt will lock and reduce your risk of striking the inside of the vehicle or being thrown out.

WARNING!

- **Wearing a seat belt incorrectly is dangerous. Seat belts are designed to go around the large bones of your body. These are the strongest parts of your body and can take the forces of a collision the best. Wearing your belt in the wrong place could make your injuries in a collision much worse. You might suffer internal injuries, or you could even slide out of part of the belt. Follow these instructions to wear your seat belt safely and to keep your passengers safe, too.**
- **Two people should never be belted into a single seat belt. People belted together can crash into one another in an accident, hurting one another badly. Never use a lap/shoulder belt or a lap belt for more than one person, no matter what their size.**

Lap/Shoulder Belt Operating Instructions

1. Enter the vehicle and close the door. Sit back and adjust the front seat.



2. The seat belt latch plate is on the back of your seat. Grasp the latch plate and pull out the belt. Slide the latch plate up the webbing as far as necessary to allow the belt go around your lap.

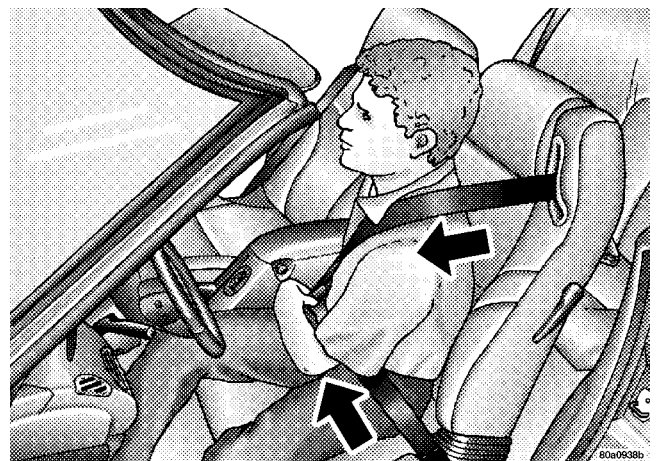

3. When the belt is long enough to fit, insert the latch plate into the buckle until you hear a "click."

WARNING!

- A belt that is buckled into the wrong buckle will not protect you properly. The lap portion could ride too high on your body, possibly causing internal injuries. Always buckle your belt into the buckle nearest you.
- A belt that is too loose will not protect you as well. In a sudden stop you could move too far forward, increasing the possibility of injury. Wear your seat belt snugly.
- A belt that is worn under your arm is very dangerous. Your body could strike the inside surfaces of the vehicle in a collision, increasing head and neck injury. A belt worn under the arm can cause internal injuries. Ribs aren't as strong as shoulder bones. Wear the belt over your shoulder so that your strongest bones will take the force in a collision.
- A shoulder belt placed behind you will not protect you from injury during a collision. You are more likely to hit your head in a collision if you do not wear your shoulder belt. The lap and shoulder belt are meant to be used together.

4. Position the lap belt across your thighs, below your abdomen. To remove slack in the lap belt portion, pull up a bit on the shoulder belt. To loosen the lap belt if it is too tight, tilt the latch plate and pull on the lap belt. A snug belt reduces the risk of sliding under the belt in a collision.



WARNING!

- A lap belt worn too high can increase the risk of internal injury in a collision. The belt forces won't be at the strong hip and pelvic bones, but across your abdomen. Always wear the lap belt as low as possible and keep it snug.
- A twisted belt can't do its job as well. In a collision it could even cut into you. Be sure the belt is straight. If you can't straighten a belt in your vehicle, take it to your dealer and have it fixed.

5. Position the shoulder belt on your chest so that it is comfortable and not resting on your neck. The retractor will withdraw any slack in the belt.

6. To release the belt, push the red button on the buckle. The belt will automatically retract to its stowed position. If necessary, slide the latch plate down the webbing to allow the belt to retract fully.

WARNING!

A frayed or torn belt could rip apart in a collision and leave you with no protection. Inspect the belt system periodically, checking for cuts, frays, or loose parts. Damaged parts must be replaced immediately. Do not disassemble or modify the system. Seat belt assemblies must be replaced after a collision if they have been damaged (bent retractor, torn webbing, etc.).

Pretensioners

The seat belts for both front seating positions are equipped with pretensioning devices that are designed to remove any slack from the seat belts in the event of a collision. These devices improve the performance of the seat belt system by assuring that the belt is tight about the occupant early in a collision. Pretensioners work for all size occupants.

NOTE: These devices are not a substitute for proper seat belt placement by the occupant. The seat belt still must be worn snugly and positioned properly.

The pretensioners are triggered by the front airbag control module (see Airbag Section). Like the front airbags, the pretensioners are single use items. After a collision that is severe enough to deploy the airbags and pretensioners, both must be replaced.

Enhanced Driver Seat Belt Reminder System (BeltAlert)

If the driver's seat belt has not been buckled within 60 seconds of starting the vehicle and if the vehicle speed is greater than 5 mph (8 km/h), the Enhanced Warning System (BeltAlert) will alert the driver to buckle their seat belt. The driver should also instruct all other occupants to buckle their seat belts. Once the warning is triggered, the Enhanced Warning System (BeltAlert) will continue to chime and flash the Seat Belt Warning Light for 96 seconds or until the driver's seat belt is buckled. The Enhanced Warning System (BeltAlert) will be reactivated if the driver's seat belt is unbuckled for more than 10 seconds and the vehicle speed is greater than 5 mph (8 km/h).

The Enhanced Warning System (BeltAlert) can be enabled or disabled by your authorized dealer or by following these steps:

NOTE: The following steps must occur within the first 60 seconds of the ignition switch being turned to the ON or START position. DaimlerChrysler does not recommend deactivating the Enhanced Warning System (BeltAlert).

1. Turn the ignition switch to the OFF position and buckle the driver's seat belt.
2. Start the engine and wait for the Seat Belt Warning Light to turn off.
3. Within 60 seconds of starting the vehicle, unbuckle and then re-buckle the driver's seat belt at least three times within 10 seconds, ending with the seat belt buckled.

NOTE: Watch for the Seat Belt Warning Light to turn on while unbuckling and off while re-buckling the seat belt. It may be necessary to retract the seat belt.

4. Turn off the engine. A single chime will sound to signify that you have successfully completed the programming.

The Enhanced Warning System (BeltAlert) can be reactivated by repeating this procedure.

NOTE: Although the Enhanced Warning System (BeltAlert) has been deactivated, the Seat Belt Warning Light will continue to illuminate while the driver's seat belt remains unbuckled.

Seat Belts and Pregnant Women

We recommend that pregnant women use the seat belts throughout their pregnancy. Keeping the mother safe is the best way to keep the baby safe.

Pregnant women should wear the lap part of the belt across the thighs and as snug across the hips as possible. Keep the belt low so that it does not come across the abdomen. That way the strong bones of the hips will take the force if there is a collision.

Seat Belt Extender

If a seat belt is too short, even when fully extended and when the adjustable upper shoulder belt anchorage (if so equipped) is in its lowest position, your dealer can provide you with a seat belt extender. This extender should be used only if the existing belt is not long enough. When it is not required, remove the extender and store it.

WARNING!

Using a seat belt extender when not needed can increase the risk of injury in a collision. Only use when the seat belt is not long enough when it is worn low and snug, and in the recommended seating positions. Remove and store the extender when not needed.

Driver and Right Front Passenger Supplemental Restraint System (SRS) - Airbag

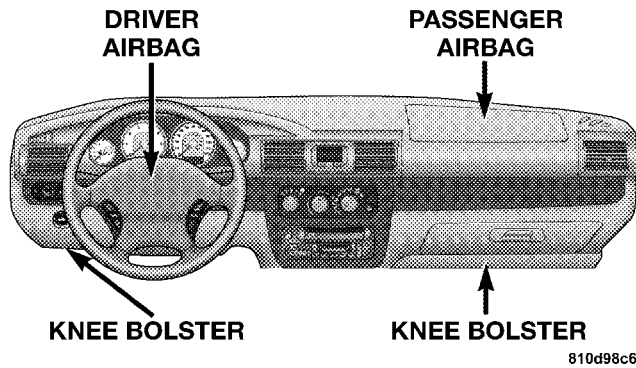

This vehicle has front airbags for both the driver and front passenger as a supplement to the seat belt restraint systems. The driver's airbag is mounted in the center of the steering wheel. The passenger's front airbag is mounted in the instrument panel, above the glove compartment. The words SRS AIRBAG are embossed on the airbag covers.

NOTE: These airbags are certified to the new Federal regulations that allow less forceful airbags.

WARNING!

- Do not put anything on or around the front airbag covers or attempt to manually open them. You may damage the airbags and you could be injured because the airbags are not there to protect you. These protective covers for the airbag cushions are designed to open only when the airbags are inflating.
- Do not drill, cut or tamper with knee bolster in any way.
- Do not mount any accessories to the knee bolster such as alarm lights, stereos, citizens band radios etc.

Airbags inflate in moderate to high speed impacts. Along with the seat belts, front airbags work with the instrument panel knee bolsters to provide improved protection for the driver and front passenger.

The seat belts are designed to protect you in many types of collisions. The front airbags deploy only in moderate to severe frontal collisions. But even in collisions where

the airbags work, you need the seat belts to keep you in the right position for the airbags to protect you properly.

Here are some simple steps you can take to minimize the risk of harm from a deploying airbag.

1. Children 12 years old and under should ride buckled up in the rear seat. Infants in rear-facing child restraints should **NEVER** ride in the front seat of a vehicle with a passenger front airbag. An airbag deployment could cause severe injury or death to infants in that position.

Children that are not big enough to properly wear the vehicle seat belt (see section on “Child Restraints”) should be secured in the rear seat in child restraints or belt-positioning booster seats appropriate for the size and age of the child.

Older children who do not use child restraints or belt-positioning booster seats should ride properly buckled up in the rear seat. Never allow children to slide the shoulder belt behind them or under their arm.

If a child from 1 to 12 years old must ride in the front passenger seat because the vehicle is crowded, move the

seat as far back as possible, and use the proper child restraint. See the section on “Child Restraint”.

2. You should read the instructions provided with your child restraint to make sure that you are using it properly.

3. All occupants should use their seat belts properly.

4. The driver and front passenger seats should be moved back as far as practical to allow the airbags time to inflate.

WARNING!

- **Relying on the airbags alone could lead to more severe injuries in a collision. The airbags work with your seat belt to restrain you properly. In some collisions the airbags won't deploy at all. Always wear your seat belts even though you have airbags.**
- **Being too close to the steering wheel or instrument panel during airbag deployment could cause serious injury. Airbags need room to inflate. Sit back, comfortably extending your arms to reach the steering wheel or instrument panel.**

Airbag System Components

The front airbag system consists of the following:

- Airbag Control Module
- **AIRBAG** Readiness Light
- Driver Airbag
- Passenger Airbag
- Steering Wheel and Column
- Instrument Panel
- Interconnecting Wiring
- Knee Impact Bolsters

How The Airbag System Works

- The front airbag control module determines if a frontal collision is severe enough to require the airbags to inflate. The control module receives the level of crash severity and determines the proper level of airbag to be deployed. The frontal airbag inflators are designed to provide two different rates of air bag inflation.
- The airbag control module will not detect roll over or rear collisions.
- The airbag control module also monitors the readiness of the electronic parts of the system whenever the ignition switch is in the **START** or **RUN** positions. These include all of the items listed above except the knee bolster, the instrument panel, and the steering wheel and column. If the key is in the “off” position, in the **ACC** position, or not in the ignition, the airbags are not on and will not inflate.

**AIR
BAG**

- The airbag control module also turns on the AIRBAG light in the instrument panel for 6 to 8 seconds when the ignition is first turned on, then turns the light off. If it detects a malfunction in any part of the system, it turns on the light either momentarily or continuously.

WARNING!

Ignoring the AIRBAG light in your instrument panel could mean you won't have the airbags to protect you in a collision. If the light does not come on, stays on after you start the vehicle, or if it comes on as you drive, have the airbag system checked right away.

- When the airbag control module detects a collision requiring the airbags, it signals the inflator units. A large quantity of nontoxic gas exits the airbag inflator and inflates the airbag. Two levels of airbag inflation rates are possible. These rates are determined by the airbag control module based on collision severity. The airbag covers separate and fold out of the way as the airbags inflate to their full size. The airbags fully

inflate in about 60 milliseconds. This is only about half of the time it takes you to blink your eyes. The airbags then quickly deflate while helping to restrain the driver and front passenger. The driver's front airbag gas is vented through a vent hole in the rear of the airbag. The passenger's front airbag gas is vented through vent holes in the sides of the airbag. In this way the airbags do not interfere with your control of the vehicle.

- The Knee Impact Bolsters help protect the knees and position you for the best interaction with the front airbag.

If A Deployment Occurs

The airbag system is designed to deploy when the airbag control module detects a moderate-to-severe frontal collision, to help restrain the driver and front passenger, and then to immediately deflate.

NOTE: A frontal collision that is not severe enough to need airbag protection will not activate the system. This does not mean something is wrong with the airbag system.

If you do have a collision which deploys the airbags, any or all of the following may occur:

- The nylon airbag material may sometimes cause abrasions and/or skin reddening to the driver and right front passenger as the airbags deploy and unfold. The abrasions are similar to friction rope burns or those you might get sliding along a carpet or gymnasium floor. They are not caused by contact with chemicals. They are not permanent and normally heal quickly. However, if you haven't healed significantly within a few days, or if you have any blistering, see your doctor immediately.
- As the airbags deflate you may see some smoke-like particles. The particles are a normal by-product of the process that generates the nontoxic gas used for airbag inflation. These airborne particles may irritate the skin, eyes, nose, or throat. If you have skin or eye irritation, rinse the area with cool water. For nose or throat irritation, move to fresh air. If the irritation continues, see your doctor. If these particles settle on your clothing, follow the garment manufacturer's instructions for cleaning.

- It is not advisable to drive your vehicle after the airbags have been deployed. If you are involved in another collision, the airbags will not be in place to protect you.

2

WARNING!

Deployed airbags can't protect you in another collision. Have the airbags replaced by an authorized dealer as soon as possible.

Maintaining Your Airbag System

WARNING!

- **Modifications to any part of the airbag system could cause it to fail when you need it. You could be injured because the airbags are not there to protect you. Do not modify the components or wiring, including adding any kind of badges or stickers to the steering wheel hub trim cover or the upper right side of the instrument panel. Do not modify the front bumper, vehicle body structure, or frame.**
- **You need proper knee impact protection in a collision. Do not mount or locate any aftermarket equipment on or behind the knee impact bolster.**
- **It is dangerous to try to repair any part of the airbag system yourself. Be sure to tell anyone who works on your vehicle that it has airbags.**

Airbag Light

AIR BAG You will want to have the airbags ready for your protection in an impact. While the airbag system is designed to be maintenance free, if any of the following occurs, have an authorized dealer service the system promptly:

- The **AIRBAG** light does not come on or flickers during the 6 to 8 seconds when the ignition switch is first turned on.
- The light remains on or flickers after the 6 to 8 second interval.
- The light flickers or comes on and remains on while driving.

Child Restraint

Everyone in your vehicle needs to be buckled up all the time— babies and children too. Every state in the United States and all Canadian provinces require that small children ride in proper restraint systems. This is the law, and you can be prosecuted for ignoring it.

Children 12 years and under should ride properly buckled up in a rear seat. According to crash statistics, children are safer when properly restrained in the rear seat rather than in the front.

WARNING!

In a collision, an unrestrained child, even a tiny baby, can become a missile inside the vehicle. The force required to hold even an infant on your lap could become so great that you could not hold the child, no matter how strong you are. The child and others could be badly injured. Any child riding in your vehicle should be in a proper restraint for the child's size.

There are different sizes and types of restraints for children from newborn size to the child almost large enough for an adult safety belt. Always check the child seat Owner's Manual to ensure you have the right seat for your child. Use the restraint that is correct for your child:

Infants and Child Restraints

- Safety experts recommend that children ride rearward-facing in the vehicle until they are at least one year old **and** weigh at least 20 lbs (9 kg). Two types of child restraints can be used rearward-facing: infant carriers and “convertible” child seats.
- The infant carrier is only used rearward-facing in the vehicle. It is recommended for children who weigh up to about 20 lbs (9 kg). “Convertible” child seats can be used either rearward-facing or forward-facing in the vehicle. Convertible child seats often have a higher weight limit in the rearward-facing direction than infant carriers do, so they can be used rearward-facing by children who weigh more than 20 lbs (9 kg) but are less than one year old. Both types of child restraints are held in the vehicle by the lap/shoulder belt or the LATCH child restraint anchorage system. (See the LATCH-Child Seat Anchorage System section.)
- Rearward-facing child seats must **NEVER** be used in the front seat of a vehicle with the front passenger airbag. An airbag deployment could cause severe injury or death to infants in this position.

WARNING!

- **Improper installation can lead to failure of an infant or child restraint. It could come loose in a collision. The child could be badly injured or killed. Follow the manufacturer's directions exactly when installing an infant or child restraint.**
- **A rearward facing infant restraint should only be used in a rear seat. A rearward facing infant restraint in the front seat may be struck by a deploying passenger airbag which may cause severe or fatal injury to the infant.**

Here are some tips on getting the most out of your child restraint:

- Before buying any restraint system, make sure that it has a label certifying that it meets all applicable Safety Standards. We also recommend that you make sure that you can install the child restraint in the vehicle where you will use it before you buy it.

- The restraint must be appropriate for your child's weight and height. Check the label on the restraint for weight and height limits.
- Carefully follow the instructions that come with the restraint. If you install the restraint improperly, it may not work when you need it.
- Buckle the child into the seat according to the child restraint manufacturer's directions.
- When your child restraint is not in use, secure it in the vehicle with the seat belt or remove it from the vehicle. Do not leave it loose in the vehicle. In a sudden stop or collision, it could strike the occupants or seat backs and cause serious personal injury.

NOTE: For additional information, refer to www.seatcheck.org or call 1-866-SEATCHECK.

Older Children and Child Restraints

Children who weigh more than 20 lbs (9 kg) and who are older than one year can ride forward-facing in the vehicle. Forward-facing child seats and convertible child seats used in the forward-facing direction are for children who weigh 20 to 40 lbs (9 to 18 kg) and who are older

than one year. These child seats are also held in the vehicle by the lap/shoulder belt or the LATCH child restraint anchorage system. (See the LATCH — Child Seat Anchorage System Section.)

The belt-positioning booster seat is for children weighing more than 40 lbs (18 kg), but who are still too small to fit the vehicle's seat belts properly. If the child cannot sit with knees bent over the vehicle's seat cushion while the child's back is against the seat back, they should use a belt-positioning booster seat. The child and belt-positioning booster seat are held in the vehicle by the lap/shoulder belt.

Children Too Large For Booster Seats

Children who are large enough to wear the shoulder belt comfortably, and whose legs are long enough to bend over the front of the seat when their back is against the seat back, should use the lap/shoulder belt in a rear seat.

- Make sure that the child is upright in the seat.
- The lap portion should be low on the hips and as snug as possible.

- Check belt fit periodically. A child's squirming or slouching can move the belt out of position.
- If the shoulder belt contacts the face or neck, move the child closer to the center of the vehicle. Never allow a child to put the shoulder belt under an arm or behind their back.

LATCH — Child Seat Anchorage System (Lower Anchors and Tether for Children)

Your vehicle's rear seat is equipped with the child restraint anchorage system called LATCH. The LATCH system provides for the installation of child restraints without using the vehicle's seat belts, instead securing the child restraint using lower anchorages and upper tether straps from the child restraint to the vehicle structure.

LATCH-compatible child restraint systems are now available. However, because the lower anchorages are to be introduced over a period of years, child restraint systems having attachments for those anchorages will continue to also have features for installation using the vehicle's seat belts. Child restraints having tether straps and hooks for

connection to the top tether anchorages have been available for some time. For some older child restraints, many child restraint manufacturers offer add-on tether strap kits or retro-fit kits. You are urged to take advantage of all the available attachments provided with your child restraint in any vehicle.

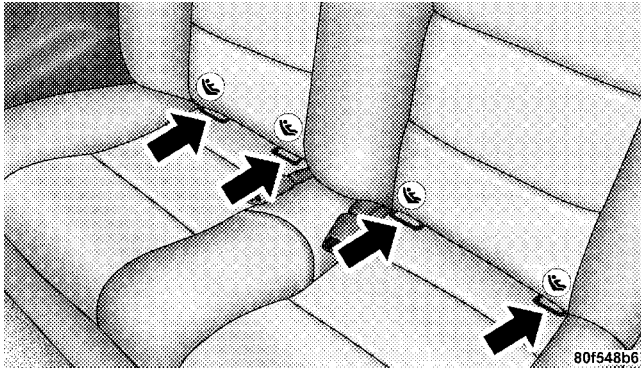

Both rear seating positions have lower anchorages that are capable of accommodating LATCH-compatible child seats. These are round bars, located at the lower area of the seat back, designated by four round labels with a symbol of a

child in a car seat. (Symbol shown to the left). Install your child seat as per child seat manufacturer recommendations.

WARNING!

Do not install a LATCH-equipped child restraint in the center of the rear seat of the vehicle. This is not a seating position in the vehicle, and a child seat cannot be correctly installed in this position. Additionally, there is no tether anchorage provided for correctly installing a child seat in the center of the rear seat. Only install child seats in the right or left rear positions in the vehicle, using either the lap/shoulder belt or LATCH attachments to secure the child seat. Always use the tether anchor directly behind the seating position when securing a child restraint.

Installing the LATCH-Compatible Child Restraint System

We urge that you carefully follow the directions of the manufacturer when installing your child restraint. Not all

child restraint systems will be installed as described here. Again, carefully follow the installation instructions that were provided with the child restraint system.

The rear seat lower anchorages are round bars, located at the rear of the seat cushion where it meets the seat back, and are just visible when you lean into the rear seat to install the child restraint. You will easily feel them if you run your finger along the intersection of the seatback and seat cushion surfaces.



In addition, there are tether strap anchorages behind each rear seating position located in the bottom of the convertible top well, behind the seat back. The anchors are under the carpet cutouts marked with this symbol. (Shown to the left).

Many, but not all restraint systems will be equipped with separate straps on each side, with each having a hook or connector for attachment to the lower anchorage and a means of adjusting the tension in the strap. Forward-facing toddler restraints and some rear-facing infant restraints will also be equipped with a tether strap, a hook for attachment to the tether strap anchorage and a means of adjusting the tension of the strap.

You will first loosen the adjusters on the lower straps and on the tether strap so that you can more easily attach the hooks or connectors to the vehicle anchorages. Next attach the lower hooks or connectors over the top of the anchorage bars, pushing aside the seat cover material. Then lift the carpet flap to expose the tether anchor directly behind the seat where you are placing the child restraint and attach the tether strap to provide the most direct path between the anchor and the child restraint. Finally, tighten all three straps as you push the child restraint rearward and downward into the seat, removing slack in the straps according to the child restraint manufacturer's instructions.

2

WARNING!

Improper installation of a child restraint to the LATCH anchorages can lead to failure of an infant or child restraint. The child could be badly injured or killed. Follow the manufacturer's directions exactly when installing an infant or child restraint.

Installing Child Restraints Using the Vehicle Seat Belts

The passenger seat belts are equipped with cinching latch plates which are designed to keep the lap portion tight around the child restraint so that it is not necessary to use a locking clip. Pulling up on the shoulder portion of the lap/shoulder belt will tighten the belt. The cinching latch plate will keep the belt tight, however, any seat belt system will loosen with time, so check the belt occasionally and pull it tight if necessary.

In the rear seat, you may have trouble tightening the lap/shoulder belt on the child restraint because the buckle or latch plate is too close to the belt path opening on the restraint. Disconnect the latch plate from the buckle and twist the short buckle-end belt several times to shorten it. Insert the latch plate into the buckle with the release button facing out.

If the belt still can't be tightened, or if by pulling and pushing on the restraint loosens the belt, you may need to do something more. Disconnect the latch plate from the buckle, turn the buckle around, and insert the latch

plate into the buckle again. If you still can't make the child restraint secure, try a different seating position.

To attach a child restraint tether strap:

1. Lift the carpet flap to expose the anchor directly behind the seat where you are placing the child restraint.



2. Route the tether strap to provide the most direct path for the strap between the anchor and the child seat.

3. Attach the tether strap hook (A) of the child restraint to the anchor and remove slack in the tether strap (B) according to the child restraint manufacturer's instructions.

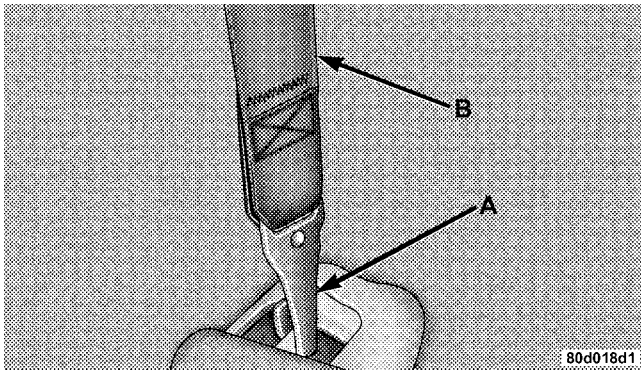

WARNING!

An incorrectly anchored tether strap could lead to increased head motion and possible injury to the child. Use only the anchor positions directly behind the child seat to secure a child restraint top tether strap.

2

Transporting Pets

Airbags deploying in the front seat could harm your pet. An unrestrained pet will be thrown about and possibly injured, or injure a passenger during panic braking or in a collision.

Pets should be restrained in the rear seat in pet harnesses or pet carriers that are secured by seat belts.

ENGINE BREAK-IN RECOMMENDATIONS

The engine in your new vehicle does not require a long break-in period.

Drive moderately during the first 300 miles (500 km). After the initial 60 miles (100 km), speeds up to 50 or 55 mph (80 or 90 km/h) are desirable.

While cruising, brief full-throttle acceleration, within the limits of local traffic laws, contributes to a good break-in.

Wide open throttle acceleration in low gear can be detrimental and should be avoided.

The crankcase oil installed in the engine at the factory is a high quality energy conserving type lubricant. Oil changes should be consistent with expected climate conditions under which vehicle operations will occur. The recommended viscosity and quality grades are in Section 7 of this manual.

Do not use non-detergent or straight mineral oils.

A new engine may consume some oil during its first few thousand miles of operation. This is a normal part of the break-in and not an indication of a problem.

SAFETY TIPS

Exhaust Gas

WARNING!

Exhaust gases can injure or kill. They contain carbon monoxide (CO) which is colorless and odorless. Breathing it can make you unconscious and can eventually poison you. To avoid breathing (CO) follow the safety tips below.

- Do not run the engine in a closed garage or in confined areas any longer than needed to move your vehicle in or out of the area.
- If it is necessary to sit in a parked vehicle with the engine running, adjust your heating or cooling controls to force outside air into the vehicle. Set the blower at high speed.
- To avoid drawing exhaust gases into the vehicle, close the trunk while driving. However, if for some reason it

must remain open, close all windows. Adjust the heating or cooling system to force outside air into the vehicle. Set the blower at high speed.

Safety Checks You Should Make Inside the Vehicle

Seat Belts

Inspect the belt system periodically, checking for cuts, frays and loose parts. Damaged parts must be replaced immediately. Do not disassemble or modify the system.

Safety belt assemblies must be replaced after a collision if they have been damaged (bent retractor, torn webbing, etc.). If there is any question regarding belt or retractor condition, replace the belt.

Airbag Light

AIR BAG The light should come on and remain on for 6 to 8 seconds as a bulb check when the ignition switch is first turned ON. If the bulb is not lit during starting, have it replaced. If the light stays on or comes on while driving, have the system checked by an authorized dealer.

Defrosters

Check operation by selecting the defrost mode and place the blower control on high speed. You should be able to feel the air directed against the windshield.

Periodic Safety Checks You Should Make Outside the Vehicle

Tires

Examine tires for excessive tread wear or uneven wear patterns. Check for stones, nails, glass, or other objects lodged in the tread. Inspect for tread cuts or sidewall cracks. Check wheel nuts for tightness, and tires (including spare) for proper pressure.

Lights

Have someone observe the operation of exterior lights while you work the controls. Check turn signal and high beam indicator lights on the instrument panel.

Fluid Leaks

Check area under vehicle after overnight parking for fuel, water, oil, or other fluid leaks. Also, if gasoline fumes are present, the cause should be corrected immediately.

UNDERSTANDING THE FEATURES OF YOUR VEHICLE

CONTENTS

■ Convertible Top Operation47	□ Illuminated Vanity Mirrors58
□ To Lower The Top47	■ Seats58
□ To Raise The Top49	□ Manual Front Seat Adjustments58
□ Top Cover Installation50	□ Power Driver's Seat60
□ Top Cover Removal54	□ Heated Seats — If Equipped60
■ Console Features55	□ To Fold The Front Seatback Forward61
■ Mirrors56	□ Easy Entry System61
□ Inside Day/Night Mirror — If Equipped56	□ Adjustable Head Restraints62
□ Automatic Dimming Mirror — If Equipped56	■ To Open And Close The Hood62
□ Exterior Mirrors Folding Feature — If Equipped57	■ Lights64
□ Electric Remote-Control Mirrors57	□ Front Map/Reading Lights64

46 UNDERSTANDING THE FEATURES OF YOUR VEHICLE

□ Interior Lights64	■ Electronic Speed Control— If Equipped70
□ Multi-Function Control Lever66	□ To Activate71
□ Headlights, Parking Lights, Instrument Panel Lights66	□ To Set At A Desired Speed71
□ Daytime Running Lights (Canada Only)66	□ To Deactivate71
□ Lights-On Reminder67	□ To Resume Speed71
□ Fog Lights — If Equipped67	□ To Vary The Speed Setting71
□ Turn Signals67	□ To Accelerate For Passing72
□ Headlight Beam Select Switch67	□ Using Speed Control On Hills72
□ Passing Light67	■ Garage Door Opener — If Equipped73
□ Headlight Time Delay67	□ Programming The Universal Transceiver74
■ Windshield Wipers And Washers68	□ “Rolling Code” Programming75
□ Mist68	□ Canadian Programming/Gate Programming77
□ Speed Sensitive Intermittent Wiper System69	□ Operation77
■ Tilt Steering Column69	□ Reprogramming A Single Button77
■ Traction Control— If Equipped70	□ Security77
		■ Electrical Power Outlet78

CONVERTIBLE TOP OPERATION

WARNING!
<p>The convertible top does not provide the structural protection that a reinforced metal roof does, and the fabric top cannot be expected to prevent the ejection of the occupants of a vehicle in a collision. Therefore it is important that all occupants wear their seat belts at all times when riding in a convertible. Studies have shown that it is generally safer to remain inside a vehicle during a collision, than to be ejected from the vehicle.</p>

NOTE: The top and top storage area should be thoroughly dry before lowering the top.

To Lower The Top:

NOTE: To avoid damage to the convertible top or its components, your vehicle is equipped with a feature that prevents convertible top operation at speeds over 10 mph (16 km/h).

CAUTION!
<p>To fully insure that no damage occurs, be sure that the vehicle is at a complete stop with the gear selector in the Park position before lowering or raising the top.</p>

1. To avoid damage to either the top or the rear window, check the top storage area at the rear of the vehicle interior to be sure that it is clear of debris or other items. Be sure that child seat flip up bars are lowered. Do not use the top storage area for other storage purposes.
2. Turn the ignition key to the On position.

3. Release the top from the windshield header by pulling both latch handles rearward until the latch hooks are free.

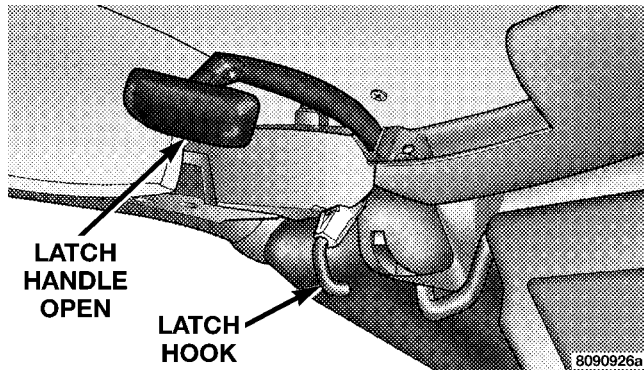

4. Press the Power Top Switch to disengage the top pins from the header. As soon as the top is free, close both latch handles.

NOTE: The Power Top Switch has two detent positions for lowering the convertible top. Pressing and holding the Power Top Switch lightly in the first detent position will automatically lower the convertible top. Pressing

and holding the switch in the second detent position will lower all four windows and the top to the full down position.

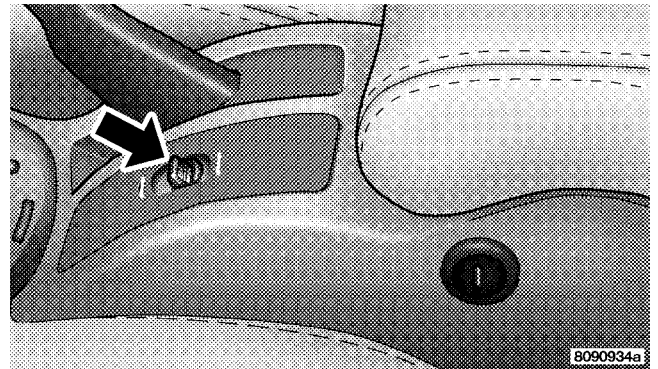

CAUTION!

Damage to the top material could result if the latch handles are not completely closed when the top is lowered. The convertible top cover cannot be installed while the latch handles are open.

To Raise The Top:

CAUTION!
To insure no damage occurs to the visors, they should be rotated to the forward (against glass) position prior to raising or lowering the convertible top.

NOTE: To avoid damage to the convertible top or its components, your vehicle is equipped with a feature that prevents convertible top operation at speeds over 10 mph (16 km/h).

NOTE: If the power convertible top system fails, raise the top by manually pulling the top until it meets the windshield and open both front latch handles. Pull the top until the two pins are seated in the windshield header. Using the center pull cup, pull down and hook each latch hook to its striker. Latch both sides. This may require a considerable amount of physical effort.

CAUTION!
To fully insure that no damage occurs, be sure that the vehicle is at a complete stop with the gear selector in the Park position before lowering or raising the top.

1. Remove the top cover and store it in the trunk.
2. Turn the ignition to the ON position.
3. Press the Power Top Switch to raise the top. Before the top reaches the windshield, open both front latch handles. Press the switch again to continue raising the top until the two pins seat themselves in the windshield header.
4. Use the center pull cup to pull down on the header. Hook each latch hook to its striker. Latch both sides.

CAUTION!
Car top carriers, ski racks, etc., should not be attached to the convertible top mechanism as they will damage the top.

Top Cover Installation

With the top down and the convertible top latch handles in the closed position, there are two ways to install the convertible top cover. Lay the unfolded convertible top cover across the convertible top and choose the way that suits you best.

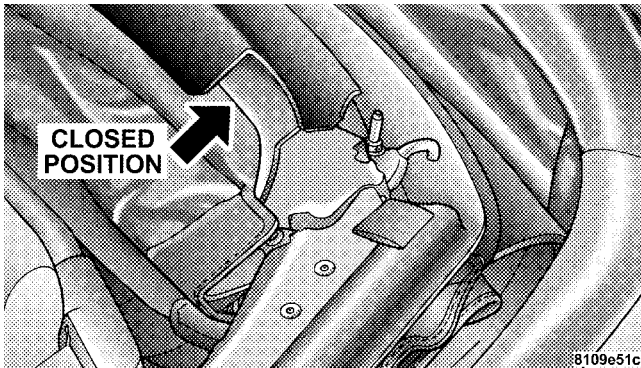

Installation From Inside The Vehicle

1. Kneel on the rear seat and tuck the rear edge and side edges of the top cover under the black molding near the trunk.

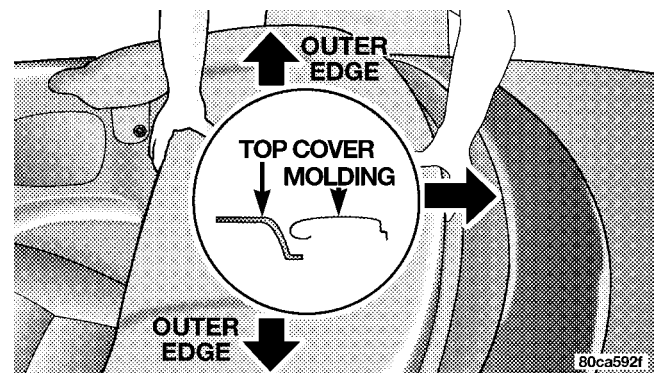

2. Insert both tabs located on the front of the top cover in between the seatback and seatback bracket.

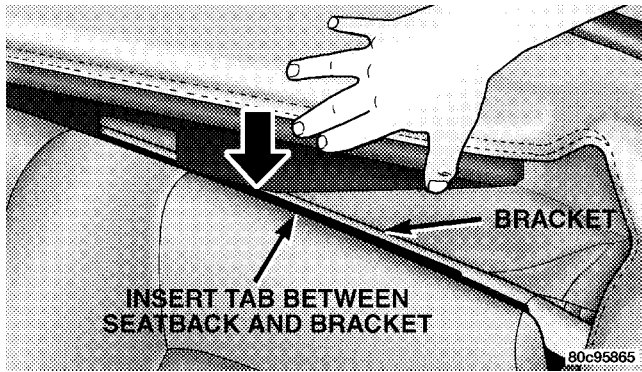

3. Snap the top cover flaps to the inner trim panel snaps. The side of the seat back cushion hides the snap.

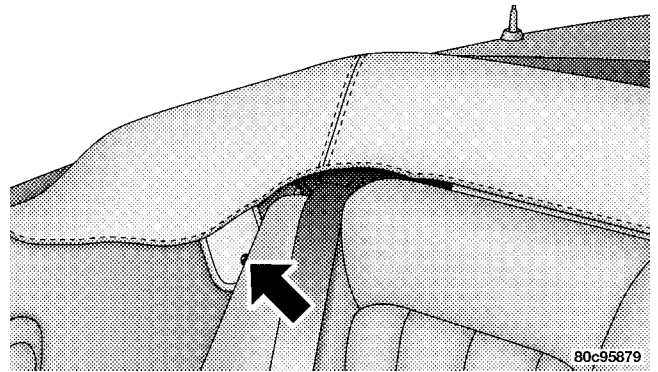

4. Press down on the forward portion of the top cover to engage the hook and loop fasteners.

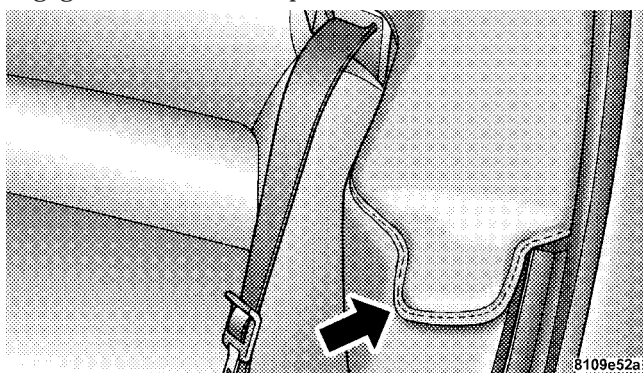

Installation From Outside The Vehicle

1. Start on one side of the vehicle and tuck as much of the top cover as possible under the black molding.

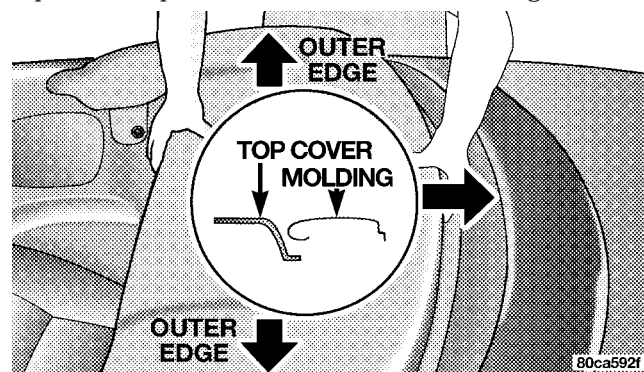

2. Snap the top cover flap to the inner trim panel snap. (The side of the seat back cushion hides the snap.)

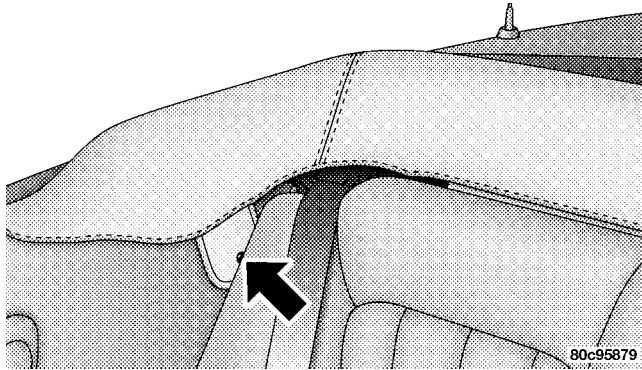

3. Tuck the top cover tab closest to you into the space between the seatback and the seatback bracket.

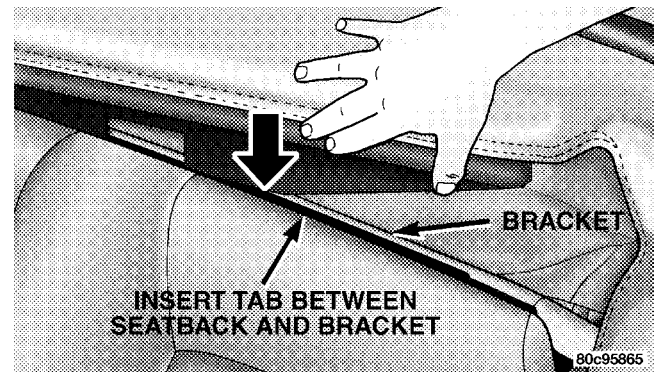

4. Walk to the other side of the vehicle and finish tucking the top cover under the black molding. Insert the remaining tab between the seatback and the seatback bracket.

5. Snap the remaining top cover flap to the inner trim panel snap.

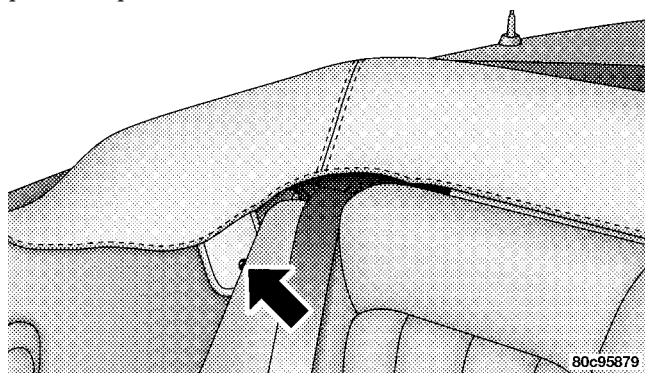

6. Press down on the forward portion of the top cover to engage the hook and loop fasteners.

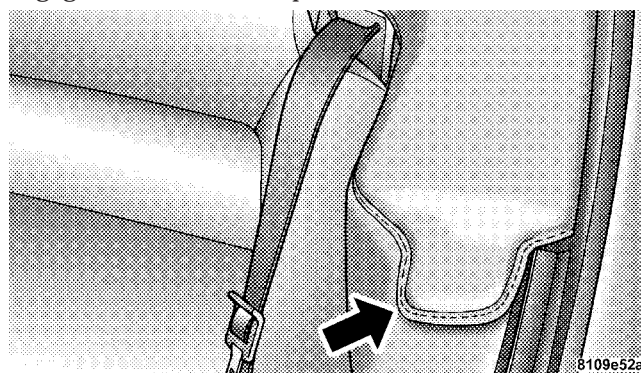

Top Cover Removal

Unsnap the snaps and disengage the hook and loop fasteners, slide the tabs from the rear seat and then from the rear of the top storage area. Remove the top cover, fold, and store in the trunk or a dry secure area.

CONSOLE FEATURES

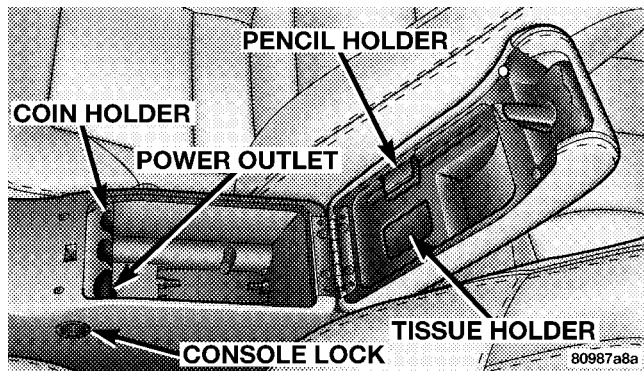

The front console has two cup holders. An optional removable ashtray may be located in the driver's side cup holder.

The center console/armrest has a pencil /tire gage holder and a tissue holder mounted on the underside of the cover. The bottom of the console bin also has built in holders for compact discs or cassette tapes. The power outlet is also mounted inside the center console (if equipped). There are also two cup holders for rear seat passengers and a rear courtesy lamp located directly in back of the center console. The center console can be locked using the "master" key.

Two coin holders are located toward the front of the inside of the console bin. Both can also accommodate various combinations of different types of coins, including some international currencies. The slot on the far left side is not for coins, but for an optional power outlet, if so equipped.

MIRRORS

Inside Day/Night Mirror — If Equipped

Adjust the mirror to center on the view through the rear window. A two point pivot system allows for horizontal and vertical mirror adjustment. If the driver's sunvisor interferes with the mirror, the mirror can be moved to the right to eliminate the interference.

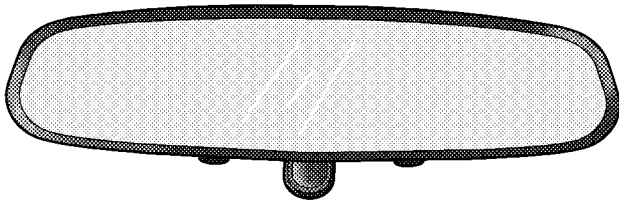

80a334b8

Annoying headlight glare can be reduced by moving the small control under the mirror to the night position (toward rear of vehicle). The mirror should be adjusted while set in the day position (toward windshield).

Automatic Dimming Mirror — If Equipped

This mirror will automatically adjust for annoying headlight glare from vehicles behind you. Push in the button on the face of the mirror to activate the dimming feature.

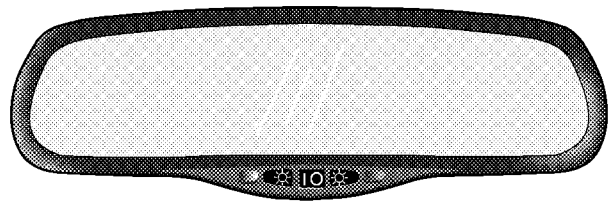

80a334c6

CAUTION!

To avoid damage to the mirror during cleaning, never spray any cleaning solution directly onto the mirror. Apply the solution onto a clean cloth and wipe the mirror clean.

Exterior Mirrors Folding Feature — If Equipped

Both mirrors have hinges and can be folded either forward or rearward to resist damage.

Electric Remote-Control Mirrors

Both of the outside mirrors can be adjusted by using the remote controls mounted on the instrument panel located to the left of the steering wheel.

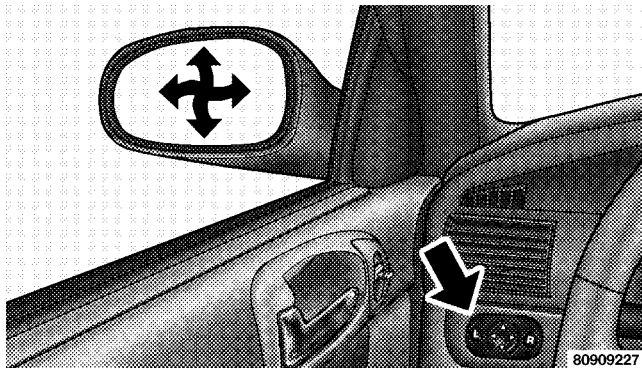

NOTE: Place the mirror selector switch in the center (neutral) position to prevent accidental movement of the mirrors.

Outside Mirror Adjustment — Driver's Side

Adjust the outside mirror to center on the adjacent lane of traffic, with a slight overlap of the view obtained on the inside mirror.

Right Side Mirror Adjustment

Adjust the convex outside mirror so you can just see the side of your vehicle in the part of the mirror closest to the vehicle.

3

WARNING!

Vehicles and other objects seen in the right side convex mirror will look smaller and farther away than they really are. Relying too much on your right side mirror could cause you to collide with another vehicle or other object. Use your inside mirror when judging the size or distance of a vehicle seen in this convex mirror.

Illuminated Vanity Mirrors

An illuminated vanity mirror is on each sun visor. To use the mirror, rotate the sun visor down and swing the mirror cover upward. The lights will turn on automatically. Closing the mirror cover turns off the lights.

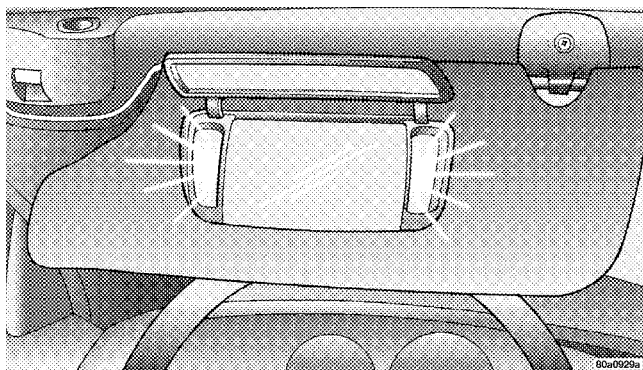

SEATS

Manual Front Seat Adjustments

Forward/Rearward — If Equipped

The adjusting bar is at the front of the seats, near the floor. Pull the bar up to move the seat to the desired position.

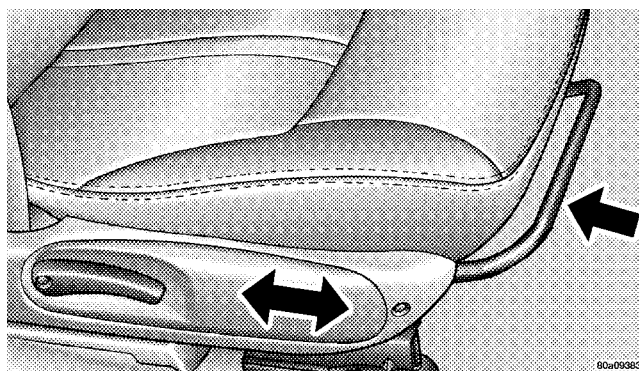

Using body pressure, move forward and rearward on the seat to be sure the seat adjusters have latched.

Reclining Bucket Seats

The recliner control is on the side of the seat. To recline, lean forward slightly before lifting the lever, then lean back to the desired position and release the lever. To return the seat to the upright position, lean forward slightly before lifting the lever, then lean forward to the desired position and release the lever.

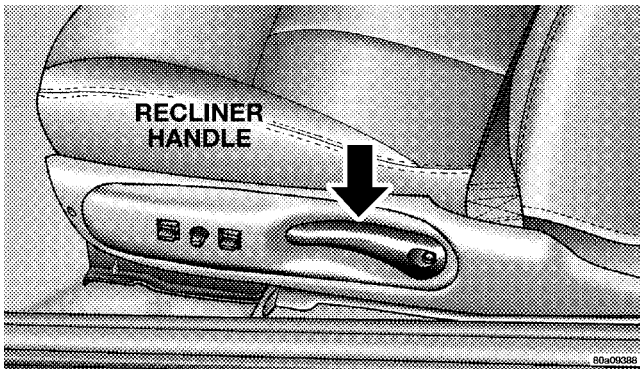

WARNING!

- **Adjusting a seat while the vehicle is moving is dangerous. The sudden movement of the seat could cause you to lose control. The seat belt might not be properly adjusted and you could be injured. Adjust the seat only while the vehicle is parked.**
- **Do not ride with the seatback reclined so that the shoulder belt is no longer resting against your chest. In a collision you could slide under the seat belt and be seriously or even fatally injured. Use the recliner only when the vehicle is parked.**

Lumbar Support — If Equipped

This feature allows you to increase or decrease the amount of lumbar support. The control lever is located on the inboard side of the driver's seatback. Turn the control lever forward to increase and rearward to decrease the desired amount of lumbar support.

Power Driver's Seat

The power seat switches are on the outboard side of the seat, near the floor. Use the forward switch to move the front of the seat cushion up and down. Use the rear switch to move the rear of the seat cushion up and down. The middle switch will move either the entire seat forward and rearward or the seat cushion up and down.

The rear lever controls the seatback reclining angle. The seatback may have to be readjusted if the seat cushion position is changed.

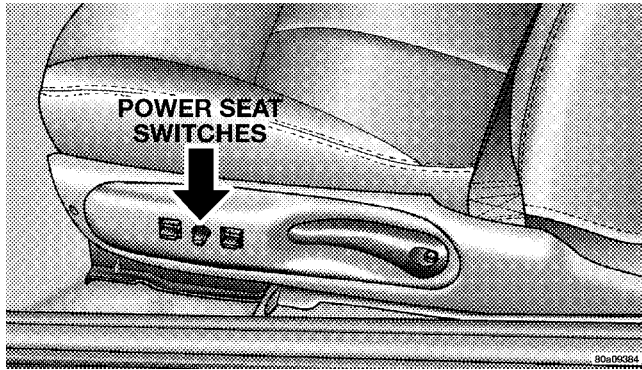

CAUTION!

Do not place any article under a power seat as it may cause damage to the seat controls.

Heated Seats — If Equipped

This feature heats the front driver and passenger seats on models equipped with leather seats. The controls for the heated seats are located in the floor console next to the parking brake.

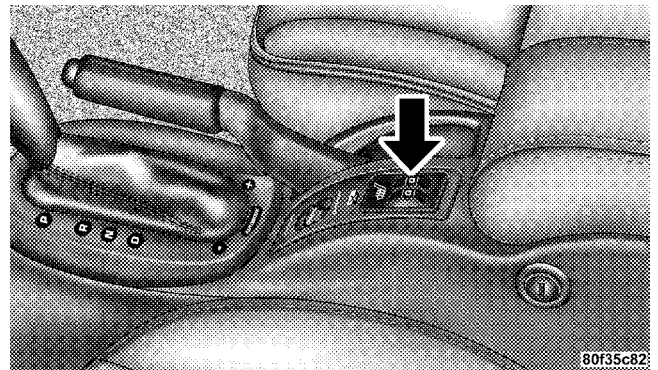

The left rotary switch controls the heat level for the driver's seat, and the right rotary switch controls the heat level for the passenger's seat. These switches feature several heat settings ranging from 0 to 6.

To Fold The Front Seatback Forward:

Turn the high mounted release lever rearward and fold the seatback forward. If you release the lever early, a safety feature locks the seat into that position. Turn the release lever again to continue lowering the seat. Just before the seatback reaches the full forward position, a soft "click " will be heard. This is a signal that the seatback is unlocked and can be raised without the use of the release handle. Raise the seatback until it locks into position.

Easy Entry System

How to operate the passenger front seat:

1. Rotate front seat handle rearward until seat back releases.

2. While holding the handle, push seat back forward until a click is heard, then let go of the handle.
3. Continue pushing the entire seat forward until it slides toward the dashboard.
4. To return seat to a sitting position, push seat rearward.
5. Rotate seat back upright until it locks.

3

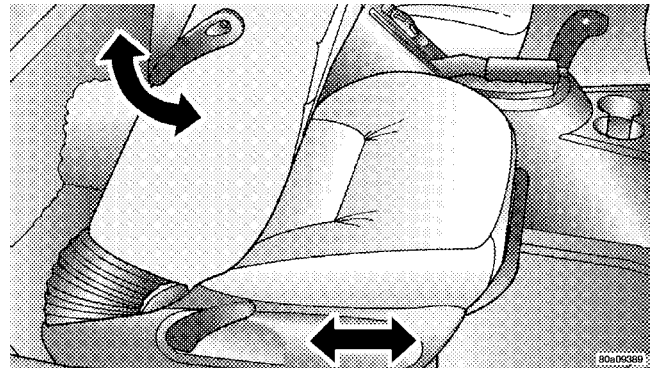

Adjustable Head Restraints

Head restraints can reduce the risk of whiplash injury in the event of impact from the rear. Adjust the restraints so that the upper edge is as high as practical. To raise, pull up on the head restraint. To lower, depress the button on the post guide and push down on the head restraint.

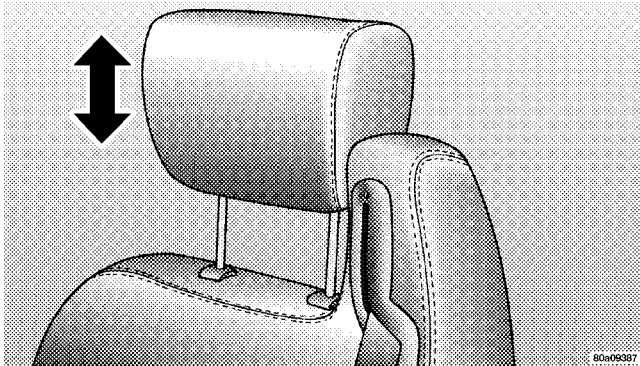

TO OPEN AND CLOSE THE HOOD

To open the hood, two latches must be released. First pull the hood release lever located under the left side of the instrument panel.

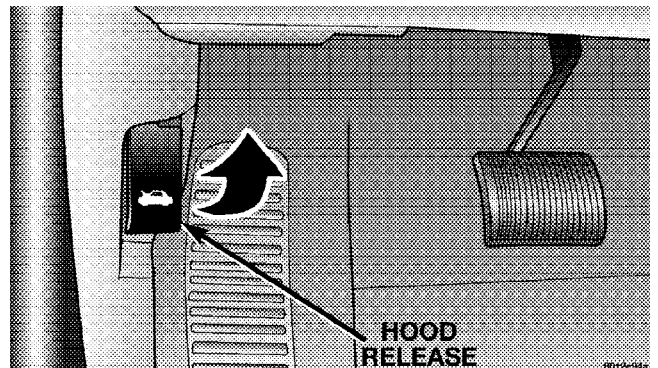

Then lift the secondary latch located under the front edge of the hood, near the center and raise the hood.

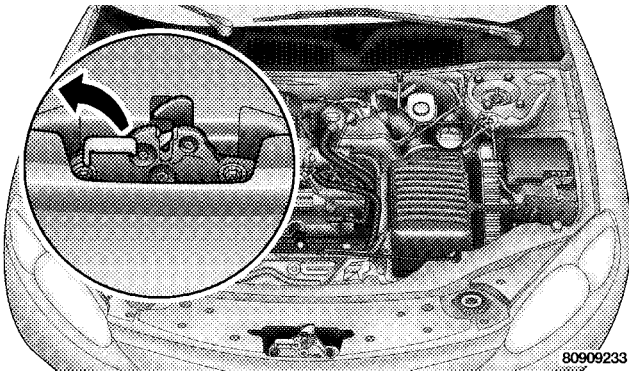

Use the hood prop rod to secure the hood in the open position. Place the upper end of the prop rod in the hole marked "prop" on the underside of the hood.

To prevent possible damage, do not slam the hood to close it. Use a firm downward push at the center of the hood to ensure that both latches engage.

WARNING!

If the hood is not fully latched it could fly up when the vehicle is moving and block your forward vision. You could have a collision. Be sure all hood latches are fully latched before driving.

LIGHTS

Front Map/Reading Lights

These lights, located under the rearview mirror, come on whenever a door is opened or the illuminated entry system is activated. The lights can also be turned on with the doors closed by means of switches located on the front of the rearview mirror.

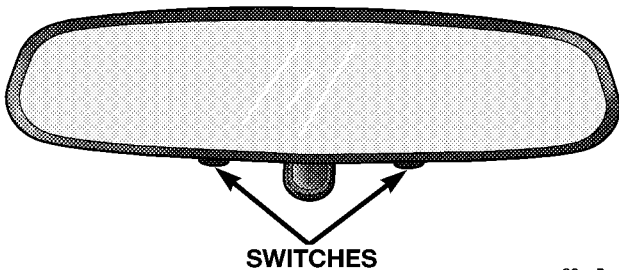

80ce5aaa

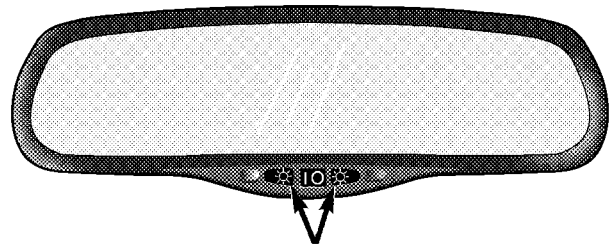

SWITCHES

80ce5ac9

NOTE: The map lights will remain on until the mirror switches have been turned to the OFF position, so be sure that they have been turned off before leaving the vehicle.

Interior Lights

The console rear light, map/courtesy lights, and the optional under-door courtesy lights come on when a door is opened and the panel lamp dimmer switch (located on the turn signal control stalk) is in any detent except fully counter-clockwise (dome lamp ON position) or fully clockwise (dome lamp OFF position). Rotating the panel dimmer switch fully counter-clockwise will

turn on the lights. Turn the panel dimmer switch fully clockwise to prevent the lights from coming on when a door is opened.

NOTE: The interior lights have a “fade to off” feature. When the lights are turned off, they gradually “fade” off.

Dimmer Control

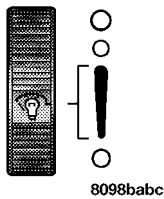

With the parking lights or headlights on, rotating the dimmer control for the interior lights on the Multi-Function Control Lever upward will increase the brightness of the instrument panel lights.

Dome Light Position

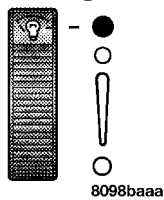

Rotate the dimmer control completely upward to the second detent to turn on the interior lights. The interior lights will remain on when the dimmer control is in this position.

Interior light Defeat (OFF)

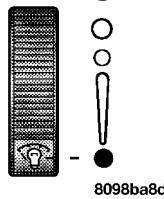

Rotate the dimmer control to the extreme bottom full-circle position. The interior lights will remain off when the doors are open.

Daytime Mode (Daytime Brightness Feature)

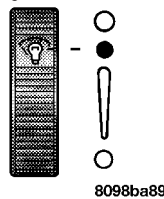

Rotate the dimmer control to the first detent (full-circle). This feature brightens the odometer and radio display when the parking lights or headlights are on during daylight conditions.

Multi-Function Control Lever

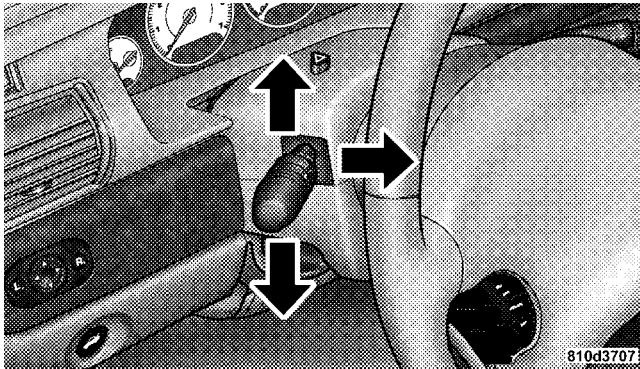

The Multi-Function lever controls the operation of the headlights, turn signals, headlight beam select switch, instrument panel light dimming, passing light, dome light, and fog lights.

Headlights, Parking Lights, Instrument Panel Lights

Turn the end of the control lever to the first detent for parking light operation. Turn to the second detent for headlight operation.

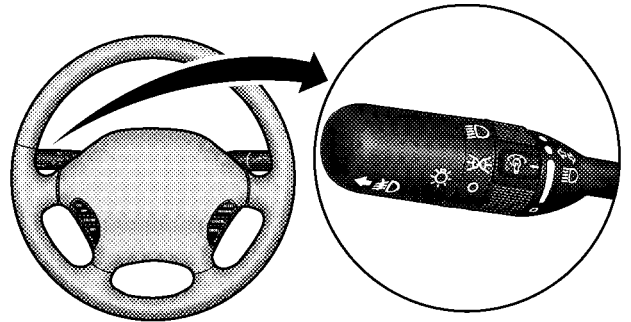

80925f6c

To change the brightness of the instrument panel lights, turn the center portion of the lever up or down. Turning the dimmer control to the full up position also turns on the courtesy lights. Turning the dimmer control to the full down position prevents the courtesy lights from coming on when a door is opened.

Daytime Running Lights (Canada Only)

The headlights come on at a low intensity level whenever the ignition switch is turned on. The lights remain on

until the ignition switch is turned OFF or the parking brake is engaged. The headlight switch must be used for normal night time driving.

Lights-on Reminder

If the headlights or parking lights are on after the ignition is turned off, a chime will sound when the driver's door is opened.

Fog Lights — If Equipped

 The fog light switch is in the multi-function lever. To activate the fog lights, turn on the low beam headlights and pull out the end of the control lever. A light in the instrument cluster shows when the fog lights are on.

NOTE: The switch will turn on the fog lights only if the low beam headlights are on. Turning on the high beam headlights turns off the fog lights.

Turn Signals

Move the turn signal lever up or down and the arrows in the instrument cluster flash to show proper operation of the front and rear turn signal lights. You can signal a lane change by moving the lever partially up or down.

Headlight Beam Select Switch

Pull the turn signal lever towards you to switch the headlights to HIGH beam. Pull the turn signal lever a second time to switch the headlights to LOW beam.

Passing Light

You can signal another vehicle with your headlights by lightly pulling the turn signal lever toward the steering wheel. This will cause the headlights to turn on at high beam and remain on until the lever is released.

Headlight Time Delay

This feature provides the safety of headlight illumination for about 90 seconds when leaving your vehicle in an unlighted area.

To activate the delay, turn off the ignition while the headlights are still on. Then turn off the headlights. The delay interval begins when the ignition is turned off.

If the headlights are turned off before the ignition, they will go off in the normal manner.

WINDSHIELD WIPERS AND WASHERS

The wipers and washers are operated by a switch in the right side control lever. Turn the end of the control lever to select the desired wiper speed.

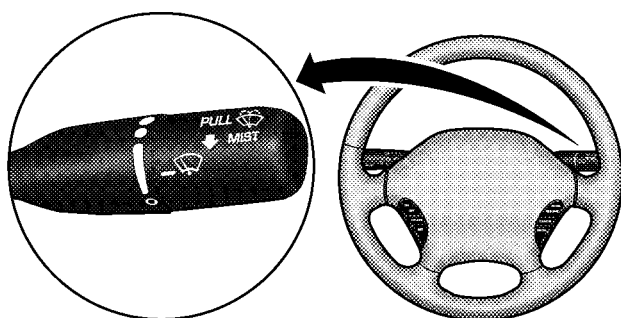

80925f8e

NOTE: Always remove any build-up of snow that prevents the windshield wiper blades from returning to the OFF position. If the windshield wiper switch is turned OFF and the blades cannot return to the OFF position, damage to the wiper motor may occur.

To use the washer, pull the lever toward you and hold while spray is desired. If the lever is pulled while in the

delay range, the wiper will operate for several cycles after the lever is released, and then resume the intermittent interval previously selected.

If the lever is pulled while in the OFF position, the wipers will operate for several cycles, then turn OFF.

WARNING!

Sudden loss of visibility through the windshield could lead to an accident. You might not see other vehicles or other obstacles. To avoid sudden icing of the windshield during freezing weather, warm the windshield with defroster before and during windshield washer use.

Mist

Use this feature when weather conditions make occasional usage of the wipers necessary. Pull down and release the control lever for a single wiping cycle.

Speed Sensitive Intermittent Wiper System

Use the intermittent wiper when weather conditions make a single wiping cycle, with a variable pause between cycles, desirable. Turn the lever to the delay position, then select the delay interval. The delay can be regulated from a maximum of approximately 18 seconds between cycles, to a cycle every 1/2 second.

NOTE: The wiper delay times depend on vehicle speed. If the vehicle is moving less than 16 km/h (10 mph), delay times will be doubled.

TILT STEERING COLUMN

To tilt the column, push down on the lever below the turn signal control and move the wheel up or down, as desired. Push the lever back up to lock the column firmly in place.

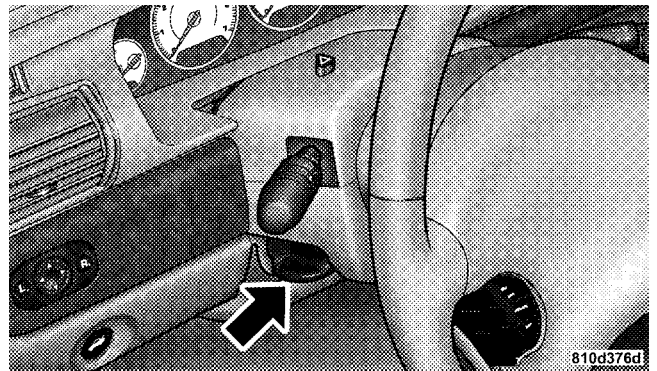

WARNING!

Tilting the steering column while the vehicle is moving is dangerous. Without a stable steering column, you could lose control of the vehicle and have an accident. Adjust the column only while the vehicle is stopped. Be sure it is locked before driving.

TRACTION CONTROL— IF EQUIPPED



To turn the Traction Control System Off, press the switch located on the top of the steering column, to the right of the hazard switch, until the Traction Control indicator in the instrument cluster lights up.

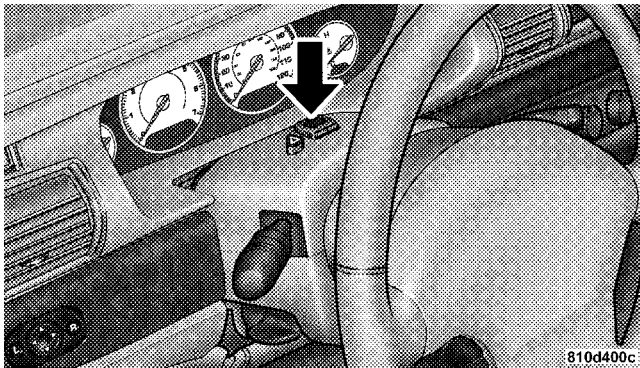

To turn the Traction Control System On, press the switch until the Traction Control indicator in the instrument cluster turns off.

NOTE: The Traction Control System is enabled each time the ignition switch is turned On. This will occur

even if you used the switch to turn the system off before powering down or turning the ignition to Lock.

ELECTRONIC SPEED CONTROL— IF EQUIPPED

When engaged, this device will control the throttle operation to maintain a constant vehicle speed between 30 mph (48 km/h) and 85 mph (137 km/h). The controls are on the steering wheel.

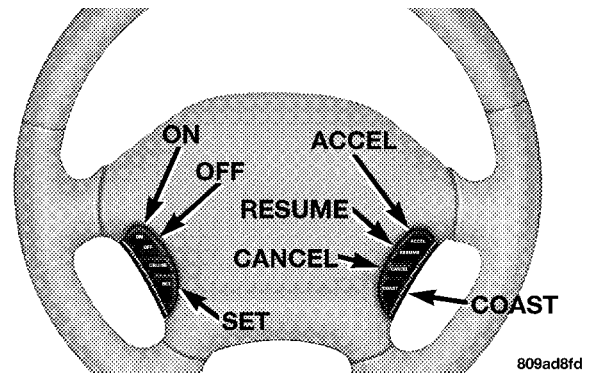

To Activate:

Press the ON/OFF switch to turn the speed control system ON. To turn the system OFF, press the ON/OFF switch again. The system should be turned OFF when not in use. The CRUISE Indicator in the instrument cluster will light up when the Speed Control is ON.

NOTE: You must press the ON button to activate the system each time the engine is started.

WARNING!

Leaving the Electronic Speed Control system ON when not in use is dangerous. You could accidentally set the system or cause it to go faster than you want. You could lose control and have an accident. Always leave the system OFF when you aren't using it.

To Set At A Desired Speed:

When the vehicle has reached the desired speed and the system is ON, press and release the SET button. Release the accelerator and the vehicle will operate at the selected speed. The speed control is now Engaged.

To Deactivate:

A soft tap on the brake pedal, pushing the CANCEL button, or normal brake or clutch pressure will deactivate speed control without erasing the memory. Pushing the ON/OFF button or turning off the ignition turns the speed control system off and erases the memory.

To Resume Speed:

To resume a previously set speed, push and release the RESUME/ACCEL button. Resume can be used at any speed above 25 mph (40 km/h).

To Vary The Speed Setting:

When the speed control is Engaged (actively controlling to a SET speed), speed can be increased by pressing and holding the RESUME/ACCEL button. When the button is released, a new set speed will be established.

Tapping the RESUME/ACCEL button once will result in a 2 mph (3 km/h) increase in the SET speed. Each time the button is tapped, the SET speed increases. For example tapping the button three times will increase speed by 6 mph (10 km/h), etc.

To decrease speed while speed control is Engaged, press and hold the COAST button. Releasing the button when the desired speed is reached, will establish a new SET speed.

Tapping the COAST button once will result in a 1 mph (1.6 km/h) decrease in the SET speed. Each time the button is tapped, the SET speed decreases. For example, tapping the button three times will decrease speed by 3 mph (5 km/h).

To Accelerate For Passing:

NOTE: If the set speed is exceeded by 20 mph (32 km/h) or more during the acceleration, the set speed will have to manually re-engaged.

Depress the accelerator as you would normally. When the pedal is released, the vehicle will return to the SET speed.

Using Speed Control On Hills

Vehicles with automatic transmissions are equipped with Interactive Speed Control. This feature operates when travelling up or down hills with the Speed Control engaged and the driver's foot off of the accelerator.

When Climbing A Hill

If vehicle speed drops 3 mph (5 km/h) below the Speed Control set speed, the transaxle will downshift to third gear. Under severe conditions the transaxle may downshift again to second gear. The transaxle will upshift to fourth gear after the vehicle has reached the top of the hill.

When Descending A Hill

If vehicle speed rises 3 mph (5 km/h) over the Speed Control set speed, the transaxle will downshift to third gear. This provides engine braking to keep vehicle speed under control. The transaxle will not downshift below third gear to control vehicle overspeed. The transaxle will upshift to fourth gear after the vehicle has reached the bottom of the hill.

NOTE: On very steep hills, a greater speed loss or gain may occur. It may be preferable to drive without Speed Control.

Rolling Hills

The transaxle may downshift into third gear and remain there as the vehicle travels over rolling hills. The transaxle will upshift into fourth gear when the road flattens out.

The transaxle will resume its normal shift schedule if you depress the accelerator pedal during any of the above conditions.

WARNING!

Speed Control can be dangerous where the system can't maintain a constant speed. Your vehicle could go too fast for the conditions, and you could lose control. An accident could be the result. Don't use Speed Control in heavy traffic or on roads that are winding, icy, snow-covered, or slippery.

GARAGE DOOR OPENER — IF EQUIPPED

The HomeLink® Universal Transceiver replaces up to three remote controls (hand held transmitters) that operate devices such as garage door openers, motorized gates, or home lighting. It triggers these devices at the push of a button. The Universal Transceiver operates off your vehicle's battery and charging system; no batteries are needed.

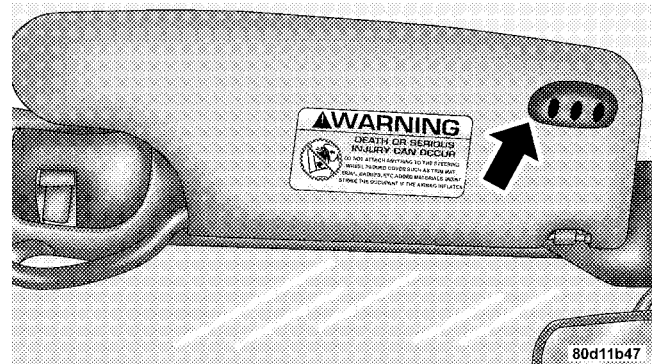

For additional information on HomeLink®, call 1-800-355-3515, or on the internet at www.homelink.com.

WARNING!

A moving garage door can cause injury to people and pets in the path of the door. People or pets could be seriously or fatally injured. Only use this transceiver with a garage door opener that has a “stop and reverse” feature as required by federal safety standards. This includes most garage door opener models manufactured after 1982. Do not use a garage door opener without these safety features it could cause injury or death. Call toll-free 1-800-355-3515 or, on the Internet at www.homelink.com for safety information or assistance.

Programming The Universal Transceiver

For best results, install a new battery in the hand held transmitter before programming. If your garage door opener (located in the garage) is equipped with an antenna, make sure that the antenna is hanging straight down.

1. Turn off the engine.

WARNING!

Vehicle exhaust contains carbon monoxide, a dangerous gas. Do not run the vehicle's exhaust while training the transceiver. Exhaust gas can cause serious injury or death.

WARNING!

Your motorized door or gate will open and close while you are training the Universal Transceiver. Do not train the transceiver if people or pets are in the path of the door or gate. A moving door or gate can cause serious injury or death to people and pets or damage to objects.

2. Erase the factory test codes by pressing the two outside buttons. Release the buttons when the light in the Universal Transceiver begins to flash (about 20 seconds).

NOTE: Step 2 does not have to be followed to program additional hand held transmitters.

3. Choose one of the three Universal Transceiver buttons to program. Place the hand held controller one to three inches from the Universal Transceiver while keeping its indicator light in view.

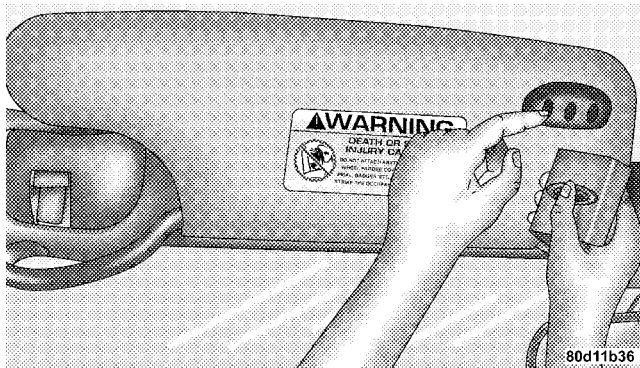

4. Using both hands, press the hand held transmitter button and the desired Universal Transceiver button. Do not release the buttons until step 5 has been completed.

NOTE: Some entry gates and garage door openers may require you to replace step 4 with the procedures listed under Canadian Programming.

5. The indicator light in the Universal Transceiver will begin to flash, first slowly and then rapidly. The rapid flashing indicates successful programming. If after 90 seconds the indicator light does not flash rapidly or goes out, return to step 1 and repeat the procedure. To train the other buttons, repeat steps 3 and 4. Be sure to keep your hand held transmitters in case you need to retrain the Universal Transceiver.

NOTE: If you do not successfully program the Universal Transceiver to learn the signal of your hand held transmitter, refer to the Rolling Code Paragraph, or call toll free for customer assistance at 1-800-355-3515, or on the internet at www.homelink.com.

“Rolling Code” Programming

NOTE: If your hand held transmitter appears to program the Universal Transceiver, but your garage door or other device does not operate, and your device was manufactured after 1996, your garage door opener or other device may have a “Rolling Code” system.

On garage door openers with the “Rolling Code” feature, the transmitter code changes after each use to prevent the copying of your code.

To check if your device is protected by a “Rolling Code” system:

- Check the owner’s manual for the device for mention of “Rolling Codes”.
- Press and hold the programmed button on the Universal Transceiver. If the Universal Transceiver indicator light flashes rapidly and then stays on after 2 seconds, the device has the “Rolling Code” feature.

To train a garage door opener (or other rolling code equipped devices) with the rolling code feature, follow these instructions **after** completing the **Programming** portion of this text:

NOTE: The assistance of a second person may make the following programming procedure quicker and easier.

1. Locate the training button on the garage door motor head unit. The exact location and color of the button may vary by garage door opener manufacturer. If you have

difficulty in locating the training button, check your garage door opener manual, or call 1-800-355-3515 or, on the Internet, at www.homelink.com.

2. Press and hold the training button on the garage door opener head unit. This will activate the “training” light.

NOTE: After completing step 2, you have 30 seconds to start step 3.

3. Return to the Universal Transceiver in the vehicle and firmly press and release the garage door button. Press and release the button a second time to complete the training process. Some garage door openers may require you to do this procedure a third time to complete the training.

Your garage door opener should now recognize your Universal Transceiver. The remaining two buttons may now be programmed if this has not previously been done. Refer to the Programming instructions. You may use either your Universal Transceiver or your original hand-held transmitter to open your garage door.

Canadian Programming/Gate Programming

Canadian frequency laws, and the technology of some entry gates, require you to press and release the hand held transmitter button every two seconds during programming

Continue to press and hold the Universal Transceiver button while you press and release the hand held transmitter button until the frequency signal has been learned. The Universal Transceiver light will flash slowly and then rapidly when the programming is successful.

NOTE: When programming such a garage door opener or gate, unplug the device to prevent possible damage to the garage door or gate motor.

Operation

Press and hold the desired button on the Universal Transceiver until the garage door or other device begins to operate. The light in the display shows that the signal is being transmitted. The hand held transmitter may also be used at any time.

Reprogramming A Single Button

1. Press and hold the Universal Transceiver button to be reprogrammed. Do not release until step 4 has been completed.
2. When the indicator light begins to flash slowly (after 20 seconds) position the hand held transmitter one to three inches away from the button to be trained.
3. Press and hold the hand held transmitter button.
4. The Universal Transceiver indicator light will begin to flash, first slowly, then rapidly. When the indicator lights begin to flash rapidly, release both buttons.

Security

If you sell your vehicle, be sure to erase the frequencies.

To erase all of the previously trained frequencies, hold down both outside buttons until the green light begins to flash.

This device complies with part 15 of FCC rules and with RS-210 of Industry Canada. Operation is subject to the following conditions:

1. This device may not cause harmful interference.
2. This device must accept any interference that may be received including interference that may cause undesired operation.

NOTE: Changes or modifications not expressly approved by the party responsible for compliance could void the user's authority to operate the equipment.

HomeLink® is a trademark owned by Johnson Controls, Inc.

ELECTRICAL POWER OUTLET

The power outlet is located in the lower center of your instrument panel. A second power outlet is located inside the center console, if so equipped. All accessories connected to any outlet should be removed or turned off when the vehicle is not in use.

CAUTION!

Electrical Outlet Use With Engine Off

- Many accessories that can be plugged in draw power from the vehicle's battery, even when not in use (i.e., cellular phones, etc.). Eventually, if plugged in long enough, the vehicle's battery will discharge sufficiently to degrade battery life and/or prevent engine starting.
- Accessories that draw higher power (i.e., coolers, vacuum cleaners, lights, etc.) will degrade the battery even more quickly. Only use these intermittently and with greater caution.
- After the use of high power draw accessories, or long periods of the vehicle not being started (with accessories still plugged in), the vehicle must be driven a sufficient length of time to allow the alternator to recharge the vehicle's battery.

UNDERSTANDING YOUR INSTRUMENT PANEL

CONTENTS

■ Instruments And Controls83	□ To Set The Clock96
■ Instrument Cluster Standard84	■ Radio General Information96
■ Instrument Cluster Premium85	□ Radio Broadcast Signals96
■ Instrument Cluster – GTC Model86	□ Two Types Of Signals97
■ Instrument Cluster Description87	□ Electrical Disturbances97
■ Compass, Temperature, And Trip Computer Display — If Equipped92	□ AM Reception97
□ Control Buttons92	□ FM Reception97
□ Trip Conditions93	■ Sales Code RAZ—AM/ FM Stereo Radio With Cassette Tape Player, CD Player And CD Changer Controls — If Equipped97
□ Compass Temperature Display94	□ Operating Instructions — Radio97
■ Cigar Lighter/Ashtray96	□ Power Switch, Volume Control97
■ Electronic Digital Clock96		

80 UNDERSTANDING YOUR INSTRUMENT PANEL

□ Seek Button (Radio Mode)98	□ Changing Tape Direction101
□ Tuning98	□ Metal Tape Selection101
□ PTY (Program Type) Button98	□ Pinch Roller Release101
□ Balance99	□ Noise Reduction102
□ Fade99	□ Operating Instructions — CD Player102
□ Tone Control99	□ Inserting The Compact Disc102
□ AM/FM Selection100	□ Seek Button103
□ Scan Button100	□ EJT CD (Eject) Button103
□ To Set The Radio Push-Button Memory100	□ FF/Tune/RW103
□ To Change From Clock To Radio Mode100	□ Program Button 4 (Random Play)103
□ Operating Instructions — Tape Player100	□ Mode103
□ Seek Button101	□ Tape CD Button104
□ Fast Forward (FF)101	□ Time Button104
□ Rewind (RW)101	□ Scan Button104
□ Tape Eject101	□ CD Changer Control Capability — If Equipped104
□ Scan Button101		

<ul style="list-style-type: none"> ■ Sales Code RBB—AM/FM Stereo Radio With Cassette Tape Player And CD Changer Capability 105 <ul style="list-style-type: none"> □ Operating Instructions 105 □ Power Button 106 □ Electronic Volume Control 106 □ Seek 106 □ Tune 106 □ To Set The Push-Button Memory 106 □ Balance 107 □ Fade 107 □ Bass And Treble Tone Control 107 □ AM/FM Selection 107 □ Mode Button 107 □ Cassette Player Features 108 □ CD Changer Control Capability — If Equipped 109 	<ul style="list-style-type: none"> □ Radio Display Messages 110 ■ Sales Code RBK—AM/ FM Stereo Radio With CD Player And CD Changer Controls 111 <ul style="list-style-type: none"> □ Radio Operation 111 □ CD Player Operation 113 □ CD Changer Control Capability — If Equipped 114 □ Radio Display Messages 115 ■ 6 Disc CD Changer — If Equipped 116 <ul style="list-style-type: none"> □ Loading The CD Changer 116 □ Playing Discs 116 □ Seek Button 117 □ FF/Tune/RW 117 □ Mode Button 117 □ Program Button 1 117 □ Program Button 4 (Random Play) 117
---	--

82 UNDERSTANDING YOUR INSTRUMENT PANEL

□ Program Button 5	117	□ Tape Player	119
□ Time Button	117	□ CD Player — Single Disc In Radio	119
□ Changing Modes	117	□ CD Player — 6 Disc CD Changer	119
□ Removing Discs From The CD Changer	118	■ Cassette Tape And Player Maintenance	120
□ CD Changer Operation With The Changer Off	118	■ Compact Disc Maintenance	121
■ Remote Sound System Controls — If Equipped	118	■ Radio Operation And Cellular Phones	121
□ Radio Operation	119	■ Climate Controls	122
		□ Manual Air Conditioning/Heater Control	122

INSTRUMENTS AND CONTROLS

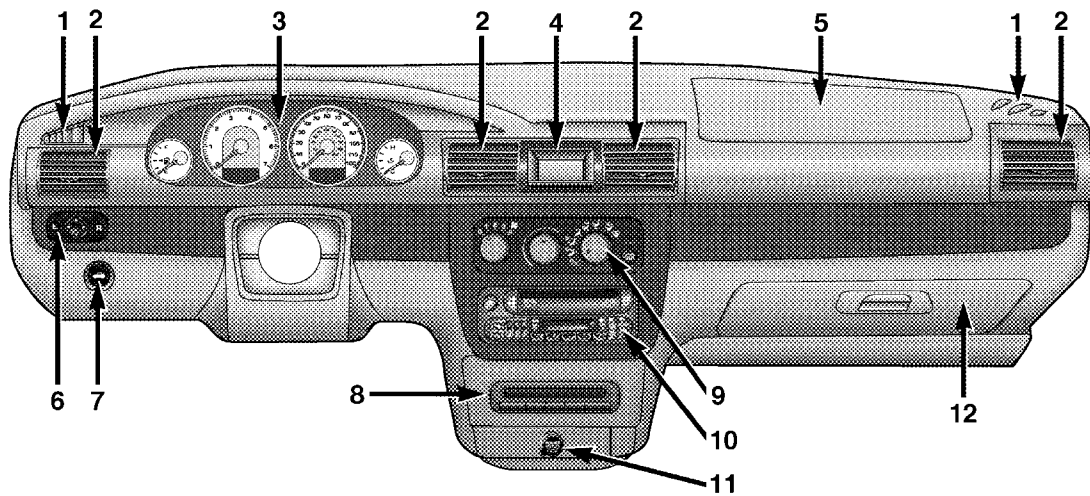

- | | | |
|-------------------------------------|--|--------------------|
| 1. Side Window Demist Outlet | 5. Passenger Airbag | 9. Climate Control |
| 2. Air Outlet | 6. Electric Remote-Control Mirror Switch | 10. Radio |
| 3. Instrument Cluster | 7. Remote Trunk Release Button | 11. Power Source |
| 4. Storage Tray or Travel Computer* | 8. Storage Tray or CD Changer* | 12. Storage Bin |
| | | *Optional |

INSTRUMENT CLUSTER STANDARD

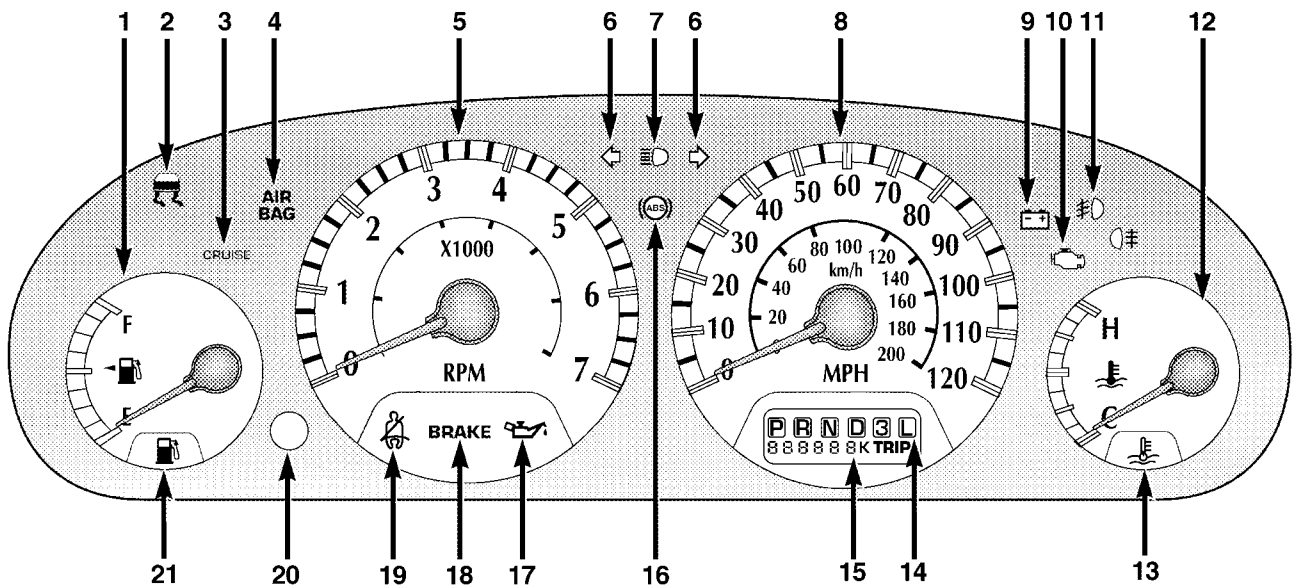

INSTRUMENT CLUSTER PREMIUM

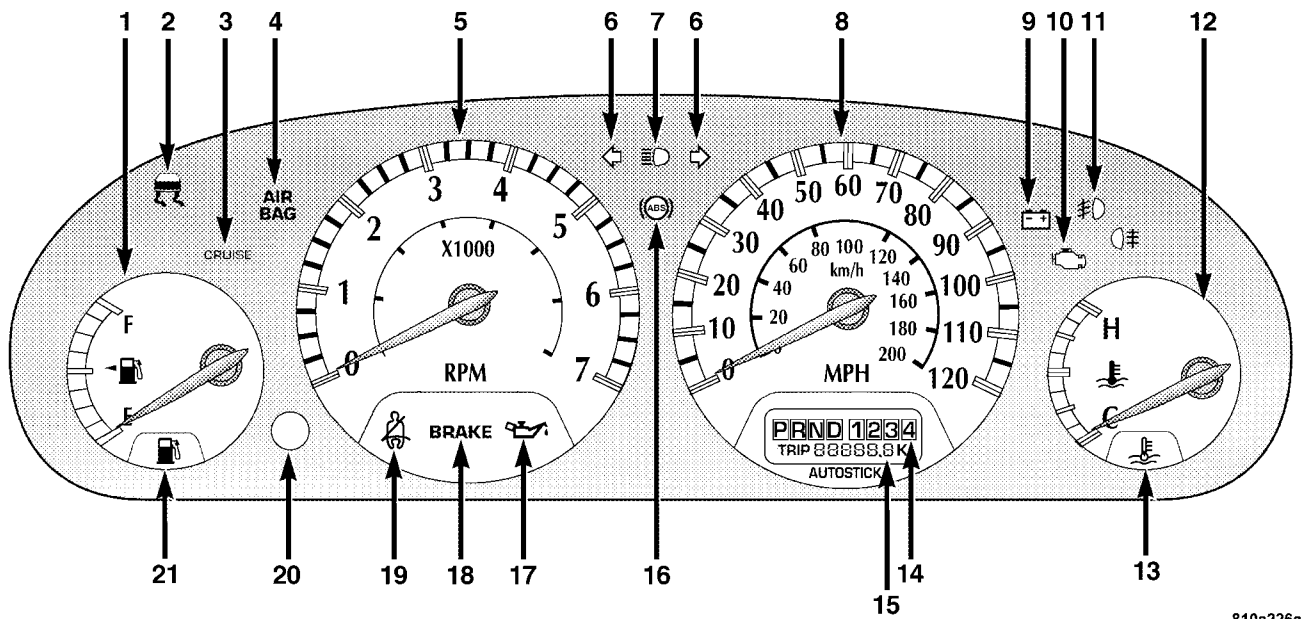

INSTRUMENT CLUSTER – GTC MODEL

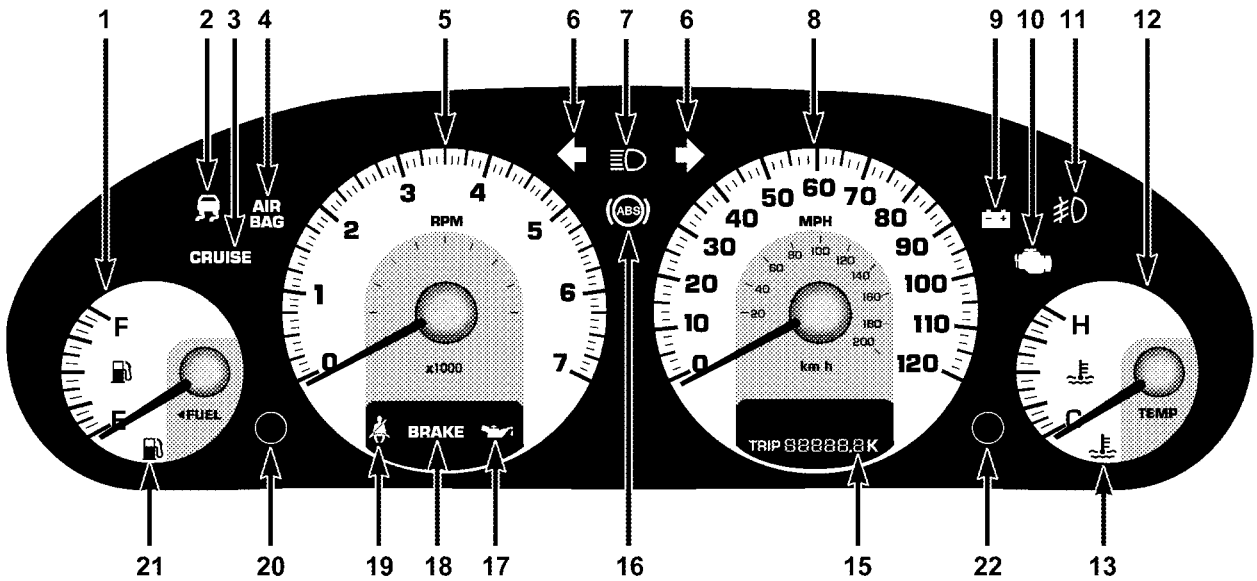

INSTRUMENT CLUSTER DESCRIPTION

1. Fuel Gauge



When the ignition key is in the ON position, the pointer will show the level of fuel remaining in the fuel tank.

2. Traction Control — If Equipped



This display indicator illuminates momentarily as a bulb check when the ignition switch is first turned ON. The indicator will blink during an active traction event, but will remain solid when the system is deactivated or if a system malfunction occurs.

The Traction Control indicator will turn ON if:

- The Traction Control system is in use.
- The Traction Control switch has been used to turn the system OFF.
- There is an Anti-Lock Brake system malfunction or Traction Control system malfunction.
- The system has been deactivated to prevent damage to the brake system due to overheated brake temperatures.

NOTE: Extended heavy use of Traction Control may cause the system to deactivate and turn on the Traction Control indicator. This is to prevent overheating of the brake system and is a normal condition. The system will remain disabled for about 4 minutes until the brakes have cooled. The system will automatically reactivate and turn off the Traction Control indicator.

3. Cruise Light — If Equipped

This light shows that the Speed Control System is ON. This light will also illuminate for a 5-second bulb check when the ignition switch is first turned to the ON position.

4. Airbag Light



The light comes on and remains on for 6 to 8 seconds as a bulb check when the ignition switch is first turned ON. If the bulb does not come on during starting, have the bulb replaced. If the light stays on, or comes on while driving, have the system checked by an authorized dealer.

5. Tachometer

The red area of the scale shows the maximum permissible engine revolutions-per-minute (rpm x 1000) for each gear

range. Before reaching the red area (over 6,500 rpm), ease up on the accelerator to prevent engine over speed.

6. Turn Signal Indicators

The arrows will flash in unison with the exterior turn signal, when using the turn signal lever.

7. High Beam Indicator

 This light shows that the headlights are on high beam. Pull the turn signal lever toward the steering wheel to switch the headlights from high or low beam.

8. Speedometer

Shows the vehicle speed in miles-per-hour and kilometers-per-hour.

9. Charging System Light

 This light shows the status of the electrical charging system. The light should come on briefly when the ignition is first turned on and remain on briefly as a bulb check. If the light stays on or comes on while driving, turn off some of the vehicle's electrical devices, such as the Fog Lights or Rear Defroster. If the Charging System Light remains on, it

means that the vehicle is experiencing a problem with the charging system. Obtain SERVICE IMMEDIATELY. See your local authorized dealer.

10. Malfunction Indicator Light

 This light is part of an onboard diagnostic system called OBD that monitors engine and automatic transmission control systems. The light will illuminate as long as the key is in the ON position, prior to engine start up. Approximately 15 seconds later the MIL may blink for 10 seconds then resume to full illumination. (See "EMISSIONS INSPECTION AND MAINTENANCE PROGRAMS" in the "MAINTAINING YOUR VEHICLE" section of your Owner Manual for more details). If the bulb does not come on when turning the key from OFF to ON, have the condition checked promptly.

Certain conditions such as a loose or missing gas cap or poor fuel quality may illuminate the light after engine start. The vehicle should be serviced if the light stays on through several of your typical driving cycles. In most situations the vehicle will drive normally and will not require towing.

The Malfunction Indicator Light flashes to alert to serious conditions that could lead to immediate loss of power or severe catalytic converter damage. The vehicle should be serviced as soon as possible if this occurs.

11. Fog Light Indicator — If Equipped

 This light shows when the fog lights are ON.

12. Temperature Gauge

 The temperature gauge shows engine coolant temperature. Any reading within the normal range (approximately mid point on the scale) shows that the cooling system is operating properly. The gauge pointer may show a higher than normal temperature when driving in hot weather, up mountain grades, in heavy stop and go traffic, or when towing a trailer.

If the pointer rises to the “H” mark, stop the vehicle and turn off the engine until the problem is corrected.

There are steps that you can take to slow down an impending overheat condition. If your air conditioning is on, turn it off. The air conditioning system adds heat to

the cooling system and turning off the A/C removes this heat. You can also turn the Temperature control to maximum heat, the Mode control to Floor and the Fan control to High. This allows the heater core to act as a supplement to the radiator and aids in removing heat from the cooling system.

13. Engine Temperature Warning Light

 This light warns of an overheated engine coolant condition.

14. Transmission Range Indicator

This indicator illuminates to show the automatic transmission gear selection.

An optional *AutoStick Gear Indicator* displays the current transaxle gear when in AutoStick mode.

15. Odometer/Trip Odometer

The odometer shows the total distance the vehicle has been driven.

U.S. federal regulations require that upon transfer of vehicle ownership, the seller certify to the purchaser the correct mileage that the vehicle has been driven. Therefore, if the odometer reading is changed, during repair or

replacement, be sure to keep a record of the reading before and after the service so that the correct mileage can be determined.

The trip odometer shows individual trip mileage. To switch from odometer to trip odometer, press and release the Trip Odometer button. Press and release the Trip button a second time to return to the odometer. While in trip mode, press and hold the button for at least ½ second to reset the trip odometer.

Door, Deck or Trunk Ajar Warnings

If you move the vehicle and a door is not completely closed, the word DOOR will replace the odometer display and a chime will sound once. The odometer display will reappear when the door is closed. If the trunk is not completely closed, the word DECK will replace the odometer display. The odometer display will reappear when the trunk is closed.

16. Anti-Lock Warning Light — If Equipped

 This light monitors the Anti-Lock Brake System described elsewhere in this manual. This light will come on when the ignition key is turned to the

RUN position and may stay on for several seconds. If the light does not come on, have the system checked by an authorized dealer. The warning light should be checked frequently to assure that it is operating properly.

If the ABS light remains on or comes on during driving, it indicates that the Anti-Lock portion of the brake system is not functioning and that service is required, however, the conventional brake system will continue to operate normally provided that the BRAKE warning light is not on.

17. Oil Pressure Light

 Shows low engine oil pressure. The light will come on and remain on briefly when the ignition is turned on as a bulb check. If the bulb does not come on during starting, have the bulb repaired promptly.

If the light comes on and remains on while driving, stop the vehicle and shut off the engine. Do not operate the vehicle until the cause is corrected.

The light does not show the quantity of oil in the engine. This can be determined using the procedure shown in Section 7.

18. Brake System Warning Light

BRAKE This light monitors both the brake fluid level and the parking brake. If the light comes on, it indicates either that the parking brake is on or there is a low fluid level in the brake master cylinder. On vehicles equipped with Anti-lock (ABS), the brake light may also indicate reduced braking performance.

If the parking brake is off and the light remains on, have the brake system inspected as soon as possible.

WARNING!
Driving a vehicle with the brake light on is dangerous. A significant decrease in braking performance may occur. It will take you longer to stop the vehicle. You could have an accident. Have the vehicle checked immediately.

The warning light should be checked frequently to assure that it is operating properly. Turn the ignition key to the RUN position. (Refer to “A Word About Your Keys, Ignition Key Removal” in this manual for an illustration of the ignition positions.) The light should come on. If the light does not come on, have the system checked by an authorized dealer.

The light will also come on when the parking brake is applied with the ignition in the RUN position.

NOTE: This light shows only that the parking brake is on. It does not show the degree of brake application.

In an ABS equipped vehicle, the Brake System Warning light will come on if the ABS light is not functioning or if the ABS system is not communicating.

19. Seat Belt Reminder Light

 When the ignition switch is first turned ON, this light will turn on for 5 to 8 seconds as a bulb check. During the bulb check, if the driver’s seat belt is unbuckled, a chime will sound. After the bulb check or when driving, if the driver seat belt remains unbuckled, the Seat Belt Warning Light will flash or

remain on continuously. Refer to "Enhanced Driver Seat Belt Reminder System (BeltAlert™)" in the Occupant Restraints section for more information.

20. Theft Alarm Light — If Equipped

The light in the instrument cluster will flash rapidly for 15 seconds. This shows that the system is arming. If the light comes on but does not flash, the system is still armed, but there is a problem in the trunk circuit. After 15 seconds the light will continue to flash slowly. This shows that the system is fully armed.

21. Low Fuel Light

 When the fuel level drops to about 2 ½ gallons (9 ½ liters), the fuel symbol will light and remain lit until fuel is added.

22. Trip Odometer Button

Press and release this button to change the display from odometer to trip odometer. The word TRIP will appear when in the trip odometer mode. To reset the trip odometer, press and hold the button for at least 1/2 second.

COMPASS, TEMPERATURE, AND TRIP COMPUTER DISPLAY — IF EQUIPPED

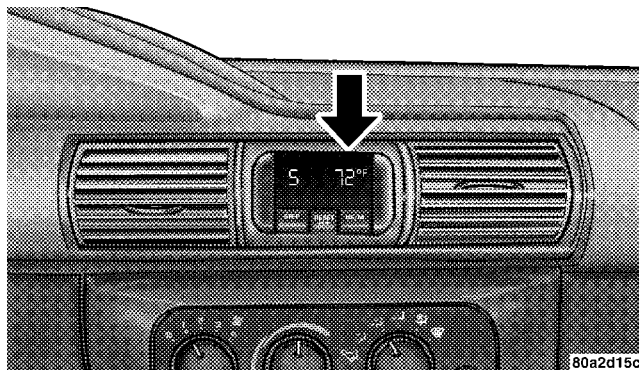

This feature allows you to choose between a compass / temperature display and one of five trip conditions being monitored.

Control Buttons

Step Button

Use this button to choose or cycle through the five trip conditions.

Reset

The following trip conditions can be reset:

- AVG ECO (changes to present fuel economy)
- ODO
- ET

To reset only the trip condition currently displayed, press and release the STEP and US/M buttons simultaneously until a chime sounds. To reset all trip conditions, hold down the STEP and US/M buttons simultaneously (about 2 seconds) until a second chime sounds and then release the buttons.

NOTE: The screen must display one of the trip conditions above in order to reset either (or all) of these conditions.

US / M Button

Use this button to change the display from U.S. to metric measurement units.

Trip Conditions**Average Fuel Economy (AVG ECO)**

This display shows the average fuel economy since the last reset.

Estimated Range (DTE)

This display shows the estimated distance that can be traveled with the fuel remaining in the tank. This estimated distance is based on the most recent trip information: (Average Fuel Economy) x (Fuel Remaining)

This display cannot be reset.

Present Fuel Economy (ECO)

This display shows fuel economy for the last few seconds.

This display cannot be reset.

Trip Odometer (ODO)

This display shows the distance traveled since the last reset.

Elapsed Time (ET)

This display shows the accumulated ignition ON time since the last reset.

Compass Temperature Display

This display provides the outside temperature and one of eight compass readings to indicate the direction the vehicle is facing.

WARNING!

Even if the display still reads a few degrees above 32°F (0°C), the road surface may be icy, particularly in woods or on bridges. Drive carefully under such conditions to prevent an accident and possible personal injury or property damage.

Compass Calibration

The Automatic Compass Calibration feature eliminates the need for the operator intervention under normal conditions. If the CAL indicator is lit, the compass needs to be calibrated. A good calibration requires a level surface and an environment free of large metal objects such as large buildings, bridges, underground cables, railroad tracks, etc.

Automatic Compass Calibration

The self-calibrating feature of the compass eliminates the need to calibrate the compass for normal conditions. During a short initial period, the compass may appear erratic and the CAL symbol will appear on the display. After the vehicle has completed at least one complete circle in an area free from large metal objects, calibration will be complete when the CAL symbol is extinguished.

After initial calibration, the compass will continue to automatically update this calibration whenever the vehicle is in motion.

Manual Compass Calibration

Compass calibration can also be requested. To manually calibrate the compass, use the STEP button to step to the compass/ temperature display and then hold down both the STEP and US/M buttons simultaneously until the CAL symbol is displayed. Release the buttons once the CAL symbol appears. Manual compass calibration has been initiated at this point. Drive the vehicle in circles in an area free from large metal objects until the CAL symbol is extinguished.

When the CAL indicator goes off, the compass is calibrated and should display correct headings. Verify proper calibration by checking North (N), South (S), East (E), and West (W). If the compass does not appear accurate, repeat the calibration procedure in another area.

Compass Variance

Variance is the difference between magnetic North and geographic North. For proper compass function, the correct variance zone must be set.

Setting the Compass Variance

Refer to the variance map for the correct compass variance zone. To check the variance zone, the ignition must be on and the compass / temperature displayed. Hold down both the US / M and STEP buttons simultaneously until the VAR symbol is lit and then immediately release both buttons. The current variance zone will now be displayed. To change the zone, press the STEP button until the correct zone is displayed. Wait for about 5 seconds. The trip computer will store this variance in memory and the compass will resume normal operation.

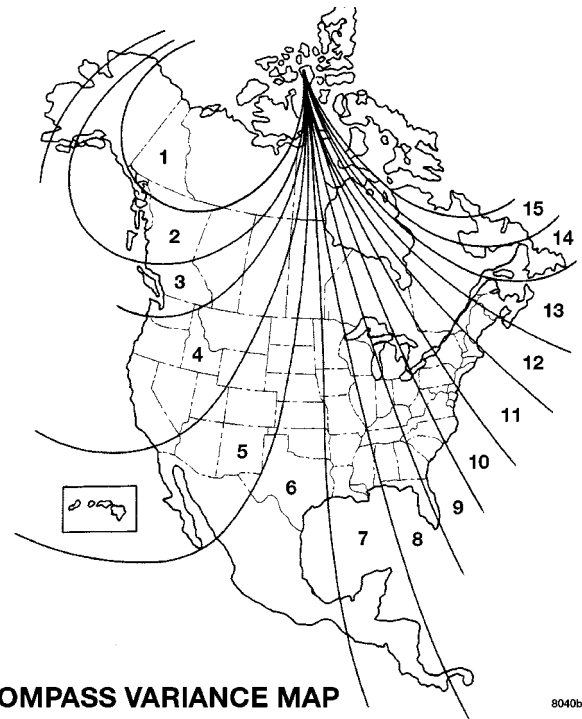

COMPASS VARIANCE MAP

8040b197

Outside Temperature

If the outside temperature is more than 131°F (55°C), the display will show 131°F. When the outside temperature is less than -40°F (-40°C), the display will show -40°F/C.

CIGAR LIGHTER/ASHTRAY

For a nominal charge your dealer can provide a “smoker’s” package. This package consists of a cigar lighter and an ashtray that utilizes one of the cup holders.

ELECTRONIC DIGITAL CLOCK

The clock and radio each use the display panel built into the radio. A digital readout indicates the time in hours and minutes whenever the ignition switch is in the ON or ACC position. Whenever the radio is turned on, it first comes up on either tape, cd or radio, whichever was previously on, and will revert back to Time/Clock after a few seconds. If Time/Clock was not previously selected, the display will revert back to whichever was previously on after a few seconds, whether it was tape, cd or radio.

When the ignition switch is in the OFF position, pressing the Time button will cause the radio to display time for several seconds, then turn off.

To Set The Clock:

1. Use a ballpoint pen or similar object to press the hour (H) or minute (M) buttons on the radio. The time setting will increase each time you press the button.
2. Press any other button to exit from the clock setting mode. Or, it will exit the mode automatically if left alone for 5 or 6 seconds.

RADIO GENERAL INFORMATION**Radio Broadcast Signals**

Your new radio will provide excellent reception under most operating conditions. Like any system, however, car radios have performance limitations, due to mobile operation and natural phenomena, which might lead you to believe your sound system is malfunctioning. To help you understand and save you concern about these “apparent” malfunctions, you must understand a point or two about the transmission and reception of radio signals.

Two Types of Signals

There are two basic types of radio signals... AM or Amplitude Modulation, in which the transmitted sound causes the amplitude, or height, of the radio waves to vary... and FM or Frequency Modulation, in which the frequency of the wave is varied to carry the sound.

Electrical Disturbances

Radio waves may pick up electrical disturbances during transmission. They mainly affect the wave amplitude, and thus remain a part of the AM reception. They interfere very little with the frequency variations that carry the FM signal.

AM Reception

AM sound is based on wave amplitude, so AM reception can be disrupted by such things as lightning, power lines and neon signs.

FM Reception

Because FM transmission is based on frequency variations, interference that consists of amplitude variations can be filtered out, leaving the reception relatively clear, which is the major feature of FM radio.

SALES CODE RAZ—AM/ FM STEREO RADIO WITH CASSETTE TAPE PLAYER, CD PLAYER AND CD CHANGER CONTROLS — IF EQUIPPED

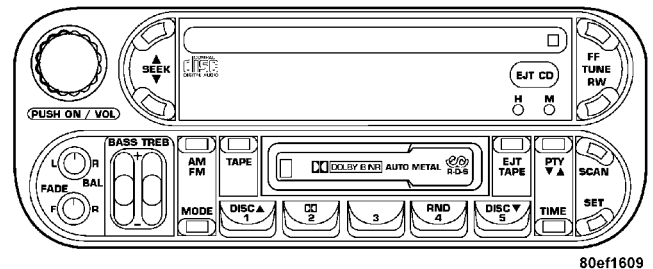

4

Operating Instructions — Radio

NOTE: Power to operate the radio is controlled by the ignition switch. It must be in the ON or ACC position to operate the radio.

Power Switch, Volume Control

Press the ON/VOL control to turn the radio on. Turn the volume control clockwise to increase the volume. The volume will be displayed and continuously updated while the button is pressed.

Seek Button (Radio Mode)

Press and release the Seek button to search for the next station in either the AM or FM mode. Press the top of the button to seek up and the bottom to seek down. Holding the button will by pass stations until you release the button.

Tuning

Press the TUNE control up or down to increase or decrease the frequency. If you press and hold the button, the radio will continue to tune until you release the button. The frequency will be displayed and continuously updated while the button is pressed.

PTY (Program Type) Button

Pressing this button once will turn on the PTY mode for 5 seconds. If no action is taken during the 5 second time out the PTY icon will turn off. Pressing the PTY button within 5 seconds will allow the program format type to be selected. Many radio stations do not currently broadcast PTY information.

Toggle the PTY button to select the following format types:

Program Type	Radio Display
Adult Hits	Adlt Hit
Classical	Classicl
Classic Rock	Cls Rock
College	College
Country	Country
Information	Inform
Jazz	Jazz
Foreign Language	Language
News	News
Nostalgia	Nostalga
Oldies	Oldies
Personality	Persnlty
Public	Public
Rhythm and Blues	R & B
Religious Music	Rel Musc
Religious Talk	Rel Talk
Rock	Rock
Soft	Soft
Soft Rock	Soft Rck

Program Type	Radio Display
Soft Rhythm and Blues	Soft R&B
Sports	Sports
Talk	Talk
Top 40	Top 40
Weather	Weather

By pressing the SEEK button when the PTY icon is displayed, the radio will be tuned to the next frequency station with the same selected PTY name. The PTY function only operates when in the FM mode.

The radio display will flash “SEEK” and the selected PTY program type when searching for the next PTY station. If no station is found with the selected PTY program type, the radio will return to the last preset station.

If a preset button is activated while in the PTY (Program Type) mode, the PTY mode will be exited and the radio will tune to the preset station.

Pressing PTY, then SCAN will scan the FM Band and stop at all RDS stations. Each RDS station will be played for a

5 second scan once around the FM Band and stop at the last station. The PTY icon will then turn off.

Balance

The Balance control adjusts the left-to-right speaker balance. Push in the button and it will pop out. Adjust the balance and push the button back in. The balance will be displayed and continuously updated while the button is turned.

Fade

The Fade control provides for balance between the front and rear speakers. Push in the button and it will pop out. Adjust the balance and push the button back in. The fade will be displayed and continuously updated while the button is turned.

Tone Control

Slide the Bass and/or Treble controls up or down to adjust the sound for the desired tone. The treble, and bass will be displayed and continuously updated while the slide is moved.

AM/FM Selection

Press the AM/FM button to change from AM to FM. The operating mode will be displayed next to the station frequency. The display will show ST when a stereo station is received.

Scan Button

Pressing the SCAN button causes the tuner to search for the next station, in either AM or FM, pausing for 5 seconds at each listenable station before continuing to the next.

Pressing the AM/FM button continues the search in the alternate frequency band.

To stop the search, press SCAN a second time.

To Set The Radio Push-button Memory

When you are receiving a station that you wish to commit to push-button memory, press the SET button. SET 1 will show in the display window. Select the push-button you wish to lock onto this station and press and release that button. If a station is not selected within 5 seconds after pressing the SET button, the station will continue to play but will not be locked into push-button memory.

You may add a second station to each push-button by repeating the above procedure with this exception: Press the SET button twice and SET 2 will show in the display window. Each button can be set for SET 1 and SET 2 in both AM and FM. This allows a total of 10 AM and 10 FM stations to be locked into memory. You can recall the stations stored in SET 2 memory by pressing the push-button twice.

To Change From Clock To Radio Mode

Press the Time button to change the display between radio frequency and time.

Operating Instructions — Tape Player

Insert the cassette with the exposed tape side toward the right and the mechanical action of the player will gently pull the cassette into the play position.

NOTE: When subjected to extremely cold temperatures, the tape mechanism may require a few minutes to warm up for proper operation. Sometimes poor playback may be experienced due to a defective cassette tape. Clean and demagnetize the tape heads at least twice a year.

Seek Button

Press the SEEK button up for the next selection on the tape and down to return to the beginning of the current selection.

Press the SEEK button up or down to move the track number to skip forward or backward 1 to 6 selections. Press the SEEK button once to move 1 selection, twice to move 2 selections, etc.

Fast Forward (FF)

Press the FF button up momentarily to advance the tape in the direction that it is playing. The tape will advance until the button is pressed again or the end of the tape is reached. At the end of the tape, the tape will play in the opposite direction.

Rewind (RW)

Press the RW button momentarily to reverse the tape direction. The tape will reverse until the button is pressed again or until the end of the tape is reached. At the end of the tape, the tape will play in the opposite direction.

Tape Eject

Press the EJT Tape button and the cassette will disengage and eject from the radio.

Scan Button

Press this button to play 10 seconds of each selection. Press the scan button a second time to cancel the feature.

Changing Tape Direction

If you wish to change the direction of tape travel (side being played), press the PTY button. The lighted arrow in the display window will show the new direction.

Metal Tape Selection

If a standard metal tape is inserted into the player, the player will automatically select the correct equalization and the 70 symbol will appear in the display window.

Pinch Roller Release

If ignition power or the radio ON/OFF switch are turned off, the pinch roller will automatically retract to protect the tape from any damage. When power is restored to the tape player, the pinch roller will automatically reengage and the tape will resume play.

Noise Reduction

The Dolby Noise Reduction System* is on whenever the tape player is on, but may be switched off.

To turn off the Dolby Noise reduction System: Press the Dolby button (button 2) after you insert the tape. The NR light in the display will go off when the Dolby System is off. The Dolby System is automatically reactivated each time a tape is inserted.

* "Dolby" noise reduction manufactured under license from Dolby Laboratories Licensing Corporation. Dolby and the double-D symbol are trademarks of Dolby Laboratories Licensing Corporation.

Operating Instructions — CD Player

NOTE: The ignition switch must be in the ON or ACC position and the volume control ON before the CD player will operate.

CAUTION!

This CD player will accept 4 ¾ inch (12 cm) discs only. The use of other sized discs may damage the CD player mechanism.

Inserting The Compact Disc

The CD player contained within the radio is not a multi-disc changer, and will only accept one CD. Gently insert one CD into the CD player with the CD label facing up. The CD will automatically be pulled into the CD Player.

If the volume control is ON, the unit will switch from radio to CD mode and begin to play. The display will show the track number and index time in minutes and seconds. Play will begin at the start of track one.

NOTE:

- You may eject a disc with the radio OFF. The ignition switch must be in the ON or ACC position to insert a disc with the radio OFF.

- If you insert a disc with the ignition ON and the radio OFF, the CD will automatically be pulled into the CD Player and the display will show the time of day. If you insert a disc with the ignition OFF, the display will show the time of day for about 5 seconds, then go out.

Seek Button

Press the top of the SEEK button for the next selection on the CD. Press the bottom of the button to return to the beginning of the current selection, or return to the beginning of the previous selection if the CD is within the first 10 seconds of the current selection.

EJT CD (Eject) Button

Press this button and the disc will unload and move to the entrance for easy removal. The unit will switch to the radio mode.

If you do not remove the disc within 15 seconds, it will be reloaded. The radio mode will continue to appear.

The disc can be ejected with the radio OFF.

FF/TUNE/RW

Press FF (Fast Forward) and the CD player will begin to fast forward until FF is released. The RW (Reverse) button works in a similar manner.

Program Button 4 (Random Play)

Press this button while the CD is playing to activate Random Play. This feature plays the tracks on the selected disc in random order to provide an interesting change of pace.

Press the SEEK button to move to the next randomly selected track.

Press TUNE FF to fast forward through the tracks. Press the FF button a second time to stop the fast forward feature. If TUNE RW is pressed, the current track will reverse to the beginning of the track and begin playing.

Press button 4 a second time to stop Random Play.

MODE

Press the MODE button to select between the tape player, CD player, or satellite radio (if equipped).

To select Satellite Radio (if equipped), press the MODE button until the word SIRIUS appears. The following will be displayed in this order: After three seconds, the current channel name and number will be displayed for five seconds. The current program type and channel number will then be displayed for five seconds. The current channel name and number will then be displayed until an action occurs. A CD or tape may remain in the player while in the Satellite Radio mode.

Tape CD Button

Press this button to select between CD player and Tape player.

Time Button

Press this button to change the display from elapsed CD playing time to time of day.

Scan Button

Press this button to play the first 10 seconds of each track. To stop the scan function, press the button a second time.

CD Changer Control Capability — If Equipped

This radio is compatible with a remote mounted CD changer available through Mopar Accessories. The following instructions are for the radio controls that operate this CD changer.

Mode Button

To activate the CD changer, press the MODE button until CD information appears on the display.

Push-Button

While the CD changer is playing, press the NUMBER 1 push-button or the NUMBER 5 push-button to select a disc numbered higher or lower than the one currently being played.

Seek Button

Press the SEEK up or down to select another track on the same disc. A SEEK symbol will appear on the display.

Fast Forward And Rewind Buttons

Press and hold the FF button for fast forward. Press and hold the RW button for fast reverse.

The audio output can be heard when fast forward and fast reverse are activated.

Random Play (RND)

Press the Random button to play the tracks on the selected disc in random order for an interesting change of pace.

Random can be cancelled by pressing the button a second time or by ejecting the CD from the changer.

CD Diagnostic Indicators

When driving over a very rough road, the CD player may skip momentarily. Skipping will not damage the disc or the player, and play will resume automatically.

As a safeguard and to protect your CD player, one of the following warning symbols may appear on your display.

A CD HOT symbol indicates the player is too hot.

CD HOT will pause the operation. Play can be resumed when the operating temperature is corrected or another MODE is selected.

An ERR symbol will appear on the display if the laser is unable to read the Disc data for the following reasons:

- Excessive vibration

- Disc inserted upside down
- Damaged disc
- Water condensation on optics

SALES CODE RBB—AM/FM STEREO RADIO WITH CASSETTE TAPE PLAYER AND CD CHANGER CAPABILITY

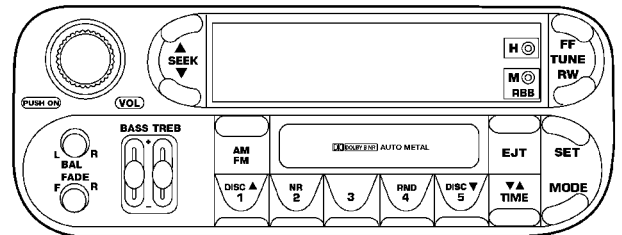

Operating Instructions

NOTE: Power to operate the radio is supplied through the ignition switch. It must be in the ON or ACC position to operate the radio.

NOTE: When first learning the control functions, the user should set the controls as shown in the following list.

Tone Controls...As illustrated.

Speaker Control...Centered.

Power Button

The volume control/power button pops out when pressed, this turns the sound system ON in the mode last used. Pushing the button back in turns the sound system OFF.

Electronic Volume Control

The electronic volume control turns continuously (360 degrees) in either direction without stopping. Turning the volume control to the right increases the volume and to the left decreases it.

When the audio system is turned on, the sound will be set at the same volume level as last played.

For your convenience, the volume can be turned down, but not up, when the audio system is off and the ignition is ON.

Seek

Press and release the SEEK button to search for the next station in either the AM or FM mode. Press the top of the button to seek up and the bottom to seek down. The radio will remain tuned to the new station until you make another selection. Holding the button will bypass stations without stopping until you release it.

Tune

Press the TUNE control up or down to increase or decrease the frequency. If the button is pushed and held, the radio will continue to tune until the button is released. The frequency will be displayed and continuously updated while the button is pushed.

To Set The Push-Button Memory

When you are receiving a station that you wish to commit to push-button memory, press the SET button. The symbol SET 1 will now show in the display window. Select the "1-5" button you wish to lock onto this station and press and release that button. If a button is not selected within 5 seconds after pressing the SET button, the station will continue to play but will not be locked into push-button memory.

You may add a second station to each push-button by repeating the above procedure with this exception: Press the SET button twice and SET 2 will show in the display window. Each button can be set for SET 1 and SET 2 in both AM and FM. This allows a total of 10 AM and 10 FM stations to be locked into push-button memory. The stations stored in SET 2 memory can be selected by pressing the push-button twice.

Every time a preset button is used a corresponding button number will be displayed.

Balance

The balance control adjusts the left-to-right speaker balance. Press the BAL button in and it will pop out. Adjust the balance and push the button back in.

Fade

The fade control provides for balance between the front and rear speakers. Press the FADE button in and it will pop out. Adjust the balance and push the button back in.

Bass and Treble Tone Control

The tone controls consist of 2 separate bands. The bass band is on the left, and the treble band is on the right. Each band is adjusted by a slider control with a detent at the mid-position. Moving the control up or down increases or decreases amplification of that band. The mid position provides a balanced output.

AM/FM Selection

Press the AM/FM button to change from AM to FM. The operating mode will be displayed next to the station frequency. The display will show ST when a stereo station is received in the FM mode.

Mode Button

Press the MODE button to select between the cassette tape player, CD changer, or the Satellite Radio (if equipped). When the Satellite Radio (if equipped) is selected "SA" will appear in your radio display.

A CD or tape may remain in the player while in the Satellite or radio mode.

Cassette Player Features

With ignition OFF and the sound system OFF, you can eject the tape cassette by pushing the EJECT button.

You can turn the tape player ON by inserting a cassette or activating the MODE button (with a cassette in the radio), but only when the ignition and radio are on.

Each time a cassette is inserted the tape player will begin playing on the side of the cassette that is facing up in the player.

Music Search

Pressing the SEEK button while playing a tape will start the Music Search mode. Press the SEEK button up for the next selection on the tape and down to return to the beginning of the current selection, or return to the beginning of the previous selection if the tape is within the first 5 seconds of the current selection.

The SEEK symbol appears on the display when Music Search is in operation. Music Search shuts off automatically when a selection has been located.

Selective Music Search

Press the SEEK button up or down to move the track number to skip forward or backward 1 to 7 selections. Press the SEEK button once to move 1 selection, twice to move 2 selections, etc.

Fast Forward And Rewind Buttons

Pressing the TUNE button up or down momentarily activates Fast Forward or Rewind and makes the directional arrows appear on the display.

To stop Fast Forward or Rewind, press the TUNE button again.

Time Button

Press the time button to toggle between station frequency and time of day.

Pressing this button while playing a cassette tape will change the side of the tape being played.

NR (Noise Reduction)

Pushing the Number 2 Pre-set button when a tape is playing deactivates the Dolby Noise Reduction System*. When Dolby is ON, the NR symbol appears on the display. Each time a tape is inserted the Dolby will turn ON.

* “Dolby” noise reduction manufactured under license from Dolby Laboratories Licensing Corporation. Dolby and the double-D symbol are trademarks of Dolby Laboratories Licensing Corporation.

CD Changer Control Capability — If Equipped

This radio is compatible with a remote mounted CD changer available through Mopar Accessories. The following instructions are for the radio controls that operate this CD changer.

Mode Button

To activate the CD changer, press the MODE button until CD information appears on the display.

Push-Button

While the CD changer is playing, press the NUMBER 1 push-button or the NUMBER 5 push-button to select a disc numbered higher or lower than the one currently being played.

Seek Button

Press the SEEK up or down to select another track on the same disc. A SEEK symbol will appear on the display.

Fast Forward And Rewind Buttons

Press and hold the FF button for fast forward. Press and hold the RW button for fast reverse.

The audio output can be heard when fast forward and fast reverse are activated.

Random Play (RND)

Press the Random button to play the tracks on the selected disc in random order for an interesting change of pace.

Random can be cancelled by pressing the button a second time or by ejecting the CD from the changer.

CD Diagnostic Indicators

When driving over a very rough road, the CD player may skip momentarily. Skipping will not damage the disc or the player, and play will resume automatically.

As a safeguard and to protect your CD player, one of the following warning symbols may appear on your display.

A CD HOT symbol indicates the player is too hot.

CD HOT will pause the operation. Play can be resumed when the operating temperature is corrected or another MODE is selected.

An ERR symbol will appear on the display if the laser is unable to read the Disc data for the following reasons:

- Excessive vibration
- Disc inserted upside down
- Damaged disc
- Water condensation on optics

Radio Display Messages

Your radio has been designed to display certain messages when a problem is detected with the CD player.

DISPLAY	EXPLANATION	WHAT TO DO
E-01	Deadlock problem	See your dealer for service
E-02	Disc eject problem	See your dealer for service
E-06	Elevator problem	See your dealer for service
E-07	Magazine eject problem	Check that magazine is OK- if not see your dealer for service
	No discs in magazine. Load discs in magazine.	
	Player overheating. Allow to cool down.	

SALES CODE RBK—AM/ FM STEREO RADIO WITH CD PLAYER AND CD CHANGER CONTROLS

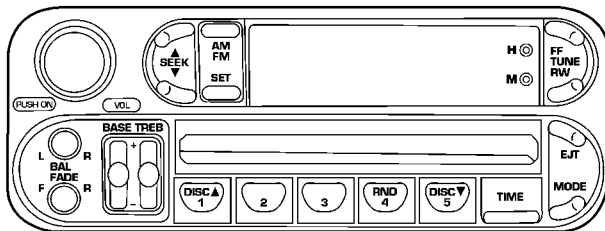

80e571f6

Radio Operation

Power/Volume Control

Press the ON/VOL control to turn the radio on. Turn the volume control clockwise to increase the volume.

NOTE: Power to operate the radio is supplied through the ignition switch. It must be in the ON or ACC position to operate the radio.

Seek

Press and release the SEEK button to search for the next station in either the AM or FM mode. Press the top of the button to seek up and the bottom to seek down. The radio will remain tuned to the new station until you make another selection. Holding the button in will bypass stations without stopping until you release it.

Tune

Press the TUNE control up or down to increase or decrease the frequency. If you press and hold the button, the radio will continue to tune until you release the button. The frequency will be displayed and continuously updated while the button is pressed.

Balance

The Balance control adjusts the left-to-right speaker balance. Press the BAL button in and it will pop out. Adjust the balance and push the button back in.

Fade

The Fade control provides for balance between the front and rear speakers. Press the FADE button in and it will pop out. Adjust the balance and push the button back in.

Bass and Treble Tone Control

The tone controls consist of 2 separate bands. The bass band is on the left, and the treble band is on the right. Each band is adjusted by a slider control with a detent at the mid-position. Moving the control up or down increases or decreases amplification of that band. The mid position provides a balanced output.

AM/FM Selection

Press the AM/FM button to change from AM to FM. The operating mode will be displayed next to the station frequency. The display will show ST when a stereo station is received.

To Set The Radio Push-Button Memory

When you are receiving a station that you wish to commit to push-button memory, press the SET button. SET 1 will show in the display window. Select the "1-5" button you wish to lock onto this station and press and release that button. If a button is not selected within 5 seconds after pressing the SET button, the station will continue to play but will not be locked into push-button memory.

You may add a second station to each push-button by repeating the above procedure with this exception: Press

the SET button twice and SET 2 will show in the display window. Each button can be set for SET 1 and SET 2 in both AM and FM. This allows a total of 10 AM and 10 FM stations to be locked into push-button memory. The stations stored in SET 2 memory can be selected by pressing the push-button twice. Every time a preset button is used a corresponding button number will be displayed.

Time

Press the TIME button to change the display between radio frequency and time.

General Information

This radio complies with Part 15 of FCC rules and with RSS-210 of Industry Canada. Operation is subject to the following conditions:

1. This device may not cause harmful interference,
2. This device must accept any interference received, including interference that may cause undesired operation.

NOTE: Changes or modifications not expressly approved by the party responsible for compliance could void the user's authority to operate the equipment.

CD Player Operation

NOTE: The ignition switch must be in the ON or ACC position and the volume control ON before the CD player will operate.

Inserting The Compact Disc

CAUTION!
This CD player will accept 4 ¾ inch (12 cm) discs only. The use of other sized discs may damage the CD player mechanism.

You may either insert or eject a disc with the radio OFF.

If you insert a disc with the ignition ON and the radio OFF, the display will show the time of day.

If the power is ON, the unit will switch from radio to CD mode and begin to play when you insert the disc. The display will show the track number and index time in minutes and seconds. Play will begin at the start of track one.

Seek

Press the top of the SEEK button for the next selection on the CD. Press the bottom of the button to return to the beginning of the current selection, or return to the beginning of the previous selection if the CD is within the first second of the current selection.

EJT — Eject

Press the EJT button and the disc will unload and move to the entrance for easy removal. The unit will switch to the radio mode.

If you do not remove the disc within 15 seconds, it will be reloaded. The unit will continue in radio mode.

The disc can be ejected with the radio and ignition OFF.

FF/TUNE/RW

Press FF (Fast Forward) and the CD player will begin to fast forward until FF is released. The RW (Reverse) button works in a similar manner.

Random Play — RND/Program Button 4

Press the RND (button 4) button while the CD is playing to activate Random Play. This feature plays the tracks on the selected disc in random order to provide an interesting change of pace.

Press the SEEK button to move to the next randomly selected track.

Press the RND (button 4) button a second time to stop Random Play.

Mode

Press the MODE button repeatedly to select between the CD player, the optional remote CD changer and the Satellite Radio (if equipped). When Satellite Radio (if equipped) is selected "SA" will appear in your radio display.

A CD or tape may remain in the player while in the Satellite mode.

Time

Press the TIME button to change the display from elapsed CD playing time to time of day.

CD Changer Control Capability — If Equipped

This radio is compatible with a remote mounted CD changer available through Mopar Accessories. The following instructions are for the radio controls that operate this CD changer.

Mode Button

To activate the CD changer, press the MODE button until CD information appears on the display.

Push-Button

While the CD changer is playing, press the NUMBER 1 push-button or the NUMBER 5 push-button to select a disc numbered higher or lower than the one currently being played.

Seek Button

Press the SEEK up or down to select another track on the same disc. A SEEK symbol will appear on the display.

Fast Forward And Rewind Buttons

Press and hold the FF button for fast forward. Press and hold the RW button for fast reverse.

The audio output can be heard when fast forward and fast reverse are activated.

Random Play (RND)

Press the Random button to play the tracks on the selected disc in random order for an interesting change of pace.

Random can be cancelled by pressing the button a second time or by ejecting the CD from the changer.

CD Diagnostic Indicators

When driving over a very rough road, the CD player may skip momentarily. Skipping will not damage the disc or the player, and play will resume automatically.

As a safeguard and to protect your CD player, one of the following warning symbols may appear on your display.

A CD HOT symbol indicates the player is too hot.



CD HOT will pause the operation. Play can be resumed when the operating temperature is corrected or another MODE is selected.

An ERR symbol will appear on the display if the laser is unable to read the Disc data for the following reasons:

- Excessive vibration
- Disc inserted upside down
- Damaged disc
- Water condensation on optics

Radio Display Messages

Your radio has been designed to display certain messages when a problem is detected with the CD player.

DISPLAY	EXPLANATION	WHAT TO DO
E-01	Deadlock problem	See your dealer for service
E-02	Disc eject problem	See your dealer for service
E-06	Elevator problem	See your dealer for service
E-07	Magazine eject problem	Check that magazine is OK- if not see your dealer for service
	No discs in magazine. Load discs in magazine.	
	Player overheating. Allow to cool down.	

805c2ab6

6 DISC CD CHANGER — IF EQUIPPED

The CD changer is located below the radio in the instrument panel. The changer plays only 4 ¾ inch (12 cm) discs. The changer holds up to 6 discs. Each disc is loaded and ejected through a single slot in front of the changer. Each disc has a numbered button with an amber light above it which, when illuminated, indicates that a disc is loaded in that particular chamber.

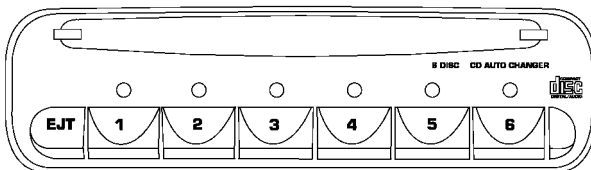

80ef1625

Loading the CD Changer

When inserting the first CD into the changer if the radio is on, wait until the single slot is illuminated on both sides and simply insert the first disc.

To insert additional CDs into the changer, the instructions follow:

1. Select and press any numbered button without an illuminated light above it.
2. Insert the CD while the light above the chosen button is flashing and the two lights on either side of the slot are illuminated.
3. Upon insertion, the CD will begin to play, and both the button light and the lights in the corner of the loading slot will illuminate.
4. Repeat the process for loading any additional CDs. The CD player will stop while additional CDs are loaded.

Playing Discs

The radio will show the CD number, the CD track number, and the Track Time Elapsed while the radio is in the CD mode. If more than one CD is loaded in the changer, the changer will automatically play the next disc after playing the last track of the current disc.

Seek Button

Press the top of this button on the radio once to play the next track. Press the bottom of the button once to return to the beginning of the current track. Press the bottom of the button twice to play the previous track.

FF/TUNE/RW

Press the FF (fast forward) button and the CD player will fast forward through the tracks until the button is released. Press the RW (rewind) button and the CD player will reverse through the tracks until the button is released.

Mode Button

Press this button to toggle between radio and cd modes.

Program Button 1

Press this button to play the next available disc.

Program Button 4 (Random Play)

Press this button while the CD is playing to activate Random Play. This feature plays the selections on the current compact disc in random order to provide an interesting change of pace. The CD changer stays in the random play mode when changing to the next disc.

NOTE: The changer will not random play between discs.

Press the top of the Seek button once to move to the next randomly selected track. Press the bottom of the Seek button to go back to the beginning of the track.

Press button 4 a second time to stop random play.

Program Button 5

Press this button to play the previous disc.

Time Button

Press this button to switch between time of day and CD track time.

Changing Modes

While in the radio mode, if a cassette is loaded, press the Mode button to switch to the tape mode. If a CD is loaded, press the Mode button to select the CD mode. If neither a tape nor CD is loaded, the radio will ignore the command.

- Inserting either a tape or CD automatically starts that mode of play.

- Pressing the AM/FM button while in the tape or CD mode will select the radio mode.
- If in the CD mode and the last CD is ejected, the radio will tune to the last station selected.

Removing Discs from the CD Changer

If there is a single CD in the changer, press the EJT button and the CD will eject. If the CD is not removed within 15 seconds, it will automatically reload into the CD changer. To eject additional CDs from the changer, first select the numbered button where the CD is located and then press the EJT button.

CD Changer Operation with the Changer Off

The CD changer is able to load and eject discs with the ignition power off. However, while the ignition is off, one of the six numbered buttons must be pressed first.

REMOTE SOUND SYSTEM CONTROLS — IF EQUIPPED

The remote sound system controls are located on the rear surface of the steering wheel. Reach behind the wheel to access the switches.

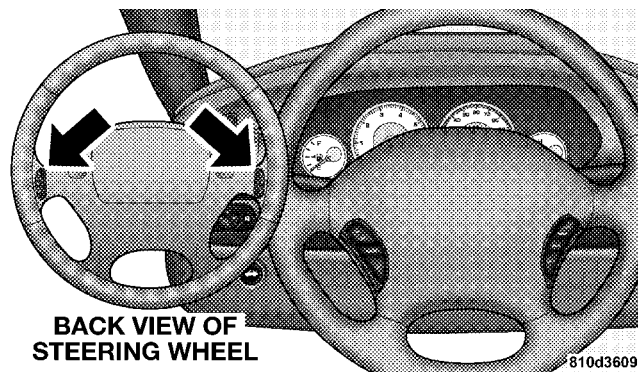

The right hand control is a rocker type switch with a push-button in the center and controls the volume and mode of the sound system. Pressing the top of the rocker switch will increase the volume and pressing the bottom of the rocker switch will decrease the volume.

Pressing the center button will make the radio switch between the various modes available (AM/FM/TAPE/CD, Etc.).

The left hand control is a rocker type switch with a push-button in the center. The function of the left hand control is different depending on which mode you are in.

The following describes the left hand control operation in each mode.

Radio Operation

Pressing the top of the switch will “Seek” up for the next listenable station and pressing the bottom of the switch will “Seek” down for the next listenable station.

The button located in the center of the left hand control will tune to the next preset station that you have programmed in the radio preset push-button.

Tape Player

Pressing the top of the switch once will go to the next selection on the cassette. Pressing the bottom of the switch once will go to the beginning of the current selection or to the beginning of the previous selection if it is within the first 5 seconds of the current selection.

If you press the switch up or down twice it plays the second selection, three times, it will play the third, etc.

The button in the center of the left hand switch has no function in this mode.

CD Player — Single Disc in Radio

Pressing the top of the switch once will go to the next track on the CD. Pressing the bottom of the switch once will go to the beginning of the current track or to the beginning of the previous track if it is within one second after the current track begins to play.

If you press the switch up or down twice it plays the second track, three times, it will play the third, etc.

The button in the center of the left hand switch has no function in this mode.

CD Player — 6 Disc CD Changer

Pressing the top of the switch once will go to the next track on the CD. Pressing the bottom of the switch once will go to the beginning of the current track or to the beginning of the previous track if it is within one second after the current track begins to play.

If you press the switch up or down twice it plays the second track, three times, it will play the third, etc.

The button in the center of the left hand switch will cause the CD changer to play the next available disc.

CASSETTE TAPE AND PLAYER MAINTENANCE

To keep the cassette tapes and player in good condition, take the following precautions:

1. Do not use cassette tapes longer than C-90; otherwise, sound quality and tape durability will be greatly diminished.
2. Keep the cassette tape in its case to protect from slackness and dust when it is not in use.
3. Keep the cassette tape away from direct sunlight, heat and magnetic fields such as the radio speakers.
4. Before inserting a tape, make sure that the label is tightly secured to the cassette.
5. A loose tape should not be inserted into the radio.

Maintain your cassette tape player. The head and capstan shaft in the cassette player can pick up dirt or tape deposits each time a cassette is played. The result of deposits on the capstan shaft may cause the tape to wrap around and become lodged in the tape transport. The other adverse condition is low or "muddy" sound from one or both channels, as if the treble tone control were turned all the way down. To prevent this, you should periodically clean the head with a commercially available WET cleaning cassette.

As preventive maintenance, clean the head about every 30 hours of use. If you wait until the head becomes very dirty (noticeably poor sound), it may not be possible to remove all deposits with a simple WET cleaning cassette.

COMPACT DISC MAINTENANCE

To keep the compact discs in good condition, take the following precautions:

1. Handle the disc by its edge or center; avoid touching the surface.
2. If the disc is stained, clean the surface with a soft cloth, wiping from center to edge.
3. Do not apply paper or tape to the disc; avoid scratching the disc.
4. Do not use solvents such as benzine, thinner, cleaners, or antistatic sprays.
5. Store the disc in its case after playing.
6. Do not expose the disc to direct sunlight.
7. Do not store the disc where temperatures may become too high.

NOTE: If you experience difficulty in playing a particular disc, it may be damaged, oversized, or have theft protection encoding. Try a known good disc before considering disc player service. You may have a problem with CD-R (recordable) and CD-RW (recordable and writable) disks.

RADIO OPERATION AND CELLULAR PHONES

Under certain conditions, the operation of a cellular phone in your vehicle can cause erratic or noisy performance from your radio. This condition may be lessened or eliminated by relocating the cellular phone antenna. This condition is not harmful to the radio. If your radio performance does not satisfactorily “clear” by the repositioning of the cellular antenna, it is recommended that the radio volume be turned down or off during cellular phone operation.

CLIMATE CONTROLS

Manual Air Conditioning/Heater Control

The Air Conditioning System allows you to balance the temperature, amount, and direction of air circulating throughout the vehicle.

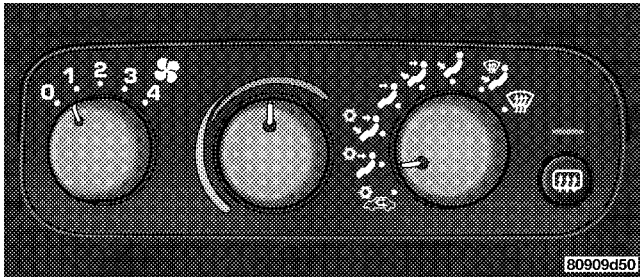

The air conditioning system of your vehicle contains R-134a, a refrigerant that does not deplete the ozone layer in the upper atmosphere.

The controls are as follows:

Fan and Air Conditioning Control

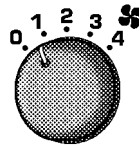

80909dad

Use this control to regulate the amount of air forced through the system in any mode you select. The 0 Setting represents OFF and the 4 Setting is the greatest amount of air flow.

Air Conditioning Operation

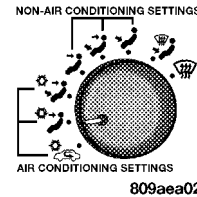

To turn on the Air Conditioning, choose the direction of the air through the outlets by selecting between the Air Conditioning Recirculation, Panel-Air Conditioning, or Bi-Level Air Conditioning modes on the Mode Control. Air Conditioning modes are indicated

by the snowflake symbol shown above in illustration. Adjust the Temperature and Fan Controls.

Slight changes in engine speed or power may be noticed when the air conditioning compressor is on. This is a normal occurrence as the compressor will cycle on and off to maintain comfort and increase fuel economy.

NOTE: If your air conditioning performance seems lower than expected, check the front of the air conditioning condenser for an accumulation of dirt or insects. The air conditioning condenser is located in front of the radiator. Clean with a gentle water spray from behind the radiator and through the condenser. Fabric front fascia protectors may reduce air flow to the condenser, reducing air conditioning performance.

Temperature Control

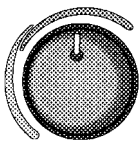

8091f160

Use this control to regulate the temperature of the air inside the passenger compartment. The blue area of the scale indicates cooler temperatures while the red area indicates warmer temperatures.

Mode Control

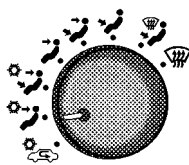

80909dd2

The mode control allows you to choose from several patterns of air distribution.

• **Recirculation — Air Conditioning**



Recirculated interior air is cooled and sent through the instrument panel vents. Upon initial start up of the vehicle in very hot or humid weather, open windows and put in outside air modes to flush hot/humid air out. Then turn on the Recirculation mode to cool the vehicle interior rapidly. The Recirculation mode can also be used to temporarily block out any outside odors, smoke, or dust.

NOTE: Continuous use of the Recirculation mode may make the inside air stuffy and under mild, humid conditions cause windows to fog. Use of this mode for longer than 15 minutes is not recommended.

• **Panel — Air Conditioning**



Outside air flows through the air conditioning system and then through the outlets located in the instrument panel.

• **Bi-Level — Air Conditioning**



Outside air flows through the air conditioning system and then through the outlets located in both the instrument panel and floor outlets.

- **Panel**

 Air is directed through the outlets in the instrument panel. These outlets can be adjusted to direct air flow.

- **Bi-Level**

 Air is directed through the instrument panel and floor outlets.

NOTE: There is a difference in temperature between the upper and lower outlets for added comfort. The warmer air goes to the floor outlets. This feature gives improved comfort during sunny but cool conditions.

- **Floor**

 Air is directed through the floor outlets with a lesser amount through the defrost and side window demist outlets.

- **Mix**

 Air is directed through the floor, defrost and side window demist outlets. This setting works best in cold or snowy conditions that require extra heat at the windshield. This setting is good for maintaining comfort while reducing moisture on the windshield.

- **Defrost**

 Air is directed through the windshield and side window demist outlets. Use this mode with maximum fan and temperature settings for best windshield and side window defrosting.

NOTE: The air conditioning compressor operates in both Mix and Defrost modes even if the Air Conditioning is not selected. This dehumidifies the air to help dry the windshield.

Rear Seat Outlets

These outlets are located under the front seats and direct warm air to the rear seat passengers. Air is directed through these outlets when you select either the Floor, Bi-Level, or Mix modes.

Rear Window Defroster

 The Rear Window Defroster button is located to the right of the Mode Control. Press this button once to turn on the Rear Window Defrost and a second time to turn them off. A light above the button shows that the defroster is on.

NOTE: The defroster turns off automatically after 15 minutes of operation. Each later activation will allow 10 minutes of operation.

Side Window Demisters

A side window demister outlet is at each end of the instrument panel. These non-adjustable outlets direct air toward the side windows when the system is in either the FLOOR, MIX, or DEFROST modes. A small amount of air is directed to the side window demisters in BI-LEVEL mode as well. The air is directed at the area of the windows through which you view the outside mirrors.

Windshield and Side Window Fogging



Interior fogging on the windshield can be quickly removed by using the defrost position on the mode control.



Your side windows may fog on the inside in mild rainy or humid weather. To clear the windows, select the Panel-Air Conditioning mode on the Mode Control. Point the panel outlets toward the side windows.

NOTE: Do not use the recirculation mode as it will not clear windows under these conditions.

Summer Operation





















Air conditioned vehicles must be protected with a high-quality antifreeze coolant to provide proper corrosion protection and to raise the boiling point of the coolant for protection against overheating. A 50 % concentration is recommended.

Winter Operation

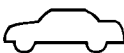
The blower air will heat faster in cold weather if you use only the low blower speeds for the first 10 minutes of operation. During engine warm up in cold weather, use the Defrost mode to direct any cold air away from vehicle occupants. Use of the Recirculate-Air Conditioning Mode during winter months is not recommended due to the possibility of window fogging.

NOTE: See Operating Tips chart (for Manual A/C Control) at the end of this section for suggested control settings in different weather conditions.

Operating Tips (Manual A/C Control Only)

WEATHER	CONTROL SETTINGS
<p>HOT WEATHER AND VEHICLE INTERIOR IS VERY HOT</p>  	<p>Open the windows, start the vehicle, and set the Mode control at Panel A/C  or Bi-Level A/C . Set the Fan control to the High position (full clockwise). Set the temperature control to full cool (counter-clockwise). After the hot air is flushed from the vehicle, turn the Mode control to Recirculate A/C  and roll up the windows. Once you are comfortable, place the Mode control at Panel A/C  or Bi-Level A/C .</p>
<p>WARM WEATHER</p>  	<p>If it's sunny, set the Mode control at Panel A/C . If it's cloudy or dark, set the Mode control at Bi-Level A/C . Adjust Temperature control for comfort.</p>
<p>COOL OR COLD HUMID CONDITIONS</p>  	<p>Set the Mode control at Mix  or Defrost . Set the Fan Control to the High position (full clockwise). Adjust Fan and Temperature control for comfort if windows are clear.</p>
<p>COLD DRY CONDITIONS</p>  	<p>Set the Mode control at Floor . If it's sunny, you may want more upper air. In this case, set the Mode control at Bi-Level . In very cold weather, if you need extra heat at the windshield, set the Mode control at Mix  or Defrost  as needed. Adjust Fan and Temperature control for comfort.</p>

Outside Air Intake

When operating the system during the winter months, make sure the air intake, directly in front of the windshield, is free of ice, slush, snow or other obstructions such as leaves. Leaves collected in the air-intake plenum may reduce air flow and plug the plenum water drains.

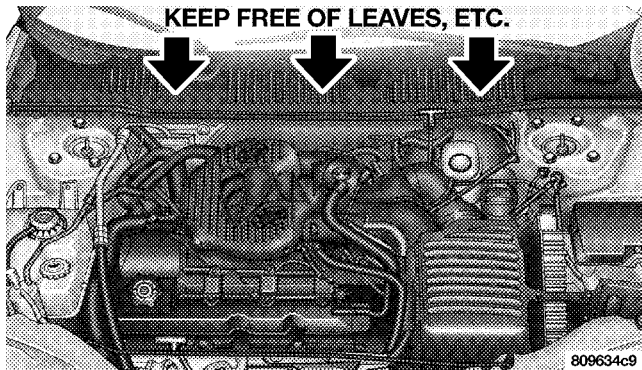

STARTING AND OPERATING

CONTENTS

■ Starting Procedures	132	□ Automatic Transaxle Ignition Interlock System	136
□ Automatic Transaxle	132	□ Four Speed Automatic Transaxle	137
□ Manual Transaxle	132	□ Reset Mode	137
□ Normal Starting	132	□ Gear Ranges For Four Speed Automatic Transaxle	137
□ Extreme Cold Weather (Below -20°F Or -29°C)	133	■ Manual Transaxle	139
□ If Engine Fails To Start	134	□ Recommended Shift Speeds	140
□ After Starting	134	□ Downshifting	140
■ Battery And Engine Block Heaters — If Equipped	134	□ Cruise Control	140
■ Automatic Transaxle	135	■ Parking Brake	141
□ Brake/Transmission Interlock	135	■ Brake System	142

- Anti-Lock Brake System (ABS) — If Equipped142
- Power Steering143
- Traction Control — If Equipped144
- Tire Safety Information145
 - Tire Markings145
 - Tire Identification Number (TIN)148
 - Tire Loading And Tire Pressure149
- Tires—General Information152
 - Tire Pressure152
 - Tire Inflation Pressures153
 - Radial-Ply Tires155
 - Compact Spare Tire — If Equipped155
 - Tire Spinning156
 - Tread Wear Indicators157
 - Replacement Tires157
- Alignment And Balance158
- Tire Chains159
- Snow Tires159
- Tire Rotation Recommendations159
- AutoStick — If Equipped160
 - AutoStick Operation160
 - AutoStick General Information161
- Fuel Requirements162
 - Reformulated Gasoline162
 - Gasoline/Oxygenate Blends162
 - MMT In Gasoline163
 - Sulfur In Gasoline163
 - Materials Added To Fuel164
- Adding Fuel164
 - Fuel Filler Cap (Gas Cap)164
- Vehicle Loading166

■ Trailer Towing	166	□ Selection Of Engine Oil	169
□ Warranty Requirements	166	□ Starting	170
■ Flexible Fuel – (2.7L Engines With Automatic Transmission Only)	168	□ Cruising Range	170
□ E-85 General Information	168	□ Replacement Parts	171
□ Ethanol Fuel (E-85)	168	□ Maintenance	171
□ Fuel Requirements	168		

STARTING PROCEDURES

Before starting your vehicle, adjust your seat, adjust both inside and outside mirrors, and fasten your seat belts.

CAUTION!

Long periods of engine idling, especially at high engine speeds can cause excessive exhaust temperatures which can damage your vehicle. Do not leave your vehicle unattended with the engine running.

WARNING!

Do not leave children or animals inside parked vehicles in hot weather. Interior heat build up may cause serious injury or death.

Automatic Transaxle

The gear selector must be in the NEUTRAL or PARK position before you can start the engine. Apply the brakes before shifting to any driving gear.

Manual Transaxle

Fully apply the parking brake, press the clutch pedal to the floor and place the gear selector in NEUTRAL before starting the engine.

Normal Starting

Normal Starting of either a cold or a warm engine does not require pumping or depressing the accelerator pedal. Simply turn the key to the "START" position and release when the engine starts. If the engine has not started within 3 seconds, slightly depress the accelerator pedal while continuing to crank. If the engine fails to start within 15 seconds, turn the key to the "OFF" position, wait 10 to 15 seconds, then repeat the normal starting procedure.

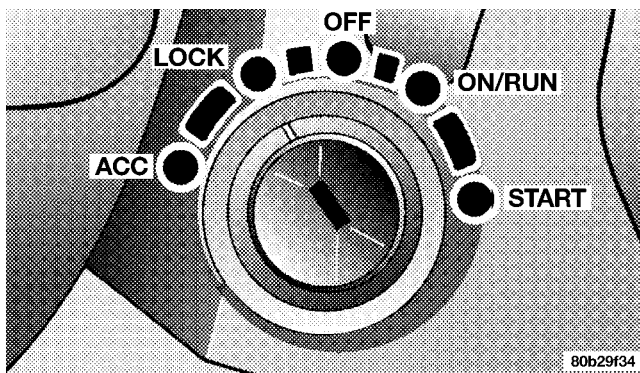
**WARNING!**

Never pour fuel or other flammable liquid into the throttle body air inlet opening in an attempt to start the vehicle. This could result in flash fire causing serious personal injury.

CAUTION!

Do not attempt to push or tow your vehicle to get it started. Vehicles equipped with an automatic trans-axle cannot be started this way. Unburned fuel could enter the catalytic converter and once the engine has started, ignite and damage the converter and vehicle. If the vehicle has a discharged battery, booster cables may be used to obtain a start from another vehicle. This type of start can be dangerous if done improperly, so follow the procedure carefully. See section 6 of this manual for jump starting instructions.

Extreme Cold Weather (below -20°F or -29°C)

To insure reliable starting at these temperatures, use of an externally powered electric engine block heater and battery blanket heater package (available from your dealer) is recommended.

If Engine Fails to Start

If the engine fails to start after you have followed the “NORMAL STARTING” or “EXTREME COLD WEATHER” procedures, it may be flooded. Push the accelerator pedal all the way to the floor and hold it there while cranking the engine. This should clear any excess fuel in case the engine is flooded.

CAUTION!

To prevent damage to the starter, do not crank the engine for more than 15 seconds at a time. Wait 10 to 15 seconds before trying again.

If the engine has been flooded, it may start to run, but not have enough power to continue running when the key is released. If this occurs, continue cranking with the accelerator pedal pushed all the way to the floor. Release the accelerator pedal and the key once the engine is running smoothly.

If the engine shows no sign of starting after two 15 second periods of cranking with the accelerator pedal held to the floor, the “NORMAL STARTING” or “EXTREME COLD WEATHER” procedure should be repeated.

After Starting

The idle speed will automatically decrease as the engine warms up. At cooler ambient temperatures, the idle speed for the 2.7L engine may increase during extended idles for improved heater performance.

BATTERY AND ENGINE BLOCK HEATERS — If EQUIPPED

The engine block heater warms engine coolant and permits quicker starts in cold weather. Connect the cord to a standard 110-115 volt AC electrical outlet with a grounded, three wire extension cord. The engine block heater cord is found under the hood near the air cleaner housing.

WARNING!

Remember to disconnect the cord before driving. Damage to the 110-115 volt AC electrical cord could cause electrocution.

Use the heater when temperatures below 0°F (-18°C) are expected to last for several days.

AUTOMATIC TRANSAXLE**Brake/Transmission Interlock**

This interlock system prevents you from moving the gear selector out of the Park position unless the brake pedal is pressed. The system is active when the ignition switch is in the RUN position.

WARNING!

Unintended movement of a vehicle could injure those in and near the vehicle. As with all vehicles, you should never exit a vehicle while the engine is running. Before exiting a vehicle you should shift the transmission into Park, remove the key from the ignition, and apply the park brake. Once the key is removed from the ignition the transmission shift lever is locked in the Park position, securing the vehicle against unwanted movement. Furthermore, you should never leave children unattended inside a vehicle. The following indicators should be used to ensure that you have engaged the transmission shift lever into the "Park" position:

- When shifting into Park, depress the button on the shift lever and firmly move the lever all the way forward until it stops.
- Look at the shift indicator window on the console to ensure it is in the "P" position.
- When engaged in Park you will not be able to move the shifter rearward without depressing the shift lever button.

CAUTION!

Damage to the transaxle may occur if the following precautions are not observed:

- Shift into PARK only after the vehicle has come to a complete stop.
- Shift into or out of REVERSE only after the vehicle has come to a complete stop and the engine is at idle speed.
- Do not shift from REVERSE, PARK, or NEUTRAL into any forward gear when the engine is above idle speed.
- Before shifting into any gear, make sure your foot is firmly on the brake pedal.

WARNING!

It is dangerous to shift the selector lever out of "P" or "N" if the engine speed is higher than idle speed. If your foot is not firmly on the brake pedal, the vehicle could accelerate quickly forward or in reverse. You could lose control of the vehicle and hit someone or something. Only shift into gear when the engine is idling normally and when your right foot is firmly on the brake pedal.

Automatic Transaxle Ignition Interlock System

This system prevents the key from being removed unless the shift lever is in PARK and the shift knob push-button is out. It also prevents shifting out of PARK unless the key is in the OFF or RUN positions.

NOTE: If a malfunction occurs, the system may trap the key in the ignition cylinder to warn you that this safety feature is inoperable. The engine can be started and stopped but the key cannot be removed until you obtain service.

Four Speed Automatic Transaxle

The electronically controlled transaxle provides a precise shift schedule. The transaxle electronics are self calibrating; therefore, the first few shifts on a new vehicle may be somewhat abrupt. This is a normal condition, and precision shifts will develop within a few shift cycles.

Reset Mode

The transaxle is monitored electronically for abnormal conditions. If a condition is detected that could cause damage, the transaxle shifts automatically into second gear. The transaxle remains in second gear despite the forward gear selected. Park (P), Reverse (R), and Neutral (N) will continue to operate. This Reset feature allows the vehicle to be driven to a dealer for service without damaging the transaxle.

In the event that the problem has been momentary, the transaxle can be reset to regain all forward gears.

Stop the vehicle and shift into Park (P).

Turn the Key to LOCK then restart the engine.

Shift into D and resume driving.

NOTE: Even if the transaxle can be reset, it is recommended that you visit a dealer at your earliest possible convenience. Your dealer has diagnostic equipment to determine if the problem could recur.

If the transaxle cannot be reset, dealer service is required.

Gear Ranges For Four Speed Automatic Transaxle

DO NOT race the engine when shifting from PARK or NEUTRAL positions into another gear range.

NOTE: If the key is in the RUN position, you must press the brake pedal to shift out of the "P" Park position.

"P" Park

Supplements parking by locking the transaxle. Engine can be started in this range. Never attempt to use PARK while vehicle is in motion.

Apply parking brake when leaving the vehicle in this range.

WARNING!

Your vehicle could move and injure you and others if it is not completely in P (Park). Check by trying to move the gearshift lever back and forth without depressing the shift button after you have set it in P. Make sure it is in Park before leaving the vehicle.

WARNING!

Never use the Park position as a substitute for the parking brake. Always apply the parking brake fully when parked to guard against vehicle movement and possible injury or damage.

“R” Reverse

Shift into this range only after the vehicle has come to a complete stop.

“N” Neutral

Engine may be started in this range.

“D” Overdrive

This range should be used for most city and highway driving. It provides smoothest up shifts and down shifts and best fuel economy.

When frequent transaxle shifting occurs while using the Overdrive range, such as when operating the vehicle under heavy loading conditions (in hilly terrain, traveling into strong head winds, or while towing heavy trailers), use the “3” range.

“3” Drive

This range eliminates shifts into Overdrive. The transaxle will operate normally in first and second while in this range.

A delayed shift from second to third will occur at speeds of about 31 to 38 mph (50 to 60 km/h) and low levels of accelerator pedal travel. An early down-shift from third to second will occur at a speed of about 34 to 30 mph (54 to 48 km/h). This is done to provide second gear engine braking at speeds less than 30 mph (48 km/h).

NOTE: Using the “3” range while operating the vehicle under heavy operating conditions will improve performance, fuel economy, and extend transaxle life by reducing excessive shifting and heat build up.

Use the “3” range when descending steep grades to prevent brake system distress.

“L” Low

This range should be used for maximum engine braking when descending steep grades. In this range, up shifts will occur only to prevent engine over speed while down shifts occur as early as possible.

WARNING!

Never use Park position on an automatic transmission as a substitute for the parking brake. Always apply parking brake fully when parked to guard against vehicle movement and possible injury or damage.

MANUAL TRANSAXLE

NOTE: The parking brake should be engaged and the gear selector placed in REVERSE before leaving the vehicle, especially on an incline.

Fully depress the clutch pedal before you shift gears. As you release the clutch pedal, lightly depress the accelerator pedal.

Use each gear in numerical order – do not skip a gear. Be sure the transaxle is in FIRST gear, (not THIRD), when starting from a standing position. Damage to the clutch can result from starting in THIRD.

For most city driving you will find it easier to use only the lower gears. For steady highway driving with light accelerations, 5th gear is recommended.

Never drive with your foot resting on the clutch pedal, or try to hold the vehicle on a hill with the clutch pedal partially engaged. This will cause abnormal wear on the clutch.

Never shift into REVERSE until the vehicle has come to a complete stop.

NOTE: During cold weather, until the transaxle lubricant has warmed, you may have difficulty shifting. This is normal and not harmful to the transaxle.

Recommended Shift Speeds

To use your manual transaxle for both fuel economy and performance, it should be upshifted as listed. Shift at the vehicle speeds listed for acceleration. Earlier upshifts during cruise conditions (relatively steady speeds) will result in increased fuel economy, and may be used as indicated.

MANUAL TRANSAXLE RECOMMENDED SHIFT SPEEDS				
ENGINE SIZE	MINIMUM ACCELERATION SHIFT SPEEDS			
	1 to 2	2 to 3	3 to 4	4 to 5
2.7L	15 mph (24 km/h)	25 mph (40 km/h)	35 mph (56 km/h)	45 mph (72 km/h)

Higher upshift speeds may be used to obtain a desired acceleration rate.

Downshifting

Proper downshifting will improve fuel economy and prolong engine life.

CAUTION!

If you skip more than one gear while downshifting or downshift at too high an engine speed, you could damage the engine, transmission, or clutch.

To maintain a safe speed and prolong brake life, shift down to 2nd or 1st when descending a steep grade.

When turning a corner, or driving up a steep grade, shift down early so that the engine will not be overburdened.

Cruise Control

In most cases, the cruise control system will not operate with the transmission in 1st or 2nd gear.

PARKING BRAKE

When the parking brake is applied with the ignition on, the brake light in the instrument cluster will come on.

NOTE: This light only shows that the parking brake is on. It does not show the degree of brake application.

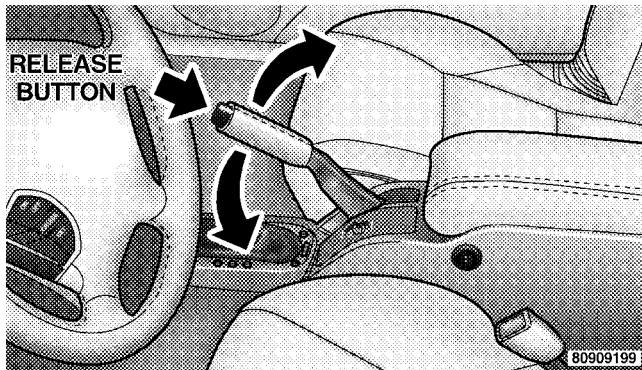

Before leaving the vehicle, make sure that the parking brake is set. To set the parking brake, pull up firmly on the lever. Also place the gear selector in the Park position. To release the parking brake, apply the brake pedal and pull up on the parking brake lever. Push the release button and lower the lever fully.

When parking on a hill, it is important to set the parking brake before placing the gear selector in Park, otherwise the load on the transmission locking mechanism may make it difficult to move the selector out of Park. As an added precaution, turn the front wheels toward the curb on a downhill grade and away from the curb on an uphill grade.

You should always apply the parking brake before leaving the vehicle.

WARNING!

- Leaving children in a vehicle unattended is dangerous for a number of reasons. A child or others could be injured. Children should be warned not to touch the parking brake or the gear selector. Don't leave the keys in the ignition. A child could operate power windows, other controls, or move the vehicle.
- Be sure the parking brake is fully disengaged before driving; failure to do so can lead to brake failure and an accident.

BRAKE SYSTEM

Your vehicle is equipped with power assisted brakes as standard equipment. In the event power assist is lost for any reason (for example, repeated brake applications with the engine off), the brakes will still function. The effort required to brake the vehicle will be much greater than that required with the power system operating.

WARNING!

Riding the brakes can lead to brake failure and possibly an accident. Driving with your foot resting or riding on the brake pedal can result in abnormally high brake temperatures, excessive lining wear, and possible brake damage. You wouldn't have your full braking capacity in an emergency.

If either of the two hydraulic systems lose normal capability, the remaining system will still function with some loss of overall braking effectiveness. This will be evident by increased pedal travel during application and greater pedal force required to slow or stop.

Anti-Lock Brake System (ABS) — If Equipped

The ABS gives increased vehicle stability and brake performance under most braking conditions. The system automatically “pumps” the brakes during severe braking conditions to prevent wheel lock-up.

All vehicle wheels and tires must be the same size and tires must be properly inflated to produce accurate signals for the ABS computer. However, the system will compensate when the compact spare is in use.

During stops where ABS is activated, a vibration of the brake pedal may be felt and associated system noises may be heard.

WARNING!

Pumping of the brake pedal will diminish the effectiveness of Anti-lock brakes and may lead to an accident. Pumping makes the stopping distance longer. Just press firmly on your brake pedal when you need to slow down or stop.

WARNING!

- **Anti-lock system (ABS) cannot prevent the natural laws of physics from acting on the vehicle, nor can it increase braking or steering efficiency beyond that afforded by the condition of the vehicle brakes and tires or the traction afforded.**
- **The ABS cannot prevent accidents, including those resulting from excessive speed in turns, following another vehicle too closely, or hydroplaning. Only a safe, attentive, and skillful driver can prevent accidents.**
- **The capabilities of an ABS equipped vehicle must never be exploited in a reckless or dangerous manner which could jeopardize the user's safety or the safety of others.**

POWER STEERING

The power assisted steering system of your vehicle provides mechanical steering capability in the event power assist is lost.

If for some reason the hydraulic pressure is interrupted, it will still be possible to steer your vehicle. Under these conditions you will observe a substantial increase in steering effort.

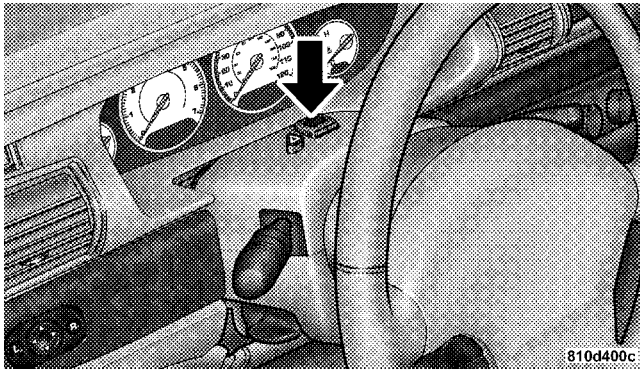
TRACTION CONTROL — IF EQUIPPED

The Traction Control System reduces wheel slip and maintains traction at the driving (front) wheels. The system reduces wheel slip by engaging the brake on the wheel that is losing traction while spinning. The traction system operates at speeds below 35 mph (56 km/h).

The system is always in the “stand by” mode unless:

- The Traction Control switch has been used to turn the system off;
- There is an Anti-Lock Brake or Traction System malfunction;
- The system has been deactivated to prevent damage to the brake system due to overheated brake temperatures.

NOTE: Extended heavy use of Traction Control may cause the system to deactivate and turn on the Traction Control indicator located in the instrument cluster.

This is to prevent overheating of the brake system and is a normal condition. After cooling, the system will automatically reactivate and turn off the Traction Control Light.

TIRE SAFETY INFORMATION

Tire Markings

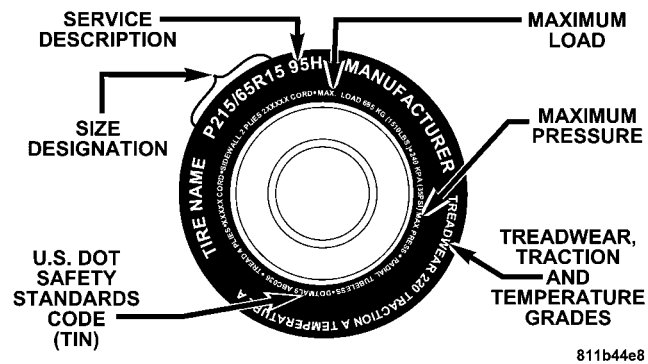

NOTE:

- P(Passenger)-Metric tire sizing is based on U.S. design standards. P-Metric tires have the letter "P" molded into the sidewall preceding the size designation. Example: P215/65R15 95H.

- European Metric tire sizing is based on European design standards. Tires designed to this standard have the tire size molded into the sidewall beginning with the section width. The letter "P" is absent from this tire size designation. Example: 215/65R15 96H
- LT(Light Truck)-Metric tire sizing is based on U.S. design standards. The size designation for LT-Metric tires is the same as for P-Metric tires except for the letters "LT" that are molded into the sidewall preceding the size designation. Example: LT235/85R16.
- Temporary Spare tires are high pressure compact spares designed for temporary emergency use only. Tires designed to this standard have the letter "T" molded into the sidewall preceding the size designation. Example: T145/80D18 103M.
- High Flotation tire sizing is based on U.S. design standards and begins with the tire diameter molded into the sidewall. Example: 31x10.5 R15 LT.

Tire Sizing Chart

EXAMPLE:	
Size Designation:	
P = Passenger car tire size based on U.S. design standards	
"...blank..." = Passenger car tire based on European design standards	
LT = Light Truck tire based on U.S. design standards	
T = Temporary Spare tire	
31 = Overall Diameter in Inches (in)	
215 = Section Width in Millimeters (mm)	
65 = Aspect Ratio in Percent (%)	—Ratio of section height to section width of tire.
10.5 = Section Width in Inches (in)	
R = Construction Code	—"R" means Radial Construction. —"D" means Diagonal or Bias Construction.
15 = Rim Diameter in Inches (in)	

EXAMPLE:**Service Description:****95** = Load Index

—A numerical code associated with the maximum load a tire can carry.

H = Speed Symbol

—A symbol indicating the range of speeds at which a tire can carry a load corresponding to its load index under certain operating conditions.

—The maximum speed corresponding to the Speed Symbol should only be achieved under specified operating conditions. (ie. tire pressure, vehicle loading, road conditions and posted speed limits).

Load Identification:**"...blank..."** = Absence of any text on sidewall of the tire indicates a Standard Load (SL) Tire**Extra Load (XL)** = Extra Load (or Reinforced) Tire**Light Load** = Light Load Tire**C,D,E** = Load range associated with the maximum load a tire can carry at a specified pressure**Maximum Load** — Maximum Load indicates the maximum load this tire is designed to carry.**Maximum Pressure** — Maximum Pressure indicates the maximum permissible cold tire inflation pressure for this tire.

Tire Identification Number (TIN)

The TIN may be found on one or both sides of the tire however the date code may only be on one side. Tires with white sidewalls will have the full TIN including date code located on the white sidewall side of the tire.

Look for the TIN on the outboard side of black sidewall tires as mounted on the vehicle. If the TIN is not found on the outboard side then you will find it on the inboard side of the tire.

EXAMPLE:	
DOT MA L9 ABCD 0301	
DOT	= Department of Transportation —This symbol certifies that the tire is in compliance with the U.S. Department of Transportation tire safety standards, and is approved for highway use.
MA	= Code representing the tire manufacturing location.(2 digits)
L9	= Code representing the tire size.(2 digits)
ABCD	= Code used by tire manufacturer.(1 to 4 digits)
03	= Number representing the week in which the tire was manufactured.(2 digits) —03 means the 3rd week.
01	= Number representing the year in which the tire was manufactured.(2 digits) —01 means the year 2001. —Prior to July 2000, tire manufacturers were only required to have 1 number to represent the year in which the tire was manufactured. Example: 031 could represent the 3rd week of 1981 or 1991.

Tire Loading and Tire Pressure

Tire Placard Location

NOTE: Some vehicles have a “Tire and Loading Information” placard located on the driver’s side “B” pillar.

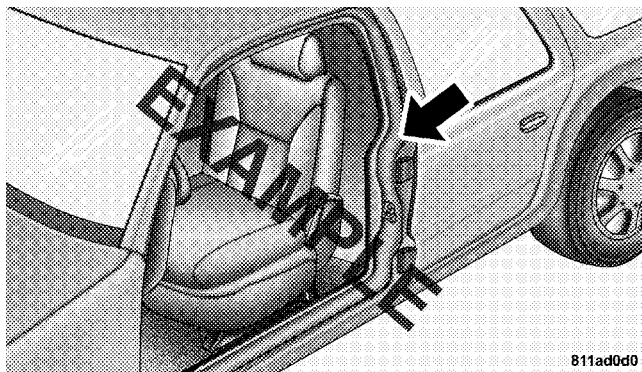

Tire and Loading Information Placard

TIRE AND LOADING INFORMATION

SEATING CAPACITY - TOTAL 5 FRONT 2 REAR 3

THE COMBINED WEIGHT OF OCCUPANTS AND CARGO SHOULD NEVER EXCEED XXX KG OR XXX LBS

TIRE	FRONT	REAR	SPARE
ORIGINAL TIRE SIZE	P195/70R14	P195/70R14	T125/70D15
COLD TIRE INFLATION PRESSURE	200kPa, 29PSI	200kPa, 29PSI	420kPa, 60PSI

SEE OWNER'S MANUAL FOR ADDITIONAL INFORMATION

4N109268

811b5a9a

This placard tells you important information about the,

- 1) number of people that can be carried in the vehicle
- 2) the total weight your vehicle can carry
- 3) the tire size designed for your vehicle
- 4) the cold tire inflation pressures for the front, rear and spare tires.

Loading

The vehicle maximum load on the tire must not exceed the load carrying capacity of the tire on your vehicle. You will not exceed the tire’s load carrying capacity if you

adhere to the loading conditions, tire size and cold tire inflation pressures specified on the Tire and Loading Information placard and the Vehicle Loading section of this manual.

NOTE: Under a maximum loaded vehicle condition, gross axle weight ratings (GAWR's) for the front and rear axles must not be exceeded. For further information on GAWR's, vehicle loading and trailer towing, see the Vehicle Loading section of this manual.

To determine the maximum loading conditions of your vehicle, locate the statement "The combined weight of occupants and cargo should never exceed XXX kg or XXX lbs." on the Tire and Loading Information placard. The combined weight of occupants, cargo/luggage and trailer tongue weight (if applicable) should never exceed the weight referenced here.

Steps for Determining Correct Load Limit

1. Locate the statement "The combined weight of occupants and cargo should never exceed XXX pounds" on your vehicle's placard.
2. Determine the combined weight of the driver and passengers that will be riding in your vehicle.

3. Subtract the combined weight of the driver and passengers from XXX kilograms or XXX pounds.

4. The resulting figure equals the available amount of cargo and luggage load capacity. For example, if "XXX" amount equals 1400 lbs. and there will be five 150 lb. passengers in your vehicle, the amount of available cargo and luggage load capacity is 650 lb. (1400-750 (5 x 150) = 650 lb.)

5. Determine the combined weight of luggage and cargo being loaded on the vehicle. That weight may not safely exceed the available cargo and luggage load capacity calculated in step 4.

6. If your vehicle will be towing a trailer, load from your trailer will be transferred to your vehicle. Consult this manual to determine how this reduces the available cargo and luggage load capacity of your vehicle.

NOTE: The following table shows examples on how to calculate total load, cargo/luggage and towing capacities of your vehicle with varying seating configurations and number and size of occupants. This table is for illustration purposes only and may not be accurate for the seating and load carry capacity of your vehicle.

NOTE: For the following example the combined weight of occupants and cargo should never exceed 865 lbs. (392 Kg).

Occupants			Combined weight of occupants and cargo from Tire Placard	MINUS	Combined Occupant's weight	=	AVAILABLE Cargo/Luggage and Trailer Tongue Weight
TOTAL	FRONT	REAR					
EXAMPLE 1			865 lbs	minus	Occupant 1: 200 lbs Occupant 2: 130 lbs Occupant 3: 160 lbs Occupant 4: 100 lbs Occupant 5: 80 lbs TOTAL WEIGHT: 670 lbs	=	195 lbs
5	2	3					
EXAMPLE 2			865 lbs	minus	Occupant 1: 210 lbs Occupant 2: 180 lbs Occupant 3: 150 lbs TOTAL WEIGHT: 540 lbs	=	325 lbs
3	2	1					
EXAMPLE 3			865 lbs	minus	Occupant 1: 200 lbs Occupant 2: 200 lbs TOTAL WEIGHT: 400 lbs	=	465 lbs
2	2	0					

WARNING!

Overloading of your tire is dangerous. Overloading can cause tire failure, affect vehicle handling, and increase your stopping distance. Use tires of the recommended load capacity for your vehicle. Never overload them.

TIRES—GENERAL INFORMATION**Tire Pressure**

Proper tire inflation pressure is essential to the safe and satisfactory operation of your vehicle. Three primary areas are affected by improper tire pressure:

1. Safety—**WARNING!**

Improperly inflated tires are dangerous and can cause accidents.

- Under inflation increases tire flexing and can result in tire failure.
- Over inflation reduces a tire's ability to cushion shock. Objects on the road and chuck holes can cause damage that results in tire failure.
- Unequal tire pressures can cause steering problems. You could lose control of your vehicle.
- Over inflated or under inflated tires can affect vehicle handling and can fail suddenly, resulting in loss of vehicle control.
- Unequal tire pressures from one side of the vehicle to the other can cause the vehicle to drift to the right or left.

Always drive with each tire inflated to the recommended cold tire inflation pressure.

2. *Economy*—

Improper inflation pressures can cause uneven wear patterns to develop across the tire tread. These abnormal wear patterns will reduce tread life resulting in a need for earlier tire replacement. Underinflation also increases tire rolling resistance and results in higher fuel consumption.

3. *Ride Comfort and Vehicle Stability*—

Proper tire inflation contributes to a comfortable ride. Overinflation produces a jarring and uncomfortable ride.

Tire Inflation Pressures

The proper cold tire inflation pressure for passenger cars is listed on either the face of the driver's door or the driver's side "B" pillar. For vehicles other than passenger cars, the cold tire inflation pressures are listed on either the "B" pillar, the Certification Label or in the Tire Inflation Pressures brochure in the glove compartment.

Some vehicles may have Supplemental Tire Pressure Information for vehicle loads that are less than the maximum loaded vehicle condition. These pressure conditions will be found in the "Supplemental Tire Pressure Information" section of this manual.

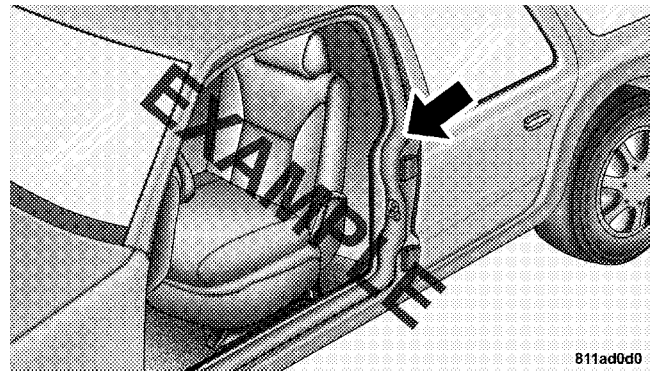

"B" PILLAR

The pressure should be checked and adjusted as well as inspecting for signs of tire wear or visible damage at least once a month. Use a good quality pocket-type gauge to check tire pressure. Do not make a visual judgement when determining proper inflation. Radial tires may look properly inflated even when they are underinflated.

CAUTION!

After inspecting or adjusting the tire pressure always reinstall the valve stem cap—if equipped. This will prevent moisture and dirt from entering the valve stem, which could damage the valve stem.

Inflation pressures specified on the placard are always “cold tire inflation pressure”. Cold tire inflation pressure is defined as the tire pressure after the vehicle has not been driven for at least 3 hours, or driven less than 1 mile (1 km) after a 3 hour period. The cold tire inflation pressure must not exceed the maximum inflation pressure molded into the tire side wall.

Check tire pressures more often if subject to a wide range of outdoor temperatures, as tire pressures vary with temperature changes.

Tire pressures change by approximately 1 psi (7 kPa) per 12° F (7° C) of air temperature change. Keep this in mind when checking tire pressure inside a garage especially in the winter.

Example: If garage temperature = 68° F (20° C) and the outside temperature = 32° F (0° C) then the cold tire inflation pressure should be increased by 3 psi (21 kPa), which equals 1 psi (7 kPa) for every 12° F (7° C) for this outside temperature condition.

Tire pressure may increase from 2 to 6 psi (13 to 40 kPa) during operation. DO NOT reduce this normal pressure build up or your tire pressure will be too low.

Tire Pressures for High Speed Operation

The manufacturer advocates driving at safe speeds within posted speed limits. Where speed limits or conditions are such that the vehicle can be driven at high speeds, maintaining correct tire inflation pressure is very important. Increased tire pressure and reduced vehicle loading may be required for high speed vehicle operation. Refer to original equipment or an authorized tire dealer for recommended safe operating speeds, loading and cold tire inflation pressures.

WARNING!

High speed driving with your vehicle under maximum load is dangerous. The added strain on your tires could cause them to fail. You could have a serious accident. Don't drive a vehicle loaded to the maximum capacity at continuous speeds above 75 mph (120 km/h).

Radial-Ply Tires**WARNING!**

Combining radial ply tires with other types of tires on your vehicle will cause your vehicle to handle poorly. The instability could cause an accident. Always use radial ply tires in sets of four (or 6, in case of trucks with dual rear wheels). Never combine them with other types of tires.

Cuts and punctures in radial tires are repairable only in the tread area because of sidewall flexing. Consult your authorized tire dealer for radial tire repairs.

Compact Spare Tire — If Equipped

The compact spare is for temporary emergency use with radial tires. It is engineered to be used on your style vehicle only. Since this tire has limited tread life, the original tire should be repaired (or replaced) and reinstalled at the first opportunity.

WARNING!

Temporary use spare tires are for emergency use only. With these tires, do not drive more than 50 mph (80 km/h). Temporary-use spare tires have a total tread life of 3,000 miles (4 800 km). Be sure to follow the warnings which apply to your spare. Failure to do so could result in spare tire failure and loss of vehicle control.

Do not install a wheel cover or attempt to mount a conventional tire on the compact spare wheel, since the wheel is designed specifically for the compact spare.

Do not install more than one compact spare tire/wheel on the vehicle at any given time.

CAUTION!

Because of the reduced ground clearance, do not take your vehicle through an automatic car wash with the compact spare installed. Damage to the vehicle may result.

Tire Spinning

When stuck in mud, sand, snow, or ice conditions, do not spin your vehicle's wheels above 35 mph (55 km/h).

See the paragraph on Freeing A Stuck Vehicle in Section 6 of this manual.

WARNING!

Fast spinning tires can be dangerous. Forces generated by excessive wheel speeds may cause tire damage or failure. A tire could explode and injure someone. Do not spin your vehicle's wheels faster than 35 mph (55km/h) when you are stuck. And don't let anyone near a spinning wheel, no matter what the speed.

Tread Wear Indicators

Tread wear indicators are in the original equipment tires to help you in determining when your tires should be replaced.

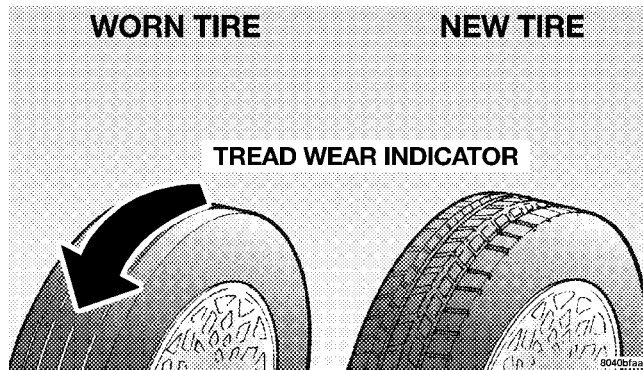

These indicators are molded into the bottom of the tread grooves and will appear as bands when the tread depth becomes 1/16 inch (2 mm). When the indicators appear in 2 or more adjacent grooves, the tire should be replaced.

Many states have laws requiring tire replacement at this point.

Replacement Tires

The tires on your new vehicle provide a balance of many characteristics. They should be inspected regularly for wear and correct cold tire inflation pressure. The manufacturer strongly recommends that you use tires equivalent to the originals in size, quality and performance when replacement is needed (see the paragraph on tread wear indicators). Refer to the Tire and Loading Information placard for the size designation of your tire. The service description and load identification will be found on the original equipment tire. Failure to use equivalent replacement tires may adversely affect the safety, handling, and ride of your vehicle. We recommend that you contact your original equipment or an authorized tire dealer with any questions you may have on tire specifications or capability.

WARNING!

- Do not use a tire, wheel size or rating other than that specified for your vehicle. Some combinations of unapproved tires and wheels may change suspension dimensions and performance characteristics, resulting in changes to steering, handling, and braking of your vehicle. This can cause unpredictable handling and stress to steering and suspension components. You could lose control and have an accident resulting in serious injury or death. Use only the tire and wheel sizes with load ratings approved for your vehicle.
- Never use a tire with a smaller load index or capacity, other than what was originally equipped on your vehicle. Using a tire with a smaller load index could result in tire overloading and failure. You could lose control and have an accident.
- Failure to equip your vehicle with tires having adequate speed capability can result in sudden tire failure and loss of vehicle control.

CAUTION!

Replacing original tires with tires of a different size may result in false speedometer and odometer readings.

Alignment And Balance

Poor suspension alignment may result in:

- Fast tire wear.
- Uneven tire wear, such as feathering and one-sided wear.
- Vehicle pull to right or left.

Tires may also cause the vehicle to pull to the left or right. Alignment will not correct this condition. See your dealer for proper diagnosis.

Improper alignment will not cause vehicle vibration. Vibration may be a result of tire and wheel out-of-balance. Proper balancing will reduce vibration and avoid tire cupping and spotty wear.

TIRE CHAINS

Due to limited clearance, tire chains are not recommended.

CAUTION!

Damage to the vehicle may result if tire chains are used.

SNOW TIRES

Some areas of the country require the use of snow tires during winter. Standard tires are of the all season type and satisfy this requirement as indicated by the M+S designation on the tire side wall.

If you need snow tires, select tires equivalent in size and type to the original equipment tires. Use snow tires only in sets of 4, failure to do so may adversely affect the safety and handling of your vehicle.

Snow tires generally have lower speed ratings than what was originally equipped with your vehicle and should not be operated at sustained speeds over 75 mph (120 km/h).

Tire Rotation Recommendations

Tires on the front and rear axles of vehicles operate at different loads and perform different steering, driving and braking functions. For these reasons, they wear at unequal rates, and tend to develop irregular wear patterns.

These effects can be reduced by timely rotation of tires. The benefits of rotation are especially worthwhile with aggressive tread designs such as those on all season type tires. Rotation will increase tread life, help to maintain mud, snow and wet traction levels, and contribute to a smooth, quiet ride.

Follow the recommended tire rotation frequency for your type of driving found in the “Maintenance Schedules” Section of this manual. More frequent rotation is permissible if desired. The suggested rotation method is the “forward-cross” shown in the diagram.

TIRE ROTATION PATTERN

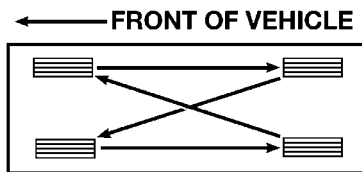

4 TIRE ROTATION

80ba79fe

AUTOSTICK — IF EQUIPPED

Autostick is a driver-interactive transaxle that offers manual gear shifting capability to provide you with more control. Autostick allows you to maximize engine braking, eliminate undesirable upshifts and downshifts, and improve overall vehicle performance. This system can also provide you with more control during passing, city driving, cold slippery conditions, mountain driving, trailer towing, and many other situations.

Autostick Operation

The autostick position is just below the Overdrive position and is identified by the word “AUTOSTICK”. When you place the shift lever in the Autostick position, it can be moved from side to side. Moving the lever to the left (-) triggers a downshift and to the right (+) an upshift.

You can shift in or out of the autostick mode at any time without taking your foot off the accelerator pedal. If you choose the Overdrive mode, the transaxle will operate automatically; shifting between the four available gears. When you wish to engage autostick, simply move the

autostick lever to the AUTOSTICK position. The transaxle will remain in the current gear until an upshift or downshift is chosen.

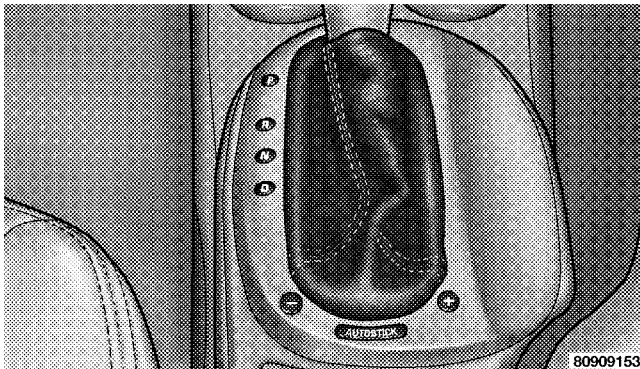

Move the lever back to the Overdrive position to shift out of the Autostick mode.

Autostick General Information

- The transaxle will automatically upshift from first to second gear and from second to third gear when engine speed reaches about 6300 RPM.
- Downshifts from third to second gear above 66 mph (106 km/h) and from second to first gear above 37 mph (60 km/h) will be ignored.
- You can start out in first, second, or third gear. Shifting into fourth gear can occur only after vehicle speed reaches 15 mph (24 km/h).
- The transaxle will automatically downshift to first gear when coming to a stop.
- Starting out in third gear is helpful in snowy or icy conditions.
- While in the Autostick mode, Speed Control will only function in third or fourth gear. Downshifting out of third gear turns off speed control.
- If the system detects powertrain overheating, the transaxle will revert to the automatic shift mode and remain in that mode until the powertrain cools off.
- If the system detects a problem it will disable the Autostick mode and the transaxle will return to the automatic mode until the problem is corrected.

FUEL REQUIREMENTS

Your vehicle is designed to meet all emission regulations and provide excellent fuel economy when using high quality regular unleaded gasoline with an octane rating of 87. The use of premium gasoline is not recommended. The use of premium gaso-

line will provide no benefit over high quality regular gasolines, and in some circumstances, may result in poorer performance.

Light spark knock at low engine speeds is not harmful to your engine. However, continued heavy spark knock at high speeds can cause damage and should be reported to your dealer immediately. Engine damage resulting from operating with a heavy spark knock may not be covered by the new vehicle warranty.

Poor quality gasoline can cause problems such as hard starting, stalling and stumble. If you experience these problems, try another brand of regular gasoline before considering service for the vehicle.

Reformulated Gasoline

Many areas of the country require the use of cleaner burning fuel referred to as "Reformulated Gasoline".

Reformulated gasolines contain oxygenates, and are specially blended to reduce vehicle emissions and improve air quality.

The manufacturer supports the use of reformulated gasolines. Properly blended reformulated gasolines will provide excellent performance and durability of engine and fuel system components.

Gasoline/Oxygenate Blends

Some fuel suppliers blend unleaded gasoline with materials called oxygenates such as 10% ethanol, MTBE and ETBE. Oxygenates are required in some areas of the country during the winter months to reduce carbon monoxide emissions. Fuels blended with these oxygenates may be used in your vehicle.

CAUTION!

DO NOT use gasolines containing Methanol. Use of these blends may result in starting and driveability problems and may damage critical fuel system components.

Problems that result from using methanol/gasoline blends are not the responsibility of the manufacturer and may not be covered by the vehicle warranty. While MTBE is an oxygenate made from Methanol, it does not have the negative effects of Methanol.

MMT in Gasoline

MMT is a manganese containing metallic additive that is blended into some gasoline to increase the octane number. Gasolines blended with MMT offer no performance advantage beyond gasolines of the same octane number without MMT. Gasolines blended with MMT have shown to reduce spark plug life and reduce emission system performance in some vehicles. The manufacturer recommends using gasolines without MMT. Since the MMT

content of gasoline may not be indicated on the pump, you should ask your gasoline retailer whether or not his/her gasoline contains MMT.

It is even more important to look for gasolines without MMT in Canada because MMT can be used at higher levels than allowed in the United States.

MMT is prohibited in both Federal and California reformulated gasolines.

Sulfur in Gasoline

If you live in the Northeast United States, your vehicle may have been designed to meet California low emission standards with cleaner burning California reformulated gasoline with low sulfur. If such fuels are not available in states adopting California emission standards, your vehicle will operate satisfactorily on fuels meeting Federal specifications, but emission control system performance may be adversely affected.

Gasoline sold outside of California is permitted to have higher sulfur levels which may affect the performance of the vehicle's catalytic converter. This may cause the

Malfunction Indicator Light to illuminate. The manufacturer recommends that you try a different brand of unleaded gasoline having lower sulfur to determine if the problem is fuel related prior to returning your vehicle to an authorized dealer for service.

CAUTION!

If the Malfunction Indicator Light is flashing, immediate service is required. See the On Board Diagnostics paragraph in the Maintenance section of this manual.

Materials Added to Fuel

All gasoline sold in the United States is required to contain effective detergent additives. Use of additional detergents or other additives is not needed under normal conditions and would result in additional cost. Therefore you should not have to add anything to the fuel.

ADDING FUEL**Fuel Filler Cap (Gas Cap)**

The gas cap is behind the fuel filler door, on the driver's side of the vehicle. If the gas cap is lost or damaged, be sure the replacement cap is for use with this vehicle.

CAUTION!

Damage to the fuel system or emission control system could result from using an improper fuel tank filler tube cap (gas cap). A poorly fitting cap could let impurities into the fuel system.

CAUTION!

To avoid fuel spillage and overfilling, do not "top off" the fuel tank after filling.

NOTE: Tighten the gas cap until you hear a “clicking” sound. This is an indication that the gas cap is properly tightened.

The Malfunction Indicator Light will come on if the gas cap is not properly secured. Make sure that the gas cap is tightened each time the vehicle is refueled.

NOTE: When the fuel nozzle “clicks” or shuts off, the fuel tank is full.

NOTE: The fuel tank filler tube may have a restricting door about 50 mm (2 inches) down from the opening. If fuel is poured from a portable container, the container should have a flexible nozzle long enough to force open the restricting door.

CAUTION!

A poorly fitting gas cap may cause the Malfunction Indicator Lamp to turn on.

WARNING!

- **Never have any smoking materials lit in or near the vehicle when the gas cap is removed or the tank filled.**
- **Never add fuel to the vehicle when the engine is running.**
- **A fire may result if gasoline is pumped into a portable container that is inside of a vehicle. You could be burned. Always place gas containers on the ground while filling.**

VEHICLE LOADING

Vehicle Loading Capacities

Front Seat Occupants	2
Rear Seat Occupants	2
Luggage	115 lbs. (52 kg)
Rated Vehicle Capacity.	715 lbs. (324 kg)

TRAILER TOWING

In this section you will find safety tips and information on limits to the type of towing you can reasonably do with your vehicle. Before towing a trailer carefully review this information to tow your load as efficiently and safely as possible.

To maintain warranty coverage, follow the requirements and recommendations in this manual concerning vehicles used for trailer towing.

Perform maintenance services as prescribed in the maintenance schedules manual. When your vehicle is used for trailer towing, never exceed the gross axle weight rating (GAWR) by the addition of:

- The tongue weight of the trailer.

- The weight of any other type of cargo or equipment put in or on your vehicle.
- Remember that everything put in or on the trailer adds to the load on your vehicle.

Warranty Requirements

The Manufacturer's Passenger Vehicle Warranty will apply to vehicles used to tow trailers for non-commercial use. However the following conditions must be met:

- The maximum trailer load is 1,000 lbs (450 kg).
- The maximum frontal area of the trailer cannot exceed 20 square feet (1.86 square meters).
- If using a manual transaxle vehicle for trailer towing, all starts must be in FIRST gear to avoid excessive clutch slippage.
- The trailer tongue load must be considered as part of the combined weight of occupants and cargo, and should never exceed the weight referenced on the Tire and Loading Information placard. Refer to the Tire-Safety Information Section in this manual.

- The “D” range can be selected when towing. However, if frequent shifting occurs while in this range, the “3” range must be selected.

NOTE: Using the “3” range while operating the vehicle under heavy operating conditions will improve performance and extend transaxle life by reducing excessive shifting and heat build up.

WARNING!

Connecting trailer brakes to your vehicle’s hydraulic brake lines can overload your brake system and cause it to fail. You might not have brakes when you need them and could have an accident.

- Do not attempt to tow a trailer while using a compact spare tire.
- Whenever you pull a trailer, regardless of the trailer size, stop lights and turn signals on the trailer are recommended for motoring safety.

- The automatic transaxle fluid and filter should be changed if you **REGULARLY** tow a trailer for more than 45 minutes of continuous operation. See Schedule “B” in section 8 of this manual for transaxle fluid change intervals.

NOTE: Check the automatic transaxle fluid level before towing. Fluid discoloration, or a burnt odor, shows the need for a transmission fluid and filter change.

NOTE: For vehicles equipped with Autostick. By using the Autostick modes, and selecting a specific gear range, frequent shifting can be avoided. The highest gear range should be selected that allows for adequate performance. For example, choose “4” if the desired speed can be maintained. Choose “3” or “2” if needed to maintain the desired speed.

NOTE: Extended driving at high RPM should be avoided to prevent excess heat generation. A reduction in vehicle speed may be required to avoid extended driving at high RPM. Return to a higher gear range or vehicle speed when road conditions and RPM level allows.

FLEXIBLE FUEL – (2.7L Engines with Automatic Transmission Only)**E-85 General Information**

The information in this section is for Flexible Fuel vehicles only. These vehicles can be identified by the unique fuel filler door label that states **Ethanol (E-85) or Unleaded Gasoline Only**. This section only covers those subjects that are unique to these vehicles. Please refer to the other sections of this manual for information on features that are common between Flexible Fuel and gasoline only powered vehicles.

CAUTION!

Only vehicles with the E-85 fuel filler door label can operate on E-85.

ETHANOL FUEL (E-85)

E-85 is a mixture of approximately 85% fuel ethanol and 15% unleaded gasoline.

WARNING!

Ethanol vapors are extremely flammable and could cause serious personal injury. Never have any smoking materials lit in or near the vehicle when removing the fuel filler tube cap (gas cap) or filling the tank. Do not use E-85 as a cleaning agent and never use it near an open flame.

Fuel Requirements

Your vehicle will operate on both unleaded gasoline with an octane rating of 87, or E-85 fuel, or any mixture of these two.

For best results, a refueling pattern that alternates between E-85 and unleaded gasoline should be avoided. When you do switch fuels, it is recommended that:

- you do not switch when the fuel gauge indicates less than 1/4 full
- you do not add less than 5 gallons (19 liters) when refueling

- you operate the vehicle immediately after refueling for a period of at least 5 minutes

Observing these precautions will avoid possible hard starting and/or significant deterioration in drivability during warm up.

NOTE: When the ambient temperature is above 90°F (32°C), you may experience hard starting and rough idle following start up even if the above recommendations are followed.

Selection of Engine Oil

For best performance and protection of your vehicle, use only crankcase engine oils that meet the following requirements:

American Petroleum Institute (API) Engine Oil Identification Symbol



This symbol means that the oil has been certified by the American Petroleum Institute (API). We only recommend API Certified engine oils that meet the requirements of DaimlerChrysler's Material Standard MS-9214. Use Mopar or an equivalent oil meeting the specification MS-9214.

The manufacturer strongly recommends against the addition of any additives (other than leak detection dyes) to engine oil. Engine oil is an engineered product and its performance may be impaired by supplemental additives.

- **Engine Oil Selection for Operating on E-85**

If you operate the vehicle on E-85 fuel, either full or part-time, use only Mopar Flexible Fuel 5W-30 engine oil (P/N 4318086) or an equivalent that meets the Manufacturer's Standard MS-9214. Equivalent commercial Flexible Fuel engine oils may be labeled as Flexible Fuel (FFV) or Alternate Fuel (AFV). These engine oils may be satisfactory if they meet the Manufacturer's Standard.

The 5W-30 engine oil installed at the factory meets the manufacturer's requirements for Flexible Fuel engine oil.

SAE 5W-30 engine oil is preferred for use in Flexible Fuel engines.

CAUTION!
If Flexible Fuel engine oil is not used when using E-85, engine wear may be increased significantly. This may void your warranty.

- **Engine Oil Selection for Operating on Gasoline**

If you operate the vehicle on regular unleaded gasoline ONLY, use Mopar oil or an equivalent that meets certified API (American Petroleum Institute) Quality.

Starting

The characteristics of E-85 fuel make it unsuitable for use when ambient temperatures fall below 0°F (-18°C). In the range of 0°F to 32°F (-18°C to 0°C), you may experience an increase in the time it takes for your engine to start, and a deterioration in drivability (sags and/or hesitations) until the engine is fully warmed up.

Cruising Range

Because E-85 fuel contains less energy per gallon than gasoline, you will experience an increase in fuel consumption. You can expect your MPG and your driving range to decrease by about 30% compared to gasoline operation.

Replacement Parts

Many components in your Flexible Fuel Vehicle (FFV) are designed to be compatible with ethanol. Always be sure that your vehicle is serviced with correct ethanol compatible parts.

CAUTION!

Replacing fuel system components with non-ethanol compatible components can damage your vehicle and may void the warranty.

Maintenance

If you operate the vehicle using E-85 fuel, follow Schedule B in the maintenance schedule section of this manual.

CAUTION!

Do not use ethanol mixture greater than 85% in your vehicle. It will cause difficulty in cold starting and may affect driveability.

WHAT TO DO IN EMERGENCIES

CONTENTS

■ Hazard Warning Flasher	174	■ Freeing A Stuck Vehicle	185
■ If Your Engine Overheats	174	■ Towing A Disabled Vehicle	185
■ Jacking And Tire Changing	176	■ Towing This Vehicle Behind Another Vehicle (Flat Towing With All Four Wheels On The Ground)	186
□ Preparations For Jacking	176	□ Automatic Transaxle	186
■ Jump-Starting The Battery	181	□ Manual Transaxle	186
■ Driving On Slippery Surfaces	184	□ All Transaxles	186
□ Acceleration	184		
□ Traction	184		

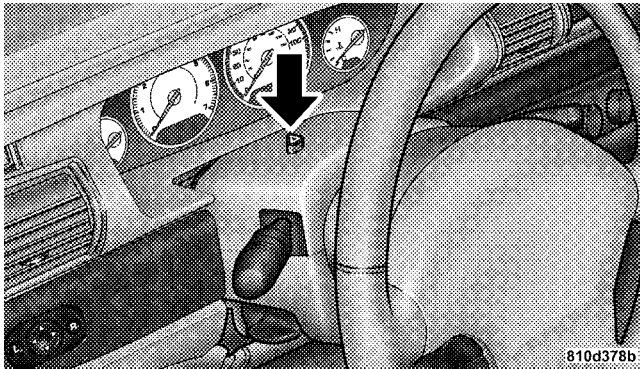
HAZARD WARNING FLASHER

 The flasher switch is on top of the steering column, just behind the steering wheel. Depress the switch and both cluster indicators and all front and rear directional signals will flash. Depress the switch again to turn Hazard Warning Flashers off.

Do not use this emergency warning system when the vehicle is in motion. Use it when your vehicle is disabled and is creating a safety hazard for other motorists.

If it is necessary to leave the vehicle to go for service, the flasher system will continue to operate with the ignition key removed and the vehicle locked.

NOTE: With extended use, the flasher may wear down your battery.

IF YOUR ENGINE OVERHEATS

In any of the following situations, you can reduce the potential for overheating by taking the appropriate action.

- On the highways — Slow down.
- In city traffic — While stopped, put transaxle in neutral, but do not increase engine idle speed.

NOTE: There are steps that you can take to slow down an impending overheat condition. If your air conditioner is on, turn it off. The air conditioning system adds heat to the engine cooling system and turning off the A/C removes this heat. You can also turn the Temperature control to maximum heat, the Mode control to floor, and

the fan control to High. This allows the heater core to act as a supplement to the radiator and aids in removing heat from the engine cooling system.

CAUTION!

Driving with a hot cooling system could damage your vehicle. If temperature gauge reads “H”, pull over and stop the vehicle. Idle the vehicle in Park with the air conditioner turned off until the pointer drops back into the normal range. If the pointer remains on the “H”, turn the engine off immediately, and call for service.

WARNING!

A hot engine cooling system is dangerous. You or others could be badly burned by steam or boiling coolant. You may want to call a service center if your vehicle overheats. If you decide to look under the hood yourself, see Section 7, Maintenance, of this manual. Follow the warnings under the Cooling System Pressure Cap paragraph.

JACKING AND TIRE CHANGING**WARNING!**

- **Getting under a jacked-up vehicle is dangerous. The vehicle could slip off the jack and fall on you. You could be crushed. Never get any part of your body under a vehicle that is on a jack. Never start or run the engine while the vehicle is on a jack. If you need to get under a raised vehicle, take it to a service center where it can be raised on a lift.**
- **Do not attempt to change a tire on the side of the vehicle close to moving traffic. Pull far enough off the road to avoid the danger of being hit when operating the jack or changing the wheel.**
- **The jack is designed to use as a tool for changing tires only. The jack should not be used to lift the vehicle for service purposes. The vehicle should be jacked on a firm level surface only. Avoid ice or slippery areas.**

Preparations for Jacking

Park the vehicle on a firm level surface, avoid ice or slippery areas, and set the parking brake. Place the gear selector in PARK.

- Turn on the Hazard Warning Flasher, park vehicle on firm, level surface.
- Put gear shift in park (automatic transmission) or reverse (manual transmission).
- Set parking brake and turn off engine.
- Passengers should not remain in the vehicle while the vehicle is being jacked.

Changing a Tire

The spare wheel, scissors jack, and lug wrench are stowed under the spare tire cover in the rear cargo area.

Do not attempt to raise this vehicle using a bumper jack.

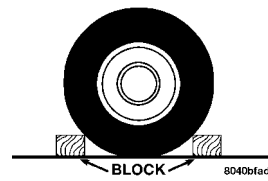
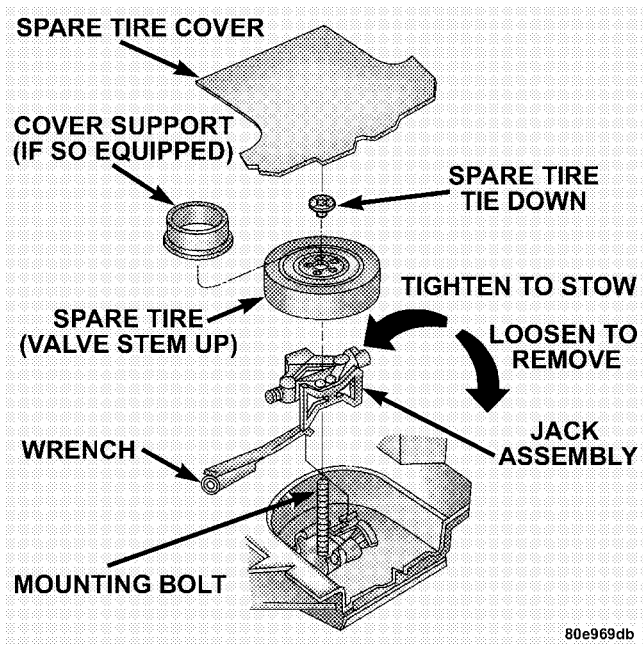

1. Block wheel diagonally opposite flat tire.
2. Remove the spare tire, scissors jack and lug wrench from stowage.

3. Before raising the vehicle, use lug wrench to carefully pry off wheel cover (if equipped with steel wheels) or center cap (if equipped with aluminum wheels). Loosen, but do not remove, the wheel nuts by turning them counterclockwise one turn while the wheel is still on the ground.

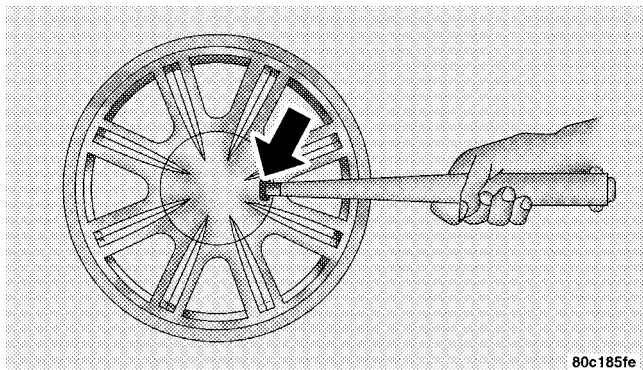

80c185fe

CENTER CAP REMOVAL

WARNING!

To avoid possible personal injury, handle the wheel covers with care to avoid contact with the metal edges and retention teeth.

4. Turn the jack screw clockwise to firmly engage the jack saddle with the lift area of the sill flange. Use the lift area closest to the flat tire
5. Raise the vehicle just enough to remove flat tire and install spare tire.

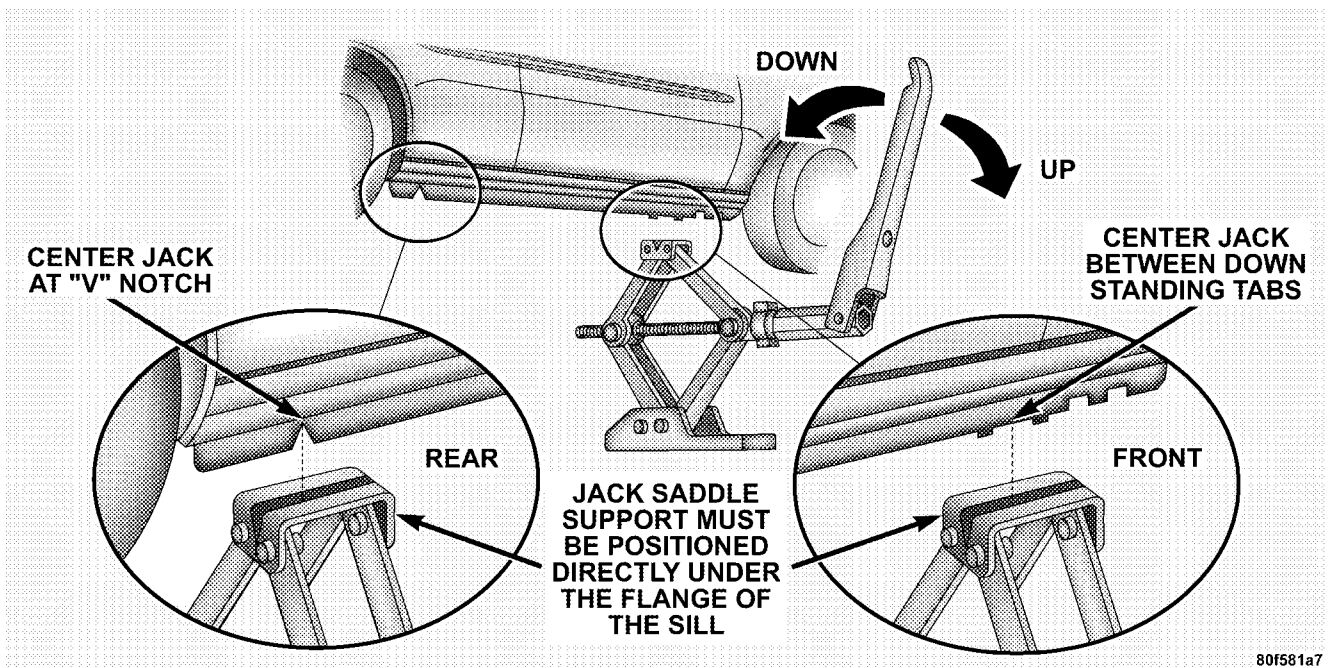

801581a7

WARNING!

Raising the vehicle higher than necessary can make the vehicle less stable. It could slip off the jack and hurt someone near it. Raise the vehicle only enough to remove the tire.

6. Remove lug nuts and tire.
7. Mount spare tire.
8. Tighten all lug nuts on mounting studs.
9. Lower the vehicle to the ground by turning the jack handle counterclockwise.
10. Fully tighten the lug nuts. Torque wheel lug nuts to 100 ft. lbs. (135 N·m).
11. Store the flat tire, jack, and tools.

WARNING!

A loose tire or jack thrown forward in a collision or hard stop could endanger the occupants of the vehicle. Always stow the jack parts and the spare tire in the places provided.

12. Wheel cover installation (if required). Do not attempt to install a wheel cover on a compact spare. align valve notch in wheel cover with valve stem on wheel. Snap cover into place.

NOTE: When reinstalling the center cap it is necessary to align the center cap notch with the first spoke, just right of the valve stem.

13. Adjust the tire pressure as soon as possible. Correct pressure is on the label located on the driver's door.

JUMP-STARTING THE BATTERY**WARNING!**

- **Do not attempt to push or tow your vehicle to get it started. Vehicles equipped with an automatic transaxle cannot be started this way. Unburned fuel could enter the catalytic converter and once the engine has started, ignite and damage the converter and vehicle. If the vehicle has a discharged battery, booster cables may be used to obtain a start from another vehicle. This type of start can be dangerous if done improperly, so follow this procedure carefully.**
- **Take care to avoid the radiator cooling fan whenever the hood is raised. It can start anytime the ignition switch is on. You can be hurt by the fan.**

NOTE: The battery is stored in a compartment behind the left front fender and is accessible without removing the tire and wheel. Remote battery terminals are located in the engine compartment for jump starting.

1. Wear eye protection and remove any metal jewelry such as watch bands or bracelets that might make an inadvertent electrical contact.
2. When boosting from a battery in another vehicle, park that vehicle within booster cable reach but without letting the vehicles touch. Set parking brake, place automatic transaxle in PARK and turn ignition to OFF for both vehicles.
3. Turn off the heater, radio and all unnecessary electrical loads.
4. Connect one end of a jumper cable to the positive terminal of the booster battery. Connect the other end to the positive jump start attachment of the discharged battery.

WARNING!

Do not permit vehicles to touch each other as this could establish a ground connection and person injury could result.

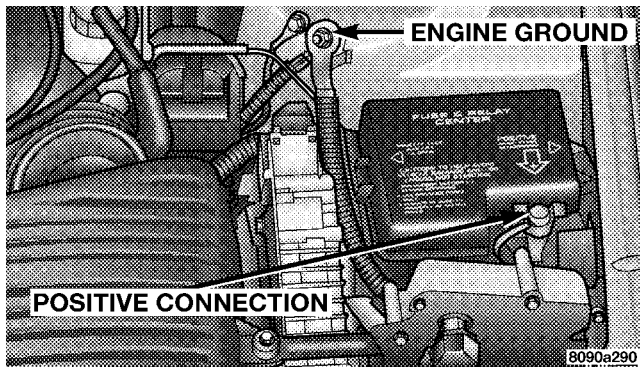

5. Connect the other cable, first to the negative terminal of the booster battery and then to the jump start attachment of the vehicle with the discharged battery. Make sure you have a good contact on the engine.

WARNING!

Do not connect the cable to the negative post of the discharged battery. The resulting electrical spark could cause the battery to explode.

During cold weather when temperatures are below freezing point, electrolyte in a discharged battery may freeze. Do not attempt jump starting because the battery could rupture or explode. The battery temperature must be brought up above freezing point before attempting to jump start.

6. Start the engine in the vehicle that has the booster battery, let the engine idle a few minutes, then start the engine in the vehicle with the discharged battery.

7. When removing the jumper cables, reverse the above sequence exactly. Be careful of the moving belts and fan.

WARNING!

Any procedure other than above could result in:

1. Personal injury caused by electrolyte squirting out the battery vent;
2. Personal injury or property damage due to battery explosion;
3. Damage to charging system of booster vehicle or of immobilized vehicle.

WARNING!

Battery fluid is a corrosive acid solution; do not allow battery fluid to contact eyes, skin or clothing. Don't lean over battery when attaching clamps or allow the clamps to touch each other. If acid splashes in eyes or on skin, flush the contaminated area immediately with large quantities of water.

A battery generates hydrogen gas which is flammable and explosive. Keep flame or spark away from the battery. Do not use a booster battery or any other booster source with an output that exceeds 12 volts.

WARNING!

Battery posts, terminals and related accessories contain lead and lead compounds. Wash hands after handling.

DRIVING ON SLIPPERY SURFACES

Acceleration

Rapid acceleration on snow covered, wet, or other slippery surfaces may cause the front wheels to pull erratically to the right or left. This phenomenon occurs when there is a difference in the surface traction under the front (driving) wheels, particularly with high output engines.

WARNING!

Rapid acceleration on slippery surfaces is dangerous. Unequal traction can cause sudden pulling of the front wheels. You could lose control of the vehicle and possibly have an accident. Accelerate slowly and carefully whenever there is likely to be poor traction (ice, snow, wet, mud, loose sand, etc.).

Traction

When driving on wet or slushy roads, it is possible for a wedge of water to build up between the tire and road surface. This is hydroplaning and may cause partial or complete loss of vehicle control and stopping ability. To reduce this possibility, the following precautions should be observed:

1. Slow down during rainstorms or when roads are slushy.
2. Slow down if road has standing water or puddles.
3. Replace tires when tread wear indicators first become visible.
4. Keep tires properly inflated.
5. Maintain enough distance between your vehicle and the vehicle in front of you to avoid a collision in a sudden stop.

NOTE: If so equipped, turn on the Traction Control System to accelerate on slippery surfaces.

FREEING A STUCK VEHICLE

If your vehicle is equipped with Traction Control, turn the system off before attempting to “rock” the vehicle.

If your vehicle becomes stuck in mud, sand or snow, it can often be moved by a rocking motion. Turn your steering wheel right and left to clear the area around the front wheels. Then shift back and forth between Reverse and First gear. Usually the least accelerator pedal pressure to maintain the rocking motion without spinning the wheels is most effective.

CAUTION!

Racing the engine or spinning the wheels too fast may lead to transaxle overheating and failure. It can also damage the tires. Do not spin the wheels above 30 mph (48 km/h).

TOWING A DISABLED VEHICLE

Flat bed towing is the preferred towing method. If a flat bed towing vehicle is not available, a wheel lift towing vehicle may be used.

Rear towing is not recommended with the front wheels on the ground, as transaxle damage can result. If rear towing is the only alternative, a front end dolly must be used.

CAUTION!

Do not use sling type towing equipment. Damage to the fascia and air dam may result.

TOWING THIS VEHICLE BEHIND ANOTHER VEHICLE (Flat towing with all four wheels on the ground)**Automatic Transaxle**

Your vehicle may be towed under the following conditions: The gear selector must be in NEUTRAL, the distance to be towed must not exceed 15 miles (25 km), and the towing speed must not exceed 25 mph (40 km/h). If the transaxle is not operative, or if the vehicle is to be towed more than 15 miles (25 km), the vehicle must be towed with the front wheels off the ground.

Manual Transaxle

If your vehicle is equipped with a manual transaxle, it may be towed at any legal highway speed, for any distance, if the transaxle is in neutral.

All Transaxles**CAUTION!**

If the vehicle being towed requires steering, the ignition switch must be in the OFF position, not in the LOCK or ACCESSORY positions.

If it is necessary to use the accessories while being towed (wipers, defrosters, etc.), the key must be in the ON position, not the ACCESSORY position. Make certain the transaxle remains in NEUTRAL.

MAINTAINING YOUR VEHICLE

CONTENTS

■ 2.4L Engine	189	□ Power Steering Fluid Check	202
■ 2.7L Engine	190	□ Suspension Ball Joints	203
■ Onboard Diagnostic System — OBD II	191	□ Body Mechanism Lubrication	203
■ Emissions Inspection And Maintenance Programs	192	□ Windshield Wiper Blades	205
■ Replacement Parts	193	□ Windshield Washers	205
■ Dealer Service	193	□ Exhaust System	206
■ Maintenance Procedures	194	□ Cooling System	207
□ Engine Oil	194	□ Hoses And Vacuum/Vapor Harnesses	211
□ Crankcase Emission Control System	200	□ Brakes	211
□ Maintenance-Free Battery	200	□ Fuel System Hoses	213
□ Air Conditioner	201	□ Automatic Transmission	213

□ Appearance Care And Protection From Corrosion	216	□ Headlight Bulb Replacement	226
■ Convertible Top Care	221	□ Park, Turn Signal, Sidemarket Bulb Replacement	228
□ Washing	221	□ Fog Light Bulb Replacement	229
□ General Cleaning	221	□ Center Stoplight Bulb Replacement	230
□ Cloth Top Additional Cleaning Procedure	222	□ Rear Light Bulb Replacement	230
□ Cloth Top Protection	222	□ License Plate Bulb Replacement	231
□ Weather Strip Care	222	□ Headlight Aiming	232
■ Fuses	223	■ Fluids And Capacities	232
□ Underhood Fuses (Power Distribution Center)	223	■ Recommended Fluids, Lubricants And Genuine Parts	233
□ Interior Fuses	223	□ Engine	233
■ Replacement Light Bulbs	225	□ Chassis	233
■ Bulb Replacement	226		

2.4L ENGINE

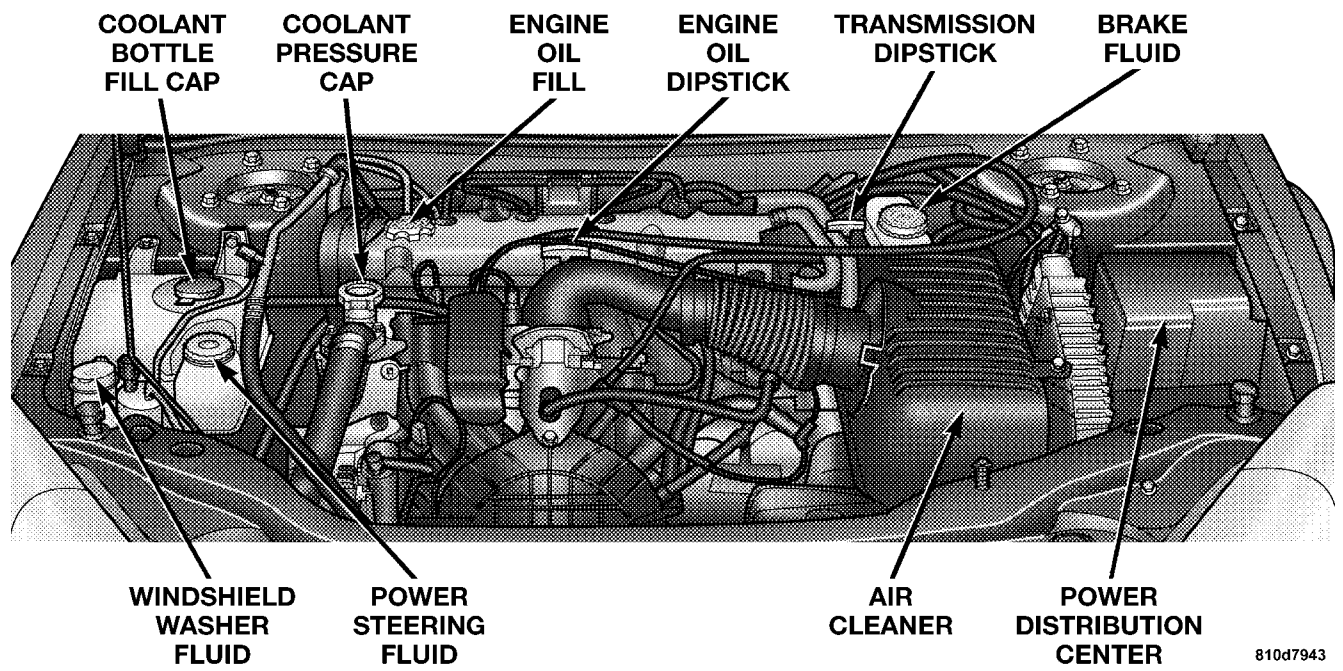

2.7L ENGINE

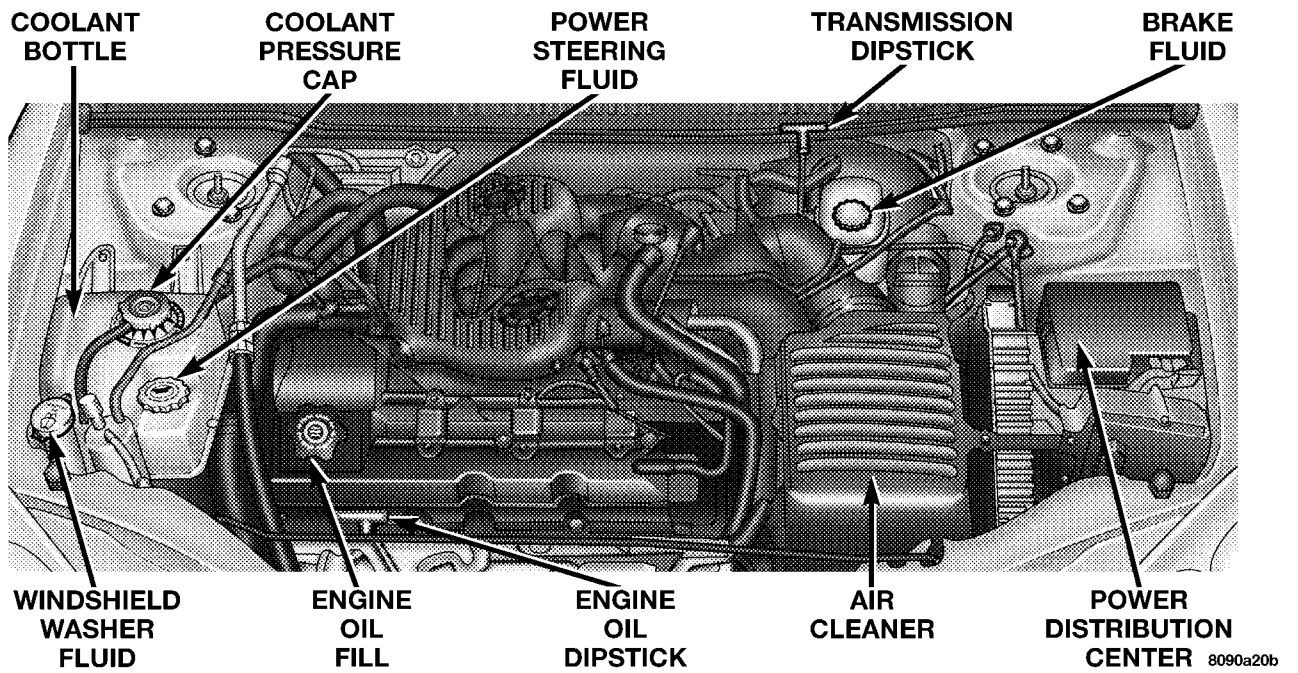

ONBOARD DIAGNOSTIC SYSTEM — OBD II

Your vehicle is equipped with a sophisticated onboard diagnostic system called OBD II. This system monitors the performance of the emissions, engine, and automatic transmission control systems. When these systems are operating properly, your vehicle will provide excellent performance and fuel economy, as well as engine emissions well within current government regulations.

If any of these systems require service, the OBD II system will turn on the “Malfunction Indicator Light.” It will also store diagnostic codes and other information to assist your service technician in making repairs. Although your vehicle will usually be drivable and not need towing, see your dealer for service as soon as possible.

CAUTION!

- **Prolonged driving with the “Malfunction Indicator Light” on could cause further damage to the emission control system. It could also affect fuel economy and driveability. The vehicle must be serviced before any emissions tests can be performed.**
- **If the “Malfunction Indicator Light” is flashing while the engine is running, severe catalytic converter damage and power loss will soon occur. Immediate service is required.**

EMISSIONS INSPECTION AND MAINTENANCE PROGRAMS

In some localities, it may be a legal requirement to pass an inspection of your vehicle's emissions control system. Failure to pass could prevent vehicle registration.



For states which have an I/M (Inspection and Maintenance) requirement, this check verifies the following: the MIL (Malfunction Indicator Lamp) is functioning and is not on when the engine is running, and that the OBD (On Board Diagnostic) system is ready for testing.

Normally, the OBD system will be ready. The OBD system may **not** be ready if your vehicle was recently serviced, if you recently had a dead battery, or a battery replacement. If the OBD system should be determined not ready for the I/M test, your vehicle may fail the test.

Your vehicle has a simple ignition key actuated test which you can use prior to going to the test station. To check if your vehicle's OBD system is ready, you must do the following:

1. Insert your ignition key into the ignition switch.

2. Turn the ignition to the ON position, but do not crank or start the engine.

3. If you crank or start the engine, you will have to start this test over.

4. As soon as you turn your key to the ON position, you will see your MIL symbol come on as part of a normal bulb check.

5. Approximately 15 seconds later, one of two things will happen:

a. The MIL will flash for about 10 seconds and then return to being fully illuminated until you turn off the ignition key or start the engine. This means that your vehicle's OBD system is **not ready** and you should **not** proceed to the I/M station.

b. The MIL will not flash at all and will remain fully illuminated until you turn off the ignition key or start the engine. This means that your vehicle's OBD system is **ready** and you can proceed to the I/M station.

If your OBD system is **not ready**, you should see your authorized dealer or repair facility. If your vehicle was recently serviced or had a battery failure or replacement, you may need to do nothing more than drive your vehicle as you normally would in order for your OBD system to update. A recheck with the above test routine may then indicate that the system is now ready.

Regardless of whether your vehicle's OBD system is ready or not ready, if the MIL symbol is illuminated during normal vehicle operation, you should have your vehicle serviced before going to the I/M station. The I/M station can fail your vehicle because the MIL symbol is on with the engine running.

REPLACEMENT PARTS

Use of genuine Mopar parts for normal/scheduled maintenance and repairs is highly recommended to insure the designed performance. Damage or failures caused by the use of non-Mopar parts for maintenance and repairs will not be covered by the manufacturer's warranty.

DEALER SERVICE

Your dealer has the qualified service personnel, special tools and equipment to perform all service operations in an expert manner. Service manuals are available which include detailed service information for your vehicle. Refer to these manuals before attempting any procedure yourself.

NOTE: Intentional tampering with emissions control systems can result in civil penalties being assessed against you.

WARNING!

You can be badly injured working on or around a motor vehicle. Do only that service work for which you have the knowledge and the proper equipment. If you have any doubt about your ability to perform a service job, take your vehicle to a competent mechanic.

MAINTENANCE PROCEDURES

The pages that follow contain the **required** maintenance services determined by the engineers who designed your vehicle.

Besides the maintenance items for which there are fixed maintenance intervals, there are other items that should operate satisfactorily without periodic maintenance. However, if a malfunction of these items does occur, it could adversely affect the engine or vehicle performance. These items should be inspected if a malfunction is observed or suspected.

Engine Oil**Checking Oil Level**

To assure proper lubrication of your vehicle's engine, the engine oil must be maintained, at the correct level. Check the oil level at regular intervals, such as every fuel stop.

The best time to check the oil level is about 5 minutes after a fully warmed engine is shut off or before starting the engine after it has sat overnight.

Checking the oil while the vehicle is on level ground will improve the accuracy of the oil level readings. Maintain the oil level between the MIN and MAX markings on the dipstick. Adding one quart of oil when the reading is at the MIN mark will result in a MAX reading on these engines.

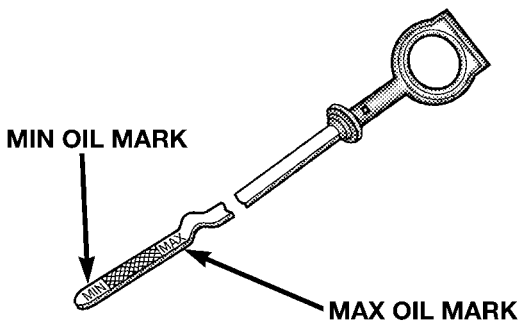

809744ab

CAUTION!

Overfilling or underfilling will cause aeration or loss of oil pressure. This could damage your engine.

Change Engine Oil

Road conditions and your kind of driving affects the interval at which your oil should be changed. Check the following list to decide if any apply to you.

- Day and night temperatures are below 32° F (0° C)

- Stop and Go driving
- Extensive engine idling.
- Driving in dusty conditions
- Short trips of less than 10 miles (16.2 km)
- More than 50% of your driving is at sustained high speeds during hot weather, above 90° F (32° C)
- Trailer towing
- Taxi, Police or delivery service (commercial service)
- Off— road or desert operation
- **If equipped for and operating with E-85 (ethanol) fuel.**

NOTE: If ANY of these apply to you then change your engine oil every 3,000 miles (5 000 km) or 3 months, whichever comes first and follow schedule “B” of the “Maintenance Schedules” section of this manual.

If none of these apply to you, then change your engine oil at every interval shown on schedule “A” of the “Maintenance Schedules” section of this manual.

NOTE: Under no circumstances should oil change intervals exceed 6,000 miles (10 000 km) or 6 months whichever comes first.

Engine Oil Selection

For best performance and maximum protection under all types of operating conditions, we recommend engine oils that are API Certified and meet the requirements of DaimlerChrysler's Material Standard MS-6395. Use Mopar or an equivalent oil meeting the specification MS-6395.

American Petroleum Institute (API) Engine Oil Identification Symbol



This symbol means that the oil has been certified by the American Petroleum Institute (API). We only recommend API Certified engine oils that meet the requirements of DaimlerChrysler's Material Standard MS-6395. Use Mopar or an equivalent oil meeting the specification MS-6395.

Engine Oil Viscosity Chart

The proper SAE viscosity grade of engine oil should be selected based on the following recommendation and be within the operating temperature shown in the engine oil viscosity chart.

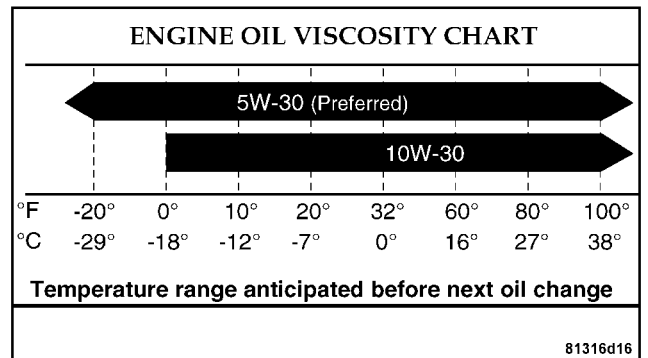

Flexible Fuel Engine Oil

If you operate the vehicle on E-85 fuel either full or part-time, use only Mopar Flexible Fuel 5W-30 engine oil or an equivalent that meets the manufacturers Standard MS-9214. Equivalent commercial Flexible Fuel engine oils

may be labeled as Flexible Fuel (FFV) or Alternate Fuel (AFV). These engine oils may be satisfactory if they meet the manufacturer's standard.

CAUTION!

If Flexible Fuel engine oil is not used when using E-85, engine wear may be increased significantly. This may void your warranty.

Synthetic Engine Oils

There are a growing number of engine oils being promoted as either synthetic or semi-synthetic. If you choose to use such a product, use **only** those oils that meet the American Petroleum Institute (API) and SAE viscosity standard. Follow the service schedule that describes your driving type.

Materials Added To Engine Oils

The manufacturer strongly recommends against the addition of any additives (other than leak detection dyes) to

engine oil. Engine oil is an engineered product and its performance may be impaired by supplemental additives.

Disposing of Used Engine Oil and Oil Filters

Care should be taken in disposing of used engine oil from your vehicle. Used oil, indiscriminately discarded, can present a problem to the environment. Contact your dealer, service station, or governmental agency for advice on how and where used oil can be safely discarded in your area.

Engine Oil Filter

The engine oil filter should be replaced at every engine oil change.

Engine Oil Filter Selection

All manufacturer's engines have a full-flow type disposable oil filter. Use a filter of this type for replacement. The quality of replacement filters varies considerably. Only high quality filters should be used to assure most efficient service. Mopar Engine Oil Filters are high quality oil filters and are recommended.

Drive Belts — Check Condition and Tension

At the mileage shown in the maintenance schedules, check all drive belts for condition and proper tension. Improper belt tension can cause belt slippage and failure.

Inspect the drive belts for evidence of cuts, cracks, or glazing and replace them if there is any sign of damage which could result in belt failure. If adjustment is required, adjust the belts according to the specifications and procedures shown in the Service Manual.

Special tools are required to properly measure tension and to restore belt tension to factory specifications. Also, check belt routing to make sure there is no interference between the belts and other engine components.

Spark Plugs

Spark plugs must fire properly to assure engine performance and emission control. New plugs should be installed at the specified mileage. The entire set should be replaced if there is any malfunction due to a faulty spark plug. Check the specifications section for the proper type of spark plug for use in your vehicle.

Engine Air Cleaner Filter

Under normal driving conditions, replace the air filter at the intervals shown on Schedule "A". If, however, you drive the vehicle frequently under dusty or severe conditions, the filter element should be inspected periodically and replaced if necessary at the intervals shown on Schedule "B".

WARNING!

The air cleaner can provide a measure of protection in the case of engine backfire. Do not remove the air cleaner unless such removal is necessary for repair or maintenance. Make sure that no one is near the engine compartment before starting the vehicle with the air cleaner removed. Failure to do so can result in serious personal injury.

Engine Fuel Filter

A plugged fuel filter can cause hard starting or limit the speed at which a vehicle can be driven. Should an excessive amount of dirt accumulate in the fuel tank, frequent filter replacement may be necessary.

Catalytic Converter

The catalytic converter requires the use of unleaded fuel only. Leaded gasoline will destroy the effectiveness of the catalyst as an emission control device.

Under normal operating conditions, the catalytic converter will not require maintenance. However, it is important to keep the engine properly serviced to assure proper catalyst operation and prevent possible catalyst damage.

CAUTION!

Damage to the catalytic converter can result if your vehicle is not kept in proper operating condition. In the event of engine malfunction, particularly involving engine misfire or other apparent loss of performance, have your vehicle serviced promptly. Continued operation of your vehicle with a severe malfunction could cause the converter to overheat, resulting in possible damage to the converter and the vehicle.

WARNING!

A hot exhaust system can start a fire if you park over materials that can burn. Such materials might be grass or leaves coming into contact with your exhaust system. Do not park or operate your vehicle in areas where your exhaust system can contact anything that can burn.

In unusual situations involving grossly malfunctioning engine operation, a scorching odor may suggest severe and abnormal catalyst overheating. If this occurs, stop the vehicle, turn off the engine and allow it to cool. Service, to the manufacturer's specifications, should be obtained immediately.

To minimize the possibility of catalyst damage:

- Do not shut off the engine or interrupt the ignition when the transaxle is in gear and the vehicle is in motion.
- Do not try to start the engine by pushing or towing the vehicle.

- Do not idle the engine with any spark plug wires disconnected for prolonged period.

Engine Timing Belt

Replace the engine timing belt (2.4L Only) at the intervals described in the appropriate maintenance schedule.

Crankcase Emission Control System

Proper operation of this system depends on freedom from sticking or plugging due to deposits. As vehicle mileage builds up, the Positive Crankshaft Ventilation (PCV) valve and passages may accumulate deposits. If a valve is not working properly, replace it with a new valve. **DO NOT ATTEMPT TO CLEAN THE OLD PCV VALVE!**

Check ventilation hose for indication of damage or plugging deposits. Replace if necessary.

Maintenance-Free Battery

The top of the MAINTENANCE-FREE battery is permanently sealed. You will never have to add water, nor is periodic maintenance required.

NOTE: The battery is stored in a compartment behind the left front fender and is accessible without removing the tire and wheel. Remote battery terminals are located in the engine compartment for jump starting.

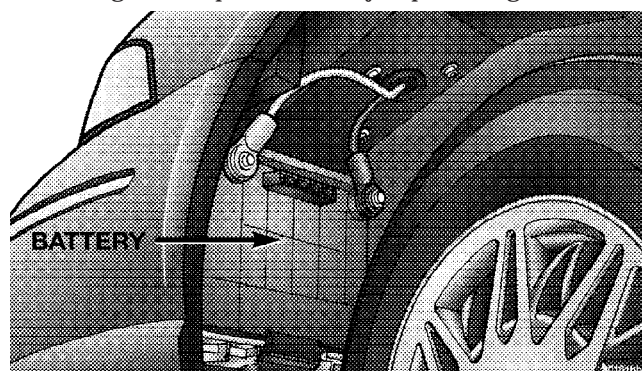

To access the battery, turn the steering wheel fully to the right and remove the inner fender shield.

WARNING!

Battery posts, terminals and related accessories contain lead and lead compounds. Wash hands after handling. Battery fluid is a corrosive acid solution and can burn or even blind you. Don't allow battery fluid to contact your eyes, skin or clothing. Don't lean over a battery when attaching clamps. If acid splashes in eyes or on skin, flush the area immediately with large amounts of water. Battery gas is flammable and explosive. Keep flame or sparks away from the battery. Don't use a booster battery or any other booster source with an output greater than 12 volts. Don't allow cable clamps to touch each other.

CAUTION!

It is essential when replacing the cables on the battery that the positive cable is attached to the positive post and the negative cable is attached to the negative post. Battery posts are marked positive (+) and negative (-) and identified on the battery case. Cable clamps should be tight on the terminal posts and free of corrosion. Apply grease to posts and clamps after tightening. If a "fast charger" is used while the battery is in the vehicle, disconnect both vehicle battery cables before connecting the charger to battery. Do not use a "fast charger" to provide starting voltage as battery damage can result.

Air Conditioner

Check the air conditioning system at the start of the warm weather season.

NOTE: If your air conditioning performance seems lower than expected, check the front of the A/C condenser for an accumulation of dirt or insects. Clean with a gentle water spray from behind the radiator and

through the condenser as required. Fabric front fascia protectors may reduce air flow to the condenser, reducing air conditioning performance.

WARNING!

The air conditioning system contains refrigerant under high pressure. To avoid risk of personal injury or damage to the system, adding refrigerant or any repair requiring lines to be disconnected should be done by an experienced repairman.

Refrigerant Recovery and Recycling

The air conditioning system of your vehicle contains R-134a, a refrigerant that does not deplete the ozone layer in the upper atmosphere. The manufacturer recommends that air conditioning service be done by facilities using refrigerant recycling and recovery equipment that meets SAE standard J1991.

Power Steering Fluid Check

Checking the power steering fluid level at a defined service interval is not required. The fluid should only be checked if a leak is suspected, abnormal noises are apparent, and/or the system is not functioning as anticipated. Coordinate inspection efforts through a certified "DaimlerChrysler Dealership".

Before removing the reservoir cap, wipe the outside of the cap and reservoir so that no dirt can fall into the reservoir.

WARNING!

Fluid level should be checked on a level surface with the engine off to prevent injury from moving parts, and to insure accurate fluid level reading. Do not overfill. Use only manufacturer's recommended fluid.

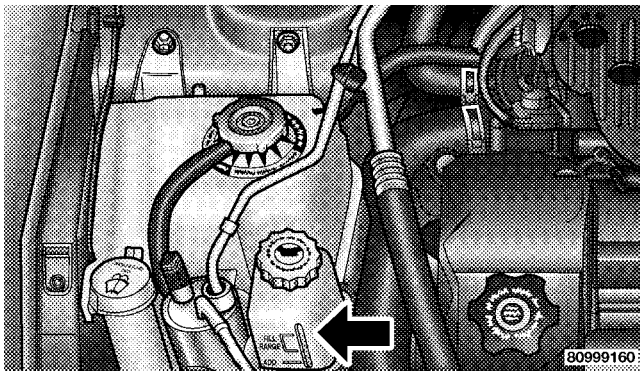

Fluid level should be maintained at the proper level indicated on the side of the reservoir. If necessary, add fluid to restore to the proper indicated level. With a clean cloth, wipe any spilled fluid from all surfaces. Refer to Recommended Fluids, Lubricants, and Genuine Parts for correct fluid type.

Suspension Ball Joints

There are two upper front and rear suspension ball joints. Inspect these ball joints whenever under vehicle service is done. If the seals are damaged, the ball joint should be replaced.

Body Mechanism Lubrication

Locks and all body pivot points, including such items as seat tracks, doors, liftgate and hood hinges, should be lubricated periodically to assure quiet, easy operation and to protect against rust and wear. Prior to the application of any lubricant, the parts concerned should be wiped clean to remove dust and grit; after lubricating excess oil and grease should be removed. Particular attention should also be given to hood latching components to insure proper function. When performing other underhood services, the hood latch, release mechanism and safety catch should be cleaned and lubricated.

The external lock cylinders should be lubricated twice a year, preferably in the fall and spring. Apply a small amount of a high quality lubricant such as Mopar® Lock Cylinder Lubricant directly into the lock cylinder.

Hood Latch

When performing other under hood services, the hood latch release mechanism and safety catch should be inspected, cleaned, and lubricated.

It is important to maintain proper lubrication to insure that the hood mechanisms work properly and safely.

Multi-Purpose Lubricant, NLGI Grade 2, should be applied sparingly to all pivot and sliding contact areas.

External Lock Cylinders

Lubricate the external lock cylinders twice a year, preferably in the fall and spring. Apply a small amount of lubricant, such as Mopar Lock Cylinder Lubricant directly into the lock cylinder (avoid excess lubricant). Insert the key into the lock cylinder and rotate from the unlocked to the locked position; without adding more lubricant. Repeat this procedure three or four times. Wipe all the lubricant off the key with a clean cloth, to avoid soiling clothing.

If you use a lubricant that cannot be dispensed directly into the lock cylinder, apply a small amount of the lubricant to the key. Insert the key into the lock cylinder, then proceed as described above, to distribute the lubricant within the lock cylinder. Pay attention to trunk hinges, especially during cold weather, to ensure ease of trunk operation.

Other Body Mechanisms

The following body mechanisms should be inspected and, if necessary, all pivot and sliding contact areas of these components should be lubricated with the lubricant specified as follows:

Engine Oil

- Door hinges
- Hood hinges
- Trunk hinges

Smooth White Body Lubricant - Such as Mopar Spray White Lube:

- Hood hinge springs and links
- Lock cylinders
- Parking brake mechanism
- Trunk latches
- Ash tray

Windshield Wiper Blades

Clean the rubber edges of the wiper blades and the windshield periodically with a sponge or soft cloth and a mild non abrasive cleaner. This will remove accumulations of salt or road film.

Operation of the wipers on dry glass for long periods may cause deterioration of the wiper blades. Always use washer fluid when using the wipers to remove salt or dirt from a dry windshield. Avoid using the wiper blades to remove frost or ice from the windshield. Keep the blade rubber out of contact with petroleum products such as engine oil, gasoline, etc.

Windshield Wiper Blade Replacement

- Lift the wiper arm away from the glass.
- Push the release tab and slide the wiper blade assembly away from the wiper arm. Gently place the wiper arm on the windshield.
- Install the new blade assembly onto the wiper arm tip until it locks in place.

Windshield Washers

The fluid reservoir in the engine compartment should be checked for fluid level at regular intervals. Fill the reservoir with windshield antifreeze (not radiator antifreeze) rated not to freeze at -25°F (-31°C). Operate the system for a few seconds to flush out the residual water.

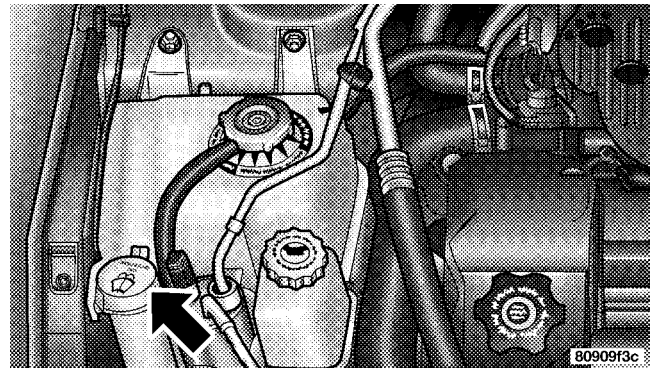

WARNING!

Commercially available windshield washer solvents are flammable. They could ignite and burn you. Care must be exercised when filling or working around the washer solution.

WARNING!

Exhaust gases can injure or kill. They contain carbon monoxide (CO) which is colorless and odorless. Breathing it can make you unconscious and can eventually poison you. To avoid breathing CO, follow the preceding safety tips.

Exhaust System

The best protection against carbon monoxide entry into the vehicle body is a properly maintained engine exhaust system.

If you notice a change in the sound of the exhaust system; or if exhaust fumes can be detected inside the vehicle; or when the underside or rear of the vehicle is damaged; have a competent mechanic inspect the complete exhaust system and adjacent body areas for broken, damaged, deteriorated, or mispositioned parts. Open seams or loose connections could permit exhaust fumes to seep into the passenger compartment. In addition, inspect the exhaust system each time the vehicle is raised for lubrication or oil change. Replace as required.

Cooling System

Inspection

WARNING!

- When working near the radiator cooling fan, disconnect the fan motor lead or turn the ignition key to the OFF position. The fan is controlled by both the temperature of the engine cooling system and the pressure in the air conditioning system and can start at any time the ignition key is in the ON position.
- You or others can be badly burned by hot coolant or steam from your radiator. If you see or hear steam coming from under the hood, don't open the hood until the radiator has had time to cool. Never try to open a cooling system pressure cap when the radiator or cap is hot.

Coolant Checks

Check coolant protection every 12 months (before the onset of freezing weather, where applicable). If coolant is

dirty or rusty in appearance, the system should be drained, flushed and refilled with fresh coolant.

Check the front of the radiator for any accumulation of bugs, leaves, etc. Clean the radiator by gently spraying water from a garden hose at the back of the core.

Check the recovery bottle tank tubing for condition and tightness of connections at the bottle. Inspect the entire system for leaks.

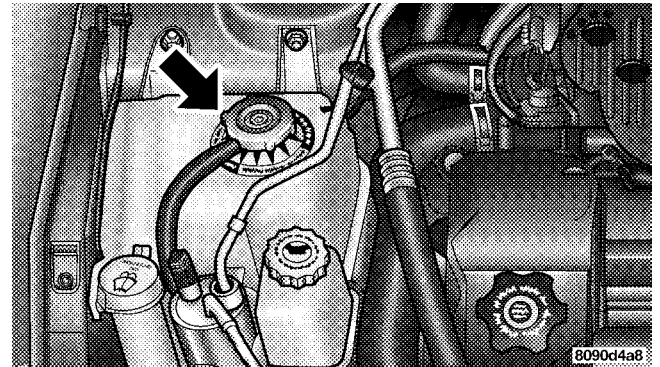

(2.7L Engine Shown)

Do not remove the cap when the cooling system is hot.

Cooling System — Drain, Flush and Refill

At the intervals shown on the Maintenance Schedules, the system should be drained, flushed and refilled. The first change should not be required until 5 years or 100,000 miles (160,000 km), whichever comes first. The coolant should be flushed and changed every two years or 36,000 miles (57,600 km) thereafter.

If the solution is dirty and contains a considerable amount of sediment, clean and flush with a reliable cooling system cleaner. Follow with a thorough rinsing to remove all deposits and chemicals. Used automotive antifreeze is a recyclable commodity. Discard or recycle as facilities exist in your area.

Selection Of Coolant

Use only the manufacturer's recommended coolant, refer to Recommended Fluids, Lubricants and Genuine Parts for correct coolant type.

CAUTION!

Failure to use the proper antifreeze could cause radiator plugging and engine overheating. Do not mix antifreeze brands or use plain water alone or alcohol base antifreeze products. Do not use additional rust inhibitors or antirust products, as they may not be compatible with the radiator coolant and may plug the radiator or heater core.

Adding Coolant

When adding coolant, a solution of 50% ethylene glycol antifreeze coolant in distilled water should be used. Use higher concentrations (not to exceed 60%) if temperatures below -32°F (-35°C) are anticipated.

Please note that it is the owner's responsibility to maintain the proper level of protection against freezing according to the temperatures occurring in the area where the vehicle is operated.

Coolant Pressure Cap

The cap must be fully tightened to prevent loss of coolant, and to insure that coolant will return to the radiator from the coolant reserve tank.

The cap should be inspected and cleaned if there is any accumulation of foreign material on the sealing surfaces.

WARNING!

The warning words “DO NOT OPEN HOT” on the cooling system pressure cap are a safety precaution. Never add coolant when the engine is overheated. Do not loosen or remove the cap to cool an overheated engine. Heat causes pressure to build up in the cooling system. To prevent scalding or injury, do not remove the pressure cap while the system is hot or under pressure.

CAUTION!

Be sure to use only the cooling system pressure cap specified for your vehicle. Use of any other pressure cap may result in decreased engine cooling system performance and/or damage to your vehicle.

Disposal Of Used Engine Coolant

Used ethylene glycol based engine coolant is a regulated substance requiring proper disposal. Check with your local authorities to determine the disposal rules for your community. Do not store ethylene glycol based engine coolant in open containers or allow it to remain in puddles on the ground. Prevent ingestion by animals or children. If ingested by a child, contact a physician immediately.

Coolant Level

The coolant bottle provides a quick visual method for determining that the coolant level is adequate. With the engine off and cold, the coolant level should be between the “MIN” and “MAX” marks on the side of the coolant bottle. Some darkening of the coolant bottle will occur

over time. This is normal. If the coolant level is hard to see, jostling the coolant bottle will make it easier to see.

There is no need to remove the radiator cap unless checking for coolant freeze point, adding, or replacing coolant. Advise your service attendant of this. As long as the engine operating temperature is satisfactory, the coolant bottle need only be checked once a month. Heater performance may also be adversely affected by low coolant levels.

When additional coolant is needed to maintain the proper level, it should be added to the coolant bottle. Do not overfill. Special procedures are required when filling the engine cooling system of the 2.7L Engine. See your authorized dealer for details.

Points to Remember

NOTE: When the vehicle is stopped after a few miles of operation, you may observe vapor coming from the front of the engine compartment. This is normally a result of moisture from rain, snow, or high humidity accumulating on the radiator and being vaporized when the thermostat opens, allowing hot water to enter the radiator.

If an examination of your engine compartment shows no evidence of radiator or hose leaks, the vehicle may be safely driven. The vapor will soon dissipate.

- Do not overfill the coolant bottle.
- Check coolant freeze point in the system.
- If frequent coolant additions are required, or if the level in the bottle does not drop when the engine cools, the cooling system should be pressure tested for leaks.
- Maintain coolant concentration of 50% ethylene glycol (minimum) with recommended antifreeze for proper corrosion protection of your engine that contains aluminum components.
- Make sure that the radiator and coolant bottle hoses are not kinked or obstructed.
- Keep the front of the radiator clean. If your vehicle has air conditioning, keep the front of the condenser clean, also.
- Do not change the thermostat for summer or winter operation. If replacement is ever necessary, install

ONLY the correct type thermostat. Other designs may result in unsatisfactory cooling performance, poor gas mileage, and increased emissions.

Hoses and Vacuum/Vapor Harnesses

Inspect surfaces of hoses and nylon tubing for evidence of heat and mechanical damage. Hard or soft spots, brittle rubber, cracking, checking, tears, cuts, abrasions, and excessive swelling indicate deterioration of the rubber.

Pay particular attention to those hoses nearest to high heat sources such as the exhaust manifold. Inspect hose routing to be sure hoses do not touch any heat source or moving component that may cause heat damage or mechanical wear.

Insure nylon tubing in these areas has not melted or collapsed. Inspect all hose connections such as clamps and couplings to make sure they are secure and no leaks are present. Components should be replaced immediately if there is any evidence of degradation that could cause failure.

Brakes

In order to assure brake system performance, all brake system components should be inspected periodically. Suggested service intervals can be found in section 8.

WARNING!

Riding the brakes can lead to brake failure and possibly an accident. Driving with your foot resting or riding on the brake pedal can result in abnormally high brake temperatures, excessive lining wear, and possible brake damage. You may not have your full braking capacity in an emergency.

Brake and Power Steering System Hoses

When servicing the vehicle for scheduled maintenance, inspect surface of hoses and nylon tubing for evidence of heat and mechanical damage. Hard and brittle rubber, cracking, checking, tears, cuts, abrasion, and excessive swelling suggest deterioration of the rubber. Particular attention should be made to examining those hose surfaces nearest to high heat sources, such as the exhaust manifold.

Inspect all hose clamps and couplings to make sure they are secure and no leaks are present.

Insure nylon tubing in these areas has not melted or collapsed.

NOTE: Often, fluids such as oil, power steering fluid, and brake fluid are used during assembly plant operations to ease the assembly of hoses to couplings. Therefore, oil wetness at the hose-coupling area is not necessarily an indication of leakage. Actual dripping of hot fluid when systems are under pressure (during vehicle operation) should be noted before hose is replaced based on leakage.

NOTE: Inspection of brake hoses should be done whenever the brake system is serviced and every engine oil change.

WARNING!

Worn brake hoses can burst and cause brake failure. You could have an accident. If you see any signs of cracking, scuffing, or worn spots, have the brake hoses replaced immediately.

Master Cylinder

The fluid level in the master cylinder should be checked when performing under hood services, or immediately if the brake system warning lamp shows system failure.

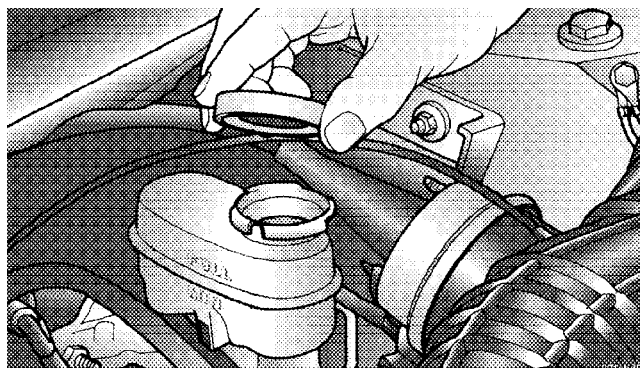

Be sure to clean the top of the master cylinder area before removing the cap. If necessary, fill brake fluid reservoir to the top of the fill mark chevron. With disc brakes, fluid level can be expected to fall as the brake pads wear. However, low fluid level may be caused by a leak and a checkup may be needed.

Use only manufacturer's recommended brake fluid, refer to Recommended Fluids, Lubricants and Genuine Parts for correct fluid type.

WARNING!

Use of a brake fluid that has a lower initial boiling point than MOPAR DOT 3 Brake Fluid or that is unidentified as to DOT FMVSS specification may result in sudden brake failure during hard or prolonged braking. You could have an accident.

WARNING!

Overfilling the brake fluid reservoir can result in spilling brake fluid on hot engine parts and the brake fluid catching fire.

Use only brake fluid that has been in a tightly closed container to avoid contamination from foreign matter.

Do not allow petroleum base fluid to contaminate the brake fluid as seal damage will result!

Fuel System Hoses

Electronic Fuel Injection high pressure fuel systems are designed with hoses and clamps which have unique material characteristics to provide adequate sealing and resist attack by deteriorated gasoline.

You are urged to use only manufacturer specified hoses and clamps, or their equivalent in material and specification, in any fuel system servicing. It is mandatory to replace all clamps that have been loosened or removed during service. Care should be taken in installing new clamps to insure they are properly torqued.

Automatic Transmission

Your front wheel drive vehicle has a transmission and differential assembly contained within a single housing. This is referred to as a "Transaxle."

Selection of Lubricant

It is important that the proper lubricant is used in the transmission to assure optimum transmission performance. Use only manufacturers recommended transmission fluid, refer to Recommended Fluids, Lubricants and Genuine Parts for correct fluid type. It is important that the transmission fluid be maintained at the prescribed level using the recommended fluid.

CAUTION!

Using a transmission fluid other than the manufacturers recommended fluid may cause deterioration in transmission shift quality and/or torque converter shudder. Using a transmission fluid other than the manufacturers recommended fluid will result in more frequent fluid and filter changes. Refer to Recommended Fluids, Lubricants and Genuine Parts for correct fluid type.

Procedure For Checking Fluid Level

The fluid level in the automatic transaxle should be checked whenever the vehicle is serviced. Operation with an improper fluid level will greatly reduce the life of the transaxle and of the fluid.

To properly check the automatic transaxle fluid level, the following procedure must be used:

- The vehicle must be on level ground.
- The engine should be running at curb idle speed for a minimum of 60 seconds.
- Fully apply parking brake.
- Place the gear selector momentarily in each gear position ending with the lever in P (PARK).
- Wipe the dipstick clean and reinsert until seated. Remove dipstick and note reading.
- If the fluid is cold (80°F / 27°C), the reading should be in the cross hatched area marked "COLD" (between the lower two holes in the dipstick).

- If the fluid is hot (180°F / 82°C), the reading should be in the cross hatched area marked "HOT" (between the upper two holes in the dipstick).
- If the fluid level shows low, add sufficient transmission fluid to bring to the proper level.

CAUTION!

Do not overfill. Dirt and water in the transaxle can cause serious damage. To prevent dirt and water from entering the transaxle after checking or replenishing fluid, make certain that the dipstick cap is seated properly.

Fluid and Filter Changes

Automatic transmission fluid and filter should be changed as follows:

Maintenance schedule "A" — No change necessary.

Maintenance schedule "B" — Every 60,000 miles (96 000 km) change fluid and filter under the following conditions:

- Police, taxi, limousine, commercial type operation, or trailer towing where the vehicle is driven **regularly** for more than 45 minutes of continuous operation.

NOTE: Refer to Section 8 of this manual for maintenance schedules.

If the transaxle is disassembled for any reason, the fluid and filter should be changed.

Special Additives

The manufacturer recommends against the addition of any fluid additives to the transaxle. The only exception to this policy is the use of special dyes to aid in detecting fluid leaks. The use of transmission sealers should be avoided as they may adversely affect seals.

Manual Transaxle

Use only the manufacturer's recommended transmission fluid for the manual transaxle, NV-T350 or NV-T850, in your vehicle. Refer to Recommended Fluids, Lubricants and Genuine Parts section for correct fluid type. If it becomes necessary to top off or replace completely, this fluid should be used. The fill plug for the NV-T850 is located on the aluminum rear end cover.

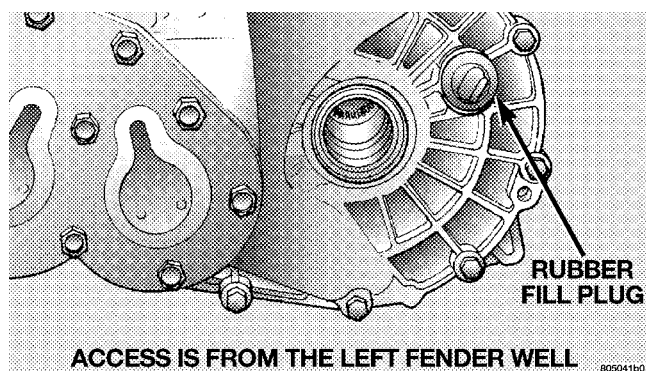

Fluid Level Check

Check the fluid level by removing the fill plug. The fluid level should be between the bottom of the fill hole and a

point not more than 4.0 mm below the bottom of the hole. Add fluid, if necessary, to maintain the proper level.

Frequency of Fluid Change

Under normal operating conditions, the fluid installed at the factory will give satisfactory lubrication for the life of the vehicle. Fluid changes are not necessary unless the lubricant has become contaminated with water. If contaminated with water, the fluid should be changed immediately.

Appearance Care And Protection From Corrosion

Protection of Body and Paint from Corrosion

Vehicle body care requirements vary according to geographic locations and usage. Chemicals that make roads passable in snow and ice, and those that are sprayed on trees and road surfaces during other seasons, are highly corrosive to the metal in your vehicle. Outside parking, which exposes your vehicle to airborne contaminants, road surfaces on which the vehicle is operated, extreme hot or cold weather and other extreme conditions will have an adverse effect on paint, metal trim, and underbody protection.

The following maintenance recommendations will enable you to obtain maximum benefit from the corrosion resistance built into your vehicle.

What Causes Corrosion?

Corrosion is the result of deterioration or removal of paint and protective coatings from your vehicle.

The most common causes are:

- Road salt, dirt and moisture accumulation.
- Stone and gravel impact.
- Insects, tree sap and tar.
- Salt in the air near seacoast localities.
- Atmospheric fallout/industrial pollutants.

Washing

- Wash your vehicle regularly. Always wash your vehicle in the shade using a mild car wash soap, and rinse the panels completely with clear water.
- If insects, tar or other similar deposits have accumulated on your vehicle, wash it as soon as possible.

- Use Mopar auto polish to remove road film and stains and to polish your vehicle. Take care never to scratch the paint.
- Avoid using abrasive compounds and power buffing that may diminish the gloss or thin out the paint finish.

CAUTION!

Do not use abrasive or strong cleaning materials such as steel wool or scouring powder, which will scratch metal and painted surfaces.

7

Special Care

- If you drive on salted or dusty roads or if you drive near the ocean, hose off the undercarriage at least once a month.
- It is important that the drain holes in the lower edges of the doors, rocker panels and rear deck lid be kept clear and open.

- If you detect any stone chips or scratches in the paint, touch them up immediately. The cost of such repairs is considered the responsibility of the owner.
- Use Mopar touch up paint on scratches or chips as soon as possible. Your dealer has touch up paint to match the color of your vehicle.
- If your vehicle is damaged due to an accident or similar cause which destroys the paint and protective coating have your vehicle repaired as soon as possible. The cost of such repairs is considered the responsibility of the owner.
- Aluminum wheels should be cleaned regularly with mild soap and water to prevent corrosion. To remove heavy soil, select a non abrasive, non acidic cleaner. Do not use scouring pads or metal polishes. Avoid automatic car washes that use acidic solutions or harsh brushes that may damage the wheels' protective finish.
- Your painted and chrome aluminum wheels should be treated as you would treat the finish on your car. Always use a soft non-abrasive cloth with a mild dish

washing soap and water when cleaning your wheels. Never use scouring pads, steel wool or a bristle brush. Never use cleaners that contain acid, oven cleaners or any abrasive metal cleaner as they will cause permanent staining and/or corrosion.

- If you carry special cargo such as chemicals, fertilizers, deicer salt, etc., be sure that such materials are well packaged and sealed.
- If a lot of driving is done on gravel roads, consider mud or stone shields behind each wheel.

Interior Care

Use Mopar Fabric Cleaner to clean fabric upholstery and carpeting.

Use Mopar Vinyl Cleaner to clean vinyl or leather upholstery.

Mopar Vinyl Cleaner is specifically recommended for vinyl trim.

Use mild (Ivory Flake) solution to clean all surfaces. Wipe with clear water and soft (lint free) cloth.

Do not use cleaners, conditioners and protectants containing silicon or bleach as these may cause gloss level increases and/or discoloration.

You should not increase the gloss level, especially on top of the instrument panel top surface. Higher gloss levels will increase the reflectivity in the windshield that could decrease visibility under bright light driving conditions.

WARNING!

Do not use volatile solvents for cleaning purposes. Many are potentially flammable, and if used in closed areas they may cause respiratory harm.

Leather Seat Care and Cleaning

CAUTION!

Never use polishes, oils, cleaning fluids, solvents, detergents, or ammonia based cleaners to clean the leather. The leather has already been pretreated. The application of any leather conditioner may damage the factory applied top coat.

Leather is best preserved by regular cleaning with a damp soft cloth. Small particles of dirt can act as an abrasive and damage the leather surface and should be removed immediately with a damp cloth. Stubborn soils can be removed easily with a soft cloth and Mopar Total Clean. Care should be taken to avoid soaking the leather with any liquid.

Cleaning Headlights

Your vehicle has plastic headlights that are lighter and less susceptible to stone breakage than glass headlights.

Plastic is not as scratch resistant as glass and therefore different lens cleaning procedures must be followed.

To minimize the possibility of scratching the lenses and reducing light output, avoid wiping with a dry cloth. To remove road dirt, wash with a mild soap solution followed by rinsing.

Do not use abrasive cleaning components, solvents, steel wool or other aggressive material to clean the lenses.

Glass Surfaces

All glass surfaces should be cleaned on a regular basis with any commercial household-type glass cleaner. Never use an abrasive type cleaner. Use caution when cleaning inside rear windows equipped with electric defrosters. Do not use scrapers or other sharp instruments which may scratch the elements.

Instrument Panel Cover

The instrument panel cover has a low glare surface which minimizes reflections in the windshield. Do not use protectants or other products which may cause undesirable reflections. Use soap and warm water to restore the low glare surface.

Cleaning Plastic Instrument Cluster Lenses

The lenses in front of the instruments in this vehicle are molded in clear plastic. When cleaning the lenses, care must be taken to avoid scratching the plastic.

- Clean with a wet soft rag. A mild soap solution may be used, but do not use high alcohol content or abrasive cleaners. If soap is used, wipe clean with a clean damp rag.
- Dry with a soft tissue.

Seat Belt Maintenance

Do not bleach, dye or clean the belts with chemical solvents or abrasive cleaners. This will weaken the fabric. Sun damage will also weaken the fabric.

If the belts need cleaning, use a mild soap solution or lukewarm water. Do not remove the belts from the vehicle to wash them.

Replace the belts if they appear frayed or worn or if the buckles do not work properly.

CONVERTIBLE TOP CARE

Immediate removal of any contaminant is recommended. Regular washing of the top will enhance its life and appearance, and make successive cleanings easier. Do not subject the top to excessive heat. Frequently vacuum the top and storage compartment.

Washing

Hand washing is highly recommended. Automatic car washing equipment can damage the top material. If you must use an automatic car wash, soft cloth systems are preferred.

CAUTION!
Avoid high pressure car washes, as they can damage the top material. Also, increased water pressure may force water past the weather strips.

General Cleaning

Careful vacuuming of the top before washing is helpful in removing dust and other foreign particles. Wash in partial shade instead of direct sun. Wet the entire vehicle before washing the top. The top should be washed with a soft, natural bristle scrub brush, and a mild soap solution such as liquid dish washing soap. Do not use detergent.

CAUTION!
Never use an abrasive type cleaner or bleaches. Cleaners should not contain silicones, organic solvents, petroleum distillates or plasticizers. always wait until the top is thoroughly dry before lowering it into the storage area.

Scrub in all directions, covering an area of about two square feet at a time. Avoid heavy scrubbing. Rinse the entire vehicle with water to remove all soap and dirt from the top fabric and to prevent streaking on painted and chrome surfaces. Allow the top to dry before lowering.

Vacuumping the top with a wet/dry shop vacuum will decrease the top's drying time, ensure removal of all dirt, and delete streaks in the material. Multiple cleanings may be necessary to remove stubborn stains. If stains persist, contact your local dealership for further suggestions.

Cloth Top Additional Cleaning Procedure

For additional cleaning assistance in removing stubborn stains, apply Mopar Convertible Cloth Top Cleaner # 4883061 to the complete stain, extending 2 inches (50 mm) beyond the stain. With a soft bristle brush, scrub in all directions over the stain. Avoid heavy scrubbing. Rinse the area with warm water. If the stain is still apparent, repeat the cleaning procedure. When the stain is no longer showing, rinse the complete top with warm water. Let the top dry before lowering it.

Cloth Top Protection

For appearance purposes, you may wish to protect your Twillfast™ (cloth) top periodically. A fabric protectant such as Scotchguard® is suggested. The top should be clean and dry before application of the protectant.

CAUTION!

Avoid getting Scotchguard® on the surrounding weather strips, moldings, paint, or glass. Damage to these items might occur.

Weather Strip Care

Lubricate all top and door glass weather strips periodically with Mopar Weather Strip Lubricant (part number 4773427), to keep them soft and pliable.

FUSES

Underhood Fuses (Power Distribution Center)

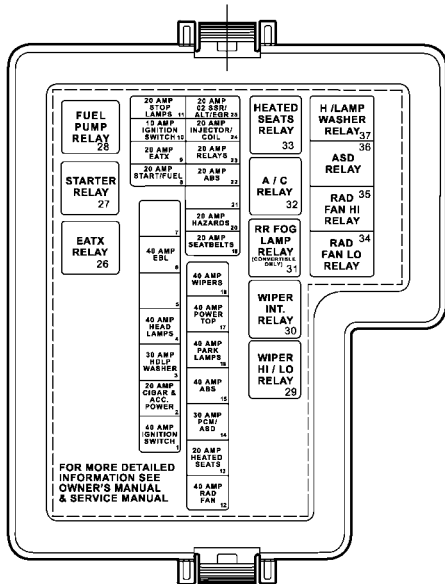

810d5788

A Power Distribution Center is located in the engine compartment, near the air cleaner. This information applies to vehicles built without the fuse and relay numbering embossed on the Power Distribution Center Top Cover.

Interior Fuses



The fuse access panel is behind the end cover at the left side of the instrument panel. To remove the panel, pull it out, as shown.

Cavity	Fuse	Circuit
1	30 Amp Green	Blower Motor
2	10 Amp Red	Right High Beam Headlight, High Beam Indicator
3	10 Amp Red	Left High Beam Headlight
4	15 Amp Blue	Power Door Lock Switch Illumination, Power Top Switch, Transmission Range Switch, Daytime Running Light Module (Canada), Power Windows, Anti-lock Brake System Module
5	10 Amp Red	Power Door Lock and Door Lock Arm/Disarm Switches, Vanity, Reading, Map, Rear Seating, Ignition, and Trunk Lights, Illuminated Entry, Radio, Power Antenna, Data Link Connector, Body Control Module, Power Amplifier
6	10 Amp Red	Heated Rear Window Indicator
7	20 Amp Yellow	Instrument cluster illumination, Park and tail Lights
8	20 Amp Yellow	Power Receptacle, Horns, Ignition, Fuel, Start

Cavity	Fuse	Circuit
9	15 Amp Blue	Power Door Lock Motors (Body Control Module)
10	20 Amp Yellow	Daytime Running Light Module (Canada)
11	10 Amp Red	Instrument Cluster, Transmission Control, Park/Neutral Switch, Body Control Module
12	10 Amp Red	Left Low beam Headlight
13	20 Amp Yellow	Right Low Beam Headlight, Fog Light Switch
14	10 Amp Red	Radio
15	10 Amp Red	Turn Signal and Hazard Flashers, Wiper Switch, Seat Belt Control Module, Wiper Relays, Rear Window Defroster Relay
16	10 Amp Red	Airbag Control Module
17	10 Amp	Airbag Control Module
18	20 Amp C/BRKR	Power Seat Switch, Remote Trunk Release
19	30 Amp C/BRKR	Power Windows

CAUTION!

When replacing a blown fuse, it is important to use only a fuse having the correct amperage rating. The use of a fuse with a rating other than indicated may result in a dangerous electrical system overload. If a properly rated fuse continues to blow, it shows a problem in the circuit that must be corrected.

REPLACEMENT LIGHT BULBS

LIGHT BULBS — Interior	Bulb Number
Instrument Cluster	PC 194
ABS Indicator	PC 161
Fog Indicators	PC 161
Floor Console, Courtesy Light, Door Courtesy Light, Trunk Light	562
Climate Control Light	37
Traction Control Light	PC161

LIGHT BULBS — Exterior	Bulb Number
Headlight	9007
Park/Turn Signal (Front)	3157A
Side/Marker (Front)	168
Turn Signal (Rear)	3757A
Fog Light	880L
Center Stop Light (CHMSL)	Dealer Service Item
Tail/Stop	3157
Tail Light	W3W/2821
Back Up Light	W16W/921
License Light	W5W/2825

BULB REPLACEMENT

Headlight Bulb Replacement

1. Open the hood and remove the two headlight mounting screws.

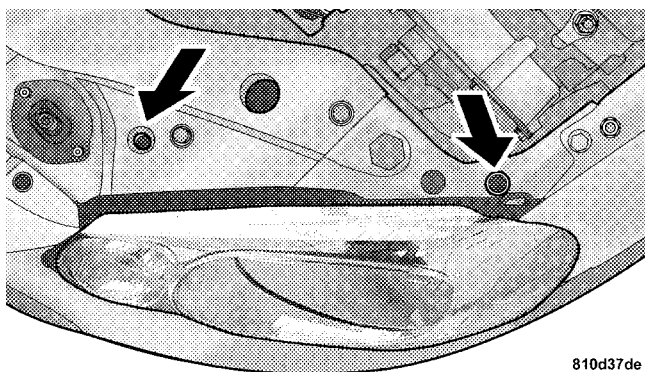

2. Remove the push-in fasteners by prying under the head of the fasteners with a flat bladed tool.

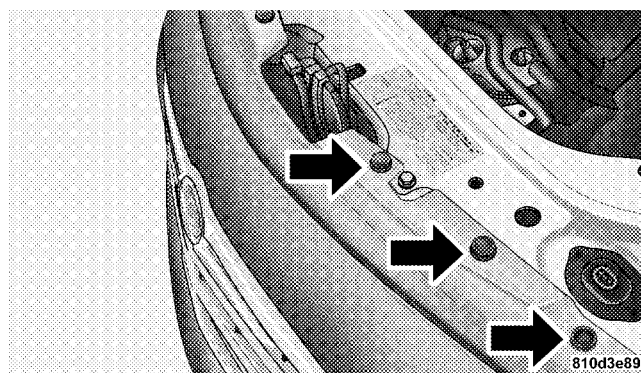

3. Gently pry the headlight assembly away from the fender as shown in the picture. This will free the ball stud from its retainer in the fender. Pull the headlight assembly away from the vehicle.

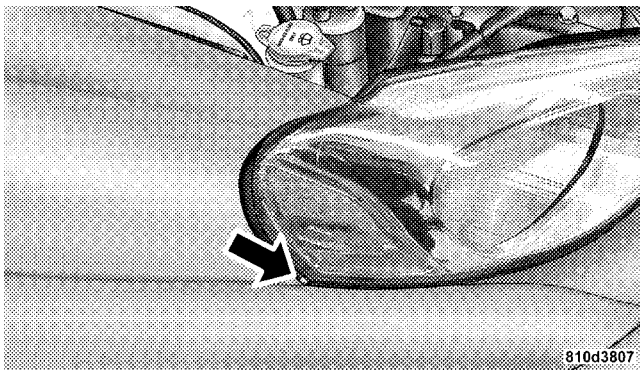

4. Turn the retaining ring counterclockwise and remove the bulb and socket assembly.

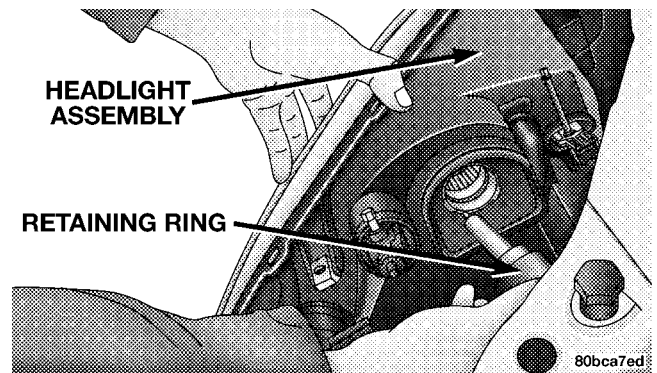

5. Pull the bulb out of the socket and replace the bulb.

CAUTION!

Do not touch the new bulb with your fingers. Oil contamination will severely shorten bulb life.

6. If the bulb comes in contact with any oily surface, clean the bulb with rubbing alcohol.

7. Reinsert the bulb and socket assembly and turn the retaining ring clockwise to secure the bulb.

8. Reinstall the headlight assembly.

Park, Turn Signal, Sidemarker Bulb Replacement

1. Open the hood and remove the two headlight assembly mounting screws. Pull the headlight assembly away from the vehicle.

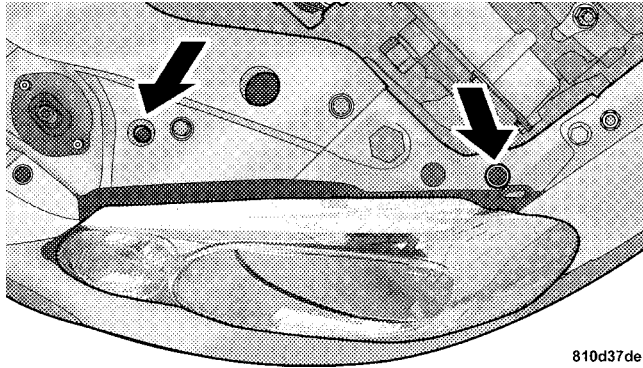

810d37de

2. Gently pry the headlight assembly away from the fender as shown in the picture. This will free the ball stud from its retainer in the fender. Pull the headlight assembly away from the vehicle.

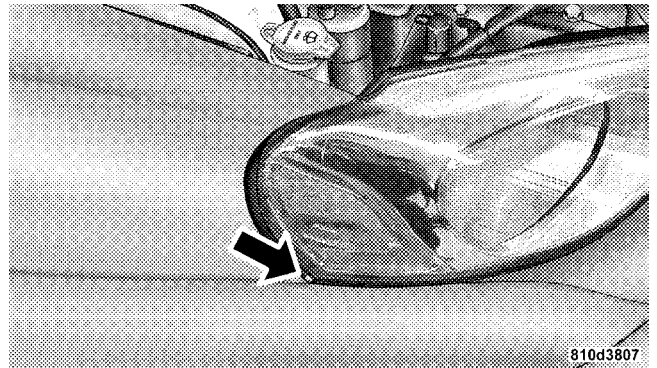

810d3807

3. Turn the bulb socket counterclockwise and remove the bulb and socket assembly.

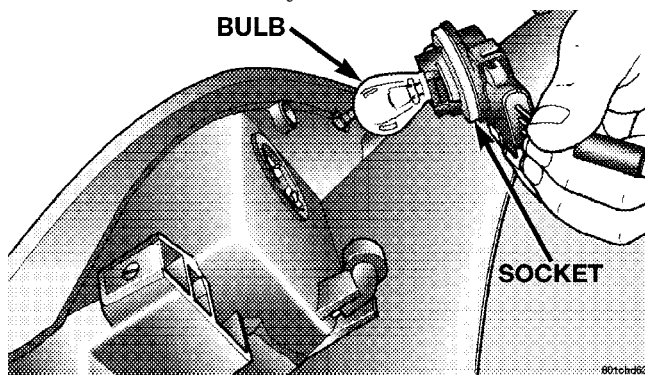

4. Pull the bulb out of the socket, replace the bulb, and reinstall the bulb and socket to the headlight assembly. Reinstall the headlight assembly.

Fog Light Bulb Replacement

1. Remove the screw securing the light assembly to the front fascia.

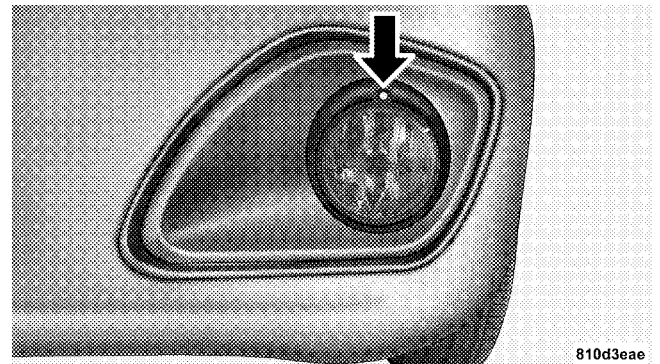

2. Pull the bulb and socket assembly away from the vehicle to expose the bulb and socket assembly.

3. Disconnect the wiring connector from the bulb and socket assembly.

4. Turn the bulb and socket assembly counterclockwise to remove it from the housing.

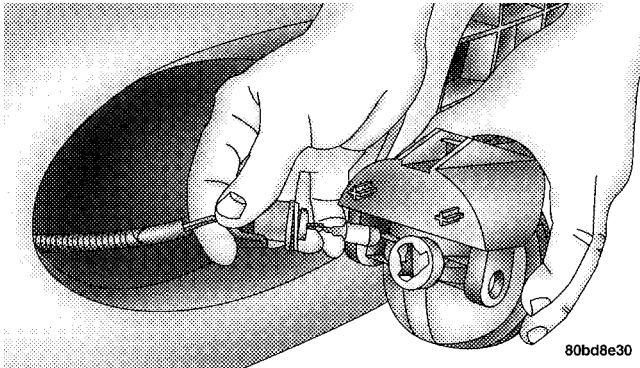

5. Install the new bulb and socket assembly, reattach the wiring connector, and reinstall the fog light assembly.

Center Stoplight Bulb Replacement

You may wish to see your dealer for service of this light. A detailed service procedure is contained in the manufacturer's Service Manual. Information on purchasing a Service Manual can be found at the back of this Owner's Manual.

Rear Light Bulb Replacement

1. Open the trunk and pull the trunk liner away to expose the wiring connector and light housing plastic retainers.

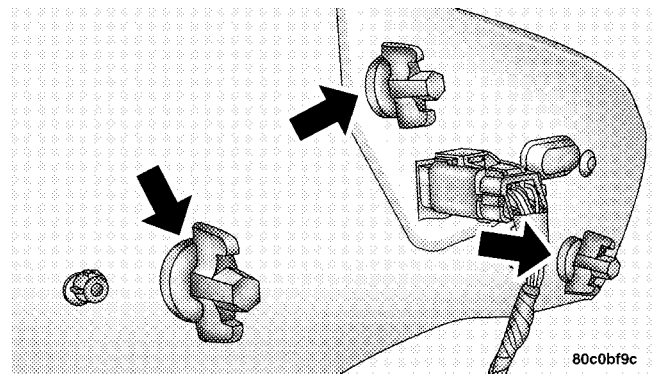

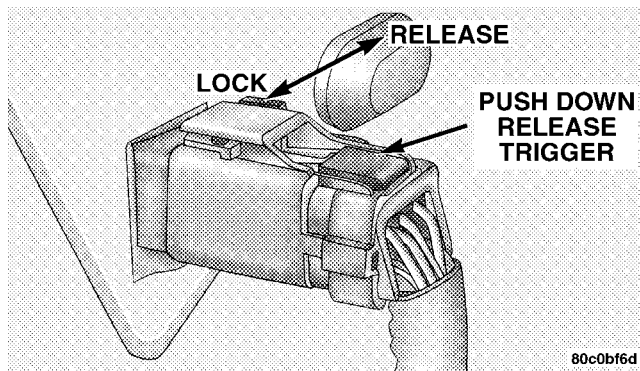

License Plate Bulb Replacement

1. Locate both small slots on the outboard side of the license lamp. Using a small screwdriver, remove the entire housing.
2. Turn the bulb socket counterclockwise to remove it from the housing. Pull the bulb out of the socket. Replace the bulb and snap it back into place on the housing of the chrome appliqué.

2. Disconnect the wiring connector as shown and remove the plastic retainers. Remove the light housing from the vehicle.
3. Turn the bulb socket counterclockwise to remove it from the housing. Remove the bulb and reinstall the bulb and socket assembly.
4. Reinstall the light housing and reconnect the wiring connector. Push the trunk liner back into place.

Headlight Aiming

The headlights on your new vehicle were aimed at the factory. The factory setting was made at a no load setting. A great increase in weight will change the aiming and it may be necessary to readjust the headlights if carrying an excessive amount of weight in the trunk, rear seats or pulling a trailer. To readjust the headlights first mark the position of the headlights on a wall prior to loading the vehicle. Load the vehicle and then readjust the headlights to the original position. If any further adjustments are necessary contact your manufacturer's dealer. A detailed service procedure is contained in the manufacturer's Service Manual. Information on purchasing a Service Manual can be found at the back of this Owner's Manual.

FLUIDS AND CAPACITIES

	U.S.	Metric
Fuel (Approximate)		
2.4 Liter Engine (87 Octane)	16 Gal- lons	61 Liters
2.7 Liter Engine (87 Octane)	16 Gal- lons	61 Liters
Engine Oil-with filter		
2.4 Liter Engines (SAE 5W-30)	5 qts.	4.7 Liters
2.7 Liter Engines (SAE 5W-30)	5 qts.	4.7 Liters
Cooling System *		
2.4 Liter Engines* (Mopar® Antifreeze/Coolant 5 Year/ 100,000 Mile Formula)	8 qts.	7.5 Liters
2.7 Liter Engines (Mopar® Antifreeze/Coolant 5 Year/ 100,000 Mile Formula)	9.5 qts.	9.0 Liters
* Includes 1 qt. for coolant tank.		

RECOMMENDED FLUIDS, LUBRICANTS AND GENUINE PARTS

Engine

Component	Fluid, Lubricant, or Genuine Part
Engine Coolant	Mopar® Antifreeze/Coolant 5 Year/100,000 Mile Formula HOAT (Hybrid Organic Additive Technology)
Engine Oil	Use API Certified (GF-3). Refer to oil viscosity chart for correct SAE grade.
Spark Plugs	Refer to the Vehicle Emission Control Information label under the engine hood.
Oil Filter (2.4L Engine)	Mopar® Oil Filter (P/N 4105409) or equivalent.
Oil Filter (2.7L Engine)	Mopar® Oil Filter (P/N 5281090) or equivalent.
Fuel Selection	87 Octane

Chassis

Component	Fluid, Lubricant, or Genuine Part
Automatic Transmission	Mopar® ATF+4 Automatic Transmission Fluid.
Manual Transmission	Mopar® ATF+4 Automatic Transmission Fluid.
Brake Master Cylinder	Mopar® Brake Fluid DOT 3 Motor Vehicle.
Power Steering Reservoir	Mopar® ATF+4 Automatic Transmission Fluid.
Steering Gear & Linkage, Ball Joints, Prop Shafts & Yokes, Wheel Bearings	Mopar® Multi-Purpose Lubricant NLGI Grade 2.

MAINTENANCE SCHEDULES

CONTENTS

■ Emission Control System Maintenance	236	□ Schedule "B"	239
■ Maintenance Schedules	236	□ Schedule "A"	246

EMISSION CONTROL SYSTEM MAINTENANCE

The “Scheduled” maintenance services, listed in **bold type** must be done at the times or mileages specified to assure the continued proper functioning of the emission control system. These, and all other maintenance services included in this manual, should be done to provide best vehicle performance and reliability. More frequent maintenance may be needed for vehicles in severe operating conditions such as dusty areas and very short trip driving.

Inspection and service also should be done any time a malfunction is suspected.

NOTE: Maintenance, replacement, or repair of the emission control devices and systems on your vehicle may be performed by any automotive repair establishment or individual using any automotive part which has been certified pursuant to U.S. EPA or, in the State of California, California Air Resources Board regulations.

MAINTENANCE SCHEDULES

There are two maintenance schedules that show the **required** service for your vehicle.

First is Schedule “**B**”. It is for vehicles that are operated under the conditions that are listed below and at the beginning of the schedule.

- Day or night temperatures are below 32° F (0° C).
- Stop and go driving.
- Extensive engine idling.
- Driving in dusty conditions.
- Short trips of less than 10 miles (16 km).
- More than 50% of your driving is at sustained high speeds during hot weather, above 90° F (32° C).
- Trailer towing. ◇

- Taxi, police, or delivery service (commercial service). ◇
- Off-road or desert operation.
- **If equipped for and operating with E-85 (ethanol) fuel.**

NOTE: If ANY of these apply to you then change your engine oil every 3,000 miles (5,000 km) or 3 months, whichever comes first and follow schedule B of the “Maintenance Schedules” section of this manual.

NOTE: Most vehicles are operated under the conditions listed for Schedule “B”.

Second is Schedule “A”. It is for vehicles that are not operated under any of the conditions listed under Schedule “B”.

Use the schedule that best describes your driving conditions. Where time and mileage are listed, follow the interval that occurs first.

NOTE: Under no circumstances should oil change intervals exceed 6 months or 6,000 miles, whichever comes first.

CAUTION!
Failure to perform the required maintenance items may result in damage to the vehicle.

At Each Stop for Fuel

- Check the engine oil level about 5 minutes after a fully warmed engine is shut off. Checking the oil level while the vehicle is on level ground will improve the accuracy of the oil level reading. Add oil only when the level is at or below the ADD or MIN mark.
- Check the windshield washer solvent and add if required.

Once a Month

- Check tire pressure and look for unusual wear or damage.
- Inspect the battery and clean and tighten the terminals as required.
- Check the fluid levels of coolant reservoir, brake master cylinder, and transaxle and add as needed.
- Check all lights and all other electrical items for correct operation.
- Check rubber seals on each side of the radiator for proper fit.

At Each Oil Change

- Change the engine oil filter.
- Inspect the exhaust system.
- Inspect the brake linings, hoses and calipers.
- Inspect the CV joints and front and rear suspension components.
- Check the automatic transmission fluid level.
- Check the brake master cylinder fluid level.
- Check the manual transmission fluid level.
- Check the coolant level, hoses, and clamps.
- Rotate the tires at each oil change interval shown on Schedule "A" 6,000 miles (10 000 km) or every other interval shown on Schedule "B" 6,000 miles (10 000 km).

NOTE: In 2.7L Engines equipped with Flex Fuel Engine (FFV), change engine oil every 5 months or 5,000 miles, whichever comes first. This applies to both Maintenance Schedule A and B.

SCHEDULE "B"

Follow schedule "B" if you usually operate your vehicle under one or more of the following conditions. Change the automatic transmission fluid and filter every 60,000 miles (96 000 km) if the vehicle is usually operated under one or more of the conditions marked with an ◇.

- Day or night temperatures are below 32° F (0° C).
- Stop and go driving.
- Extensive engine idling.
- Driving in dusty conditions.
- Short trips of less than 10 miles (16.2 km).
- More than 50% of your driving is at sustained high speeds during hot weather, above 90° F (32° C).

- Trailer towing. ◇
- Taxi, police or delivery service (commercial services). ◇
- Off-road or desert operation.
- **If equipped for and operating with E-85 (ethanol) fuel.**

NOTE: If **ANY** of these apply to you then change your engine oil every 3,000 miles (5 000 km) or 3 months, whichever comes first and follow schedule "B" of the "Maintenance Schedules" section of this manual.

240 SCHEDULE "B"

Miles (Kilometers)	3,000 (5 000)	6,000 (10 000)	9,000 (14 000)	12,000 (19 000)	15,000 (24 000)	18,000 (29 000)
Change engine oil and engine oil filter.	X	X	X	X	X	X
Inspect the air cleaner filter and replace if necessary.*	X	X	X	X	X	X
Inspect the front and rear brake pads, linings, rotors, rear drums and shoes.				X		

Miles (Kilometers)	21,000 (34 000)	24,000 (38 000)	27,000 (43 000)	30,000 (48 000)	33,000 (53 000)	36,000 (58 000)
Change engine oil and engine oil filter.	X	X	X	X	X	X
Inspect the air cleaner filter and replace if required.*	X	X	X		X	X
Replace the air cleaner filter .				X		
Inspect and check tension for power steering belt (2.4 Liter Engine). Adjust or replace if required.				X		
Inspect the front and rear brake pads, linings, rotors, rear drums and shoes.		X				X
Check and replace, if necessary, the PCV valve . *				X		
Replace the spark plugs on 2.4 liter engine.				X		

242 SCHEDULE "B"

Miles (Kilometers)	39,000 (62 000)	42,000 (67 000)	45,000 (72 000)	48,000 (77 000)	51,000 (82 000)	54,000 (86 000)
Change engine oil and engine oil filter.	X	X	X	X	X	X
Inspect the air cleaner filter and replace if necessary.*	X	X	X	X	X	X
Inspect the front and rear brake pads, linings, rotors, rear drums and shoes.				X		

Miles (Kilometers)	57,000 (91 000)	60,000 (96 000)	63,000 (101 000)	66,000 (106 000)	69,000 (110 000)	72,000 (115 000)
Change engine oil and engine oil filter.	X	X	X	X	X	X
Inspect the air cleaner filter and replace if necessary.*	X		X	X	X	X
Replace the air cleaner filter .		X				
Inspect and check tension for power steering belt (2.4 Liter Engine). Adjust or replace if required.		X				
Inspect the front and rear brake pads, linings, rotors, rear drums and shoes.		X				X
Replace the ignition cables on 2.4 liter engine.		X				
Replace the accessory drive belts on the 2.7 liter engine.		X				
Replace the spark plugs on the 2.4 liter engine.		X				
Check and replace, if necessary, the PCV valve . *†		X				
Change the automatic transmission fluid and filter. ◇		X				

244 SCHEDULE "B"

Miles (Kilometers)	75,000 (120 000)	78,000 (125 000)	81,000 (130 000)	84,000 (134 000)	87,000 (139 000)	90,000 (144 000)
Change engine oil and engine oil filter.	X	X	X	X	X	X
Inspect the air cleaner filter and replace if necessary.*	X	X	X	X	X	
Replace the air cleaner filter . *						X
Inspect and check tension for power steering belt (2.4 Liter Engine). Adjust or replace if required.						X
Replace the engine timing belt on 2.4 liter engine.						X
Inspect the front and rear brake pads, linings, rotors, rear drums and shoes.				X		
Replace the spark plugs on 2.4 liter engine.						X
Check and replace, if necessary, the PCV valve .						X

Miles (Kilometers)	93,000 (149 000)	96,000 (154 000)	99,000 (158 000)	100,000 (160 000)	102,000 (163 000)	105,000 (168 000)
Change engine oil and engine oil filter.	X	X	X		X	X
Inspect the air cleaner filter and replace if necessary.*	X	X	X		X	X
Inspect the front and rear brake pads, linings, rotors, rear drums and shoes.		X				
Flush and replace the engine coolant.				X		
Replace the spark plugs on the 2.7 liter engine.				X		
Check and retension accessory drive belts on 2.7 liter engine.						X
Replace the accessory drive belts on 2.4 liter engine.					X	

* This maintenance is recommended by the manufacture to the owner but is not required to maintain the emissions warranty.

Inspection and service should also be performed anytime a malfunction is observed or suspected. Retain all receipts.

‡ This maintenance is not required if previously replaced.

246 SCHEDULE "A"

SCHEDULE "A"

Miles (Kilometers) [Months]	6,000 (10 000) [6]	12,000 (19 000) [12]	18,000 (29 000) [18]	24,000 (38 000) [24]	30,000 (48 000) [30]	36,000 (58 000) [36]
Change engine oil and engine oil filter.	X	X	X	X	X	X
Inspect the air cleaner filter and replace if necessary.*	X	X	X	X		X
Replace the air cleaner filter . *					X	
Replace the spark plugs on 2.4 liter engine.					X	
Inspect the front and rear brake pads, linings, rotors, rear drums and shoes.			X			X
Inspect and replace PCV valve if required.					X	

Miles (Kilometers)	42,000 (67 000)	48,000 (77 000)	54,000 (86 000)	60,000 (96 000)	66,000 (106 000)	72,000 (115 000)
[Months]	[42]	[48]	[54]	[60]	[66]	[72]
Change engine oil and engine oil filter.	X	X	X	X	X	X
Inspect the air cleaner filter and replace if required.*	X	X	X		X	X
Replace the air cleaner filter . *				X		
Inspect and check tension for power steering belt (2.4 Liter Engine). Adjust or replace if required.				X		
Inspect the front and rear brake pads, linings, rotors, rear drums and shoes.			X			X
Replace the spark plugs on 2.4 liter engine.				X		
Flush and replace engine coolant at 60 months or 100,000 miles.				X		
Check and replace, if necessary, the PCV valve . *†				X		
Replace the ignition cables on 2.4 liter engine.				X		
Replace the accessory drive belts in 2.7 liter engine.				X		

248 SCHEDULE "A"

Miles (Kilometers)	78,000 (125 000)	84,000 (134 000)	90,000 (144 000)	96,000 (154 000)	102,000 (163 000)
[Months]	[78]	[84]	[90]	[96]	[102]
Change engine oil and engine oil filter.	X	X	X	X	X
Inspect the air cleaner filter and replace if required.*	X	X		X	X
Replace the air cleaner filter . *			X		
Inspect the front and rear brake pads, linings, rotors, rear drums and shoes.			X		
Replace the spark plugs on 2.4 liter engine.			X		
Replace the spark plugs on 2.7 liter engine.					X
Check and replace, if necessary, the PCV valve . *‡			X		
Replace the engine timing belt on 2.4 liter engine.*					X
Check and retension alternator drive belts on 2.7 liter engine.					X
Replace the accessory drive belts on 2.4L engine.					X

* This maintenance is recommended by the manufacture to the owner but is not required to maintain the emissions warranty.

‡ This maintenance is not required if previously replaced.

Inspection and service should also be performed anytime a malfunction is observed or suspected. Retain all receipts.

WARNING!

You can be badly injured working on or around a motor vehicle. Do only that service work for which you have the knowledge and the right equipment. If you have any doubt about your ability to perform a service job, take your vehicle to a competent mechanic.

IF YOU NEED CONSUMER ASSISTANCE

CONTENTS

■ Suggestions For Obtaining Service For Your Vehicle	252	■ Reporting Safety Defects	255
□ Prepare For The Appointment	252	□ In Canada	255
□ Prepare A List	252	■ Publication Order Forms	255
□ Be Reasonable With Requests	252	■ Department Of Transportation Uniform Tire Quality Grades	257
■ If You Need Assistance	252	□ Treadwear	257
■ Warranty Information	254	□ Traction Grades	257
■ Mopar® Parts	255	□ Temperature Grades	257

SUGGESTIONS FOR OBTAINING SERVICE FOR YOUR VEHICLE**Prepare For The Appointment**

If you're having warranty work done, be sure to have the right papers with you. Take your warranty folder. All work to be performed may not be covered by the warranty, discuss additional charges with the service manager. Keep a maintenance log of your vehicle's service history. This can often provide a clue to the current problem.

Prepare A List

Make a written list of your vehicle's problems or the specific work you want done. If you've had an accident, or work done that is not on your maintenance log, let the service advisor know.

Be Reasonable With Requests

If you list a number of items, and you must have your vehicle by the end of the day, discuss the situation with the service advisor and list the items in order of priority. At many dealers you may obtain a rental vehicle at a

minimal daily charge. If you need a rental, it is advisable to make these arrangements when you call for an appointment.

IF YOU NEED ASSISTANCE

The manufacturer and its dealers are vitally interested in your satisfaction. We want you to be happy with our products and services.

Your selling dealer is best equipped and most anxious to provide prompt resolution for any warranty issue or related matter that you may experience. The manufacturer's dealers have the facilities, factory-trained technicians, special tools, and the latest information to assure your vehicle is fixed correctly and in a timely manner. The manufacturer has empowered its dealers to make warranty and repair decisions that ensure you are not inconvenienced. There is no need for you to wait for a decision from the manufacturer. If a special circumstance occurs that requires information from the manufacturer, we have asked the dealer's service management to make the contact on your behalf.

This is why you should always talk to your dealer's service manager first. Most matters can be resolved with this process.

- If for some reason you are still not satisfied, talk to the general manager or owner of the dealership. They want to know if you need assistance.
- If your dealership is unable to resolve the concern, you may contact the Manufacturer's Customer Center.

Any communication to the Manufacturer's Customer Center should include the following information:

- Owner's name and address
- Owner's telephone number (home and office)
- Dealership name
- Vehicle identification number
- Vehicle delivery date and mileage

DaimlerChrysler Motors Corporation Customer Center

P.O. Box 21-8004
Auburn Hills, MI 48321-8004
Phone: (800) 992-1997

DaimlerChrysler Canada Inc. Customer Center

P.O. Box 1621
Windsor, Ontario N9A 4H6
Phone —(800) 465-2001

In Mexico contact:

Av. Prolongacion Paseo de la Reforma, 1240
Sante Fe C.P. 05109
Mexico, D. F.
In Mexico (915) 729-1248 or 729-1240
Outside Mexico (525) 729-1248 or 729-1240

Customer Assistance For The Hearing Or Speech Impaired (TDD/TTY)

To assist customers who have hearing difficulties, the manufacturer has installed special TDD (Telecommunication Devices for the Deaf) equipment at its Customer Center. Any hearing or speech impaired customer who has access to a TDD or a conventional teletypewriter (TTY) in the United States can communicate with the manufacturer by dialing 1-800-380-CHRY.

Service Contract

You may have purchased a service contract for your vehicle to help protect you from the high cost of unexpected repairs after your manufacturer's new vehicle limited warranty expires. The manufacturer stands behind only the manufacturer's Service Contracts. If you purchased a manufacturer's Service Contract, you will receive Plan Provisions and an Owner Identification Card in the mail within three weeks of your vehicle delivery date. If you have any questions about your service contract, call the manufacturer's Service Contract National Customer Hotline at 1-800-521-9922.

The manufacturer will not stand behind any service contract that is not the manufacturer's Service Contract. It is not responsible for any service contract other than the manufacturer's Service Contract. If you purchased a service contract that is not a manufacturer's Service Contract, and you require service after your manufacturer's new vehicle limited warranty expires, please refer to your contract documents, and contact the person listed in those documents.

We appreciate that you have made a major investment when you purchased your new vehicle. Your dealer has also made a major investment in facilities, tools, and training to assure that you are absolutely delighted with your ownership experience. You'll be pleased with their sincere efforts to resolve any warranty issues or related concerns.

WARRANTY INFORMATION

See your manufacturer's Warranty Information Booklet for information on warranty coverage and transfer of warranty.

TIME/MILEAGE							
1 YEAR/ 12,000	2 YEAR/ 24,000	3 YEAR/ 36,000	3 YEAR/ 50,000	3 YEAR/ UNLMTD	5 YEAR/ 100,000	7 YEAR/ 70,000	8 YEAR/ 80,000
BASIC LIMITED WARRANTY COVERAGE							
SPECIAL EXTENDED WARRANTY COVERAGE							
■ ■ ■ ■ ■ ■ ■ ■ ■ ■		■ ■ ■ ■ ■ ■ ■ ■ ■ ■		POWERTRAIN LIMITED WARRANTY (\$100 DEDUCTIBLE)			
ANTI-CORROSION PERFORATION: ALL PANELS							
OUTER PANELS							
FED. EMISSION WARR.							
FEDERAL EMISSION WARRANTY - SPECIFIED COMPONENTS							
CALIFORNIA EMISSION WARRANTY							
CALIFORNIA EMISSION WARRANTY - SPECIFIED COMPONENTS							
							80eee94a

MOPAR® PARTS

Mopar® fluids, lubricants, parts, and accessories are available from your dealer. They will help you keep your vehicle operating at its best.

REPORTING SAFETY DEFECTS

In the 50 United States and Washington D.C.: If you believe that your vehicle has a defect which could cause a crash or cause injury or death, you should immediately inform the National Highway Traffic Safety Administration (NHTSA) in addition to notifying the manufacturer.

If NHTSA receives similar complaints, it may open an investigation, and if it finds that a safety defect exists in a group of vehicles, it may order a recall and remedy campaign. However, NHTSA cannot become involved in individual problems between you, your dealer, and the manufacturer.

To contact NHTSA, you may either call the Auto Safety Hotline toll free at 1-800-424-9393 (or 366-0123 in Washington DC area) or write to: NHTSA, U.S. Dept. of

Transportation, Washington DC 20590. You can also obtain other information about motor vehicle safety from the Hotline.

In Canada:

If you believe that your vehicle has a safety defect, you should contact the Customer Service Department immediately. Canadian customers who wish to report a safety defect to the Canadian government should write to Transport Canada, Motor Vehicle Defect Investigations and Recalls, 2780 Sheffield Road, Ottawa, Ontario K1B 3V9.

PUBLICATION ORDER FORMS

To order the following manuals, you may use either the website or the phone numbers listed below. Visa, Mastercard, American Express, and Discover orders are accepted. If you prefer mailing your payment, please call for an order form.

NOTE: A street address is required when ordering manuals. (No P.O. Boxes).

- *Service Manuals.*

These comprehensive service manuals provide the information that students and professional technicians need in diagnosing/troubleshooting, problem solving, maintaining, servicing and repairing DaimlerChrysler Corporation vehicles. A complete working knowledge of the vehicle, system and/or components is written in straightforward language with illustrations, diagrams and charts.

- *Diagnostic Procedure Manuals.*

Filled with diagrams, charts and detailed illustrations, these practical manuals make it easy for students and technicians to find and fix problems on computer-controlled vehicle systems and features. They show exactly how to find and correct problems the first time, using step-by-step troubleshooting and driveability procedures, proven diagnostic tests and a complete list of all tools and equipment.

- *Owner's Manuals.*

These manuals have been prepared with the assistance of service and engineering specialists to acquaint you with specific Chrysler group vehicles. Included are starting, operating, emergency and maintenance procedures as well as specifications, capabilities and safety tips.

Call Toll Free at **1-800-890-4038 (U.S.)** or **1-800-387-1143 (Canada)**

Or

Visit us on the World Wide Web at:

www.techauthority.daimlerchrysler.com or
www.daimlerchrysler.ca/manuals

DEPARTMENT OF TRANSPORTATION UNIFORM TIRE QUALITY GRADES

The following describes the tire grading categories established by the National Highway Traffic Safety Administration. The specific grade rating assigned by the tire's manufacturer in each category is shown on the sidewall of the tires on your car.

All Passenger Car Tires Must Conform to Federal Safety Requirements in Addition to These Grades.

Treadwear

The treadwear grade is a comparative rating based on the wear rate of the tire when tested under controlled conditions on a specified government test course. For example, a tire graded 150 would wear one and a half (1 1/2) times as well on the government course as a tire graded 100. The relative performance of tires depends upon the actual conditions of their use, however, and may depart significantly from the norm due to variations in driving habits, service practices and differences in road characteristics and climate.

Traction Grades

The traction grades, from highest to lowest, are A, B, and C, and they represent the tire's ability to stop on wet pavement as measured under controlled conditions on specified government test surfaces of asphalt and concrete. A tire marked C may have poor traction performance.

WARNING!

The traction grade is based on braking (straight-ahead) traction tests and does not include cornering (turning) performance.

Temperature Grades

The temperature grades are A (highest), B, and C, representing the tire's resistance to the generation of heat and its ability to dissipate heat when tested under controlled conditions on a specified indoor laboratory test wheel. Sustained high temperature can cause the material of the tire to degenerate and reduce tire life, and excessive temperature can lead to sudden tire failure. The grade C

corresponds to a level of performance which all passenger car tires must meet under the Federal Motor Vehicle Safety Standard No. 109. Grades B and A represent higher levels of performance on the laboratory test wheel than the minimum required by law.

WARNING!

The temperature grade is established for a tire that is properly inflated and not overloaded. Excessive speed, underinflation, or excessive loading, either separately or in combination, can cause heat buildup and possible tire failure.

INDEX

- About Your Brakes 142
- Adding Engine Coolant (Antifreeze) 208
- Adding Fuel 164
- Aiming Headlights 232
- Air Cleaner, Engine 198
- Air Conditioning 122
- Air Conditioning, Operating Tips 126
- Air Conditioning Refrigerant 202
- Air Conditioning System 122,201
- Air Pressure, Tires 153
- Airbag 29
- Airbag Deployment 32
- Airbag Light 32,34,43,87
- Airbag Maintenance 34
- Alarm, Panic 17
- Alarm System 19,92
- Alignment and Balance 158
- Alterations/Modifications, Vehicle 6
- Antifreeze Disposal 209
- Antifreeze (Engine Coolant) 208
- Capacities 232
- Anti-Lock Brake System 142
- Anti-Lock Warning Light 90
- Anti-Theft Security Alarm 19
- Appearance Care 216
- Automatic Dimming Mirror 56
- Automatic Door Locks 14
- Automatic Transaxle 135,186,213
- Filter 215
- Fluid and Filter Changes 215
- Fluid Level Check 214
- Interlock System 10,136
- Reset Mode 137
- Selection Of Lubricant 214
- Shifting 137
- Special Additives 215
- Autostick 160
- Auxiliary Power Outlet 78
- Ball Joints 203
- Battery 200
- Emergency Starting 181
- Gas Caution 183,201
- Heater 134
- Jump Starting 181
- Keyless Transmitter Replacement 18

- Location 181,200
- Belts, Drive 198
- Belts, Engine 200
- Body Mechanism Lubrication 203
- Boot, Convertible Top 50
- B-Pillar Location 149
- Brake, Parking 141
- Brake System 142,211
 - Anti-Lock 142
 - Fluid Check 212
 - Hoses 211
 - Master Cylinder 212
 - Warning Light 91
- Brake/Transmission Interlock 135,137
- Break-In Recommendations, New Vehicle 42
- Bulb Replacement 226
- Bulbs, Light 225

- Capacities, Antifreeze (Engine Coolant) 232
- Capacities, Fluid 232
- Capacity, Cargo Weight 166
- Car Washes 217
- Carpeting 218

- Cassette Tape and Player Maintenance 120
- Cassette Tape Player 97,105,108
- Catalytic Converter 199
- CD Changer 104,109,114,116
- CD Player 102,111,113,119
- Center High Mounted Stop Light 230
- Central Locking 13
- Chains, Tire 159
- Changing A Flat Tire 176
- Charging System Light 88
- Chart, Tire Sizing 146
- Checking Your Vehicle For Safety 42
- Child Restraint 34,36,40
- Cigar Lighter 96
- Circuit Breakers 223
- Cleaning
 - Glass 220
 - Headlights 219
 - Instrument Panel 220
- Climate Control 122
- Clock 96
- Compact Disc Changer 116
- Compact Disc Maintenance 121

- Compact Disc Player 97,102
Compact Spare Tire 155
Compass 92
Compass Calibration 94
Console 55
Contract, Service 254
Convertible 47
Convertible Boot 50
Convertible Top 47
Convertible Top Maintenance 221
Cooling System 207
 Adding Coolant (Antifreeze) 208
 Coolant Capacity 232
 Coolant Level 209
 Disposal of Used Coolant 209
 Drain, Flush, and Refill 208
 Inspection 207
 Points to Remember 210
 Pressure Cap 209
 Radiator Cap 209
 Rubber and Plastic Components 211
 Selection of Coolant 208
Corrosion Protection 216
Crankcase Emission Control System 200
Cruise Control 70
Cruise Light 87
Customer Assistance 252
Daytime Running Lights 66
Dealer Service 193
Defroster, Rear Window 124
Defroster, Windshield 43,124
Diagnostic System, Onboard 191
Dimmer Control 65
Dimmer Switch, Headlight 67
Dipsticks
 Automatic Transaxle 214
Disposal
 Antifreeze 209
 Engine Oil 197
Door Ajar Warning 14
Door Locks 12
Door Locks, Automatic 14
Door Opener, Garage 73
Drive Belts 198

Driving		
On Slippery Surfaces	184
Electrical Outlet, Auxiliary	78
Electronic Speed Control	70
Emergency Brake	141
Emergency, In Case of		
Jacking	176
Emergency Trunk Release	20,21
Emission Control System Maintenance	192,236
Engine	189,190
Block Heater	134
Break-In Recommendations	42
Checking Oil Level	194
Compartment	189,190
Cooling	207
Oil	194,232
Oil Change Interval	195
Oil Selection	196
Oil Synthetic	197
Overheating	174
Timing Belt	200
Engine Oil Viscosity	196,232
Engine Oil Viscosity Chart	196
Entry System, Illuminated	12
Exhaust Gas Caution	206
Exhaust System	206
Exterior Light Service	226
Filters		
Air Cleaner	198
Automatic Transaxle	215
Engine Fuel	198
Engine Oil	197
Flashers		
Hazard Warning	174
Flexible Fuel Vehicles		
Cruising Range	170
Engine Oil	196
Maintenance	171
Replacement Parts	171
Starting	170
Fluid Capacities	232
Fluid Leaks	43
Fluid Level Checks		
Automatic Transaxle	214

Capacities	232	Voltmeter	88
Fog Light Service	229	Gearshift	137
Fog Lights	67,229	Glass Cleaning	220
Freeing A Stuck Vehicle	185		
Fuel		Hazard Warning Flasher	174
Adding	164	Head Restraints	62
Filler Cap	164	Headlights	226
Filter	198	Aiming	232
Gauge	87	Bulb Replacement	226
Hoses	213	Cleaning	219
Light	92	High Beam	88
Tank Capacity	232	Switch	66
Fuses	223	Time Delay	67
		Heater	122
Garage Door Opener	73	High Beam Indicator	88
Gas Cap	164	Homelink Transmitter	73
Gas Gauge	87	Hood Prop	63
Gasoline, Reformulated	162	Hood Release	62
Gasoline/Oxygenate Blends	162	Hoses	211,213
Gauges			
Coolant Temperature	89	Ignition	
Fuel	87	Key	9
Tachometer	87	Lock	9

Illuminated Entry	12	Lap/Shoulder Belts	23
Immobilizer	10	LATCH	
Infant Restraint	35	(Lower Anchors and Tether for Children)	37,38
Inside Rearview Mirror	56	Leaks, Fluid	43
Instrument Cluster	84,85,86	Lights	64
Instrument Panel and Controls	83	Airbag	32,43,87
Instrument Panel Cover	220	Anti-Lock Warning	90
Instrument Panel Lens Cleaning	220	Brake Warning	91,141
Interior Fuses	223	Bulb Replacement	225
Interior Lighting	64	Check Engine	88
Interior Lights	64	Daytime Running	66
Introduction	4	Dimmer Switch, Headlight	66,67
		Exterior Check	43
Jack Location	176	Fog	67,89,229
Jack Operation	176	Front Replacement	228,229
Jump Starting	181	Headlight Switch	66
		Illuminated Entry	12
Key, Programming	11	Instrument Cluster	66
Key, Sentry	10	Interior	64
Key-In Reminder	10	License	231
Keyless Entry System	15	Lights On Reminder	67
Keys	9	Low Fuel	92
		Map Reading	64

Oil Pressure	90	Maintenance Free Battery	200
Park	228	Maintenance Procedures	194
Passing	67	Maintenance Schedule	236
Reading	64	Light Duty Schedule "B"	239
Rear Servicing	230	Schedule "A"	246
Seat Belt Reminder	91	Schedule "B"	239
Security Alarm	19	Malfunction Indicator Light	192
Service	225,226	Manual, Service	255
Service Engine Soon	88	Manual Transaxle	139,186
Theft Alarm	92	Mirrors	56
Turn Signal	67	Electric Remote	57
Voltage	88	Exterior Folding	57
Loading Vehicle	166	Outside	57
Capacities	166	Rearview	56
Tires	149	Vanity	58
Locks		Modifications/Alterations, Vehicle	6
Central	13	Mopar Parts	193,255
Door	12	Multi-Function Control Lever	66
Ignition	9	Occupant Restraints	22
Lower Anchors and Tether for Children (LATCH)	37,38	Odometer	89
Lubricants	203	Tampering	89
Luggage/Cargo Capacity	166	Trip	89

- Oil, Engine 194,232
 Capacity 232
 Change Interval 195
 Checking 194
 Disposal 197
 Filter 197
 Identification Logo 169,196
 Materials Added to 197
 Pressure Gauge 90
 Quality 169,196
 Recommendation 196
 Synthetic 197
 Onboard Diagnostic System 191,192
 Opener, Garage Door 73
 Overheating, Engine 174
 Owner's Manual 255
- Paint Care 216
 Paint Damage 216
 Panic Alarm 17
 Parking Brake 141
 Parking On Hill 141
 Passing Light 67
- Pets, Transporting 41
 Placard, Tire and Loading Information 149
 Power
 Brakes 142
 Distribution Center 223
 Door Locks 12
 Outlet 78
 Seats 60
 Steering 143
 Steering, Checking 202
 Windows 21
 Pregnant Women and Seat Belts 28
 Programmable Electronic Features 74,77
 Programming Transmitters 17,74,77
- Radial Ply Tires 155
 Radiator Cap 209
 Radio 97,105,111
 Radio Broadcast Signals 96
 Radio Operation 105,111,119
 Radio Remote Controls 118
 Rear Window Defroster 124

Recommended Fluids, Lubricants and Genuine Parts	233	Extender	28
Reformulated Gasoline	162	Inspection	43
Refrigerant	202	Reminder	91
Reminder, Seat Belt	27	Seats	58
Remote Keyless Entry	15	Adjustment	58
Remote Trunk Release	20	Cleaning	218
Replacement Tires	157	Head Restraints	62
Reporting Safety Defects	255	Lumbar Support	59
Restraints, Child	34	Power	60
Restraints, Occupant	22	Reclining	59
Rotation, Tires	159	Security Alarm	19
Safety Checks Outside Vehicle	43	Sentry Key	9,10
Safety Defects, Reporting	255	Service Assistance	252
Safety Information, Tire	145	Service Contract	254
Safety Tips	42	Service Engine Soon Light	88
Schedule, Maintenance	236	Service Manuals	255
Seat Belt Maintenance	220	Setting the Clock	96
Seat Belt Reminder	27	Side Window Demisters	125
Seat Belts	22,23,40	Slippery Surfaces, Driving On	184
And Pregnant Women	28	Snow Tires	159
Child Restraint	40	Spark Plugs	198
		Speed Control	70,87
		Speedometer	88

- Starting 132
 Cold Weather 133
 Engine Fails to Start 134
- Steering
 Power 143,202
 Tilt Column 69
- Steering Wheel Mounted Sound System
 Controls 118
- Stuck, Freeing 185
- Supplemental Restraint System - Airbag 29
- Synthetic Engine Oil 197
- Tachometer 87
- Tape Player 119
- Temperature Gauge, Engine Coolant 89,175
- Theft Alarm 19
- Theft System 19
- Tilt Steering Column 69
- Time Delay, Headlight 67
- Tire and Loading Information Placard 149
- Tire Identification Number (TIN) 148
- Tire Markings 145
- Tire Safety Information 145
- Tires 43,152,257
 Air Pressure 152
 Alignment 158
 Chains 159
 Changing 176
 Compact Spare 155
 Flat Changing 176
 General Information 152
 High Speed 154
 Inflation Pressures 153
 Load Capacity 149
 Quality Grading 257
 Radial 155
 Replacement 157
 Rotation 159
 Safety 145,152
 Sizes 146
 Snow Tires 159
 Spinning 156
 Tread Wear Indicators 157
- Top Cover 50
- Towing 185,186
 Disabled Vehicle 185

- Traction Control 70,87,144
- Trailer Towing 166
- Minimum Requirements 166
- Trailer and Tongue Weight 166
- Warnings 166
- Transaxle 213
- Additives 215
- Automatic 213
- Filter 215
- Manual 139,186
- Selection of Lubricant 214
- Transmission
- Range Indicator 89
- Transmission *See Transaxle*
- Transmitter Battery Service 18
- Transmitter, Garage Door Opener 73
- Transmitter, Remote Keyless Entry 15
- Tread Wear Indicators 157
- Trip Computer 92
- Trip Odometer 89
- Trunk Release, Emergency 20,21
- Trunk Release Remote Control 20
- Turn Signals 67,88
- Underhood Fuses 223
- Uniform Tire Quality Grades 257
- Universal Transmitter 73
- Vacuum/Vapor Harnesses 211
- Vanity Mirrors 58
- Vehicle Identification Number 6
- Vehicle Loading 149
- Vehicle Modifications/Alterations 6
- Vehicle Theft Alarm 19
- Vinyl Trim 218
- Viscosity, Engine Oil 196,232
- Voltmeter 88
- Warning, Door Ajar 14
- Warning Flasher, Hazard 174
- Warnings and Cautions 6
- Warranty Information 254
- Washers, Windshield 68,205
- Washing Vehicle 217
- Waxing and Polishing 217
- Wheel Alignment and Balance 158
- Wind Buffeting 22

Windows		Windshield Wipers	68,205
Power	21	Wiper Blade Replacement	205
Windshield Washers	68,205	Wipers, Intermittent	69