

Table of Contents

Introduction	4
---------------------	----------

Instrument Cluster	12
---------------------------	-----------

Warning lights and chimes	12
Gauges	17

Entertainment Systems	19
------------------------------	-----------

AM/FM stereo	19
AM/FM Stereo single CD/MP3 system	21
CDX6/MP3 Premium/Audiophile Pioneer system	26
Auxiliary input jack (Line in)	32
Satellite radio information	37

Climate Controls	41
-------------------------	-----------

Heater only	41
Manual heating and air conditioning	42

Lights	44
---------------	-----------

Headlamps	44
Turn signal control	48
Bulb replacement	48

Driver Controls	55
------------------------	-----------

Windshield wiper/washer control	55
Steering wheel adjustment	56
Power windows	57
Mirrors	58
Speed control	59

Locks and Security	62
---------------------------	-----------

Keys	62
Locks	62
Anti-theft system	66

Table of Contents

Seating and Safety Restraints	69
Seating	69
Safety restraints	75
Airbags	89
Child restraints	100
Tires, Wheels and Loading	118
Tire information	120
Tire inflation	122
Tire Pressure Monitoring System (TPMS)	135
Vehicle loading	140
Trailer towing	147
Recreational towing	157
Driving	159
Starting	159
Brakes	164
AdvanceTrac®	167
Transmission operation	174
Roadside Emergencies	188
Getting roadside assistance	188
Hazard flasher control	189
Fuel pump shut-off switch	190
Fuses and relays	190
Changing tires	200
Wheel lug nut torque	210
Jump starting	210
Wrecker towing	216
Customer Assistance	218
Reporting safety defects (U.S. only)	224
Reporting safety defects (Canada only)	224
Cleaning	225

Table of Contents

Maintenance and Specifications	232
Engine compartment	234
Engine oil	237
Battery	242
Engine coolant	244
Fuel information	249
Air filter(s)	265
Part numbers	267
Maintenance product specifications and capacities	268
Engine data	273
Accessories	277
Ford Extended Service Plan	279
Index	282

All rights reserved. Reproduction by any means, electronic or mechanical including photocopying, recording or by any information storage and retrieval system or translation in whole or part is not permitted without written authorization from Ford Motor Company. Ford may change the contents without notice and without incurring obligation.

Copyright © 2009 Ford Motor Company

Introduction

CONGRATULATIONS

Congratulations on acquiring your new Ford. Please take the time to get well acquainted with your vehicle by reading this handbook. The more you know and understand about your vehicle, the greater the safety and pleasure you will derive from driving it.

For more information on Ford Motor Company and its products visit the following website:

- In the United States: www.ford.com
- In Canada: www.ford.ca
- In Australia: www.ford.com.au
- In Mexico: www.ford.com.mx

Additional owner information is given in separate publications.

This Owner's Guide describes every option and model variant available and therefore some of the items covered may not apply to your particular vehicle. Furthermore, due to printing cycles it may describe options before they are generally available.

Remember to pass on this Owner's Guide when reselling the vehicle. It is an integral part of the vehicle.



WARNING: Fuel pump shut-off switch: In the event of an accident the safety switch will automatically cut off the fuel supply to the engine. The switch can also be activated through sudden vibration (e.g. collision when parking). To reset the switch, refer to the *Fuel pump shut-off switch* in the *Roadside Emergencies* chapter.

SAFETY AND ENVIRONMENT PROTECTION



Warning symbols in this guide

How can you reduce the risk of personal injury to yourself or others? In this guide, answers to such questions are contained in comments highlighted by the warning triangle symbol. These comments should be read and observed.

Warning symbols on your vehicle

When you see this symbol, it is imperative that you consult the relevant section of this guide before touching or attempting adjustment of any kind.



Protecting the environment

We must all play our part in protecting the environment. Correct vehicle usage and the authorized disposal of waste, cleaning and lubrication materials are significant steps towards this aim. Information in this respect is highlighted in this guide with the tree symbol.



CALIFORNIA Proposition 65 Warning

 **WARNING:** Engine exhaust, some of its constituents, and certain vehicle components contain or emit chemicals known to the State of California to cause cancer and birth defects or other reproductive harm. In addition, certain fluids contained in vehicles and certain products of component wear contain or emit chemicals known to the State of California to cause cancer and birth defects or other reproductive harm.

PERCHLORATE MATERIAL

Certain components of this vehicle such as airbag modules, seat belt pretensioners, and button cell batteries may contain Perchlorate Material – Special handling may apply for service or vehicle end of life disposal. See www.dtsc.ca.gov/hazardouswaste/perchlorate.

BREAKING-IN YOUR VEHICLE

Your vehicle does not need an extensive break-in. Try not to drive continuously at the same speed for the first 1,000 miles (1,600 km) of new vehicle operation. Vary your speed frequently in order to give the moving parts a chance to break in.

Drive your new vehicle at least 1,000 miles (1,600 km) before towing a trailer. For more detailed information about towing a trailer, refer to *Trailer towing* in the *Tires, Wheels and Loading* chapter.

Introduction

Do not add friction modifier compounds or special break-in oils since these additives may prevent piston ring seating. See *Engine oil* in the *Maintenance and Specifications* chapter for more information on oil usage.

SPECIAL NOTICES

New Vehicle Limited Warranty

For a detailed description of what is covered and what is not covered by your vehicle's New Vehicle Limited Warranty, refer to the *Warranty Guide/Customer Information Guide* that is provided to you along with your Owner's Guide.

Special instructions

For your added safety, your vehicle is fitted with sophisticated electronic controls.



WARNING: Please read the section *Airbag Supplemental Restraint System (SRS)* in the *Seating and Safety Restraints* chapter. Failure to follow the specific warnings and instructions could result in personal injury.



WARNING: Front seat mounted rear-facing child or infant seats should **NEVER** be placed in front of an active passenger airbag.

Notice to owners of pickup trucks and utility type vehicles



WARNING: Utility vehicles have a significantly higher rollover rate than other types of vehicles.

Before you drive your vehicle, please read this Owner's Guide carefully. Your vehicle is not a passenger car. As with other vehicles of this type, failure to operate this vehicle correctly may result in loss of vehicle control, vehicle rollover, personal injury or death.

Using your vehicle with a snowplow

Do not use this vehicle for snowplowing.

Your vehicle is not equipped with a snowplowing package.

Using your vehicle as an ambulance

Do not use this vehicle as an ambulance.

Your vehicle is not equipped with the Ford Ambulance Preparation Package.

DATA RECORDING

Service Data Recording

Service data recorders in your vehicle are capable of collecting and storing diagnostic information about your vehicle. This potentially includes information about the performance or status of various systems and modules in the vehicle, such as engine, throttle, steering or brake systems. In order to properly diagnose and service your vehicle, Ford Motor Company, Ford of Canada, and service and repair facilities may access or share among them vehicle diagnostic information received through a direct connection to your vehicle when diagnosing or servicing your vehicle. For U.S. only (if equipped), if you choose to use the SYNC® Vehicle Health Report, you consent that certain diagnostic information may also be accessed electronically by Ford Motor Company and Ford authorized service facilities, and that the diagnostic information may be used for any purpose. See your SYNC® supplement for more information.

Event Data Recording

Other modules in your vehicle — event data recorders — are capable of collecting and storing data during a crash or near crash event. The recorded information may assist in the investigation of such an event. The modules may record information about both the vehicle and the occupants, potentially including information such as:

- **how various systems in your vehicle were operating;**
- **whether or not the driver and passenger seatbelts were buckled;**
- **how far (if at all) the driver was depressing the accelerator and/or the brake pedal;**
- **how fast the vehicle was traveling;**
- **where the driver was positioning the steering wheel; and**
- **longitude and latitude of vehicle at last location, using GPS technology and advanced vehicle sensors.**

To access this information, special equipment must be directly connected to the recording modules. Ford Motor Company and

Introduction

Ford of Canada do not access event data recorder information without obtaining consent, unless pursuant to court order or where required by law enforcement, other government authorities or other third parties acting with lawful authority. Other parties may seek to access the information independently of Ford Motor Company and Ford of Canada. To the extent that any law pertaining to Event Data Recording applies to SYNC® or its features, please note the following: Once 911 Assist (if equipped) is enabled (set ON), 911 Assist may, through any paired and connected cell phone, disclose to emergency services that the vehicle has been in a crash involving the deployment of an airbag or, in certain vehicles, the activation of the fuel pump shut-off. Certain versions or updates to 911 Assist may also be capable of electronically or verbally disclosing to 911 operators the vehicle location, and/or other details about the vehicle or crash to assist 911 operators to provide the most appropriate emergency services. If you do not want to disclose this information, do not activate the feature. See your SYNC® supplement for more information. Additionally, when you connect to Traffic, Directions and Information (if equipped, U.S. only), the service uses GPS technology and advanced vehicle sensors to collect the vehicle's current location, travel direction, and speed ("vehicle travel information") only to help provide you with the directions, traffic reports, or business searches you request. If you do not want Ford or its vendors to receive this information, do not activate the service. Ford Motor Company and the vendors it uses to provide you with this information do not store your vehicle travel information. For more information, see Traffic, Directions and Information, Terms and Conditions. See your SYNC® supplement for more information.

CELL PHONE USE

The use of Mobile Communications Equipment has become increasingly important in the conduct of business and personal affairs. However, drivers must not compromise their own or others' safety when using such equipment. Mobile Communications can enhance personal safety and security when appropriately used, particularly in emergency situations. Safety must be paramount when using mobile communications equipment to avoid negating these benefits.

Mobile Communication Equipment includes, but is not limited to cellular phones, pagers, portable email devices, in-vehicle communications systems, telematics devices and portable two-way radios.



WARNING: Driving while distracted can result in loss of vehicle control, accident and injury. Ford strongly recommends that drivers use extreme caution when using any device that may take their focus off the road. The driver's primary responsibility is the safe operation of their vehicle. Only use cell phones and other devices not essential to the driving task when it is safe to do so.

EXPORT UNIQUE (NON-UNITED STATES/CANADA) VEHICLE SPECIFIC INFORMATION

For your particular global region, your vehicle may be equipped with features and options that are different from the features and options that are described in this Owner's Guide. A market unique supplement may be supplied that complements this book. By referring to the market unique supplement, if provided, you can properly identify those features, recommendations and specifications that are unique to your vehicle. This Owner's Guide is written primarily for the U.S. and Canadian Markets. Features or equipment listed as standard may be different on units built for Export. **Refer to this Owner's Guide for all other required information and warnings.**

Introduction

These are some of the symbols you may see on your vehicle.

Vehicle Symbol Glossary

Safety Alert		See Owner's Guide	
Fasten Safety Belt		Airbag - Front	
Airbag - Side		Child Seat Lower Anchor	
Child Seat Tether Anchor		Brake System	
Anti-Lock Brake System		Parking Brake System	
Brake Fluid - Non-Petroleum Based		Parking Aid System	
Stability Control System		Speed Control	
Master Lighting Switch		Hazard Warning Flasher	
Fog Lamps-Front		Fuse Compartment	
Fuel Pump Reset		Windshield Wash/Wipe	
Windshield Defrost/Demist		Rear Window Defrost/Demist	

Vehicle Symbol Glossary

Power Windows
Front/Rear



Power Window Lockout



Child Safety Door
Lock/Unlock



Interior Luggage
Compartment Release



Panic Alarm



Engine Oil



Engine Coolant



Engine Coolant
Temperature



Do Not Open When Hot



Battery



Avoid Smoking, Flames,
or Sparks



Battery Acid



Explosive Gas



Fan Warning



Power Steering Fluid



Maintain Correct Fluid
Level



Service Engine Soon



Engine Air Filter



Passenger Compartment
Air Filter



Jack



Check Fuel Cap



Low Tire Pressure
Warning



Instrument Cluster

WARNING LIGHTS AND CHIMES

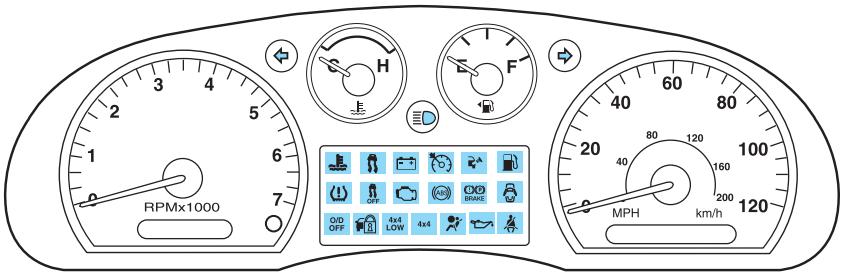



Warning lights and gauges can alert you to a vehicle condition that may become serious enough to cause expensive repairs. A warning light may illuminate when a problem exists with one of your vehicle's functions. Many lights will illuminate when you start your vehicle to make sure the bulb works. If any light remains on after starting the vehicle, refer to the respective system warning light for additional information.

Service engine soon: The service engine soon indicator 

illuminates when the ignition is first turned to the on position to check the bulb and to indicate whether the vehicle is ready for Inspection/Maintenance (I/M) testing. Normally, the service engine soon indicator will stay on until the engine is cranked, then turn itself off if no malfunctions are present. However, if after 15 seconds the service engine soon indicator blinks eight times, it means that the vehicle is not ready for I/M testing. See the *Readiness for Inspection/Maintenance (I/M) testing* in the *Maintenance and Specifications* chapter.

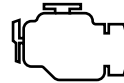
Solid illumination after the engine is started indicates the on board diagnostics system (OBD-II) has detected a malfunction. Refer to *On board diagnostics (OBD-II)* in the *Maintenance and Specifications* chapter. If the indicator is blinking, engine misfire is occurring which could damage your catalytic converter. Drive in a moderate fashion (avoid heavy acceleration and deceleration) and contact your authorized dealer as soon as possible.



 **WARNING:** Under engine misfire conditions, excessive exhaust temperatures could damage the catalytic converter, the fuel system, interior floor coverings or other vehicle components, possibly causing a fire.

Check fuel cap: Illuminates when the fuel cap may not be properly installed. Continued driving with this light on may cause the service engine soon indicator  to come on.



It may take a long period of time for the system to detect an improperly installed or properly re-installed fuel filler cap depending on driving and fuel tank level conditions. Refer to *Fuel filler cap* in the *Maintenance and Specifications* chapter.

Brake system warning light: To confirm the brake system warning light is functional, it will momentarily illuminate when the ignition is turned to the on position



when the engine is not running, or in a position between on and start, or by applying the parking brake when the ignition is turned to the on position. If the brake system warning light does not illuminate at this time, contact your authorized dealer as soon as possible. Illumination after releasing the parking brake indicates low brake fluid level or a failure to brake proportioning. Contact your authorized dealer as soon as possible.



WARNING: Driving a vehicle with the brake system warning light on is dangerous. A significant decrease in braking performance may occur. It will take you longer to stop the vehicle. Contact your authorized dealer as soon as possible. Driving extended distances with the parking brake engaged can cause brake failure and the risk of personal injury.

Anti-lock brake system: If the ABS light stays illuminated or continues to flash, a malfunction has been detected; contact your authorized dealer as soon as possible. Normal braking is still functional unless the brake warning light also is illuminated.



Instrument Cluster

Airbag readiness: If this light fails to illuminate when the ignition is turned on, continues to flash or remains on, contact your authorized dealer as soon as possible. A chime will sound when there is a malfunction in the indicator light.



Safety belt: Reminds you to fasten your safety belt. A Belt-Minder® chime will also sound to remind you to fasten your safety belt. Refer to the *Seating and Safety Restraints* chapter to activate/deactivate the Belt-Minder® chime feature.



Low tire pressure warning: Illuminates when your tire pressure is low. If the light remains on at start up or while driving, the tire pressure should be checked. Refer to *Inflating your tires* in the *Tires, Wheels and Loading* chapter. When the ignition is first turned to on, the light will illuminate for three seconds to ensure the bulb is working. If the light does not turn on, contact your authorized dealer as soon as possible. For more information on this system, refer to *Tire pressure monitoring system (TPMS)* in the *Tires, Wheels and Loading* chapter.

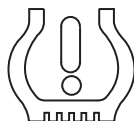

Charging system: Illuminates when the battery is not charging properly. If it stays on while the engine is running, there may be a malfunction with the charging system. Contact your authorized dealer as soon as possible. This indicates a problem with the electrical system or a related component.



Engine oil pressure: Illuminates when the oil pressure falls below the normal range. Refer to *Engine oil* in the *Maintenance and Specifications* chapter.



Engine coolant temperature (if equipped): Illuminates when the engine coolant temperature is high. Stop the vehicle as soon as possible, switch off the engine and let cool. Refer to *Engine coolant* in the *Maintenance and Specifications* chapter.





WARNING: Never remove the coolant reservoir cap while the engine is running or hot.

AdvanceTrac®/traction control:

Illuminates when the AdvanceTrac®/traction control is active. If the light remains on, contact your authorized dealer as soon as possible. Refer to the *Driving* chapter for more information.



AdvanceTrac®/traction control

off light: Illuminates when AdvanceTrac®/traction control has been disabled by the driver. Refer to the *Driving* chapter for more information.



Low fuel: Illuminates when the fuel level in the fuel tank is at or near empty. Refer to *Fuel gauge* in this chapter.



Door ajar: Illuminates when the ignition is in the on position and any door is open.



Overdrive off (if equipped):

Illuminates when the overdrive function of the transmission has been turned off; refer to the *Driving* chapter. If the light flashes steadily or does not illuminate, contact your authorized dealer as soon as possible.



Four wheel drive low (if equipped): Illuminates when four-wheel drive low is engaged.



Instrument Cluster

Four wheel drive high (if equipped): Illuminates when four-wheel drive high is engaged. It may also illuminate when the 4WD LOW is engaged. Refer to the *Driving* chapter for more information.

4x4

Anti-theft system: Flashes when the SecuriLock® Passive Anti-theft System has been activated.



Speed control (if equipped): Illuminates when the speed control is engaged. Turns off when the speed control system is disengaged.



Turn signal: Illuminates when the left or right turn signal or the hazard lights are turned on. If the indicators stay on or flash faster, check for a burned out bulb.



High beams: Illuminates when the high beam headlamps are turned on.



Key-in-ignition warning chime: Sounds when the key is left in the ignition in the off or accessory position and the driver's door is opened.

Headlamps on warning chime: Sounds when the headlamps or parking lamps are on, the ignition is off (the key is not in the ignition) and the driver's door is opened.

Door ajar warning chime: Sounds when any door is opened (or not fully closed).

Parking brake on warning chime: Sounds when the parking brake is set, the engine is running and the vehicle is driven more than 3 mph (5 km/h).

Instrument Cluster

GAUGES

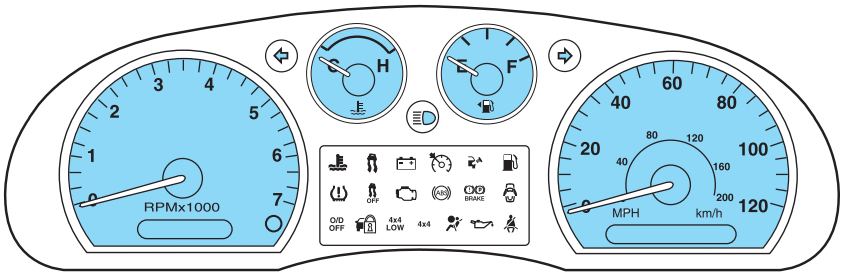

Speedometer: Indicates the current vehicle speed.

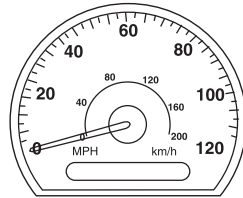

Engine coolant temperature gauge: Indicates engine coolant temperature. At normal operating temperature, the needle will be in the normal range (between “H” and “C”). **If it enters the red section, the engine is overheating. Stop the vehicle as soon as safely possible, switch off the engine and let the engine cool.** Refer to *Engine coolant* in the *Maintenance and Specifications* chapter.

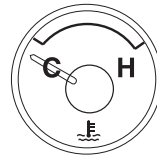

WARNING: Never remove the coolant reservoir cap while the engine is running or hot.

Odometer: Registers the total miles (kilometers) of the vehicle.



Instrument Cluster

Trip odometer: Registers the miles (kilometers) of individual journeys. Press the button once until TRIP appears in the display (this represents the trip mode). To reset the trip, press and hold the control again for approximately two seconds, until the trip reading is 0.0 miles (kilometers). To switch between trip and odometer, press and release the control.

RPMx1000
0.0



Tachometer: Indicates the engine speed in revolutions per minute. Driving with your tachometer pointer continuously at the top of the scale may damage the engine.

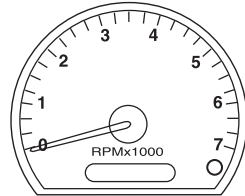

Fuel gauge: Indicates approximately how much fuel is left in the fuel tank (when the ignition is in the on position). The fuel gauge may vary slightly when the vehicle is in motion or on a grade.

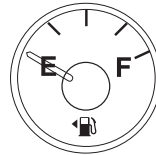

Proper gauge indication requires the ignition to be in the off or accessory position during refueling, otherwise correct fuel indication after refueling can be slow to update. Also, a minimum of three gallons (11 liters) is needed for correct indication after refueling.

The arrow near the fuel pump icon indicates which side of the vehicle the fuel filler door is located.

Refer to *Filling the tank* in the *Maintenance and Specifications* chapter for more information.

Entertainment Systems

AUDIO SYSTEMS

AM/FM stereo (if equipped)

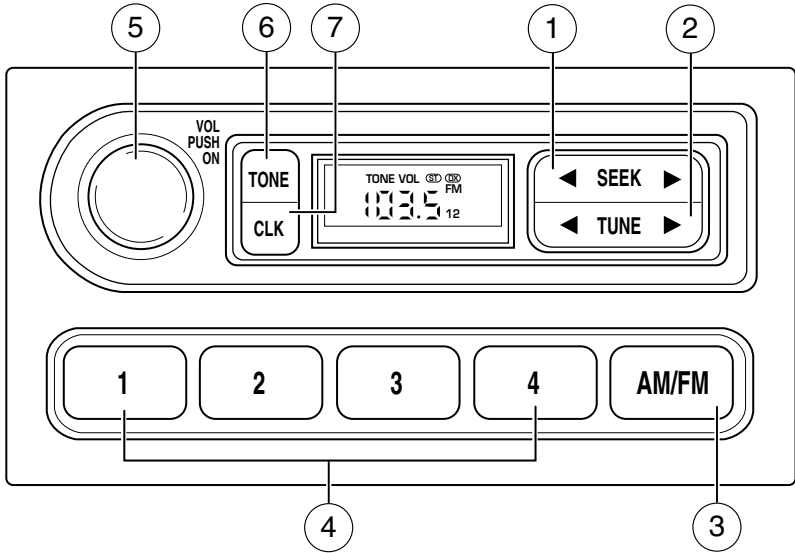

WARNING: Driving while distracted can result in loss of vehicle control, accident and injury. Ford strongly recommends that drivers use extreme caution when using any device that may take their focus off the road. The driver's primary responsibility is the safe operation of their vehicle. Only use cell phones and other devices not essential to the driving task when it is safe to do so.

1. **Seek:** Press ◀ / ▶ to find the next strong station down/up the frequency band.



2. **Tune:** Press ◀ / ▶ to manually change radio frequency down/up.



Entertainment Systems

3. **AM/FM:** Press to choose a frequency band in radio mode.



4. **Memory preset buttons:** To set a station: Select frequency band AM/FM1/FM2; tune to a station, press and hold a preset button until sound returns.



5. **Power/volume:** Press to turn ON/OFF; turn to increase or decrease volume levels.



6. **Tone:** Press TONE until the desired level — Bass, Treble, Bal appears on the display. Turn the volume control to raise/lower the levels, or to move the audio sound from the right to left.

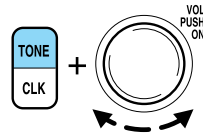

7. **CLK (Clock):** To set the hours, press and hold CLK until CLOCK SET appears in the display. Continue to hold CLK as you press SEEK to decrease ◀ or increase ▶ the hours.



To set the minutes, press and hold CLK until CLOCK SET appears in the display. Continue to hold CLK as you press TUNE to decrease ◀ or increase ▶ the minutes.

Entertainment Systems

AM/FM stereo single CD/MP3 Satellite Compatible system (if equipped)

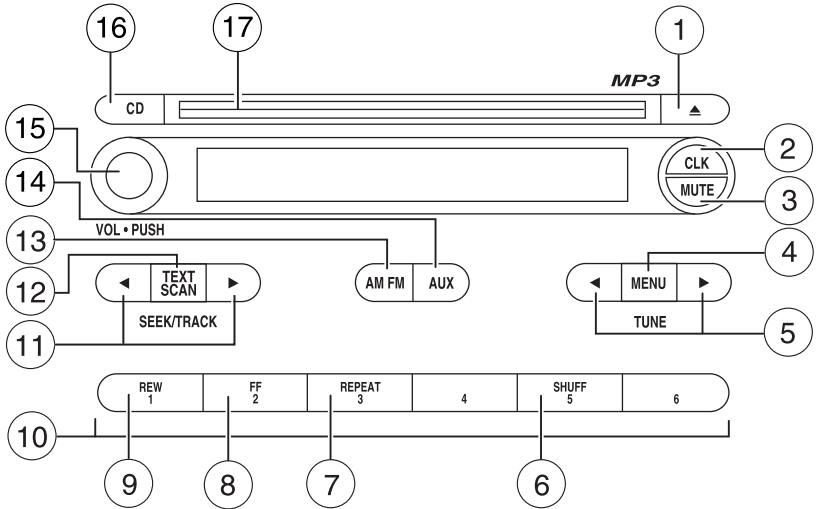

WARNING: Driving while distracted can result in loss of vehicle control, accident and injury. Ford strongly recommends that drivers use extreme caution when using any device that may take their focus off the road. The driver's primary responsibility is the safe operation of their vehicle. Only use cell phones and other devices not essential to the driving task when it is safe to do so.

1. **CD eject:** Press to eject the CD.



2. **CLK (Clock):** Press CLK until SELECT HOUR or SELECT MINS is displayed. Press

◀ MENU ▶ to adjust the

hours/minutes. Press CLK to display the time when the ignition is off.



Entertainment Systems

3. **MUTE:** Press to mute the playing media. Press again to return to the playing media.



4. **MENU:** Press MENU repeatedly to scroll through the following modes and use ◀ MENU ▶ to make an adjustment in those modes.



SATELLITE RADIO MENU (if equipped): Press MENU repeatedly when satellite radio mode is active until SAT MENU is displayed. Press SEEK ▶ or preset #6 to enter into the satellite radio menu. Press ◀ MENU ▶ to cycle through the following options:



- **CATEGORY:** Press SEEK ▶ or preset #6 to enter category mode. Press ◀ MENU ▶ to scroll through the list of available SIRIUS® channel Categories (Pop, Rock, News, etc.) Press SEEK ▶ or preset #6 when the desired category appears in the display. After a category is selected, press SEEK to search for that specific category of channels only (i.e. ROCK). You may also select CATEGORY ALL to seek all available SIRIUS® categories and channels.
- **SAVE SONG:** Press SEEK ▶ or preset #6 to save the currently playing song title in the system's memory. (If you try to save something other than a song, CANT SAVE will appear in the display.) When the chosen song is playing on any satellite radio channel, the system will alert you with an audible prompt. Press SEEK ▶ or preset #6 while SONG ALERT is in the display and the system will take you to the channel playing the desired song. You can save up to 20 song titles. If you attempt to save a song when the system is full, the display will read REPLACE SONG? Press SEEK ▶ or preset #6 to access the saved songs and press ◀ MENU ▶ to cycle through the saved songs. When the song appears in the display that you would like to replace, press SEEK ▶ or preset #6. SONG REPLACED will appear in the display.
- **DELETE SONG:** Press SEEK ▶ or preset #6 to delete a song title from the system's memory. Press ◀ MENU ▶ to cycle through the saved songs. When the song title appears in the display that you

Entertainment Systems

would like to delete, press SEEK ► or preset #6. The song will appear in the display for confirmation. Press SEEK ► or preset #6 again and the display will read SONG DELETED. If you do not want to delete the currently listed song, press ◀ MENU ► to select either RETURN or CANCEL.

Note: If there are no songs presently saved, the display will read NO SONGS.

- **DELETE ALL SONGS:** Press SEEK ► or preset #6 to delete all song titles from the system's memory. The display will read ARE YOU SURE ? Press SEEK ► or preset #6 to confirm deletion of all saved songs and the display will read ALL DELETED.

Note: If there are no songs presently saved, the display will read NO SONGS.

- **ENABLE ALERTS / DISABLE ALERTS:** Press SEEK ► or preset #6 to enable/disable the satellite alert status which alerts you when your selected songs are playing on a satellite radio channel. (The system default is disabled.) SONG ALERTS ENABLED/DISABLED will appear in the display. The menu listing will display the opposite state. For example, if you have chosen to enable the song alerts, the menu listing will read DISABLE as the alerts are currently on, so your other option is to turn them off.

Satellite radio is available only with a valid SIRIUS® radio subscription. Check with your authorized dealer for availability.

Autoset: Press ◀ MENU ► to set the strongest local radio stations for AM/FM1/FM2 without losing your original manually set preset stations.

When the six strongest stations are filled, the station stored in preset #1 will begin playing. If there are less than six strong stations, the system will store the last one in the remaining presets.

Bass: Press ◀ MENU ► to decrease/increase the bass setting.

Treble: Press ◀ MENU ► to decrease/increase the treble setting.

Balance: Press ◀ MENU ► to adjust the audio between the left and right speakers.

Fade: Press ◀ MENU ► to adjust the audio between the front and rear speakers.

Next/previous directory: In MP3 mode, press ◀ MENU ► to go to the previous/next directory.

Entertainment Systems

Flat file/directory mode: In MP3 mode, use ◀ MENU ▶ to select flat file mode or directory mode.

Normal / Track title / File name: Use ◀ / ▶ to scroll through MP3 display options (track #, normal music name or file name).

5. **TUNE:** Press to manually go down/up (◀ / ▶) the radio frequency and also to select various settings in menu mode.

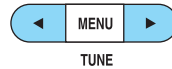

6. **SHUFF (Shuffle):** Press to play the current CD/MP3 tracks in random order. In MP3 directory mode, press to play the tracks within the current directory in random order.



7. **REPEAT:** Press to repeat the current CD/MP3 track. The selection will repeat continuously until deactivated. Press REPEAT again to deactivate.



8. **FF (Fast forward):** Press to manually advance in a CD/MP3 track.



9. **REW (Rewind):** Press to manually reverse in a CD/MP3 track.



10. **Memory presets:** To set a station: Select frequency band AM/FM; tune to a station, press and hold a preset button until sound returns. To recall a previously set station, press the desired memory preset button briefly. You can save up to 18 stations, six in AM, six in FM1 and FM2.



In satellite radio mode (if equipped), there are 18 available presets, six each for SAT1, SAT2 and SAT3. To save satellite channels in your memory presets, tune to the desired channel then press and hold a preset control until sound returns.

Satellite radio is available only with a valid SIRIUS® subscription. Check with your authorized dealer for availability.

11. **SEEK/TRACK:** Press to access the previous/next (◀/▶) strong station. In CD/MP3 mode, press to advance to the previous/next (◀/▶) track.



In satellite radio mode (if equipped), press ◀ SEEK ▶ to seek to the previous/next channel.

In CATEGORY MODE, press ◀ SEEK ▶ to select a channel within that category. Press and hold ◀ SEEK ▶ to fast seek through the previous /next channels.

In TEXT MODE, press ◀ SEEK ▶ to view the previous/additional display text.

Satellite radio is available only with a valid SIRIUS® subscription. Check with your authorized dealer for availability.

12. **TEXT/SCAN: In radio and CD mode,** press for a brief sampling of radio stations or CD tracks. Press again to stop.



In MP3 mode, press and release to view the next 12 characters in the MP3 music name/file name of the current MP3 track and directory. Press and hold to hear a brief sampling of MP3 tracks.

In MP3 directory mode, press and hold to hear a brief sampling of all tracks in the current directory. Press and hold again to stop.

In satellite radio mode (if equipped), press and release to view the Satellite text message. Press and hold to hear a brief sampling of the next channels. Press and hold again to stop

13. **AM/FM:** Press to select AM/FM1/FM2 frequency band.



14. **AUX:** Press repeatedly to scroll through SAT1, SAT2, SAT3 (Satellite Radio modes, if equipped) and LINE IN (Auxiliary audio mode, if equipped).



For further information on Auxiliary audio mode, refer to *Auxiliary input jack* later in this chapter.

Satellite radio is available only with a valid SIRIUS® subscription. Check with your authorized dealer for availability.

Entertainment Systems

15. **ON/OFF/Volume:** Press to turn on/off. Turn to increase/decrease volume.

If the volume is set above a certain level and the ignition is turned off, the volume will come back on at a “nominal” listening level when the ignition switch is turned back on.



VOL - PUSH

16. **CD:** Press to enter CD/MP3 mode. If a CD is already present in the system, the disc will begin to play.



17. **CD slot:** Insert a CD label side up.

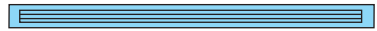

Premium / Premium sound In-dash CD6/MP3 disc satellite compatible audio systems (if equipped)

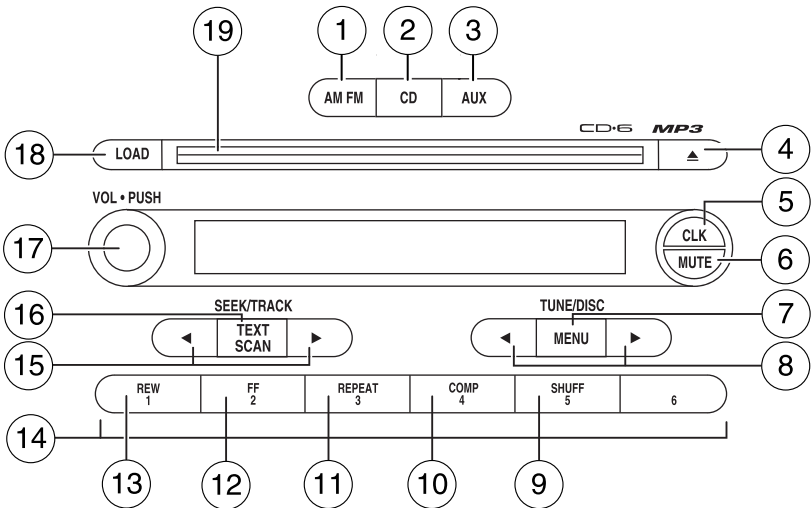

Entertainment Systems



WARNING: Driving while distracted can result in loss of vehicle control, accident and injury. Ford strongly recommends that drivers use extreme caution when using any device that may take their focus off the road. The driver's primary responsibility is the safe operation of their vehicle. Only use cell phones and other devices not essential to the driving task when it is safe to do so.

1. **AM/FM:** Press to select AM/FM1/FM2 frequency bands.

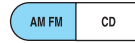

2. **CD:** Press to enter CD/MP3 mode. If a CD is already in the system, the disc will start playing.

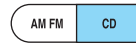

3. **AUX:** Press AUX repeatedly to cycle through SAT1, SAT2, SAT3 (Satellite radio modes, if equipped) and LINE IN (Auxiliary audio mode, if equipped).



For more information on Auxiliary audio mode, refer to *Auxiliary input jack* later in this chapter.

Satellite radio is available only with a valid SIRIUS® subscription. Check with your authorized dealer for availability.

4. **EJ** (CD eject): To eject an individual CD, press the eject control and select the correct slot number by pressing the corresponding memory preset. Press and hold to eject all loaded CDs.



5. **CLK (Clock):** Press CLK until SELECT HOUR or SELECT MINS is displayed. Press ◀ MENU ▶ to adjust the hours/minutes. Press CLK to display the time when the ignition is off.



6. **MUTE:** Press to mute the playing media. Press again to return to the playing media.



Entertainment Systems

7. **MENU:** Press MENU repeatedly to cycle through the following modes and use ◀/▶ to make adjustment in those modes.



SATELLITE RADIO MENU (if equipped):

Press MENU when satellite radio mode is active to access. Press SEEK ▶ to enter

into the satellite radio menu. Press ◀/▶ to cycle through the following options:



- **CATEGORY:** Press SEEK ▶ or preset #6 to enter category mode. Press ◀ MENU ▶ to scroll through the list of available SIRIUS® channel Categories (Pop, Rock, News, etc.) Press SEEK ▶ or preset #6 when the desired category appears in the display. After a category is selected, press SEEK to search for that specific category of channels only (i.e. ROCK). You may also select CATEGORY ALL to seek all available SIRIUS® categories and channels.
- **SAVE SONG:** Press SEEK ▶ or preset #6 to save the currently playing song title in the system's memory. (If you try to save something other than a song, CANT SAVE will appear in the display.) When the chosen song is playing on any satellite radio channel, the system will alert you with an audible prompt. Press SEEK ▶ or preset #6 while SONG ALERT is in the display and the system will take you to the channel playing the desired song. You can save up to 20 song titles. If you attempt to save a song when the system is full, the display will read REPLACE SONG? Press SEEK ▶ or preset #6 to access the saved songs and press ◀ MENU ▶ to cycle through the saved songs. When the song appears in the display that you would like to replace, press SEEK ▶ or preset #6. SONG REPLACED will appear in the display.

Entertainment Systems

- **DELETE SONG:** Press SEEK ► or preset #6 to delete a song title from the system's memory. Press ◀ MENU ► to cycle through the saved songs. When the song title appears in the display that you would like to delete, press SEEK ► or preset #6. The song will appear in the display for confirmation. Press SEEK ► or preset #6 again and the display will read SONG DELETED. If you do not want to delete the currently listed song, press ◀ MENU ► to select either RETURN or CANCEL.
Note: If there are no songs presently saved, the display will read NO SONGS.
- **DELETE ALL SONGS:** Press SEEK ► or preset #6 to delete all song titles from the system's memory. The display will read ARE YOU SURE ? Press SEEK ► or preset #6 to confirm deletion of all saved songs and the display will read ALL DELETED.
Note: If there are no songs presently saved, the display will read NO SONGS.
- **ENABLE ALERTS / DISABLE ALERTS:** Press SEEK ► or preset #6 to enable/disable the satellite alert status which alerts you when your selected songs are playing on a satellite radio channel. (The system default is disabled.) SONG ALERTS ENABLED/DISABLED will appear in the display. The menu listing will display the opposite state. For example, if you have chosen to enable the song alerts, the menu listing will read DISABLE as the alerts are currently on, so your other option is to turn them off.

Satellite radio is available only with a valid SIRIUS® radio subscription. Check with your authorized dealer for availability.

AUTOSET: Allows you to set the strongest local radio stations without losing your original manually set preset stations for AM/FM1/FM2 . Press MENU to access. Use ◀ MENU ► to set.

When the six strongest stations are filled, the station stored in preset #1 will begin playing. If there are less than six strong stations, the system will store the last one in the remaining presets.

BASS: Press ◀ MENU ► to decrease/increase the bass setting.

TREBLE: Press ◀ MENU ► to decrease/increase the treble setting.

BALANCE: Press ◀ MENU ► to adjust the audio between the left and right speakers.

FADE: Press ◀ MENU ► to adjust the audio between the front and rear speakers.

Entertainment Systems

Next/previous directory: In MP3 mode, press MENU ◀ / ▶ to go to the previous/next directory.

Flat file/directory mode: In MP3 mode, press MENU to access this feature. Use ◀ MENU ▶ to select flat file mode or directory mode.

Track #/ normal music name/file name: Press MENU to access and use ◀ / ▶ to scroll through MP3 display options (track #, normal music name or file name).

8. **TUNE/DISC:** Press to manually go down/up (◀ / ▶) the radio frequency, or to access another CD. Also use in menu mode to select various settings.

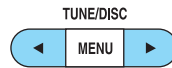

In **CATEGORY ALL**, press ◀ / ▶ to scroll through the list of available SIRIUS® channel categories (Pop, Rock, News, etc.). Refer to *Category* under *Menu* for further information.

9. **SHUFF (Shuffle):** Press to play the tracks on the current CD in random order. In **MP3 directory mode**, press to play the tracks within the current directory in random order.



10. **COMP (Compression):** In CD/MP3 modes, press to bring loud and soft passages together for a more consistent listening level.



11. **REPEAT:** Press to repeat the current CD/MP3 track. The selection will repeat continuously until deactivated. Press REPEAT again to deactivate.



12. **FF (Fast forward):** Press to manually advance in a CD/MP3 track.



13. **REW (Rewind):** Press to manually reverse in a CD/MP3 track.



Entertainment Systems

14. Memory presets: To set a station: Select frequency band AM/FM; tune to a station, press and hold a preset button until sound returns. To select a preset station, press the desired memory preset. You can save up to 18 stations, six in AM, six in FM1 and FM2.



In satellite radio mode (if equipped), there are 18 available presets, six each for SAT1, SAT2 and SAT3. To save satellite channels in your memory presets, tune to the desired channel then press and hold a preset control until sound returns.

Satellite radio is available only with a valid SIRIUS® subscription. Check with your authorized dealer for availability.

15. SEEK/TRACK: In radio, CD and MP3 flat file mode,

press ◀/▶ to access the previous/next strong station or track. **In MP3 directory mode,** press to select the next/previous track in the current directory.



In satellite radio mode (if equipped), press ◀ SEEK ▶ to seek to the previous/next channel. **In CATEGORY MODE,** press ◀ SEEK ▶ to select a channel within the chosen category. Press and hold ◀ SEEK ▶ to fast seek through the previous /next channels.

In TEXT MODE, press ◀ SEEK ▶ to view the previous/additional display text.

Satellite radio is available only with a valid SIRIUS® subscription. Check with your authorized dealer for availability.

16. TEXT/SCAN: In radio and CD mode, press for a brief sampling of radio stations or CD tracks. Press again to stop.



In MP3 mode, Press and release to view the next 12 characters in the MP3 music name/file name of the current MP3 track and directory. Press and hold to hear a brief sampling of MP3 tracks.

In MP3 directory mode, press and hold to hear a brief sampling of all tracks in the current directory. Press and hold again to stop.

In satellite radio mode (if equipped), press and release to view the Satellite text message. Press and hold to hear a brief sampling of the next channels. Press and hold again to stop.

Entertainment Systems

Satellite radio is available only with a valid SIRIUS® subscription. Check with your authorized dealer for availability.

17. ON/OFF/Volume: Press to turn on/off. Turn to increase/decrease volume.

VOL - PUSH



If the volume is set above a certain level and the ignition is turned off, the volume will come back on at a “nominal” listening level when the ignition switch is turned back on.

18. LOAD: Press to load a CD. To load a CD disc to a specific slot, press LOAD and select the slot number by pressing the memory preset buttons. Press and hold LOAD to autoloop up to six discs.



19. CD slot: Insert a CD, label side up.



Auxiliary input jack (Line in)-(if equipped)



WARNING: Driving while distracted can result in loss of vehicle control, accident and injury. Ford strongly recommends that drivers use extreme caution when using any device that may take their focus off the road. The driver's primary responsibility is the safe operation of their vehicle. Only use cell phones and other devices not essential to the driving task when it is safe to do so.

Your vehicle may be equipped with an auxiliary input jack (AIJ). The auxiliary input jack provides a way to connect your portable music player to the in-vehicle audio system. This allows the audio from a portable music player to be played through the vehicle speakers with high fidelity. To achieve optimal performance, please observe the following instructions when attaching your portable music device to the audio system.

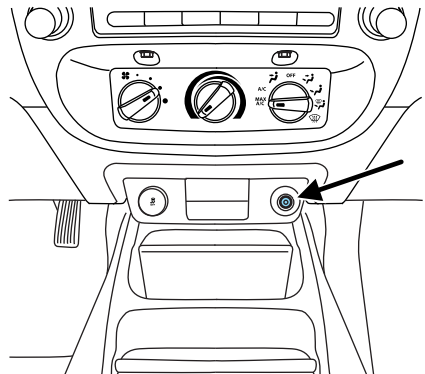

Required equipment:

1. Any portable music player designed to be used with headphones
2. An audio extension cable with stereo male 1/8 in. (3.5 mm) connectors at each end

To play your portable music player using the auxiliary input jack:

1. Begin with the vehicle parked and the radio turned off.
2. Ensure that the battery in your portable music player is new or fully charged and that the device is turned off.
3. Attach one end of the audio extension cable to the headphone output of your player and the other end of the audio extension cable to the AIJ in your vehicle.
4. Turn the radio on, using either a tuned FM station or a CD loaded into the system. Adjust the volume to a comfortable listening level.
5. Turn the portable music player on and adjust the volume to 1/2 the volume.
6. Press AUX on the vehicle radio repeatedly until LINE IN appears in the display.
You should hear audio from your portable music player although it may be low.
7. Adjust the sound on your portable music player until it reaches the level of the FM station or CD by switching back and forth between the AUX and FM or CD controls.

Troubleshooting:

1. Do not connect the audio input jack to a line level output. Line level outputs are intended for connection to a home stereo and are not compatible with the AIJ. The AIJ will only work correctly with devices that have a headphone output with a volume control.
2. Do not set the portable music player's volume level higher than is necessary to match the volume of the CD or FM radio in your audio system as this will cause distortion and will reduce sound quality. Many portable music players have different output levels, so not all players should be set at the same levels. Some players will sound best at full volume and others will need to be set at a lower volume.
3. If the music sounds distorted at lower listening levels, turn the portable music player volume down. If the problems persists, replace or recharge the batteries in the portable music player.
4. The portable music player must be controlled in the same manner when it is used with headphones as the AIJ does not provide control (play, pause, etc.) over the attached portable music player.

Entertainment Systems

5. For safety reasons, connecting or adjusting the settings on your portable music player should not be attempted while the vehicle is moving. Also, the portable music player should be stored in a secure location, such as the center console or the glove box, when the vehicle is in motion. The audio extension cable must be long enough to allow the portable music player to be safely stored while the vehicle is in motion.

GENERAL AUDIO INFORMATION

Radio frequencies:

AM and FM frequencies are established by the Federal Communications Commission (FCC) and the Canadian Radio and Telecommunications Commission (CRTC). Those frequencies are:

AM: 530, 540–1700, 1710 kHz

FM: 87.7, 87.9–107.7, 107.9 MHz

Radio reception factors:

There are three factors that can affect radio reception:

- Distance/strength: The further you travel from an FM station, the weaker the signal and the weaker the reception.
- Terrain: Hills, mountains, tall buildings, power lines, electric fences, traffic lights and thunderstorms can interfere with your reception.
- Station overload: When you pass a broadcast tower, a stronger signal may overtake a weaker one and play while the weak station frequency is displayed.

CD/CD player care

Do:

- Handle discs by their edges only. (Never touch the playing surface).
- Inspect discs before playing.
- Clean only with an approved CD cleaner.

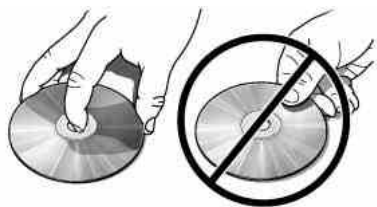

Entertainment Systems

- Wipe discs from the center out.



Don't:

- Expose discs to direct sunlight or heat sources for extended periods of time.
- Clean using a circular motion.

CD units are designed to play commercially pressed 4.75 in (12 cm) audio compact discs only. Due to technical incompatibility, certain recordable and re-recordable compact discs may not function correctly when used in Ford CD players.

Do not use any irregular shaped CDs or discs with a scratch protection film attached.

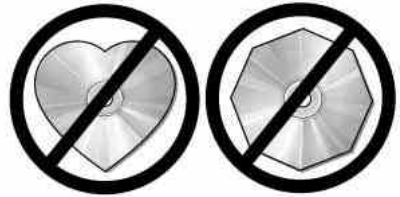

CDs with homemade paper (adhesive) labels should not be inserted into the CD player as the label may peel and cause the CD to become jammed. It is recommended that homemade CDs be identified with permanent felt tip marker rather than adhesive labels. Ballpoint pens may damage CDs. Please contact your authorized dealer for further information.

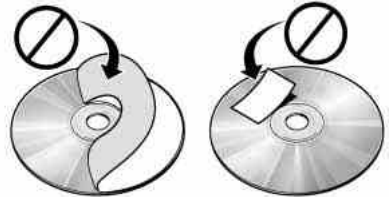

Audio system warranty and service

Refer to the *Warranty Guide/Customer Information Guide* for audio system warranty information. If service is necessary, see your dealer or qualified technician.

Entertainment Systems

Operating your audio system with MP3-formatted discs

Your MP3 system recognizes MP3 discs upon insertion and provides you with two ways to listen to these discs:

- **Flat file mode**– This mode ignores any folders on the discs and plays all MP3 files found in any folder on the disc exactly as if there were no folders on the disc.

When in flat file mode press ◀ / ▶ to access the previous/next track.

- **Directory mode**– This mode finds all of the folders on the disc and then allows you to pick any folder on the disc and play only the MP3 files in that folder.

When in directory mode press ◀ / ▶ to access the previous/next MP3 file in the current folder only.

To change directories (folders), press MENU and then press ◀ / ▶ to select the desired directory (folder).

Changing between flat file mode and directory mode

Your radio MP3 system will default to directory mode when an MP3 disc is first inserted. When the MP3 system is in directory mode, the **DIR** icon will be illuminated on the radio display.

- To change from directory mode to flat file mode while playing an MP3 CD: Press MENU until the radio display reads **Directory**. Then press ▶. The display will change from **DIR** to **Flat File**. The MP3 system is now in flat file mode.
- To change from flat file mode to directory mode while playing an MP3 CD: Press MENU until the radio display reads **Flat File**. Then press ▶. The display will change from **Flat File** to **DIR**. The MP3 system is now in directory mode.

MP3 track and folder structure

Your MP3 system recognizes MP3 individual tracks and folder structure as follows:

- There are two different modes for MP3 disc playback: MP3 directory mode (system default) and MP3 flat file mode. For more information on directory and flat file mode, refer to *Sample MP3 structure* following.

- MP3 flat file mode ignores any folder structure on the MP3 disc. The player numbers each MP3 track on the disc (noted by the .mp3 file extension) from T001 to a maximum of T255.
Note: The maximum number of playable MP3 files may be less depending on the structure of the CD and exact model of radio present.
- MP3 directory mode represents a folder structure consisting of one level of folders. The CD player numbers all MP3 tracks on the disc (noted by the .mp3 file extension) and all folders containing MP3 files, from F001 (folder) T001 (track) to F253 T255.
- Creating discs with only one level of folders will help with navigation through the disc files.

Sample MP3 structure

If you are burning your own MP3 discs, it is important to understand how the system will read the structures you create. While various files may be present, (files with extensions other than mp3), only files with the .mp3 extension will be played. Other files will be ignored by the system. This enables you to use the same MP3 disc for a variety of tasks on your work computer, home computer and your in vehicle system.

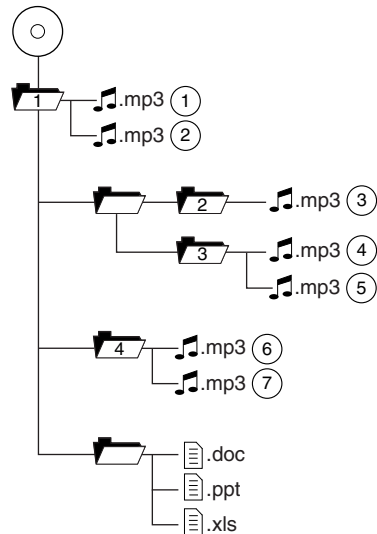

In flat file mode, the system will display and play the structure as if it were only one level deep (all .mp3 files will be played, regardless of being in a specific folder. In directory mode, the system will only play the .mp3 files in the current folder.

Satellite radio information (if equipped)

Satellite radio channels: SIRIUS® broadcasts a variety of music, news, sports, weather, traffic and entertainment satellite radio channels. For

Entertainment Systems

more information and a complete list of SIRIUS® satellite radio channels, visit www.sirius.com in the United States, www.sirius-canada.ca in Canada, or call SIRIUS® at 1-888-539-7474.

Satellite radio reception factors: To receive the satellite signal, your vehicle has been equipped with a satellite radio antenna located on the roof of your vehicle. The vehicle roof provides the best location for an unobstructed, open view of the sky, a requirement of a satellite radio system. Like AM/FM, there are several factors that can affect satellite radio reception performance:

- **Antenna obstructions:** For optimal reception performance, keep the antenna clear of snow and ice build-up and keep luggage and other material as far away from the antenna as possible.
- **Terrain:** Hills, mountains, tall buildings, bridges, tunnels, freeway overpasses, parking garages, dense tree foliage and thunderstorms can interfere with your reception.
- **Station overload:** When you pass a ground based broadcast repeating tower, a stronger signal may overtake a weaker one and result in an audio mute.

Unlike AM/FM audible static, you will hear an audio mute when there is a satellite radio signal interference. Your radio display may display NO SIGNAL to indicate the interference.

SIRIUS® satellite radio service: SIRIUS® satellite radio is a subscription based satellite radio service that broadcasts music, sports, news and entertainment programming. A service fee is required in order to receive SIRIUS® service. Vehicles that are equipped with a factory installed SIRIUS® satellite radio system include hardware and a limited subscription term, which begins on the date of sale or lease of the vehicle.

For information on extended subscription terms, the online media player and other SIRIUS® features, please contact SIRIUS® at 1-888-539-7474.

Note: SIRIUS® reserves the unrestricted right to change, rearrange, add or delete programming including canceling, moving or adding particular channels, and its prices, at any time, with or without notice to you. Ford Motor Company shall not be responsible for any such programming changes.

Satellite radio electronic serial number (ESN): This 12-digit Satellite Serial Number is needed to activate, modify or track your satellite radio account. You will need this number when communicating with SIRIUS®. While in satellite radio mode, you can view this number on the radio display by pressing the AUX and preset 1 controls simultaneously.

Entertainment Systems

Radio Display	Condition	Action Required
ACQUIRING	Radio requires more than two seconds to produce audio for the selected channel.	No action required. This message should disappear shortly.
SAT FAULT	Internal module or system failure present.	If this message does not clear within a short period of time, or with an ignition key cycle, your receiver may have a fault. See your authorized dealer for service.
INVALID CHNL	Channel no longer available.	This previously available channel is no longer available. Tune to another channel. If the channel was one of your presets, you may choose another channel for that preset button.
UNSUBSCRIBED	Subscription not available for this channel.	Contact SIRIUS® at 1-888-539-7474 to subscribe to the channel or tune to another channel.
NO TEXT	Artist information not available.	Artist information not available at this time on this channel. The system is working properly.

Entertainment Systems

Radio Display	Condition	Action Required
NO TEXT	Song title information not available.	Song title information not available at this time on this channel. The system is working properly.
NO TEXT	Category information not available.	Category information not available at this time on this channel. The system is working properly.
NO SIGNAL	Loss of signal from the SIRIUS® satellite or SIRIUS® tower to the vehicle antenna.	You are in a location that is blocking the SIRIUS® signal (i.e., tunnel, under an overpass, dense foliage, etc). The system is working properly. When you move into an open area, the signal should return.
UPDATING	Update of channel programming in progress.	No action required. The process may take up to three minutes.
CALL SIRIUS® 1-888-539-7474	Satellite service has been deactivated by SIRIUS® satellite radio.	Call SIRIUS® at 1-888-539-7474 to re-activate or resolve subscription issues.

Climate Controls

HEATER ONLY SYSTEM (IF EQUIPPED)

1. **Fan speed adjustment:** Controls the volume of air circulated in the vehicle.

2. **Temperature selection:**
Controls the temperature of the airflow in the vehicle.

3. **Air flow selections:** Controls the direction of the airflow in the vehicle. See the following for a brief description on each control.

 : Distributes outside air through the instrument panel vents.

OFF: Outside air is shut out and the fan will not operate.

 : Distributes outside air through the instrument panel vents and the floor vents.

 : Distributes outside air through the floor vents.

 : Distributes outside air through the windshield defroster vents and floor vents.

 : Distributes outside air through the windshield defroster vents.

Operating tips

- To reduce fog build-up on the windshield during humid weather, place the air flow selector in the  position.
- To reduce humidity build-up inside the vehicle during cold or warm weather, do not drive with the air flow selector in the OFF position.
- Under normal weather conditions, do not leave the air flow selector in OFF when the vehicle is parked. This allows the vehicle to “breathe” using the outside air inlet vents.
- Do not put objects under the front seats that will interfere with the air flow to the back seats.
- Remove any snow, ice or leaves from the air intake area at the base of the windshield.

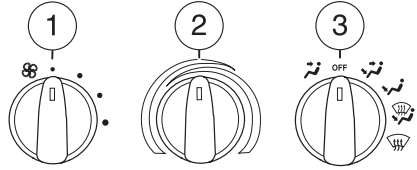

Climate Controls

To aid in side window defogging/demisting in cold weather:

1. Select .
2. Adjust the temperature control to maintain comfort.
3. Set the fan speed to the highest setting.
4. Direct the outer instrument panel vents towards the side windows.

To increase airflow to the outer instrument panel vents, close the vents located in the middle of the instrument panel.

MANUAL HEATING AND AIR CONDITIONING SYSTEM (IF EQUIPPED)

1. **Fan speed adjustment:** Controls the volume of air circulated in the vehicle.

2. **Temperature selection:** Controls the temperature of the airflow in the vehicle.

3. **Air flow selections:** Controls the direction of the airflow in the vehicle. See the following for a brief description on each control.

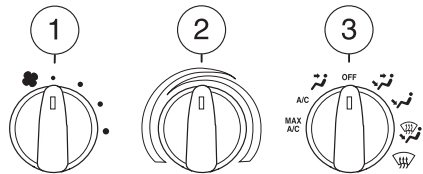

MAX A/C: Uses recirculated air to cool the vehicle. Air flows from the instrument panel vents only. Temperature of airflow not adjustable.

A/C: Uses outside air to cool the vehicle. Air flows from the instrument panel vents only.

 : Distributes outside air through the instrument panel vents.

OFF: Outside air is shut out and the fan will not operate.

 : Distributes outside air through the instrument panel vents and the floor vents.

 : Distributes outside air through the floor vents.

 : Distributes outside air through the windshield defroster vents and floor vents.

 : Distributes outside air through the windshield defroster vents.

Operating tips

- To reduce fog build-up on the windshield during humid weather, place the air flow selector in the  position.
- To reduce humidity build-up inside the vehicle: do not drive with the air flow selector in the OFF position.
- Under normal weather conditions, do not leave the air flow selector in MAX A/C or OFF when the vehicle is parked. This allows the vehicle to “breathe” using the outside air inlet vents.
- Do not put objects under the front seats that will interfere with the airflow to the back seats.
- Remove any snow, ice or leaves from the air intake area at the base of the windshield.

During extreme high ambient temperatures when idling stationary for extended periods of time in gear, it is recommended to run the A/C in the MAX A/C position, reduce blower fan speed from the highest setting and put the vehicle’s transmission into the P (Park) gear position (automatic transmission only) to continue to receive cool air from your A/C system.

To aid in side window defogging/demisting in cold weather:

1. Select .
2. Adjust the temperature control to maintain comfort.
3. Set the highest fan speed.
4. Direct the outer instrument panel vents towards the side windows.

To increase airflow to the outer instrument panel vents, close the vents located in the middle of the instrument panel.

Lights

HEADLAMP CONTROL

○ Turns the lamps off.

P≡ Turns on the parking lamps, instrument panel lamps, license plate lamps and tail lamps.

≡D Turns the low beam headlamps on.

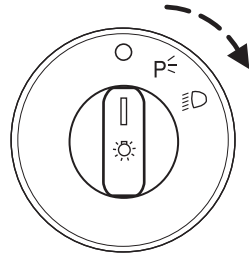

Fog lamp control (if equipped)

The fog lamps can be turned on when the headlamp control is in the ≡D or P≡ position and the high beams are not turned on.

Pull the headlamp control towards you to turn fog lamps on.

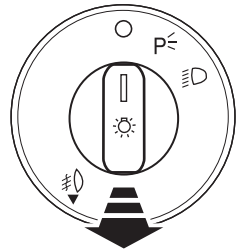

High beams

Push the lever toward the instrument panel to activate. Pull the lever toward you to deactivate.

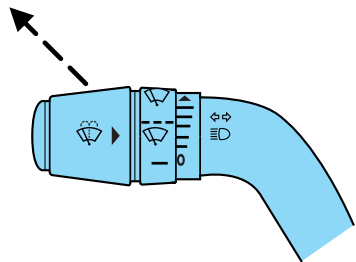

Flash-to-pass

Pull toward you slightly to activate and release to deactivate.

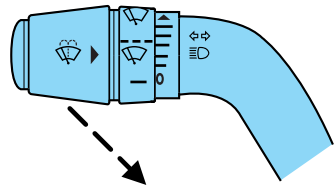

Daytime running lamps (DRL) (if equipped)

The daytime running light system turns the headlamps on with a reduced light output.

To activate:

- the ignition must be in the on position and
- the headlamp system is in the off position or parking lamp position.



WARNING: Always remember to turn on your headlamps at dusk or during inclement weather. The daytime running light (DRL) system does not activate your tail lamps and generally may not provide adequate lighting during these conditions. Failure to activate your headlamps under these conditions may result in a collision.

PANEL DIMMER CONTROL

Use to adjust the brightness of the instrument panel and all applicable switches in the vehicle during headlamp and parking lamp operation.

Move the control up or down to adjust the intensity of the panel lighting.

Move the control to the full upright position, past detent, to turn on the interior lamps.

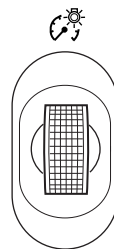

Lights

Note: If the battery is disconnected, discharged, or a new battery is installed, the dimmer switch requires re-calibration. Rotate the dimmer switch from the full dim position to the full dome/on position to reset. This will ensure that your displays are visible under all lighting conditions.

AIMING THE HEADLAMPS

The headlamps on your vehicle are properly aimed before leaving the assembly plant. If your vehicle is involved in an accident or if you have problems fixing the alignment of your headlamps, have them checked by a qualified service technician.

Headlamp aim adjustment

The headlamps are designed to be mechanically aimed, but can also be aimed visually by doing the following:

1. Park your vehicle on a level surface about 25 feet (7.6 meters) away from a vertical plain surface (3). Check your headlamp alignment at night or in a dark area so that you can see the headlamp beam pattern.

- (1) 8 feet (2.4 meters)
- (2) Center height of lamp to ground
- (3) 25 feet (7.6 meters)
- (4) Horizontal reference line
- (5) Center of headlamps
- (6) Center line of the vehicle

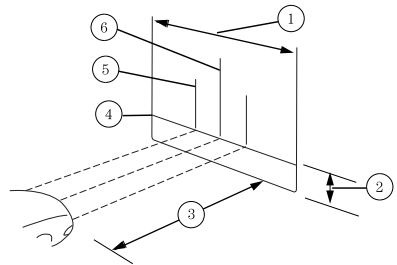

2. The center of the headlamp is marked either on the lens (a circle or cross marker) or on the bulb shield, internal to the lamp (mark or feature). Measure the height from the center of your headlamp to the ground (2) and mark an 8 foot (2.4 meter) long horizontal line on the wall or screen (1) at this height (masking tape works well).

3. Turn on the low beam headlamps and open the hood.

4. Locate the high intensity area of the beam pattern and place the top edge of the intensity zone even with the horizontal reference line (4). If the top edge of the high intensity area is not even with the horizontal line, follow the next step to adjust it.

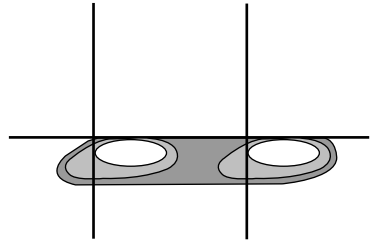

5. Locate the vertical adjuster for each headlamp. Adjust the aim by turning the adjuster control either clockwise (to adjust down) or counterclockwise (to adjust up).

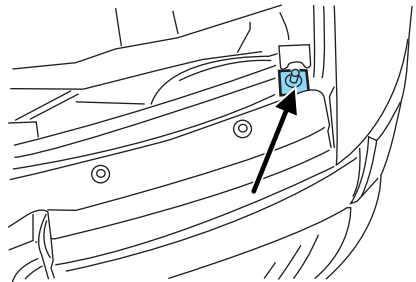

6. In addition to the horizontal line marked in step 2, a pair of vertical lines (5) must be marked at the center line of the headlamps on the wall or screen.

7. On the wall or screen, locate the high intensity area of the beam pattern. The left edge of the high intensity area should be even with the vertical line corresponding to the headlamp under adjustment. If the left edge of the high intensity area is not even with the vertical line, follow the next step to adjust it.

8. Locate the horizontal adjuster for each headlamp. Turn it clockwise or counterclockwise, to place the left edge of the high intensity area even with the vertical line corresponding to the headlamp under adjustment.

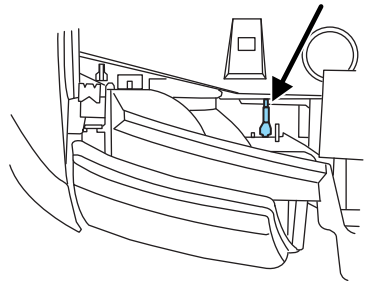

Lights

TURN SIGNAL CONTROL

- Push down to activate the left turn signal.
- Push up to activate the right turn signal.

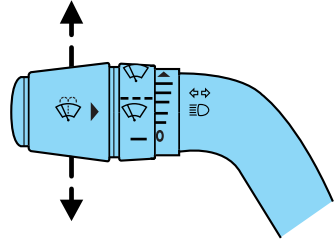

INTERIOR LAMPS

Courtesy/reading lamps (if equipped)

The courtesy lamp lights when:

- any door is opened.
- the instrument panel dimmer switch is held up until the courtesy lamps come on.
- the remote entry controls are pressed and the ignition is off.

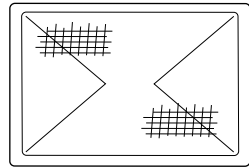

BULB REPLACEMENT

Lamp assembly condensation

Exterior lamps are vented to accommodate normal changes in pressure. Condensation can be a natural by-product of this design. When moist air enters the lamp assembly through the vents, there is a possibility that condensation can occur when the temperature is cold. When normal condensation occurs, a thin film of mist can form on the interior of the lens. The thin mist eventually clears and exits through the vents during normal operation. Clearing time may take as long as 48 hours under dry weather conditions.

Examples of acceptable condensation are:

- Presence of thin mist (no streaks, drip marks or droplets)
- Fine mist covers less than 50% of the lens

Lights

Examples of unacceptable moisture (usually caused by a lamp water leak) are:

- Water puddle inside the lamp
- Large water droplets, drip marks or streaks present on the interior of the lens

Take your vehicle to dealer for service if any of the above conditions of unacceptable moisture are present.

Using the right bulbs

Replacement bulbs are specified in the chart below. Headlamp bulbs must be marked with an authorized "D.O.T." for North America and an "E" for Europe to ensure lamp performance, light brightness and pattern and safe visibility. The correct bulbs will not damage the lamp assembly or void the lamp assembly warranty and will provide quality bulb burn time.

Function	Number of bulbs	Trade number
Park/turn (front)	2	3157 A (amber)
Sidemarkers lamps	2	194 NA
Headlamps	2	9007
Fog lamps (if equipped)	2	9145
Hi-mount brake lamp	1	922
Rear stop/turn/tail lamps	2	4157K or 3157K
Rear license plate lamps	2	194
Backup lamps	2	3155
Dome lamp	1	912
Map/dome-SuperCab (if equipped)	2	904
Map/dome-Regular Cab (if equipped)	1	904
All replacement bulbs are clear in color except where noted.		
To replace all instrument panel lights - see your authorized dealer.		

Replacing interior bulbs

Check the operation of all bulbs frequently.

Lights

Replacing exterior bulbs

Check the operation of all the bulbs frequently.

Replacing headlamp bulbs/front park bulbs/turn signal bulbs

To remove the bulb(s):

1. Make sure the headlamp switch is in the off position, then open the hood.

2. At the back of the headlamp, pry up the two retainer pins to release the headlamp assembly from the vehicle and pull headlamp forward.

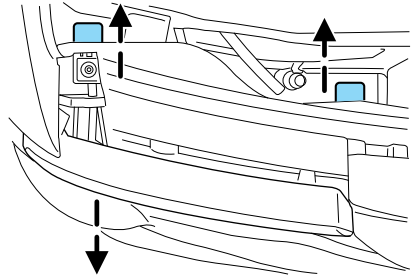

3. Disconnect the electrical connector from the bulb by pulling rearward.

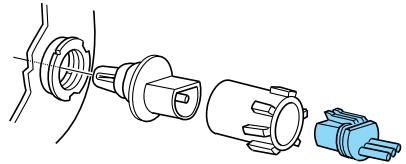

4. Remove the bulb retaining ring by rotating it counterclockwise and slide the ring off the plastic base.

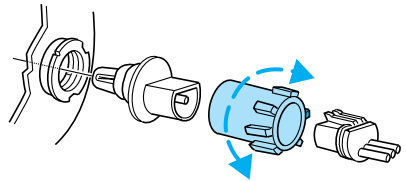

5. Remove the old bulb by pulling it straight out of the lamp.

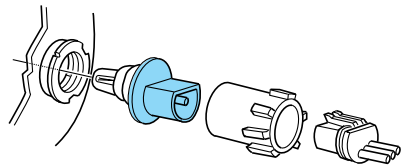



WARNING: Handle a halogen headlamp bulb carefully and keep out of children's reach. Grasp the bulb only by its plastic base and do not touch the glass. The oil from your hand could cause the bulb to break the next time the headlamps are operated.

Install the new bulb(s) in reverse order.

Replacing front sidemarker bulbs

1. Turn the headlamp switch to the off position, then open the hood.
2. At the back of the headlamp, pry up the two retainer pins to release the headlamp assembly from the vehicle and pull headlamp forward.

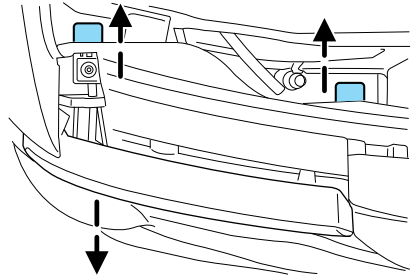

3. Remove bolt(s) from lamp assembly and disengage lamp assembly.

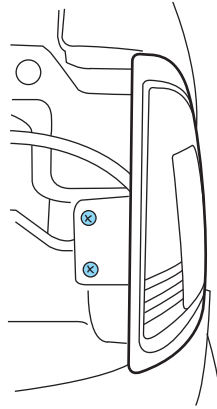

Lights

4. Rotate bulb socket counterclockwise and remove from lamp assembly.
 5. Carefully pull bulb straight out of socket and push in the new bulb.
 6. Install the bulb socket in lamp assembly by turning clockwise.
- Install the new bulb in reverse order.

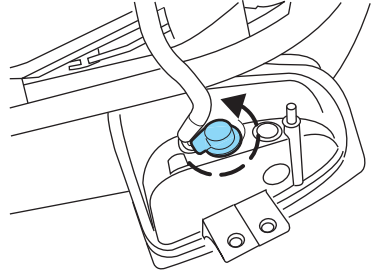

Replacing tail lamp/backup lamp bulbs

1. Make sure the headlamp switch is in the off position, then open the tailgate to expose the lamp assemblies.
2. Remove the four screws and the lamp assembly from vehicle.

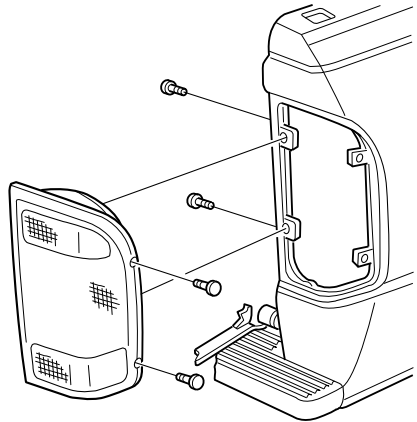

3. Rotate bulb socket counterclockwise turn and remove from lamp assembly.
 4. Carefully pull the bulb straight out of the socket.
- Install the new bulb(s) in reverse order.

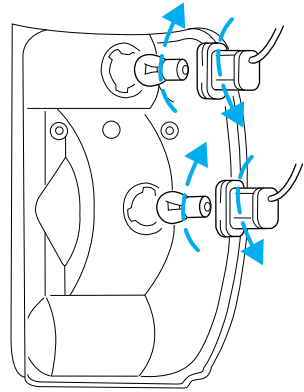

Replacing fog lamp bulbs (if equipped)

1. Make sure the headlamp switch is in the off position and remove the bulb socket from the fog lamp by turning it counterclockwise.
2. Disconnect the electrical connector.

Install the new bulb in reverse order.

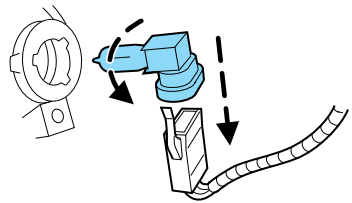

Replacing high-mount brakelamp bulb

1. Make sure the headlamp switch is in the off position and remove the two screws and lamp assembly from vehicle.
2. Remove the bulb socket from lamp assembly by rotating it counterclockwise.
3. Carefully pull bulb straight out of socket.

Install the new bulb in reverse order.



Lights

Replacing license plate lamp bulbs

1. Make sure the headlamp switch is in the off position and reach behind the rear bumper to locate the bulb socket.
2. Twist the socket counterclockwise and remove.
3. Carefully pull the bulb straight out of the socket.

Install the new bulb(s) in reverse order.

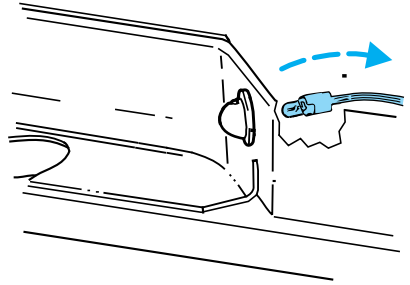

MULTI-FUNCTION LEVER

Windshield wiper: Rotate the end of the control away from you to increase the speed of the wipers (from desired interval to low or high speed position); rotate towards you to decrease the speed of the wipers.

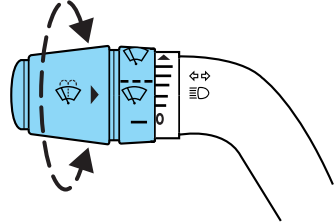

Windshield washer: Press the end of the stalk:

- briefly: causes a single swipe of the wipers without washer fluid.
- a quick press and hold: the wipers will swipe several times with washer fluid.
- a long press and hold: the wipers and washer fluid will be activated for up to ten seconds.

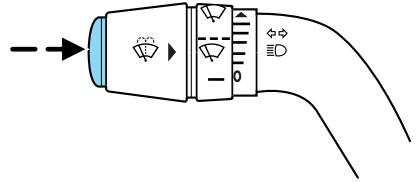

Courtesy wipe feature: One extra wipe will occur a few seconds after washing the front window to clear any excess washer fluid remaining on the windshield.

Note: Do not operate the washer when the washer reservoir is empty. This may cause the washer pump to overheat. Check the washer fluid level frequently. Do not operate the wipers when the windshield is dry. This may scratch the glass, damage the wiper blades and cause the wiper motor to burn out. Before operating the wiper on a dry windshield, always use the windshield washer. In freezing weather, be sure the wiper blades are not frozen to the windshield before operating the wipers.

Driver Controls

TILT STEERING WHEEL (IF EQUIPPED)

To adjust the steering wheel:

1. Pull and hold the steering wheel release control toward you.
2. Move the steering wheel up or down until you find the desired location.
3. Release the steering wheel release control. This will lock the steering wheel in position.

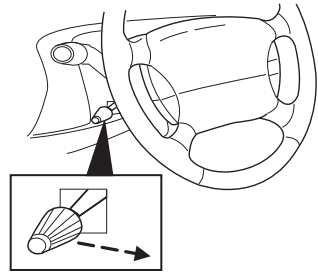

WARNING: Never adjust the steering wheel when the vehicle is moving.

CENTER CONSOLE (IF EQUIPPED)

Your vehicle may be equipped with a variety of console features. These include:

- Utility compartment with cassette/compact disc storage
- Cupholders
- Flip-up armrest

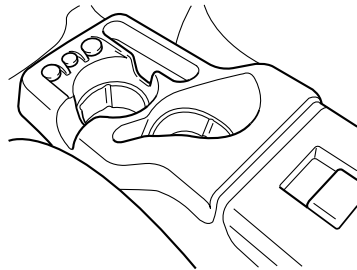

WARNING: Use only soft cups in the cupholder. Hard objects can injure you in a collision.

AUXILIARY POWER POINT (12VDC)

Power outlets are designed for accessory plugs only. Do not insert any other object in the power outlet as this will damage the outlet and blow the fuse. Do not hang any type of accessory or accessory bracket from the plug. Improper use of the power outlet can cause damage not covered by your warranty.

The auxiliary power points are located on the instrument panel.

Driver Controls

Do not use the power point for operating the cigarette lighter element (if equipped).

To prevent the fuse from being blown, do not use the power point(s) over the vehicle capacity of 12 VDC/180W. If the power point or cigar lighter socket is not working, a fuse may have blown. Refer to *Fuses and relays* in the *Roadside Emergencies* chapter for fuse ratings and information on checking and replacing fuses.

To have full capacity usage of your power point, the engine is required to be running to avoid unintentional discharge of the battery. To prevent the battery from being discharged:

- do not use the power point longer than necessary when the engine is not running,
- do not leave battery chargers, video game adapters, computers and other devices plugged in overnight or when the vehicle is parked for extended periods.

Always keep the power point caps closed when not being used.

POWER WINDOWS (IF EQUIPPED)



WARNING: Do not leave children unattended in the vehicle and do not let children play with the power windows. They may seriously injure themselves.



WARNING: When closing the power windows, you should verify they are free of obstructions and ensure that children and/or pets are not in the proximity of the window openings.

Press and pull the window switches to open and close windows.

- Press down (to the first detent) and hold the switch to open.
- Pull up and hold the switch to close.

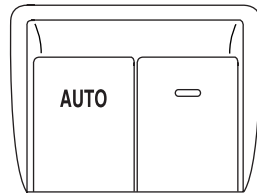

Driver Controls

One-touch down

Allows the driver's window to open fully without holding the control down. Press the switch completely down to the second detent and release quickly. The window will open fully. Momentarily press the switch to any position to stop the window operation.

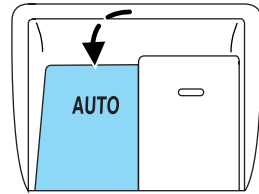

INTERIOR MIRROR

The interior rear view mirror has two pivot points on the support arm which lets you adjust the mirror up or down and from side to side.



WARNING: Do not adjust the mirror while the vehicle is in motion.

EXTERIOR MIRRORS

Power side view mirrors (if equipped)



WARNING: Do not adjust the mirror while the vehicle is in motion.

To adjust your mirrors:

1. Rotate the control clockwise to adjust the right mirror and rotate the control counterclockwise to adjust the left mirror.
2. Move the control in the direction you wish to tilt the mirror.
3. Return to the center position to lock mirrors in place.



Fold-away mirrors

Pull the side mirrors in carefully when driving through a narrow space, like an automatic car wash.

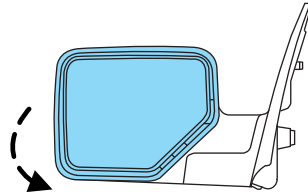

SPEED CONTROL (IF EQUIPPED)

With speed control set, you can maintain a set speed without keeping your foot on the accelerator pedal.



WARNING: Do not use the speed control in heavy traffic or on roads that are winding, slippery or unpared.

Using speed control

The speed controls are located on the steering wheel. The following buttons work with speed control:

ON: Press to turn system on.

OFF: Press to turn system off.

RES (Resume): Press to resume a set speed.

SET+: Press to set the speed or increase the set speed.

CST- (Coast): Press to decrease the set speed.

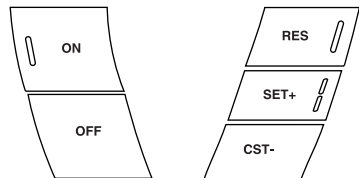

Setting speed control

1. Press and release ON.
2. Accelerate to the desired speed.
3. Press and release SET+.
4. Take your foot off the accelerator pedal.
5. The indicator light  on the instrument cluster will turn on.

Driver Controls

Note:

- Vehicle speed may vary momentarily when driving up and down a steep hill.
- If the vehicle speed increases above the set speed on a downhill, you may want to apply the brakes to reduce the speed.
- If the vehicle speed decreases more than 10 mph (16 km/h) below your set speed on an uphill, your speed control will disengage.

Disengaging speed control

To disengage the speed control, press the brake pedal or the clutch pedal (if equipped). Disengaging the speed control will not erase the previous set speed.

Note: When you use the clutch pedal to disengage the speed control, the engine speed may briefly increase, this is normal.

Resuming a set speed

Press and release RES. This will automatically return the vehicle to the previously set speed.

Increasing speed while using speed control

To set a higher speed:

- Press and hold SET+ until you get to the desired speed, then release the control. You can also use SET+ to operate the tap-up function. Press and release SET+ to increase the set speed in 1 mph (1.6 km/h) increments.
- Use the accelerator pedal to get to the desired speed. When the vehicle reaches that speed, press and release SET +.

Reducing speed while using speed control

To reduce a set speed:

- Press and hold CST- until you get to the desired speed, then release the control. You can also use CST- to operate the tap-down function. Press and release the CST- to decrease the set speed in 1 mph (1.6 km/h) increments.
- Press the brake pedal or the clutch pedal (if equipped) until the desired vehicle speed is reached, then press and release SET+.

Turning off speed control

To turn off the speed control, press OFF or turn off the ignition.

Note: When you turn off the speed control or the ignition, your speed control set speed memory is erased.

BEDRAILS (IF EQUIPPED)

- This bedrail is for appearance use only.



WARNING: To help prevent injury, do not use bedrail to retain cargo.

- Retain cargo with the pickup tiedown hooks.

Locks and Security

KEYS

The key operates all locks on your vehicle. You should always carry a second key with you in a safe place in case you require it in an emergency.

If your vehicle is equipped with the SecuriLock® passive anti-theft system, your keys are coded to your vehicle; using a non-coded key will not permit your vehicle to start. If you lose your dealer supplied keys, replacement keys are available through your authorized dealer.

POWER DOOR LOCKS (IF EQUIPPED)

Press the control to unlock or lock all the doors.



REMOTE ENTRY SYSTEM (IF EQUIPPED)

This device complies with part 15 of the FCC rules and with RS-210 of Industry Canada. Operation is subject to the following two conditions: (1) This device may not cause harmful interference, and (2) This device must accept any interference received, including interference that may cause undesired operation.

Changes or modifications not expressly approved by the party responsible for compliance could void the user's authority to operate the equipment.

The typical operating range for your remote entry transmitter is approximately 33 feet (10 meters). A decrease in operating range could be caused by:

- weather conditions,
- nearby radio towers,
- structures around the vehicle, or
- other vehicles parked next to your vehicle.

Locks and Security

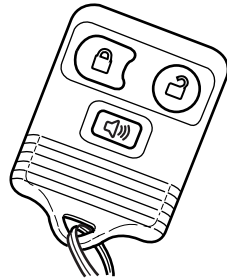

Your vehicle is equipped with a remote entry system which allows you to:

- unlock the vehicle doors without a key.
- lock all the vehicle doors without a key.
- activate the personal alarm.





If there are problems with the remote entry system, make sure to take **ALL remote entry transmitters** with you to your authorized dealer in order to aid in troubleshooting the problem.

Unlocking the doors

1. Press  and release to unlock the driver's door. **Note:** The interior lamps will illuminate.
2. Press  and release again within three seconds to unlock all the doors.

Vehicles with alarm system, when the doors are not opened after 45 seconds, the system will lock them again.

Locking the doors

1. Press  and release to lock all the doors. The external lights will flash once to confirm lock; if any of the doors are not properly closed, the lamps will not flash.
2. If  is pressed a second time within three seconds, the lamps will flash again and the horn will chirp to confirm all doors are locked and closed. If either door is ajar the lights will not flash and the horn will chirp twice.

Car finder

Press  twice within three seconds. The horn will chirp and the turn lamps will flash. It is recommended that this method be used to locate your vehicle, rather than using the panic alarm.

Sounding a panic alarm

Press  to activate the alarm. The horn will sound and the parklamps will flash for approximately three minutes. Press again or turn the ignition to the on position to deactivate, or wait for the alarm to timeout in three minutes.

Locks and Security

Note: The panic alarm will only operate when the ignition is in the off position.

Replacing the battery

The remote entry transmitter uses one coin type three-volt lithium battery CR2032 or equivalent.

To replace the battery:

1. Twist a thin coin between the two halves of the remote entry transmitter near the key ring. DO NOT TAKE THE RUBBER COVER AND CIRCUIT BOARD OFF THE FRONT HOUSING OF THE REMOTE ENTRY TRANSMITTER.

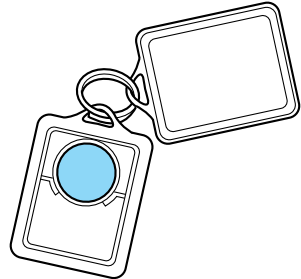

2. Do not wipe off any grease on the battery terminals on the back surface of the circuit board.

3. Remove the old battery.

Note: Please refer to local regulations when disposing of transmitter batteries.

4. Insert the new battery. Refer to the diagram inside the remote entry transmitter for the correct orientation of the battery. Press the battery down to ensure that the battery is fully seated in the battery housing cavity.

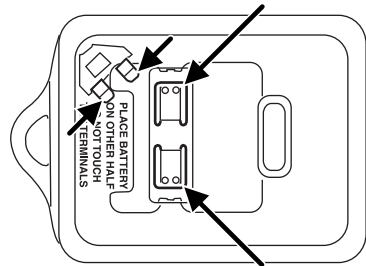

5. Snap the two halves back together.

Note: Replacement of the battery will **not** cause the remote transmitter to become deprogrammed from your vehicle. The remote transmitter should operate normally after battery replacement.

Replacing lost remote entry transmitters

If you would like to have your remote entry transmitter reprogrammed because you lost one, or would like to buy additional remote entry transmitters, you can either reprogram them yourself, or take **all remote entry transmitters** to your authorized dealer for reprogramming.

How to reprogram your remote entry transmitters

You must have **all remote entry transmitters** (maximum of four) available before beginning this procedure.

Note: Ensure the brake pedal is not pressed during this sequence.

To reprogram the remote entry transmitters:

1. Ensure the vehicle is electronically unlocked.
2. Put the key in the ignition.
3. Turn the key from the 2 (lock) position to 3 (off).
4. Cycle eight times rapidly (within 10 seconds) between the 3 (off) position and 4 (on). **Note:** The eighth turn must end in the 4 (on) position.
5. The doors will lock, then unlock, to confirm that the programming mode has been activated.
6. Within 20 seconds press any button on the remote entry transmitter.
Note: If more than 20 seconds have passed you will need to start the procedure over again.
7. The doors will lock, then unlock, to confirm that this remote entry transmitter has been programmed.
8. Repeat Step 6 to program each additional remote entry transmitter.
9. Turn the ignition to the 3 (off) position after you have finished programming all of the remote entry transmitters. **Note:** After 20 seconds, you will automatically exit the programming mode.
The doors will lock, then unlock, to confirm that the programming mode has been exited.

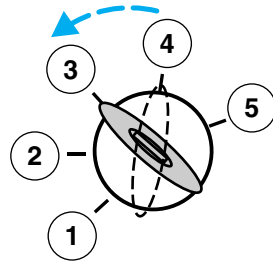

Illuminated entry

The interior lamps illuminate when the remote entry system is used to unlock the door(s) or sound the personal alarm.

The illuminated entry system will turn off the interior lights if:

- the ignition switch is turned to the on position, or
- the remote transmitter lock control is pressed, or
- after 25 seconds of illumination.

Locks and Security

The inside lights will not turn off if:

- they have been turned on with the dimmer control, or
- any door is open.

The battery saver will shut off the interior lamps after several minutes if they are left on accidentally.

SECURILOCK® PASSIVE ANTI-THEFT SYSTEM (IF EQUIPPED)

SecuriLock® passive anti-theft system is an engine immobilization system. This system is designed to help prevent the engine from being started unless a **coded key programmed to your vehicle** is used. The use of the wrong type of coded key may lead to a “no-start” condition.

Your vehicle comes with two coded keys; additional coded keys may be purchased from your authorized dealer. The authorized dealer can program your spare keys to your vehicle or you can program the keys yourself. Refer to *Programming spare keys* for instructions on how to program the coded key.

Note: The SecuriLock® passive anti-theft system is not compatible with non-Ford aftermarket remote start systems. Use of these systems may result in vehicle starting problems and a loss of security protection.

Note: Large metallic objects, electronic devices that are used to purchase gasoline or similar items, or a second coded key on the same key chain may cause vehicle starting issues. You need to prevent these objects from touching the coded key while starting the engine. These objects will not cause damage to the coded key, but may cause a momentary issue if they are too close to the key when starting the engine. If a problem occurs, turn the ignition off, remove all objects on the key chain away from the coded key and restart the engine.

Note: Do not leave a duplicate coded key in the vehicle. Always take your keys and lock all doors when leaving the vehicle.

Anti-theft indicator

The anti-theft indicator is located in the instrument cluster.

Vehicles equipped with the SecuriLock® passive anti-theft system behave as follows:



- When the ignition is in the off position, the indicator will flash once every two seconds for a total of 10 seconds to indicate the SecuriLock® system is functioning as a theft deterrent.
- When the ignition is in the on position, the indicator will glow for three seconds to indicate a programmed key has been validated and the SecuriLock® passive anti-theft system has enabled the engine.

Vehicles without the SecuriLock® passive anti-theft system behave as follows:

- When the ignition is in the off position, the indicator will not flash.
- When the ignition is in the on position, the indicator will glow for three seconds to indicate the engine is enabled.

Replacement keys

If your keys are lost or stolen and you don't have an extra coded key, you will need to have your vehicle towed to an authorized dealer. The key codes need to be erased from your vehicle and new coded keys will need to be programmed.

Replacing coded keys can be very costly. Store an extra programmed key away from the vehicle in a safe place to help prevent any inconveniences. Please visit an authorized dealer to purchase additional spare or replacement keys.

Programming spare keys

You can program your own coded keys to your vehicle. Please read and understand the entire procedure before you begin.

Tips:

- A maximum of eight keys can be coded to your vehicle.
- Only use SecuriLock® keys.
- You must have two previously programmed coded keys (keys that already operate your vehicle's engine) and the new unprogrammed key(s) readily accessible.
- If no previously programmed coded keys are available, you must take your vehicle to your authorized dealer to have the spare key(s) programmed.

Locks and Security

1. Insert a previously programmed coded key into the ignition.
2. Turn the ignition from the 3 (off) position to the 4 (on) position. Keep the ignition in the 4 (on) position for at least one second, but no more than 10 seconds.
3. Turn the ignition to the 3 (off) position, and remove the coded key from the ignition.

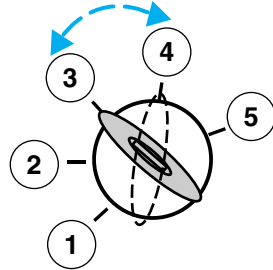

4. After three seconds but within 10 seconds of removing the previously programmed coded key, insert the other previously programmed coded key into the ignition.
5. Turn the ignition from the 3 (off) position to the 4 (on) position. Keep the ignition in the 4 (on) position for at least one second but not more than 10 seconds.
6. Turn the ignition to the 3 (off) position, and remove the second key from the ignition.
7. After three seconds but within 20 seconds of removing the previously programmed coded key, insert the unprogrammed key (new/valet key) into the ignition.
8. Turn the ignition from the 3 (off) position to the 4 (on) position. Keep the ignition in the 4 (on) position for at least one second.
9. Your new unprogrammed key is now programmed.

If the key has been successfully programmed it will start the vehicle's engine and the theft indicator light will illuminate for three seconds and then go out. If the key was not successfully programmed, it will not start your vehicle's engine and the theft indicator light will flash on and off rapidly. If failure repeats, bring your vehicle to your authorized dealer to have the new key(s) programmed.

To program additional new unprogrammed key(s), repeat this procedure from Step 1 for each additional key.

Seating and Safety Restraints

SEATING

! **WARNING:** Reclining the seatback can cause an occupant to slide under the seat's safety belt, resulting in severe personal injuries in the event of a collision.

! **WARNING:** Do not pile cargo higher than the seatbacks to reduce the risk of injury in a collision or sudden stop.

! **WARNING:** Before returning the seatback to its original position, make sure that cargo or any objects are not trapped behind the seatback. After returning the seatback to its original position, pull on the seatback to ensure that it has fully latched. An unlatched seat may become dangerous in the event of a sudden stop or collision.

Adjustable head restraints

Your vehicle is equipped with front row outboard head restraints that are vertically adjustable.

! **WARNING:** To minimize the risk of neck injury in the event of a crash, the driver and passenger occupants should not sit in and/or operate the vehicle, until the head restraint is placed in its proper position. The driver should never adjust the head restraint while the vehicle is in motion.

The adjustable head restraints consist of:

- a trimmed energy absorbing foam and structure (1),
- two steel stems (2),
- a guide sleeve adjust/release button (3),
- and a guide sleeve unlock/remove button (4).

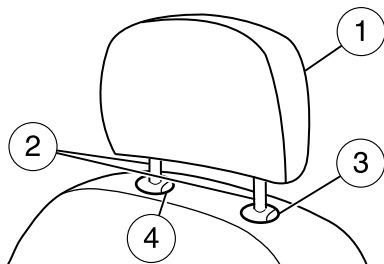

Seating and Safety Restraints

To adjust the head restraint, do the following:

1. Adjust the seatback to an upright driving/riding position.
2. Raise the head restraint by pulling up on the head restraint.

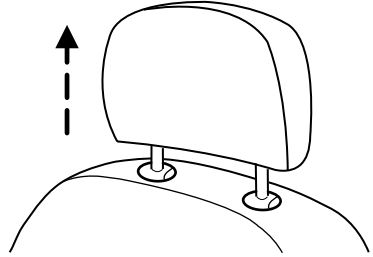

3. Lower the head restraint by pressing and holding the guide sleeve adjust/release button and pushing down on the head restraint.

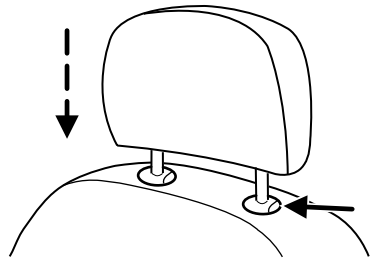

Properly adjust the head restraint so that the top of the head restraint is even with the top of your head and positioned as close as possible to the back of your head. For occupants of extremely tall stature, adjust the head restraint to its full up position.



WARNING: The adjustable head restraint is a safety device. Whenever possible it should be installed and properly adjusted when the seat is occupied.

Seating and Safety Restraints

To remove the adjustable head restraint, do the following:

1. Pull up the head restraint until it reaches the highest adjustment position.

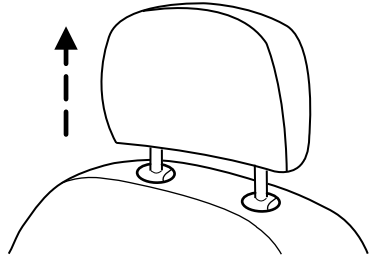

2. Simultaneously press and hold both the adjust/release button and the unlock/remove button, then pull up on the head restraint.

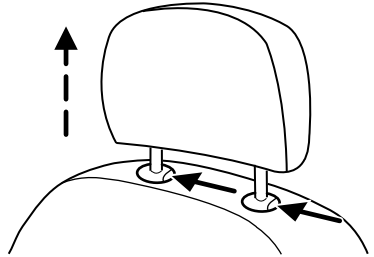

To reinstall the adjustable head restraint, do the following:

1. Insert the two stems into the guide sleeve collars.

2. Push the head restraint down until it locks.

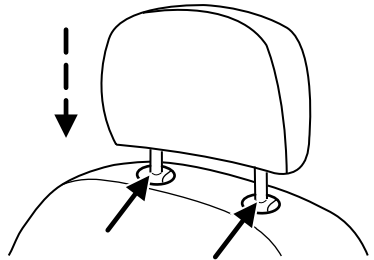

Seating and Safety Restraints

Properly adjust the head restraint so that the top of the head restraint is even with the top of your head and positioned as close as possible to the back of your head. For occupants of extremely tall stature, adjust the head restraint to its full up position.



WARNING: To minimize the risk of neck injury in the event of a crash, head restraints must be installed properly.

Adjusting the front manual seat



WARNING: Never adjust the driver's seat or seatback when the vehicle is moving.



WARNING: Always drive and ride with your seatback upright and the lap belt snug and low across the hips.



WARNING: Sitting improperly out of position or with the seat back reclined too far can take off weight from the seat cushion and affect the decision of the front passenger sensing system, resulting in serious injury or death in a crash.

Always sit upright against your seatback, with your feet on the floor.



WARNING: To reduce the risk of possible serious injury: Do not hang objects off seat back or stow objects in the seatback map pocket (if equipped) when a child is in the front passenger seat. Do not place objects underneath the front passenger seat or between the seat and the center console (if equipped). Check the "passenger airbag off" or "pass airbag off" indicator lamp for proper airbag status. Refer to *Front passenger sensing system* in the *Airbag supplemental restraint system (SRS)* section for additional details. Failure to follow these instructions may interfere with the front passenger seat sensing system.

Seating and Safety Restraints

Lift the release bar to move seat forward or backward. Ensure that the seat is locked into place.

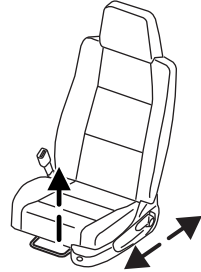

Pull lever located at the side of the seat cushion up to adjust seatback.

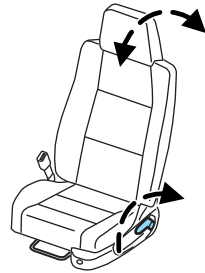

60/40 seat (if equipped)

To gain access to the storage compartment in your armrest (if equipped), lift the latch to open lid.

The 60/40 seat cupholder (if equipped) is detachable for cleaning.

- Firmly grasp the bottom of the cup holder and pull up.

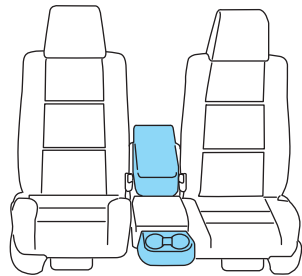

To re-attach:

- Slide the cupholder over the two pins located on the front of the 60% driver's seat.
- Press down until it is firmly latched into place.

Seating and Safety Restraints

Passenger side rear access

Pull up on the recliner handle. The seat will lean forward. Lift the release bar to move the seat forward to access the rear area of the cab.

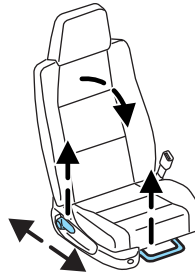

To return seat to original position, slide the seat bottom back, then push the seatback up to lock it in place. The seat will lock, and you will have to use the release bar to move the seat back to the original position.

REAR SEATS

Center facing jump seat (2-door SuperCab) (if equipped)

To open, pull inboard and down on the seat strap.

To stow the seat, pull seat bottom back to the fully upright position.



WARNING: Do not install a child seat in the center facing jump seats as there are no child restraints recommended for use in this seating position.

Center facing jump seat (4-door SuperCab) (if equipped)

To open, pull seat assembly down, then raise seatback.

To stow the seat, fold seat back down and raise seat assembly to the fully upright position.



WARNING: Do not install a child seat in the center facing jump seats as there are no child restraints recommended for use in this seating position.

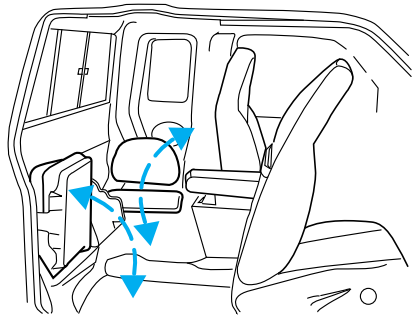

Seating and Safety Restraints



WARNING: Booster seats must be installed only in seating positions equipped with a combination lap/shoulder belt.

SAFETY RESTRAINTS

Personal Safety System™

The Personal Safety System™ provides an improved overall level of frontal crash protection to front seat occupants and is designed to help further reduce the risk of airbag-related injuries. The system is able to analyze different occupant classifications and conditions and crash severity before activating the appropriate safety devices to help better protect a range of occupants in a variety of frontal crash situations.

Your vehicle's Personal Safety System™ consists of:

- Driver and passenger dual-stage airbag supplemental restraints.
- Front outboard safety belts with pretensioners, energy management retractors, and safety belt usage sensors.
- Driver's seat position sensor.
- Front crash severity sensor.
- Front passenger sensing system
- Passenger Airbag Off indicator light.
- Restraints Control Module (RCM) with impact and safing sensors.
- Restraint system warning light and back-up tone.
- The electrical wiring for the airbags, crash sensor(s), safety belt pretensioners, front safety belt usage sensors, driver seat position sensor, and indicator lights.

How does the Personal Safety System™ work?

The Personal Safety System™ can adapt the deployment strategy of your vehicle's safety devices according to crash severity and occupant classification and conditions. A collection of crash and occupant sensors provides information to the Restraints Control Module (RCM). During a crash, the RCM may activate the safety belt pretensioners and/or either none, one, or both stages of the dual-stage airbag supplemental restraints based on crash severity and occupant classification and conditions.

The fact that the pretensioners or airbags did not activate for both front seat occupants in a collision does not mean that something is wrong with

Seating and Safety Restraints

the system. Rather, it means the Personal Safety System™ determined the accident conditions (crash severity, belt usage, etc.) were not appropriate to activate these safety devices. Front airbags and pretensioners are designed to activate only in frontal and near-frontal collisions, not rollovers, side-impacts, or rear-impacts unless the collision causes sufficient longitudinal deceleration.

Driver and passenger dual-stage airbag supplemental restraints

The dual-stage airbags offer the capability to tailor the level of airbag inflation energy. A lower, less forceful energy level is provided for more common, moderate-severity impacts. A higher energy level is used for the most severe impacts. Refer to *Airbag supplemental restraints (SRS)* section in this chapter.

Front crash severity sensor

The front crash severity sensor enhances the ability to detect the severity of an impact. Positioned up front, it provides valuable information early in the crash event on the severity of the impact. This allows your Personal Safety System™ to distinguish between different levels of crash severity and modify the deployment strategy of the dual-stage airbags and safety belt pretensioners.

Driver's seat position sensor

The driver's seat position sensor allows your Personal Safety System™ to tailor the deployment level of the driver dual-stage airbag based on seat position. The system is designed to help protect smaller drivers sitting close to the driver airbag by providing a lower airbag output level.

Front passenger sensing system

For airbags to do their job they must inflate with great force, and this force can pose a potentially deadly risk to occupants that are very close to the airbag when it begins to inflate. For some occupants, like infants in rear-facing child seats, this occurs because they are initially sitting very close to the airbag. For other occupants, this occurs when the occupant is not properly restrained by safety belts or child safety seats and they move forward during pre-crash braking. The most effective way to reduce the risk of unnecessary injuries is to make sure all occupants are properly restrained. Accident statistics suggest that children are much safer when properly restrained in the rear seating positions than in the front.

Seating and Safety Restraints



WARNING: Airbags can kill or injure a child in a child seat. **NEVER** place a rear-facing child seat in front of an active airbag. If you must use a forward-facing child seat in the front seat, move the seat all the way back.



WARNING: Always transport children 12 years old and under in the back seat and always properly use appropriate child restraints.

The front passenger sensing system can automatically turn off the passenger front airbag when a rear facing child seat, a forward-facing child restraint, or a booster seat is detected. Even with this technology, parents are **STRONGLY** encouraged to always properly restrain children in the rear seat. The sensor also turns off the airbag when the passenger seat is empty to prevent unnecessary replacement of the airbag(s) after a collision.

When the front passenger seat is occupied and the sensing system has turned off the passenger's frontal airbag, the "pass airbag off" indicator will light and stay lit to remind you that the front passenger frontal airbag is off. See *Front passenger sensing system* in the *Airbag supplemental restraint system (SRS)* section of this chapter.

Front safety belt usage sensors

The front safety belt usage sensors detect whether or not the driver and front outboard passenger safety belts are fastened. This information allows your Personal Safety System™ to tailor the airbag deployment and safety belt pretensioner activation depending upon safety belt usage.

Front outboard safety belt pretensioners

The safety belt pretensioners at the front outboard seating positions are designed to tighten the safety belts firmly against the occupant's body during frontal collisions. This helps increase the effectiveness of the safety belts. In frontal collisions, the safety belt pretensioners can be activated alone or, if the collision is of sufficient severity, together with the front airbags.

Front outboard safety belt energy management retractors

The front safety belt energy management retractors allow webbing to be pulled out of the retractor in a gradual and controlled manner in response to the occupant's forward momentum. This helps reduce the risk of force-related injuries to the occupant's chest by limiting the load on the occupant. Refer to *Energy management feature* section in this chapter.

Seating and Safety Restraints

Determining if the Personal Safety System™ is operational

The Personal Safety System™ uses a warning light in the instrument cluster or a back-up tone to indicate the condition of the system. Refer to the *Warning lights and chimes* section in the *Instrument Cluster* chapter. Routine maintenance of the Personal Safety System™ is not required.

The Restraints Control Module (RCM) monitors its own internal circuits and the circuits for the airbag supplemental restraints, crash sensor(s), safety belt pretensioners, front safety belt buckle sensors, front passenger sensing system, and the driver seat position sensor. In addition, the RCM also monitors the restraints warning light in the instrument cluster. A difficulty with the system is indicated by one or more of the following.

- The warning light will either flash or stay lit.
- The warning light will not illuminate immediately after ignition is turned on.
- A series of five beeps will be heard. The tone pattern will repeat periodically until the problem and warning light are repaired.

If any of these things happen, even intermittently, contact your authorized dealer as soon as possible. Unless serviced, the system may not function properly in the event of a collision.

Safety restraints precautions



WARNING: Always drive and ride with your seatback upright and the lap belt snug and low across the hips.



WARNING: To reduce the risk of injury, make sure children sit where they can be properly restrained.



WARNING: Never let a passenger hold a child on his or her lap while the vehicle is moving. The passenger cannot protect the child from injury in a collision.



WARNING: All occupants of the vehicle, including the driver, should always properly wear their safety belts, even when an airbag supplemental restraint system (SRS) is provided

Seating and Safety Restraints

WARNING: It is extremely dangerous to ride in a cargo area, inside or outside of a vehicle. In a collision, people riding in these areas are more likely to be seriously injured or killed. Do not allow people to ride in any area of your vehicle that is not equipped with seats and safety belts. Be sure everyone in your vehicle is in a seat and using a safety belt properly.

WARNING: In a rollover crash, an unbelted person is significantly more likely to die than a person wearing a safety belt.

WARNING: Each seating position in your vehicle has a specific safety belt assembly which is made up of one buckle and one tongue that are designed to be used as a pair. 1) Use the shoulder belt on the outside shoulder only. Never wear the shoulder belt under the arm. 2) Never swing the safety belt around your neck over the inside shoulder. 3) Never use a single belt for more than one person.

WARNING: Do not attempt to open the rear door when the rear safety belt is buckled as damage to the belt may occur.

WARNING: Front and rear seat occupants, including pregnant women, should wear safety belts for optimum protection in an accident.

Combination lap and shoulder belts

1. Insert the belt tongue into the proper buckle (the buckle closest to the direction the tongue is coming from) until you hear a snap and feel it latch. Make sure the tongue is securely fastened in the buckle.

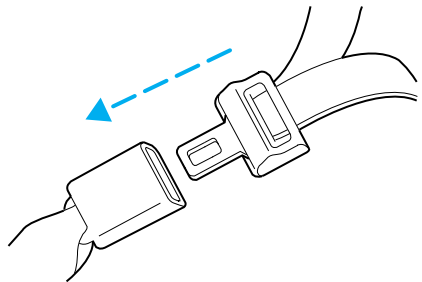

Seating and Safety Restraints

2. To unfasten, press the release button and remove the tongue from the buckle.

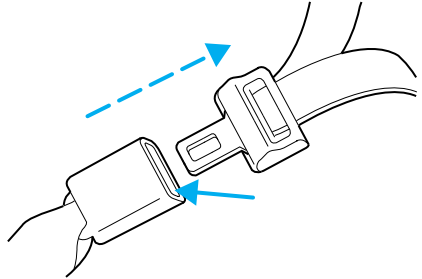

Lap belts

Adjusting the front center seat and rear center facing jump seat lap belts (if equipped)

The lap belt does not adjust automatically.



WARNING: The lap belt should fit snugly and as low as possible around the hips, not across the waist.

Insert the tongue into the correct buckle (the buckle closest to the direction the tongue is coming from). To lengthen the belt, turn the tongue at a right angle to the belt and pull across your lap until it reaches the buckle. To tighten the belt, pull the loose end of the belt through the tongue until it fits snugly across the hips.

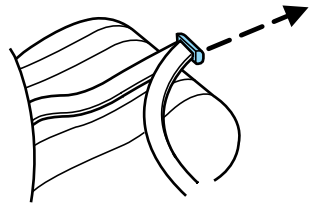

Shorten and fasten the belt when not in use.

For the rear jump seat, shorten and fold the belt into the seat when not in use.

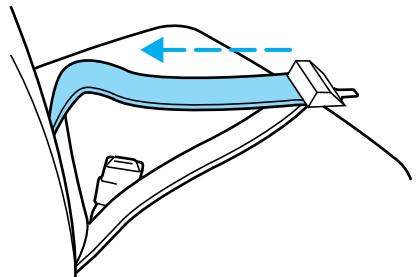

Seating and Safety Restraints

Energy management feature

- This vehicle has a safety belt system with an energy management feature at the front outboard seating positions to help further reduce the risk of injury in the event of a head-on collision.
- This energy management system has a retractor assembly that is designed to pay out webbing in a controlled manner. This feature is designed to help reduce the belt force acting on the occupant's chest.

The front outboard safety restraints in the vehicle are combination lap and shoulder belts. The driver safety belt has the first two types of locking modes and the front passenger outboard safety belt has all three types of locking modes described below:

Vehicle sensitive mode

This is the normal retractor mode, which allows free shoulder belt length adjustment to your movements and locking in response to vehicle movement. For example, if the driver brakes suddenly or turns a corner sharply, or the vehicle receives an impact of approximately 5 mph (8 km/h) or more, the combination safety belts will lock to help reduce forward movement of the driver and passengers.

Webbing extraction sensitive mode

The webbing sensitive locking mode locks the webbing and prevents more belt from being pulled out if the belt is pulled out too quickly. The belt will unlock when you stop pulling on it.

Automatic locking mode

The automatic locking mode is not available on the driver safety belt.

When to use the automatic locking mode

In this mode, the shoulder belt is automatically pre-locked. The belt will still retract to remove any slack in the shoulder belt. The automatic locking mode is not available on the driver safety belt.

This mode should be used **any time** a child safety seat is installed in a passenger front seat. Refer to *Safety restraints for children* or *Safety seats for children* later in this chapter.

Seating and Safety Restraints

How to use the automatic locking mode

- Buckle the combination lap and shoulder belt.

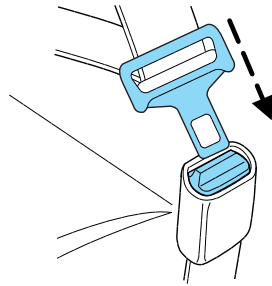

- Grasp the shoulder portion and pull downward until the entire belt is pulled out.



- Allow the belt to retract. As the belt retracts, you will hear a clicking sound. This indicates the safety belt is now in the automatic locking mode.

How to disengage the automatic locking mode

Disconnect the combination lap/shoulder belt and allow it to retract completely to disengage the automatic locking mode and activate the vehicle sensitive (emergency) locking mode.



WARNING: After any vehicle collision, the safety belt system at all outboard seating positions (except driver, which has no “automatic locking retractor” feature) must be checked by an authorized dealer to verify that the “automatic locking retractor” feature for child seats is still functioning properly. In addition, all safety belts should be checked for proper function.

Seating and Safety Restraints

 **WARNING:** BELT AND RETRACTOR ASSEMBLY MUST BE REPLACED if the safety belt assembly “automatic locking retractor” feature or any other safety belt function is not operating properly when checked by an authorized dealer.

 **WARNING:** Failure to replace the Belt and Retractor assembly could increase the risk of injury in collisions.

Safety belt pretensioner

Your vehicle is equipped with safety belt pretensioners at the driver and front outboard passenger seating positions.

The safety belt pretensioner tightens the safety belts firmly against the occupant's body at the start of the crash.

 **WARNING:** The driver and front passenger safety belt system (including retractors, buckles and height adjusters) must be replaced if the vehicle is involved in a collision that results in deployment of front airbags, side airbags, and safety belt pretensioners.

Refer to the *Safety belt maintenance* section in this chapter.

Front safety belt height adjustment

Your vehicle has safety belt height adjustments for the driver and front outboard passenger. Adjust the height of the shoulder belt so the belt rests across the middle of your shoulder.

- Regular Cab and 4-door Super Cab

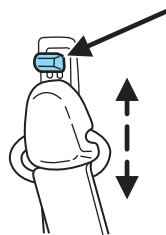

Seating and Safety Restraints

- 2-door SuperCab

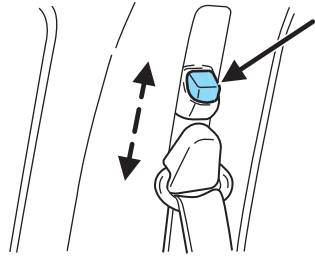

To lower the shoulder belt height, press the button and slide the height adjuster down. To raise the height of the shoulder belt, press the button and slide the height adjuster up. Pull down on the height adjuster to make sure it is locked in place.



WARNING: Position the safety belt height adjusters so that the belt rests across the middle of your shoulder. Failure to adjust the safety belt properly could reduce the effectiveness of the seat belt and increase the risk of injury in a collision.

Safety belt extension assembly

If the safety belt is too short when fully extended, there is an 8 inch (20 cm) safety belt extension assembly that can be added (part number 611C22). This assembly can be obtained from an authorized dealer.

Use only extensions manufactured by the same supplier as the safety belt. Manufacturer identification is located at the end of the webbing on the label. Also, use the safety belt extension only if the safety belt is too short for you when fully extended.



WARNING: Do not use extensions to change the fit of the shoulder belt across the torso.

Safety belt warning light and indicator chime

The safety belt warning light illuminates in the instrument cluster and a chime sounds to remind the occupants to fasten their safety belts.

Seating and Safety Restraints

Conditions of operation

If...	Then...
The driver's safety belt is not buckled before the ignition switch is turned to the on position...	The safety belt warning light illuminates 1-2 minutes and the warning chime sounds 4-8 seconds.
The driver's safety belt is buckled while the indicator light is illuminated and the warning chime is sounding...	The safety belt warning light and warning chime turn off.
The driver's safety belt is buckled before the ignition switch is turned to the on position...	The safety belt warning light and indicator chime remain off.

Belt-Minder®

The Belt-Minder® feature is a supplemental warning to the safety belt warning function. This feature provides additional reminders by intermittently sounding a chime and illuminating the safety belt warning light in the instrument cluster when the driver's and front passenger's safety belt is unbuckled.

The Belt-Minder® feature uses information from the front passenger sensing system to determine if a front seat passenger is present and therefore potentially in need of a warning. To avoid activating the Belt-Minder® feature for objects placed in the front passenger seat, warnings will only be given to large front seat occupants as determined by the front passenger sensing system.

Both the driver's and passenger's safety belt usages are monitored and either may activate the Belt-Minder® feature. The warnings are the same for the driver and the front passenger. If the Belt-Minder® warnings have expired (warnings for approximately five minutes) for one occupant (driver or front passenger), the other occupant can still activate the Belt-Minder® feature.

Seating and Safety Restraints

If...	Then...
The driver's and front passenger's safety belts are buckled before the ignition switch is turned to the on position or less than 1-2 minutes have elapsed since the ignition switch has been turned to on...	The Belt-Minder® feature will not activate.
The driver's or front passenger's safety belt is not buckled when the vehicle has reached at least 3 mph (5 km/h) and 1-2 minutes have elapsed since the ignition switch has been turned to on...	The Belt-Minder® feature is activated - the safety belt warning light illuminates and the warning chime sounds for six seconds every 30 seconds, repeating for approximately five minutes or until the safety belts are buckled.
The driver's or front passenger's safety belt becomes unbuckled for approximately one minute while the vehicle is traveling at least 3 mph (5 km/h) and more than 1-2 minutes have elapsed since the ignition switch has been turned to on...	The Belt-Minder® feature is activated - the safety belt warning light illuminates and the warning chime sounds for six seconds every 30 seconds, repeating for approximately five minutes or until the safety belts are buckled.

Seating and Safety Restraints

The following are reasons most often given for not wearing safety belts
(All statistics based on U.S. data):

Reasons given...	Consider...
“Crashes are rare events”	36700 crashes occur every day. The more we drive, the more we are exposed to “rare” events, even for good drivers. <i>1 in 4 of us will be seriously injured in a crash during our lifetime.</i>
“I’m not going far”	3 of 4 fatal crashes occur within 25 miles (40 km) of home.
“Belts are uncomfortable”	We design our safety belts to enhance comfort. If you are uncomfortable - try different positions for the safety belt upper anchorage and seatback which should be as upright as possible; this can improve comfort.
“I was in a hurry”	Prime time for an accident. Belt-Minder® reminds us to take a few seconds to buckle up.
“Safety belts don’t work”	Safety belts , when used properly, reduce risk of death to front seat occupants by 45% in cars , and by 60% in light trucks .
“Traffic is light”	Nearly 1 of 2 deaths occur in single-vehicle crashes , many when no other vehicles are around.
“Belts wrinkle my clothes”	Possibly, but a serious crash can do much more than wrinkle your clothes, particularly if you are unbelted.
“The people I’m with don’t wear belts”	Set the example, teen deaths occur 4 times more often in vehicles with TWO or MORE people. Children and younger brothers/sisters imitate behavior they see.
“I have an airbag”	Airbags offer greater protection when used with safety belts. Frontal airbags are not designed to inflate in rear and side crashes or rollovers.
“I’d rather be thrown clear”	Not a good idea. People who are ejected are 40 times more likely to DIE . Safety belts help prevent ejection, WE CAN’T “PICK OUR CRASH”.

Seating and Safety Restraints



WARNING: Do not sit on top of a buckled safety belt or insert a latchplate into the buckle to avoid the Belt-Minder® chime. To do so may adversely affect the performance of the vehicle's airbag system.

One-time disable

If at any time the driver/front passenger quickly buckles then unbuckles the safety belt for that seating position, the Belt-Minder® is disabled for the current ignition cycle. The Belt-Minder® feature will enable during the same ignition cycle if the occupant buckles and remains buckled for approximately 30 seconds. Confirmation is not given for the one-time disable.

Deactivating/activating the Belt-Minder® feature

The driver and front passenger Belt-Minder® are deactivated/activated independently. When deactivating/activating one seating position, do not buckle the other position as this will terminate the process.

Read Steps 1 - 4 thoroughly before proceeding with the deactivation/activation programming procedure.

Note: The driver and front passenger Belt-Minder® features must be disabled/enabled separately. Both cannot be disabled/enabled during the same key cycle.

The driver and front passenger Belt-Minder® features can be deactivated/activated by performing the following procedure:

Before following the procedure, make sure that:

- The parking brake is set
- the gearshift is in P (Park) (automatic transmission) or the neutral position (manual transmission)
- The ignition switch is in the off position
- The driver and front passenger safety belts are unbuckled



WARNING: While the design allows you to deactivate your Belt-Minder®, this system is designed to improve your chances of being safely belted and surviving an accident. We recommend you leave the Belt-Minder® system activated for yourself and others who may use the vehicle. To reduce the risk of injury, do not deactivate/activate the Belt-Minder® feature while driving the vehicle.

Seating and Safety Restraints

1. Turn the ignition switch to the on position. DO NOT START THE ENGINE.
2. Wait until the safety belt warning light turns off (Approximately one minute).
 - Step 3 must be completed within 50 seconds after the safety belt warning light turns off.
3. For the seating position being disabled, buckle then unbuckle the safety belt nine times at a moderate speed, ending in the unbuckled state. Step 3 must be completed within 50 seconds after the safety belt warning light turns off.
 - After Step 3, the safety belt warning light will be turned on for three seconds.
4. Within approximately seven seconds of the light turning off, buckle then unbuckle the safety belt.
 - This will disable the Belt-Minder® feature for that seating position if it is currently enabled. As confirmation, the safety belt warning light will flash four times per second for three seconds.
 - This will enable the Belt-Minder® feature for that seating position if it is currently disabled. As confirmation, the safety belt warning light will flash four times per second for three seconds, followed by three seconds with the light off, then followed by the safety belt warning light flashing four times per second for three seconds again.

AIRBAG SUPPLEMENTAL RESTRAINT SYSTEM (SRS)

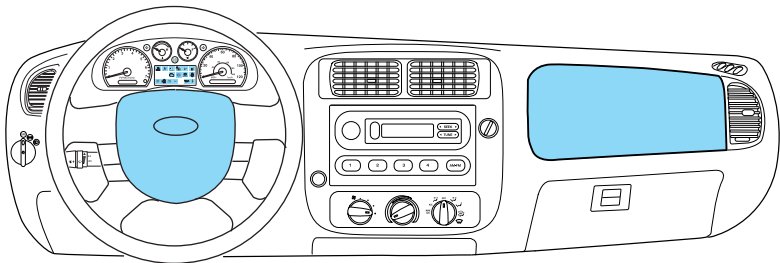

The airbag supplemental restraint system is designed to work in conjunction with the safety belts to help protect the driver and front outboard passenger from certain upper body injuries. The term “supplemental restraint” means the airbags are intended as a supplement to the safety belts. Airbags alone cannot protect as well as airbags plus

Seating and Safety Restraints

safety belts in impacts for which the airbags are designed to deploy, and airbags do not offer any protection in crashes for which they do not deploy.

The airbag supplemental restraint system consists of:

- driver and passenger dual stage airbag modules (which include the inflators and airbags).
- one or more impact and safing sensors.
- the same indicator light, RCM (restraints control module) and diagnostic unit used for the Personal safety system.
- Front passenger sensing system
- Passenger airbag off indicator light.

The airbag supplemental restraints are an integral part of the Personal Safety System. They are designed to be deployed in cases where the Personal Safety System has determined the occupant conditions and crash severity are appropriate to activate these devices. Refer to the *Personal Safety System* section in this chapter.

Important supplemental restraint system (SRS) precautions

The supplemental restraint system is designed to work with the safety belt to help protect the driver and right front passenger from certain upper body injuries.

Airbags DO NOT inflate slowly or gently and the risk of injury from a deploying airbag is greatest close to the trim covering the airbag module.



WARNING: Rear facing child seats should NEVER be placed in front of an active airbag.



WARNING: All occupants of the vehicle, including the driver, should always properly wear their safety belts, even when an airbag supplemental restraint system (SRS) is provided.



Seating and Safety Restraints

 **WARNING:** National Highway Traffic Safety Administration (NHTSA) recommends a minimum distance of at least 25 cm (10 inches) between an occupant's chest and the driver airbag module.

 **WARNING:** Never place your arm over the air bag module as a deploying airbag can result in serious arm fractures or other injuries.

Steps you can take to properly position yourself away from the airbag:

- Move your seat to the rear as far as you can while still reaching the pedals comfortably.
- Recline the seat slightly (one or two degrees) from the upright position.

 **WARNING:** Do not put anything on or over the airbag module. Placing objects on or over the airbag inflation area may cause those objects to be propelled by the airbag into your face and torso causing serious injury.

 **WARNING:** Do not attempt to service, repair, or modify the Airbag Supplemental Restraint System or its fuses. Contact your authorized dealer as soon as possible.

 **WARNING:** The front passenger airbag is not designed to offer protection to an occupant in the center front seating position.

 **WARNING:** Modifying or adding equipment to the front end of the vehicle (including frame, bumper, front end body structure and tow hooks) may affect the performance of the airbag system, increasing the risk of injury. Do not modify the front end of the vehicle.

 **WARNING:** Additional equipment may affect the performance of the airbag sensors increasing the risk of injury.

Seating and Safety Restraints

Children and airbags

For additional important safety information, read all information on safety restraints in this guide.



WARNING: Do not install a child seat in a center facing jump seat.

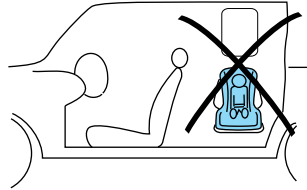

WARNING: Airbags can kill or injure a child in a child seat. **NEVER** place a rear-facing child seat in front of an active airbag. If you must use a forward-facing child seat in the front seat, move the seat all the way back.



WARNING: Front seating positions only: If seating two adults and a child, Ford recommends properly restraining the child in the center front seating position, but only if doing so will not interfere with driving the vehicle. This arrangement provides lap and shoulder belt and airbag protection for adult occupants and an attachment method for a child restraint. If the child seat interferes with driving the vehicle and the child restraint is forward-facing, the child may be restrained in the passenger seat. Move the seat as far rearward as possible to minimize the likelihood of interaction with the front passenger airbag. Never place a rear-facing child seat in front of an active airbag. Always properly restrain all occupants, including the child in an appropriate child seat or booster.



WARNING: Installing a child safety seat in the front row lap seating position should be avoided if at all possible.



WARNING: Never place a rear-facing child seat in the front center seating position of a vehicle with rear seating positions.



WARNING: Booster seats must be installed only in seating positions equipped with a combination lap/shoulder belt.

Seating and Safety Restraints



WARNING: To reduce the risk of injury, make sure children sit where they can be properly restrained.

How does the airbag supplemental restraint system work?

The airbag SRS is designed to activate when the vehicle sustains sufficient longitudinal deceleration.

The fact that the airbags did not inflate in a collision does not mean that something is wrong with the system. Rather, it means the forces were not of the type sufficient to cause activation. Airbags are designed to inflate in frontal and near-frontal collisions, not rollover, side-impact, or rear-impacts.

The airbags inflate and deflate rapidly upon activation. After airbag deployment, it is normal to notice a smoke-like, powdery residue or smell the burnt propellant. This may consist of cornstarch, talcum powder (to lubricate the bag) or sodium compounds (e.g., baking soda) that result from the combustion process that inflates the airbag. Small amounts of sodium hydroxide may be present which may irritate the skin and eyes, but none of the residue is toxic.

While the system is designed to help reduce serious injuries, it may also cause minor abrasions, swelling or temporary hearing loss. Because airbags must inflate rapidly and with considerable force, there is the risk of death or serious injuries such as fractures, facial and eye injuries or internal injuries, particularly to occupants who are not properly restrained or are otherwise out of position at the time of airbag deployment. Thus, it is extremely important that occupants be properly restrained as far away from the airbag cover as possible while maintaining vehicle control.

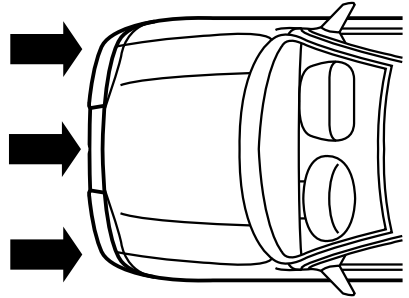

Seating and Safety Restraints



WARNING: Several airbag system components get hot after inflation. Do not touch them after inflation.



WARNING: If the airbag has deployed, **the airbag will not function again and must be replaced immediately.** If the airbag is not replaced, the unrepaired area will increase the risk of injury in a collision.

Front passenger sensing system

The front passenger sensing system will turn off the front passenger's frontal airbag under certain conditions. The driver's frontal airbag is not part of the front passenger sensing system. The front passenger sensing system works with sensors that are part of the front passenger's seat and safety belt. The sensors are designed to detect the presence of a properly seated occupant and determine if the front passenger's frontal airbag should be enabled (may inflate) or not.

The front passenger sensing system is designed to meet the regulatory requirements of Federal Motor Vehicle Safety Standard (FMVSS) 208 and is designed to turn off the front passenger's frontal airbag if:

- the front passenger seat is unoccupied, or has small/medium objects in the front seat,
- the system determines that a small child is present in a rear-facing child seat that is installed according to the manufacturer's instructions.
- the system determines that a small child is present in a forward-facing child restraint that is installed according to the manufacturer's instructions,
- the system determines that a small child is present in a booster seat,
- a front passenger takes his/her weight off of the seat for a period of time,

When the passenger airbag off light is illuminated, the passenger side airbag may be disabled to avoid the risk of airbag deployment injuries.



WARNING: Even with Advanced Restraints Systems, children 12 and under should be properly restrained in a rear seating position (if equipped).

Seating and Safety Restraints

When the front passenger seat is occupied and the sensing system has turned off the passenger's frontal airbag, the "passenger airbag off" or "pass airbag off" indicator will light and stay lit to remind you that the front passenger frontal airbag is off. When the front passenger seat is not occupied (empty seat) or in the event that the front passenger frontal airbag is enabled (may inflate), the indicator light will be unlit.

The indicator light is located in the center stack of the instrument panel. To confirm the "pass airbag light" is functional, it will momentarily illuminate when the ignition is turned to the on position.



The front passenger sensing system is designed to turn off the front passenger's frontal airbag when a rear facing child seat, a forward-facing child restraint, or a booster seat is detected. If the child restraint has been installed and the indicator is not lit, then turn the vehicle off, remove the child restraint from the vehicle and reinstall the restraint following the child restraint manufacturer's directions.

The front passenger sensing system is designed to enable (may inflate) the right front passenger's frontal airbag anytime the system senses that a person of adult size is sitting properly in the front passenger seat. When the passenger sensing system has allowed the airbag to be enabled, the indicator will be unlit and stay unlit to remind you that the airbag is enabled (may inflate).

If a person of adult-size is sitting in the front passenger's seat, but the "passenger airbag off" or "pass airbag off" indicator is lit, it could be that the person isn't sitting properly in the seat. If this happens, turn the vehicle off and ask the person to place the seatback in the full upright position, then sit upright in the seat, centered on the seat cushion, with the person's legs comfortably extended. Restart the vehicle and have the person remain in this position for about two minutes. This will allow the system to detect that person and then enable the passenger's airbag. If the indicator lamp remains lit even after this, then the occupant should be advised to ride in the back seat.

Seating and Safety Restraints

Occupant	Pass Airbag Off Indicator Lamp	Passenger Airbag
Empty seat	Unlit	Disabled
Small child in child safety seat or booster	Lit	Disabled
Small child with safety belt buckled or unbuckled	Lit	Disabled
Adult	Unlit	Enabled

After all occupants have adjusted their seats and put on safety belts, it's very important that they continue to sit upright, with their back against the seatback, with their feet comfortably extended on the floor while the vehicle is still in motion. Sitting improperly can increase the chance of injury in a crash event. For example, if an occupant slouches, lies down, turns sideways, sits forward, leans forward or sideways, or puts one or both feet up, the chance of injury during a crash is greatly increased.



WARNING: Sitting improperly out of position or with the seat back reclined too far can take off weight from the seat cushion and affect the decision of the front passenger sensing system, resulting in serious injury or death in a crash.

Always sit upright against your seatback, with your feet on the floor.

In case there is a problem with the passenger sensing system, the airbag readiness lamp in the instrument cluster will stay lit. Do NOT attempt to repair or service the system; take your vehicle immediately to the dealer.



WARNING: The front passenger airbag is not designed to offer protection to an occupant in the center seating position.



WARNING: An out of position front center occupant could affect the decision of the front passenger sensing system.

If it is necessary to modify an advanced front airbag system to accommodate a person with disabilities, contact the Ford Customer Relationship Center at the phone number shown in the *Customer Assistance* section of this owner's guide.

Seating and Safety Restraints

The front passenger sensing system may detect small or medium objects placed on the seat cushion. For most objects that are in the front passenger seat, the passenger airbag will be disabled. Even though the passenger airbag is disabled, the "pass airbag off" light may or may not be illuminated according to the table below.

Objects	Pass Airbag Off Indicator Lamp	Passenger Airbag
Small (i.e. three-ring binder, small purse, bottled water)	Unlit	Disabled
Medium (i.e. heavy briefcase, fully packed luggage)	Lit	Disabled
Empty seat, or small to medium object with safety belt buckled	Lit	Disabled



WARNING: Any alteration/modification to the front passenger seat may affect the performance of the front passenger sensing system.

Determining if the system is operational

The SRS uses readiness lights in the instrument cluster or a tone to indicate the condition of the system. Refer to *Airbag readiness* in the *Instrument Cluster* chapter. Routine maintenance of the airbag is not required.

A difficulty with the system is indicated by one or more of the following:

- The readiness lights will either flash or stay lit.
- The readiness lights will not illuminate immediately after ignition is turned on.
- A series of five beeps will be heard. The tone pattern will repeat periodically until the problem and/or light are repaired.



If any of these things happen, even intermittently, contact your authorized dealer as soon as possible. Unless serviced, the system may not function properly in the event of a collision.

Seating and Safety Restraints

Seat-mounted side airbag system

 **WARNING:** Do not place objects or mount equipment on or near the airbag cover on the side of the seatbacks of the front seats or in front seat areas that may come into contact with a deploying airbag. Failure to follow these instructions may increase the risk of personal injury in the event of a collision.

 **WARNING:** Do not use accessory seat covers. The use of accessory seat covers may prevent the deployment of the side airbags and increase the risk of injury in an accident.

 **WARNING:** Do not lean your head on the door. The side airbag could injure you as it deploys from the side of the seatback.

 **WARNING:** Do not attempt to service, repair, or modify the airbag SRS, its fuses or the seat cover on a seat containing an airbag. See an authorized dealer.

 **WARNING:** All occupants of the vehicle should always wear their safety belts even when an airbag SRS is provided.

How does the side airbag system work?

The design and development of the side airbag system included recommended testing procedures that were developed by a group of automotive safety experts known as the Side Airbag Technical Working Group. These recommended testing procedures help reduce the risk of injuries related to the deployment of side airbags.

The side airbag system consists of the following:

- An inflatable bag (airbag) with a gas generator concealed behind the outboard bolster of the driver and front passenger seatbacks.
- A special seat cover designed to allow airbag deployment.

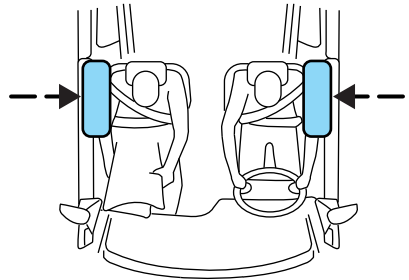

Seating and Safety Restraints

- The same warning light, electronic control and diagnostic unit as used for the front airbags.
- Two crash sensors located on the front doors (one on each side of the vehicle).

Side airbags, in combination with safety belts, can help reduce the risk of severe injuries in the event of a significant side impact collision.

The side airbags are fitted on the outboard side of the seatbacks of the front seats. In certain lateral collisions, the airbag on the side affected by the collision will be inflated. The airbag was designed to inflate between the door panel and occupant to further enhance the protection provided occupants in side impact collisions.

The airbag SRS is designed to activate when the vehicle sustains lateral deceleration sufficient to cause the sensors to close an electrical circuit that initiates airbag inflation.

The fact that the airbags did not inflate in a collision does not mean that something is wrong with the system. Rather, it means the forces were not of the type sufficient to cause activation. Side airbags are designed to inflate in side-impact collisions, not roll-over, rear-impact, frontal or near-frontal collisions, unless the collision causes sufficient lateral deceleration.



WARNING: Several airbag system components get hot after inflation. Do not touch them after inflation.



WARNING: If the side airbag has deployed, **the airbag will not function again. The side airbag system (including the seat) must be inspected and serviced by an authorized dealer.** If the airbag is not replaced, the unrepaired area will increase the risk of injury in a collision.

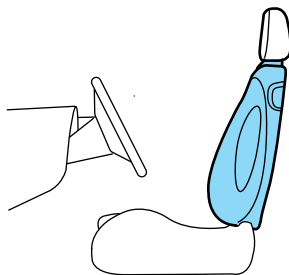

Seating and Safety Restraints

Determining if the system is operational

The SRS uses a readiness light in the instrument cluster or a tone to indicate the condition of the system. Refer to *Warning lights and chimes* in the *Instrument Cluster* chapter. Routine maintenance of the side airbag is not required.

A difficulty with the system is indicated by one or more of the following:

- The readiness light (same light as for front airbag system) will either flash or stay lit.
- The readiness light will not illuminate immediately after ignition is turned on.
- A series of five beeps will be heard. The tone pattern will repeat periodically until the problem and/or light are repaired.

If any of these things happen, even intermittently, have the SRS serviced at your authorized dealer immediately. Unless serviced, the system may not function properly in the event of a collision.

Disposal of airbags and airbag equipped vehicles (including pretensioners)

Contact your authorized dealer as soon as possible. Airbags **MUST BE** disposed of by qualified personnel.

SAFETY RESTRAINTS FOR CHILDREN

See the following sections for directions on how to properly use safety restraints for children. Also see *Airbag supplemental restraint system (SRS)* in this chapter for special instructions about using airbags.

Seating and Safety Restraints

Important child restraint precautions



WARNING: Always make sure your child is secured properly in a device that is appropriate for their height, age and weight. Child safety restraints must be purchased separately from the vehicle. Failure to follow these instructions and guidelines may result in an increased risk of serious injury or death to your child.



WARNING: All children are shaped differently. The Recommendations for Safety Restraints are based on probable child height, age and weight thresholds from NHTSA and other safety organizations or are the minimum requirements of law. Ford recommends checking with a NHTSA Certified Child Passenger Safety Technician (CPST) and consult your pediatrician to make sure your child seat is appropriate for your child, and is compatible with and properly installed in the vehicle. To locate a child seat fitting station and CPST contact the NHTSA toll free at 1-888-327-4236 or on the internet at <http://www.nhtsa.dot.gov>. In Canada, check with your local St. John Ambulance office for referral to a CPST or for further information, contact your provincial ministry of transportation, your local St. John Ambulance office at <http://www.sfa.ca>, or Transport Canada at 1-800-333-0371 (<http://www.tc.gc.ca>). Failure to properly restrain children in safety seats made especially for their height, age, and weight may result in an increased risk of serious injury or death to your child.

Seating and Safety Restraints

Recommendations for Safety Restraints for Children		
	Child size, height, weight, or age	Recommended restraint type
Infants or toddlers	Children weighing 40 lb (18 kg) or less (generally age four or younger)	Use a child safety seat (sometimes called an infant carrier, convertible seat, or toddler seat).
Small children	Children who have outgrown or no longer properly fit in a child safety seat (generally children who are less than 4 feet 9 inches (1.45 meters) tall, are greater than age four (4) and less than age twelve (12), and between 40 lb (18 kg) and 80 lb (36 kg) and upward to 100 lb (45 kg) if recommended by your child restraint manufacturer)	Use a belt-positioning booster seat.
Larger children	Children who have outgrown or no longer properly fit in a belt-positioning booster seat (generally children who are at least 4 feet 9 inches (1.45 meters) tall or greater than 80 lb (36 kg) or 100 lb (45 kg) if recommended by child restraint manufacturer)	Use a vehicle safety belt having the lap belt snug and low across the hips, shoulder belt centered across the shoulder and chest, and seatback upright.

- You are required by law to properly use safety seats for infants and toddlers in the U.S. and Canada.
- Many states and provinces require that small children use approved booster seats until they reach age eight, a height of 4 ft 9 in. (1.45 meters) tall, or 80 lb (36 kg). Check your local and state or provincial laws for specific requirements regarding the safety of children in your vehicle.

Seating and Safety Restraints

- When possible, always properly restrain children twelve (12) years of age and under in a rear seating position of your vehicle. Accident statistics suggest that children are safer when properly restrained in the rear seating positions than in a front seating position.

Recommendations for attaching child safety restraints for children

Restraint Type	Child Weight	Use any attachment method as indicated below by "X"				
		LATCH (lower anchors and top tether anchor)	LATCH (lower anchors only)	Safety belt and top tether anchor	Safety belt and LATCH (lower anchors and top tether anchor)	Safety belt only
Rear facing child seat	Up to 48 lb (21 kg)		X			X
Forward facing child seat	Up to 48 lb (21 kg)	X		X	X	
Forward facing child seat	Over 48 lb (21 kg)			X	X	



WARNING: Airbags can kill or injure a child in a child seat. NEVER place a rear-facing child seat in front of an active airbag. If you must use a forward-facing child seat in the front seat, move the vehicle seat all the way back. When possible, all children age 12 and under should be properly restrained in a rear seating position. If all children cannot be seated and restrained properly in a rear seating position, properly restrain the largest child in the front seat.

Seating and Safety Restraints



WARNING: Always carefully follow the instructions and warnings provided by the manufacturer of any child restraint to determine if the restraint device is appropriate for your child's size, height, weight, or age. Follow the child restraint manufacturer's instructions and warnings provided for installation and use in conjunction with the instructions and warnings provided by the vehicle manufacturer. A safety seat that is improperly installed or utilized, is inappropriate for your child's height, age, or weight or does not properly fit the child may increase the risk of serious injury or death.



WARNING: Never let a passenger hold a child on his or her lap while the vehicle is moving. The passenger cannot protect the child from injury in a collision, which may result in serious injury or death.



WARNING: Never use pillows, books, or towels to boost a child. They can slide around and increase the likelihood of injury or death in a collision.



WARNING: Always restrain an unoccupied child seat or booster seat. These objects may become projectiles in a collision or sudden stop, which may increase the risk of serious injury.



WARNING: Never place, or allow a child to place, the shoulder belt under a child's arm or behind the back because it reduces the protection for the upper part of the body and may increase the risk of injury or death in a collision.



WARNING: Do not leave children, unreliable adults, or pets unattended in your vehicle.

Transporting children

Always make sure your child is secured properly in a device that is appropriate for their age, height and weight. All children are shaped differently. The child height, age and weight thresholds provided are recommendations or the minimum requirements of law. The National Highway Traffic Safety Administration (NHTSA) provides education and

Seating and Safety Restraints

training to ensure that all children ages 0 to 16 are properly restrained in the correct restraint system. Ford recommends checking with a NHTSA Certified Child Passenger Safety Technician (CPST) and your pediatrician to make sure your seat is appropriate for your child and properly installed in the vehicle. To locate a child seat fitting station and CPST contact the NHTSA toll free at **1-888-327-4236** or on the internet at <http://www.nhtsa.dot.gov>. In Canada, check with your local St. John Ambulance office for referral to a CPST or for further information, contact your provincial ministry of transportation, your local St. John Ambulance office at <http://www.sfa.ca>, or Transport Canada at 1-800-333-0371 (<http://www.tc.gc.ca>).

Follow all the safety restraint and airbag precautions that apply to adult passengers in your vehicle.

If the child is the proper height, age, and weight (as specified by your child safety seat or booster manufacturer), fits the restraint and can be restrained properly, then restrain the child in the child safety seat or with the belt-positioning booster. Remember that child seats and belt-positioning boosters vary and may be designed to fit children of different heights, ages and weights. Children who are too large for child safety seats or belt-positioning boosters (as specified by your child safety seat manufacturer) should always properly wear safety belts.

SAFETY SEATS FOR CHILDREN

Infant and/or toddler seats

Use a safety seat that is recommended for the size and weight of the child.

When installing a child safety seat:

- Review and follow the information presented in the *Airbag supplemental restraint system (SRS)* section in this chapter.
- Carefully follow all of the manufacturer's instructions included with the safety seat you put in your vehicle. If you do not install and use the safety seat properly, the child may be injured in a sudden stop or collision.



Seating and Safety Restraints

Airbags can kill or injure a child in a child seat. NEVER place a rear-facing child seat in front of an active airbag. If you must use a forward-facing child seat in the front seat, move the vehicle seat all the way back.

Children 12 and under should be properly restrained in a rear seating position whenever possible. If all children cannot be seated and restrained properly in a rear seating position, properly restrain the largest child in the front seat.

Installing child safety seats with combination lap and shoulder belts

Check to make sure the child seat is properly secured before each use. Children 12 and under should be properly restrained in a rear seating position whenever possible. If all children cannot be seated and restrained properly in a rear seating position, properly restrain the largest child in the front seat.

When installing a child safety seat with combination lap/shoulder belts:

- Use the correct safety belt buckle for that seating position.
- Insert the belt tongue into the proper buckle until you hear a snap and feel it latch. Make sure the tongue is securely fastened in the buckle.
- Keep the buckle release button pointing up and away from the safety seat, with the tongue between the child seat and the release button, to prevent accidental unbuckling.
- Place vehicle seat back in upright position.
- Put the safety belt in the automatic locking mode. Refer to step 5 below. This vehicle does not require the use of a locking clip.



WARNING: Depending on where you secure a child restraint, and depending on the child restraint design, you may block access to certain safety belt buckle assemblies and/or LATCH lower anchors, rendering those features potentially unusable. To avoid risk of injury, occupants should only use seating positions where they are able to be properly restrained.

Perform the following steps when installing the child seat with combination lap/shoulder belts:

Note: Although the child seat illustrated is a forward facing child seat, the steps are the same for installing a rear facing child seat.

Seating and Safety Restraints

1. Position the child safety seat in a seat with a combination lap and shoulder belt.

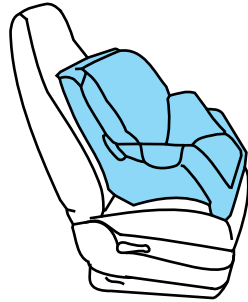

WARNING: Rear facing child seats should NEVER be placed in front of an active airbag.

2. Pull down on the shoulder belt and then grasp the shoulder belt and lap belt together.

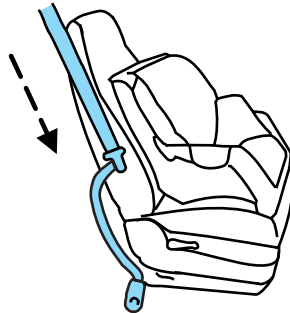

3. While holding the shoulder and lap belt portions together, route the tongue through the child seat according to the child seat manufacturer's instructions. Be sure the belt webbing is not twisted.

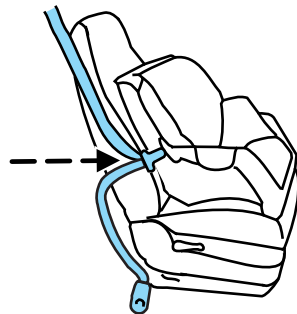

Seating and Safety Restraints

4. Insert the belt tongue into the proper buckle (the buckle closest to the direction the tongue is coming from) for that seating position until you hear and feel the latch engage. Make sure the tongue is latched securely by pulling on it.



5. To put the retractor in the automatic locking mode, grasp the shoulder portion of the belt and pull downward until all of the belt is extracted and a click is heard.

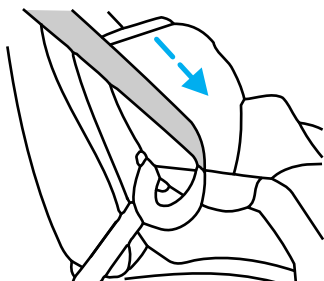

6. Allow the belt to retract. The belt will click as it retracts to indicate it is in the automatic locking mode.

7. Try to pull the belt out of the retractor to make sure the retractor is in the automatic locking mode (you should not be able to pull more belt out). If the retractor is not locked, unbuckle the belt and repeat Steps 5 and 6.

8. Remove remaining slack from the belt. Force the seat down with extra weight, e.g., by kneeling on the child restraint while pulling up on the shoulder belt in order to force slack from the belt. This is necessary to remove the remaining slack that will exist once the additional weight of the child is added to the child restraint. It also helps to achieve the proper snugness of the child seat to the vehicle. Sometimes, a slight lean

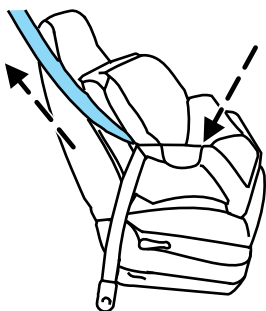

Seating and Safety Restraints

towards the buckle will additionally help to remove remaining slack from the belt

9. Attach the tether strap (if the child seat is equipped). Refer to *Attaching child safety seats with tether straps* later in this chapter.

10. Before placing the child in the seat, forcibly move the seat forward and back to make sure the seat is securely held in place. To check this, grab the seat at the belt path and attempt to move it side to side and forward. There should be no more than one inch (2.5 cm) of movement for proper installation.

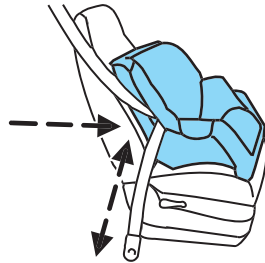

11. Ford recommends checking with a NHTSA Certified Child Passenger Safety Technician (CPST) to make certain the child restraint is properly installed. In Canada, check with your local St. John Ambulance office for referral to a CPST.

Installing child safety seats in the lap belt seating positions

1. Lengthen the lap belt. To lengthen the belt, hold the tongue so that its bottom is perpendicular to the direction of webbing while sliding the tongue up the webbing.

2. Place the child safety seat in the center seating position.

3. Route the tongue and webbing through the child seat according to the child seat manufacturer's instructions.

4. Insert the belt tongue into the proper buckle for the center seating position until you hear a snap and feel it latch. Make sure the tongue is securely fastened to the buckle by pulling on the tongue.

5. Push down on the child seat while pulling on the loose end of the lap belt webbing to tighten the belt.

6. Before placing the child into the child seat, forcibly tilt the child seat from side to side and in forward direction to make sure that the seat is securely held in place. To check this, grab the seat at the belt path and attempt to move it side to side and forward and back. There should be no more than one inch (2.5 cm) of movement for proper installation.

7. Ford recommends checking with a NHTSA Certified Child Passenger Safety Technician (CPST) to make certain the child restraint is properly installed. In Canada, check with your local St. John Ambulance office for referral to a CPST.

Seating and Safety Restraints

Attaching child safety seats with LATCH (Lower Anchors and Tethers for Children) attachments

The LATCH system is composed of three vehicle anchor points: two (2) lower anchors located where the vehicle seat back and seat cushion meet (called the “seat bight”) and one (1) top tether anchor located behind that seating position. Your vehicle is **not** equipped with the lower anchor points in the seat bight. For this vehicle use the vehicle safety belt and upper tether to secure a child seat. See *Attaching child safety seats with tether straps* and *Recommendations for attaching safety restraints for children* in this chapter for more information.

Attaching child safety seats with tether straps

Many forward-facing child safety seats include a tether strap which extends from the back of the child safety seat and hooks to an anchoring point called the top tether anchor. Tether straps are available as an accessory for many older safety seats. Contact the manufacturer of your child seat for information about ordering a tether strap, or to obtain a longer tether strap if the tether strap on your safety seat does not reach the appropriate top tether anchor in the vehicle.

The tether anchors in your vehicle are located on the back of the front seat cushion.

The tether strap anchors in your vehicle are in the following positions (shown from top view):

- **Bucket seats**

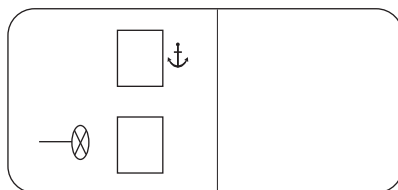

Seating and Safety Restraints

- **60/40 seats**

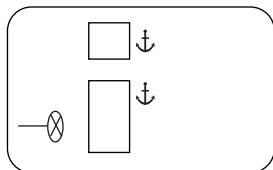

Attach the tether strap only to the appropriate tether anchor as shown. The tether strap may not work properly if attached somewhere other than the correct tether anchor.

Once the child safety seat has been installed using the safety belt, you can attach the top tether strap.

Perform the following steps to install a child safety seat with tether anchors:

1. Route the child safety seat tether strap over the back of the seat.

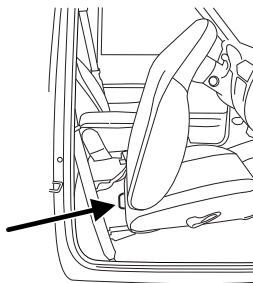

2. Locate the correct anchor for the selected seating position.

Seating and Safety Restraints

The tether anchor is located on the rear lower portion of the passenger seat.

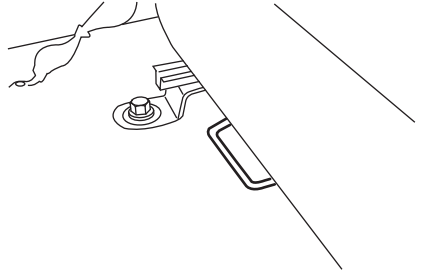

3. Clip the tether strap to the anchor.

If the tether strap is clipped incorrectly, the child safety seat may not be retained properly in the event of a collision.

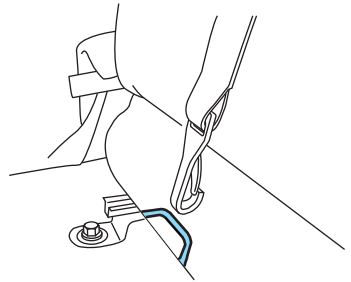
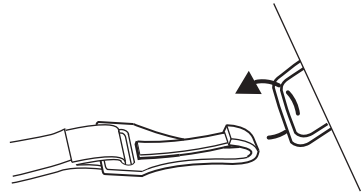

Seating and Safety Restraints

Center seating location

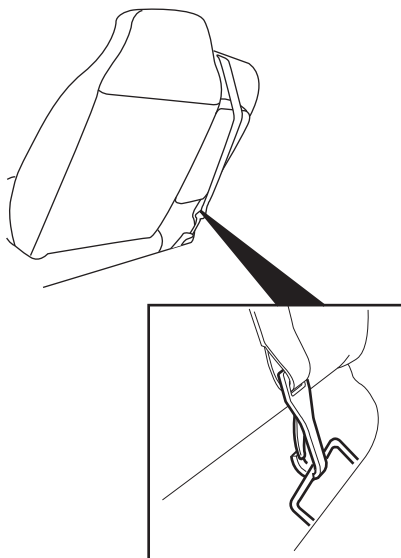

When installing a child safety seat in the front center position, route the tether strap over the center arm rest and clip it to the center anchor.

If the tether strap is clipped incorrectly, the child safety seat may not be retained properly in the event of a collision.

4. Tighten the child safety seat tether strap according to the manufacturer's instructions.

If the safety seat is not anchored properly, the risk of a child being injured in a collision greatly increases.

If your child restraint system is equipped with a tether strap, and the child restraint manufacturer recommends its use, Ford also recommends its use.

Child booster seats

The belt-positioning booster (booster seat) is used to improve the fit of the vehicle safety belt. Children outgrow a typical child seat (e.g., convertible or toddler seat) when they weigh about 40 lb (18 kg) and are around four (4) years of age. Consult your child safety seat owner guide for the weight, height, and age limits specific to your child safety seat.

Seating and Safety Restraints

Keep your child in the child safety seat if it properly fits the child, remains appropriate for their weight, height and age AND if properly secured to the vehicle.

Although the lap/shoulder belt will provide some protection, children who have outgrown a typical child seat are still too small for lap/shoulder belts to fit properly, and wearing an improperly fitted vehicle safety belt could increase the risk of serious injury in a crash. To improve the fit of both the lap and shoulder belt on children who have outgrown child safety seats, Ford Motor Company recommends use of a belt-positioning booster.

Booster seats position a child so that vehicle lap/shoulder safety belts fit better. They lift the child up so that the lap belt rests low across the hips and the knees bend comfortably at the edge of the cushion, while minimizing slouching. Booster seats may also make the shoulder belt fit better and more comfortably. Try to keep the belt near the middle of the shoulder and across the center of the chest. Moving the child closer (a few centimeters or inches) to the center of the vehicle, but remaining in the same seating position, may help provide a good shoulder belt fit.

When children should use booster seats

Children need to use booster seats from the time they outgrow the toddler seat until they are big enough for the vehicle seat and lap/shoulder belt to fit properly. Generally this is when they reach a height of at least 4 feet 9 inches (1.45 meters) tall (around age eight to age twelve and between 40 lb (18 kg) and 80 lb (36 kg) or upward to 100 lb (45 kg) if recommended by your child restraint manufacturer). Many state and provincial laws require that children use approved booster seats until they reach age eight, a height of 4 feet 9 inches (1.45 meters) tall, or 80 lb (36 kg).

Booster seats should be used until you can answer YES to ALL of these questions when seated without a booster seat:

- Can the child sit all the way back against the vehicle seat back with knees bent comfortably at the edge of the seat cushion?
- Can the child sit without slouching?

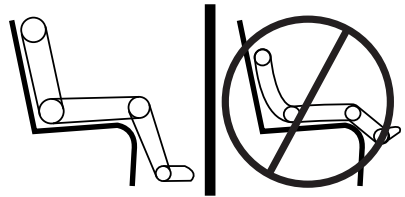

- Does the lap belt rest low across the hips?
- Is the shoulder belt centered on the shoulder and chest?

Seating and Safety Restraints

- Can the child stay seated like this for the whole trip?

Types of booster seats

There are generally two types of belt-positioning booster seats: backless and high back. Always use booster seats in conjunction with the vehicle lap/shoulder belt.

- Backless booster seats

If your backless booster seat has a removable shield, remove the shield. If a vehicle seating position has a low seat back or no head restraint, a backless booster seat may place your child's head (as measured at the tops of the ears) above the top of the seat. In this case, move the backless booster to another seating position with a higher seat back or head restraint and lap/shoulder belts, or consider using a high back booster seat.



- High back booster seats

If, with a backless booster seat, you cannot find a seating position that adequately supports your child's head, a high back booster seat would be a better choice.



Seating and Safety Restraints

Children and booster seats vary in size and shape. Choose a booster that keeps the lap belt low and snug across the hips, never up across the stomach, and lets you adjust the shoulder belt to cross the chest and rest snugly near the center of the shoulder. The drawings below compare the ideal fit (center) to a shoulder belt uncomfortably close to the neck and a shoulder belt that could slip off the shoulder. The drawings below also show how the lap belt should be low and snug across the child's hips.

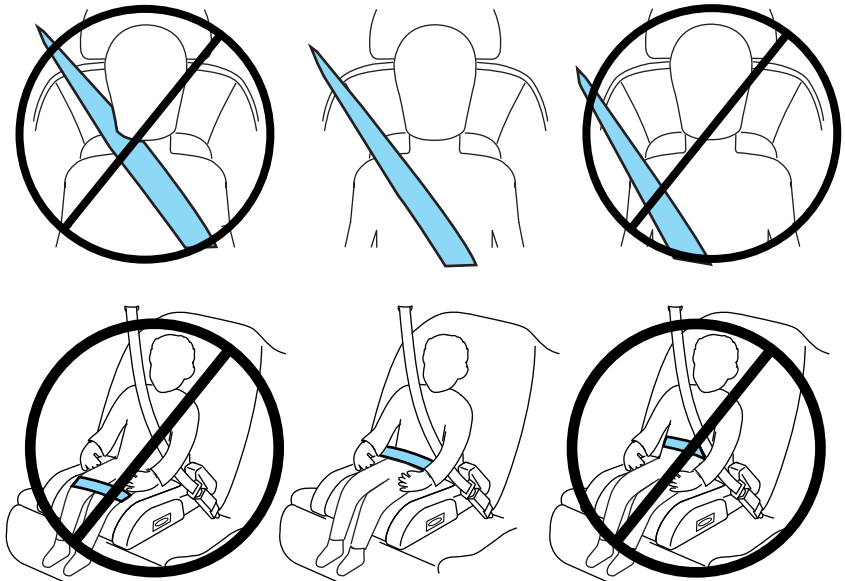

If the booster seat slides on the vehicle seat, placing a rubberized mesh sold as shelf or carpet liner under the booster seat may improve this condition. Do not introduce any item thicker than this under the booster seat. Check with the booster seat manufacturer's instructions.

The importance of shoulder belts

Using a booster without a shoulder belt increases the risk of a child's head hitting a hard surface in a collision. For this reason, you should never use a booster seat with a lap belt only. It is generally best to use a booster seat with lap/shoulder belts in the back seat.

Move a child to a different seating location if the shoulder belt does not stay positioned on the shoulder during use.

Seating and Safety Restraints

Follow all instructions provided by the manufacturer of the booster seat.



WARNING: Never place, or allow a child to place, the shoulder belt under a child's arm or behind the back because it reduces the protection for the upper part of the body and may increase the risk of injury or death in a collision.

Child restraint and safety belt maintenance



WARNING: Failure to inspect and if necessary replace the safety belt assembly under the above conditions could result in severe personal injuries in the event of a collision.

Inspect the vehicle safety belts and child safety seat systems periodically to make sure they work properly and are not damaged. Inspect the vehicle and child seat safety belts to make sure there are no nicks, tears or cuts. Replace if necessary. All vehicle safety belt assemblies, including retractors, buckles, front safety belt buckle assemblies, buckle support assemblies (slide bar-if equipped), shoulder belt height adjusters (if equipped), shoulder belt guide on seatback (if equipped), child safety seat LATCH (if equipped) and tether anchors, and attaching hardware, should be inspected after a collision. Refer to the child restraint manufacturer's instructions for additional inspection and maintenance information specific to the child restraint. Ford Motor Company recommends that all safety belt assemblies in use in vehicles involved in a collision be replaced. However, if the collision was minor and an authorized dealer finds that the belts do not show damage and continue to operate properly, they do not need to be replaced. Safety belt assemblies not in use during a collision should also be inspected and replaced if either damage or improper operation is noted.

For proper care of soiled safety belts, refer to *Interior* in the *Cleaning* chapter.



WARNING: Failure to inspect and if necessary replace the safety belt assembly or child restraint system under the above conditions could result in severe personal injuries in the event of a collision.

Tires, Wheels and Loading

NOTICE TO UTILITY VEHICLE AND TRUCK OWNERS

Utility vehicles and trucks handle differently than passenger cars in the various driving conditions that are encountered on streets, highways and off-road. Utility vehicles and trucks are not designed for cornering at speeds as high as passenger cars any more than low-slung sports cars are designed to perform satisfactorily under off-road conditions.

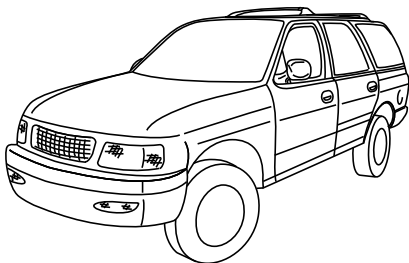

WARNING: Utility vehicles have a significantly higher rollover rate than other types of vehicles. To reduce the risk of serious injury or death from a rollover or other crash you must:

- Avoid sharp turns and abrupt maneuvers;
- Drive at safe speeds for the conditions;
- Keep tires properly inflated;
- Never overload or improperly load your vehicle; and
- Make sure every passenger is properly restrained.



WARNING: In a rollover crash, an unbelted person is significantly more likely to die than a person wearing a seat belt. All occupants must wear seat belts and children/infants must use appropriate restraints to minimize the risk of injury or ejection.

Study your owner's guide and any supplements for specific information about equipment features, instructions for safe driving and additional precautions to reduce the risk of an accident or serious injury.

VEHICLE CHARACTERISTICS

4WD and AWD Systems (if equipped)

A vehicle equipped with AWD or 4WD (when selected) has the ability to use all four wheels to power itself. This increases traction which may enable you to safely drive over terrain and road conditions that a conventional two-wheel drive vehicle cannot.

Tires, Wheels and Loading

Power is supplied to all four wheels through a transfer case or power transfer unit. 4WD vehicles allow you to select different drive modes as necessary. Information on transfer case operation and shifting procedures can be found in the *Driving* chapter. Information on transfer case maintenance can be found in the *Maintenance and Specifications* chapter. You should become thoroughly familiar with this information before you operate your vehicle.

On some 4WD models, the initial shift from two-wheel drive to 4WD while the vehicle is moving can cause a momentary clunk and ratcheting sound. These sounds are normal as the front drivetrain comes up to speed and is not cause for concern.



WARNING: Do not become overconfident in the ability of 4WD and AWD vehicles. Although a 4WD or AWD vehicle may accelerate better than two-wheel drive vehicle in low traction situations, it won't stop any faster than two-wheel drive vehicles. Always drive at a safe speed.

How your vehicle differs from other vehicles

SUV and trucks can differ from some other vehicles in a few noticeable ways. Your vehicle may be:

- Higher – to allow higher load carrying capacity and to allow it to travel over rough terrain without getting hung up or damaging underbody components.
- Shorter – to give it the capability to approach inclines and drive over the crest of a hill without getting hung up or damaging underbody components. All other things held equal, a shorter wheelbase may make your vehicle quicker to respond to steering inputs than a vehicle with a longer wheelbase.

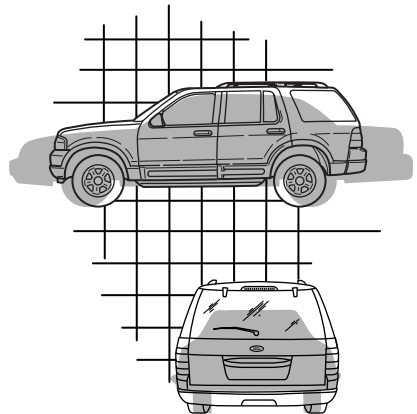

Tires, Wheels and Loading

- Narrower — to provide greater maneuverability in tight spaces, particularly in off-road use.

As a result of the above dimensional differences, SUV's and trucks often will have a higher center of gravity and a greater difference in center of gravity between the loaded and unloaded condition.

These differences that make your vehicle so versatile also make it handle differently than an ordinary passenger car.

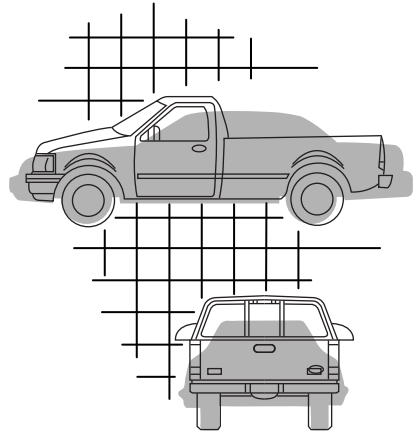

INFORMATION ABOUT UNIFORM TIRE QUALITY GRADING

Tire Quality Grades apply to new pneumatic passenger car tires. The Quality grades can be found where applicable on the tire sidewall between tread shoulder and maximum section width. For example:

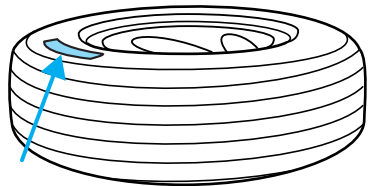

- **Treadwear 200 Traction AA Temperature A**

These Tire Quality Grades are determined by standards that the United States Department of Transportation has set.

Tire Quality Grades apply to new pneumatic passenger car tires. They do not apply to deep tread, winter-type snow tires, space-saver or temporary use spare tires, light truck or "LT" type tires, tires with nominal rim diameters of 10 to 12 inches or limited production tires as defined in Title 49 Code of Federal Regulations Part 575.104(c)(2).

U.S. Department of Transportation-Tire quality grades: The U.S. Department of Transportation requires Ford Motor Company to give you the following information about tire grades exactly as the government has written it.

Treadwear

The treadwear grade is a comparative rating based on the wear rate of the tire when tested under controlled conditions on a specified

Tires, Wheels and Loading

government test course. For example, a tire graded 150 would wear one and one-half (1½) times as well on the government course as a tire graded 100. The relative performance of tires depends upon the actual conditions of their use, however, and may depart significantly from the norm due to variations in driving habits, service practices, and differences in road characteristics and climate.

Traction AA A B C

The traction grades, from highest to lowest are AA, A, B, and C. The grades represent the tire's ability to stop on wet pavement as measured under controlled conditions on specified government test surfaces of asphalt and concrete. A tire marked C may have poor traction performance.



WARNING: The traction grade assigned to this tire is based on straight-ahead braking traction tests, and does not include acceleration, cornering, hydroplaning or peak traction characteristics.

Temperature A B C

The temperature grades are A (the highest), B and C, representing the tire's resistance to the generation of heat and its ability to dissipate heat when tested under controlled conditions on a specified indoor laboratory test wheel. Sustained high temperature can cause the material of the tire to degenerate and reduce tire life, and excessive temperature can lead to sudden tire failure. The grade C corresponds to a level of performance which all passenger car tires must meet under the Federal Motor Vehicle Safety Standard No. 139. Grades B and A represent higher levels of performance on the laboratory test wheel than the minimum required by law.



WARNING: The temperature grade for this tire is established for a tire that is properly inflated and not overloaded. Excessive speed, underinflation, or excessive loading, either separately or in combination, can cause heat buildup and possible tire failure.

TIRES

Tires are designed to give many thousands of miles of service, but they must be maintained in order to get the maximum benefit from them.

Glossary of tire terminology

- **Tire label:** A label showing the OE (Original Equipment) tire sizes, recommended inflation pressure and the maximum weight the vehicle can carry.

Tires, Wheels and Loading

- **Tire Identification Number (TIN):** A number on the sidewall of each tire providing information about the tire brand and manufacturing plant, tire size and date of manufacture. Also referred to as DOT code.
- **Inflation pressure:** A measure of the amount of air in a tire.
- **Standard load:** A class of P-metric or Metric tires designed to carry a maximum load at 35 psi [37 psi (2.5 bar) for Metric tires]. Increasing the inflation pressure beyond this pressure will not increase the tire's load carrying capability.
- **Extra load:** A class of P-metric or Metric tires designed to carry a heavier maximum load at 41 psi [43 psi (2.9 bar) for Metric tires]. Increasing the inflation pressure beyond this pressure will not increase the tire's load carrying capability.
- **kPa:** Kilopascal, a metric unit of air pressure.
- **PSI:** Pounds per square inch, a standard unit of air pressure.
- **Cold inflation pressure:** The tire pressure when the vehicle has been stationary and out of direct sunlight for an hour or more and prior to the vehicle being driven for 1 mile (1.6 km).
- **Recommended inflation pressure:** The cold inflation pressure found on the Safety Compliance Certification Label or Tire Label located on the B-Pillar or the edge of the driver's door.
- **B-pillar:** The structural member at the side of the vehicle behind the front door.
- **Bead area of the tire:** Area of the tire next to the rim.
- **Sidewall of the tire:** Area between the bead area and the tread.
- **Tread area of the tire:** Area of the perimeter of the tire that contacts the road when mounted on the vehicle.
- **Rim:** The metal support (wheel) for a tire or a tire and tube assembly upon which the tire beads are seated.

INFLATING YOUR TIRES

Safe operation of your vehicle requires that your tires are properly inflated. Remember that a tire can lose up to half of its air pressure without appearing flat.

Every day before you drive, check your tires. If one looks lower than the others, use a tire gauge to check pressure of all tires and adjust if required.

Tires, Wheels and Loading

At least once a month and before long trips, inspect each tire and check the tire pressure with a tire gauge (including spare, if equipped). Inflate all tires to the inflation pressure recommended by Ford Motor Company.

You are strongly urged to buy a reliable tire pressure gauge, as automatic service station gauges may be inaccurate. Ford recommends the use of a digital or dial-type tire pressure gauge rather than a stick-type tire pressure gauge.

Use the recommended cold inflation pressure for optimum tire performance and wear. Under-inflation or over-inflation may cause uneven treadwear patterns.



WARNING: Under-inflation is the most common cause of tire failures and may result in severe tire cracking, tread separation or "blowout", with unexpected loss of vehicle control and increased risk of injury. Under-inflation increases sidewall flexing and rolling resistance, resulting in heat buildup and internal damage to the tire. It also may result in unnecessary tire stress, irregular wear, loss of vehicle control and accidents. A tire can lose up to half of its air pressure and not appear to be flat!

Always inflate your tires to the Ford recommended inflation pressure even if it is less than the maximum inflation pressure information found on the tire. The Ford recommended tire inflation pressure is found on the Safety Compliance Certification Label or Tire Label which is located on the B-Pillar or the edge of the driver's door. Failure to follow the tire pressure recommendations can cause uneven treadwear patterns and adversely affect the way your vehicle handles.

Maximum Permissible Inflation Pressure is the tire manufacturer's maximum permissible pressure and/or the pressure at which the maximum load can be carried by the tire. This pressure is normally higher than the manufacturer's recommended cold inflation pressure which can be found on the Safety Compliance Certification Label or Tire Label which is located on the B-Pillar or the edge of the driver's door. The cold inflation pressure should never be set lower than the recommended pressure on the Safety Compliance Certification Label or Tire Label.

When weather temperature changes occur, tire inflation pressures also change. A 10°F (6°C) temperature drop can cause a corresponding drop of 1 psi (7 kPa) in inflation pressure. Check your tire pressures frequently and adjust them to the proper pressure which can be found on the Safety Compliance Certification Label or Tire Label.

Tires, Wheels and Loading

To check the pressure in your tire(s):

1. Make sure the tires are cool, meaning they are not hot from driving even a mile.

If you are checking tire pressure when the tire is hot, (i.e. driven more than 1 mile [1.6 km]), never “bleed” or reduce air pressure. The tires are hot from driving and it is normal for pressures to increase above recommended cold pressures. A hot tire at or below recommended cold inflation pressure could be significantly under-inflated.

Note: If you have to drive a distance to get air for your tire(s), check and record the tire pressure first and add the appropriate air pressure when you get to the pump. It is normal for tires to heat up and the air pressure inside to go up as you drive.

2. Remove the cap from the valve on one tire, then firmly press the tire gauge onto the valve and measure the pressure.

3. Add enough air to reach the recommended air pressure.

Note: If you overfill the tire, release air by pressing on the metal stem in the center of the valve. Then recheck the pressure with your tire gauge.

4. Replace the valve cap.

5. Repeat this procedure for each tire, including the spare.

Note: Some spare tires operate at a higher inflation pressure than the other tires. For T-type/mini-spare tires (see the *Dissimilar spare tire/wheel information* section for description): Store and maintain at 60 psi (4.15 bar). For Full Size and Dissimilar spare tires (see the *Dissimilar spare tire/wheel information* section for description): Store and maintain at the higher of the front and rear inflation pressure as shown on the Tire Label.

6. Visually inspect the tires to make sure there are no nails or other objects embedded that could poke a hole in the tire and cause an air leak.

7. Check the sidewalls to make sure there are no gouges, cuts or bulges.

TIRE CARE

Inspecting your tires and wheel valve stems

Periodically inspect the tire treads for uneven or excessive wear and remove objects such as stones, nails or glass that may be wedged in the tread grooves. Check the tire and valve stems for holes, cracks, or cuts that may permit air leakage and repair or replace the tire and replace

Tires, Wheels and Loading

the valve stem. Inspect the tire sidewalls for cracking, cuts, bruises and other signs of damage or excessive wear. If internal damage to the tire is suspected, have the tire demounted and inspected in case it needs to be repaired or replaced. For your safety, tires that are damaged or show signs of excessive wear should not be used because they are more likely to blow out or fail.

Improper or inadequate vehicle maintenance can cause tires to wear abnormally. Inspect all your tires, including the spare, frequently, and replace them if one or more of the following conditions exist:

Tire wear

When the tread is worn down to 1/16th of an inch (2 mm), tires must be replaced to help prevent your vehicle from skidding and hydroplaning. Built-in treadwear indicators, or “wear bars”, which look like narrow strips of smooth rubber across the tread will appear on the tire when the tread is worn down to 1/16th of an inch (2 mm). When the tire tread wears down to the same height as these “wear bars”, the tire is worn out and must be replaced.

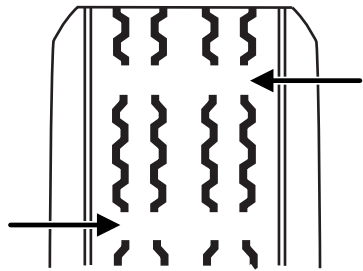

Damage

Periodically inspect the tire treads and sidewalls for damage (such as bulges in the tread or sidewalls, cracks in the tread groove and separation in the tread or sidewall). If damage is observed or suspected have the tire inspected by a tire professional. Tires can be damaged during off-road use, so inspection after off-road use is also recommended.



WARNING: Age

Tires degrade over time depending on many factors such as weather, storage conditions, and conditions of use (load, speed, inflation pressure, etc.) the tires experience throughout their lives. In general, tires should be replaced after six years regardless of tread wear. However, heat caused by hot climates or frequent high loading conditions can accelerate the aging process and may require tires to be replaced more frequently.

You should replace your spare tire when you replace the road tires or after six years due to aging even if it has not been used.

Tires, Wheels and Loading

U.S. DOT Tire Identification Number (TIN)

Both U.S. and Canada Federal regulations require tire manufacturers to place standardized information on the sidewall of all tires. This information identifies and describes the fundamental characteristics of the tire and also provides a U.S. DOT Tire Identification Number for safety standard certification and in case of a recall.

This begins with the letters “DOT” and indicates that the tire meets all federal standards. The next two numbers or letters are the plant code designating where it was manufactured, the next two are the tire size code and the last four numbers represent the week and year the tire was built. For example, the numbers 317 mean the 31st week of 1997. After 2000 the numbers go to four digits. For example, 2501 means the 25th week of 2001. The numbers in between are identification codes used for traceability. This information is used to contact customers if a tire defect requires a recall.

Tire replacement requirements

Your vehicle is equipped with tires designed to provide a safe ride and handling capability.



WARNING: Only use replacement tires and wheels that are the same size, load index, speed rating and type (such as P-metric versus LT-metric or all-season versus all-terrain) as those originally provided by Ford. The recommended tire and wheel size may be found on either the Safety Compliance Certification Label or the Tire Label which is located on the B-Pillar or edge of the driver's door. If this information is not found on these labels then you should contact your authorized dealer as soon as possible. Use of any tire or wheel not recommended by Ford can affect the safety and performance of your vehicle, which could result in an increased risk of loss of vehicle control, vehicle rollover, personal injury and death. Additionally the use of non-recommended tires and wheels could cause steering, suspension, axle or transfer case/power transfer unit failure. If you have questions regarding tire replacement, contact your authorized dealer as soon as possible.

Tires, Wheels and Loading



WARNING: When mounting replacement tires and wheels, you should not exceed the maximum pressure indicated on the sidewall of the tire to set the beads without additional precautions listed below. If the beads do not seat at the maximum pressure indicated, re-lubricate and try again.

When inflating the tire for mounting pressures up to 20 psi (1.38 bar) greater than the maximum pressure on the tire sidewall, the following precautions must be taken to protect the person mounting the tire:

1. Make sure that you have the correct tire and wheel size.
2. Lubricate the tire bead and wheel bead seat area again.
3. Stand at a minimum of 12 ft (3.66 m) away from the tire wheel assembly.
4. Use both eye and ear protection.

For a mounting pressure more than 20 psi (1.38 bar) greater than the maximum pressure, a Ford Dealer or other tire service professional should do the mounting.

Always inflate steel carcass tires with a remote air fill with the person inflating standing at a minimum of 12 ft (3.66 m) away from the tire wheel assembly.

Important: Remember to replace the wheel valve stems when the road tires are replaced on your vehicle.

It is recommended that the two front tires or two rear tires generally be replaced as a pair.

The tire pressure sensors mounted in the wheels (originally installed on your vehicle) are not designed to be used in aftermarket wheels.

The use of wheels or tires not recommended by Ford Motor Company may affect the operation of your Tire Pressure Monitoring System.

If the TPMS indicator is flashing, your TPMS is malfunctioning. Your replacement tire might be incompatible with your TPMS, or some component of the TPMS may be damaged.

Safety practices

Driving habits have a great deal to do with your tire mileage and safety.

- Observe posted speed limits
- Avoid fast starts, stops and turns
- Avoid potholes and objects on the road

Tires, Wheels and Loading

- Do not run over curbs or hit the tire against a curb when parking



WARNING: If your vehicle is stuck in snow, mud, sand, etc., **do not** rapidly spin the tires; spinning the tires can tear the tire and cause an explosion. A tire can explode in as little as three to five seconds.



WARNING: Do not spin the wheels at over 35 mph (56 km/h). The tires may fail and injure a passenger or bystander.

Highway hazards

No matter how carefully you drive there's always the possibility that you may eventually have a flat tire on the highway. Drive slowly to the closest safe area out of traffic. This may further damage the flat tire, but your safety is more important.

If you feel a sudden vibration or ride disturbance while driving, or you suspect your tire or vehicle has been damaged, immediately reduce your speed. Drive with caution until you can safely pull off the road. Stop and inspect the tires for damage. If a tire is under-inflated or damaged, deflate it, remove wheel and replace it with your spare tire and wheel. If you cannot detect a cause, have the vehicle towed to the nearest repair facility or tire dealer to have the vehicle inspected.

Tire and wheel alignment

A bad jolt from hitting a curb or pothole can cause the front end of your vehicle to become misaligned or cause damage to your tires. If your vehicle seems to pull to one side when you're driving, the wheels may be out of alignment. Have an authorized dealer check the wheel alignment periodically.

Wheel misalignment in the front or the rear can cause uneven and rapid treadwear of your tires and should be corrected by an authorized dealer. Front-wheel drive (FWD) vehicles and those with an independent rear suspension (if equipped) may require alignment of all four wheels.

The tires should also be balanced periodically. An unbalanced tire and wheel assembly may result in irregular tire wear.

Tire rotation

Rotating your tires at the recommended interval (as indicated in the *scheduled maintenance information* that comes with your vehicle) will help your tires wear more evenly, providing better tire performance and longer tire life.

Tires, Wheels and Loading

- Rear-wheel drive (RWD) vehicles/Four-wheel drive (4WD)/All-wheel drive (AWD) vehicles (front tires at top of diagram)

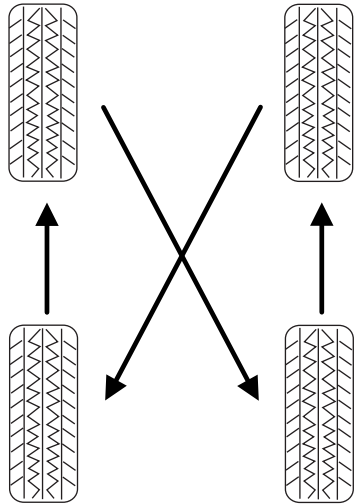

Sometimes irregular tire wear can be corrected by rotating the tires.

Note: If your tires show uneven wear ask an authorized dealer to check for and correct any wheel misalignment, tire imbalance or mechanical problem involved before tire rotation.

Note: Your vehicle may be equipped with a dissimilar spare tire/wheel. A dissimilar spare tire/wheel is defined as a spare tire and/or wheel that is different in brand, size or appearance from the road tires and wheels. If you have a dissimilar spare tire/wheel it is intended for temporary use only and should not be used in a tire rotation.

Note: After having your tires rotated, inflation pressure must be checked and adjusted to the vehicle requirements.

INFORMATION CONTAINED ON THE TIRE SIDEWALL

Both U.S. and Canada Federal regulations require tire manufacturers to place standardized information on the sidewall of all tires. This information identifies and describes the fundamental characteristics of the tire and also provides a U.S. DOT Tire Identification Number for safety standard certification and in case of a recall.

Tires, Wheels and Loading

Information on “P” type tires

P215/65R15 95H is an example of a tire size, load index and speed rating. The definitions of these items are listed below. (Note that the tire size, load index and speed rating for your vehicle may be different from this example.)

1. **P:** Indicates a tire, designated by the Tire and Rim Association (T&RA), that may be used for service on cars, SUVs, minivans and light trucks.

Note: If your tire size does not begin with a letter this may mean it is designated by either ETRTO (European Tire and Rim Technical Organization) or JATMA (Japan Tire Manufacturing Association).

2. **215:** Indicates the nominal width of the tire in millimeters from sidewall edge to sidewall edge. In general, the larger the number, the wider the tire.

3. **65:** Indicates the aspect ratio which gives the tire’s ratio of height to width.

4. **R:** Indicates a “radial” type tire.

5. **15:** Indicates the wheel or rim diameter in inches. If you change your wheel size, you will have to purchase new tires to match the new wheel diameter.

6. **95:** Indicates the tire’s load index. It is an index that relates to how much weight a tire can carry. You may find this information in your Owner’s Guide. If not, contact a local tire dealer.

Note: You may not find this information on all tires because it is not required by federal law.

7. **H:** Indicates the tire’s speed rating. The speed rating denotes the speed at which a tire is designed to be driven for extended periods of time under a standard condition of load and inflation pressure. The tires on your vehicle may operate at different conditions for load and inflation pressure. These speed ratings may need to be adjusted for the difference in conditions. The ratings range from 81 mph (130 km/h) to 186 mph (299 km/h). These ratings are listed in the following chart.

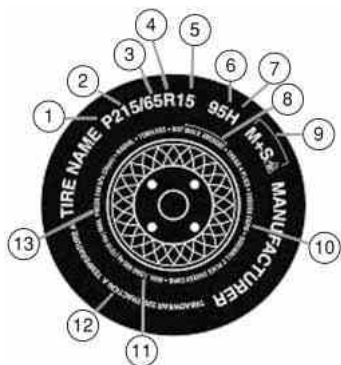

Tires, Wheels and Loading

Note: You may not find this information on all tires because it is not required by federal law.

Letter rating	Speed rating - mph (km/h)
M	81 mph (130 km/h)
N	87 mph (140 km/h)
Q	99 mph (159 km/h)
R	106 mph (171 km/h)
S	112 mph (180 km/h)
T	118 mph (190 km/h)
U	124 mph (200 km/h)
H	130 mph (210 km/h)
V	149 mph (240 km/h)
W	168 mph (270 km/h)
Y	186 mph (299 km/h)

Note: For tires with a maximum speed capability over 149 mph (240 km/h), tire manufacturers sometimes use the letters ZR. For those with a maximum speed capability over 186 mph (299 km/h), tire manufacturers always use the letters ZR.

8. U.S. DOT Tire Identification Number (TIN): This begins with the letters “DOT” and indicates that the tire meets all federal standards. The next two numbers or letters are the plant code designating where it was manufactured, the next two are the tire size code and the last four numbers represent the week and year the tire was built. For example, the numbers 317 mean the 31st week of 1997. After 2000 the numbers go to four digits. For example, 2501 means the 25th week of 2001. The numbers in between are identification codes used for traceability. This information is used to contact customers if a tire defect requires a recall.

9. M+S or M/S: Mud and Snow, or

AT: All Terrain, or

AS: All Season.

10. Tire Ply Composition and Material Used: Indicates the number of plies or the number of layers of rubber-coated fabric in the tire tread and sidewall. Tire manufacturers also must indicate the ply materials in the tire and the sidewall, which include steel, nylon, polyester, and others.

11. Maximum Load: Indicates the maximum load in kilograms and pounds that can be carried by the tire. Refer to the Safety Compliance Certification Label, which is located on the B-Pillar or the edge of the driver’s door, for the correct tire pressure for your vehicle.

Tires, Wheels and Loading

12. Treadwear, Traction and Temperature Grades

- **Treadwear:** The treadwear grade is a comparative rating based on the wear rate of the tire when tested under controlled conditions on a specified government test course. For example, a tire graded 150 would wear one and one-half ($1\frac{1}{2}$) times as well on the government course as a tire graded 100.
- **Traction:** The traction grades, from highest to lowest are AA, A, B, and C. The grades represent the tire's ability to stop on wet pavement as measured under controlled conditions on specified government test surfaces of asphalt and concrete. A tire marked C may have poor traction performance.
- **Temperature:** The temperature grades are A (the highest), B and C, representing the tire's resistance to the generation of heat and its ability to dissipate heat when tested under controlled conditions on a specified indoor laboratory test wheel.

13. **Maximum Permissible Inflation Pressure:** Indicates the tire manufacturers' maximum permissible pressure and/or the pressure at which the maximum load can be carried by the tire. This pressure is normally higher than the manufacturer's recommended cold inflation pressure which can be found on the Safety Compliance Certification Label or Tire Label which is located on the B-Pillar or the edge of the driver's door. The cold inflation pressure should never be set lower than the recommended pressure on the vehicle label.

The tire suppliers may have additional markings, notes or warnings such as standard load, radial tubeless, etc.

Tires, Wheels and Loading

Additional information contained on the tire sidewall for “LT” type tires

“LT” type tires have some additional information beyond those of “P” type tires; these differences are described below.

Note: Tire Quality Grades do not apply to this type of tire.

1. **LT:** Indicates a tire, designated by the Tire and Rim Association (T&RA), that is intended for service on light trucks.

2. **Load Range/Load Inflation**

Limits: Indicates the tire’s load-carrying capabilities and its inflation limits.

3. **Maximum Load Dual lb (kg) at psi (kPa) cold:** Indicates the maximum load and tire pressure when the tire is used as a dual; defined as four tires on the rear axle (a total of six or more tires on the vehicle).

4. **Maximum Load Single lb (kg) at psi (kPa) cold:** Indicates the maximum load and tire pressure when the tire is used as a single; defined as two tires (total) on the rear axle.

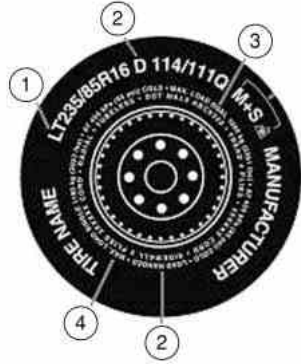

Tires, Wheels and Loading

Information on “T” type tires

“T” type tires have some additional information beyond those of “P” type tires; these differences are described below:

T145/80D16 is an example of a tire size.

Note: The temporary tire size for your vehicle may be different from this example. Tire Quality Grades do not apply to this type of tire.

1. **T:** Indicates a type of tire, designated by the Tire and Rim Association (T&RA), that is intended for temporary service on cars, SUVs, minivans and light trucks.

2. **145:** Indicates the nominal width of the tire in millimeters from sidewall edge to sidewall edge. In general, the larger the number, the wider the tire.

3. **80:** Indicates the aspect ratio which gives the tire’s ratio of height to width. Numbers of 70 or lower indicate a short sidewall.

4. **D:** Indicates a “diagonal” type tire.

R: Indicates a “radial” type tire.

5. **16:** Indicates the wheel or rim diameter in inches. If you change your wheel size, you will have to purchase new tires to match the new wheel diameter.

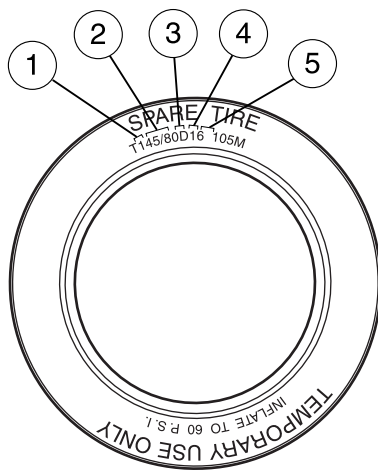

Location of the tire label

You will find a Tire Label containing tire inflation pressure by tire size and other important information located on the B-Pillar or the edge of the driver’s door. Refer to the payload description and graphic in the *Vehicle loading — with and without a trailer* section.

Tires, Wheels and Loading

TIRE PRESSURE MONITORING SYSTEM (TPMS)

Each tire, including the spare (if provided), should be checked monthly when cold and inflated to the inflation pressure recommended by the vehicle manufacturer on the vehicle placard or tire inflation pressure label. (If your vehicle has tires of a different size than the size indicated on the vehicle placard or tire inflation pressure label, you should determine the proper tire inflation pressure for those tires.)



As an added safety feature, your vehicle has been equipped with a tire pressure monitoring system (TPMS) that illuminates a low tire pressure telltale when one or more of your tires is significantly under-inflated. Accordingly, when the low tire pressure telltale illuminates, you should stop and check your tires as soon as possible, and inflate them to the proper pressure. Driving on a significantly under-inflated tire causes the tire to overheat and can lead to tire failure. Under-inflation also reduces fuel efficiency and tire tread life, and may affect the vehicle's handling and stopping ability.

Please note that the TPMS is not a substitute for proper tire maintenance, and it is the driver's responsibility to maintain correct tire pressure, even if under-inflation has not reached the level to trigger illumination of the TPMS low tire pressure telltale.

Your vehicle has also been equipped with a TPMS malfunction indicator to indicate when the system is not operating properly. The TPMS malfunction indicator is combined with the low tire pressure telltale. When the system detects a malfunction, the telltale will flash for approximately one minute and then remain continuously illuminated. This sequence will continue upon subsequent vehicle start-ups as long as the malfunction exists.

When the malfunction indicator is illuminated, the system may not be able to detect or signal low tire pressure as intended. TPMS malfunctions may occur for a variety of reasons, including the installation of replacement or alternate tires or wheels on the vehicle that prevent the TPMS from functioning properly. Always check the TPMS malfunction telltale after replacing one or more tires or wheels on your vehicle to ensure that the replacement or alternate tires and wheels allow the TPMS to continue to function properly.

Tires, Wheels and Loading

The Tire Pressure Monitoring System complies with part 15 of the FCC rules and with RSS-210 of Industry Canada. Operation is subject to the following two conditions: (1) This device may not cause harmful interference, and (2) This device must accept any interference received, including interference that may cause undesired operation.



WARNING: The Tire Pressure Monitoring System is NOT a substitute for manually checking tire pressure. The tire pressure should be checked periodically (at least monthly) using a tire gauge, see *Inflating your tires* in this chapter. Failure to properly maintain your tire pressure could increase the risk of tire failure, loss of control, vehicle rollover and personal injury.

Changing tires with TPMS

Each road tire is equipped with a tire pressure sensor fastened to the inside rim of the wheel. The pressure sensor is covered by the tire and is not visible unless the tire is removed. The pressure sensor is located opposite (180 degrees) from the valve stem. Care must be taken when changing the tire to avoid damaging the sensor. It is recommended that you always have your tires serviced by an authorized dealer.

The tire pressure should be checked periodically (at least monthly) using an accurate tire gauge, refer to *Inflating your tires* in this chapter.

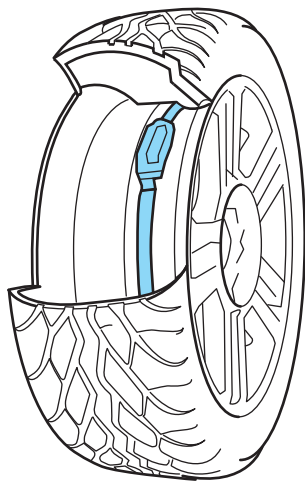

Tires, Wheels and Loading

Understanding your Tire Pressure Monitoring System (TPMS)

The Tire Pressure Monitoring System measures pressure in your four road tires and sends the tire pressure readings to your vehicle. The Low Tire Pressure Warning Lamp will turn ON if the tire pressure is significantly low. Once the light is illuminated, your tires are under inflated and need to be inflated to the manufacturer's recommended tire pressure. Even if the light turns ON and a short time later turns OFF, your tire pressure still needs to be checked. Visit www.checkmytires.org for additional information.

When your temporary spare tire is installed

When one of your road tires needs to be replaced with the temporary spare, the TPMS system will continue to identify an issue to remind you that the damaged road wheel/tire needs to be repaired and put back on your vehicle.

To restore the full functionality of the Tire Pressure Monitoring System, have the damaged road wheel/tire repaired and remounted on your vehicle. For additional information, refer to *Changing tires with TPMS* in this section.

Tires, Wheels and Loading

When you believe your system is not operating properly

The main function of the Tire Pressure Monitoring System is to warn you when your tires need air. It can also warn you in the event the system is no longer capable of functioning as intended. Please refer to the following chart for information concerning your Tire Pressure Monitoring System:

Low Tire Pressure Warning Light	Possible cause	Customer Action Required
Solid Warning Light	Tire(s) under-inflated	<ol style="list-style-type: none">1. Check your tire pressure to ensure tires are properly inflated; refer to <i>Inflating your tires</i> in this chapter.2. After inflating your tires to the manufacturer's recommended inflation pressure as shown on the Tire Label (located on the edge of driver's door or the B-Pillar), the vehicle must be driven for at least two minutes over 20 mph (32 km/h) before the light will turn OFF.
	Spare tire in use	Your temporary spare tire is in use. Repair the damaged road wheel/tire and reinstall it on the vehicle to restore system functionality. For a description on how the system functions, refer to <i>When your temporary spare tire is installed</i> in this section.
	TPMS malfunction	If your tires are properly inflated and your spare tire is not in use and the light remains ON, contact your authorized dealer as soon as possible.

Tires, Wheels and Loading

Low Tire Pressure Warning Light	Possible cause	Customer Action Required
Flashing Warning Light	Spare tire in use	Your temporary spare tire is in use. Repair the damaged road wheel and re-mount it on the vehicle to restore system functionality. For a description of how the system functions under these conditions, refer to <i>When your temporary spare tire is installed</i> in this section.
	TPMS malfunction	If your tires are properly inflated and your spare tire is not in use and the TPMS warning light still flashes, contact your authorized dealer as soon as possible.

When inflating your tires

When putting air into your tires (such as at a gas station or in your garage), the Tire Pressure Monitoring System may not respond immediately to the air added to your tires.

It may take up to two minutes of driving over 20 mph (32 km/h) for the light to turn OFF after you have filled your tires to the recommended inflation pressure.

How temperature affects your tire pressure

The Tire Pressure Monitoring System (TPMS) monitors tire pressure in each pneumatic tire. While driving in a normal manner, a typical passenger tire inflation pressure may increase approximately 2 to 4 psi (14 to 28 kPa) from a cold start situation. If the vehicle is stationary over night with the outside temperature significantly lower than the daytime temperature, the tire pressure may decrease approximately 3 psi (21 kPa) for a drop of 30°F (17°C) in ambient temperature. This lower pressure value may be detected by the TPMS as being significantly lower than the recommended inflation pressure and activate the TPMS warning for low tire pressure. If the low tire pressure warning light is ON, visually check each tire to verify that no tire is flat. (If one or more tires are flat, repair as necessary.) Check air pressure in the road tires. If any tire is under-inflated, carefully drive the vehicle to the nearest location where air can be added to the tires. Inflate all the tires to the recommended inflation pressure.

Tires, Wheels and Loading

SNOW TIRES AND CHAINS



WARNING: Driving too fast for conditions creates the possibility of loss of vehicle control. Driving at very high speeds for extended periods of time may result in damage to vehicle components.



WARNING: Snow tires must be the same size, load index, speed rating as those originally provided by Ford. Use of any tire or wheel not recommended by Ford can affect the safety and performance of your vehicle, which could result in an increased risk of loss of vehicle control, vehicle rollover, personal injury and death. Additionally, the use of non-recommended tires and wheels could cause steering, suspension, axle or transfer case/power transfer unit failure.

The tires on your vehicle have all weather treads to provide traction in rain and snow. However, in some climates, you may need to use snow tires and chains. If you need to use chains, it is recommended that steel wheels (of the same size and specifications) be used, as chains may chip aluminum wheels.

Follow these guidelines when using snow tires and chains:

- Use only SAE Class S chains.
- Install chains securely, verifying that the chains do not touch any wiring, brake lines or fuel lines.
- Drive cautiously. If you hear the chains rub or bang against your vehicle, stop and re-tighten the chains. If this does not work, remove the chains to prevent damage to your vehicle.
- If possible, avoid fully loading your vehicle.
- Remove the tire chains when they are no longer needed. Do not use tire chains on dry roads.
- The suspension insulation and bumpers will help prevent vehicle damage. Do not remove these components from your vehicle when using snow tires and chains.

VEHICLE LOADING – WITH AND WITHOUT A TRAILER

This section will guide you in the proper loading of your vehicle and/or trailer, to keep your loaded vehicle weight within its design rating capability, with or without a trailer. Properly loading your vehicle will provide maximum return of vehicle design performance. Before loading

Tires, Wheels and Loading

your vehicle, familiarize yourself with the following terms for determining your vehicle's weight ratings, with or without a trailer, from the vehicle's Tire Label or Safety Compliance Certification Label:

Base Curb Weight – is the weight of the vehicle including a full tank of fuel and all standard equipment. It does not include passengers, cargo, or optional equipment.

Vehicle Curb Weight – is the weight of your new vehicle when you picked it up from your authorized dealer plus any aftermarket equipment.

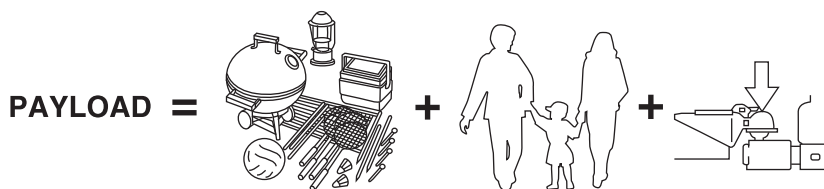

Payload – is the combined weight of cargo and passengers that the vehicle is carrying. The maximum payload for your vehicle can be found on the Tire Label on the B-Pillar or the edge of the driver's door (vehicles exported outside the US and Canada may not have a Tire Label). Look for **“THE COMBINED WEIGHT OF OCCUPANTS AND CARGO SHOULD NEVER EXCEED XXX kg OR XXX lb.”** for maximum payload. The payload listed on the Tire Label is the maximum payload for the vehicle as built by the assembly plant. If any aftermarket or authorized-dealer installed equipment has been installed on the vehicle, the weight of the equipment must be subtracted from the payload listed on the Tire Label in order to determine the new payload.



WARNING: The appropriate loading capacity of your vehicle can be limited either by volume capacity (how much space is available) or by payload capacity (how much weight the vehicle should carry). Once you have reached the maximum payload of your vehicle, do not add more cargo, even if there is space available. Overloading or improperly loading your vehicle can contribute to loss of vehicle control and vehicle rollover.

Tires, Wheels and Loading

Example only:





TIRE AND LOADING INFORMATION

SEATING CAPACITY	TOTAL 5	FRONT 2	REAR 3
------------------	---------	---------	--------

The combined weight of occupants and cargo should never exceed : XXX kg or XXX lbs.

TIRE	SIZE	COLD TIRE PRESSURE	SEE OWNERS MANUAL FOR ADDITIONAL INFORMATION
FRONT	LT225/75R 16.5E	200 KPA, 29 PSI	
REAR	LT225/75R 16.5E	200 KPA, 29 PSI	
SPARE	T145/80D16 P225/60R17	420 KPA, 60 PSI 200 KPA, 29 PSI	

XXXX XXXXXXXXXX

XXXXXXXXXXXXXXXX



TIRE AND LOAD INFORMATION

RENSEIGNEMENTS RELATIFS AUX PNEUS ET À LA CHARGE

SEATING CAPACITY NOMBRE DE PLACES	TOTAL TOTAL	FRONT AVANT	REAR ARRIERE
	XX	XX	X

The combined weight of occupants and cargo should never exceed : XXX kg.
La charge du véhicule (occupants et bagages) ne doit jamais dépasser : XXX lbs.

TIRE PNEUS	SIZE DIMENSIONS	COLD TIRE PRESSURE PRESSION A FROID	SEE OWNERS MANUAL FOR ADDITIONAL INFORMATION CONSULTER LE GUIDE DU PROPRIETAIRE POUR DE PLUS AMPLES RENSEIGNEMENTS
FRONT/ AVANT	LT225/75R 16.5E	200 KPA, 29 PSI	
REAR/ ARRIERE	LT225/75R 16.5E	200 KPA, 29 PSI	
SPARE/ PNEU DE SECOURS	T145/80D16 P225/60R17	420 KPA, 60 PSI 200 KPA, 29 PSI	

XXXX XXXXXXXXXX

XXXXXXXXXXXXXXXX

CARGO

=

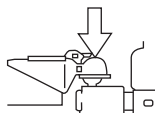

+



Cargo Weight – includes all weight added to the Base Curb Weight, including cargo and optional equipment. When towing, trailer tongue load or king pin weight is also part of cargo weight.

Tires, Wheels and Loading

GAW (Gross Axle Weight) – is the total weight placed on each axle (front and rear) – including vehicle curb weight and all payload.

GAWR (Gross Axle Weight Rating) – is the maximum allowable weight that can be carried by a single axle (front or rear). **These numbers are shown on the Safety Compliance Certification Label located on the B-Pillar or the edge of the driver's door. The total load on each axle must never exceed its GAWR.**

Note: For trailer towing information refer to *Trailer towing* found in this chapter or the *RV and Trailer Towing Guide* provided by your authorized dealer.

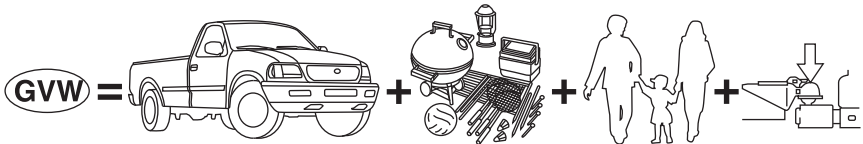

GVW (Gross Vehicle Weight) – is the Vehicle Curb Weight + cargo + passengers.

GVWR (Gross Vehicle Weight Rating) – is the maximum allowable weight of the fully loaded vehicle (including all options, equipment, passengers and cargo). **The GVWR is shown on the Safety Compliance Certification Label located on the B-Pillar or the edge of the driver's door. The GVW must never exceed the GVWR.**

Tires, Wheels and Loading



GCW (Gross Combined Weight) – is the weight of the loaded vehicle (GVW) plus the weight of the fully loaded trailer.

GCWR (Gross Combined Weight Rating) – is the maximum allowable weight of the vehicle and the loaded trailer – including all cargo and passengers – that the vehicle can handle without risking damage. (Important: The towing vehicle's braking system is rated for operation at GVWR, not at GCWR.) Separate functional brakes should be used for safe control of towed vehicles and for trailers where the GCW of the towing vehicle plus the trailer exceed the GVWR of the towing vehicle. **The GCW must never exceed the GCWR.**

Maximum Loaded Trailer Weight – is the highest possible weight of a fully loaded trailer the vehicle can tow. It assumes a vehicle with only mandatory options, no cargo (internal or external), a tongue load of 10–15% (conventional trailer) or king pin weight of 15–25% (fifth wheel trailer), and driver only (150 lb. [68 kg]). **Consult your authorized dealer (or the *RV and Trailer Towing Guide* provided by your authorized dealer) for more detailed information.**

Tongue Load or Fifth Wheel King Pin Weight – refers to the amount of the weight that a trailer pushes down on a trailer hitch.

Examples: For a 5,000 lb. (2,268 kg) conventional trailer, multiply 5,000 by 0.10 and 0.15 to obtain a proper tongue load range of 500 to 750 lb. (227 to 340 kg). For an 11,500 lb. (5,216 kg) fifth wheel trailer, multiply by 0.15 and 0.25 to obtain a proper king pin load range of 1,725 to 2,875 lb. (782 to 1,304 kg)



WARNING: Do not exceed the GVWR or the GAWR specified on the Safety Compliance Certification Label.



WARNING: Do not use replacement tires with lower load carrying capacities than the original tires because they may lower the vehicle's GVWR and GAWR limitations. Replacement tires with a higher limit than the original tires do not increase the GVWR and GAWR limitations.

Tires, Wheels and Loading



WARNING: Exceeding any vehicle weight rating limitation could result in serious damage to the vehicle and/or personal injury.

Steps for determining the correct load limit:

1. Locate the statement “The combined weight of occupants and cargo should never exceed XXX kg or XXX lb.” on your vehicle’s placard.
2. Determine the combined weight of the driver and passengers that will be riding in your vehicle.
3. Subtract the combined weight of the driver and passengers from XXX kg or XXX lb.
4. The resulting figure equals the available amount of cargo and luggage load capacity. For example, if the “XXX” amount equals 1,400 lb. and there will be five 150 lb. passengers in your vehicle, the amount of available cargo and luggage load capacity is 650 lb. ($1400 - 750 (5 \times 150) = 650$ lb.). In metric units ($635 - 340 (5 \times 68) = 295$ kg.)
5. Determine the combined weight of luggage and cargo being loaded on the vehicle. That weight may not safely exceed the available cargo and luggage load capacity calculated in Step 4.
6. If your vehicle will be towing a trailer, load from your trailer will be transferred to your vehicle. Consult this manual to determine how this reduces the available cargo and luggage load capacity of your vehicle.

The following gives you a few examples on how to calculate the available amount of cargo and luggage load capacity:

- Another example for your vehicle with 1,400 lb. (635 kg) of cargo and luggage capacity. You decide to go golfing. Is there enough load capacity to carry you, 4 of your friends and all the golf bags? You and four friends average 220 lb. (99 kg) each and the golf bags weigh approximately 30 lb. (13.5 kg) each. The calculation would be: $1400 - (5 \times 220) - (5 \times 30) = 1400 - 1100 - 150 = 150$ lb. Yes, you have enough load capacity in your vehicle to transport four friends and your golf bags. In metric units, the calculation would be: $635 \text{ kg} - (5 \times 99 \text{ kg}) - (5 \times 13.5 \text{ kg}) = 635 - 495 - 67.5 = 72.5$ kg.
- A final example for your vehicle with 1,400 lb. (635 kg) of cargo and luggage capacity. You and one of your friends decide to pick up cement from the local home improvement store to finish that patio you have been planning for the past 2 years. Measuring the inside of the vehicle with the rear seat folded down, you have room for 12-100 lb. (45 kg) bags of cement. Do you have enough load capacity

Tires, Wheels and Loading

to transport the cement to your home? If you and your friend each weigh 220 lb. (99 kg), the calculation would be: $1400 - (2 \times 220) - (12 \times 100) = 1400 - 440 - 1200 = -240$ lb. No, you do not have enough cargo capacity to carry that much weight. In metric units, the calculation would be: $635 \text{ kg} - (2 \times 99 \text{ kg}) - (12 \times 45 \text{ kg}) = 635 - 198 - 540 = -103$ kg. You will need to reduce the load weight by at least 240 lb. (104 kg). If you remove 3-100 lb. (45 kg) cement bags, then the load calculation would be:

$1400 - (2 \times 220) - (9 \times 100) = 1400 - 440 - 900 = 60$ lb. Now you have the load capacity to transport the cement and your friend home. In metric units, the calculation would be: $635 \text{ kg} - (2 \times 99 \text{ kg}) - (9 \times 45 \text{ kg}) = 635 - 198 - 405 = 32$ kg.

The above calculations also assume that the loads are positioned in your vehicle in a manner that does not overload the Front or the Rear Gross Axle Weight Rating specified for your vehicle on the Safety Compliance Certification Label found on the edge of the driver's door.

Special loading instructions for owners of pick-up trucks and utility-type vehicles



WARNING: For important information regarding safe operation of this type of vehicle, see the *Preparing to drive your vehicle* section in the *Driving* chapter of this Owner's Guide.



WARNING: Loaded vehicles may handle differently than unloaded vehicles. Extra precautions, such as slower speeds and increased stopping distance, should be taken when driving a heavily loaded vehicle.

Your vehicle can haul more cargo and people than most passenger cars. Depending upon the type and placement of the load, hauling cargo and people may raise the center of gravity of the vehicle.

TRAILER TOWING

Your vehicle may tow a class I, II or III trailer provided the maximum trailer weight is less than or equal to the maximum trailer weight listed for your engine and rear axle ratio on the following charts.

Your vehicle's load capacity is designated by weight, not by volume, so you cannot necessarily use all available space when loading a vehicle.

Towing a trailer places an additional load on your vehicle's engine, transmission, axle, brakes, tires and suspension. Inspect these components carefully after any towing operation.

Tires, Wheels and Loading

Regular Cab			
Engine	Rear axle ratio	Maximum GCWR - lb (kg)	Maximum trailer weight - lb (kg)
Short Wheel Base			
2.3L w/manual transmission	3.73	4800 (2177)	1540 (698)
2.3L w/automatic transmission	4.10	5500 (2495)	2200 (998)
Long Wheel Base			
2.3L w/manual transmission	3.73	4800 (2177)	1500 (680)
2.3L w/automatic transmission	4.10	5500 (2495)	2160 (980)
4.0L	3.55	9500 (4309)	5940 (2694)
SuperCab 4x2			
Engine	Rear axle ratio	Maximum GCWR - lb (kg)	Maximum trailer weight - lb (kg)
2-Door Payload Package 1 without Jump Seat			
2.3L w/manual transmission	4.10	4800 (2177)	1340 (608)
2.3L w/automatic transmission	4.10	5500 (2495)	2020 (916)
4.0L w/manual transmission	3.55	7000 (3175)	3340 (1515)
4.0L w/automatic transmission	3.55	9500 (4309)	5780 (2623)

Tires, Wheels and Loading

SuperCab 4x2			
Engine	Rear axle ratio	Maximum GCWR - lb (kg)	Maximum trailer weight - lb (kg)
4-Door Payload Package 1 without Jump Seat			
2.3L w/manual transmission	4.10	4800 (2177)	1260 (572)
2.3L w/automatic transmission	4.10	5500 (2495)	1920 (871)
4.0L w/manual transmission	3.55	7000 (3175)	3260 (1479)
4.0L w/automatic transmission	3.55	9500 (4309)	5700 (2586)
2-Door Payload Package 1 with Jump Seat			
2.3L w/manual transmission	4.10	4800 (2177)	1320 (599)
2.3L w/automatic transmission	4.10	5500 (2495)	1980 (898)
4.0L w/manual transmission	3.55	7000 (3175)	3300 (1497)
4.0L w/automatic transmission	3.55	9500 (4309)	5760 (2613)

Tires, Wheels and Loading

SuperCab 4x2			
Engine	Rear axle ratio	Maximum GCWR - lb (kg)	Maximum trailer weight - lb (kg)
4-Door Payload Package 1 with Jump Seat			
2.3L w/manual transmission	4.10	4800 (2177)	1220 (553)
2.3L w/automatic transmission	4.10	5500 (2495)	1900 (862)
4.0L w/manual transmission	3.55	7000 (3175)	3220 (1461)
4.0L w/automatic transmission	3.55	9500 (4309)	5680 (2576)
2-Door Payload Package 2 without Jump Seat			
4.0L w/manual transmission	3.55	7000 (3175)	3320 (1506)
4.0L w/automatic transmission	3.55	9500 (4309)	5780 (2622)
4-Door Payload Package 2 without Jump Seat			
4.0L w/manual transmission	3.55	7000 (3175)	3240 (1470)
4.0L w/automatic transmission	3.55	9500 (4309)	5700 (2586)
2-Door Payload Package 2 with Jump Seat			
4.0L w/manual transmission	3.55	7000 (3175)	3300 (1497)
4.0L w/automatic transmission	3.55	9500 (4309)	5760 (2613)

Tires, Wheels and Loading

SuperCab 4x2			
Engine	Rear axle ratio	Maximum GCWR - lb (kg)	Maximum trailer weight - lb (kg)
4-Door Payload Package 2 with Jump Seat			
4.0L w/manual transmission	3.55	7000 (3175)	3220 (1461)
4.0L w/automatic transmission	3.55	9500 (4309)	5660 (2567)
SuperCab 4x2 Sport			
Engine	Rear axle ratio	Maximum GCWR - lb (kg)	Maximum trailer weight - lb (kg)
2-Door Payload Package 1 without Jump Seat			
4.0L w/manual transmission	3.55	7000 (3175)	3240 (1470)
4.0L w/automatic transmission	3.55	9500 (4309)	5700 (2586)
4-Door Payload Package 1 without Jump Seat			
4.0L w/manual transmission	3.55	7000 (3175)	3160 (1433)
4.0L w/automatic transmission	3.55	9500 (4309)	5620 (2549)
2-Door Payload Package 1 with Jump Seat			
4.0L w/manual transmission	3.55	7000 (3175)	3220 (1461)
4.0L w/automatic transmission	3.55	9500 (4309)	5660 (2567)

Tires, Wheels and Loading

SuperCab 4x2 Sport			
Engine	Rear axle ratio	Maximum GCWR - lb (kg)	Maximum trailer weight - lb (kg)
4-Door Payload Package 1 with Jump Seat			
4.0L w/manual transmission	3.55	7000 (3175)	3120 (1415)
4.0L w/automatic transmission	3.55	9500 (4309)	5580 (2531)
SuperCab 4x4			
Engine	Rear axle ratio	Maximum GCWR - lb (kg)	Maximum trailer weight - lb (kg)
2-Door without Jump Seat			
4.0L w/manual transmission	All	7000 (3175)	3120 (1415)
4.0L w/automatic transmission	All	9500 (4309)	5580 (2531)
4-Door without Jump Seat			
4.0L w/manual transmission	All	7000 (3175)	3040 (1379)
4.0L w/automatic transmission	All	9500 (4309)	5500 (2495)
2-Door with Jump Seat			
4.0L w/manual transmission	All	7000 (3175)	3080 (1397)
4.0L w/automatic transmission	All	9500 (4309)	5540 (2513)

Tires, Wheels and Loading

SuperCab 4x4			
Engine	Rear axle ratio	Maximum GCWR - lb (kg)	Maximum trailer weight - lb (kg)
4-Door with Jump Seat			
4.0L w/manual transmission	All	7000 (3175)	3000 (1361)
4.0L w/automatic transmission	All	9500 (4309)	5460 (2477)

For high altitude operation, reduce GCW by 2% per 1,000 ft. (300 m) elevation.

For definition of terms used in this table and to determine maximum trailer weight designed for your particular vehicle, see *Vehicle loading - with and without a trailer* earlier in this chapter.

Maximum trailer weight is shown. The combined weight of the completed towing vehicle (including hitch, passengers and cargo) and the loaded trailer must not exceed the Gross Combined Weight Rating (GCWR).

Your vehicle is capable of pulling the maximum trailer weight(s) as specified above. Certain states require electric trailer brakes for trailers over a specified weight. This vehicle's electrical system is not equipped to accommodate electric trailer brakes.



WARNING: Do not exceed the GVWR or the GAWR specified on the certification label.



WARNING: Towing trailers beyond the maximum recommended gross trailer weight exceeds the limit of the vehicle and could result in engine damage, transmission damage, structural damage, loss of vehicle control, vehicle rollover and personal injury.

Preparing to tow

Use the proper equipment for towing a trailer and make sure it is properly attached to your vehicle. Contact your authorized dealer or a reliable trailer dealer as soon as possible if you require assistance.

Hitches

For towing trailers up to 2,000 lb (907 kg), use a weight-carrying hitch and ball which uniformly distributes the trailer tongue loads through the

Tires, Wheels and Loading

underbody structure. For trailers over 2,000 lb (907 kg), use a frame-mounted weight-distributing hitch.

Do not install a single or multi-clamp type bumper hitch, or a hitch which attaches to the axle. Underbody-mounted hitches are acceptable if they are installed properly. Follow the towing instructions of a reputable rental agency.

Whenever a trailer hitch and hardware are removed, make sure all mounting holes in the underbody are properly sealed to prevent noxious gases or water from entering.

Safety chains

Always connect the trailer's safety chains to the frame or hook retainers of the vehicle hitch. To connect the trailer's safety chains, cross the chains under the trailer tongue and allow slack for turning corners.

If you use a rental trailer, follow the instructions that the rental agency gives to you.

Do not attach safety chains to the bumper.

Trailer brakes

Electric brakes and manual, automatic or surge-type trailer brakes are safe if installed properly and adjusted to the manufacturer's specifications. The trailer brakes must meet local and Federal regulations.



WARNING: Do not connect a trailer's hydraulic brake system directly to your vehicle's brake system. Your vehicle may not have enough braking power and your chances of having a collision greatly increase.

The braking system of the tow vehicle is rated for operation at the GVWR not GCWR.

Trailer lamps

Trailer lamps are required on most towed vehicles. Make sure all running lights, brake lights, turn signals and hazard lights are working. Contact your authorized dealer or trailer rental agency for proper instructions and equipment for hooking-up trailer lamps.

Using a step bumper (if equipped)

The optional step bumper is equipped with an integral hitch and requires only a ball with a $\frac{3}{4}$ in. (19 mm) shank diameter. The bumper has a 2,000 lb (907 kg) trailer weight and 200 lb (91 kg) tongue weight capability.

Tires, Wheels and Loading

The rated capacities (as shown in this guide) for trailer towing with the factory bumper are only valid when the trailer hitch ball is installed directly into the ball hole in the bumper. Addition of bracketry to either lower the ball hitch position or extend the ball hitch rearward will significantly increase the loads on the bumper and its attachments. This can result in the failure of the bumper or the bumper attachments. Use of any type of hitch extensions should be considered abuse.

Trailer tow connector

The trailer tow connector is located under the rear bumper, on the driver's side of the vehicle.

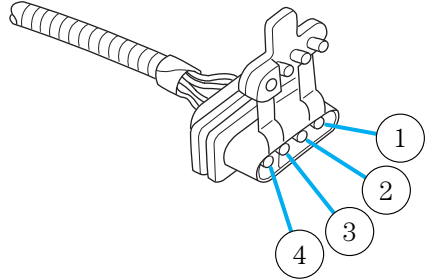

Refer to the following chart for information regarding the factory-equipped trailer tow connector:

Color	Function	Comment
1. Dark Green	Trailer right turn signal	Circuit activated when brake pedal is pressed or when ignition is on and right turn signal is applied.
2. Yellow	Trailer left turn signal	Circuit activated when brake pedal is pressed or when ignition is on and left turn signal is applied.
3. Tan/White	Tail lamp	Relay-controlled circuit activated when the park lamps/headlamps are on.
4. White	Ground	Matching vehicle circuit returns to battery's negative ground.

Tires, Wheels and Loading

Driving while you tow

When towing a trailer:

- To ensure proper break-in of powertrain components, do not trailer tow during the first 1,000 miles (1,600 km) of a new vehicle.
- To ensure proper break-in of powertrain components during the first 500 miles (800 km) of trailer towing, drive no faster than 70 mph (113 km/h) with no full throttle starts.
- Consult your local motor vehicle speed regulations for towing a trailer.
- Turn off the speed control. The speed control may shut off automatically when you are towing on long, steep grades.
- To eliminate excessive automatic transmission shifting, use a lower gear. This will also assist in transmission cooling. For additional information, refer to *Automatic transmission operation* in the *Driving* chapter.
- Under extreme conditions with large frontal trailers, high outside temperatures and highway speeds, the coolant gauge may indicate higher than normal coolant temperatures. If this occurs, reduce speed until the coolant temperature returns to the normal range. Refer to *Gauges* in the *Instrument Cluster* chapter.
- Anticipate stops and brake gradually.
- Do not exceed the GCWR rating or transmission damage may occur.

Servicing after towing

If you tow a trailer for long distances, your vehicle will require more frequent service intervals. Refer to your *scheduled maintenance information* for more information.

Trailer towing tips

- The trailer tongue weight should be 10–15% of the loaded trailer weight.
- Practice turning, stopping and backing-up before starting on a trip to get the feel of the vehicle-trailer combination. When turning, make wider turns so the trailer wheels will clear curbs and other obstacles.
- Allow more distance for stopping with a trailer attached.
- To aid in engine/transmission cooling and A/C efficiency during hot weather while stopped in traffic, place the gearshift lever in P (Park) (automatic transmission) or neutral (manual transmissions).
- After you have traveled 50 miles (80 km), thoroughly check your hitch, electrical connections and trailer wheel lug nuts.

Tires, Wheels and Loading

- If you will be towing a trailer frequently in hot weather, hilly conditions, at GCWR, or any combination of these factors, consider refilling your rear axle with synthetic gear lube if not already so equipped. Refer to the *Maintenance and Specifications* chapter for the lubricant specification. Remember that regardless of the rear axle lube used, do not tow a trailer for the first 1,000 miles (1,600 km) of a new vehicle, and that the first 500 miles (800 km) of towing be done at no faster than 70 mph (113 km/h) with no full throttle starts.
- Vehicles with trailers should not be parked on a grade. If you must park on a grade, place wheel chocks under the trailer's wheels.

Launching or retrieving a boat

Disconnect the wiring to the trailer before backing the trailer into the water. Reconnect the wiring to the trailer after the trailer is removed from the water.

When backing down a ramp during boat launching or retrieval:

- do not allow the static water level to rise above the bottom edge of the rear bumper.
- do not allow waves to break higher than 6 in. (15 cm) above the bottom edge of the rear bumper.

Exceeding these limits may allow water to enter vehicle components:

- causing internal damage to the components.
- affecting driveability, emissions and reliability.

Replace the rear axle lubricant any time the axle has been submerged in water. Rear axle lubricant quantities are not to be checked or changed unless a leak is suspected or repair required.

RECREATIONAL TOWING

Follow these guidelines if you have a need for recreational (RV) towing. An example of recreational towing would be towing your vehicle behind a motorhome. These guidelines are designed to ensure that your transmission is not damaged.

Note: Put your climate control system in recirculated air mode to prevent exhaust fumes from entering the vehicle. Refer to the *Climate Controls* chapter for more information.

Tires, Wheels and Loading

Vehicles equipped with a manual transmission:

Before you tow your vehicle:

- Release the parking brake.
- Move the gearshift to the neutral position.
- Turn the key in the ignition to the off/unlocked position.
- The maximum towing speed is 55 mph (88 km/h).
- The maximum recommended distance is unlimited.
- Put 4WD switch in 2WD mode (4WD only)
- The vehicle must be towed in the forward direction to ensure no damage is done to the internal transmission components.

In addition, it is recommended that you follow the instructions provided by the aftermarket manufacturer of the towing equipment, if provided.

In case of a roadside emergency with a disabled vehicle, see *Wrecker towing* in the *Roadside Emergencies* chapter.

2WD vehicles equipped with an automatic transmissions: Do not tow your vehicle with any wheels on the ground, as vehicle or transmission damage may occur. It is recommended to tow your vehicle with all four (4) wheels off the ground such as when using a car-hauling trailer. Otherwise, no recreational towing is permitted.

4WD vehicles equipped with an automatic transmission and electronic shift transfer case (Neutral tow kit accessory):

On vehicles equipped with 4WD, an accessory is available that allows you to tow your vehicle, behind another vehicle, with all the wheels on the ground. Contact your authorized dealer for more details. Do not tow your vehicle with all wheels on the ground unless you install the neutral tow kit as vehicle damage may occur.

In case of a roadside emergency with a disabled vehicle, see *Wrecker towing* in the *Roadside Emergencies* chapter.

CAMPER BODIES

Your vehicle is not recommended for slide-in camper bodies.

STARTING

Positions of the ignition

1. Accessory — allows the electrical accessories such as the radio to operate while the engine is not running.
2. Lock — locks the steering wheel, automatic transmission gearshift lever and allows key removal. For vehicles equipped with a manual transmission, you must press the ignition release lever to release the key.
3. Off — shuts off the engine and all accessories without locking the steering wheel.
4. On — all electrical circuits operational. Warning lights illuminated. Key position when driving.
5. Start — cranks the engine. Release the key as soon as the engine starts.

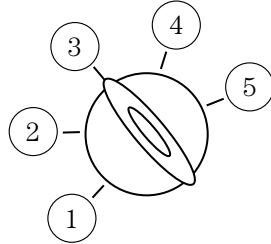

Preparing to start your vehicle

Engine starting is controlled by the powertrain control system.

Note: This system meets all Canadian interference-causing equipment standard requirements regulating the impulse electrical field strength of radio noise.

When starting a fuel-injected engine, don't press the accelerator before or during starting. Only use the accelerator when you have difficulty starting the engine. For more information on starting the vehicle, refer to *Starting the engine* in this chapter.



WARNING: Extended idling at high engine speeds can produce very high temperatures in the engine and exhaust system, creating the risk of fire or other damage.



WARNING: Do not park, idle, or drive your vehicle in dry grass or other dry ground cover. The emission system heats up the engine compartment and exhaust system, which can start a fire.

Driving

! **WARNING:** Do not start your vehicle in a closed garage or in other enclosed areas. Exhaust fumes can be toxic. Always open the garage door before you start the engine. See *Guarding against exhaust fumes* in this chapter for more instructions.

! **WARNING:** If you smell exhaust fumes inside your vehicle, have your dealer inspect your vehicle immediately. Do not drive if you smell exhaust fumes.

Important safety precautions

When the engine starts, the idle RPM runs faster to warm the engine. If the engine idle speed does not slow down automatically, have the vehicle checked.

Before starting the vehicle:

1. Make sure all occupants buckle their safety belts. For more information on safety belts and their proper usage, refer to the *Seating and Safety Restraints* chapter.
2. Make sure the headlamps and electrical accessories are off.

If starting a vehicle with an automatic transmission:

- Make sure the parking brake is set.

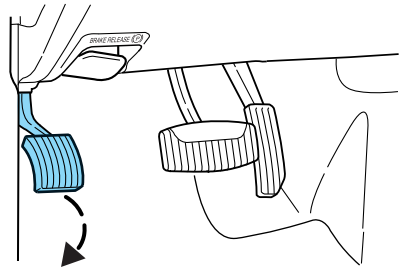

- Make sure the gearshift is in P (Park).

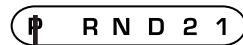

If starting a vehicle with a manual transmission:

- Make sure the parking brake is set.
- Press and hold the clutch pedal to the floor, then put the gearshift lever in the N (Neutral) position.

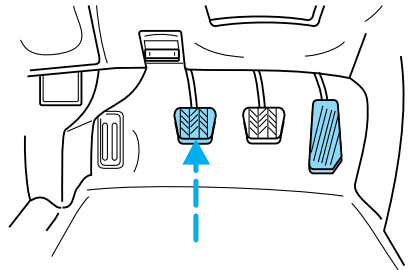

3. Turn the key to 4 (on) without turning the key to 5 (start).

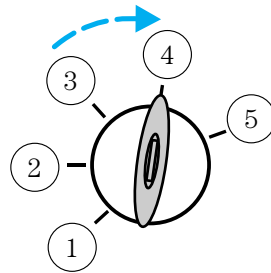

If there is difficulty in turning the key, firmly rotate the steering wheel left and right until the key turns freely. This condition may occur when:

- the front wheels are turned,
- the front wheel is against the curb, or
- the steering wheel is turned when getting in or out of the vehicle.

Some warning lights will briefly illuminate. See *Warning lights and chimes* in the *Instrument Cluster* chapter for more information regarding the warning lights.

Starting the engine

Note: Whenever you start your vehicle, release the key as soon as the engine starts. Excessive cranking could damage the starter.

Driving

1. Turn the key to 4 (on) without turning the key to 5 (start). If there is difficulty in turning the key, rotate the steering wheel until the key turns freely. This condition may occur when:

- the front wheels are turned, or
- a front wheel is against the curb.

2. Turn the key to 5 (start), then release the key as soon as the engine starts. Excessive cranking could damage the starter.

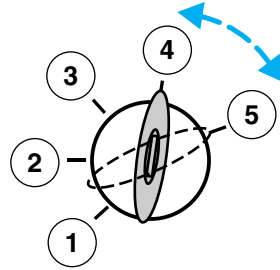

Note: If the engine does not start within five seconds on the first try, turn the key to off, wait 10 seconds and try again. If the engine still fails to start, press the accelerator to the floor and try again. This will allow the engine to crank with the fuel shut off in case the engine is flooded with fuel.

Guarding against exhaust fumes

Carbon monoxide is present in exhaust fumes. Take precautions to avoid its dangerous effects.



WARNING: If you smell exhaust fumes inside your vehicle, have your dealer inspect your vehicle immediately. Do not drive if you smell exhaust fumes.

Important ventilating information

If the engine is idling while the vehicle is stopped for a long period of time, open the windows at least 1 inch (2.5 cm) or adjust the heating or air conditioning to bring in fresh air.

ENGINE BLOCK HEATER (IF EQUIPPED)

An engine block heater warms the engine coolant which aids in starting and allows the heater/defroster system to respond quickly. If your vehicle is equipped with this system, your equipment includes a heater element which is installed in your engine block and a wire harness which allows the user to connect the system to a grounded 120 volt A/C electrical source. The block heater system is most effective when outdoor temperatures reach below 0°F (-18°C).



WARNING: Failure to follow engine block heater instructions could result in property damage or physical injury.



WARNING: To reduce the risk of electrical shock, do not use your heater with ungrounded electrical systems or two-pronged (cheater) adapters.

Prior to using the engine block heater, follow these recommendations for proper and safe operation:

- For your safety, use an outdoor extension cord that is product certified by Underwriter's Laboratory (UL) or Canadian Standards Association (CSA). Use only an extension cord that can be used outdoors, in cold temperatures, and is clearly marked "Suitable for Use with Outdoor Appliances." Never use an indoor extension cord outdoors; it could result in an electric shock or fire hazard.
- Use a 16-gauge outdoor extension cord, minimum.
- Use as short an extension cord as possible.
- Do not use multiple extension cords. Instead, use one extension cord which is long enough to reach from the engine block heater cord to the outlet without stretching.
- Make certain that the extension cord is in excellent condition (not patched or spliced). Store your extension cord indoors at temperatures above 32°F (0°C). Outdoor conditions can deteriorate extension cords over a period of time.
- To reduce the risk of electrical shock, do not use your heater with ungrounded electrical systems or two pronged (cheater) adapters. Also ensure that the block heater, especially the cord, is in good condition before use.
- Make sure that when in operation, the extension cord plug/engine block heater cord plug connection is free and clear of water in order to prevent possible shock or fire.
- Be sure that areas where the vehicle is parked are clean and clear of all combustibles such as petroleum products, dust, rags, paper and similar items.
- Be sure that the engine block heater, heater cord and extension cord are solidly connected. A poor connection can cause the cord to become very hot and may result in an electrical shock or fire. Be sure to check for heat anywhere in the electrical hookup once the system has been operating for approximately a half hour.

Driving

- Finally, have the engine block heater system checked during your fall tune-up to be sure it's in good working order.

How to use the engine block heater

Ensure the receptacle terminals are clean and dry prior to use. To clean them, use a dry cloth.

Depending on the type of factory installed equipment, your engine block heater will use .4 to 1.0 kilowatt-hours of energy per hour of use. Your factory installed block heater system does not have a thermostat; however, maximum temperature is attained after approximately three hours of operation. Block heater operation longer than three hours will not improve system performance and will unnecessarily use additional electricity.

Make sure system is unplugged and properly stowed before driving the vehicle. While not in use, make sure the protective cover seals the prongs of the engine block heater cord plug.

BRAKES

Occasional brake noise is normal. If a metal-to-metal, continuous grinding or continuous squeal sound is present, the brake linings may be worn-out and should be inspected by an authorized dealer. If the vehicle has continuous vibration or shudder in the steering wheel while braking, the vehicle should be inspected by an authorized dealer.

Refer to *Warning lights and chimes* in the *Instrument Cluster* chapter for information on the brake system warning light.



Four-wheel anti-lock brake system (ABS)

This vehicle is equipped with an anti-lock braking system (ABS). A noise from the hydraulic pump motor and pulsation in the pedal may be observed during ABS braking events and the brake pedal may suddenly travel a little farther as soon as ABS braking is done and normal brake operation resumes. Pedal pulsation coupled with noise while braking under panic conditions or on loose gravel, bumps, wet or snowy roads is normal and indicates proper functioning of the vehicle's anti-lock brake system.

Note: The ABS performs a self-check after you start the engine and begin to drive away.

A brief mechanical noise may be heard during this test. This is normal. If a malfunction is found, the ABS warning light will come on. If the vehicle

has continuous vibration or shudder in the steering wheel while braking, the vehicle should be inspected by an authorized dealer.

The ABS operates by detecting the onset of wheel lockup during brake applications and compensates for this tendency. The wheels are prevented from locking even when the brakes are firmly applied. The accompanying illustration depicts the advantage of an ABS equipped vehicle (on bottom) to a non-ABS equipped vehicle (on top) during hard braking with loss of front braking traction.

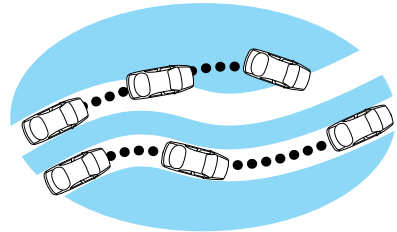

WARNING: The anti-lock system does not decrease the time necessary to apply the brakes or always reduce stopping distance. Always leave enough room between your vehicle and the vehicle in front of you to stop.

Using ABS

When hard braking is required, apply continuous force on the brake pedal; do not pump the brake pedal since this will reduce the effectiveness of the ABS and will increase your vehicle's stopping distance. The ABS will be activated immediately, allowing you to retain steering control during hard braking and on slippery surfaces. However, the ABS does not decrease stopping distance.

ABS warning lamp

The ABS lamp in the instrument cluster momentarily illuminates when the ignition is turned on. If the light does not illuminate during start up, remains on or flashes, the ABS may be disabled and may need to be serviced.

Even when the ABS is disabled, normal braking is still effective. If your BRAKE warning lamp illuminates with the parking brake released, have your brake system serviced immediately by an authorized dealer.

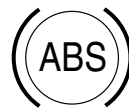

Driving

Parking brake

Apply the parking brake whenever the vehicle is parked. To set the parking brake, press the parking brake pedal down until the pedal stops.

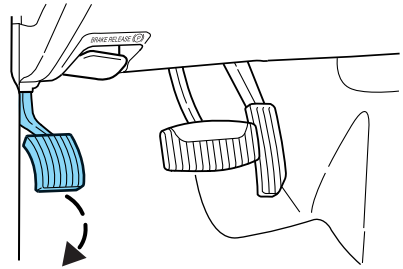

The BRAKE warning lamp in the instrument cluster illuminates and remains illuminated (when the ignition is turned on) until the parking brake is released.



WARNING: Always set the parking brake fully and make sure that the gearshift is securely latched in P (Park) (automatic transmission) or in 1 (First) (manual transmission).

Note: The parking brake is not recommended to stop a moving vehicle. However, if the normal brakes fail, the parking brake can be used to stop your vehicle in an emergency. Since the parking brake applies only the rear brakes, the vehicle's stopping distance will increase greatly and the handling of your vehicle will be adversely affected.

Pull the release lever to release the brake.

Driving with the parking brake on will cause the brakes to wear out quickly and reduce fuel economy.

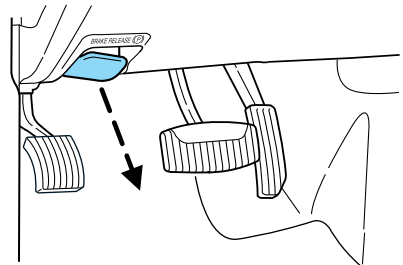

ADVANCETRAC® WITH ROLL STABILITY CONTROL™ (RSC®) STABILITY ENHANCEMENT SYSTEM

Your vehicle is equipped with the AdvanceTrac® with RSC® system. The AdvanceTrac® with RSC® system provides the following stability enhancement features for certain driving situations:

- Traction control system (TCS), which functions to help avoid drive-wheel spin and loss of traction.
- Electronic stability control (ESC), which functions to help avoid skids or lateral slides
- Roll Stability Control™ (RSC®), which functions to help avoid a vehicle roll-over.



WARNING: Vehicle modifications involving braking system, aftermarket roof racks, suspension, steering system, tire construction and/or wheel/tire size may change the handling characteristics of the vehicle and may adversely affect the performance of the AdvanceTrac® with RSC® system. In addition, installing any stereo loudspeakers may interfere with and adversely affect the AdvanceTrac® with RSC® system. Install any aftermarket stereo loudspeaker as far as possible from the front center console, the tunnel, and the front seats in order to minimize the risk of interfering with the AdvanceTrac® with RSC® sensors. Reducing the effectiveness of the AdvanceTrac® with RSC® system could lead to an increased risk of loss of vehicle control, vehicle rollover, personal injury and death.





WARNING: Remember that even advanced technology cannot defy the laws of physics. It's always possible to lose control of a vehicle due to inappropriate driver input for the conditions. Aggressive driving on any road condition can cause you to lose control of your vehicle increasing the risk of personal injury or property damage. Activation of the AdvanceTrac® with RSC® system is an indication that at least some of the tires have exceeded their ability to grip the road; this could reduce the operator's ability to control the vehicle, potentially resulting in a loss of vehicle control, vehicle rollover, personal injury and death. If your AdvanceTrac® with RSC® system activates, SLOW DOWN.



Driving





WARNING: If a failure has been detected within the AdvanceTrac® with RSC® system, the “sliding car” icon  will illuminate steadily and you may hear a chime. If equipped with a message center, the vehicle will also indicate a failure with the brake system, have the system serviced by an authorized dealer immediately.

The AdvanceTrac® with RSC® system automatically enables each time the engine is started. All features of the AdvanceTrac® with RSC® system (TCS, ESC, and RSC®) are active and monitor the vehicle from start-up). However, the system will only intervene if the driving situation requires it.

The AdvanceTrac® with RSC® system includes an AdvanceTrac® with RSC® button on the center of the instrument panel, the “sliding car” icon  and a “sliding car off” icon  in the instrument cluster.

Both the “sliding car” icon  and the “sliding car off” icon  in the

instrument cluster will illuminate temporarily during start-up as part of a normal system self-check. The “sliding car” icon  may illuminate (flash) during certain driving situation which cause the AdvanceTrac® with RSC® system to operate. If the “sliding car” icon  illuminates steadily, have the system serviced by an authorized dealer immediately.

When AdvanceTrac® with RSC® performs a normal system self-check, some drivers may notice a slight movement of the brake, and/or a rumble, grunting, or grinding noise after startup and when driving off.

When an event occurs that activates AdvanceTrac® with RSC® you may experience the following:

- A slight deceleration of the vehicle
- The “sliding car”  indicator light will flash.
- If your foot is on the brake pedal, a vibration in the pedal.
- If the driving condition is severe and your foot is not on the brake, the brake pedal may move as the system applies higher brake forces. You may also hear a whoosh of air from under the instrument panel during this severe condition.
- The brake pedal may feel stiffer than usual.

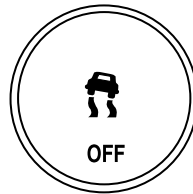

Traction control system (TCS)

Traction control is a driver aid feature that helps your vehicle maintain traction of the wheels, typically when driving on slippery and/or hilly road surfaces, by detecting and controlling wheel spin.

Excessive wheel spin is controlled in two ways, which may work separately or in tandem: engine traction control and brake traction control. Engine traction control works to limit drive-wheel spin by momentarily reducing engine power. Brake traction control works to limit wheel spin by momentarily applying the brakes to the wheel that is slipping. Traction control is most active at low speeds.

During traction control events the “sliding car” icon  in the instrument cluster will flash.

If the traction control system is activated excessively in a short period of time, the braking portion of the system may become temporarily disabled to allow the brakes to cool down. In this situation, traction control will use only engine power reduction or transfer to help control the wheels from over-spinning. When the brakes have cooled down, the system will regain all features. Anti-lock braking, RSC®, and ESC will continue to function during the cool-down period.

The engine traction control and brake traction control system may be deactivated in certain situations. See the *Switching off AdvanceTrac® with RSC®* section following.

Electronic stability control (ESC)

Electronic stability control (ESC) may enhance your vehicle’s directional stability during adverse maneuvers, for example when cornering severely or avoiding objects in the roadway. ESC operates by applying brakes to one or more of the wheels individually and, if necessary, reducing engine power if the system detects that the vehicle is about to skid or slide laterally.

During ESC events the “sliding car” icon  in the instrument cluster will flash.

Certain adverse driving maneuvers may activate the ESC system, which include but are not limited to:

- Taking a turn too fast
- Maneuvering quickly to avoid an accident, pedestrian or obstacle
- Driving over a patch of ice or other slippery surfaces
- Changing lanes on a snow-rutted road

Driving

- Entering a snow-free road from a snow-covered side street, or vice versa
- Entering a paved road from a gravel road, or vice versa
- Cornering while towing a heavily loaded trailer (refer to *Trailer towing* in the *Tires, Wheels and Loading* chapter).

The ESC system may be deactivated in certain situations. See the *Switching off AdvanceTrac® with RSC®* section following.

Roll Stability Control™ (RSC®)

Roll Stability Control™ (RSC®) may help to maintain roll stability of the vehicle during adverse maneuvers. RSC® operates by detecting the vehicle's roll motion and the rate at which it changes and by applying the brakes to one or more wheels individually.

During an event that activates the Roll Stability Control™ (RSC®) the “sliding car” icon  in the instrument cluster will flash.

Certain adverse driving maneuvers may activate the RSC® system, which include:

- Emergency lane-change
- Taking a turn too fast
- Quick maneuvering to avoid an accident, pedestrian or obstacle

The RSC® system may be deactivated in certain situations. See the *Switching off AdvanceTrac® with RSC®* section following.

Switching off AdvanceTrac® with RSC®

If the vehicle is stuck in snow, mud or sand, and seems to lose engine power, switching off certain features of the AdvanceTrac® with RSC® system may be beneficial because the wheels are allowed to spin. This will restore full engine power and will enhance momentum through the obstacle.

To switch off the AdvanceTrac® with RSC® system press the AdvanceTrac® with RSC® button. Full features of the AdvanceTrac® with RSC® system can be restored by pressing the AdvanceTrac® with RSC® button again or by turning off and restarting the engine.



If you switch off the AdvanceTrac® with RSC® system, the “sliding car off” icon  will illuminate steadily. Pressing the AdvanceTrac® with RSC® button again will turn off the “sliding car off” icon.



In R (Reverse), ABS and the engine traction control and brake traction control features will continue to function; however, ESC and RSC® are disabled.

AdvanceTrac® Features				
Button functions	 icon status	RSC®	ESC	TCS
Default at start-up	Illuminated during bulb check	Enabled	Enabled	Enabled
Button pressed momentarily	Illuminated solid	Enabled	Enabled	Disabled
Button pressed and held more than 5 seconds (speed under 35 mph)	Illuminated for 5 seconds, turns off for 3 seconds, then illuminated solid	Disabled	Disabled	Disabled
Button pressed and held less than 5 seconds (speed over 35 mph)	Illuminated solid	Enabled	Enabled	Disabled
Button pressed again after deactivation	Not illuminated	Enabled	Enabled	Enabled
Transfer case in 4L (4WD Low)	Illuminated solid	Disabled	Disabled	Disabled

Driving

STEERING

To help prevent damage to the power steering system:

- Never hold the steering wheel at its furthest turning points (until it stops) for more than a few seconds when the engine is running.
- Do not operate the vehicle with a low power steering fluid level (below the MIN mark on the reservoir).
- Some noise is normal during operation. If the noise is excessive, check for a low power steering fluid level before seeking service by your authorized dealer.
- Heavy or uneven steering efforts may be caused by a low power steering fluid level. Check for a low power steering fluid level before seeking service by your authorized dealer.
- Do not fill the power steering fluid reservoir above the MAX mark on the reservoir.

If the power steering system breaks down (or if the engine is turned off), you can steer the vehicle manually, but it takes more effort.

If the steering wanders or pulls, check for:

- An improperly inflated tire
- Uneven tire wear
- Loose or worn suspension components
- Loose or worn steering components
- Improper steering alignment

A high crown in the road or high crosswinds may also make the steering seem to wander/pull.

PREPARING TO DRIVE



WARNING: Utility vehicles have a significantly higher rollover rate than other types of vehicles.



WARNING: In a rollover crash, an unbelted person is significantly more likely to die than a person wearing a seat belt.

Utility vehicles and trucks have larger tires and increased ground clearance, giving the vehicle a higher center of gravity than a passenger car.



WARNING: Vehicles with a higher center of gravity such as utility vehicles and trucks handle differently than vehicles with a lower center of gravity. Utility vehicles and trucks are **not** designed for cornering at speeds as high as passenger cars any more than low-slung sports cars are designed to perform satisfactorily under off-road conditions. Avoid sharp turns, excessive speed or abrupt maneuvers in these vehicles. Failure to drive cautiously could result in an increased risk of loss of vehicle control, vehicle rollover, personal injury and death.



WARNING: Loaded vehicles, with a higher center of gravity, may handle differently than unloaded vehicles. Do not overload your vehicle and use extra precautions, such as driving at slower speeds, avoiding abrupt steering changes and allowing for increased stopping distance, when driving a heavily loaded vehicle. Over-loading or loading the vehicle improperly can deteriorate handling capability and contribute to loss of vehicle control and vehicle rollover.

BRAKE-SHIFT INTERLOCK

The vehicle is equipped with a brake-shift interlock feature that prevents the gearshift lever from being moved from P (Park) unless the brake pedal is pressed.

If you cannot move the gearshift lever out of P (Park) with the ignition in the on position and the brake pedal pressed, it is possible that a fuse has blown or the vehicle's brakelamps are not operating properly. Refer to *Fuses and relays* in the *Roadside Emergencies* chapter.

Driving

If the fuse is not blown and the brakelamps are working properly, the following procedure will allow you to move the gearshift lever from P (Park):

1. Apply the parking brake, and turn the ignition to the on position.
2. Remove the lower trim panel under the steering column. Make sure not disturb the wires on the electrical connector.
3. Locate the BSI solenoid underneath the steering column.
4. With your hand, pull back on the solenoid, and at the same time, shift the transmission into N (Neutral).
5. Start the vehicle.

See your authorized dealer as soon as possible if this procedure is used.

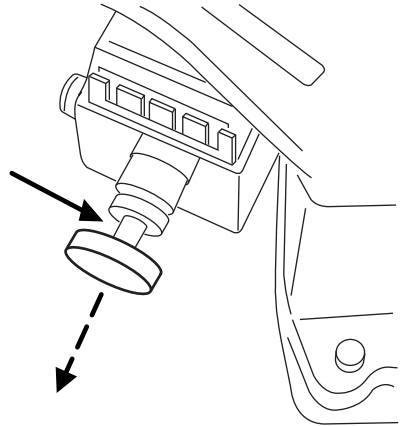

WARNING: Do not drive your vehicle until you verify that the brakelamps are working.



WARNING: Always set the parking brake fully and make sure the gearshift is latched in P (Park). Turn the ignition to the lock position and remove the key whenever you leave your vehicle.



WARNING: If the parking brake is fully released, but the brake warning lamp remains illuminated, the brakes may not be working properly. See your authorized dealer.

AUTOMATIC TRANSMISSION OPERATION (IF EQUIPPED)

Driving with a 5-speed automatic transmission (if equipped)

This vehicle is equipped with an adaptive transmission shift strategy. Adaptive shift strategy offers the optimal transmission operation and

shift quality. When the vehicle's battery has been disconnected for any type of service or repair, the transmission will need to relearn the normal shift strategy parameters, much like having to reset your radio stations when your vehicle battery has been disconnected. The adaptive transmission strategy allows the transmission to relearn these operating parameters. This learning process could take several transmission upshifts and downshifts; during this learning process, slightly firmer shifts may occur. After this learning process, normal shift feel and shift scheduling will resume.

P (Park)

This position locks the transmission and prevents the rear wheels from turning.

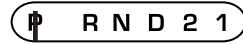

To put your vehicle in gear:

- Start the engine
- Press the brake pedal
- Move the gearshift lever into the desired gear

To put your vehicle in P (Park):

- Come to a complete stop
- Move the gearshift lever and securely latch it in P (Park)



WARNING: Always set the parking brake fully and make sure the gearshift is latched in P (Park). Turn the ignition to the lock position and remove the key whenever you leave your vehicle.

R (Reverse)

With the gearshift lever in R (Reverse), the vehicle will move backward. Always come to a complete stop before shifting into and out of R (Reverse).

N (Neutral)

With the gearshift lever in N (Neutral), the vehicle can be started and is free to roll. Hold the brake pedal down while in this position.

D (Drive) with Overdrive

The normal driving position for the best fuel economy. Transmission operates in gears one through five.

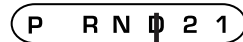

Driving

D (Drive) without Overdrive

D (Drive) without Overdrive can be deactivated by pressing the transmission control switch on the end of the gearshift lever.

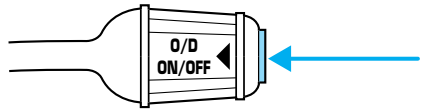

- This position allows for all forward gears except overdrive.
 - O/D OFF lamp is illuminated.
- O/D
OFF**
- Provides engine braking.
 - Use when driving conditions cause excessive shifting from O/D to other gears. Examples: city traffic where continuous shifting in and out of overdrive occurs, hilly terrain, heavy loads, trailer towing and when engine braking is required.
 - To return to O/D (Overdrive), press the transmission control switch. The O/D OFF lamp will not be illuminated.
 - O/D (Overdrive) is automatically returned each time the key is turned off.

2 (Second)

Use 2 (Second) to start-up on slippery roads or to provide additional engine braking on downgrades.

1 (First)

- Provides maximum engine braking.
- Allows upshifts by moving gearshift lever.
- Will not downshift into 1 (First) at high speeds; allows for 1 (First) when vehicle reaches slower speeds.

Forced downshifts

- Allowed in D (Drive) with Overdrive or D (Drive) without Overdrive.
- Press the accelerator to the floor.
- Allows transmission to select an appropriate gear.

MANUAL TRANSMISSION OPERATION (IF EQUIPPED)

Using the clutch

Manual transmission vehicles have a starter interlock that prevents cranking the engine unless the clutch pedal is fully pressed.

To start the vehicle:

1. Make sure the parking brake is fully set.
2. Press and hold the clutch pedal to the floor, then put the gearshift lever in the neutral position.
3. Start the engine.
4. Press the brake pedal and move the gearshift lever to the desired gear; 1 (First) or R (Reverse).
5. Release the parking brake, then slowly release the clutch pedal while slowly pressing on the accelerator.

During each shift, the clutch pedal must be fully pressed to the floor. Make sure the floor mat is properly positioned so it doesn't interfere with the full extension of the clutch pedal.

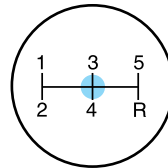
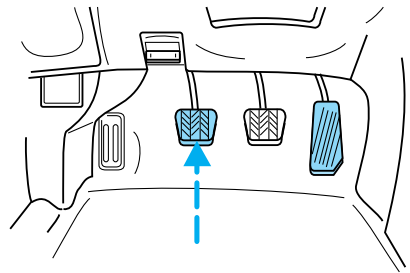

Failure to fully press the clutch pedal to the floor may cause increased shift efforts, prematurely wear transmission components or damage the transmission.

Do not drive with your foot resting on the clutch pedal or use the clutch pedal to hold your vehicle at a standstill while waiting on a hill. These actions will severely reduce the life of the clutch and could nullify a clutch warranty claim.

Recommended shift speeds

Upshift and downshift according to the following charts:

Upshifts when accelerating (for best fuel economy)		
Shift from:	Transfer case position (if equipped)	
	2H or 4H	4L
1 - 2	10 mph (14 km/h)	4 mph (5 km/h)
2 - 3	22 mph (32 km/h)	9 mph (11 km/h)
3 - 4	33 mph (50 km/h)	13 mph (19 km/h)
4 - 5 (Overdrive)	41 mph (71 km/h)	17 mph (27 km/h)

Driving

Upshifts when cruising (recommended for best fuel economy)		
Shift from:	Transfer case position (if equipped)	
	2H or 4H	4L
1 - 2	10 mph (16 km/h)	4 mph (6 km/h)
2 - 3	19 mph (26 km/h)	8 mph (10 km/h)
3 - 4	28 mph (43 km/h)	12 mph (16 km/h)
4 - 5 (Overdrive)	40 mph (68 km/h)	16 mph (26 km/h)

Maximum downshift speeds		
Shift from:	Transfer case position (if equipped)	
	2H or 4H	4L
5 (Overdrive) - 4	55 mph (88 km/h)	22 mph (34 km/h)
4 - 3	45 mph (72 km/h)	18 mph (27 km/h)
3 - 2	35 mph (56 km/h)	14 mph (21 km/h)
2 - 1	20 mph (32 km/h)	8 mph (11 km/h)

Reverse

1. Make sure that your vehicle is at a complete stop before you shift into R (Reverse). Failure to do so may damage the transmission.

2. Move the gearshift lever into the neutral position and wait at least three seconds before shifting into R (Reverse).

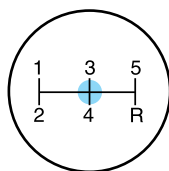

Note: The gearshift lever can only be moved into R (Reverse) by moving it from left of 3 (Third) and 4 (Fourth) before shifting into R (Reverse). This is a lockout feature that protects the transmission from accidentally being shifted into R (Reverse) from 5 (Overdrive).

Parking your vehicle

1. Apply the brake and shift into the neutral position.
2. Fully apply the parking brake, then shift into 1 (First).
3. Turn the ignition off.



WARNING: Do not park your vehicle in Neutral, it may move unexpectedly and injure someone. Use 1 (First) gear and set the parking brake fully.

Removing the key

Turn the ignition off, push the release lever (located above the ignition), then turn the key toward you and remove the key.



If your vehicle gets stuck in mud or snow

If your vehicle gets stuck in mud or snow, it may be rocked out by shifting between forward and reverse gears, stopping between shifts in a steady pattern. Press lightly on the accelerator in each gear.

Do not rock the vehicle if the engine is not at normal operating temperature or damage to the transmission may occur.

Do not rock the vehicle for more than a minute or damage to the transmission and tires may occur, or the engine may overheat.

FOUR-WHEEL DRIVE (4WD) OPERATION (IF EQUIPPED)



WARNING: For important information regarding safe operation of this type of vehicle, see *Preparing to drive your vehicle* in this chapter.

Four-wheel drive (4WD) supplies power to all four wheels. 4WD should not be operated on dry pavement; driveline damage may occur.

If equipped with the electronic shift 4WD system, and 4WD Low is selected while the vehicle is moving above 3 mph (5 km/h), the 4WD system will not engage. This is normal and should be no reason for concern. Refer to *Shifting to/from 4L (4WD Low)* for proper operation.

4WD system indicator lights

- **4x4** - Momentarily illuminates when the vehicle is started.
Illuminates when 4H (4WD High) is engaged.

4x4

Driving

- **4x4 LOW** – Momentarily illuminates when the vehicle is started. Illuminates when 4L (4WD Low) is engaged.

**4x4
LOW**

Using the electronic shift 4WD system

2H (2WD High) - Power to the rear wheels only; used for street and highway driving.

4H (4WD High) - Used for extra traction such as in snow or icy roads or in off-road situations. Not intended for use on dry pavement.

4L (4WD Low) - Uses extra gearing to provide maximum power to all four wheels. Intended only for off-road applications such as deep sand, steep grades or pulling heavy objects. 4L (4WD Low) will not engage while the vehicle is moving; this is normal and should be no reason for concern. Refer to *Shifting to/from 4L (4WD Low)* for proper operation.

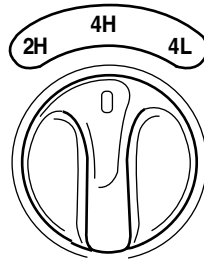

Shifting between 2H (2WD High) and 4H (4WD High)

- Move the 4WD control between 2H and 4H at a stop or any forward speed.

Note: Do not perform this operation if the rear wheels are slipping.

Shifting to/from 4L (4WD Low)

Note: Some noise may be heard as the 4WD system shifts or engages. This is normal and should be no reason for concern.

1. Bring the vehicle to a complete stop
2. On vehicles equipped with an automatic transmission, place the transmission in N (Neutral); on vehicles equipped with a manual transmission, press the clutch.
3. Move the 4WD control to the desired position.
 - If shifting into 4L (4WD Low), wait for the 4WD LOW light in the instrument cluster to turn **on** indicating the shift is complete.
 - If shifting out of 4L (4WD Low), wait for the 4WD LOW light in the instrument cluster to turn **off** indicating the shift is complete.

Driving off-road with truck and utility vehicles

4WD vehicles are specially equipped for driving on sand, snow, mud and rough terrain and have operating characteristics that are somewhat different from conventional vehicles, both on and off the road.

How your vehicle differs from other vehicles

Truck and utility vehicles can differ from some other vehicles. Your vehicle may be higher to allow it to travel over rough terrain without getting hung up or damaging underbody components.

The differences that make your vehicle so versatile also make it handle differently than an ordinary passenger car.

Maintain steering wheel control at all times, especially in rough terrain. Since sudden changes in terrain can result in abrupt steering wheel motion, make sure you grip the steering wheel from the outside. Do not grip the spokes.

Drive cautiously to avoid vehicle damage from concealed objects such as rocks and stumps.

You should either know the terrain or examine maps of the area before driving. Map out your route before driving in the area. To maintain steering and braking control of your vehicle, you must have all four wheels on the ground and they must be rolling, not sliding or spinning.

Basic operating principles

- Do not use 4WD on dry, hard surfaced roads. Doing so will produce excessive noise, increase tire wear and may damage drive components. 4WD modes are only intended for consistently slippery or loose surfaces.
- Drive slower in strong crosswinds which can affect the normal steering characteristics of your vehicle.
- Be extremely careful when driving on pavement made slippery by loose sand, water, gravel, snow or ice.

If your vehicle goes off the edge of the pavement

- If your vehicle goes off the edge of the pavement, slow down, but avoid severe brake application, ease the vehicle back onto the pavement only after reducing your speed. Do not turn the steering wheel too sharply while returning to the road surface.
- It may be safer to stay on the apron or shoulder of the road and slow down gradually before returning to the pavement. You may lose control if you do not slow down or if you turn the steering wheel too sharply or abruptly.

Driving

- It often may be less risky to strike small objects, such as highway reflectors, with minor damage to your vehicle rather than attempt a sudden return to the pavement which could cause the vehicle to slide sideways out of control or roll over. Remember, your safety and the safety of others should be your primary concern.



WARNING: Vehicles with a higher center of gravity such as utility and four-wheel drive vehicles handle differently than vehicles with a lower center of gravity. Utility and four-wheel drive vehicles are **not** designed for cornering at speeds as high as passenger cars any more than low-slung sports cars are designed to perform satisfactorily under off-road conditions. Avoid sharp turns, excessive speed and abrupt maneuvers in these vehicles. Failure to drive cautiously could result in an increased risk of loss of vehicle control, vehicle rollover, personal injury and death.

If your vehicle gets stuck

If your vehicle gets stuck in mud or snow it may be rocked out by shifting between forward and reverse gears, stopping between shifts, in a steady pattern. Press lightly on the accelerator in each gear.

Do not rock the vehicle if the engine is not at normal operating temperature or damage to the transmission may occur.

Do not rock the vehicle for more than a few minutes or damage to the transmission and tires may occur or the engine may overheat.



WARNING: Do not spin the wheels at over 35 mph (56 km/h). The tires may fail and injure a passenger or bystander.

Emergency maneuvers

- In an unavoidable emergency situation where a sudden sharp turn must be made, remember to avoid “over-driving” your vehicle, i.e., turn the steering wheel only as rapidly and as far as required to avoid the emergency. Excessive steering will result in less vehicle control, not more. Additionally, smooth variations of the accelerator and/or brake pedal pressure should be utilized if changes in vehicle speed are called for. Avoid abrupt steering, acceleration or braking which could result in an increased risk of loss of vehicle control, vehicle rollover and/or personal injury. Use all available road surface to return the vehicle to a safe direction of travel.

- In the event of an emergency stop, avoid skidding the tires and do not attempt any sharp steering wheel movements.



WARNING: Vehicles with a higher center of gravity such as utility and four-wheel drive vehicles handle differently than vehicles with a lower center of gravity. Utility and four-wheel drive vehicles are **not** designed for cornering at speeds as high as passenger cars any more than low-slung sports cars are designed to perform satisfactorily under off-road conditions. Avoid sharp turns, excessive speed and abrupt maneuvers in these vehicles. Failure to drive cautiously could result in an increased risk of loss of vehicle control, vehicle rollover, personal injury and death.

- If the vehicle goes from one type of surface to another (i.e., from concrete to gravel) there will be a change in the way the vehicle responds to a maneuver (steering, acceleration or braking). Again, avoid these abrupt inputs.

4WD Systems

4WD (when you select a 4WD mode) uses all four wheels to power the vehicle. This increases traction, enabling you to drive over terrain and road conditions that a conventional two-wheel drive vehicle cannot.

Power is supplied to all four wheels through a transfer case. On 4WD vehicles, the transfer case allows you to select 4WD when necessary. Information on transfer case operation and shifting procedures can be found in the *Driving* chapter. Information on transfer case maintenance can be found in the *Maintenance and Specifications* chapter. You should become thoroughly familiar with this information before you operate your vehicle.

Normal characteristics

On some 4WD models, the initial shift from two-wheel drive to 4x4 while the vehicle is moving can cause some momentary clunk and ratcheting sounds.

Sand

When driving over sand, try to keep all four wheels on the most solid area of the trail. Avoid reducing the tire pressures but shift to a lower gear and drive steadily through the terrain. Apply the accelerator slowly and avoid spinning the wheels.

Avoid excessive speed because vehicle momentum can work against you and cause the vehicle to become stuck to the point that assistance may

Driving

be required from another vehicle. Remember, you may be able to back out the way you came if you proceed with caution.

Mud and water

If you must drive through high water, drive slowly. Traction or brake capability may be limited.

When driving through water, determine the depth; avoid water higher than the bottom of the hubs (if possible) and proceed slowly. If the ignition system gets wet, the vehicle may stall.

Once through water, always try the brakes. Wet brakes do not stop the vehicle as effectively as dry brakes. Drying can be improved by moving your vehicle slowly while applying light pressure on the brake pedal.

Be cautious of sudden changes in vehicle speed or direction when you are driving in mud. Even 4WD vehicles can lose traction in slick mud. As when you are driving over sand, apply the accelerator slowly and avoid spinning your wheels. If the vehicle does slide, steer in the direction of the slide until you regain control of the vehicle.

If the transmission, transfer case or front axle are submerged in water, their fluids should be checked and changed, if necessary.

Driving through deep water may damage the transmission.

If the front or rear axle is submerged in water, the axle lubricant should be replaced.

After driving through mud, clean off residue stuck to rotating driveshafts and tires. Excess mud stuck on tires and rotating driveshafts causes an imbalance that could damage drive components.

“Tread Lightly” is an educational program designed to increase public awareness of land-use regulations and responsibilities in our nations wilderness areas. Ford Motor

Company joins the U.S. Forest Service and the Bureau of Land Management in encouraging you to help preserve our national forest and other public and private lands by “treading lightly.”



Driving on hilly or sloping terrain

Although natural obstacles may make it necessary to travel diagonally up or down a hill or steep incline, you should always try to drive straight up

or straight down. **Avoid driving crosswise or turning on steep slopes or hills.** A danger lies in losing traction, slipping sideways and possibly rolling over. Whenever driving on a hill, determine beforehand the route you will use. Do not drive over the crest of a hill without seeing what conditions are on the other side. Do not drive in reverse over a hill without the aid of an observer.

When climbing a steep slope or hill, start in a lower gear rather than downshifting to a lower gear from a higher gear once the ascent has started. This reduces strain on the engine and the possibility of stalling.

If you do stall out, do not try to turn around because you might roll over. It is better to back down to a safe location.

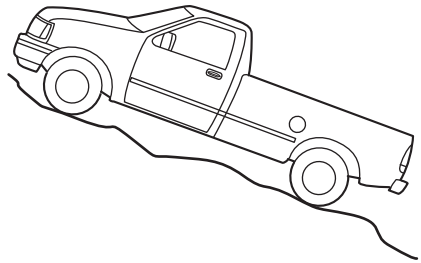

Apply just enough power to the wheels to climb the hill. Too much power will cause the tires to slip, spin or lose traction, resulting in loss of vehicle control.

Descend a hill in the same gear you would use to climb up the hill to avoid excessive brake application and brake overheating. Do not descend in neutral; instead, disengage overdrive or manually shift to a lower gear. When descending a steep hill, avoid sudden hard braking as you could lose control. When you brake hard, the front wheels can't turn and if they aren't turning, you won't be able to steer. The front wheels have to be turning in order to steer the vehicle. Rapid pumping of the brake pedal will help you slow the vehicle and still maintain steering control.

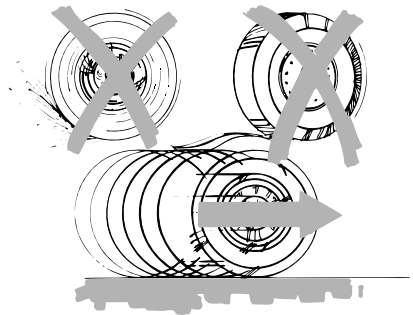

Your vehicle is equipped with a four-wheel anti-lock brake system (ABS), apply the brakes steadily. Do not “pump” the brakes.

Driving on snow and ice

4WD vehicles have advantages over 2WD vehicles in snow and ice but can skid like any other vehicle.

Driving

Should you start to slide while driving on snowy or icy roads, turn the steering wheel in the direction of the slide until you regain control.

Avoid sudden applications of power and quick changes of direction on snow and ice. Apply the accelerator slowly and steadily when starting from a full stop.

Avoid sudden braking as well. Although a 4WD vehicle may accelerate better than a two-wheel drive vehicle in snow and ice, it won't stop any faster, because as in other vehicles, braking occurs at all four wheels. Do not become overconfident as to road conditions.

Make sure you allow sufficient distance between you and other vehicles for stopping. Drive slower than usual and consider using one of the lower gears. Your vehicle is equipped with a four-wheel anti-lock brake system (ABS); apply the brake steadily. Do not pump the brakes. Refer to the *Brakes* section of this chapter for additional information on the operation of the anti-lock brake system.



WARNING: If you are driving in slippery conditions that require tire chains or cables, then it is critical that you drive cautiously.

Keep speeds down, allow for longer stopping distances and avoid aggressive steering to reduce the chances of a loss of vehicle control which can lead to serious injury or death. If the rear end of the vehicle slides while cornering, steer in the direction of the slide until you regain control of the vehicle.

Maintenance and modifications

The suspension and steering systems on your vehicle have been designed and tested to provide predictable performance whether loaded or empty and durable load carrying capability. For this reason, Ford Motor Company strongly recommends that you do not make modifications such as adding or removing parts (such as lift kits or stabilizer bars) or by using replacement parts not equivalent to the original factory equipment.

Any modifications to a vehicle that raise the center of gravity can make it more likely the vehicle will roll over as a result of a loss of control. Ford Motor Company recommends that caution be used with any vehicle equipped with a high load or device (such as ladder racks or pickup box cover).

Failure to maintain your vehicle properly may void the warranty, increase your repair cost, reduce vehicle performance and operational capabilities and adversely affect driver and passenger safety. Frequent inspection of vehicle chassis components is recommended if the vehicle is subjected to heavy off-road usage.

DRIVING THROUGH WATER

If driving through deep or standing water is unavoidable, proceed very slowly especially when the depth is not known. Never drive through water that is higher than the bottom of the wheel rims (for cars) or the bottom of the hubs (for trucks).

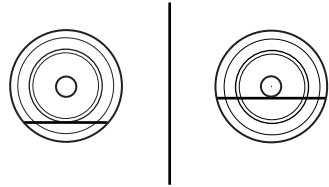

When driving through water, traction or brake capability may be limited. Also, water may enter your engine's air intake and severely damage your engine or your vehicle may stall. **Driving through deep water where the transmission vent tube is submerged may allow water into the transmission and cause internal transmission damage.**

Once through the water, always dry the brakes by moving your vehicle slowly while applying light pressure on the brake pedal. Wet brakes do not stop the vehicle as quickly as dry brakes.

Roadside Emergencies

ROADSIDE ASSISTANCE

Getting roadside assistance

To fully assist you should you have a vehicle concern, Ford Motor Company offers a complimentary roadside assistance program. This program is separate from the New Vehicle Limited Warranty. The service is available:

- 24-hours, seven days a week
- for the coverage period listed on the Roadside Assistance Card included in your Owner Guide portfolio.

Roadside assistance will cover:

- a flat tire change with a good spare (except vehicles that have been supplied with a tire inflation kit)
- battery jump start
- lock-out assistance (key replacement cost is the customer's responsibility)
- fuel delivery – Independent Service Contractors, if not prohibited by state, local or municipal law shall deliver up to 2.0 gallons (7.5L) of gasoline or 5.0 gallons (18.9L) of diesel fuel to a disabled vehicle. Fuel delivery service is limited to two no-charge occurrences within a 12-month period.
- winch out – available within 100 feet (30.5 meters) of a paved or county maintained road, no recoveries.
- towing – Ford/Mercury/Lincoln eligible vehicle towed to an authorized dealer within 35 miles (56 km) of the disablement location or to the nearest authorized dealer. If a member requests to be towed to an authorized dealer more than 35 miles (56 km) from the disablement location, the member shall be responsible for any mileage costs in excess of 35 miles (56 km).

Trailers shall be covered up to \$200 if the disabled eligible vehicle requires service at the nearest authorized dealer. If the trailer is disabled, but the towing vehicle is operational, the trailer does not qualify for any roadside services.

Canadian customers refer to your Customer Information Guide for information on:

- coverage period
- exact fuel amounts

Roadside Emergencies

- towing of your disabled vehicle
- emergency travel expense reimbursement
- travel planning benefits

In Canada, for uninterrupted Roadside Assistance coverage, you may purchase extended coverage prior to your Basic Warranty's Roadside Assistance expiring. For more information and enrollment, contact 1-877-294-2582 or visit our website at www.ford.ca.

Using roadside assistance

Complete the roadside assistance identification card and place it in your wallet for quick reference. In the United States, this card is found in the Owner Guide portfolio in the glove compartment. In Canada, the card is found in the *Customer Information Guide* in the glove compartment.

U.S. Ford, Mercury and Lincoln vehicle customers who require Roadside Assistance, call 1-800-241-3673.

Canadian customers who require roadside assistance, call 1-800-665-2006.

If you need to arrange roadside assistance for yourself, Ford Motor Company will reimburse a reasonable amount for towing to the nearest dealership within 35 miles (56 km). To obtain reimbursement information, U.S. Ford, Mercury and Lincoln vehicle customers call 1-800-241-3673. Customers will be asked to submit their original receipts.

Canadian customers who need to obtain reimbursement information, call 1-800-665-2006.

HAZARD FLASHER CONTROL

The hazard flasher is located on the steering column, just behind the steering wheel. The hazard flashers will operate when the ignition is in any position or if the key is not in the ignition.

Press in the flasher control and all front and rear direction signals will flash. Press the flasher control again to turn them off. Use it when your vehicle is disabled and is creating a safety hazard for other motorists.

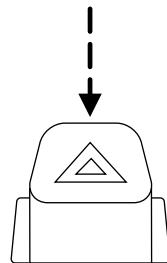

Roadside Emergencies

Note: With extended use, the flasher may run down your battery.

FUEL PUMP SHUT-OFF SWITCH

This device stops the electric fuel pump from sending fuel to the engine when your vehicle has had a substantial jolt.

After an accident, if the engine cranks but does not start, this switch may have been activated.

The fuel pump shut-off switch is located on the right side of the passenger footwell, behind the fuse panel door.

To reset the switch:

1. Turn the ignition off.
2. Check the fuel system for leaks.
3. If no leaks are apparent, reset the switch by pressing the reset button.
4. Turn the ignition on.
5. Wait a few seconds and return the key to off.
6. Make another check for leaks.

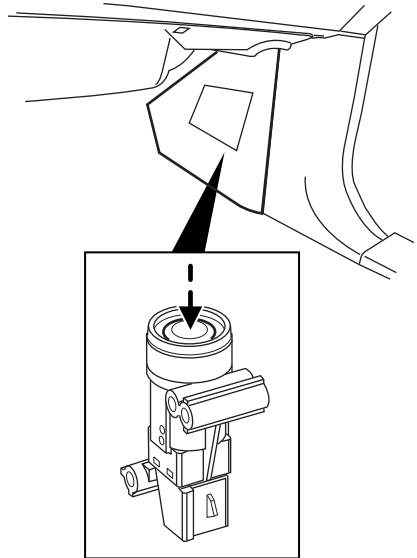

FUSES AND RELAYS

Fuses

If electrical components in the vehicle are not working, a fuse may have blown. Blown fuses are identified by a broken wire within the fuse. Check the appropriate fuses before replacing any electrical components.

Note: Always replace a fuse with one that has the specified amperage rating. Using a fuse with a higher amperage rating can cause severe wire damage and could start a fire.

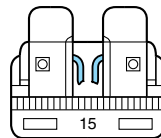

Roadside Emergencies

Standard fuse amperage rating and color

COLOR					
Fuse rating	Mini fuses	Standard fuses	Maxi fuses	Cartridge maxi fuses	Fuse link cartridge
2A	Grey	Grey	—	—	—
3A	Violet	Violet	—	—	—
4A	Pink	Pink	—	—	—
5A	Tan	Tan	—	—	—
7.5A	Brown	Brown	—	—	—
10A	Red	Red	—	—	—
15A	Blue	Blue	—	—	—
20A	Yellow	Yellow	Yellow	Blue	Blue
25A	Natural	Natural	—	—	—
30A	Green	Green	Green	Pink	Pink
40A	—	—	Orange	Green	Green
50A	—	—	Red	Red	Red
60A	—	—	Blue	Yellow	Yellow
70A	—	—	Tan	—	Brown
80A	—	—	Natural	Black	Black

Passenger compartment fuse panel

The fuse panel is located under the right-hand side of the instrument panel, behind the kick panel. A fuse puller tool is located near the lower right corner of the fuse box; this tool will assist you in pulling the fuses out for inspection, if necessary.

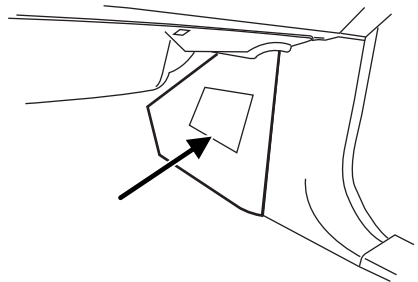

Roadside Emergencies

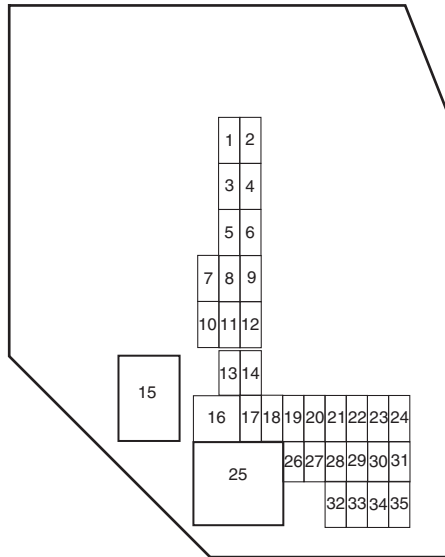

The fuses are coded as follows:

Fuse/Relay Location	Fuse Amp Rating	Passenger Compartment Fuse Panel Description
1	5A	Instrument panel dimmer switch
2	10A	Trailer tow park lamps
3	10A	Right low beam headlamp
4	10A	Left low beam headlamp
5	5A	Windshield wiper module (RUN/ACCY)
6	10A	Radio (RUN/ACCY), Door switch illumination
7	5A	Anti-lock brake system (ABS) (roll stability control)

Roadside Emergencies

Fuse/Relay Location	Fuse Amp Rating	Passenger Compartment Fuse Panel Description
8	10A	Restraints control module (RCM), Passenger airbag deactivation indicator (PADI), Occupant classification sensor (OCS)
9	5A	Cluster air bag indicator
10	10A	Cluster (RUN/START), 4x4 module (RUN/START)
11	10A	Passenger compartment fuse panel (Logic power)
12	15A	Satellite radio
13	15A	Horn, Interior lamps
14	15A	High beam headlamp, High beam indicator (cluster)
15	—	Not used
16	30A cartridge fuse	Power windows
17	15A	Turn signals/Hazards
18	—	Not used
19	20A	Center high-mounted stop lamp (CHMSL)/Stop lamps
20	10A	ABS module, Speed control module, Back-up lamps, Overdrive cancel switch, Electronic flasher (turn)
21	5A	Starter relay coil
22	5A	Radio (START)
23	30A	Headlamps (low and high beam)
24	20A	Radio battery feed (B+)
25	—	Accessory relay (power windows)
26	2A	Redundant cruise switch
27	10A	Climate control blower relay/blend doors

Roadside Emergencies

Fuse/Relay Location	Fuse Amp Rating	Passenger Compartment Fuse Panel Description
28	15A	4x4 module battery feed (B+)
29	20A	Cigar lighter, Diagnostic connector (OBD II)
30	5A	Power mirrors
31	20A	Front park lamps, Rear park lamps, License plate lamps, Dimmer switch, Trailer tow park lamps
32	5A	Brake switch (logic)
33	5A	Instrument cluster battery feed (B+)
34	20A	Power point
35	15A	Power locks

Power distribution box

The power distribution box is located in the engine compartment. The power distribution box contains high-current fuses that protect your vehicle's main electrical systems from overloads.

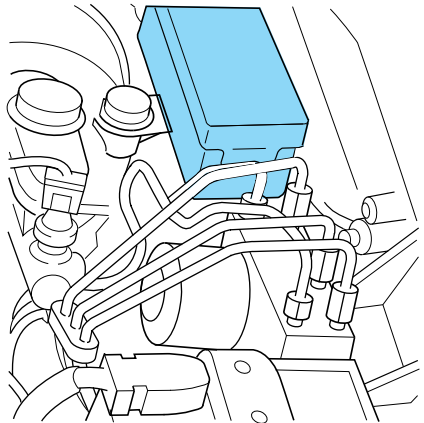

WARNING: Always disconnect the battery before servicing high current fuses.

Roadside Emergencies



WARNING: To reduce risk of electrical shock, always replace the cover to the Power Distribution Box before reconnecting the battery or refilling fluid reservoirs.

If the battery has been disconnected and reconnected, refer to the *Battery* section of the *Maintenance and Specifications* chapter.

2.3L engine (if equipped)

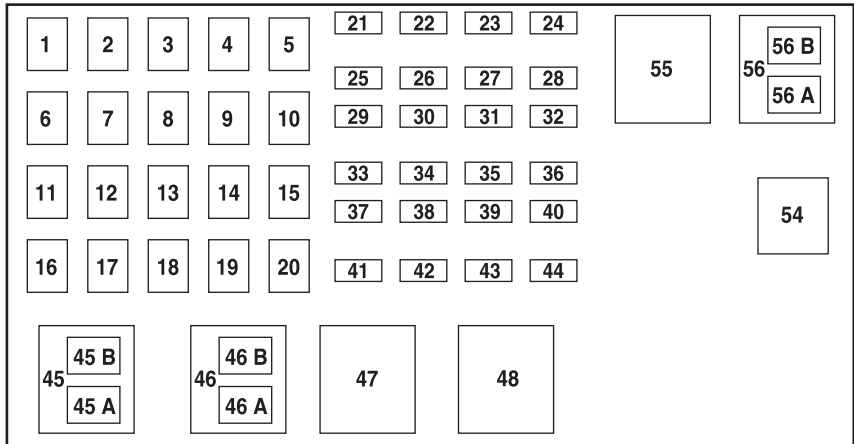

The high-current fuses are coded as follows:

Fuse/Relay Location	Fuse Amp Rating	Power Distribution Box Description
1	40A**	Passenger compartment fuse panel
2	—	Not used
3	40A**	Passenger compartment fuse panel
4	—	Not used
5	50A**	Passenger compartment fuse panel
6	—	Not used

Roadside Emergencies

Fuse/Relay Location	Fuse Amp Rating	Power Distribution Box Description
7	30A**	Starter solenoid
8	—	Not used
9	40A**	Ignition switch
10	—	Not used
11	30A**	Powertrain control module (PCM) relay
12	—	Not used
13	30A**	Blower motor (climate control)
14	—	Not used
15	—	Not used
16	—	Not used
17	40A**	Anti-lock brake system (ABS) module
18	—	Not used
19	20A**	Engine fan
20	—	Not used
21	10A*	PCM keep alive power, Canister purge valve solenoid
22	—	Not used
23	30A*	Fuel pump motor, Fuel injectors
24	—	Not used
25	10A*	A/C clutch solenoid
26	—	Not used
27	—	Not used
28	—	Not used
29	30A*	Wipers/washer
30	—	Not used
31	15A*	Fog lamps
32	—	Not used
33	30A*	Anti-lock brake system (ABS) module
34	—	Not used

Roadside Emergencies

Fuse/Relay Location	Fuse Amp Rating	Power Distribution Box Description
35	—	Not used
36	—	Not used
37	—	Not used
38	7.5A*	Trailer tow (right turn)
39	15A*	PCM power
40	—	Not used
41	10A*	Automatic transmission
42	7.5A*	Trailer tow (left turn)
43	20A*	Engine fan relay coil, A/C relay coil, IAC, Mass air flow sensor, Heated exhaust gas oxygen sensor, Catalyst module sensor, Vapor management valve solenoid
44	15A*	Ignition coil, Capacitor
45A	—	Not used
45B	—	Not used
46A	—	Fuel pump relay, Fuel injectors relay
46B	—	Not used
47	—	Engine fan relay
48	—	Starter relay
49	—	Not used
50	—	Not used
51	—	Not used
52	—	Not used
53	—	Not used
54	—	PCM relay
55	—	Blower relay
56A	—	A/C clutch solenoid relay
56B	—	Fog lamp relay

* Mini Fuses ** Maxi Fuses

Roadside Emergencies

4.0L engines (if equipped)

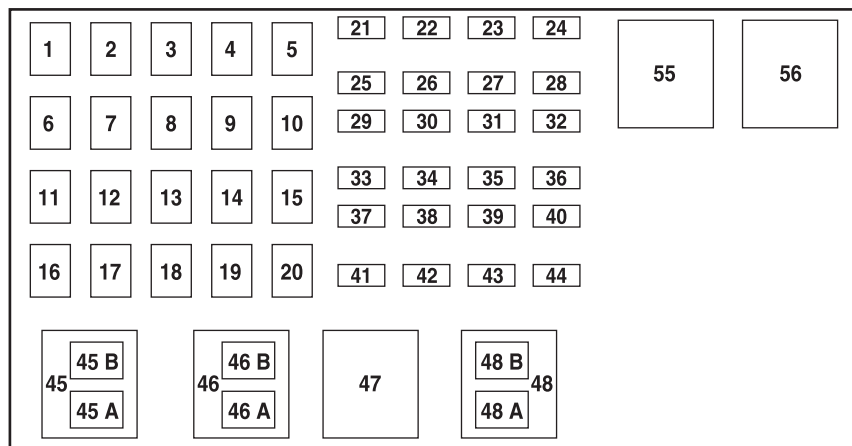

The high-current fuses are coded as follows:

Fuse/Relay Location	Fuse Amp Rating	Protected Circuits
1	40A**	Passenger compartment fuse panel
2	—	Not used
3	40A**	Passenger compartment fuse panel
4	—	Not used
5	50A**	Passenger compartment fuse panel
6	—	Not used
7	30A**	Starter solenoid
8	—	Not used
9	40A**	Ignition switch
10	—	Not used
11	30A**	Powertrain control module (PCM) relay
12	—	Not used
13	30A**	Blower motor (climate control)
14	—	Not used

Roadside Emergencies

Fuse/Relay Location	Fuse Amp Rating	Protected Circuits
15	—	Not used
16	—	Not used
17	40A**	Anti-lock brake system (ABS) module
18	—	Not used
19	—	Not used
20	—	Not used
21	10A*	PCM keep alive power, Canister purge valve solenoid
22	—	Not used
23	30A*	Fuel pump motor, Fuel injectors
24	—	Not used
25	10A*	A/C clutch solenoid
26	—	Not used
27	20A*	4x4 module
28	—	Not used
29	30A*	Wipers/washer
30	—	Not used
31	15A*	Fog lamps
32	—	Not used
33	30A*	ABS module
34	—	Not used
35	—	Not used
36	—	Not used
37	—	Not used
38	7.5A*	Trailer tow (right turn)
39	15A*	PCM power
40	—	Not used
41	10A*	Automatic transmission
42	7.5A*	Trailer tow (left turn)

Roadside Emergencies

Fuse/Relay Location	Fuse Amp Rating	Protected Circuits
43	20A*	A/C relay coil, IAC, Mass air flow sensor, Heated exhaust gas oxygen sensor, Catalyst module sensor, Vapor management valve solenoid, EGR solenoid, Heated PCV
44	15A*	Ignition coil, Capacitor
45A	—	Not used
45B	—	Not used
46A	—	A/C clutch solenoid
46B	—	Not used
47	—	PCM relay
48A	—	Fuel pump relay, Fuel injectors relay
48B	—	Fog lamp relay
51	—	Not used
52	—	Not used
53	—	Not used
54	—	Not used
55	—	Blower relay
56	—	Starter relay
* Mini Fuses ** Maxi Fuses		

CHANGING THE TIRES

If you get a flat tire while driving, do not apply the brake heavily. Instead, gradually decrease your speed. Hold the steering wheel firmly and slowly move to a safe place on the side of the road.

Note: The tire pressure monitoring system (TPMS) indicator light will illuminate when the spare tire is in use. To restore the full functionality of the monitoring system, all road wheels equipped with tire pressure monitoring sensors must be mounted on the vehicle.

Have a flat serviced by an authorized dealer in order to prevent damage to the TPMS sensors, refer to *Tire pressure monitoring system (TPMS)* in the *Tires, Wheels and Loading* chapter. Replace the spare tire with a road tire as soon as possible. During repairing or replacing of the flat tire, have the authorized dealer inspect the TPMS sensor for damage.

Roadside Emergencies



WARNING: The use of tire sealants may damage your tire pressure monitoring system and should not be used.



WARNING: Refer to *Tire pressure monitoring system (TPMS)* in the *Tires, Wheels and Loading* chapter for important information. If the tire pressure monitor sensor becomes damaged, it will no longer function.

Dissimilar spare tire/wheel information



WARNING: Failure to follow these guidelines could result in an increased risk of loss of vehicle control, injury or death.

If you have a dissimilar spare tire/wheel, then it is intended for temporary use only. This means that if you need to use it, you should replace it as soon as possible with a road tire/wheel that is the same size and type as the road tires and wheels that were originally provided by Ford. If the dissimilar spare tire or wheel is damaged, it should be replaced rather than repaired.

A dissimilar spare tire/wheel is defined as a spare tire and/or wheel that is different in brand, size or appearance from the road tires and wheels and can be one of three types:

1. **T-type mini-spares:** This spare tire begins with the letter “T” for tire size and may have “Temporary Use Only” molded in the sidewall
2. **Full-size dissimilar spare with label on wheel:** This spare tire has a label on the wheel that states: “THIS TIRE AND WHEEL FOR TEMPORARY USE ONLY”

When driving with one of the dissimilar spare tires listed above, **do not:**

- Exceed 50 mph (80 km/h)
- Load the vehicle beyond maximum vehicle load rating listed on the Safety Compliance Label
- Tow a trailer
- Use snow chains on the end of the vehicle with the dissimilar spare tire
- Use more than one dissimilar spare tire at a time
- Use commercial car washing equipment
- Try to repair the dissimilar spare tire

Roadside Emergencies

Use of one of the dissimilar spare tires listed above at any one wheel location can lead to impairment of the following:

- Handling, stability and braking performance
- Comfort and noise
- Ground clearance and parking at curbs
- Winter weather driving capability
- Wet weather driving capability

3. Full-size dissimilar spare without label on wheel

When driving with the full-size dissimilar spare tire/wheel, **do not:**

- Exceed 70 mph (113 km/h)
- Use more than one dissimilar spare tire/wheel at a time
- Use commercial car washing equipment
- Use snow chains on the end of the vehicle with the dissimilar spare tire/wheel

The usage of a full-size dissimilar spare tire/wheel can lead to impairment of the following:

- Handling, stability and braking performance
- Comfort and noise
- Ground clearance and parking at curbs
- Winter weather driving capability
- Wet weather driving capability
- All-Wheel driving capability (if applicable)
- Load leveling adjustment (if applicable)

When driving with the full-size dissimilar spare tire/wheel additional caution should be given to:

- Towing a trailer
- Driving vehicles equipped with a camper body
- Driving vehicles with a load on the cargo rack

Drive cautiously when using a full-size dissimilar spare tire/wheel and seek service as soon as possible.

Roadside Emergencies

Stopping and securing the vehicle

1. Park on a level surface, activate hazard flashers and place gearshift lever in P (Park) (automatic transmission) or 1 (First) (manual transmission).
2. Set the parking brake and turn engine OFF.

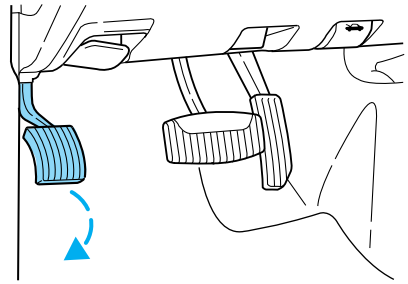

Location of the spare tire and tools

Note: The tire pressure monitoring system (TPMS) indicator light will illuminate when the spare is in use. To restore the full functionality of the TPMS system, all road wheels equipped with the tire pressure monitoring sensors must be mounted on the vehicle.

Have a flat tire serviced by an authorized dealer in order to prevent damage to the TPMS sensor, refer to *Tire pressure monitoring system (TPMS)* in the *Tires, Wheels and Loading* chapter. Replace the spare tire with a road tire as soon as possible.

The spare tire and tools for your vehicle are stowed in the following locations:

Tool	Location
Spare tire	Under the vehicle, just forward of the rear bumper
Jack, jack handle, wheel nut wrench	Regular Cab: behind the passenger seat, underneath the jack and tools cover on the floor
	SuperCab: stowed in the passenger side rear cab under the plastic tray inside the storage bin or behind the jump seat in a separate tool bag
	Four-door models: stowed behind the front seats, between jump seats and underneath jack and tools cover. The lug wrench is held in place with a wingnut.
Key, spare tire lock (if equipped)	In the glove box

Roadside Emergencies

Removing the spare tire or spare tire and tether (if equipped)

1. Assemble the jack handle to the lug wrench as shown in the illustrations.

When connecting the jack handle, assemble the following:

- One handle extension and one typical extension. To assemble, slide parts together. To disconnect, press the button and pull apart.
- One wheel nut wrench. Press the button and slide together.

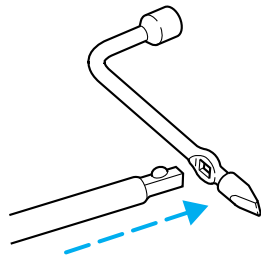
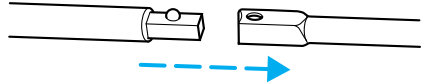

2. If equipped, unlock and remove the spare tire carrier lock from the rear access hole located just above the rear bumper and below the tailgate.

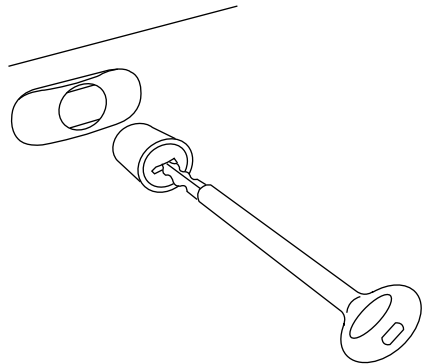

Roadside Emergencies

3. Insert the square end of the jack handle into the rear access hole located just above the rear bumper and below the tailgate.

Forward motion will stop and resistance to turning will be felt when properly engaged.

4. Turn the handle counterclockwise until tire is lowered to the ground and the cable is slightly slack.

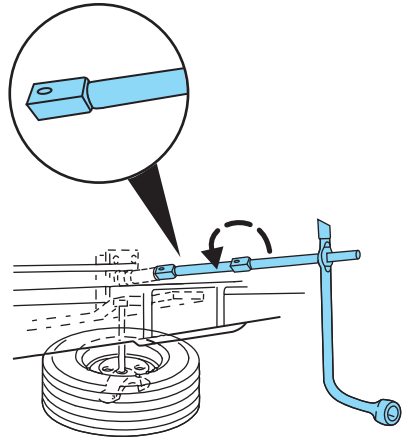

5. With the spare tire on the ground, remove the retainer from the spare tire.

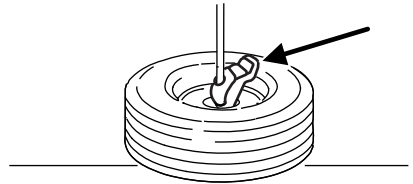

If equipped with a tether, perform the following additional steps:

6. Lift the spare tire on end to access tether attachment.

7. Use the lug wrench to remove the lug nut from the spare tire tether.

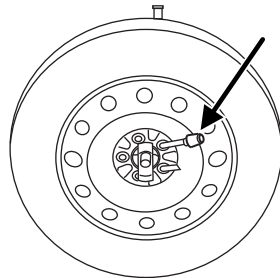

8. If not replacing the spare or flat tire to the underbody storage area, raise the wheel retainer up into the installed position.

Roadside Emergencies

9. Use the attached fastener strap (on spare tire tether) to attach the tether end to the winch retainer prior to raising to the installed position.

Tire change procedure



WARNING: When one of the front wheels is off the ground, the transmission alone will not prevent the vehicle from moving or slipping off the jack, even if the vehicle is in P (Park) (automatic transmission) or R (Reverse) (manual transmission).



WARNING: To help prevent the vehicle from moving when you change a tire, be sure the parking brake is set, then block (in both directions) the wheel that is diagonally opposite (other side and end of the vehicle) to the tire being changed.



WARNING: If the vehicle slips off the jack, you or someone else could be seriously injured.



WARNING: Do not attempt to change a tire on the side of the vehicle close to moving traffic. Pull far enough off the road to avoid the danger of being hit when operating the jack or changing the wheel.

Note: Passengers should not remain in the vehicle when the vehicle is being jacked.

1. Block the diagonally opposite wheel.

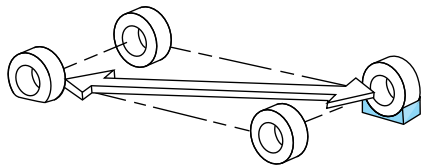

Roadside Emergencies

2. Insert tapered end of the lug wrench behind hub caps and twist them off.

3. Loosen each wheel lug nut one-half turn counterclockwise but do not remove them until the wheel is raised off the ground.

4. Position the jack according to the following guides and turn the jack handle clockwise until the tire is a maximum of 1 inch (25 mm) off the ground.

- Front

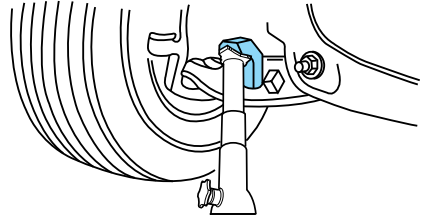
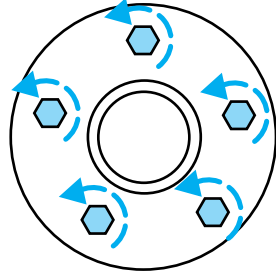

- Rear

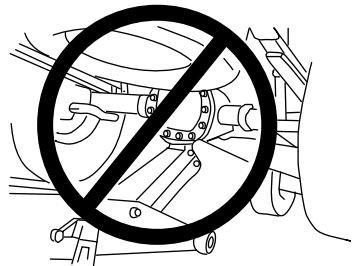
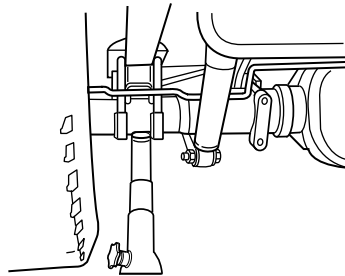

Roadside Emergencies



WARNING: To lessen the risk of personal injury, do not put any part of your body under the vehicle while changing a tire. Do not start the engine when your vehicle is on the jack. The jack is only meant for changing the tire.

- **Never use the differential as a jacking point.**

5. Remove the wheel lug nuts with the lug wrench.
6. Replace the flat tire with the spare tire, making sure the valve stem is facing outward. Reinstall the lug nuts until the wheel is snug against the hub. Do not fully tighten the lug nuts until the wheel has been lowered.
7. Lower the wheel by turning the jack handle counterclockwise.
8. Remove the jack and fully tighten the lug nuts, in the order shown. Refer to *Wheel lug nut torque specifications* later in this chapter for the proper lug nut torque specification.
9. Stow the flat tire. Refer to *Stowing the flat/spare tire*.
10. Stow the jack and lug wrench. Make sure the jack is fastened so it does not rattle when you drive.
11. Unblock the wheels.

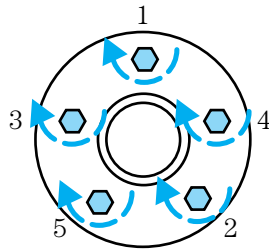

Stowing the flat/spare tire

Note: Failure to follow spare tire stowage instructions may result in failure of cable or loss of spare tire.

Roadside Emergencies

If you are stowing a tire that requires reattaching it to the vehicle with a tether, perform these steps first, then proceed with the steps following.

1. Place the tire on end with the valve stem facing rearward, away from the vehicle.
2. Place the tether into the bolt holes in the wheel and attach the lug nut using the lug wrench.

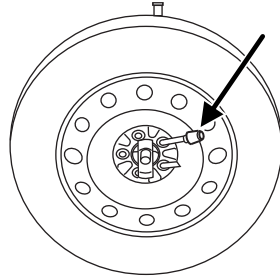

3. Lay the tire on the ground with the valve stem facing up.
4. Slide the wheel partially under the vehicle and install the wire and retainer through the center of the wheel.
5. Turn the jack handle clockwise until the tire is raised to its original position underneath the vehicle. The effort to turn the jack handle increases significantly as the tire contacts the frame. The spare tire carrier will ratchet when the tire is in the fully stowed position. The spare tire carrier has a built-in ratchet feature that will not allow you to overtighten. If the spare tire carrier ratchets with very little effort, take the vehicle to your authorized dealer for assistance at your earliest convenience.
6. Check that the tire lies flat against the frame assembly. Push against the tire to make sure it is tightly seated under the vehicle. Loosen and retighten, if necessary. Failure to properly stow the spare tire may result in failure of the winch cable and loss of the spare tire.
7. Repeat this tightness check procedure when servicing the spare tire pressure (every six months, per *scheduled maintenance information*), or at any time that the spare tire is disturbed through service of other components.
8. Install the spare tire lock (if equipped) into the access hole above the rear bumper with the spare tire lock key (if equipped) and jack handle.

Roadside Emergencies

WHEEL LUG NUT TORQUE SPECIFICATIONS

Retighten the lug nuts to the specified torque within 100 miles (160 km) after any wheel disturbance (rotation, flat tire, wheel removal, etc.).

Lug nut socket size/Bolt size	Wheel lug nut torque*	
	ft-lb	N•m
Lug nut socket size: $\frac{3}{4}$ inch (19 mm) hex Bolt size: $\frac{1}{2}$ x 20	100	135
* Torque specifications are for nut and bolt threads free of dirt and rust. Use only Ford recommended replacement fasteners.		



WARNING: When a wheel is installed, always remove any corrosion, dirt or foreign materials present on the mounting surfaces of the wheel or the surface of the wheel hub, brake drum or brake disc that contacts the wheel. Ensure that any fasteners that attach the rotor to the hub are secured so they do not interfere with the mounting surfaces of the wheel. Installing wheels without correct metal-to-metal contact at the wheel mounting surfaces can cause the wheel nuts to loosen and the wheel to come off while the vehicle is in motion, resulting in loss of control.

Note: Inspect the wheel pilot hole prior to installation. If there is visible corrosion in wheel pilot hole, remove loose particles by wiping with clean rag and apply grease. Apply grease only to the wheel pilot hole surface by smearing a “dime” (1 square cm) sized glob of grease around the wheel pilot surface (1) with end of finger. DO NOT apply grease to lugnut/stud holes or wheel-to-brake surfaces.

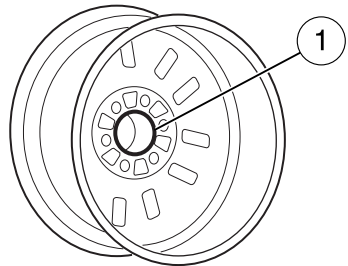

JUMP STARTING



WARNING: The gases around the battery can explode if exposed to flames, sparks, or lit cigarettes. An explosion could result in injury or vehicle damage.

Roadside Emergencies



WARNING: Batteries contain sulfuric acid which can burn skin, eyes and clothing, if contacted.

Do not attempt to push-start your automatic transmission vehicle. Automatic transmissions do not have push-start capability. Attempting to push-start a vehicle with an automatic transmission may cause transmission damage.

Preparing your vehicle

When the battery is disconnected or a new battery is installed, the automatic transmission must relearn its shift strategy. As a result, the transmission may have firm and/or soft shifts. This operation is considered normal and will not affect function or durability of the transmission. Over time, the adaptive learning process will fully update transmission operation.

1. **Use only a 12-volt supply to start your vehicle.**
2. Do not disconnect the battery of the disabled vehicle as this could damage the vehicle's electrical system.
3. Park the booster vehicle close to the hood of the disabled vehicle making sure the two vehicles **do not** touch. Set the parking brake on both vehicles and stay clear of the engine cooling fan and other moving parts.
4. Check all battery terminals and remove any excessive corrosion before you attach the battery cables. Ensure that vent caps are tight and level.
5. Turn the heater fan on in both vehicles to protect from any electrical surges. Turn all other accessories off.

Connecting the jumper cables

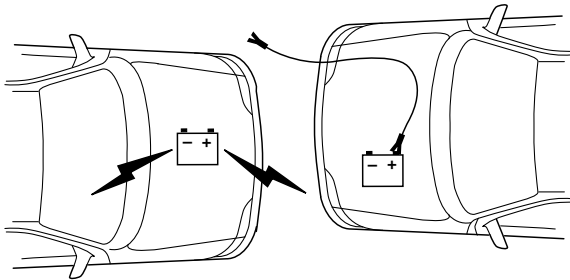

Roadside Emergencies

1. Connect the positive (+) jumper cable to the positive (+) terminal of the discharged battery.

Note: In the illustrations, *lightning bolts* are used to designate the assisting (boosting) battery.

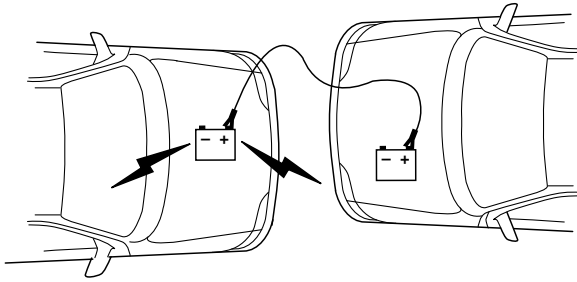

2. Connect the other end of the positive (+) cable to the positive (+) terminal of the assisting battery.

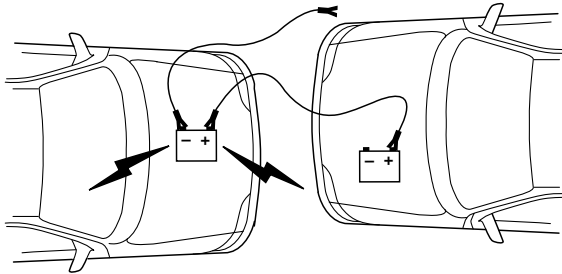

3. Connect the negative (-) cable to the negative (-) terminal of the assisting battery.

Roadside Emergencies

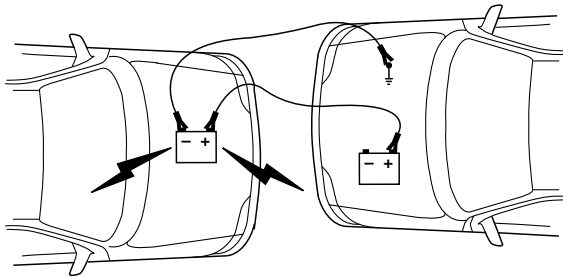

4. Make the final connection of the negative (-) cable to an exposed metal part of the stalled vehicle's engine, away from the battery and the carburetor/fuel injection system.

Note: Do not attach the negative (-) cable to fuel lines, engine rocker covers, the intake manifold or electrical components as *grounding* points.



WARNING: Do not connect the end of the second cable to the negative (-) terminal of the battery to be jumped. A spark may cause an explosion of the gases that surround the battery.

5. Ensure that the cables are clear of fan blades, belts, moving parts of both engines, or any fuel delivery system parts.

Jump starting

1. Start the engine of the booster vehicle and run the engine at moderately increased speed.
2. Start the engine of the disabled vehicle.
3. Once the disabled vehicle has been started, run both engines for an additional three minutes before disconnecting the jumper cables.

Roadside Emergencies

Removing the jumper cables

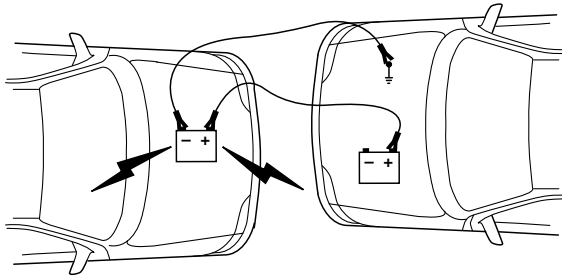

Remove the jumper cables in the reverse order that they were connected.

1. Remove the jumper cable from the *ground* metal surface.

Note: In the illustrations, *lightning bolts* are used to designate the assisting (boosting) battery.

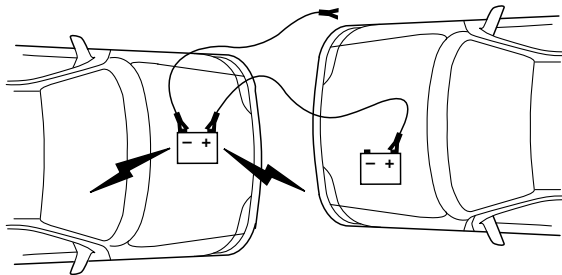

2. Remove the jumper cable on the negative (-) connection of the booster vehicle's battery.

Roadside Emergencies

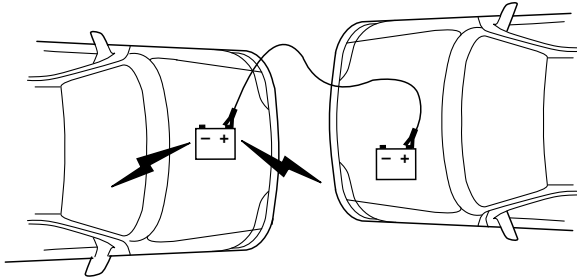

3. Remove the jumper cable from the positive (+) terminal of the booster vehicle's battery.

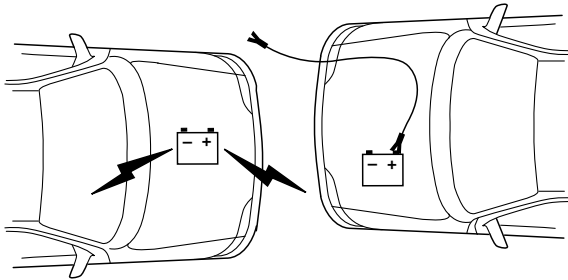

4. Remove the jumper cable from the positive (+) terminal of the disabled vehicle's battery.

After the disabled vehicle has been started and the jumper cables removed, allow it to idle for several minutes so the engine computer can *relearn* its idle conditions.

Roadside Emergencies

WRECKER TOWING

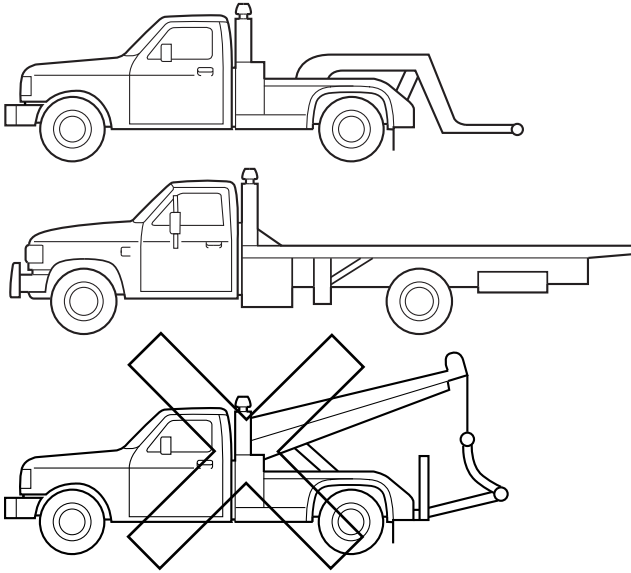

If you need to have your vehicle towed, contact a professional towing service or, if you are a member of a roadside assistance program, your roadside assistance service provider.

It is recommended that your vehicle be towed with a wheel lift or flatbed equipment. Do not tow with a slingbelt. Ford Motor Company has not approved a slingbelt towing procedure.

On 4x2 vehicles, it is acceptable to tow the vehicle with the front wheels on the ground and the rear wheels off the ground.

On 4x4 vehicles, it is recommended that your vehicle be towed with a wheel lift and dollies or flatbed equipment with all the wheels off the ground.

Roadside Emergencies

If the vehicle is towed by other means or incorrectly, vehicle damage may occur.

Ford Motor Company produces a towing manual for all authorized tow truck operators. Have your tow truck operator refer to this manual for proper hook-up and towing procedures for your vehicle.

Emergency towing

In case of a roadside emergency with a disabled vehicle (without access to wheel dollies, car hauling trailer, or flatbed transport vehicle) your vehicle (regardless of transmission powertrain configuration) can be flat towed (all wheels on the ground) under the following conditions:

- Vehicle is facing forward so that it is being towed in a forward direction.
- Place the transmission in N (Neutral). Refer to *Brake-shift interlock* in the *Driving* chapter for specific instructions if you cannot move the gear shift lever into N (Neutral).
- Maximum speed is not to exceed 35 mph (56 km/h).
- Maximum distance is 50 miles (80 km).

Customer Assistance

GETTING THE SERVICES YOU NEED

Warranty repairs to your vehicle must be performed by an authorized Ford, Lincoln, or Mercury dealer. While any authorized dealer handling your vehicle line will provide warranty service, we recommend you return to your selling authorized dealer who wants to ensure your continued satisfaction.

Please note that certain warranty repairs require special training and/or equipment, so not all authorized dealers are authorized to perform all warranty repairs. This means that, depending on the warranty repair needed, you may have to take your vehicle to another authorized dealer.

A reasonable time must be allowed to perform a repair after taking your vehicle to the authorized dealer. Repairs will be made using Ford or Motorcraft® parts, or remanufactured or other parts that are authorized by Ford.

Away from home

If you are away from home when your vehicle needs service, contact the Ford Customer Relationship Center or use the online resources listed below to find the nearest authorized dealer.

In the United States:

Mailing address

Ford Motor Company
Customer Relationship Center
P.O. Box 6248
Dearborn, MI 48121

Telephone

1-800-392-3673 (FORD)
(TDD for the hearing impaired: 1-800-232-5952)

Online

Additional information and resources are available online at www.genuineservice.com.

- U.S. dealer locator by Dealer Name, City/State, or Zip Code
- Owner Guides
- Maintenance Schedules
- Recalls
- Ford Extended Service Plans
- Ford Genuine Accessories
- Service specials and promotions.

In Canada:

Mailing address (Ford vehicles)

Customer Relationship Centre
Ford Motor Company of Canada, Limited
P.O. Box 2000
Oakville, Ontario L6J 5E4

Telephone

1-800-565-3673 (FORD)

Online

www.ford.ca

Mailing address (Lincoln vehicles)

Lincoln Centre
Ford Motor Company of Canada, Limited
P.O. Box 2000
Oakville, Ontario L6J 5E4

Telephone

1-800-387-9333

Online

www.lincolncanada.com

Additional assistance

If you have questions or concerns, or are unsatisfied with the service you are receiving, follow these steps:

1. Contact your Sales Representative or Service Advisor at your selling/servicing authorized dealer.
2. If your inquiry or concern remains unresolved, contact the Sales Manager, Service Manager or Customer Relations Manager.
3. If you require assistance or clarification on Ford Motor Company policies, please contact the Ford Customer Relationship Center

In order to help you serve you better, please have the following information available when contacting a Customer Relationship Center:

- Vehicle Identification Number (VIN)
- Your telephone number (home and business)
- The name of the authorized dealer and city where located
- The vehicle's current odometer reading

In some states, you must directly notify Ford in writing before pursuing remedies under your state's warranty laws. Ford is also allowed a final repair attempt in some states.

Customer Assistance

In the United States, a warranty dispute must be submitted to the BBB AUTO LINE before taking action under the Magnuson-Moss Warranty Act, or to the extent allowed by state law, before pursuing replacement or repurchase remedies provided by certain state laws. This dispute handling procedure is not required prior to enforcing state created rights or other rights which are independent of the Magnuson-Moss Warranty Act or state replacement or repurchase laws.

IN CALIFORNIA (U.S. ONLY)

California Civil Code Section 1793.2(d) requires that, if a manufacturer or its representative is unable to repair a motor vehicle to conform to the vehicle's applicable express warranty after a reasonable number of attempts, the manufacturer shall be required to either replace the vehicle with one substantially identical or repurchase the vehicle and reimburse the buyer in an amount equal to the actual price paid or payable by the consumer (less a reasonable allowance for consumer use). The consumer has the right to choose whether to receive a refund or replacement vehicle.

California Civil Code Section 1793.22(b) presumes that the manufacturer has had a reasonable number of attempts to conform the vehicle to its applicable express warranties if, within the first 18 months of ownership of a new vehicle or the first 18,000 miles (29,000 km), whichever occurs first:

1. Two or more repair attempts are made on the same non-conformity likely to cause death or serious bodily injury OR
2. Four or more repair attempts are made on the same nonconformity (a defect or condition that substantially impairs the use, value or safety of the vehicle) OR
3. The vehicle is out of service for repair of nonconformities for a total of more than 30 calendar days (not necessarily all at one time)

In the case of 1 or 2 above, the consumer must also notify the manufacturer of the need for the repair of the nonconformity at the following address:

Ford Motor Company
16800 Executive Plaza Drive
Mail Drop 3NE-B
Dearborn, MI 48126

THE BETTER BUSINESS BUREAU (BBB) AUTO LINE PROGRAM (U.S. ONLY)

Your satisfaction is important to Ford Motor Company and to your dealer. If a warranty concern has not been resolved using the three-step

Customer Assistance

procedure outlined on the first page of the *Customer Assistance* section, you may be eligible to participate in the BBB AUTO LINE program.

The BBB AUTO LINE program consists of two parts – mediation and arbitration. During mediation, a representative of the BBB will contact both you and Ford Motor Company to explore options for settlement of the claim. If an agreement is not reached during mediation and your claim is eligible, you may participate in the arbitration process. An arbitration hearing will be scheduled so that you can present your case in an informal setting before an impartial person. The arbitrator will consider the testimony provided and make a decision after the hearing.

You are not bound by the decision, but should you choose to accept the BBB AUTO LINE decision, Ford must abide by the accepted decision as well. Disputes submitted to the BBB AUTO LINE program are usually decided within forty days after you file your claim with the BBB.

BBB AUTO LINE Application: Using the information provided below, please call or write to request a program application. You will be asked for your name and address, general information about your new vehicle, information about your warranty concerns, and any steps you have already taken to try to resolve them. A Customer Claim Form will be mailed that will need to be completed, signed and returned to the BBB along with proof of ownership. Upon receipt, the BBB will review the claim for eligibility under the Program Summary Guidelines.

You can get more information by calling BBB AUTO LINE at 1-800-955-5100, or writing to:

**BBB AUTO LINE
4200 Wilson Boulevard, Suite 800
Arlington, Virginia 22203-1833**

BBB AUTO LINE applications can also be requested by calling the Ford Motor Company Customer Relationship Center at 1-800-392-3673.

Note: Ford Motor Company reserves the right to change eligibility limitations, modify procedures, or to discontinue this process at any time without notice and without obligation.

UTILIZING THE MEDIATION/ARBITRATION PROGRAM (CANADA ONLY)

For vehicles delivered to authorized Canadian dealers. In those cases where you continue to feel that the efforts by Ford of Canada and the authorized dealer to resolve a factory-related vehicle service concern have been unsatisfactory, Ford of Canada participates in an impartial third party mediation/arbitration program administered by the Canadian Motor Vehicle Arbitration Plan (CAMVAP).

Customer Assistance

The CAMVAP program is a straight forward and relatively speedy alternative to resolve a disagreement when all other efforts to produce a settlement have failed. This procedure is without cost to you and is designed to eliminate the need for lengthy and expensive legal proceedings.

In the CAMVAP program, impartial third-party arbitrators conduct hearings at mutually convenient times and places in an informal environment. These impartial arbitrators review the positions of the parties, make decisions and, when appropriate, render awards to resolve disputes. CAMVAP decisions are fast, fair, and final as the arbitrator's award is binding to both you and Ford of Canada.

CAMVAP services are available in all territories and provinces. For more information, without charge or obligation, call your CAMVAP Provincial Administrator directly at 1-800-207-0685.

GETTING ASSISTANCE OUTSIDE THE U.S. AND CANADA

Before exporting your vehicle to a foreign country, contact the appropriate foreign embassy or consulate. These officials can inform you of local vehicle registration regulations and where to find unleaded fuel.

If you cannot find unleaded fuel or can only get fuel with an anti-knock index lower than is recommended for your vehicle, contact a regional office or owner relations/customer relationship office.

The use of leaded fuel in your vehicle without proper conversion may damage the effectiveness of your emission control system and may cause engine knocking or serious engine damage. Ford Motor Company/Ford of Canada is not responsible for any damage caused by use of improper fuel. Using leaded fuel may also result in difficulty importing your vehicle back into the U.S.

If your vehicle must be serviced while you are traveling or living in Central America, the Caribbean, or the Middle East, contact the nearest authorized dealer. If the authorized dealer cannot help you, contact:

FORD MOTOR COMPANY
FORD EXPORT OPERATIONS
1555 Fairlane Drive
Fairlane Business Park #3
Allen Park, Michigan 48101
U.S.A.
Telephone: (313) 594-4857
FAX: (313) 390-0804
Email: expcac@ford.com

Customer Assistance

If you are in another foreign country, contact the nearest authorized dealer. If the authorized dealer employees cannot help you, they can direct you to the nearest Ford affiliate office.

If you buy your vehicle in North America and then relocate outside of the U.S. or Canada, register your vehicle identification number (VIN) and new address with Ford Motor Company Export Operations.

Customers in the U.S. should call 1-800-392-3673.

ORDERING ADDITIONAL OWNER'S LITERATURE

To order the publications in this portfolio, contact Helm, Incorporated at:

HELM, INCORPORATED
P.O. Box 07150
Detroit, Michigan 48207

Or to order a free publication catalog, call toll free: 1-800-782-4356

Monday-Friday 8:00 a.m. - 6:00 p.m. EST

Helm, Incorporated can also be reached by their website:
www.helminc.com.

(Items in this catalog may be purchased by credit card, check or money order.)

Obtaining a French Owner's Guide

French Owner's Guides can be obtained from your authorized dealer or by writing to:

Ford Motor Company of Canada, Limited
Service Publications CHQ202
The Canadian Road
P.O. Box 2000
Oakville, ON, Canada
L6J 5E4

Customer Assistance

REPORTING SAFETY DEFECTS (U.S. ONLY)

If you believe that your vehicle has a defect which could cause a crash or could cause injury or death, you should immediately inform the National Highway Traffic Safety Administration (NHTSA) in addition to notifying Ford Motor Company.



If NHTSA receives similar complaints, it may open an investigation, and if it finds that a safety defect exists in a group of vehicles, it may order a recall and remedy campaign. However, NHTSA cannot become involved in individual problems between you, your dealer, or Ford Motor Company.

To contact NHTSA, you may call the Vehicle Safety Hotline toll-free at 1-888-327-4236 (TTY: 1-800-424-9153); go to <http://www.safercar.gov>; or write to:

Administrator
1200 New Jersey Avenue, Southeast
Washington, D.C. 20590

You can also obtain other information about motor vehicle safety from <http://www.safercar.gov>.

REPORTING SAFETY DEFECTS (CANADA ONLY)

If you believe that your vehicle has a defect which could cause a crash or could cause injury or death, you should immediately inform Transport Canada, using their toll-free number: 1-800-333-0510.

WASHING THE EXTERIOR

Wash your vehicle regularly with cool or lukewarm water and a neutral pH shampoo, such as Motorcraft® Detail Wash (ZC-3-A), which is available from your authorized dealer.

- Never use strong household detergents or soap, such as dish washing or laundry liquid. These products can discolor and spot painted surfaces.
- Never wash a vehicle that is “hot to the touch” or during exposure to strong, direct sunlight.
- Always use a clean sponge or car wash mitt with plenty of water for best results.
- Dry the vehicle with a chamois or soft terry cloth towel in order to eliminate water spotting.
- It is especially important to wash the vehicle regularly during the winter months, as dirt and road salt are difficult to remove and cause damage to the vehicle.
- Immediately remove items such as gasoline, diesel fuel, bird droppings and insect deposits because they can cause damage to the vehicle's paintwork and trim over time. Use Motorcraft® Bug and Tar Remover (ZC-42), which is available from your authorized dealer.
- Remove any exterior accessories, such as antennas, before entering a car wash.
- **Suntan lotions and insect repellents can damage any painted surface; if these substances come in contact with your vehicle, wash off as soon as possible.**
- **If your vehicle is equipped with running boards, do not use rubber, plastic and vinyl protectant products on the running board surface, as the area may become slippery.**

Exterior chrome

- Wash the vehicle first, using cool or lukewarm water and a neutral pH shampoo, such as Motorcraft® Detail Wash (ZC-3-A).
- Use Motorcraft® Custom Bright Metal Cleaner (ZC-15), available from your authorized dealer. Apply the product as you would a wax to clean bumpers and other chrome parts; allow the cleaner to dry for a few minutes, then wipe off the haze with a clean, dry rag.
- **Never use abrasive materials such as steel wool or plastic pads as they can scratch the chrome surface.**

Cleaning

WAXING

- Wash the vehicle first.
- Do not use waxes that contain abrasives; use Motorcraft® Premium Liquid Wax (ZC-53-A), which is available from your authorized dealer, or an equivalent quality product.
- Do not allow paint sealant to come in contact with any non-body (low-gloss black) colored trim, such as grained door handles, roof racks, bumpers, side moldings, mirror housings or the windshield cowl area. The paint sealant will “gray” or stain the parts over time.

PAINT CHIPS

Your authorized dealer has touch-up paint to match your vehicle’s color. Take your color code (printed on a sticker in the driver’s door jamb) to your authorized dealer to ensure you get the correct color.

- Remove particles such as bird droppings, tree sap, insect deposits, tar spots, road salt and industrial fallout before repairing paint chips.
- Always read the instructions before using the products.

ALUMINUM WHEELS AND WHEEL COVERS

Aluminum wheels and wheel covers are coated with a clearcoat paint finish. In order to maintain their shine:

- Clean weekly with Motorcraft® Wheel and Tire Cleaner (ZC-37-A), which is available from your authorized dealer. Heavy dirt and brake dust accumulation may require agitation with a sponge. Rinse thoroughly with a strong stream of water.
- Never apply any cleaning chemical to hot or warm wheel rims or covers.
- Some automatic car washes may cause damage to the finish on your wheel rims or covers. Chemical-strength cleaners, or cleaning chemicals, in combination with brush agitation to remove brake dust and dirt, could wear away the clearcoat finish over time.
- Do not use hydrofluoric acid-based or high caustic-based wheel cleaners, steel wool, fuels or strong household detergent.
- To remove tar and grease, use Motorcraft® Bug and Tar Remover (ZC-42), available from your authorized dealer.

ENGINE

Engines are more efficient when they are clean because grease and dirt buildup keep the engine warmer than normal. When washing:

- Take care when using a power washer to clean the engine. The high-pressure fluid could penetrate the sealed parts and cause damage.
- Do not spray a hot engine with cold water to avoid cracking the engine block or other engine components.
- Spray Motorcraft Engine Shampoo and Degreaser (ZC-20) on all parts that require cleaning and pressure rinse clean. In Canada use Motorcraft Engine Shampoo (CXC-66-A).
- Never wash or rinse the engine while it is running; water in the running engine may cause internal damage.
- Never wash or rinse any ignition coil, spark plug wire or spark plug well, or the area in and around these locations.
- Cover the highlighted areas to prevent water damage when cleaning the engine.

2.3L I4 ENGINE

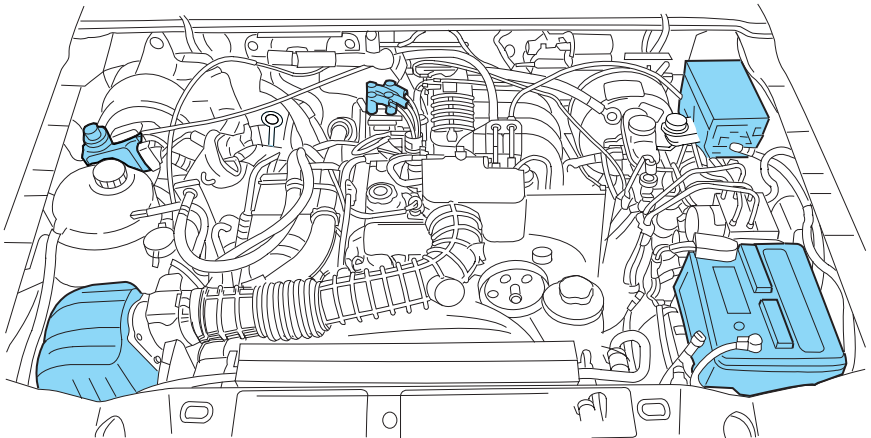

Cleaning

4.0L V6 ENGINE

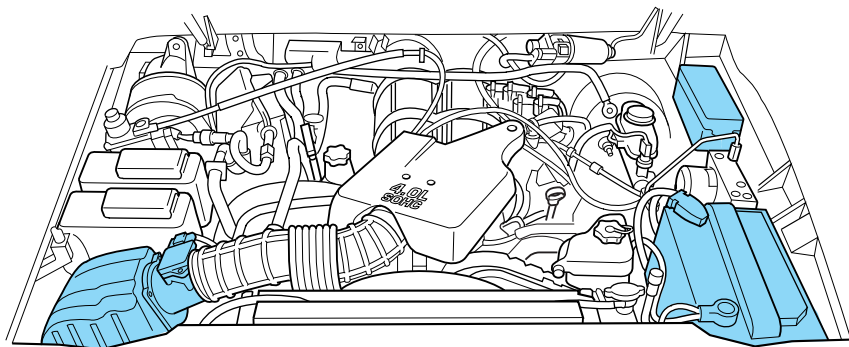

PLASTIC (NON-PAINTED) EXTERIOR PARTS

Use only approved products to clean plastic parts. These products are available from your authorized dealer.

- For routine cleaning, use Motorcraft® Detail Wash (ZC-3-A).
- If tar or grease spots are present, use Motorcraft® Bug and Tar Remover (ZC-42).

WINDOWS AND WIPER BLADES

The windshield, rear and side windows and the wiper blades should be cleaned regularly. If the wipers do not wipe properly, substances on the vehicle's glass or the wiper blades may be the cause. These may include hot wax treatments used by commercial car washes, water repellent coatings, tree sap, or other organic contamination; these contaminants may cause squeaking or chatter noise from the blades, and streaking and smearing of the windshield. To clean these items, follow these tips:

- The windshield, rear windows and side windows may be cleaned with a non-abrasive cleaner such as Motorcraft® Ultra-Clear Spray Glass Cleaner (ZC-23) in the U.S., or Premium Quality Windshield Washer Fluid [CXC-37-(A, B, D, or F)] in Canada, available from your authorized dealer.
- The wiper blades can be cleaned with isopropyl (rubbing) alcohol or Motorcraft® Premium Windshield Washer Concentrate (ZC-32-A), available from your authorized dealer. This washer fluid contains special solution in addition to alcohol which helps to remove the hot wax deposited on the wiper blade and windshield from automated car

wash facilities. Be sure to replace wiper blades when they appear worn or do not function properly.

- Do not use abrasives, as they may cause scratches.
- Do not use fuel, kerosene, or paint thinner to clean any parts.

If you cannot remove those streaks after cleaning with the glass cleaner or if the wipers chatter and move in a jerky motion, clean the outer surface of the windshield and the wiper blades using a sponge or soft cloth with a neutral detergent or mild-abrasive cleaning solution. After cleaning, rinse the windshield and wiper blades with clean water. The windshield is clean if beads do not form when you rinse the windshield with water.

INSTRUMENT PANEL/INTERIOR TRIM AND CLUSTER LENS

Clean the instrument panel, interior trim areas and cluster lens with a clean, damp, white cotton cloth, then use a clean and dry white cotton cloth to dry these areas.

- Avoid cleaners or polishes that increase the gloss of the upper portion of the instrument panel. The dull finish in this area helps protect the driver from undesirable windshield reflection.
- Be certain to wash or wipe your hands clean if you have been in contact with certain products such as insect repellent and suntan lotion in order to avoid possible damage to the interior painted surfaces.
- Do not use household or glass cleaners as these may damage the finish of the instrument panel, interior trim and cluster lens.



WARNING: Do not use chemical solvents or strong detergents when cleaning the steering wheel or instrument panel to avoid contamination of the airbag system.

If a staining liquid like coffee/juice has been spilled on the instrument panel or on interior trim surfaces, clean as follows:

1. Wipe up spilled liquid using a clean, white, cotton cloth.
2. Wipe the surface with a damp, clean, white cotton cloth. For more thorough cleaning, use a mild soap and water solution. If the spot cannot be completely cleaned by this method, the area may be cleaned using a commercially available cleaning product designed for automotive interiors.
3. If necessary, apply more soap and water solution or cleaning product to a clean, white, cotton cloth and press the cloth onto the soiled area—allow this to set at room temperature for 30 minutes.

Cleaning

4. Remove the soaked cloth, and if it is not soiled badly, use this cloth to clean the area by using a rubbing motion for 60 seconds.
5. Following this, wipe area dry with a clean, white, cotton cloth.

INTERIOR

For fabric, carpets, cloth seats and safety belts:

- Remove dust and loose dirt with a vacuum cleaner.
- Remove light stains and soil with Motorcraft® Professional Strength Carpet & Upholstery Cleaner (ZC-54).
- If grease or tar is present on the material, spot-clean the area first with Motorcraft® Spot and Stain Remover (ZC-14). In Canada, use Motorcraft® Multi-Purpose Cleaner (CXC-101).
- If a ring forms on the fabric after spot cleaning, clean the entire area immediately (but do not oversaturate) or the ring will set.
- Do not use household cleaning products or glass cleaners, which can stain and discolor the fabric and affect the flame retardant abilities of the seat materials.



WARNING: Do not use cleaning solvents, bleach or dye on the vehicle's seatbelts, as these actions may weaken the belt webbing.

LEATHER SEATS (IF EQUIPPED)

Your leather seating surfaces have a clear, protective coating over the leather.

- For routine cleaning, wipe the surface with a soft, damp cloth. For more thorough cleaning, wipe the surface with a mild soap and water solution. In Canada, use Motorcraft® Vinyl Cleaner (CXC-93). Dry the area with a soft cloth.
- If the leather cannot be completely cleaned using a mild soap and water solution, the leather may be cleaned using a commercially available cleaning product designed for automotive leather.
- Do not use household cleaning products, alcohol solutions, solvents or cleaners intended for rubber, vinyl and plastics, or oil/petroleum-based leather conditioners. These products may cause premature wearing of the clear, protective coating.

Note: In some instances, color or dye transfer can occur when wet clothing comes in contact with leather upholstery. If this occurs, the leather should be cleaned immediately to avoid permanent staining.

UNDERBODY

Flush the complete underside of your vehicle frequently. Keep body and door drain holes free from packed dirt.

FORD AND LINCOLN MERCURY CAR CARE PRODUCTS

Your Ford or Lincoln Mercury authorized dealer has many quality products available to clean your vehicle and protect its finishes. These quality products have been specifically engineered to fulfill your automotive needs; they are custom designed to complement the style and appearance of your vehicle. Each product is made from high quality materials that meet or exceed rigid specifications. For best results, use the following products or products of equivalent quality:

Motorcraft® Bug and Tar Remover (ZC-42)

Motorcraft® Custom Bright Metal Cleaner (ZC-15)

Motorcraft® Custom Clear Coat Polish (ZC-8-A)

Motorcraft® Detail Wash (ZC-3-A)

Motorcraft® Dusting Cloth (ZC-24)

Motorcraft® Engine Shampoo and Degreaser (U.S. only) (ZC-20)

Motorcraft® Engine Shampoo (Canada only) (CXC-66-A)

Motorcraft® Multi-Purpose Cleaner (Canada only) (CXC-101)

Motorcraft® Premium Glass Cleaner (Canada only) (CXC-100)

Motorcraft® Premium Liquid Wax (ZC-53-A)

Motorcraft® Premium Windshield Washer Concentrate (U.S. only) (ZC-32-A)

Motorcraft® Professional Strength Carpet & Upholstery Cleaner (ZC-54)

Motorcraft® Spot and Stain Remover (U.S. only) (ZC-14)

Motorcraft® Tire Clean and Shine (ZC-28)

Motorcraft® Ultra-Clear Spray Glass Cleaner (ZC-23)

Motorcraft® Vinyl Cleaner (Canada only) (CXC-93)

Motorcraft® Wheel and Tire Cleaner (ZC-37-A)

Maintenance and Specifications

SERVICE RECOMMENDATIONS

To help you service your vehicle, we provide *scheduled maintenance information* which makes tracking routine service easy.

If your vehicle requires professional service, your authorized dealer can provide the necessary parts and service. Check your *Warranty Guide/Customer Information Guide* to find out which parts and services are covered.

Use only recommended fuels, lubricants, fluids and service parts conforming to specifications. Motorcraft® parts are designed and built to provide the best performance in your vehicle.

PRECAUTIONS WHEN SERVICING YOUR VEHICLE

- Do not work on a hot engine.
- Make sure that nothing gets caught in moving parts.
- Do not work on a vehicle with the engine running in an enclosed space, unless you are sure you have enough ventilation.
- Keep all open flames and other burning material (such as cigarettes) away from the battery and all fuel related parts.

Working with the engine off

1. For vehicles equipped with an automatic transmission, set the parking brake and shift to P (Park). For vehicles equipped with a manual transmission, set the parking brake, press and hold the clutch pedal, place the gearshift in 1 (First), and release the clutch pedal.
2. Turn off the engine and remove the key.
3. Block the wheels.

Maintenance and Specifications

Working with the engine on

1. For vehicles equipped with an automatic transmission, set the parking brake and shift to P (Park). For vehicles equipped with a manual transmission, set the parking brake, press and hold the clutch pedal, place the gearshift in N (Neutral), and release the clutch pedal.
2. Block the wheels.



WARNING: To reduce the risk of vehicle damage and/or personal burn injuries, do not start your engine with the air cleaner removed and do not remove it while the engine is running.

OPENING THE HOOD

1. Inside the vehicle, pull the hood release handle located under the bottom of the instrument panel near the steering column.
2. Go to the front of the vehicle and release the auxiliary latch that is located under the front center of the hood.
3. Lift the hood and support it with the prop rod.

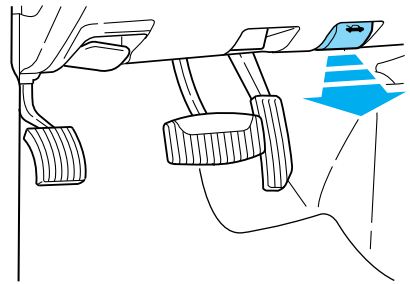

Maintenance and Specifications

IDENTIFYING COMPONENTS IN THE ENGINE COMPARTMENT

2.3L I4 engine

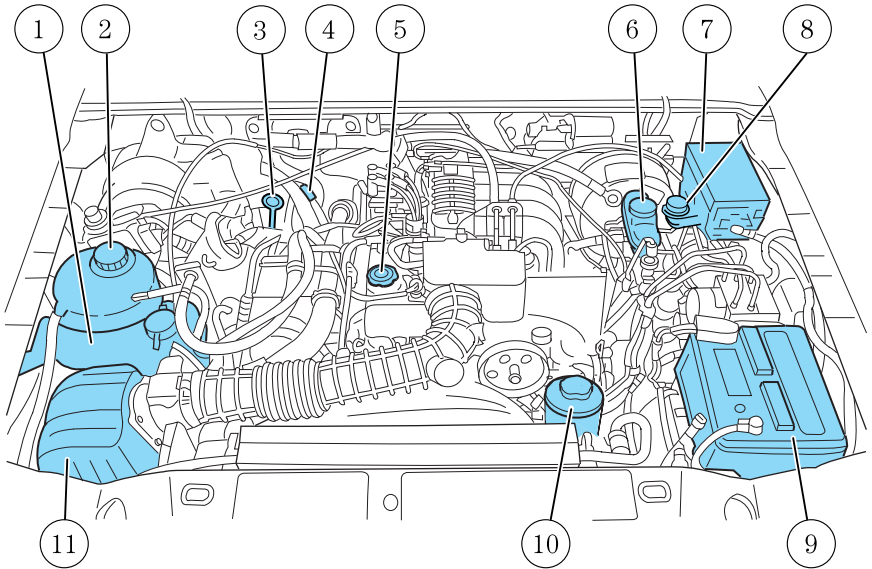

1. Windshield washer fluid reservoir
2. Engine coolant reservoir
3. Engine oil dipstick
4. Transmission fluid dipstick (automatic transmission)
5. Engine oil filler cap
6. Brake fluid reservoir
7. Power distribution box
8. Clutch fluid reservoir (manual transmission)
9. Battery
10. Power steering fluid reservoir
11. Air filter assembly

Maintenance and Specifications

4.0L V6 engine

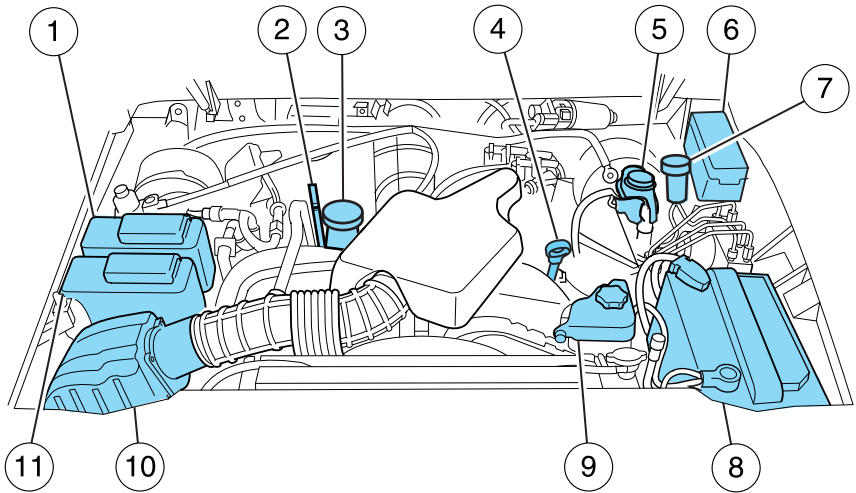

1. Windshield washer fluid reservoir
2. Transmission fluid dipstick (automatic transmission)
3. Engine oil filler cap
4. Engine oil dipstick
5. Brake fluid reservoir
6. Power distribution box
7. Clutch fluid reservoir (manual transmission)
8. Battery
9. Power steering fluid reservoir
10. Air filter assembly
11. Engine coolant reservoir

Maintenance and Specifications

WINDSHIELD WASHER FLUID

- 2.3L engine

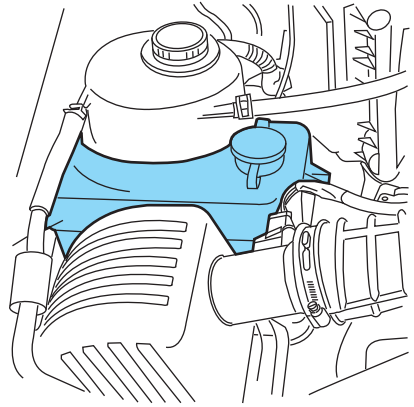

- 4.0L engine

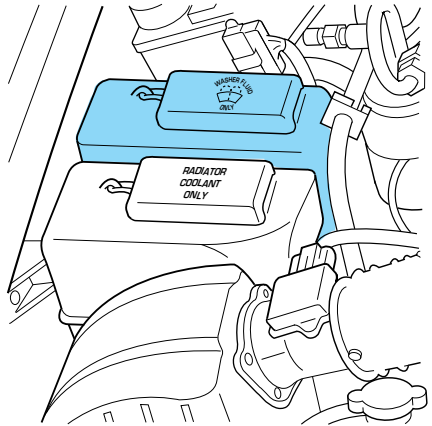

Add fluid to fill the reservoir if the level is low. In very cold weather, do not fill the reservoir completely.

Only use a washer fluid that meets Ford specifications. Do not use any special washer fluid such as windshield water repellent type fluid or bug wash. They may cause squeaking, chatter noise, streaking and smearing. Refer to the *Maintenance product specifications and capacities* section in this chapter.

State or local regulations on volatile organic compounds may restrict the use of methanol, a common windshield washer antifreeze additive.

Maintenance and Specifications

Washer fluids containing non-methanol antifreeze agents should be used only if they provide cold weather protection without damaging the vehicle's paint finish, wiper blades or washer system.



WARNING: If you operate your vehicle in temperatures below 40°F (5°C), use washer fluid with antifreeze protection. Failure to use washer fluid with antifreeze protection in cold weather could result in impaired windshield vision and increase the risk of injury or accident.

Note: Do not put washer fluid in the engine coolant reservoir. Washer fluid placed in the cooling system may harm engine and cooling system components.

CHANGING THE WIPER BLADES

1. Pull the wiper arm away from the vehicle. Turn the blade at an angle from the wiper arm. Press the lock tab to release the blade and pull the wiper blade down toward the windshield to remove it from the arm.

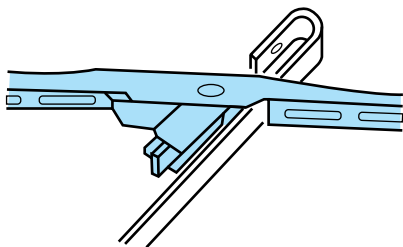

2. Attach the new wiper to the wiper arm and press it into place until a click is heard.

Replace wiper blades at least once per year for optimum performance.

Poor wiper quality can be improved by cleaning the wiper blades and the windshield. Refer to *Windows and wiper blades* in the *Cleaning* chapter.

To prolong the life of the wiper blades, it is highly recommended to scrape off the ice on the windshield before turning on the wipers. The layer of ice has many sharp edges and can damage the micro edge of the wiper rubber element.

ENGINE OIL

Checking the engine oil

Refer to *scheduled maintenance information* for the appropriate intervals for checking the engine oil.

1. Make sure the vehicle is on level ground.

Maintenance and Specifications

2. Turn the engine off and wait 15 minutes for the oil to drain into the oil pan.
 3. Set the parking brake and ensure the gearshift is securely latched in P (Park) (automatic transmission) or 1 (First) (manual transmission).
 4. Open the hood. Protect yourself from engine heat.
 5. Locate and carefully remove the engine oil level dipstick.
- 2.3L I4 engine

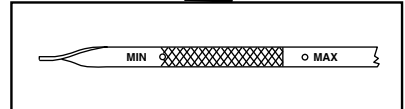
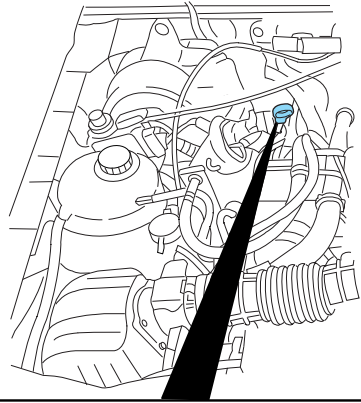

- 4.0L V6 engine

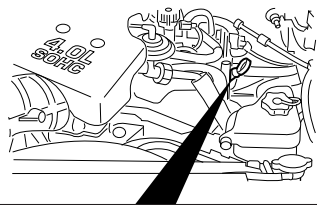

6. Wipe the dipstick clean. Insert the dipstick fully, then remove it again.
- If the oil level is **between the two holes or between the MIN and MAX marks (depending on application)**, the oil level is acceptable, **DO NOT ADD OIL.**

Maintenance and Specifications

- If the oil level is below the lower hole or the MIN mark, add enough oil to raise the level between the two holes or between the MIN-MAX range.
- 2.3L I4 engine

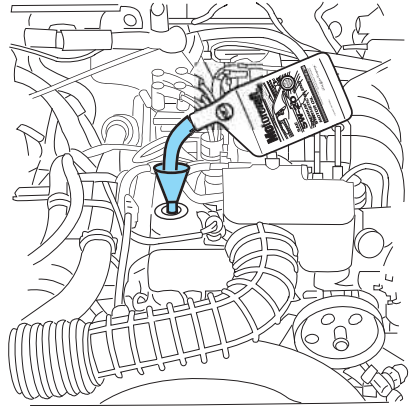

- 4.0L V6 engine

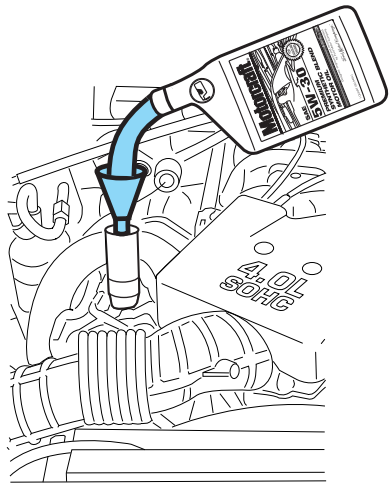

- Oil levels above the upper hole or MAX mark may cause engine damage. Some oil must be removed from the engine by an authorized dealer.

Maintenance and Specifications

7. Put the dipstick back in and ensure it is fully seated.

Adding engine oil

1. Check the engine oil. For instructions, refer to *Checking the engine oil* in this chapter.
2. If the engine oil level is not within the normal range, add only certified engine oil of the recommended viscosity. Remove the engine oil filler cap and use a funnel to pour the engine oil into the opening.
3. Recheck the engine oil level. Make sure the oil level is within the normal range on the engine oil level dipstick.
4. Install the dipstick and ensure it is fully seated.
5. Fully install the engine oil filler cap by turning the filler cap 1/4 turn until it stops.

To avoid possible oil loss, DO NOT operate the vehicle with the engine oil level dipstick and/or the engine oil filler cap removed.

Engine oil recommendations

2.3L engine

Look for this certification trademark.

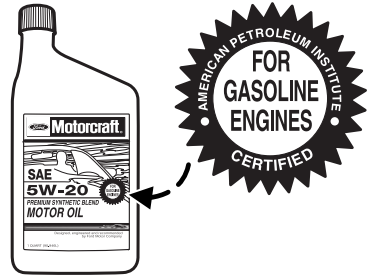

Use SAE 5W-20 engine oil

Only use oils certified for gasoline engines by the American Petroleum Institute (API). An oil with this trademark symbol conforms to the current engine and emission system protection standards and fuel economy requirements of the International Lubricant Standardization and Approval Committee (ILSAC), comprised of U.S. and Japanese automobile manufacturers.

To protect your engine and engine's warranty, use Motorcraft® SAE 5W-20 or an equivalent SAE 5W-20 oil meeting Ford specification WSS-M2C930-A. **SAE 5W-20 oil provides optimum fuel economy and durability performance meeting all requirements for your vehicle's engine.**

Maintenance and Specifications

Do not use supplemental engine oil additives, cleaners or other engine treatments. They are unnecessary and could lead to engine damage that is not covered by Ford warranty.

Change your engine oil according to the appropriate schedule listed in the *scheduled maintenance information*.

Ford production and Motorcraft® replacement oil filters are designed for added engine protection and long life. If a replacement oil filter is used that does not meet Ford material and design specifications, start-up engine noises or knock may be experienced.

It is recommended you use the appropriate Motorcraft® oil filter or another with equivalent performance for your engine application.

4.0L engine

Look for this certification trademark.

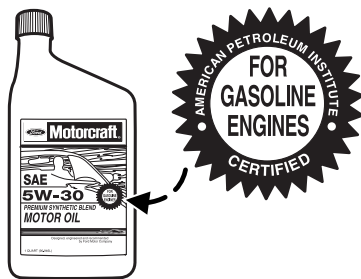

Use SAE 5W-30 engine oil

Only use oils “Certified For Gasoline Engines” by the American Petroleum Institute (API). An oil with this trademark symbol conforms to the current engine and emission system protection standards and fuel economy requirements of the International Lubricant Standardization and Approval Committee (ILSAC), comprised of U.S. and Japanese automobile manufacturers.

To protect your engine and engine’s warranty, use Motorcraft® SAE 5W-30 or an equivalent SAE 5W-30 oil meeting Ford specification WSS-M2C929-A.

Do not use supplemental engine oil additives, cleaners or other engine treatments. They are unnecessary and could lead to engine damage that is not covered by Ford warranty.

Change your engine oil according to the appropriate schedule listed in the *scheduled maintenance information*.

Ford production and Motorcraft® replacement oil filters are designed for added engine protection and long life. If a replacement oil filter is used

Maintenance and Specifications

that does not meet Ford material and design specifications, start-up engine noises or knock may be experienced.

It is recommended you use the appropriate Motorcraft® oil filter or another with equivalent performance for your engine application.

BATTERY

Your vehicle is equipped with a Motorcraft® maintenance-free battery which normally does not require additional water during its life of service.

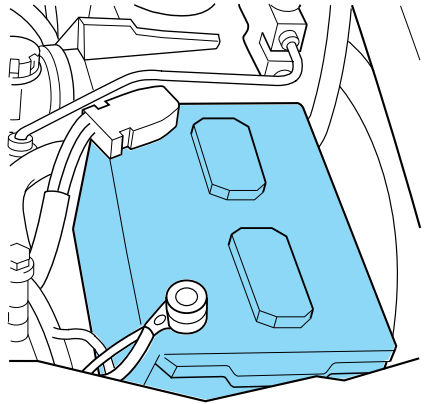

If your battery has a cover/shield, make sure it is reinstalled after the battery has been cleaned or replaced.

For longer, trouble-free operation, keep the top of the battery clean and dry. Also, make certain the battery cables are always tightly fastened to the battery terminals.

If you see any corrosion on the battery or terminals, remove the cables from the terminals and clean with a wire brush. You can neutralize the acid with a solution of baking soda and water.

It is recommended that the negative battery cable terminal be disconnected from the battery if you plan to store your vehicle for an extended period of time. This will minimize the discharge of your battery during storage.

Note: Electrical or electronic accessories or components added to the vehicle by the dealer or the owner may adversely affect battery performance and durability.



WARNING: Batteries normally produce explosive gases which can cause personal injury. Therefore, do not allow flames, sparks or lighted substances to come near the battery. When working near the battery, always shield your face and protect your eyes. Always provide proper ventilation.

Maintenance and Specifications



WARNING: When lifting a plastic-cased battery, excessive pressure on the end walls could cause acid to flow through the vent caps, resulting in personal injury and/or damage to the vehicle or battery. Lift the battery with a battery carrier or with your hands on opposite corners.



WARNING: Keep batteries out of reach of children. Batteries contain sulfuric acid. Avoid contact with skin, eyes or clothing. Shield your eyes when working near the battery to protect against possible splashing of acid solution. In case of acid contact with skin or eyes, flush immediately with water for a minimum of 15 minutes and get prompt medical attention. If acid is swallowed, call a physician immediately.



WARNING: Battery posts, terminals and related accessories contain lead and lead compounds. **Wash hands after handling.**

Because your vehicle's engine is electronically controlled by a computer, some control conditions are maintained by power from the battery. When the battery is disconnected or a new battery is installed, the engine must relearn its idle and fuel trim strategy for optimum driveability and performance. To begin this process:

1. With the vehicle at a complete stop, set the parking brake.
 2. Put the gearshift in P (Park) (automatic transmission) or the neutral position (manual transmission), turn off all accessories and start the engine.
 3. Run the engine until it reaches normal operating temperature.
 4. Allow the engine to idle for at least one minute.
 5. Turn the A/C on and allow the engine to idle for at least one minute.
 6. Drive the vehicle to complete the relearning process.
- The vehicle may need to be driven 10 miles (16 km) or more to relearn the idle and fuel trim strategy.
 - **If you do not allow the engine to relearn its idle trim, the idle quality of your vehicle may be adversely affected until the idle trim is eventually relearned.**

When the battery is disconnected or a new battery installed, the transmission must relearn its adaptive strategy. As a result of this, the

Maintenance and Specifications

transmission may shift firmly. This operation is considered normal and will not affect function or durability of the transmission. Over time the adaptive learning process will fully update transmission operation to its optimum shift feel.

If the battery has been disconnected or a new battery has been installed, the clock and the preset radio stations must be reset once the battery is reconnected.

- Always dispose of automotive batteries in a responsible manner. Follow your local authorized standards for disposal. Call your local authorized recycling center to find out more about recycling automotive batteries.

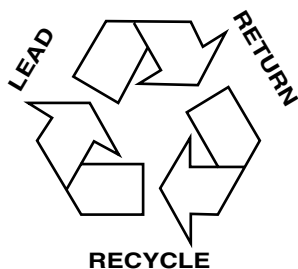

ENGINE COOLANT

Checking engine coolant

The concentration and level of engine coolant should be checked at the intervals listed in the *scheduled maintenance information*. The coolant concentration should be maintained at 50/50 coolant and distilled water, which equates to a freeze point of -34°F (-36°C). Coolant concentration testing is possible with a hydrometer or antifreeze tester. The level of coolant should be maintained at the FULL COLD level or within the COLD FILL RANGE in the coolant reservoir. If the level falls below, add coolant per the instructions in the *Adding engine coolant* section.

Your vehicle was factory-filled with a 50/50 engine coolant and water concentration. If the concentration of coolant falls below 40% or above 60%, the engine parts could become damaged or not work properly. **A 50/50 mixture of coolant and water provides the following:**

- **Freeze protection down to -34°F (-36°C).**
- **Boiling protection up to 265°F (129°C).**
- **Protection against rust and other forms of corrosion.**
- **Enables calibrated gauges to work properly.**

Maintenance and Specifications

- 2.3L engine

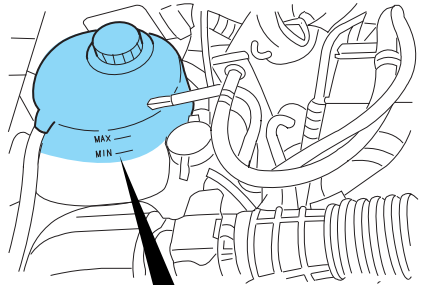

- 4.0L engine

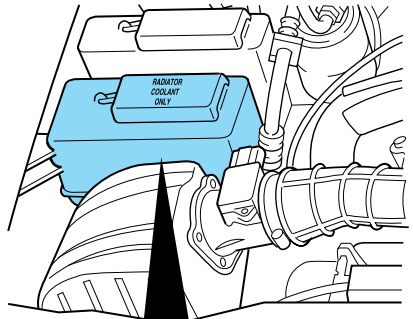

Maintenance and Specifications

When the engine is cold, check the level of the engine coolant in the reservoir.

- The engine coolant should be at the FULL COLD level or within the COLD FILL RANGE as listed on the engine coolant reservoir (depending upon application).
- Refer to the *scheduled maintenance information* for service interval schedules.

If the engine coolant has not been checked at the recommended interval, the engine coolant reservoir may become low or empty. If the reservoir is low or empty, add engine coolant to the reservoir. Refer to *Adding engine coolant* in this chapter.

Note: Automotive fluids are not interchangeable; do not use engine coolant/antifreeze or windshield washer fluid outside of its specified function and vehicle location.

Adding engine coolant

When adding coolant, make sure it is a 50/50 mixture of engine coolant and distilled water. Add the mixture to the coolant reservoir, **when the engine is cool**, until the appropriate fill level is obtained. If coolant is filled to the COLD FILL RANGE or FULL COLD level when the engine is not cool, the system will remain underfilled.



WARNING: Do not add engine coolant when the engine is hot.

Steam and scalding liquids released from a hot cooling system can burn you badly. Also, you can be burned if you spill coolant on hot engine parts.



WARNING: Do not put engine coolant in the windshield washer

fluid container. If sprayed on the windshield, engine coolant could make it difficult to see through the windshield.

- **DO NOT MIX** different colors or types of coolant in your vehicle. Make sure the correct coolant is used. **DO NOT MIX** recycled coolant and new (unused) coolant together in the vehicle. Mixing of engine coolants may harm your engine's cooling system. The use of an improper coolant may harm engine and cooling system components and may void the warranty. Refer to *Maintenance product specifications and capacities* in this chapter.

Note: Do not use stop leak pellets or cooling system sealants/additives as they can cause damage to the engine cooling and/or heating systems. This damage would not be covered under your vehicle's warranty.

Maintenance and Specifications

- A large amount of water without engine coolant may be added, in case of emergency, to reach a vehicle service location. In this instance, the cooling system must be drained and refilled with a 50/50 mixture of engine coolant and distilled water as soon as possible. Water alone (without engine coolant) can cause engine damage from corrosion, overheating or freezing.
- **Do not use alcohol, methanol, brine or any engine coolants mixed with alcohol or methanol antifreeze (coolant).** Alcohol and other liquids can cause engine damage from overheating or freezing.
- **Do not add extra inhibitors or additives to the coolant.** These can be harmful and compromise the corrosion protection of the engine coolant.

For vehicles with overflow coolant systems with a non-pressurized cap on the coolant recovery system, add coolant to the coolant recovery reservoir when the engine is cool. Add the proper mixture of coolant and water to the FULL COLD level. For all other vehicles which have a coolant degas system with a pressurized cap, or if it is necessary to remove the coolant pressure relief cap on the radiator of a vehicle with an overflow system, follow these steps to add engine coolant.

Note: The 4.0L V6 engine uses the overflow system, and the 2.3L I4 engine uses the degas system.



WARNING: To reduce the risk of personal injury, make sure the engine is cool before unscrewing the coolant pressure relief cap. The cooling system is under pressure; steam and hot liquid can come out forcefully when the cap is loosened slightly.

Add the proper mixture of coolant and water to the cooling system by following these steps:

1. Before you begin, turn the engine off and let it cool.
2. When the engine is cool, wrap a thick cloth around the coolant pressure relief cap on the coolant reservoir (a translucent plastic bottle). Slowly turn cap counterclockwise (left) until pressure begins to release.
3. Step back while the pressure releases.
4. When you are sure that all the pressure has been released, use the cloth to turn it counterclockwise and remove the cap.
5. Fill the coolant reservoir slowly with the proper coolant mixture, to within the COLD FILL RANGE or the FULL COLD level on the reservoir.

Maintenance and Specifications

If you removed the radiator cap in an overflow system, fill the radiator until the coolant is visible and radiator is almost full.

6. Replace the cap. Turn until tightly installed. Cap must be tightly installed to prevent coolant loss.

After any coolant has been added, check the coolant concentration (refer to *Checking engine coolant*). If the concentration is not 50/50 (protection to $-34^{\circ}\text{F}/-36^{\circ}\text{C}$), drain some coolant and adjust the concentration. It may take several drains and additions to obtain a 50/50 coolant concentration.

Whenever coolant has been added, the coolant level in the coolant reservoir should be checked the next few times you drive the vehicle. If necessary, add enough 50/50 concentration of engine coolant and distilled water to bring the liquid level to the proper level.

If you have to add more than 1.0 quart (1.0 liter) of engine coolant per month, have your authorized dealer check the engine cooling system. Your cooling system may have a leak. Operating an engine with a low level of coolant can result in engine overheating and possible engine damage.

Recycled engine coolant

Ford Motor Company does NOT recommend the use of recycled engine coolant since a Ford-approved recycling process is not yet available.



Used engine coolant should be disposed of in an appropriate manner. Follow your community's regulations and standards for recycling and disposing of automotive fluids.

Coolant refill capacity

To find out how much fluid your vehicle's cooling system can hold, refer to *Maintenance product specifications and capacities* in this chapter.

Fill your engine coolant reservoir as outlined in *Adding engine coolant* in this section.

Severe climates

If you drive in extremely cold climates (less than -34°F [-36°C]):

- **It may be necessary to increase the coolant concentration above 50%.**
- **NEVER increase the coolant concentration above 60%. Increased engine coolant concentrations above 60% will**

Maintenance and Specifications

decrease the overheat protection characteristics of the engine coolant and may cause engine damage.

- **Refer to the chart on the coolant container to ensure the coolant concentration in your vehicle will provide adequate freeze protection at the temperatures in which you drive in the winter months.**

If you drive in extremely hot climates:

- **It is still necessary to maintain the coolant concentration above 40%.**
- **NEVER decrease the coolant concentration below 40%. Decreased engine coolant concentrations below 40% will decrease the corrosion/freeze protection characteristics of the engine coolant and may cause engine damage.**
- **Refer to the chart on the coolant container to ensure the coolant concentration in your vehicle will provide adequate protection at the temperatures in which you drive.**

Vehicles driven year-round in non-extreme climates should use a 50/50 mixture of engine coolant and distilled water for optimum cooling system and engine protection.

FUEL FILTER

For fuel filter replacement, see your authorized dealer. Refer to *scheduled maintenance information* for the appropriate intervals for changing the fuel filter.

Replace the fuel filter with an authorized Motorcraft® part. The customer warranty may be void for any damage to the fuel system if an authorized Motorcraft® fuel filter is not used.

WHAT YOU SHOULD KNOW ABOUT AUTOMOTIVE FUELS

Important safety precautions



WARNING: Do not overfill the fuel tank. The pressure in an overfilled tank may cause leakage and lead to fuel spray and fire.



WARNING: The fuel system may be under pressure. If the fuel filler cap is venting vapor or if you hear a hissing sound, wait until it stops before completely removing the fuel filler cap. Otherwise, fuel may spray out and injure you or others.

Maintenance and Specifications



WARNING: If you do not use the proper fuel filler cap, excessive vacuum in the fuel tank may damage the fuel system or cause the fuel cap to disengage in a collision, which may result in serious personal injury.



WARNING: Automotive fuels can cause serious injury or death if misused or mishandled.



WARNING: Gasoline may contain benzene, which is a cancer-causing agent.

Observe the following guidelines when handling automotive fuel:

- Extinguish all smoking materials and any open flames before refueling your vehicle.
- Always turn off the vehicle before refueling.
- Automotive fuels can be harmful or fatal if swallowed. Fuel such as gasoline is highly toxic and if swallowed can cause death or permanent injury. If fuel is swallowed, call a physician immediately, even if no symptoms are immediately apparent. The toxic effects of fuel may not be visible for hours.
- Avoid inhaling fuel vapors. Inhaling too much fuel vapor of any kind can lead to eye and respiratory tract irritation. In severe cases, excessive or prolonged breathing of fuel vapor can cause serious illness and permanent injury.
- Avoid getting fuel liquid in your eyes. If fuel is splashed in the eyes, remove contact lenses (if worn), flush with water for 15 minutes and seek medical attention. Failure to seek proper medical attention could lead to permanent injury.
- Fuels can also be harmful if absorbed through the skin. If fuel is splashed on the skin and/or clothing, promptly remove contaminated clothing and wash skin thoroughly with soap and water. Repeated or prolonged skin contact with fuel liquid or vapor causes skin irritation.
- Be particularly careful if you are taking “Antabuse” or other forms of disulfiram for the treatment of alcoholism. Breathing gasoline vapors, or skin contact could cause an adverse reaction. In sensitive individuals, serious personal injury or sickness may result. If fuel is



Maintenance and Specifications

splashed on the skin, promptly wash skin thoroughly with soap and water. Consult a physician immediately if you experience an adverse reaction.

 **WARNING:** When refueling always shut the engine off and never allow sparks or open flames near the filler neck. Never smoke while refueling. Fuel vapor is extremely hazardous under certain conditions. Care should be taken to avoid inhaling excess fumes.

 **WARNING:** The flow of fuel through a fuel pump nozzle can produce static electricity, which can cause a fire if fuel is pumped into an ungrounded fuel container.

Refueling

 **WARNING:** Fuel vapor burns violently and a fuel fire can cause severe injuries. To help avoid injuries to you and others:

- Read and follow all the instructions on the pump island;
- Turn off your engine when you are refueling;
- Do not smoke if you are near fuel or refueling your vehicle;
- Keep sparks, flames and smoking materials away from fuel;
- Stay outside your vehicle and do not leave the fuel pump unattended when refueling your vehicle — this is against the law in some places;
- Keep children away from the fuel pump; never let children pump fuel.
- Do not use a cellphone while refueling.

Use the following guidelines to avoid electrostatic charge build-up when filling an ungrounded fuel container:

- Place approved fuel container on the ground.
- DO NOT fill a fuel container while it is in the vehicle (including the cargo area).
- Keep the fuel pump nozzle in contact with the fuel container while filling.
- DO NOT use a device that would hold the fuel pump handle in the fill position.



Maintenance and Specifications



Fuel filler cap

When fueling your vehicle:

1. Turn the engine off.
2. Carefully turn the fuel filler cap counterclockwise until it spins off.
3. Carefully hang the cap from the tether.
4. To install the cap, place the cap into the filler pipe and rotate until you hear at least one click.

If the check fuel cap light  comes on, the fuel filler cap may not be properly installed. The light can come on after several driving events after you've refueled your vehicle.

At the next opportunity, safely pull off of the road, remove the fuel filler cap, align the cap properly and reinstall it. The check fuel cap light  may not reset immediately; it may take several driving cycles for the check fuel cap light  to turn off. A driving cycle consists of an engine start-up (after four or more hours with the engine off) followed by city and highway driving.

Continuing to drive with the check fuel cap light  on may cause the service engine soon  light to turn on as well.

If you must replace the fuel filler cap, replace it with a fuel filler cap that is designed for your vehicle. The customer warranty may be void for any damage to the fuel tank or fuel system if the correct genuine Ford, Motorcraft or other certified fuel filler cap is not used.



WARNING: The fuel system may be under pressure. If the fuel filler cap is venting vapor or if you hear a hissing sound, wait until it stops before completely removing the fuel filler cap. Otherwise, fuel may spray out and injure you or others.

Maintenance and Specifications



WARNING: If you do not use the proper fuel filler cap, excessive vacuum in the fuel tank may damage the fuel system or cause the fuel cap to disengage in a collision, which may result in personal injury.

FORD RECOMMENDS BP



Choosing the right fuel

Use only UNLEADED fuel or UNLEADED fuel blended with a maximum of 10% ethanol. Do not use fuel ethanol (E85), diesel, methanol, leaded fuel or any other fuel. The use of leaded fuel is prohibited by law and could damage your vehicle.

Your vehicle was not designed to use fuel or fuel additives with metallic compounds, including manganese-based additives.

Note: Use of any fuel other than those recommended may cause powertrain damage, a loss of vehicle performance, and repairs may not be covered under warranty.

Cleaner air

Ford endorses the use of reformulated “cleaner-burning” gasolines to improve air quality, per the recommendations in the *Choosing the right fuel* section.

Octane recommendations

Your vehicle is designed to use “Regular” unleaded gasoline with a pump (R+M)/2 octane rating of 87.

Some stations offer fuels posted as “Regular” with an octane rating

below 87, particularly in high altitude areas. Fuels with octane levels below 87 are not recommended.

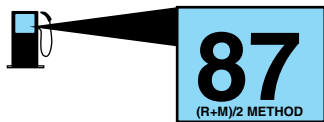

Maintenance and Specifications

Do not be concerned if your engine sometimes knocks lightly. However, if it knocks heavily under most driving conditions while you are using fuel with the recommended octane rating, see your authorized dealer to prevent any engine damage.

Fuel quality

If you are experiencing starting, rough idle or hesitation driveability problems during a cold start, try a different brand of “Regular” unleaded gasoline. Premium unleaded gasoline is not recommended for vehicles designed to use “Regular” unleaded gasoline because it may cause these problems to become more pronounced. If the problems persist, see your authorized dealer.



Do not add aftermarket fuel additive products to your fuel tank. It should not be necessary to add any aftermarket products to your fuel tank if you continue to use high quality fuel of the recommended octane rating. These products have not been approved for your engine and could cause damage to the fuel system. Repairs to correct the effects of using an aftermarket product in your fuel may not be covered by your warranty.

Many of the world’s automakers approved the World-Wide Fuel Charter that recommends gasoline specifications to provide improved performance and emission control system protection for your vehicle. Gasolines that meet the World-Wide Fuel Charter should be used when available. Ask your fuel supplier about gasolines that meet the World-Wide Fuel Charter.

Running out of fuel

Avoid running out of fuel because this situation may have an adverse effect on powertrain components.

If you have run out of fuel:

- You may need to cycle the ignition from off to on several times after refueling to allow the fuel system to pump the fuel from the tank to the engine. On restarting, cranking time will take a few seconds longer than normal.
- Normally, adding 1 gallon (3.8L) of fuel is enough to restart the engine. If the vehicle is out of fuel and on a steep grade, more than 1 gallon (3.8L) may be required.
- The service engine soon  indicator may come on. For more information on the service engine soon  indicator, refer to *Warning lights and chimes* in the *Instrument Cluster* chapter.

Maintenance and Specifications

ESSENTIALS OF GOOD FUEL ECONOMY

Measuring techniques

Your best source of information about actual fuel economy is you, the driver. You must gather information as accurately and consistently as possible. Fuel expense, frequency of fill-ups or fuel gauge readings are NOT accurate as a measure of fuel economy. We do not recommend taking fuel economy measurements during the first 1,000 miles (1,600 km) of driving (engine break-in period). You will get a more accurate measurement after 2,000 miles–3,000 miles (3,000 km–5,000 km).

Filling the tank

The advertised fuel capacity of the fuel tank on your vehicle is equal to the rated refill capacity of the fuel tank as listed in the *Maintenance product specifications and capacities* section of this chapter.

The advertised capacity is the amount of the indicated capacity and the empty reserve combined. Indicated capacity is the difference in the amount of fuel in a full tank and a tank when the fuel gauge indicates empty. Empty reserve is the small amount of fuel remaining in the fuel tank after the fuel gauge indicates empty.

The amount of usable fuel in the empty reserve varies and should not be relied upon to increase driving range. When refueling your vehicle after the fuel gauge indicates empty, you might not be able to refuel the full amount of the advertised capacity of the fuel tank due to the empty reserve still present in the tank.

For consistent results when filling the fuel tank:

- Turn the engine/ignition switch to the off position prior to refueling, an error in the reading will result if the engine is left running.
- Use the same filling rate setting (low — medium — high) each time the tank is filled.
- Allow no more than two automatic click-offs when filling.
- Always use fuel with the recommended octane rating.
- Use a known quality gasoline, preferably a national brand.
- Use the same side of the same pump and have the vehicle facing the same direction each time you fill up.
- Have the vehicle loading and distribution the same every time.

Your results will be most accurate if your filling method is consistent.

Maintenance and Specifications

Calculating fuel economy

1. Fill the fuel tank completely and record the initial odometer reading (in miles or kilometers).
2. Each time you fill the tank, record the amount of fuel added (in gallons or liters).
3. After at least three to five tank fill-ups, fill the fuel tank and record the current odometer reading.
4. Subtract your initial odometer reading from the current odometer reading.
5. Follow one of the simple calculations in order to determine fuel economy:

Calculation 1: **Divide total miles traveled by total gallons used.**

Calculation 2: **Multiply liters used by 100, then divide by total kilometers traveled.**

Keep a record for at least one month and record the type of driving (city or highway). This will provide an accurate estimate of the vehicle's fuel economy under current driving conditions. Additionally, keeping records during summer and winter will show how temperature impacts fuel economy. In general, lower temperatures give lower fuel economy.

Driving style — good driving and fuel economy habits

Give consideration to the lists that follow and you may be able to change a number of variables and improve your fuel economy.

Habits

- Smooth, moderate operation can yield up to 10% savings in fuel.
- Steady speeds without stopping will usually give the best fuel economy.
- Idling for long periods of time (greater than one minute) may waste fuel.
- Anticipate stopping; slowing down may eliminate the need to stop.
- Sudden or hard accelerations may reduce fuel economy.
- Slow down gradually.
- Driving at reasonable speeds (traveling at 55 mph [88 km/h] uses 15% less fuel than traveling at 65 mph [105 km/h]).
- Revving the engine before turning it off may reduce fuel economy.
- Using the air conditioner or defroster may reduce fuel economy.

Maintenance and Specifications

- You may want to turn off the speed control in hilly terrain if unnecessary shifting between the top gears occurs. Unnecessary shifting of this type could result in reduced fuel economy.
- Warming up a vehicle on cold mornings is not required and may reduce fuel economy.
- Resting your foot on the brake pedal while driving may reduce fuel economy.
- Combine errands and minimize stop-and-go driving.

Maintenance

- Keep tires properly inflated and use only recommended size.
- Operating a vehicle with the wheels out of alignment will reduce fuel economy.
- Use recommended engine oil. Refer to *Maintenance product specifications and capacities* in this chapter.
- Perform all regularly scheduled maintenance items. Follow the recommended maintenance schedule and owner maintenance checks found in *scheduled maintenance information*.

Conditions

- Heavily loading a vehicle or towing a trailer may reduce fuel economy at any speed.
- Carrying unnecessary weight may reduce fuel economy (approximately 1 mpg [0.4 km/L] is lost for every 400 lb [180 kg] of weight carried).
- Adding certain accessories to your vehicle (for example bug deflectors, rollbars/light bars, running boards, ski/luggage racks) may reduce fuel economy.
- Using fuel blended with alcohol may lower fuel economy.
- Fuel economy may decrease with lower temperatures during the first 8–10 miles (12–16 km) of driving.
- Driving on flat terrain offers improved fuel economy as compared to driving on hilly terrain.
- Transmissions give their best fuel economy when operated in the top cruise gear and with steady pressure on the gas pedal.
- Four-wheel drive operation (if equipped) is less fuel efficient than two-wheel drive operation.
- Close windows for high speed driving.

Maintenance and Specifications

EPA fuel economy estimates

Every new vehicle should have a sticker on the window called the Monroney Label which contains EPA fuel economy estimates. Contact your authorized dealer if the Monroney Label is not supplied with your vehicle. The EPA fuel economy estimates should be your guide for the fuel economy comparisons with other vehicles. Your fuel economy may vary depending upon the method of operation and conditions.

EMISSION CONTROL SYSTEM

Your vehicle is equipped with various emission control components and a catalytic converter which will enable your vehicle to comply with applicable exhaust emission standards. To make sure that the catalytic converter and other emission control components continue to work properly:

- Use only the specified fuel listed.
- Avoid running out of fuel.
- Do not turn off the ignition while your vehicle is moving, especially at high speeds.
- Have the items listed in *scheduled maintenance information* performed according to the specified schedule.

The scheduled maintenance items listed in *scheduled maintenance information* are essential to the life and performance of your vehicle and to its emissions system.

If other than Ford, Motorcraft® or Ford-authorized parts are used for maintenance replacements or for service of components affecting emission control, such non-Ford parts should be equivalent to genuine Ford Motor Company parts in performance and durability.



WARNING: Do not park, idle, or drive your vehicle in dry grass or other dry ground cover. The emission system heats up the engine compartment and exhaust system, which can start a fire.

Illumination of the service engine soon  indicator, charging system warning light or the temperature warning light, fluid leaks, strange odors, smoke or loss of engine power could indicate that the emission control system is not working properly.

An improperly operating or damaged exhaust system may allow exhaust to enter the vehicle. Have a damaged or improperly operating exhaust system inspected and repaired immediately.

Maintenance and Specifications





WARNING: Exhaust leaks may result in entry of harmful and potentially lethal fumes into the passenger compartment.

Do not make any unauthorized changes to your vehicle or engine. By law, vehicle owners and anyone who manufactures, repairs, services, sells, leases, trades vehicles, or supervises a fleet of vehicles are not permitted to intentionally remove an emission control device or prevent it from working. Information about your vehicle's emission system is on the Vehicle Emission Control Information Decal located on or near the engine. This decal also lists engine displacement.

Please consult your *Warranty Guide/Customer Information Guide* for complete emission warranty information.

On-board diagnostics (OBD-II)

Your vehicle is equipped with a computer that monitors the engine's emission control system. This system is commonly known as the on-board diagnostics system (OBD-II). The OBD-II system protects the environment by ensuring that your vehicle continues to meet government emission standards. The OBD-II system also assists your authorized dealer in properly servicing your vehicle. When the service engine soon  indicator illuminates, the OBD-II system has detected a malfunction. Temporary malfunctions may cause the service engine soon  indicator to illuminate. Examples are:

1. The vehicle has run out of fuel—the engine may misfire or run poorly.
2. Poor fuel quality or water in the fuel—the engine may misfire or run poorly.
3. The fuel cap may not have been securely tightened. See *Fuel filler cap* in this chapter.
4. Driving through deep water—the electrical system may be wet.

These temporary malfunctions can be corrected by filling the fuel tank with good quality fuel, properly tightening the fuel cap or letting the electrical system dry out. After three driving cycles without these or any other temporary malfunctions present, the service engine soon  indicator should stay off the next time the engine is started. A driving cycle consists of a cold engine startup followed by mixed city/highway driving. No additional vehicle service is required.

If the service engine soon  indicator remains on, have your vehicle serviced at the first available opportunity. Although some malfunctions



Maintenance and Specifications

detected by the OBD-II may not have symptoms that are apparent, continued driving with the service engine soon  indicator can result in increased emissions, lower fuel economy, reduced engine and transmission smoothness, and lead to more costly repairs.

Readiness for Inspection/Maintenance (I/M) testing

Some state/provincial and local governments may have Inspection/Maintenance (I/M) programs to inspect the emission control equipment on your vehicle. Failure to pass this inspection could prevent you from getting a vehicle registration. Your vehicle may not pass the I/M test if the service engine soon  indicator is on or not working properly (bulb is burned out), or if the OBD-II system has determined that some of the emission control systems have not been properly checked. In this case, the vehicle is considered not ready for I/M testing.

If the service engine soon  indicator is on or the bulb does not work, the vehicle may need to be serviced. Refer to *On-board diagnostics (OBD-II)* in this chapter.

If the vehicle's engine or transmission has just been serviced, or the battery has recently run down or been replaced, the OBD-II system may indicate that the vehicle is not ready for I/M testing. To determine if the vehicle is ready for I/M testing, turn the ignition key to the on position for 15 seconds without cranking the engine. If the service engine soon  indicator blinks eight times, it means that the vehicle is not ready for I/M testing; if the service engine soon  indicator stays on solid, it means that the vehicle is ready for I/M testing.

The OBD-II system is designed to check the emission control system during normal driving. A complete check may take several days. If the vehicle is not ready for I/M testing, the following driving cycle consisting of mixed city and highway driving may be performed:

15 minutes of steady driving on an expressway/highway followed by 20 minutes of stop-and-go driving with at least four 30-second idle periods.

Allow the vehicle to sit for at least eight hours without starting the engine. Then, start the engine and complete the above driving cycle. The engine must warm up to its normal operating temperature. Once started, do not turn off the engine until the above driving cycle is complete. If the vehicle is still not ready for I/M testing, the above driving cycle will have to be repeated.

POWER STEERING FLUID

Check the power steering fluid. Refer to the scheduled maintenance guide for more information.

Maintenance and Specifications

- 2.3L I4 engine

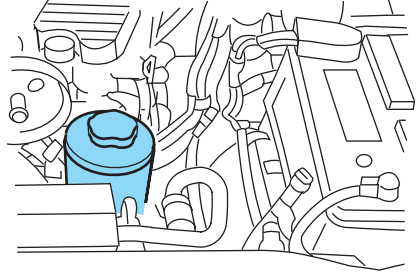

- 4.0L V6 engine

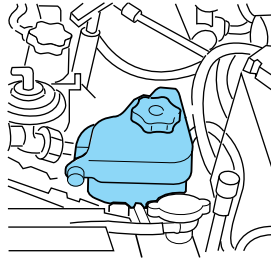

1. Start the engine and let it run until it reaches normal operating temperature (the engine coolant temperature gauge indicator will be near the center of the normal area between H and C).
2. While the engine idles, turn the steering wheel left and right several times.
3. Turn the engine off.
4. Check the fluid level in the reservoir. It should be between the MIN and MAX lines. Do not add fluid if the level is within this range.
5. If the fluid is low, add fluid in small amounts, until it reaches between the MIN and MAX lines. Refer to *Maintenance product specifications and capacities* in this chapter for the proper fluid type.

Maintenance and Specifications

BRAKE FLUID

The fluid level will drop slowly as the brakes wear, and will rise when the brake components are replaced. Fluid levels between the MIN and MAX lines are within the normal operating range; there is no need to add fluid. If the fluid levels are outside of the normal operating range, the performance of the system could be compromised; seek service from your authorized dealer immediately.

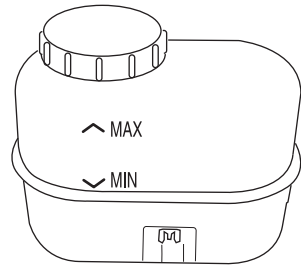

CLUTCH FLUID (IF EQUIPPED)

Check the fluid level. Refer to *scheduled maintenance information* for the service interval schedules.

During normal operation, the fluid level in the clutch reservoir should remain constant. If the fluid level drops, refill the fluid level to the step in the reservoir.

Use only a DOT 3 brake fluid designed to meet Ford specifications. Refer to *Maintenance product specifications and capacities* in this chapter.

1. Clean the reservoir cap before removal to prevent dirt and water from entering the reservoir.
2. Remove cap and rubber diaphragm from reservoir.
3. Add fluid until the level reaches the step in the reservoir.
4. Reinstall rubber diaphragm and cap onto reservoir.

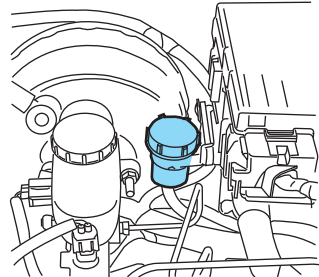

TRANSMISSION FLUID

Checking automatic transmission fluid

- Refer to *scheduled maintenance information* for scheduled check and change intervals.
- Transmission does not consume fluid.

Maintenance and Specifications

- Check fluid when transmission is not operating properly or if you see a leak.
- Fluid level must be checked at normal operating temperature, 20 miles (30 km) of driving.

To check and add fluid:

1. Drive the vehicle 20 miles (30 km) to reach normal operating temperatures.
2. If driven in hot weather, city traffic, pulling a trailer, allow transmission to cool for 30 minutes before checking.
3. Engage parking brake, start engine.
4. Put your foot on the brake pedal and move the gearshift lever slowly through all of the gear ranges.
5. Shift to P (Park) and leave the engine running.
6. Remove the dipstick, wipe clean with a dry lint free rag.
7. Install and fully seat the dipstick into the filler tube.
8. Remove the dipstick and inspect the fluid level. Level should be in the cross-hatched area.

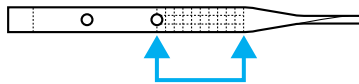

9. If necessary, add fluid in 1/2 pint (250 ml) increments through the filler tube until the level is correct at normal operating temperatures. Refer to the *Maintenance product specifications and capacities* section in this chapter for the correct fluid type. The use of any other non-approved fluid may cause internal transmission damage.

10. Fluid can be checked at ambient temperatures between 50–95°F (10–30°C). DO NOT ADD fluid until the transmission is at normal operating temperatures or the transmission will be overfilled.

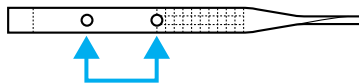

Low fluid level

Do not drive the vehicle if the fluid level is at or below the bottom of the dipstick.

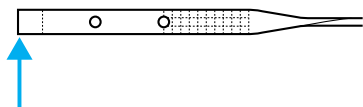

Maintenance and Specifications

High fluid level

Fluid levels above the safe range may cause overheating, shift and/or engagement concerns and internal transmission damage. If an overfill condition occurs, excess fluid should be removed by an authorized dealer.

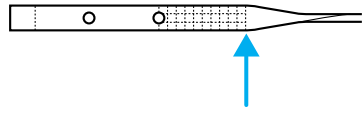

Checking and adding manual transmission fluid (if equipped)

1. Clean the filler plug.
2. Remove the filler plug and inspect the fluid level.

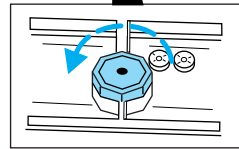
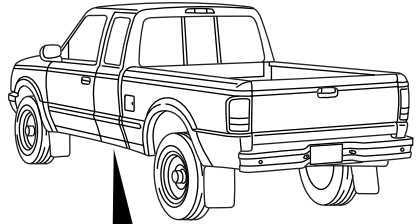

3. Fluid level should be at the bottom of the opening.
4. Add enough fluid through the filler opening so that the fluid level is at the bottom of the opening.
5. Install and tighten the fill plug securely.

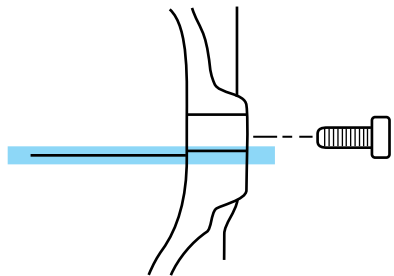

Use only fluid that meets Ford specifications. Refer to the *Maintenance product specifications and capacities* section in this chapter.

Maintenance and Specifications

TRANSFER CASE FLUID (IF EQUIPPED)

1. Clean the filler plug.
2. Remove the filler plug and inspect the fluid level.

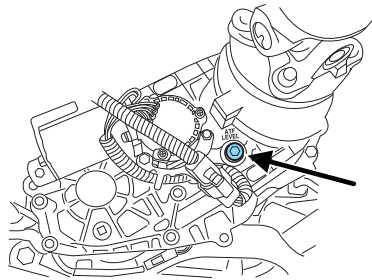

3. Add only enough fluid through the filler opening so that the fluid level is at the bottom of the opening.

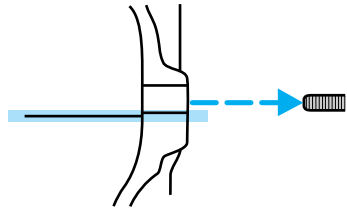

Use only fluid that meets Ford specifications. Refer to the *Maintenance product specifications and capacities* section in this chapter.

DRIVELINE UNIVERSAL JOINT AND SLIP YOKE

Your vehicle is equipped with universal joints that do not require lubrication. If the original universal joints are replaced with universal joints equipped with grease fittings, periodic lubrication will be necessary.

AIR FILTER

Refer to *scheduled maintenance information* for the appropriate intervals for changing the air filter element.

When changing the air filter element, use only the air filter element listed. Refer to *Motorcraft® part numbers* in this chapter.



WARNING: To reduce the risk of vehicle damage and/or personal burn injuries do not start your engine with the air cleaner removed and do not remove it while the engine is running.

Maintenance and Specifications

1. Loosen the clamp that secures the air inlet tube to the engine air filter cover and disconnect the tube from the cover (for V6 only).
2. Release the clamps that secure the air filter housing cover.
3. Carefully separate the two halves of the air filter housing.

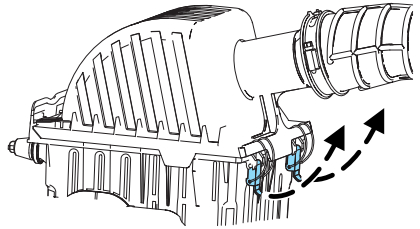

4. Remove the air filter element from the air filter housing.
5. Wipe the air filter housing and cover clean to remove any dirt or debris and to ensure good sealing.
6. Install a new air filter element. Be careful not to crimp the filter element edges between the air filter housing and cover. This could cause filter damage and allow unfiltered air to enter the engine if not properly seated.

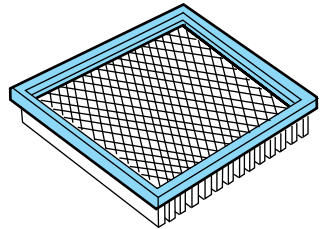

7. Replace the air filter housing cover and secure the clamps.
8. Replace the air inlet tube and secure the clamp.

Note: Failure to use the correct air filter element may result in severe engine damage. The customer warranty may be void for any damage to the engine if the correct air filter element is not used.

Maintenance and Specifications

MOTORCRAFT PART NUMBERS

Component	2.3L I4 Engine	4.0L V6 Engine
Air filter element	FA-1744	FA-1744
Fuel filter	FG-1036	FG-1036
Battery	BXT-59	BXT-59
Oil filter	FL-910	FL-820S
Spark plugs	¹	

¹For spark plug replacement, see your authorized dealer. Refer to *scheduled maintenance information* for the appropriate intervals for changing the spark plugs.

Replace the spark plugs with ones that meet Ford material and design specifications for your vehicle, such as Motorcraft® or equivalent replacement parts. The customer warranty may be void for any damage to the engine if such spark plugs are not used.

Maintenance and Specifications

MAINTENANCE PRODUCT SPECIFICATIONS AND CAPACITIES

Item	Capacity	Ford Part Name or Equivalent	Ford Part Number / Ford Specification
Brake fluid and (clutch fluid—if equipped)	Between MIN/MAX on brake fluid reservoir and to the line or step on clutch fluid reservoir	Motorcraft® High Performance DOT 3 Motor Vehicle Brake Fluid	PM-1-C / WSS-M6C62-A or WSS-M6C65-A1
Door weather strips	—	Silicone Spray Lubricant	XL-6 / ESR-M13P4-A
Hinges, door checks, latches, striker plates, fuel filler door hinge and seat tracks	—	Multi-Purpose Grease	XG-4 or XL-5 / ESB-M1C93-B
Transmission / steering/parking brake linkages and pivots, brake and clutch pedal shaft	—	Motorcraft® Premium Long-Life Grease	XG-1-C or XG-1-K / ESA-M1C75-B

Maintenance and Specifications

Item	Capacity	Ford Part Name or Equivalent	Ford Part Number / Ford Specification
Engine coolant (2.3L engine with manual transmission)	10.5 quarts (10.0L)	Motorcraft® Premium Gold Engine Coolant with bittering agent (yellow-colored) ¹	VC-7-B / WSS-M97B51-A1
Engine coolant (2.3L engine with automatic transmission)	10.2 quarts (9.7L)		
Engine coolant (4.0L engine with manual transmission)	13.7 quarts (13.0L)		
Engine coolant (4.0L engine with automatic transmission)	13.2 quarts (12.5L)		
Engine oil (2.3L engine)	4.0 quarts (3.8L)	Motorcraft® SAE 5W-20 Premium Synthetic Blend Motor Oil (US) Motorcraft® SAE 5W-20 Super Premium Motor Oil (Canada) ²	XO-5W20-QSP (US) CXO-5W20-LSP12 (Canada) / WSS-M2C930-A and API Certification Mark

Maintenance and Specifications

Item	Capacity	Ford Part Name or Equivalent	Ford Part Number / Ford Specification
Engine oil (4.0L engine)	5.0 quarts (4.7L)	Motorcraft® SAE 5W-30 Premium Synthetic Blend Motor Oil (US) Motorcraft® SAE 5W-30 Super Premium Motor Oil (Canada) ²	XO-5W30-QSP (US) CXO-5W30-LSP12 (Canada) / WSS-M2C929-A and API Certification Mark
Automatic transmission fluid (4X2 vehicles with 2.3L engine)	9.9 quarts (9.4L) ³	Motorcraft® MERCOR® V ATF ⁴	XT-5-QM / MERCOR® V
Automatic transmission fluid (4X2 vehicles with 4.0L engine)	10.0 quarts (9.5L) ³		
Automatic transmission fluid (4X4 vehicles with 4.0L engine)	10.3 quarts (9.8L) ³		
Manual transmission fluid (5-speed)	2.8 quarts (2.65L) ⁵	Motorcraft® Transfer Case Fluid	XL-12 / —
Transfer case fluid (4X4)	1.25 quarts (1.2L)		

Maintenance and Specifications

Item	Capacity	Ford Part Name or Equivalent	Ford Part Number / Ford Specification
Power steering fluid	Fill between MIN/MAX line on reservoir	Motorcraft® MERCON® V ATF	XT-5-QM / MERCON® V
Front axle fluid (4X4)	3.6 pints (1.7L)	Motorcraft® SAE 80W-90 Premium Rear Axle Lubricant	XY-80W90-QL / WSP-M2C197-A
Rear axle fluid	5.0-5.3 pints (2.4-2.5L) ^{6,7,8}	Motorcraft® SAE 80W-90 Premium Rear Axle Lubricant	XY-80W90-QL / WSP-M2C197-A
Rear axle fluid (FX4 only)	5.25-5.5 pints (2.5-2.6L) ^{6,7,8}	Motorcraft® SAE 75W-140 Synthetic Rear Axle Lubricant	XY-75W140-QL / WSL-M2C192-A
Windshield washer fluid	Fill as required	Motorcraft® Premium Windshield Washer Concentrate	ZC-32-A / WSB-M8B16-A2
Fuel tank—regular cab (short wheel base)	17 gallons (64.4L)	—	—

Maintenance and Specifications

Item	Capacity	Ford Part Name or Equivalent	Ford Part Number / Ford Specification
Fuel tank—regular cab (long wheel base)	20.3 gallons (76.8L)	—	—
Fuel tank—SuperCab	19.5 gallons (73.8L)	—	—

¹Add the coolant type originally equipped in your vehicle.

²Use of synthetic or synthetic blend motor oil is not mandatory. Engine oil need only have the API Certification mark and meet the requirements of Ford specification WSS-M2C929-A (4.0L) or WSS-M2C930-A (2.3L).

³Indicates only approximate dry-fill capacity. Some applications may vary based on cooler size and if equipped with an in-tank cooler. The amount of transmission fluid and fluid level should be set by the indication on the dipstick's normal operating range.

⁴Automatic transmissions that require MERCON® V should only use MERCON® V fluid or fluid that is specified dual usage MERCON®/MERCOR® V. Refer to *scheduled maintenance* to determine the correct service interval. Use of any fluid other than the recommended fluid may cause transmission damage.

⁵Service refill capacity for the manual transmission is determined by filling the transmission to the bottom of the filler hole with the vehicle on a level surface.

⁶Traction-Lok axles use 4.75-5.0 pints (2.2-2.4L) of rear axle lubricant.

⁷Service refill capacities are determined by filling the rear axle 1/4 inch to 9/16 inch (6 mm to 14 mm) below the bottom of the filler hole.

⁸Add 4 oz. (118 ml) of Additive Friction Modifier XL-3 or equivalent meeting Ford specification EST-M2C118-A for complete refill of Traction-Lok axles.

Maintenance and Specifications

ENGINE DATA

Engine	2.3L I4 engine	4.0L V6 engine
Cubic inches	138	245
Required fuel	87 octane	87 octane
Firing order	1-3-4-2	1-4-2-5-3-6
Ignition system	EDIS	EDIS
Spark plug gap	0.049–0.053 inch (1.25–1.35 mm)	0.052–0.056 inch (1.32–1.42 mm)
Compression ratio	9.7:1	9.7:1

Engine drivebelt routing

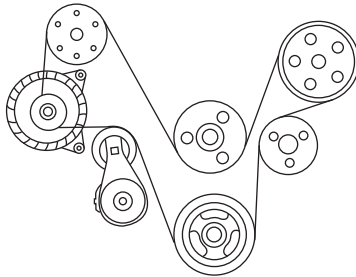

- 2.3L I4 engine with A/C

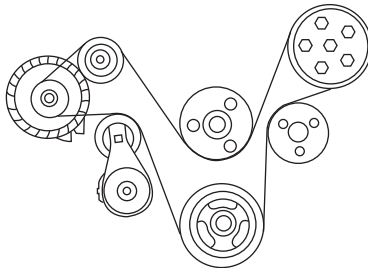

- 2.3L I4 engine without A/C

Maintenance and Specifications

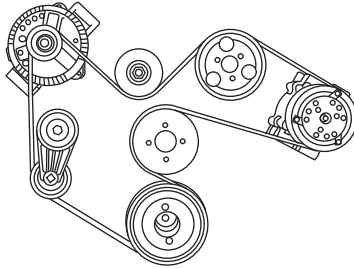

- 4.0L V6 engine with A/C

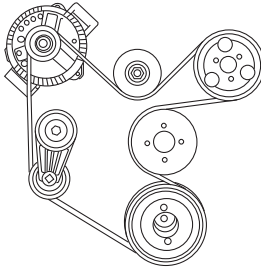

- 4.0L V6 engine without A/C

Maintenance and Specifications

IDENTIFYING YOUR VEHICLE

Safety Compliance Certification Label

The National Highway Traffic Safety Administration Regulations require that a Safety Compliance Certification Label be affixed to a vehicle and prescribe where the Safety Compliance Certification Label may be located. The Safety Compliance Certification Label is located on the structure (B-Pillar) by the trailing edge of the driver's door or the edge of the driver's door.

MFD. BY FORD MOTOR CO.			
DATE: XX/XX	GVWR: XXXXXLB/ XXXXXKG		
FRONT GAWR: XXXXL	WITH	REAR GAWR: XXXXLB	WITH
XXXXKG	TIRES:	XXXXKG	TIRES
XXXX/XXXXXX	RIMS:	XXXX/XXXXXX	RIMS
XXXX,XX	AT XXX kPa/XX	XXXX,XX	PSI COLD
PSI COLD	AT XXX kPa/XX	PSI COLD	
THIS VEHICLE CONFORMS TO ALL APPLICABLE FEDERAL MOTOR VEHICLE SAFETY AND THEFT PREVENTION STANDARDS IN EFFECT ON THE DATE OF MANUFACTURE SHOWN ABOVE.			
VIN: XXXXXXXXXXXXXXXXX	XXXXX XXXXX		
TYPE: XXX			
			
EXT PNT: XX	RC: XX	DSO:	
WB ¹ BRK ¹ INT TR ¹ TP/PS ¹ TR ¹	AXLE ¹ TR ¹ SPR ¹	XXXXX	
XXX X XX	X XX X XX	XXX	
XXXXXXXXXXXXXXX XXX XXXX-XXXXXXX-XX			

Vehicle identification number (VIN)

The vehicle identification number is located on the driver side instrument panel.

Please note that in the graphic, XXXX is representative of your vehicle identification number.

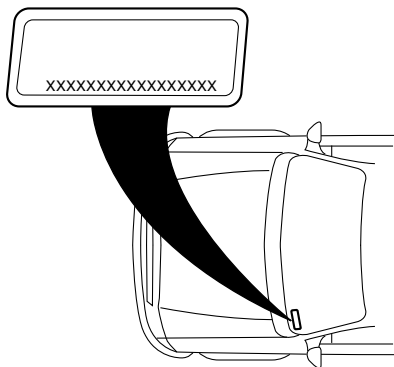

Maintenance and Specifications

The Vehicle Identification Number (VIN) contains the following information:

1. World manufacturer identifier
2. Brake system / Gross Vehicle Weight Rating (GVWR) / Restraint Devices and their location
3. Make, vehicle line, series, body type
4. Engine type
5. Check digit
6. Model year
7. Assembly plant
8. Production sequence number

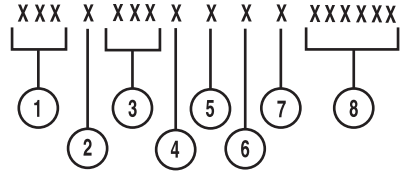

TRANSMISSION CODE DESIGNATIONS

You can find a transmission code on the Safety Compliance Certification Label. The following table tells you which transmission each code represents.

MFD. BY FORD MOTOR CO.

DATE: XX/XX GVWR: XXXXXLB/ XXXXXKG
 FRONT GAWR: XXXXL REAR GAWR: XXXXLB
 XXXXKG WITH XXXXKG WITH
 XXXX/XXXXXX TIRES XXXX/XXXXXX TIRES
 XXXX RIMS XXXX RIMS
 AT XXX kPa/XX PSI COLD AT XXX kPa/XX PSI COLD

THIS VEHICLE CONFORMS TO ALL APPLICABLE FEDERAL MOTOR VEHICLE SAFETY AND THEFT PREVENTION STANDARDS IN EFFECT ON THE DATE OF MANUFACTURE SHOWN ABOVE.

VIN: XXXXXXXXXXXXXXXXXXXX XXXXX
 TYPE: XXX XXXXX



EXT PNT: XX RC: XX DSO: X
 WB BRK INT TR TP/PS R AXLE TR SPR XXXX
 XXX X XX X XX X XX XXX

XXXXXXXXXXXXXXXX XXX XXXXX-XXXXXXXX-XX

Description	Code
Five-speed automatic (5R44E/5R55E)	D
Five-speed manual (HD)	J
Five-speed manual (R1)	R

GENUINE FORD ACCESSORIES FOR YOUR VEHICLE

A wide selection of Genuine Ford Accessories are available for your vehicle through your local Ford or Ford of Canada dealer. These quality accessories have been specifically engineered to fulfill your automotive needs; they are custom designed to complement the style and aerodynamic appearance of your vehicle. In addition, each accessory is made from high quality materials and meets or exceeds Ford's rigorous engineering and safety specifications. Ford Motor Company will repair or replace any properly dealer-installed Genuine Ford Accessories found to be defective in factory-supplied materials or workmanship during the warranty period, as well as any component damaged by the defective accessories. The accessories will be warranted for whichever provides you the greatest benefit:

- 12 months or 12,000 miles (20,000 km) (whichever occurs first), or
- the remainder of your new vehicle limited warranty.

Contact your dealer for details and a copy of the warranty.

The following is a list of several Genuine Ford Accessories. Not all accessories are available for all models. For a complete listing of the accessories that are available for your vehicle, please contact your dealer or visit our online store at: www.fordaccessories.com.

Exterior style

Bug shields

Chrome exhaust tips

Deflectors

Running boards

Splash guards

Step bars

Tonneau covers

Wheels

Interior style

Electrochromatic compass/temperature interior mirrors

Floor mats

Accessories

Lifestyle

Ash cup / smoker's package

Bed products

Cargo organization and management

Trailer hitches, wiring harnesses and accessories

TripTunes™ Advanced portable audio connection

Peace of mind

Keyless entry keypad

Remote start

Vehicle security systems

Wheel locks

For maximum vehicle performance, keep the following information in mind when adding accessories or equipment to your vehicle:

- When adding accessories, equipment, passengers and luggage to your vehicle, do not exceed the total weight capacity of the vehicle or of the front or rear axle (GVWR or GAWR as indicated on the Safety Compliance Certification label). Consult your authorized dealer for specific weight information.
- The Federal Communications Commission (FCC) and Canadian Radio Telecommunications Commission (CRTC) regulate the use of mobile communications systems — such as two-way radios, telephones and theft alarms - that are equipped with radio transmitters. Any such equipment installed in your vehicle should comply with FCC or CRTC regulations and should be installed only by a qualified service technician.
- Mobile communications systems may harm the operation of your vehicle, particularly if they are not properly designed for automotive use.
- To avoid interference with other vehicle functions, such as anti-lock braking systems, amateur radio users who install radios and antennas onto their vehicle should not locate the Amateur Radio Antennas in the area of the driver's side hood.
- Electrical or electronic accessories or components that are added to the vehicle by the authorized dealer or the owner may adversely affect battery performance and durability.

Ford Extended Service Plan

FORD ESP EXTENDED SERVICE PLANS

More than 30 million Ford, Lincoln, and Mercury owners have discovered the powerful protection of Ford ESP. It is the only extended service plan backed by Ford Motor Company, and provides “peace of mind” protection beyond the New Vehicle Limited Warranty coverage.

Up to 500+ Covered Vehicle Components

There are four, new-vehicle Extended Service Plans with different levels of coverage. Ask your dealer for details.

PremiumCare – Our most comprehensive coverage. With over 500 covered components, this plan is so complete that we generally only discuss what’s not covered!

ExtraCare – Covers 113 components, and includes many high-tech items.

BaseCare – Covers 84 components.

PowertrainCare – Covers 29 critical components.

Ford ESP is honored by all Ford, Lincoln and Mercury Dealers in the U.S. and Canada It’s the only extended service plan authorized and backed by Ford Motor Company. That means you get:

- Reliable, quality service anywhere you go.
- **Factory-trained technicians.**
- **Genuine Ford and Motorcraft® Parts.**

Rental car reimbursement

If your vehicle is kept overnight for covered repairs, you are eligible for rental car coverage, including Bumper-to-Bumper warranty repairs, or manufacturer’s recalls.

Transferable coverage

If you sell your vehicle before your Ford ESP coverage expires, you can transfer any remaining coverage to the new owner. Whenever you’re ready to sell your car, prospective buyers may feel better about taking a risk on your used vehicle. Ford ESP may add resale value!

Plus, **exclusive 24/7 roadside assistance**, including:

- Towing, flat-tire change and battery jump starts.
- Out-of-fuel and lock-out assistance.
- Travel expense reimbursement for lodging, meals and rental car.
- Destination assistance for taxi, shuttle, rental car coverage and emergency transportation.

Ford Extended Service Plan

Ford ESP Can Quickly Pay for Itself

One service bill – the cost of parts and labor – can easily exceed the price of your Ford ESP Service Contract. With Ford ESP, you minimize your risk for unexpected repair bills and rising repair costs.

Avoid the rising cost of properly maintaining your vehicle!

Ford ESP also offers a Premium Maintenance Plan that covers items that **routinely wear out**.

The coverage is prepaid, so you never have to worry about affording your vehicle maintenance. It covers regular checkups, routine inspections, preventive care and replacement of items that require periodic attention for **normal “wear”**:

- **Wiper blades**
- **Spark plugs (except California)**
- **Clutch disc**
- **Brake pads and linings**
- **Shock absorbers**
- **Belts and hoses**

Contact your selling Ford, Lincoln, or Mercury dealership today so they can customize a Ford Extended Service Plan that fits your driving lifestyle and budget.

Interest free finance options available

Take advantage of our installment payment plan, just a 10% down payment will provide you with an affordable no interest, no-fee payment opportunity.

Get Genuine Peace of Mind with Ford ESP!

To learn more, complete the information below and mail this to:

**Ford ESP
P.O. Box 8072
Royal Oak, MI 48068-9933**

NAME (PLEASE PRINT) _____

ADDRESS _____

APT.NO. _____

CITY _____

STATE _____

ZIP _____

E-MAIL: _____

Index

- A**
- ABS (see Brakes)164
 - AdvanceTrac167
 - Air cleaner filter265, 267
 - Airbag supplemental restraint system89–90, 98
 - and child safety seats92
 - description90, 98
 - disposal100
 - driver airbag90, 93, 98
 - indicator light97, 100
 - operation90, 93, 98
 - passenger airbag90, 93, 98
 - side airbag98
 - Ambulance packages7
 - Antifreeze (see Engine coolant)244
 - Anti-lock brake system (see Brakes)164–165
 - Anti-theft system66
 - Audio system (see Radio)19, 21, 26
 - Automatic transmission174
 - driving an automatic overdrive174
 - fluid, refill capacities268
 - fluid, specification268
 - Auxiliary input jack (Line in)32
 - Auxiliary power point56
 - Axle
 - lubricant specifications268
 - refill capacities268
- B**
- Battery242
 - acid, treating emergencies242
 - jumping a disabled battery210
 - maintenance-free242
 - replacement, specifications ...267
 - servicing242
 - Belt-Minder®85
 - Booster seats114
 - Brakes164
 - anti-lock164–165
 - anti-lock brake system (ABS) warning light165
 - fluid, checking and adding262
 - fluid, refill capacities268
 - fluid, specifications268
 - lubricant specifications268
 - parking166
 - shift interlock173
 - Bulbs48
- C**
- Capacities for refilling fluids268
 - Cell phone use8
 - Changing a tire200
 - Child safety seats105
 - attaching with
 - tether straps110
 - in front seat106
 - in rear seat106, 109
 - LATCH110
 - recommendations103
 - Child safety seats - booster seats114

Cleaning your vehicle	
engine compartment	227
instrument panel	229
interior	230
plastic parts	228
safety belts	230
washing	225
waxing	226
wheels	226
wiper blades	228
Clock adjust	
AM/FM	20
AM/FM stereo CD	21
Premium AM/FM stereo	
CD6/MP3	27
Clutch	
fluid	262
operation while driving	176
recommended shift speeds	177
Console	56
Coolant	
checking and adding	244
refill capacities	248, 268
specifications	268
Cruise control	
(see Speed control)	59
Customer Assistance	188
Ford Extended	
Service Plan	279
Getting assistance outside the	
U.S. and Canada	222
Getting roadside assistance	188
Getting the service	
you need	218
Ordering additional owner's	
literature	223
Utilizing the	
Mediation/Arbitration	
Program	221

D

Daytime running lamps	
(see Lamps)	45
Dipstick	
engine oil	237
Driveline universal joint and	
slip yoke	265
Driving under special	
conditions	179, 182, 184
sand	183
snow and ice	185
through water	184, 187

E

Emergencies, roadside	
jump-starting	210
Emergency Flashers	189
Emission control system	258
Engine	273
cleaning	227
coolant	244
idle speed control	242
lubrication specifications	268
refill capacities	268
service points	234–235
starting after a collision	190
Engine block heater	162
Engine oil	237
checking and adding	237
dipstick	237
filter, specifications	240, 267
recommendations	240
refill capacities	268
specifications	268
Event data recording	7
Exhaust fumes	162

Index

- F**
- Fluid capacities268
 - Fog lamps44
 - Four-Wheel Drive vehicles179
 - driving off road181
 - electronic shift180
 - indicator light179
 - preparing to drive your vehicle172
 - Fuel249
 - calculating fuel economy255
 - cap252
 - capacity268
 - choosing the right fuel253
 - comparisons with EPA fuel economy estimates258
 - detergent in fuel253
 - filling your vehicle with fuel249, 252, 255
 - filter, specifications249, 267
 - fuel pump shut-off switch190
 - improving fuel economy255
 - octane rating253, 273
 - quality254
 - running out of fuel254
 - safety information relating to automotive fuels249
 - Fuel pump shut-off switch190
 - Fuses190–191
- G**
- Gas cap (see Fuel cap)252
 - Gas mileage (see Fuel economy)255
 - Gauges17
- H**
- Hazard flashers189
 - Headlamps44
 - aiming46
 - bulb specifications49
 - daytime running lights45
 - flash to pass45
 - high beam44
 - replacing bulbs50
 - turning on and off44
 - Heating
 - heating and air conditioning system41–42
 - Hood233
- I**
- Ignition159, 273
 - Infant seats (see Safety seats)105
 - Inspection/maintenance (I/M) testing260
 - Instrument panel
 - cleaning229
 - cluster12
 - lighting up panel and interior45
- J**
- Jack200
 - positioning200, 206
 - storage200, 203–204
 - Jump-starting your vehicle210

- K**
- Keys62, 67
 - positions of the ignition159
- L**
- Lamps
 - bulb replacement
 - specifications chart49
 - daytime running light45
 - fog lamps44
 - headlamps44
 - headlamps, flash to pass45
 - instrument panel, dimming45
 - interior lamps48–49
 - replacing bulbs50
 - LATCH anchors110
 - Lights, warning and indicator12
 - anti-lock brakes (ABS)165
 - Load limits140
 - Loading instructions147
 - Locks
 - doors62
 - Lubricant specifications268
 - Lug nuts210
- M**
- Manual transmission176
 - fluid capacities268
 - lubricant specifications268
 - reverse178
 - Mirrors58
 - fold away59
 - side view mirrors
 - (power)58–59
 - Motorcraft® parts231, 249, 267
- O**
- Octane rating253
 - Oil (see Engine oil)237
- P**
- Parking brake166
 - Parts
 - (see Motorcraft® parts)267
 - Passenger Occupant Classification Sensor76
 - Power distribution box
 - (see Fuses)194
 - Power door locks62
 - Power mirrors58–59
 - Power point56
 - Power steering172
 - fluid, checking and adding260
 - fluid, refill capacity268
 - fluid, specifications268
 - Power Windows57
 - Preparing to drive
 - your vehicle172
- R**
- Radio19, 21, 26
 - Recommendations for
 - attaching safety restraints for
 - children103
 - Relays190
 - Remote entry system62
 - illuminated entry65
 - locking/unlocking doors63
 - panic alarm63
 - replacing the batteries64
 - Roadside assistance188
- 285

Index

- S**
- Safety Belt Maintenance117
 - Safety belts (see Safety restraints)75, 78–79, 81–83
 - Safety Canopy98
 - Safety defects, reporting224
 - Safety restraints75, 78–79, 81–83
 - Belt-Minder®85
 - extension assembly84
 - for adults79, 81–82
 - for children100
 - lap belt80
 - Occupant Classification
 - Sensor76
 - safety belt maintenance117
 - warning light and chime84–85
 - Safety restraints - LATCH anchors110
 - Safety seats for children105
 - Safety Compliance Certification Label275
 - Satellite Radio Information37
 - Seats69
 - child safety seats105
 - SecuriLock passive anti-theft system66
 - Servicing your vehicle232
 - Setting the clock
 - AM/FM stereo20
 - AM/FM stereo CD21
 - Premium AM/FM stereo CD6/MP327
 - Snowplowing6
 - Spark plugs, specifications267, 273
 - Special notice
 - ambulance conversions7
 - utility-type vehicles6
 - Specification chart, lubricants268
 - Speed control59
 - Starting your vehicle159–161
 - jump starting210
 - Steering wheel
 - tilting56
- T**
- Tilt steering wheel56
 - Tire Pressure Monitoring System (TPMS)
 - Tires, Wheels and Loading135
 - Tires120–121, 200
 - alignment128
 - care124
 - changing200, 206
 - checking the pressure124
 - inflating122
 - label134
 - replacing126
 - rotating128
 - safety practices127
 - sidewall information129
 - snow tires and chains140
 - spare tire201
 - terminology121
 - tire grades121
 - treadwear120, 125
 - Towing147
 - recreational towing157
 - trailer towing147
 - wrecker216

Transfer case
fluid checking265

Transmission
automatic operation174
brake-shift interlock (BSI)173
fluid, checking and adding
(manual)264
fluid, refill capacities268
lubricant specifications268
manual operation176

Turn signal48

V

Vehicle Identification Number
(VIN)275
Vehicle loading140

camper bodies158
Ventilating your vehicle162

W

Warning lights (see Lights)12
Washer fluid236
Water, Driving through187
Windows
power57
Windshield washer fluid and
wipers55
checking and adding fluid236
replacing wiper blades237
Wrecker towing216