

## Table of Contents

<b>Introduction</b>	<b>4</b>
<b>Instrument Cluster</b>	<b>14</b>
Warning lights and chimes	14
Gauges	20
Message center	21
<b>Entertainment Systems</b>	<b>49</b>
AM/FM stereo	49
AM/FM stereo with CD/MP3	51
Auxiliary input jack (Line in)	60
USB port	61
Satellite radio information	65
Navigation system	68
SYNC®	68
<b>Climate Controls</b>	<b>69</b>
Manual heating and air conditioning	69
Dual electronic automatic temperature control	72
Navigation system based climate control	77
Rear window defroster	81
<b>Lights</b>	<b>83</b>
Headlamps	83
Turn signal control	86
Bulb replacement	89
<b>Driver Controls</b>	<b>95</b>
Windshield wiper/washer control	95
Steering wheel adjustment	96
Power windows	103
Mirrors	106
Speed control	111
Tailgate	124

## Table of Contents

### **Locks and Security 137**

Keys	137
Locks	145
Anti-theft system	158

### **Seating and Safety Restraints 162**

Seating	162
Safety restraints	178
Airbags	194
Child restraints	209

### **Tires, Wheels and Loading 232**

Tire information	234
Tire inflation	237
Tire Pressure Monitoring System (TPMS)	249
Vehicle loading	256
Trailer towing	264
Trailer brake controller-integrated	270
Recreational towing	276

### **Driving 278**

Starting	278
Brakes	284
AdvanceTrac®	286
Transmission operation	299
Reverse sensing system	304
Rear-view camera system	306

### **Roadside Emergencies 327**

Getting roadside assistance	327
Hazard flasher control	328
Fuel pump shut-off	328
Fuses and relays	329
Changing tires	339
Wheel lug nut torque	347
Jump starting	348
Wrecker towing	352

## Table of Contents

<b>Customer Assistance</b>	<b>354</b>
Reporting safety defects (U.S. only)	361
Reporting safety defects (Canada only)	361
<b>Cleaning</b>	<b>362</b>
<b>Maintenance and Specifications</b>	<b>373</b>
Engine compartment	375
Engine oil	380
Battery	383
Engine coolant	386
Fuel information	393
Air filter(s)	408
Part numbers	414
Maintenance product specifications and capacities	415
Engine data	419
<b>Accessories</b>	<b>424</b>
<b>Ford Extended Service Plan</b>	<b>427</b>
<b>Scheduled Maintenance</b>	<b>431</b>
Normal scheduled maintenance and log	437
<b>Index</b>	<b>458</b>

All rights reserved. Reproduction by any means, electronic or mechanical including photocopying, recording or by any information storage and retrieval system or translation in whole or part is not permitted without written authorization from Ford Motor Company. Ford may change the contents without notice and without incurring obligation.

Copyright © 2011 Ford Motor Company

## Introduction

### CONGRATULATIONS

Congratulations on acquiring your new Ford. Please take the time to get well acquainted with your vehicle by reading this handbook. The more you know and understand about your vehicle, the greater the safety and pleasure you will derive from driving it.

For more information on Ford Motor Company and its products visit the following website:

- In the United States: [www.ford.com](http://www.ford.com)
- In Canada: [www.ford.ca](http://www.ford.ca)
- In Australia: [www.ford.com.au](http://www.ford.com.au)
- In Mexico: [www.ford.com.mx](http://www.ford.com.mx)

Additional owner information is given in separate publications.

This Owner's Guide describes every option and model variant available and therefore some of the items covered may not apply to your particular vehicle. Furthermore, due to printing cycles it may describe options before they are generally available.

Remember to pass on this Owner's Guide when reselling the vehicle. It is an integral part of the vehicle.



**WARNING: Fuel pump shut-off:** In the event of an accident this feature will automatically cut off the fuel supply to the engine. It can also be activated through sudden vibration (e.g. collision when parking). To restart your vehicle, refer to *Fuel pump shut-off* in the *Roadside Emergencies* chapter.

### SAFETY AND ENVIRONMENT PROTECTION



#### Warning symbols in this guide

How can you reduce the risk of personal injury to yourself or others? In this guide, answers to such questions are contained in comments highlighted by the warning triangle symbol. These comments should be read and observed.

## Introduction

### **Warning symbols on your vehicle**

When you see this symbol, it is imperative that you consult the relevant section of this guide before touching or attempting adjustment of any kind.



### **Protecting the environment**

We must all play our part in protecting the environment. Correct vehicle usage and the authorized disposal of waste, cleaning and lubrication materials are significant steps towards this aim. Information in this respect is highlighted in this guide with the tree symbol.



### **CALIFORNIA Proposition 65 Warning**



**WARNING:** Engine exhaust, some of its constituents, and certain vehicle components contain or emit chemicals known to the State of California to cause cancer and birth defects or other reproductive harm. In addition, certain fluids contained in vehicles and certain products of component wear contain or emit chemicals known to the State of California to cause cancer and birth defects or other reproductive harm.

### **PERCHLORATE MATERIAL**

Certain components of this vehicle such as airbag modules, seat belt pretensioners, and button cell batteries may contain Perchlorate Material – Special handling may apply for service or vehicle end of life disposal. See [www.dtsc.ca.gov/hazardouswaste/perchlorate](http://www.dtsc.ca.gov/hazardouswaste/perchlorate).

### **BREAKING-IN YOUR VEHICLE**

Your vehicle does not need an extensive break-in. Try not to drive continuously at the same speed for the first 1,000 miles (1,600 km) of new vehicle operation. Vary your speed frequently in order to give the moving parts a chance to break in.

Drive your new vehicle at least 1,000 miles (1,600 km) before towing a trailer. For more detailed information about towing a trailer, refer to *Trailer towing* in the *Tires, Wheels and Loading* chapter.

## Introduction

Do not add friction modifier compounds or special break-in oils since these additives may prevent piston ring seating. See *Engine oil* in the *Maintenance and Specifications* chapter for more information on oil usage.

### SPECIAL NOTICES

#### New Vehicle Limited Warranty

For a detailed description of what is covered and what is not covered by your vehicle's New Vehicle Limited Warranty, refer to the *Warranty Guide* that is provided to you along with your Owner's Guide.

#### Special instructions

For your added safety, your vehicle is fitted with sophisticated electronic controls.



**WARNING:** Please read the section *Airbag Supplemental Restraint System (SRS)* in the *Seating and Safety Restraints* chapter. Failure to follow the specific warnings and instructions could result in personal injury.



**WARNING:** Front seat mounted rear-facing child or infant seats should **NEVER** be placed in front of an active passenger airbag.

#### Using your vehicle with a snowplow

##### Do not use this vehicle for snowplowing.

Your vehicle is not equipped with a snowplowing package.

#### Using your vehicle as an ambulance

##### Do not use this vehicle as an ambulance.

Your vehicle is not equipped with the Ford Ambulance Preparation Package.

## Introduction

### Notice to owners of pickup trucks and utility type vehicles



**WARNING:** Utility vehicles have a significantly higher rollover rate than other types of vehicles.

Before you drive your vehicle, please read this Owner's Guide carefully. Your vehicle is not a passenger car. As with other vehicles of this type, failure to operate this vehicle correctly may result in loss of vehicle control, vehicle rollover, personal injury or death.

### NOTICE TO OWNERS ABOUT HIGH PERFORMANCE TIRES

**Note:** Your vehicle is equipped with high performance tires. When first driving the vehicle after it has been parked for a period of time, you may experience a temporary ride disturbance. This is a characteristic of the tires and should be no reason for concern. The condition should correct itself within 5-15 miles (8-25 km) of driving. If the disturbance persists, have the tires serviced by an authorized dealer.

### DATA RECORDING

#### Service Data Recording

Service data recorders in your vehicle are capable of collecting and storing diagnostic information about your vehicle. This potentially includes information about the performance or status of various systems and modules in the vehicle, such as engine, throttle, steering or brake systems. In order to properly diagnose and service your vehicle, Ford Motor Company, Ford of Canada, and service and repair facilities may access or share among them vehicle diagnostic information received through a direct connection to your vehicle when diagnosing or servicing your vehicle. For U.S. only (if equipped), if you choose to use the SYNC® Vehicle Health Report, you consent that certain diagnostic information may also be accessed electronically by Ford Motor Company and Ford authorized service facilities, and that the diagnostic information may be used for any purpose. See your SYNC® supplement for more information.

## Introduction

### Event Data Recording

This vehicle is equipped with an event data recorder (EDR). The main purpose of an EDR is to record, in certain crash or near crash-like situations, such as an airbag deployment or hitting a road obstacle; this data will assist in understanding how a vehicle's systems performed. The EDR is designed to record data related to vehicle dynamics and safety systems for a short period of time, typically 30 seconds or less. The EDR in this vehicle is designed to record such data as:

- How various systems in your vehicle were operating;
- Whether or not the driver and passenger seatbelts were buckled/fastened;
- How far (if at all) the driver was depressing the accelerator and/or the brake pedal; and
- How fast the vehicle was travelling; and
- Where the driver was positioning the steering wheel.

This data can help provide a better understanding of the circumstances in which crashes and injuries occur.

**Note:** EDR data is recorded by your vehicle only if a non-trivial crash situation occurs; no data is recorded by the EDR under normal driving conditions and no personal data or information (e.g., name, gender, age, and crash location) is recorded (see limitations regarding 911 Assist and Traffic, directions and Information privacy below). However, parties, such as law enforcement, could combine the EDR data with the type of personally identifying data routinely acquired during a crash investigation.

To read data recorded by an EDR, special equipment is required, and access to the vehicle or the EDR is needed. In addition to the vehicle manufacturer, other parties, such as law enforcement, that have such special equipment, can read the information if they have access to the vehicle or the EDR. Ford Motor Company and Ford of Canada do not access event data recorder information without obtaining consent, unless pursuant to court order or where required by law enforcement, other government authorities or other third parties acting with lawful authority. Other parties may seek to access the information independently of Ford Motor Company and Ford of Canada.



## Introduction

**Note:** Including to the extent that any law pertaining to Event Data Recorders applies to SYNC® or its features, please note the following: Once 911 Assist (if equipped) is enabled (set ON), 911 Assist may, through any paired and connected cell phone, disclose to emergency services that the vehicle has been in a crash involving the deployment of an airbag or, in certain vehicles, the activation of the fuel pump shut-off. Certain versions or updates to 911 Assist may also be capable of being used to electronically or verbally provide to 911 operators the vehicle location (such as latitude and longitude), and/or other details about the vehicle or crash or personal information about the occupants to assist 911 operators to provide the most appropriate emergency services. If you do not want to disclose this information, do not activate the 911 Assist feature. See your SYNC® supplement for more information.

Additionally, when you connect to Traffic, Directions and Information (if equipped, U.S. only) the service uses GPS technology and advanced vehicle sensors to collect the vehicle's current location, travel direction, and speed ("vehicle travel information") only to help provide you with the directions, traffic reports, or business searches your request. If you do not want Ford or its vendors to receive this information, do not activate the service. Ford Motor Company and the vendors it uses to provide you with this information do not store your vehicle travel information. For more information, see Traffic, Directions and Information, Terms and Conditions. See your SYNC® supplement for more information.

## Introduction

### CELL PHONE USE

The use of Mobile Communications Equipment has become increasingly important in the conduct of business and personal affairs. However, drivers must not compromise their own or others' safety when using such equipment. Mobile Communications can enhance personal safety and security when appropriately used, particularly in emergency situations. Safety must be paramount when using mobile communications equipment to avoid negating these benefits.

Mobile Communication Equipment includes, but is not limited to, cellular phones, pagers, portable email devices, text messaging devices and portable two-way radios.



**WARNING:** Driving while distracted can result in loss of vehicle control, accident and injury. Ford strongly recommends that you use extreme caution when using any device or feature that may take your focus off the road. Your primary responsibility is the safe operation of your vehicle. We recommend against the use of any handheld device while driving and that you comply with all applicable laws.

## Introduction









### **EXPORT UNIQUE (NON-UNITED STATES/CANADA) VEHICLE SPECIFIC INFORMATION**

For your particular global region, your vehicle may be equipped with features and options that are different from the features and options that are described in this Owner's Guide. A market unique supplement may be supplied that complements this book. By referring to the market unique supplement, if provided, you can properly identify those features, recommendations and specifications that are unique to your vehicle. This Owner's Guide is written primarily for the U.S. and Canadian Markets. Features or equipment listed as standard may be different on units built for Export. **Refer to this Owner's Guide for all other required information and warnings.**

## Introduction













These are some of the symbols you may see on your vehicle.

### Vehicle Symbol Glossary

Safety Alert		See Owner's Guide	
Fasten Safety Belt		Airbag - Front	
Airbag - Side		Child Seat Lower Anchor	
Child Seat Tether Anchor		Brake System	
Anti-Lock Brake System		Parking Brake System	
Brake Fluid - Non-Petroleum Based		Parking Aid System	
Stability Control System		Speed Control	
Master Lighting Switch		Hazard Warning Flasher	
Fog Lamps-Front		Fuse Compartment	
Fuel Pump Reset		Windshield Wash/Wipe	
Windshield Defrost/Demist		Rear Window Defrost/Demist	

## Introduction

### Vehicle Symbol Glossary

Power Windows Front/Rear		Power Window Lockout	
Child Safety Door Lock/Unlock		Interior Luggage Compartment Release	
Panic Alarm		Engine Oil	
Engine Coolant		Engine Coolant Temperature	
Do Not Open When Hot		Battery	
Avoid Smoking, Flames, or Sparks		Battery Acid	
Explosive Gas		Fan Warning	
Power Steering Fluid		Maintain Correct Fluid Level	
Service Engine Soon		Engine Air Filter	
Passenger Compartment Air Filter		Jack	
Check Fuel Cap		Low Tire Pressure Warning	

## Instrument Cluster

### WARNING LIGHTS AND CHIMES

Base instrument cluster shown in standard measure; metric similar. Uplevel clusters similar.

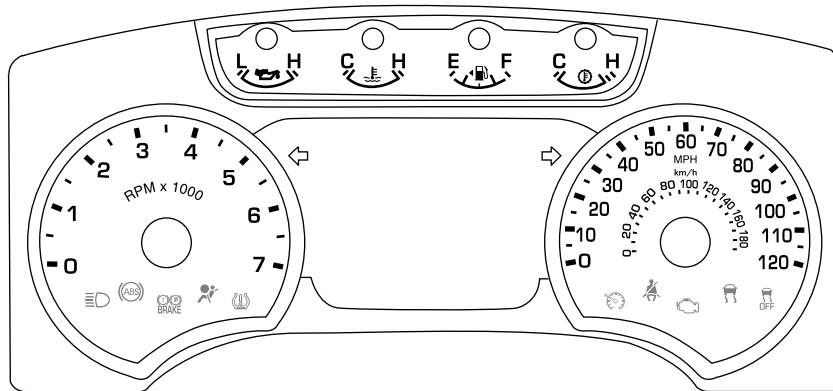

Warning lights and gauges can alert you to a vehicle condition that may become serious enough to cause expensive repairs. A warning light may illuminate when a problem exists with one of your vehicle's functions. Many lights will illuminate when you start your vehicle to make sure the bulb works. If any light remains on after starting the vehicle, refer to the respective system warning light for additional information.

### Base message center

**Note:** Some warning lights are reconfigurable telltale (RTT) indicator lights and will illuminate in the message center. These lights function the same as the other warning lights.

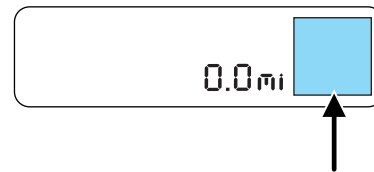

## Instrument Cluster

### Uplevel message center

**Note:** Some warning lights are reconfigurable telltale (RTT) indicator lights and will illuminate in the message center. These lights function the same as the other warning lights. The first three positions will only display one warning telltale at a time; the last three positions can cycle between different warning telltales.

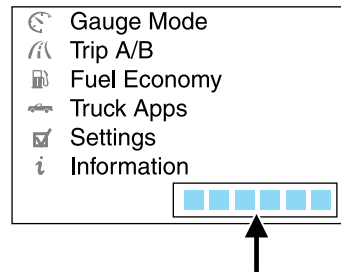

**Service engine soon:** The service engine soon indicator light illuminates when the ignition is first turned to the on position to check the bulb and to indicate whether the vehicle is ready for Inspection/Maintenance (I/M) testing. Normally, the service engine soon light will stay on until the engine is cranked, then turn itself off if no malfunctions are present. However, if after 15 seconds the service engine soon light blinks eight times, it means that the vehicle is not ready for I/M testing. See the *Readiness for Inspection/Maintenance (I/M) testing* in the *Maintenance and Specifications* chapter.

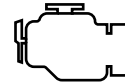

Solid illumination after the engine is started indicates the on-board diagnostics system (OBD-II) has detected a malfunction. Refer to *On-board diagnostics (OBD-II)* in the *Maintenance and Specifications* chapter. If the light is blinking, engine misfire is occurring which could damage your catalytic converter. Drive in a moderate fashion (avoid heavy acceleration and deceleration) and have your vehicle serviced immediately by your authorized dealer.

 **WARNING:** Under engine misfire conditions, excessive exhaust temperatures could damage the catalytic converter, the fuel system, interior floor coverings or other vehicle components, possibly causing a fire.

## Instrument Cluster

### **Powertrain malfunction/Reduced power/Electronic throttle control (RTT):**

Displays when the engine has defaulted to a “limp-home” operation or when a transmission problem has been detected and shifting may be restricted. If the light remains on, have the system serviced immediately by your authorized dealer.



### **Check 4X4 (RTT) (if equipped):**

Displays with the message CHECK 4X4 when a four-wheel drive fault is present.



Refer to *Message center* in this chapter.

### **Brake system warning light:**

To confirm the brake system warning light is functional, it will momentarily illuminate when the ignition is turned to the on position when the engine is not running, or in a position between on and start, or by applying the parking brake when the ignition is turned to the on position.



If the brake system warning light does not illuminate at this time, seek service immediately from your authorized dealer. Illumination after releasing the parking brake indicates low brake fluid level and the brake system should be inspected immediately by your authorized dealer.



**WARNING:** Driving a vehicle with the brake system warning light on is dangerous. A significant decrease in braking performance may occur. It will take you longer to stop the vehicle. Have the vehicle checked by your authorized dealer. Driving extended distances with the parking brake engaged can cause brake failure and the risk of personal injury.

**Anti-lock brake system:** If the ABS light stays illuminated or continues to flash, a malfunction has been detected, have the system serviced immediately by your authorized dealer. Normal braking is still functional unless the brake warning light also is illuminated.





## Instrument Cluster

**Airbag readiness:** If this light fails to illuminate when the ignition is turned to on, continues to flash or remains on, have the system serviced immediately by your authorized dealer. A chime will sound if there is a malfunction in the indicator light.



**Safety belt:** Reminds you to fasten your safety belt. A Belt-Minder® chime will also sound to remind you to fasten your safety belt. Refer to the *Seating and Safety Restraints* chapter to activate/deactivate the Belt-Minder® chime feature.



**Charging system (RTT):** Illuminates when the battery is not charging properly. If it stays on while the engine is running, there may be a malfunction with the charging system. Contact your authorized dealer as soon as possible. This indicates a problem with the electrical system or a related component.



**Engine oil pressure (RTT):** Displays when the oil pressure falls below the normal range. Refer to *Engine oil* in the *Maintenance and Specifications* chapter.



**Door ajar (RTT):** Displays when the ignition is in the on position and any door is not completely closed.



**Engine coolant temperature (RTT):** Illuminates when the engine coolant temperature is high. Stop the vehicle as soon as possible, switch off the engine and let cool. Refer to *Engine coolant* in the *Maintenance and Specifications* chapter.



**WARNING:** Never remove the coolant reservoir cap while the engine is running or hot.

## Instrument Cluster

### **Low tire pressure warning:**

Illuminates when your tire pressure is low. If the light remains on at start up or while driving, the tire pressure should be checked. Refer

to *Inflating your tires* in the *Tires, Wheels and Loading* chapter. When the ignition is first turned to on, the light will illuminate for three seconds to ensure the bulb is working. If the light does not turn on, have the system inspected by your authorized dealer. For more information on this system, refer to *Tire pressure monitoring system (TPMS)* in the *Tires, Wheels and Loading* chapter.

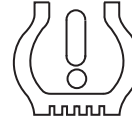

### **Transmission Tow/Haul Feature (RTT and static) (if equipped):**

Displays when the Tow/Haul feature has been activated. Refer to the

*Driving* chapter for transmission function and operation. If the light flashes steadily, have the system serviced immediately, damage to the transmission could occur.

**TOW  
HAUL**

### **AdvanceTrac®/Traction control (if equipped):**

Displays when the AdvanceTrac®/Traction control is active. If the light remains on, have the system serviced immediately, refer to the *Driving* chapter for more information.



**AdvanceTrac®/Traction control off light (if equipped):** Illuminates when AdvanceTrac®/Traction control has been disabled by the driver. Refer to the *Driving* chapter for more information.



### **4X2 (RTT) (if equipped):**

Displays momentarily when two-wheel drive high is selected. If the light fails to display when the ignition is turned on, or remains on, have the system serviced immediately by your authorized dealer.

**4x2**

## Instrument Cluster

**Four-wheel drive low (RTT) (if equipped):** Displays when four-wheel drive low is engaged. If the light fails to display when the ignition is turned on, or remains on, have the system serviced immediately by your authorized dealer.

**4x4  
LOW**

**Four-wheel drive high (RTT) (if equipped):** Displays when four-wheel drive high is engaged. If the light fails to display when the ignition is turned on, or remains on, have the system serviced immediately by your authorized dealer.

**4x4  
HIGH**

**All-wheel drive (RTT) (if equipped):** Displays when using the AWD system.

**AWD**

**Electronic locking differential (RTT) (if equipped):** Displays when using the electronic locking differential.



**Speed control (if equipped):** The speed control system indicator light changes color to indicate what mode the system is in:

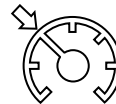

- **On (amber light):** Illuminates when the speed control system is turned on. Turns off when the speed control system is engaged or turned off.
- **Engaged (green light):** Illuminates when the speed control system is engaged. Turns off when the speed control system is disengaged.

**Turn signal:** Illuminates when the left or right turn signal or the hazard lights are turned on. If the indicators stay on or flash faster, check for a burned out bulb.



**High beams:** Illuminates when the high beam headlamps are turned on.



## Instrument Cluster

**Key-in-ignition warning chime:** Sounds when the key is left in the ignition in the off or accessory position and the driver's door is opened.

**Headlamps on warning chime:** Sounds when the headlamps or parking lamps are on, the ignition is off (the key is not in the ignition) and the driver's door is opened.

### GAUGES

**Standard measure base cluster with automatic transmission shown; metric similar and uplevel clusters similar.**

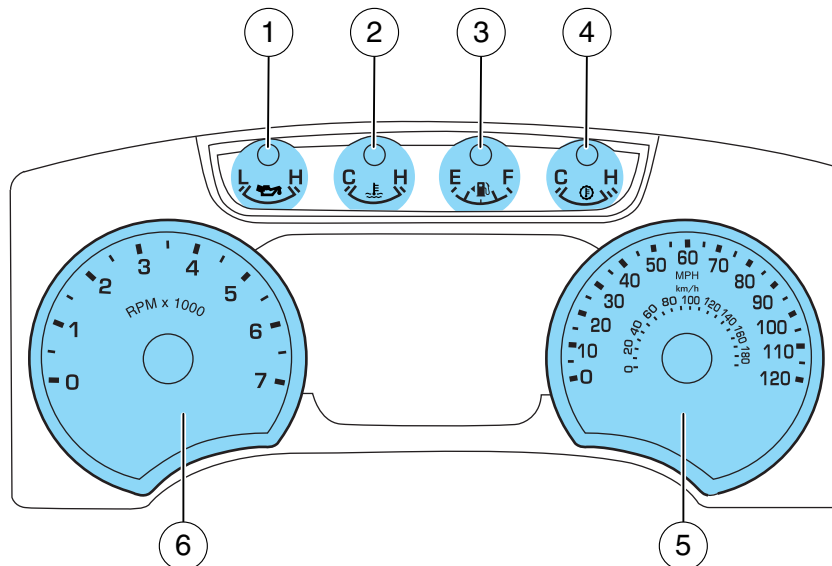

1. **Engine oil pressure gauge:** Indicates engine oil pressure. The needle should stay in the normal operating range (between L and H). If the needle falls below the normal range, stop the vehicle, turn off the engine and check the engine oil level. Add oil if needed. If the oil level is correct, have your vehicle checked at your authorized dealer.

2. **Engine coolant temperature gauge:** Indicates engine coolant temperature. At normal operating temperature, the needle will be in the normal range (between H and C). **If it enters the red section, the engine is overheating. Stop the vehicle as soon as safely possible, switch off the engine and let the engine cool.**

20

## Instrument Cluster



**WARNING:** Never remove the coolant reservoir cap while the engine is running or hot.

3. **Fuel gauge:** Indicates approximately how much fuel is left in the fuel tank (when the ignition is in the on position). The fuel gauge may vary slightly when the vehicle is in motion or on a grade. The fuel icon and arrow indicates which side of the vehicle the fuel filler door is located.

Refer to *Filling the tank* in the *Maintenance and Specifications* chapter for more information.

4. **Transmission fluid temperature gauge:** If the gauge is in the:

**Normal area** The transmission fluid is within the normal operating temperature (between H and C).

**Yellow area** The transmission fluid is higher than normal operating temperature. This can be caused by special operation conditions (i.e. snowplowing, towing or off-road use). Refer to *Special operating conditions* in the *scheduled maintenance information* for instructions. Operating the transmission for extended periods of time with the gauge in the yellow area may cause internal transmission damage.

Altering the severity of the driving conditions is recommended to lower the transmission temperature into the normal range.

**Red area** The transmission fluid is overheating. Stop the vehicle to allow the temperature to return to normal range.

If the gauge is operating in the yellow or red area, stop the vehicle and verify the airflow is not restricted such as snow or debris blocking airflow through the grill. If the gauge continues to show high temperatures, see your authorized dealer.

5. **Speedometer:** Indicates the current vehicle speed.

6. **Tachometer:** Indicates the engine speed in revolutions per minute. Driving with your tachometer pointer continuously at the top of the scale may damage the engine.

**Odometer and trip odometer:** The odometer is displayed on the lower line in the message center and registers the total accumulated distance the vehicle has traveled. For trip odometer, refer to *Base message center* or *Uplevel message center* in this chapter.

### BASE MESSAGE CENTER

Your vehicle's message center is capable of monitoring many vehicle systems and will alert you to potential vehicle problems and various conditions with an informational message followed by a long indicator chime.

## Instrument Cluster

The message center display is located in the instrument cluster.

### Info (information menu)

Press the INFO button repeatedly to cycle through the following features:

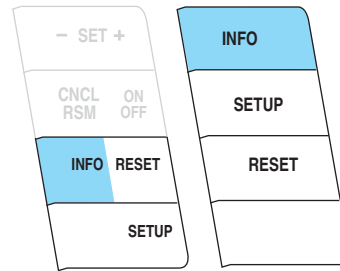

### TRIP A/B

Registers the distance of individual journeys. Press and release INFO button until the A or B trip appears in the display (this represents the trip mode). Press the RESET button to reset.

Refer to *UNITS* later in this section to switch the display from metric to English.

### MYKEY MILES (km) (if programmed)

For more information, refer to *MyKey*® in the *Locks and Security* chapter.

### MILES (km) TO E

This displays an estimate of approximately how far you can drive with the fuel remaining in your tank under normal driving conditions. Remember to turn the ignition off when refueling to allow this feature to correctly detect the added fuel.

Distance to empty is calculated using a running average fuel economy, which is based on your recent driving history of 500 miles (800 km). This value is not the same as the average fuel economy display. The running average fuel economy is re-initialized to a factory default value if the battery is disconnected.

### AVG MPG (L/100km)

Average fuel economy displays your average fuel economy in miles/gallon or liters/100 km.

## Instrument Cluster

If you calculate your average fuel economy by dividing distance traveled by gallons of fuel used (liters of fuel used by 100 kilometers traveled), your figure may be different than displayed for the following reasons:

- Your vehicle was not perfectly level during fill-up
- Differences in the automatic shut-off points on the fuel pumps at service stations
- Variations in top-off procedure from one fill-up to another
- Rounding of the displayed values to the nearest 0.1 gallon (liter)

To determine your average highway fuel economy, do the following:

1. Drive the vehicle at least 5 miles (8 km) with the speed control system engaged to display a stabilized average.
2. Record the highway fuel economy for future reference.

It is important to press the RESET button (press and hold RESET for two seconds in order to reset the function) after setting the speed control to get accurate highway fuel economy readings.

For more information refer to *Essentials of good fuel economy* in the *Maintenance and Specifications* chapter.

### **MPG (L/km) ↑ ↓**

This displays instantaneous fuel economy as a bar graph ranging from ↓ poor economy to ↑ excellent economy.

Your vehicle must be moving to calculate instantaneous fuel economy. When your vehicle is not moving, this function shows ↓, one or no bars illuminated. Instantaneous fuel economy cannot be reset.

### **TIMER**

Timer displays the trip elapsed drive time.

To operate, do the following:

1. Press and release RESET in order to start the timer.
2. Press and release RESET to pause the timer.
3. Press and hold RESET until the timer resets.

### **TBC GAIN (if equipped)**

Displays the level of trailer brake gain or if the trailer is not connected.

## Instrument Cluster

### System check and vehicle feature customization

Press the SETUP button repeatedly to cycle the message center through the following features:

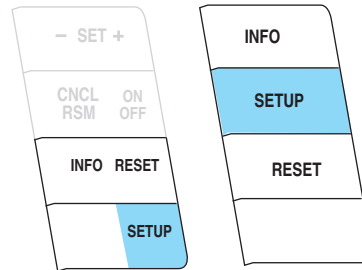

### RESET FOR SYSTEM CHECK

When this message appears, press the RESET button and the message center will begin to cycle through the following systems and provide a status of the item if needed.

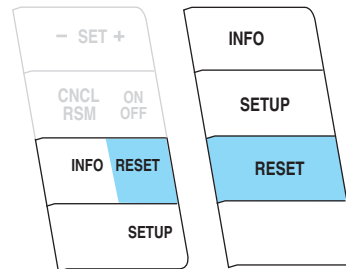

**Note:** Some systems show a message only if a condition is present.

1. XXX% OIL LIFE
2. DOOR STATUS
3. BRAKE SYSTEM
4. FUEL LEVEL LOW
5. TBC GAIN = XX.X  
NO TRAILER (if equipped and no trailer connected)
6. TBC GAIN = XX.X  
OUTPUT = // (if equipped and trailer connected)
7. MYKEY DISTANCE (if programmed)
8. MYKEY(S) PROGRAMMED
9. ADMIN KEYS PROGRAMMED



## Instrument Cluster

### **OIL LIFE**

This displays the remaining oil life.

An oil change is required whenever indicated by the message center and according to the recommended maintenance schedule. **USE ONLY RECOMMENDED ENGINE OILS.**

To reset the oil monitoring system to 100% after each oil change, perform the following:

1. Press and release the SETUP button to display “OIL LIFE XXX% HOLD RESET = NEW”.
2. Press and hold the RESET button for two seconds and release to reset the oil life to 100%.

**Note:** To change oil life 100% value (if equipped with this feature) to another value, proceed to Step 3.

3. Once “OIL LIFE SET TO XXX%” is displayed, release and press the RESET button to change the Oil Life Start Value. Each release and press will reduce the value by 10%.

### **UNITS**

Displays the current units in English or Metric.

Press the RESET button to change from English to Metric.

### **AUTOLAMP (SEC)**

This feature keeps your headlights on for up to three minutes after the ignition is switched off.

Press the RESET button to select the new autolamp delay values of 0, 10, 20, 30, 60, 90, 120 or 180 seconds.

### **AUTOLOCK**

This feature automatically locks all vehicle doors when the vehicle is shifted into any gear, putting the vehicle in motion.

Press the RESET button to turn autolock on or off.

### **AUTOUNLOCK**

This feature automatically unlocks all vehicle doors when the driver's door is opened within 10 minutes of the ignition being turned off.

Press the RESET button to turn autounlock on or off.

### **COURTESY WIPE**

This feature allows for an extra swipe of the wipers after a wipe/wash cycle.

## Instrument Cluster

Press the RESET button to turn it on or off.

### **EASY ENTRY**

This feature automatically moves the driver's seat backwards for easy exit/entry from the vehicle.

Press the RESET button to turn the easy entry/exit seat on or off.

### **REAR PARK AID (if equipped)**

This feature sounds a tone to warn the driver of obstacles near the rear bumper, and functions only when R (Reverse) gear is selected.

Press the RESET button to turn the rear park aid on or off.

### **TRAILER SWAY (if equipped)**

This feature uses the electronic stability control to mitigate trailer sway,

Press the RESET button to turn trailer sway on or off.

### **CREATE MYKEY / MYKEY SETUP / CLEAR MYKEY**

For more information refer to *MyKey*® in the *Locks and Security* chapter.

### **RESET FOR REMOTE START (if equipped)**

Press RESET to choose:

- Remote start on or off
- Duration: 5, 10, 15 minutes
- Remote start climate on or off
- Remote start quiet on or off

### **LANGUAGE = ENGLISH / SPANISH / FRENCH**

Allows you to choose which language the message center will display in. Selectable languages are English, Spanish, or French.

Waiting four seconds or pressing the RESET button cycles the message center through each of the language choices.

Press the RESET button to set the language choice.

### **System warnings**

System warnings alert you to possible problems or malfunctions in your vehicle's operating systems.

In the event of a multiple warning situation, the message center will cycle the display to show all warnings by displaying each one for four seconds.

26

## Instrument Cluster

The message center will display the last selected feature if there are no more warning messages.

Types of messages and warnings:

- Some messages will appear briefly to inform you of something you may need to take action on or be informed of.
- Some messages will appear once and then again when the vehicle is restarted.
- Some messages will reappear after clearing or being reset if a problem or condition is still present and needs your attention.
- Some messages can be acknowledged and reset by pressing RESET. This allows you to use the full message center functionality by clearing the message.

**DRIVER DOOR AJAR** — Displayed when the driver door is not completely closed.

**PASSENGER DOOR AJAR** — Displayed when the passenger door is not completely closed.

**REAR LEFT DOOR AJAR** — Displayed when the rear left door is not completely closed.

**REAR RIGHT DOOR AJAR** — Displayed when the rear right door is not completely closed.

**FUEL LEVEL LOW** — Displayed as an early reminder of a low fuel condition.

**PARK BRAKE ENGAGED** — Displayed when the parking brake is set, the engine is running and the vehicle is driven more than 3 mph (5 km/h). If the warning stays on after the parking brake is released, contact your authorized dealer as soon as possible.

**CHECK BRAKE SYSTEM** — Displayed when a fault has been detected by the ABS module.

**CHECK CHARGING SYSTEM** — Displayed when the electrical system is not maintaining proper voltage. If you are operating electrical accessories when the engine is idling at a low speed, turn off as many of the electrical loads as soon as possible. If the warning stays on or comes on when the engine is operating at normal speeds, contact your authorized dealer as soon as possible.

## Instrument Cluster

**TURN POWER OFF TO SAVE BATT (if equipped)** — Displayed when the battery management system determines that:

- the battery is at a low state of charge or,
- the ignition has been in accessory position or on position with the engine off for approximately 45 minutes.

Turn the ignition off as soon as possible to protect the battery. This message will clear once the vehicle has been started and the battery state of charge has recovered. Turning off unnecessary electrical loads while driving will allow faster battery state-of-charge recovery. See *Battery management system* in the *Maintenance and Specifications* chapter for more information.

**LOW BATTERY LESS FEATURES (if equipped)** — Displayed when the battery management system detects an extended low-voltage condition. Various vehicle features will be disabled to help preserve the battery. Turn off as many of the electrical loads as soon as possible to improve system voltage. If the system voltage has recovered, the disabled features will operate again as normal.

**CHECK REAR PARK AID (if equipped)** — Displayed when the transmission is in R (Reverse). Refer to *Reverse sensing system* in the *Driving* chapter.

**TIRE PRESSURE SENSOR FAULT** — Displayed when a tire pressure sensor is malfunctioning, or your spare tire is in use. For more information on how the system operates under these conditions, refer to *Understanding Your Tire Pressure Monitoring System (TPMS)* in the *Tires, Wheels and Loading* chapter. If the warning stays on or continues to come on, contact your authorized dealer as soon as possible.

**LOW TIRE PRESSURE** — Displayed when one or more tires on your vehicle have low tire pressure. Refer to *Inflating Your Tires* in the *Tires, Wheels and Loading* chapter.

**CHECK FUEL FILL INLET** — Displayed when the fuel fill inlet may not be properly closed. Refer to *Easy Fuel® “no cap” fuel system* in the *Maintenance and Specifications* chapter.

**SERVICE ADVANCETRAC** — Displayed when the AdvanceTrac® system has detected a condition that requires service. Contact your authorized dealer as soon as possible.

**ADVANCETRAC OFF (if equipped)** — Displayed when the AdvanceTrac® system has been disabled by the driver.

**ADVANCETRAC ON (if equipped)** — Displayed when the AdvanceTrac® system has been enabled by the driver.

28

## Instrument Cluster

**TRACTION CONTROL OFF (if equipped)** — Displayed when the traction control has been disabled by the driver. Refer to the *Driving* chapter for more information.

**TRACTION CONTROL ON (if equipped)** — Displayed when the traction control has been enabled by the driver. Refer to the *Driving* chapter for more information.

**CHECK 4X4 (if equipped)** — Displayed when a 4X4 system fault is present. For more information, refer to *Four-wheel drive (4WD) operation* in the *Driving* chapter.

**TIRE PRESSURE MONITOR FAULT** — Displayed when the tire pressure monitoring system (TPMS) is malfunctioning. If the warning stays on or continues to come on, contact your authorized dealer as soon as possible.

**BRAKE FLUID LEVEL LOW** — Indicates the brake fluid level is low and the brake system should be inspected immediately. Refer to *Brake fluid* in the *Maintenance and Specifications* chapter.

**OIL CHANGE REQUIRED** — Displayed when an oil change is required.

**XX%ENGINE OIL CHANGE SOON**—Displayed when an oil change will soon be required and shows the percentage of oil life left.

**TRAILER BRAKE MODULE FAULT (if equipped)**— Displayed and accompanied by a single chime, in response to faults sensed by the TBC. Refer to *Trailer towing* in the *Tires, Wheels and Loading* chapter for more information.

**WIRING FAULT ON TRAILER (if equipped)** — Displayed if there are certain faults in the vehicle wiring and trailer wiring/brake system. Refer to *Trailer towing* in the *Tires, Wheels and Loading* chapter for more information.

**TRAILER SWAY REDUCE SPEED (if equipped)** — Displayed when the trailer sway control has detected trailer sway. For more information, refer to the *Driving* chapter for more information.

**4X4 SHIFT IN PROGRESS** — Displayed when the 4X4 system is making a shift. For further information, refer to *Four-wheel drive (4WD) operation* in the *Driving* chapter.

**FOR 4X4 LOW SLOW TO 3 MPH (if equipped)** — Displayed when 4X4 LOW is selected while the vehicle is moving. For more information, refer to *Four-wheel drive (4WD) operation* in the *Driving* chapter.

**FOR 4X4 LOW SHIFT TO N (if equipped)** — Displayed when 4X4 LOW is selected and the vehicle is stopped. For more information, refer to *Four-wheel drive (4WD) operation* in the *Driving* chapter.

## Instrument Cluster

**TO EXIT 4X4 LOW SLOW TO 3 MPH (if equipped)** — Displayed when 2WD is selected while the vehicle is operating in 4X4 LOW. For more information, refer to *Four-wheel drive (4WD) operation* in the *Driving* chapter.

**TO EXIT 4X4 LOW SHIFT TO N (if equipped)** — Displayed when 2WD is selected while the vehicle has been stopped in 4X4 LOW. For more information, refer to *Four-wheel drive (4WD) operation* in the *Driving* chapter.

**SHIFT DELAYED PULL FORWARD (if equipped)** — May display when shifting to or from 4X4 LOW. For more information, refer to *Four-wheel drive (4WD) operation* in the *Driving* chapter.

**TRAIN LEFT FRONT TIRE (if equipped)** — Displayed when training the TPMS system. Refer to *TPMS reset procedure* in the *Tires, Wheels and Loading* chapter for more information.

**TRAIN RIGHT FRONT TIRE (if equipped)** — Displayed when training the TPMS system. Refer to *TPMS reset procedure* in the *Tires, Wheels and Loading* chapter for more information.

**TRAIN RIGHT REAR TIRE (if equipped)** — Displayed when training the TPMS system. Refer to *TPMS reset procedure* in the *Tires, Wheels and Loading* chapter for more information.

**TRAIN LEFT REAR TIRE (if equipped)** — Displayed when training the TPMS system. Refer to *TPMS reset procedure* in the *Tires, Wheels and Loading* chapter for more information.

**TIRES NOT TRAINED – REPEAT (if equipped)** — Displayed when an error occurs while training the TPMS system. Refer to *TPMS reset procedure* in the *Tires, Wheels and Loading* chapter for more information.

**TRAINING COMPLETE (if equipped)** — Displayed when training of the TPMS system is complete. Refer to *TPMS reset procedure* in the *Tires, Wheels and Loading* chapter for more information.

**MYKEY ACTIVE DRIVE SAFELY** — Displayed at startup when MyKey® is in use. Refer to *MyKey®* in the *Locks and Security* chapter for more information.

**KEY COULD NOT PROGRAM** — Displayed when an attempt is made to program a spare key using two existing MyKeys. Refer to *MyKey®* in the *Locks and Security* chapter for more information.

**VEHICLE SPEED 80 MPH MAX** — Displayed when a MyKey® is in use and the Admin has enabled the MyKey speed limit and the vehicle

## Instrument Cluster

speed is 80 mph (130 km/h). Refer to *MyKey*® in the *Locks and Security* chapter for more information.

**SPEED LIMITED TO 80 MPH** — Displayed when starting the vehicle and *MyKey*® is in use and the *MyKey* speed limit is on. Refer to *MyKey*® in the *Locks and Security* chapter for more information.

**CHECK SPEED DRIVE SAFELY** — Displayed when a *MyKey*® is in use and the optional setting is on and the vehicle exceeds a preselected speed. Refer to *MyKey*® in the *Locks and Security* chapter for more information.

**VEHICLE NEAR TOP SPEED** — Displayed when a *MyKey*® is in use and the *MyKey* speed limit is on and the vehicle speed is approaching 80 mph (130 km/h). Refer to *MyKey*® in the *Locks and Security* chapter for more information.

**TOP SPEED MYKEY SETTING** — Displayed when a *MyKey*® is in use and the *MyKey* speed limit is on and the vehicle speed is 80 mph (130 km/h). Refer to *MyKey*® in the *Locks and Security* chapter for more information.

**BUCKLE UP TO UNMUTE AUDIO** — Displayed when a *MyKey*® is in use and *Belt-Minder*® is activated. Refer to *MyKey*® in the *Locks and Security* chapter for more information.

**ADVTRAC ON MYKEY SETTING** — Displayed when a *MyKey*® is in use when trying to disable the *AdvanceTrac*® system and the optional setting is on. Refer to *MyKey*® in the *Locks and Security* chapter for more information.

**TO STOP ALARM START VEHICLE** — Displayed when the perimeter alarm system is armed and the vehicle is entered using the key on the driver's side door. In order to prevent the perimeter alarm system from triggering, the ignition must be turned to start or on before the 12 second chime expires. See *Perimeter alarm system* in the *Locks and security* chapter.

**SECURITY SYSTEM FAULT** — Displayed when the security system has detected a fault. See your authorized dealer for service.

**INTKEY COULD NOT PROGRAM** — Displayed when an attempt is made to program a fifth integrated key to the remote keyless entry system. For more information on integrated key, refer to the *Locks and Security* chapter.

**KEY COULD NOT PROGRAM** — Displayed when an attempt is made to program a spare key using two existing *MyKeys*. Refer to *MyKey*® in the *Locks and Security* chapter for more information.

## Instrument Cluster

**SLOW VEHICLE TO XX MPH FOR ELD (if equipped)** — Displayed when the vehicle speed requirement for the electronic locking differential mode has not been met.

**CHECK LOCKING DIFFERENTIAL (if equipped)** — Displayed when an electronic locking differential (ELD) system fault is present. For more information, refer to *Electronic locking differential (ELD)* in the *Driving* chapter.

**HILL DESCENT CONTROL FAULT (if equipped)** — Displayed when a hill descent system fault is present.

**HILL CNTRL OFF SYSTEM COOLING (if equipped)** — Displayed when a hill descent system fault is present.

**FOR OFF ROAD SLOW TO 5 MPH (if equipped)** — Displayed when the vehicle speed requirement for off-road mode entry has not been met.

**OFF ROAD MODE ENABLED (if equipped)** — Displayed when off-road mode becomes active.

**EXITING OFF ROAD MODE (if equipped)** — Displayed when off-road mode becomes inactive.

**HILL DESCENT CONTROL ACTIVE (if equipped)** — Displayed when hill descent control mode becomes active.

**HILL DESCENT CONTROL OFF (if equipped)** — Displayed when hill descent control mode becomes inactive.

**FOR HILL CNTRL 20 MPH OR LESS (if equipped)** — Displayed when the vehicle speed requirement for hill control mode entry has not been met.

**DRIVER RESUME CONTROL (if equipped)** — Displayed when the hill control and off-road mode require the driver to resume control.

**FOR HILL CNTRL SELECT GEAR (if equipped)** — Displayed when the driver is requested to select a transmission gear to enable operation of the hill mode and off-road mode.

**COAST DOWN MODE (if equipped)** — Displayed when vehicle enters coast down mode.

### UPLEVEL MESSAGE CENTER (IF EQUIPPED)

Your vehicle's message center is capable of monitoring many vehicle systems and will alert you to potential vehicle problems and various conditions with informational messages and/or warnings.

The message center is also used to program/configure the different features of your vehicle.



## Instrument Cluster

The message center display is located in the instrument cluster. Use the steering wheel mounted buttons to navigate through the message center.

Press the up/down buttons to move up/down through the message center choices.

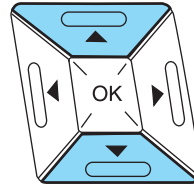

Press the left/right buttons to move left/right through the message center choices.

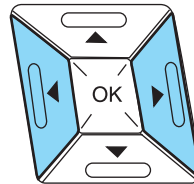

Press the OK button to select highlighted options and confirm choices/messages.

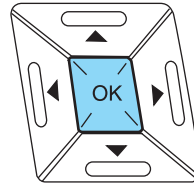

### Main menu

From the main menu screen you can choose the following:

- Gauge Mode
- Trip A/B
- Fuel Economy
- Truck Apps (if equipped)
- Settings
- Information

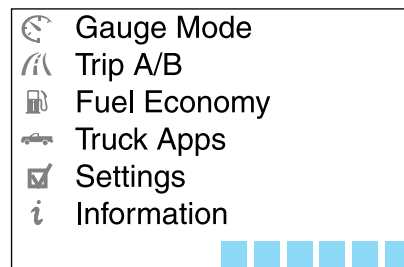

## Instrument Cluster

Scroll up/down to highlight one of the options, then press the right arrow key or OK to enter into that menu option.

### **Gauge Mode**

**Gauge Detail:** In this mode, the following options are available in different graphical formats:

- Trans Temp
- Blank screen

### **Trip A/B**

In this mode, Trip A or B registers the following:

- Trip time — shows the elapsed trip time. This timer will stop when the vehicle is turned off and will restart when the vehicle is restarted.
- Trip distance — shows the accumulated trip distance.
- Fuel used — shows the amount of fuel used for a given trip.
- Average MPG (L/100km) — shows the average distance traveled per unit of fuel used for a given trip.
- Odometer — shows the vehicle's total accumulated distance. This value cannot be reset.

Press the right arrow key to reach Trip B. Press the left arrow to go back to Trip A.

Press OK to pause the Trip A or B screen/press again to un-pause.

Press and hold OK to reset the currently displayed trip information.

### **Fuel Economy**

In this mode, fuel economy information is displayed as follows:

- Instant MPG (L/100km) — shows instantaneous fuel usage.
- Miles (kilometers) to empty — shows the approximate distance the vehicle can travel before running out of fuel.
- Average MPG (L/100km) — shows the average fuel usage based on time. See Fuel Hist. following to change the time interval. Press and hold OK to reset this value.

## Instrument Cluster

If you calculate your average fuel economy by dividing miles traveled by gallons of fuel used (liters of fuel used by 100 kilometers traveled), your figure may be different than displayed for the following reasons:

- Your vehicle was not perfectly level during fill-up.
- Differences in the automatic shut-off points on the fuel pumps at service stations.
- Variations in top-off procedure from one fill-up to another.
- Rounding of the displayed values to the nearest 0.1 gallon (liter).

To determine your average highway fuel economy, do the following:

1. Drive the vehicle at least 5 miles (8 km) with the speed control system engaged to display a stabilized average.
2. Record the highway fuel economy for future reference.

It is important to press RESET in order to reset the function after setting the speed control to get accurate highway fuel economy readings.

For more information refer to *Essentials of good fuel economy* in the *Maintenance and Specifications* chapter.

**Fuel Hist.:** Press the right arrow key (when in the Fuel Econ. menu) to reach Fuel Hist. Fuel history shows fuel usage (AVG MPG or L/100km) as a bar graph based on time. The duration time can be changed as follows:

Duration– Press the right arrow key (when in the Fuel Hist. menu) to reach the following duration choices.

- 5 Minutes
- 10 Minutes
- 30 Minutes
- Last 5 Resets

Use the up/down arrows keys to highlight one of the choices; press and hold OK to set your choice.

The graph is updated each minute with the fuel economy that was achieved during the prior 5, 10, 30 minutes or last 5 resets of driving.

## Instrument Cluster

### **Truck Apps (if equipped)**

In this mode, off-road and trailer towing application options are available.

<b>*Off Road</b>
Pitch and bank angle (in degrees): Displays the pitch angle (front to rear) and bank angle (side to side) of the road surface.
Steering angle (in degrees): Displays the steering angle of the front wheels after the vehicle has been driven for a period of time.
Differential lock/unlock: Displays the state (locked or unlocked) of the electronic locking differential.
Torque flow: Displays the torque flow to the front and rear driveline and operating mode of the transfer case: 4X2, 4X4 High, 4X4 Low, AWD.
AdvanceTrac® sport mode, hill descent control, off-road mode: Displays which modes are active.

\* If equipped—your vehicle may be equipped with some or all of these options.

When “Press OK for info” is displayed, pressing OK will give you information on the following options if equipped (**Note:** Information is only available when traveling less than 3 mph [5 km/h]):

- 4X4 System
- AdvanceTrac®
- AWD (All-Wheel Drive)
- ELD (Electronic Locking Differential)
- HDC (Hill Descent Control)
- Off-Road Mode

\***Trailer:** Press the right arrow key (when in the Off-Road menu) to reach the Trailer menu. The following information is displayed

- Active trailer name or default trailer
- Accumulated trailer distance
- Trailer gain and output
- Trailer disconnected (Disregard this status if your vehicle is not equipped with a factory installed trailer brake controller. This message may appear when an aftermarket TBC is used even when the trailer is connected.)

## Instrument Cluster

When “Press OK for options” is displayed, pressing OK will open the trailer options menus:

<b>Trailer</b>	
Change Active Trailer	<p>When this is highlighted, press the right arrow key to change the currently selected trailer. Use the up and down arrows to select a trailer and press the OK button to choose the highlighted trailer.</p> <p>Adding a new trailer– Use the up/down arrows to highlight “New Trailer” from the Change Active Trailer menu and press the right arrow key to enter the New Trailer input screen. Use the up/down arrow keys to choose alpha, numeric and symbol characters and then press the right arrow to move the character space over. Continue adding characters as needed. Press the left arrow to go back and change a previously selected character. When finished with the new trailer name, press OK to accept the new trailer name.</p>
Connection Checklist (if equipped)	Press the right arrow button when this is highlighted to show the trailer connection types: Conventional, Fifth Wheel and Gooseneck. Use the up/down arrows to highlight one of these choices and press OK to display the connection checklist. Follow the on-screen instructions to go through the connections list.
Delete Trailer	Press the right arrow button when this is highlighted to show currently stored trailers. Use the up/down arrows to highlight the trailer you want to delete and press OK to delete. Follow the on-screen prompts to exit or confirm delete.
Information Screen	Press the right arrow button when this is highlighted to display information on the following vehicle features: Tow Haul mode, Trailer Brake Controller.

## Instrument Cluster

Trailer	
Rename Trailer	Press the right arrow button when this is highlighted to display saved or default trailers. Use the up/down buttons to highlight a trailer and press OK to select it. Use the up/down arrow buttons to change the characters as needed. When done, press OK to accept the change.
Reset Trailer Mileage / Kilometers (if equipped)	Press the right arrow button when this is highlighted to display accumulated distance on a given trailer within the list of trailer(s). Use the up/down buttons to select a trailer, then press and hold OK to reset the trailer mileage (kilometers).

\* If equipped—your vehicle may be equipped with some or all of these options.

### Settings

In this mode, you can configure different driver setting choices (if equipped). Press the right arrow key (when in the Settings menu) to reach the Driver Assist menu:

Driver Assist		
Rear Park Aid	On/Off	
Rear Video Camera	Camera Delay	On/Off
	Visual Park Aid	On/Off
	Guidelines	Fixed/Off
	Zoom Levels (This will only be shown when Reverse (R) is selected.)	Off, Level 1–3
Trailer Brake Mode	Electric or Elect. Over Hydraulic	
Trailer Sway Control	On/Off	

## Instrument Cluster

Vehicle			
Autolamp Delay	Off or XXX seconds		
DTE Calculation (distance to empty)	Normal History Used		
	Towing History Used		
Easy Entry/Exit	On/Off		
Locks	Autolock,	On/Off	
	Autounlock	On/Off	
	Unlocking	One Stage or Two Stage	
Menu Control	Standard: with standard set, pressing the up/down arrows from a lower level menu will escape to the main menu. Memory On: with memory on set, pressing the up/down arrows will navigate to the previous lower level menu.		
Oil Life Reset	Set to XXX% (Press and hold OK to set).		
Pwr Running Boards	Auto/Off/Out		
Remote Start	Climate Control	Front Defrost	Auto/Off
		Rear Defrost	
		Driver Seat	
		Passenger Seat	
	Heater-A/C	Auto/ Last Setting	
Duration	5, 10 or 15 minutes, Off		
Quiet Start	On/Off		
Wipers	Courtesy Wipe	On/Off	
	Rain Sensing wipers	On/Off	

## Instrument Cluster

<b>MyKey</b>	
Create MyKey	Hold OK to create MyKey
*AdvanceTrac	Always on or Selectable
*MAX Speed	80 MPH (120 km/h) or Off
*Speed Warning	45, 55 or 65 MPH (75, 90 or 105 km/h), Off
*Volume Limiter	On/Off
*Clear MyKeys	Hold OK to Clear MyKeys

\*Only displays if MyKey is programmed.

<b>Language</b>	
English, Español, Français	

<b>Units</b>	
Units	English or Metric

<b>System Reset</b>	
Hold OK to Reset System to Factory Default	

### Information

In this mode, you can view different vehicle system information and perform a system check.

When “Press OK for info” is displayed, pressing OK will give you information on the currently selected/displayed options. Information is only available when traveling less than 3 mph (5 km/h).

<b>MyKey</b>	
Admin Keys (Number of admin keys)	
MyKeys (Number of MyKeys programmed)	
MyKey Miles (km) (Distance traveled using a programmed MyKey)	

<b>System Check</b>	
Oil Life	
Doors	
Brakes	
Trailer Brake Ctrl.	Gain and Output (when trailer is connected) No trailer (when no trailer is connected)
Park Aid	Check Rear Park Aid
Fuel Level (distance to empty)	

40



## Instrument Cluster

Some items will only display during a system check if a problem has been detected. If an issue exists on one of the monitored systems, the message center will display the number of warnings that need immediate attention in red and the number of informational warnings will be listed in amber. Use the up/down arrow buttons to scroll through the list; press the right arrow button to display specific information on the highlighted warning.

### ***Transmission indicator display***

The transmission gear indicator displays in the right side of the message center when using the SelectShift Automatic™ transmission feature. This display will not be shown in all screen modes. For example: when programming certain vehicle features or in certain information menus.

### ***System warnings and status messages***

System warnings alert you to possible problems or malfunctions in your vehicle's operating systems.

In the event of a multiple warning situation, the message center will cycle the display to show all warnings by displaying each one for four seconds.

The message center will display the last selected feature if there are no more warning messages.

Types of messages and warnings:

- Some messages will appear briefly to inform you of something you may need to take action on or be informed of.
- Some messages will appear once and then again when the vehicle is restarted.
- Some messages will reappear after clearing or being reset if a problem or condition is still present and needs your attention.
- Some messages can be acknowledged and reset by pressing OK. This allows you to use the full message center functionality by clearing the message.

**DOOR AJAR** — Displayed when the door is not completely closed.

**DRIVER DOOR AJAR** — Displayed when the driver door is not completely closed.

**LEFT REAR DOOR AJAR** — Displayed when the rear left door is not completely closed.

**PASSENGER DOOR AJAR** — Displayed when the passenger door is not completely closed.

## Instrument Cluster

**RIGHT REAR DOOR AJAR** — Displayed when the rear right door is not completely closed.

**CHECK FUEL FILL INLET** — Displayed when the fuel fill inlet may not be properly closed. Refer to *Easy Fuel*® “no cap” fuel system in the *Maintenance and Specifications* chapter.

**FUEL LEVEL LOW** — Displayed as an early reminder of a low fuel condition.

**CHECK CHARGING SYSTEM** — Displayed when the electrical system is not maintaining proper voltage. If you are operating electrical accessories when the engine is idling at a low speed, turn off as many of the electrical loads as soon as possible. If the warning stays on or comes on when the engine is operating at normal speeds, contact your authorized dealer as soon as possible.

**TURN POWER OFF TO SAVE BATTERY (if equipped)** — Displayed when the battery management system determines that:

- the battery is at a low state of charge or,
- the ignition has been in accessory position or on position with the engine off for approximately 45 minutes.

Turn the ignition off as soon as possible to protect the battery. This message will clear once the vehicle has been started and the battery state of charge has recovered. Turning off unnecessary electrical loads while driving will allow faster battery state-of-charge recovery. See *Battery management system* in the *Maintenance and Specifications* chapter for more information.

**LOW BATTERY FEATURES TEMPORARILY TURNED OFF (if equipped)** — Displayed when the battery management system detects an extended low-voltage condition. Various vehicle features will be disabled to help preserve the battery. Turn off as many of the electrical loads as soon as possible to improve system voltage. If the system voltage has recovered, the disabled features will operate again as normal.

**BRAKE FLUID LEVEL LOW** — Indicates the brake fluid level is low and the brake system should be inspected immediately. Refer to *Brake fluid* in the *Maintenance and Specifications* chapter.

**CHECK BRAKE SYSTEM** — Displayed when the brake system needs servicing. If the warning stays on or continues to come on, contact your authorized dealer as soon as possible.

## Instrument Cluster

**PARK BRAKE ENGAGED** — Displayed when the parking brake is set, the engine is running and the vehicle is driven more than 3 mph (5 km/h). If the warning stays on after the parking brake is released, contact your authorized dealer as soon as possible.

**ADVANCETRAC OFF (if equipped)** — Displayed when the AdvanceTrac® system has been disabled by the driver.

**ADVANCETRAC ON (if equipped)** — Displayed when the AdvanceTrac® system has been enabled by the driver.

**SERVICE ADVANCETRAC (if equipped)** — Displayed when the AdvanceTrac® system has detected a condition that requires service. Contact your authorized dealer as soon as possible.

**POWER REDUCED TO LOWER ENGINE TEMP** — Displayed when the engine temperature gauge needle moves to H. You may notice reduced engine power. Refer to *Engine coolant* in the *Maintenance and Specifications* chapter for more information.

**ENGINE OIL CHANGE SOON** — Displayed when the engine oil life remaining is 5% to 1%.

**OIL CHANGE REQUIRED** — Displayed when the oil life left reaches 0%.

**LOW TIRE PRESSURE** — Displayed when one or more tires on your vehicle have low tire pressure. Refer to *Inflating Your Tires* in the *Tires, Wheels and Loading* chapter.

**TIRE PRESSURE MONITOR FAULT** — Displayed when the tire pressure monitoring system is malfunctioning. If the warning stays on or continues to come on, have the system inspected by your authorized dealer.

**TIRE PRESSURE SENSOR FAULT** — Displayed when a tire pressure sensor is malfunctioning, or your spare tire is in use. For more information on how the system operates under these conditions, refer to *Understanding your Tire Pressure Monitoring System (TPMS)* in the *Tires, Wheels and Loading* chapter. If the warning stays on or continues to come on, contact your authorized dealer as soon as possible.

**TIRES NOT TRAINED - REPEAT** — Displayed when an error occurs while training the TPMS. Refer to *TPMS reset procedure* in the *Tires, Wheels and Loading* chapter for more information.

**TRAIN LEFT FRONT TIRE** — Displayed when training the TPMS system. Refer to *TPMS reset procedure* in the *Tires, Wheels and Loading* chapter for more information.

## Instrument Cluster

**TRAIN LEFT REAR TIRE** — Displayed when training the TPMS system. Refer to *TPMS reset procedure* in the *Tires, Wheels and Loading* chapter for more information.

**TRAIN RIGHT FRONT TIRE** — Displayed when training the TPMS system. Refer to *TPMS reset procedure* in the *Tires, Wheels and Loading* chapter for more information.

**TRAIN RIGHT REAR TIRE** — Displayed when training the TPMS system. Refer to *TPMS reset procedure* in the *Tires, Wheels and Loading* chapter for more information.

**TRAINING COMPLETE** — Displayed when training of the TPMS system is complete. Refer to *TPMS reset procedure* in the *Tires, Wheels and Loading* chapter for more information.

**POWER STEERING ASSIST FAULT** — The power steering system has disabled power steering assist due to a system error; service is required.

**SERVICE POWER STEERING** — The power steering system has detected a condition that requires service.

**SERVICE POWER STEERING NOW** — The power steering system has detected a condition that requires service immediately.

**BUCKLE UP TO UNMUTE AUDIO** — Displayed when a MyKey® is in use and Belt-Minder® is activated. Refer to *MyKey®* in the *Locks and Security* chapter for more information.

**TRACTION CONTROL OFF (if equipped)** — Displayed when the traction control has been disabled by the driver. Refer to the *Driving* chapter for more information.

**TRACTION CONTROL ON (if equipped)** — Displayed when the traction control has been enabled by the driver. Refer to the *Driving* chapter for more information.

**CHECK 4X4 (if equipped)** — Displayed when a 4X4 system fault is present. For more information, refer to *Four-wheel drive (4WD) operation* in the *Driving* chapter.

**4X4 SHIFT IN PROGRESS (if equipped)** — Displayed when the 4X4 system is making a shift. For further information, refer to *Four-wheel drive (4WD) operation* in the *Driving* chapter.

**FOR 4X4 LOW APPLY BRAKE (if equipped)** — Displayed when trying to select 4X4 LOW. For more information, refer to *Four-wheel drive (4WD) operation* in the *Driving* chapter.

**FOR 4X4 LOW SHIFT TO N (if equipped)** — Displayed when 4X4 LOW is selected and the vehicle is stopped. For more information, refer to *Four-wheel drive (4WD) operation* in the *Driving* chapter.

44

## Instrument Cluster

**FOR 4X4 LOW SLOW TO 3 MPH (if equipped)** — Displayed when 4X4 LOW is selected while the vehicle is moving. For more information, refer to *Four-wheel drive (4WD) operation* in the *Driving* chapter.

**TO EXIT 4X4 LOW APPLY BRAKE (if equipped)** — Displayed when 2WD is selected from 4X4 LOW mode. For more information, refer to *Four-wheel drive (4WD) operation* in the *Driving* chapter.

**TO EXIT 4X4 LOW SHIFT TO N (if equipped)** — Displayed when 2WD is selected while the vehicle has been stopped in 4X4 LOW. For more information, refer to *Four-wheel drive (4WD) operation* in the *Driving* chapter.

**TO EXIT 4X4 LOW SLOW TO 3 MPH (if equipped)** — Displayed when 2WD is selected while the vehicle is operating in 4X4 LOW. For more information, refer to *Four-wheel drive (4WD) operation* in the *Driving* chapter.

**SHIFT DELAYED PULL FORWARD (if equipped)** — May display when shifting to or from 4X4 LOW. For more information, refer to *Four-wheel drive (4WD) operation* in the *Driving* chapter.

**CHECK LOCKING DIFFERENTIAL (if equipped)** — Displayed when an electronic locking differential (ELD) system fault is present. For more information, refer to *Electronic locking differential (ELD)* in the *Driving* chapter.

**CHECK SPEED DRIVE SAFELY** — Displayed when a MyKey® is in use and the optional setting is on and the vehicle exceeds a preselected speed. Refer to *MyKey®* in the *Locks and Security* chapter for more information.

**COULD NOT PROGRAM INTEGRATED KEY** — Displayed when an attempt is made to program a fifth integrated key to the remote keyless entry system. For more information on integrated key, refer to the *Locks and Security* chapter.

**ESC ALWAYS ON - MYKEY SETTING** — Displayed when a MyKey® is in use and the ESC cannot be deactivated. Refer to *MyKey®* in the *Locks and Security* chapter for more information.

**MYKEY ACTIVE DRIVE SAFELY** — Displayed when a MyKey® is in use. Refer to *MyKey®* in the *Locks and Security* chapter for more information.

**MYKEY COULD NOT PROGRAM** — Displayed when an attempt is made to program a spare key using two existing MyKeys. Refer to *MyKey®* in the *Locks and Security* chapter for more information.

**SECURITY SYSTEM FAULT (if equipped)** — Displayed when the security system has detected a fault. See your authorized dealer for service.

## Instrument Cluster

**SPEED LIMITED TO 130 KM/H** — Displayed when starting the vehicle and MyKey® is in use and the MyKey speed limit is on. Refer to *MyKey®* in the *Locks and Security* chapter for more information.

**SPEED LIMITED TO 80 MPH** — Displayed when starting the vehicle and MyKey® is in use and the MyKey speed limit is on. Refer to *MyKey®* in the *Locks and Security* chapter for more information.

**VEHICLE AT TOP SPEED - MYKEY SETTING** — Displayed when a MyKey® is in use and the MyKey speed limit is on and the vehicle speed is 80 mph (130 km/h). Refer to *MyKey®* in the *Locks and Security* chapter for more information.

**VEHICLE NEAR TOP SPEED** — Displayed when a MyKey® is in use and the MyKey speed limit is on and the vehicle speed is approaching 80 mph (130 km/h). Refer to *MyKey®* in the *Locks and Security* chapter for more information.

**CHECK REAR PARK AID (if equipped)** — Displayed when the transmission is in R (Reverse) and the park aid is disabled.

**REAR PARK AID OFF (if equipped)** — Displayed when the rear park aid is disabled by the driver.

**REAR PARK AID ON (if equipped)** — Displayed when the rear park aid is enabled.

**TO STOP ALARM, START VEHICLE (if equipped)** — Displayed when the perimeter alarm system is armed and the vehicle is entered using the key on the driver's side door. In order to prevent the perimeter alarm system from triggering, the ignition must be turned to start or on before the 12 second chime expires. See *Perimeter alarm system* in the *Locks and security* chapter.

**TRAILER BRAKE GAIN: XX.X [OUTPUT] (if equipped)** — Displays the current gain setting for the trailer brake. Refer to *Trailer towing* in the *Tires, Wheels and Loading* chapter for more information.

**TRAILER BRAKE GAIN: XX.X NO TRAILER (if equipped)** — Displays the current gain setting for the trailer brake when a trailer is not connected. Refer to *Trailer towing* in the *Tires, Wheels and Loading* chapter for more information.

**TRAILER BRAKE MODULE FAULT (if equipped)** — Displayed and accompanied by a single chime, in response to faults sensed by the TBC. Refer to *Trailer towing* in the *Tires, Wheels and Loading* chapter for more information.

## Instrument Cluster

**TRAILER CONNECTED (if equipped)** — Displayed when a correct trailer connection (a trailer with electric trailer brakes) is sensed during a given ignition cycle. Refer to *Trailer towing* in the *Tires, Wheels and Loading* chapter for more information.

**TRAILER DISCONNECTED (if equipped)** — Displayed when a trailer connection becomes disconnected, either intentionally or unintentionally, and has been sensed during a given ignition cycle. Disregard this status if your vehicle is not equipped with a factory installed trailer brake controller. This message may appear when an aftermarket TBC is used even when the trailer is connected. Refer to *Trailer towing* in the *Tires, Wheels and Loading* chapter for more information.

**TRAILER SWAY REDUCE SPEED (if equipped)** — Displayed when the trailer sway control has detected trailer sway. For more information, refer to the *Driving* chapter for more information.

**WIRING FAULT ON TRAILER (if equipped)** — Displayed if there are certain faults in the vehicle wiring and trailer wiring/brake system. Refer to *Trailer towing* in the *Tires, Wheels and Loading* chapter for more information.

**FOR OFF ROAD SLOW TO 5 MPH (if equipped)**— Displayed when the vehicle speed requirement for off-road mode entry has not been met.

**OFF ROAD MODE ENABLED (if equipped)**— Displayed when off-road mode becomes active.

**EXITING OFF ROAD MODE (if equipped)**— Displayed when off-road mode becomes inactive.

**HILL DESCENT CONTROL ACTIVE (if equipped)**— Displayed when hill descent control mode becomes active.

**HILL DESCENT CONTROL OFF (if equipped)**— Displayed when hill descent control mode becomes inactive.

**DRIVER RESUME CONTROL (if equipped)**— Displayed when the hill control and off-road mode require the driver to resume control.

**COAST DOWN MODE (if equipped)**— Displayed when vehicle enters coast down mode.

**FOR HILL DESCENT REDUCE SPEED (if equipped)** — Displayed when the vehicle speed requirement for off-road mode entry has not been met.

**FOR HILL DESCENT SELECT GEAR (if equipped)** — Displayed when the driver is able to select a transmission gear for hill descent mode.

## Instrument Cluster

**HILL DESCENT - DRIVER RESUME CONTROL (if equipped)** — Displayed when hill descent control mode is deactivated and the driver must resume control.

**HILL DESCENT CONTROL FAULT (if equipped)** — Displayed when a hill descent system fault is present.

**HILL DESCENT CONTROL OFF SYSTEM COOLING (if equipped)** — Displayed when the hill descent system is cooling due to overuse.

**HILL DESCENT CONTROL READY (if equipped)** — Displayed when the hill descent control switch is turned on.

**REDUCE ACCELERATOR TO PREVENT WHEEL SLIP (if equipped)** — Displayed when the vehicle senses that torque to the drive wheels has overcome the available traction.

**CAMERA MALFUNCTION (if equipped)** — Displayed when the front camera is not operating properly.



## Entertainment Systems

### AUDIO SYSTEMS

#### AM/FM stereo system (if equipped)

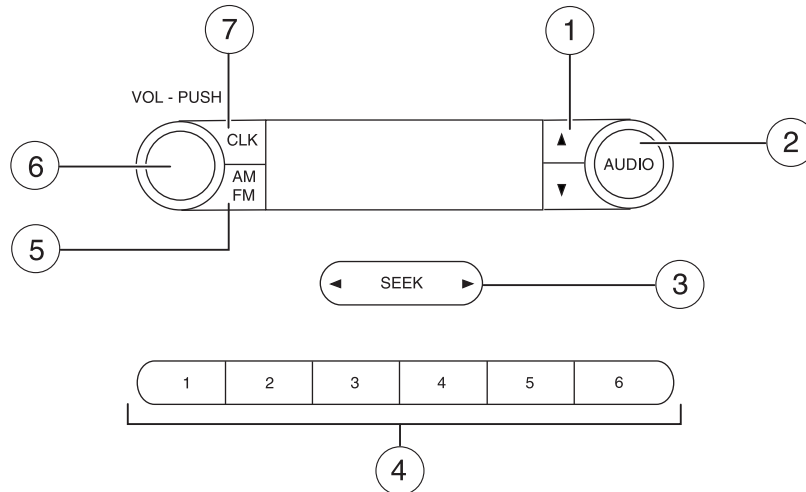

**WARNING:** Driving while distracted can result in loss of vehicle control, accident and injury. Ford strongly recommends that drivers use extreme caution when using any device or feature that may take their focus off the road. Your primary responsibility is the safe operation of the vehicle. We recommend against the use of any handheld device while driving, encourage the use of voice-operated systems when possible and that you become aware of applicable state and local laws that may affect use of electronic devices while driving.

**Accessory delay:** Your vehicle is equipped with accessory delay which allows you to operate the radio and other electrical accessories for up to ten minutes after the ignition has been turned off or until either front door is opened.

1. ▲ / ▼ : Press ▲ / ▼ to manually go up or down the radio frequency. Press and hold for a fast advance through radio frequencies. Also use in AUDIO mode to gain access to various settings.



## Entertainment Systems

2. **AUDIO:** Press AUDIO repeatedly to gain access to the following settings:



- **BAL (Balance):** Press AUDIO to reach the balance setting. Use ▲ / ▼ / ◀ SEEK ▶ to adjust the audio between the left (L) and right (R) speakers.
- **FAD (Fade):** Press AUDIO to reach the fade feature. Use ▲ / ▼ / ◀ SEEK ▶ to adjust the audio between the front (F) and back (B) speakers.
- **TREB (Treble):** Press to adjust the treble setting. Use ▲ / ▼ / ◀ SEEK ▶ to adjust.
- **BASS (Bass):** Press to adjust the bass setting. Use ▲ / ▼ / ◀ SEEK ▶ to adjust.

3. **SEEK:** Press ◀ SEEK ▶ to access the previous/next strong station.



4. **Memory presets:** To set a station: Select frequency band AM/FM1/FM2; tune to a station, press and hold a preset button until sound returns. You can save up to 18 stations, six in AM, six in FM1 and FM2.

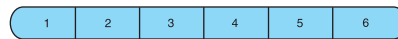

5. **AM/FM:** Press AM/FM to select AM/FM1/FM2 frequency band.



6. **ON/OFF/Volume:** Press VOL-PUSH to turn ON/OFF. Turn VOL-PUSH to increase/decrease volume.

VOL - PUSH



## Entertainment Systems

7. **CLK (Clock):** Press CLK to toggle between displaying the radio frequency and the clock setting.



**Setting the clock:** Press and hold

CLK until the hours begin to flash. Press ▲ / ▼ / ◀ SEEK ▶ to manually increase/decrease the hours.

Press CLK again to set the minutes using ▲ / ▼ / ◀ SEEK ▶ to manually increase/decrease the minutes. Allow 10 seconds to pass to confirm that the time has been set.

**Note:** If your vehicle is equipped with a navigation system, refer to *Setting the clock* in your *Navigation supplement*.

### AM/FM in-dash CD/MP3 satellite compatible sound system

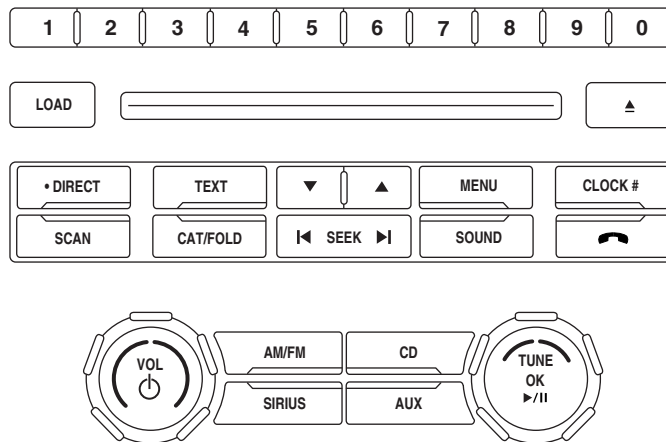

**WARNING:** Driving while distracted can result in loss of vehicle control, accident and injury. Ford strongly recommends that drivers use extreme caution when using any device or feature that may take their focus off the road. Your primary responsibility is the safe operation of the vehicle. We recommend against the use of any handheld device while driving, encourage the use of voice-operated systems when possible and that you become aware of applicable state and local laws that may affect use of electronic devices while driving.

## Entertainment Systems

**Accessory delay:** Your vehicle is equipped with accessory delay. With this feature, the radio and other electrical accessories may be used for up to ten minutes after the ignition is turned off or until either front door is opened.

**Battery management:** When the engine is off, your audio system may turn off if the battery is at a low state of charge or if the ignition has been in the accessory position or in the on position for approximately 45 minutes. The display will temporarily show SYS OFF TO SAVE BATT and the audio system will be turned off. The audio system will return to normal operation once the vehicle has been started and battery state of charge allowed to recover. The battery state of charge recovery can be accelerated by turning off any unnecessary electrical loads while driving. Refer to the *Battery management system* section in the *Maintenance and Specifications* chapter for more information.

**Note:** Your vehicle is equipped with a unique audio system. If your display shows six small circles in the display, your audio system is a CD6 system (six disc changer). If not, your system is a single CD system.

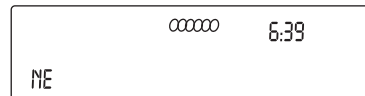

### Setting the clock

To set the time, press CLOCK. The display will read SET TIME. Use the memory preset numbers (0–9) to enter in the desired time—hours and minutes and press OK. The clock will then begin from that time.

**Note:** If your vehicle is equipped with a navigation system, refer to *Setting the clock* in your *Navigation supplement*.

### AM/FM Radio

**⏻ / VOL (Power/Volume):** Press to turn the radio on/off. Turn the knob to increase/decrease volume.

If the volume is set above a certain level and the ignition is turned off, the volume will come back on at a nominal listening level when the ignition switch is turned back on.

**AM/FM:** Press repeatedly to select AM/FM1/FM2 frequency band.

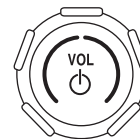

## Entertainment Systems

**TUNE:** Turn the knob to go up/down the frequency band in individual increments.



**DIRECT:** Press DIRECT and then manually enter the desired radio station (i.e. 93.9) using the memory preset numbers (0–9).

**SEEK:** Press ◀ SEEK ▶ to access the previous/next strong radio station.

**SCAN:** Press for a brief sampling of all strong radio stations.

**0–9 (MEMORY PRESETS):** When tuned to any station, press and hold a preset button until sound returns and PRESET # SAVED appears in the display. You can save up to 30 stations, 10 in AM, 10 in FM1 and FM2.

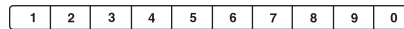

*Saving presets automatically:* Autoset allows you to set the strongest local radio stations without losing your original manually set preset stations for AM/FM1/FM2.

*To activate the autoset feature:* Press MENU repeatedly until AUTO PRESET ON/OFF appears in the display. Use ◀ SEEK ▶ to toggle AUTO PRESET to ON, and either wait five seconds for the search to initiate or press OK to immediately initiate the search. If you press another control within those five seconds, the search will not initiate. The 10 strongest stations will be filled and the station stored in preset 1 will begin playing.

If there are fewer than 10 strong stations, the system will store the last one in the remaining presets.

### **RDBS Radio**

Available only in FM mode. This feature allows you to search RDBS-equipped stations for a certain category of music format: CLASSIC, COUNTRY, JAZZ/RB, ROCK, etc.

*To activate:* Press MENU repeatedly until RDBS (ON/OFF) appears in the display. Use ◀ SEEK ▶ to toggle RDBS ON/OFF. When RDBS is off, you will not be able to search for RDBS equipped stations or view the station name or type.

**CAT/FOLD (Category/Folder):** This feature allows you to select from various music categories.

## Entertainment Systems

*To change RDBS categories:* Press MENU repeatedly until RDBS ON/OFF appears in the display. Use ◀ SEEK ▶ to toggle RDBS between ON/OFF. Press CAT. PRESS UP OR DOWN TO CHANGE RDBS CATEGORY will appear in the display. Press ▼ ▲ to scroll through all possible categories. When the desired category appears in the display, press ◀ SEEK ▶ to find the next station playing that selection or press SCAN for a brief sampling of all stations playing that category of music.

### **CD/MP3 Player**

**CD:** Press to enter CD/MP3 mode. If a disc is already loaded into the system, CD/MP3 play will begin where it ended last. If no CD is loaded, NO DISC will appear in the display.

#### **LOAD:**

**For a single CD system–** This control is not operational. To load a CD, simply insert the disc, label side up, into the CD slot.

**For a CD6 system–** Press LOAD. When the display reads SELECT SLOT, choose the desired slot number using memory presets 1–6. When the display reads LOAD CD #, load the desired disc, label side up. If you do not choose a slot within five seconds, the system will choose for you. Once loaded, the first track will begin to play.

*To auto load up to six discs–* Press and hold LOAD until the display reads AUTOLOAD #. Load the desired disc, label side up. The system will prompt you to load discs for the remaining available slots. Insert the discs, one at a time, label side up, when prompted. Once loaded, the disc in preset #1 will begin to play.

Press the number preset buttons (1–6) to choose the disc you want to play.

▶ / || **Play/Pause:** Press to play/pause a track when playing a CD.



#### **▲ (Eject):**

**For a single CD system–** press ▲ to eject the CD.

**For a CD6 system–** press ▲ and select the desired CD slot by pressing the corresponding memory preset number. The display will read EJECTING #. When the system has ejected the CD, the display will read

54

## Entertainment Systems

**REMOVE CD #.** Remove the CD. If you do not remove the CD, the system will reload the disc.

*To auto eject all loaded discs*– Press and hold **▲** . The system will eject all discs and prompt you when to remove them.

**SEEK:** Press **◀ SEEK ▶** to access the previous/next track.

### **CAT (Category) / FOLD (Folder):**

*In MP3 mode only*– Press CAT/FOLD and then press **◀ SEEK ▶** to access the previous/next folder.

**SCAN:** Press for a brief sampling of all tracks on the current disc or MP3 folder.

### **DIRECT:**

*In CD mode*– Press DIRECT. The display will read DIRECT TRACK MODE SELECT TRACK. Enter the desired track number using the memory preset buttons (0–9). The system will then begin playing that track.

*In MP3 folder mode*– Press DIRECT and the memory preset buttons (0–9) of the desired folder. The system will advance to that specific track in the folder selected.

### **TEXT:**

*In MP3 mode only*– Press TEXT repeatedly to view Album (AL), Folder (FL), Song (SO) and Artist (AR) in the display, if available.

*In TEXT MODE:* Sometimes the display requires additional text to be displayed. When the **▶** indicator is active, press TEXT and then press **◀ SEEK ▶** to view the additional display text.

**COMPRESSION:** Press MENU repeatedly until COMPRESSION ON/OFF appears in the display. Use **◀ SEEK ▶** to toggle between ON/OFF. When COMPRESSION is ON, the system will bring the soft and loud CD passages together for a more consistent listening level.

**SHUFFLE:** Press MENU repeatedly until SHUFFLE ON/OFF appears in the display. Use **◀ SEEK ▶** to toggle between ON/OFF. If you wish to engage shuffle mode right away, press **◀ SEEK ▶** to begin random play. Otherwise, random play will begin when the current track is finished playing. The system will only shuffle the disc currently playing.

### **Satellite Radio (if equipped)**

*Satellite radio is available only with a valid SIRIUS radio subscription. Check with your authorized dealer for availability.*

## Entertainment Systems

**SIRIUS:** Press repeatedly to access satellite radio mode, if equipped. Press repeatedly to cycle through SAT1, SAT2 and SAT3 modes.

**TUNE:** Turn to go to the next / previous available SIRIUS satellite station.

**DIRECT:** Press DIRECT then enter the desired channel (i.e. 002) using the memory preset buttons (0–9). If you only enter one digit, press OK and the system will go to that satellite channel. If you enter three digits, the system will automatically go to that channel, if available. You may cancel your entry by pressing DIRECT. If an invalid station number is entered, INVALID CHANNEL will appear in the display and the system will continue playing the current station.

**SEEK:** Press ◀ SEEK ▶ to seek to the previous/next channel. If a specific category is selected, (Jazz, Rock, News, etc.), press ◀ SEEK ▶ to seek to the previous/next channel in the selected category. Press and hold ◀ SEEK ▶ to fast seek through the previous/next channels.

**SCAN:** Press SCAN for a brief sampling of all available SIRIUS satellite channels. If a specific category is selected, (Jazz, Rock, News, etc.) press SCAN for a brief sampling of all available SIRIUS satellite channels within the selected category.

**MEMORY PRESETS (0–9):** There are 30 available presets, 10 each for SAT1, SAT2 and SAT3. To save satellite channels in your memory presets, tune to the desired channel then press and hold a memory preset number (0–9) until sound returns.

1	2	3	4	5	6	7	8	9	0
---	---	---	---	---	---	---	---	---	---

**TEXT:** Press and release to display the artist and song title. While in TEXT MODE, press again to scroll through the Artist (AR), Song (SO), Channel (CH) and Category (CA).

*In TEXT MODE:* Sometimes the display requires additional text to be displayed. When the ▶ indicator is active, press TEXT and then press ◀ SEEK ▶ to view the additional display text.

**CAT (Category) / FOLD (Folder):** Press to toggle between turning the most recently selected satellite radio category on or off. The category icon (CAT) will illuminate in the display when a specific category is selected (the icon will not illuminate during CATEGORY ALL). If no category has ever been selected, NO CATEGORY SELECTED will display.

**Note:** Separate categories can be set for SAT1, SAT2 or SAT3. Refer to *Satellite radio menu* for further information on selecting a satellite radio category.

56



## Entertainment Systems

**SATELLITE RADIO MENU:** Press MENU when satellite radio mode is active to access. Press OK to enter into the satellite radio menu.

Press ▼ ▲ to cycle through the following options:

- **CATEGORY-** Press OK to enter category mode. Press ▼ ▲ to scroll through the list of available SIRIUS channel Categories (Pop, Rock, News, etc.) Press OK when the desired category appears in the display. After a category is selected, press ◀ SEEK ▶ to search for that specific category of channels only (i.e. ROCK). You may also select CATEGORY ALL to seek all available SIRIUS categories and channels. Press OK to close and return to the main menu.
- **SONG SEEK MENU-** Press OK to enter song seek menu. Press ▼ ▲ to scroll through the following options:
  - a. SAVE THIS SONG:** Press OK to save the currently playing song's title in the system's memory. (If you try to save something other than a song, CANT SAVE will appear in the display.) When the chosen song is playing on any satellite radio channel, the system will alert you with an audible prompt. Press OK while SONG ALERT is in the display and the system will take you to the channel playing the desired song. You can save up to 20 song titles. If you attempt to save more than 20 titles, the display will read REPLACE SONG? Press OK to access the saved titles and press ▼ ▲ to cycle through the saved titles. When the song title appears in the display that you would like to replace, press OK. SONG REPLACED will appear in the display.
  - b. DELETE A SONG:** Press OK to delete a song from the system's memory. Press ▼ ▲ to cycle through the saved songs. When the song appears in the display that you would like to delete, press OK. The song will appear in the display for confirmation. Press OK again and the display will read SONG DELETED. If you do not want to delete the currently listed song, press ▼ ▲ to select either RETURN or CANCEL.
  - c. DELETE ALL SONGS:** Press OK to delete all song's from the system's memory. The display will read ARE YOU SURE ? Press OK to confirm deletion of all saved songs and the display will read ALL DELETED.

## Entertainment Systems

**d. DISABLE ALERTS/ENABLE ALERTS:** Press OK to enable/disable the satellite alert status which alerts you when your selected songs are playing on a satellite radio channel. (The system default is disabled.) SONG ALERTS ENABLED/DISABLED will appear in the display. The menu listing will display the opposite state. For example, if you have chosen to enable the song alerts, the menu listing will read DISABLE as the alerts are currently on, so your other option is to turn them off.

- **CHANNEL LOCKOUT MENU-** Press OK to enter the Channel Lockout menu. Press the ▼ ▲ to scroll through the following options:
  - a. LOCK/UNLOCK THIS CHANNEL:** Press OK when LOCK/UNLOCK THIS CHANNEL is displayed and the display will read ENTER PIN. Enter your four-digit PIN number (initial PIN is 1234) and the system will lock/unlock the channel and CHANNEL LOCKED or UNLOCKED will be displayed.  
Note: you must be tuned to the specific channel you want to lock/unlock when using this feature.
  - b. CHANGE PIN:** Press OK when CHANGE PIN is displayed. The display will read ENTER OLD PIN. Enter your current (old) PIN number and when the system accepts your entry it will display ENTER NEW PIN. Enter your new four-digit PIN and the system will save the new PIN and PIN SAVED will display.
  - c. UNLOCK ALL CHANNELS:** Press OK when UNLOCK ALL CHANNELS is displayed and the display will read ENTER PIN. Enter your four-digit PIN and the system will unlock all channels and the display will read CHANNEL UNLOCKED.
  - d. RESET PIN:** Press OK when RESET PIN is displayed. The display will read ARE YOU SURE. Press OK again to automatically reset the PIN number to its initial password setting (1234). PIN RESET TO DEFAULT PIN will be displayed.
  - e. RETURN:** Press OK when RETURN is displayed and the system will exit back to the satellite radio menu.

### **Sound Adjustments**

Press SOUND repeatedly to cycle through the following features:

**BASS:** Press ◀ SEEK ▶ to adjust the level of bass.

**TREBLE:** Press ◀ SEEK ▶ to adjust the level of treble.

**BALANCE:** Press ◀ SEEK ▶ to adjust the audio between the left (L) and right (R) speakers.

58

## Entertainment Systems

**FADE:** Press ◀ SEEK ▶ to adjust the audio between the back (B) and front (F) speakers.

**SPEED COMPENSATED VOLUME:** With this feature on, radio volume automatically gets louder with increasing vehicle speed to compensate for road and wind noise.

The default setting is *off*.

Use ◀ SEEK ▶ to adjust between SPEED OFF and levels 1–7: Increasing the level from 1 (lowest setting) to 7 (highest setting) allows the radio volume to automatically change slightly with vehicle speed to compensate for road and wind noise.

Recommended level is 1–3; SPEED OFF turns the feature off and level 7 is the maximum setting.

### Extra Features

**AUX:** Press repeatedly to cycle through LINE IN (auxiliary audio mode), and SYNC® (if equipped).

For location and further information on auxiliary audio mode, refer to *Auxiliary input jack* later in this chapter.

If your vehicle is equipped with SYNC®, please refer to supplemental information on SYNC®.

**OK:** Your vehicle may be equipped with special phone and media features which will require you to confirm commands by pressing OK. For further information, refer to supplemental information on SYNC®.



**☎ (Phone):** If your vehicle is equipped with SYNC®, press to access SYNC PHONE features. For further information, please refer to supplemental information on SYNC®.

If your vehicle is not equipped with SYNC®, the display may read NO PHONE.

### Audio system–Navigation system based (if equipped)

If your vehicle is equipped with the navigation system, it will have an integrated navigation/audio system. See the *Navigation system* supplement for operating instructions on using this audio system.

## Entertainment Systems

### Auxiliary input jack (Line in — if equipped)

 **WARNING:** Driving while distracted can result in loss of vehicle control, accident and injury. Ford strongly recommends that drivers use extreme caution when using any device or feature that may take their focus off the road. Your primary responsibility is the safe operation of the vehicle. We recommend against the use of any handheld device while driving, encourage the use of voice-operated systems when possible and that you become aware of applicable state and local laws that may affect use of electronic devices while driving.

The Auxiliary Input Jack provides a way to connect your portable music player to the in-vehicle audio system. This allows the audio from a portable music player to be played through the vehicle speakers with

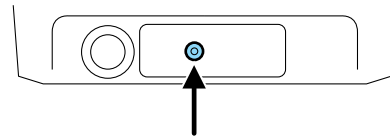

high fidelity. To achieve optimal performance, please observe the following instructions when attaching your portable music device to the audio system.

If your vehicle is equipped with a navigation system, refer to *Auxiliary input jack* section in the *Audio features* chapter of your *Navigation system* supplement.

#### **Required equipment:**

1. Any portable music player designed to be used with headphones
2. An audio extension cable with stereo male 1/8 in. (3.5 mm) connectors at each end

#### **To play your portable music player using the auxiliary input jack:**

1. Begin with the vehicle parked and the radio turned off.
2. Ensure that the battery in your portable music player is new or fully charged and that the device is turned off.
3. Attach one end of the audio extension cable to the headphone output of your player and the other end of the audio extension cable to the AIJ in your vehicle.
4. Turn the radio on, using either a tuned FM station or a CD loaded into the system. Adjust the volume to a comfortable listening level.
5. Turn the portable music player on and adjust the volume to 1/2 the volume.

60

## Entertainment Systems

6. Press AUX on the vehicle radio repeatedly until LINE, LINE IN or SYNC LINE IN appears in the display. You should hear audio from your portable music player although it may be low.
7. Adjust the sound on your portable music player until it reaches the level of the FM station or CD by switching back and forth between the AUX and FM or CD controls.

### Troubleshooting:

1. Do not connect the audio input jack to a line level output. Line level outputs are intended for connection to a home stereo and are not compatible with the AIJ. The AIJ will only work correctly with devices that have a headphone output with a volume control.
2. Do not set the portable music player's volume level higher than is necessary to match the volume of the CD or FM radio in your audio system as this will cause distortion and will reduce sound quality. Many portable music players have different output levels, so not all players should be set at the same levels. Some players will sound best at full volume and others will need to be set at a lower volume.
3. If the music sounds distorted at lower listening levels, turn the portable music player volume down. If the problems persists, replace or recharge the batteries in the portable music player.
4. The portable music player must be controlled in the same manner when it is used with headphones as the AIJ does not provide control (play, pause, etc.) over the attached portable music player.
5. For safety reasons, connecting or adjusting the settings on your portable music player should not be attempted while the vehicle is moving. Also, the portable music player should be stored in a secure location, such as the center console or the glove box, when the vehicle is in motion. The audio extension cable must be long enough to allow the portable music player to be safely stored while the vehicle is in motion.

### USB port (if equipped)



**WARNING:** Driving while distracted can result in loss of vehicle control, accident and injury. Ford strongly recommends that drivers use extreme caution when using any device that may take their focus off the road. Your primary responsibility is the safe operation of the vehicle. We recommend against the use of any handheld device while driving, encourage the use of voice-operated systems when possible and that you become aware of applicable state and local laws that may affect the use of electronic devices while driving.

## Entertainment Systems

Your vehicle may be equipped with a USB port located on the instrument panel. This feature allows you to plug in media playing devices, memory sticks, and also to charge devices if they support this feature.

For further information on this feature, refer to *Accessing and using your USB port* in the SYNC® supplement or *Navigation System* supplement.

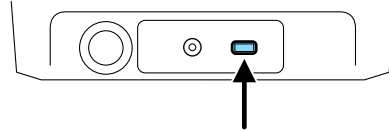

### GENERAL AUDIO INFORMATION

#### Radio frequencies:

AM and FM frequencies are established by the Federal Communications Commission (FCC) and the Canadian Radio and Telecommunications Commission (CRTC). Those frequencies are:

AM: 530, 540–1700, 1710 kHz

FM: 87.7, 87.9–107.7, 107.9 MHz

#### Radio reception factors:

There are three factors that can affect radio reception:

- Distance/strength: The further you travel from an FM station, the weaker the signal and the weaker the reception.
- Terrain: Hills, mountains, tall buildings, power lines, electric fences, traffic lights and thunderstorms can interfere with your reception.
- Station overload: When you pass a broadcast tower, a stronger signal may overtake a weaker one and play while the weak station frequency is displayed.

#### CD/CD player care

Do:

- Handle discs by their edges only. (Never touch the playing surface).
- Inspect discs before playing.
- Clean only with an approved CD cleaner.

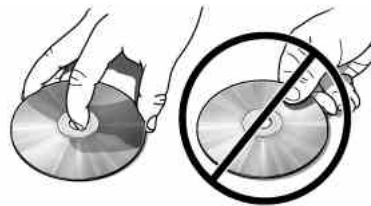

## Entertainment Systems

- Wipe discs from the center out.



Don't:

- Expose discs to direct sunlight or heat sources for extended periods of time.
- Clean using a circular motion.

**CD units are designed to play commercially pressed 4.75 in (12 cm) audio compact discs only. Due to technical incompatibility, certain recordable and re-recordable compact discs may not function correctly when used in Ford CD players.**

**Do not use any irregular shaped CDs or discs with a scratch protection film attached.**

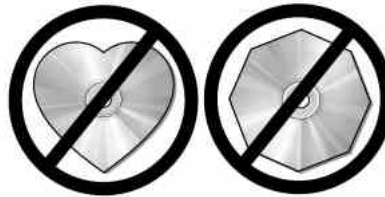

**CDs with homemade paper (adhesive) labels should not be inserted into the CD player as the label may peel and cause the CD to become jammed. It is recommended that homemade CDs be identified with permanent felt tip marker rather than adhesive labels. Ballpoint pens may damage CDs. Please contact your authorized dealer for further information.**



### **Audio system warranty and service**

Refer to the *Warranty Guide/Customer Information Guide* for audio system warranty information. If service is necessary, see your dealer or qualified technician.

## Entertainment Systems

### MP3 track and folder structure

Your MP3 system recognizes MP3 individual tracks and folder structure as follows:

- There are two different modes for MP3 disc playback: MP3 track mode (system default) and MP3 folder mode. For more information on track and folder mode, refer to *Sample MP3 structure* in the following section.
- MP3 track mode allows the CD to play all tracks in all folders.
- MP3 folder mode limits the playable tracks to the current folder.
- Creating discs with only one level of folders will help with navigation through the disc files.

### Sample MP3 structure

If you are burning your own MP3 discs, it is important to understand how the system will read the structures you create. While various files may be present, (files with extensions other than mp3), only files with the .mp3 extension will be played. Other files will be ignored by the system. This enables you to use the same MP3 disc for a variety of tasks on your work computer, home computer and your in vehicle system.

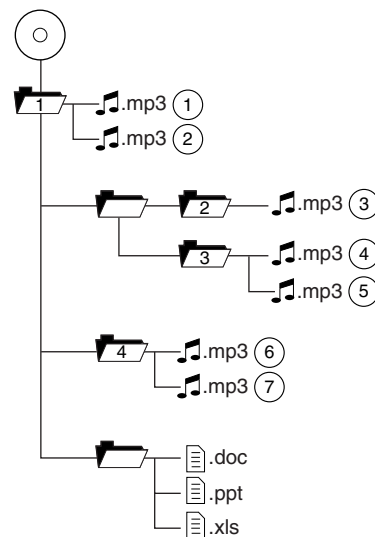

In track mode, the system will display and play the structure as if it were only one level deep (all .mp3 files will be played, regardless of being in a specific folder). In folder mode, the system will only play the .mp3 files in the current folder.



## Entertainment Systems

### Satellite radio information (if equipped)

**Satellite radio channels:** SIRIUS® broadcasts a variety of music, news, sports, weather, traffic and entertainment satellite radio channels. For more information and a complete list of SIRIUS® satellite radio channels, visit [www.sirius.com](http://www.sirius.com) in the United States, [www.siriuscanada.ca](http://www.siriuscanada.ca) in Canada, or call SIRIUS® at 1-888-539-7474.

**Satellite radio reception factors:** To receive the satellite signal, your vehicle has been equipped with a satellite radio antenna located on the roof of your vehicle. The vehicle roof provides the best location for an unobstructed, open view of the sky, a requirement of a satellite radio system. Like AM/FM, there are several factors that can affect satellite radio reception performance:

- **Antenna obstructions:** For optimal reception performance, keep the antenna clear of snow and ice build-up and keep luggage and other material as far away from the antenna as possible.
- **Terrain:** Hills, mountains, tall buildings, bridges, tunnels, freeway overpasses, parking garages, dense tree foliage and thunderstorms can interfere with your reception.
- **Station overload:** When you pass a ground based broadcast repeating tower, a stronger signal may overtake a weaker one and result in an audio mute.

Unlike AM/FM audible static, you will hear an audio mute when there is a satellite radio signal interference. Your radio display may display NO SIGNAL to indicate the interference.

**SIRIUS® satellite radio service:** SIRIUS® satellite radio is a subscription based satellite radio service that broadcasts music, sports, news and entertainment programming. A service fee is required in order to receive SIRIUS® service. Vehicles that are equipped with a factory installed SIRIUS® satellite radio system include hardware and a limited subscription term, which begins on the date of sale or lease of the vehicle.

For information on extended subscription terms, the online media player and other SIRIUS® features, please contact SIRIUS® at 1-888-539-7474.

**Note:** SIRIUS® reserves the unrestricted right to change, rearrange, add or delete programming including canceling, moving or adding particular channels, and its prices, at any time, with or without notice to you. Ford Motor Company shall not be responsible for any such programming changes.

## Entertainment Systems

**Satellite Radio Electronic Serial Number (ESN):** This 12-digit Satellite Serial Number is needed to activate, modify or track your satellite radio account. You will need this number when communicating with SIRIUS®. While in satellite radio mode, you can view this number on the radio display by pressing SIRIUS and the preset 1 control simultaneously.

Radio Display	Condition	Action Required
ACQUIRING	Radio requires more than two seconds to produce audio for the selected channel.	No action required. This message should disappear shortly.
SAT FAULT	Internal module or system failure present.	If this message does not clear within a short period of time, or with an ignition key cycle, your receiver may have a fault. See your authorized dealer for service.
INVALID CHNL	Channel no longer available.	This previously available channel is no longer available. Tune to another channel. If the channel was one of your presets, you may choose another channel for that preset button.
UNSUBSCRIBED	Subscription not available for this channel.	Contact SIRIUS® at 1-888-539-7474 to subscribe to the channel or tune to another channel.

## Entertainment Systems

<b>Radio Display</b>	<b>Condition</b>	<b>Action Required</b>
NO TEXT	Artist information not available.	Artist information not available at this time on this channel. The system is working properly.
NO TEXT	Song title information not available.	Song title information not available at this time on this channel. The system is working properly.
NO TEXT	Category information not available.	Category information not available at this time on this channel. The system is working properly.
NO SIGNAL	Loss of signal from the SIRIUS® satellite or SIRIUS® tower to the vehicle antenna.	You are in a location that is blocking the SIRIUS® signal (i.e., tunnel, under an overpass, dense foliage, etc). The system is working properly. When you move into an open area, the signal should return.
UPDATING	Update of channel programming in progress.	No action required. The process may take up to three minutes.
CALL SIRIUS® 1-888-539-7474	Satellite service has been deactivated by SIRIUS® satellite radio.	Call SIRIUS® at 1-888-539-7474 to re-activate or resolve subscription issues.

## Entertainment Systems

### NAVIGATION SYSTEM (IF EQUIPPED)

Your vehicle may be equipped with a navigation system. Refer to the *Navigation System* supplement for further information.

**Battery management:** When the engine is off, your Navigation system may turn off if the battery is at a low state of charge or if the ignition has been in the accessory position or in the on position for approximately 45 minutes. The display will temporarily show BATTERY SAVER — SYSTEM OFF PLEASE START THE ENGINE and the Navigation system will be turned off. The Navigation system will return to normal operation once the vehicle has been started and battery state of charge allowed to recover. The battery state of charge recovery can be accelerated by turning off any unnecessary electrical loads while driving. Refer to the *Battery management system* section in the *Maintenance and Specifications* chapter for more information.

### SYNC® (IF EQUIPPED)

Your vehicle may be equipped with SYNC®, a hands-free communications and entertainment system with special phone and media features. For more information, please refer to the SYNC® supplement or to the SYNC® section in the *Navigation System* supplement (if equipped).





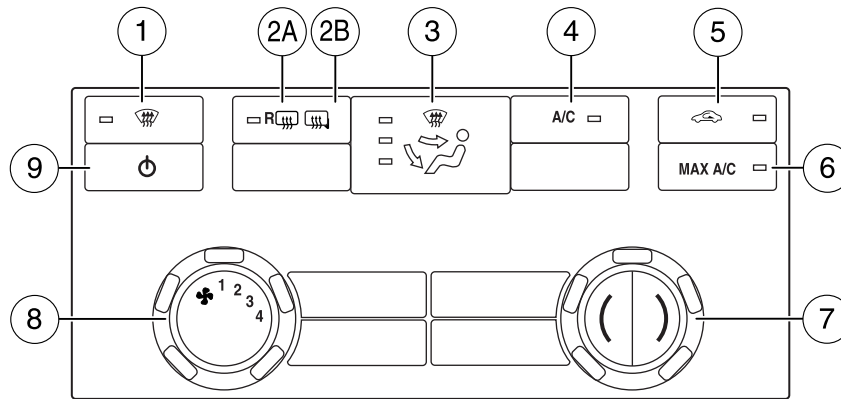

## Climate Controls

### SINGLE ZONE CLIMATE CONTROL





1. **Defrost:** Distributes outside air through the windshield defroster vents and de-mister vents. Can be used to clear the windshield of fog and thin ice. The system will automatically provide outside air to reduce window fogging. Press this button again to return to the previous air flow selection.
2. A. **Rear defroster (if equipped):** Press to activate/deactivate the rear window defroster. Refer to *Rear window defroster* later in this chapter for more information. If your vehicle is equipped with both rear defroster and heated mirrors, the same button will activate both.
2. B. **Heated mirrors (if equipped):** Press to activate/deactivate. This feature will remove ice and snow from the side view mirrors.
3. **Multifunction control:** Press repeatedly to toggle through the settings to choose:
  - : Distributes air through the windshield defroster vents, de-mister vents, floor vents and rear seat floor vents (if equipped). The system will automatically provide outside air to reduce window fogging.
  - : Distributes air through the instrument panel vents and center console vents (if equipped).
  - : Distributes air through the instrument panel vents, floor vents, rear seat floor vents (if equipped), de-mister vents and center console vents (if equipped).

## Climate Controls

-  : Distributes air through the floor vents, demister vents and rear seat floor vents (if equipped).
4. **A/C:** Press to activate/deactivate air conditioning. Use with recirculated air to improve cooling performance and efficiency. A/C engages automatically in MAX A/C,  (defrost) and  (floor/defrost).
  5.  **Recirculated air:** Press to recirculate the air in the vehicle. Recirculated air may reduce the amount of time needed to cool down the interior of the vehicle (when used with A/C) and may also help reduce undesired odors and dust/debris from reaching the interior of the vehicle. This button engages automatically when MAX A/C is selected or can be engaged manually in any airflow mode except  (defrost). This button may turn off automatically in all airflow modes (except MAX A/C) and when the ignition is cycled (if the A/C indicator light is not illuminated ) in order to prevent window fogging. Even when this button is not selected, air may still recirculate in some instances in order to reduce vehicle warm-up time in cold conditions or to cool down time in hot conditions. **Note:** You may notice changes in sound between recirculated mode and other airflow modes.
  6. **MAX A/C:** Distributes recirculated air through the instrument panel vents and center console vents (if equipped) to cool the vehicle. This re-cooling of the interior air is more economical and efficient. Recirculated air may also help reduce undesirable odors and dust/debris from entering the vehicle. Press the MAX A/C button again for normal A/C operation.
  7. **Temperature control:** Controls the temperature of the airflow in the vehicle.
  8.  **Fan speed adjustment:** Controls the volume of air circulated in the vehicle.
  9.  **Power:** Press to activate/deactivate the climate control system. When the system is off, outside air is prevented from entering the vehicle.

### Operating tips

- To reduce fog build-up on the windshield during humid weather, select  (defrost) or  (floor/defrost). Temperature and/or fan speed can also be increased to improve clearing.
- To reduce humidity build-up inside the vehicle: do not drive with the system off or with  (recirculated air) engaged and A/C off.



70

## Climate Controls

- Do not put objects under the front seats that will interfere with the airflow to the back seats.
- Remove any snow, ice or leaves from the air intake area at the base of the windshield.
- To improve the A/C cool down, drive with the windows slightly open for not more than 2-3 minutes after start up to “air out” the vehicle.
- For maximum cooling performance when using Max A/C or  (recirculated air), all windows and doors should remain closed.
- A small amount of air may be felt from the floor vent regardless of the air distribution setting that is selected.

If you are driving during extreme high ambient temperatures and idling for extended periods of time in gear, it is recommended to run the A/C in the MAX A/C position, adjust the blower fan speed to the lowest setting and put the vehicle’s transmission into the P (Park) position to continue to receive cool air from your A/C system.

### **For maximum cooling performance (MAX A/C):**

- Select MAX A/C.
-  (Panel) and  (panel/floor) modes:
- Move the temperature control to the coolest setting.
- Select A/C and  (recirculated air). Use recirculated air with A/C to provide colder airflow.
- Set the fan to the highest speed initially, then adjust to maintain comfort.

To aid in side window defogging/demisting in cold weather:

1. Select  (panel/floor).
2. Select A/C.
3. Adjust the temperature control to maintain comfort.
4. Set the fan speed to the highest setting.
5. Direct the outer instrument panel vents towards the side windows.

To increase airflow to the outer instrument panel vents, close the vents located in the middle of the instrument panel.

## Climate Controls

### DUAL ZONE AUTOMATIC TEMPERATURE CONTROL WITH HEATED SEATS (IF EQUIPPED)

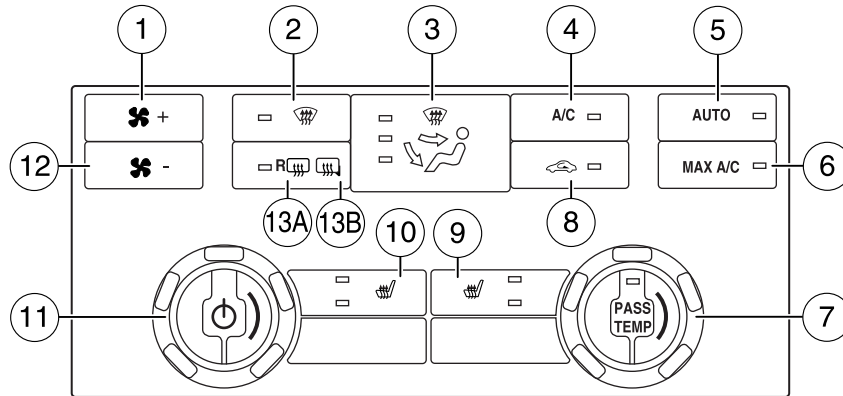







**Temperature conversion:** To switch between Fahrenheit and Celsius, refer to *Message center* in the *Instrument Cluster* chapter.





1. **+ Fan speed control:** Press to increase the fan speed.
2. **Defrost:** Distributes outside air through the windshield defroster vents and de-mister vents. Can be used to clear the windshield of fog and thin ice. The system will automatically provide outside air to reduce window fogging. Press this button again to return to the previous air flow selection. To return to full automatic control, press AUTO.
3. **Manual override control:** Allows you to manually select where airflow is directed. To return to full automatic control, press AUTO. When choosing to control airflow manually, press repeatedly to toggle through the settings to choose:
  - : Distributes air through the windshield defroster vents, de-mister vents, floor vents and rear seat floor vents. The system will automatically provide outside air to reduce window fogging.
  - : Distributes air through the instrument panel vents.
  - : Distributes air through the instrument panel vents, floor vents, rear seat floor vents and de-mister vents.
  - : Distributes air through the floor vents and rear seat floor vents and demister vents.



## Climate Controls

4. **A/C:** Press to activate/deactivate air conditioning. Use with recirculated air to improve cooling performance and efficiency. A/C engages automatically in MAX A/C,  (defrost) and  (floor/defrost).
5. **AUTO:** Press to engage full automatic operation. Select the desired temperature using the temperature control. The system will automatically determine fan speed, airflow distribution, A/C on or off, and outside or recirculated air, to heat or cool the vehicle to reach the desired temperature.
6. **MAX A/C:** Distributes recirculated air through the instrument panel vents to cool the vehicle. This re-cooling of the interior air is more economical and efficient. Recirculated air may also help reduce undesirable odors and dust/debris from entering the vehicle. Press the MAX A/C button again for normal A/C operation.
7. **PASS TEMP:** Press to activate separate passenger temperature control and turn the dial to increase/decrease the airflow temperature for the passenger in the front of the vehicle.
8.  **Recirculated air:** Press to recirculate the air in the vehicle. Recirculated air may reduce the amount of time needed to cool down the interior of the vehicle (when used with A/C) and may also help reduce undesired odors and dust/debris from reaching the interior of the vehicle. This button engages automatically when MAX A/C is selected or can be engaged manually in any airflow mode except  (defrost). This button may turn off automatically in all airflow modes (except MAX A/C) and when the ignition is cycled (if the A/C indicator light is not illuminated ) in order to prevent window fogging. Even when this button is not selected, air may still recirculate in some instances in order to reduce vehicle warm-up time in cold conditions or to cool down time in hot conditions. **Note:** You may notice changes in sound between recirculated mode and other airflow modes.
9.  **Passenger heated seat control:** Press to control the passenger heated seat. Refer to *Heated seats* in the *Seating and Safety Restraints* chapter for more information.
10.  **Driver heated seat control:** Press to control the driver heated seat. Refer to *Heated seats* in the *Seating and Safety Restraints* chapter for more information.

## Climate Controls

11.  **Power/Driver temperature:** Press to activate/deactivate the climate control system. When the system is off, outside air is prevented from entering the vehicle through the vents. Turn to increase/decrease the air temperature on the driver side of the vehicle. The control also adjusts the passenger side temperature when PASS TEMP is disengaged. The recommended initial setting is between 72°F (22°C) and 75°F (24°C), then adjust for comfort. The driver side temperature setting will appear in the upper left corner of the display.
12.  – **Front fan speed control:** Press to decrease the fan speed.
13. A.  **Rear defroster (if equipped):** Press to activate/deactivate the rear window defroster. Refer to *Rear window defroster* later in this chapter for more information. If your vehicle is equipped with both rear defroster and heated mirrors, the same button will activate both.
13. B.  **Heated mirrors (if equipped):** Press to activate/deactivate. This feature will remove ice and snow from the side view mirrors.

### DUAL ZONE AUTOMATIC TEMPERATURE CONTROL WITH HEATED AND COOLED SEATS (IF EQUIPPED)

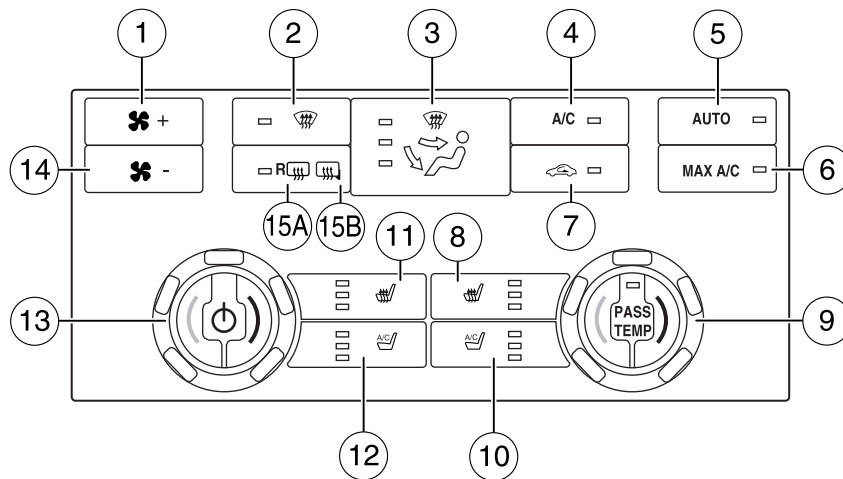





**Temperature conversion:** To switch between Fahrenheit and Celsius, refer to *Message center* in the *Instrument Cluster* chapter.



1.  + **Fan speed control:** Press to increase the fan speed.

## Climate Controls

2.  **Defrost:** Distributes outside air through the windshield defroster vents and de-mister vents. Can be used to clear the windshield of fog and thin ice. The system will automatically provide outside air to reduce window fogging. Press this button again to return to the previous air flow selection.



3.  **Manual override control:** Allows you to manually select where airflow is directed. To return to full automatic control, press AUTO. When choosing to control airflow manually, press repeatedly to toggle through the settings to choose:

-  : Distributes air through the windshield defroster vents, de-mister vents, floor vents and rear seat floor vents. The system will automatically provide outside air to reduce window fogging.
-  : Distributes air through the instrument panel vents.
-  : Distributes air through the instrument panel vents, floor vents, rear seat floor vents and de-mister vents.
-  : Distributes air through the floor vents and rear seat floor vents.

4. **A/C:** Press to activate/deactivate air conditioning. Use with recirculated air to improve cooling performance and efficiency. A/C engages automatically in MAX A/C,  (defrost) and  (floor/defrost).









5. **AUTO:** Press to engage automatic temperature control. Select the desired temperature using the temperature control. The system will automatically determine fan speed, airflow location, A/C on or off, and outside or recirculated air, to heat or cool the vehicle to reach the desired temperature.

6. **MAX A/C:** Distributes recirculated air through the instrument panel vents to cool the vehicle. This re-cooling of the interior air is more economical and efficient. Recirculated air may also help reduce undesirable odors and dust/debris from entering the vehicle. Press the MAX A/C button again for normal A/C operation.

7.  **Recirculated air:** Press to recirculate the air in the vehicle. Recirculated air may reduce the amount of time needed to cool down the interior of the vehicle (when used with A/C) and may also help reduce undesired odors and dust/debris from reaching the interior of the vehicle. This button engages automatically when MAX A/C is selected or can be engaged manually in any airflow mode except  (defrost). This button may turn off automatically in all airflow modes (except MAX A/C)

## Climate Controls

and when the ignition is cycled (if the A/C indicator light is not illuminated ) in order to prevent window fogging. Even when this button is not selected, air may still recirculate in some instances in order to reduce vehicle warm-up time in cold conditions or to cool down time in hot conditions. **Note:** You may notice changes in sound between recirculated mode and other airflow modes.

8.  **Passenger heated seat:** Press to control the passenger heated seat. Refer to *Heated and cooled seats* in the *Seating and Safety Restraints* chapter for more information.
9. **PASS TEMP:** Press to engage/disengage separate passenger side temperature control. Turn to increase/decrease the air temperature on the passenger side of the vehicle. The recommended initial setting is between 72°F (22°C) and 75°F (24°C), then adjust for comfort. The passenger side temperature setting will appear in the upper right corner of the display.
10.  **Passenger cooled seat:** Press to control the passenger cooled seat. Refer to *Heated and cooled seats* in the *Seating and Safety Restraints* chapter for more information.
11.  **Driver heated seat:** Press to control the driver heated seat. Refer to *Heated and cooled seats* in the *Seating and Safety Restraints* chapter for more information.
12.  **Driver cooled seat:** Press to control the driver cooled seat. Refer to *Heated and cooled seats* in the *Seating and Safety Restraints* chapter for more information.
13.  **Power/Driver temperature:** Press to activate/deactivate the climate control system. When the system is off, outside air is prevented from entering the vehicle. Turn to increase/decrease the air temperature on the driver side of the vehicle. The control also adjusts the passenger side temperature when PASS TEMP is disengaged. The recommended initial setting is between 72°F (22°C) and 75°F (24°C), then adjust for comfort. The driver side temperature setting will appear in the upper left corner of the display.
14.  – **Fan speed control:** Press to decrease the fan speed.
15. A.  **Rear defroster (if equipped):** Press to activate/deactivate the rear window defroster. Refer to *Rear window defroster* later in this chapter for more information. If your vehicle is equipped with both rear defroster and heated mirrors, the same button will activate both.
15. B.  **Heated mirrors (if equipped):** Press to activate/deactivate. This feature will remove ice and snow from the side view mirrors.

## Climate Controls

### DUAL ZONE AUTOMATIC TEMPERATURE CONTROL WITH HEATED AND COOLED SEATS (NAVIGATION BASED-IF EQUIPPED)

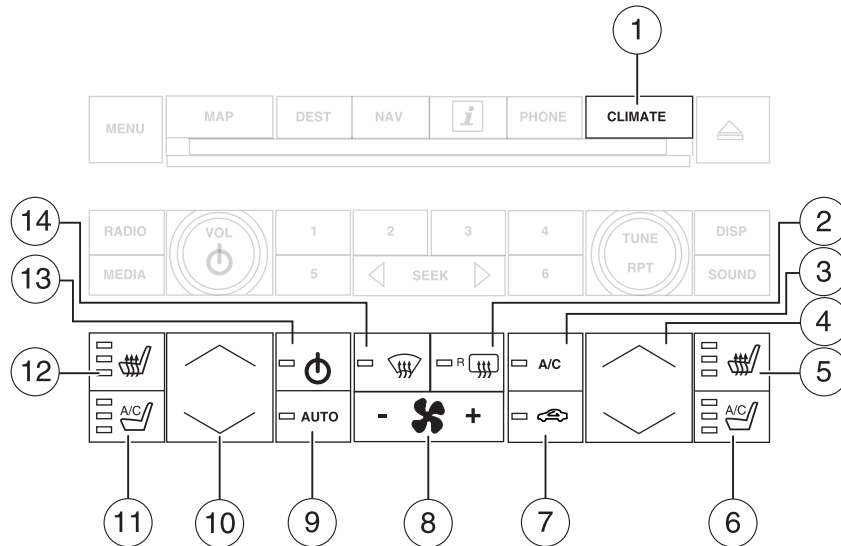









**Temperature conversion:** To switch between Fahrenheit and Celsius, refer to *Message center* in the *Instrument Cluster* chapter.

1. **CLIMATE:** Press to control the climate control system through the touch display screen. See *Touchscreen functions* later in this section.
2. **Rear defroster (if equipped):** Press to activate/deactivate the rear window defroster. Refer to *Rear window defroster* later in this chapter for more information. If your vehicle is equipped with both rear defroster and heated mirrors, the same button will activate both.

**Heated mirrors (if equipped):** Press to activate/deactivate. This feature will remove ice and snow from the side view mirrors.

3. **A/C:** Press to activate/deactivate air conditioning. Use with recirculated air to improve cooling performance and efficiency. A/C engages automatically in MAX A/C, (defrost) and (floor/defrost).

## Climate Controls

4. **Passenger temperature:** Press to activate separate passenger temperature control to increase/decrease the air temperature on the passenger side of the vehicle.
5.  **Passenger heated seat (if equipped):** Press to control the passenger heated seat. Refer to *Heated and cooled seats* in the *Seating and Safety Restraints* chapter for more information.
6.  **Passenger cooled seat (if equipped):** Press to control the passenger cooled seat. Refer to *Heated and cooled seats* in the *Seating and Safety Restraints* chapter for more information.
7.  **Recirculated air:** Press to recirculate the air in the vehicle. Recirculated air may reduce the amount of time needed to cool down the interior of the vehicle (when used with A/C) and may also help reduce undesired odors and dust/debris from reaching the interior of the vehicle. This button engages automatically when MAX A/C is selected or can be engaged manually in any airflow mode except  (defrost). This button may turn off automatically in all airflow modes (except MAX A/C) and when the ignition is cycled (if the A/C indicator light is not illuminated ) in order to prevent window fogging. Even when this button is not selected, air may still recirculate in some instances in order to reduce vehicle warm-up time in cold conditions or to cool down time in hot conditions. **Note:** You may notice changes in sound between recirculated mode and other airflow modes.
8.  **Fan speed control:** Press to decrease/increase the fan speed.
9. **AUTO:** Press to engage full automatic operation. Select the desired temperature using the temperature control. The system will automatically determine fan speed, airflow location, A/C on or off, and outside or recirculated air, to heat or cool the vehicle to reach the desired temperature.
10. **Driver temperature:** Press to increase/decrease the air temperature for the driver side of the vehicle. This control also adjusts the passenger side temperature when dual zone operation is disengaged.
11.  **Driver cooled seat (if equipped):** Press to control the driver cooled seat. Refer to *Heated and cooled seats* in the *Seating and Safety Restraints* chapter for more information.
12.  **Driver heated seat (if equipped):** Press to control the driver heated seat. Refer to *Heated and cooled seats* in the *Seating and Safety Restraints* chapter for more information.
13.  **Power:** Press to activate/deactivate the climate control system. When the system is off, outside air is prevented from entering the vehicle. The climate status in the touchscreen will also be turned off.

78

## Climate Controls



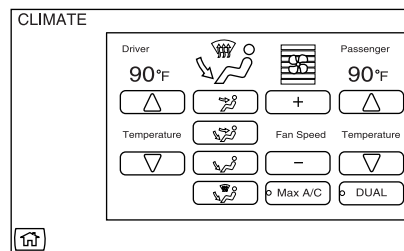

14.  **Defrost:** Distributes outside air through the windshield defroster vents and de-mister vents. Can be used to clear the windshield of fog and thin ice. The system will automatically provide outside air to reduce window fogging. Press this button again to return to the previous air flow selection.

### TOUCHSCREEN FUNCTIONS



*Temperature conversion:* To switch between Fahrenheit and Celsius, refer to *Message center* in the *Instrument Cluster* chapter.

**Temperature:** Press the up and down arrows on the left side of the screen to increase/decrease the airflow temperature for the driver side of the vehicle. This control also adjusts the passenger side temperature when dual zone operation is disengaged. Press the up and down arrows on the right side of the screen to increase/decrease the airflow temperature for the passenger side of the vehicle.

-  : Distributes air through the instrument panel vents.
-  : Distributes air through the instrument panel vents, floor vents, rear seat floor vents and de-mister vents.
-  : Distributes air through the floor vents, rear seat floor vents.
-  : Distributes air through the windshield defroster vents, de-mister vents, floor vents and rear seat floor vents. The system will automatically provide outside air to reduce window fogging.

To return to full automatic control, press AUTO on the main bezel.

**Fan Speed:** Press to decrease/increase the fan speed.

**Dual:** Press to activate/deactivate separate driver and passenger temperature controls.



## Climate Controls

**Max A/C:** Distributes recirculated air through the instrument panel vents to cool the vehicle. This re-cooling of the interior air is more economical and efficient. Recirculated air may also help reduce undesirable odors from entering the vehicle. Press MAX A/C again for normal operation.

### VOICE COMMANDS IN CLIMATE MODE



Please refer to the *Voice commands in climate mode* section of the *Navigation supplement* for more information on using voice commands with the climate control system.

### Operating tips

- To reduce fog build-up on the windshield during humid weather, select  (defrost). Temperature and/or fan speed can also be increased to improve clearing.
- To reduce humidity build-up inside the vehicle: do not drive with the system off or with  (recirculated air) engaged.
- Do not put objects under the front seats that will interfere with the airflow to the back seats.
- Remove any snow, ice or leaves from the air intake area at the base of the windshield.
- To improve the A/C cool down, drive with the windows slightly open for not more than 2-3 minutes after start up to “air out” the vehicle.
- For maximum cooling performance when using Max A/C or  (recirculated air), all windows and doors should remain closed.
- A small amount of air may be felt from the floor vent regardless of the air distribution setting that is selected.

If you are driving during extreme high ambient temperatures and idling for extended periods of time in gear, it is recommended to run the A/C in the MAX A/C mode, adjust the blower fan speed to the lowest setting and put the vehicle's transmission in P (Park) to continue to receive cool air from your A/C system.

### For maximum cooling performance (MAX A/C):

1. Press MAX A/C. The system will default to single zone operation and set the temperature to 60°F (16°C). The blower will automatically go to maximum.
2. A/C,  (recirculated air) and  (panel) will be selected.
3. Fan speed can be adjusted as desired.

80



## Climate Controls

### To aid in side window defogging/demisting in cold weather:

1. Select .
2. Select A/C.
3. Adjust the temperature control to maintain comfort.
4. Set the fan speed to the highest setting.
5. Direct the outer instrument panel vents towards the side windows.

To increase airflow to the outer instrument panel vents, close the vents located in the middle of the instrument panel.

### REAR WINDOW DEFROSTER (IF EQUIPPED)

The rear defroster control is located on the climate control panel and works to defrost your rear window from fog and thin ice. If equipped, it also operates the heated mirror to remove snow and thin ice from the side mirrors.

Ensure that the ignition on. Press to turn the defroster on/off. The indicator light will illuminate when activated. For vehicles with a sliding rear window– the defroster will be disabled when the window is opened.

**Do not use razor blades or other sharp objects to clean the inside of the rear window or to remove decals from the inside of the rear window. This may cause damage to the heated grid lines and will not be covered by your warranty.**

### REMOTE START CLIMATE OPERATION (IF EQUIPPED)

The climate control system will condition the cabin temperature during remote start based on the outside temperature. Engine idle may increase to help with adjusting the cabin temperature.

**Note:** No climate control adjustments will be recognized during remote start operation and none of the climate function indicators will be illuminated while the vehicle is in remote start. Once the ignition is cycled to the on position, the climate control system will return to the previous settings (last ignition-on cycle) and adjustments can be made normally. If the previous setting was off, the climate control system will turn off.

If you previously had any of the following activated: heated seats (if equipped), cooled seats (if equipped), heated mirrors (if equipped), or rear defrost, they will not return to their previous settings (on) when the ignition is turned on and will need to be re-activated if desired.

For more information on remote start climate settings and options, refer to *Message Center* in the *Instrument Cluster* chapter.

## Climate Controls

### Manual climate control

For hot weather conditions:

- The climate control system will be set to MAX A/C.

For cold weather conditions:

- The climate control system will be set to provide maximum heating in  (floor/defrost) mode.
- Rear defrost/heated mirrors (if equipped) will be activated.

For moderate weather conditions:

- The interior cabin will be heated, cooled or off, based upon the previous operating state (last ignition-on cycle).
- Rear defrost/heated mirrors (if equipped) will be deactivated.

### Automatic climate control

For hot weather conditions:

- The interior cabin will be cooled to 72°F (22°C).
- The cooled seats (if equipped and if the feature is selected to AUTO in the message center) will be set to high.

For cold weather conditions:

- The interior cabin will be heated to 72°F (22°C).
- The heated seats (if equipped and if the feature is selected to AUTO in the message center) will be set to high.
- Rear defrost/heated mirrors (if equipped) will be activated.

For moderate weather conditions:

- The interior cabin will be heated, cooled, or off, based upon the previous operating state (last ignition-on cycle).
- Heated/cooled seats (if equipped) will be deactivated.
- Rear defrost/heated mirrors (if equipped) will be deactivated.

## Lights

### HEADLAMP CONTROL

Rotate the headlamp control clockwise to the first position  to turn on the parking lamps.

Rotate clockwise to the second position  to also turn on the headlamps.

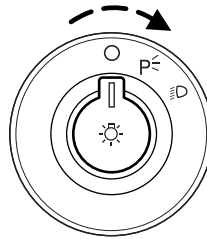



### Autolamp control (if equipped)

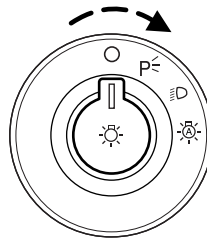

The autolamp system provides light sensitive automatic on-off control of the exterior lights normally controlled by the headlamp control.

The autolamp system also keeps the lights on for a predetermined amount of time after the ignition switch is turned off. Using the message center, you can select a delay from 0–180 seconds.



- To turn autolamps on, rotate the control to  .
- To turn autolamps off, rotate the control to  .

### Fog lamp control (if equipped)

The headlamp control also operates the fog lamps. The fog lamps can be turned on only when the headlamp control is in the ,  or  position and the high beams are not turned on.

Pull headlamp control towards you to turn fog lamps on. The fog lamp indicator light  will illuminate.

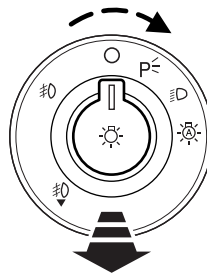

## Lights

### High beams

Pull the lever fully past the detent to activate. Pull the lever fully again to deactivate.

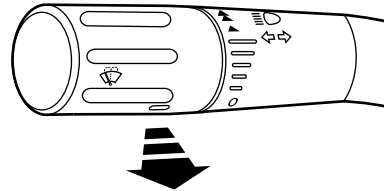

### Flash-to-pass

Pull toward you slightly to activate and release to deactivate.

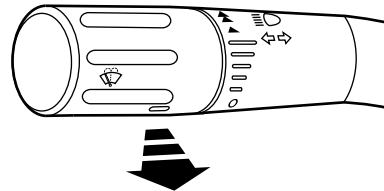

### Daytime running lamps (DRL) (if equipped)

Turns the headlamps on with a reduced output.

In order for the DRLs to function:

- the ignition must be in the on position and
- the headlamp control is in the , parking lamp or autolamp position.



**WARNING:** Always remember to turn on your headlamps at dusk or during inclement weather. The Daytime Running Lamp (DRL) system does not activate the tail lamps and generally may not provide adequate lighting during these conditions. Failure to activate your headlamps under these conditions may result in a collision.

## Lights

### PANEL DIMMER CONTROL

Use to adjust the brightness of the instrument panel and all applicable lit components in the vehicle during headlamp and parking lamp operation.

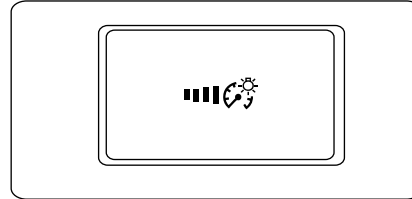

- Tap the left or right of the control to brighten/dim all interior lit components incrementally, or
- Press and hold at the first position the left or right of the control until the desired lighting level is reached.
- Press and hold the right of the control to the full on position to activate the “dome on” feature. This will turn on the interior courtesy lights.
- Press and hold the left of the control to turn off the interior courtesy lights.

### AIMING THE HEADLAMPS

The headlamps on your vehicle are properly aimed at the assembly plant. If your vehicle has been in an accident, the alignment of your headlamps should be checked by your authorized dealer.

#### Vertical aim adjustment

1. Park the vehicle directly in front of a wall or screen on a level surface, approximately 25 feet (7.6 meters) away.

- (1) 8 feet (2.4 meters)
- (2) Center height of lamp to ground
- (3) 25 feet (7.6 meters)
- (4) Horizontal reference line

2. Measure the height from the center of your headlamp (indicated by a 3.0 mm circle on the lens) to the ground and mark an 8 foot (2.4 meter) horizontal reference line on the vertical wall or screen at this height (a piece of masking tape works well).

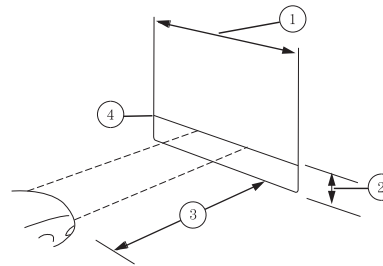

## Lights

3. Turn on the low beam headlamps to illuminate the wall or screen and open the hood. Cover one of the headlamps so no light hits the wall.

4. On the wall or screen you will observe a light pattern with a distinct horizontal edge towards the right. If this edge is not at the horizontal reference line, the beam will need to be adjusted so the edge is at the same height as the horizontal reference line.

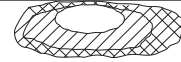

5. Locate the vertical adjuster on each headlamp, then use a #2 Philips screwdriver to turn the adjuster either counterclockwise (to adjust up) or clockwise (to adjust down) aligning the upper edge of the light pattern up to the horizontal line.

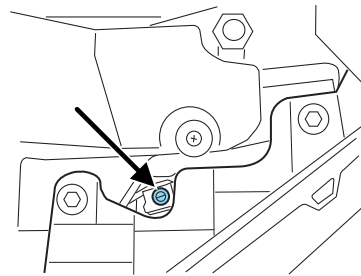

6. HORIZONTAL AIM IS NOT REQUIRED FOR THIS VEHICLE AND IS NON-ADJUSTABLE.

7. Repeat Steps 3–5 for the other headlamp.

8. Close the hood and turn off the lamps.

### TURN SIGNAL CONTROL

The turn signal lever does not mechanically lock in the upward or downward position when activated. The turn signal control activation and cancellation is electronic.

- To operate the left turn signal, push the lever down until it stops and release.
- To operate the right turn signal, push the lever up until it stops and release.
- To manually cancel turn signal operation, push the lever again in either direction.

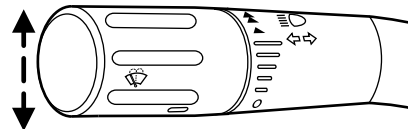

### Lane change

To indicate a left or right lane change:

- Push the lever up/down to the first stop position and release. The turn signals will flash three times and stop.

## Lights

- Push the lever up/down to the first stop position and hold. The turn signals will flash for as long as the lever is held in this position.

### INTERIOR LAMPS



#### Front row map lamps (if equipped)

To turn on the map lamps, press the outer edge of the clear lens. The front row map lamp lights when:

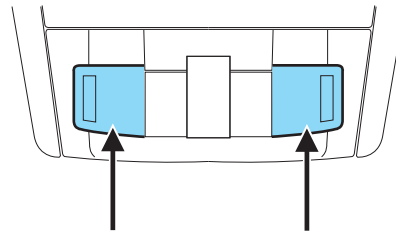
- any door is opened.
- the instrument panel dimmer button is pressed until the courtesy lamp comes on.
- the remote entry controls are pressed and the ignition is off.



#### Rear dome lamp (if equipped)

- ON or  : The dome light will stay on.
- DOOR or middle position: The dome light will only come on if a door is opened.
- OFF or  : The lamp will not come on at all.

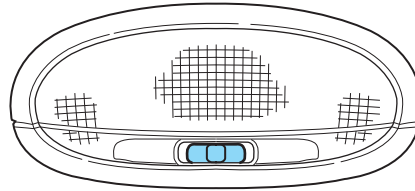

The rear dome lamp can be turned on or off by sliding the control.

#### Rear dome/courtesy lamps (if equipped)

The dome lamp lights when:

- any door is opened.
- the instrument panel dimmer button is pressed until the courtesy lamp comes on.
- any of the remote entry controls are pressed and the ignition is off.

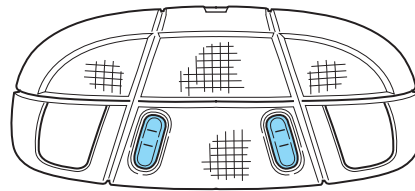

The reading portion, the two outer lights, can only be turned on and off at the lamp.

## Lights

### **Rear courtesy/reading/cargo lamps (if equipped)**

The rear lamps can be turned on when the panel dimmer control is rotated until the lamps come on or when any door is opened.

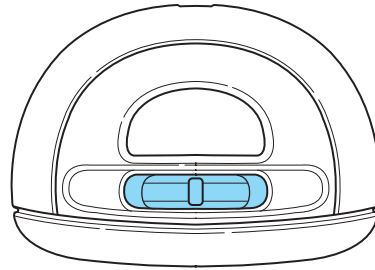

The lamps can be turned on or off by sliding the control.

- When the control is in the middle position, the lamp will come on when a door is opened or the unlock button is pressed on the remote keyless entry.
- If the control is moved to the left position, the lamp will stay on.
- If the control is moved to the right position, the lamp will not come on at all.

### **Ambient lighting (if equipped)**

Illuminates footwells and cupholders with a choice of several colors. The ambient lighting control is located on the floor console.

- To activate, press and release the left side of the control to cycle through the color choices plus the off state.
- Press the right side of the control to adjust color intensity.

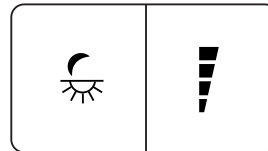

The lights come on whenever the ignition is in either the on or accessory position and the headlamps or parking lamps are on.

**Note:** The ambient lights will stay on until the ignition is placed in the off position and either of the front doors are opened or the accessory delay timer expires.



### **BULB REPLACEMENT**

#### **Lamp assembly condensation**

Exterior lamps are vented to accommodate normal changes in pressure. Condensation can be a natural by-product of this design. When moist air enters the lamp assembly through the vents, there is a possibility that condensation can occur when the temperature is cold. When normal condensation occurs, a thin film of mist can form on the interior of the lens. The thin mist eventually clears and exits through the vents during normal operation. Clearing time may take as long as 48 hours under dry weather conditions.

Examples of acceptable condensation are:

- Presence of thin mist (no streaks, drip marks or droplets)
- Fine mist covers less than 50% of the lens

Examples of unacceptable moisture (usually caused by a lamp water leak) are:

- Water puddle inside the lamp
- Large water droplets, drip marks or streaks present on the interior of the lens

Take your vehicle to a dealer for service if any of the above conditions of unacceptable moisture are present.

#### **Using the right bulbs**

Replacement bulbs are specified in the chart below. Headlamp bulbs must be marked with an authorized "D.O.T." for North America and an "E" for Europe to ensure lamp performance, light brightness and pattern and safe visibility. The correct bulbs will not damage the lamp assembly or void the lamp assembly warranty and will provide quality bulb burn time.

## Lights

Function	Number of bulbs	Trade number
Headlamps	2	H13/9008
Front park/turn lamps	2	3157NA (natural amber)
Front sidemarker	2	168
Fog lamps	2	9140
Backup lamp (styleside)	2	921
Backup lamp (Harley)	2	921
Rear stop/turn/sidemarker/tail lamp (styleside)	4	3057K
High-mount brakelamp	1	912
Cargo lamp	2	912
License plate lamp	2	194
Exterior mounted mirror turn signal indicator (if equipped)	2	See your dealer
Puddle lamp (if equipped)	2	See your dealer
All replacement bulbs are clear in color except where noted.		
To replace all instrument panel lights - see your authorized dealer		

### Replacing exterior bulbs

Check the operation of all the bulbs frequently.

#### Replacing headlamp bulbs

1. Make sure that the headlamp control is in the off position and open the hood.
2. Remove the pushpin that holds the air deflector/protective cover from the upper inboard corner of the lamp.

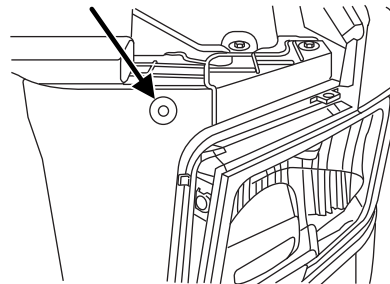

## Lights

3. Loosen the three retaining bolts (two at top of lamp, one at lower inboard corner).

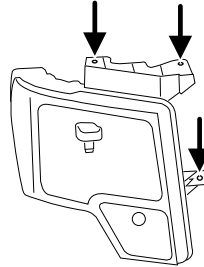

4. Once the three retaining bolts have been removed, slide the headlamp assembly forward, disconnecting the two snap attachments at the fender.
5. Disconnect the electrical connector from the bulb by pulling rearward.
6. Remove the bulb and socket by turning it counterclockwise, then pull it straight out.

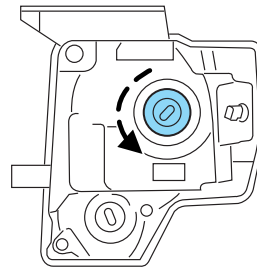

**!** **WARNING:** Handle a halogen headlamp bulb carefully and keep out of children's reach. Grasp the bulb only by its plastic base and do not touch the glass. The oil from your hand could cause the bulb to break the next time the headlamps are operated.

Install the new bulb in reverse order.

## Lights

### **Replacing front parking lamp/turn signal/sidemarkers bulbs**

1. Make sure that the headlamp control is in the off position and open the hood.
2. Remove the pushpin that holds the air deflector/protective cover from the upper inboard corner of the lamp.
3. Loosen the three retaining bolts (two at top of lamp, one at lower inboard corner).
4. Once the three retaining bolts have been removed, slide the headlamp assembly forward, disconnecting the two snap attachments at the fender.
5. Remove the bulb and socket by turning it counterclockwise, then pull it straight out.
6. Pull the bulb straight out of the socket.

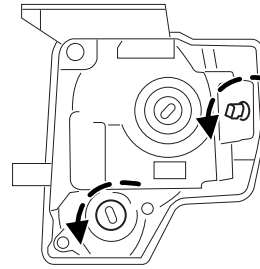
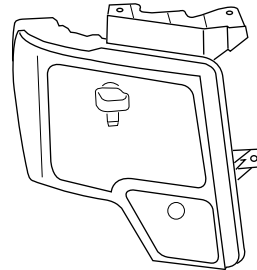

Install the new bulb(s) in reverse order.

### **Replacing tail/brake/turn signal/backup lamp bulbs**

1. Make sure the headlamp control is in the off position.
2. Open the tailgate to expose the lamp assembly and remove the two bolts from the tail lamp assembly.

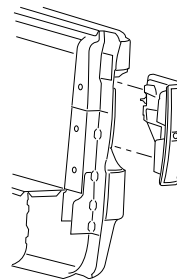

## Lights

3. Carefully pull the lamp assembly straight rearward from the tailgate pillar to disengage two hidden snap-in retainers. (Flare side tail lamps are not equipped with snap-in retainers.)

4. Remove bulb socket from the lamp assembly by turning it counterclockwise.

5. Pull bulb straight out of socket and press in the new bulb.

Install the new bulb(s) in reverse order.

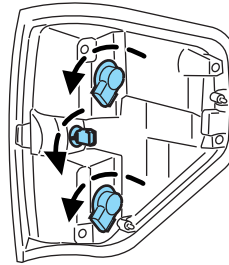

### **Replacing high-mount brake and cargo lamp bulbs**

Make sure the headlamp control is in the off position.

1. Remove the two screws and move the lamp assembly away from the vehicle to expose the bulb sockets.

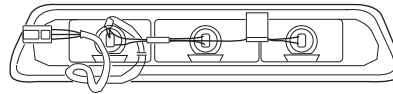

2. Remove the bulb socket by rotating counterclockwise and pulling it out of the lamp assembly.

3. Pull the bulb straight out of the socket and push in the new bulb.

Install the new bulbs in reverse order.

### **Replacing fog lamp bulbs (if equipped)**

1. Make sure the headlamp control is in the off position.

2. Remove the bulb socket from the fog lamp by turning counterclockwise.

3. Disconnect the electrical connector from the fog lamp bulb.

Install the new bulb in reverse order.

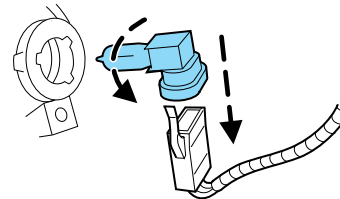

## Lights

### **Replacing exterior mounted mirror turn signal indicator lamp bulbs**

For bulb replacement, see your authorized dealer.

### **Replacing license plate lamp bulbs**

The license plate bulbs are located behind the rear bumper. To change the license plate lamp bulbs:

1. Reach behind the rear bumper to locate the bulb.
2. Twist the bulb socket counterclockwise and carefully pull to remove it from the lamp assembly.
3. Pull out the old bulb from the socket and push in the new bulb.
4. Install the bulb socket in lamp assembly by turning it clockwise.

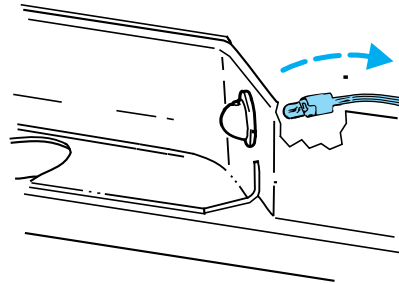

## Driver Controls

### MULTI-FUNCTION LEVER

**Windshield wiper:** Rotate the end of the control away from you to increase the speed of the wipers; rotate toward you to decrease the speed of the wipers.

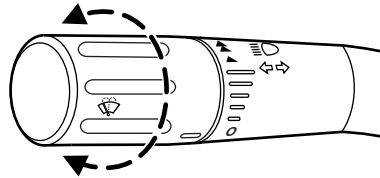

**Speed-dependent wipers (if equipped):** When the wiper control is set to any of the interval settings except the longest pause setting, the pause time between wiping will automatically adjust with the vehicle speed. The faster your vehicle is travelling the shorter the pause time between wipes will become.

**Rain-sensing wipers (if equipped):** The rain-sensing wipers, designated with AUTO on the control, will automatically activate when moisture is present on the windshield and the control is set to one of five auto/interval moisture sensitivity settings. Rotate the end of the control toward the windshield to increase the sensitivity. The speed of the rain-sensing wipers will vary based on the amount of moisture detected on the windshield and the auto/interval setting. There are no interval (intermittent wipe) settings on vehicles with rain-sensing wipers. The wipers will continue to wipe as long as the presence of moisture is detected on the windshield. More or less wiping may occur depending on humidity, mist or light rain, or road spray.

This feature can be enabled/disabled through the message center. Refer to *Message center* in the *Instrument Cluster* chapter.

Keep the outside of the windshield clean, especially the area around the rear view mirror where the sensor is located or rain sensor performance may be affected.

**Note:** During winter driving conditions with ice, snow or a salty road mist, inconsistent or unexpected wiping or smearing may occur. In these conditions, you can lower the sensitivity to reduce the amount of smearing or override the feature by selecting low- or high-speed wiping or turning the wiper system off.

**Note:** The rain sensing wiper feature must be turned off before entering a car wash.

## Driver Controls

**Windshield washer:** Press the end of the stalk:

- briefly: causes a single swipe of the wipers without washer fluid.
- a quick press and hold: the wipers will swipe three times with washer fluid.
- a long press and hold: the wipers and washer fluid will be activated for up to ten seconds.

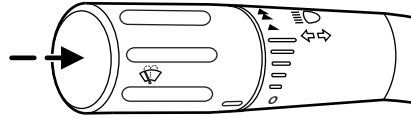

**Note:** Do not operate the washer when the washer reservoir is empty. This may cause the washer pump to overheat. Check the washer fluid level frequently. Do not operate the wipers when the windshield is dry. This may scratch the glass, damage the wiper blades and cause the wiper motor to burn out. Before operating the wiper on a dry windshield, always use the windshield washer. In freezing weather, be sure the wiper blades are not frozen to the windshield before operating the wipers.

**Courtesy wipe feature:** One extra wipe will occur a few seconds after washing the front window to clear any excess washer fluid remaining on the windshield. This feature can be enabled/disabled through the message center. Refer to *Message center* in the *Instrument Cluster* chapter.

### Windshield wiper rainlamp feature (if equipped with autolamp)

When the windshield wipers are turned on during daylight, and the headlamp control is in the autolamp position, the exterior lamps will turn on after a brief delay and will remain on until the wipers are turned off.

### TILT OR TILT/TELESCOPE STEERING COLUMN (IF EQUIPPED)

To adjust the steering column:

1. Pull the lever down to unlock the steering column.
2. Adjust the steering wheel up or down.
3. If also equipped with the telescope feature, adjust the steering wheel in or out.
4. While holding the steering wheel in place, pull the lever up to its original position to lock the steering column.

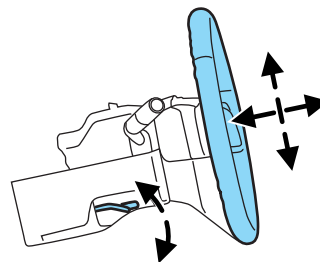



## Driver Controls



**WARNING:** Never adjust the steering column when the vehicle is moving.

### Power Tilt/Telescope Steering Column (if equipped)

The steering column can be adjusted using the control on the side of the steering column. Press and hold the front or rear of the control to adjust the telescope. Press and hold the top or bottom of the control to adjust the tilt.

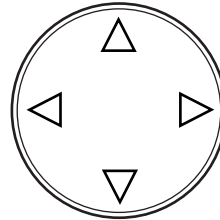

### Easy entry/exit feature

When you remove the key from the ignition, the column will move to the full up and in position if this feature is activated through the message center. Refer to *Message center* in the *Instrument Cluster* chapter. When the key is inserted into the ignition, the column will return to the previous setting.

**Note:** The easy entry/exit feature will prevent the steering wheel from returning to the memory position until the key is inserted into the ignition.

### Memory feature

The steering column positions are saved when doing a memory set function and can be recalled along with the vehicle personality features when a memory position is selected through the remote entry transmitter, keyless entry keypad or memory switch on the side of the driver's seat (if equipped with memory feature). Refer to *Front seating* in the *Seating and Safety Restraints* chapter.

If the steering column adjustment control is pressed during memory recall it will cancel the automatic operation and the column will respond to manual adjustment of the control.



**WARNING:** Never adjust the steering column when the vehicle is moving.

## Driver Controls

On vehicles with memory feature, to prevent damage to the steering column, the steering column is designed to set a stopping position just short of the end of the column position. If the steering column encounters an object while moving up or down, a new stopping position will be set. To reset the steering column to its normal stopping position:

- After encountering the new stopping position, press the steering column control again to override.
- Continue pressing the control until it reaches the end of the column position.
- A new soft stop will be automatically set. The next time the steering column is tilted it will stop just short of the end of the column position.

### ILLUMINATED VISOR MIRROR (IF EQUIPPED)

Lift the mirror cover to turn on the visor mirror lamp.

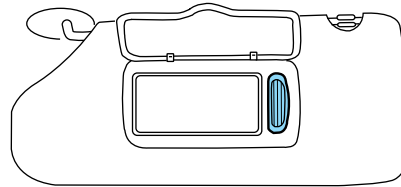

### Slide-on-rod feature

Rotate the visor towards the side window and extend it rearward for additional sunlight coverage.

**Note:** To stow the visor back into the headliner, visor must be retracted before moving it back towards the windshield.

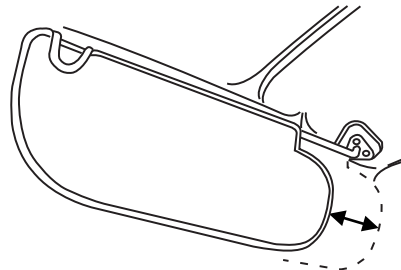

## Driver Controls

### CENTER CONSOLE (IF EQUIPPED)

Your vehicle may be equipped with a variety of console features. These include:

- Locking storage compartment with hanging file folder supports
- Utility compartment with coin holder slots, cardholder and pen holder (on underside of lid).
- Storage for laptop computer
- One 12V power point inside the storage compartment and one on the rear of the console
- 110V AC power point outlet on the rear of the console
- Front and rear cupholders
- Rear passenger air registers

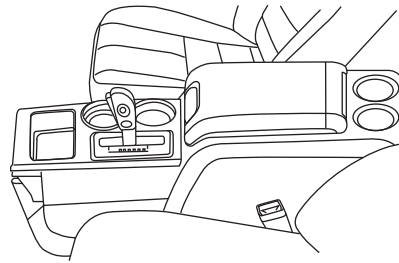

**WARNING:** Use only soft cups in the cupholder. Hard objects can injure you in a collision.

### ELECTRONIC COMPASS (IF EQUIPPED)

The compass heading is displayed in the Center Integrated Display (CID).

The compass reading may be affected when you drive near large buildings, bridges, power lines and powerful broadcast antenna. Magnetic or metallic objects placed in, on or near the vehicle may also affect compass accuracy.

Usually, when something affects the compass readings, the compass will correct itself after a few days of operating your vehicle in normal conditions. If the compass still appears to be inaccurate, a manual calibration may be necessary. Refer to *Compass calibration adjustment*.

Most geographic areas (zones) have a magnetic north compass point that varies slightly from the northerly direction on maps. This variation is four degrees between adjacent zones and will become noticeable as the vehicle crosses multiple zones. A correct zone setting will eliminate this error. Refer to *Compass zone adjustment*.

## Driver Controls

### Compass zone adjustment

1. Determine which magnetic zone you are in for your geographic location by referring to the zone map.
2. Turn ignition to the on position.

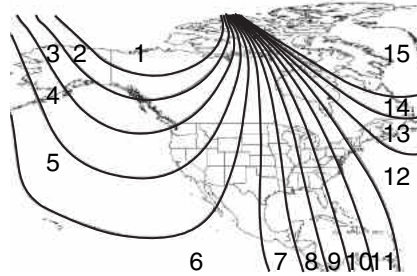

3. Press and hold the 7 and 9 radio preset buttons together for approximately five seconds until ZONE XX appears in the CID.

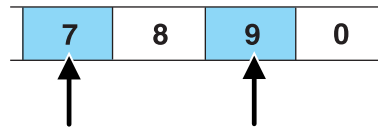

4. Press and release the 7 and 9 radio preset buttons together, repeatedly until ZONE XX changes to the correct zone (1–15) in the CID.

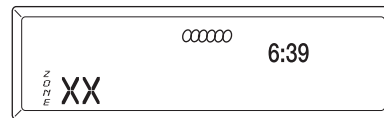

5. The direction will display after the buttons are released. The zone is now updated.

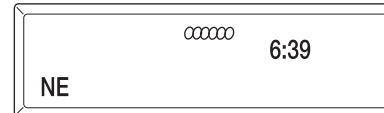

### Compass calibration adjustment

Perform compass calibration in an open area free from steel structures and high voltage lines. For optimum calibration, turn off all electrical accessories (heater/air conditioning, wipers, etc.) and make sure all vehicle doors are shut.

1. Start the vehicle.

## Driver Controls

2. To calibrate, press and hold the 7 and 9 radio preset buttons together for approximately 10 seconds until CAL appears. Release the buttons.

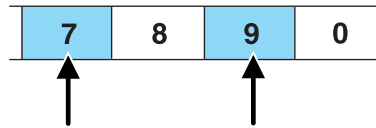

3. Slowly drive the vehicle in a circle (less than 3 mph [5 km/h]) until the CAL display changes to the direction value (N, S, E, W, etc.). It may take up to five circles to complete calibration.

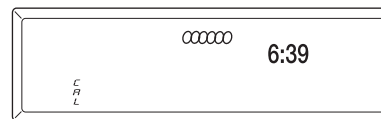

4. The compass is now calibrated.

### AUXILIARY POWER POINT (12V DC)

**Power outlets are designed for accessory plugs only. Do not insert any other object in the power outlet as this will damage the outlet and blow the fuse. Do not hang any type of accessory or accessory bracket from the plug. Improper use of the power outlet can cause damage not covered by your warranty.**

Auxiliary power points can be found in the following locations:

- On the instrument panel
- Inside the center console storage area (if equipped)
- On the rear of the center console (if equipped) accessible from the rear seat

Always keep the power point caps closed when not being used.

Do not use the power point for operating the cigarette lighter element (if equipped).

**Note:** Do not plug optional electrical accessories into the cigarette lighter socket (if equipped). Improper use of the lighter can cause damage not covered by your warranty, and can result in fire or serious injury.

To prevent the fuse from being blown, do not use the power point(s) over the vehicle capacity of 12V DC/180W. If the power point or cigar lighter socket is not working, a fuse may have blown. Refer to *Fuses and relays* in the *Roadside Emergencies* chapter for information on checking and replacing fuses.

## Driver Controls

To have full capacity usage of your power point, the engine is required to be running to avoid unintentional discharge of the battery. To prevent the battery from being discharged:

- do not use the power point longer than necessary when the engine is not running,
- do not leave battery chargers, video game adapters, computers and other devices plugged in overnight or when the vehicle is parked for extended periods.

### Power point (110V AC) (if equipped)

The 110V AC power point outlet is used for powering electrical devices that require up to 150W. Exceeding the 150W limit will cause the power point to cut off the power temporarily to provide overload protection.

**Note:** The 110V AC power point is equipped with a cap which provides protection from inserting objects into the socket. The cap should always be in a closed position whenever the power point outlet is not in use.

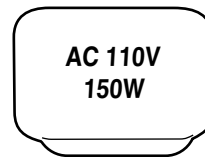

The 110V AC power point is located on the back of the center console.

The power outlet is not designed for the following electric appliances; they may not work properly:

- Cathode ray tube type televisions
- Motor loads, such as vacuum cleaners, electric saws and other electric power tools, compressor-driven refrigerators, etc.
- Measuring devices, which process precise data, such as medical equipment, measuring equipment, etc.
- Other appliances requiring an extremely stable power supply: microcomputer-controlled electric blankets, touch sensor lamps, etc.

 **WARNING:** Do not keep electrical devices plugged in the power point whenever the device is not in use. Do not use any extension cord with the 110V AC power point, since it will defeat the safety protection design provided by the cap and twist tab. Doing so may cause the power point to overload due to powering multiple devices that can reach beyond the 150W load limit and could result in fire or serious injury.

## Driver Controls

The power point can switch to a fault mode when it is overloaded, overheated, or shorted. For overloading and shorting conditions, unplug your device and turn the ignition key off then on. For an overheating condition, let the system cool off, then turn the ignition key off then on. The 110V AC power point can provide power whenever the vehicle ignition is in the on position and the power point green indicator light located in the top left corner is turned on. Refer to the indicator light code below for the power point status.

### Indicator light codes

Green light is on — Power point is ready to supply power

Green light is off — Power point power supply is off. Ignition is not in the on position

Green light is blinking — Power point is in fault mode

**Note:** The 110V AC power point will turn off after 13 minutes if the ignition is in the on position without the engine running. Keep the engine running or cycle the ignition before the 13 minute time-out to keep the inverter on.

### Ashtray (if equipped)

The ashtray is located on the instrument panel.

To open ashtray, push in on the door and release. The ashtray assembly will tip out. To close, push assembly in completely and release.

*Up-level ashtray shown; base similar.*

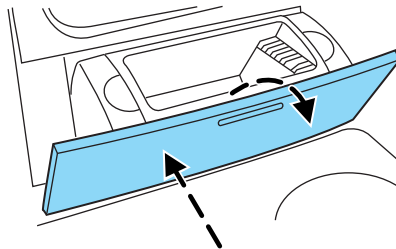

### POWER WINDOWS (IF EQUIPPED)



**WARNING:** Do not leave children unattended in the vehicle and do not let children play with the power windows. They may seriously injure themselves.



**WARNING:** When closing the power windows, you should verify they are free of obstructions and ensure that children and/or pets are not in the proximity of the window openings.

## Driver Controls

Press and pull the window switches to open and close windows.

- Press down (to the first detent) and hold the switch to open.
- Pull up (to the first detent) and hold the switch to close.

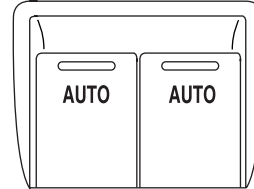

**Rear Window Buffeting:** When one or both of the rear windows are open, the vehicle may demonstrate a wind throb or buffeting noise. This noise can be alleviated by lowering a front window approximately 2–3 in. (5–8 cm).

### **One-touch up or down (front windows only)**

This feature allows the driver or passenger's window to open or close fully without holding the control down.

To operate one-touch down, press the switch completely down to the second detent and release quickly. The window will open fully. Momentarily press the switch to any position to stop the window operation.

To operate one-touch up, pull the switch completely up to the second detent and release quickly. The window will close fully. Momentarily press the switch to any position to stop the window operation.

### **Restoring the one-touch up functionality (front windows only)**

Under low battery power conditions, one-touch up only functionality may be lost. To reset this function after restoring full battery power, pull the switch to the one-touch up position, hold the switch until the glass reaches the stall position and continue to hold for two seconds. Press the window switch down and operate the window to the full down position. One-touch up will now be functional. **Perform one-touch up re-calibration with the door closed only. Calibrating with the door open will cause the window to continuously bounce back.**

### **Bounce-back (front windows only)**

When an obstacle has been detected in the window opening as the window is moving upward, the window will automatically move down and stop.



## Driver Controls

### **Bounce-back override (front windows only)**

To override bounce-back, within two seconds after reaching bounce-back position, if the switch is moved from the neutral to the one-touch up position **the window will travel up with no bounce-back protection.** If the switch is released before the window reaches fully closed position, the window will stop. For example: bounce-back override can be used to overcome the resistance of ice on the window or seals.

### **Window lock**

The window lock feature allows only the driver and front passenger to operate the power windows.

To lock out all the window controls (except for the driver's and front passenger's) press the right side of the control. Press the left side to restore the window controls.

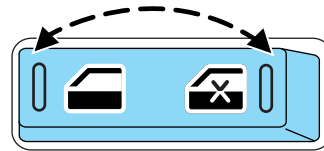

**Note:** The rear window switches will not illuminate when the window control is in the locked position.

### **Power sliding back window (if equipped)**

The control is located on the overhead console.

Press and hold the  control to open the window all the way to the full open position.

Pull and hold the  control to close the window.

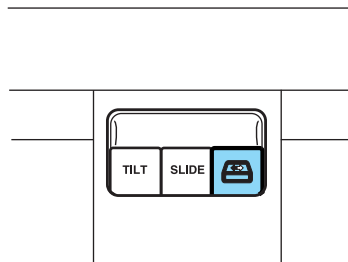

**WARNING:** When operating the power sliding back window you must ensure all rear seat occupants and/or cargo are not in the proximity of the back window.



**WARNING:** Do not leave children unattended in the vehicle and do not let children play with the power sliding back window. They may seriously injure themselves.

## Driver Controls

### Accessory delay (if equipped)

With accessory delay, the window switches may be used for up to 10 minutes after the ignition switch is turned to the off position or until any door is opened.

### INTERIOR MIRROR

The interior rearview mirror has two pivot points on the support arm which lets you adjust the mirror up or down and from side to side.



**WARNING:** Do not adjust the mirror while the vehicle is in motion.

### Automatic dimming interior rear view mirror (if equipped)

The interior rear view mirror has an auto-dimming function (optional on the driver's side exterior mirror). The electronic day/night mirror will change from the normal (high reflective) state to the non-glare (darkened) state when bright lights (glare) reach the interior mirror. When the interior mirror detects bright light from behind the vehicle, the interior rear view mirror and the driver's side exterior mirror (if equipped) will automatically adjust (darken) to minimize glare.

The mirrors will automatically return to the normal state whenever the vehicle is placed in R (Reverse) to ensure a bright clear view when backing up.

**Do not block the sensors on the front and back of the interior rear view mirror since this may impair proper mirror performance.**

**Note:** A rear center passenger and/or raised rear center headrest (if equipped) may also block the light from reaching the sensor.

**Do not clean the housing or glass of any mirror with harsh abrasives, fuel or other petroleum-based cleaning products.**

**Note:** If equipped with a rearview camera system, a video image will display in the mirror or the navigation system display (if equipped) when the vehicle is put in R (Reverse). As you shift into any other gear from R (Reverse), the image will remain for a few seconds and then turn off. Refer to *Rearview camera system* in the *Driving* chapter.

106

## Driver Controls

### EXTERIOR MIRRORS

#### Power side view mirrors (if equipped)



**WARNING:** Do not adjust the mirror while the vehicle is in motion.

To adjust your mirrors:

1. Rotate the control clockwise to adjust the right mirror and rotate the control counterclockwise to adjust the left mirror.
2. Move the control in the direction you wish to tilt the mirror.
3. Return to the center position to lock mirrors in place.

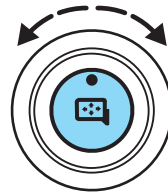

#### Memory feature (if equipped)

The power side view mirror positions are saved when doing a memory set function and can be recalled along with the vehicle personality features when a memory position is selected through the remote entry transmitter, keyless entry keypad or memory switch on the driver's seat. Refer to *Memory seats and mirrors* in the *Seating and Safety Restraints* chapter.

#### Automatic dimming feature (if equipped)

The driver's side view mirror has an auto-dimming function. For more information, refer to *Automatic dimming interior rear view mirror* in this chapter.

## Driver Controls

### Fold-away mirrors

Fold the side mirrors in carefully before driving through a narrow space, like an automatic car wash.

### Powerfold mirrors (if equipped)

With powerfold mirrors, you can fold the side mirrors using the power mirror switch.

1. Rotate the switch to the center/neutral position.
2. Momentarily pull the switch rearward to auto fold in.
3. Momentarily pull the switch rearward again to fold back to design position.

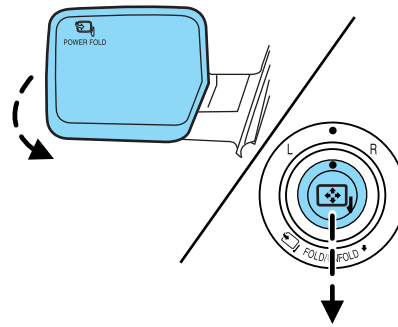

The powerfold mirrors may be moved inward/outward manually.

However, if a mirror is moved manually, it will need to be reset. A mirror which has not been reset may appear to be loose. To reset: with the switch in the center position, momentarily pull the switch rearward to fold the mirrors in. An audible "click" will be heard indicating re-synchronization. If the click is not heard, use the switch to fold the mirrors out, then in, until the click is heard. After that, the mirrors will operate normally until they are again moved manually.

**Note:** 10 or more switch activations within one minute, or repeated folding/unfolding of the mirrors while holding the switch rearward during full travel, may cause the system to disable the fold/unfold function to protect motors from overheating. Should this occur, wait approximately three minutes with the vehicle running and up to 10 minutes with the vehicle off, for the system to reset and for function to return to normal.

### Heated outside mirrors (if equipped)

Heated mirrors remove ice, mist and fog. To activate the heated mirrors, press the rear defrost button  located on the climate control panel.

Refer to *Rear window defroster* in the *Climate Controls* chapter for more information.

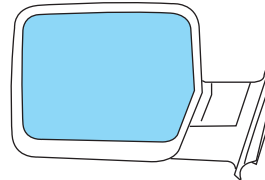

## Driver Controls

On vehicles not equipped with rear defrost, press the heated mirror control  located on the climate control panel. For more information refer to the *Climate Controls* chapter.

**Note:** If your vehicle is equipped with the Auto dimming feature, the mirror glass is thicker and will take longer to defrost.

**Do not remove ice from the mirrors with a scraper or attempt to readjust the mirror glass if it is frozen in place. These actions could cause damage to the glass and mirrors.**

**Do not clean the housing or glass of any mirror with harsh abrasives, fuel or other petroleum-based cleaning products.**

### Signal indicator mirrors (if equipped)

When the vehicle turn signal is activated, the lower portion of the mirror housing will blink.

This feature provides an indicator to the driver that the vehicle turn signal is working properly.

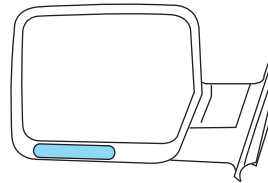

### Telescoping trailer tow mirrors (if equipped)

The telescoping feature allows the mirror to extend approximately 3.5 inches (90 mm). This feature is especially useful to the driver when towing a trailer. Pull the mirrors inward carefully when driving through a narrow space.

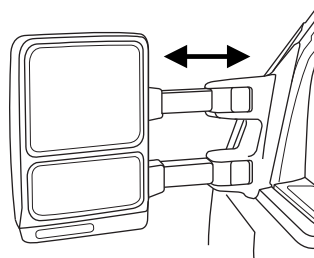

### Blind spot mirrors (if equipped)

Your vehicle may be equipped with blind spot mirrors. Refer to *Blind spot mirrors* in the *Driving* chapter.

### POWER ADJUSTABLE FOOT PEDALS (IF EQUIPPED)

The accelerator and brake pedal should only be adjusted when the vehicle is stopped and the gearshift lever is in the P (Park) position. The control is located on the side of the steering column.

## Driver Controls

Press and hold the rear of the control to adjust the pedals toward you. Press and hold the front of the control to adjust the pedals away from you.



**WARNING:** Never adjust the accelerator and brake pedal with feet on the pedals while the vehicle is moving.

### POWER DEPLOYABLE RUNNING BOARDS (IF EQUIPPED)

Deployable running boards (DRB) automatically move when the doors are opened to assist entering and exiting the vehicle.

#### Automatic power deploy:

- The running boards will extend down and out when the doors are opened.

#### Automatic power stow:

- The running boards will return to the stowed position when the doors are closed. There will be a two second delay before the running boards move in to the stowed position.

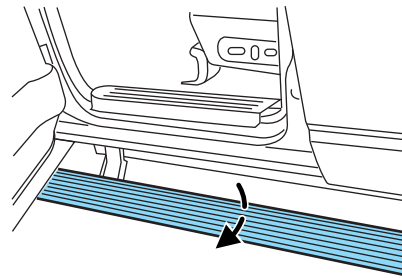

#### Manual power deploy:

To manually operate the running boards, refer to *Message center* in the *Instrument Cluster* chapter.

- This feature can manually set the running boards in the deployed (OUT) position for access to the roof.
- When running boards are manually set in the deployed position, the boards will return to the stowed position and enter automatic mode when the vehicle speed exceeds 5 mph (8 km/h).

#### Enable/disable:

To enable/disable the power running board feature, refer to *Message center* in the *Instrument Cluster* chapter.

- When this feature is disabled (OFF), the running boards will move to the stowed position regardless of the position of the doors.
- When this feature is enabled (AUTO), the running boards will move back to the correct positions based off of the door positions.

110

## Driver Controls

### **Bounce-back:**

- If an object is in the way of the moving running board, the running board will automatically bounce back in the reverse direction and move to the end of travel.

**Note:** The running boards may operate slower in cooler temperatures. In adverse conditions, debris such as mud, dirt, and salt may become trapped in the running board mechanism, possibly leading to unwanted noise. If this occurs, manually set the running boards to the deployed position and flush the system (in particular the front and rear hinge arms) with a high-pressure car wash wand.

**Note:** Do not use the running boards, front and rear hinge assemblies, running board motors, or the running board under body mounts to lift the vehicle when jacking. Please utilize proper jacking points. Refer to *Changing the tires* in the *Roadside Emergencies* chapter.



**WARNING:** In extreme climates, excessive ice buildup may occur, causing the running boards not to deploy. Be sure that the running boards have deployed, and have finished moving before attempting to step on them. Note: The running boards will resume normal function once the blockage is cleared.



**WARNING:** Turn off the running boards before jacking or placing any object under the vehicle. Never place your hand between the extended running board and the vehicle. A moving running board may cause injury.

### **SPEED CONTROL (IF EQUIPPED)**

With speed control set, you can maintain a set speed without keeping your foot on the accelerator pedal.



**WARNING:** Do not use the speed control in heavy traffic or on roads that are winding, slippery or unpaved.

## Driver Controls

### Using speed controls

The speed controls are located on the steering wheel. The following buttons work with speed control:

– **SET +**: Press to set a speed or to increase or decrease the set speed.

**CNCL (Cancel)/RSM (Resume)**: Press to cancel or resume a set speed.

**ON/OFF**: Press to turn speed control on or off.

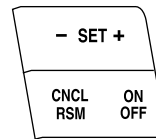

The speed control system uses two  indicator lights in the instrument cluster:

- an amber indicator light which illuminates when the system is on, and
- a green indicator light which illuminates when the system is engaged.

### Setting speed control

To set speed control:

1. Press and release ON.
2. Accelerate to the desired speed.
3. Press and release SET +.
4. Take your foot off the accelerator pedal.
5. The green indicator  light on the instrument cluster will turn on.

#### Note:

- Vehicle speed may vary momentarily when driving up and down a steep hill.
- If the vehicle speed increases above the set speed on a downhill, you may want to apply the brakes to reduce the speed.
- If the vehicle speed decreases more than 10 mph (16 km/h) below your set speed on an uphill, your speed control will disengage.

### Disengaging speed control

To disengage speed control, tap the brake pedal or clutch pedal (if equipped) or press CNCL.

Disengaging the speed control will not erase the previous set speed.

**Note:** When you use the clutch pedal to disengage the speed control, the engine speed may briefly increase, this is normal.



## Driver Controls

### ***Resuming a set speed***

Press and release RSM. This will automatically return the vehicle to the previously set speed.

### ***Increasing speed while using speed control***

To increase the set speed:

- Press and hold SET + until you get to the desired speed, then release. You can also use SET + to operate the tap-up function. Press and release SET + to increase the vehicle set speed in 1 mph (1.6 km/h) increments.
- Use the accelerator pedal to get to the desired speed then press and release SET +.

### ***Reducing speed while using speed control***

To reduce the set speed:

- Press and hold – SET until you get to the desired speed, then release. You can also use – SET to operate the tap-down function. Press and release – SET to decrease the vehicle set speed in 1 mph (1.6 km/h) increments.
- Press the brake pedal or the clutch pedal (if equipped) until the desired vehicle speed is reached then press SET +.

### ***Turning off speed control***

To turn off the speed control, press OFF or turn off the ignition.

**Note:** When you turn off the speed control or the ignition, your speed control set speed memory is erased.

## Driver Controls

### STEERING WHEEL CONTROLS (IF EQUIPPED)

#### Radio control features



– **VOL + (Volume):** Press to decrease or increase the volume.

**◀◀ ▶▶** (**Seek**): Press to select the previous/next radio station preset, CD track or satellite radio station preset depending on which media mode you are in.

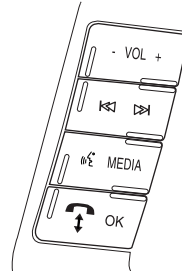
**MEDIA:** Press repeatedly to scroll through available audio modes.



#### Navigation system hands-free control features (if equipped)



Press and hold  control briefly until the voice  icon appears on the navigation display to use the voice command feature.

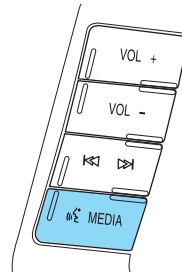

Press  to complete a voice command.

For further information on the navigation system, refer to the *Navigation System* supplement.



#### SYNC® system hands-free control feature (if equipped)

Press  briefly to use the voice command feature. You will hear a tone and LISTENING will appear in the radio display. Press and hold  to exit voice command.

Press  to activate phone mode or answer a phone call. Press and hold  to end a call or exit phone mode.

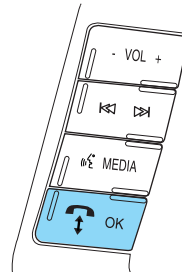





Press **◀◀ ▶▶** to scroll through various menus and selections. Press OK to confirm your selection.

## Driver Controls

For further information on the SYNC® system, refer to the *SYNC®* supplement.

### Navigation system/SYNC® hands-free control features (if equipped)

Press  control briefly until the voice  icon appears on the Navigation display to use the voice command feature.

Press  to activate phone mode or answer a phone call. Press and hold  to exit phone mode or end a call.

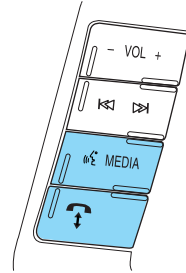

For further information on the Navigation system/SYNC® system, refer to the *Navigation System* and *SYNC®* supplements.

### MOON ROOF (IF EQUIPPED)

The moon roof control is located on the overhead console.



**WARNING:** Do not let children play with the moon roof or leave children unattended in the vehicle. They may seriously hurt themselves.



**WARNING:** When closing the moon roof, you should verify that it is free of obstructions and ensure that children and/or pets are not in the proximity of the moon roof opening.

The moon roof is equipped with an automatic, one-touch, express opening and closing feature. To stop motion at any time during the one-touch operation, press the control a second time.

## Driver Controls

**To open the moon roof:** Press and release the SLIDE control, the moon roof will open automatically. Press the switch again to stop the moon roof.

**To close the moon roof:** Pull and release the SLIDE control, the moon roof will close automatically. Press the switch again to stop the moon roof.

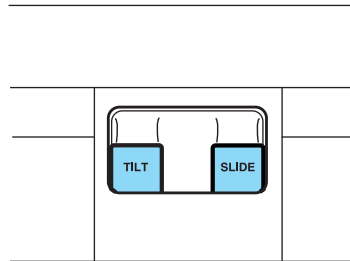

**Bounce-back:** When an obstacle has been detected in the moon roof opening as the moon roof is closing, the moon roof will automatically open and stop at a prescribed position.

**Bounce-back override:** To override bounce-back function, pull and hold the SLIDE switch within two seconds of a bounce-back event. The closing force will begin to increase each time the moon roof is closed for the first three closing cycles, with bounce-back active. For example: Bounce-back can be used to overcome the resistance of ice on the moon roof or seals

**To vent the moon roof:** Press and release the TILT control, the moon roof will move to the vent position automatically from any moon roof position. Press the switch again to stop the moon roof. Pull and hold the TILT control to close the moon roof.

The moon roof has a built-in sliding shade that can be manually opened or closed when the glass panel is shut. To close the shade, pull it toward the front of the vehicle.

### UNIVERSAL GARAGE DOOR OPENER (IF EQUIPPED)

Your vehicle may be equipped with a universal garage door opener which can be used to replace the common hand-held transmitter.

## Driver Controls

### Car2U® Home Automation System (if equipped)

The Car2U® Home Automation System is a universal transmitter located in the driver's visor that includes two primary features – a garage door opener and a platform for remote activation of devices within the home. The Car2U®

system's garage door opener function replaces the common hand-held garage door opener with a three-button transmitter that is integrated into the interior of your vehicle. After being programmed for garage doors, the Car2U® system transmitter can be programmed to operate security devices and home lighting systems.

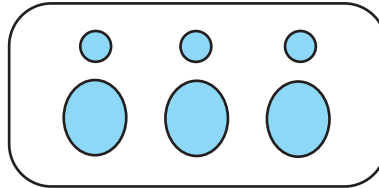

**WARNING:** Make sure that people and objects are clear of the garage door or security device you are programming. Do not program the Car2U® system with the vehicle in the garage.

Do not use the Car2U® system with any garage door opener that lacks safety stop and reverse features as required by U.S. Federal Safety Standards (this includes any garage door opener manufactured before April 1, 1982).

Be sure to keep the original remote control transmitter for use in other vehicles as well as for future Car2U® system programming. It is also recommended that upon the sale or lease termination of the vehicle, the programmed Car2U® system buttons should be erased for security reasons. Refer to *Erasing the Car2U® Home Automation System buttons* later in this section.

Read the instructions completely before attempting to program the Car2U® system. Because of the steps involved, it may be helpful to have another person assist you in programming the transmitter.

Additional Car2U® system information can be found on-line at [www.learcar2U.com](http://www.learcar2U.com) or by calling the toll-free Car2U® system help line at 1-866-572-2728.

### **Types of garage door openers (rolling code and fixed code)**

The Car2U® Home Automation System may be programmed to operate rolling code and fixed code garage door openers.

- Rolling code garage door openers were produced after 1996 and are code protected. Rolling code means the coded signal is changed every time your remote control garage door opener is used.

## Driver Controls

- Fixed code garage door openers were produced prior to 1996. Fixed code uses the same coded signal every time. It is manually programmed by setting DIP switches for a unique personal code.

If you do not know if your garage door opener is a rolling code or fixed code device, open your garage door opener's remote control battery cover. If a panel of DIP switches is present your garage door opener is a fixed code device. If not, your garage door opener is a rolling code device.

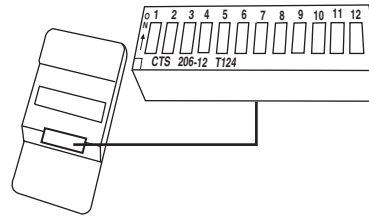

**Note:** Programming the Car2U® system to a community gate will require a unique set of instructions depending on the gate system model. Contact the Car2U® help line at 1-866-572-2728 to program your Car2U® system.

**Note:** Accidentally entering the program mode may override previously programmed buttons. This can happen by pressing and releasing the outer two buttons, or all three buttons, simultaneously. If this happens, do not press any button until the module times out after approximately 2.5 seconds and resets to normal mode. When time-out occurs, all three LEDs will flash rapidly for a few seconds then turn off. Any settings should remain as previously set.

### ***Rolling code programming***

**Note:** Programming the rolling code garage door opener involves time-sensitive actions. Read the entire procedure prior to beginning so you will know which actions are time-sensitive. If you do not follow the time-sensitive actions, the device will time out and you will have to repeat the procedure.

**Note:** Do not program the Car2U® system with the vehicle in the garage.

Make sure that your key is on and engine off while programming the transmitter.

## Driver Controls

1. Firmly press the two outer Car2U® system buttons for 1–2 seconds, then release.

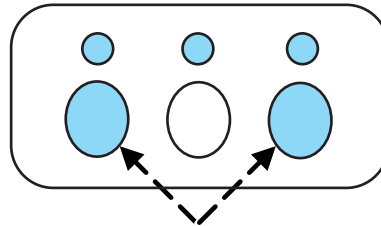

2. Go to the garage to locate the garage door opener motor and its “learn” button. You may need a ladder to reach the unit and you may need to remove the unit’s cover or light lens to locate the “learn” button. Press the “learn” button, after which you will have 10–30 seconds to return to your vehicle and complete the following steps. If you cannot locate the “learn” button, refer to the Owner’s Guide of your garage door opener or call the toll-free Car2U® system help line at 1-866-57Car2U (1-866-572-2728).

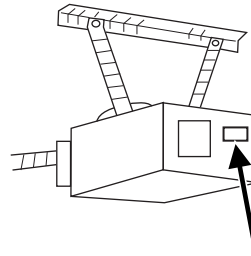

3. Return to your vehicle. Press and hold the Car2U® system button you would like to use to control the garage door. You may need to hold the button from 5–20 seconds, during which time the selected button indicator light will blink slowly. Immediately (within 1 second) release the button once the garage door moves. When the button is released, the indicator light will begin to blink rapidly until programming is complete.

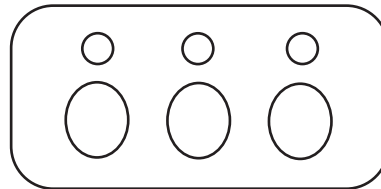

4. Press and release the button again. The garage door should move, confirming that programming is successful. If your garage door does not operate, repeat the previous steps in this section.

After successful programming, you will be able to operate your Car2U® system by pressing the button you programmed to activate the opener.

## Driver Controls

The indicator light above the selected button will turn on to confirm that the Car2U® system is responding to the button command.

To program another rolling code device such as an additional garage door opener, a security device or home lighting, repeat Steps 1 through 4 substituting a different function button in Step 3 than what you used for the garage door opener. For example, you could assign the left-most button to the garage door, the center button to a security device, and the right-most button to another garage door opener.

**Note:** The Car2U® system allows for three devices to be programmed. If you need to change or replace any of the three devices after it has been initially programmed, it is necessary to erase the current settings using the *Erasing the Car2U® Home Automation System buttons* procedure and then programming all of the devices being used.

### **Fixed code programming**

**Note:** Do not program the Car2U® system with the vehicle in the garage.

Make sure that your key is on and engine off while programming the transmitter.

1. To program units with fixed code DIP switches, you will need the garage door hand-held transmitter, paper and a pen or pencil.
2. Open the battery cover and record the switch settings from left to right for all 8 to 12 switches. Use the figure below:

When a switch is in the up, on, or + position, circle “L.”

When a switch is in the middle, neutral, or 0 position, circle “M.”

When a switch is in the down, off, or – position, circle “R.”

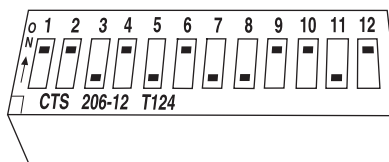



## Driver Controls

Switch position	1	2	3	4	5	6	7	8	9	10	11	12
Up, on or +	L	L	L	L	L	L	L	L	L	L	L	L
Middle, neutral or 0	M	M	M	M	M	M	M	M	M	M	M	M
Down, off or -	R	R	R	R	R	R	R	R	R	R	R	R
L=left; M=middle; R=right												

3. To input these positions into the Car2U® system, simultaneously press all three Car2U® system buttons for a few seconds and then release to put the device into programming mode. The indicator lights will blink slowly. Within 2.5 minutes enter your corresponding DIP switch settings from left to right into your Car2U® system by pressing and releasing the buttons corresponding to the settings you circled.

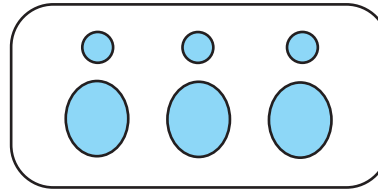

4. After inputting switch settings, simultaneously press and release all three Car2U® system buttons. The indicator lights will turn on.

5. Press and hold the Car2U® system button you would like to use to control the garage door. Immediately (within 1 second) release the button once the garage door moves. During this time the selected button indicator light will blink slowly. Do not release the button until you see the garage door move. Most garage doors open quickly. You may need to hold the button from 5–55 seconds before observing movement of the garage door.

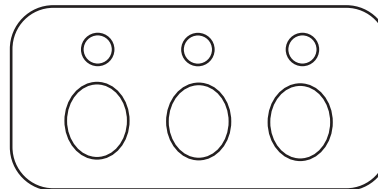

6. The indicator light will (begin to) blink rapidly until programming is complete. If your garage door opener does not operate following these steps, repeat Steps 2 through 6. Otherwise, call the toll-free Car2U® help line at 1-866-57Car2U (1-866-572-2728).

## Driver Controls

After successful programming, you will be able to operate your Car2U® system by pressing the button you programmed to activate the opener. The indicator light above the selected button will turn on to confirm that the Car2U® system is responding to the button command.

### **Erasing the Car2U® Home Automation System buttons**

**Note:** The system allows for three devices to be programmed. If you need to change or replace any of the three devices after it has been initially programmed, it will be necessary to erase the current settings using the procedure below and then reprogramming all of the devices being used.

To erase programming on the Car2U® system (individual buttons cannot be erased), use the following procedure:

1. Firmly press the two outside Car2U® system buttons simultaneously for approximately 20 seconds until the indicator lights begin to blink rapidly. The indicator lights are located directly above the buttons.

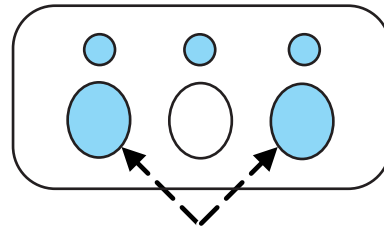

2. Once the indicator lights begin to blink, release your fingers from the buttons. The codes for all buttons are erased.

If you sell your vehicle equipped with the Car2U® system, it is recommended that you erase the programming for security reasons.

### **FCC and RSS-210 Industry Canada Compliance**

The Car2U® system complies with Part 15 of the FCC rules and with RSS-210 of Industry Canada. Operation is subject to the following two conditions: (1) This device may not cause harmful interference, and (2) This device must accept any interference received including interference that may cause undesired operation.

Changes and modifications to the Car2U® system transmitter by other than an authorized service facility could void authorization to use the equipment.

## Driver Controls

### POSITIVE RETENTION FLOOR MAT (IF EQUIPPED)

 **WARNING:** Always use floor mats that are designed to fit the foot well of your vehicle. Only use floor mats that leave the pedal area unobstructed. Only use floor mats that are firmly secured to retention posts so that they cannot slip out of position and interfere with the pedals or impair safe operation of your vehicle in other ways.

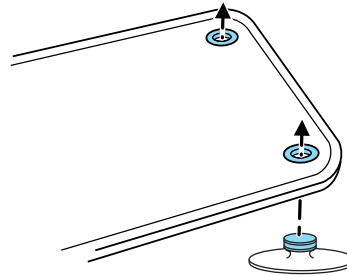

- Pedals that cannot move freely can cause loss of vehicle control and increase the risk of serious personal injury.
- Always make sure that the floor mats are properly attached to the retention posts in the carpet that are supplied with your vehicle. Floor mats must be properly secured to both retention posts to ensure mats do not shift out of position.
- Never place floor mats or any other covering in the vehicle foot well that cannot be properly secured to prevent them from moving and interfering with the pedals or the ability to control the vehicle.
- Never place floor mats or any other covering on top of already installed floor mats. Floor mats should always rest on top of vehicle carpeting surface and not another floor mat or other covering. Additional floor mats or any other covering will reduce the pedal clearance and potentially interfere with pedal operation.
- Check attachment of floor mats on a regular basis. Always properly reinstall and secure floor mats that have been removed for cleaning or replacement.
- Always make sure that objects cannot fall into the driver foot well while the vehicle is moving. Objects that are loose can become trapped under the pedals causing a loss of vehicle control.
- Failure to properly follow floor mat installation or attachment instructions can potentially cause interference with pedal operation causing loss of control of vehicle.
- To install floor mats, position the floor mat so that the eyelet is over the retention post and press down to lock in.
- To remove the floor mat, reverse the installation procedure.

## Driver Controls

### TAILGATE LOCK

Your vehicle may be equipped with a tailgate lock designed to help prevent theft of the tailgate.

- Insert ignition key and turn to the right to engage lock.
- Turn ignition key to the left to unlock.

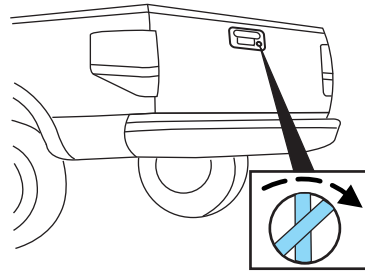

### Tailgate removal

Your tailgate is removable to allow more room for loading.



**WARNING:** Always properly secure cargo to prevent shifting cargo or cargo falling from vehicle, which could result in compromised vehicle stability and serious personal injury to vehicle occupants or others.

**Note:** If equipped with a rearview camera system, do Steps 1 through 3 before removing the tailgate.

1. Before removal of the tailgate, locate and disconnect the tailgate in-line connector under the pickup box on the passenger side of the vehicle near the spare tire.
2. Install a protective cap (located in the glove box) onto the in-line rearview camera system connector that remains under the pickup box.
3. Partially lower tailgate and carefully feed tailgate harness up through the gap between the pickup box and the bumper. Place the tailgate harness out of the way under the pickup box.

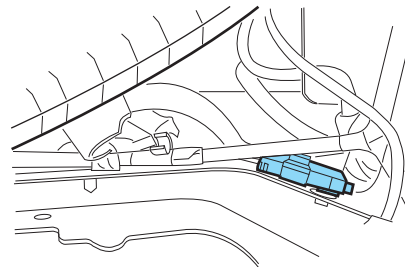

## Driver Controls

4. Lower the tailgate.
  5. Using a screwdriver, gently pry the spring clip (on each connector) past the head of the support screw. Disconnect cable.
  6. Disconnect the other cable.
  7. Lift tailgate to a 45-degree angle from horizontal.
  8. Lift right side off of its hinge.
  9. Lift tailgate to a 80-degree angle from horizontal.
  10. Remove tailgate from left side hinge by sliding tailgate to the right.
- To install, follow the removal procedures in reverse order.

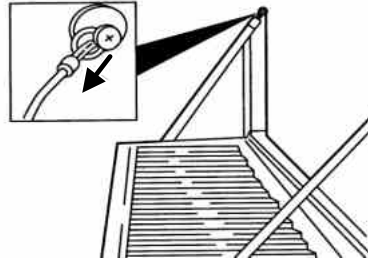

### Tailgate step (if equipped)

Your vehicle may be equipped with a feature that allows easier entry into the truck bed. To open the tailgate step:

1. Flip down the tailgate.
2. Pull the yellow latch lever to the unlock position (🔓) to release the grab handle from its stowed position and raise the handle upright until you feel it latch and see the latch lever in the lock position (🔒). The yellow lever only needs to be used when releasing the grab handle.
3. Rotate the center molding to unlatch the tailgate step and pull it towards you to extend it.
4. Flip open the step panel to widen the step.

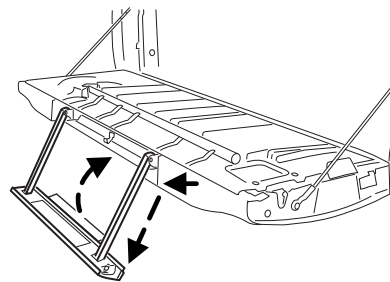
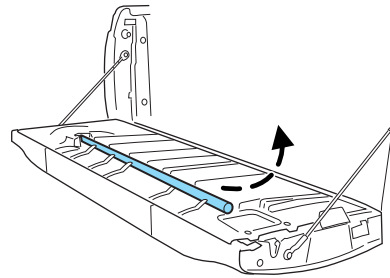

**Note:** To reduce risk of falling:

- Operate step only when the vehicle is on level surface.
- Operate step only in areas with sufficient lighting
- Always open flip panel to widen step.

## Driver Controls

- Always use grab handle when stepping up and down.
- Step not intended for bare-footed use.
- Keep step clean from contamination before use (e.g. snow, mud)
- Keep the step load (you + load) below 350 lb (159 kg).
- Never drive with step deployed.

To close the tailgate step:

1. Close the step panel, then lift and fully close the tailgate step into the tailgate.
2. Slide the latch at the bottom of the handle, then lower the handle.

**Note:**

- Fully close and latch the tailgate step before moving the vehicle.
- Never drive with the step or grab handle deployed.
- Replace slip resistance tape (serviceable item) if worn out.
- Replace handle molding (serviceable item) if damaged.
- Do not tow with grab handle or step frame.

### Box side step (if equipped)

Your vehicle may be equipped with a box side step that allows easier access to the truck bed.

**Note:** Do not drive vehicle with box side step(s) in the deployed position.

**Note:** The box side step load carrying capability (1 person + cargo) is 500 lb (227 kg). Do not exceed 500 lb (227 kg).

## Driver Controls

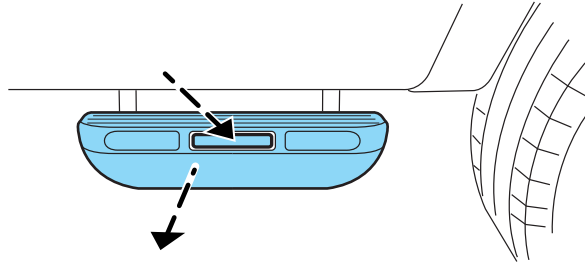

To deploy the box side step, with your foot, push down on the button. The step will automatically extend out from the stowed position.

**Note:** The box side steps may operate slower in cooler temperatures. In adverse conditions, debris such as mud, dirt, snow, ice, and salt may become trapped in the box side step mechanism, possibly causing the box side step to not deploy automatically after pressing the button. If this occurs, ensure that the button is pressed down, carefully manually pull out the box side step, wash off the debris with a high-pressure car wash wand, and re-stow the step.

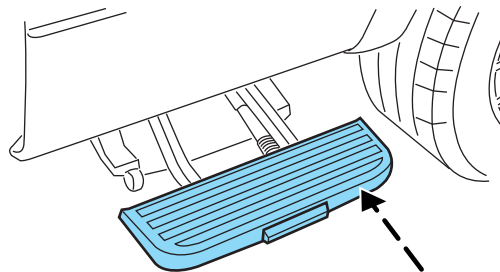

To stow the box side step, with your foot, push the box side step under the truck until fully latched. Do not push on the button while stowing the box side step.

**Note:** Do not use the box side steps to lift the vehicle when jacking. Utilize proper jacking points. Refer to *Changing the tires* in the *Roadside Emergencies* chapter.

## Driver Controls

### BED EXTENDER (IF EQUIPPED)

Your vehicle may be equipped with a cargo management feature in the truck bed.

**Note:** This feature is not intended for off-road usage.

To open the bed extender into tailgate mode:

1. Pull the locking pin toward the center of the vehicle.

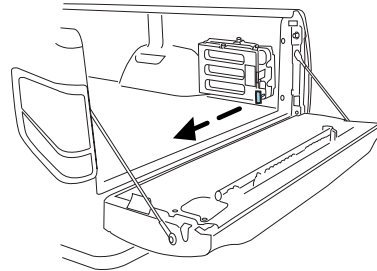

2. Open the latches to release the panels.

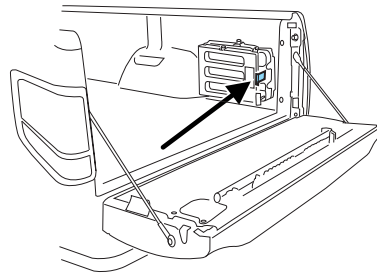

3. Rotate the panels toward the tailgate.

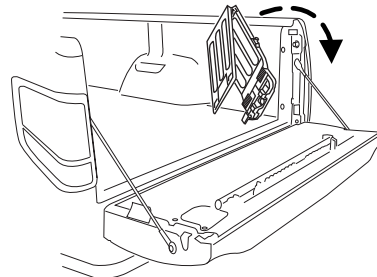

Repeat Steps 1–3 for the other side of the bed extender.



## Driver Controls

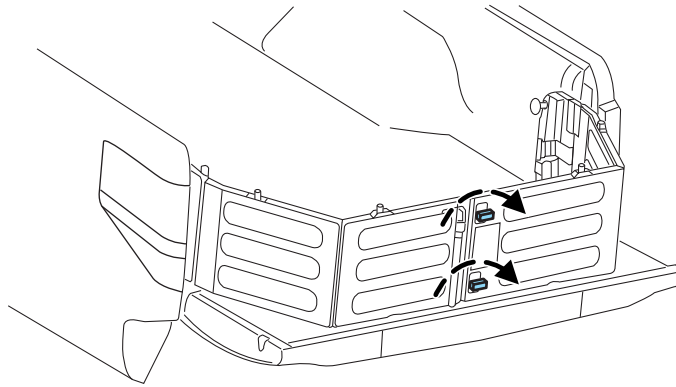

4. Connect the two panels, then rotate both knobs a quarter-turn clockwise to secure the panels.
5. Ensure the latch rod is inserted into the tailgate hole and the locking pins on both sides are engaged into their holes in the pick-up box.
6. Reverse steps for storage of the bed extender.

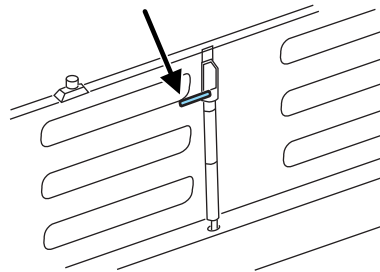

**Note:** When the vehicle is in motion, ensure the locking pins and knobs are fully engaged.

**Note:** Ensure all cargo is secured.

**Note:** When the vehicle is in motion, the tailgate load must not exceed 150 lb (68 kg).

**Note:** The bed extender should always be kept in the grocery mode or stowed position with the tailgate closed when not being used for the purpose of restraining cargo in the tailgate mode.

## Driver Controls

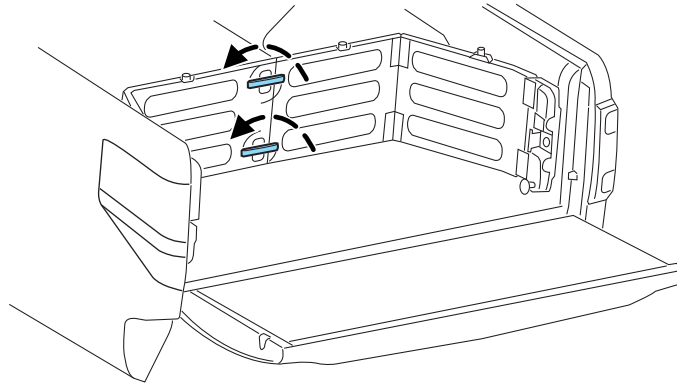

To open the bed extender into grocery mode, follow Steps 1–4 by rotating the panels away from the tailgate. Close the tailgate.

### **CARGO MANAGEMENT SYSTEM (IF EQUIPPED)**

The cargo management system consists of the Cargo rail package with the following as optional accessories:

- Front header bar (if equipped)
- Cross bars (if equipped)
- Bed divider (if equipped)
- Side mounted tool bins (if equipped)

## Driver Controls

**Cargo rail package:** The strong extruded aluminum double channel rails and four adjustable cleats are designed to hold loads up to 600 lb (272 kg) per cleat (maximum of two cleats per rail).

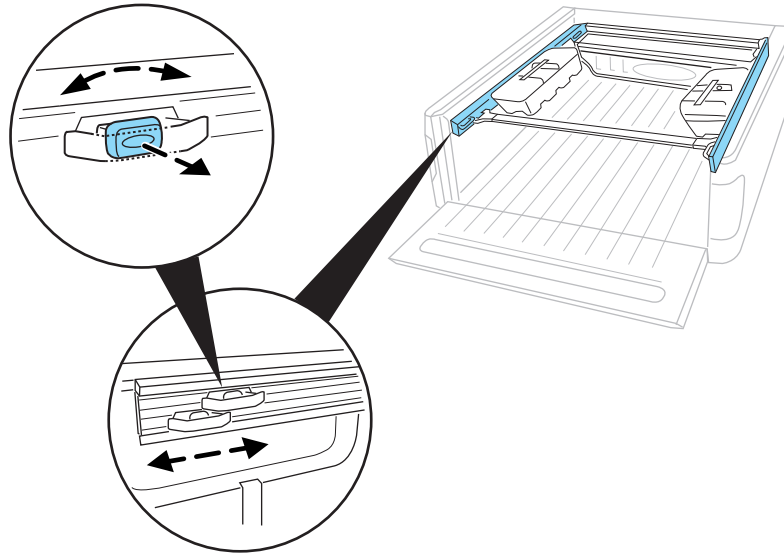

- Cleat positions are adjusted by pulling the knob and turning slightly to lock open. The cleat can then be moved along the rail. Once the desired position is reached, return the knob to the horizontal position. Pull the cleat side-to-side to ensure it has locked into the next available hole location.
- To remove cleat from rail, pull the knob and turn slightly to lock open and slide it off the end of the rail.

When installing cleat, reverse instructions above.

**Note:** When replacing a cleat into the rail, make sure the oval embossed on the knob is not upside down. This will ensure that the cleat is properly oriented to accept accessory attachments.

## Driver Controls

**Front header bar:** Spans the header area of the pickup box, providing the function of a header rail.

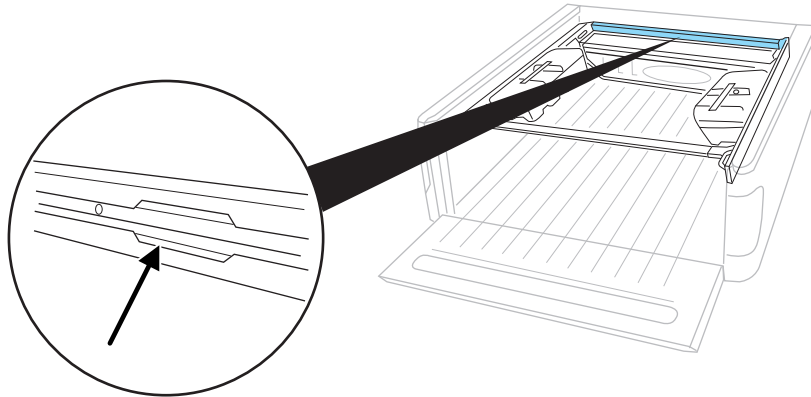

- Attachment cleats from side rails or other attachments may be positioned in the front header bar to secure loads up to 600 lb (272 kg) per cleat (maximum of two cleats).
- Cleats and other attachments may be inserted through the access window located in the center of the header bar. These items can then be slid to either side, and secured the same way as the side rails.

## Driver Controls

**Cross bars:** Aluminum cross bars with T-slot channels in all four sides, and a latch mechanism that allows the end supports to snap over the existing cleats. Cross bars are rated to hold loads up to 100 lb (45 kg) load evenly distributed between the two crossbars, and the T-slots are sized to accept industry-standard roof rack accessories.

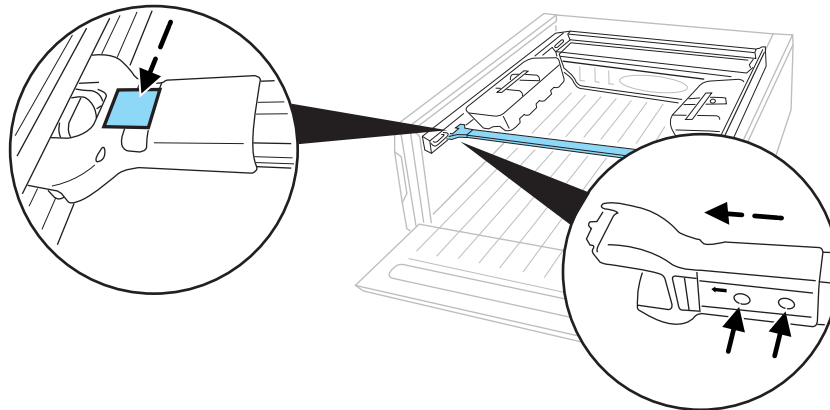

- To remove cross bar, lift handle on each side and lift end support shroud off of the cleat.
- To install cross bar, align cleats directly across from each other on the same rail (upper or lower). Then place crossbar end support onto cleat and press down on each side until the latch handle cycles up and then press the handle down to secure (pull up on the bars to ensure they are securely attached).
- To install accessories into T-slots, remove cross bar and turn upside down, then find the slip joint end, indicated with an arrow embossed on the bottom of the support. Using a T25 Torx driver, remove two Torx head bolts from bottom, and slide end support off of aluminum extrusion. Insert accessory into desired T-slot, and install end support. When tightening Torx head bolts, hand tightening with a Torx driver is sufficient, DO NOT over torque by using a ratchet.

## Driver Controls

**Bed divider:** This panel will keep small items up to 400 lb (180 kg) in position in the pickup box. Also includes T-slots to allow attachment of industry-standard roof rack accessories.

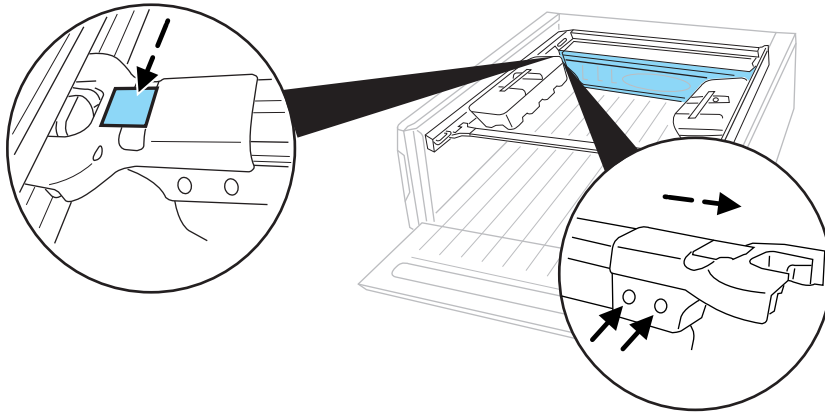

- To remove bed divider, lift handle on each side and lift end support shroud off of the cleat.
- To install bed divider, align cleats directly across from each other on the lower rail. Then place divider end support onto the cleats and press down on each side until the latch handle cycles up then press the handle down to secure (pull up on the divider to ensure they are securely attached).
- To install accessories into T-slots, remove bed divider, then find the slip joint end, indicated with an arrow embossed on the support. Using a T25 Torx driver, remove two Torx head bolts and slide end support off of the aluminum extrusion. Insert accessory into desired T-slot and install end support. When tightening Torx head bolts, hand tightening with a Torx driver is sufficient, DO NOT over torque by using a ratchet.

## Driver Controls

**Side mounted tool bins:** Watertight bins can be positioned at any point along the side rails and can be easily removed (even when full), and carried to wherever the contents are needed. Each bin will hold up to 60 lb (27 kg) of cargo, and has a drain plug for use as a cooler. **Note:** When multiple bins are placed on one side of the pickup box, the total cargo weight in all bins on that side of the pickup box cannot exceed 60 lb (27 kg).

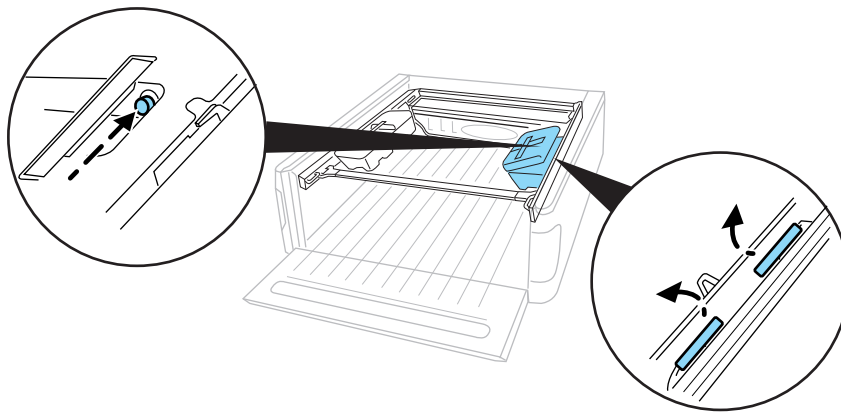

- To access the lock, pull the tab at the base of the rubber cap to uncover the lock. When you are done with the lock always reinstall the rubber cap on the lock to ensure proper sealing. When the bin is unlocked the rubber cap does not need to be removed to open the bin, just press the rubber cap to unlatch the lid.
- The lock cylinder is keyed to the first ignition key to be turned in the lock. This allows one key to work all bins, even if more are ordered through the dealer. The dealer will usually key the locks during pre-delivery, but if necessary, simply remove the sticker covering the keyhole, insert ignition key and turn to the extent of travel in each direction. This key will then be the only key to unlock the bin.
- Once the key has been set, simply turn the key to the right to lock, or to the left to unlock. When locked, the push-button will not depress when pushed.

## Driver Controls

- To remove the bin from the rail, open lid and pull up on both levers located on the outboard edge (next to the pickup box top rail) until the handles are all the way up (approximately 90 degrees). Once both handles are raised, the lid may be closed. **Note:** Windows in the lid will allow the handles to stick up above the lid (with the lid closed). After closing the lid, simply lift up and inboard away from the pickup box side to release bin from rail.
- To install, reverse the above instructions.

**Note:** Remove the bins during severe off-road driving to avoid damage to the cargo bins and pickup box.



**WARNING:** If any levers are visible above the lid of the bin, the bin is not securely attached to the rail, and may become detached from the vehicle if driven in that configuration.



## Locks and Security

### KEYS

Your vehicle may be equipped with two integrated keyhead transmitters (IKTs). The key blade functions as a programmed key which starts the vehicle and unlocks/locks all the doors. The transmitter portion functions as the remote entry transmitter.

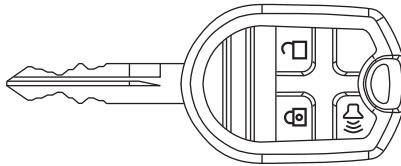

Your IKTs are programmed to your vehicle; using a non-programmed key will not permit your vehicle to start. If you lose one or both of your original programmed IKTs, replacement IKTs are available through your authorized dealer. Standard SecuriLock® keys without remote entry transmitter functionality can also be purchased from your authorized dealer if desired.

Always carry a spare key with you in case of an emergency.

For more information regarding programming replacement IKTs, refer to the *SecuriLock® passive anti-theft system* section later in this chapter.

**Note:** Your vehicle's IKTs were issued with a security tag that provides important vehicle key cut information. It is recommended that you keep the tag in a safe place for future reference.



### MYKEY® (IF EQUIPPED)

The MyKey® feature allows you to program a restricted driving mode to promote good driving habits. All but one of the keys programmed to the vehicle can be activated as a MyKey®. The key will remain restricted until MyKey® is cleared. Any remaining keys are referred to as an “administrator key” or admin key. The admin key can be used to create a MyKey®, program optional MyKey® settings, and clear the MyKey® feature. When the MyKey® feature is enabled the user can use the system check in the message center to see how many MyKeys™ and admin keys are programmed to the vehicle, and how many total miles have been driven with the MyKey® active.

## Locks and Security

### MyKey® restricted features

#### Standard settings – These settings cannot be changed

- The audio system will be muted whenever Belt-Minder® is activated until the safety belts are buckled. Refer to the *Seating and Safety Restraints* chapter for a detailed description of Belt-Minder® operation.
- Low fuel warnings are displayed in the message center followed by a chime when the vehicle has only 1/8 tank of fuel.
- If equipped, any of the following: parking aid, Blind Spot Information System (BLIS™) with cross traffic alert and forward collision warning systems cannot be turned off.

#### Optional settings – These settings can be changed

- Vehicle speed is limited to 80 mph (130 km/h). Visual warnings are displayed followed by a chime when the vehicle speed has reached 80 mph (130 km/h).
- Visual warnings are displayed followed by a chime when a preselected vehicle speed of 45, 55 or 65 mph (75, 90, or 105 km/h) is exceeded.
- The maximum volume of the audio system is limited to 45%. MYKEY VOLUME LIMITED will be displayed in the radio or navigation screen (if equipped) when attempting to exceed the limited volume.
- The AdvanceTrac® system cannot be turned off. When this optional setting is on, the MyKey® user will not be able to deactivate the system. **Note:** It may be beneficial to deactivate the AdvanceTrac® system if the vehicle is stuck in snow, mud, or sand.

### Create a MyKey®

To program MyKey® on one of the keys programmed to the vehicle, insert the key that you want to make a MyKey® into the ignition. (For vehicles equipped with push button start, put the intelligent access key in the backup slot with the buttons facing out of the slot; see the *Driving* chapter for the location of the backup slot.) Turn the ignition on. Use the message center buttons to do the following:

For standard message center:

1. Press SETUP until PRESS RESET TO CREATE MYKEY is displayed.
2. Press and release the RESET button. HOLD RESET TO CONFIRM MYKEY will be displayed.
3. Press and hold the RESET button for two seconds until MARK THIS AS RESTRICTED is displayed.
4. Wait until KEY RESTRICTED AT NEXT START is displayed.

138

## Locks and Security

For optional message center:

1. At the main menu screen select SETTING then MYKEY by pressing OK or the right arrow key.
2. Press OK to select CREATE MYKEY.
3. Hold OK as prompted until you see MARK THIS KEY AS RESTRICTED.

MyKey® is successfully programmed. Make sure you label it so you can distinguish it from the admin keys. **Note:** To program the optional settings go to Step 2 in the *Programming MyKey® optional settings* section. If your vehicle is equipped with remote start, see the *Using MyKey® with remote start systems* section.

**Note:** The MyKey® can be cleared within the same key cycle that it was created, otherwise a standard key (administrator key) is required to clear the MyKey® programming. To clear all MyKeys® go to Step 2 in the *Clear MyKey®* section.

### Programming MyKey® optional settings

To program the optional settings, use the message center buttons to do the following:

For standard message center:

1. Press SETUP until RESET FOR MYKEY SETTINGS is displayed.
2. Press and release the RESET button to display MyKey® setup menus. The first menu shown is:

MYKEY MAX MPH <80 MPH> OFF

3. If you don't want to change the maximum speed setting, press the SETUP button to display the next menu. The remaining menus appear as follows with the default settings shown:

MYKEY MPH TONES 45 55 65 <OFF>  
MYKEY VOLUME LIMIT <ON> OFF  
MYKEY ADVTRAC CTRL ON <OFF>.

4. On any of the menus press RESET to highlight your choice with the <...>.
5. Press SETUP to enter your choice. The next optional setting will be displayed.
6. Repeat Steps 4 and 5 until you are done changing the optional settings.

## Locks and Security

For optional message center:

1. At the main menu screen select **SETTING** then **MYKEY** by pressing **OK** or the right arrow key.
2. Use the up and down arrows to get to any of the optional features.
3. Press the right arrow key to bring up the settings available for each feature.
4. Press **OK** or the right arrow key to make your choice.

### **Clear MyKey®**

To reset all MyKeys® as admin keys do the following:

For standard message center:

1. Turn the vehicle on using the admin key.
2. Press **SETUP** until **PRESS RESET TO CLEAR MYKEY** is displayed.
3. Press and release the **RESET** button. **HOLD RESET TO CONFIRM CLEAR** is displayed.
4. Press and hold the **RESET** button for two seconds until **ALL MYKEYS CLEARED** is displayed.

For optional message center:

1. At the main menu screen select **SETTING** then **MYKEY** by pressing **OK** or the right arrow key.
2. Press the down arrow key to get to **CLEAR MYKEYS**.
3. Hold **OK** until you see **ALL MYKEYS CLEARED**.

### **Check MyKey® system status**

The vehicle system check will provide the status of the following MyKey® parameters:

- **MYKEY MILES** — This odometer only tracks distance when a MyKey® is used. If mileage does not accumulate as expected, then the MyKey® is not being used by the intended user. The only way to reset this odometer to zero is by clearing MyKey®. If this odometer is lower than the last time you checked, then the MyKey® system has been recently cleared.
- **# MYKEY(S) PROGRAMMED** — Indicates how many MyKeys® are programmed to the vehicle. Can be used to detect deletion of a MyKey®.
- **# ADMIN KEYS PROGRAMMED** — Indicates how many admin keys are programmed to the vehicle. Can be used to detect if an additional spare key has been programmed to the vehicle

140

## Locks and Security

Refer to *Message center* in the *Instrument Cluster* chapter for MyKey® system warnings displays.

### **Using MyKey® with remote start systems**

MyKey® is not compatible with non Ford-approved aftermarket remote start systems. If you choose to install a remote start system please see your authorized dealer for a Ford approved remote start system.

The following information MAY help customers who choose to use a non Ford-approved remote start system. The actions proved below do not make MyKey® compatible with non Ford-approved remote start system, but it MAY help you to retain some MyKey® functions.

### ***Vehicles equipped with traditional keys***

When using a non Ford-approved remote start system, the default settings may recognize the remote start system as an additional admin key with its associated privileges. This makes it NOT compatible with MyKey®. The following action may help you to retain some MyKey® functions:

1. Restart the engine when you insert a key into the ignition cylinder.
2. In addition to the key that you have already programmed as a MyKey®, owners of vehicles equipped with traditional keys may want to program the non Ford-approved remote start system as a MyKey® if the remote start fob is used by the MyKey® driver.

To program a non Ford-approved remote start system as MyKey®, do the following:

1. Enter the vehicle and close all doors.
2. Remote start the vehicle using a remote start fob.
3. Follow steps 1-4 in the *Create a MyKey®* section.

### ***Vehicles equipped with intelligent access key (push button start)***

- It is not possible to program any remote start system as MyKey® on vehicles equipped with an intelligent access key (push button start). Therefore, you should treat the remote start fob as you would any other admin key. When the vehicle is started using remote start, the system will stall the engine when you either enter the vehicle or shift the vehicle into gear. Prior to the engine stall, the vehicle will have administrative privileges. When you restart the engine, the vehicle will identify the user as an admin or MyKey® drive depending on the settings of the actual key used to start the vehicle.

## Locks and Security

**Note:** For all vehicles, the number of MYKEY(S) PROGRAMMED or ADMIN KEYS PROGRAMMED that is displayed in the MyKey® system status menus will include the non Ford-approved remote start system as an additional key in the total count. See the *Check MyKey® system status* section.

**Note:** For all vehicles with a non Ford-approved remote start installed, it is possible to program all “real” keys as MyKeys®, in which case, you will need to use your remote start system to reset all MyKeys® as admin keys by doing the following:

1. Enter the vehicle, close all doors.
2. Remote start the vehicle using your remote start fob.
3. Follow steps 1-4 in the *Clear MyKey®* section.

### Using MyKey® with remote start systems

MyKey® is not compatible with non Ford-approved aftermarket remote start systems. If you choose to install a remote start system please see your authorized dealer for a Ford-approved remote start system.

When using a Ford-approved remote start system, the default settings will recognize the remote start system as an additional admin key with its associated privileges. Owners of vehicles equipped with traditional keys should program the remote start system as a MyKey® in addition to the key that they have already programmed as a MyKey®. To program the remote start system as MyKey®, do the following:

1. Enter the vehicle and close all doors.
2. Remote start the vehicle using a remote start fob.
3. Follow Steps 1-4 in the *Create a MyKey®* section.

**Note:** For all vehicles, the number of MYKEY(S) PROGRAMMED or ADMIN KEYS PROGRAMMED that is displayed in the MyKey® system status menus will include the remote start system as an additional key in the total count. See the *Check MyKey® system status* section.

**Note:** For all vehicles with remote start installed, it is possible to program all “real” keys as MyKeys®, in which case, you will need to use your remote start system to reset all MyKeys® as admin keys by doing the following:

1. Enter the vehicle, close all doors.
2. Remote start the vehicle using your remote start fob.
3. Follow Steps 1-4 in the *Clear MyKey®* section.

## Locks and Security

### Troubleshooting

Condition	Potential Causes
Can't create a MyKey®	<ul style="list-style-type: none"> <li>• Key in the ignition is already a MyKey®.</li> <li>• Key in the ignition is the last remaining admin key (there always has to be at least one admin key).</li> <li>• SecuriLock® passive anti-theft system is disabled or in unlimited mode.</li> <li>• Vehicle has been started using a non Ford-approved remote start system that is programmed as MyKey®. Refer to <i>Using MyKey® with remote start systems</i> section.</li> </ul>
Cannot program the MyKey® optional settings	<ul style="list-style-type: none"> <li>• Key in the ignition is a MyKey®.</li> <li>• No MyKeys® are programmed to the vehicle. Refer to <i>Create a MyKey®</i> section.</li> <li>• Vehicle has been started using a non Ford-approved remote start system that is programmed as MyKey®. Refer to <i>Using MyKey® with remote start systems</i> section.</li> </ul>
Cannot clear MyKey®	<ul style="list-style-type: none"> <li>• Key in the ignition is a MyKey® .</li> <li>• No MyKeys® are programmed to the vehicle. Refer to <i>Create a MyKey®</i> section.</li> <li>• Vehicle has been started using a non Ford-approved remote start system that is programmed as MyKey®. Refer to <i>Using MyKey® with remote start systems</i> section.</li> </ul>
Lost the only admin key	<ul style="list-style-type: none"> <li>• Purchase a new key from your authorized dealer.</li> </ul>

## Locks and Security

Condition	Potential Causes
Lost any key	<ul style="list-style-type: none"> <li>• For programming spare keys, refer to the <i>Programming spare keys</i> section in this chapter.</li> </ul>
I accidentally programmed all keys as MyKeys®	<ul style="list-style-type: none"> <li>• Vehicle has a non Ford-approved remote start system that is recognized as an admin key. Refer to the <i>Using MyKey® with remote start systems</i> section to reset all MyKeys® as admin keys.</li> </ul>
No MyKey® function with (if equipped) intelligent access key with push button start	<ul style="list-style-type: none"> <li>• An admin intelligent access key is present at a push-and-start vehicle.</li> <li>• No MyKeys® are programmed to the vehicle. Refer to <i>Create a MyKey®</i> section.</li> <li>• Vehicle has been started using a non Ford-approved remote start system (as an admin key) then a MyKey® is inserted without restarting the engine.</li> </ul>
MyKey® programmed total includes one additional key	<ul style="list-style-type: none"> <li>• Unknown key has been programmed to the vehicle as a MyKey®.</li> <li>• Vehicle is equipped with a non Ford-approved remote start system. Refer to <i>Using MyKey® with remote start systems</i> section.</li> </ul>
Admin keys programmed total includes one additional key	<ul style="list-style-type: none"> <li>• Unknown key has been programmed to the vehicle as admin key.</li> <li>• Vehicle is equipped with a non Ford-approved remote start system. Refer to <i>Using MyKey® with remote start systems</i> section.</li> </ul>



## Locks and Security

Condition	Potential Causes
MyKey® distance does not accumulate	<ul style="list-style-type: none"> <li>• MyKey® is not being used by the intended user.</li> <li>• MyKey® system has been recently cleared.</li> <li>• Vehicles has been started using a non Ford-approved remote start system (as an admin key) then a MyKey® is inserted without recycling the MyKey® in ignition.</li> </ul>

### POWER DOOR LOCKS (IF EQUIPPED)

Press control to unlock all doors.

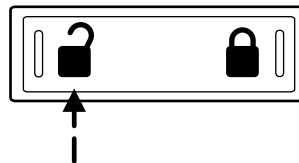

Press control to lock all doors.

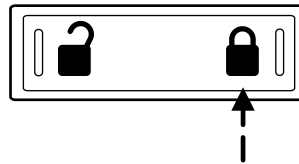

### Smart locks (if equipped)

This feature prevents you from locking yourself out of the vehicle if your key is still in the ignition.

When you open the driver's door and you lock the vehicle with the power door lock control, all the doors will lock, then the driver's door will automatically unlock reminding you that your key is still in the ignition.

## Locks and Security

The vehicle can still be locked, with the key in the ignition, using the manual lock button on the door, locking the driver's door with a key, by simultaneously pressing button 7 • 8 and the 9 • 0 controls on the remote entry keypad (if equipped), or using the  button on the remote entry transmitter (if equipped).

### **Autolock feature (if equipped)**

The autolock feature will lock all the doors when:

- all the doors are closed,
- the ignition is in the on position,
- you shift into any gear putting the vehicle in motion, and
- the vehicle attains a speed greater than 12 mph (20 km/h) for greater than two seconds.

The autolock feature repeats when:

- any door is opened then closed while the ignition is in the on position and the vehicle speed is 9 mph (15 km/h) or lower, and
- the vehicle then attains a speed greater than 12 mph (20 km/h) for greater than two seconds.

### **Deactivating/activating autolock feature**

There are four methods to enable/disable this feature:

- Through your authorized dealer,
- by using a power door unlock/lock procedure,
- using a keypad procedure (if equipped), or
- or by using the instrument cluster message center (if equipped). Refer to *Message center* in the *Instrument Cluster* chapter.

**Note:** The autolock feature can be activated/deactivated independently of the autounlock feature.

### **Power door lock switch autolock enable/disable procedure**

Before starting, ensure the ignition is in the off position and all vehicle doors are closed. You must complete Steps 1–5 within 30 seconds or the procedure will have to be repeated. If the procedure needs to be repeated, wait a minimum of 30 seconds before beginning again.

146

## Locks and Security

1. Place the key in the ignition and turn the ignition to the on position.

2. Press the power door unlock control on the door panel three times.

3. Turn the ignition from the on position to the off position.

4. Press the power door unlock control on the door panel three times.

5. Turn the ignition back to the on position. The horn will chirp one time to confirm programming mode has been entered and is active.

6. To enable/disable the autolock feature, press the unlock control, then press the lock control. The horn will chirp once if autolock was deactivated or twice (one short and one long chirp) if autolock was activated.

7. Turn the ignition to the off position. The horn will chirp once to confirm the procedure is complete.

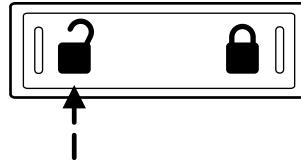

### **Keyless entry keypad autolock enable/disable procedure**

1. Turn the ignition to the off position.

2. Close all the doors.

3. Enter factory-set 5-digit entry code.

4. Press and hold the 3 • 4. While holding the 3 • 4 press the 7 • 8.

5. Release the 7 • 8.

6. Release the 3 • 4.



The user should receive a **horn chirp** to indicate the system has been disabled or a chirp followed by a honk to indicate the system has been enabled.

### **Autounlock feature (if equipped)**

The autounlock feature will unlock all the doors when:

- the ignition is in the on position, all the doors are closed, and the vehicle has been in motion at a speed greater than 12 mph (20 km/h);
- the vehicle has then come to a stop and the ignition is turned to the off ) or accessory position; and
- the driver door is opened within 10 minutes of the ignition being transitioned to the off or accessory position.

## Locks and Security

**Note:** The doors will not autounlock if the vehicle has been electronically locked before the driver door is opened.

### **Deactivating/activating autounlock feature**

There are three methods to enable/disable this feature:

- Through your authorized dealer,
- by using a power door unlock/lock sequence,
- using a keypad procedure (if equipped)
- or by using the instrument cluster message center (if equipped). Refer to *Optional message center* in the *Driver controls* chapter.

**Note:** The autounlock feature can be activated/deactivated independently of the autolock feature.

### **Power door lock switch autounlock enable/disable procedure**

Before starting, ensure the ignition is in the off position and all vehicle doors are closed. You must complete Steps 1–5 within 30 seconds or the procedure will have to be repeated. If the procedure needs to be repeated, wait a minimum of 30 seconds before beginning again.

1. Place the key in the ignition and turn the ignition to the on position.
2. Press the power door unlock control on the door panel three times.
3. Turn the ignition from the on position to the off position.
4. Press the power door unlock control on the door panel three times.
5. Turn the ignition back to the on position. The horn will chirp one time to confirm programming mode has been entered and is active.
6. To enable/disable the autounlock feature, press the lock control, then press the unlock control. The horn will chirp once if autounlock was deactivated or twice (one short and one long chirp) if autounlock was activated.
7. Turn the ignition to the off position. The horn will chirp once to confirm the procedure is complete.

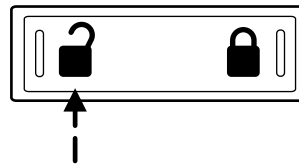

## Locks and Security

### **Keyless entry keypad autounlock enable/disable procedure**

1. Turn the ignition to the off position.
2. Close all the doors.
3. Enter factory-set 5-digit entry code.
4. Press and hold the 3 • 4. While holding the 3 • 4, press and release the 7 • 8. While still holding the 3 • 4, press and release the 7 • 8 a second time.
5. Release the 3 • 4.



The user should receive a **horn chirp** to indicate the system has been disabled or a chirp followed by a honk to indicate the system has been enabled.

### **CHILDPROOF DOOR LOCKS (ON VEHICLES WITH REAR DOORS)**

- When these locks are set, the rear doors cannot be opened from the inside.
- The rear doors can be opened from the outside when the childproof door locks are set, but the doors are unlocked.

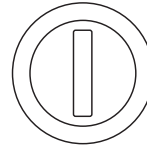

The childproof locks are located on the rear edge of each rear door and must be set separately for each door. Setting the lock for one door will not automatically set the lock for both doors.

- Insert the key and turn to the lock position (key horizontal) to engage the childproof locks.
- Insert the key and turn to the unlock position (key vertical) to disengage the childproof locks.

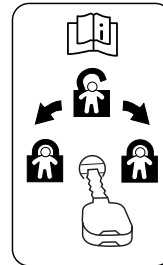

## Locks and Security

### REMOTE ENTRY SYSTEM (IF EQUIPPED)

The integrated keyhead transmitter (IKT) complies with part 15 of the FCC rules and with RSS-210 of Industry Canada. Operation is subject to the following two conditions: (1) This device may not cause harmful interference, and (2) This device must accept any interference received, including interference that may cause undesired operation.

**Changes or modifications not expressly approved by the party responsible for compliance could void the user's authority to operate the equipment.**

There are two possible types of IKTs: vehicles with the remote start feature will have the IKT shown. Vehicle's without remote start will not have the remote start button (2x) .

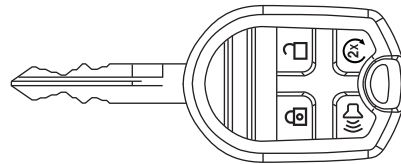

The typical operating range for your IKT is approximately 33 feet (10 meters). A decrease in operating range could be caused by:

- weather conditions,
- nearby radio towers,
- structures around the vehicle, or
- other vehicles parked next to your vehicle.

The IKT allows you to:

- remotely unlock the vehicle doors.
- remotely lock all the vehicle doors.
- remotely start the engine (if equipped with remote start).
- activate the personal alarm.
- operate the illuminated entry feature.



The remote entry lock/unlock feature operates in any ignition position except while the key is held in the start position. The panic feature operates with the key in the off position.

If there are problems with the remote entry system, make sure to take **ALL integrated keyhead transmitters** with you to the authorized dealer in order to aid in troubleshooting the problem.

150

## Locks and Security

### Two step door unlocking



1. Press  and release to unlock the driver's door. **Note:** The parking lamps and interior lamps will illuminate (refer to the *Illuminated entry* feature later in this section) if the control on the overhead lamp is **not** set to the **off** position.
2. Press  and release again within three seconds to unlock the passenger doors.

The battery saver feature will turn off the lamps 10 minutes after the ignition is turned to the off position.



### One step door unlocking

If the one step door unlocking feature is activated, press  and release once to unlock all of the doors. **Note:** The parking lamps and interior lamps will illuminate (refer to the *Illuminated entry* feature later in this section) if the control on the overhead lamp is **not** set to the **off** position.

### Switching from two step to one step door unlocking

Your vehicle comes with two step unlocking enabled. Unlocking can be switched between two step and one step door unlocking by pressing and holding both the  and  buttons simultaneously on the remote entry transmitter for approximately four seconds. The hazard lamps will flash twice to indicate that the vehicle has switched to one step unlocking. Repeat the procedure to switch back to two-step unlocking.

### Locking the doors

1. Press  and release to lock all the doors. The parking lamps will illuminate if all the doors are closed and locked.
  2. Press  and release again within three seconds to confirm that all the doors are closed and locked. **Note:** The doors will lock again, the horn will chirp once, and the parking lamps will illuminate once more.
- If any of the doors are not properly closed the horn will make two quick chirps and the parking lamps will not flash.

### Car finder

Press  twice within three seconds. The horn will chirp and the turn lamps will flash. It is recommended that this method be used to locate your vehicle, rather than using the panic alarm.

### Sounding a panic alarm

Press  to activate the alarm. Press again or turn the ignition to on to deactivate.

## Locks and Security

**Note:** The panic alarm will only operate when the ignition is off.



### Memory feature (seat, mirrors and adjustable pedals)

The integrated keyhead transmitter (IKT) allows you to recall the memory seat/power mirrors/adjustable pedals feature.

Press  to automatically move the driver seat, power mirrors and adjustable pedals to the desired memory position. (The seat position corresponds to the transmitter being used).

### Programming memory feature to transmitter

To activate this feature:

1. Move the driver seat, power mirrors, and adjustable pedals to the desired positions using the associated controls.
2. Press and hold control button 1 for five seconds. A tone will be heard after two seconds confirming memory position has been set. Continue to hold until a second tone is heard after five seconds.
3. Within three seconds press  .
4. Wait 10 seconds, then press  .
5. Repeat this procedure for memory 2 and another transmitter if desired.

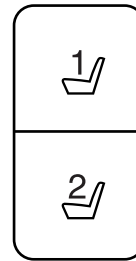

### Deprogramming memory feature from transmitter

To deactivate this feature:

1. Press and hold either the 1 or 2 control on the driver's door for five seconds. A tone will be heard after 1½ seconds when the memory store is done, continue to hold until a second tone is heard after five seconds.
2. Within three seconds press  .
3. Repeat this procedure for another transmitter if desired.

### Replacing the battery

The integrated keyhead transmitter (IKT) or intelligent access key (IA key) uses one coin type three-volt lithium battery CR2032 or equivalent.



## Locks and Security

### Integrated keyhead transmitter (IKT)

To replace the battery:

1. Twist a thin coin in the slot near the key ring to remove the battery cover (1).

**Note:** Do not wipe off any grease on the battery terminals on the back surface of the circuit board.

2. Carefully peel up the rubber gasket (2) from the transmitter if it does not come off with battery cover.

3. Remove the old battery (3).

**Note:** Please refer to local regulations when disposing of transmitter batteries.

4. Insert the new battery. Refer to the instructions inside the IKT for the correct orientation of the battery. Press the battery down to ensure that the battery is fully seated in the battery housing cavity.

5. Snap the battery cover back onto the key.

**Note:** Replacement of the battery will **not** cause the IKT or IA key to become de-programmed from your vehicle. They should operate normally after battery replacement.

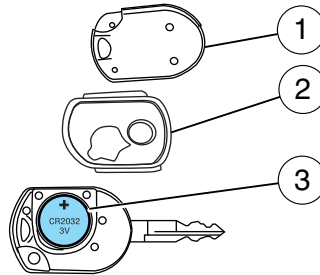

### Replacing lost Integrated Keyhead Transmitters (IKTs)

If you would like to have your Integrated Keyhead Transmitters reprogrammed because you lost one, or would like to buy additional IKTs, you can either reprogram them yourself, or take **all IKTs** to your authorized dealer for reprogramming.

### **How to reprogram your Integrated Keyhead Transmitters (IKTs)**

To program a new Integrated Keyhead Transmitter yourself, refer to *Programming spare keys* in the *SecuriLock® passive anti-theft system* section of this chapter. **Note:** At least two IKTs are required to perform this procedure yourself.

## Locks and Security

### Illuminated entry

The interior lamps and parking lamps illuminate when the remote entry system is used to unlock the door(s).

The illuminated entry system will turn off the lights if:

- the ignition switch is turned to the on position, or
- the remote transmitter lock control is pressed, or
- the 7 • 8 and the 9 • 0 controls on the keyless entry keypad are pressed, or
- after 25 seconds of illumination.

The dome lamp control (if equipped) must **not** be set to the off position for the illuminated entry system to operate.

The lights will not turn off if:

- they have been turned on with the dimmer control, or
- any door is open.

The battery saver will shut off the interior lamps 30 minutes after the ignition has been turned to the off position, 10 minutes after if the dome lamp is off, and 30 minutes after if the dome lamp switch is left on.

### Remote start (if equipped)

Your vehicle may be equipped with the remote start feature which allows you to start the engine from outside the vehicle. If your transmitter has a  icon, you have remote start. The remote start feature has an extended operating range which allows you to remote start your vehicle from a farther distance from your vehicle. All the buttons have this increased range performance capability when equipped with remote start.

Many states and provinces have restrictions for the use of remote start. Check your local and state or provincial laws for specific requirements regarding remote start systems.

**Note:** Do not use remote start if your vehicle is low on fuel.



**WARNING:** To avoid exhaust fumes, do not use remote start if your vehicle is parked indoors or areas that are not well ventilated.

## Locks and Security



The remote start system will not work if:

- The ignition is in the on position.
- The alarm system is triggered.
- The feature has been disabled.
- The hood is not closed.
- Two remote vehicle starts have already been attempted within the last hour.
- The vehicle is not in P (Park).

### Starting the engine with remote start

To start the engine using remote start:

**Note:** Each button press must be done within 3 seconds of each other. If this sequence is not followed the vehicle will not remote start and the horn will not chirp.

1. Press  on the IKT to lock all the doors.
2. Press  two times. The exterior lamps will flash twice.  
If for some reason, the system fails to start, the horn will chirp twice.
3. Insert the key in the ignition and turn to the on position before driving.

The power windows will be inhibited during the remote start and the radio will not turn on.

The parking lamps will remain on and the engine will run for 5, 10, or 15 minutes, depending on how you programmed the system. To select the duration of the remote start system refer to *Message center* in the *Instrument Cluster* chapter.

### Extending the engine run time

To keep the engine running for another remote start duration, repeat Steps 1 and 2 with the engine still running. If you programmed the duration to last 10 minutes, the second 10 minutes will begin immediately so that, for example, if the vehicle had been running from the first remote start for five minutes, the engine will continue to run for a total of 15 minutes. You can only extend the remote start once.

If the vehicle is remote started then remote stopped, wait at least five seconds before remote starting a second time.

The ignition switch must be turned to the on position and then back to the off position or allow one hour to pass before using remote start again.

## Locks and Security

### Turning the engine off after using remote start

- Press (2x) one time. The parking lamps will turn off.

You may have to be closer to the vehicle than when starting due to ground reflection and the added noise of the running engine.

You can disable or enable the remote start system through the message center. Refer to *Message center* in the *Instrument Cluster* chapter.

### SECURICODE™ KEYLESS ENTRY SYSTEM (IF EQUIPPED)

You can use the keyless entry keypad to lock or unlock the doors without using a key.

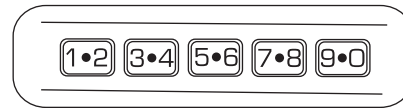

The keypad can be operated with the factory set 5–digit entry code; this code is located on the owner's wallet card in the glove box, is marked on the computer module, and is available from your authorized dealer. You can also create your own 5–digit personal entry code.

When pressing the controls on the keypad, press the middle of the controls to ensure a good activation.

### Programming a personal entry code and keypad association to memory feature

To create your own personal entry code:

1. Enter the factory set code.
2. Within five seconds press the 1 • 2 on the keypad.
3. Enter your personal 5-digit code. Each number must be entered within five seconds of each other.
4. To associate the entry code with a memory setting, enter a sixth digit to indicate which driver should be set in a memory recalled by the personal entry code:
  - Pressing 1 • 2 recalls Driver 1 settings.
  - Pressing 3 • 4 recalls Driver 2 settings.
  - Pressing other keypad buttons or not pressing a keypad button as a sixth digit does not set a driver and will not recall a memory setting.

**Note:** The factory-set code cannot be associated with a memory setting.
5. The doors will again lock then unlock to confirm that your personal entry code has been programmed to the module.

156

## Locks and Security

### Tips:

- Do not set a code that uses five of the same number.
- Do not use five numbers in sequential order.
- The factory set code will work even if you have set your own personal code.

### Erasing personal code

1. Enter the factory set 5–digit code.
2. Within five seconds, press the 1 • 2 on the keypad and release.
3. Press and hold the 1 • 2 for two seconds. This must be done within five seconds of completing Step 2.

Your personal code is now erased and only the factory set 5–digit code will work.

### Anti-scan feature

If an incorrect code has been entered seven times (35 consecutive button presses), the keypad will go into an anti-scan mode. This mode disables the keypad for one minute and the keypad lamp will flash during this time.

The anti-scan feature will turn off after:

- one minute of keypad inactivity.
- pressing the  control on the remote entry transmitter.
- the ignition is turned to the on position.

### Unlocking and locking the doors using keyless entry

**To unlock the driver's door**, enter the factory set 5-digit code or your personal code. Each number must be pressed within five seconds of each other. The interior lamps will illuminate after entering a valid keypad entry code.

**To unlock all doors**, press the 3 • 4 control within five seconds.

**To lock all doors**, press the 7 • 8 and the 9 • 0 at the same time. You **do not** need to enter the keypad code first. **Note:** The interior lamps will turn off.

## Locks and Security

### SECURILOCK® PASSIVE ANTI-THEFT SYSTEM (IF EQUIPPED)

SecuriLock® passive anti-theft system is an engine immobilization system. This system is designed to help prevent the engine from being started unless a **coded key programmed to your vehicle** is used. The use of the wrong type of coded key may lead to a “no-start” condition. The message center will display: **STARTING SYSTEM FAULT**.

Your vehicle comes with two coded keys; additional coded keys may be purchased from your authorized dealer. The authorized dealer can program your spare keys to your vehicle or you can program the keys yourself. Refer to *Programming spare keys* for instructions on how to program the coded key.

**Note:** The SecuriLock® passive anti-theft system is not compatible with non-Ford aftermarket remote start systems. Use of these systems may result in vehicle starting problems and a loss of security protection.

**Note:** Large metallic objects, electronic devices that are used to purchase gasoline or similar items, or a second coded key on the same key chain may cause vehicle starting issues. You need to prevent these objects from touching the coded key while starting the engine. These objects will not cause damage to the coded key, but may cause a momentary issue if they are too close to the key when starting the engine. If a problem occurs, turn the ignition off, remove all objects on the key chain away from the coded key and restart the engine.

**Note: Do not leave a duplicate coded key in the vehicle. Always take your keys and lock all doors when leaving the vehicle.**

#### Automatic arming

The vehicle is armed immediately after turning the ignition off.

#### Automatic disarming

Switching the ignition on with a **coded key** disarms the vehicle.

#### Replacement keys

If your keys are lost or stolen and you don't have an extra coded key, you will need to have your vehicle towed to an authorized dealer. The key codes need to be erased from your vehicle and new coded keys will need to be programmed.

Replacing coded keys can be very costly. Store an extra programmed key away from the vehicle in a safe place to help prevent any inconveniences. Please visit an authorized dealer to purchase additional spare or replacement keys.

158

## Locks and Security

### Programming spare keys

A maximum of eight keys can be coded to your vehicle. Only SecuriLock® keys can be used. To program a **coded key** yourself, you will need two previously programmed **coded keys** (keys that already operate your vehicle's engine) and the new unprogrammed key(s) readily accessible for timely implementation of each step in the procedure.

If two previously programmed coded keys are not available, you must bring your vehicle to your authorized dealer to have the spare coded key(s) programmed.

Please read and understand the entire procedure before you begin.

1. Insert the first previously programmed **coded key** into the ignition and turn the ignition from the 1 (off) position to the 3 (on) position (maintain ignition in the 3 (on) position for at least one second, but no more than 10 seconds).

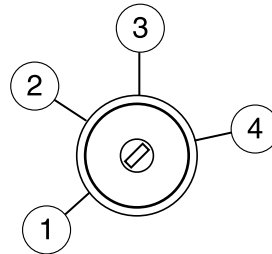

2. Turn ignition from the 3 (on) position back to the 1 (off) position in order to remove the first **coded key** from the ignition.

3. After three seconds but within 10 seconds of removing the first **coded key**, insert the second previously programmed **coded key** into the ignition and turn the ignition from the 1 (off) position to the 3 (on) position (maintain ignition in the 3 (on) position for at least one second but no more than 10 seconds).

4. Turn the ignition from the 3 (on) position back to the 1 (off) position in order to remove the second **coded key** from the ignition.

5. After three seconds but within 10 seconds of removing the second **coded key**, insert the new unprogrammed key (new key/valet key) into the ignition and turn the ignition from the 1 (off) position to the 3 (on) position (maintain ignition in the 3 (on) position for at least one second, but no more than 10 seconds). This step will program your new key to a coded key.

6. To program additional new unprogrammed key(s), repeat Steps 1 through 5.

If successful, the new coded key(s) will start the vehicle's engine.

159

## Locks and Security

If not successful, the new coded key(s) will not start the vehicle's engine and you may repeat Steps 1 through 5. If failure repeats, bring your vehicle to your authorized dealer to have the new spare key(s) programmed.

### PERIMETER ALARM SYSTEM (IF EQUIPPED)

The perimeter anti-theft system will warn you in the event of an unauthorized entry to your vehicle.

If there is any potential perimeter anti-theft problem with your vehicle, ensure **ALL remote entry transmitters** are taken to the authorized dealer to aid in troubleshooting.

### Arming the system

When armed, this system will respond if unauthorized entry is attempted. When unauthorized entry occurs, the system will flash the park/turn lamps and will sound the horn.

The system is ready to arm whenever the key is removed from the ignition. Either of the following actions will prearm the alarm system:

- Press the  control on the remote entry transmitter.
- Open a door and press the power door lock control to lock all the doors, and then close the door.
- Press and hold the 7 • 8 and 9 • 0 controls on the keyless entry pad at the same time to lock the doors (driver's door must be closed).

There is a 20 second countdown when any of the above actions occur before the vehicle becomes armed.

Each door and the hood is armed individually, and if any are open, they must be closed before the open entry point can enter the 20 second countdown.

The turn signal lamps will flash once when all doors and the hood are closed indicating the vehicle is locked and entering the 20 second countdown.



## Locks and Security

### **Disarming the system**

You can disarm the system by any of the following actions:

- Unlock the doors by pressing the  control on your remote entry transmitter.
- Turn the ignition to the on position with a programmed coded ignition key.
- Unlock the doors by using your keyless entry pad.
- If using a key in the driver's door to unlock the vehicle, a chime will sound when you open the door and you will have 12 seconds to disarm the alarm system using any of the actions above, otherwise the alarm will trigger.

Pressing the power door unlock control within the 20 second prearmed mode will return the vehicle to a disarmed state.

### **Triggering the anti-theft system**

The armed system will be triggered if any door or hood is opened without using the key or the remote entry transmitter.

## Seating and Safety Restraints

### FRONT SEATS



**WARNING:** Reclining the seatback can cause an occupant to slide under the seat's safety belt, resulting in severe personal injuries in the event of a collision.



**WARNING:** Do not pile cargo higher than the seatbacks to reduce the risk of injury in a collision or sudden stop.



**WARNING:** Before returning the seatback to its original position, make sure that cargo or any objects are not trapped behind the seatback. After returning the seatback to its original position, pull on the seatback to ensure that it has fully latched. An unlatched seat may become dangerous in the event of a sudden stop or collision.



**WARNING:** Never adjust the driver's seat or seatback when the vehicle is moving.



**WARNING:** Always drive and ride with your seatback upright and the lap belt snug and low across the hips.

### Adjustable head restraints

Your vehicle is equipped with front row outboard head restraints that are vertically adjustable.



**WARNING:** To minimize the risk of neck injury in the event of a crash, the driver and passenger occupants should not sit in and/or operate the vehicle, until the head restraint is placed in its proper position. The driver should never adjust the head restraint while the vehicle is in motion.

## Seating and Safety Restraints

The adjustable head restraints consist of :

- a trimmed energy absorbing foam and structure (1),
- two steel stems (2),
- a guide sleeve adjust/release button (3),
- and a guide sleeve unlock/remove button (4).

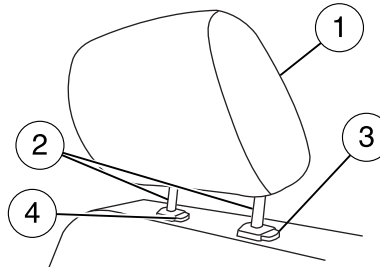

To adjust the head restraint, do the following:

1. Adjust the seatback to an upright driving/riding position.
2. Raise the head restraint by pulling up on the head restraint.
3. Lower the head restraint by pressing and holding the guide sleeve adjust/release button (3) and pushing down on the head restraint.

Properly adjust the head restraint so that the top of the head restraint is even with the top of your head and positioned as close as possible to the back of your head. For occupants of extremely tall stature, adjust the head restraint to its full up position.



**WARNING:** The adjustable head restraint is a safety device. Whenever possible it should be installed and properly adjusted when the seat is occupied.

To remove the adjustable head restraint, do the following:

1. Pull up the head restraint until it reaches the highest adjustment position.
2. Simultaneously press and hold both the adjust/release button (3) and the unlock/remove button (4), then pull up on the head restraint.

## Seating and Safety Restraints

To reinstall the adjustable head restraint, do the following:

1. Insert the two stems (2) into the guide sleeve collars.
2. Push the head restraint down until it locks.

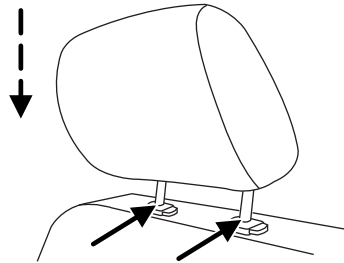

Properly adjust the head restraint so that the top of the head restraint is even with the top of your head and positioned as close as possible to the back of your head. For occupants of extremely tall stature, adjust the head restraint to its full up position.



**WARNING:** To minimize the risk of neck injury in the event of a crash, head restraints must be installed properly.

## Seating and Safety Restraints

### Front seat

- Lift the track release bar to move the seat forward or rearward. Make sure that the seat is relocked into place.

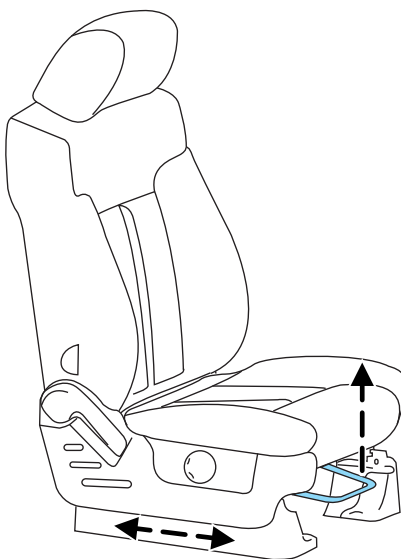

## Seating and Safety Restraints

- Pull the release lever handle located on the side of the seat up to move the seatback forward or backward.

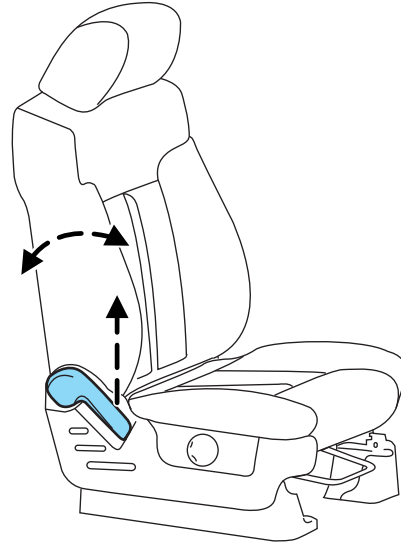

### Using the armrest (if equipped)

- Push the release control to move the armrest up or down.
- Pull out the drawer at the bottom of the center seat to access the cup holders (if equipped)

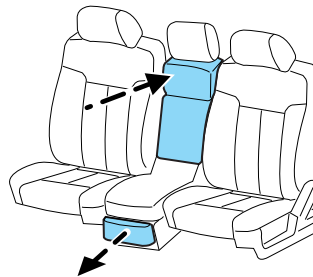

## Seating and Safety Restraints

- To gain access to the storage compartment (if equipped) in your armrest, lift the latch to open the lid.

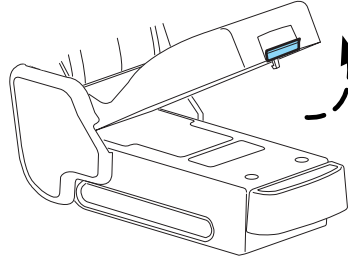

### Using the manual lumbar support (if equipped)

For more lumbar support, turn the lumbar support control toward the front of vehicle.

For less lumbar support, turn the lumbar support control toward the rear of vehicle.

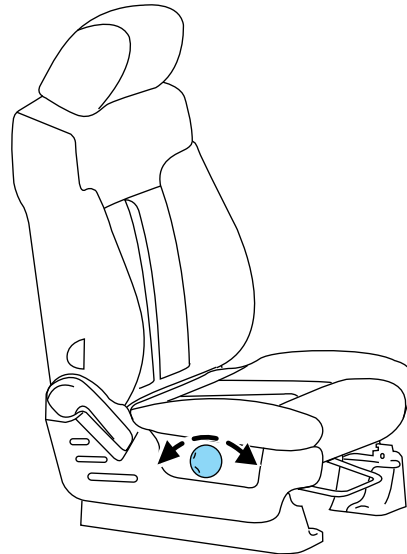

## Seating and Safety Restraints

### Using the power lumbar support (if equipped)

The power lumbar control is located on the outboard side of the seat.

Press the forward side of the control for additional support.

Press the rear side of the control to reduce support.

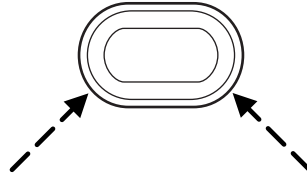

### Adjusting the front power seat (if equipped)



**WARNING:** Never adjust the driver's seat or seatback when the vehicle is moving.



**WARNING:** Always drive and ride with your seatback upright and the lap belt snug and low across the hips.



**WARNING:** Reclining the seatback can cause an occupant to slide under the seat's safety belt, resulting in severe personal injuries in the event of a collision.



**WARNING:** Sitting improperly out of position or with the seat back reclined too far can take off weight from the seat cushion and affect the decision of the passenger sensing system, resulting in serious injury or death in a crash. Always sit upright against your seatback, with your feet on the floor.



**WARNING:** To reduce the risk of possible serious injury: Do not hang objects off seat back or stow objects in the seatback map pocket (if equipped) when a child is in the front passenger seat. Do not place objects underneath the front passenger seat or between the seat and the center console (if equipped). Check the "passenger airbag off" or "pass airbag off" indicator lamp for proper airbag status. Refer to *Front passenger sensing system* in the *Airbag supplemental restraint system (SRS)* section for additional details. Failure to follow these instructions may interfere with the front passenger seat sensing system.



## Seating and Safety Restraints

The control is located on the outboard side of the seat cushion.

Move the switch to raise or lower the front or rear portion of the seat cushion.

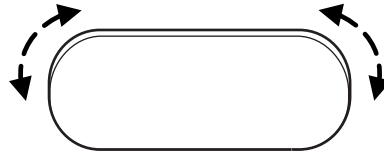

Move the switch to move the seat forward, backward, up or down.

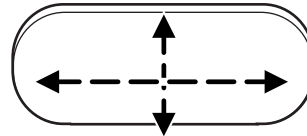

### **Power recline (if equipped)**

Move the switch to recline the seatback forward or rearward.

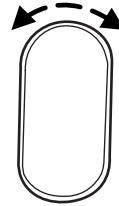

## Seating and Safety Restraints

### Memory seat/power mirrors/adjustable pedals/steering column (if equipped)

This system allows automatic positioning of the driver seat, power mirrors, adjustable pedals, and steering column to two programmable positions.

The memory seat control is located on the driver's seat.

- To program position 1, move the memory features to the desired positions using the associated controls. Press and hold button 1 for at least two seconds. A chime will sound confirming that a memory position has been set.
- To program position 2, repeat the previous procedure using button 2.

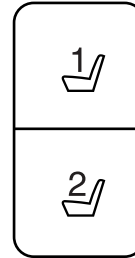

A memory seat position may be programmed at any time.

To program the memory feature to a remote entry transmitter, refer to *Remote entry system* in the *Locks and Security* chapter.

A programmed memory position can be recalled:

- in any gearshift position if the ignition is **not** on.
- only in P (Park) or N (Neutral) if the ignition is on.

The memory positions are also recalled when you press your remote entry transmitter  (unlock) control (if the transmitter is programmed to a memory position) or, when you enter a valid personal entry code that is programmed to a memory position. The mirrors will move to the programmed position and the seat will move to the easy entry position. The seat will move to the final position when the key is in the ignition (if easy entry feature is enabled).

### Easy-access/easy-out feature (if equipped)

The easy entry feature can be turned off or on through the vehicle message center. Refer to *Message center* in the *Instrument Cluster* chapter.

The easy entry feature automatically moves the driver's seat 2 inches (5 cm) forward when:

- the transmission is in P (Park)
- the key is inserted into the ignition cylinder

170

## Seating and Safety Restraints

(If the seat is located less than 2 inches [5 cm] from the front of the seat track, the seat will travel up to ¼ inch (6 mm) to the front of the seat track).

The easy out feature automatically moves the driver's seat 2 inches (5 cm) backward when:

- the transmission is in P (Park)
- the key is removed from the ignition cylinder

(If the seat is located less than 2 inches (5 cm) from the rear of the seat track, the seat will travel up to ¼ inch (6 mm) to the rear of the seat track).

If the memory setting is programmed through the remote transmitter, upon unlocking the door via remote entry system, the seat position will travel to the desired memory setting less 2 inches (5 cm). Once entering the vehicle and inserting the key in the ignition while in P (Park), the easy entry feature will move the seat an additional 2 inches (5 cm) to the desired memory location. See *Locks and Security* for activating the memory seat feature through the remote entry system.

### Heated seats (if equipped)



**WARNING:** Persons who are unable to feel pain to the skin because of advanced age, chronic illness, diabetes, spinal cord injury, medication, alcohol use, exhaustion, or other physical conditions, must exercise care when using the seat heater. The seat heater may cause burns even at low temperatures, especially if used for long periods of time. Do not place anything on the seat that insulates against heat, such as a blanket or cushion, because this may cause the seat heater to overheat. Do not puncture the seat with pins, needles, or other pointed objects because this may damage the heating element which may cause the seat heater to overheat. An overheated seat may cause serious personal injury.

**Note:** Do not do the following:

- Place heavy objects on the seat
- Operate the seat heater if water or any other liquid is spilled on the seat. Allow the seat to dry thoroughly.

## Seating and Safety Restraints

To operate the heated seats, do the following:

Press the heated seat button/symbol to cycle through the various heat settings and off. Warmer settings are indicated by more indicator lights.



### Heated and cooled seats (if equipped)

The controls for the climate controlled seats are located on the climate control system.

#### Heated seats



**WARNING:** Persons who are unable to feel pain to the skin because of advanced age, chronic illness, diabetes, spinal cord injury, medication, alcohol use, exhaustion, or other physical conditions, must exercise care when using the seat heater. The seat heater may cause burns even at low temperatures, especially if used for long periods of time. Do not place anything on the seat that insulates against heat, such as a blanket or cushion, because this may cause the seat heater to overheat. Do not puncture the seat with pins, needles, or other pointed objects because this may damage the heating element which may cause the seat heater to overheat. An overheated seat may cause serious personal injury.

**Note:** Do not do the following:

- Place heavy objects on the seat
- Operate the seat heater if water or any other liquid is spilled on the seat. Allow the seat to dry thoroughly.

The heated seats will only function when the engine is running.

To operate the heated seats:

Press the heated seat button/symbol to cycle through the various heat settings and off. Warmer settings are indicated by more indicator lights.



## Seating and Safety Restraints

### Cooled seats

The cooled seats will only function when the engine is running.

To operate the cooled seats:

Press the cooled seat button/symbol to cycle through the various cooling settings and off. Cooler settings are indicated by more indicator lights.



If the engine falls below 350 rpm while the cooled seats are on, the feature will turn itself off and will need to be reactivated.

### ***Climate controlled seats air filter replacement (if equipped)***

The heated and cooled seat system includes air filters that must be replaced periodically. Refer to *Scheduled maintenance information*.

- There is a filter located under each front seat.

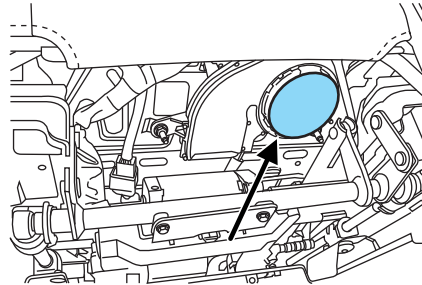

- The filter can be accessed from the 2nd row foot-well area. Move the front seats all the way to the full front and full up positions to ease access.

To remove an air filter:

1. Turn the vehicle off.
2. Push up on the outside rigid edge of the filter until the tabs are released, then rotate the air filter toward the front of the vehicle.

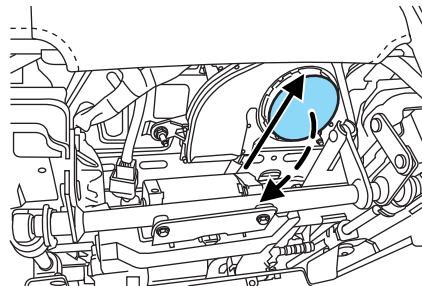

## Seating and Safety Restraints

3. Remove filter.

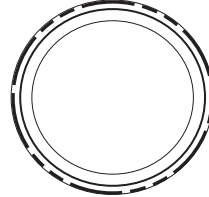

To install a filter:

1. First, position the filter in its housing making sure that the far forward end is all the way up in the housing.
2. Push in on the center of the outside edge of the filter and rotate up into the housing until it clips into position.

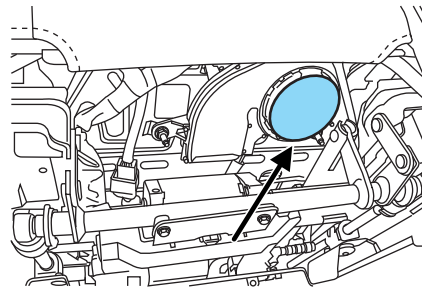

## REAR SEATS

### Second row head restraints

Your vehicle is equipped with head restraints that are vertically adjustable.



**WARNING:** To minimize the risk of neck injury in the event of a crash, the driver and passenger occupants should not sit in and/or operate the vehicle, until the head restraint is placed in its proper position. The driver should never adjust the head restraint while the vehicle is in motion.



**WARNING:** The adjustable head restraint is a safety device. Whenever possible it should be installed and properly adjusted when the seat is occupied.

## Seating and Safety Restraints

The adjustable head restraints consist of :

- a trimmed energy absorbing foam and structure (1),
- two steel stems (2),
- a guide sleeve adjust/release button (3),
- and a guide sleeve unlock/remove button (4).

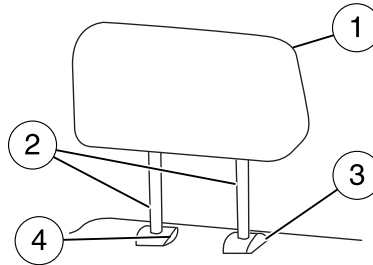

The second row head restraints look differently than the front head restraints, but function similarly. For details about how to raise, lower and remove/reinstall the second row head restraints, refer to *Adjustable head restraints* at the beginning of this chapter.

### Folding up the rear seats (SuperCab only)

The rear seat has a split 60/40 cushion. Each seat cushion can be flipped up into a vertical storage position.

1. Pull control to release seat cushion.
2. Rotate seat cushion up until it locks into vertical storage position.

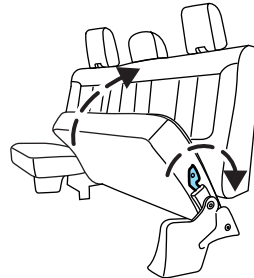

### Returning the seat to seating position



**WARNING:** Make sure that cargo or any objects are not trapped underneath the seat cushion before returning the seat cushion to its original position, and that the seat cushion locks into place. Failure to do so may prevent the seat from operating properly in the event of a crash, which could increase the risk of serious injury.

1. Pull control on the side of the seat to release seat cushion from storage position.
2. Push seat cushion down until it locks into horizontal position.

## Seating and Safety Restraints

### Folding up the rear seats (SuperCrew vehicles only)

The rear seat has a split 60/40 cushion. Each seat cushion can be flipped up into a vertical storage position.

- Rotate the seat cushion up by lifting on the corner until it locks into vertical storage position.

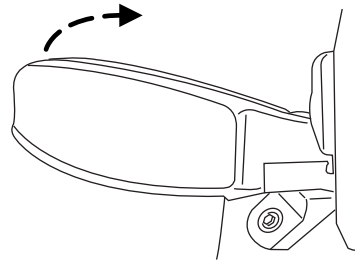

### Returning the seat to seating position



**WARNING:** Before returning the seat cushion to its original position, make sure that cargo or any objects are not trapped underneath the seat cushion.

1. Pull control on the bottom of the seat cushion to release seat cushion from storage position.
2. Push seat cushion down until it rests into the horizontal position.

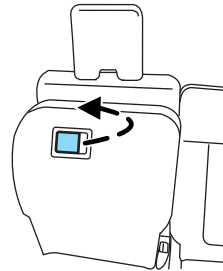



## Seating and Safety Restraints

### **Armrest and cupholders (if equipped)**

Pull the strap located on the center seatback to access the armrest and cupholders.

The cupholders are located inside the rear seat armrest. To open the cupholders:

- Push in gently on the center of the plastic panel on the front edge of the armrest. The cupholders will partially open.
- Pull the cupholder fully open before using.

To close the cupholders:

- Push the front edge back into the seat until the cupholders are fully seated.
- Make sure there is nothing in the cupholders before attempting to close them.

Make sure that the cupholders are fully seated before stowing the armrest.

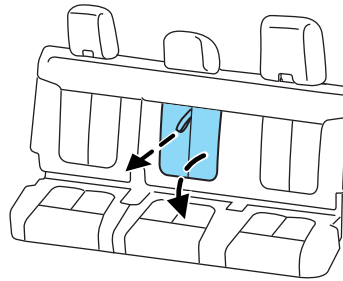

### **Rear heated seats (if equipped)**



**WARNING:** Persons who are unable to feel pain to the skin because of advanced age, chronic illness, diabetes, spinal cord injury, medication, alcohol use, exhaustion, or other physical conditions, must exercise care when using the seat heater. The seat heater may cause burns even at low temperatures, especially if used for long periods of time. Do not place anything on the seat that insulates against heat, such as a blanket or cushion, because this may cause the seat heater to overheat. Do not puncture the seat with pins, needles, or other pointed objects because this may damage the heating element which may cause the seat heater to overheat. An overheated seat may cause serious personal injury.

**Note:** Do not do the following:

- Place heavy objects on the seat
- Operate the seat heater if water or any other liquid is spilled on the seat. Allow the seat to dry thoroughly.

The rear seat heat controls are located on the rear door armrest.

## Seating and Safety Restraints

To operate the heated seats:

- Push the indicated side of the control for maximum heat.
- Push again to deactivate.

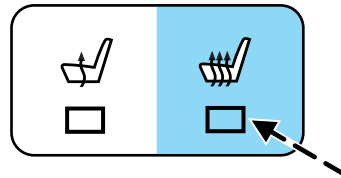

- Push the indicated side of the control for minimum heat.
- Push again to deactivate.

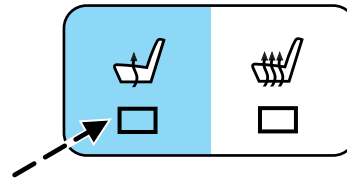

The heated seat module resets at every ignition run cycle. While the ignition is in the on position, activating the high or low heated seat switch enables heating mode. When activated, they will turn off automatically when the engine is turned off.

The indicator light will illuminate when the heated seats have been activated.

### SAFETY RESTRAINTS

#### Personal Safety System™

The Personal Safety System provides an improved overall level of frontal crash protection to front seat occupants and is designed to help further reduce the risk of airbag-related injuries. The system is able to analyze different occupant classifications and conditions and crash severity before activating the appropriate safety devices to help better protect a range of occupants in a variety of frontal crash situations.

Your vehicle's Personal Safety System consists of:

- Driver and passenger dual-stage airbag supplemental restraints.
- Front outboard safety belts with pretensioners, energy management retractors, and safety belt usage sensors.
- Driver's seat position sensor.
- Front crash severity sensor.
- Front passenger sensing system

178

## Seating and Safety Restraints

- Passenger Airbag Off indicator light.
- Restraints Control Module (RCM) with impact and safing sensors.
- Restraint system warning light and back-up tone.
- The electrical wiring for the airbags, crash sensor(s), safety belt pretensioners, front safety belt usage sensors, driver seat position sensor, and indicator lights.

### ***How does the Personal Safety System™ work?***

The Personal Safety System can adapt the deployment strategy of your vehicle's safety devices according to crash severity and occupant classification and conditions. A collection of crash and occupant sensors provides information to the Restraints Control Module (RCM). During a crash, the RCM may activate the safety belt pretensioners and/or either none, one, or both stages of the dual-stage airbag supplemental restraints based on crash severity and occupant classification and conditions.

The fact that the pretensioners or airbags did not activate for both front seat occupants in a collision does not mean that something is wrong with the system. Rather, it means the Personal Safety System determined the accident conditions (crash severity, belt usage, etc.) were not appropriate to activate these safety devices. Front airbags are designed to activate only in frontal and near-frontal collisions, not rollovers, side-impacts, or rear-impacts unless the collision causes sufficient longitudinal deceleration.

### ***Driver and passenger dual-stage airbag supplemental restraints***

The dual-stage airbags offer the capability to tailor the level of airbag inflation energy. A lower, less forceful energy level is provided for more common, moderate-severity impacts. A higher energy level is used for the most severe impacts. Refer to *Airbag Supplemental Restraints (SRS)* section in this chapter.

### ***Front crash severity sensor***

The front crash severity sensor enhances the ability to detect the severity of an impact. Positioned up front, it provides valuable information early in the crash event on the severity of the impact. This allows your Personal Safety System to distinguish between different levels of crash severity and modify the deployment strategy of the dual-stage airbags and safety belt pretensioners.

### ***Driver's seat position sensor***

The driver's seat position sensor allows your Personal Safety System to tailor the deployment level of the driver dual-stage airbag based on seat

## Seating and Safety Restraints

position. The system is designed to help protect smaller drivers sitting close to the driver airbag by providing a lower airbag output level.

### **Front passenger sensing system**

For airbags to do their job they must inflate with great force, and this force can pose a potentially deadly risk to occupants that are very close to the airbag when it begins to inflate. For some occupants, like infants in rear-facing child seats, this occurs because they are initially sitting very close to the airbag. For other occupants, this occurs when the occupant is not properly restrained by safety belts or child safety seats and they move forward during pre-crash braking. The most effective way to reduce the risk of unnecessary injuries is to make sure all occupants are properly restrained. Accident statistics suggest that children are much safer when properly restrained in the rear seating positions than in the front.



**WARNING:** Airbags can kill or injure a child in a child seat. **NEVER** place a rear-facing child seat in front of an active air bag. If you must use a forward-facing child seat in the front seat, move the seat all the way back.



**WARNING:** Always transport children 12 years old and under in the back seat and always properly use appropriate child restraints.



**WARNING:** When possible, all children 12 years old and under should be properly restrained in a rear seating position.

The front passenger sensing system can automatically turn off the passenger front airbag when a rear facing child seat, a forward-facing child restraint, or a booster seat is detected. Even with this technology, parents are **STRONGLY** encouraged to always properly restrain children in the rear seat. The sensor also turns off the passenger front airbag and passenger seat-mounted side airbag when the passenger seat is empty.

When the front passenger seat is occupied and the sensing system has turned off the passenger's frontal airbag, the "pass airbag off" indicator will light and stay lit to remind you that the front passenger frontal airbag is off. See *Front passenger sensing system* in the *Airbag supplemental restraint system (SRS)* section of this chapter.

180

## Seating and Safety Restraints

### **Front safety belt usage sensors**

The front safety belt usage sensors detect whether or not the driver and front outboard passenger safety belts are fastened. This information allows your Personal Safety System to tailor the airbag deployment and safety belt pretensioner activation depending upon safety belt usage. Refer to *Safety belt usage sensors* later in this chapter.

### **Front outboard safety belt pretensioners**

The safety belt pretensioners at the front outboard seating positions are designed to tighten the safety belts firmly against the occupant's body during frontal collisions, and in side collisions and rollovers. This helps increase the effectiveness of the safety belts. In frontal collisions, the safety belt pretensioners can be activated alone or, if the collision is of sufficient severity, together with the front airbags.

### **Front outboard safety belt energy management retractors**

The front outboard safety belt energy management retractors allow webbing to be pulled out of the retractor in a gradual and controlled manner in response to the occupant's forward momentum. This helps reduce the risk of force-related injuries to the occupant's chest by limiting the load on the occupant. Refer to *Energy management retractors* section in this chapter.

### **Determining if the Personal Safety System is operational**

The Personal Safety System uses a warning light in the instrument cluster or a back-up tone to indicate the condition of the system. Refer to the *Warning lights and chimes* section in the *Instrument Cluster* chapter. Routine maintenance of the Personal Safety System is not required.

The Restraints Control Module (RCM) monitors its own internal circuits and the circuits for the airbag supplemental restraints, crash sensor(s), safety belt pretensioners, front safety belt buckle sensors, and the driver seat position sensor. In addition, the RCM also monitors the restraints warning light in the instrument cluster. A difficulty with the system is indicated by one or more of the following.

- The warning light will either flash or stay lit.
- The warning light will not illuminate immediately after ignition is turned on.
- A series of five beeps will be heard. The tone pattern will repeat periodically until the problem and warning light are repaired.

## Seating and Safety Restraints

If any of these things happen, even intermittently, have the Personal Safety System serviced at an authorized dealer immediately. Unless serviced, the system may not function properly in the event of a collision.

### Safety restraints precautions



**WARNING:** Always drive and ride with your seatback upright and the lap belt snug and low across the hips.



**WARNING:** To reduce the risk of injury, make sure children sit in a rear seating position where they can be properly restrained.



**WARNING:** Never let a passenger hold a child on his or her lap while the vehicle is moving. The passenger cannot protect the child from injury in a collision.



**WARNING:** All occupants of the vehicle, including the driver, should always properly wear their safety belts, even when an airbag supplemental restraint system (SRS) is provided.



**WARNING:** It is extremely dangerous to ride in a cargo area, inside or outside of a vehicle. In a collision, people riding in these areas are more likely to be seriously injured or killed. Do not allow people to ride in any area of your vehicle that is not equipped with seats and safety belts. Be sure everyone in your vehicle is in a seat and using a safety belt properly.





**WARNING:** In a rollover crash, an unbelted person is significantly more likely to die than a person wearing a safety belt.



**WARNING:** Each seating position in your vehicle has a specific safety belt assembly which is made up of one buckle and one tongue that are designed to be used as a pair. 1) Use the shoulder belt on the outside shoulder only. Never wear the shoulder belt under the arm. 2) Never swing the safety belt around your neck over the inside shoulder. 3) Never use a single belt for more than one person.

## Seating and Safety Restraints

 **WARNING:** When possible, all children 12 years old and under should be properly restrained in a rear seating position.

 **WARNING:** Safety belts and seats can become hot in a vehicle that has been closed up in sunny weather; they could burn a small child. Check seat covers and buckles before you place a child anywhere near them.

 **WARNING:** Front and rear seat occupants, including pregnant women, should wear safety belts for optimum protection in an accident.

### Combination lap and shoulder belts

1. Insert the belt tongue into the proper buckle (the buckle closest to the direction the tongue is coming from) until you hear a snap and feel it latch. Make sure the tongue is securely fastened in the buckle.

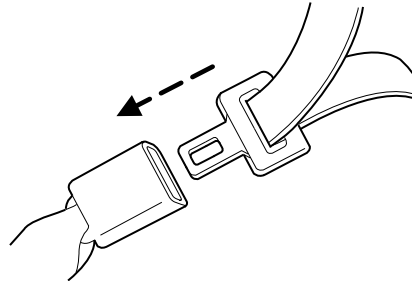

2. To unfasten, push the release button and remove the tongue from the buckle.

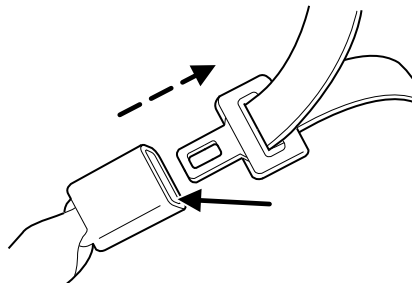

## Seating and Safety Restraints

### **Safety belt with cinch tongue (front center seat only)**

The cinch tongue will slide up and down the belt webbing when the belt is stowed or while putting safety belts on. When the lap/shoulder safety belt is buckled, the cinch tongue will allow the lap portion to be shortened, but pinches the webbing to keep the lap portion from getting longer. The cinch tongue is designed to slip during a crash, so always wear the shoulder belt properly and don't allow any slack in either the lap or shoulder portions.

Before you can reach and latch a combination lap and shoulder belt having a cinch tongue into the buckle, you may have to lengthen the lap belt portion of it.

1. To lengthen the lap belt, pull some webbing out of the shoulder belt retractor.
2. While holding the webbing below the tongue, grasp the tip (metal portion) of the tongue so that it is parallel to the webbing and slide the tongue upward.

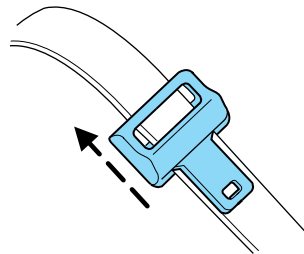

3. Provide enough lap belt length so that the tongue can reach the buckle.

### **How to fasten the cinch tongue**

1. Pull the combination lap and shoulder belt from the retractor so that the shoulder belt portion of the safety belt crosses your shoulder and chest.
2. Be sure the belt is not twisted. If the belt is twisted, remove the twist.
3. Insert the belt tongue into the proper buckle for your seating position until you hear a snap and feel it latch.
4. Make sure the tongue is securely fastened to the buckle by pulling on the tongue.



**WARNING:** The lap belt should fit snugly and as low as possible around the hips, not across the waist.



**WARNING:** Front and rear seat occupants, including pregnant women, should wear safety belts for optimum protection in an accident.



## Seating and Safety Restraints

**!** **WARNING:** Each seating position in your vehicle has a specific safety belt assembly which is made up of one buckle and one tongue that are designed to be used as a pair. 1) Use the shoulder belt on the outside shoulder only. Never wear the shoulder belt under the arm. 2) Never swing the safety belt around your neck over the inside shoulder. 3) Never use a single belt for more than one person.

While you are fastened in the safety belt, the combination lap/shoulder belt with a cinch tongue adjusts to your movement. However, if you brake hard, turn hard, or if your vehicle receives an impact of 5 mph (8 km/h) or more, the safety belt will become locked and help reduce your forward movement.

### **Restraint of pregnant women**

**!** **WARNING:** Always ride and drive with your seatback upright and the safety belt properly fastened. The lap portion of the safety belt should fit snug and be positioned low across the hips. The shoulder portion of the safety belt should be positioned across the chest. Pregnant women should also follow this practice. See figure below.

Pregnant women should always wear their safety belt. The lap belt portion of a combination lap and shoulder belt should be positioned low across the hips below the belly and worn as tight as comfort will allow. The shoulder belt should be positioned to cross the middle of the shoulder and the center of the chest.

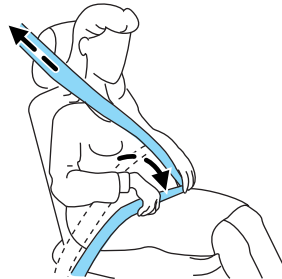

### **Energy management retractors**

Your vehicle has a safety belt system equipped with energy management retractors at the driver and front outboard passenger seating positions.

An energy management retractor is a device which pays out webbing in a controlled manner. This feature is designed to help further reduce the risk of force-related injuries to the occupant.

## Seating and Safety Restraints

Safety belt systems equipped with an energy management retractor must be replaced if they were in use during a frontal collision which resulted in deployment of the frontal airbags. Refer to the *Safety belt maintenance* section in this chapter.

### Safety belt locking modes

All safety restraints in the vehicle are combination lap and shoulder belts. The driver safety belt and the optional front center seat's safety belt have the first locking mode only. All outboard passenger and rear safety belts have both types of locking modes described as follows:

#### Vehicle sensitive mode

This is the normal retractor mode, which allows free shoulder belt length adjustment to your movements and locking in response to vehicle movement. For example, if the driver brakes suddenly or turns a corner sharply, or the vehicle receives an impact of approximately 5 mph (8 km/h) or more, the combination safety belts will lock to help reduce forward movement of the driver and passengers.

In addition, the retractor is designed to lock if the webbing is pulled out too quickly. If this occurs, let the belt retract slightly and pull webbing out again in a slow and controlled manner.

#### Automatic locking mode

In this mode, the shoulder belt is automatically pre-locked. The belt will still retract to remove any slack in the shoulder belt. The automatic locking mode is not available on the driver safety belt or the optional front seat's center safety belt.

#### *When to use the automatic locking mode*

This mode should be used **any time** a child safety seat is installed in a front outboard passenger seating position in a Regular Cab / SuperCab / SuperCrew or any rear seating position of a SuperCab or SuperCrew. The optional front seat's center safety belt has a cinch mechanism. Refer to Safety belt with cinch tongue earlier in this chapter. Children 12 years old and under should be properly restrained in a rear seat whenever possible. Refer to *Safety restraints for children* or *Safety seats for children* later in this chapter.

## Seating and Safety Restraints

### ***How to use the automatic locking mode***

1. Buckle the combination lap and shoulder belt (front safety belt/buckle shown, rear similar).
2. Grasp the shoulder portion and pull downward until the entire belt is pulled out.

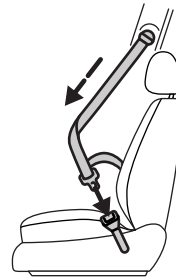

- Allow the belt to retract. As the belt retracts, you will hear a clicking sound. This indicates the safety belt is now in the automatic locking mode.

### **How to disengage the automatic locking mode**

Disconnect the combination lap/shoulder belt and allow it to retract completely to disengage the automatic locking mode and activate the vehicle sensitive (emergency) locking mode.

**!** **WARNING:** After any vehicle collision, the safety belt system at all passenger seating positions must be checked by an authorized dealer to verify that the “automatic locking retractor” feature for child seats is still functioning properly. In addition, all safety belts should be checked for proper function.

**!** **WARNING:** BELT AND RETRACTOR ASSEMBLY MUST BE REPLACED if the safety belt assembly “automatic locking retractor” feature or any other safety belt function is not operating properly when checked by an authorized dealer. Failure to replace the belt and retractor assembly could increase the risk of injury in collisions.

### **Safety belt pretensioner**

Your vehicle is equipped with safety belt pretensioners at the driver and right front passenger seating positions.

The safety belt pretensioner removes some slack from the safety belt system at the start of a crash. The safety belt pretensioner uses the same crash sensor system as the front airbags and Safety Canopy® System. When the safety belt pretensioner deploys, the lap and shoulder belt are tightened.

## Seating and Safety Restraints

When the Safety Canopy® System and/or the front airbags are activated, the safety belt pretensioners for the driver and right front passenger seating positions will be activated when the respective seatbelt is properly buckled.



**WARNING:** The driver and the right front passenger safety belt system (including retractors, buckles and height adjusters) must be replaced if the vehicle is involved in a collision that results in deployment of front airbags or Safety Canopy® System and safety belt pretensioners.



**WARNING:** Failure to replace the safety belt assembly under the above conditions could result in severe personal injuries in the event of a collision.

Refer to the *Safety belt maintenance* section in this chapter.

### Safety belt usage sensors

The driver and front outboard passenger safety belt buckles are equipped with sensors that detect if the safety belts are fastened. The sensors provide information to the Personal Safety System® which can then adapt the airbag deployment or safety belt pretensioner activation based upon safety belt usage.



**WARNING:** The Personal Safety System® provides the most benefit to belted occupants. The system monitors and tailors the airbag deployment based upon safety belt usage. Failure to properly wear your safety belt will increase your risk of injury.

## Seating and Safety Restraints

### Front safety belt height adjustment

Your vehicle has safety belt height adjustments at the front outboard seating positions. Adjust the height of the shoulder belt so the belt rests across the middle of your shoulder.

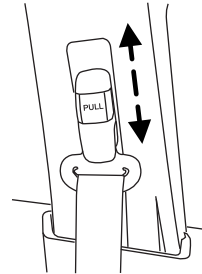

To adjust the shoulder belt height, pull on the center button and slide the height adjuster down. Release the button and pull down on the height adjuster to make sure it is locked in place. To adjust the belt upward, slide the adjuster up and then pull down on the height adjuster to make sure it is locked in place.



**WARNING:** Position the safety belt height adjusters so that the belt rests across the middle of your shoulder. Failure to adjust the safety belt properly could reduce the effectiveness of the safety belt and increase the risk of injury in a collision.

### Safety belt warning light and indicator chime

The safety belt warning light illuminates in the instrument cluster and a chime sounds to remind the occupants to fasten their safety belts.

#### **Conditions of operation**

If...	Then...
The driver's safety belt is not buckled before the ignition switch is turned to the on position...	The safety belt warning light illuminates 1-2 minutes and the warning chime sounds 4-8 seconds.
The driver's safety belt is buckled while the indicator light is illuminated and the warning chime is sounding...	The safety belt warning light and warning chime turn off.
The driver's safety belt is buckled before the ignition switch is turned to the on position...	The safety belt warning light and indicator chime remain off.

## Seating and Safety Restraints

### Belt-Minder®

The Belt-Minder® feature is a supplemental warning to the safety belt warning function. This feature provides additional reminders by intermittently sounding a chime and illuminating the safety belt warning lamp in the instrument cluster when the driver's and front passenger's safety belt is unbuckled.

The Belt-Minder® feature uses information from the front passenger sensing system to determine if a front seat passenger is present and therefore potentially in need of a warning. To avoid activating the Belt-Minder® feature for objects placed in the front passenger seat, warnings will only be given to large front seat occupants as determined by the front passenger sensing system.

Both the driver's and passenger's safety belt usages are monitored and either may activate the Belt-Minder® feature. The warnings are the same for the driver and the front passenger. If the Belt-Minder® warnings have expired (warnings for approximately five minutes) for one occupant (driver or front passenger), the other occupant can still activate the Belt-Minder® feature.

**Note:** If you are using MyKey®, the Belt-Minder® warning will not expire. Refer to *MyKey®* in the *Locks and security* chapter.

When the Belt-Minder® feature is activated, the safety belt warning light illuminates and the warning chime sounds for six seconds every 30 seconds, repeating for approximately five minutes or until the safety belts are buckled.

The Belt-Minder® feature uses two different warning chimes. During the first minute of activation, the warning chime will sound once every second. The remaining warning chimes will sound twice every second while the system is activated.

If...	Then...
The driver's and front passenger's safety belts are buckled...	The Belt-Minder® feature will not activate.
The driver's or front passenger's safety belt is not buckled when the vehicle has reached at least 6 mph and 1-2 minutes have elapsed since the ignition switch has been turned to ON...	The Belt-Minder® feature is activated - the safety belt warning light illuminates and the warning chime sounds for six seconds every 30 seconds, repeating for approximately five minutes or until the safety belts are buckled.

## Seating and Safety Restraints

If...	Then...
The driver's or front passenger's safety belt becomes unbuckled for approximately 1 minute while the vehicle is traveling at least 6 mph and 1-2 minutes have elapsed since the ignition switch has been turned to ON...	The Belt-Minder® feature is activated - the safety belt warning light illuminates and the warning chime sounds for six seconds every 30 seconds, repeating for approximately five minutes or until the safety belts are buckled.
The Belt-Minder® feature is activated and the vehicle speed is less than 3 mph...	The Belt-Minder® feature is suspended - the safety belt warning light remains illuminated, but the warning chime does not sound. This time does not count towards the five-minute expiration time.

The following are reasons most often given for not wearing safety belts:  
(All statistics based on U.S. data)

Reasons given...	Consider..
"Crashes are rare events"	<b>36700 crashes occur every day.</b> The more we drive, the more we are exposed to "rare" events, even for good drivers. <i>1 in 4 of us will be seriously injured in a crash during our lifetime.</i>
"I'm not going far"	<b>3 of 4</b> fatal crashes occur within <b>25</b> miles of home.
"Belts are uncomfortable"	We design our safety belts to enhance comfort. If you are uncomfortable - try different positions for the safety belt upper anchorage and seatback which should be as upright as possible; this can improve comfort.
"I was in a hurry"	<b>Prime time for an accident.</b> Belt-Minder® reminds us to take a few seconds to buckle up.

## Seating and Safety Restraints

Reasons given...	Consider...
“Safety belts don’t work”	<b>Safety belts</b> , when used properly, <b>reduce risk of death</b> to front seat occupants by <b>45% in cars</b> , and by <b>60% in light trucks</b> .
“Traffic is light”	<b>Nearly 1 of 2 deaths occur in single-vehicle crashes</b> , many when no other vehicles are around.
“Belts wrinkle my clothes”	Possibly, but a serious crash can do much more than wrinkle your clothes, particularly if you are unbelted.
“The people I’m with don’t wear belts”	Set the example, teen deaths occur 4 times more often in vehicles with TWO or MORE people. Children and younger brothers/sisters imitate behavior they see.
“I have an airbag”	Airbags offer greater protection when used with safety belts. Frontal airbags are not designed to inflate in rear and side crashes or rollovers.
“I’d rather be thrown clear”	Not a good idea. <b>People</b> who are <b>ejected are 40 times more likely to DIE</b> . Safety belts help prevent ejection, WE CAN’T “PICK OUR CRASH”.



**WARNING:** Do not sit on top of a buckled safety belt or insert a latchplate into the buckle to avoid the Belt-Minder® chime. To do so may adversely affect the performance of the vehicle’s airbag system.

### ***Deactivating/activating the Belt-Minder® feature***

**The driver and front passenger Belt-Minder® are deactivated/activated independently. When deactivating/activating one seating position, do not buckle the other position as this will terminate the process.**

192



## Seating and Safety Restraints

Read Steps 1 - 4 thoroughly before proceeding with the deactivation/activation programming procedure.

**Note:** If you are using MyKey®, the Belt-Minder® cannot be disabled. Also, if the Belt-Minder® has been previously disabled, it will be re-enabled after the use of MyKey®. Refer to *MyKey®* in the *Locks and security* chapter.

The driver and front passenger Belt-Minder® features can be deactivated/activated by performing the following procedure:

Before following the procedure, make sure that:

- The parking brake is set
- The gearshift is in P (Park)
- The ignition switch is in the off position
- The driver and front passenger safety belts are unbuckled



**WARNING:** While the design allows you to deactivate your Belt-Minder®, this system is designed to improve your chances of being safely belted and surviving an accident. We recommend you leave the Belt-Minder® system activated for yourself and others who may use the vehicle. To reduce the risk of injury, do not deactivate/activate the Belt-Minder® feature while driving the vehicle.

1. Turn the ignition switch to the on position. **DO NOT START THE ENGINE.**
2. Wait until the safety belt warning light turns off. (Approximately one minute)
  - Step 3 must be completed within 30 seconds after the safety belt warning light turns off.
3. For the seating position being disabled, buckle then unbuckle the safety belt three times, ending in the unbuckled state.
  - After Step 3, the restraint system warning light (airbag light) will be turned on for three seconds.
4. Within approximately seven seconds of the light turning off, buckle then unbuckle the safety belt.
  - This will disable the Belt-Minder® feature for that seating position if it is currently enabled. As confirmation, the restraint system warning light will flash four times per second for three seconds.

## Seating and Safety Restraints

- This will enable the Belt-Minder® feature for that seating position if it is currently disabled. As confirmation, the restraint system warning light will flash four times per second for three seconds, followed by three seconds with the light off, then followed by the restraint system warning light flashing four times per second for three seconds again.

### Safety belt extension assembly

If the safety belt is too short when fully extended, there is an 8 inch (20 cm) safety belt extension assembly that can be added (part number 611C22). This assembly can be obtained from an authorized dealer.

Use only extensions manufactured by the same supplier as the safety belt. Manufacturer identification is located at the end of the webbing on the label. Also, use the safety belt extension only if the safety belt is too short for you when fully extended.



**WARNING:** Do not use extensions to change the fit of the shoulder belt across the torso.

### AIRBAG SUPPLEMENTAL RESTRAINT SYSTEM (SRS)

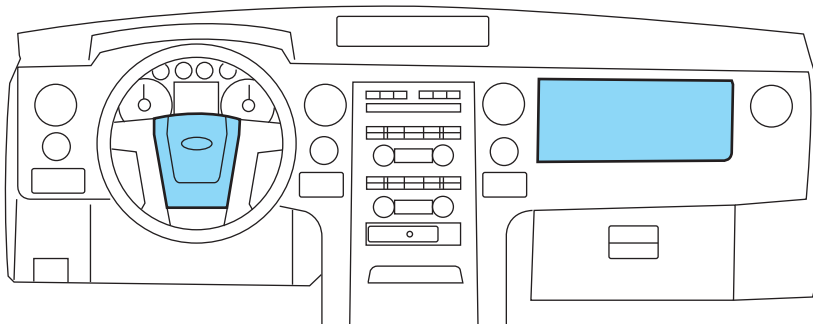

The airbag supplemental restraint system is designed to work in conjunction with the safety belts to help protect the driver and front outboard passenger from certain upper body injuries. The term “supplemental restraint” means the airbags are intended as a supplement to the safety belts. Airbags alone cannot protect as well as airbags plus safety belts in impacts for which the airbags are designed to deploy, and airbags do not offer any protection in crashes for which they do not deploy.

194

## Seating and Safety Restraints

The airbag supplemental restraint system consists of:

- driver and passenger dual stage airbag modules (which include the inflators and airbags).
- side airbags and Safety Canopy®. Refer to *Seat-mounted side airbag system* and *Safety Canopy® system* later in this chapter.
- one or more impact and safing sensors.
- the same indicator light, RCM (restraints control module) and diagnostic unit used for the Personal safety system.
- Front passenger sensing system
- Passenger airbag off indicator light.

The airbag supplemental restraints are an integral part of the Personal Safety System. They are designed to be deployed in cases where the Personal Safety System has determined the occupant conditions and crash severity are appropriate to activate these devices. Refer to the *Personal Safety System™* section in this chapter.

### Important SRS precautions

The SRS is designed to work with the safety belt to help protect the driver and right front passenger from certain upper body injuries. Airbags DO NOT inflate slowly; there is a risk of injury from a deploying airbag.

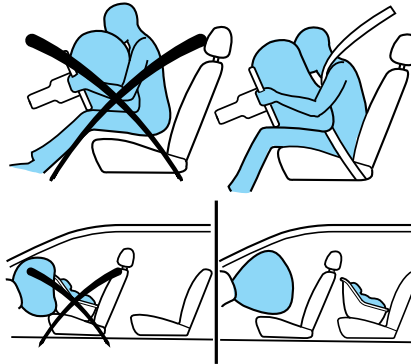

 **WARNING:** All occupants of the vehicle, including the driver, should always properly wear their safety belts, even when an air bag supplemental restraint system (SRS) is provided.

 **WARNING:** When possible, all children 12 years old and under should be properly restrained in a rear seating position.

## Seating and Safety Restraints

 **WARNING:** The National Highway Traffic Safety Administration (NHTSA) recommends a minimum distance of at least 10 inches (25 cm) between an occupant's chest and the driver airbag module.

 **WARNING:** Never place your arm over the airbag module as a deploying airbag can result in serious arm fractures or other injuries.

To properly position yourself away from the airbag:

- Move your seat to the rear as far as you can while still reaching the pedals comfortably.
- Recline the seat slightly one or two degrees from the upright position.

 **WARNING:** Do not put anything on or over the airbag module. Placing objects on or over the airbag inflation area may cause those objects to be propelled by the airbag into your face and torso causing serious injury.

 **WARNING:** Do not attempt to service, repair, or modify the airbag supplemental restraint systems or its fuses. Contact your authorized dealer as soon as possible.

 **WARNING:** The front passenger airbag is not designed to offer protection to an occupant in the center front seating position.

 **WARNING:** Modifying or adding equipment to the front end of the vehicle (including frame, bumper, front end body structure and tow hooks) may affect the performance of the airbag system, increasing the risk of injury. Do not modify the front end of the vehicle.

 **WARNING:** Additional equipment may affect the performance of the airbag sensors increasing the risk of injury.

## Seating and Safety Restraints

### Children and airbags

For additional important safety information, read all information on safety restraints in this guide.

Children must always be properly restrained. Accident statistics suggest that children are safer when properly restrained in the rear seat than in the front seat. Failure to follow these instructions may increase the risk of injury in a collision.



**WARNING:** Airbags can kill or injure a child in a child seat. **NEVER** place a rear-facing child seat in front of an active airbag. If you must use a forward-facing child seat in the front seat, move the seat all the way back.

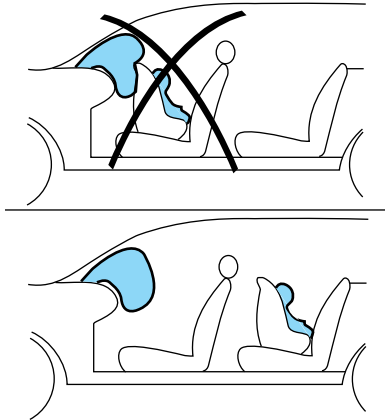

If two adults and a child occupy a **Regular Cab**, properly restrain the child in the center front unless doing so would interfere with driving the vehicle. This arrangement provides lap and shoulder belt protection for all occupants, and airbag protection for the adults. All occupants of the vehicle should always properly wear their safety belts. Ensure the child is properly restrained in an appropriate child seat or with the use of a booster. A child or infant properly restrained in the center front seat should not incur risk of serious injury from the airbags.

## Seating and Safety Restraints

### How does the airbag supplemental restraint system work?

The airbag SRS is designed to activate when the vehicle sustains sufficient longitudinal deceleration.

The fact that the airbags did not inflate in a collision does not mean that something is wrong with the system. Rather, it means the forces were not of the type sufficient to cause activation. Airbags are designed to inflate in frontal and near-frontal collisions, not rollover, side-impact, or rear-impacts.

The airbags inflate and deflate rapidly upon activation. After airbag deployment, it is normal to notice a smoke-like, powdery residue or smell the burnt propellant. This may consist of cornstarch, talcum powder (to lubricate the bag) or sodium compounds (e.g., baking soda) that result from the combustion process that inflates the airbag. Small amounts of sodium hydroxide may be present which may irritate the skin and eyes, but none of the residue is toxic.

While the system is designed to help reduce serious injuries, it may also cause minor abrasions, swelling or temporary hearing loss. Because airbags must inflate rapidly and with considerable force, there is the risk of death or serious injuries such as fractures, facial and eye injuries or internal injuries, particularly to occupants who are not properly restrained or are otherwise out of position at the time of airbag deployment. Thus, it is extremely important that occupants be properly restrained as far away from the airbag cover as possible while maintaining vehicle control.

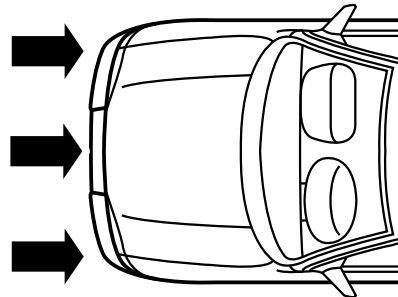

**WARNING:** Several airbag system components get hot after inflation. Do not touch them after inflation.

## Seating and Safety Restraints



**WARNING:** If the airbag has deployed, **the airbag will not function again and must be replaced immediately.** If the airbag is not replaced, the unrepaired area will increase the risk of injury in a collision.

### Front passenger sensing system

The front passenger sensing system is designed to meet the regulatory requirements of Federal Motor Vehicle Safety Standard (FMVSS) 208 and is designed to disable (will not inflate) the front passenger's frontal airbag under certain conditions.

The front passenger sensing system works with sensors that are part of the front passenger's seat and safety belt. The sensors are designed to detect the presence of a properly seated occupant and determine if the front passenger's frontal airbag should be enabled (may inflate) or disabled (will not inflate).

The front passenger sensing system will disable (will not inflate) the front passenger's frontal airbag if:

- the front passenger seat is unoccupied, or has small/medium objects in the front seat,
- the system determines that an infant is present in a rear-facing infant seat that is installed according to the manufacturer's instructions,
- the system determines that a small child is present in a forward-facing child restraint that is installed according to the manufacturer's instructions,
- the system determines that a small child is present in a booster seat,
- a front passenger takes his/her weight off of the seat for a period of time,
- a child or a small person occupies the front passenger seat.

**Note:** When the passenger airbag off light is illuminated, the passenger (seat mounted) side airbag may be disabled to avoid the risk of airbag deployment injuries.

## Seating and Safety Restraints

The front passenger sensing system uses a "passenger airbag off" or "pass airbag off" indicator which will illuminate and stay lit to remind you that the front passenger frontal airbag is disabled. The indicator lamp is located in the center stack of the instrument panel just above the radio.



**Note:** The indicator lamp will illuminate for a short period of time when the ignition is turned to the on position to confirm it is functional.

When the front passenger seat is not occupied (empty seat) or in the event that the front passenger frontal airbag is enabled (may inflate), the indicator lamp will be unlit.

The front passenger sensing system is designed to disable (will not inflate) the front passenger's frontal airbag when a rear facing infant seat, a forward-facing child restraint, or a booster seat is detected.

- When the front passenger sensing system disables (will not inflate) the front passenger frontal airbag, the indicator lamp will illuminate and stay lit to remind you that the front passenger frontal airbag is disabled.
- If the child restraint has been installed and the indicator lamp is not lit, then turn the vehicle off, remove the child restraint from the vehicle and reinstall the restraint following the child restraint manufacturer's instructions.

The front passenger sensing system is designed to enable (may inflate) the front passenger's frontal airbag anytime the system senses that a person of adult size is sitting properly in the front passenger seat.

- When the front passenger sensing system enables the front passenger frontal airbag (may inflate), the indicator will be unlit and stay unlit.

If a person of adult size is sitting in the front passenger's seat, but the "passenger airbag off" or "pass airbag off" indicator lamp is lit, it is possible that the person isn't sitting properly in the seat. If this happens:

- Turn the vehicle off and ask the person to place the seatback in the full upright position.
- Have the person sit upright in the seat, centered on the seat cushion, with the person's legs comfortably extended.
- Restart the vehicle and have the person remain in this position for about two minutes. This will allow the system to detect that person and enable the passenger's frontal airbag.

200



## Seating and Safety Restraints

- If the indicator lamp remains lit even after this, the person should be advised to ride in the rear seat.

Occupant	Pass Airbag Off Indicator Lamp	Passenger Airbag
Empty seat	Unlit	Disabled
Small child in child safety seat or booster	Lit	Disabled
Small child with safety belt buckled or unbuckled	Lit	Disabled
Adult	Unlit	Enabled



**WARNING:** Even with Advanced Restraints Systems, children 12 and under should be properly restrained in a rear seating position.

After all occupants have adjusted their seats and put on safety belts, it's very important that they continue to sit properly. A properly seated occupant sits upright, leaning against the seat back, and centered on the seat cushion, with their feet comfortably extended on the floor. Sitting improperly can increase the chance of injury in a crash event. For example, if an occupant slouches, lies down, turns sideways, sits forward, leans forward or sideways, or puts one or both feet up, the chance of injury during a crash is greatly increased.



**WARNING:** Sitting improperly out of position or with the seat back reclined too far can take off weight from the seat cushion and affect the decision of the front passenger sensing system, resulting in serious injury or death in a crash. Always sit upright against your seatback, with your feet on the floor.

The front passenger sensing system may detect small or medium objects placed on the seat cushion. For most objects that are in the front passenger seat, the passenger airbag will be disabled. Even though the passenger airbag is disabled, the "pass airbag off" lamp may or may not be illuminated according to the table below.

## Seating and Safety Restraints

Objects	Pass Airbag Off Indicator Lamp	Passenger Airbag
Small (i.e. three-ring binder, small purse, bottled water)	Unlit	Disabled
Medium (i.e. heavy briefcase, fully packed luggage)	Lit	Disabled
Empty seat, or small to medium object with safety belt buckled	Lit	Disabled

In case there is a problem with the front passenger sensing system, the airbag readiness lamp in the instrument cluster will stay lit.



DO NOT attempt to repair or service the system; take your vehicle immediately to an authorized dealer.



**WARNING:** The front passenger airbag is not designed to offer protection to an occupant in the center seating position.



**WARNING:** An out of position front center occupant could affect the decision of the front passenger sensing system.

If it is necessary to modify an advanced front airbag system to accommodate a person with disabilities, contact the Ford Customer Relationship Center at the phone number shown in the *Customer Assistance* chapter of this *Owner's Guide*.



**WARNING:** Any alteration/modification to the front passenger seat may affect the performance of the front passenger sensing system.

### Determining if the system is operational

The SRS uses readiness lights in the instrument cluster or a tone to indicate the condition of the system. Refer to *Airbag readiness* in the *Instrument Cluster* chapter. Routine maintenance of the airbag is not required.

202

## Seating and Safety Restraints

A difficulty with the system is indicated by one or more of the following:

- The readiness lights will either flash or stay lit.
- The readiness lights will not illuminate immediately after ignition is turned on.
- A series of five beeps will be heard. The tone pattern will repeat periodically until the problem and/or light are repaired.



If any of these things happen, even intermittently, have the SRS serviced at an authorized dealer immediately. Unless serviced, the system may not function properly in the event of a collision.

### Seat-mounted side airbag system



**WARNING:** Do not place objects or mount equipment on or near the airbag cover on the side of the seatbacks of the front seats or in front seat areas that may come into contact with a deploying airbag. Failure to follow these instructions may increase the risk of personal injury in the event of a collision.



**WARNING:** Do not use accessory seat covers. The use of accessory seat covers may prevent the deployment of the side airbags and increase the risk of injury in an accident.



**WARNING:** Do not lean your head on the door. The side airbag could injure you as it deploys from the side of the seatback.



**WARNING:** Do not attempt to service, repair, or modify the airbag SRS, its fuses or the seat cover on a seat containing an airbag. See an authorized dealer.



**WARNING:** All occupants of the vehicle should always wear their safety belts even when an airbag SRS is provided.

## Seating and Safety Restraints

### ***How does the side airbag system work?***

The design and development of the side airbag system included recommended testing procedures that were developed by a group of automotive safety experts known as the Side Airbag Technical Working Group. These recommended testing procedures help reduce the risk of injuries related to the deployment of side airbags.

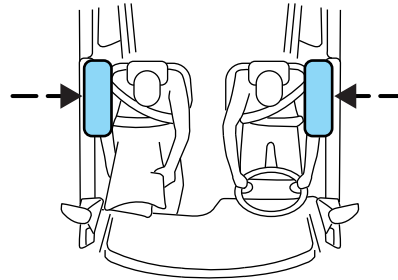

The side airbag system consists of the following:

- An inflatable bag (airbag) with a gas generator concealed behind the outboard bolster of the driver and front passenger seatbacks.
- A special seat cover designed to allow airbag deployment.
- The same warning light, electronic control and diagnostic unit as used for the front airbags.
- Crash sensors located on the front doors.
- One crash sensor located on each side of the b-pillar, (SuperCab only).
- One crash sensor located on each side of the c-pillar, (SuperCrew only).

Side airbags, in combination with safety belts, can help reduce the risk of severe injuries in the event of a significant side impact collision.

The side airbags are fitted on the outboard side of the seatbacks of the front seats. In certain lateral collisions, the airbag on the side affected by the collision will be inflated. The airbag was designed to inflate between the door panel and occupant to further enhance the protection provided occupants in side impact collisions.

The airbag SRS is designed to activate when the vehicle sustains lateral deceleration sufficient to cause the sensors to close an electrical circuit that initiates airbag inflation.

The fact that the airbags did not inflate in a collision does not mean that something is wrong with the system. Rather, it means the forces were not of the type sufficient to cause activation. Side airbags are designed to inflate in side-impact collisions, not roll-over, rear-impact, frontal or near-frontal collisions, unless the collision causes sufficient lateral deceleration.

204

## Seating and Safety Restraints



**WARNING:** Several airbag system components get hot after inflation. Do not touch them after inflation.



**WARNING:** If the side airbag has deployed, **the airbag will not function again. The side airbag system (including the seat) must be inspected and serviced by an authorized dealer.** If the airbag is not replaced, the unrepaired area will increase the risk of injury in a collision.

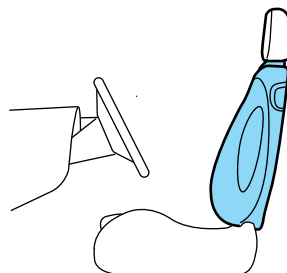

### ***Determining if the system is operational***

The SRS uses a readiness light in the instrument cluster or a tone to indicate the condition of the system. Refer to *Warning lights and chimes* in the *Instrument Cluster* chapter. Routine maintenance of the side airbag is not required.

A difficulty with the system is indicated by one or more of the following:

- The readiness light (same light as for front airbag system) will either flash or stay lit.
- The readiness light will not illuminate immediately after ignition is turned on.
- A series of five beeps will be heard. The tone pattern will repeat periodically until the problem and/or light are repaired.

If any of these things happen, even intermittently, have the SRS serviced at your authorized dealer immediately. Unless serviced, the system may not function properly in the event of a collision.

## Seating and Safety Restraints

### Safety Canopy® System

 **WARNING:** Do not place objects or mount equipment on or near the headliner at the siderail that may come into contact with a deploying Safety Canopy®. Failure to follow these instructions may increase the risk of personal injury in the event of a collision.

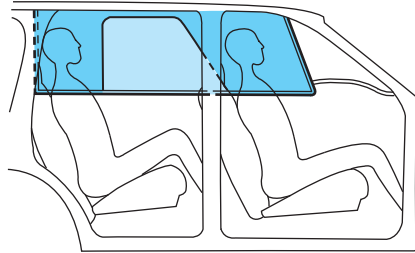

 **WARNING:** Do not lean your head on the door. The Safety Canopy® could injure you as it deploys from the headliner.

 **WARNING:** Do not attempt to service, repair, or modify the Safety Canopy® System, its fuses, the A, B, or C pillar trim, or the headliner on a vehicle containing a Safety Canopy®. Contact your authorized dealer as soon as possible.

 **WARNING:** All occupants of the vehicle including the driver should always wear their safety belts even when an airbag SRS and Safety Canopy® System is provided.

 **WARNING:** To reduce risk of injury, do not obstruct or place objects in the deployment path of the inflatable Safety Canopy®.

## Seating and Safety Restraints

### **How does the Safety Canopy® System work?**

The design and development of the Safety Canopy system included recommended testing procedures that were developed by a group of automotive safety experts known as the Side Airbag Technical Working Group. These recommended testing procedures help reduce the risk of injuries related to the deployment of side airbags (including the Safety Canopy®).

The Safety Canopy system consists of the following:

- An inflatable curtain with a gas generator concealed behind the headliner and in the corner or C pillar behind the doors.
- A headliner designed to flex open above the side doors to allow Safety Canopy deployment.
- The same warning light, electronic control and diagnostic unit as used for the front airbags.
- Two crash sensors located on the C-pillar (one on each side) (SuperCab and SuperCrew only).
- Crash sensors located on the front doors.
- Rollover sensor in the restraints control module (RCM).

The Safety Canopy system, in combination with safety belts, can help reduce the risk of severe injuries in the event of a significant side impact collision or rollover event.

Children 12 years old and under should always be properly restrained in the second row seats. The Safety Canopy will not interfere with children restrained using a properly installed child or booster seat because it is designed to inflate downward from the headliner above the doors along the side window opening.

The Safety Canopy system is designed to activate when the vehicle sustains lateral deceleration sufficient to cause the RCM to initiate Safety Canopy inflation or when a certain likelihood of a rollover event is detected by the rollover sensor.

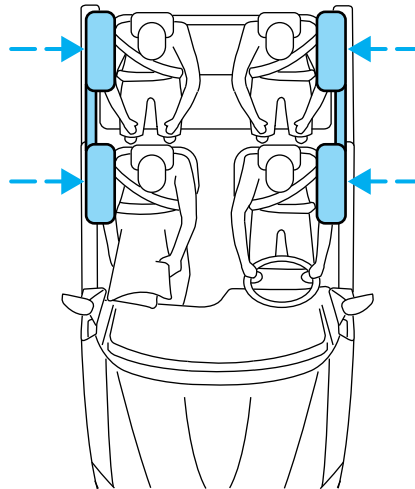

## Seating and Safety Restraints

The Safety Canopy is mounted to roof side-rail sheet metal, behind the headliner, above each row of seats. The Safety Canopy is designed to inflate between the side window area and occupants to further enhance protection provided in side impact collisions and rollover events.

The fact that the Safety Canopy did not activate in a collision does not mean that something is wrong with the system. Rather, it means the forces were not of the type sufficient to cause activation. The Safety Canopy is designed to inflate in certain side impact collisions or rollover events, not in rear impact, frontal or near-frontal collisions, unless the collision causes sufficient lateral deceleration or rollover likelihood.



**WARNING:** Several Safety Canopy system components get hot after inflation. Do not touch them after inflation.

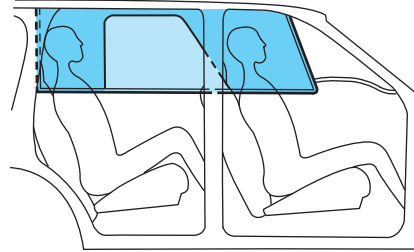

**WARNING:** If the Safety Canopy system has deployed, the Safety Canopy will not function again unless replaced. The Safety Canopy system (including the A, B, C, and D pillar trim and headliner) must be inspected and serviced by an authorized dealer. If the Safety Canopy is not replaced, it will not function again, which will increase the risk of injury in a future collision.

### ***Determining if the system is operational***

The SRS uses a readiness light in the instrument cluster or a tone to indicate the condition of the system. Refer to *Warning lights and chimes* in the *Instrument Cluster* chapter. Routine maintenance of the side airbag is not required.

A difficulty with the system is indicated by one or more of the following:

- The readiness light (same light as for front airbag system) will either flash or stay lit.
- The readiness light will not illuminate immediately after ignition is turned on.
- A series of five beeps will be heard. The tone pattern will repeat periodically until the problem and/or light are repaired.

208



## Seating and Safety Restraints

If any of these things happen, even intermittently, have the SRS serviced at your authorized dealer immediately. Unless serviced, the system may not function properly in the event of a collision.

### SOS Post-Crash Alert System™

The system automatically flashes the turn signal lamps and sounds the horn three times at four second intervals in the event of a serious impact that deploys an airbag (front, side, side curtain [if equipped] or Safety Canopy® [if equipped]) or the safety belt pretensioners.

The system can be turned off when any one of the following actions are taken by the driver or any other person:

- pressing the hazard control button,
- or pressing the panic button on the remote entry transmitter.

The feature will continue to operate until the vehicle runs out of power.

### Disposal of airbags and airbag equipped vehicles (including pretensioners)

Contact your authorized dealer as soon as possible. Airbags MUST BE disposed of by qualified personnel.

### SAFETY RESTRAINTS FOR CHILDREN

See the following sections for directions on how to properly use safety restraints for children. Also see *Airbag supplemental restraint system (SRS)* in this chapter for special instructions about using airbags.

#### Important child restraint precautions



**WARNING:** Always make sure your child is secured properly in a device that is appropriate for their height, age and weight. Child safety restraints must be purchased separately from the vehicle. Failure to follow these instructions and guidelines may result in an increased risk of serious injury or death to your child.

## Seating and Safety Restraints



**WARNING:** All children are shaped differently. The Recommendations for Safety Restraints are based on probable child height, age and weight thresholds from NHTSA and other safety organizations or are the minimum requirements of law. Ford recommends checking with a NHTSA Certified Child Passenger Safety Technician (CPST) and consult your pediatrician to make sure your child seat is appropriate for your child, and is compatible with and properly installed in the vehicle. To locate a child seat fitting station and CPST contact the NHTSA toll free at 1-888-327-4236 or on the internet at <http://www.nhtsa.dot.gov>. In Canada, check with your local St. John Ambulance office for referral to a CPST or for further information, contact your provincial ministry of transportation, your local St. John Ambulance office at <http://www.sfa.ca>, or Transport Canada at 1-800-333-0371 (<http://www.tc.gc.ca>). Failure to properly restrain children in safety seats made especially for their height, age, and weight may result in an increased risk of serious injury or death to your child.

Recommendations for Safety Restraints for Children		
	Child size, height, weight, or age	Recommended restraint type
Infants or toddlers	Children weighing 40 lb (18 kg) or less (generally age four or younger)	Use a child safety seat (sometimes called an infant carrier, convertible seat, or toddler seat).
Small children	Children who have outgrown or no longer properly fit in a child safety seat (generally children who are less than 4 feet 9 inches (1.45 meters) tall, are greater than age four (4) and less than age twelve (12), and between 40 lb (18 kg) and 80 lb (36 kg) and upward to 100 lb (45 kg) if recommended by your child restraint manufacturer)	Use a belt-positioning booster seat.

## Seating and Safety Restraints

<b>Recommendations for Safety Restraints for Children</b>		
	<b>Child size, height, weight, or age</b>	<b>Recommended restraint type</b>
Larger children	Children who have outgrown or no longer properly fit in a belt-positioning booster seat (generally children who are at least 4 feet 9 inches (1.45 meters) tall or greater than 80 lb (36 kg) or 100 lb (45 kg) if recommended by child restraint manufacturer)	Use a vehicle safety belt having the lap belt snug and low across the hips, shoulder belt centered across the shoulder and chest, and seatback upright.

- You are required by law to properly use safety seats for infants and toddlers in the U.S. and Canada.
- Many states and provinces require that small children use approved booster seats until they reach age eight, a height of 4 ft 9 in. (1.45 meters) tall, or 80 lb (36 kg). Check your local and state or provincial laws for specific requirements regarding the safety of children in your vehicle.
- When possible, always properly restrain children twelve (12) years of age and under in a rear seating position of your vehicle. Accident statistics suggest that children are safer when properly restrained in the rear seating positions than in a front seating position.

## Seating and Safety Restraints

### Recommendations for attaching child safety restraints for children

Restraint Type	Child Weight	Use any attachment method as indicated below by "X"				
		LATCH (lower anchors and top tether anchor)	LATCH (lower anchors only)	Safety belt and top tether anchor	Safety belt and LATCH (lower anchors and top tether anchor)	Safety belt only
Rear facing child seat	Up to 48 lb (21 kg)		X			X
Forward facing child seat	Up to 48 lb (21 kg)	X		X	X	
Forward facing child seat	Over 48 lb (21 kg)			X	X	





**WARNING:** Airbags can kill or injure a child in a child seat. NEVER place a rear-facing child seat in front of an active airbag. If you must use a forward-facing child seat in the front seat, move the vehicle seat all the way back. When possible, all children age 12 and under should be properly restrained in a rear seating position. If all children cannot be seated and restrained properly in a rear seating position, properly restrain the largest child in the front seat.





**WARNING:** Always carefully follow the instructions and warnings provided by the manufacturer of any child restraint to determine if the restraint device is appropriate for your child's size, height, weight, or age. Follow the child restraint manufacturer's instructions and warnings provided for installation and use in conjunction with the instructions and warnings provided by the vehicle manufacturer. A safety seat that is improperly installed or utilized, is inappropriate for your child's height, age, or weight or does not properly fit the child may increase the risk of serious injury or death.

## Seating and Safety Restraints

 **WARNING:** Never let a passenger hold a child on his or her lap while the vehicle is moving. The passenger cannot protect the child from injury in a collision, which may result in serious injury or death.

 **WARNING:** Never use pillows, books, or towels to boost a child. They can slide around and increase the likelihood of injury or death in a collision.

 **WARNING:** Always restrain an unoccupied child seat or booster seat. These objects may become projectiles in a collision or sudden stop, which may increase the risk of serious injury.

 **WARNING:** Never place, or allow a child to place, the shoulder belt under a child's arm or behind the back because it reduces the protection for the upper part of the body and may increase the risk of injury or death in a collision.

 **WARNING:** Do not leave children, unreliable adults, or pets unattended in your vehicle.

### Transporting children

Always make sure your child is secured properly in a device that is appropriate for their age, height and weight. All children are shaped differently. The child height, age and weight thresholds provided are recommendations or the minimum requirements of law. The National Highway Traffic Safety Administration (NHTSA) provides education and training to ensure that all children ages 0 to 16 are properly restrained in the correct restraint system. Ford recommends checking with a NHTSA Certified Child Passenger Safety Technician (CPST) and your pediatrician to make sure your seat is appropriate for your child and properly installed in the vehicle. To locate a child seat fitting station and CPST contact the NHTSA toll free at **1-888-327-4236** or on the internet at <http://www.nhtsa.dot.gov>. In Canada, check with your local St. John Ambulance office for referral to a CPST or for further information, contact your provincial ministry of transportation, your local St. John Ambulance office at <http://www.sfa.ca>, or Transport Canada at 1-800-333-0371 (<http://www.tc.gc.ca>).

## Seating and Safety Restraints

Follow all the safety restraint and airbag precautions that apply to adult passengers in your vehicle.

If the child is the proper height, age, and weight (as specified by your child safety seat or booster manufacturer), fits the restraint and can be restrained properly, then restrain the child in the child safety seat or with the belt-positioning booster. Remember that child seats and belt-positioning boosters vary and may be designed to fit children of different heights, ages and weights. Children who are too large for child safety seats or belt-positioning boosters (as specified by your child safety seat manufacturer) should always properly wear safety belts.

### SAFETY SEATS FOR CHILDREN

#### Infant and/or toddler seats

Use a safety seat that is recommended for the size and weight of the child.

When installing a child safety seat:

- Review and follow the information presented in the *Airbag supplemental restraint system (SRS)* section in this chapter.
- Carefully follow all of the manufacturer's instructions included with the safety seat you put in your vehicle. If you do not install and use the safety seat properly, the child may be injured in a sudden stop or collision.
- In order to install your child seat properly, you may need to remove the head restraint to access the child seat tether. See *Front seats* and *Rear seats* in this chapter for information on removing the headrests.

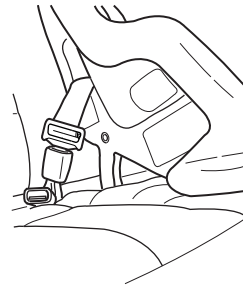

Airbags can kill or injure a child in a child seat. NEVER place a rear-facing child seat in front of an active airbag. If you must use a forward-facing child seat in the front seat, move the vehicle seat all the way back.

Children 12 and under should be properly restrained in a rear seating position whenever possible. If all children cannot be seated and restrained properly in a rear seating position, properly restrain the largest child in the front seat.

214

## Seating and Safety Restraints

### Installing child safety seats with combination lap and shoulder belts

Check to make sure the child seat is properly secured before each use. Children 12 and under should be properly restrained in a rear seating position whenever possible. If all children cannot be seated and restrained properly in a rear seating position, properly restrain the largest child in the front seat.

When installing a child safety seat with combination lap/shoulder belts:

- Use the correct safety belt buckle for that seating position.
- Insert the belt tongue into the proper buckle until you hear a snap and feel it latch. Make sure the tongue is securely fastened in the buckle.
- Keep the buckle release button pointing up and away from the safety seat, with the tongue between the child seat and the release button, to help prevent accidental unbuckling.
- Place vehicle seat back in upright position.
- Put the safety belt in the automatic locking mode. Refer to step 5 below. This vehicle does not require the use of a locking clip.



**WARNING:** Depending on where you secure a child restraint, and depending on the child restraint design, you may block access to certain safety belt buckle assemblies and/or LATCH lower anchors, rendering those features potentially unusable. To avoid risk of injury, occupants should only use seating positions where they are able to be properly restrained.

## Seating and Safety Restraints

If you are using a front center seat, see *Installing child safety seats in cinch tongue combination lap and shoulder belt seating position* later in this chapter for instructions.

Perform the following steps when installing the child seat with combination lap/shoulder belts:

**Note:** Although the child seat illustrated is a forward facing child seat, the steps are the same for installing a rear facing child seat.

1. Position the child safety seat in a seat with a combination lap and shoulder belt.

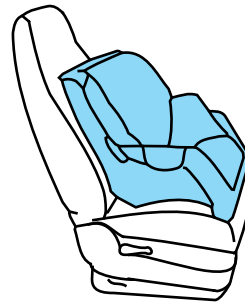

2. Pull down on the shoulder belt and then grasp the shoulder belt and lap belt together.

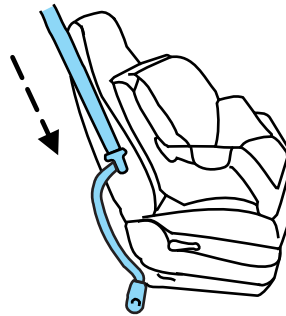



## Seating and Safety Restraints

3. While holding the shoulder and lap belt portions together, route the tongue through the child seat according to the child seat manufacturer's instructions. Be sure the belt webbing is not twisted.

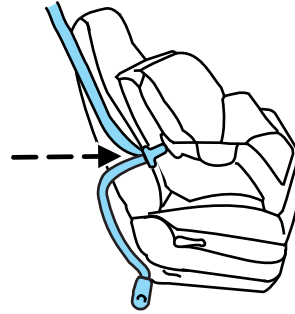

4. Insert the belt tongue into the proper buckle (the buckle closest to the direction the tongue is coming from) for that seating position until you hear a snap and feel the latch engage. Make sure the tongue is latched securely by pulling on it.

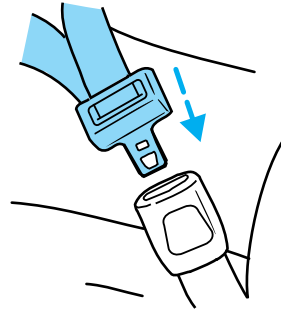

5. To put the retractor in the automatic locking mode, grasp the shoulder portion of the belt and pull downward until all of the belt is pulled out and a click is heard.

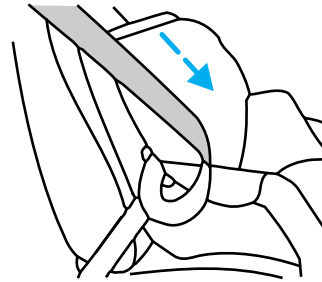

6. Allow the belt to retract to remove slack. The belt will click as it retracts to indicate it is in the automatic locking mode.

7. Try to pull the belt out of the retractor to make sure the retractor is in the automatic locking mode (you should not be able to pull more belt out). If the retractor is not locked, unbuckle the belt and repeat Steps 5 and 6.

## Seating and Safety Restraints

8. Remove remaining slack from the belt. Force the seat down with extra weight, e.g., by pressing down or kneeling on the child restraint while pulling up on the shoulder belt in order to force slack from the belt. This is necessary to remove the remaining slack that will exist once the additional weight of the child is added to the child restraint. It also helps to achieve the proper snugness of the child seat to the vehicle. Sometimes, a slight lean towards the buckle will additionally help to remove remaining slack from the belt.

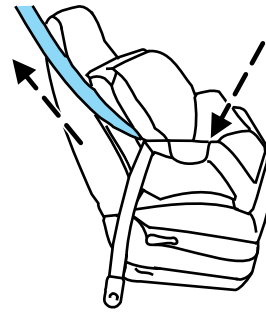

9. Attach the tether strap (if the child seat is equipped). Refer to *Attaching child safety seats with tether straps* later in this chapter.

10. Before placing the child in the seat, forcibly move the seat forward and back to make sure the seat is securely held in place. To check this, grab the seat at the belt path and attempt to move it side to side and forward and back. There should be no more than 1 inch (2.5 cm) of movement for proper installation.

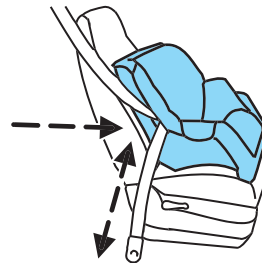

11. Ford recommends checking with a NHTSA Certified Child Passenger Safety Technician (CPST) to make certain the child restraint is properly installed.

### ***Installing child safety seats in cinch tongue combination lap and shoulder belt seating position (front center seating position only)***

The belt webbing below the tongue is the lap portion of the combination lap/shoulder belt, and the belt webbing above the tongue is the shoulder belt portion of the combination lap/shoulder belt.



**WARNING:** Always use both lap and shoulder safety belt in the center seating position.

## Seating and Safety Restraints

1. Position the child safety seat in the center front seat.

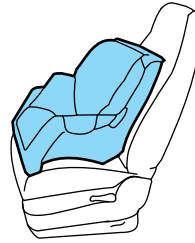

2. If the center lap/shoulder safety belt has been disconnected from the seat to carry large cargo behind the seat, reconnect it by buckling the small buckle on the end of the belt into the mini-buckle on the driver's side.

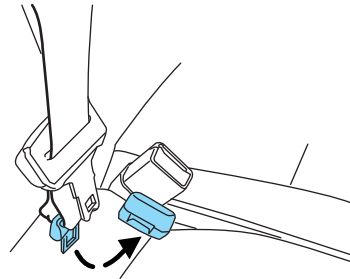

3. Slide the tongue up the webbing.

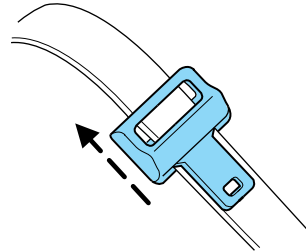

4. While holding both shoulder and lap portions next to the tongue, route the tongue and webbing through the child seat according to the child seat manufacturer's instructions. Be sure that the belt webbing is not twisted.

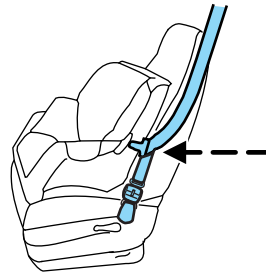

## Seating and Safety Restraints

5. Insert the belt tongue into the proper buckle (the buckle closest to the direction the tongue is coming from) for that seating position until you hear a snap and feel the latch engage. Make sure the tongue is latched securely by pulling on it.

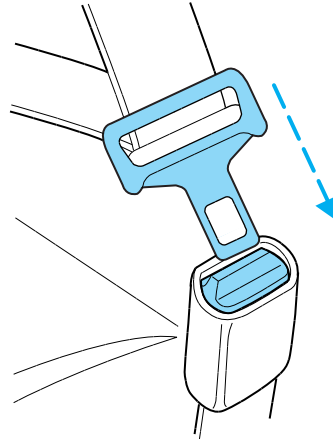

6. While pushing down with your knee on the child seat pull up on the shoulder belt portion to tighten the lap belt portion of the combination lap and shoulder belt.

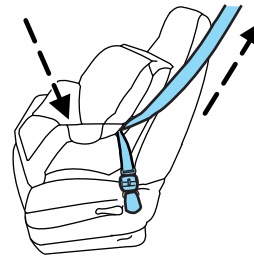

7. Allow the safety belt to retract and remove any slack in the belt to securely tighten the child safety seat in the vehicle.

8. Attach the tether strap (if the child seat is equipped). Refer to *Attaching child safety seats with tether straps* later in this chapter.

## Seating and Safety Restraints

9. Before placing the child into the child seat, forcibly pull the child seat forward and back to make sure that the seat is held securely in place. To check this, grab the seat at the belt path and attempt to move it side to side and forward and back. There should be no more than 1 inch (2.5 cm) of movement for proper installation.

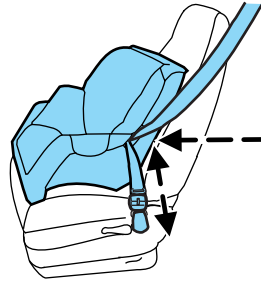

10. Check from time to time to be sure that there is no slack in the lap/shoulder belt. The shoulder belt must be snug to keep the lap belt tight during a collision.

11. Ford recommends checking with a NHTSA Certified Child Passenger Safety Technician (CPST) to make certain the child restraint is properly installed. In Canada, check with your local St. John Ambulance office for referral to a CPST.



**WARNING:** Airbags can kill or injure a child in a child seat. If you must use a forward-facing child seat in the front seat, move seat all the way back.



**WARNING:** Rear facing child seats should NEVER be placed in front of an active airbag.

### Attaching child safety seats with LATCH (Lower Anchors and Tethers for CHildren) attachments

The LATCH system is composed of three vehicle anchor points: two (2) lower anchors located where the vehicle seat back and seat cushion meet (called the “seat bight”) and one (1) top tether anchor located behind that seating position.

LATCH compatible child safety seats have two rigid or webbing mounted attachments that connect to the two lower anchors at the LATCH equipped seating positions in your vehicle. This type of attachment method eliminates the need to use safety belts to attach the child seat, however the safety belt can still be used to attach the child seat if the lower anchors are not used. For forward-facing child seats, the top tether strap must also be attached to the proper top tether anchor, if a top tether strap has been provided with your child seat. See *Attaching child safety seats with tether straps* in this chapter for more information.

221

## Seating and Safety Restraints

Your vehicle is equipped with LATCH lower anchors for child seat installation at the following seating positions (LATCH is not available on F150 Regular cab) :

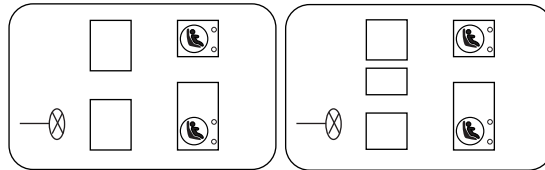

- F150 SuperCab and SuperCrew

The lower LATCH anchors are located at the rear section of the rear seat between the cushion and seatback. Follow the child seat manufacturer's instructions to properly install a child seat with LATCH attachments.

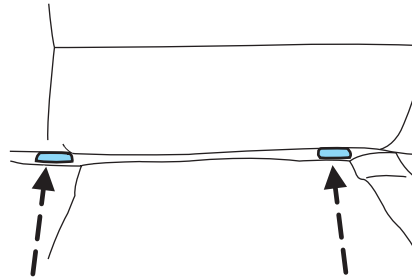

Follow the instructions later in this chapter on attaching child safety seats with tether straps.

Attach LATCH lower attachments of the child seat only to the anchors shown.

**!** **WARNING:** Never attach two child safety seats to the same anchor. In a crash, one anchor may not be strong enough to hold two child safety seat attachments and may break, causing serious injury or death.

**!** **WARNING:** Depending on where you secure a child restraint, and depending on the child restraint design, you may block access to certain safety belt buckle assemblies and/or LATCH lower anchors, rendering those features potentially unusable. To avoid risk of injury, occupants should only use seating positions where they are able to be properly restrained.

## Seating and Safety Restraints

### ***Use of inboard lower anchors from the outboard seating positions (center seating use)***

The lower anchors at the center of the second row rear seat are spaced 25.7 inches (652 mm) apart. The standardized spacing for LATCH lower anchors is 11 inches (280 mm) center to center. A child seat with rigid LATCH attachments cannot be installed at the center seating position. LATCH compatible child seats (with attachments on belt webbing) can only be used at this seating position provided that the child seat manufacturer's instructions permit use with the anchor spacing stated. Do not attach a child seat to any lower anchor if an adjacent child seat is attached to that anchor.



**WARNING:** The standardized spacing for LATCH lower anchors is 280 mm (11 inches) center to center. Do not use LATCH lower anchors for the center seating position unless the child seat manufacturer's instructions permit and specify using anchors spaced at least as far apart as those in this vehicle.

Each time you use the safety seat, check that the seat is properly attached to the lower anchors and tether anchor, if applicable. Tug the child seat from side to side and forward and back where it is secured to the vehicle. The seat should move less than one inch when you do this for a proper installation.

If the safety seat is not anchored properly, the risk of a child being injured in a crash greatly increases.

### ***Combining safety belt and LATCH lower anchors for attaching child safety seats***

When used in combination, either the safety belt or the LATCH lower anchors may be attached first, provided a proper installation is achieved. Attach the tether strap afterward, if included with the child seat. Refer to *Recommendations for attaching child safety restraints for children* in this chapter.

### **Attaching child safety seats with tether straps**

Many forward-facing child safety seats include a tether strap which extends from the back of the child safety seat and hooks to an anchoring point called the top tether anchor. Tether straps are available as an accessory for many older safety seats. Contact the manufacturer of your child seat for information about ordering a tether strap, or to obtain a longer tether strap if the tether strap on your safety seat does not reach the appropriate top tether anchor in the vehicle.

## Seating and Safety Restraints

The passenger seats of your vehicle are equipped with built-in tether strap anchors located behind the seats as described below.

The tether anchors in your vehicle may be loops of webbing above the seatback or an anchor bracket behind the seat on the rear edge of the seat cushion.

The rear seat in the SuperCab and SuperCrew has three straps along the top of the seatback that function as both routing loops for the tether straps and anchor loops.

The tether strap anchors in your vehicle are in the following positions (shown from top view):

- **F150 Regular Cab**

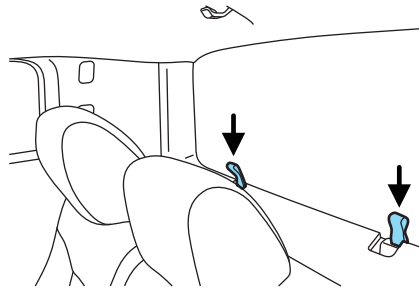

- **F150 SuperCrew and SuperCab**

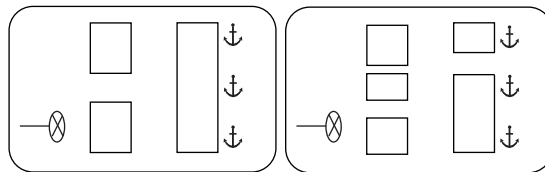

Attach the tether strap only to the appropriate tether anchor as shown. The tether strap may not work properly if attached somewhere other than the correct tether anchor.

If you install a child seat with rigid LATCH attachments, do not tighten the tether strap enough to lift the child seat off the vehicle seat cushion when the child is seated in it. Keep the tether strap just snug without lifting the front of the child seat. Keeping the child seat just touching the vehicle seat gives the best protection in a severe crash.

224



## Seating and Safety Restraints

Once the child safety seat has been installed using either the safety belt, the lower anchors of the LATCH system, or both, you can attach the top tether strap.

### Front seat tether strap attachment (Regular cab)

1. Route the child safety seat tether strap over the back of the seat and under the head restraint.

For vehicles with adjustable head restraints, route the tether strap under the head restraint and between the head restraint posts, otherwise route the tether strap over the top of the seatback.

2. Locate the correct anchor for the selected seating position.

- You may need to pull the seatback forward to access the tether anchors. Make sure the seatback is locked in the upright position before installing the child seat.
3. Clip the tether strap to the anchor as shown.
- Regular Cab passenger and center seats (located on back panel)

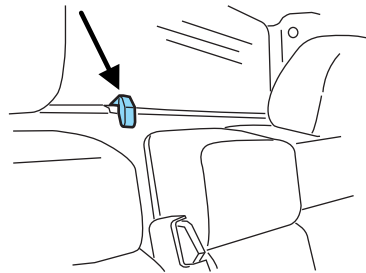

If the tether strap is clipped incorrectly, the child safety seat may not be retained properly in the event of a collision.

4. Tighten the child safety seat tether strap according to the manufacturer's instructions.

If the safety seat is not anchored properly, the risk of a child being injured in a collision greatly increases.

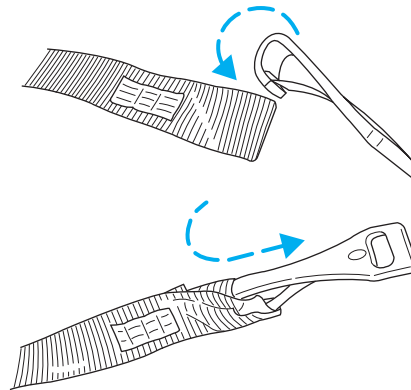

## Seating and Safety Restraints

### **Rear seat tether strap attachment (SuperCab and SuperCrew)**

There are three loops of webbing just above the back of the rear seat (along the bottom edge of the rear window). These loops are to be used as both routing loops and anchor loops for up to three child safety seat tether straps. For example, the center loop can be used as a routing loop for a child safety seat in the center rear seat and as an anchoring loop for child seats installed in the outboard rear seats.

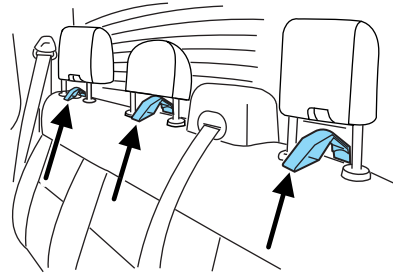

Many tether straps cannot be tightened if the tether strap is hooked to the loop directly behind the child seat. To provide a tight tether strap:

1. Route the tether strap under the head restraint and through the loop directly behind the child seat.



2. Route the tether strap behind the head restraint supports to a loop behind an adjacent seating position, and hook the strap hook onto the loop. If using the driver's side, pass the strap behind the shoulder belt mounting for the center seat.

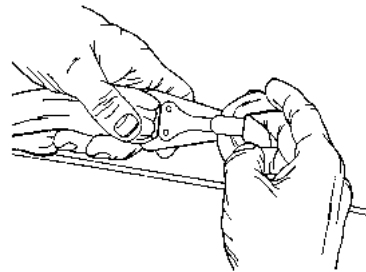

- Always put the tether strap through the routing loop. The head restraint support post will hold the child seat tightly, but the head restraint post is not strong enough to hold the child seat during a collision.

## Seating and Safety Restraints

3. Tighten the tether strap according to the child seat manufacturer's instructions.

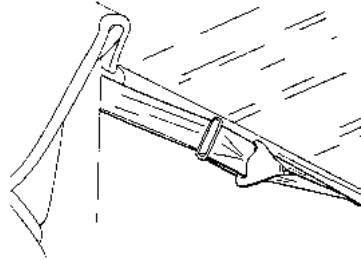

If the safety seat is not anchored properly, the risk of a child being injured in a collision greatly increases.

If your child restraint system is equipped with a tether strap, and the child restraint manufacturer recommends its use, Ford also recommends its use.

### Child booster seats

The belt-positioning booster (booster seat) is used to improve the fit of the vehicle safety belt. Children outgrow a typical child seat (e.g., convertible or toddler seat) when they weigh about 40 lb (18 kg) and are around four (4) years of age. Consult your child safety seat owner guide for the weight, height, and age limits specific to your child safety seat. Keep your child in the child safety seat if it properly fits the child, remains appropriate for their weight, height and age AND if properly secured to the vehicle.

Although the lap/shoulder belt will provide some protection, children who have outgrown a typical child seat are still too small for lap/shoulder belts to fit properly, and wearing an improperly fitted vehicle safety belt could increase the risk of serious injury in a crash. To improve the fit of both the lap and shoulder belt on children who have outgrown child safety seats, Ford Motor Company recommends use of a belt-positioning booster.

Booster seats position a child so that vehicle lap/shoulder safety belts fit better. They lift the child up so that the lap belt rests low across the hips and the knees bend comfortably at the edge of the cushion, while minimizing slouching. Booster seats may also make the shoulder belt fit better and more comfortably. Try to keep the belt near the middle of the shoulder and across the center of the chest. Moving the child closer (a few centimeters or inches) to the center of the vehicle, but remaining in the same seating position, may help provide a good shoulder belt fit.

227

## Seating and Safety Restraints

### **When children should use booster seats**

Children need to use booster seats from the time they outgrow the toddler seat until they are big enough for the vehicle seat and lap/shoulder belt to fit properly. Generally this is when they reach a height of at least 4 feet 9 inches (1.45 meters) tall (around age eight to age twelve and between 40 lb (18 kg) and 80 lb (36 kg) or upward to 100 lb (45 kg) if recommended by your child restraint manufacturer). Many state and provincial laws require that children use approved booster seats until they reach age eight, a height of 4 feet 9 inches (1.45 meters) tall, or 80 lb (36 kg).

Booster seats should be used until you can answer YES to ALL of these questions when seated without a booster seat:

- Can the child sit all the way back against the vehicle seat back with knees bent comfortably at the edge of the seat cushion?
- Can the child sit without slouching?

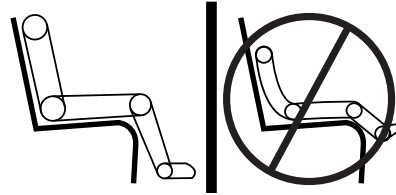

- Does the lap belt rest low across the hips?
- Is the shoulder belt centered on the shoulder and chest?
- Can the child stay seated like this for the whole trip?

### **Types of booster seats**

There are generally two types of belt-positioning booster seats: backless and high back. Always use booster seats in conjunction with the vehicle lap/shoulder belt.

- Backless booster seats

If your backless booster seat has a removable shield, remove the shield. If a vehicle seating position has a low seat back or no head restraint, a backless booster seat may place your child's head (as measured at the tops of the ears) above the top of the seat. In this case, move the backless booster to another seating position with a higher seat back or head restraint and lap/shoulder belts, or consider using a high back booster seat.

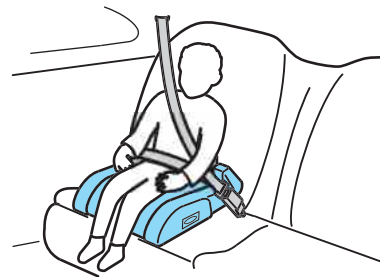

## Seating and Safety Restraints

- High back booster seats

If, with a backless booster seat, you cannot find a seating position that adequately supports your child's head, a high back booster seat would be a better choice.



Children and booster seats vary in size and shape. Choose a booster that keeps the lap belt low and snug across the hips, never up across the stomach, and lets you adjust the shoulder belt to cross the chest and rest snugly near the center of the shoulder. The drawings below compare the ideal fit (center) to a shoulder belt uncomfortably close to the neck and a shoulder belt that could slip off the shoulder. The drawings below also show how the lap belt should be low and snug across the child's hips.

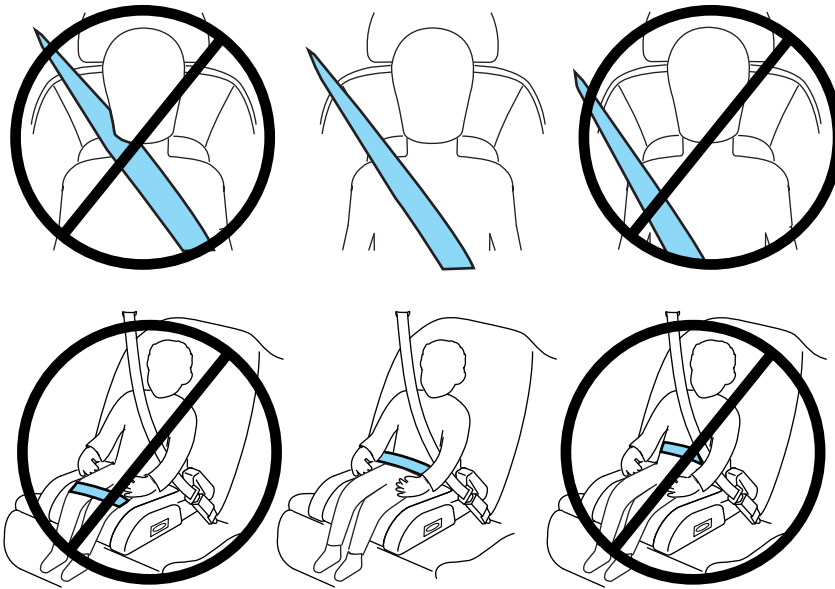

## Seating and Safety Restraints

If the booster seat slides on the vehicle seat, placing a rubberized mesh sold as shelf or carpet liner under the booster seat may improve this condition. Do not introduce any item thicker than this under the booster seat. Check with the booster seat manufacturer's instructions.

### ***The importance of shoulder belts***

Using a booster without a shoulder belt increases the risk of a child's head hitting a hard surface in a collision. For this reason, you should never use a booster seat with a lap belt only. It is generally best to use a booster seat with lap/shoulder belts in the back seat.

Move a child to a different seating location if the shoulder belt does not stay positioned on the shoulder during use.

Follow all instructions provided by the manufacturer of the booster seat.



**WARNING:** Never place, or allow a child to place, the shoulder belt under a child's arm or behind the back because it reduces the protection for the upper part of the body and may increase the risk of injury or death in a collision.

### **Child restraint and safety belt maintenance**

Inspect the vehicle safety belts and child safety seat systems periodically to make sure they work properly and are not damaged. Inspect the vehicle and child seat safety belts to make sure there are no nicks, tears or cuts. Replace if necessary. All vehicle safety belt assemblies, including retractors, buckles, front safety belt buckle assemblies, buckle support assemblies (slide bar-if equipped), shoulder belt height adjusters (if equipped), shoulder belt guide on seatback (if equipped), child safety seat LATCH and tether anchors, and attaching hardware, should be inspected after a collision. Refer to the child restraint manufacturer's instructions for additional inspection and maintenance information specific to the child restraint. Ford Motor Company recommends that all safety belt assemblies in use in vehicles involved in a collision be replaced. However, if the collision was minor and an authorized dealer finds that the belts do not show damage and continue to operate properly, they do not need to be replaced. Safety belt assemblies not in use during a collision should also be inspected and replaced if either damage or improper operation is noted.

## Seating and Safety Restraints

For proper care of soiled safety belts, refer to *Interior* in the *Cleaning* chapter.



**WARNING:** Failure to inspect and if necessary replace the safety belt assembly or child restraint system under the above conditions could result in severe personal injuries in the event of a collision.

## Tires, Wheels and Loading

### NOTICE TO UTILITY VEHICLE AND TRUCK OWNERS

Utility vehicles and trucks handle differently than passenger cars in the various driving conditions that are encountered on streets, highways and off-road. Utility vehicles and trucks are not designed for cornering at speeds as high as passenger cars any more than low-slung sports cars are designed to perform satisfactorily under off-road conditions.

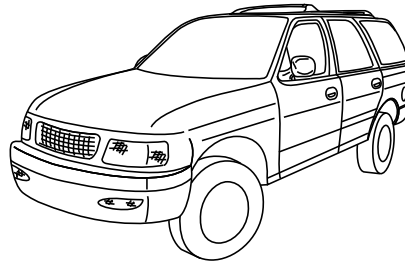

**WARNING:** Utility vehicles have a significantly higher rollover rate than other types of vehicles. To reduce the risk of serious injury or death from a rollover or other crash you must:

- Avoid sharp turns and abrupt maneuvers;
- Drive at safe speeds for the conditions;
- Keep tires properly inflated;
- Never overload or improperly load your vehicle; and
- Make sure every passenger is properly restrained.



**WARNING:** In a rollover crash, an unbelted person is significantly more likely to die than a person wearing a seat belt. All occupants must wear seat belts and children/infants must use appropriate restraints to minimize the risk of injury or ejection.

Study your owner's guide and any supplements for specific information about equipment features, instructions for safe driving and additional precautions to reduce the risk of an accident or serious injury.

### VEHICLE CHARACTERISTICS

#### Four-wheel drive (4WD) system (if equipped)

A vehicle equipped with 4WD (when selected) has the ability to use all four wheels to power itself. This increases traction which may enable you to safely drive over terrain and road conditions that a conventional two-wheel drive vehicle cannot.

232



## Tires, Wheels and Loading

Power is supplied to all four wheels through a transfer case or power transfer unit. 4WD vehicles allow you to select different drive modes as necessary. Information on transfer case operation and shifting procedures can be found in the *Driving* chapter. Information on transfer case maintenance can be found in the *Maintenance and Specifications* chapter. You should become thoroughly familiar with this information before you operate your vehicle.

On some 4WD models, the initial shift from two-wheel drive to 4WD while the vehicle is moving can cause a momentary clunk and ratcheting sound. These sounds are normal as the front drivetrain comes up to speed and is not cause for concern.



**WARNING:** Do not become overconfident in the ability of 4WD vehicles. Although a 4WD vehicle may accelerate better than two-wheel drive vehicle in low traction situations, it won't stop any faster than two-wheel drive vehicles. Always drive at a safe speed.

### How your vehicle differs from other vehicles

SUVs and trucks can differ from some other vehicles in a few noticeable ways. Your vehicle may be:

- Higher – to allow higher load carrying capacity and to allow it to travel over rough terrain without getting hung up or damaging underbody components.
- Shorter – to give it the capability to approach inclines and drive over the crest of a hill without getting hung up or damaging underbody components. All other things held equal, a shorter wheelbase may make your vehicle quicker to respond to steering inputs than a vehicle with a longer wheelbase.

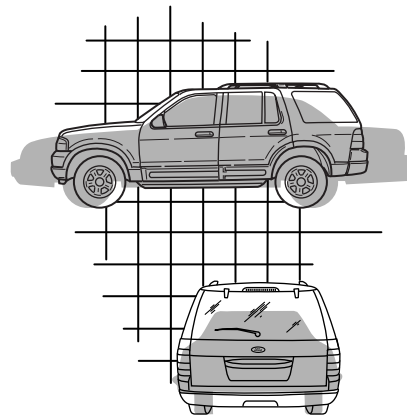

## Tires, Wheels and Loading

- Narrower – to provide greater maneuverability in tight spaces, particularly in off-road use.

As a result of the above dimensional differences, SUVs and trucks often will have a higher center of gravity and a greater difference in center of gravity between the loaded and unloaded condition.

These differences that make your vehicle so versatile also make it handle differently than an ordinary passenger car.

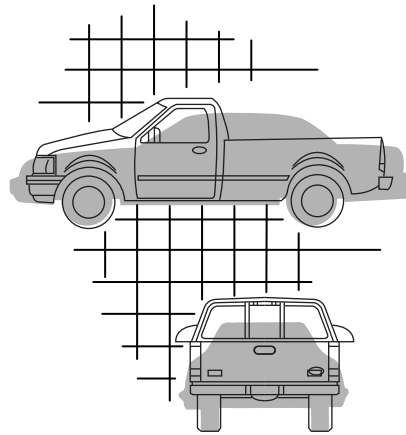

### INFORMATION ABOUT UNIFORM TIRE QUALITY GRADING

Tire Quality Grades apply to new pneumatic passenger car tires. The Quality grades can be found where applicable on the tire sidewall between tread shoulder and maximum section width. For example:

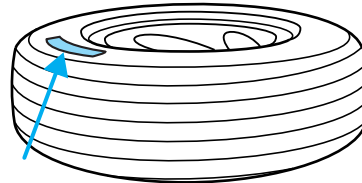

- **Treadwear 200 Traction AA Temperature A**

These Tire Quality Grades are determined by standards that the United States Department of Transportation has set.

Tire Quality Grades apply to new pneumatic passenger car tires. They do not apply to deep tread, winter-type snow tires, space-saver or temporary use spare tires, light truck or “LT” type tires, tires with nominal rim diameters of 10 to 12 inches or limited production tires as defined in Title 49 Code of Federal Regulations Part 575.104(c)(2).

**U.S. Department of Transportation-Tire quality grades:** The U.S. Department of Transportation requires Ford Motor Company to give you the following information about tire grades exactly as the government has written it.

## Tires, Wheels and Loading

### Treadwear

The treadwear grade is a comparative rating based on the wear rate of the tire when tested under controlled conditions on a specified government test course. For example, a tire graded 150 would wear one and one-half (1½) times as well on the government course as a tire graded 100. The relative performance of tires depends upon the actual conditions of their use, however, and may depart significantly from the norm due to variations in driving habits, service practices, and differences in road characteristics and climate.

### Traction AA A B C

The traction grades, from highest to lowest are AA, A, B, and C. The grades represent the tire's ability to stop on wet pavement as measured under controlled conditions on specified government test surfaces of asphalt and concrete. A tire marked C may have poor traction performance.



**WARNING:** The traction grade assigned to this tire is based on straight-ahead braking traction tests, and does not include acceleration, cornering, hydroplaning or peak traction characteristics.

### Temperature A B C

The temperature grades are A (the highest), B and C, representing the tire's resistance to the generation of heat and its ability to dissipate heat when tested under controlled conditions on a specified indoor laboratory test wheel. Sustained high temperature can cause the material of the tire to degenerate and reduce tire life, and excessive temperature can lead to sudden tire failure. The grade C corresponds to a level of performance which all passenger car tires must meet under the Federal Motor Vehicle Safety Standard No. 139. Grades B and A represent higher levels of performance on the laboratory test wheel than the minimum required by law.



**WARNING:** The temperature grade for this tire is established for a tire that is properly inflated and not overloaded. Excessive speed, underinflation, or excessive loading, either separately or in combination, can cause heat buildup and possible tire failure.

## Tires, Wheels and Loading

### TIRES

Tires are designed to give many thousands of miles of service, but they must be maintained in order to get the maximum benefit from them.

#### Glossary of tire terminology

- **Tire label:** A label showing the OE (Original Equipment) tire sizes, recommended inflation pressure and the maximum weight the vehicle can carry.
- **Tire Identification Number (TIN):** A number on the sidewall of each tire providing information about the tire brand and manufacturing plant, tire size and date of manufacture. Also referred to as DOT code.
- **Inflation pressure:** A measure of the amount of air in a tire.
- **Standard load:** A class of P-metric or Metric tires designed to carry a maximum load at 35 psi [37 psi (2.5 bar) for Metric tires]. Increasing the inflation pressure beyond this pressure will not increase the tire's load carrying capability.
- **Extra load:** A class of P-metric or Metric tires designed to carry a heavier maximum load at 41 psi [43 psi (2.9 bar) for Metric tires]. Increasing the inflation pressure beyond this pressure will not increase the tire's load carrying capability.
- **kPa:** Kilopascal, a metric unit of air pressure.
- **PSI:** Pounds per square inch, a standard unit of air pressure.
- **Cold inflation pressure:** The tire pressure when the vehicle has been stationary and out of direct sunlight for an hour or more and prior to the vehicle being driven for 1 mile (1.6 km).
- **Recommended inflation pressure:** The cold inflation pressure found on the Safety Compliance Certification Label or Tire Label located on the B-Pillar or the edge of the driver's door.
- **B-pillar:** The structural member at the side of the vehicle behind the front door.
- **Bead area of the tire:** Area of the tire next to the rim.
- **Sidewall of the tire:** Area between the bead area and the tread.
- **Tread area of the tire:** Area of the perimeter of the tire that contacts the road when mounted on the vehicle.
- **Rim:** The metal support (wheel) for a tire or a tire and tube assembly upon which the tire beads are seated.

236

## Tires, Wheels and Loading

### INFLATING YOUR TIRES

Safe operation of your vehicle requires that your tires are properly inflated. Remember that a tire can lose up to half of its air pressure without appearing flat.

Every day before you drive, check your tires. If one looks lower than the others, use a tire gauge to check pressure of all tires and adjust if required.

At least once a month and before long trips, inspect each tire and check the tire pressure with a tire gauge (including spare, if equipped). Inflate all tires to the inflation pressure recommended by Ford Motor Company.

You are strongly urged to buy a reliable tire pressure gauge, as automatic service station gauges may be inaccurate. Ford recommends the use of a digital or dial-type tire pressure gauge rather than a stick-type tire pressure gauge.

Use the recommended cold inflation pressure for optimum tire performance and wear. Under-inflation or over-inflation may cause uneven treadwear patterns.



**WARNING:** Under-inflation is the most common cause of tire failures and may result in severe tire cracking, tread separation or “blowout”, with unexpected loss of vehicle control and increased risk of injury. Under-inflation increases sidewall flexing and rolling resistance, resulting in heat buildup and internal damage to the tire. It also may result in unnecessary tire stress, irregular wear, loss of vehicle control and accidents. A tire can lose up to half of its air pressure and not appear to be flat!

Always inflate your tires to the Ford recommended inflation pressure even if it is less than the maximum inflation pressure information found on the tire. The Ford recommended tire inflation pressure is found on the Safety Compliance Certification Label or Tire Label which is located on the B-Pillar or the edge of the driver's door. Failure to follow the tire pressure recommendations can cause uneven treadwear patterns and adversely affect the way your vehicle handles.

**Maximum Permissible Inflation Pressure** is the tire manufacturer's maximum permissible pressure and/or the pressure at which the maximum load can be carried by the tire. This pressure is normally higher than the manufacturer's recommended cold inflation pressure which can be found on the Safety Compliance Certification Label or Tire Label which is located on the B-Pillar or the edge of the driver's door.

237

## Tires, Wheels and Loading

The cold inflation pressure should never be set lower than the recommended pressure on the Safety Compliance Certification Label or Tire Label.

When weather temperature changes occur, tire inflation pressures also change. A 10°F (6°C) temperature drop can cause a corresponding drop of 1 psi (7 kPa) in inflation pressure. Check your tire pressures frequently and adjust them to the proper pressure which can be found on the Safety Compliance Certification Label or Tire Label.

To check the pressure in your tire(s):

1. Make sure the tires are cool, meaning they are not hot from driving even a mile.

If you are checking tire pressure when the tire is hot, (i.e. driven more than 1 mile [1.6 km]), never “bleed” or reduce air pressure. The tires are hot from driving and it is normal for pressures to increase above recommended cold pressures. A hot tire at or below recommended cold inflation pressure could be significantly under-inflated.

**Note:** If you have to drive a distance to get air for your tire(s), check and record the tire pressure first and add the appropriate air pressure when you get to the pump. It is normal for tires to heat up and the air pressure inside to go up as you drive.

2. Remove the cap from the valve on one tire, then firmly press the tire gauge onto the valve and measure the pressure.

3. Add enough air to reach the recommended air pressure.

**Note:** If you overfill the tire, release air by pressing on the metal stem in the center of the valve. Then recheck the pressure with your tire gauge.

4. Replace the valve cap.

5. Repeat this procedure for each tire, including the spare.

**Note:** Some spare tires operate at a higher inflation pressure than the other tires. For T-type/mini-spare tires (see the *Dissimilar spare tire/wheel information* section for description): Store and maintain at 60 psi (4.15 bar). For full-size and dissimilar spare tires (see the *Dissimilar spare tire/wheel information* section for description): Store and maintain at the higher of the front and rear inflation pressure as shown on the Tire Label.

6. Visually inspect the tires to make sure there are no nails or other objects embedded that could poke a hole in the tire and cause an air leak.

7. Check the sidewalls to make sure there are no gouges, cuts or bulges.

238

## Tires, Wheels and Loading

### TIRE CARE

#### Inspecting your tires and wheel valve stems

Periodically inspect the tire treads for uneven or excessive wear and remove objects such as stones, nails or glass that may be wedged in the tread grooves. Check the tire and valve stems for holes, cracks, or cuts that may permit air leakage and repair or replace the tire and replace the valve stem. Inspect the tire sidewalls for cracking, cuts, bruises and other signs of damage or excessive wear. If internal damage to the tire is suspected, have the tire demounted and inspected in case it needs to be repaired or replaced. For your safety, tires that are damaged or show signs of excessive wear should not be used because they are more likely to blow out or fail.

Improper or inadequate vehicle maintenance can cause tires to wear abnormally. Inspect all your tires, including the spare, frequently, and replace them if one or more of the following conditions exist:

#### Tire wear

When the tread is worn down to 1/16th of an inch (2 mm), tires must be replaced to help prevent your vehicle from skidding and hydroplaning. Built-in treadwear indicators, or “wear bars”, which look like narrow strips of smooth rubber across the tread will appear on the tire when the tread is worn down to 1/16th of an inch (2 mm). When the tire tread wears down to the same height as these “wear bars”, the tire is worn out and must be replaced.

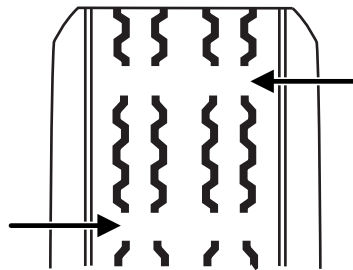

#### Damage

Periodically inspect the tire treads and sidewalls for damage (such as bulges in the tread or sidewalls, cracks in the tread groove and separation in the tread or sidewall). If damage is observed or suspected have the tire inspected by a tire professional. Tires can be damaged during off-road use, so inspection after off-road use is also recommended.

## Tires, Wheels and Loading



### **WARNING: Age**

Tires degrade over time depending on many factors such as weather, storage conditions, and conditions of use (load, speed, inflation pressure, etc.) the tires experience throughout their lives. In general, tires should be replaced after six years regardless of tread wear. However, heat caused by hot climates or frequent high loading conditions can accelerate the aging process and may require tires to be replaced more frequently. You should replace your spare tire when you replace the road tires or after six years due to aging even if it has not been used.

### **U.S. DOT Tire Identification Number (TIN)**

Both U.S. and Canada Federal regulations require tire manufacturers to place standardized information on the sidewall of all tires. This information identifies and describes the fundamental characteristics of the tire and also provides a U.S. DOT Tire Identification Number for safety standard certification and in case of a recall.

This begins with the letters “DOT” and indicates that the tire meets all federal standards. The next two numbers or letters are the plant code designating where it was manufactured, the next two are the tire size code and the last four numbers represent the week and year the tire was built. For example, the numbers 317 mean the 31st week of 1997. After 2000 the numbers go to four digits. For example, 2501 means the 25th week of 2001. The numbers in between are identification codes used for traceability. This information is used to contact customers if a tire defect requires a recall.

### **Tire replacement requirements**

Your vehicle is equipped with tires designed to provide a safe ride and handling capability.



## Tires, Wheels and Loading



**WARNING:** Only use replacement tires and wheels that are the same size, load index, speed rating and type (such as P-metric versus LT-metric or all-season versus all-terrain) as those originally provided by Ford. The recommended tire and wheel size may be found on either the Safety Compliance Certification Label or the Tire Label which is located on the B-Pillar or edge of the driver's door. If this information is not found on these labels then you should contact your authorized dealer as soon as possible. Use of any tire or wheel not recommended by Ford can affect the safety and performance of your vehicle, which could result in an increased risk of loss of vehicle control, vehicle rollover, personal injury and death. Additionally the use of non-recommended tires and wheels could cause steering, suspension, axle or transfer case/power transfer unit failure. If you have questions regarding tire replacement, contact your authorized dealer as soon as possible.



**WARNING:** When mounting replacement tires and wheels, you should not exceed the maximum pressure indicated on the sidewall of the tire to set the beads without additional precautions listed below. If the beads do not seat at the maximum pressure indicated, re-lubricate and try again.

When inflating the tire for mounting pressures up to 20 psi (1.38 bar) greater than the maximum pressure on the tire sidewall, the following precautions must be taken to protect the person mounting the tire:

1. Make sure that you have the correct tire and wheel size.
2. Lubricate the tire bead and wheel bead seat area again.
3. Stand at a minimum of 12 ft (3.66 m) away from the tire wheel assembly.
4. Use both eye and ear protection.

For a mounting pressure more than 20 psi (1.38 bar) greater than the maximum pressure, a Ford dealer or other tire service professional should do the mounting.

Always inflate steel carcass tires with a remote air fill with the person inflating standing at a minimum of 12 ft (3.66 m) away from the tire wheel assembly.

**Important:** Remember to replace the wheel valve stems when the road tires are replaced on your vehicle.

## Tires, Wheels and Loading

It is recommended that the two front tires or two rear tires generally be replaced as a pair.

The tire pressure sensors mounted in the wheels (originally installed on your vehicle) are not designed to be used in aftermarket wheels.

The use of wheels or tires not recommended by Ford Motor Company may affect the operation of your tire pressure monitoring system.

If the TPMS indicator is flashing, your TPMS is malfunctioning. Your replacement tire might be incompatible with your TPMS, or some component of the TPMS may be damaged.

### Safety practices

Driving habits have a great deal to do with your tire mileage and safety.

- Observe posted speed limits
- Avoid fast starts, stops and turns
- Avoid potholes and objects on the road
- Do not run over curbs or hit the tire against a curb when parking



**WARNING:** If your vehicle is stuck in snow, mud, sand, etc., **do not** rapidly spin the tires; spinning the tires can tear the tire and cause an explosion. A tire can explode in as little as three to five seconds.



**WARNING:** Do not spin the wheels at over 35 mph (56 km/h). The tires may fail and injure a passenger or bystander.

### Highway hazards

No matter how carefully you drive there's always the possibility that you may eventually have a flat tire on the highway. Drive slowly to the closest safe area out of traffic. This may further damage the flat tire, but your safety is more important.

If you feel a sudden vibration or ride disturbance while driving, or you suspect your tire or vehicle has been damaged, immediately reduce your speed. Drive with caution until you can safely pull off the road. Stop and inspect the tires for damage. If a tire is under-inflated or damaged, deflate it, remove wheel and replace it with your spare tire and wheel. If you cannot detect a cause, have the vehicle towed to the nearest repair facility or tire dealer to have the vehicle inspected.

242

## Tires, Wheels and Loading

### Tire and wheel alignment

A bad jolt from hitting a curb or pothole can cause the front end of your vehicle to become misaligned or cause damage to your tires. If your vehicle seems to pull to one side when you're driving, the wheels may be out of alignment. Have an authorized dealer check the wheel alignment periodically.

Wheel misalignment in the front or the rear can cause uneven and rapid treadwear of your tires and should be corrected by an authorized dealer. Front-wheel drive (FWD) vehicles and those with an independent rear suspension (if equipped) may require alignment of all four wheels.

The tires should also be balanced periodically. An unbalanced tire and wheel assembly may result in irregular tire wear.

### Tire rotation

Rotating your tires at the recommended interval (as indicated in the *Scheduled Maintenance* chapter) will help your tires wear more evenly, providing better tire performance and longer tire life.

- Rear-wheel drive (RWD) vehicles/Four-wheel drive (4WD) vehicles (front tires at top of diagram)

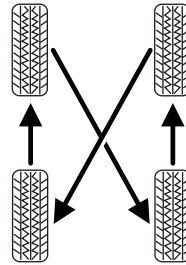

Sometimes irregular tire wear can be corrected by rotating the tires.

**Note:** If your tires show uneven wear ask an authorized dealer to check for and correct any wheel misalignment, tire imbalance or mechanical problem involved before tire rotation.

**Note:** Your vehicle may be equipped with a dissimilar spare tire/wheel. A dissimilar spare tire/wheel is defined as a spare tire and/or wheel that is different in brand, size or appearance from the road tires and wheels. If you have a dissimilar spare tire/wheel it is intended for temporary use only and should not be used in a tire rotation.

**Note:** After having your tires rotated, check tire pressure and adjust to the recommended inflation pressure.

## Tires, Wheels and Loading

 **WARNING:** If the tire label shows different tire pressures for the front and rear tires and the vehicle is equipped with TPMS (tire pressure monitoring system), then the settings for the TPMS sensors need to be updated. Always perform the TPMS reset procedure after tire rotation. If the system is not reset, it may not provide a low tire pressure warning when necessary. See the TPMS reset procedure in this chapter.

### INFORMATION CONTAINED ON THE TIRE SIDEWALL

Both U.S. and Canada Federal regulations require tire manufacturers to place standardized information on the sidewall of all tires. This information identifies and describes the fundamental characteristics of the tire and also provides a U.S. DOT Tire Identification Number for safety standard certification and in case of a recall.

#### Information on “P” type tires

P215/65R15 95H is an example of a tire size, load index and speed rating. The definitions of these items are listed below. (Note that the tire size, load index and speed rating for your vehicle may be different from this example.)

1. **P:** Indicates a tire, designated by the Tire and Rim Association (T&RA), that may be used for service on cars, SUVs, minivans and light trucks.

**Note:** If your tire size does not begin with a letter this may mean it is designated by either ETRTO (European Tire and Rim Technical Organization) or JATMA (Japan Tire Manufacturing Association).

2. **215:** Indicates the nominal width of the tire in millimeters from sidewall edge to sidewall edge. In general, the larger the number, the wider the tire.

3. **65:** Indicates the aspect ratio which gives the tire’s ratio of height to width.

4. **R:** Indicates a “radial” type tire.

244

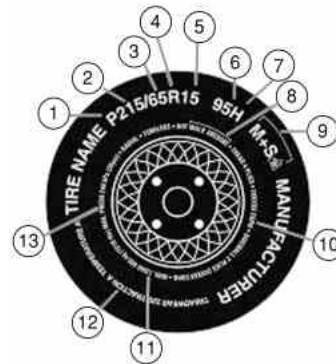

## Tires, Wheels and Loading

5. **15:** Indicates the wheel or rim diameter in inches. If you change your wheel size, you will have to purchase new tires to match the new wheel diameter.

6. **95:** Indicates the tire's load index. It is an index that relates to how much weight a tire can carry. You may find this information in your owner's guide. If not, contact a local tire dealer.

**Note:** You may not find this information on all tires because it is not required by federal law.

7. **H:** Indicates the tire's speed rating. The speed rating denotes the speed at which a tire is designed to be driven for extended periods of time under a standard condition of load and inflation pressure. The tires on your vehicle may operate at different conditions for load and inflation pressure. These speed ratings may need to be adjusted for the difference in conditions. The ratings range from 81 mph (130 km/h) to 186 mph (299 km/h). These ratings are listed in the following chart.

**Note:** You may not find this information on all tires because it is not required by federal law.

Letter rating	Speed rating - mph (km/h)
M	81 mph (130 km/h)
N	87 mph (140 km/h)
Q	99 mph (159 km/h)
R	106 mph (171 km/h)
S	112 mph (180 km/h)
T	118 mph (190 km/h)
U	124 mph (200 km/h)
H	130 mph (210 km/h)
V	149 mph (240 km/h)
W	168 mph (270 km/h)
Y	186 mph (299 km/h)

**Note:** For tires with a maximum speed capability over 149 mph (240 km/h), tire manufacturers sometimes use the letters ZR. For those with a maximum speed capability over 186 mph (299 km/h), tire manufacturers always use the letters ZR.

8. **U.S. DOT Tire Identification Number (TIN):** This begins with the letters "DOT" and indicates that the tire meets all federal standards. The next two numbers or letters are the plant code designating where it was manufactured, the next two are the tire size code and the last four

## Tires, Wheels and Loading

numbers represent the week and year the tire was built. For example, the numbers 317 mean the 31st week of 1997. After 2000 the numbers go to four digits. For example, 2501 means the 25th week of 2001. The numbers in between are identification codes used for traceability. This information is used to contact customers if a tire defect requires a recall.

9. **M+S or M/S:** Mud and Snow, or

**AT:** All Terrain, or

**AS:** All Season.

10. **Tire Ply Composition and Material Used:** Indicates the number of plies or the number of layers of rubber-coated fabric in the tire tread and sidewall. Tire manufacturers also must indicate the ply materials in the tire and the sidewall, which include steel, nylon, polyester, and others.

11. **Maximum Load:** Indicates the maximum load in kilograms and pounds that can be carried by the tire. Refer to the Safety Compliance Certification Label, which is located on the B-Pillar or the edge of the driver's door, for the correct tire pressure for your vehicle.

### 12. Treadwear, Traction and Temperature Grades

- **Treadwear:** The treadwear grade is a comparative rating based on the wear rate of the tire when tested under controlled conditions on a specified government test course. For example, a tire graded 150 would wear one and one-half (1½) times as well on the government course as a tire graded 100.
- **Traction:** The traction grades, from highest to lowest are AA, A, B, and C. The grades represent the tire's ability to stop on wet pavement as measured under controlled conditions on specified government test surfaces of asphalt and concrete. A tire marked C may have poor traction performance.
- **Temperature:** The temperature grades are A (the highest), B and C, representing the tire's resistance to the generation of heat and its ability to dissipate heat when tested under controlled conditions on a specified indoor laboratory test wheel.

13. **Maximum Permissible Inflation Pressure:** Indicates the tire manufacturers' maximum permissible pressure and/or the pressure at which the maximum load can be carried by the tire. This pressure is normally higher than the manufacturer's recommended cold inflation pressure which can be found on the Safety Compliance Certification Label or Tire Label which is located on the B-Pillar or the edge of the driver's door. The cold inflation pressure should never be set lower than the recommended pressure on the vehicle label.

The tire suppliers may have additional markings, notes or warnings such as standard load, radial tubeless, etc.

246

## Tires, Wheels and Loading

### Additional information contained on the tire sidewall for “LT” type tires

“LT” type tires have some additional information beyond those of “P” type tires; these differences are described below.

**Note:** Tire Quality Grades do not apply to this type of tire.

1. **LT:** Indicates a tire, designated by the Tire and Rim Association (T&RA), that is intended for service on light trucks.

#### 2. Load Range/Load Inflation

**Limits:** Indicates the tire’s load-carrying capabilities and its inflation limits.

3. **Maximum Load Dual lb (kg) at psi (kPa) cold:** Indicates the maximum load and tire pressure when the tire is used as a dual; defined as four tires on the rear axle (a total of six or more tires on the vehicle).

4. **Maximum Load Single lb (kg) at psi (kPa) cold:** Indicates the maximum load and tire pressure when the tire is used as a single; defined as two tires (total) on the rear axle.



## Tires, Wheels and Loading

### Information on “T” type tires

“T” type tires have some additional information beyond those of “P” type tires; these differences are described below:

T145/80D16 is an example of a tire size.

**Note:** The temporary tire size for your vehicle may be different from this example. Tire Quality Grades do not apply to this type of tire.

1. **T:** Indicates a type of tire, designated by the Tire and Rim Association (T&RA), that is intended for temporary service on cars, SUVs, minivans and light trucks.

2. **145:** Indicates the nominal width of the tire in millimeters from sidewall edge to sidewall edge. In general, the larger the number, the wider the tire.

3. **80:** Indicates the aspect ratio which gives the tire’s ratio of height to width. Numbers of 70 or lower indicate a short sidewall.

4. **D:** Indicates a “diagonal” type tire.

**R:** Indicates a “radial” type tire.

5. **16:** Indicates the wheel or rim diameter in inches. If you change your wheel size, you will have to purchase new tires to match the new wheel diameter.

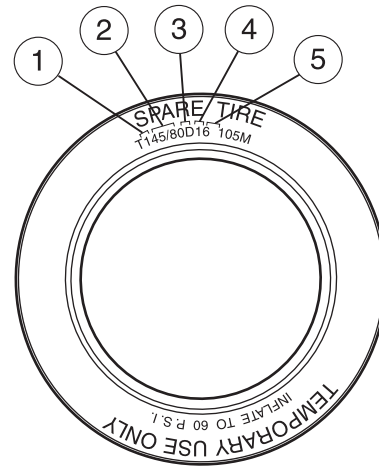

### Location of the tire label

You will find a Tire Label containing tire inflation pressure by tire size and other important information located on the B-Pillar or the edge of the driver’s door. Refer to the payload description and graphic in the *Vehicle loading – with and without a trailer* section.



## Tires, Wheels and Loading

### TIRE PRESSURE MONITORING SYSTEM (TPMS)

Each tire, including the spare (if provided), should be checked monthly when cold and inflated to the inflation pressure recommended by the vehicle manufacturer on the vehicle placard or tire inflation pressure label. (If your vehicle has tires of a different size than the size indicated on the vehicle placard or tire inflation pressure label, you should determine the proper tire inflation pressure for those tires.)

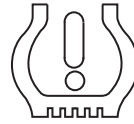

As an added safety feature, your vehicle has been equipped with a tire pressure monitoring system (TPMS) that illuminates a low tire pressure telltale when one or more of your tires is significantly under-inflated. Accordingly, when the low tire pressure telltale illuminates, you should stop and check your tires as soon as possible, and inflate them to the proper pressure. Driving on a significantly under-inflated tire causes the tire to overheat and can lead to tire failure. Under-inflation also reduces fuel efficiency and tire tread life, and may affect the vehicle's handling and stopping ability.

Please note that the TPMS is not a substitute for proper tire maintenance, and it is the driver's responsibility to maintain correct tire pressure, even if under-inflation has not reached the level to trigger illumination of the TPMS low tire pressure telltale.

Your vehicle has also been equipped with a TPMS malfunction indicator to indicate when the system is not operating properly. The TPMS malfunction indicator is combined with the low tire pressure telltale. When the system detects a malfunction, the telltale will flash for approximately one minute and then remain continuously illuminated. This sequence will continue upon subsequent vehicle start-ups as long as the malfunction exists.

When the malfunction indicator is illuminated, the system may not be able to detect or signal low tire pressure as intended. TPMS malfunctions may occur for a variety of reasons, including the installation of replacement or alternate tires or wheels on the vehicle that prevent the TPMS from functioning properly. Always check the TPMS malfunction telltale after replacing one or more tires or wheels on your vehicle to ensure that the replacement or alternate tires and wheels allow the TPMS to continue to function properly.

## Tires, Wheels and Loading

The tire pressure monitoring system complies with part 15 of the FCC rules and with RSS-210 of Industry Canada. Operation is subject to the following two conditions: (1) This device may not cause harmful interference, and (2) This device must accept any interference received, including interference that may cause undesired operation.

**WARNING:** The tire pressure monitoring system is NOT a substitute for manually checking tire pressure. The tire pressure should be checked periodically (at least monthly) using a tire gauge, see *Inflating your tires* in this chapter. Failure to properly maintain your tire pressure could increase the risk of tire failure, loss of control, vehicle rollover and personal injury.

### Changing tires with a TPMS

**Each road tire is equipped with a tire pressure sensor located inside the tire/wheel cavity. The pressure sensor is attached to the valve stem. The pressure sensor is covered by the tire and is not visible unless the tire is removed. Care must be taken when changing the tire to avoid damaging the sensor. It is**

recommended that you always have your tires serviced by an authorized dealer.

The tire pressure should be checked periodically (at least monthly) using an accurate tire gauge, refer to *Inflating your tires* in this chapter.

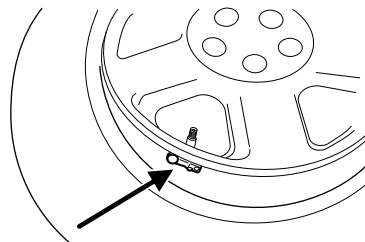

### Understanding your tire pressure monitoring system (TPMS)

The tire pressure monitoring system measures pressure in your four road tires and sends the tire pressure readings to your vehicle. The low tire pressure warning light will turn on if the tire pressure is significantly low. Once the light is illuminated, your tires are under-inflated and need to be inflated to the manufacturer's recommended tire pressure. Even if the light turns on and a short time later turns off, your tire pressure still needs to be checked. Visit [www.checkmytires.org](http://www.checkmytires.org) for additional information.

### ***When your temporary spare tire is installed***

When one of your road tires needs to be replaced with the temporary spare, the TPMS will continue to identify an issue to remind you that the damaged road wheel/tire needs to be repaired and put back on your vehicle.

250

## Tires, Wheels and Loading

To restore the full functionality of the tire pressure monitoring system, have the damaged road wheel/tire repaired and remounted on your vehicle. For additional information, refer to *Changing tires with a TPMS* in this section.

### **When you believe your system is not operating properly**

The main function of the tire pressure monitoring system is to warn you when your tires need air. It can also warn you in the event the system is no longer capable of functioning as intended. Please refer to the following chart for information concerning your tire pressure monitoring system:

Low tire pressure warning light	Possible cause	Customer action required
Solid warning light	Tire(s) under-inflated	1. Make sure tires are at the proper pressure. See <i>Inflating your tires</i> in this chapter. 2. After inflating your tires to the manufacturer's recommended pressure as shown on the Tire Label (located on the edge of driver's door or the B-Pillar), the vehicle must be driven for at least two minutes over 20 mph (32 km/h) before the light turns off.
	Spare tire in use	Repair the damaged road wheel/tire and reinstall it on the vehicle to restore system functionality. For a description on how the system functions, refer to <i>When your temporary spare tire is installed</i> in this section.
	TPMS malfunction	If the tires are properly inflated and the spare tire is not in use but the light remains on, contact your authorized dealer as soon as possible.
	Tire rotation without sensor training	On vehicles with different front and rear tire pressures, the TPMS must be retrained following every tire rotation. See <i>Tire rotation</i> in this chapter.

## Tires, Wheels and Loading

Low tire pressure warning light	Possible cause	Customer action required
Flashing warning light	Spare tire in use	Repair the damaged road wheel/tire and reinstall it on the vehicle to restore system functionality. For a description on how the system functions, refer to <i>When your temporary spare tire is installed</i> in this section.
	TPMS malfunction	If the tires are properly inflated and the spare tire is not in use but the light remains on, contact your authorized dealer as soon as possible.

### ***When inflating your tires***

When putting air into your tires (such as at a gas station or in your garage), the tire pressure monitoring system may not respond immediately to the air added to your tires.

It may take up to two minutes of driving over 20 mph (32 km/h) for the light to turn off after you have filled your tires to the recommended inflation pressure.

### ***How temperature affects your tire pressure***

The tire pressure monitoring system (TPMS) monitors tire pressure in each pneumatic tire. While driving in a normal manner, a typical passenger tire inflation pressure may increase approximately 2 to 4 psi (14 to 28 kPa) from a cold start situation. If the vehicle is stationary overnight with the outside temperature significantly lower than the daytime temperature, the tire pressure may decrease approximately 3 psi (21 kPa) for a drop of 30°F (17°C) in ambient temperature. This lower pressure value may be detected by the TPMS as being significantly lower than the recommended inflation pressure and activate the TPMS warning light for low tire pressure. If the low tire pressure warning light is on, visually check each tire to verify that no tire is flat. (If one or more tires are flat, repair as necessary.) Check air pressure in the road tires. If any tire is under-inflated, carefully drive the vehicle to the nearest location where air can be added to the tires. Inflate all the tires to the recommended inflation pressure.

252

## Tires, Wheels and Loading

### TPMS reset procedure

**The TPMS reset procedure needs to be performed after each tire rotation on vehicles that require different recommended tire pressures in the front tires as compared to the rear tires.**



**WARNING:** To determine the required pressure(s) for your vehicle, refer to the Safety Compliance Certification Label or Tire Label located on the B-Pillar or the edge of the driver's door. See *Vehicle loading - with and without a trailer* in this chapter for more information.

### Overview

To provide the vehicle's load carrying capability, some vehicles require different recommended tire pressures in the front tires as compared to the rear tires. The tire pressure monitoring system (TPMS) equipped on these vehicles is designed to illuminate the low tire pressure warning light at two different pressures; one for the front tires and one for the rear tires.

Since tires need to be rotated to provide consistent performance and maximum tire life, the tire pressure monitoring system needs to know when the tires are rotated to determine which set of tires are on the front and which are on the rear. With this information, the system can detect and properly warn of low tire pressures.

### TPMS reset tips:

- To reduce the chances of interference from another vehicle, the TPMS reset procedure should be performed at least three feet (one meter) away from another Ford Motor Company vehicle undergoing the TPMS reset procedure at the same time.
- Do not wait more than two minutes between resetting each tire sensor or the system will time-out and the entire procedure will have to be repeated on all four wheels.
- A double horn chirp indicates the need to repeat the procedure.

### Performing the TPMS reset procedure

It is recommended that you read the entire procedure before attempting.

1. Drive the vehicle above 20 mph (32 km/h) for at least two minutes and then park in a safe location where you can easily get to all four tires and have access to an air pump.
2. Place the ignition in the off position and keep the key in the ignition.

253

## Tires, Wheels and Loading

3. Cycle the ignition to the on position with the engine off.

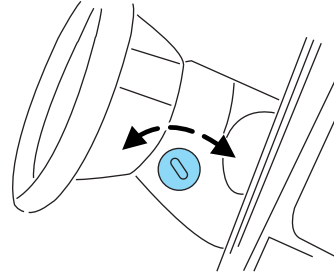

4. Turn the hazard flashers on then off three times. This must be accomplished within 10 seconds.



If the reset mode has been entered successfully, the horn will sound once, the TPMS indicator (⚠) will flash and the message center (if equipped) will display **TRAIN LEFT FRONT TIRE**. If this does not occur, please try again starting at Step 2.

If after repeated attempts to enter the reset mode, the horn does not sound, the TPMS indicator (⚠) does not flash and the message center (if equipped) does not display **TRAIN LEFT FRONT TIRE**, seek service from your authorized dealer.

5. Train the TPMS sensors in the tires using the following TPMS reset sequence starting with the **left front tire** in the following clockwise order:

- Left front (Driver's side front tire)
- Right front (Passenger's side front tire)
- Right rear (Passenger's side rear tire)
- Left rear (Driver's side rear tire)

6. Remove the valve cap from the valve stem on the left front tire; decrease the air pressure until the horn sounds.

**Note:** The single horn chirp confirms that the sensor identification code has been learned by the module for this position. If a double horn is heard, the reset procedure was unsuccessful, and must be repeated.

7. Remove the valve cap from the valve stem on the right front tire; decrease the air pressure until the horn sounds.

254

## Tires, Wheels and Loading

8. Remove the valve cap from the valve stem on the right rear tire; decrease the air pressure until the horn sounds.

9. Remove the valve cap from the valve stem on the left rear tire; decrease the air pressure until the horn sounds.

Training is complete after the horn sounds for the last tire trained (driver's side rear tire), the TPMS indicator stops flashing, and the message center (if equipped) displays:

### **TRAINING COMPLETE.**

10. Turn the ignition off. If two short horn beeps are heard, the reset procedure was unsuccessful and must be repeated.

If after repeating the procedure and two short beeps are heard when the ignition is turned to off, seek assistance from your authorized dealer.

11. Set all four tires to the recommended air pressure as indicated on the Safety Compliance Certification Label or Tire Label located on the B-Pillar or the edge of the driver's door. See *Vehicle loading - with and without a trailer* in this chapter for more information.

### **SNOW TIRES AND CHAINS**



**WARNING:** Snow tires must be the same size, load index, speed rating as those originally provided by Ford. Use of any tire or wheel not recommended by Ford can affect the safety and performance of your vehicle, which could result in an increased risk of loss of vehicle control, vehicle rollover, personal injury and death. Additionally, the use of non-recommended tires and wheels could cause steering, suspension, axle or transfer case/power transfer unit failure.

The tires on your vehicle have all-weather treads to provide traction in rain and snow. However, in some climates, you may need to use snow tires and chains. If you need to use chains, it is recommended that steel wheels (of the same size and specifications) be used, as chains may chip aluminum wheels.

**Note:** The suspension insulation and bumpers will help prevent vehicle damage. Do not remove these components from your vehicle when using snow tires and chains.

**Note:** Do not place chains on the following tires sizes: P265/60R18, P275/65R18, LT275/70R17, LT275/65R18, LT315/70R17, P275/55R20, and P275/45R22.

## Tires, Wheels and Loading

Follow these guidelines when using snow tires and chains:

- If possible, avoid fully loading your vehicle.
- Use only SAE Class S chains.
- Install chains securely, verifying that the chains do not touch any wiring, brake lines or fuel lines.
- Drive cautiously. If you hear the chains rub or bang against your vehicle, stop and retighten the chains. If this does not work, remove the chains to prevent damage to your vehicle.
- Remove the tire chains when they are no longer needed. Do not use tire chains on dry roads.

### VEHICLE LOADING – WITH AND WITHOUT A TRAILER

This section will guide you in the proper loading of your vehicle and/or trailer, to keep your loaded vehicle weight within its design rating capability, with or without a trailer. Properly loading your vehicle will provide maximum return of vehicle design performance. Before loading your vehicle, familiarize yourself with the following terms for determining your vehicle's weight ratings, with or without a trailer, from the vehicle's Tire Label or Safety Compliance Certification Label:

**Base Curb Weight** – is the weight of the vehicle including a full tank of fuel and all standard equipment. It does not include passengers, cargo, or optional equipment.

**Vehicle Curb Weight** – is the weight of your new vehicle when you picked it up from your authorized dealer plus any aftermarket equipment.



## Tires, Wheels and Loading

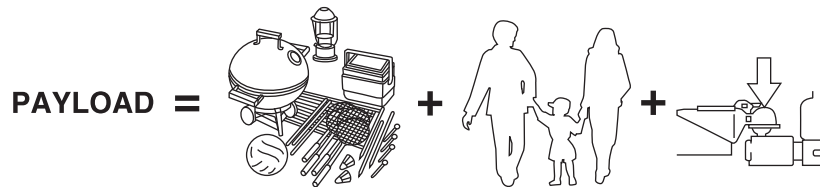

**Payload** – is the combined weight of cargo and passengers that the vehicle is carrying. The maximum payload for your vehicle can be found on the Tire Label on the B-Pillar or the edge of the driver's door (vehicles exported outside the US and Canada may not have a Tire Label). Look for **“THE COMBINED WEIGHT OF OCCUPANTS AND CARGO SHOULD NEVER EXCEED XXX kg OR XXX lb.”** for maximum payload. The payload listed on the Tire Label is the maximum payload for the vehicle as built by the assembly plant. If any aftermarket or authorized-dealer installed equipment has been installed on the vehicle, the weight of the equipment must be subtracted from the payload listed on the Tire Label in order to determine the new payload.

**!** **WARNING:** The appropriate loading capacity of your vehicle can be limited either by volume capacity (how much space is available) or by payload capacity (how much weight the vehicle should carry). Once you have reached the maximum payload of your vehicle, do not add more cargo, even if there is space available. Overloading or improperly loading your vehicle can contribute to loss of vehicle control and vehicle rollover.

# Tires, Wheels and Loading

Example only:

**TIRE AND LOADING INFORMATION**

SEATING CAPACITY | TOTAL 5 | FRONT 2 | REAR 3

The combined weight of occupants and cargo should never exceed : **XXX kg or XXX lbs.**

TIRE	SIZE	COLD TIRE PRESSURE	SEE OWNERS MANUAL FOR ADDITIONAL INFORMATION
FRONT	LT225/75R 16.5E	200 KPA, 29 PSI	
REAR	LT225/75R 16.5E	200 KPA, 29 PSI	
SPARE	T145/80D16 P225/60R17	420 KPA, 60 PSI 200 KPA, 29 PSI	

**TIRE AND LOADING INFORMATION**  
**RENSEIGNEMENTS SUR LES PNEUS ET LE CHARGEMENT**

SEATING CAPACITY | TOTAL 5 | FRONT 2 | REAR 3  
NOMBRE DE PLACES | TOTAL 5 | AVANT 2 | ARRIERE 3

The combined weight of occupants and cargo should never exceed 492 kg or 1085 lbs.  
Le poids total des occupants et du chargement ne doit jamais dépasser 492 kg ou 1085 lbs.

TIRE PNEU	SIZE DIMENSIONS	COLD TIRE PRESSURE PRESSION DES PNEUS A FROID	SEE OWNER'S MANUAL FOR ADDITIONAL INFORMATION  VOIR LE MANUEL DE L'USAGER POUR PLUS DE RENSEIGNEMENTS
FRONT AVANT	P235/70R16	240 KPA, 35 PSI	
REAR ARRIERE	P235/70R16	240 KPA, 35 PSI	
SPARE DE SECOURS	T145/90R17	415 KPA, 60 PSI	



**Cargo Weight** – includes all weight added to the Base Curb Weight, including cargo and optional equipment. When towing, trailer tongue load or king pin weight is also part of cargo weight.

**GAW (Gross Axle Weight)** – is the total weight placed on each axle (front and rear) – including vehicle curb weight and all payload.

## Tires, Wheels and Loading

**GAWR (Gross Axle Weight Rating)** – is the maximum allowable weight that can be carried by a single axle (front or rear). **These numbers are shown on the Safety Compliance Certification Label located on the B-Pillar or the edge of the driver's door. The total load on each axle must never exceed its GAWR.**

**Note:** For trailer towing information refer to *Trailer towing* found in this chapter or the *RV and Trailer Towing Guide* provided by your authorized dealer.

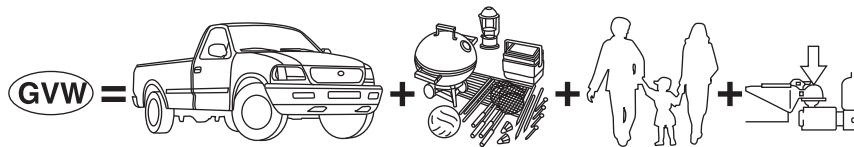

**GVW (Gross Vehicle Weight)** – is the Vehicle Curb Weight + cargo + passengers.

**GVWR (Gross Vehicle Weight Rating)** – is the maximum allowable weight of the fully loaded vehicle (including all options, equipment, passengers and cargo). **The GVWR is shown on the Safety Compliance Certification Label located on the B-Pillar or the edge of the driver's door. The GVW must never exceed the GVWR.**

## Tires, Wheels and Loading

- Example only:

**MFD. BY FORD MOTOR CO.**

DATE: XX/XX GVWR: XXXXXLB/ XXXXXKG  
 FRONT GAWR: XXXXL REAR GAWR: XXXXLB  
 XXXXKG WITH XXXXKG WITH  
 XXXX/XXXXXXX TIRES XXXX/XXXXXXX TIRES  
 XXXX.XX RIMS XXXX.XX RIMS  
 AT XXX kPa/XX PSI COLD AT XXX kPa/XX PSI COLD

THIS VEHICLE CONFORMS TO ALL APPLICABLE FEDERAL MOTOR VEHICLE SAFETY STANDARDS IN EFFECT ON THE DATE OF MANUFACTURE SHOWN ABOVE.

VIN: XXXXXXXXXXXXXXXXXXXX XXXXX  
 TYPE: XXX XXXXX

XXXXXXXXXXXXXXXX XXX XXXX-XXXXXX-XX

EXT PNT: XX RC: XX DSO: \_\_\_\_\_  
 WB INT TR TP/PS R AXLE TR SPR XXXXX  
 XXX XX X XX X XX XXX

XXXXXXXXXXXXXXXX XXX XXXX-XXXXXX-XX

**MFD. BY FORD MOTOR CO.**

DATE: XX/XX GVWR/PNBV: XXXX LB/XXXXKG  
 FRONT GAWR/PNBE AV / REAR GAWR/PNBE AR  
 XXXX/XXXXB / XXXXKG/XXXXLB  
 WITH/AVEC TIRES/PNEUS  
 XXXX/XXXXX  
 XXXX/XXXXX  
 XXXXXX RIMS/JANTES XXXXXX

AT/A kPa/PSI/LPC XXX/XX COLD/A FROID XXX/XX /JUMEELES

VIN: XXXXXXXXXXXXXXXXXXXX XXXXX  
 TYPE: XXX/XXXX COMPLIES: XXXX/XXX - XXX XXXXX  
 XXXXX

XXXXXXXXXXXXXXXX XXX XXXX-XXXXXX-XX

EXT PNT: XX RC: XX DSO: \_\_\_\_\_  
 WB INT TR TP/PS R AXLE TR SPR XXXXX  
 XXX XX X XX X XXXX XXX

XXXXXXXXXXXXXXXX XXX XXXX-XXXXXX-XX

 **WARNING:** Exceeding the Safety Compliance Certification Label vehicle weight rating limits could result in substandard vehicle handling or performance, engine, transmission and/or structural damage, serious damage to the vehicle, loss of control and personal injury.

## Tires, Wheels and Loading



**GCW (Gross Combined Weight)** – is the weight of the loaded vehicle (GVW) plus the weight of the fully loaded trailer.

**GCWR (Gross Combined Weight Rating)** – is the maximum allowable weight of the vehicle and the loaded trailer – including all cargo and passengers – that the vehicle can handle without risking damage. (Important: The towing vehicle's braking system is rated for operation at GVWR, not at GCWR.) Separate functional brakes should be used for safe control of towed vehicles and for trailers where the GCW of the towing vehicle plus the trailer exceed the GVWR of the towing vehicle. **The GCW must never exceed the GCWR.**

**Maximum Loaded Trailer Weight** – is the highest possible weight of a fully loaded trailer the vehicle can tow. It assumes a vehicle with only mandatory options, no cargo (internal or external), a tongue load of 10–15% (conventional trailer) or king pin weight of 15–25% (fifth wheel trailer), and driver only (150 lb. [68 kg]). **Consult your authorized dealer (or the *RV and Trailer Towing Guide* provided by your authorized dealer) for more detailed information.**

**Tongue Load or Fifth Wheel King Pin Weight** – refers to the amount of the weight that a trailer pushes down on a trailer hitch.

**Examples:** For a 5,000 lb. (2,268 kg) conventional trailer, multiply 5,000 by 0.10 and 0.15 to obtain a proper tongue load range of 500 to 750 lb. (227 to 340 kg). For an 11,500 lb. (5,216 kg) fifth wheel trailer, multiply by 0.15 and 0.25 to obtain a proper king pin load range of 1,725 to 2,875 lb. (782 to 1,304 kg)



**WARNING:** Do not exceed the GVWR or the GAWR specified on the Safety Compliance Certification Label.



**WARNING:** Do not use replacement tires with lower load carrying capacities than the original tires because they may lower the vehicle's GVWR and GAWR limitations. Replacement tires with a higher limit than the original tires do not increase the GVWR and GAWR limitations.

## Tires, Wheels and Loading



**WARNING:** Exceeding any vehicle weight rating limitation could result in serious damage to the vehicle and/or personal injury.

### Steps for determining the correct load limit:

1. Locate the statement “The combined weight of occupants and cargo should never exceed XXX kg or XXX lb.” on your vehicle’s placard.
2. Determine the combined weight of the driver and passengers that will be riding in your vehicle.
3. Subtract the combined weight of the driver and passengers from XXX kg or XXX lb.
4. The resulting figure equals the available amount of cargo and luggage load capacity. For example, if the “XXX” amount equals 1,400 lb. and there will be five 150 lb. passengers in your vehicle, the amount of available cargo and luggage load capacity is 650 lb. ( $1400 - 750 (5 \times 150) = 650$  lb.). In metric units ( $635 - 340 (5 \times 68) = 295$  kg.)
5. Determine the combined weight of luggage and cargo being loaded on the vehicle. That weight may not safely exceed the available cargo and luggage load capacity calculated in Step 4.
6. If your vehicle will be towing a trailer, load from your trailer will be transferred to your vehicle. Consult this manual to determine how this reduces the available cargo and luggage load capacity of your vehicle.

The following gives you a few examples on how to calculate the available amount of cargo and luggage load capacity:

- Another example for your vehicle with 1,400 lb. (635 kg) of cargo and luggage capacity. You decide to go golfing. Is there enough load capacity to carry you, 4 of your friends and all the golf bags? You and four friends average 220 lb. (99 kg) each and the golf bags weigh approximately 30 lb. (13.5 kg) each. The calculation would be:  $1400 - (5 \times 220) - (5 \times 30) = 1400 - 1100 - 150 = 150$  lb. Yes, you have enough load capacity in your vehicle to transport four friends and your golf bags. In metric units, the calculation would be:  $635 \text{ kg} - (5 \times 99 \text{ kg}) - (5 \times 13.5 \text{ kg}) = 635 - 495 - 67.5 = 72.5$  kg.

## Tires, Wheels and Loading

- A final example for your vehicle with 1,400 lb. (635 kg) of cargo and luggage capacity. You and one of your friends decide to pick up cement from the local home improvement store to finish that patio you have been planning for the past 2 years. Measuring the inside of the vehicle with the rear seat folded down, you have room for 12-100 lb. (45 kg) bags of cement. Do you have enough load capacity to transport the cement to your home? If you and your friend each weigh 220 lb. (99 kg), the calculation would be:  $1400 - (2 \times 220) - (12 \times 100) = 1400 - 440 - 1200 = -240$  lb. No, you do not have enough cargo capacity to carry that much weight. In metric units, the calculation would be:  $635 \text{ kg} - (2 \times 99 \text{ kg}) - (12 \times 45 \text{ kg}) = 635 - 198 - 540 = -103$  kg. You will need to reduce the load weight by at least 240 lb. (104 kg). If you remove 3-100 lb. (45 kg) cement bags, then the load calculation would be:

$1400 - (2 \times 220) - (9 \times 100) = 1400 - 440 - 900 = 60$  lb. Now you have the load capacity to transport the cement and your friend home. In metric units, the calculation would be:  $635 \text{ kg} - (2 \times 99 \text{ kg}) - (9 \times 45 \text{ kg}) = 635 - 198 - 405 = 32$  kg.

The above calculations also assume that the loads are positioned in your vehicle in a manner that does not overload the Front or the Rear Gross Axle Weight Rating specified for your vehicle on the Safety Compliance Certification Label found on the edge of the driver's door.

### Special loading instructions for owners of pick-up trucks and utility-type vehicles



**WARNING:** For important information regarding safe operation of this type of vehicle, see the *Preparing to drive your vehicle* section in the *Driving* chapter of this owner's guide.



**WARNING:** Loaded vehicles may handle differently than unloaded vehicles. Extra precautions, such as slower speeds and increased stopping distance, should be taken when driving a heavily loaded vehicle.

Your vehicle can haul more cargo and people than most passenger cars. Depending upon the type and placement of the load, hauling cargo and people may raise the center of gravity of the vehicle.

## Tires, Wheels and Loading

### TRAILER TOWING

Your vehicle may tow a class I, II, III or IV trailer provided the maximum trailer weight is less than or equal to the maximum trailer weight listed for your engine and rear axle ratio on the following charts.

When driving with a trailer or payload, a slight takeoff vibration or shudder may be present due to the increased payload weight. Additional information regarding proper trailer loading and setting your vehicle up for towing is noted under *Vehicle Loading – With and Without a Trailer* in this chapter and in the *RV & Trailer Towing Guide*, available at your authorized dealer.

If your vehicle is not equipped with a heavy-duty trailer towing package, the maximum weight your vehicle can tow is limited to 5,000 lb (2,268 kg).

**Note:** Do not exceed trailer weight of 5,000 lb (2,268 kg) when towing with bumper only.

**Exceeding the maximum GCWR could result in extensive damage to your vehicle and personal injury.**

Your vehicle's load capacity is designated by weight, not by volume, so you cannot necessarily use all available space when loading a vehicle.

Towing a trailer places an additional load on your vehicle's engine, transmission, axle, brakes, tires and suspension. Inspect these components carefully periodically during, and after any towing operation.

Follow these guidelines to ensure safe towing:

- Do not tow a trailer until your vehicle has been driven at least 1,000 miles (1,600 km).
- Consult your local motor vehicle laws for towing a trailer.
- Refer to the instructions included with towing accessories for the proper installation and adjustment specifications.
- Thoroughly prepare your vehicle for towing. Refer to *Preparing to tow* in this chapter.
- Stay within your vehicle's load limits.
- Use extra caution when driving while trailer towing. Refer to *Driving while you tow* in this chapter.
- Service your vehicle more frequently if you tow a trailer. Refer to *Special operating conditions* in your scheduled maintenance.



## Tires, Wheels and Loading

For load specification terms found on the label and instructions on calculating your vehicle's load, refer to *Vehicle loading - with and without a trailer* in this chapter. Remember to figure in the tongue load of your loaded vehicle when figuring the total weight.



**WARNING:** Do not exceed the GVWR or the GAWR specified on the certification label.



**WARNING:** Towing trailers beyond the maximum recommended gross trailer weight exceeds the limit of the vehicle and could result in engine damage, transmission damage, structural damage, loss of vehicle control, vehicle rollover and personal injury.

Regular Cab			
Engine	Rear axle ratio	Maximum GCWR - lb (kg)	Maximum Trailer Weight - lb (kg)
<b>2WD 126" wheelbase</b>			
3.7L	3.55	10400 (4717)	5500 (2495)
	3.73	10900 (4944)	6000 (2721)
5.0L	3.31	12900 (5851)	7900 (3583)
	3.55	13300 (6033)	8300 (3765)
<b>2WD 145" wheelbase</b>			
3.5L	3.15	14000 (6350)	8800 (3992)
	3.55	15000 (6804)	9800 (4445)
3.5L (Heavy Payload Package)	3.73	16700 (7575)	11300 (5126)
3.7L	3.55	10600 (4808)	5600 (2540)
	3.73	11100 (5035)	6100 (2767)
5.0L	3.31	13500 (6123)	8400 (3810)
	3.55	14900 (6759)	9800 (4445)
5.0L (Heavy Payload Package)	3.73	15300 (6940)	10000 (4536)
<b>4WD 126" wheelbase</b>			
3.7L	3.73	10900 (4944)	5700 (2585)
5.0L	3.55	12900 (5851)	7600 (3447)
	3.73	13300 (6033)	8000 (3629)

## Tires, Wheels and Loading

<b>Regular Cab</b>			
<b>Engine</b>	<b>Rear axle ratio</b>	<b>Maximum GCWR - lb (kg)</b>	<b>Maximum Trailer Weight - lb (kg)</b>
<b>4WD 145" wheelbase</b>			
3.5L	3.31	14000 (6350)	8600 (3901)
	3.55/3.73	15200 (6895)	9800 (4445)
3.5L (Heavy Payload Package)	3.73	17100 (7756)	11300 (5126)
3.7L	3.73	11100 (5035)	5800 (2630)
5.0L	3.55	13500 (6123)	8200 (3719)
	3.73	15100 (6849)	9800 (4445)
5.0L (Heavy Payload Package)	3.73	15300 (6940)	9700 (4400)
<b>SuperCab</b>			
<b>Engine</b>	<b>Rear axle ratio</b>	<b>Maximum GCWR - lb (kg)</b>	<b>Maximum Trailer Weight - lb (kg)</b>
<b>2WD 145" wheelbase</b>			
3.5L	3.15	14000 (6350)	8600 (3901)
	3.55	15200 (6895)	9800 (4445)
3.5L (Max Trailer Tow Package)	3.73	16900 (7666)	11300 (5126)
3.7L	3.73	11100 (5035)	5800 (2630)
5.0L	3.31	13500 (6123)	8100 (3674)
	3.55	14900 (6759)	9500 (4309)
<b>4WD 145" wheelbase</b>			
3.5L	3.31	14000 (6350)	8400 (3810)
	3.55/3.73	15400 (6985)	9800 (4445)
3.5L (Max Trailer Tow Package)	3.73/4.10	17100 (7756)	11300 (5126)
3.7L	3.73	11100 (5035)	5500 (2495)
5.0L	3.55	13500 (6123)	7800 (3538)
	3.73	15100 (6849)	9400 (4264)

## Tires, Wheels and Loading

<b>SuperCab</b>			
<b>Engine</b>	<b>Rear axle ratio</b>	<b>Maximum GCWR - lb (kg)</b>	<b>Maximum Trailer Weight - lb (kg)</b>
<b>2WD 163" wheelbase</b>			
3.5L (Heavy Payload Package)	3.73	17100 (7756)	11300 (5126)
5.0L (Heavy Payload Package)	3.73	15300 (6940)	9600 (4355)
<b>4WD 163" wheelbase</b>			
3.5L (Heavy Payload Package)	3.73	17100 (7756)	11200 (5080)
5.0L (Heavy Payload Package)	3.73	15300 (6940)	9300 (4218)
<b>SuperCrew</b>			
<b>Engine</b>	<b>Rear axle ratio</b>	<b>Maximum GCWR - lb (kg)</b>	<b>Maximum Trailer Weight - lb (kg)</b>
<b>2WD 145" wheelbase</b>			
3.5L	3.15	14000 (6350)	8500 (3856)
	3.55	15300 (6940)	9800 (4445)
3.5L (Max Trailer Tow Package)	3.73	16900 (7666)	11300 (5126)
3.7L	3.73	11100 (5035)	5700 (2585)
5.0L	3.55	13500 (6123)	8000 (3629)
	3.73	14900 (6759)	9400 (4264)
6.2L (Harley-Davidson™ and Lariat Limited)	3.73	13500 (6123)	7500 (3402)
6.2L (Max Trailer Tow Package)	3.73	17100 (7756)	11300 (5126)

## Tires, Wheels and Loading

<b>SuperCrew</b>			
<b>Engine</b>	<b>Rear axle ratio</b>	<b>Maximum GCWR - lb (kg)</b>	<b>Maximum Trailer Weight - lb (kg)</b>
<b>4WD 145" wheelbase</b>			
3.5L	3.31	14000 (6350)	8200 (3719)
	3.55/3.73	15500 (7031)	9700 (4400)
3.5L (Max Trailer Tow Package)	3.73/4.10	17100 (7756)	11300 (5126)
5.0L	3.55	13500 (6123)	7700 (3493)
	3.73	15100 (6849)	9300 (4218)
6.2L (Harley-Davidson™ and Lariat Limited)	3.73	13500 (6123)	7200 (3266)
6.2L (Max Trailer Tow Package)	3.73	17100 (7756)	11100 (5035)
<b>2WD 157" wheelbase</b>			
3.5L	3.15	14000 (6350)	8400 (3810)
	3.55	15300 (6940)	9700 (4400)
3.5L (Max Trailer Tow Package)	3.73	17000 (7711)	11300 (5126)
5.0L	3.55	13500 (6123)	7900 (3583)
	3.73	14900 (6759)	9300 (4218)
<b>4WD 157" wheelbase</b>			
3.5L	3.31	14000 (6350)	8000 (3629)
	3.55/3.73	15500 (7031)	9600 (4354)
3.5L (Max Trailer Tow Package)	3.73/4.10	17100 (7756)	11200 (5080)
5.0L	3.55	13500 (6123)	7500 (3402)
	3.73	15100 (6849)	9100 (4128)

## Tires, Wheels and Loading

**Note:** When taking into consideration trailer frontal area, ensure not to exceed:

- 45 ft<sup>2</sup> (4.18 m<sup>2</sup>) without the Trailer Tow Package or the Heavy Payload Package.
- 60 ft<sup>2</sup> (5.52 m<sup>2</sup>) with the Trailer Tow Package or the Heavy Payload Package.

### Preparing to tow

Use the proper equipment for towing a trailer and make sure it is properly attached to your vehicle. Contact your authorized dealer or a reliable trailer dealer as soon as possible if you require assistance.

### Hitches

Do not use a hitch that clamps onto the vehicle's bumper or attaches to the axle. You must distribute the load in your trailer so that 10–15% of the total weight of the trailer is on the tongue.

#### **Weight-distributing hitch**

When hooking-up a trailer using a weight-distributing hitch, always use the following procedure:

1. Park the vehicle (without the trailer) on a level surface.
2. Measure the height of the top of the front wheel opening on the fender, this is H1.
3. Attach the trailer to the vehicle without the weight distributing bars connected.
4. Measure the height of the top of the front wheel opening on the fender a second time, this is H2.
5. Install and adjust the tension in the weight distributing bars so that the height of the front fender is approximately halfway between H1 and H2.
6. Check that the trailer is level. If not level, adjust the ball height accordingly and repeat Steps 3–6.



**WARNING:** Do not adjust a weight-distributing hitch to any position where the rear bumper of the vehicle is higher than it was before attaching the trailer. Doing so will defeat the function of the weight-distributing hitch, which may cause unpredictable handling, and could result in serious personal injury.

## Tires, Wheels and Loading

### Safety chains

Always connect the trailer's safety chains to the frame or hook retainers of the vehicle hitch. To connect the trailer's safety chains, cross the chains under the trailer tongue and allow slack for turning corners.

If you use a rental trailer, follow the instructions that the rental agency gives to you.

**Do not attach safety chains to the bumper.**

### Trailer brakes

Electric brakes and manual, automatic or surge-type trailer brakes are safe if installed properly and adjusted to the manufacturer's specifications. The trailer brakes must meet local and Federal regulations.



**WARNING:** Do not connect a trailer's hydraulic brake system directly to your vehicle's brake system. Your vehicle may not have enough braking power and your chances of having a collision greatly increase.

The braking system of the tow vehicle is rated for operation at the GVWR not GCWR.

### *Integrated trailer brake controller (if equipped)*

Your vehicle may be equipped with a fully integrated electronic trailer brake controller (TBC). When used properly, the TBC helps ensure smooth and effective trailer braking by powering the trailer's electric brakes with a proportional output based on the towing vehicle's brake pressure.



**WARNING:** The Ford TBC has only been verified to be compatible with trailers having electric-actuated drum brakes (one to four axles) and not hydraulic surge or electric-over-hydraulic types. It is the responsibility of the customer to ensure that the trailer brakes are adjusted appropriately, functioning normally and all electric connections are properly made. Failure to do so may result in loss of vehicle control, crash or serious injury.

## Tires, Wheels and Loading

The TBC user interface consists of the following:

### 1. +/- (GAIN adjustment

**buttons):** Pressing these buttons adjusts the TBC's power output to the trailer brakes (in 0.5 increments). The GAIN setting can be increased to a maximum of 10.0 or decreased to a minimum of 0 (no trailer braking). Pressing and holding a button raises or lowers the setting continuously. The gain setting displays in the message center as follows: TBC GAIN = XX.X.

The trailer brake controller (TBC) is designed to display three items of information in the instrument cluster message center. These are: gain setting, output bar graph, and trailer connectivity status. They appear in the message center as follows:

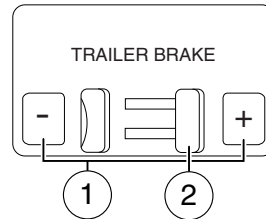

- **TBC GAIN = XX.X NO TRAILER:** The instrument cluster message center displays the current gain setting during a given ignition cycle and when adjusting the gain. This message is also displayed during manual activation without a trailer connected or when gain adjustments are made with no trailer connected.
- **TBC GAIN = XX.X OUTPUT = /////:** When the vehicle's brake pedal is pushed, or when the manual control is activated, bar indicators illuminate in the instrument cluster message center to indicate the amount of power going to the trailer brakes relative to the brake pedal or manual control input. One bar indicates the least amount of output with six bars indicating maximum output.
- **TRAILER CONNECTED:** This message is displayed when a correct trailer wiring connection (a trailer with electric trailer brakes) has been sensed during a given ignition cycle.
- **TRAILER DISCONNECTED:** This message is displayed and accompanied by a single chime, when a trailer connection was determined and then a disconnection, either intentionally or unintentionally, has been sensed during a given ignition cycle. It is also displayed if a truck or trailer wiring fault occurs causing the trailer to appear disconnected. This message is also displayed during manual activation without a trailer connected.

## Tires, Wheels and Loading

2. **Manual control lever:** Slide the control lever to the left to activate power to the trailer's electric brakes independent of the tow vehicle's brakes (see the following *Procedure for adjusting GAIN* section for instructions on proper use of this feature). If the manual control is activated while the brake is also applied, the greater of the two inputs determines the power sent to the trailer brakes.

- **Stop lamps:** Activating the TBC manual control lever illuminates both the trailer brake lamps and the tow vehicle brake lamps except the center high-mount stop lamp (presuming proper trailer electrical connection). Pressing the vehicle brake pedal also illuminates both trailer and vehicle brake lamps.

### **Procedure for adjusting GAIN:**

The GAIN setting is used to set the TBC for the specific towing condition and should be changed as towing conditions change. Changes to towing conditions include trailer load, vehicle load, road conditions and weather.

The GAIN should be set to provide the maximum trailer braking assistance while ensuring the trailer wheels do not lock when braking; locked trailer wheels may lead to trailer instability.

**Note:** This should only be performed in a traffic-free environment at speeds of approximately 20–25 mph (30–40 km/h).

1. Make sure the trailer brakes are in good working condition, functioning normally and properly adjusted. See your trailer dealer if necessary.
2. Hook up the trailer and make the electrical connections according to the trailer manufacturer's instructions.
3. When a trailer with electric brakes is plugged in, the **TRAILER CONNECTED** message displays in the instrument cluster message center.
4. Use the GAIN adjustment (+/-) buttons to increase or decrease the GAIN setting to the desired starting point. A GAIN setting of 6.0 is a good starting point for heavier loads.
5. In a traffic-free environment, tow the trailer on a dry, level surface at a speed of 20–25 mph (30–40 km/h) and squeeze the manual control lever completely.
6. If the trailer wheels lock up (indicated by squealing tires), reduce the GAIN setting; if the trailer wheels turn freely, increase the GAIN setting. Repeat Steps 5 and 6 until the GAIN setting is at a point just below trailer wheel lock-up. If towing a heavier trailer, trailer wheel lock-up may not be attainable even with the maximum GAIN setting of 10.

272



## Tires, Wheels and Loading

### Explanation of instrument cluster warning messages:

The TBC interacts with the instrument cluster message center to display the following messages:

**TRAILER BRAKE MODULE FAULT:** This message is displayed and accompanied by a single chime, in response to faults sensed by the TBC. In the event this message is seen, please contact your authorized dealer as soon as possible for diagnosis and repair. The TBC may still function, but performance may be degraded.

**WIRING FAULT ON TRAILER:** This message is displayed when a *Short circuit on the electric brake output wire* has occurred. If the **WIRING FAULT ON TRAILER** message is displayed and accompanied by a single chime, with no trailer connected, the problem is with the vehicle wiring from the TBC to the 7-pin connector at the bumper. If the message is only displayed with a trailer connected, the problem is related to the trailer wiring; consult your trailer dealer for assistance. This can be a short to ground (i.e., chaffed wire) or a short to voltage (i.e., pulled pin on trailer emergency break-away battery) or trailer brakes drawing too much current.

**Note:** Your TBC can be diagnosed by your authorized dealer to determine exactly which trailer fault has occurred; however, if the fault is with the trailer this diagnosis is **not** covered under your Ford warranty.

### Points to Remember:

- Remember to adjust gain setting before using the TBC for the first time.
- Readjust gain setting on the TBC (according to procedure above) whenever road, weather and trailer or vehicle loading conditions change from those that existed when the gain was initially set.
- The sliding lever on the TBC should be used only for manual activation of trailer brakes to assist with proper adjustment of the GAIN. Misuse, such as application during trailer sway, could cause instability of trailer and/or tow vehicle.
- Avoid towing in adverse weather conditions. The TBC does not provide anti-lock control of the trailer wheels. Trailer wheels can lock up on slippery surfaces, resulting in reduced stability of trailer and tow vehicle.
- The TBC is equipped with a feature which reduces output at vehicle speeds below 11 mph (18 km/h) so trailer and vehicle braking is not jerky or harsh. This feature is only available when applying the brakes using the vehicle's brake pedal, not the TBC.

## Tires, Wheels and Loading

- The TBC interacts with the brake system of the vehicle, including ABS, in order to reduce the likelihood of trailer wheel lock-up; therefore, if these systems are not functioning properly, the TBC may not function at full performance.
- Your vehicle's brake system and the trailer brake system work independently of each other; changing the GAIN setting on the TBC does not affect the operation of your vehicle's brakes whether a trailer is attached or not.
- When the vehicle is turned off, the TBC output is disabled and the display is shut down; turning the ignition from off to on awakens the TBC module.
- The TBC is only a factory- or dealer-installed item; Ford is not responsible for warranty or performance of the TBC due to misuse or customer installation.
- **Do not attempt removal of the TBC without consulting the Workshop Manual; damage to the unit may result.**

### Trailer lamps

Trailer lamps are required on most towed vehicles. Make sure all running lights, brake lights, turn signals and hazard lights are working. Contact your authorized dealer or trailer rental agency for proper instructions and equipment for hooking-up trailer lamps.

### Using a step bumper (if equipped)

The rear bumper is equipped with an integral hitch and only requires a ball with a one inch (25.4 mm) shank diameter. The bumper has a 5,000 lb (2,270 kg) trailer weight and 500 lb (227 kg) tongue weight capacity.

If it is necessary to relocate the trailer hitch ball position, a frame-mounted trailer hitch must be installed.

### Driving while you tow

When towing a trailer:

- Do not drive faster than 70 mph (113 km/h) during the first 500 miles (800 km) of trailer towing and don't make full-throttle starts.
- Turn off the speed control. The speed control may shut off automatically when you are towing on long, steep grades.
- Activate the tow/haul feature to eliminate excessive transmission shifting and assist in transmission cooling. For additional information, refer to *Automatic transmission operation* in the *Driving* chapter.

274

## Tires, Wheels and Loading

- Allow more distance for stopping with a trailer attached; anticipate stops and brake gradually.

If your vehicle is equipped with AdvanceTrac® with RSC, you may experience AdvanceTrac® with RSC activations during typical cornering maneuvers with a heavily loaded trailer; this is normal. Cornering at a slower speed while towing will reduce the tendency of the AdvanceTrac® stability enhancement system to activate.

### Trailer towing tips

- Practice turning, stopping and backing-up before starting on a trip to get the feel of the vehicle-trailer combination. When turning, make wider turns so the trailer wheels will clear curbs and other obstacles.
- To aid in engine/transmission cooling and A/C efficiency during hot weather while stopped in traffic, place the gearshift lever in P (Park).
- After you have traveled 50 miles (80 km), thoroughly check your hitch, electrical connections and trailer wheel lug nuts.
- If you are driving down a long or steep hill, shift to a lower gear. Do not apply the brakes continuously, as they may overheat and become less effective. Also, see the information on tow/haul mode operation under *Automatic transmission operation* in the *Driving* chapter.
- If you will be towing a trailer frequently in hot weather, hilly conditions, at GCWR, or any combination of these factors, consider refilling your rear axle with synthetic gear lube if not already so equipped. Refer to the *Maintenance and Specifications* chapter for the lubricant specification. Remember that regardless of the rear axle lube used, do not tow a trailer for the first 1,000 miles (1,600 km) of a new vehicle, and that the first 500 miles (800 km) of towing be done at no faster than 70 mph (113 km/h) with no full throttle starts.
- Vehicles with trailers should not be parked on a grade. If you must park on a grade, place wheel chocks under the trailer's wheels.

### Launching or retrieving a boat

**Disconnect the wiring to the trailer before backing the trailer into the water. Reconnect the wiring to the trailer after the trailer is removed from the water.**

When backing down a ramp during boat launching or retrieval:

- Do not allow the static water level to rise above the bottom edge of the rear bumper.
- Do not allow waves to break higher than 6 in (15 cm) above the bottom edge of the rear bumper.

## Tires, Wheels and Loading

Exceeding these limits may allow water to enter vehicle components:

- Causing internal damage to the components.
- Affecting driveability, emissions and reliability.

Replace the rear axle lubricant any time the axle has been submerged in water. Rear axle lubricant quantities are not to be checked or changed unless a leak is suspected or repair required.

### RECREATIONAL TOWING

Follow these guidelines if you have a need for recreational (RV) towing. An example of recreational towing would be towing your vehicle behind a motor home.

**Note:** Put your climate control system in recirculated air mode to prevent exhaust fumes from entering the vehicle. Refer to the *Climate Controls* chapter for more information.

In case of a roadside emergency with a disabled vehicle, see *Wrecker towing* in the *Roadside Emergencies* chapter.

These guidelines are designed to prevent damage to your vehicle and its transmission after it is hooked-up to the RV or tow dolly.

**2WD vehicles and 4WD vehicles equipped with an electronic-shift transfer case:** Do not tow your vehicle with any wheels on the ground, as vehicle or transmission damage may occur. It is recommended to tow your vehicle with all four (4) wheels off the ground such as when using a car-hauling trailer. Otherwise, no recreational towing is permitted.

#### **4WD vehicles equipped with a manual-shift transfer case:**

- Release the parking brake.
- Turn the key in the ignition to the off position.
- Place the transmission in N (Neutral).
- Place the transfer case lever in N (Neutral).
- The maximum recommended distance is unlimited.
- The vehicle must be towed in the forward position to ensure no damage is done to the internal transfer case components.

The transfer case N (Neutral) position overrides the transmission and puts the vehicle in neutral regardless of transmission gearshift lever position. The vehicle can move forward or backward. This position should only be used when towing the vehicle.

276

## Tires, Wheels and Loading



**WARNING:** Do not leave the vehicle unattended with the transfer case in the N (Neutral) position. Always set the parking brake fully and turn off the ignition when leaving the vehicle.

After reaching the destination, you must place your vehicle's 4WD gearshift lever in gear (2H, 4H or 4L).

## Driving

### STARTING

#### Positions of the ignition

1. Off — locks the automatic transmission gearshift lever and allows key removal. **Note:** In order to switch off the engine while the vehicle is in motion, shift to neutral and use the brakes to bring the vehicle to a safe stop. After the vehicle has stopped, turn the engine off and shift into park. Then, turn the key to the accessory or off position.

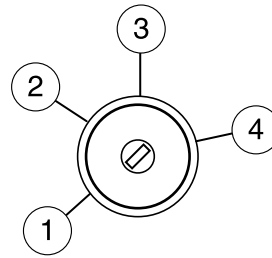

**Note:** The ignition key cannot be removed from the ignition unless the gearshift lever is securely latched in P (Park).

2. Accessory — allows the electrical accessories such as the radio to operate while the engine is not running.

3. On — all electrical circuits operational. Warning lights illuminated. Key position when driving.

4. Start — cranks the engine. Release the key as soon as the engine starts.

#### Preparing to start your vehicle

Engine starting is controlled by the powertrain control system.

This system meets all Canadian interference-causing equipment standard requirements regulating the impulse electrical field strength of radio noise.

When starting a fuel-injected engine, don't press the accelerator before or during starting. Only use the accelerator when you have difficulty starting the engine. For more information on starting the vehicle, refer to *Starting the engine* in this chapter.



**WARNING:** Extended idling at high engine speeds can produce very high temperatures in the engine and exhaust system, creating the risk of fire or other damage.

## Driving

 **WARNING:** Do not park, idle, or drive your vehicle in dry grass or other dry ground cover. The emission system heats up the engine compartment and exhaust system, which can start a fire.

 **WARNING:** Do not start your vehicle in a closed garage or in other enclosed areas. Exhaust fumes can be toxic. Always open the garage door before you start the engine. See *Guarding against exhaust fumes* in this chapter for more instructions.

 **WARNING:** If you smell exhaust fumes inside your vehicle, have your dealer inspect your vehicle immediately. Do not drive if you smell exhaust fumes.

### ***Important safety precautions***

A computer system controls the engine's idle revolutions per minute (RPM). When the engine starts, the idle RPM runs higher than normal in order to warm the engine. If the engine idle speed does not slow down automatically, have the vehicle checked. If the vehicle is operated in a heavy snow storm or blowing snow conditions, the engine air induction may become partially clogged with snow and/or ice. If this occurs the engine may experience a significant reduction in power output. At the earliest opportunity, clear all snow and/or ice away from the air induction inlet. Do not allow the vehicle to idle for more than 10 minutes at the higher engine RPM.

Before starting the vehicle:

1. Make sure all vehicle occupants have buckled their safety belts. For more information on safety belts and their proper usage, refer to the *Seating and Safety Restraints* chapter.
2. Make sure the headlamps and vehicle accessories are off.

## Driving

3. Make sure the gearshift is in P (Park).

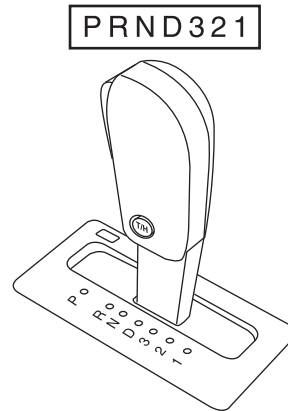

4. Make sure the parking brake is set.

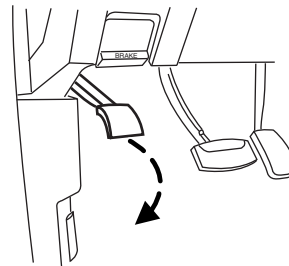

5. Turn the key to 3 (on) without turning the key to 4 (start).

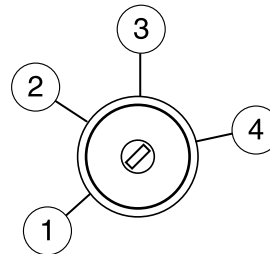

Some warning lights will briefly illuminate. See *Warning lights and chimes* in the *Instrument Cluster* chapter for more information regarding the warning lights.



### Starting the engine

1. Turn the key to 3 (on) without turning the key to 4 (start).
2. Turn the key to 4 (start), then release the key as soon as the engine begins cranking. Your vehicle has a computer assisted cranking system that assists in starting the engine. After releasing the key from the 4 (start) position, the engine may continue cranking for up to 10 seconds or until the vehicle starts.

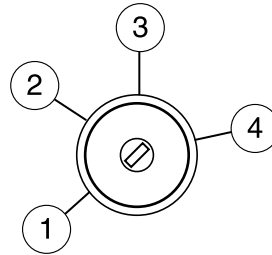

**Note:** Cranking may be stopped at any time by turning the key to the off position.

3. After idling for a few seconds, release the parking brake, apply the brake, shift into gear and drive.

**Note:** If the engine does not start on the first try, turn the key to the off position, wait 10 seconds and try Step 2 again. If the engine still fails to start, press the accelerator to the floor and try Step 2 again, keeping the accelerator on the floor until the engine begins to accelerate above cranking speeds; this will allow the engine to crank with the fuel shut off in case the engine is flooded with fuel.

### Cold weather starting (flexible fuel vehicles only)

The starting characteristics of all grades of E<sub>85</sub> ethanol make it unsuitable for use when ambient temperatures fall below 0°F (-18°C). Consult your fuel distributor for the availability of winter grade ethanol. As the outside temperature approaches freezing, ethanol fuel distributors should supply winter grade ethanol (same as with unleaded gasoline). If summer grade ethanol is used in cold weather conditions, 0°F to 32°F (-18°C to 0°C), you may experience increased cranking times, rough idle or hesitation until the engine has warmed up.

You may experience a decrease in peak performance when the engine is cold when operating on E<sub>85</sub> ethanol.

Do not crank the engine for more than 10 seconds at a time as starter damage may occur. If the engine fails to start, turn the key to off and wait 30 seconds before trying again.

Do not use starting fluid such as ether in the air intake system. Such fluid could cause immediate explosive damage to the engine and possible personal injury.

## Driving

If you should experience cold weather starting problems on E<sub>85</sub> ethanol, and neither an alternative brand of E<sub>85</sub> ethanol nor an engine block heater is available, the addition of unleaded gasoline to your tank will improve cold starting performance. Your vehicle is designed to operate on E<sub>85</sub> ethanol alone, unleaded gasoline alone, or any mixture of the two.

See *Choosing the right fuel* in the *Maintenance and Specifications* chapter for more information on ethanol.

### **If the engine fails to start using the preceding instructions (flexible fuel vehicles only)**

1. Press and hold down the accelerator 1/3 to 1/2 way to floor, then crank the engine.
2. When the engine starts, release the key, then gradually release the accelerator pedal as the engine speeds up. If the engine still fails to start, repeat Step 1.

### **Guarding against exhaust fumes**

Carbon monoxide is present in exhaust fumes. Take precautions to avoid its dangerous effects.



**WARNING:** If you smell exhaust fumes inside your vehicle, have your dealer inspect your vehicle immediately. Do not drive if you smell exhaust fumes.

### **Important ventilating information**

If the engine is idling while the vehicle is stopped for a long period of time, open the windows at least 1 inch (2.5 cm) or adjust the heating or air conditioning to bring in fresh air.

### **ENGINE BLOCK HEATER (IF EQUIPPED)**

An engine block heater warms the engine coolant which aids in starting and allows the heater/defroster system to respond quickly. If your vehicle is equipped with this system, your equipment includes a heater element which is installed in your engine block and a wire harness which allows the user to connect the system to a grounded 120 volt A/C electrical source. The block heater system is most effective when outdoor temperatures reach below 0°F (-18°C).

For flexible fuel vehicles, if operating with E85 ethanol, an engine block heater must be used if ambient temperature is below 0°F (-18°C).

See *Cold weather starting* earlier in this chapter for more information on starting with ethanol.

282

## Driving



**WARNING:** Failure to follow engine block heater instructions could result in property damage or physical injury.



**WARNING:** To reduce the risk of electrical shock, do not use your heater with ungrounded electrical systems or two-pronged (cheater) adapters.

Prior to using the engine block heater, follow these recommendations for proper and safe operation:

- For your safety, use an outdoor extension cord that is product certified by Underwriter's Laboratory (UL) or Canadian Standards Association (CSA). Use only an extension cord that can be used outdoors, in cold temperatures, and is clearly marked "Suitable for Use with Outdoor Appliances." Never use an indoor extension cord outdoors; it could result in an electric shock or fire hazard.
- Use a 16 gauge outdoor extension cord, minimum.
- Use as short an extension cord as possible.
- Do not use multiple extension cords. Instead, use one extension cord which is long enough to reach from the engine block heater cord to the outlet without stretching.
- Make certain that the extension cord is in excellent condition (not patched or spliced). Store your extension cord indoors at temperatures above 32°F (0°C). Outdoor conditions can deteriorate extension cords over a period of time.
- To reduce the risk of electrical shock, do not use your heater with ungrounded electrical systems or two pronged (cheater) adapters. Also ensure that the block heater, especially the cord, is in good condition before use.
- Make sure that when in operation, the extension cord plug /engine block heater cord plug connection is free and clear of water in order to prevent possible shock or fire.
- Be sure that areas where the vehicle is parked are clean and clear of all combustibles such as petroleum products, dust, rags, paper and similar items.
- Be sure that the engine block heater, heater cord and extension cord are solidly connected. A poor connection can cause the cord to become very hot and may result in an electrical shock or fire. Be sure to check for heat anywhere in the electrical hookup once the system has been operating for approximately a half hour.

283

## Driving

- Finally, have the engine block heater system checked during your fall tune-up to be sure it's in good working order.

### How to use the engine block heater

Ensure the receptacle terminals are clean and dry prior to use. To clean them, use a dry cloth.

Depending on the type of factory installed equipment, your engine block heater system may consume anywhere between 400 watts or 1000 watts of power per hour. Your factory installed block heater system does not have a thermostat; however, maximum temperature is attained after approximately three hours of operation. Block heater operation longer than three hours will not improve system performance and will unnecessarily use additional electricity.

Make sure system is unplugged and properly stowed before driving the vehicle. While not in use, make sure the protective cover seals the prongs of the engine block heater cord plug.

### BRAKES

Occasional brake noise is normal. If a metal-to-metal, continuous grinding or continuous squeal sound is present, the brake linings may be worn-out and should be inspected by an authorized dealer. If the vehicle has continuous vibration or shudder in the steering wheel while braking, the vehicle should be inspected by an authorized dealer.

Refer to *Warning lights and chimes* in the *Instrument Cluster* chapter for information on the brake system warning light.

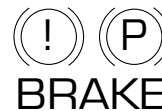

### Four-wheel anti-lock brake system (ABS)

Your vehicle is equipped with an anti-lock braking system (ABS). This system helps you maintain steering control during emergency stops by keeping the brakes from locking. Noise from the ABS pump motor and brake pedal pulsation may be observed during ABS braking and the brake pedal may suddenly travel a little farther as soon as ABS braking is done and normal brake operation resumes. These are normal characteristics of the ABS and should be no reason for concern.

**Using ABS**

When hard braking is required, apply continuous force on the brake pedal. Do not pump the brake pedal since this will reduce the effectiveness of the ABS and will increase your vehicle's stopping distance. The ABS will be activated immediately, allowing you to retain steering control during hard braking and on slippery surfaces. However, the ABS does not decrease stopping distance.

**ABS warning lamp**

The ABS lamp in the instrument cluster momentarily illuminates when the ignition is turned on. If the light does not illuminate during start up, remains on or flashes, the ABS may be disabled and may need to be serviced.

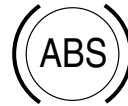

Even when the ABS is disabled, normal braking is still effective. If your BRAKE warning lamp illuminates with the parking brake released, have your brake system serviced immediately.



**Parking brake**

To set the parking brake (1), press the parking brake pedal down until the pedal stops.

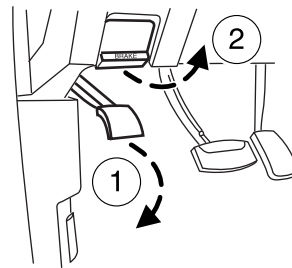

The BRAKE warning lamp will illuminate and will remain illuminated until the parking brake is released.



To release, pull the lever (2).

## Driving



**WARNING:** Always set the parking brake fully and make sure that the gearshift is securely latched in P (Park) (automatic transmission) or in 1 (First) (manual transmission).

### Brake over accelerator

This vehicle is equipped with a brake over accelerator feature. In the event the accelerator pedal becomes stuck or entrapped, applying steady and firm pressure to the brake pedal will both slow the vehicle and reduce engine power. If you experience this condition, apply the brakes and bring your vehicle to a safe stop. Turn the engine off, shift to P (Park) and apply the parking brake, and then inspect the accelerator pedal for any interferences. If none are found and the condition persists, have your vehicle towed to the nearest authorized dealer.

### ADVANCETRAC® WITH ROLL STABILITY CONTROL™ (RSC®) STABILITY ENHANCEMENT SYSTEM

The AdvanceTrac® with RSC® system provides the following stability enhancement features for certain driving situations:

- Traction control system (TCS), which functions to help avoid drive-wheel spin and loss of traction.
- Electronic stability control (ESC), which functions to help avoid skids or lateral slides.
- Roll Stability Control™ (RSC®), which functions to help avoid a vehicle roll-over.



**WARNING:** Vehicle modifications involving braking system, aftermarket roof racks, suspension, steering system, tire construction and/or wheel/tire size may change the handling characteristics of the vehicle and may adversely affect the performance of the AdvanceTrac® with RSC® system. In addition, installing any stereo loudspeakers may interfere with and adversely affect the AdvanceTrac® with RSC® system. Install any aftermarket stereo loudspeaker as far as possible from the front center console, the tunnel, and the front seats in order to minimize the risk of interfering with the AdvanceTrac® with RSC® sensors. Reducing the effectiveness of the AdvanceTrac® with RSC® system could lead to an increased risk of loss of vehicle control, vehicle rollover, personal injury and death.

## Driving

 **WARNING:** Remember that even advanced technology cannot defy the laws of physics. It's always possible to lose control of a vehicle due to inappropriate driver input for the conditions. Aggressive driving on any road condition can cause you to lose control of your vehicle increasing the risk of personal injury or property damage. Activation of the AdvanceTrac® with RSC® system is an indication that at least some of the tires have exceeded their ability to grip the road; this could reduce the operator's ability to control the vehicle, potentially resulting in a loss of vehicle control, vehicle rollover, personal injury and death. If your AdvanceTrac® with RSC® system activates, SLOW DOWN.

 **WARNING:** When a failure has been detected with the AdvanceTrac® with RSC® system, the stability control light will illuminate steadily. AdvanceTrac® with RSC® can be disabled manually by pressing the stability control off button located on the center of the instrument panel. When the system is disabled, the stability control off light will illuminate. If the stability control light still illuminates steadily, have the system serviced by an authorized dealer immediately. Operating your vehicle with AdvanceTrac® with RSC® disabled could lead to an increased risk of loss of vehicle control, vehicle rollover, personal injury and death.

The AdvanceTrac® with RSC® system automatically enables each time the engine is started. All features of the AdvanceTrac® with RSC® system (TCS, ESC, and RSC®) are active and monitor the vehicle from start-up. However, the system will only intervene if the driving situation requires it.

The AdvanceTrac® with RSC® system includes a stability control off button located on the center of the instrument panel.



There are two stability control lights in the instrument cluster. The stability control light in the instrument cluster will flash if a driving situation causes the AdvanceTrac® with RSC® system to operate. If the stability control light illuminates steadily, have the system serviced by an authorized dealer immediately.

**Note:** If the system cannot be turned off, refer to *MyKey®* in the *Locks and Security* chapter for more information.

## Driving

When AdvanceTrac® with RSC® performs a normal system self-check, some drivers may notice a slight movement of the brake, and/or a rumble, grunting, or grinding noise after startup and when driving off.

When an event occurs that activates AdvanceTrac® with RSC® you may experience the following:

- A slight deceleration of the vehicle
- The stability control light will flash.
- A vibration in the pedal when your foot is on the brake pedal
- If the driving condition is severe and your foot is not on the brake, the brake pedal may move as the systems applies higher brake forces. You may also hear a whoosh of air from under the instrument panel during this severe condition.
- The brake pedal may feel stiffer than usual.

### **Traction control system (TCS)**

Traction control is a driver aid feature that helps your vehicle maintain traction of the wheels, typically when driving on slippery and/or hilly road surfaces, by detecting and controlling wheel spin.

Excessive wheel spin is controlled in two ways, which may work separately or in tandem: engine traction control and brake traction control. Engine traction control works to limit drive-wheel spin by momentarily reducing engine power. Brake traction control works to limit single wheel spin by momentarily applying the brakes to the wheel that is slipping. Traction control is most active at low speeds.

During either engine or brake TCS events, the stability control light in the instrument cluster will flash.

If the TCS is activated excessively in a short period of time, the braking portion of the system may become temporarily disabled to allow the brakes to cool down. In this situation, TCS will use only engine power reduction or transfer to help control the wheels from over-spinning.

When the brakes have cooled down, the system will regain all features. Anti-lock braking, RSC®, and ESC are not affected by this condition and will continue to function during the cool-down period.

The engine traction control and brake traction control system may be deactivated in certain situations. But single wheel spin brake traction control is always on. See the *Switching off AdvanceTrac® with RSC®* section following.



### **Electronic stability control (ESC)**

Electronic stability control (ESC) may enhance your vehicle's directional stability during adverse maneuvers, for example when cornering severely or avoiding objects in the roadway. ESC operates by applying brakes to one or more of the wheels individually and, if necessary, reducing engine power if the system detects that the vehicle is about to skid or slide laterally.

During ESC events, the stability control light in the instrument cluster will flash.

Certain adverse driving maneuvers may activate the ESC system, which include but are not limited to:

- Taking a turn too fast
- Maneuvering quickly to avoid an accident, pedestrian or obstacle
- Driving over a patch of ice or other slippery surfaces
- Changing lanes on a snow-rutted road
- Entering a snow-free road from a snow-covered side street, or vice versa
- Entering a paved road from a gravel road, or vice versa
- Cornering while towing a heavily loaded trailer (refer to *Trailer towing* in the *Tires, Wheels and Loading* chapter).

The Electronic Stability Control system may be deactivated in certain situations. See the *Switching off AdvanceTrac® with RSC®* section following.

### **Roll Stability Control™ (RSC®)**

Roll Stability Control™ (RSC®) may help to maintain roll stability of the vehicle during adverse maneuvers. RSC® operates by detecting the vehicle's roll motion and the rate at which it changes and by applying the brakes to one or more wheels individually.

During an event that activates the Roll Stability Control™ (RSC®), the stability control light in the instrument cluster will flash.

Certain adverse driving maneuvers may activate the Roll Stability Control™ system, which include:

- Emergency lane-change
- Taking a turn too fast
- Quick maneuvering to avoid an accident, pedestrian or obstacle

The Roll Stability Control™ system may be deactivated in certain situations. See the *Switching off AdvanceTrac® with RSC®* section following.

## Driving

### Switching off AdvanceTrac® with RSC®

If the vehicle is stuck in snow, mud or sand, and seems to lose engine power, switching off certain features of the AdvanceTrac® with RSC® system may be beneficial because the wheels are allowed to spin. This will restore full engine power and will enhance momentum through the obstacle.

To switch off certain features of the AdvanceTrac® with RSC® system, press the stability control button. Full features of the AdvanceTrac® with RSC® system can be restored by pressing the button again or by turning off and restarting the engine.

If you switch off the AdvanceTrac® with RSC® system, the stability control off light will illuminate steadily. Pressing the stability control button again will turn off the stability control off light.

In R (Reverse), ABS and the engine traction control and brake traction control features will continue to function; however, ESC and RSC® are disabled.

AdvanceTrac® with RSC® Features				
Button functions	Stability control OFF light	RSC®	ESC	TCS
Default at start-up	Illuminated during bulb check	Enabled	Enabled	Enabled
Button pressed momentarily	Illuminated solid	Enabled	Enabled <sup>1</sup>	Disabled <sup>1</sup>
Button pressed and held for more than 5 seconds at vehicle speed under 35 mph (56 km/h)	Flashes then illuminated solid <sup>2</sup>	Disabled	Disabled	Disabled <sup>4</sup>

## Driving

AdvanceTrac® with RSC® Features				
Button functions	Stability control OFF light	RSC®	ESC	TCS
Vehicle speed exceeds 35 mph (56 km/h) after button is pressed and held for more than 5 seconds	Illuminated solid	Enabled	Enabled <sup>1</sup>	Disabled <sup>1</sup>
Button pressed again after deactivation	Not illuminated	Enabled	Enabled	Enabled
Transfer case switched to 4WD Low Locked <sup>3</sup>	Illuminated	Disabled	Disabled	Disabled <sup>4</sup>

<sup>1</sup>TCS could be enabled but with higher entry thresholds compared to full system. ESC entry thresholds are higher compared to full system.

<sup>2</sup>Lamp light starts blinking for three seconds after entering press and hold state.

<sup>3</sup>Control switch is not pressed. Stability control light turned on when 4WD low locked transfer case mode selected.

<sup>4</sup>Engine traction control and two-wheel spin brake traction control functions are disabled. Single wheel spin traction control is always enabled.

### Trailer sway control

Your vehicle is equipped with trailer sway control. When properly equipped, trailer sway control will use the vehicle's AdvanceTrac® with RSC® system to detect and help reduce trailer sway by applying brake force at individual wheels and, if necessary, by reducing engine power.

## Driving



**WARNING:** Trailer sway control does not prevent a trailer from swaying, it mitigates the sway from increasing once it has occurred. If you are experiencing trailer sway it is likely that the trailer is improperly loaded for the correct tongue weight or the speed of the vehicle and trailer is too high. Pull the vehicle-trailer over to a safe location to check the trailer weight distribution and tongue load and reduce speed to a safe level while towing. If trailer sway is experienced, SLOW DOWN. **Note:** When trailer sway control is activated, cruise control is disabled.

During trailer sway control events, the stability control light in the instrument cluster will flash momentarily. The message center will also display **TRAILER SWAY REDUCE SPEED**. In some cases when trailer sway is detected, the vehicle speed is too high and may be above a speed at which trailer sway will not grow continuously. This may cause the system to activate multiple times, causing a gradual reduction in speed.

**Note:** The trailer sway control will only activate at speeds greater than 31 mph (50 km/h).

### Disabling trailer sway control

Trailer sway control can be disabled during any key cycle. See trailer sway control under the *Message center* in the *Instrument Cluster* chapter. Note that regardless of chosen enable state, trailer sway control will be re-enabled at each new key cycle.



**WARNING:** Turning off trailer sway control increases the risk of loss of vehicle control, serious injury, or death. Ford does not recommend disabling this feature except in situations where speed reduction may be detrimental (e.g., hill climbing), the driver has significant trailer towing experience, and can control trailer sway and maintain safe operation.

## STEERING

### 3.7L, 5.0L and 3.5L EcoBoost™ engines:

Your vehicle is equipped with an electric power steering (EPS) system. There is no fluid reservoir to check or fill.

If your vehicle loses electrical power while you are driving (or if the ignition is turned off), you can steer the vehicle manually, but it takes more effort. Under extreme usage conditions, the steering effort may

292

## Driving

increase. This occurs to prevent overheating and permanent damage to your steering system. If this should occur, you will neither lose the ability to steer the vehicle manually nor will it cause permanent damage.

Typical steering and driving maneuvers will allow the system to cool and steering assist will return to normal.

The EPS system has diagnostic checks that continuously monitor the EPS system to ensure proper operation. When a system error is detected, the following message SERVICE POWER STEERING, SERVICE POWER STEERING NOW or POWER STEERING ASSIST FAULT may display in the message center, refer to the *Message center* in the *Driver Controls* chapter for more information.



**WARNING:** The EPS system has diagnostics checks that continuously monitor the EPS system to ensure proper operation of the electronic system. When an electronic error is detected, the message POWER STEERING ASSIST FAULT will be displayed in the message center. If this happens, stop the vehicle in a safe place, and turn off the engine. After at least 10 seconds, reset the system by restarting the engine, and watch the message center for POWER STEERING ASSIST FAULT. If the message returns, or returns while driving, take the vehicle to your dealer to have it checked. With the message displayed, the steering assist is turned off, making the vehicle harder to steer.



**WARNING:** If the message SERVICE POWER STEERING is displayed in the message center, the EPS system has detected a problem with the system function. On the next key cycle the message SERVICE POWER STEERING NOW will be displayed and steering assist will be removed until the steering system is serviced. Have your vehicle taken to the nearest dealer as soon as possible.

**6.2L engine:** Your vehicle is equipped with a hydraulic steering system.

To help prevent damage to the power steering system, never hold the steering wheel at its furthest turning points (until it stops) for more than a few seconds when the engine is running. If the power steering system breaks down (or if the engine is turned off), you can steer the vehicle manually, but it takes more effort.

- Do not operate the vehicle with a low power steering pump fluid level (below the MIN mark on the reservoir).

## Driving

- Some noise is normal during operation. If excessive, check for low power steering pump fluid level before seeking service by your authorized dealer.
- Heavy or uneven steering efforts may be caused by low power steering pump fluid level. Check for low power steering pump fluid level before seeking service by your authorized dealer.
- Do not fill the power steering pump reservoir above the MAX mark on the reservoir, as this may result in leaks from the reservoir.

### All engines

If the steering wanders or pulls equipped with either an EPS or a hydraulic steering system, check for:

- an improperly inflated tire
- uneven tire wear
- loose or worn suspension components
- loose or worn steering components
- improper steering alignment

A high crown in the road or high crosswinds may also make the steering seem to wander/pull.

### LIMITED-SLIP AXLE (IF EQUIPPED)

This axle provides added traction on slippery surfaces, particularly when one wheel is on a poor traction surface. Under normal conditions, the limited-slip axle functions like a standard rear axle. The axle may exhibit a slight noise or vibration in tight turns with low vehicle speed. This is normal behavior and indicates the axle is working.

### Electronic locking differential (ELD) (if equipped)

The electronic locking differential provides added traction on slippery and/or off-road surfaces, particularly when one wheel is on a poor traction surface. In normal driving conditions, the rear axle functions as a standard axle. The ELD may be locked or unlocked by the vehicle operator. Refer to *Four-wheel drive (4WD) operation* section in this chapter for further details on ELD function and usage. When the axle is unlocked, it will function like a standard rear axle. When the axle is locked, it will not allow the rear wheels to rotate at different speeds when turning. The ELD axle is not recommended for use on good traction surfaces such as dry pavement. Doing so may result in abnormal driving behavior while cornering and excessive tire wear.

294

## Driving

### PREPARING TO DRIVE



**WARNING:** Utility vehicles have a significantly higher rollover rate than other types of vehicles.



**WARNING:** In a rollover crash, an unbelted person is significantly more likely to die than a person wearing a seat belt.

Utility vehicles and trucks have larger tires and increased ground clearance, giving the vehicle a higher center of gravity than a passenger car.



**WARNING:** Vehicles with a higher center of gravity such as utility vehicles and trucks handle differently than vehicles with a lower center of gravity. Utility vehicles and trucks are **not** designed for cornering at speeds as high as passenger cars any more than low-slung sports cars are designed to perform satisfactorily under off-road conditions. Avoid sharp turns, excessive speed or abrupt maneuvers in these vehicles. Failure to drive cautiously could result in an increased risk of loss of vehicle control, vehicle rollover, personal injury and death.



**WARNING:** Loaded vehicles, with a higher center of gravity, may handle differently than unloaded vehicles. Do not overload your vehicle and use extra precautions, such as driving at slower speeds, avoiding abrupt steering changes and allowing for increased stopping distance, when driving a heavily loaded vehicle. Over-loading or loading the vehicle improperly can deteriorate handling capability and contribute to loss of vehicle control and vehicle rollover.

### BRAKE-SHIFT INTERLOCK - COLUMN-SHIFT TRANSMISSION

This vehicle is equipped with a park/brake-shift interlock feature that prevents the gearshift lever from being moved from P (Park) when the ignition is in the on position unless the brake pedal is pressed.

If you cannot move the gearshift lever out of P (Park) with ignition in the on position and the brake pedal pressed, it is possible that a fuse has blown or the vehicle's brake lamps are not operating properly. Refer to *Fuses and relays* in the *Roadside Emergencies* chapter.

## Driving

If the fuse is not blown, perform the following procedure:

**Note:** The following procedure is easier to perform when the steering column is adjusted to the full up position. Refer to *Tilt steering wheel* in the *Driver Controls* chapter.

1. Apply the parking brake, turn the ignition to the off position, then remove the key.
2. Move the shift lever boot by pressing on the edges and moving it up the gearshift lever.

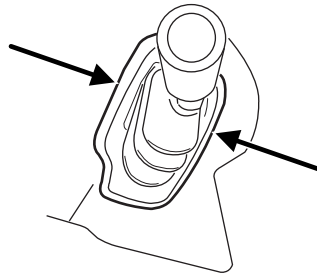

3. Turn the steering wheel one-half turn to access the slots on each side of the steering wheel.

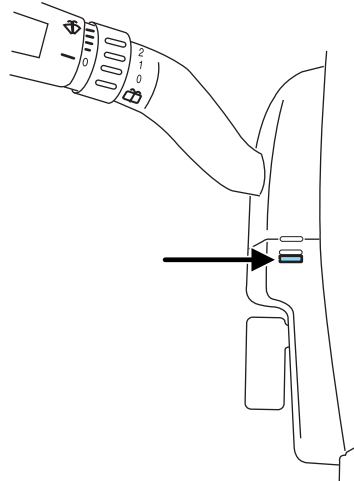



## Driving

4. Insert a flat head screwdriver into each slot to unsnap and remove the steering column cover. Rotate the column up on its hinges and pull rearward to remove the cover from the hinges.

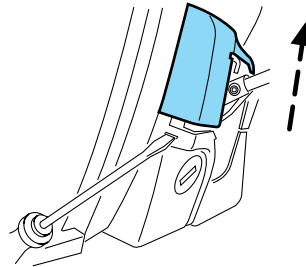

5. With the ignition in the on position, pull back on the BSI solenoid found on top of the uncovered steering column and at the same time, apply the brake pedal and shift the transmission into N (Neutral).

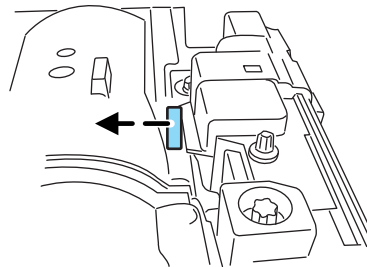

6. Reinstall the steering column cover, start the vehicle and release the parking brake.

**Note:** After the transmission is shifted to N (Neutral), it is easier to reinstall the cover when the column is in the middle or lower tilt position.



**WARNING:** Do not drive your vehicle until you verify that the brakelamps are working.



**WARNING:** Always set the parking brake fully and make sure the gearshift is latched in P (Park). Turn the ignition to the off position and remove the key whenever you leave your vehicle.



**WARNING:** If the parking brake is fully released, but the brake warning lamp remains illuminated, the brakes may not be working properly. See your authorized dealer.

## Driving

### Brake-shift interlock – floor-shift transmission

This vehicle is equipped with a brake-shift interlock feature that prevents the gearshift lever from being moved from P (Park) when the ignition is in the on position unless the brake pedal is pressed.

If you cannot move the gearshift lever out of P (Park) with ignition in the on position and the brake pedal pressed, it is possible that a fuse has blown or the vehicle's brake lamps are not operating properly. Refer to *Fuses and relays* in the *Roadside Emergencies* chapter.

If the fuse is not blown and the brake lamps are working properly, the following procedure will allow you to move the gearshift lever from P (Park):

1. Apply the parking brake, turn the ignition key to the off position, and remove the key.
2. Starting at the rear of the trim panel, using a screwdriver (or similar tool) carefully pry up the trim panel from rear attachments and disconnect it from the console to expose the inside of the gearshift.

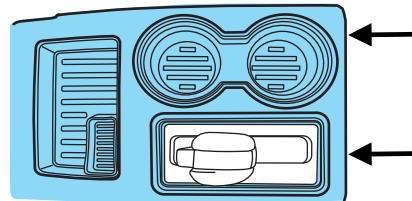

3. Locate the brake shift interlock lever on the passenger side of the shifter assembly.

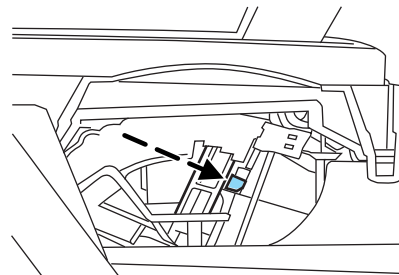

4. Apply the brake pedal. Using a screwdriver (or similar tool), press and hold the brake shift interlock lever while pulling the gearshift lever out of the P (Park) position and into the N (Neutral) position.
5. Install the trim panel.

6. Apply brake pedal, start the vehicle, and release the parking brake.

**See your authorized dealer as soon as possible if this procedure is used.**



**WARNING:** Do not drive your vehicle until you verify that the brakelamps are working.

## Driving

 **WARNING:** Always set the parking brake fully and make sure the gearshift is latched in P (Park). Turn the ignition to the off position and remove the key whenever you leave your vehicle.

 **WARNING:** If the parking brake is fully released, but the brake warning lamp remains illuminated, the brakes may not be working properly. See your authorized dealer.

### AUTOMATIC TRANSMISSION OPERATION

#### Understanding the shift positions of the 6-speed automatic transmission

This vehicle is equipped with an adaptive transmission shift strategy. The adaptive transmission shift strategy offers the optimal transmission operation and shift quality. When the engine is turned off, the shift data which includes the adaptive information will be stored automatically in the powertrain control module (PCM). If the battery is disconnected for any reason, the stored information from the last time the key was turned off will be read. This way, no information will be lost with any battery removal or battery disconnect.

#### **P (Park)**

This position locks the transmission and prevents the rear wheels from turning.

To put your vehicle in gear:

- Press the brake pedal
- Start the engine
- Move the gearshift lever into the desired gear. If your vehicle is equipped with a floor-shift transmission, press the gearshift lever release button (on the front of the lever) while shifting into the desired gear.

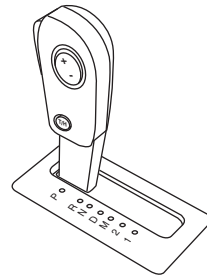

## Driving

To put your vehicle in P (Park):

- Come to a complete stop
- Move the gearshift lever and securely latch it in P (Park)



**WARNING:** Always set the parking brake fully and make sure the gearshift is latched in P (Park). Turn the ignition to the off position and remove the key whenever you leave your vehicle.

### R (Reverse)

With the gearshift lever in R (Reverse), the vehicle will move backward. Always come to a complete stop before shifting into and out of R (Reverse).

### N (Neutral)

With the gearshift lever in N (Neutral), the vehicle can be started and is free to roll. Hold the brake pedal down while in this position.

### D (Drive) with Tow/Haul Off

The normal driving position for the best fuel economy. Transmission operates in gears one through six.

### D (Drive) with Tow/Haul On

The Tow/Haul feature improves transmission operation when towing a trailer or a heavy load. All transmission gear ranges are available when using Tow/Haul.

Tow/Haul can be activated by pressing the transmission control switch on the end of the gearshift lever (column-shift transmission) or on the side of the gearshift lever (floor-shift transmission).

- Column-shift transmission

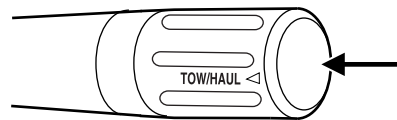

## Driving

- Floor-shift transmission

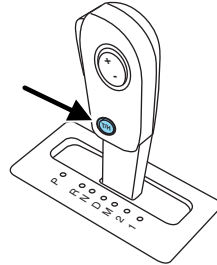

The TOW HAUL indicator light will illuminate in the instrument cluster.

**TOW  
HAUL**

Tow/haul delays upshifts to reduce frequency of transmission shifting. Tow/haul also provides engine braking in all forward gears when the transmission is in the D (Drive) position; this engine braking will slow the vehicle and assist the driver in controlling the vehicle when descending a grade. Depending on driving conditions and load conditions, the transmission may downshift, slow the vehicle and control the vehicle speed when descending a hill, without the accelerator pedal being pressed. The amount of downshift braking provided will vary based upon the amount the brake pedal is pressed.

To deactivate the tow/haul feature and return to normal driving mode, press the button on the end of the gearshift lever. The TOW HAUL light will no longer be illuminated. Tow/haul will also deactivate when the vehicle is powered down.



**WARNING:** Do not use the tow/haul feature when driving in icy or slippery conditions as the increased engine braking can cause the rear wheels to slide and the vehicle to swing around with the possible loss of vehicle control.

### **3 (Third) (column-shift only) (For vehicles without SST)**

Transmission operates in third gear only.

Used for improved traction on slippery roads. Selecting 3 (Third) provides engine braking.

### **2 (Second)**

Transmission operates in 2nd gear only.

Use 2 (Second) to start-up on slippery roads or to provide additional engine braking on downgrades.

## Driving

### 1 (First)

- Transmission operates in 1st gear only.
- Provides maximum engine braking.
- Allows upshifts by moving gearshift lever.
- Will not downshift into 1 (First) at high speeds; allows for 1 (First) when vehicle reaches slower speeds.

### Forced downshifts

- Allowed in D (Drive) only.
- Press the accelerator to the floor.
- Allows transmission to select an appropriate gear.

### ***Understanding your SelectShift Automatic™ transmission (SST) gearshift lever (if equipped)***

This vehicle may be equipped with a SelectShift Automatic™ transmission (SST) gearshift lever. The SST is an automatic transmission with the ability for the driver to change gears up or down (without a clutch) as desired. The SST feature has two modes: PRS and M mode.

### **PRS (Progressive Range Selection)**

With the gearshift lever in D (Drive), press the – button to active PRS. The available and selected gears will be indicated on the instrument cluster.

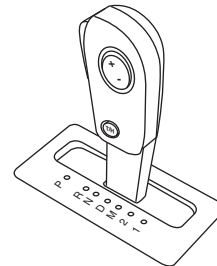
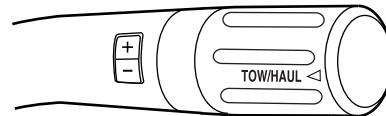

All available gears will be displayed with the current gear indicated. Press the – button again to lock out gears beginning with the highest gear. Example: press the – button twice to lock out 6th and 5th gears. Only the available gears will be displayed and the transmission will automatically shift between the available gears. Press the + button to unlock gears to allow the transmission to shift to higher gears. The transmission will shift automatically within the gear range you select.

302

### M (Manual)

With the gearshift lever in M (Manual), the driver can change gears up or down as desired. This is called SelectShift Automatic™ transmission (SST) mode. By moving the gearshift lever from drive position D (Drive) to M (Manual), you now have control of selecting the gear you desire using buttons on the shift lever. Only the current gear will be displayed. Press the + button or the – button to upshift or downshift. If the – button is pressed at a vehicle speed that would cause an engine overspeed, the requested gear will flash then disappear and the transmission will remain in the current gear.

To return to normal D (Drive) position, move the shift lever back from M to D.

The transmission will operate in gears one through six.

### Recommended shift speeds

Upshift according to the following chart:

Upshifts when accelerating	
Shift from:	
1 – 2	15 mph (24 km/h)
2 – 3	25 mph (40 km/h)
3 – 4	40 mph (64 km/h)
4 – 5	45 mph (72 km/h)
5 – 6	50 mph (80 km/h)

In order to prevent the engine from running at too low an RPM, which may cause it to stall, the SST will still automatically make some downshifts if it has determined that you have not downshifted in time. Although the SST will make some downshifts for you, it will still allow you to downshift at any time as long as the SST determines that the engine will not be damaged from over-revving.

The SST will not automatically upshift, even if the engine is approaching the RPM limit. It must be shifted manually by pressing the + button.

**Engine damage may occur if excessive engine revving is held without shifting.**

### If your vehicle gets stuck in mud or snow

If your vehicle gets stuck in mud or snow, it may be rocked out by shifting between forward and reverse gears, stopping between shifts in a steady pattern. Press lightly on the accelerator in each gear.

## Driving

**Do not rock the vehicle if the engine is not at normal operating temperature or damage to the transmission may occur.**

**Do not rock the vehicle for more than a minute or damage to the transmission and tires may occur, or the engine may overheat.**

### REVERSE SENSING SYSTEM (IF EQUIPPED)

The Reverse Sensing System (RSS) sounds a tone to warn the driver of obstacles near the rear bumper when R (Reverse) is selected and the vehicle is moving at speeds less than 3 mph (5 km/h). The system is not effective at speeds above 3 mph (5 km/h) and may not detect certain angular or moving objects.



**WARNING:** To help avoid personal injury, please read and understand the limitations of the reverse sensing system as contained in this section. Reverse sensing is only an aid for some (generally large and fixed) objects when moving in reverse on a flat surface at “parking speeds”. Inclement weather may also affect the function of the RSS; this may include reduced performance or a false activation.



**WARNING:** To help avoid personal injury, always use caution when in reverse and when using the RSS.



**WARNING:** This system is not designed to prevent contact with small or moving objects. The system is designed to provide a warning to assist the driver in detecting large stationary objects to avoid damaging the vehicle. The system may not detect smaller objects, particularly those close to the ground.



**WARNING:** Certain add-on devices such as large trailer hitches, bike or surfboard racks and any device that may block the normal detection zone of the RSS system may create false beeps.



## Driving

The RSS detects obstacles up to 6 feet (2 meters) from the rear bumper with a decreased coverage area at the outer corners of the bumper, (refer to the figures for approximate zone coverage areas). As you move closer to the obstacle, the rate of the tone increases. When the obstacle is less than 10 inches (25.0 cm) away, the tone will sound continuously. If the RSS detects a stationary or receding object further than 10 inches (25.0 cm) from the side of the vehicle, the tone will sound for only three seconds. Once the system detects an object approaching, the tone will sound again.

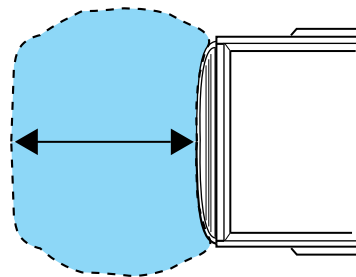
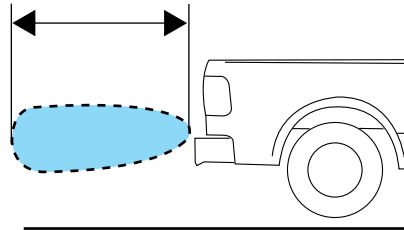

While receiving a warning the radio volume may be reduced to a predetermined level. After the warning goes away, the radio will return to the previous volume.

The RSS may have reduced performance or an increased chance of false detection if the tailgate is not locked and in the upright position. If the tailgate is down, the RSS tone may be heard intermittently or continuously. The tone may also be heard if items in the truck bed protrude rearward outside the bed.

The RSS automatically turns on when the gearshift lever is placed in R (Reverse) and the ignition is on. A control in the message center allows the driver to disable the system, refer to *Message center and Rear park aid* in the *Instrument Cluster* chapter for more information.

**Note:** If the system cannot be turned off, refer to *MyKey® restricted features* in the *Locks and Security* chapter for more information.

**Note:** If your vehicle is equipped with a fully integrated electronic trailer brake controller (TBC) and a trailer with electric trailer brakes is connected to your vehicle, the RSS will be disabled. When the vehicle is shifted into reverse, the message center display will remain in the Rear Park Aid Off selection. For more information on the TBC, refer to the *Tires, Wheels and Loading* chapter.

## Driving

**Keep the RSS sensors (located on the rear bumper/fascia) free from snow, ice and large accumulations of dirt (do not clean the sensors with sharp objects). If the sensors are covered, it will affect the accuracy of the RSS.**

**If your vehicle sustains damage to the rear bumper/fascia, leaving it misaligned or bent, the sensing zone may be altered causing inaccurate measurement of obstacles or false alarms.**

### **REARVIEW CAMERA SYSTEM (IF EQUIPPED)**

The rear video camera system, located on the tailgate, provides a video image which appears on the rearview mirror or touchscreen display, of the area behind the vehicle. It adds assistance to the driver while reversing or reverse parking the vehicle. To use the rear video camera system, place the transmission in R (Reverse). An image will display on the rearview mirror or on the touchscreen display. The area displayed on the screen may vary according to the vehicle orientation and/or road condition. The rear video camera includes the following features that will assist the driver in reverse driving.

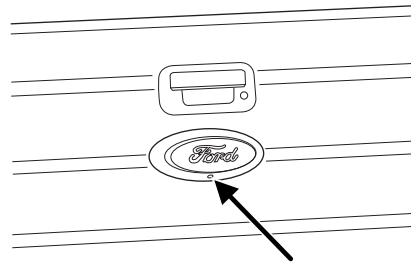

#### **Fixed guidelines**

The fixed guidelines assist a driver with backing into a parking space or aligning with an object behind the vehicle.

If equipped with touch screen display: To turn this feature on or off when the vehicle is in R (Reverse), select Settings on the touch screen display. The fixed guideline options are FIXED and OFF.

If equipped with rearview mirror display and optional instrument cluster: To turn this feature on or off, select the following from the message center in the instrument cluster:

1. Settings
2. Driver Assist
3. Rear View Camera
4. Guidelines

The guidelines options are FIXED and OFF. If the vehicle is equipped with a rearview mirror display and a standard instrument cluster, the fixed guidelines will always remain on. There is no option to turn the fixed guidelines off.

306

### Visual park aid alert (if equipped)

Visual park aid alert allows the driver to see the area that is causing the reverse sensing system to beep. The visual alerts are red, yellow or green highlights which appear on top of the video image when an object is detected by the reverse sensing system. The visual alert will highlight the closest object detected by the reverse sensing system. The reverse sensing alert can be disabled and if visual park aid alert is enabled, highlighted areas will still be displayed.

If equipped with touch screen display: To turn this feature on or off when the vehicle is in R (Reverse), select Settings on the touch screen display. The visual park aid alert options are ON and OFF.

If equipped with rearview mirror display and optional instrument cluster: To turn this feature on or off, select the following from the message center in the instrument cluster:

1. Settings
2. Driver Assist
3. Rear View Camera
4. Visual Park Aid

The visual park aid alert options are ON and OFF. The visual park aid alert feature is not available on vehicles with a rearview mirror and a standard instrument cluster.

**Note:** The reverse sensing system is not effective at speeds above 3 mph (5 km/h) and may not detect certain angular or moving objects.

- (1) Rear bumper
- (2) Red zone
- (3) Yellow zone
- (4) Green zone
- (5) Center line of vehicle

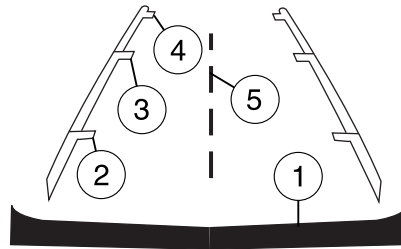

Always use caution while backing. Objects in the red zone (2) are closest to your vehicle and objects in the green zone (4) are further away. Objects are getting closer to your vehicle as they move from the green zone (4) to the yellow (3) or red zones (2). Use the side mirrors and rearview mirror to get better coverage on both sides and rear of the vehicle.

## Driving

When towing, the reverse camera system will only see what is being towed behind the vehicle. This might not provide adequate coverage as it usually provides in normal operation and some objects might not be seen.

Fixed guidelines and visual park aid alert features are only available when the vehicle is in R (Reverse).

### Manual zoom

The manual zoom feature assists drivers with connecting their vehicle to a trailer for the purpose of towing. It allows the driver to manually zoom closer to an object behind the vehicle. The zoomed image keeps the bumper in the image to provide a reference.

If equipped with touch screen display: To turn the manual zoom feature on or off, do the following:

1. Place the vehicle in R (Reverse).
2. Select Zoom on the touch screen display.

Press ▲ or ▼ to manually adjust the zoom levels. You can choose from OFF, Level 1, Level 2 and Level 3. The selected level will appear between the buttons (i.e. Level 1). When activating manual zoom mode, the system always starts from OFF.

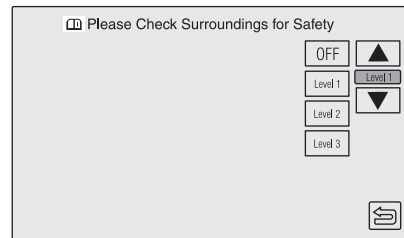

If equipped with rearview mirror display and optional instrument cluster: To turn the manual zoom feature on or off, do the following:

1. Place the vehicle in R (Reverse).
2. A rear park aid menu will appear. Select either ON or OFF by using the steering wheel controls to scroll up or down and the OK button to make a selection. A selection must be made in order to get to the camera zoom menu.

## Driving

Press ▲ and ▼ on the steering wheel controls to select a zoom option. You can choose from OFF, Level 1, Level 2 and Level 3. Use the OK button to make a selection. When activating manual zoom mode, the system will always start from OFF.

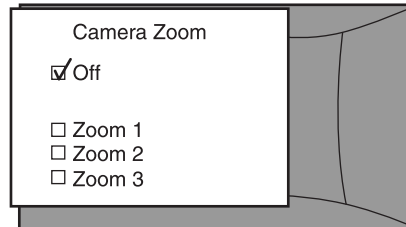

The manual zoom feature is not available on vehicles equipped a rearview mirror display and a standard instrument cluster.

When manual zoom is enabled, only the centerline will be shown.

### **Rear camera delay**

If equipped with rearview mirror display and optional instrument cluster: After shifting out of R (Reverse) and into any gear, the image will remain until vehicle speed reaches 5 mph (8 km/h). This will only occur if the rear camera delay feature is ON. The default setting for the rear camera delay is ON. To turn this feature on or off, select the following from the message center in the instrument cluster:

1. Settings
2. Driver Assist
3. Rear View Camera
4. Camera Delay

The camera delay options are ON and OFF. If the vehicle is equipped with a rearview mirror display and the standard instrument cluster, the camera delay will always remain on. There is no option to turn the camera delay off.

If equipped with the touchscreen display: After shifting out of R (Reverse) and into any gear other than P (Park), the image will remain until the vehicle speed reaches five mph (8 km/h). This will only occur if the rear camera delay feature is on, or until any radio button is selected.

The default setting for the rear camera delay is ON. Use the Settings function on the touchscreen display to set the rear camera delay on or off. Refer to the navigation supplement for more information.

When towing, the rearview camera system will only see what is being towed behind the vehicle. This might not provide adequate coverage it usually provides in normal operation and some objects might not be seen.

## Driving

The camera lens for the reverse camera system is located on the tailgate. Keep the lens clean so the video image remains clear and undistorted. Clean the lens with a soft, lint-free cloth and non-abrasive cleaner.

**Note:** If the camera system image is not clear or seems distorted, it may be covered with water droplets, snow, mud or any other substance. If this occurs, clean the camera lens before using the camera system.



**WARNING:** The rearview camera system is a reverse aid supplement device that still requires the driver to use it in conjunction with the rearview mirror and the side mirrors for maximum coverage.



**WARNING:** Objects that are close to either corner of the bumper or under the bumper, might not be seen on the screen due to the limited coverage of the camera system.



**WARNING:** Backup as slow as possible since higher speeds might limit your reaction time to stop the vehicle.



**WARNING:** Do not use the rearview camera system when the tailgate is open. If the back end of the vehicle is hit or damaged, check with your authorized dealer to have your rear camera system checked for proper coverage and operation.



**WARNING:** When manual zoom is enabled (Level 1, Level 2 or Level 3), the full area behind the vehicle will not be shown. Be aware of your surroundings when using the manual zoom feature.

### Night time and dark area use

At night time or in dark areas, the camera system relies on the reverse lamp lighting to produce an image. Therefore it is necessary that both reverse lamps are operating in order to get a clear image in the dark. If either of the lamps are not operating, stop using the camera system, at least in the dark, until the lamp(s) are replaced and functioning.

### Servicing

- If the image comes on while the vehicle is not in R (Reverse), have the system inspected by your authorized dealer.
- If the image is not clear, then check if there is anything covering the lens such as dirt, mud, ice, snow, etc. If the image is still not clear after cleaning, have your system inspected by your authorized dealer.

### BLIND SPOT MIRRORS (IF EQUIPPED)

Blind spot mirrors have a convex spotter mirror built into the upper outboard corner of the outside mirrors. They are designed to assist the driver by increasing visibility along the side of the vehicle. This vehicle is equipped with a spotter mirror on the driver side only. The addition of this spotter mirror on the passenger side would not increase that mirror's field of view.

#### Driving with blind spot mirrors

Before a lane change, check the main mirror first, then check the blind spot mirror. If no vehicles are present in the blind spot mirror and the traffic in the adjacent lane is at a safe distance, signal that you are going to change lanes. Glance over your shoulder to verify traffic is clear, and carefully change lanes.

When the approaching vehicle is at a distance, its image is small and near the inboard edge of the main mirror (1). As the vehicle approaches, the image becomes larger and begins to move outboard across the main mirror (1). As the vehicle approaches its image will transition from the main mirror and begin to appear in the blind spot mirror (2).

As the vehicle leaves the blind spot mirror it will transition to the driver's peripheral field of view (3).

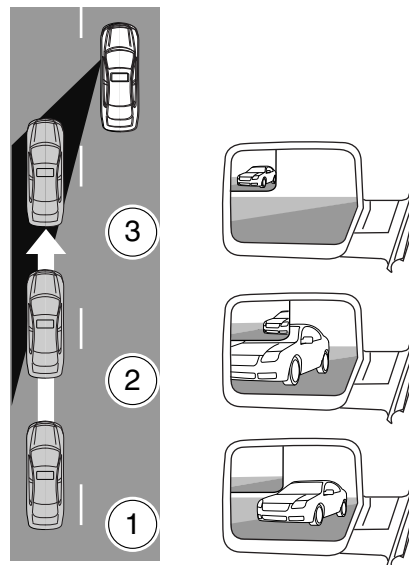

**WARNING:** Objects in the blind spot mirror are closer than they appear.

## Driving

### FOUR-WHEEL DRIVE (4WD) OPERATION (IF EQUIPPED)



**WARNING:** For important information regarding safe operation of this type of vehicle, see **Preparing to drive your vehicle** in this chapter.

Four-wheel drive (4WD) supplies power to all four wheels. 4WD should not be operated on dry pavement; driveline damage may occur.

**If equipped with the electronic shift 4WD system, and 4X4 low is selected while the vehicle is moving above 3 mph (5 km/h), the 4WD system will not perform a shift. This is normal and should be no reason for concern.** Refer to *Shifting to/from 4L (4X4 Low)* for proper operation.

#### 4WD indicator lights

The indicator lights illuminate in the message center in the reconfigurable telltale (RTT) location under the following conditions. Refer to *Warning lights and chimes* in the *Instrument Cluster* chapter.

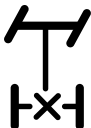
- **4X2** - Momentarily illuminates when 2H is selected on electronic shift 4WD systems only. **4x2**
- **AWD** - Illuminates when AWD is selected (all-wheel drive equipped vehicles only). **AWD**
- **4X4 HIGH** - Illuminates when 4H is selected. **4x4 HIGH**
- **4X4 LOW** - Illuminates when 4L is selected. **4x4 LOW**
-  - Illuminates when the electronic locking differential (ELD) is selected (if equipped). 



- **CHECK 4X4** - Displays when a 4X4 fault is present.



**Note:** When a 4X4 system fault is present, the system will typically remain in whichever 4X4 mode was selected prior to the fault condition occurring. It will not default to 4X2 in all circumstances. When this warning is displayed, have your vehicle serviced by an authorized dealer.

### Using a manual 4WD system (if equipped)

**2H (4X2)** – Power to the rear wheels only; used for street and highway driving. Provides optimal smoothness and fuel economy at high speeds.

**4H (4X4 High)** – Used for extra traction such as in snow or icy roads or in off-road situations. Not intended for use on dry pavement.

**N (Neutral)** – No power to either front or rear wheels.

**4L (4X4 Low)** – Uses extra gearing to provide maximum power to all four wheels at reduced speeds. Intended only for off-road applications such as deep sand, steep grades or pulling heavy objects. The shift lever will not engage 4L (4X4 LOW) until the transmission is in N (neutral) and the vehicle is moving below 3 mph (5 km/h); this is normal and should be no reason for concern. Refer to *Shifting to/from 4L (4X4 Low)* for proper operation.

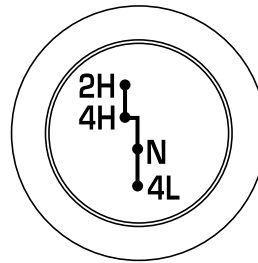

### Shifting between 2H (4X2) and 4H (4X4 high)

- Move the transfer case lever between 2H (4X2) and 4H (4X4 high) at a stop or any forward speed.

**Note:** Momentarily releasing the accelerator pedal while performing a shift will improve engagement/disengagement times.

**Note:** Do not perform this operation if the rear wheels are slipping.

**Note:** Some noise may be heard as the system shifts or engages; this is normal.

**Note:** 4X4 high mode is not intended for use on dry pavement.

### Shifting to/from 4L (4X4 low)

1. Bring the vehicle to a speed of 3 mph (5 km/h) or less.
2. Place the transmission in N (Neutral).

## Driving

3. Move the transfer case lever through N (Neutral) directly to the desired position.

- If the transfer case **will not** engage into 4L (4X4 low) **do not force the lever**. Allow the vehicle to coast at a speed below 3 mph (5 km/h), then repeat Steps 2 and 3.

**Note:** Some noise may be heard as the system shifts or engages; this is normal.

**Note:** 4X4 low mode is not intended for use on dry pavement.

**Note:** For proper operation in 4X4 low, ensure the transfer case shift lever is moved entirely rearward in to the 4L (4X4 Low) position and that the 4x4 Low light is displayed in the message center.

**Note:** Ideal 4L (4X4 low) shift conditions occur when the vehicle is rolling at a speed below 3 mph (5 km/h) and the transmission is in N (Neutral).

### Using the N (Neutral) position

**The transfer case N (Neutral) position overrides the transmission and puts the vehicle in neutral regardless of transmission gearshift lever position. The vehicle can move forward or backward.**

This position should only be used when towing the vehicle.



**WARNING:** Do not leave the vehicle unattended with the transfer case in the N (Neutral) position. Always set the parking brake fully and turn off the ignition when leaving the vehicle.

### Using the electronic shift 4WD system (if equipped)

**2H (2WD)** - For general on-road driving. Sends power to the rear wheels only and should be used for street and highway driving. Provides optimal smoothness and fuel economy at high speeds.

**4H (4X4 High)** - Used for extra traction such as in snow or icy roads or in off road situations. **This mode is not intended for use on dry pavement.**

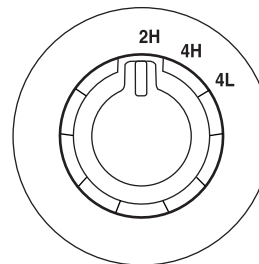

**4L (4X4 Low)** - Uses extra gearing to provide maximum power to all four wheels at reduced speeds. Intended only for off-road applications such as deep sand, steep grades or pulling heavy objects. 4L (4X4 low) will not engage while the vehicle is moving above 3 mph (5 km/h); this is normal and should be no reason for concern. Refer to *Shifting to/from 4L (4X4 low)* for proper operation.

### **Shifting between 2H (4X2) and 4H (4X4 high)**

Move the 4WD control between 2H (4X2) and 4H (4X4 high) at any forward speed. The message center will display **4X4 SHIFT IN PROGRESS** during the system shift. “4X4 HIGH” will display in the message center if 4H is selected and “4X2” will momentarily display in the message center if 2H is selected.

If **SHIFT DELAYED PULL FORWARD** is displayed in the message center during the mode shift, transfer case gear tooth blockage is present. To alleviate this condition, place the transmission in a forward gear and move the vehicle forward approximately 5 feet (2 meters) to allow the transfer case to complete the mode shift.

**Note:** Momentarily releasing the accelerator pedal while performing a shift will improve engagement/disengagement times.

**Note:** Do not perform this operation if the rear wheels are slipping.

**Note:** Some noise may be heard as the system shifts or engages; this is normal.

**Note:** 4X4 high mode is not intended for use on dry pavement.

### **Shifting to/from 4L (4X4 low)**

1. Bring the vehicle to a speed of 3 mph (5 km/h) or less.
2. Place the transmission in N (Neutral).
3. Move the 4WD control to the desired position.

The message center will display **4X4 SHIFT IN PROGRESS** during the shift. The message center will then display the system mode selected. If any of the above shift conditions are not met, the shift will not occur and the message center will display information guiding the driver through the proper shifting procedures.

If **SHIFT DELAYED PULL FORWARD** is displayed in the message center, transfer case gear tooth blockage is present. To alleviate this condition, place the transmission in a forward gear, move the vehicle forward approximately 5 feet (1.5 m), and shift the transmission back to neutral to allow the transfer case to complete the range shift.

## Driving

**Note:** Some noise may be heard as the system shifts or engages; this is normal.

**Note:** 4x4 low mode is not intended for use on dry pavement.

### **Using the all-wheel drive (AWD) system (if equipped, Harley-Davidson™ only)**

This system includes an electronically controlled transfer case. The system is interactive with the road, continually monitoring and adjusting torque delivery to the front and rear wheels to optimize traction.

**2H (4X2)** - Power to the rear wheels only; used for street and highway driving. Provides optimal smoothness and fuel economy at high speeds. The message center will momentarily display “4X2” when this mode is selected.

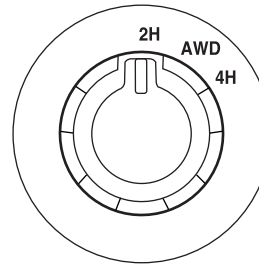

**AWD (4X4 auto)** - Power delivered to all four wheels, as required, for increased traction.

**4H (4X4 high)** - Used for extra traction on snow covered or icy roads and in off-road situations. This position is not recommended for use on dry pavement. This position is only intended for severe winter or off-road conditions, such as deep snow, ice or deep sand. The message center will display “4X4 High” when this mode is selected.

**Note:** Do not use 4H (4X4 high) on dry, hard surfaced roads. Doing so will produce excessive noise, increased tire wear and may damage drive components. 4H (4X4 High) is only intended for consistently slippery or loose surfaces. Use of 4H (4X4 High) on these surfaces may produce some noise (such as occasional clunks), but will not damage drive components.

### **Shifting between 2H (4X2) and AWD (auto) or 4H (high)**

Move the control from the 2H position to the AWD or 4H position at a stop or while driving at any forward speed. The message center may display “4X4 SHIFT IN PROGRESS” during the system shift. The message center will then display “AWD” if AWD has been selected or “4X4 high” if 4H is selected. The message center will momentarily display “4X2” if 2H has been selected.

**Note:** 4X4 high mode is not intended for use on dry pavement

316

### ***Shifting between AWD (auto) and 4H (high)***

Move the control from AWD to 4H at a stop or while driving at any speed. The message center will display “AWD” if AWD has been selected and “4X4 high” if 4H has been selected

**Note:** 4X4 high mode is not intended for use on dry pavement

### ***Electronic locking differential (ELD) (if equipped)***

The electronic locking differential (ELD) is a device housed in the rear axle which allows both rear wheels to turn at the same speed. The ELD can provide additional traction should the vehicle become stuck. The ELD is electronically activated by the driver and can be shifted on the fly. It is intended for use in mud, rocks, sand, or any off-road condition where maximum traction is needed. It is not intended for use on dry pavement.

The ELD is affected by the following conditions:



- The 4WD control must be in either 4H (4X4 high) or 4L (4X4 low) mode.
- The ELD will not engage if the vehicle speed is above 20 mph (30 km/h) in 4X4 high or 56 mph (90 km/h) in 4X4 low.
- In 4H (4X4 high), the ELD will disengage at speeds above 25 mph (40 km/h) and will automatically reengage at speeds below 20 mph (30 km/h).
- In 4L (4X4 low), the ELD will disengage at speeds above 62 mph (100 km/h) and will automatically reengage at speeds below 56 mph (90 km/h).



The ELD is designed for off-road use only and is not intended for use on dry pavement.



## Driving

### **Activating the electronic locking differential (ELD)**

The ELD can be turned on by pulling the knob on the 4WD control toward you while the control is in either 4H (4X4 high) or 4L (4X4 low) mode.

Once the knob is pulled, the  light located on the control will blink for approximately two seconds and then it will remain solid. The  indicator light will also display in the message center.

Once the  light on the control remains solid and the  indicator light is displayed in the message center, both rear wheel axle shafts will be locked together providing added traction.

If the  light blinks for 10 seconds, then turns off, and the  indicator light in the message center turns off, one of the following has occurred:

- The vehicle speed is too high.
- The left and right rear wheel speed difference is too high during an engagement attempt.
- The system has malfunctioned and will be accompanied by a **CHECK LOCKING DIFFERENTIAL** message in the message center.

**Note:** If the ELD has difficulty disengaging, release the accelerator pedal and turn the steering wheel in the opposite direction while rolling.

### **Driving off-road with truck and utility vehicles**

4WD vehicles are specially equipped for driving on sand, snow, mud and rough terrain and have operating characteristics that are somewhat different from conventional vehicles, both on and off the road.

Your vehicle may be equipped with a front air dam that can become damaged (due to reduced ground clearance) when taking your vehicle off-road. This air dam can be taken off by removing two bolts.

For vehicles equipped with a 3.5L Ecoboost™ engine:

Your vehicle is equipped with an underbody transmission shield and brackets that may become damaged (due to reduced ground clearance)

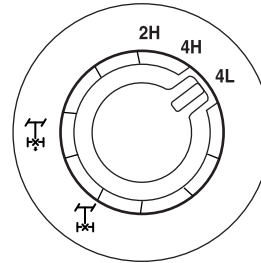

## Driving

when taking your vehicle off-road. Remove the shield by disengaging the fasteners at each corner of the shield. Then, remove the shield rear brackets by removing the bracket to frame bolts, or have your authorized dealer perform the work for you

### ***How your vehicle differs from other vehicles***

Truck and utility vehicles can differ from some other vehicles. Your vehicle may be higher to allow it to travel over rough terrain without getting hung up or damaging underbody components.

The differences that make your vehicle so versatile also make it handle differently than an ordinary passenger car.

Maintain steering wheel control at all times, especially in rough terrain. Since sudden changes in terrain can result in abrupt steering wheel motion, make sure you grip the steering wheel from the outside. Do not grip the spokes.

Drive cautiously to avoid vehicle damage from concealed objects such as rocks and stumps.

You should either know the terrain or examine maps of the area before driving. Map out your route before driving in the area. To maintain steering and braking control of your vehicle, you must have all four wheels on the ground and they must be rolling, not sliding or spinning.

### ***Basic operating principles***

- Do not use 4WD on dry, hard surfaced roads. Doing so will produce excessive noise, increase tire wear and may damage drive components. 4WD modes are only intended for consistently slippery or loose surfaces.
- Drive slower in strong crosswinds which can affect the normal steering characteristics of your vehicle.
- Be extremely careful when driving on pavement made slippery by loose sand, water, gravel, snow or ice.

### ***If your vehicle goes off the edge of the pavement***

- If your vehicle goes off the edge of the pavement, slow down, but avoid severe brake application, ease the vehicle back onto the pavement only after reducing your speed. Do not turn the steering wheel too sharply while returning to the road surface.
- It may be safer to stay on the apron or shoulder of the road and slow down gradually before returning to the pavement. You may lose control if you do not slow down or if you turn the steering wheel too sharply or abruptly.

## Driving

- It often may be less risky to strike small objects, such as highway reflectors, with minor damage to your vehicle rather than attempt a sudden return to the pavement which could cause the vehicle to slide sideways out of control or roll over. Remember, your safety and the safety of others should be your primary concern.



**WARNING:** Vehicles with a higher center of gravity such as utility and four-wheel drive vehicles handle differently than vehicles with a lower center of gravity. Utility and four-wheel drive vehicles are **not** designed for cornering at speeds as high as passenger cars any more than low-slung sports cars are designed to perform satisfactorily under off-road conditions. Avoid sharp turns, excessive speed and abrupt maneuvers in these vehicles. Failure to drive cautiously could result in an increased risk of loss of vehicle control, vehicle rollover, personal injury and death.

### ***If your vehicle gets stuck***

If your vehicle gets stuck in mud or snow it may be rocked out by shifting between forward and reverse gears, stopping between shifts, in a steady pattern. Press lightly on the accelerator in each gear.

**Do not rock the vehicle if the engine is not at normal operating temperature or damage to the transmission may occur.**

**Do not rock the vehicle for more than a few minutes or damage to the transmission and tires may occur or the engine may overheat.**



**WARNING:** Do not spin the wheels at over 35 mph (56 km/h). The tires may fail and injure a passenger or bystander.

### ***Emergency maneuvers***

- In an unavoidable emergency situation where a sudden sharp turn must be made, remember to avoid “over-driving” your vehicle, i.e., turn the steering wheel only as rapidly and as far as required to avoid the emergency. Excessive steering will result in less vehicle control, not more. Additionally, smooth variations of the accelerator and/or brake pedal pressure should be utilized if changes in vehicle speed are called for. Avoid abrupt steering, acceleration or braking which could result in an increased risk of loss of vehicle control, vehicle rollover and/or personal injury. Use all available road surface to return the vehicle to a safe direction of travel.

320



## Driving

- In the event of an emergency stop, avoid skidding the tires and do not attempt any sharp steering wheel movements.



**WARNING:** Vehicles with a higher center of gravity such as utility and four-wheel drive vehicles handle differently than vehicles with a lower center of gravity. Utility and four-wheel drive vehicles are **not** designed for cornering at speeds as high as passenger cars any more than low-slung sports cars are designed to perform satisfactorily under off-road conditions. Avoid sharp turns, excessive speed and abrupt maneuvers in these vehicles. Failure to drive cautiously could result in an increased risk of loss of vehicle control, vehicle rollover, personal injury and death.

- If the vehicle goes from one type of surface to another (i.e., from concrete to gravel) there will be a change in the way the vehicle responds to a maneuver (steering, acceleration or braking). Again, avoid these abrupt inputs.

### **Parking**

On some 4WD vehicles, when the transfer case is in the N (Neutral) position, the engine and transmission are disconnected from the rest of the driveline. Therefore, the vehicle is free to roll even if the automatic transmission is in P (Park) or the manual transmission is in gear. Do not leave the vehicle unattended with the transfer case in the N (Neutral) position. Always set the parking brake fully and turn off the ignition when leaving the vehicle.



**WARNING:** Always set the parking brake fully and make sure the gearshift is latched in P (Park). Turn the ignition to the off position and remove the key whenever you leave your vehicle.



**WARNING:** If the parking brake is fully released, but the brake warning lamp remains illuminated, the brakes may not be working properly. See your authorized dealer.

### **4WD systems**

4WD (when you select a 4WD mode) uses all four wheels to power the vehicle. This increases traction, enabling you to drive over terrain and road conditions that a conventional two-wheel drive vehicle cannot.

Power is supplied to all four wheels through a transfer case. On 4WD vehicles, the transfer case allows you to select 4WD when necessary.

## Driving

Information on transfer case operation and shifting procedures can be found in this chapter. Information on transfer case maintenance can be found in the *Maintenance and Specifications* chapter. You should become thoroughly familiar with this information before you operate your vehicle.

### **Normal characteristics**

On some 4WD models, the initial shift from two-wheel drive to 4x4 while the vehicle is moving can cause some momentary clunk and ratcheting sounds. This is the front drivetrain coming up to speed and the automatic locking hubs engaging and is not cause for concern.

### **Sand**

When driving over sand, try to keep all four wheels on the most solid area of the trail. Avoid reducing the tire pressures but shift to a lower gear and drive steadily through the terrain. Apply the accelerator slowly and avoid spinning the wheels.

Avoid excessive speed because vehicle momentum can work against you and cause the vehicle to become stuck to the point that assistance may be required from another vehicle. Remember, you may be able to back out the way you came if you proceed with caution.

### **Mud and water**

If you must drive through high water, drive slowly. Traction or brake capability may be limited.

When driving through water, determine the depth; avoid water higher than the bottom of the hubs (if possible) and proceed slowly. If the ignition system gets wet, the vehicle may stall.

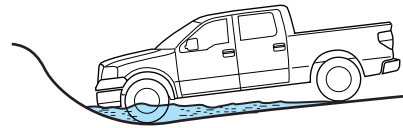

Once through water, always try the brakes. Wet brakes do not stop the vehicle as effectively as dry brakes. Drying can be improved by moving your vehicle slowly while applying light pressure on the brake pedal.

Be cautious of sudden changes in vehicle speed or direction when you are driving in mud. Even 4WD vehicles can lose traction in slick mud. As when you are driving over sand, apply the accelerator slowly and avoid spinning your wheels. If the vehicle does slide, steer in the direction of the slide until you regain control of the vehicle.

If the transmission, transfer case or front axle are submerged in water, their fluids should be checked and changed, if necessary.

322

## Driving

### **Driving through deep water may damage the transmission.**

If the front or rear axle is submerged in water, the axle lubricant should be replaced.

After driving through mud, clean off residue stuck to rotating driveshafts and tires. Excess mud stuck on tires and rotating driveshafts causes an imbalance that could damage drive components.

“Tread Lightly” is an educational program designed to increase public awareness of land-use regulations and responsibilities in our nation’s wilderness areas. Ford Motor



Company joins the U.S. Forest Service and the Bureau of Land Management in encouraging you to help preserve our national forest and other public and private lands by “treading lightly.”

### **Driving on hilly or sloping terrain**

Although natural obstacles may make it necessary to travel diagonally up or down a hill or steep incline, you should always try to drive straight up or straight down. **Avoid driving crosswise or turning on steep slopes or hills.** A danger lies in losing traction, slipping sideways and possibly rolling over. Whenever driving on a hill, determine beforehand the route you will use. Do not drive over the crest of a hill without seeing what conditions are on the other side. Do not drive in reverse over a hill without the aid of an observer.

When climbing a steep slope or hill, start in a lower gear rather than downshifting to a lower gear from a higher gear once the ascent has started. This reduces strain on the engine and the possibility of stalling.

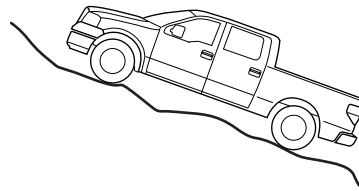

If you do stall out, do not try to turn around because you might roll over. It is better to back down to a safe location.

Apply just enough power to the wheels to climb the hill. Too much power will cause the tires to slip, spin or lose traction, resulting in loss of vehicle control.

## Driving

Descend a hill in the same gear you would use to climb up the hill to avoid excessive brake application and brake overheating. Do not descend in neutral; instead, disengage overdrive or manually shift to a lower gear. When descending a steep hill, avoid sudden hard braking as you could lose control. When you brake hard, the front wheels can't turn and if they aren't turning, you won't be able to steer. The front wheels have to be turning in order to steer the vehicle. Rapid pumping of the brake pedal will help you slow the vehicle and still maintain steering control.

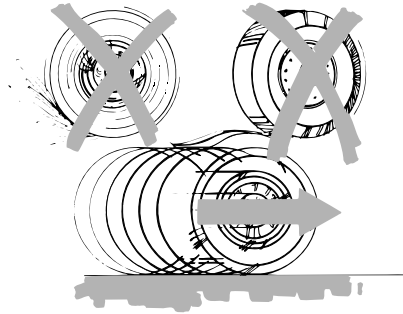

If your vehicle has anti-lock brakes, apply the brakes steadily. Do not “pump” the brakes.

### ***Driving on snow and ice***

4WD vehicles have advantages over 2WD vehicles in snow and ice but can skid like any other vehicle.

Should you start to slide while driving on snowy or icy roads, turn the steering wheel in the direction of the slide until you regain control.

Avoid sudden applications of power and quick changes of direction on snow and ice. Apply the accelerator slowly and steadily when starting from a full stop.

Avoid sudden braking as well. Although a 4WD vehicle may accelerate better than a two-wheel drive vehicle in snow and ice, it won't stop any faster, because as in other vehicles, braking occurs at all four wheels. Do not become overconfident as to road conditions.

Make sure you allow sufficient distance between you and other vehicles for stopping. Drive slower than usual and consider using one of the lower gears. In emergency stopping situations, apply the brake steadily. Do not “pump” the brakes. Refer to the *Brakes* section of this chapter for additional information on the operation of the Anti-lock Brake System (ABS).

## Driving



**WARNING:** If you are driving in slippery conditions that require tire chains or cables, then it is critical that you drive cautiously. Keep speeds down, allow for longer stopping distances and avoid aggressive steering to reduce the chances of a loss of vehicle control which can lead to serious injury or death. If the rear end of the vehicle slides while cornering, steer in the direction of the slide until you regain control of the vehicle.

### ***Maintenance and modifications***

The suspension and steering systems on your vehicle have been designed and tested to provide predictable performance whether loaded or empty and durable load carrying capability. For this reason, Ford Motor Company strongly recommends that you do not make modifications such as adding or removing parts (such as lift kits or stabilizer bars) or by using replacement parts not equivalent to the original factory equipment.

### **Snow plow restriction**



**WARNING:** Ford does not recommend the use of any F-150 model to be upfitted and equipped with snow plow hardware for use as a snow plow vehicle.

Any modifications to a vehicle that raise the center of gravity can make it more likely the vehicle will roll over as a result of a loss of control. Ford Motor Company recommends that caution be used with any vehicle equipped with a high load or device (such as ladder racks or pickup box cover).

Failure to maintain your vehicle properly may void the warranty, increase your repair cost, reduce vehicle performance and operational capabilities and adversely affect driver and passenger safety. Frequent inspection of vehicle chassis components is recommended if the vehicle is subjected to heavy off-road usage.

## Driving

### DRIVING THROUGH WATER

If driving through deep or standing water is unavoidable, proceed very slowly. Never drive through water that is higher than the bottom of the wheel rims (for cars) or the bottom of the hubs (for trucks).

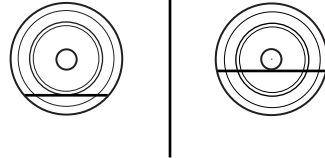

When driving through water, traction or brake capability may be limited. Also, water may enter your engine's air intake and severely damage your engine or your vehicle may stall. **Driving through deep water where the transmission vent tube is submerged may allow water into the transmission and cause internal transmission damage.**

**Once through the water, always dry the brakes by moving your vehicle slowly while applying light pressure on the brake pedal.** Wet brakes do not stop the vehicle as quickly as dry brakes.

## Roadside Emergencies

### ROADSIDE ASSISTANCE

#### Vehicles sold in the U.S. : Getting roadside assistance

To fully assist you should you have a vehicle concern, Ford Motor Company offers a complimentary roadside assistance program. This program is separate from the New Vehicle Limited Warranty. The service is available:

- 24-hours, seven days a week
- for the coverage period listed on the Roadside Assistance Card included in your Owner Guide portfolio.

Roadside assistance will cover:

- a flat tire change with a good spare (except vehicles that have been supplied with a tire inflation kit)
- battery jump start
- lock-out assistance (key replacement cost is the customer's responsibility)
- fuel delivery – Independent Service Contractors, if not prohibited by state, local or municipal law shall deliver up to 2.0 gallons (7.5L) of gasoline or 5.0 gallons (18.9L) of diesel fuel to a disabled vehicle. Fuel delivery service is limited to two no-charge occurrences within a 12-month period.
- winch out – available within 100 feet (30.5 meters) of a paved or county maintained road, no recoveries.
- towing – Ford and Lincoln eligible vehicles towed to an authorized dealer within 35 miles (56 km) of the disablement location or to the nearest authorized dealer. If a member requests to be towed to an authorized dealer more than 35 miles (56 km) from the disablement location, the member shall be responsible for any mileage costs in excess of 35 miles (56 km).

Trailers shall be covered up to \$200 if the disabled eligible vehicle requires service at the nearest authorized dealer. If the trailer is disabled, but the towing vehicle is operational, the trailer does not qualify for any roadside services.

#### Vehicles sold in the U.S. : Using roadside assistance

Complete the roadside assistance identification card and place it in your wallet for quick reference. This card is found in the Owner's Guide portfolio in the glove compartment.

327

## Roadside Emergencies

U.S. Ford vehicle customers who require Roadside Assistance, call 1-800-241-3673.

If you need to arrange roadside assistance for yourself, Ford Motor Company will reimburse a reasonable amount for towing to the nearest dealership within 35 miles (56 km). To obtain reimbursement information, U.S. Ford vehicle customers call 1-800-241-3673. Customers will be asked to submit their original receipts.

### Vehicles sold in Canada : Getting roadside assistance

Canadian customers who require roadside assistance, call 1-800-665-2006.

### Vehicles sold in Canada : Using roadside assistance

Complete the roadside assistance identification card and place it in your wallet for quick reference. In Canada, the card is found in the Warranty Guide in the glove box.

Canadian Roadside coverage and benefits may differ from the U.S. coverage. Please refer to your Warranty Guide or visit our website at [www.ford.ca](http://www.ford.ca) for information on Canadian services and benefits.

Canadian customers who need to obtain roadside information, call 1-800-665-2006 or visit our website at [www.ford.ca](http://www.ford.ca).

## HAZARD FLASHER CONTROL

The hazard flasher control is located on the instrument panel by the radio. The hazard flashers will operate when the ignition is in any position or if the key is not in the ignition.



- Press the flasher control and all front and rear direction signals will flash.
- Press the flasher control again to turn them off.

Use it when your vehicle is disabled and is creating a safety hazard for other motorists.

**Note:** With extended use, the flasher may run down your battery.

## FUEL PUMP SHUT-OFF

In the event of a moderate to severe collision, this vehicle is equipped with a fuel pump shut-off feature that stops the flow of fuel to the engine. Not every impact will cause a shut-off.

328



## Roadside Emergencies

Should your vehicle shut off after a collision due to this feature, you may restart your vehicle by doing the following:

1. Turn the ignition switch to the off position.
2. Turn the ignition switch to the on position.

In some instances the vehicle may not restart the first time you try to restart and may take one additional attempt.



**WARNING:** Failure to inspect and if necessary repair fuel leaks after a collision may increase the risk of fire and serious injury. Ford Motor Company recommends that the fuel system be inspected by an authorized dealer after any collision.

## FUSES AND RELAYS

### Fuses

If electrical components in the vehicle are not working, a fuse may have blown. Blown fuses are identified by a broken wire within the fuse. Check the appropriate fuses before replacing any electrical components.

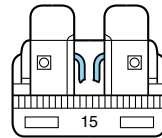

**Note:** Always replace a fuse with one that has the specified amperage rating. Using a fuse with a higher amperage rating can cause severe wire damage and could start a fire.

### Standard fuse amperage rating and color

COLOR					
Fuse rating	Mini fuses	Standard fuses	Maxi fuses	Cartridge maxi fuses	Fuse link cartridge
2A	Grey	Grey	—	—	—
3A	Violet	Violet	—	—	—
4A	Pink	Pink	—	—	—
5A	Tan	Tan	—	—	—
7.5A	Brown	Brown	—	—	—
10A	Red	Red	—	—	—
15A	Blue	Blue	—	—	—

## Roadside Emergencies

COLOR					
Fuse rating	Mini fuses	Standard fuses	Maxi fuses	Cartridge maxi fuses	Fuse link cartridge
20A	Yellow	Yellow	Yellow	Blue	Blue
25A	Natural	Natural	—	Natural	Natural
30A	Green	Green	Green	Pink	Pink
40A	—	—	Orange	Green	Green
50A	—	—	Red	Red	Red
60A	—	—	Blue	Yellow	Yellow
70A	—	—	Tan	—	Brown
80A	—	—	Natural	Black	Black

### Passenger compartment fuse panel

The fuse panel is located under the right-hand side of the instrument panel.

To remove the trim panel for access to the fuse box, pull the panel toward you and swing it out away from the side and remove it. To reinstall it, line up the tabs with the grooves on the panel, then push it shut.

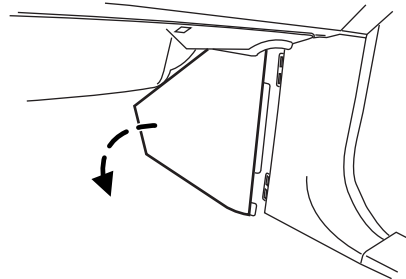

To remove the fuse box cover, press in the tabs on both sides of the cover, then pull the cover off.

To reinstall the fuse box cover, place the top part of the cover on the fuse panel, then push the bottom part of the cover until you hear it click shut. Gently pull on the cover to make sure it is seated properly.

## Roadside Emergencies

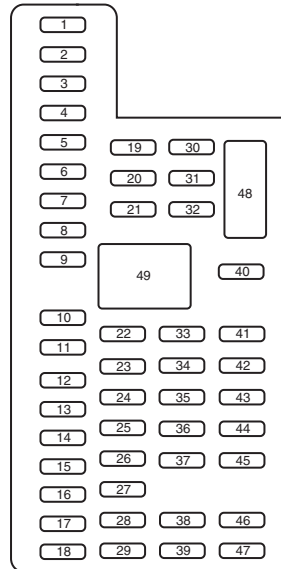

The fuses are coded as follows.

Fuse/Relay Location	Fuse Amp Rating	Protected Circuits
1	30A	Driver side front window
2	15A	SYNC®
3	30A	Passenger side front window
4	10A	Interior lamps
5	20A	Memory module
6	5A	Not used (spare)
7	7.5A	Power mirror switch, Memory seat module
8	10A	Not used (spare)
9	10A	Radio display, GPS module, Navigation display
10	10A	Run/accessory relay
11	10A	Instrument cluster

## Roadside Emergencies

Fuse/Relay Location	Fuse Amp Rating	Protected Circuits
12	15A	Interior lighting, Puddle lamps, Backlighting, Cargo lamp
13	15A	Right turn signals/stop lamps
14	15A	Left turn signals/stop lamps
15	15A	Reverse lights, High-mounted stop lamp
16	10A	Right low-beam headlamp
17	10A	Left low-beam headlamp
18	10A	Brake-shift interlock, Keypad illumination, PCM wakeup, PATS
19	20A	Audio amplifier
20	20A	Power door locks
21	10A	Ambient lighting
22	20A	Horn
23	15A	Steering wheel control module
24	15A	Datalink connector, Steering wheel control module
25	15A	Not used (spare)
26	5A	Radio frequency module
27	20A	Not used (spare)
28	15A	Ignition switch
29	20A	Radio/Navigation
30	15A	Front parking lamps
31	5A	BOO – IP, BOO – Engine
32	15A	Delay/accessory – moon roof, power windows, locks, Automatic dimming mirror/Compass
33	10A	Heated seats
34	10A	Reverse sensing system, 4x4 switch, Rear video, Off road indicator (SVT Raptor)
35	5A	Hill descent switch (SVT Raptor)

## Roadside Emergencies

Fuse/Relay Location	Fuse Amp Rating	Protected Circuits
36	10A	Restraint control module, Occupant classification system module
37	10A	Trailer brake control
38	10A	Delayed accessory – 110V power point, Radio (AM/FM)
39	15A	High beam headlamps
40	10A	Rear park lamps
41	7.5A	Passenger airbag deactivation indicator, Upfitter switch (SVT Raptor)
42	5A	Overdrive cancel switch
43	10A	Not used (spare)
44	10A	Not used (spare)
45	5A	Not used (spare)
46	10A	Climate controls module
47	15A	Fog lamps, Exterior mirror turn signals
48	30A Circuit Breaker	Power rear windows, Power sliding back window
49	Relay	Delayed accessory

### Power distribution box

The power distribution box is located in the engine compartment. The power distribution box contains high-current fuses that protect your vehicle's main electrical systems from overloads.



**WARNING:** Always disconnect the battery before servicing high current fuses.



**WARNING:** To reduce risk of electrical shock, always replace the cover to the power distribution box before reconnecting the battery or refilling fluid reservoirs.

## Roadside Emergencies

If the battery has been disconnected and reconnected, refer to the *Battery* section of the *Maintenance and Specifications* chapter.

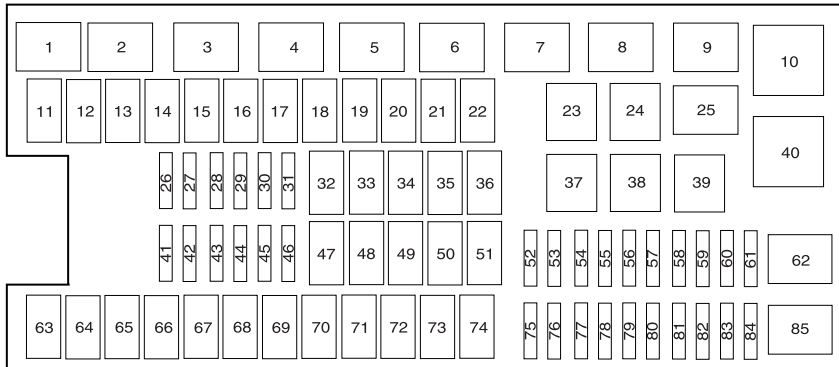

The high-current fuses are coded as follows:

Fuse/Relay Location	Fuse Amp Rating	Protected Circuits
1	—	Powertrain control module (PCM) relay (3.7L, 5.0L and 6.2L engines)
2	—	Starter relay
3	—	Blower motor relay
4	—	Rear window defroster relay
5	—	Electric fan relay (high speed)
6	—	Trailer tow (TT) park lamp relay
7	—	Run/start relay
8	—	Fuel pump relay
9	—	TT Battery charger relay
10	—	PCM relay (3.5L engine)
11	30A**	Power running board motors
12	40A**	Electric fan
	50A**	Electric fan (6.2L with max trailer tow, SVT Raptor)

## Roadside Emergencies

Fuse/Relay Location	Fuse Amp Rating	Protected Circuits
13	30A**	Starter relay power
14	30A**	Passenger power seat
15	40A**	Electric fan
	50A**	Electric fan (6.2L with max trailer tow, SVT Raptor)
16	—	Not used
17	30A**	Trailer brake control
18	30A**	Upfitter 1 (SVT Raptor)
19	30A**	Upfitter 2 (SVT Raptor)
20	20A**	4x4 module (electronic shift)
21	30A**	TT battery charge relay power
22	20A**	Cigar lighter
23	—	A/C clutch relay
24	—	Not used
25	—	Vacuum pump relay (3.5L engine)
26	10A*	PCM – keep alive power, PCM relay coil, canister vent solenoid (3.7L, 5.0L and 6.2L engines)
27	20A*	Fuel pump relay power
28	10A*	Upfitter 4 (SVT Raptor)
29	10A*	4x4 IWE solenoid
30	10A*	A/C clutch
31	15A*	Run/start relay power
32	40A**	Rear window defroster relay power
33	40A**	110V AC power point
34	40A**	PCM relay power (3.7L, 5.0L and 6.2L engines)
	50A**	PCM relay power (3.5L engine)
35	—	Not used
36	30A**	Roll stability control (RSC)/Anti-lock brake system (ABS)

## Roadside Emergencies

Fuse/Relay Location	Fuse Amp Rating	Protected Circuits
37	—	TT left stop/turn relay
38	—	TT right stop/turn relay
39	—	TT back-up lamps relay
40	—	Electric fan relay
41	—	Not used
42	5A*	Run/start coil
43	15A*	TT back-up lamp relay power
44	15A*	Upfitter 3 (SVT Raptor)
45	10A*	Alternator sensor (non-6.2L engines)
46	10A*	Brake on/off (BOO) switch
47	60A**	RSC/ABS module
48	20A**	Moon roof
49	30A**	Wipers
50	—	Not used
51	40A**	Blower motor relay power
52	5A*	Run/start – Electronic power assist steering, Blower relay coil
53	5A*	Run/start – PCM
54	5A*	Run/start – 4x4 module, Back-up lamps, RSC/ABS, TT battery charge relay coil, Rear window defroster relay coil
55	—	Not used
56	15A*	Heated mirrors
57	—	Not used
58	—	Not used
59	—	Not used
60	—	Not used
61	—	Not used
62	—	Wiper motor relay
63	25A**	Electric fan



## Roadside Emergencies

Fuse/Relay Location	Fuse Amp Rating	Protected Circuits
64	40A**	Vacuum pump relay power (3.5L engine)
65	20A**	Auxiliary power point (instrument panel)
66	20A**	Auxiliary power point (inside center console)
67	20A**	TT park lamps relay power
68	25A**	4x4 module
69	30A**	Passenger heated/cooled seats
70	—	Not used
71	20A**	Heated rear seats
72	20A**	Auxiliary power point (Rear)
73	20A**	TT stop/turn lamps relay power
74	30A**	Driver power seat/memory module
75	15A*	PCM – voltage power 1 (3.7L, 5.0L, 6.2L engines PCM module)
	25A*	PCM – voltage power 1 (3.5L engine PCM module)
76	20A*	PCM – Voltage power 2 (General powertrain components, Mass air flow/Intake air temp sensor) (3.7L, 5.0L, 6.2L engines)
	20A*	PCM – Voltage power 2 (General powertrain components, Canister vent solenoid) (3.5L engine)
77	10A*	PCM – Voltage power 3 (Emission related powertrain components, Electric fan relays coil)
78	15A*	PCM – Voltage power 4 – Ignition coils (3.5L, 3.7L, 5.0L engines)
	20A*	PCM – Voltage power 4 – Ignition coils (6.2L engine)
79	5A*	Rain sensor
80	—	Not used

## Roadside Emergencies

Fuse/Relay Location	Fuse Amp Rating	Protected Circuits
81	—	Not used
82	—	Not used
83	—	Not used
84	—	Not used
85	—	Electric fan relay (low speed)

\*Mini fuse \*\*Cartridge fuse

### Auxiliary relay box (SVT Raptor only)

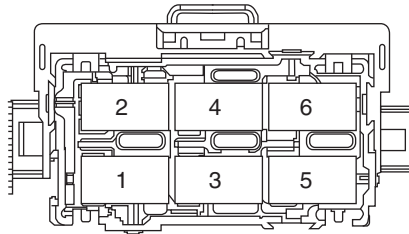

The relay box is located in the left rear corner of the engine compartment.

Fuse/Relay location	Fuse amp rating	Description
1	—	Upfitter 1 relay
2	—	Upfitter 2 relay
3	—	Upfitter 3 relay
4	—	Upfitter 4 relay
5	—	Not used
6	—	Not used

## Roadside Emergencies

### CHANGING THE TIRES

If you get a flat tire while driving, do not apply the brake heavily. Instead, gradually decrease your speed. Hold the steering wheel firmly and slowly move to a safe place on the side of the road.

**Note:** If your vehicle is equipped with the tire pressure monitoring system (TPMS), the indicator light will illuminate when the spare tire is in use. To restore the full functionality of the monitoring system, all road wheels equipped with tire pressure monitoring sensors must be mounted on the vehicle.

If your vehicle is equipped with TPMS, have a flat serviced by an authorized dealer in order to prevent damage to the TPMS sensors, refer to *Tire pressure monitoring system (TPMS)* in the *Tires, Wheels and Loading* chapter. Replace the spare tire with a road tire as soon as possible. During repairing or replacing of the flat tire, have the authorized dealer inspect the TPMS sensor for damage.



**WARNING:** The use of tire sealants may damage your tire pressure monitoring system (TPMS) and should not be used. However, if you must use a sealant, the TPMS sensor and valve stem on the wheel must be replaced by an authorized Ford dealer.



**WARNING:** Refer to *Tire pressure monitoring system (TPMS)* in the *Tires, Wheels and Loading* chapter for important information. If the tire pressure monitor sensor becomes damaged, it will no longer function.

### Dissimilar spare tire/wheel information



**WARNING:** Failure to follow these guidelines could result in an increased risk of loss of vehicle control, injury or death.

If you have a dissimilar spare tire/wheel, then it is intended for temporary use only. This means that if you need to use it, you should replace it as soon as possible with a road tire/wheel that is the same size and type as the road tires and wheels that were originally provided by Ford. If the dissimilar spare tire or wheel is damaged, it should be replaced rather than repaired.

## Roadside Emergencies

A dissimilar spare tire/wheel is defined as a spare tire and/or wheel that is different in brand, size or appearance from the road tires and wheels and can be one of three types:

1. **T-type mini-spares:** This spare tire begins with the letter “T” for tire size and may have “Temporary Use Only” molded in the sidewall
2. **Full-size dissimilar spare with label on wheel:** This spare tire has a label on the wheel that states: “THIS TIRE AND WHEEL FOR TEMPORARY USE ONLY”

When driving with one of the dissimilar spare tires listed above, **do not:**

- Exceed 50 mph (80 km/h)
- Load the vehicle beyond maximum vehicle load rating listed on the Safety Compliance Label
- Tow a trailer
- Use snow chains on the end of the vehicle with the dissimilar spare tire
- Use more than one dissimilar spare tire at a time
- Use commercial car washing equipment
- Try to repair the dissimilar spare tire

Use of one of the dissimilar spare tires listed above at any one wheel location can lead to impairment of the following:

- Handling, stability and braking performance
- Comfort and noise
- Ground clearance and parking at curbs
- Winter weather driving capability
- Wet weather driving capability
- All-wheel driving capability (if applicable)

### 3. **Full-size dissimilar spare without label on wheel**

When driving with the full-size dissimilar spare tire/wheel, **do not:**

- Exceed 70 mph (113 km/h)
- Use more than one dissimilar spare tire/wheel at a time
- Use commercial car washing equipment
- Use snow chains on the end of the vehicle with the dissimilar spare tire/wheel

## Roadside Emergencies

The usage of a full-size dissimilar spare tire/wheel can lead to impairment of the following:

- Handling, stability and braking performance
- Comfort and noise
- Ground clearance and parking at curbs
- Winter weather driving capability
- Wet weather driving capability
- All-wheel driving capability (if applicable)
- Load leveling adjustment (if applicable)

When driving with the full-size dissimilar spare tire/wheel additional caution should be given to:

- Towing a trailer
- Driving vehicles equipped with a camper body
- Driving vehicles with a load on the cargo rack

Drive cautiously when using a full-size dissimilar spare tire/wheel and seek service as soon as possible.

### ***Stopping and securing the vehicle***

1. Park on a level surface, activate the hazard flashers and set the parking brake.
2. Place the gearshift in P (Park) and turn the engine off.

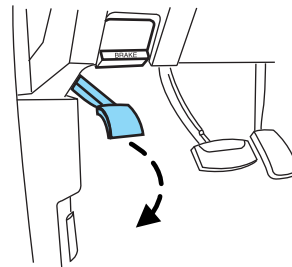

## Roadside Emergencies

### **Location of the spare tire and tools**

The spare tire is located under the vehicle, just forward of the rear bumper. The jack, jack handle and lug wrench are located in the following locations:

Body Style	Location
Regular Cab	Attached to a floor bracket behind/under the driver's seat (for easier access move the driver seat forward)
SuperCab	Attached to a floor bracket under the rear seat on the driver's side
SuperCrew	In a plastic box in the floor under the rear seat

### **To remove the jack on Regular Cab and SuperCab models:**

Remove the wing nut and turn the jack screw counterclockwise to release pressure before removing the jack from the bracket.

### **To remove the jack on SuperCrew models:**

1. Lift both rear seat cushions.
2. Remove the insert containing the Easy Fuel™ funnel from the driver's side.
3. Remove the two small wing nuts on the passenger side.
4. Slide the plastic box toward the driver's side and remove.

### **Removing the spare tire**

1. Use the ignition key to remove the lock cylinder from the access hole of the bumper to allow access to the guide tube. Assemble the jack handle as shown in the illustration.

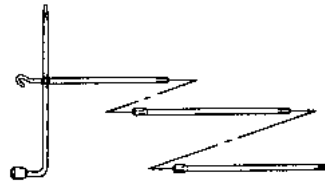

## Roadside Emergencies

2. Fully insert the jack handle through the bumper hole and into the guide tube through the access hole in the rear bumper.

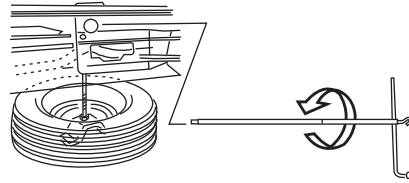

3. Turn the handle counterclockwise until tire is lowered to the ground, the tire can be slid rearward and the cable is slightly slack.

4. Slide the retainer through the center of the wheel.

### Tire change procedure

**!** **WARNING:** To help prevent the vehicle from moving when you change a tire, be sure the parking brake is set, then block (in both directions) the wheel that is diagonally opposite (other side and end of the vehicle) to the tire being changed.

**!** **WARNING:** If the vehicle slips off the jack, you or someone else could be seriously injured.

**!** **WARNING:** Do not attempt to change a tire on the side of the vehicle close to moving traffic. Pull far enough off the road to avoid the danger of being hit when operating the jack or changing the wheel.

**Note:** Passengers should not remain in the vehicle when the vehicle is being jacked.

Refer to the instruction sheet (located with the jack) for detailed tire change instructions.

1. Block the diagonally opposite wheel.

2. Obtain the spare tire and jack from their storage locations. **Note:** F-150 SVT Raptor also includes a chock, saddle extension and wing bolt.

3. Use the tip of the lug wrench to remove any wheel trim that is blocking the lug nuts.

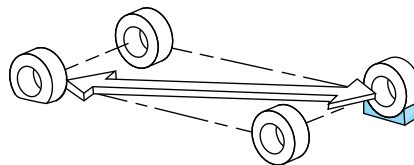

## Roadside Emergencies

4. Loosen each wheel lug nut one-half turn counterclockwise but do not remove them until the wheel is raised off the ground.

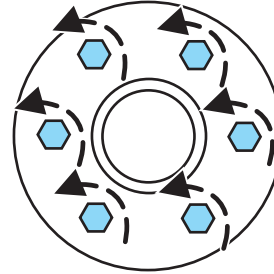

**Note:** For F-150 SVT Raptor, install the saddle extension on the jack as shown in the jack usage and storage instructions.

5. Position the jack according to the following guides and turn the jack handle clockwise until the wheel is completely off the ground.

**!** **WARNING:** When one of the rear wheels is off the ground, the transmission alone will not prevent the vehicle from moving or slipping off the jack, even if the transmission is in P (Park). To prevent the vehicle from moving when you change the tire, be sure that the parking brake is set and the diagonally opposite wheel is blocked. If the vehicle slips off the jack, someone could be seriously injured.

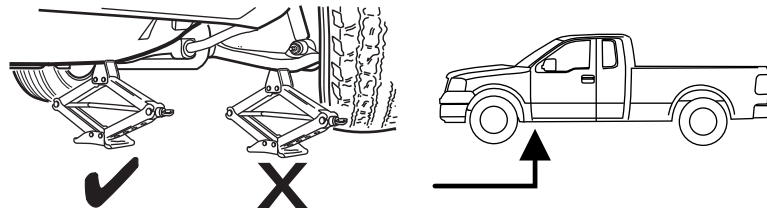

- Front

**Note:** Use the frame rail as the jacking location point, NOT the control arm.

**Note:** For F-150 SVT Raptor, you must always use the jack saddle extension.



## Roadside Emergencies

- Rear

**Note:** Never use the front or rear differential as a jacking point.

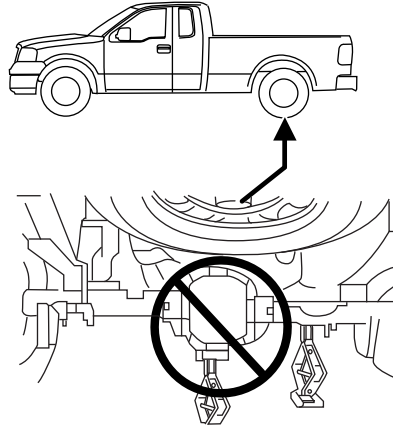

**WARNING:** To lessen the risk of personal injury, do not put any part of your body under the vehicle while changing a tire. Do not start the engine when your vehicle is on the jack. The jack is only meant for changing the tire.

6. Remove the lug nuts with the lug wrench.
7. Replace the flat tire with the spare tire, making sure the valve stem is facing outward. Reinstall the lug nuts until the wheel is snug against the hub. Do not fully tighten the lug nuts until the wheel has been lowered.
8. Lower the wheel by turning the jack handle counterclockwise.

## Roadside Emergencies

9. Remove the jack and fully tighten the lug nuts in the order shown (Refer to *Wheel lug nut torque specifications* later in this chapter for the proper lug nut torque specification):

- Six lug nut wheel
- Seven lug nut wheel

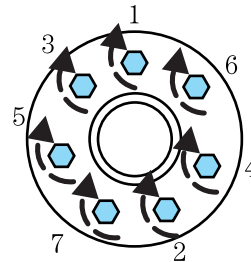
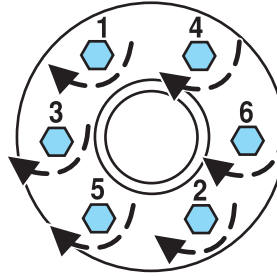

10. Stow the flat tire. Refer to *Stowing the flat/spare tire*.
11. Stow the jack and lug wrench. Make sure the jack is fastened so it does not rattle when you drive.
12. Unblock the wheels.

### **Stowing the flat/spare tire**

**Note:** Failure to follow spare tire stowage instructions may result in failure of cable or loss of spare tire.

1. Lay the tire on the ground with the valve stem facing in the direction specified on the Tire Changing Instructions located with the jack hardware.
2. Slide the wheel partially under the vehicle and install the retainer through the wheel center. Pull on the cable to align the components at the end of the cable.

## Roadside Emergencies

3. Turn the jack handle clockwise until the tire is raised to its stowed position underneath the vehicle. The effort to turn the jack handle increases significantly and the spare tire carrier ratchets or slips when the tire is raised to the maximum tightness. Tighten to the best of your ability, to the point where the ratchet/slip occurs, if possible. The spare tire carrier will not allow you to overtighten. If the spare tire carrier ratchets or slips with little effort, take the vehicle to your authorized dealer for assistance at your earliest convenience.
4. Check that the tire lies flat against the frame and is properly tightened. Try to push or pull, then turn the tire to be sure it will not move. Loosen and retighten, if necessary. Failure to properly stow the spare tire may result in failure of the winch cable and loss of the tire.
5. Repeat this tightness check procedure when servicing the spare tire pressure (every six months, as per your *scheduled maintenance information*), or at any time that the spare tire is disturbed through service of other components.
6. If removed, install the spare tire lock (if equipped) into the bumper drive tube with the spare tire lock key (if equipped) and jack handle.

### WHEEL LUG NUT TORQUE SPECIFICATIONS

Retighten the lug nuts to the specified torque within 100 miles (160 km) after any wheel disturbance (rotation, flat tire, wheel removal, etc.).

Bolt size	Wheel lug nut torque*	
	ft-lb	N•m
M14 x 2.0	150	200

\* Torque specifications are for nut and bolt threads free of dirt and rust. Use only Ford recommended replacement fasteners.



**WARNING:** When a wheel is installed, always remove any corrosion, dirt or foreign materials present on the mounting surfaces of the wheel or the surface of the wheel hub, brake drum or brake disc that contacts the wheel. Ensure that any fasteners that attach the rotor to the hub are secured so they do not interfere with the mounting surfaces of the wheel. Installing wheels without correct metal-to-metal contact at the wheel mounting surfaces can cause the wheel nuts to loosen and the wheel to come off while the vehicle is in motion, resulting in loss of control.

## Roadside Emergencies

**Note:** Inspect the wheel pilot hole prior to installation. If there is visible corrosion in wheel pilot hole, remove loose particles by wiping with clean rag and apply grease. Apply grease only to the wheel pilot hole surface by smearing a “dime” (1 square cm) sized glob of grease around the wheel pilot surface (1) with end of finger. **DO NOT** apply grease to lugnut/stud holes or wheel-to-brake surfaces.

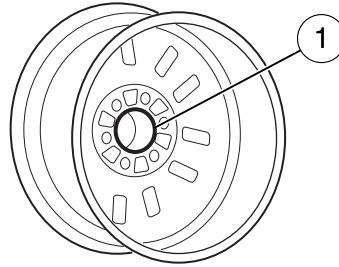

### RUNNING OUT OF FUEL

If you have run out of fuel and need to refill the vehicle with a portable fuel container, see *Running out of fuel* in the *Maintenance and Specifications* chapter for proper fuel filling method using a portable fuel container and the included fuel filler funnel. **Do not** insert the nozzle of portable fuel containers or any type of aftermarket funnels into the Easy Fuel® “no cap” fuel system as it can be damaged. You must use the included funnel in such circumstances.

**WARNING:** Do not insert the nozzle of portable fuel containers or aftermarket funnels into the Easy Fuel® system. This could damage the fuel system and its seal, and may cause fuel to run onto the ground instead of filling the tank, all of which could result in serious personal injury.

### JUMP STARTING

**WARNING:** The gases around the battery can explode if exposed to flames, sparks, or lit cigarettes. An explosion could result in injury or vehicle damage.

**WARNING:** Batteries contain sulfuric acid which can burn skin, eyes and clothing, if contacted.

**Do not attempt to push-start your automatic transmission vehicle. Automatic transmissions do not have push-start capability. Attempting to push-start a vehicle with an automatic transmission may cause transmission damage.**

348

## Roadside Emergencies

### Preparing your vehicle

When the battery is disconnected or a new battery is installed, the automatic transmission must relearn its shift strategy. As a result, the transmission may have firm and/or soft shifts. This operation is considered normal and will not affect function or durability of the transmission. Over time, the adaptive learning process will fully update transmission operation.

1. **Use only a 12-volt supply to start your vehicle.**
2. Do not disconnect the battery of the disabled vehicle as this could damage the vehicle's electrical system.
3. Park the booster vehicle close to the hood of the disabled vehicle making sure the two vehicles **do not** touch. Set the parking brake on both vehicles and stay clear of the engine cooling fan and other moving parts.
4. Check all battery terminals and remove any excessive corrosion before you attach the battery cables. Ensure that vent caps are tight and level.
5. Turn the heater fan on in both vehicles to protect from any electrical surges. Turn all other accessories off.

### Connecting the jumper cables

**Note:** In the illustration, the vehicle on the bottom is used to designate the assisting (boosting) battery.

## Roadside Emergencies

1. Connect the positive (+) jumper cable to the positive (+) terminal of the discharged battery.
2. Connect the other end of the positive (+) cable to the positive (+) terminal of the assisting battery.
3. Connect the negative (-) cable to the negative (-) terminal of the assisting battery.
4. Make the final connection of the negative (-) cable to an exposed metal part of the stalled vehicle's engine, away from the battery and the carburetor/fuel injection system.

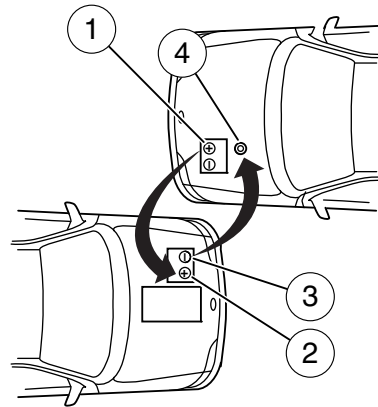

**Note:** Do not attach the negative (-) cable to fuel lines, engine rocker covers, the intake manifold or electrical components as grounding points.



**WARNING:** Do not connect the end of the second cable to the negative (-) terminal of the battery to be jumped. A spark may cause an explosion of the gases that surround the battery.

Ensure that the cables are clear of fan blades, belts, moving parts of both engines, or any fuel delivery system parts.

### Jump starting

1. Start the engine of the booster vehicle and run the engine at moderately increased speed.
2. Start the engine of the disabled vehicle.
3. Once the disabled vehicle has been started, run both engines for an additional three minutes before disconnecting the jumper cables.

## Roadside Emergencies

### Removing the jumper cables

Remove the jumper cables in the reverse order that they were connected.

**Note:** In the illustration, the vehicle on the bottom is used to designate the assisting (boosting) battery.

1. Remove the jumper cable from the ground metal surface.
2. Remove the jumper cable on the negative (-) terminal of the booster vehicle's battery.
3. Remove the jumper cable from the positive (+) terminal of the booster vehicle's battery.
4. Remove the jumper cable from the positive (+) terminal of the disabled vehicle's battery.

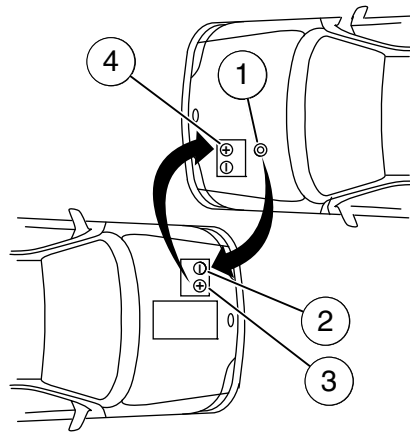

After the disabled vehicle has been started and the jumper cables removed, allow it to idle for several minutes so the engine computer can relearn its idle conditions.

## Roadside Emergencies

### WRECKER TOWING

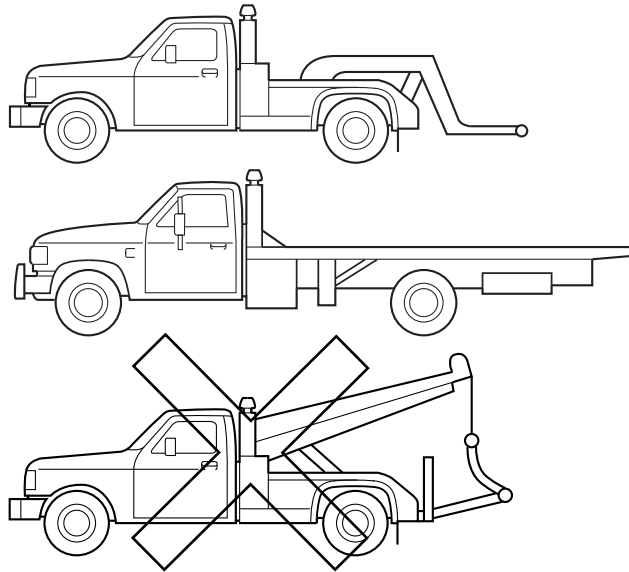

If you need to have your vehicle towed, contact a professional towing service or, if you are a member of a roadside assistance program, your roadside assistance service provider.

Ford recommends your vehicle be towed with a wheel lift or flatbed. Do not tow with a slingbelt. Ford Motor Company has not approved a slingbelt towing procedure.

On 4x2 vehicles, it is acceptable to tow the vehicle with the front wheels on the ground (without dollies) and the rear wheels off the ground.

On 4x4 vehicles, it is recommended that your vehicle be towed with a wheel lift and dollies or flatbed equipment with all the wheels off the ground.

**If the vehicle is towed by other means or incorrectly, vehicle damage may occur.**



## Roadside Emergencies

### Emergency towing

In case of a roadside emergency with a disabled vehicle (without access to wheel dollies, car hauling trailer, or flatbed transport vehicle) your vehicle (regardless of transmission powertrain configuration) can be flat towed (all wheels on the ground) under the following conditions:

- Vehicle is facing forward so that it is being towed in a forward direction.
- Place the transmission in N (Neutral). If you cannot move the gear shift lever, refer to *Brake shift interlock* in the *Driving* chapter for instructions.
- Maximum speed is not to exceed 35 mph (56 km/h).
- Maximum distance is 50 miles (80 km).

## Customer Assistance

### GETTING THE SERVICES YOU NEED

Warranty repairs to your vehicle must be performed by an authorized dealer. While any authorized dealer handling your vehicle line will provide warranty service, we recommend you return to your selling authorized dealer who wants to ensure your continued satisfaction.

Please note that certain warranty repairs require special training and/or equipment, so not all authorized dealers are authorized to perform all warranty repairs. This means that, depending on the warranty repair needed, you may have to take your vehicle to another authorized dealer.

A reasonable time must be allowed to perform a repair after taking your vehicle to the authorized dealer. Repairs will be made using Ford or Motorcraft® parts, or remanufactured or other parts that are authorized by Ford.

### Away from home

If you are away from home when your vehicle needs service, contact the Ford Customer Relationship Center or use the online resources listed below to find the nearest authorized dealer.

In the United States:

#### Mailing address

Ford Motor Company  
Customer Relationship Center  
P.O. Box 6248  
Dearborn, MI 48121

#### Telephone

1-800-392-3673 (FORD)  
(TDD for the hearing impaired: 1-800-232-5952)

#### Online

Additional information and resources are available online at [www.genuineservice.com](http://www.genuineservice.com).

These are some of the items that can be found online:

- U.S. dealer locator by Dealer Name, City/State, or Zip Code
- Owner Guides
- Maintenance Schedules
- Recalls
- Ford Extended Service Plans
- Ford Genuine Accessories
- Service specials and promotions.

354

## Customer Assistance

In Canada:

**Mailing address (Ford vehicles)**

Customer Relationship Centre  
Ford Motor Company of Canada, Limited  
P.O. Box 2000  
Oakville, Ontario L6J 5E4

**Telephone**

1-800-565-3673 (FORD)

**Online**

[www.ford.ca](http://www.ford.ca)

**Mailing address (Lincoln vehicles)**

Lincoln Centre  
Ford Motor Company of Canada, Limited  
P.O. Box 2000  
Oakville, Ontario L6J 5E4

**Telephone**

1-800-387-9333

**Online**

[www.lincolncanada.com](http://www.lincolncanada.com)

**Additional assistance**

If you have questions or concerns, or are unsatisfied with the service you are receiving, follow these steps:

1. Contact your Sales Representative or Service Advisor at your selling/servicing authorized dealer.
2. If your inquiry or concern remains unresolved, contact the Sales Manager, Service Manager or Customer Relations Manager.
3. If you require assistance or clarification on Ford Motor Company policies, please contact the Ford Customer Relationship Center

In order to help you serve you better, please have the following information available when contacting a Customer Relationship Center:

- Vehicle Identification Number (VIN)
- Your telephone number (home and business)
- The name of the authorized dealer and city where located
- The vehicle's current odometer reading

In some states, you must directly notify Ford in writing before pursuing remedies under your state's warranty laws. Ford is also allowed a final repair attempt in some states.

355

## Customer Assistance

In the United States, a warranty dispute must be submitted to the BBB AUTO LINE before taking action under the Magnuson-Moss Warranty Act, or to the extent allowed by state law, before pursuing replacement or repurchase remedies provided by certain state laws. This dispute handling procedure is not required prior to enforcing state created rights or other rights which are independent of the Magnuson-Moss Warranty Act or state replacement or repurchase laws.

### IN CALIFORNIA (U.S. ONLY)

California Civil Code Section 1793.2(d) requires that, if a manufacturer or its representative is unable to repair a motor vehicle to conform to the vehicle's applicable express warranty after a reasonable number of attempts, the manufacturer shall be required to either replace the vehicle with one substantially identical or repurchase the vehicle and reimburse the buyer in an amount equal to the actual price paid or payable by the consumer (less a reasonable allowance for consumer use). The consumer has the right to choose whether to receive a refund or replacement vehicle.

California Civil Code Section 1793.22(b) presumes that the manufacturer has had a reasonable number of attempts to conform the vehicle to its applicable express warranties if, within the first 18 months of ownership of a new vehicle or the first 18,000 miles (29,000 km), whichever occurs first:

1. Two or more repair attempts are made on the same non-conformity likely to cause death or serious bodily injury OR
2. Four or more repair attempts are made on the same nonconformity (a defect or condition that substantially impairs the use, value or safety of the vehicle) OR
3. The vehicle is out of service for repair of nonconformities for a total of more than 30 calendar days (not necessarily all at one time)

In the case of 1 or 2 above, the consumer must also notify the manufacturer of the need for the repair of the nonconformity at the following address:

Ford Motor Company  
16800 Executive Plaza Drive  
Mail Drop 3NE-B  
Dearborn, MI 48126

## Customer Assistance

You are required to submit your warranty dispute to BBB AUTO LINE before asserting in court any rights or remedies conferred by California Civil Code Section 1793.22(b). You are also required to use BBB AUTO LINE before exercising rights or seeking remedies created by the Federal Magnuson-Moss Warranty Act, 15 U.S.C. sec. 2301 et seq. If you choose to seek redress by pursuing rights and remedies not created by California Civil Code Section 1793.22(b) or the Magnuson-Moss Warranty Act, resort to BBB AUTO LINE is not required by those statutes.

### **THE BETTER BUSINESS BUREAU (BBB) AUTO LINE PROGRAM (U.S. ONLY)**

Your satisfaction is important to Ford Motor Company and to your dealer. If a warranty concern has not been resolved using the three-step procedure outlined earlier in this chapter in the *Getting the services you need* section, you may be eligible to participate in the BBB AUTO LINE program.

The BBB AUTO LINE program consists of two parts – mediation and arbitration. During mediation, a representative of the BBB will contact both you and Ford Motor Company to explore options for settlement of the claim. If an agreement is not reached during mediation or you do not want to participate in mediation, and if your claim is eligible, you may participate in the arbitration process. An arbitration hearing will be scheduled so that you can present your case in an informal setting before an impartial person. The arbitrator will consider the testimony provided and make a decision after the hearing.

Disputes submitted to the BBB AUTO LINE program are usually decided within forty days after you file your claim with the BBB. You are not bound by the decision, and may reject the decision and proceed to court where all findings of the BBB Auto Line dispute, and decision, are admissible in the court action. Should you choose to accept the BBB AUTO LINE decision, Ford is then bound by the decision, and must comply with the decision within 30 days of receipt of your acceptance letter.

BBB AUTO LINE Application: Using the information provided below, please call or write to request a program application. You will be asked for your name and address, general information about your new vehicle, information about your warranty concerns, and any steps you have already taken to try to resolve them. A Customer Claim Form will be mailed that will need to be completed, signed and returned to the BBB along with proof of ownership. Upon receipt, the BBB will review the claim for eligibility under the Program Summary Guidelines.

357

## Customer Assistance

**You can get more information by calling BBB AUTO LINE at 1-800-955-5100, or writing to:**

**BBB AUTO LINE  
4200 Wilson Boulevard, Suite 800  
Arlington, Virginia 22203-1833**

BBB AUTO LINE applications can also be requested by calling the Ford Motor Company Customer Relationship Center at 1-800-392-3673.

**Note:** Ford Motor Company reserves the right to change eligibility limitations, modify procedures, or to discontinue this process at any time without notice and without obligation.

### **UTILIZING THE MEDIATION/ARBITRATION PROGRAM (CANADA ONLY)**

For vehicles delivered to authorized Canadian dealers. In those cases where you continue to feel that the efforts by Ford of Canada and the authorized dealer to resolve a factory-related vehicle service concern have been unsatisfactory, Ford of Canada participates in an impartial third party mediation/arbitration program administered by the Canadian Motor Vehicle Arbitration Plan (CAMVAP).

The CAMVAP program is a straight forward and relatively speedy alternative to resolve a disagreement when all other efforts to produce a settlement have failed. This procedure is without cost to you and is designed to eliminate the need for lengthy and expensive legal proceedings.

In the CAMVAP program, impartial third-party arbitrators conduct hearings at mutually convenient times and places in an informal environment. These impartial arbitrators review the positions of the parties, make decisions and, when appropriate, render awards to resolve disputes. CAMVAP decisions are fast, fair, and final as the arbitrator's award is binding on both you and Ford of Canada.

CAMVAP services are available in all Canadian territories and provinces. For more information, without charge or obligation, call your CAMVAP Provincial Administrator directly at 1-800-207-0685 or visit [www.camvap.ca](http://www.camvap.ca).

### **GETTING ASSISTANCE OUTSIDE THE U.S. AND CANADA**

Before exporting your vehicle to a foreign country, contact the appropriate foreign embassy or consulate. These officials can inform you of local vehicle registration regulations and where to find unleaded fuel.

If you cannot find unleaded fuel or can only get fuel with an anti-knock index lower than is recommended for your vehicle, contact a regional office or owner relations/customer relationship office.

358

## Customer Assistance

The use of leaded fuel in your vehicle without proper conversion may damage the effectiveness of your emission control system and may cause engine knocking or serious engine damage. Ford Motor Company/Ford of Canada is not responsible for any damage caused by use of improper fuel. Using leaded fuel may also result in difficulty importing your vehicle back into the U.S.

If your vehicle must be serviced while you are traveling or living in Asia-Pacific Region, Sub-Saharan Africa, U.S. Virgin Islands, Central America, the Caribbean, and Israel, contact the nearest authorized dealer. If the authorized dealer cannot help you, contact:

FORD MOTOR COMPANY  
FORD EXPORT OPERATIONS & GLOBAL INITIATIVES  
1555 Fairlane Drive  
Fairlane Business Park #3  
Allen Park, Michigan 48101  
U.S.A.

Telephone: (313) 594-4857

For customers in Guam, the Commonwealth of the Northern Mariana Islands (CNMI), American Samoa, and the U.S. Virgin Islands, please feel free to call our Toll-Free Number: (800) 841-FORD (3673).

FAX: (313) 390-0804

Email: [expcac@ford.com](mailto:expcac@ford.com)

If your vehicle must be serviced while you are traveling or living in Puerto Rico, contact the nearest authorized dealer. If the authorized dealer cannot help you, contact:

Ford International Business Development Inc.  
Customer Relationship Center  
P.O. Box 11957

Caparra Heights Station  
San Juan, Puerto Rico 00922-1957

Telephone: (800) 841-FORD (3673)

FAX: (313) 390-0804

Email: [prcac@ford.com](mailto:prcac@ford.com)

[www.ford.com.pr](http://www.ford.com.pr)

## Customer Assistance

If your vehicle must be serviced while you are traveling or living in the Middle East, contact the nearest authorized dealer. If the authorized dealer cannot help you, contact:

Ford Middle East  
Customer Relationship Center  
P.O. Box 21470  
Dubai, United Arab Emirates  
Telephone: +971 4 3326084  
Toll-Free Number for the Kingdom of Saudi Arabia: 800 8971409  
Local Telephone Number for Kuwait: 24810575  
FAX: +971 4 3327299  
Email: [menacac@ford.com](mailto:menacac@ford.com)  
[www.me.ford.com](http://www.me.ford.com)

If you buy your vehicle in North America and then relocate to any of the above locations, register your vehicle identification number (VIN) and new address with Ford Motor Company Export Operations & Global Growth Initiatives by emailing [expcac@ford.com](mailto:expcac@ford.com).

If you are in another foreign country, contact the nearest authorized dealer. If the authorized dealer employees cannot help you, they can direct you to the nearest Ford affiliate office.

**Customers in the U.S. should call 1-800-392-3673.**

### ORDERING ADDITIONAL OWNER'S LITERATURE

To order the publications in this portfolio, contact Helm, Incorporated at:

HELM, INCORPORATED  
P.O. Box 07150  
Detroit, Michigan 48207

Or to order a free publication catalog, call toll free: 1-800-782-4356

Monday-Friday 8:00 a.m. - 6:00 p.m. EST

Helm, Incorporated can also be reached by their website:  
[www.helminc.com](http://www.helminc.com).

*(Items in this catalog may be purchased by credit card, check or money order.)*

### Obtaining a French Owner's Guide

French Owner's Guides can be obtained from your authorized dealer or by contacting Helm, Incorporated using the contact information listed previously in this section.

360



## Customer Assistance

### REPORTING SAFETY DEFECTS (U.S. ONLY)

If you believe that your vehicle has a defect which could cause a crash or could cause injury or death, you should immediately inform the National Highway Traffic Safety



Administration (NHTSA) in addition to notifying Ford Motor Company.

If NHTSA receives similar complaints, it may open an investigation, and if it finds that a safety defect exists in a group of vehicles, it may order a recall and remedy campaign. However, NHTSA cannot become involved in individual problems between you, your dealer, or Ford Motor Company.

To contact NHTSA, you may call the Vehicle Safety Hotline toll-free at 1-888-327-4236 (TTY: 1-800-424-9153); go to <http://www.safercar.gov>; or write to:

Administrator  
1200 New Jersey Avenue, Southeast  
Washington, D.C. 20590

You can also obtain other information about motor vehicle safety from <http://www.safercar.gov>.

### REPORTING SAFETY DEFECTS (CANADA ONLY)

If you believe that your vehicle has a defect which could cause a crash or could cause injury or death, you should immediately inform Transport Canada, using their toll-free number: 1-800-333-0510, or online at: <https://wwwapps.tc.gc.ca/Saf-Sec-Sur/7/PCDB-BDPP/Index.aspx>.

## Cleaning

### WASHING THE EXTERIOR

Wash your vehicle regularly with cool or lukewarm water and a neutral pH shampoo, such as Motorcraft® Detail Wash (ZC-3-A), which is available from your authorized dealer.

- Never use strong household detergents or soap, such as dish washing or laundry liquid. These products can discolor and spot painted surfaces.
- Never wash a vehicle that is “hot to the touch” or during exposure to strong, direct sunlight.
- Always use a clean sponge or car wash mitt with plenty of water for best results.
- Dry the vehicle with a chamois or soft terry cloth towel in order to eliminate water spotting.
- It is especially important to wash the vehicle regularly during the winter months, as dirt and road salt are difficult to remove and cause damage to the vehicle.
- Immediately remove items such as gasoline, diesel fuel, bird droppings and insect deposits because they can cause damage to the vehicle’s paintwork and trim over time. Use Motorcraft® Bug and Tar Remover (ZC-42), which is available from your authorized dealer.
- Remove any exterior accessories, such as antennas, before entering a car wash.
- **Suntan lotions and insect repellents can damage any painted surface; if these substances come in contact with your vehicle, wash off as soon as possible.**
- **If your vehicle is equipped with running boards, use Motorcraft Detail Wash, ZC-3-A, and, as required, Motorcraft Bug and Tar Remover, ZC-42, both as per the directions on the products’ labels. To manually dry, use a clean, dry, lint-free towel. Do not use rubber, plastic and vinyl protectant products on the running board surface, as the area may become slippery.**

### Exterior chrome

- Wash the vehicle first, using cool or lukewarm water and a neutral pH shampoo, such as Motorcraft® Detail Wash (ZC-3-A).
- Use Motorcraft® Custom Bright Metal Cleaner (ZC-15), available from your authorized dealer. Apply the product as you would a wax to clean bumpers and other chrome parts; allow the cleaner to dry for a few minutes, then wipe off the haze with a clean, dry rag.
- **Never use abrasive materials such as steel wool or plastic pads as they can scratch the chrome surface.**

362

### WAXING

- Wash the vehicle first.
- Use a quality wax that does not contain abrasives.
- Do not allow paint sealant to come in contact with any non-body (low-gloss black) colored trim, such as grained door handles, roof racks, bumpers, side moldings, mirror housings or the windshield cowl area. The paint sealant will “gray” or stain the parts over time.

### PAINT CHIPS

Your authorized dealer has touch-up paint to match your vehicle's color. Take your color code (printed on a sticker in the driver's door jamb) to your authorized dealer to ensure you get the correct color.

- Remove particles such as bird droppings, tree sap, insect deposits, tar spots, road salt and industrial fallout before repairing paint chips.
- Always read the instructions before using the products.

### ALUMINUM WHEELS AND WHEEL COVERS

Aluminum wheels and wheel covers are coated with a clear coat paint finish. In order to maintain their shine:

- Clean weekly with Motorcraft® Wheel and Tire Cleaner, which is available from your authorized dealer. Heavy dirt and brake dust accumulation may require agitation with a sponge. Rinse thoroughly with a strong stream of water.
- Never apply any cleaning chemical to hot or warm wheel rims or covers.
- Some automatic car washes may cause damage to the finish on your wheel rims or covers. Industrial-strength (heavy-duty) cleaners, or cleaning chemicals, in combination with brush agitation to remove brake dust and dirt, could wear away the clear coat finish over time.
- Do not use hydrofluoric acid-based or high caustic-based wheel cleaners, steel wool, fuels or strong household detergent.
- To remove tar and grease, use Motorcraft® Bug and Tar Remover , available from your authorized dealer.

## Cleaning

### ENGINE

Engines are more efficient when they are clean because grease and dirt buildup keep the engine warmer than normal. When washing:

- Take care when using a power washer to clean the engine. The high-pressure fluid could penetrate the sealed parts and cause damage.
- Do not spray a hot engine with cold water to avoid cracking the engine block or other engine components.
- Spray Motorcraft Engine Shampoo and Degreaser (ZC-20) on all parts that require cleaning and pressure rinse clean. In Canada use Motorcraft Engine Shampoo (CXC-66-A).
- Cover the highlighted areas to prevent water damage when cleaning the engine.
- Never wash or rinse the engine while it is hot or running; water in the running engine may cause internal damage.
- Never wash or rinse any ignition coil, spark plug wire or spark plug well, or the area in and around these locations.

3.7L engine

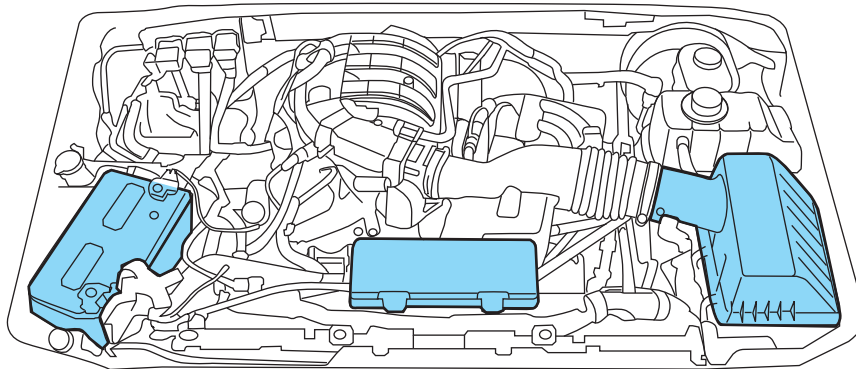

## Cleaning

5.0L engine

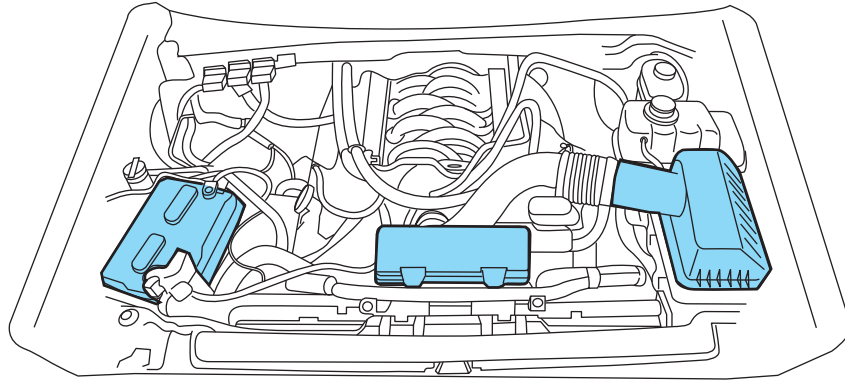

6.2L engine

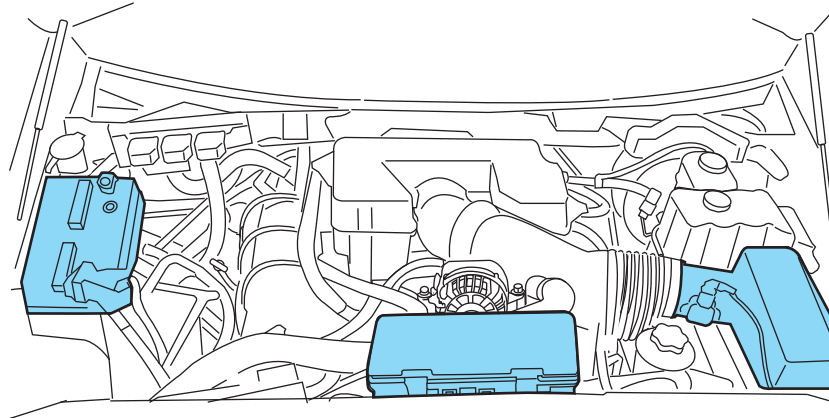

## Cleaning

3.5L EcoBoost™ engine

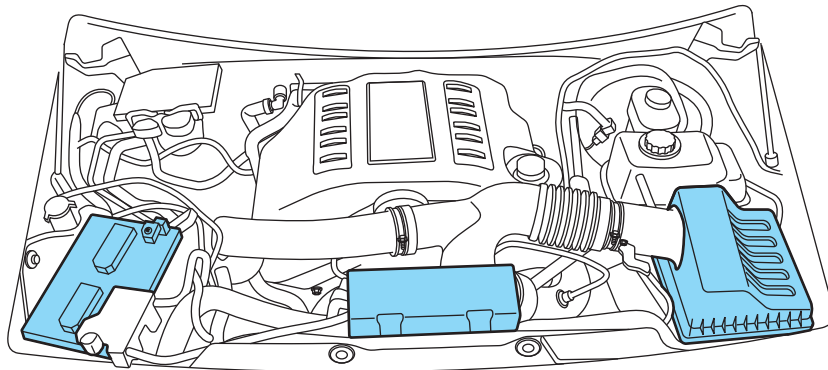

### PLASTIC (NON-PAINTED) EXTERIOR PARTS

Use only approved products to clean plastic parts. These products are available from your authorized dealer.

- For routine cleaning, use Motorcraft® Detail Wash (ZC-3-A).
- If tar or grease spots are present, use Motorcraft® Bug and Tar Remover (ZC-42).

### WINDOWS AND WIPER BLADES

The windshield, rear and side windows and the wiper blades should be cleaned regularly. If the wipers do not wipe properly, substances on the vehicle's glass or the wiper blades may be the cause. These may include hot wax treatments used by commercial car washes, water repellent coatings, tree sap, or other organic contamination; these contaminants may cause squeaking or chatter noise from the blades, and streaking and smearing of the windshield. To clean these items, follow these tips:

- The windshield, rear windows and side windows may be cleaned with a non-abrasive cleaner such as Motorcraft® Ultra-Clear Spray Glass Cleaner (ZC-23), available from your authorized dealer.

366

## Cleaning

- The wiper blades can be cleaned with isopropyl (rubbing) alcohol or Motorcraft® Premium Windshield Washer Concentrate (ZC-32-A) in the U.S., or Premium Quality Windshield Washer Fluid [CXC-37-(A, B, D, or F)] in Canada, available from your authorized dealer. This washer fluid contains special solution in addition to alcohol which helps to remove the hot wax deposited on the wiper blade and windshield from automated car wash facilities. Be sure to replace wiper blades when they appear worn or do not function properly.
- Do not use abrasives, as they may cause scratches.
- Do not use fuel, kerosene, or paint thinner to clean any parts.

If you cannot remove those streaks after cleaning with the glass cleaner or if the wipers chatter and move in a jerky motion, clean the outer surface of the windshield and the wiper blades using a sponge or soft cloth with a neutral detergent or mild-abrasive cleaning solution. After cleaning, rinse the windshield and wiper blades with clean water. The windshield is clean if beads do not form when you rinse the windshield with water.

**Do not use sharp objects, such as a razor blade, to clean the inside of the rear window or to remove decals, as it may cause damage to the rear window defroster's heated grid lines (if equipped).**

### **INSTRUMENT PANEL AND CONSOLE (HARLEY-DAVIDSON EDITION ONLY)**

Your vehicle's instrument panel and console are uniquely painted with both high and low gloss paints that require special care. The high gloss area is similar to that of the vehicle's exterior; the low gloss area is designed to help protect the driver from undesirable windshield reflection.

#### **High gloss paint area**

In order to maintain the finish of the instrument panel and console, the high gloss areas should be treated similar to the that of exterior paint or glossy plastic surfaces. When cleaning the high gloss areas:

- **Do not use** paper towels or newspaper.
- **Do not use** silicone or Teflon® (PTFE)-based products.

Dust the high gloss areas with a clean, dry cloth, or use Motorcraft Dusting Cloth (ZC-24).

For general cleaning, use mild, soapy water and a soft, damp cloth, then dry with a clean, dry cloth.

## Cleaning

For removal of fine scuffs and scratches, use Scotch-Brite® Microfiber Cloth or cheese cloth along with Motorcraft Premium Liquid Wax (ZC-53-A), Motorcraft Paint Sealant (ZC-45), or Motorcraft Custom Clear Coat Polish (ZC-8-A). **Note:** Removal of deep scuffs and scratches should be performed by an authorized dealer or an experienced repair facility.

### Low gloss paint area

The low gloss area of the instrument panel's upper dash should be cleaned with mild, soapy water and a soft, damp cloth, then dried with a clean, dry cloth. When cleaning the low gloss areas:

- **Do not use** paper towels or newspaper.
- **Do not use** silicone or Teflon® (PTFE)-based products.
- **Do not use** exterior paint waxes or sealants.

Dust the low gloss areas with a clean, dry cloth, or use Motorcraft Dusting Cloth (ZC-24).

### INSTRUMENT PANEL/INTERIOR TRIM AND CLUSTER LENS

Clean the instrument panel, interior trim areas and cluster lens with a clean, damp, white cotton cloth, then use a clean and dry white cotton cloth to dry these areas.

- Avoid cleaners or polishes that increase the gloss of the upper portion of the instrument panel. The dull finish in this area helps protect the driver from undesirable windshield reflection.
- Be certain to wash or wipe your hands clean if you have been in contact with certain products such as insect repellent and suntan lotion in order to avoid possible damage to the interior painted surfaces.
- Do not use household or glass cleaners as these may damage the finish of the instrument panel, interior trim and cluster lens.
- Do not allow air fresheners and hand sanitizers to spill on interior surfaces. If a spill occurs, **wipe off immediately**. Damage may not be covered by your warranty.



**WARNING:** Do not use chemical solvents or strong detergents when cleaning the steering wheel or instrument panel to avoid contamination of the airbag system.



## Cleaning

If a staining liquid like coffee/juice has been spilled on the instrument panel or on interior trim surfaces, clean as follows:

1. Wipe up spilled liquid using a clean, white, cotton cloth.
2. Wipe the surface with a damp, clean, white cotton cloth. For more thorough cleaning, use a mild soap and water solution. If the spot cannot be completely cleaned by this method, the area may be cleaned using a commercially available cleaning product designed for automotive interiors.
3. If necessary, apply more soap and water solution or cleaning product to a clean, white, cotton cloth and press the cloth onto the soiled area—allow this to set at room temperature for 30 minutes.
4. Remove the soaked cloth, and if it is not soiled badly, use this cloth to clean the area by using a rubbing motion for 60 seconds.
5. Following this, wipe area dry with a clean, white, cotton cloth.

### INTERIOR

For fabric, carpets, cloth seats and safety belts:

- Remove dust and loose dirt with a vacuum cleaner.
- Remove light stains and soil with Motorcraft® Professional Strength Carpet & Upholstery Cleaner (ZC-54).
- If grease or tar is present on the material, spot-clean the area first with Motorcraft® Spot and Stain Remover (ZC-14). In Canada, use Motorcraft® Multi-Purpose Cleaner (CXC-101).
- If a ring forms on the fabric after spot cleaning, clean the entire area immediately (but do not oversaturate) or the ring will set.
- Do not use household cleaning products or glass cleaners, which can stain and discolor the fabric and affect the flame retardant abilities of the seat materials.



**WARNING:** Do not use cleaning solvents, bleach or dye on the vehicle's seatbelts, as these actions may weaken the belt webbing.

## Cleaning

### **LEATHER SEATS (IF EQUIPPED, EXCEPT FOR THE KING RANCH® EDITION)**

**For King Ranch® leather seats, refer to a separate section in this chapter.**

- Clean spills and stains as quickly as possible.
- For routine cleaning, wipe the surface with a soft, damp cloth. For more thorough cleaning, wipe the surface with a mild soap and water solution. In Canada, use Motorcraft® Vinyl Cleaner (CXC-93). Dry the area with a soft cloth.
- If the leather cannot be completely cleaned using a mild soap and water solution, the leather may be cleaned using a commercially available leather cleaning product designed for automotive interiors.
- To check for compatibility, first test any cleaner or stain remover on an inconspicuous part of the leather.
- Do not use household cleaning products, alcohol solutions, solvents or cleaners intended for rubber, vinyl and plastics, or oil/petroleum-based leather conditioners. These products may cause premature wearing or damage to the leather.

### **Leather seats for the King Ranch® edition only (if equipped)**

Your vehicle is equipped with seating covered in premium, top-grain leather which is extremely durable, but still requires special care and maintenance in order to ensure longevity and comfort.

Regular cleaning and conditioning will maintain the appearance of the leather.

#### **Cleaning**

For dirt, use a vacuum cleaner then use a clean, damp cloth or soft brush.

For routine cleaning, wipe the surface with a soft, damp cloth. For more thorough cleaning, wipe the surface with a mild soap and water solution.

- Clean spills as quickly as possible.
- Test any cleaner or stain remover on an inconspicuous part of the leather as cleaners may darken the leather.
- Do not spill coffee, ketchup, mustard, orange juice or oil-based products on the leather as they may permanently stain the leather.
- Do not use household cleaning products, alcohol solutions, solvents or cleaners intended for rubber, vinyl or plastics.

370

## Cleaning

### Scratches

Natural Markings - Because the leather in the seat comes from genuine steer hides, there will be evidence of naturally occurring markings, such as small scars. These markings give character to the seating covers and should be considered as proof of a genuine leather product.

In order to lessen the appearance of certain scratches and other wear marks, apply conditioner on the affected area following the same instructions as in the *Conditioning* section.

### Conditioning

Bottles of King Ranch® Leather Conditioner are available at the King Ranch® Saddle Shop. Visit the website at [www.krsaddleshop.com](http://www.krsaddleshop.com), or telephone (in the United States) 1-800-282-KING (5464). If you are unable to obtain King Ranch® Leather Conditioner, use another premium leather conditioner.

- Clean the surfaces using the steps outlined in the *Cleaning* section.
- Ensure the leather is dry then apply a nickel-sized amount of conditioner to a clean, dry cloth.
- Rub the conditioner into leather until it disappears. Allow the conditioner to dry and repeat the process for the entire interior. If a film appears, wipe off film with a dry, clean cloth.

### UNDERBODY

Flush the complete underside of your vehicle frequently. Keep body and door drain holes free from packed dirt.

Rear suspension components may require regular cleaning with a power washer or a thorough rinse with a strong stream of water if the vehicle is operated in dusty or muddy environments. Rear leaf springs or other suspension components may emit squeak or popping noises while operating the vehicle if particles such as dirt, rocks, or other debris are present in the components.

## Cleaning

### FORD AND LINCOLN CAR CARE PRODUCTS

Your Ford or Lincoln authorized dealer has many quality products available to clean your vehicle and protect its finishes. These quality products have been specifically engineered to fulfill your automotive needs; they are custom designed to complement the style and appearance of your vehicle. Each product is made from high quality materials that meet or exceed rigid specifications. For best results, use the following products or products of equivalent quality:

- Motorcraft® Bug and Tar Remover (ZC-42)
- Motorcraft® Custom Bright Metal Cleaner (ZC-15)
- Motorcraft® Detail Wash (ZC-3-A)
- Motorcraft® Dusting Cloth (ZC-24)
- Motorcraft® Engine Shampoo and Degreaser (U.S. only) (ZC-20)
- Motorcraft® Engine Shampoo (Canada only) (CXC-66-A)
- Motorcraft® Multi-Purpose Cleaner (Canada only) (CXC-101)
- Motorcraft® Premium Glass Cleaner (Canada only) (CXC-100)
- Motorcraft® Premium Quality Windshield Washer Fluid (Canada only) [CXC-37-(A, B, D or F)]
- Motorcraft® Premium Windshield Washer Concentrate (U.S. only) (ZC-32-A)
- Motorcraft® Professional Strength Carpet & Upholstery Cleaner (ZC-54)
- Motorcraft® Spot and Stain Remover (U.S. only) (ZC-14)
- Motorcraft® Ultra-Clear Spray Glass Cleaner (ZC-23)
- Motorcraft® Vinyl Cleaner (Canada only) (CXC-93)
- Motorcraft® Wheel and Tire Cleaner (ZC-37-A)

## Maintenance and Specifications

### SERVICE RECOMMENDATIONS

To help you service your vehicle, we provide *scheduled maintenance information* which makes tracking routine service easy.

If your vehicle requires professional service, your authorized dealer can provide the necessary parts and service. Check your *Warranty Guide* to find out which parts and services are covered.

Use only recommended fuels, lubricants, fluids and service parts conforming to specifications. Motorcraft® parts are designed and built to provide the best performance in your vehicle.

### PRECAUTIONS WHEN SERVICING YOUR VEHICLE

- Do not work on a hot engine.
- Make sure that nothing gets caught in moving parts.
- Do not work on a vehicle with the engine running in an enclosed space, unless you are sure you have enough ventilation.
- Keep all open flames and other lit material away from the battery and all fuel related parts.



**WARNING:** Turn off the power running boards, if equipped, before working under the vehicle, jacking or placing any object under the vehicle. Never place your hand between the extended running board and the vehicle. A moving running board may cause injury.

### Working with the engine off

1. Set the parking brake and ensure the gearshift is securely latched in P (Park).
2. Turn off the engine and remove the key.
3. Block the wheels to prevent the vehicle from moving unexpectedly.

### Working with the engine on



**WARNING:** To reduce the risk of vehicle damage and/or personal burn injuries, do not start your engine with the air cleaner removed and do not remove it while the engine is running.

1. Set the parking brake and shift to P (Park).
2. Block the wheels.

## Maintenance and Specifications

### OPENING THE HOOD

1. Inside the vehicle, pull the hood release handle located under the bottom of the instrument panel.

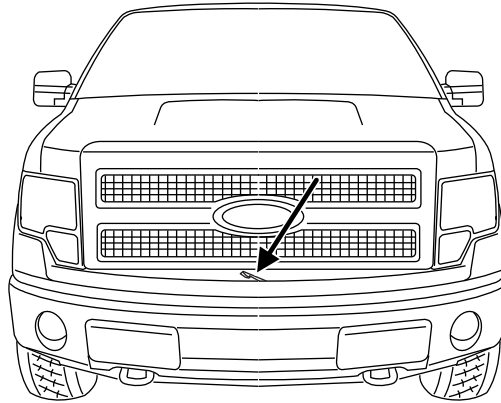
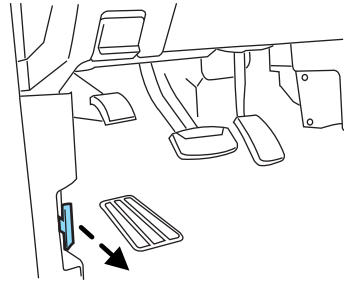

2. Go to the front of the vehicle and release the auxiliary latch that is located on the front bumper under the grill.
3. Lift the hood until the lift cylinders hold it open.

## Maintenance and Specifications

### IDENTIFYING COMPONENTS IN THE ENGINE COMPARTMENT

#### 3.7L V6 engine

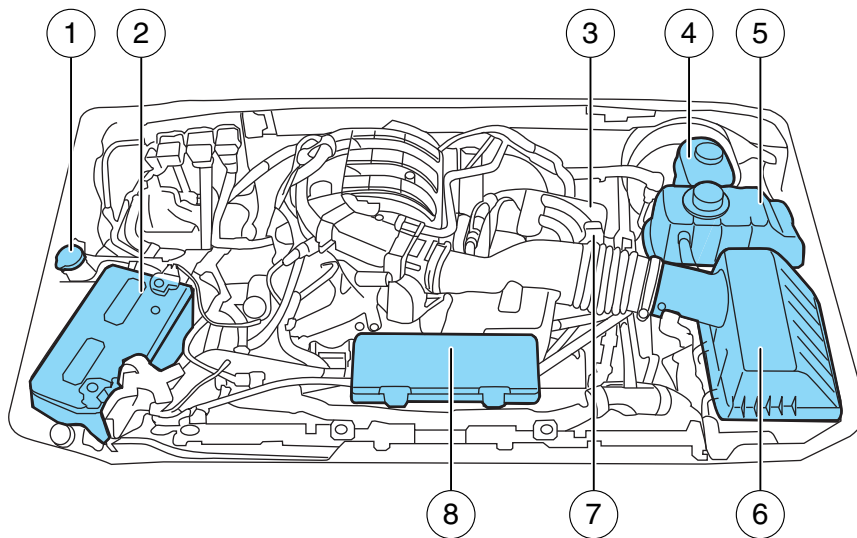

1. Windshield washer fluid reservoir
2. Battery
3. Engine oil dipstick (out of view)
4. Brake fluid reservoir
5. Engine coolant reservoir
6. Air filter assembly
7. Engine oil filler cap (out of view)
8. Power distribution box

## Maintenance and Specifications

### 5.0L V8 engine

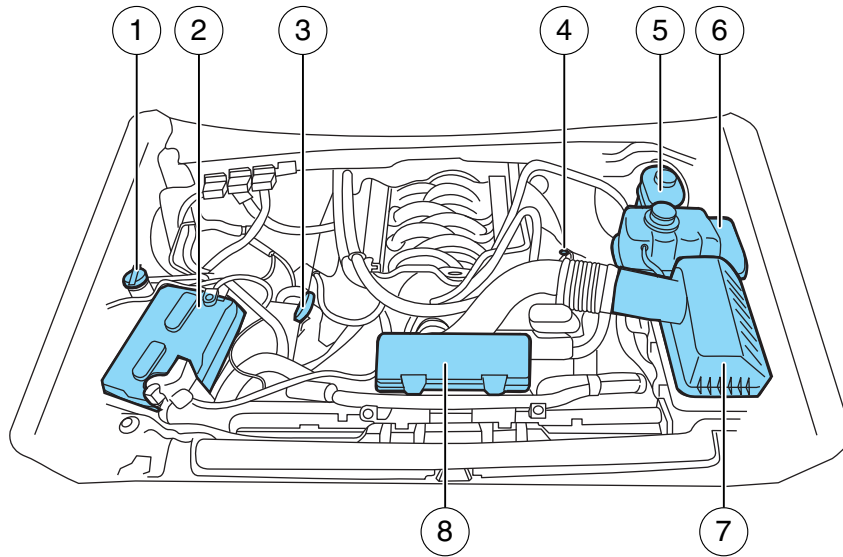

1. Windshield washer fluid reservoir
2. Battery
3. Engine oil filler cap
4. Engine oil dipstick
5. Brake fluid reservoir
6. Engine coolant reservoir
7. Air filter assembly
8. Power distribution box



## Maintenance and Specifications

### 6.2L V8 engine

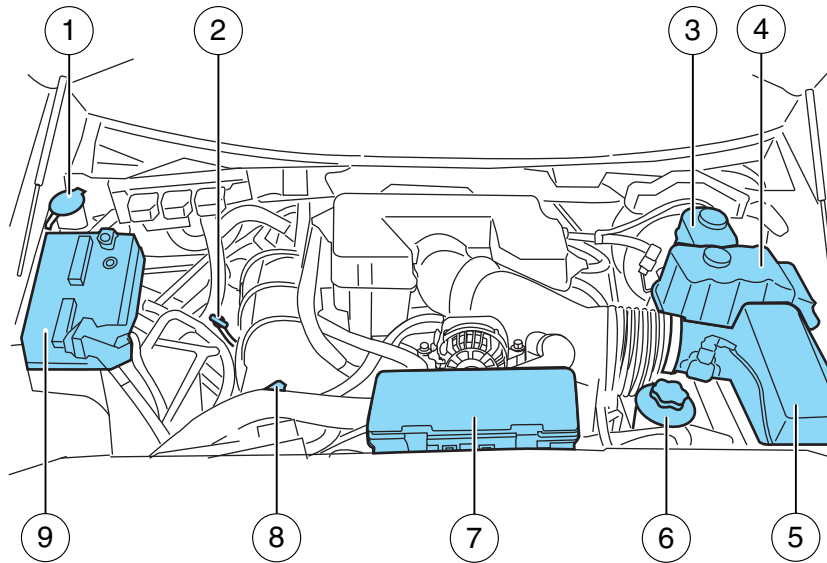

1. Windshield washer fluid reservoir
2. Engine oil dipstick
3. Brake fluid reservoir
4. Engine coolant reservoir
5. Air filter assembly
6. Power steering fluid reservoir
7. Power distribution box
8. Engine oil filler cap
9. Battery

## Maintenance and Specifications

### 3.5L V6 EcoBoost™ engine

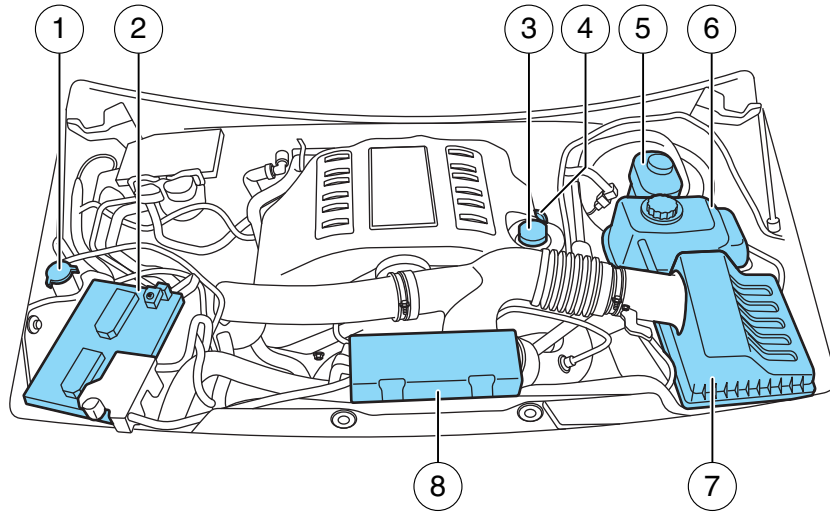

1. Windshield washer fluid reservoir
2. Battery
3. Engine oil filler cap
4. Engine oil dipstick
5. Brake fluid reservoir
6. Engine coolant reservoir
7. Air filter assembly
8. Power distribution box

## Maintenance and Specifications

### WINDSHIELD WASHER FLUID

Add fluid to fill the reservoir if the level is low. In very cold weather, do not fill the reservoir completely.

Only use a washer fluid that meets Ford specifications. Do not use any special washer fluid such as windshield water repellent type fluid or bug wash. They may cause squeaking, chatter noise, streaking and smearing. Refer to *Maintenance product specifications and capacities* in this chapter.

State or local regulations on volatile organic compounds may restrict the use of methanol, a common windshield washer antifreeze additive.

Washer fluids containing non-methanol antifreeze agents should be used only if they provide cold weather protection without damaging the vehicle's paint finish, wiper blades or washer system.

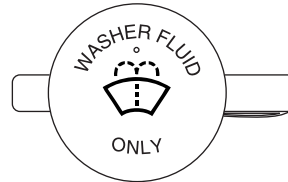

**WARNING:** If you operate your vehicle in temperatures below 40°F (5°C), use washer fluid with antifreeze protection. Failure to use washer fluid with antifreeze protection in cold weather could result in impaired windshield vision and increase the risk of injury or accident.

### CHANGING THE WIPER BLADES

1. Pull the wiper arm away from the vehicle. Turn the blade at an angle from the wiper arm. Press the lock tab to release the blade and pull the wiper blade down toward the windshield to remove it from the arm.

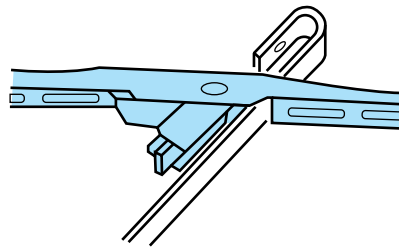

2. Attach the new wiper to the wiper arm and press it into place until a click is heard.

Replace wiper blades at least once per year for optimum performance. Poor wiper quality can be improved by cleaning the wiper blades and the windshield. Refer to *Windows and wiper blades* in the *Cleaning* chapter.

## Maintenance and Specifications

To prolong the life of the wiper blades, it is highly recommended to scrape off the ice on the windshield before turning on the wipers. The layer of ice has many sharp edges and can damage the micro edge of the wiper rubber element.

### ENGINE OIL

#### Checking the engine oil

Refer to the *scheduled maintenance information* for the appropriate intervals for checking the engine oil.

1. Make sure the vehicle is on level ground.
2. Turn the engine off and wait 15 minutes for the oil to drain into the oil pan.
3. Set the parking brake and ensure the gearshift is securely latched in P (Park).
4. Open the hood. Protect yourself from engine heat.
5. Locate and carefully remove the engine oil level dipstick. See *Identifying components in the engine compartment* in this chapter for location of dipstick.



6. Wipe the dipstick clean. Insert the dipstick fully, then remove it again.
  - If the oil level is **between the lower and upper holes or between the MIN and MAX marks (depending on application)**, the oil level is acceptable. **DO NOT ADD OIL.**
  - If the oil level is below the lower hole or the MIN mark, add enough oil to raise the level within the lower and upper holes or within the MIN-MAX range.
  - Oil levels above the upper hole or the MAX mark may cause engine damage. Some oil must be removed from the engine by an authorized dealer.
7. Put the dipstick back in and ensure it is fully seated.

#### Adding engine oil

1. Check the engine oil. For instructions, refer to *Checking the engine oil* in this chapter.

380

## Maintenance and Specifications

2. If the engine oil level is not within the normal range, add only certified engine oil of the recommended viscosity. Remove the engine oil filler cap and use a funnel to pour the engine oil into the opening.
3. Recheck the engine oil level. Make sure the oil level is not above the normal operating range on the engine oil level dipstick.
4. Install the dipstick and ensure it is fully seated.
5. Fully install the engine oil filler cap by turning the filler cap clockwise 1/4 of a turn until three clicks are heard or until the cap is fully seated.

**To avoid possible oil loss, DO NOT operate the vehicle with the engine oil level dipstick and/or the engine oil filler cap removed.**

### Engine oil and filter recommendations

#### 3.7L V6, 5.0L V8, and 6.2L V8 engines

Look for this certification trademark.

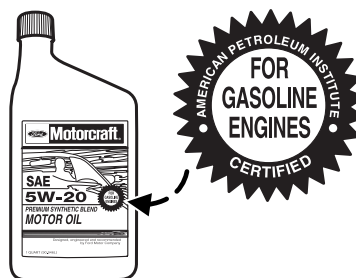

#### **Use SAE 5W-20 engine oil**

Only use oils certified for gasoline engines by the American Petroleum Institute (API). An oil with this trademark symbol conforms to the current engine and emission system protection standards and fuel economy requirements of the International Lubricant Standardization and Approval Committee (ILSAC), comprised of U.S. and Japanese automobile manufacturers.

To protect your engine and engine's warranty, use Motorcraft® SAE 5W-20 or an equivalent SAE 5W-20 oil meeting Ford specification WSS-M2C930-A. **SAE 5W-20 oil provides optimum fuel economy and durability performance meeting all requirements for your vehicle's engine.** Refer to *Maintenance product specifications and capacities* later in this section for more information.

Do not use supplemental engine oil additives, cleaners or other engine treatments. They are unnecessary and could lead to engine damage that is not covered by Ford warranty.

## Maintenance and Specifications

Change your engine oil according to the appropriate schedule listed in the *scheduled maintenance information*.

Ford production and Motorcraft® replacement oil filters are designed for added engine protection and long life. If a replacement oil filter is used that does not meet Ford material and design specifications, start-up engine noises or knock may be experienced.

It is recommended you use the appropriate Motorcraft® oil filter or another with equivalent performance for your engine application.

### 3.5L V6 EcoBoost™ engine

Look for this certification trademark.

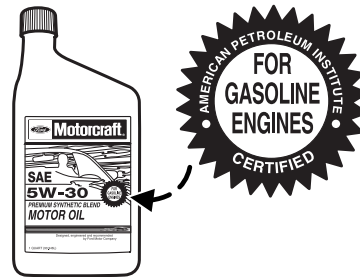

### Use SAE 5W-30 engine oil

Only use oils “Certified For Gasoline Engines” by the American Petroleum Institute (API). An oil with this trademark symbol conforms to the current engine and emission system protection standards and fuel economy requirements of the International Lubricant Standardization and Approval Committee (ILSAC), comprised of U.S. and Japanese automobile manufacturers.

To protect your engine and engine’s warranty, use Motorcraft® SAE 5W-30 or an equivalent SAE 5W-30 oil meeting Ford specification WSS-M2C929-A. Refer to *Maintenance product specifications and capacities* later in this section for more information.

Do not use supplemental engine oil additives, cleaners or other engine treatments. They are unnecessary and could lead to engine damage that is not covered by Ford warranty.

Change your engine oil according to the appropriate schedule listed in the *scheduled maintenance information*.

Ford production and Motorcraft® replacement oil filters are designed for added engine protection and long life. If a replacement oil filter is used that does not meet Ford material and design specifications, start-up engine noises or knock may be experienced.

382

## Maintenance and Specifications

It is recommended you use the appropriate Motorcraft® oil filter or another with equivalent performance for your engine application.

### BATTERY

Your vehicle is equipped with a Motorcraft® maintenance-free battery which normally does not require additional water during its life of service.

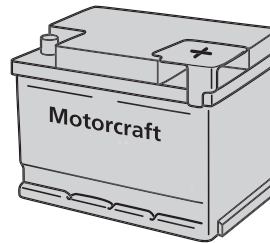

### **If your battery has a cover/shield, make sure it is reinstalled after the battery has been cleaned or replaced.**

For longer, trouble-free operation, keep the top of the battery clean and dry. Also, make certain the battery cables are always tightly fastened to the battery terminals.

If you see any corrosion on the battery or terminals, remove the cables from the terminals and clean with a wire brush. You can neutralize the acid with a solution of baking soda and water.

It is recommended that the negative battery cable terminal be disconnected from the battery if you plan to store your vehicle for an extended period of time. This will minimize the discharge of your battery during storage.

**Note:** Electrical or electronic accessories or components added to the vehicle by the dealer or the owner may adversely affect battery performance and durability.





**WARNING:** Batteries normally produce explosive gases which can cause personal injury. Therefore, do not allow flames, sparks or lighted substances to come near the battery. When working near the battery, always shield your face and protect your eyes. Always provide proper ventilation.



**WARNING:** When lifting a plastic-cased battery, excessive pressure on the end walls could cause acid to flow through the vent caps, resulting in personal injury and/or damage to the vehicle or battery. Lift the battery with a battery carrier or with your hands on opposite corners.

## Maintenance and Specifications

 **WARNING:** Keep batteries out of reach of children. Batteries contain sulfuric acid. Avoid contact with skin, eyes or clothing. Shield your eyes when working near the battery to protect against possible splashing of acid solution. In case of acid contact with skin or eyes, flush immediately with water for a minimum of 15 minutes and get prompt medical attention. If acid is swallowed, call a physician immediately.

 **WARNING:** Battery posts, terminals and related accessories contain lead and lead compounds. **Wash hands after handling.**

Because your vehicle's engine is electronically controlled by a computer, some control conditions are maintained by power from the battery. When the battery is disconnected or a new battery is installed, the engine must relearn its idle and fuel trim strategy for optimum driveability and performance. Flexible fuel vehicles (FFV) must also relearn the ethanol content of the fuel for optimum driveability and performance. To begin this process:

1. With the vehicle at a complete stop, set the parking brake.
2. Put the gearshift in P (Park), turn off all accessories and start the engine.
3. Run the engine until it reaches normal operating temperature.
4. Allow the engine to idle for at least one minute.
5. Turn the A/C on and allow the engine to idle for at least one minute.
6. Release the parking brake. With your foot on the brake pedal and with the A/C on, put the vehicle in D (Drive) and allow the engine to idle for at least one minute.
7. Drive the vehicle to complete the relearning process.
  - The vehicle may need to be driven 10 miles (16 km) or more to relearn the idle and fuel trim strategy along with the ethanol content for flexible fuel vehicles.
  - **If you do not allow the engine to relearn its idle trim, the idle quality of your vehicle may be adversely affected until the idle trim is eventually relearned.**
  - For flexible fuel vehicles, if you are operating on E85, you may experience poor starts or an inability to start the engine and driveability problems until the fuel trim and ethanol content have been relearned.

384



## Maintenance and Specifications

If the battery has been disconnected or a new battery has been installed, the clock and radio settings must be reset once the battery is reconnected.

- Always dispose of automotive batteries in a responsible manner. Follow your local authorized standards for disposal. Call your local authorized recycling center to find out more about recycling automotive batteries.

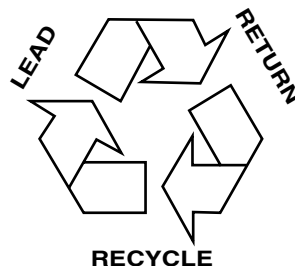

### Battery management system (if equipped)

The battery management system (BMS) monitors battery conditions and takes actions to extend battery life. If excessive battery drain is detected, the system may temporarily disable certain electrical features to protect the battery. Those electrical accessories affected include the rear defrost, heated/cooled seats, climate control fan, heated steering wheel, audio and navigation system. A message may be displayed on the instrument cluster or center stack display to alert the driver that battery protection actions are active. See the *Message center* in the *Instrument Cluster* chapter and *Entertainment Systems* chapter for more information. These messages are only for notification that an action is taking place, and not intended to indicate an electrical problem or that the battery requires replacement.

### Electrical accessory installation

To ensure proper operation of the BMS, any electrical devices that are added to the vehicle should not have their ground connection made directly at the negative battery post. A connection at the negative battery post can cause inaccurate measurements of the battery condition and potential incorrect system operation.

**Note:** Electrical or electronic accessories added to the vehicle by the dealer or the owner may adversely affect battery performance and durability, and may also affect the performance of other electrical systems in the vehicle.

When a battery replacement is required, the battery should only be replaced with a Ford recommended replacement battery which matches the electrical requirements of the vehicle. After battery replacement, or

385

## Maintenance and Specifications

in some cases after charging the battery with the external charger, the BMS requires eight hours of vehicle sleep time (key off with doors closed) to relearn the new battery state of charge. Prior to relearning the state of charge, the BMS may disable electrical features (to protect the battery) earlier than normal.

### ENGINE COOLANT

#### Checking engine coolant

The concentration and level of engine coolant should be checked at the intervals listed in *scheduled maintenance information*. The coolant concentration should be maintained at 50/50 coolant and distilled water. For best results, coolant concentration should be tested with a refractometer such as Rotunda tool 300-ROB75240E available from your dealer. Ford does not recommend the use of hydrometers or coolant test strips for measuring coolant concentration. The level of coolant should be maintained at the FULL COLD level or within the COLD FILL RANGE in the coolant reservoir. If the level falls below, add coolant per the instructions in the *Adding engine coolant* section.

Your vehicle was factory-filled with a 50/50 engine coolant and water concentration. If the concentration of coolant falls below 40% or above 60%, the engine parts could become damaged or not work properly. **A 50/50 mixture of coolant and water provides the following:**

- **Improved freeze protection.**
- **Improved boiling protection.**
- **Protection against rust and other forms of corrosion.**
- **Proper function of calibrated gauges.**

When the engine is cold, check the level of the engine coolant in the reservoir.

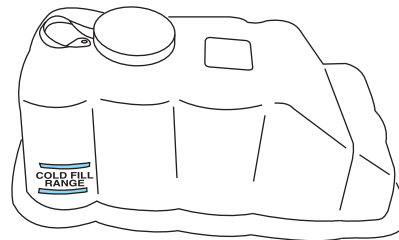

- The engine coolant should be at the FULL COLD level, or within the COLD FILL or MIN / MAX range as listed on the engine coolant reservoir (depending upon application).

386

## Maintenance and Specifications

- Refer to *scheduled maintenance information* for service interval schedules.

If the engine coolant has not been checked at the recommended interval, the engine coolant reservoir may become low or empty. If the reservoir is low or empty, add engine coolant to the reservoir. Refer to *Adding engine coolant* in this chapter.

**Note:** Automotive fluids are not interchangeable; do not use engine coolant/antifreeze or windshield washer fluid outside of its specified function and vehicle location.

### Adding engine coolant

When adding coolant, make sure it is a 50/50 mixture of engine coolant and distilled water. Add the mixture to the coolant reservoir, **when the engine is cool**, until the appropriate fill level is obtained. If coolant is filled to the COLD FILL RANGE or FULL COLD level when the engine is not cool, the system will remain underfilled.



**WARNING:** Do not add engine coolant when the engine is hot. Steam and scalding liquids released from a hot cooling system can burn you badly. Also, you can be burned if you spill coolant on hot engine parts.



**WARNING:** Do not put engine coolant in the windshield washer fluid container. If sprayed on the windshield, engine coolant could make it difficult to see through the windshield.

- **DO NOT MIX** different colors or types of coolant in your vehicle. Make sure the correct coolant is used. Mixing of engine coolants may harm your engine's cooling system. The use of an improper coolant may harm engine and cooling system components and may void the warranty. Refer to *Maintenance product specifications and capacities* in this chapter.
- A large amount of water without engine coolant may be added, in case of emergency, to reach a vehicle service location. In this instance, the cooling system must be drained and refilled with a 50/50 mixture of engine coolant and distilled water as soon as possible. Water alone (without engine coolant) can cause engine damage from corrosion, overheating or freezing.
- **Do not use alcohol, methanol, brine or any engine coolants mixed with alcohol or methanol antifreeze (coolant).** Alcohol and other liquids can cause engine damage from overheating or freezing.

## Maintenance and Specifications

- **Do not add extra inhibitors or additives to the coolant.** These can be harmful and compromise the corrosion protection of the engine coolant.

For vehicles with overflow coolant systems with a non-pressurized cap on the coolant recovery system, add coolant to the coolant recovery reservoir when the engine is cool. Add the proper mixture of coolant and distilled water to the FULL COLD level. For all other vehicles which have a coolant degas system with a pressurized cap, or if it is necessary to remove the coolant pressure relief cap on the radiator of a vehicle with an overflow system, follow these steps to add engine coolant.



**WARNING:** To reduce the risk of personal injury, make sure the engine is cool before unscrewing the coolant pressure relief cap. The cooling system is under pressure; steam and hot liquid can come out forcefully when the cap is loosened slightly.

Add the proper mixture of coolant and water to the cooling system by following these steps:

1. Before you begin, turn the engine off and let it cool.
2. When the engine is cool, wrap a thick cloth around the coolant pressure relief cap on the coolant reservoir (a translucent plastic bottle). Slowly turn cap counterclockwise (left) until pressure begins to release.
3. Step back while the pressure releases.
4. When you are sure that all the pressure has been released, use the cloth to turn it counterclockwise and remove the cap.
5. Fill the coolant reservoir slowly with the proper coolant mixture, to within the COLD FILL RANGE or the FULL COLD level on the reservoir. If you removed the radiator cap in an overflow system, fill the radiator until the coolant is visible and radiator is almost full.
6. Replace the cap. Turn until tightly installed. Cap must be tightly installed to prevent coolant loss.

After any coolant has been added, check the coolant concentration (refer to *Checking engine coolant*). If the concentration is not 50/50, drain some coolant and adjust the concentration. It may take several drains and additions to obtain a 50/50 coolant concentration.

Whenever coolant has been added, the coolant level in the coolant reservoir should be checked the next few times you drive the vehicle. If necessary, add enough 50/50 concentration of engine coolant and distilled water to bring the liquid level to the proper level.

388

## Maintenance and Specifications

If you have to add more than 1.0 quart (1.0 liter) of engine coolant per month, have your authorized dealer check the engine cooling system. Your cooling system may have a leak. Operating an engine with a low level of coolant can result in engine overheating and possible engine damage.

### Recycled engine coolant

Ford Motor Company does NOT recommend the use of recycled engine coolant since a Ford-approved recycling process is not yet available.



Used engine coolant should be disposed of in an appropriate manner. Follow your community's regulations and standards for recycling and disposing of automotive fluids.

### Coolant refill capacity

To find out how much fluid your vehicle's cooling system can hold, refer to *Maintenance product specifications and capacities* in this chapter. Fill your engine coolant reservoir as outlined previously in the *Adding engine coolant* section.

### Severe climates

If you drive in extremely cold climates:

- **It may be necessary to increase the coolant concentration above 50%.**
- **NEVER increase the coolant concentration above 60%.**
- **A coolant concentration of 60% will provide improved freeze point protection. Increased engine coolant concentrations above 60% will decrease the overheat protection characteristics of the engine coolant and may cause engine damage.**
- **If available, refer to the chart on the coolant container to ensure the coolant concentration in your vehicle will provide adequate freeze protection at the temperatures in which you drive in the winter months.**

If you drive in extremely hot climates:

- **It is still necessary to maintain the coolant concentration above 40%.**
- **NEVER decrease the coolant concentration below 40%.**
- **Decreased engine coolant concentrations below 40% will decrease the corrosion/freeze protection characteristics of the engine coolant and may cause engine damage.**

## Maintenance and Specifications

- **If available, refer to the chart on the coolant container to ensure the coolant concentration in your vehicle will provide adequate protection at the temperatures in which you drive.**

Vehicles driven year-round in non-extreme climates should use a 50/50 mixture of engine coolant and distilled water for optimum cooling system and engine protection.

### **What you should know about fail-safe cooling (if equipped)**

If the engine coolant supply is depleted, this feature allows the vehicle to be driven temporarily before incremental component damage is incurred. The “fail-safe” distance depends on ambient temperatures, vehicle load and terrain.

#### ***How fail-safe cooling works***

If the engine begins to overheat:

- The engine coolant temperature gauge will move to the red (hot) area.
- The mini message center (if equipped) will indicate “Check Gauges”, refer to *Warning lights and chimes* in the *Instrument Cluster* chapter.
- The  light will illuminate.

If the engine reaches a preset over-temperature condition, the engine will automatically switch to alternating cylinder operation. Each disabled cylinder acts as an air pump and cools the engine.

When this occurs the vehicle will still operate. However:

- The engine power will be limited.
- The air conditioning system will be disabled.

Continued operation will increase the engine temperature:

- The engine will completely shut down.
- Steering and braking effort will increase.

Once the engine temperature cools, the engine can be re-started. Take your vehicle to an authorized dealer as soon as possible to minimize engine damage.

## Maintenance and Specifications

### ***When fail-safe mode is activated***

You have limited engine power when in the fail-safe mode, so drive the vehicle with caution. The vehicle will not be able to maintain high speed operation and the engine will run rough. Remember that the engine is capable of completely shutting down automatically to prevent engine damage, therefore:

1. Pull off the road as soon as safely possible and turn off the engine.
2. Arrange for the vehicle to be taken to an authorized dealer.
3. If this is not possible, wait a short period for the engine to cool.
4. Check the coolant level and replenish if low.



**WARNING:** Fail-safe mode is for use during emergencies only.

Operate the vehicle in fail-safe mode only as long as necessary to bring the vehicle to rest in a safe location and seek immediate repairs. When in fail-safe mode, the vehicle will have limited power, will not be able to maintain high-speed operation, and may completely shut down without warning, potentially losing engine power, power steering assist, and power brake assist, which may increase the possibility of a crash resulting in serious injury.



**WARNING:** Never remove the coolant reservoir cap while the engine is running or hot.

5. Restart the engine and take your vehicle to an authorized dealer.

**Driving the vehicle without repairing the engine problem increases the chance of engine damage. Take your vehicle to an authorized dealer as soon as possible.**

### **Engine fluid temperature management (if equipped)**

Your vehicle has been designed to pull a trailer, but because of the added load, the vehicle's engine may temporarily reach higher temperatures during severe operating conditions such as ascending a long or steep grade while pulling a trailer in hot ambient temperatures.

At this time, you may notice your engine coolant temperature gauge needle move toward the H and the POWER REDUCED TO LOWER TEMP message may appear on the message center.

## Maintenance and Specifications

You may notice a reduction in the vehicle's speed caused by reduced engine power. Your vehicle has been designed to enter this mode if certain high temperature/high load conditions take place in order to manage the engine's fluid temperatures. The amount of speed reduction will depend on the vehicle loading, towing, grade, ambient temperature, and other factors. If this occurs, there is no need to pull off the road. The vehicle can continue to be driven while this message is active.



**WARNING:** To reduce the risk of collision and injury, be prepared that the vehicle speed may reduce and the vehicle may not be able to accelerate with full power until the fluid temperatures reduce.

The air conditioning may also cycle on and off during severe operating conditions to protect overheating of the engine. When the engine coolant temperature decreases to a more normal operating temperature, the air conditioning will turn on once again.

If you notice any of the following:

- the engine coolant temperature gauge moves fully into the red (hot) area
  - the coolant temperature warning light illuminates
  - the service engine soon indicator illuminates
1. Pull off the road as soon as safely possible and place the vehicle in P (Park).
  2. Leave the engine running until the coolant temperature gauge needle moves away from the H range. After several minutes, if this does not happen, follow the remaining steps.
  3. Turn the engine off and wait for it to cool before checking the coolant level.



**WARNING:** Never remove the coolant reservoir cap while the engine is running or hot.

4. If the coolant level is normal, you may restart your engine and continue on.
5. If the coolant is low, add coolant, restart the engine and take your vehicle to an authorized dealer. See *Adding engine coolant* in this chapter for more information.

Refer to fail-safe cooling for additional information.

392



## Maintenance and Specifications

### FUEL FILTER

Your vehicle is equipped with a lifetime fuel filter that is integrated with the fuel tank. Regular maintenance or replacement is not needed.

### WHAT YOU SHOULD KNOW ABOUT AUTOMOTIVE FUELS

#### Important safety precautions



**WARNING:** Do not overfill the fuel tank. The pressure in an overfilled tank may cause leakage and lead to fuel spray and fire.



**WARNING:** The fuel system may be under pressure. If you hear a hissing sound near the fuel filler door (Easy Fuel® “no cap” fuel system), do not refuel until the sound stops. Otherwise, fuel may spray out, which could cause serious personal injury.



**WARNING:** Automotive fuels can cause serious injury or death if misused or mishandled.



**WARNING:** Fuel ethanol and gasoline may contain benzene, which is a cancer-causing agent.

Observe the following guidelines when handling automotive fuel:

- Extinguish all smoking materials and any open flames before fueling your vehicle.
- Always turn off the vehicle before fueling.
- Automotive fuels can be harmful or fatal if swallowed. Fuels such as gasoline and ethanol are highly toxic and if swallowed can cause death or permanent injury. If fuel is swallowed, call a physician immediately, even if no symptoms are immediately apparent. The toxic effects of fuel may not be visible for hours.
- Avoid inhaling fuel vapors. Inhaling too much fuel vapor of any kind can lead to eye and respiratory tract irritation. In severe cases, excessive or prolonged breathing of fuel vapor can cause serious illness and permanent injury.



## Maintenance and Specifications

- Avoid getting fuel liquid in your eyes. If fuel is splashed in the eyes, remove contact lenses (if worn), flush with water for 15 minutes and seek medical attention. Failure to seek proper medical attention could lead to permanent injury.
- Fuels can also be harmful if absorbed through the skin. If fuel is splashed on the skin and/or clothing, promptly remove contaminated clothing and wash skin thoroughly with soap and water. Repeated or prolonged skin contact with fuel liquid or vapor causes skin irritation.
- Be particularly careful if you are taking “Antabuse” or other forms of disulfiram for the treatment of alcoholism. Breathing gasoline and/or ethanol vapors, or skin contact could cause an adverse reaction. In sensitive individuals, serious personal injury or sickness may result. If fuel is splashed on the skin, promptly wash skin thoroughly with soap and water. Consult a physician immediately if you experience an adverse reaction.
- FFV fuel tanks may contain zero to 85% ethanol. Any fuel blends containing gasoline and ethanol should be treated the same as “Fuel Ethanol.” Flex fuel vehicles have a yellow bezel placed over the fuel fill inlet.

Pure ethanol is the alcohol which is the intoxicating agent in liquor, beer and wine. It is distilled from the fermentation of plants such as field corn and sugar cane. When ethanol is produced for use in motor fuels, a small amount of gasoline is added to make it unfit for beverage use. The resulting ethanol blend is called denatured fuel ethanol meaning that it is denatured with 2% to 5% gasoline and is suitable for automotive use.

During the summer season, fuel ethanol may contain a maximum of 85% denatured ethanol (Ed85) and 15% unleaded gasoline. The fuel ethanol has a higher octane rating than unleaded regular or premium gasoline and this allows the design of engines with greater efficiency and power.

Winter blends may contain up to 75% denatured ethanol (Ed75) and up to 25% unleaded gasoline to enhance cold engine starts. Severely cold weather may require additional measures for reliable starting.

Ethanol is more chemically active than gasoline. It corrodes some metals and causes some plastic and rubber components to swell, break down or become brittle and crack, especially when mixed with gasoline. Special materials and procedures have been developed for flexible fuel vehicles and the dispensers used by ethanol fuel providers.

394

## Maintenance and Specifications

 **WARNING:** Flexible fuel components and standard unleaded gasoline fuel components are not interchangeable. If your vehicle is not serviced in accordance with flexible fuel vehicles procedures, damage may occur and your warranty may be invalidated.

 **WARNING:** When refueling always shut the engine off and never allow sparks or open flames near the filler neck. Never smoke while refueling. Fuel vapor is extremely hazardous under certain conditions. Care should be taken to avoid inhaling excess fumes.

 **WARNING:** The flow of fuel through a fuel pump nozzle can produce static electricity, which can cause a fire if fuel is pumped into an ungrounded fuel container.

### Refueling

 **WARNING:** Fuel vapor burns violently and a fuel fire can cause severe injuries. To help avoid injuries to you and others:

- Read and follow all the instructions on the pump island;
- Turn off your engine when you are refueling;
- Do not smoke if you are near fuel or refueling your vehicle;
- Keep sparks, flames and smoking materials away from fuel;
- Stay outside your vehicle and do not leave the fuel pump unattended when refueling your vehicle — this is against the law in some places;
- Keep children away from the fuel pump; never let children pump fuel.
- Do not use personal electronic devices while refueling.

Use the following guidelines to avoid electrostatic charge build-up when filling an ungrounded fuel container:

- Place approved fuel container on the ground.
- DO NOT fill a fuel container while it is in the vehicle (including the cargo area).
- Keep the fuel pump nozzle in contact with the fuel container while filling.

## Maintenance and Specifications

- DO NOT use a device that would hold the fuel pump handle in the fill position.

### Easy Fuel® “no cap” fuel system

Your fuel tank is equipped with an Easy Fuel® “no cap” fuel filler system. This allows you to simply open the fuel filler door and insert the fuel filler nozzle into the fuel system. The Easy Fuel® system is self-sealing and protected against dust, dirt, water and snow/ice.

When fueling your vehicle:

1. Turn the engine off.
2. Open the fuel filler door.
3. Slowly insert the fuel filler nozzle fully into the fuel system, and leave the nozzle fully inserted until you are done pumping. Pump fuel as normal.
4. After you are done pumping fuel, slowly remove the fuel filler nozzle—allow about five seconds after pumping fuel before removing the fuel filler nozzle. This allows residual fuel to drain back into the fuel tank and not spill onto the vehicle.

**Note:** A fuel spillage concern may occur if overfilling the fuel tank. Do not overfill the tank to the point that the fuel is able to bypass the fuel filler nozzle. The overfilled fuel may run down the drain located below and in front of the fuel filler door.

If the check fuel fill inlet lamp or CHECK FUEL FILL INLET message comes on, the fuel fill inlet may not have properly closed. The inlet may have stuck open or debris may be preventing the inlet from fully closing. At the next opportunity, safely pull off the road, turn off the engine, open the fuel filler door and remove any visible debris from the fuel fill opening. Insert either the fuel fill nozzle or the fuel fill funnel (see *Refilling with a portable fuel container* for funnel location) provided with the vehicle several times to dislodge any debris and/or allow the inlet to close properly. If this action corrects the problem, the check fuel fill inlet lamp or CHECK FUEL FILL INLET message may not reset immediately. It may take several driving cycles for the check fuel fill inlet lamp or CHECK FUEL FILL INLET message to turn off. A driving cycle consists of an engine start-up (after four or more hours with the engine off) followed by city/highway driving. Continuing to drive with the check fuel fill inlet lamp or CHECK FUEL FILL INLET message on may cause the service engine soon lamp to turn on as well.

396

## Maintenance and Specifications



**WARNING:** The fuel system may be under pressure. If you hear a hissing sound near the fuel filler door (Easy Fuel® “no cap” fuel system), do not refuel until the sound stops. Otherwise, fuel may spray out, which could cause serious personal injury.

### ***Flex fuel vehicle (FFV) fuel fill inlet***

If your vehicle is flex fuel capable, it will have a yellow bezel placed over the fuel fill inlet.

### **Choosing the right fuel**

If your vehicle is a flexible fuel vehicle (FFV), use only UNLEADED FUEL and FUEL ETHANOL (Ed75–Ed85).

If your vehicle is not a flexible fuel vehicle (FFV), then only use UNLEADED fuel or UNLEADED fuel blended with a maximum of 10% ethanol. Do not use fuel ethanol (E85), diesel, methanol, leaded fuel or any other fuel.

The use of leaded fuel is prohibited by law and could damage your vehicle.

Your vehicle was not designed to use fuel or fuel additives with metallic compounds, including manganese-based additives.

**Note:** Use of any fuel other than those recommended may cause powertrain damage, a loss of vehicle performance, and repairs may not be covered under warranty.

### **Octane recommendations**

#### **3.7L V6/5.0L V8/6.2L V8 engines**

Your vehicle will run normally on 87 octane regular fuel. Premium fuel will provide improved performance.

#### **3.5L V6 EcoBoost™ engine**

Your vehicle is designed to run on regular fuel with an octane rating of 87 or higher. For best overall performance, premium fuel with an octane rating of 91 or higher is recommended. The performance gained by using premium fuel will be most noticeable in hot weather or in severe duty applications such as towing a trailer.

## Maintenance and Specifications

Some stations offer fuels posted as "Regular" with an octane rating below 87, particularly in high altitude areas. Fuels with octane levels below 87 are not

recommended for either engine. Do not be concerned if your engine sometimes knocks lightly. However, if it knocks heavily while you are using fuel with the recommended octane rating, see your authorized dealer to prevent any engine damage.



### ***FFV engine (if equipped)***

If your vehicle is flex fuel capable, it is designed to use Fuel Ethanol (Ed75–Ed85), "Regular" unleaded gasoline or any mixture of the two fuels.

**Use of other fuels such as Fuel Methanol may cause powertrain damage, a loss of vehicle performance, and your warranty may be invalidated.**

It is best not to alternate repeatedly between gasoline and E85. If you do switch fuels, it is recommended that you add as much fuel as possible—at least half a tank. Do not add less than five gallons (18.9L) when refueling. You should drive the vehicle immediately after refueling for at least 5 miles (8 km) to allow the vehicle to adapt to the change in ethanol concentration.

If you exclusively use E85 fuel, it is recommended to fill the fuel tank with regular unleaded gasoline at each scheduled oil change.

### **Fuel quality**

#### *Unleaded gasoline engines*

If you experience starting, rough idle or hesitation driveability problems during a cold start, try a different brand of "Regular" unleaded gasoline. "Premium" unleaded gasoline is not recommended for vehicles designed to use "Regular" unleaded gasoline because it may cause these problems to become more pronounced. If the problems persist, see your authorized dealer.

#### *FFV engines*

If you experience starting, rough idle or hesitation driveability problems during a cold start, try a different brand of E85 fuel. If the driveability problems continue, fill the vehicle with regular unleaded gasoline and drive vehicle normally until gasoline is used. See your authorized dealer if the problem persists.

398

## Maintenance and Specifications

Do not add aftermarket fuel additive products to your fuel tank. It should not be necessary to add any aftermarket products to your fuel tank if you continue to use high quality fuel of the recommended octane rating. These products have not been approved for your engine and could cause damage to the fuel system. Repairs to correct the effects of using an aftermarket product in your fuel may not be covered by your warranty.

Many of the world's automakers approved the World-Wide Fuel Charter that recommends gasoline specifications to provide improved performance and emission control system protection for your vehicle. Gasolines that meet the World-Wide Fuel Charter should be used when available. Ask your fuel supplier about gasolines that meet the World-Wide Fuel Charter.

### Cleaner air

Ford endorses the use of reformulated "cleaner-burning" gasolines to improve air quality, per the recommendations in the *Choosing the right fuel* section.

### Running out of fuel

Avoid running out of fuel because this situation may have an adverse effect on powertrain components.

If you have run out of fuel:

- You may need to cycle the ignition from off to on several times after refueling to allow the fuel system to pump the fuel from the tank to the engine. On restarting, cranking time will take a few seconds longer than normal.
- Normally, adding 1 gallon (3.8L) of fuel is enough to restart the engine. If the vehicle is out of fuel and on a steep grade, more than 1 gallon (3.8L) may be required.
- The service engine soon  indicator may come on. For more information on the service engine soon indicator, refer to *Warning lights and chimes* in the *Instrument Cluster* chapter.

## Maintenance and Specifications

### **Refilling with a portable fuel container**

With the Easy Fuel® “no cap” fuel system, use the following directions when filling from a portable fuel container:

 **WARNING:** Do not insert the nozzle of portable fuel containers or aftermarket funnels into the Easy Fuel® system. This could damage the fuel system and its seal, and may cause fuel to run onto the ground instead of filling the tank, which could result in serious personal injury.

 **WARNING:** Do not try to pry open or push open the Easy Fuel® system with foreign objects. This could damage the fuel system and its seal and cause injury to you or others.

When filling the vehicle’s fuel tank from a portable fuel container, use the funnel included with the vehicle.

1. Locate the white plastic funnel. In SuperCab and Super Crew vehicles, it is located under the second row driver side seat near the spare tire tool box. On regular cab vehicles, the funnel is located behind the driver seat.

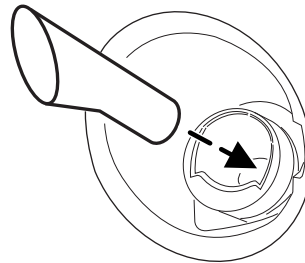

2. Slowly insert the funnel into the Easy Fuel® system.  
3. Fill the vehicle with fuel from the portable fuel container.  
4. When done, clean the funnel or properly dispose of it. Extra funnels can be purchased from your authorized dealer if you choose to dispose of the funnel. **Do not** use aftermarket funnels; they will not work with the Easy Fuel® system and can damage it. The included funnel has been specially designed to work safely with your vehicle.



## Maintenance and Specifications

### ESSENTIALS OF GOOD FUEL ECONOMY

#### Measuring techniques

Your best source of information about actual fuel economy is you, the driver. You must gather information as accurately and consistently as possible. Fuel expense, frequency of fill-ups or fuel gauge readings are NOT accurate as a measure of fuel economy. We do not recommend taking fuel economy measurements during the first 1,000 miles (1,600 km) of driving (engine break-in period). You will get a more accurate measurement after 2,000 miles–3,000 miles (3,000 km–5,000 km).

#### Filling the tank

The advertised fuel capacity of the fuel tank on your vehicle is equal to the rated refill capacity of the fuel tank as listed in the *Maintenance product specifications and capacities* section of this chapter.

The advertised capacity is the amount of the indicated capacity and the empty reserve combined. Indicated capacity is the difference in the amount of fuel in a full tank and a tank when the fuel gauge indicates empty. Empty reserve is the small amount of fuel remaining in the fuel tank after the fuel gauge indicates empty.

**The amount of usable fuel in the empty reserve varies and should not be relied upon to increase driving range. When refueling your vehicle after the fuel gauge indicates empty, you might not be able to refill the full amount of the advertised capacity of the fuel tank due to the empty reserve still present in the tank.**

For consistent results when filling the fuel tank:

- Turn the engine/ignition switch to the off position prior to refueling, an error in the reading may result if the engine is left running.
- Use the same filling rate setting (low — medium — high) each time the tank is filled.
- Allow no more than three automatic click-offs when filling.
- Always use fuel with the recommended octane rating.
- Use a known quality gasoline, preferably a national brand.
- Have the vehicle loading and distribution the same every time.

Your results will be most accurate if your filling method is consistent.

## Maintenance and Specifications

### Calculating fuel economy

1. Fill the fuel tank completely and record the initial odometer reading (in miles or kilometers).
2. Each time you fill the tank, record the amount of fuel added (in gallons or liters).
3. After at least three to five tank fill-ups, fill the fuel tank and record the current odometer reading.
4. Subtract your initial odometer reading from the current odometer reading.
5. Follow one of the simple calculations in order to determine fuel economy:

Calculation 1: **Divide total miles traveled by total gallons used.**

Calculation 2: **Multiply liters used by 100, then divide by total kilometers traveled.**

Keep a record for at least one month and record the type of driving (city or highway). This will provide an accurate estimate of the vehicle's fuel economy under current driving conditions. Additionally, keeping records during summer and winter will show how temperature impacts fuel economy. In general, lower temperatures give lower fuel economy.

### Driving style — good driving and fuel economy habits

Give consideration to the lists that follow and you may be able to change a number of variables and improve your fuel economy.

#### **Habits**

- Smooth, moderate operation can yield up to 10% savings in fuel.
- Steady speeds without stopping will usually give the best fuel economy.
- Idling for long periods of time (greater than one minute) may waste fuel.
- Anticipate stopping; slowing down may eliminate the need to stop.
- Sudden or hard accelerations may reduce fuel economy.
- Slow down gradually.
- Driving at reasonable speeds (traveling at 55 mph [88 km/h] uses 15% less fuel than traveling at 65 mph [105 km/h]).
- Revving the engine before turning it off may reduce fuel economy.
- Using the air conditioner or defroster may reduce fuel economy.

402

## Maintenance and Specifications

- You may want to turn off the speed control in hilly terrain if unnecessary shifting between the top gears occurs. Unnecessary shifting of this type could result in reduced fuel economy.
- Warming up a vehicle on cold mornings is not required and may reduce fuel economy.
- Resting your foot on the brake pedal while driving may reduce fuel economy.
- Combine errands and minimize stop-and-go driving.

### **Maintenance**

- Keep tires properly inflated and use only recommended size.
- Operating a vehicle with the wheels out of alignment will reduce fuel economy.
- Use recommended engine oil. Refer to *Maintenance product specifications and capacities* in this chapter.
- Perform all regularly scheduled maintenance items. Follow the recommended maintenance schedule and owner maintenance checks found in *scheduled maintenance information*.

### **Conditions**

- Heavily loading a vehicle or towing a trailer may reduce fuel economy at any speed.
- Carrying unnecessary weight may reduce fuel economy (approximately 1 mpg [0.4 km/L] is lost for every 400 lb [180 kg] of weight carried).
- Adding certain accessories to your vehicle (for example bug deflectors, rollbars/light bars, running boards, ski/luggage racks) may reduce fuel economy.
- To maximize the fuel economy, drive with the tonneau cover installed (if equipped).
- Using fuel blended with alcohol may lower fuel economy.
- Fuel economy may decrease with lower temperatures during the first 8–10 miles (12–16 km) of driving.
- Driving on flat terrain offers improved fuel economy as compared to driving on hilly terrain.
- Transmissions give their best fuel economy when operated in the top cruise gear and with steady pressure on the gas pedal.
- Four-wheel-drive operation (if equipped) is less fuel efficient than two-wheel-drive operation.
- Close windows for high speed driving.

## Maintenance and Specifications

### EMISSION CONTROL SYSTEM

Your vehicle is equipped with various emission control components and a catalytic converter which will enable your vehicle to comply with applicable exhaust emission standards. To make sure that the catalytic converter and other emission control components continue to work properly:

- Use only the specified fuel listed.
- Avoid running out of fuel.
- Do not turn off the ignition while your vehicle is moving, especially at high speeds.
- Have the items listed in *scheduled maintenance information* performed according to the specified schedule.

The scheduled maintenance items listed in *scheduled maintenance information* are essential to the life and performance of your vehicle and to its emissions system.

If other than Ford, Motorcraft® or Ford-authorized parts are used for maintenance replacements or for service of components affecting emission control, such non-Ford parts should be equivalent to genuine Ford Motor Company parts in performance and durability.



**WARNING:** Do not park, idle, or drive your vehicle in dry grass or other dry ground cover. The emission system heats up the engine compartment and exhaust system, which can start a fire.

Illumination of the service engine soon  indicator, charging system warning light or the temperature warning light, fluid leaks, strange odors, smoke or loss of engine power could indicate that the emission control system is not working properly.

An improperly operating or damaged exhaust system may allow exhaust to enter the vehicle. Have a damaged or improperly operating exhaust system inspected and repaired immediately.





**WARNING:** Exhaust leaks may result in entry of harmful and potentially lethal fumes into the passenger compartment.

## Maintenance and Specifications

Do not make any unauthorized changes to your vehicle or engine. By law, vehicle owners and anyone who manufactures, repairs, services, sells, leases, trades vehicles, or supervises a fleet of vehicles are not permitted to intentionally remove an emission control device or prevent it from working. Information about your vehicle's emission system is on the Vehicle Emission Control Information Decal located on or near the engine. This decal also lists engine displacement.



Please consult your *Warranty Guide* for complete emission warranty information.

### On-board diagnostics (OBD-II)

Your vehicle is equipped with a computer that monitors the engine's emission control system. This system is commonly known as the on-board diagnostics system (OBD-II). The OBD-II system protects the environment by ensuring that your vehicle continues to meet government emission standards. The OBD-II system also assists your authorized dealer in properly servicing your vehicle. When the service engine soon  indicator illuminates, the OBD-II system has detected a malfunction. Temporary malfunctions may cause the service engine soon  indicator to illuminate. Examples are:

1. The vehicle has run out of fuel—the engine may misfire or run poorly.
2. Poor fuel quality or water in the fuel—the engine may misfire or run poorly.
3. The fuel fill inlet may not have been properly closed. See *Easy Fuel*® “no cap” fuel system in this chapter.
4. Driving through deep water—the electrical system may be wet.

These temporary malfunctions can be corrected by filling the fuel tank with good quality fuel, properly closing the fuel fill inlet or letting the electrical system dry out. After three driving cycles without these or any other temporary malfunctions present, the service engine soon  indicator should stay off the next time the engine is started. A driving cycle consists of a cold engine startup followed by mixed city/highway driving. No additional vehicle service is required.



If the service engine soon  indicator remains on, have your vehicle serviced at the first available opportunity. Although some malfunctions detected by the OBD-II may not have symptoms that are apparent, continued driving with the service engine soon  indicator on can result in increased emissions, lower fuel economy, reduced engine and transmission smoothness, and lead to more costly repairs.

## Maintenance and Specifications

### Readiness for Inspection/Maintenance (I/M) testing

Some state/provincial and local governments may have Inspection/Maintenance (I/M) programs to inspect the emission control equipment on your vehicle. Failure to pass this inspection could prevent you from getting a vehicle registration. Your vehicle may not pass the I/M test if the service engine soon  indicator is on or not working properly (bulb is burned out), or if the OBD-II system has determined that some of the emission control systems have not been properly checked. In this case, the vehicle is considered not ready for I/M testing.

If the service engine soon  indicator is on or the bulb does not work, the vehicle may need to be serviced. Refer to *On-board diagnostics (OBD-II)* in this chapter.

If the vehicle's engine or transmission has just been serviced, or the battery has recently run down or been replaced, the OBD-II system may indicate that the vehicle is not ready for I/M testing. To determine if the vehicle is ready for I/M testing, turn the ignition key to the on position for 15 seconds without cranking the engine. If the service engine soon  indicator blinks eight times, it means that the vehicle is not ready for I/M testing; if the service engine soon  indicator stays on solid, it means that the vehicle is ready for I/M testing.

The OBD-II system is designed to check the emission control system during normal driving. A complete check may take several days. If the vehicle is not ready for I/M testing, the following driving cycle consisting of mixed city and highway driving may be performed:

15 minutes of steady driving on an expressway/highway followed by 20 minutes of stop-and-go driving with at least four 30-second idle periods.

Allow the vehicle to sit for at least eight hours without starting the engine. Then, start the engine and complete the above driving cycle. The engine must warm up to its normal operating temperature. Once started, do not turn off the engine until the above driving cycle is complete. If the vehicle is still not ready for I/M testing, the above driving cycle will have to be repeated.

### POWER STEERING FLUID (6.2L V8 ENGINE ONLY)

Check the power steering fluid. Refer to *scheduled maintenance information*.

406

## Maintenance and Specifications

1. Start the engine and let it run until it reaches normal operating temperature (the engine coolant temperature gauge indicator will be near the center of the normal area between H and C).

2. While the engine idles, turn the steering wheel left and right several times.

3. Turn the engine off.

4. Check the fluid level in the reservoir. It should be between the MIN and MAX lines. Do not add fluid if the level is in this range.

5. If the fluid is low, add fluid in small amounts, continuously checking the level until it reaches the range between the MIN and MAX lines. Be sure to put the cap back on the reservoir. Refer to *Maintenance product specifications and capacities* in this chapter for the proper fluid type.

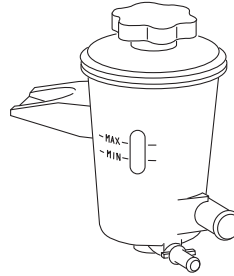

### BRAKE FLUID

The fluid level will drop slowly as the brakes wear, and will rise when the brake components are replaced. Fluid levels between the MIN and MAX lines are within the normal operating range; there is no need to add fluid. If the fluid levels are outside of the normal operating range, the performance of the system could be compromised; seek service from your authorized dealer immediately.

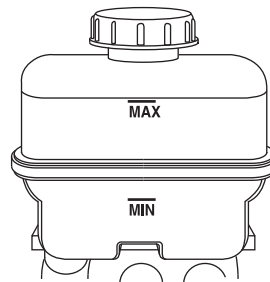

### TRANSMISSION FLUID

#### Checking 6-speed automatic transmission fluid

The automatic transmission does not have a transmission fluid dipstick.

Refer to your *scheduled maintenance information* for scheduled intervals for fluid checks and changes. Your transmission does not consume fluid. However, the fluid level should be checked if the transmission is not working properly, (i.e., if the transmission slips or shifts slowly) or if you notice some sign of fluid leakage.

## Maintenance and Specifications

**Transmission fluid should be checked by an authorized dealer. If required, fluid should be added by an authorized dealer.**

Do not use supplemental transmission fluid additives, treatments or cleaning agents. The use of these materials may affect transmission operation and result in damage to internal transmission components.

### TRANSFER CASE FLUID (IF EQUIPPED)

1. Clean the filler plug.
2. Remove the filler plug and inspect the fluid level.

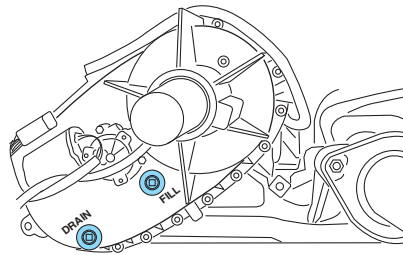

3. Add only enough fluid through the filler opening so that the fluid level is at the bottom of the opening.

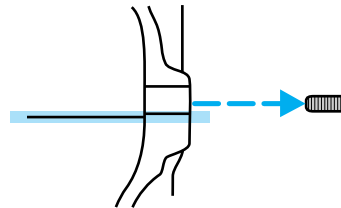

Use only fluid that meets Ford specifications. Refer to the *Maintenance product specifications and capacities* section in this chapter.

### AIR FILTER

Refer to *scheduled maintenance information* for the appropriate intervals for changing the air filter element.

When changing the air filter element, use only the air filter element listed. Refer to *Motorcraft® part numbers* in this chapter.



**WARNING:** To reduce the risk of vehicle damage and/or personal burn injuries do not start your engine with the air cleaner removed and do not remove it while the engine is running.



## Maintenance and Specifications

### Changing the air filter element

1. Locate the mass air flow sensor electrical connector on the air outlet tube. This connector will need to be unplugged.

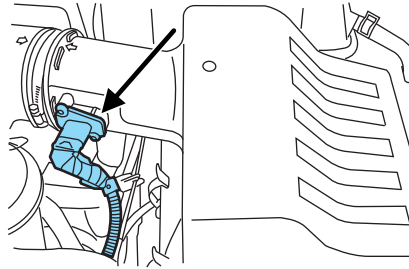

2. Reposition the locking clip on the connector (connector shown from below for clarity), squeeze the connector and pull it off of the air outlet tube.

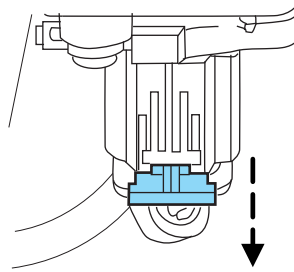

3. Clean the area around the air tube to air cover connection to prevent debris from entering the system and then loosen the bolt on the air tube clamp so the clamp is no longer snug to the air tube. It is not necessary to completely remove the clamp.

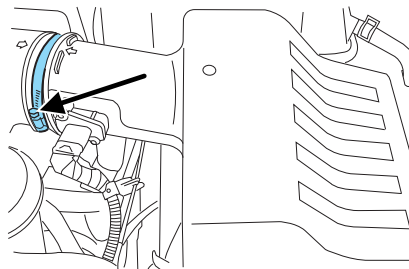

4. Pull the air tube off from the air cleaner housing.

## Maintenance and Specifications

5. Release the three clamps that secure the cover to the air filter housing. Push the air filter cover toward the center of the vehicle and up slightly to release it.

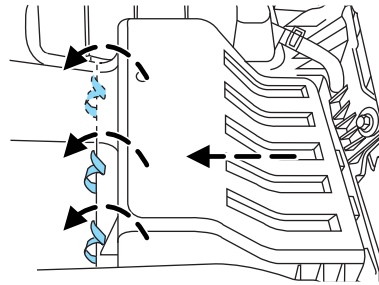

6. Remove the air filter element from the air filter housing.

7. Install a new air filter element.

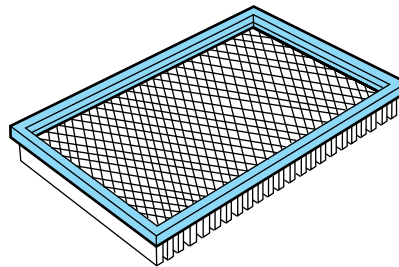

8. Replace the air filter housing cover and secure the clamps. Be careful not to crimp the filter element edges between the air filter housing and cover and ensure that the tabs on the edge are properly aligned into the slots.

9. Slip the air tube onto the air filter housing and tighten the air-tube clamp bolt snugly, but do not overtighten it.

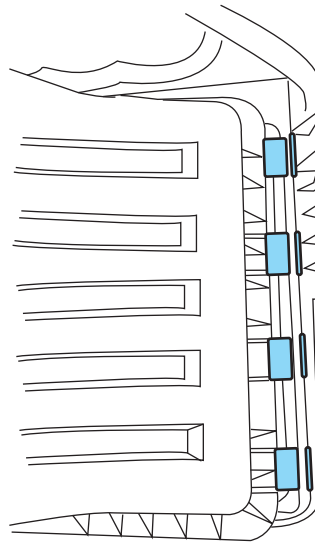

## Maintenance and Specifications

10. Reconnect the mass air flow sensor electrical connector to the outlet tube. Make sure the locking tab on the connector is in the “locked” position (connector shown from below for clarity).

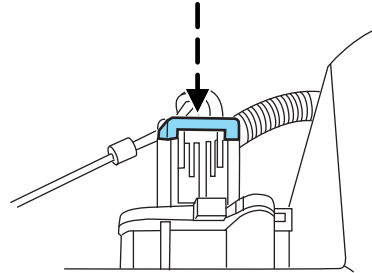

**Note:** Failure to use the correct air filter element may result in severe engine damage. The customer warranty may be void for any damage to the engine if the correct air filter element is not used.

### VEHICLE STORAGE

If you plan on storing your vehicle for an extended period of time (30 days or more), refer to the following maintenance recommendations to ensure your vehicle stays in good operating condition.

All motor vehicles and their components were engineered and tested for reliable, regular driving. Long term storage under various conditions may lead to component degradation or failure unless specific precautions are taken to preserve the components.

#### *General*

- Store all vehicles in a dry, ventilated place.
- Protect from sunlight, if possible.
- If vehicles are stored outside, they require regular maintenance to protect against rust and damage.

#### *Body*

- Wash vehicle thoroughly to remove dirt, grease, oil, tar or mud from exterior surfaces, rear-wheel housing and underside of front fenders. See the *Cleaning* chapter for more information.
- Periodically wash vehicles stored in exposed locations.
- Touch-up raw or primed metal to prevent rust.
- Cover chrome and stainless steel parts with a thick coat of auto wax to prevent discoloration. Re-wax as necessary when the vehicle is washed. See the *Cleaning* chapter for more information.
- Lubricate all hood, door and trunk lid hinges, and latches with a light grade oil. See the *Cleaning* chapter for more information.

## Maintenance and Specifications

- Cover interior trim to prevent fading.
- Keep all rubber parts free from oil and solvents.

### *Engine*

- The engine oil and filter should be changed prior to storage, as used engine oil contain contaminants that may cause engine damage.
- Start the engine every 15 days. Run at fast idle until it reaches normal operating temperature.
- With your foot on the brake, shift through all the gears while the engine is running.

### *Fuel system*

- Fill the fuel tank with high-quality fuel until the first automatic shutoff of the fuel pump nozzle.

**Note:** During extended periods of vehicle storage (30 days or more), fuel may deteriorate due to oxidation. Add a quality gas stabilizer product to the vehicle fuel system whenever actual or expected storage periods exceed 30 days. Follow the instructions on the additive label. The vehicle should then be operated at idle speed to circulate the additive throughout the fuel system.

### *Cooling system*

- Protect against freezing temperatures.
- When removing vehicle from storage, check coolant fluid level. Confirm there are no cooling system leaks, and fluid is at the recommended level.

### *Battery*

- Check and recharge as necessary. Keep connections clean.
- If storing your vehicle for more than 30 days without recharging the battery, it may be advisable to disconnect the battery cables to ensure battery charge is maintained for quick starting.

**Note:** If battery cables are disconnected, it will be necessary to reset memory features.

### *Brakes*

- Make sure brakes and parking brake are fully released.

### *Tires*

- Maintain recommended air pressure.

412

## Maintenance and Specifications

### *Miscellaneous*

- Make sure all linkages, cables, levers and pins under vehicle are covered with grease to prevent rust.
- Move vehicles at least 25 feet (8 m) every 15 days to lubricate working parts and prevent corrosion.

### **Removing vehicle from storage**

When your vehicle is ready to come out of storage, do the following:

- Wash your vehicle to remove any dirt or grease film build-up on window surfaces.
- Check windshield wipers for any deterioration.
- Check under the hood for any foreign material that may have collected during storage (mice/squirrel nests).
- Check the exhaust for any foreign material that may have collected during storage.
- Check tire pressures and set tire inflation per the Tire Label.
- Check brake pedal operation. Drive the vehicle 15 ft (4.5 meters) back and forth to remove rust build-up.
- Check fluid levels (including coolant, oil and gas) to make sure there are no leaks, and fluids are at recommended levels.
- If the battery was removed, clean the battery cable ends and inspect.

If you have any concerns or issues, contact your authorized dealer.

## Maintenance and Specifications

### MOTORCRAFT PART NUMBERS

Component	3.7L V6 engine	5.0L V8 engine	6.2L V8 engine	3.5L V6 EcoBoost™ engine
Air filter element	FA-1883	FA-1883	FA-1883	FA-1883
Battery	BXT-65-750	BXT-65-750	BXT-65-750	BXT-65-750
Oil Filter	FL-500-S	FL-500-S	FL-820-S	FL-500-S
Spark plugs	1	1	1	1

<sup>1</sup> For spark plug replacement, see your authorized dealer. Refer to *scheduled maintenance information* for the appropriate intervals for changing the spark plugs.

**Replace the spark plugs with ones that meet Ford material and design specifications for your vehicle, such as Motorcraft® or equivalent replacement parts. The customer warranty may be void for any damage to the engine if such spark plugs are not used.**

## Maintenance and Specifications

### MAINTENANCE PRODUCT SPECIFICATIONS AND CAPACITIES

Item	Capacity	Ford part name or equivalent	Ford part number / Ford specification
Brake fluid	Between MIN/MAX on brake fluid reservoir	Motorcraft® High Performance DOT 3 Motor Vehicle Brake Fluid	PM-1-C / WSS-M6C62-A or WSS-M6C65-A1
3.7L engine oil	6.0 quarts (5.7L)	<ul style="list-style-type: none"> <li>• Motorcraft® SAE 5W-20 Premium Synthetic Blend Motor Oil (US)</li> <li>• Motorcraft® SAE 5W-20 Full Synthetic Motor Oil (US)</li> <li>• Motorcraft® SAE 5W-20 Super Premium Motor Oil (Canada)</li> <li>• Motorcraft® SAE 5W-20 Synthetic Motor Oil (Canada)<sup>1</sup></li> </ul>	<ul style="list-style-type: none"> <li>• XO-5W20-QSP (US)</li> <li>• XO-5W-20 QFS (US)</li> <li>• CXO-5W20-LSP12 (Canada)</li> <li>• CXO-5W-20-LFS12 (Canada) / WSS-M2C930-A and API Certification Mark</li> </ul>
5.0L engine oil	7.7 quarts (7.3L)		
6.2L engine oil	7.0 quarts (6.6L)		
3.5L EcoBoost™ engine	6.0 quarts (5.7 L)	<ul style="list-style-type: none"> <li>• Motorcraft® SAE 5W-30 Premium Synthetic Blend Motor Oil (US)</li> <li>• Motorcraft® SAE 5W-30 Full Synthetic Motor Oil (US)</li> <li>• Motorcraft® SAE 5W-30 Super Premium Motor Oil (Canada)</li> <li>• Motorcraft® SAE 5W-30 Synthetic Motor Oil (Canada)<sup>2</sup></li> </ul>	<ul style="list-style-type: none"> <li>• XO-5W30-QSP (US)</li> <li>• XO-5W30-QFS (US)</li> <li>• CXO-5W30-LSP12 (Canada)</li> <li>• CXO-5W30-LFS12 (Canada) / WSS-M2C929-A with API Certification Mark</li> </ul>

## Maintenance and Specifications

Item	Capacity	Ford part name or equivalent	Ford part number / Ford specification
3.7L engine coolant	16.0 quarts (15.1L)	<ul style="list-style-type: none"> <li>Motorcraft® Specialty Orange Engine Coolant with Bittering Agent (US)</li> <li>Motorcraft® Specialty Orange Engine Coolant (Canada)<sup>3</sup></li> </ul>	<ul style="list-style-type: none"> <li>VC-3-B (US)</li> <li>CV-3-B (Canada) / WSS-M97B44-D</li> </ul>
5.0L engine coolant	17.0 quarts (16.1L)		
6.2L engine coolant	19.5 quarts (18.5L)		
3.5L EcoBoost™ engine coolant	16.5 quarts (15.6L)		
Front axle (4X4)	3.5 pints (1.8L)	Motorcraft® SAE 80W-90 Premium Rear Axle Lubricant	XY-80W-90-QL / WSP-M2C197-A
Rear axle fluid	5.5 pints (2.6L) <sup>4</sup>	Motorcraft® SAE 75W-140 Rear Synthetic Axle Lubricant <sup>5</sup>	XY-75W140-QL / WSL-M2C192-A
Transmission /steering/parking brake linkages and pivots, brake pedal shaft	—	Premium Long-Life Grease	XG-1-C / ESA-M1C75-B
Hinges, latches, striker plates, seat tracks, fuel filler door hinge and door check arm	—	Multi-Purpose Grease (Lithium grease)	XG-4 or XL-5 or equivalent / ESB-M1C93-B
Power steering fluid (6.2L engine only)	Fill to between MIN and MAX lines on reservoir	Motorcraft® MERCON® V ATF	XT-5-QM / MERCON® V
Transfer case fluid (4X4 / AWD)	1.6 quarts (1.5L) <sup>6</sup>	Motorcraft® Transfer Case Fluid	XL-12 / —

416



## Maintenance and Specifications

Item	Capacity	Ford part name or equivalent	Ford part number / Ford specification
Automatic transmission fluid (6R80)	12.1 quarts (11.7L) <sup>7</sup> (3.7L engine)	Motorcraft® MERCON® LV ATF <sup>8</sup>	XT-10-QLV / MERCON® LV
	13.1 quarts (12.4L) (5.0L engine)		
	13.1 quarts (12.4L) (6.2L engine)		
	13.1 quarts (12.4L) (3.5L EcoBoost™ engine)		
Windshield washer fluid	Fill as required	Motorcraft® Premium Windshield Washer Concentrate (US) Premium Quality Windshield Washer Fluid (Canada)	ZC-32-A (US) CXC-37-(A, B, D, and F) (Canada) / WSB-M8B16-A2/- -
Fuel tank Reg. Cab 6.5' box / SuperCab 5.5' box	26.0 gallons (98.4L)	—	—
Fuel tank SuperCrew 5.5' box	26.0 gallons (98.4L) Standard 36.0 gallons (136.2L) Optional	—	—
Fuel tank SuperCrew 6.5' box	26.0 gallons (98.4L) Standard 36.0 gallons (136.2L) Optional	—	—

## Maintenance and Specifications

Item	Capacity	Ford part name or equivalent	Ford part number / Ford specification
Fuel tank Reg. Cab 8' box / SuperCab 6.5' box / SuperCab 8' box	26.0 gallons (98.4L) Standard 36.0 gallons (136.2L) Optional	—	—

<sup>1</sup>Use of synthetic or synthetic blend motor oil is not mandatory. Engine oil need only meet the requirements of Ford specification WSS-M2C930-A and the API Certification mark.

<sup>2</sup>Use of synthetic or synthetic blend motor oil is not mandatory. Engine oil need only meet the requirements of Ford specification WSS-M2C946-A and the API Certification mark.

<sup>3</sup>Add the coolant type originally equipped in your vehicle.

<sup>4</sup>Service refill capacity is determined by filling the axle to 1/4-9/16 inch (6-14 mm) below the bottom of the filler hole with the vehicle on a level surface.

Add 4 oz. (118 ml) of Additive Friction Modifier XL-3 or equivalent meeting Ford specification EST-M2C118-A, for complete fill of 8.8 inch and 9.75 inch Traction-Lok axles.

<sup>5</sup>Your vehicle's rear axle is filled with a synthetic rear axle lubricant and is considered lubricated for life. These lubricants do not need to be checked or changed unless a leak is suspected, service is required or the axle assembly has been submerged in water. The axle lubricant should be changed any time the rear axle has been submerged in water.

<sup>6</sup>Service refill capacity is determined by filling the transfer case to the bottom of the filler hole with the vehicle on a level surface.

<sup>7</sup>Approximate dry fill capacity including transmission fluid cooling system, actual refill capacities will vary based on vehicle application and transmission fluid cooling system (i.e. coolers size, cooling lines, auxiliary cooler capacities). The amount of transmission fluid and fluid level should be set by the indication on the dipstick's normal operating range.

<sup>8</sup>Automatic transmissions that require MERCON® LV should only use MERCON® LV fluid. Refer to *scheduled maintenance information* to determine the correct service interval. Use of any fluid other than the recommended fluid may cause transmission damage.

## Maintenance and Specifications

### ENGINE DATA

Engine	3.7L V6 Engine	5.0L V8 Engine	6.2L V8 Engine	3.5L V6 EcoBoost™ Engine
Cubic inches	226	302	378	214
Fuel	Minimum 87 octane or E85	Minimum 87 octane or E85	Minimum 87 octane	Minimum 87 octane
Firing order	1-4-2-5-3-6	1-5-4-8-6-3-7-2	1-3-7-2-6-5-4-8	1-4-2-5-3-6
Ignition system	Coil on plug	Coil on plug	Coil on plug	Coil on plug
Spark plug gap	.052-.056 in 1.32-1.42mm	.041 - .047 in 1.04-1.20mm	.039-.043 in 1.0-1.1mm	.033-.037 in .84-.94mm
Compression ratio	10.3:1	10.5:1	9.8:1	10.0:1

## Maintenance and Specifications

### Engine drivebelt routing

3.7L engine

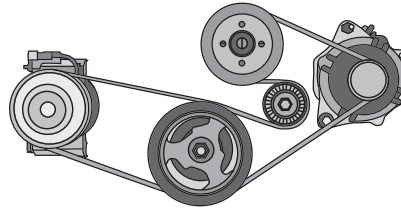

5.0L engine

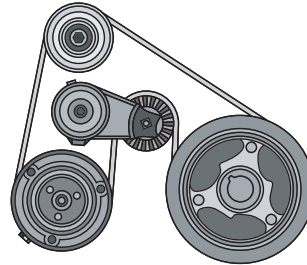

6.2L engine

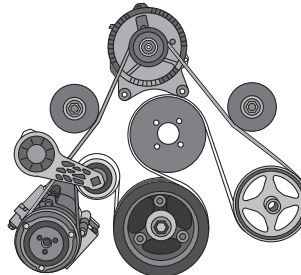

## Maintenance and Specifications

3.5L EcoBoost™ engine

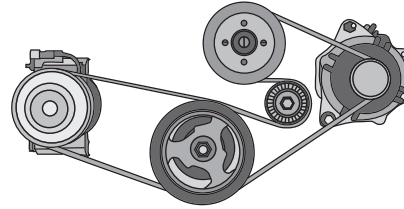

### IDENTIFYING YOUR VEHICLE

#### Safety Compliance Certification Label

The National Highway Traffic Safety Administration Regulations require that a Safety Compliance Certification Label be affixed to a vehicle and prescribe where the Safety Compliance Certification Label may be located. The Safety Compliance Certification Label is located on the structure (B-Pillar) by the trailing edge of the driver's door or the edge of the driver's door.

MFD. BY FORD MOTOR CO.					
DATE: XX/XX	GVWR: XXXXLB/ XXXXKG				
FRONT GAWR: XXXXL	REAR GAWR: XXXLB				
XXXXKG	WITH	XXXXKG	WITH		
XXXX/XXXXXXXX	TIRES	XXXX/XXXXXXXX	TIRES		
XXXX.XX	RIMS	XXXX.XX	RIMS		
AT XXX kPa/XX	PSI COLD	AT XXX kPa/XX	PSI COLD		
THIS VEHICLE CONFORMS TO ALL APPLICABLE FEDERAL MOTOR VEHICLE SAFETY STANDARDS IN EFFECT ON THE DATE OF MANUFACTURE SHOWN ABOVE.					
VIN: XXXXXXXXXXXXXXXXX			XXXXX		
TYPE: XXX			XXXXX		
EXT PNT: XX	RC: XX	DSO:			
WB <sup>1</sup>	INT TR	TRIPS	TR	AXLE	TR SPR
XXX	XX	X	XX	X XX	XXXXX
XXXXXXXXXXXX XXX XXXX-XXXXXX-XX					

## Maintenance and Specifications

### Vehicle identification number (VIN)

The vehicle identification number is located on the driver side instrument panel.

Please note that in the graphic, XXXX is representative of your vehicle identification number.

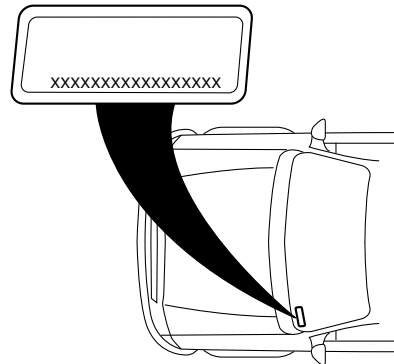

The Vehicle Identification Number (VIN) contains the following information:

1. World manufacturer identifier
2. Brake system / Gross Vehicle Weight Rating (GVWR) / Restraint Devices and their location
3. Make, vehicle line, series, body type
4. Engine type
5. Check digit
6. Model year
7. Assembly plant
8. Production sequence number

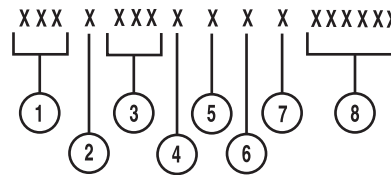

## Maintenance and Specifications

### TRANSMISSION CODE DESIGNATIONS

You can find a transmission code on the Safety Compliance Certification Label. The following table tells you which transmission each code represents.

<b>MFD. BY FORD MOTOR CO.</b>					
DATE: XX/XX	GVWR: XXXXXLB/ XXXXXKG				
FRONT GAWR: XXXXL	WITH	REAR GAWR: XXXLB			
XXXXKG		XXXXKG			
XXXX/XXXXXX	TYPES	XXXX/XXXXXX	WITH		
XXXX,XX	RIMS	XXXX,XX	TIRES		
AT XXX kPa/XX	PSI COLD	AT XXX kPa/XX	RIMS		
			PSI COLD		
THIS VEHICLE CONFORMS TO ALL APPLICABLE FEDERAL MOTOR VEHICLE SAFETY STANDARDS IN EFFECT ON THE DATE OF MANUFACTURE SHOWN ABOVE.					
VIN: XXXXXXXXXXXXXXX			XXXXX		
TYPE: XXX			XXXXX		
					
EXT PNT: XX	RC: XX		DSO:		
WB <sup>1</sup>	INT TR	TRIPS	TR	AXLE	TR
XXX	XX	X	XX	X	XX
					SPR
					XXXXX
					XXX
					XXXXXXXXXX XX
					XXXX-XXXXXX-XX

Description	Code
Six-speed automatic (6R80)	6

## Accessories

### FORD CUSTOM ACCESSORIES FOR YOUR VEHICLE

A wide selection of Ford Custom Accessories are available for your vehicle through your local Ford or Ford of Canada dealer. These quality accessories have been specifically engineered to fulfill your automotive needs; they are custom designed to complement the style and aerodynamic appearance of your vehicle. In addition, each accessory is made from high quality materials and meets or exceeds Ford's rigorous engineering and safety specifications. Ford Motor Company will repair or replace any properly dealer-installed Ford Custom Accessories found to be defective in factory-supplied materials or workmanship during the warranty period, as well as any component damaged by the defective accessories. The accessories will be warranted for whichever provides you the greatest benefit:

- 12 months or 12,000 miles (20,000 km) (whichever occurs first), or
- the remainder of your new vehicle limited warranty.

Contact your dealer for details and a copy of the warranty.

The following is a list of several Ford Custom Accessories. Not all accessories are available for all models. For a complete listing of the accessories that are available for your vehicle, please contact your dealer or visit our online store at: [www.fordaccessories.com](http://www.fordaccessories.com) (U.S. only).

#### Exterior style

- Bug shields
- Chrome exhaust tips
- Deflectors
- Front grilles
- Custom graphics\*
- Running boards
- Step bars
- Wheels
- Splash guards

#### Interior style

- Ambient lighting
- Floor mats
- Electrochromatic compass/temperature interior mirrors
- Power sliding rear window
- Leather-trimmed interior seating\*



## Accessories

### Lifestyle

- Ash cup / smoker's package
- Bedliners and bedmats
- Bed side step
- Towing mirrors
- Portable navigation\*
- Bed extender
- Tonneau covers\*
- Interior cargo organization and management
- Truck bed cargo organization and management
- Trailer hitches, wiring harnesses and accessories
- Racks and carriers\*
- Truck bed camping tent\*
- Sportliner cargo liner\*
- Rear seat entertainment\*
- Trailer brake controller
- Hitch ball and towbars

### Peace of mind

- Keyless entry keypad
- Vehicle security systems
- Bed step\*
- Protective seat covers\*
- Cable lock\*
- Locking gas plug for capless fuel system
- Vehicle tracking and recovery\*
- Bumper and hitch mounted parking sensors\*
- Bed mounted oversize spare tire carrier\*
- Remote start
- Wheel locks
- Bed hooks\*
- Back up alarm\*
- Tool/cargo boxes\*

\*Ford Licensed Accessories (FLA) are warranted by the accessory manufacturer's warranty. Ford Licensed Accessories are fully designed and developed by the accessory manufacturer and have not been designed or tested to Ford Motor Company engineering requirements. Contact your Ford dealer for details regarding the manufacturer's limited warranty and/or a copy of the FLA product limited warranty offered by the accessory manufacturer.

For maximum vehicle performance, keep the following information in mind when adding accessories or equipment to your vehicle:

- When adding accessories, equipment, passengers and luggage to your vehicle, do not exceed the total weight capacity of the vehicle or of the front or rear axle (GVWR or GAWR as indicated on the Safety Compliance Certification label). Consult your authorized dealer for specific weight information.

## Accessories

- The Federal Communications Commission (FCC) and Canadian Radio Telecommunications Commission (CRTC) regulate the use of mobile communications systems — such as two-way radios, telephones and theft alarms - that are equipped with radio transmitters. Any such equipment installed in your vehicle should comply with FCC or CRTC regulations and should be installed only by a qualified service technician.
- Mobile communications systems may harm the operation of your vehicle, particularly if they are not properly designed for automotive use.
- To avoid interference with other vehicle functions, such as anti-lock braking systems, amateur radio users who install radios and antennas onto their vehicle should not locate the Amateur Radio Antennas in the area of the driver's side hood.

To ensure proper operation of the battery management system (BMS), any electrical devices that are added to the vehicle should not have their ground connection made directly at the negative battery post. A connection at the negative battery post can cause inaccurate measurements of the battery condition and potential incorrect system operation.

- Any non-Ford electrical or electronic accessories or components that are added to the vehicle by the authorized dealer or the owner may adversely affect battery performance and durability, and may also adversely affect the performance of other electrical systems in the vehicle.

## Ford Extended Service Plan

### **FORD ESP EXTENDED SERVICE PLANS (U.S. ONLY)**

More than 30 million Ford and Lincoln owners have discovered the powerful protection of Ford ESP. It is the only extended service plan backed by Ford Motor Company, and provides “peace of mind” protection beyond the New Vehicle Limited Warranty coverage.

#### ***Up to 500+ Covered Vehicle Components***

There are four, new-vehicle Extended Service Plans with different levels of coverage. Ask your dealer for details.

**PremiumCare** – Our most comprehensive coverage. With over 500 covered components, this plan is so complete that we generally only discuss what’s not covered!

**ExtraCare** – Covers 113 components, and includes many high-tech items.

**BaseCare** – Covers 84 components.

**PowertrainCare** – Covers 29 critical components.

**Ford ESP is honored by all Ford and Lincoln Dealers in the U.S. and Canada** It’s the only extended service plan authorized and backed by Ford Motor Company. That means you get:

- Reliable, quality service anywhere you go.
- **Factory-trained technicians.**
- **Genuine Ford and Motorcraft® Parts.**

#### ***Rental car reimbursement***

**If your vehicle is kept overnight for covered repairs**, you are eligible for rental car coverage, including Bumper-to-Bumper warranty repairs, or manufacturer’s recalls.

#### ***Transferable coverage***

If you sell your vehicle before your Ford ESP coverage expires, you can transfer any remaining coverage to the new owner. Whenever you’re ready to sell your car, prospective buyers may feel better about taking a risk on your used vehicle. Ford ESP may add resale value!

Plus, **exclusive 24/7 roadside assistance**, including:

- Towing, flat-tire change and battery jump starts.
- Out-of-fuel and lock-out assistance.
- Travel expense reimbursement for lodging, meals and rental car.
- Destination assistance for taxi, shuttle, rental car coverage and emergency transportation.

## Ford Extended Service Plan

### ***Ford ESP Can Quickly Pay for Itself***

One service bill – the cost of parts and labor – can easily exceed the price of your Ford ESP Service Contract. With Ford ESP, you minimize your risk for unexpected repair bills and rising repair costs.

### ***Avoid the rising cost of properly maintaining your vehicle!***

Ford ESP also offers a Premium Maintenance Plan that covers items that **routinely wear out**.

The coverage is prepaid, so you never have to worry about affording your vehicle maintenance. It covers regular checkups, routine inspections, preventive care and replacement of items that require periodic attention for **normal “wear”**:

- **Wiper blades**
- **Spark plugs (except California)**
- **Clutch disc**
- **Brake pads and linings**
- **Shock absorbers**
- **Belts and hoses**

Contact your selling Ford or Lincoln dealership today so they can customize a Ford Extended Service Plan that fits your driving lifestyle and budget.

### ***Interest free finance options available***

Take advantage of our installment payment plan, just a 10% down payment will provide you with an affordable no interest, no-fee payment opportunity.

Ford Extended Service Plan

-----  
***Get Genuine Peace of Mind with Ford ESP!***

To learn more, complete the information below and mail this to:

**Ford ESP  
P.O. Box 8072  
Royal Oak, MI 48068-9933**

NAME (PLEASE PRINT) \_\_\_\_\_  
ADDRESS \_\_\_\_\_ APT.NO. \_\_\_\_\_  
CITY \_\_\_\_\_ STATE \_\_\_\_\_ ZIP \_\_\_\_\_  
E-MAIL: \_\_\_\_\_

## Ford Extended Service Plan

### FORD ESP EXTENDED SERVICE PLANS (CANADA ONLY)

You can get more protection for your vehicle by purchasing a Ford Extended Service Plan (ESP). Ford ESP is the only service contract backed by Ford Motor Company of Canada, Limited. Depending on the plan you purchase, Ford ESP provides benefits such as:

- Rental reimbursement
- Coverage for certain maintenance and wear items
- Protection against repair costs after your New Vehicle Limited Warranty Coverage expires
- Roadside Assistance benefits

There are several Ford ESP plans available in various time, distance and deductible combinations. Each plan is tailored to fit your own driving needs, including reimbursement for towing and rental.

When you purchase Ford ESP, you receive added peace-of-mind protection throughout Canada and the United States, provided by a network of participating Ford Motor Company dealers.

For more information, visit your local Ford of Canada dealer or [www.ford.ca](http://www.ford.ca) to find the Ford Extended Service Plan that is right for you.

**Note:** Repairs performed outside of Canada and the United States are not eligible for Ford ESP coverage. This information is subject to change.

## Scheduled Maintenance

### GENERAL MAINTENANCE INFORMATION

#### Why maintain your vehicle?

This guide describes the scheduled maintenance required for your vehicle. Carefully following this schedule helps protect against major repair expenses resulting from neglect or inadequate maintenance and may also help to increase the value of your vehicle when you sell or trade it.

It is your responsibility to see that all scheduled maintenance is performed and that the materials used meet Ford engineering specifications as identified in the *Maintenance and Specifications* chapter. Failure to perform scheduled maintenance specific in this guide will invalidate warranty coverage on parts affected by the lack of maintenance. Be sure receipts for completed maintenance are kept with the vehicle and confirmation of the work performed is always recorded in this guide.

Your dealer has factory-trained technicians who can perform the required maintenance using genuine Ford parts. They are committed to meeting your service needs and to assuring your continuing satisfaction.

#### Protecting your investment

Maintenance is an investment that will pay dividends in the form of improved reliability, durability and resale value. To ensure the proper performance of your vehicle and its emission control systems, it is imperative that scheduled maintenance be completed at the designated intervals.

For your convenience, your vehicle is equipped with a message center which determines the proper oil change service interval. You should perform the engine oil change as indicated by the message center. The message center will display ENGINE OIL CHANGE SOON or OIL CHANGE REQUIRED to indicate when an oil change is needed. The engine oil change service needs to be completed within two weeks or 500 miles (800 km) after the OIL CHANGE REQUIRED message is displayed. Your oil change service interval can be up to one year or 10,000 miles (16,000 km). Reset your Intelligent Oil Life Monitor™ after each engine oil and filter change; refer to the *Instrument Cluster* chapter.

If your message center is prematurely reset or becomes inoperative, you should perform the oil change interval at six months or 5,000 miles (8,000 km) from your last oil change.

**Note:** Vehicles equipped with a 6.2L engine do not have a message center with this feature; refer to the 7,500 mile (12,000 km) maintenance schedule for oil change service intervals.

## Scheduled Maintenance

Your vehicle is very sophisticated and built with multiple complex performance systems. Every manufacturer develops these systems using different specifications and performance features. That's why it's important to rely upon your dealership to properly diagnose and repair your vehicle.

Ford Motor Company has recommended maintenance intervals for various parts and component systems based upon engineering testing. Ford Motor Company relies upon this testing to determine the most appropriate mileage for replacement of oils and fluids to protect your vehicle at the lowest overall cost to you and recommends against maintenance schedules that deviate from the scheduled maintenance information.

Ford strongly recommends the use of genuine Ford replacement parts. Parts other than Ford, Motorcraft® or Ford-authorized remanufactured parts that are used for maintenance replacement or for the service of components affecting emission control must be equivalent to genuine Ford Motor Company parts in performance and durability. It is the owner's responsibility to determine the equivalency of such parts. Please consult your *Warranty Guide* for complete warranty information.

Chemicals or additives not approved by Ford are not required for factory recommended maintenance. In fact, Ford Motor Company recommends against the use of such additive products unless specifically recommended by Ford for a particular application.

### ***Oils, fluids and flushing***

In many cases, fluid discoloration is a normal operating characteristic and, by itself, does not necessarily indicate a concern or that the fluid needs to be changed. However, discolored fluids that also show signs of overheating and/or foreign material contamination should be inspected immediately by a qualified expert such as the factory-trained technicians at your dealership. Your vehicle's oils and fluids should be changed at the specified intervals or in conjunction with a repair. Flushing is a viable way to change fluid for many vehicle sub-systems during scheduled maintenance. It is critical that systems are flushed only with new fluid that is the same as that required to fill and operate the system, or using a Ford-approved flushing chemical.

### **Genuine Ford parts and service**

When planning your maintenance services, consider your dealership for all your vehicle's needs.

There are a lot of reasons why visiting your dealership for all your service needs is a great way to help keep your vehicle running great.

432



## Scheduled Maintenance

### ***Convenience***

Many dealerships have extended evening and Saturday hours to make your service visit more convenient. How's that for quality service?

### ***Factory-trained technicians***

Service technicians participate in extensive factory-sponsored certification training to help them become experts on the operation of your vehicle. Ask your dealership about the training and certification their technicians have received.

### ***Genuine Ford and Motorcraft® replacement parts***

Dealerships stock Ford and Motorcraft® branded replacement parts. These parts meet or exceed Ford Motor Company's specifications, and we stand behind them. Parts installed at your dealership carry a nationwide, 12 month/12,000 mile (20,000 km) parts and labor limited warranty. Your dealer can give you details.

### ***Value shopping for your vehicle's maintenance needs***

Your dealership recognizes the competitive landscape of maintenance and light repair automotive services. With factory-trained technicians, and one-stop service from routine maintenance like oil changes and tire rotations to repairs like brake service, check out the value your dealers can offer.

### ***Owner checks and services***

Certain basic maintenance checks and inspections should be performed by the owner or a service technician at the intervals indicated. Service information and supporting specifications are provided in this owner's guide.

Any adverse condition should be brought to the attention of your dealer or qualified service technician as soon as possible for the proper service advice. The owner maintenance service checks are generally not covered by warranties so you may be charged for labor, parts or fluids used.

## Scheduled Maintenance

<b>Engine oil/coolant change intervals – 3.5L, 3.7L and 5.0L engines</b>	
<b>Engine oil</b>	As indicated by the message center: do not exceed one year or 10,000 miles (16,000 km)
<b>Engine coolant, initial change</b>	6 years or 100,000 miles (160,000 km) (whichever comes first)
<b>Engine coolant, after initial change</b>	Every 3 years or 50,000 miles (80,000 km)

<b>Engine oil/coolant change intervals – 6.2L engine</b>	
<b>Engine oil</b>	6 months or 7,500 miles (12,000 km) (whichever comes first)
<b>Engine coolant, initial change</b>	6 years or 105,000 miles (168,000 km) (whichever comes first)
<b>Engine coolant, after initial change</b>	Every 3 years or 45,000 miles (72,000 km)

<b>Check every month</b>	
Engine oil level	
Function of all interior and exterior lights	
Tires for wear and proper pressure, including spare	
Windshield washer fluid level	

<b>Check every six months</b>	
Battery connections; clean if necessary	
Body and door drain holes for obstructions; clean if necessary	
Cooling system fluid level and coolant strength	
Door weatherstrips for wear; lubricate if necessary	
Hinges/latches/outside locks for proper operation; lubricate if necessary	
Parking brake for proper operation	
Safety belts and seat latches for wear and function	
Safety warning lamps (brake, ABS, airbag, safety belt) for operation	
Washer spray/wiper operation; clean or replace blades as necessary	

## Scheduled Maintenance

### Multi-point inspection

In order to keep your vehicle running right, it is important to have the systems on your vehicle checked regularly. This can help identify potential issues and prevent major problems. Ford Motor Company recommends the following multi-point inspection be performed at every scheduled maintenance interval to help ensure your vehicle keeps running great.

<b>Multi-point inspection – Recommended each visit</b>	
Accessory drive belt(s)	Half-shaft dust boots (if equipped)
Battery performance	Horn operation
Clutch operation (if equipped)	Radiator, cooler, heater and A/C hoses
Engine air filter	Suspension component for leaks or damage
Exhaust system	Steering and linkage
Exterior lamps and hazard warning system operation	Tires for wear and proper pressure, including spare
Fluid levels*; fill if necessary	Windshield for cracks, chips or pits
For oil and fluid leaks	Washer spray and wiper operation
*Brake, coolant recovery reservoir, manual and automatic transmission (with an underhood dipstick), power steering (if equipped) and window washer	

Be sure to ask your dealership service advisor or technician about the multi-point vehicle inspection. It's a comprehensive way to perform a thorough inspection of your vehicle. It's your checklist that gives you immediate feedback on the overall condition of your vehicle. You'll know what's been checked, what's okay, as well as those things that may require future or immediate attention. The multi-point vehicle inspection is one more way to keep your vehicle running great!



## Scheduled Maintenance

### NORMAL SCHEDULED MAINTENANCE AND LOG

#### 3.5L, 3.7L and 5.0L engines

For your convenience, your vehicle is equipped with a message center which determines the proper oil change service interval. You should perform the engine oil change as indicated by the message center. The message center will display ENGINE OIL CHANGE SOON or OIL CHANGE REQUIRED to indicate when an oil change is needed. The engine oil change service needs to be completed within two weeks or 500 miles (800 km) after the OIL CHANGE REQUIRED message is displayed. Your oil change service interval can be up to one year or 10,000 miles (16,000 km). Reset your Intelligent Oil Life Monitor™ after each engine oil and filter change; refer to the *Instrument Cluster* chapter.

If your message center is prematurely reset or becomes inoperative, you should perform the oil change interval at six months or 5,000 miles (8,000 km) from your last oil change.

## Scheduled Maintenance

3.5L, 3.7L and 5.0L engines															
Oil Change Service Interval*	1	2	3	4	5	6	7	8	9	10	11	12	13	14	15
Change engine oil and filter	•	•	•	•	•	•	•	•	•	•	•	•	•	•	•
Rotate tires, inspect tire wear and measure tread depth	•	•	•	•	•	•	•	•	•	•	•	•	•	•	•
Inspect wheels and related components for abnormal noise, wear, looseness or drag	•	•	•	•	•	•	•	•	•	•	•	•	•	•	•
Inspect front axle and U-joints; lubricate if equipped with grease fittings (4WD vehicles)	•	•	•	•	•	•	•	•	•	•	•	•	•	•	•
Perform multi-point inspection (recommended)	•	•	•	•	•	•	•	•	•	•	•	•	•	•	•
Inspect automatic transmission fluid level (if equipped with dipstick); consult dealer for requirements	•	•	•	•	•	•	•	•	•	•	•	•	•	•	•
Inspect brake pads, shoes, rotors, drums, brake linings, hoses and parking brake	•	•	•	•	•	•	•	•	•	•	•	•	•	•	•
Inspect engine cooling system concentration and hoses	•	•	•	•	•	•	•	•	•	•	•	•	•	•	•
Inspect exhaust system and heat shields	•	•	•	•	•	•	•	•	•	•	•	•	•	•	•
Inspect half-shaft boots (if equipped)	•	•	•	•	•	•	•	•	•	•	•	•	•	•	•
Inspect steering linkage, ball joints, suspension, tie-rod ends, driveshaft and U-joints; lubricate if equipped with grease fittings	•	•	•	•	•	•	•	•	•	•	•	•	•	•	•
Inspect cabin air filter (if equipped)	•	•	•	•	•	•	•	•	•	•	•	•	•	•	•
*Oil change service intervals should be completed as indicated by the message center															
Reset your Intelligent Oil Life Monitor™ after each engine oil and filter change; refer to the <i>Instrument Cluster</i> chapter															

## Scheduled Maintenance

Perform the services noted in the following table at the specified time/mileage (km) period either within 3,000 miles (4,800 km) of the OIL CHANGE REQUIRED message appearing in the message center or when the time/mileage (km) reading indicates service is due.

**Example #1:** The OIL CHANGE REQUIRED message comes on at 28,751 miles (46,270 km); perform the 30,000 mile (48,000 km) automatic transmission fluid replacement.

**Example #2:** The OIL CHANGE REQUIRED message has **not** come on but the odometer reads 30,000 miles (48,000 km); perform the engine air filter replacement. (i.e., Intelligent Oil Life Monitor™ was reset at 25,000 miles [40,000 km].)

Every 20,000 miles (32,000 km)	Replace cabin air filter (if equipped)
Every 30,000 miles (48,000 km)	Replace climate-controlled seat filter (if equipped)
	Replace engine air filter
Every 60,000 miles (96,000 km)	Change automatic transmission fluid and filter on 5-speed TorqShift® transmission; consult dealer for requirements
	Replace front wheel bearing grease/grease seal if non-sealed bearings are used (2WD vehicles)
Every 100,000 miles (160,000 km)	Change engine coolant <sup>1</sup>
	Change manual transmission fluid (except Escape)
	Change rear axle fluid (Dana axles only)
	Replace spark plugs
	Inspect accessory drive belt(s) <sup>2</sup>

## Scheduled Maintenance

Every 150,000 miles (240,000 km)	Change automatic transmission fluid and filter (except 5-speed TorqShift® transmission) (filter not required on 6F35, 6F50, DPS6 and AWF-21 transmissions); consult dealer for requirements
	Change front axle fluid (4WD vehicles)
	Change manual transmission fluid (Escape)
	Change rear axle fluid (RWD vehicles)
	Replace accessory drive belt(s) if not replaced within the last 100,000 miles (160,000 km)
	Replace front wheel bearings and seals if non-sealed bearings are used (2WD vehicles)
<sup>1</sup> Initial replacement at 100,000 miles (160,000 km) or 72 months; every 50,000 miles (80,000 km) or 36 months thereafter	
<sup>2</sup> Perform a follow-up inspection at 120,000 miles (192,000 km)	

### 6.2L engine

The following section contains the “Normal Schedule”. This schedule is presented at specific mileage (kilometer) intervals with exceptions noted.



## Scheduled Maintenance

6.2L engine												
Miles (x 1,000)*	7.5	15	22.5	30	37.5	45	52.5	60	67.5	75		
Kilometers (x 1,000)*	12	24	36	48	60	72	84	96	108	120		
Months*	6	12	18	24	30	36	42	48	54	60		
Change engine oil and filter	•	•	•	•	•	•	•	•	•	•	•	•
Rotate tires, inspect tire wear and measure tread depth**	•	•	•	•	•	•	•	•	•	•	•	•
Inspect wheels and related components for abnormal noise, wear, looseness or drag	•	•	•	•	•	•	•	•	•	•	•	•
Perform multi-point inspection (recommended)	•	•	•	•	•	•	•	•	•	•	•	•
Inspect automatic transmission fluid level (if equipped with dipstick); consult dealer for requirements		•		•		•		•		•		•
Inspect brake pads, shoes, rotors, drums, brake linings, hoses and parking brake		•		•		•		•		•		•
Inspect engine cooling system for strength and hoses		•		•		•		•		•		•
Inspect exhaust system and heat shields		•		•		•		•		•		•
Inspect front axle and U-joints; lubricate if equipped with grease fittings (4WD vehicles)		•		•		•		•		•		•
Inspect half-shaft boots (if equipped)		•		•		•		•		•		•
Inspect steering linkage, ball joints, suspension, tie-rod ends, driveshaft and U-joints; lubricate if equipped with grease fittings		•		•		•		•		•		•
Inspect cabin air filter (if equipped)	•		•		•		•		•		•	

\* Whichever comes first

\*\* SVT Raptor vehicles have specific tire rotation intervals; refer to the *Maintenance* chapter of the supplement  
 Reset your oil life monitoring system after each engine oil and filter change; refer to the *Instrument Cluster* chapter

## Scheduled Maintenance

6.2L engine												
Miles (x 1,000)*	82.5	90	97.5	105	112.5	120	127.5	135	142.5	150		
Kilometers (x 1,000)*	132	144	156	168	180	192	204	216	228	240		
Months*	66	72	78	84	90	96	102	108	114	120		
Change engine oil and filter	•	•	•	•	•	•	•	•	•	•	•	•
Rotate tires, inspect tire wear and measure tread depth**	•	•	•	•	•	•	•	•	•	•	•	•
Inspect wheels and related components for abnormal noise, wear, looseness or drag	•	•	•	•	•	•	•	•	•	•	•	•
Perform multi-point inspection (recommended)	•	•	•	•	•	•	•	•	•	•	•	•
Inspect automatic transmission fluid level (if equipped with dipstick); consult dealer for requirements		•		•		•		•		•		•
Inspect brake pads, shoes, rotors, drums, brake linings, hoses and parking brake		•		•		•		•		•		•
Inspect engine cooling system for strength and hoses		•		•		•		•		•		•
Inspect exhaust system and heat shields		•		•		•		•		•		•
Inspect front axle and U-joints; lubricate if equipped with grease fittings (4WD vehicles)		•		•		•		•		•		•
Inspect half-shaft boots (if equipped)		•		•		•		•		•		•
Inspect steering linkage, ball joints, suspension, tie-rod ends, driveshaft and U-joints; lubricate if equipped with grease fittings		•		•		•		•		•		•
Inspect cabin air filter (if equipped)	•		•		•		•		•		•	

\* Whichever comes first

\*\* SVT Raptor vehicles have specific tire rotation intervals; refer to the *Maintenance* chapter of the supplement  
Reset your oil life monitoring system after each engine oil and filter change; refer to the *Instrument Cluster* chapter

## Scheduled Maintenance

Every 15,000 miles (24,000 km)	Replace cabin air filter (if equipped)
Every 30,000 miles (48,000 km)	Replace climate-controlled seat filter (if equipped)
	Replace engine air filter
	Replace fuel filter (Ranger)
Every 60,000 miles (96,000 km)	Change automatic transmission fluid and filter on 5-speed TorqShift® transmission; consult dealer for requirements
	Replace front wheel bearing grease/grease seal if non-sealed bearings are used (2WD vehicles)
Every 105,000 miles (168,000 km)	Change engine coolant <sup>1</sup>
	Change manual transmission fluid (except Escape)
	Change rear axle fluid (Dana axles)
	Replace spark plugs
	Inspect accessory drive belt(s) <sup>2</sup>
Every 150,000 miles (240,000 km)	Change automatic transmission fluid and filter (except 5-speed TorqShift® transmission) (filter not required on 6F35, 6F50, DPS6 and AWF-21 transmissions); consult dealer for requirements
	Change front axle fluid (4WD vehicles)
	Change manual transmission fluid (Escape)
	Change rear axle fluid (RWD vehicles)
	Change transfer case fluid (4WD vehicles)
	Replace accessory drive belt(s) if not replaced within the last 100,000 miles (160,000 km)
	Replace front wheel bearings and seals if non-sealed bearings are used (2WD vehicles)
<sup>1</sup> Initial replacement at 105,000 miles (168,000 km) or 72 months; every 45,000 miles (72,000 km) or 36 months thereafter	
<sup>2</sup> Perform a follow-up inspection at 120,000 miles (192,000 km)	

## Scheduled Maintenance

### Maintenance schedule log

<p style="text-align: center;">DEALER VALIDATION:</p>  <p style="text-align: center;">P&amp;A CODE:</p> <p>RO#:            HOURS:</p> <p>DATE:           MILEAGE:</p>	<p style="text-align: center;">DEALER VALIDATION:</p>  <p style="text-align: center;">P&amp;A CODE:</p> <p>RO#:            HOURS:</p> <p>DATE:           MILEAGE:</p>
<p style="text-align: center;">DEALER VALIDATION:</p>  <p style="text-align: center;">P&amp;A CODE:</p> <p>RO#:            HOURS:</p> <p>DATE:           MILEAGE:</p>	<p style="text-align: center;">DEALER VALIDATION:</p>  <p style="text-align: center;">P&amp;A CODE:</p> <p>RO#:            HOURS:</p> <p>DATE:           MILEAGE:</p>
<p style="text-align: center;">DEALER VALIDATION:</p>  <p style="text-align: center;">P&amp;A CODE:</p> <p>RO#:            HOURS:</p> <p>DATE:           MILEAGE:</p>	<p style="text-align: center;">DEALER VALIDATION:</p>  <p style="text-align: center;">P&amp;A CODE:</p> <p>RO#:            HOURS:</p> <p>DATE:           MILEAGE:</p>
<p style="text-align: center;">DEALER VALIDATION:</p>  <p style="text-align: center;">P&amp;A CODE:</p> <p>RO#:            HOURS:</p> <p>DATE:           MILEAGE:</p>	<p style="text-align: center;">DEALER VALIDATION:</p>  <p style="text-align: center;">P&amp;A CODE:</p> <p>RO#:            HOURS:</p> <p>DATE:           MILEAGE:</p>
<p style="text-align: center;">DEALER VALIDATION:</p>  <p style="text-align: center;">P&amp;A CODE:</p> <p>RO#:            HOURS:</p> <p>DATE:           MILEAGE:</p>	<p style="text-align: center;">DEALER VALIDATION:</p>  <p style="text-align: center;">P&amp;A CODE:</p> <p>RO#:            HOURS:</p> <p>DATE:           MILEAGE:</p>

## Scheduled Maintenance

<p style="text-align: center;">DEALER VALIDATION:</p> <p style="text-align: center;">P&amp;A CODE:</p> <p>RO#:                    HOURS:</p> <p>DATE:                   MILEAGE:</p>	<p style="text-align: center;">DEALER VALIDATION:</p> <p style="text-align: center;">P&amp;A CODE:</p> <p>RO#:                    HOURS:</p> <p>DATE:                   MILEAGE:</p>
<p style="text-align: center;">DEALER VALIDATION:</p> <p style="text-align: center;">P&amp;A CODE:</p> <p>RO#:                    HOURS:</p> <p>DATE:                   MILEAGE:</p>	<p style="text-align: center;">DEALER VALIDATION:</p> <p style="text-align: center;">P&amp;A CODE:</p> <p>RO#:                    HOURS:</p> <p>DATE:                   MILEAGE:</p>
<p style="text-align: center;">DEALER VALIDATION:</p> <p style="text-align: center;">P&amp;A CODE:</p> <p>RO#:                    HOURS:</p> <p>DATE:                   MILEAGE:</p>	<p style="text-align: center;">DEALER VALIDATION:</p> <p style="text-align: center;">P&amp;A CODE:</p> <p>RO#:                    HOURS:</p> <p>DATE:                   MILEAGE:</p>
<p style="text-align: center;">DEALER VALIDATION:</p> <p style="text-align: center;">P&amp;A CODE:</p> <p>RO#:                    HOURS:</p> <p>DATE:                   MILEAGE:</p>	<p style="text-align: center;">DEALER VALIDATION:</p> <p style="text-align: center;">P&amp;A CODE:</p> <p>RO#:                    HOURS:</p> <p>DATE:                   MILEAGE:</p>
<p style="text-align: center;">DEALER VALIDATION:</p> <p style="text-align: center;">P&amp;A CODE:</p> <p>RO#:                    HOURS:</p> <p>DATE:                   MILEAGE:</p>	<p style="text-align: center;">DEALER VALIDATION:</p> <p style="text-align: center;">P&amp;A CODE:</p> <p>RO#:                    HOURS:</p> <p>DATE:                   MILEAGE:</p>

## Scheduled Maintenance

<p style="text-align: center;">DEALER VALIDATION:</p>  <p style="text-align: center;">P&amp;A CODE:</p> <p>RO#:            HOURS:</p> <p>DATE:           MILEAGE:</p>	<p style="text-align: center;">DEALER VALIDATION:</p>  <p style="text-align: center;">P&amp;A CODE:</p> <p>RO#:            HOURS:</p> <p>DATE:           MILEAGE:</p>
<p style="text-align: center;">DEALER VALIDATION:</p>  <p style="text-align: center;">P&amp;A CODE:</p> <p>RO#:            HOURS:</p> <p>DATE:           MILEAGE:</p>	<p style="text-align: center;">DEALER VALIDATION:</p>  <p style="text-align: center;">P&amp;A CODE:</p> <p>RO#:            HOURS:</p> <p>DATE:           MILEAGE:</p>
<p style="text-align: center;">DEALER VALIDATION:</p>  <p style="text-align: center;">P&amp;A CODE:</p> <p>RO#:            HOURS:</p> <p>DATE:           MILEAGE:</p>	<p style="text-align: center;">DEALER VALIDATION:</p>  <p style="text-align: center;">P&amp;A CODE:</p> <p>RO#:            HOURS:</p> <p>DATE:           MILEAGE:</p>
<p style="text-align: center;">DEALER VALIDATION:</p>  <p style="text-align: center;">P&amp;A CODE:</p> <p>RO#:            HOURS:</p> <p>DATE:           MILEAGE:</p>	<p style="text-align: center;">DEALER VALIDATION:</p>  <p style="text-align: center;">P&amp;A CODE:</p> <p>RO#:            HOURS:</p> <p>DATE:           MILEAGE:</p>
<p style="text-align: center;">DEALER VALIDATION:</p>  <p style="text-align: center;">P&amp;A CODE:</p> <p>RO#:            HOURS:</p> <p>DATE:           MILEAGE:</p>	<p style="text-align: center;">DEALER VALIDATION:</p>  <p style="text-align: center;">P&amp;A CODE:</p> <p>RO#:            HOURS:</p> <p>DATE:           MILEAGE:</p>

## Scheduled Maintenance

### SPECIAL OPERATING CONDITIONS - 3.5L, 3.7L AND 5.0L ENGINES

If you operate your vehicle **primarily** in one of the more demanding conditions listed below, you will need to have some items maintained more frequently. If you only **occasionally** operate your vehicle under these conditions, it is not necessary to perform the additional maintenance. For specific recommendations, see your dealership service advisor or technician.

<b>Towing a trailer or using a camper or car-top carrier</b>	
As required	Change engine oil and filter as indicated by message center and perform services listed in Normal Scheduled Maintenance chart
Inspect frequently, service as required	Inspect and lubricate U-joints
	See axle maintenance items under <i>Exceptions</i>
Every 30,000 miles (48,000 km)	Change automatic transmission fluid (except 6R80 and TorqShift® transmissions)
	Replace front wheel bearing grease/grease seals if non-sealed bearings are used (2WD vehicles)
Every 60,000 miles (96,000 km)	Change transfer case fluid (4WD vehicles)

Perform the services noted in the preceding table at the specified time/mileage (km) period either within 3,000 miles (4,800 km) of the OIL CHANGE REQUIRED message appearing in the message center or when the time/mileage (km) reading indicates service is due.

**Example #1:** The OIL CHANGE REQUIRED message comes on at 28,751 miles (46,270 km); perform the 30,000 mile (48,000 km) automatic transmission fluid replacement.

**Example #2:** The OIL CHANGE REQUIRED message has **not** come on but the odometer reads 30,000 miles (48,000 km); perform the engine air filter replacement. (i.e., Intelligent Oil Life Monitor™ was reset at 25,000 miles [40,000 km].)

## Scheduled Maintenance

<b>Extensive idling and/or low-speed driving for long distances as in heavy commercial use such as delivery, taxi, patrol car or livery</b>	
As required	Change engine oil and filter as indicated by message center and perform services listed in Normal Scheduled Maintenance chart
Inspect frequently, service as required	Replace cabin air filter (if equipped)
	Replace engine air filter
Every 30,000 miles (48,000 km)	Change automatic transmission fluid (except 6R80 and TorqShift® transmissions)
	Replace front wheel bearing grease/grease seals if non-sealed bearings are used (2WD vehicles)
Every 60,000 miles (96,000 km)	Change transfer case fluid (4WD vehicles)
	Replace spark plugs

Perform the services noted in the preceding table at the specified time/mileage (km) period either within 3,000 miles (4,800 km) of the OIL CHANGE REQUIRED message appearing in the message center or when the time/mileage (km) reading indicates service is due.

**Example #1:** The OIL CHANGE REQUIRED message comes on at 28,751 miles (46,270 km); perform the 30,000 mile (48,000 km) automatic transmission fluid replacement.

**Example #2:** The OIL CHANGE REQUIRED message has **not** come on but the odometer reads 30,000 miles (48,000 km); perform the engine air filter replacement. (i.e., Intelligent Oil Life Monitor™ was reset at 25,000 miles [40,000 km].)

<b>Operating in dusty conditions such as unpaved or dusty roads</b>	
Inspect frequently, service as required	Replace cabin air filter (if equipped)
	Replace engine air filter
Every 5,000 miles (8,000 km) or 6 months	Change engine oil and filter
	Inspect wheels and related components for abnormal noise, wear, looseness or drag
	Rotate tires, inspect tires for wear and measure tread depth



## Scheduled Maintenance

<b>Operating in dusty conditions such as unpaved or dusty roads</b>	
Every 30,000 miles (48,000 km)	Change automatic transmission fluid (except 6R80 and TorqShift® transmissions)
	Replace front wheel bearing grease/grease seals if non-sealed bearings are used (2WD vehicles)
Every 60,000 miles (96,000 km)	Change transfer case fluid (4WD vehicles)

Reset your Intelligent Oil Life Monitor™ after each engine oil and filter change; refer to the *Instrument Cluster* chapter.

<b>Off-road operation</b>	
Inspect frequently, service as required	Inspect steering linkage, ball joints and U-joints; lubricate if equipped with grease fittings
	Replace cabin air filter (if equipped)
	Replace engine air filter
Every 5,000 miles (8,000 km) or 6 months	Change engine oil and filter
	Inspect wheels and related components for abnormal noise, wear, looseness or drag
	Rotate tires, inspect tires for wear and measure tread depth
Every 30,000 miles (48,000 km)	Change automatic transmission fluid (except 6R80 and TorqShift® transmissions)
	Replace front wheel bearing grease/grease seals if non-sealed bearings are used (2WD vehicles)
Every 60,000 miles (96,000 km)	Change transfer case fluid (4WD vehicles)

Reset your Intelligent Oil Life Monitor™ after each engine oil and filter change; refer to the *Instrument Cluster* chapter.

<b>Exclusive use of E85 (Flex Fuel Vehicles only)</b>	
Every oil change interval	If ran exclusively on E85, fill the fuel tank full with regular unleaded fuel

## Scheduled Maintenance

### SPECIAL OPERATING CONDITIONS - 6.2L ENGINE

If you operate your vehicle **primarily** in one of the more demanding conditions listed below, you will need to have some items maintained more frequently. If you only **occasionally** operate your vehicle under these conditions, it is not necessary to perform the additional maintenance. For specific recommendations, see your dealership service advisor or technician.

<b>Towing a trailer or using a camper or car-top carrier</b>	
Inspect frequently, service as required	Inspect and lubricate U-joints
	See axle maintenance items under <i>Exceptions</i>
Every 5,000 miles (8,000 km)	Inspect wheels and related components for abnormal noise, wear, looseness or drag
	Rotate tires, inspect tires for wear and measure tread depth
Every 5,000 miles (8,000 km) or 6 months	Change engine oil and filter
	Inspect and lubricate U-joints
Every 30,000 miles (48,000 km)	Change automatic transmission fluid (except 6R80 and TorqShift® transmissions)
	Replace front wheel bearing grease/grease seals if non-sealed bearings are used (2WD vehicles)
Every 60,000 miles (96,000 km)	Change transfer case fluid (4WD vehicles)
<b>Extensive idling and/or low-speed driving for long distances as in heavy commercial use such as delivery, taxi, patrol car or livery</b>	
Inspect frequently, service as required	Replace cabin air filter (if equipped)
	Replace engine air filter
Every 5,000 miles (8,000 km)	Inspect brake system
	Inspect wheels and related components for abnormal noise, wear, looseness or drag
	Lubricate control arm and steering ball joints if equipped with grease fittings
	Rotate tires, inspect tires for wear and measure tread depth

## Scheduled Maintenance

<b>Extensive idling and/or low-speed driving for long distances as in heavy commercial use such as delivery, taxi, patrol car or livery</b>	
Every 5,000 miles (8,000 km) or 6 months	Change engine oil and filter
Every 5,000 miles (8,000 km), 6 months or 200 hours of engine operation	Change automatic transmission fluid (except 6R80 and TorqShift® transmissions)
	Replace front wheel bearing grease/grease seals if non-sealed bearings are used (2WD vehicles)
Every 30,000 miles (48,000 km)	Change automatic transmission fluid (except 6R80 and TorqShift® transmissions)
	Replace front wheel bearing grease/grease seals if non-sealed bearings are used (2WD vehicles)
Every 60,000 miles (96,000 km)	Change transfer case fluid (4WD vehicles)
	Replace spark plugs
<b>Operating in dusty conditions such as unpaved or dusty roads</b>	
Inspect frequently, service as required	Replace cabin air filter (if equipped)
	Replace engine air filter
Every 5,000 miles (8,000 km)	Inspect the wheels and related components for abnormal noise, wear, looseness or drag
	Rotate tires, inspect tires for wear and measure tread depth
Every 5,000 miles (8,000 km) or 6 months	Change engine oil and filter
	Inspect and lubricate U-joints
Every 30,000 miles (48,000 km)	Change automatic transmission fluid (except 6R80 and TorqShift® transmissions)
	Replace front wheel bearing grease/grease seals if non-sealed bearings are used (2WD vehicles)
Every 60,000 miles (96,000 km)	Change transfer case fluid (4WD vehicles)

## Scheduled Maintenance

<b>Off-road operation</b>	
Inspect frequently, service as required	Inspect steering linkage, ball joints and U-joints; lubricate if equipped with grease fittings
	Replace cabin air filter (if equipped)
	Replace engine air filter
Every 5,000 miles (8,000 km) or 6 months	Change engine oil and filter
	Inspect wheels and related components for abnormal noise, wear, looseness or drag
	Rotate tires, inspect tires for wear and measure tread depth
Every 30,000 miles (48,000 km)	Change automatic transmission fluid (except 6R80 and TorqShift® transmissions)
	Replace front wheel bearing grease/grease seals if non-sealed bearings are used (2WD vehicles)
Every 60,000 miles (96,000 km)	Change transfer case fluid (4WD vehicles)
<b>Exclusive use of E85 (Flex Fuel Vehicles only)</b>	
Every oil change interval	If ran exclusively on E85, fill the fuel tank full with regular unleaded fuel

## Scheduled Maintenance

### Special operating condition log

<p style="text-align: center;">DEALER VALIDATION:</p> <p>RO#: P&amp;A CODE:            DATE: HOURS:            MILEAGE:</p>	<p style="text-align: center;">DEALER VALIDATION:</p> <p>RO#: P&amp;A CODE:            DATE: HOURS:            MILEAGE:</p>
<p style="text-align: center;">DEALER VALIDATION:</p> <p>RO#: P&amp;A CODE:            DATE: HOURS:            MILEAGE:</p>	<p style="text-align: center;">DEALER VALIDATION:</p> <p>RO#: P&amp;A CODE:            DATE: HOURS:            MILEAGE:</p>
<p style="text-align: center;">DEALER VALIDATION:</p> <p>RO#: P&amp;A CODE:            DATE: HOURS:            MILEAGE:</p>	<p style="text-align: center;">DEALER VALIDATION:</p> <p>RO#: P&amp;A CODE:            DATE: HOURS:            MILEAGE:</p>
<p style="text-align: center;">DEALER VALIDATION:</p> <p>RO#: P&amp;A CODE:            DATE: HOURS:            MILEAGE:</p>	<p style="text-align: center;">DEALER VALIDATION:</p> <p>RO#: P&amp;A CODE:            DATE: HOURS:            MILEAGE:</p>
<p style="text-align: center;">DEALER VALIDATION:</p> <p>RO#: P&amp;A CODE:            DATE: HOURS:            MILEAGE:</p>	<p style="text-align: center;">DEALER VALIDATION:</p> <p>RO#: P&amp;A CODE:            DATE: HOURS:            MILEAGE:</p>

## Scheduled Maintenance

<p style="text-align: center;">DEALER VALIDATION:</p> <p style="text-align: center;">P&amp;A CODE:</p> <p>RO#:            HOURS:</p> <p>DATE:           MILEAGE:</p>	<p style="text-align: center;">DEALER VALIDATION:</p> <p style="text-align: center;">P&amp;A CODE:</p> <p>RO#:            HOURS:</p> <p>DATE:           MILEAGE:</p>
<p style="text-align: center;">DEALER VALIDATION:</p> <p style="text-align: center;">P&amp;A CODE:</p> <p>RO#:            HOURS:</p> <p>DATE:           MILEAGE:</p>	<p style="text-align: center;">DEALER VALIDATION:</p> <p style="text-align: center;">P&amp;A CODE:</p> <p>RO#:            HOURS:</p> <p>DATE:           MILEAGE:</p>
<p style="text-align: center;">DEALER VALIDATION:</p> <p style="text-align: center;">P&amp;A CODE:</p> <p>RO#:            HOURS:</p> <p>DATE:           MILEAGE:</p>	<p style="text-align: center;">DEALER VALIDATION:</p> <p style="text-align: center;">P&amp;A CODE:</p> <p>RO#:            HOURS:</p> <p>DATE:           MILEAGE:</p>
<p style="text-align: center;">DEALER VALIDATION:</p> <p style="text-align: center;">P&amp;A CODE:</p> <p>RO#:            HOURS:</p> <p>DATE:           MILEAGE:</p>	<p style="text-align: center;">DEALER VALIDATION:</p> <p style="text-align: center;">P&amp;A CODE:</p> <p>RO#:            HOURS:</p> <p>DATE:           MILEAGE:</p>
<p style="text-align: center;">DEALER VALIDATION:</p> <p style="text-align: center;">P&amp;A CODE:</p> <p>RO#:            HOURS:</p> <p>DATE:           MILEAGE:</p>	<p style="text-align: center;">DEALER VALIDATION:</p> <p style="text-align: center;">P&amp;A CODE:</p> <p>RO#:            HOURS:</p> <p>DATE:           MILEAGE:</p>

## Scheduled Maintenance

### EXCEPTIONS

There are several exceptions to the Normal Schedule. They are listed below:

**Normal vehicle axle maintenance:** Rear axles and power take-off (PTO) units with synthetic fluid and light-duty trucks equipped with Ford-design axles are lubricated for life; do not check or change fluid unless a leak is suspected, service is required or the assembly has been submerged in water. During long periods of trailer towing with outside temperatures above 70°F (21°C) and at wide-open throttle for long periods above 45 mph (72 km/h), non-synthetic rear axle fluids should be changed every 3,000 miles (4,800 km) or three months, whichever comes first. This interval can be waived if the axle is filled with 75W140 synthetic gear fluid meeting Ford specification WSL-M2C192-A, part number FITZ-19580-B or equivalent. Add friction modifier XL-3 (EST-M2C118-A) or equivalent for complete refill of Traction-Lok rear axles (refer to *Maintenance product specifications and capacities* in the *Maintenance and Specifications* chapter for details).

**Police/Taxi/Livery vehicle axle maintenance:** Change rear axle fluid every 100,000 miles (160,000 km). Rear axle fluid change may be waived if the axle was filled with 75W140 synthetic gear fluid meeting Ford specification WSL-M2C192-A, part number FITZ-19580-B or equivalent. Add four ounces (118 mL) of additive friction modifier XL-3 (EST-M2C118-A) or equivalent for complete refill of Traction-Lok rear axles. The axle fluid should be changed anytime the axle has been submerged in water.

**E-450 and F-450/550 axle maintenance:** Change rear axle fluid every 100,000 miles (160,000 km) under normal driving conditions. For vehicles operated at or near maximum Gross Vehicle Weights, the rear axle fluid should be changed every 50,000 miles (80,000 km). In addition, this 50,000 mile (80,000 km) schedule should be observed when the vehicles are operated under the Special Operating Conditions.

**California fuel filter replacement:** If the vehicle is registered in California, the California Air Resources Board has determined that the failure to perform this maintenance item will not nullify the emission warranty or limit recall liability prior to the completion of the vehicle's useful life. Ford Motor Company, however, urges you to have all recommended maintenance services performed at the specified intervals and to record all vehicle service.

## Scheduled Maintenance

**Class A Motorhome:** Change brake fluid every two years.

**Hot climate oil change intervals:** If operating conditions are normal and you drive your vehicle under typical, everyday conditions **and** you are using an API performance category oil of SL or later (for example SM, etc.) then you can follow the 7,500 mile (12,000 km) normal service oil change intervals schedule. Vehicles operating in the Middle East, North Africa, Sub-Saharan Africa or locations with similar climates must follow the oil change interval of 3,000 mile (4,800 km) if the owner is using oils defined by the American Petroleum Institute (API) performance category of API SK or earlier (for example SJ, etc).

Edge/MKX AWD only – vehicles operating off-road in sand during high ambient temperatures must replace the AWD PTU (All-wheel drive Power Transfer Unit) lube every 20,000 miles (32,000 km).

**Engine air filter & cabin air filter replacement:** Engine air filter and cabin air filter life is dependent on exposure to dusty and dirty conditions. Vehicles operated in these conditions will require frequent inspection and replacement of the engine air filter and cabin air filter.

### ENGINE COOLANT CHANGE RECORD

<b>3.5L, 3.7L and 5.0L engines</b>	
Initial change	6 years or 100,000 miles (160,000 km) (whichever comes first)
After initial change	Every 3 years or 50,000 miles (80,000 km)

<b>6.2L engine</b>	
Initial change	6 years or 105,000 miles (168,000 km) (whichever comes first)
After initial change	Every 3 years or 45,000 miles (72,000 km)



## Scheduled Maintenance

### Engine coolant change log

<p>DEALER VALIDATION:</p> <p>RO#: P&amp;A CODE: HOURS: DATE: MILEAGE:</p>	<p>DEALER VALIDATION:</p> <p>RO#: P&amp;A CODE: HOURS: DATE: MILEAGE:</p>
<p>DEALER VALIDATION:</p> <p>RO#: P&amp;A CODE: HOURS: DATE: MILEAGE:</p>	<p>DEALER VALIDATION:</p> <p>RO#: P&amp;A CODE: HOURS: DATE: MILEAGE:</p>
<p>DEALER VALIDATION:</p> <p>RO#: P&amp;A CODE: HOURS: DATE: MILEAGE:</p>	<p>DEALER VALIDATION:</p> <p>RO#: P&amp;A CODE: HOURS: DATE: MILEAGE:</p>

## Index

### A

Accessory delay .....106  
AdvanceTrac .....286  
Airbag supplemental restraint system .....194–195, 203, 206  
    and child safety seats .....197  
    description .....195, 203, 206  
    disposal .....209  
    driver airbag ....195, 198, 204, 207  
    indicator light .....202, 205, 208  
    operation .....195, 198, 204, 207  
    passenger  
    airbag .....195, 198, 204, 207  
    side airbag .....203  
Air cleaner filter .....408–409, 414  
Air conditioning .....69, 72, 74, 77  
    manual heating and air conditioning system .....69  
Ambient mood/lighting .....88  
Ambulance packages .....6  
AM/FM .....51  
Antifreeze  
    (see Engine coolant) .....386  
Anti-lock brake system  
    (see Brakes) .....284–285  
Anti-theft system .....158, 160  
    arming the system .....158, 160  
    disarming a triggered system .....161  
    triggering .....161  
Armrests .....166  
Audio system (see Radio) ...49, 51  
Automatic transmission  
    driving an automatic overdrive .....299  
    fluid, adding .....407  
    fluid, checking .....407  
458

fluid, refill capacities .....415  
fluid, specification .....415  
Selectshift (SST) .....302

Auxiliary input jack (Line in) ....60

### Axle

lubricant specifications .....415  
refill capacities .....415

### B

Battery .....383  
    acid, treating emergencies ....383  
    jumping a disabled battery ...348  
    maintenance-free .....383  
    replacement, specifications ...414  
    servicing .....383

Bed extender .....128

Belt-Minder® .....190  
    deactivating/activating the Belt-Minder® .....192

Blind spot mirror .....311

Booster seats .....228

Brakes .....284  
    anti-lock .....284–285  
    anti-lock brake system (ABS) warning light .....285  
    fluid, checking and adding ....407  
    fluid, refill capacities .....415  
    fluid, specifications .....415  
    lubricant specifications .....415  
    parking .....285  
    shift interlock .....295, 298  
    trailer .....270

Bulbs .....89

### C

Capacities for refilling fluids ....415

## Index

- Car2U® Home Automation System .....117
  - Cargo management system .....130
  - CD .....51
  - Cell phone use .....10
  - Changing a tire .....339
  - Child safety seats .....214
    - attaching with tether straps ..223
    - in front seat .....215, 221
    - in rear seat .....215, 221
    - LATCH .....221
    - recommendations .....212
  - Child safety seats - booster seats .....228
  - Cleaning your vehicle
    - engine compartment .....364
    - instrument panel .....367-368
    - interior .....369
    - plastic parts .....366
    - safety belts .....369
    - washing .....362
    - waxing .....363
    - wheels .....363
    - wiper blades .....366
  - Climate control  
(see Air conditioning or Heating) .....69, 72, 74, 77
  - Clock .....51-52
  - Clock adjust
    - AM/FM Stereo .....51
  - Compass, electronic .....99
    - calibration .....100
    - set zone adjustment .....100
  - Console .....99
  - Controls
    - power seat .....168
    - steering column .....114
  - Coolant
    - checking and adding .....386
    - refill capacities .....389, 415
    - specifications .....415
  - Cruise control  
(see Speed control) .....111
  - Customer Assistance .....327
    - Ford Extended Service Plan .....427, 430
    - Getting assistance outside the U.S. and Canada .....358
    - Getting roadside assistance ...327
    - Getting the service you need .....354
    - Ordering additional owner's literature .....360
    - Utilizing the Mediation/Arbitration Program .....358
- D**
- Daytime running lamps  
(see Lamps) .....84
  - Defrost
    - rear window and rearview mirrors .....72, 74, 77
    - windshield .....72, 74, 77
  - Dipstick
    - automatic transmission fluid .....407
    - engine oil .....380
  - Driving under special conditions .....303, 320, 323
    - sand .....322
    - snow and ice .....324
    - through water .....322, 326
- E**
- Electronic message center ...21, 32  
459

## Index

- Emergencies, roadside  
  jump-starting .....348  
  running out of fuel .....348, 399
- Emission control system .....404
- Engine .....419–420  
  cleaning .....364  
  coolant .....386  
  fail-safe cooling .....390  
  idle speed control .....383  
  lubrication specifications .....415  
  refill capacities .....415  
  service points .....375–378
- Engine block heater .....282
- Engine oil .....380  
  checking and adding .....380  
  dipstick .....380  
  filter, specifications .....414  
  refill capacities .....415  
  specifications .....415
- Event data recording .....8
- Exhaust fumes .....282
- F**
- Fail safe cooling .....390
- Fleet MyKey programming .....137
- Flexible Fuel Vehicle (FFV) ...393
- Floor mats .....123
- Fluid capacities .....415
- Fog lamps .....83
- Four-Wheel Drive vehicles .....312  
  driving off road .....318  
  electronic shift .....314  
  indicator light .....312  
  lever operated shift .....313  
  preparing to drive your  
  vehicle .....295
- Fuel .....393  
460  
  calculating fuel  
  economy .....24, 401  
  cap .....396  
  capacity .....415  
  choosing the right fuel .....397  
  detergent in fuel .....399  
  filler funnel .....399  
  filling your vehicle with  
  fuel .....393, 396, 401  
  filter, specifications .....393, 414  
  fuel pump shut-off .....328  
  improving fuel economy .....401  
  octane rating ...397–398, 419–420  
  quality .....398  
  running out of fuel .....348, 399  
  safety information relating to  
  automotive fuels .....393
- Fuel - flex fuel vehicle  
(FFV) .....393, 397–398
- Fuses .....329–330
- G**
- Garage door opener .....116
- Gas cap (see Fuel cap) .....396
- Gas mileage  
(see Fuel economy) .....401
- Gauges .....20
- H**
- Hazard flashers .....328
- Headlamps .....83  
  aiming .....85  
  autolamp system .....83  
  bulb specifications .....89  
  daytime running lights .....84  
  flash to pass .....84  
  high beam .....84  
  replacing bulbs .....90

## Index

- turning on and off .....83
- Heating
  - heating and air conditioning system .....69, 72, 74, 77
- Hood .....374
- I**
- Ignition .....278, 419–420
- Illuminated visor mirror .....98
- Infant seats
  - (see Safety seats) .....214
- Inspection/maintenance (I/M) testing .....406
- Instrument panel
  - cleaning .....367–368
  - cluster .....14
- J**
- Jack .....339
  - positioning .....339
  - storage .....339
- Jump-starting your vehicle .....348
- K**
- Keyless entry system
  - autolock .....146
  - keypad .....156
  - locking and unlocking doors ..157
  - programming entry code .....156
- Keys .....137, 158–159
  - positions of the ignition .....278
- L**
- Lamps
  - autolamp system .....83
  - bulb replacement
    - specifications chart .....89
    - daytime running light .....84
    - fog lamps .....83
    - headlamps .....83
    - headlamps, flash to pass .....84
    - interior lamps .....87
    - replacing bulbs .....90, 94
- LATCH anchors .....221
- Lights, warning and indicator ....14
  - anti-lock brakes (ABS) .....285
- Limited-slip axle .....294
- Loading instructions .....263
- Load limits .....256
- Locks
  - autolock .....146
  - childproof .....149
  - doors .....145
- Lubricant specifications .....415
- Lug nuts .....347
- Lumbar support, seats ....167–168
- M**
- Message center .....21–22, 32
  - english/metric button .....26
  - system check button .....26
  - warning messages .....26, 41
- Mirrors .....106–107
  - automatic dimming rearview mirror .....106
  - fold away .....108
  - heated .....72, 74, 77, 108
  - programmable memory .....152
  - side view mirrors (power) ....107
  - signal .....109
- Moon roof .....115
- Motorcraft® parts .....372, 414

461

## Index

- MyKey .....137
- N**
- Navigation system .....68
- O**
- Octane rating .....397–398
- Oil (see Engine oil) .....380
- P**
- Parental MyKey  
programming .....137
- Parking brake .....285
- Parts  
(see Motorcraft® parts) .....414
- Passenger Occupant  
Classification Sensor .....180
- Pedals (see Power adjustable  
foot pedals) .....109
- Power adjustable foot pedals ...109
- Power deployable running  
boards .....110
- Power distribution box  
(see Fuses) .....330, 333
- Power door locks .....145
- Power mirrors .....107
- Power point .....101
- Power steering .....292  
fluid, checking and adding ....406  
fluid, refill capacity .....415  
fluid, specifications .....415
- Power Windows .....103
- Preparing to drive your  
vehicle .....295
- 462
- R**
- Radio .....49, 51  
6-CD in dash .....51
- Rear heated seats .....177
- Rear-view camera system .....306
- Recommendations for  
attaching safety restraints for  
children .....212
- Relays .....329
- Remote entry system .....150–151  
illuminated entry .....154  
locking/unlocking doors .....151
- Remote start .....154  
replacement/additional  
transmitters .....153  
replacing the batteries .....152
- Remote start .....154
- Remote start climate  
operation .....81
- Reverse sensing system .....304
- Roadside assistance .....327
- S**
- Safety belts (see Safety  
restraints) .....178, 183–186, 189
- Safety Canopy .....204, 206
- Safety defects, reporting .....361
- Safety  
restraints .....178, 183–187, 189  
Belt-Minder® .....190  
Belt-Minder®,  
deactivating/activating .....192  
extension assembly .....194  
for adults .....183–186  
for children .....209

## Index

- Occupant Classification Sensor .....180
  - warning light and chime .....189
  - Safety restraints - LATCH anchors .....221
  - Safety seats for children .....214
  - Safety Compliance Certification Label .....421
  - Satellite Radio .....51
  - Satellite Radio Information .....65
  - Scheduled Maintenance Guide
    - Normal Scheduled Maintenance and Log .....437
  - Seats .....162
    - child safety seats .....214
    - cleaning .....370
    - climate control .....74, 77, 173
    - easy access/easyout feature ..170
    - heated .....72, 171, 177
    - memory seat .....152, 170
  - SecuriCode keyless entry system .....156
  - SecuriLock passive anti-theft system .....158–159
  - Servicing your vehicle .....373
  - Setting the clock .....51–52
    - AM/FM stereo .....51
  - Snowplowing .....6
  - SOS Post Crash Alert .....209
  - Spark plugs, specifications .....414, 419–420
  - Special notice
    - ambulance conversions .....6
    - utility-type vehicles .....7
  - Specification chart, lubricants .....415
  - Speed control .....111
  - Starting a flex fuel vehicle .....281
  - Starting your vehicle .....278–279, 281
    - jump starting .....348
  - Steering wheel
    - controls .....114
    - tilting .....96–97
  - Stereo
    - 6-CD in dash .....51
    - CD-MP3 .....51
  - SYNC® .....68
- T**
- Tailgate .....124
  - Tilt steering wheel .....96–97
  - Tire Pressure Monitoring System (TPMS)
    - Tires, Wheels and Loading ....249
  - Tires .....234–236, 339
    - alignment .....243
    - care .....239
    - changing .....339, 343
    - checking the pressure .....239
    - inflating .....237
    - label .....248
    - replacing .....240
    - rotating .....243
    - safety practices .....242
    - sidewall information .....244
    - snow tires and chains .....255
    - spare tire .....339
    - terminology .....236
    - tire grades .....235
    - treadwear .....235, 239
  - Towing .....264
    - recreational towing .....276
    - Trailer Brake Controller-Integrated .....270
    - trailer towing .....264

463

## Index

- Trailer Brake  
Controller-Integrated .....270
- Transfer case  
fluid checking .....408
- Transmission .....299  
brake-shift interlock  
(BSI) .....295, 298  
fluid, checking and adding  
(automatic) .....407  
fluid, refill capacities .....415  
lubricant specifications .....415
- Turn signal .....86
- U**
- Universal garage door opener ..116
- USB port .....61
- V**
- Vehicle Identification Number  
(VIN) .....422
- Vehicle loading .....256
- Ventilating your vehicle .....282
- W**
- Warning lights (see Lights) .....14
- Washer fluid .....379
- Water, Driving through .....326
- Windows  
power .....103
- Windshield washer fluid and  
wipers .....95  
checking and adding fluid ....379  
replacing wiper blades .....379