



fordowner.com



ford.ca

March 2015  
Second Printing  
Owner's Manual  
C-MAX Hybrid/Energi  
Litho in U.S.A.



FM5J19A321 FB

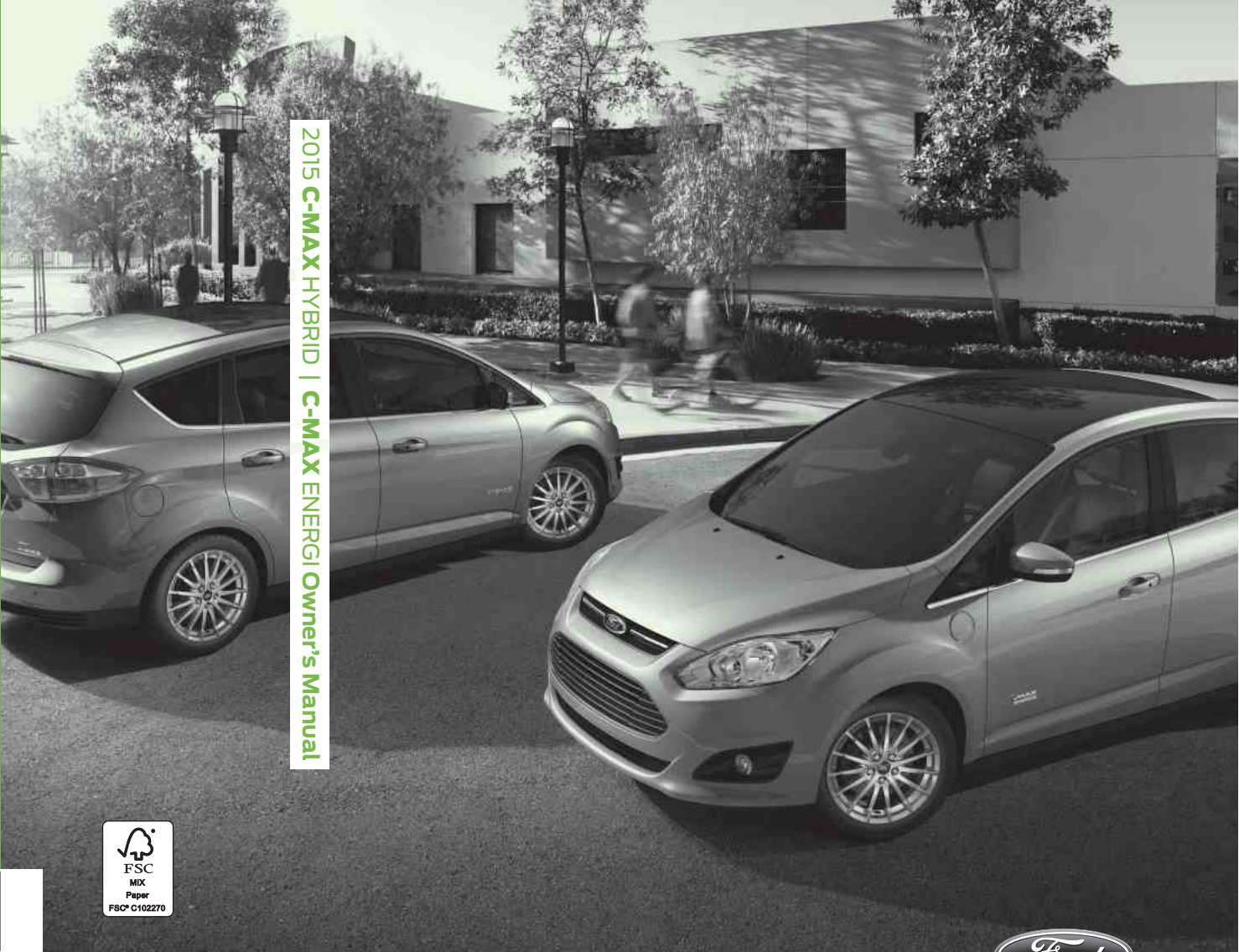

2015 C-MAX HYBRID | C-MAX ENERGI Owner's Manual





The information contained in this publication was correct at the time of going to print. In the interest of continuous development, we reserve the right to change specifications, design or equipment at any time without notice or obligation. No part of this publication may be reproduced, transmitted, stored in a retrieval system or translated into any language in any form by any means without our written permission. Errors and omissions excepted.

© Ford Motor Company 2015

All rights reserved.

Part Number: 20150223221558

# Table of Contents

## Introduction

About This Manual.....	7
Symbols Glossary.....	7
Data Recording.....	9
California Proposition 65.....	11
Perchlorate.....	11
Ford Credit.....	11
Replacement Parts Recommendation.....	11
Special Notices.....	12
Mobile Communications Equipment.....	13
Export Unique Options.....	13

## Environment

Protecting the Environment.....	14
---------------------------------	----

## Child Safety

General Information.....	15
Installing Child Seats.....	16
Booster Seats.....	22
Child Seat Positioning.....	24
Child Safety Locks.....	25

## Safety Belts

Principle of Operation.....	27
Fastening the Safety Belts.....	28
Safety Belt Height Adjustment.....	30
Safety Belt Warning Lamp and Indicator Chime.....	31
Safety Belt Minder.....	31
Child Restraint and Safety Belt Maintenance.....	33

## Personal Safety System™

Personal Safety System™.....	34
------------------------------	----

## Supplementary Restraints System

Principle of Operation.....	35
-----------------------------	----

Driver and Passenger Airbags.....	36
Front Passenger Sensing System.....	37
Side Airbags.....	39
Driver Knee Airbag.....	40
Safety Canopy™.....	41
Crash Sensors and Airbag Indicator.....	42
Airbag Disposal.....	43

## Keys and Remote Controls

General Information on Radio Frequencies.....	44
Remote Control.....	44
Replacing a Lost Key or Remote Control.....	49

## MyKey™

Principle of Operation.....	50
Creating a MyKey.....	51
Clearing All MyKeys.....	51
Checking MyKey System Status.....	53
Using MyKey With Remote Start Systems.....	54
MyKey Troubleshooting.....	54

## Locks

Locking and Unlocking.....	56
Manual Liftgate.....	60
Power Liftgate.....	61

## Security

Passive Anti-Theft System.....	65
Anti-Theft Alarm.....	66

## Steering Wheel

Adjusting the Steering Wheel.....	67
Audio Control.....	67
Voice Control.....	68
Cruise Control.....	68
Information Display Control.....	68

# Table of Contents

---

## Wipers and Washers

Windshield Wipers.....	70
Autowipers.....	70
Rear Window Wiper and Washers.....	71

## Lighting

Lighting Control.....	73
Autolamps.....	73
Instrument Lighting Dimmer.....	74
Headlamp Exit Delay.....	75
Daytime Running Lamps.....	75
Front Fog Lamps.....	76
Direction Indicators.....	76
Interior Lamps.....	76
Ambient Lighting.....	77

## Windows and Mirrors

Power Windows.....	79
Global Opening.....	80
Exterior Mirrors.....	80
Interior Mirror.....	82
Sun Visors.....	82
Sun Shades.....	82

## Instrument Cluster

Gauges.....	84
Warning Lamps and Indicators.....	86
Audible Warnings and Indicators.....	90

## Information Displays

General Information.....	91
Information Messages.....	100

## Climate Control

Automatic Climate Control.....	107
Hints on Controlling the Interior Climate.....	108
Heated Windows and Mirrors.....	110
Cabin Air Filter.....	110

Remote Start.....	110
-------------------	-----

## Seats

Sitting in the Correct Position.....	112
Head Restraints.....	112
Manual Seats.....	114
Power Seats.....	115
Rear Seats.....	117
Heated Seats.....	117
Rear Seat Armrest.....	118

## Universal Garage Door Opener

Universal Garage Door Opener.....	119
-----------------------------------	-----

## Auxiliary Power Points

Auxiliary Power Points.....	124
-----------------------------	-----

## Storage Compartments

Center Console.....	126
Overhead Console.....	126

## Starting and Stopping the Engine

General Information.....	127
Ignition Switch.....	127
Keyless Starting.....	127
Starting a Gasoline Engine.....	128
Engine Block Heater.....	130

## Unique Driving Characteristics

Hybrid Electric Vehicle.....	132
------------------------------	-----

## Fuel and Refueling

Safety Precautions.....	138
Fuel Quality.....	139
Running Out of Fuel.....	140
Refueling.....	141
Fuel Consumption.....	145

# Table of Contents

Emission Control System.....	146	Luggage Covers.....	178
<b>High Voltage Battery</b>		Load Limit.....	179
General Information.....	149	<b>Towing</b>	
Charging the High Voltage Battery.....	151	Towing a Trailer.....	186
High Voltage Battery Cut-Off Switch.....	156	Transporting the Vehicle.....	186
<b>Transmission</b>		Towing the Vehicle on Four Wheels.....	186
Automatic Transmission.....	157	<b>Driving Hints</b>	
<b>Brakes</b>		Breaking-In.....	188
General Information.....	160	Economical Driving.....	188
Hints on Driving With Anti-Lock Brakes.....	161	Driving Through Water.....	189
Parking Brake.....	161	Floor Mats.....	190
Hill Start Assist.....	161	<b>Roadside Emergencies</b>	
<b>Traction Control</b>		Roadside Assistance.....	191
Principle of Operation.....	163	Hazard Warning Flashers.....	192
Using Traction Control.....	163	Fuel Shutoff.....	192
<b>Stability Control</b>		Jump Starting the Vehicle.....	193
Principle of Operation.....	164	Collision, Damage or Fire Event.....	195
Using Stability Control.....	165	Post-Crash Alert System.....	197
<b>Parking Aids</b>		<b>Customer Assistance</b>	
Parking Aid.....	166	Getting the Services You Need.....	198
Active Park Assist.....	168	In California (U.S. Only).....	199
Rear View Camera.....	172	The Better Business Bureau (BBB) Auto Line Program (U.S. Only).....	200
<b>Cruise Control</b>		Utilizing the Mediation/Arbitration Program (Canada Only).....	200
Principle of Operation.....	175	Getting Assistance Outside the U.S. and Canada.....	201
Using Cruise Control.....	175	Ordering Additional Owner's Literature.....	202
<b>Driving Aids</b>		Reporting Safety Defects (U.S. Only).....	202
Steering.....	177	Reporting Safety Defects (Canada Only).....	203
<b>Load Carrying</b>		<b>Fuses</b>	
Rear Under Floor Storage.....	178	Fuse Specification Chart.....	204
		Changing a Fuse.....	212

# Table of Contents

## Maintenance

General Information.....	213
Opening and Closing the Hood.....	213
Under Hood Overview - Hybrid Electric Vehicle (HEV).....	214
Under Hood Overview - Plug-In Hybrid Electric Vehicle (PHEV).....	216
Engine Oil Dipstick.....	217
Engine Oil Check.....	217
Engine Coolant Check.....	218
Automatic Transmission Fluid Check.....	222
Brake Fluid Check.....	222
Power Steering Fluid Check.....	222
Washer Fluid Check.....	222
Fuel Filter.....	222
Changing the 12V Battery.....	223
Checking the Wiper Blades.....	224
Changing the Wiper Blades.....	224
Adjusting the Headlamps.....	226
Removing a Headlamp.....	227
Changing a Bulb.....	227
Bulb Specification Chart.....	231
Changing the Engine Air Filter.....	233

## Vehicle Care

General Information.....	236
Cleaning Products.....	236
Cleaning the Exterior.....	236
Waxing.....	237
Cleaning the Engine.....	237
Cleaning the Windows and Wiper Blades.....	238
Cleaning the Interior.....	238
Cleaning the Instrument Panel and Instrument Cluster Lens.....	239
Cleaning Leather Seats.....	239
Repairing Minor Paint Damage.....	240
Cleaning the Alloy Wheels.....	240
Vehicle Storage.....	240

## Wheels and Tires

Temporary Mobility Kit.....	243
Tire Care.....	255
Using Snow Chains.....	269
Tire Pressure Monitoring System.....	270
Technical Specifications.....	273

## Capacities and Specifications

Engine Specifications.....	275
Motorcraft Parts.....	276
Vehicle Identification Number.....	277
Vehicle Certification Label.....	277
Transmission Code Designation.....	278
Capacities and Specifications.....	279

## Audio System

General Information.....	282
Audio Unit - Vehicles With: AM/FM/CD/ SYNC.....	283
Audio Unit - Vehicles With: Premium AM/ FM/CD.....	285
Audio Unit - Vehicles With: Sony AM/FM/ CD.....	287
Digital Radio.....	290
Satellite Radio.....	292
Audio Input Jack.....	295
USB Port.....	295
Media Hub.....	296

## SYNC™

General Information.....	297
Using Voice Recognition.....	299
Using SYNC™ With Your Phone.....	301
SYNC™ Applications and Services.....	312
Using SYNC™ With Your Media Player.....	319
SYNC™ Troubleshooting.....	327

# Table of Contents

---

## **MyFord Touch™**

General Information.....	336
Settings.....	344
Entertainment.....	354
Phone.....	373
Electric Vehicle Information.....	378
Information.....	388
Climate.....	397
Navigation.....	401
MyFord Touch™ Troubleshooting.....	410

## **Accessories**

Accessories.....	416
------------------	-----

## **Extended Service Plan (ESP)**

Extended Service Plan (ESP).....	418
----------------------------------	-----

## **Scheduled Maintenance**

General Maintenance Information.....	420
Normal Scheduled Maintenance.....	424
Special Operating Conditions Scheduled Maintenance.....	426
Scheduled Maintenance Record.....	428

## **Appendices**

End User License Agreement.....	435
---------------------------------	-----





# Introduction

## ABOUT THIS MANUAL

Thank you for choosing Ford. We recommend that you take some time to get to know your vehicle by reading this manual. The more that you know about it, the greater the safety and pleasure you will get from driving it.

### WARNING



Driving while distracted can result in loss of vehicle control, crash and injury. We strongly recommend that you use extreme caution when using any device that may take your focus off the road. Your primary responsibility is the safe operation of your vehicle. We recommend against the use of any hand-held device while driving and encourage the use of voice-operated systems when possible. Make sure you are aware of all applicable local laws that may affect the use of electronic devices while driving.

**Note:** This manual describes product features and options available throughout the range of available models, sometimes even before they are generally available. It may describe options not fitted to the vehicle you have purchased.

**Note:** Some of the illustrations in this manual may show features as used in different models, so may appear different to you on your vehicle.

**Note:** Always use and operate your vehicle in line with all applicable laws and regulations.

**Note:** Pass on this manual when selling your vehicle. It is an integral part of your vehicle.

This manual may qualify the location of a component as left-hand side or right-hand side. The side is determined when facing forward in the seat.

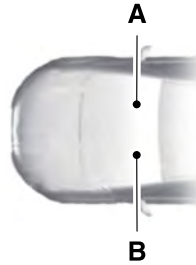

E154903

- A Right-hand side.
- B Left-hand side.

## SYMBOLS GLOSSARY

These are some of the symbols you may see on your vehicle.



Safety alert



See Owner's Manual



Air conditioning system



Anti-lock braking system



Avoid smoking, flames or sparks



Battery



Battery acid



Brake fluid - non petroleum based

# Introduction

---



Brake system



Cabin air filter



Check fuel cap



Child safety door lock or unlock



Child seat lower anchor



Child seat tether anchor



Cruise control



Do not open when hot



Engine air filter



Engine coolant



Engine coolant temperature



Engine oil



Explosive gas



Fan warning



Fasten safety belt



Front airbag



Front fog lamps



Fuel pump reset



Fuse compartment



Hazard warning flashers



Heated rear window



Heated windshield



Interior luggage compartment release



Jack



Keep out of reach of children



Lighting control



Low tire pressure warning



Maintain correct fluid level



Note operating instructions

# Introduction



Panic alarm



Parking aid



Parking brake



Power steering fluid



Power windows front/rear



Power window lockout



Service engine soon



Side airbag



Shield the eyes



Stability control



Windshield wash and wipe

## DATA RECORDING

### Service Data Recording

Service data recorders in your vehicle are capable of collecting and storing diagnostic information about your vehicle. This potentially includes information about the performance or status of various systems and modules in the vehicle, such as engine, throttle, steering or brake

systems. In order to properly diagnose and service your vehicle, Ford Motor Company, Ford of Canada, and service and repair facilities may access or share among them vehicle diagnostic information received through a direct connection to your vehicle when diagnosing or servicing your vehicle. Additionally, when your vehicle is in for service or repair, Ford Motor Company, Ford of Canada, and service and repair facilities may access or share among them data for vehicle improvement purposes. For U.S. only (if equipped), if you choose to use the SYNC Vehicle Health Report, you consent that certain diagnostic information may also be accessed electronically by Ford Motor Company and Ford authorized service facilities, and that the diagnostic information may be used for any purpose. See **SYNC™** (page 297).

### Event Data Recording

**This vehicle is equipped with an event data recorder. The main purpose of an event data recorder is to record, in certain crash or near crash-like situations, such as an airbag deployment or hitting a road obstacle; this data will assist in understanding how a vehicle's systems performed. The event data recorder is designed to record data related to vehicle dynamics and safety systems for a short period of time, typically 30 seconds or less.**

**The event data recorder in this vehicle is designed to record such data as:**

- **How various systems in your vehicle were operating;**
- **Whether or not the driver and passenger safety belts were buckled/fastened;**
- **How far (if at all) the driver was depressing the accelerator and/or the brake pedal; and**

# Introduction

---

- **How fast the vehicle was traveling; and**
- **Where the driver was positioning the steering wheel.**

**This data can help provide a better understanding of the circumstances in which crashes and injuries occur.**

**Note:** *Event data recorder data is recorded by your vehicle only if a non-trivial crash situation occurs; no data is recorded by the event data recorder under normal driving conditions and no personal data or information (e.g., name, gender, age, and crash location) is recorded (see limitations regarding 911 Assist and Traffic, directions and Information privacy below). However, parties, such as law enforcement, could combine the event data recorder data with the type of personally identifying data routinely acquired during a crash investigation.*

**To read data recorded by an event data recorder, special equipment is required, and access to the vehicle or the event data recorder is needed. In addition to the vehicle manufacturer, other parties, such as law enforcement, that have such special equipment, can read the information if they have access to the vehicle or the event data recorder. Ford Motor Company and Ford of Canada do not access event data recorder information without obtaining consent, unless pursuant to court order or where required by law enforcement, other government authorities or other third parties acting with lawful authority. Other parties may seek to access the information independently of Ford Motor Company and Ford of Canada.**

**Note:** *Including to the extent that any law pertaining to Event Data Recorders applies to SYNC or its features, please note the following: Once 911 Assist (if equipped) is enabled (set ON), 911 Assist may, through any paired and connected cell phone, disclose to emergency services that the vehicle has been in a crash involving the deployment of an airbag or, in certain vehicles, the activation of the fuel pump shut-off. Certain versions or updates to 911 Assist may also be capable of being used to electronically or verbally provide to 911 operators the vehicle location (such as latitude and longitude), and/or other details about the vehicle or crash or personal information about the occupants to assist 911 operators to provide the most appropriate emergency services. If you do not want to disclose this information, do not activate the 911 Assist feature. See SYNC™ (page 297).*

**Additionally, when you connect to Traffic, Directions and Information (if equipped, U.S. only), the service uses GPS technology and advanced vehicle sensors to collect the vehicle's current location, travel direction, and speed ("vehicle travel information"), only to help provide you with the directions, traffic reports, or business searches that you request. If you do not want Ford or its vendors to receive this information, do not activate the service. For more information, see Traffic, Directions and Information, Terms and Conditions. See SYNC™ (page 297).**

# Introduction

## CALIFORNIA PROPOSITION 65

### WARNING



Some constituents of engine exhaust, certain vehicle components, certain fluids contained in vehicles and certain products of component wear contain or emit chemicals known to the State of California to cause cancer and birth defects or other reproductive harm.

## PERCHLORATE

Certain components in your vehicle such as airbag modules, safety belt pretensioners and remote control batteries may contain perchlorate material. Special handling may apply for service or vehicle end of life disposal.

### For more information visit:

Web Address
<a href="http://www.dtsc.ca.gov/hazardouswaste/perchlorate">www.dtsc.ca.gov/hazardouswaste/perchlorate</a>

## FORD CREDIT

### (U.S. Only)

Ford Credit offers a full range of financing and lease plans to help you acquire your vehicle. If you have financed or leased your vehicle through Ford Credit, thank you for your business.

For your convenience we offer a number of ways to contact us, as well as to help manage your account.

Phone: 1-800-727-7000

For more information regarding Ford Credit, as well as to access Account Manager, please go to [www.fordcredit.com](http://www.fordcredit.com).

## REPLACEMENT PARTS RECOMMENDATION

Your vehicle has been built to the highest standards using quality parts. We recommend that you demand the use of genuine Ford and Motorcraft parts whenever your vehicle requires scheduled maintenance or repair. You can clearly identify genuine Ford and Motorcraft parts by looking for the Ford, FoMoCo or Motorcraft branding on the parts or their packaging.

### Scheduled Maintenance and Mechanical Repairs

One of the best ways for you to make sure that your vehicle provides years of service is to have it maintained in line with our recommendations using parts that conform to the specifications detailed in this Owner's Manual. Genuine Ford and Motorcraft parts meet or exceed these specifications.

### Collision Repairs

We hope that you never experience a collision, but accidents do happen. Genuine Ford replacement collision parts meet our stringent requirements for fit, finish, structural integrity, corrosion protection and dent resistance. During vehicle development we validate these parts deliver the intended level of protection as a whole system. A great way to know for sure you are getting this level of protection is to use genuine Ford replacement collision parts.

# Introduction

---

## Warranty on Replacement Parts

Genuine Ford and Motorcraft replacement parts are the only replacement parts that benefit from a Ford Warranty. Damage caused to your vehicle as a result of the failure of non-Ford parts may not be covered by the Ford Warranty. For additional information, refer to the terms and conditions of the Ford Warranty.

## SPECIAL NOTICES

### New Vehicle Limited Warranty

For a detailed description of what is covered and what is not covered by your vehicle's New Vehicle Limited Warranty, refer to the Warranty Manual that is provided to you along with your Owner's Manual.

### Special Instructions

For your added safety, your vehicle is fitted with sophisticated electronic controls.

#### WARNINGS



You risk death or serious injury to yourself and others if you do not follow the instruction highlighted by the warning symbol. Failure to follow the specific warnings and instructions could result in personal injury.



Front seat mounted rear-facing child or infant seats should **NEVER** be placed in front of an active passenger airbag.

### On-board Diagnostics (OBD-II)

Your vehicle's On-board Diagnostics (OBD-II) system has a data port for diagnostics, repair and reprogramming services with diagnostic scan tools. Installing a non-Ford-approved aftermarket OBD plug-in device that uses the port during normal driving, for example

remote insurance company monitoring, remote vehicle diagnostics, telematics or engine reprogramming, may cause interference or damage to vehicle systems. We do not recommend or endorse the use of any non-Ford-approved aftermarket OBD plug-in devices. The vehicle Warranty may not cover damage caused by any non-Ford-approved aftermarket OBD plug-in device.

### Notice to Owners of Pickup Trucks and Utility Type Vehicles

#### WARNING



Utility vehicles have a significantly higher rollover rate than other types of vehicles.

Before you drive your vehicle, please read this Owner's Guide carefully. Your vehicle is not a passenger car. As with other vehicles of this type, failure to operate this vehicle correctly may result in loss of vehicle control, vehicle rollover, personal injury or death.

### Using Your Vehicle With a Snowplow

#### Do not use this vehicle for snowplowing.

Your vehicle is not equipped with a snowplowing package.

### Using Your Vehicle as an Ambulance

#### Do not use this vehicle as an ambulance.

Your vehicle is not equipped with the Ford Ambulance Preparation Package.

# Introduction

---

## MOBILE COMMUNICATIONS EQUIPMENT

Using mobile communications equipment is becoming increasingly important in the conduct of business and personal affairs. However, you must not compromise your own or others' safety when using such equipment. Mobile communications can enhance personal safety and security when appropriately used, particularly in emergency situations. Safety must be paramount when using mobile communications equipment to avoid negating these benefits. Mobile communication equipment includes, but is not limited to, cellular phones, pagers, portable email devices, text messaging devices and portable two-way radios.

### WARNING



Driving while distracted can result in loss of vehicle control, crash and injury. We strongly recommend that you use extreme caution when using any device that may take your focus off the road. Your primary responsibility is the safe operation of your vehicle. We recommend against the use of any hand-held device while driving and encourage the use of voice-operated systems when possible. Make sure you are aware of all applicable local laws that may affect the use of electronic devices while driving.

## EXPORT UNIQUE OPTIONS

For your particular global region, your vehicle may be equipped with features and options that are different from the features and options that are described in this Owner's Manual. A market unique supplement may be supplied that complements this book. By referring to the market unique supplement, if provided, you can properly identify those features, recommendations and specifications that

are unique to your vehicle. This Owner's Manual is written primarily for the U.S. and Canadian Markets. Features or equipment listed as standard may be different on units built for Export. **Refer to this Owner's Manual for all other required information and warnings.**



# Environment

---

## **PROTECTING THE ENVIRONMENT**

You must play your part in protecting the environment. Correct vehicle usage and the authorized disposal of waste, cleaning and lubrication materials are significant steps toward this aim.

# Child Safety

---

## GENERAL INFORMATION

See the following sections for directions on how to properly use safety restraints for children.

### WARNINGS



Always make sure your child is secured properly in a device that is appropriate for their height, age and weight. Child safety restraints must be bought separately from your vehicle. Failure to follow these instructions and guidelines may result in an increased risk of serious injury or death to your child.



All children are shaped differently. The recommendations for safety restraints are based on probable child height, age and weight thresholds from National Highway Traffic Safety Administration and other safety organizations, or are the minimum requirements of law. Ford recommends checking with a NHTSA Certified Child Passenger Safety Technician (CPST) and consult your pediatrician to make sure your child seat is appropriate for your child, and

### WARNINGS

is compatible with and properly installed in your vehicle. To locate a child seat fitting station and CPST, contact the NHTSA toll free at 1-888-327-4236 or go to <http://www.nhtsa.dot.gov>. In Canada, check with your local St. John Ambulance office for referral to a CPST or for further information, contact your provincial ministry of transportation, locate your local St. John Ambulance office by searching for St. John Ambulance on the internet, or Transport Canada at 1-800-333-0371 (<http://www.tc.gc.ca>). Failure to properly restrain children in safety seats made especially for their height, age, and weight may result in an increased risk of serious injury or death to your child.



Do not leave children or animals unattended in the vehicle. On hot days, the temperature in the trunk or vehicle interior can rise very quickly. Exposure of people or animals to these high temperatures for even a short time can cause death or serious heat-related injuries, including brain damage. Small children are particularly at risk.

---

# Child Safety

## Recommendations for Safety Restraints for Children

Child	Child size, height, weight, or age	Recommended restraint type
Infants or toddlers	Children weighing 40 lb (18 kg) or less (generally age four or younger).	Use a child safety seat (sometimes called an infant carrier, convertible seat, or toddler seat).
Small children	Children who have outgrown or no longer properly fit in a child safety seat (generally children who are less than 4 ft. 9 in. (1.45 m) tall, are greater than age four and less than age 12, and between 40 lb (18 kg) and 80 lb (36 kg) and upward to 100 lb (45 kg) if recommended by your child restraint manufacturer).	Use a belt-positioning booster seat.
Larger children	Children who have outgrown or no longer properly fit in a belt-positioning booster seat (generally children who are at least 4 ft. 9 in. (1.45 m) tall or greater than 80 lb (36 kg) or 100 lb (45 kg) if recommended by child restraint manufacturer).	Use a vehicle safety belt having the lap belt snug and low across the hips, shoulder belt centered across the shoulder and chest, and seat back upright.

- You are required by law to properly use safety seats for infants and toddlers in the United States and Canada.
- Many states and provinces require that small children use approved booster seats until they reach age eight, a height of 4 feet 9 inches (1.45 meters) tall, or 80 pounds (36 kilograms). Check your local and state or provincial laws for specific requirements about the safety of children in your vehicle.
- When possible, always properly restrain children 12 years of age and under in a rear seating position of your vehicle. Accident statistics suggest that children are safer when properly restrained in the rear seating positions than in a front seating position. See **Front Passenger Sensing System** (page 37).

## INSTALLING CHILD SEATS

### Child Seats



E142594

# Child Safety

Use a child safety seat (sometimes called an infant carrier, convertible seat, or toddler seat) for infants, toddlers, or children weighing 40 pounds (18 kilograms) or less (generally age four or younger).

## Using Lap and Shoulder Belts

### WARNINGS



Airbags can kill or injure a child in a child seat. Never place a rear-facing child seat in front of an active airbag. If you must use a forward-facing child seat in the front seat, move the seat all the way back.



Airbags can kill or injure a child in a child seat. Children 12 and under should be properly restrained in the rear seat whenever possible.



Depending on where you secure a child restraint, and depending on the child restraint design, you may block access to certain safety belt buckle assemblies and LATCH lower anchors, rendering those features potentially unusable. To avoid risk of injury, occupants should only use seating positions where they are able to be properly restrained.

When installing a child safety seat with combination lap and shoulder belts:

- Use the correct safety belt buckle for that seating position.
- Insert the belt tongue into the proper buckle until you hear a snap and feel it latch. Make sure the tongue is securely fastened in the buckle.
- Keep the buckle release button pointing up and away from the safety seat, with the tongue between the child seat and the release button, to prevent accidental unbuckling.

- Place the vehicle seat upon which the child seat will be installed in the upright position.
- Put the safety belt in the automatic locking mode. See Step 5. This vehicle does not require the use of a locking clip.

Perform the following steps when installing the child seat with combination lap and shoulder belts:

**Note:** *Although the child seat illustrated is a forward facing child seat, the steps are the same for installing a rear facing child seat.*



E142528

1. Position the child safety seat in a seat with a combination lap and shoulder belt.



E142529

2. Pull down on the shoulder belt and then grasp the shoulder belt and lap belt together.

# Child Safety



E142530

3. While holding the shoulder and lap belt portions together, route the tongue through the child seat according to the child seat manufacturer's instructions. Be sure the belt webbing is not twisted.



E142875

5. To put the retractor in the automatic locking mode, grasp the shoulder portion of the belt and pull downward until all of the belt is pulled out.

**Note:** *The automatic locking mode is available on the front passenger and rear seats.*

6. Allow the belt to retract to remove slack. The belt will click as it retracts to indicate it is in the automatic locking mode.
7. Try to pull the belt out of the retractor to make sure the retractor is in the automatic locking mode (you should not be able to pull more belt out). If the retractor is not locked, unbuckle the belt and repeat Steps 5 and 6.

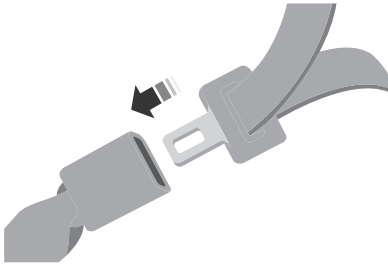

E142531

4. Insert the belt tongue into the proper buckle (the buckle closest to the direction the tongue is coming from) for that seating position until you hear a snap and feel the latch engage. Make sure the tongue is latched securely by pulling on it.



E142533

# Child Safety

- Remove remaining slack from the belt. Force the seat down with extra weight, for example, by pressing down or kneeling on the child restraint while pulling up on the shoulder belt in order to force slack from the belt. This is necessary to remove the remaining slack that will exist once the extra weight of the child is added to the child restraint. It also helps to achieve the proper snugness of the child seat to your vehicle. Sometimes, a slight lean toward the buckle will additionally help to remove remaining slack from the belt.
- Attach the tether strap (if the child seat is equipped).

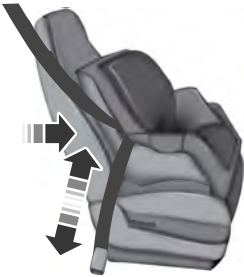



E142534

- Before placing the child in the seat, forcibly move the seat forward and back to make sure the seat is securely held in place. To check this, grab the seat at the belt path and attempt to move it side to side and forward and back. There should be no more than 1 inch (2.5 centimeters) of movement for proper installation.

Ford recommends checking with a NHTSA Certified Child Passenger Safety Technician to make certain the child restraint is properly installed. In Canada, check with your local St. John Ambulance office for referral to a Certified Passenger Seat Technician.

## Using Lower Anchors and Tethers for Children (LATCH)

### WARNINGS

-  Never attach two child safety seats to the same anchor. In a crash, one anchor may not be strong enough to hold two child safety seat attachments and may break, causing serious injury or death.
-  Depending on where you secure a child restraint, and depending on the child restraint design, you may block access to certain safety belt buckle assemblies or LATCH lower anchors, rendering those features potentially unusable. To avoid risk of injury, occupants should only use seating positions where they are able to be properly restrained.

The LATCH system is composed of three vehicle anchor points: two lower anchors located where seat back and seat cushion meet (called the seat bight) and one top tether anchor located behind that seating position.

LATCH compatible child safety seats have two rigid or webbing mounted attachments that connect to the two lower anchors at the LATCH equipped seating positions in your vehicle. This type of attachment method eliminates the need to use safety belts to attach the child seat, however the safety belt can still be used to attach the child seat. For forward-facing child seats, the top tether strap must also be attached to the proper top tether anchor, if a top tether strap has been provided with your child seat.

# Child Safety

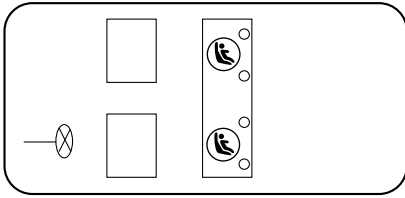

E142535

Your vehicle has LATCH lower anchors for child seat installation at the seating positions marked with the child seat symbol.



E144054

The LATCH anchors are located at the rear section of the rear seat between the cushion and seat back below the symbols as shown. Follow the child seat manufacturer's instructions to properly install a child seat with LATCH attachments. Follow the instructions on attaching child safety seats with tether straps.

Attach LATCH lower attachments of the child seat only to the anchors shown.

## Use of Inboard Lower Anchors from the Outboard Seating Positions (Center Seating Use)

### WARNING

 The standardized spacing for LATCH lower anchors is 11 inches (28 centimeters) center to center. Do not use LATCH lower anchors for the center seating position unless the child seat manufacturer's instructions permit and specify using anchors spaced at least as far apart as those in this vehicle.

The lower anchors at the center of the second row rear seat are spaced 18 inches (46 centimeters) apart. A child seat with rigid LATCH attachments cannot be installed at the center seating position. LATCH compatible child seats (with attachments on belt webbing) can only be used at this seating position provided that the child seat manufacturer's instructions permit use with the anchor spacing stated. Do not attach a child seat to any lower anchor if an adjacent child seat is attached to that anchor.

Each time you use the safety seat, check that the seat is properly attached to the lower anchors and tether anchor, if applicable. Tug the child seat from side to side and forward and back where it is secured to your vehicle. The seat should move less than one inch when you do this for a proper installation.

If the safety seat is not anchored properly, the risk of a child being injured in a crash greatly increases.

# Child Safety

## Combining Safety Belt and LATCH Lower Anchors for Attaching Child Safety Seats

When used in combination, either the safety belt or the LATCH lower anchors may be attached first, provided a proper installation is achieved. Attach the tether strap afterward, if included with the child seat.

## Using Tether Straps



Many forward-facing child safety seats include a tether strap which extends from the back of the child safety seat and hooks to an anchoring point called the top tether anchor. Tether straps are available as an accessory for many older safety seats.

Contact the manufacturer of your child seat for information about ordering a tether strap, or to obtain a longer tether strap if the tether strap on your safety seat does not reach the appropriate top tether anchor in your vehicle.

Once the child safety seat has been installed using either the safety belt, the lower anchors of the LATCH system, or both, you can attach the top tether strap.

The tether strap anchors in your vehicle are in the following positions (shown from top view):

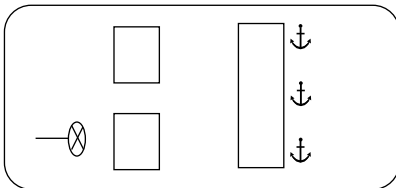

E142537

Perform the following steps to install a child safety seat with tether anchors:

**Note:** *If you install a child seat with rigid LATCH attachments, do not tighten the tether strap enough to lift the child seat off your vehicle seat cushion when the child is seated in it. Keep the tether strap just snug without lifting the front of the child seat. Keeping the child seat just touching your vehicle seat gives the best protection in a severe crash.*

1. Route the child safety seat tether strap over the back of the seat. For outboard seating positions, route the tether strap under the head restraint and between the head restraint posts. For the center seating positions, route the tether strap over the top of the head restraint. If needed, the head restraints can also be removed.

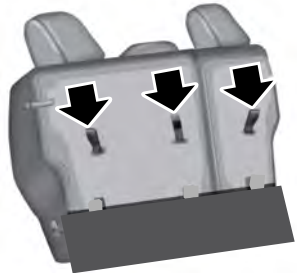

E161562

2. Locate the correct anchor on the back panel of the rear seat for the selected seating position. The anchors are labeled with the tether strap symbol and are partially covered by the gap panel. Pull the panel back to fully expose the anchors.



# Child Safety



E161563

3. Clip the tether strap to the anchor as shown.
4. Tighten the child safety seat tether strap according to the manufacturer's instructions. If your child restraint system is equipped with a tether strap, and the child restraint manufacturer recommends its use, Ford also recommends its use.

## BOOSTER SEATS

### WARNING



Never place, or allow a child to place, the shoulder belt under a child's arm or behind the back because it reduces the protection for the upper part of the body and may increase the risk of injury or death in a crash.

Use a belt-positioning booster seat for children who have outgrown or no longer properly fit in a child safety seat (generally children who are less than 4 feet 9 inches (1.45 meters) tall, are greater than age four (4) and less than age twelve (12), and between 40 pounds (18 kilograms) and 80 pounds (36 kilograms) and upward to 100 pounds (45 kilograms) if

recommended by your child restraint manufacturer). Many state and provincial laws require that children use approved booster seats until they reach age eight, a height of 4 feet 9 inches (1.45 meters) tall, or 80 pounds (36 kilograms).

Booster seats should be used until you can answer YES to ALL of these questions when seated without a booster seat:

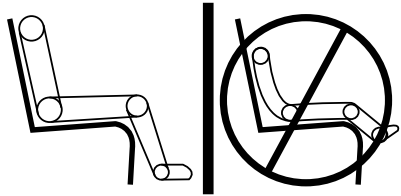

E142595

- Can the child sit all the way back against their vehicle seat back with knees bent comfortably at the edge of the seat cushion?
- Can the child sit without slouching?
- Does the lap belt rest low across the hips?
- Is the shoulder belt centered on the shoulder and chest?
- Can the child stay seated like this for the whole trip?

Always use booster seats in conjunction with your vehicle lap and shoulder belt.

# Child Safety

## Types of Booster Seats



E68924

- Backless booster seats

If your backless booster seat has a removable shield, remove the shield. If a vehicle seating position has a low seat back or no head restraint, a backless booster seat may place your child's head (as measured at the tops of the ears) above the top of the seat. In this case, move the backless booster to another seating position with a higher seat back or head restraint and lap and shoulder belts, or consider using a high back booster seat.



E70710

- High back booster seats

If, with a backless booster seat, you cannot find a seating position that adequately supports your child's head, a high back booster seat would be a better choice.

Children and booster seats vary in size and shape. Choose a booster that keeps the lap belt low and snug across the hips, never up across the stomach, and lets you adjust the shoulder belt to cross the chest and rest snugly near the center of the shoulder. The following drawings compare the ideal fit (center) to a shoulder belt uncomfortably close to the neck and a shoulder belt that could slip off the shoulder. The drawings also show how the lap belt should be low and snug across the child's hips.



E142596

# Child Safety



E142597

If the booster seat slides on the vehicle seat upon which it is being used, placing a rubberized mesh sold as shelf or carpet liner under the booster seat may improve this condition. Do not introduce any item thicker than this under the booster seat. Check with the booster seat manufacturer's instructions.

## CHILD SEAT POSITIONING

### WARNINGS



Airbags can kill or injure a child in a child seat. Never place a rear-facing child seat in front of an active airbag.

If you must use a forward-facing child seat in the front seat, move the vehicle seat upon which the child seat is installed all the way back. When possible, all children age 12 and under should be properly restrained in a rear seating position. If all children cannot be seated and restrained properly in a rear seating position, properly restrain the largest child in the front seat.



Always carefully follow the instructions and warnings provided by the manufacturer of any child restraint to determine if the restraint device is appropriate for your child's size, height, weight, or age. Follow the child restraint manufacturer's instructions and warnings provided for installation and use in conjunction with the instructions and

### WARNINGS

warnings provided by your vehicle manufacturer. A safety seat that is improperly installed or utilized, is inappropriate for your child's height, age, or weight or does not properly fit the child may increase the risk of serious injury or death.



Never let a passenger hold a child on his or her lap while your vehicle is moving. The passenger cannot protect the child from injury in a crash, which may result in serious injury or death.



Never use pillows, books, or towels to boost a child. They can slide around and increase the likelihood of injury or death in a crash.



Always restrain an unoccupied child seat or booster seat. These objects may become projectiles in a crash or sudden stop, which may increase the risk of serious injury.



Never place, or allow a child to place, the shoulder belt under a child's arm or behind the back because it reduces the protection for the upper part of the body and may increase the risk of injury or death in a crash.



To avoid risk of injury, do not leave children or pets unattended in your vehicle.

# Child Safety

## Recommendations for attaching child safety restraints for children

Restraint Type	Combined weight of child and child seat	Use any attachment method as indicated below by X				
		LATCH (lower anchors and top tether anchor)	LATCH (lower anchors only)	Safety belt and top tether anchor	Safety belt and LATCH (lower anchors and top tether anchor)	Safety belt only
Rear facing child seat	Up to 65 lb (29.5 kg)		X			X
Rear facing child seat	Over 65 lb (29.5 kg)					X
Forward facing child seat	Up to 65 lb (29.5 kg)	X		X	X	
Forward facing child seat	Over 65 lb (29.5 kg)			X	X	

**Note:** The child seat must rest tightly against the vehicle seat upon which it is installed. It may be necessary to lift or remove the head restraint. See **Seats** (page 112).

## CHILD SAFETY LOCKS

When these locks are set, the rear doors cannot be opened from the inside.



E112197

The childproof locks are located on the rear edge of each rear door and must be set separately for each door.

# Child Safety

---

## **Left-Hand Side**

Turn counterclockwise to lock and clockwise to unlock.

## **Right-Hand Side**

Turn clockwise to lock and counterclockwise to unlock.

# Safety Belts

## PRINCIPLE OF OPERATION

### WARNINGS



Always drive and ride with your seatback upright and the lap belt snug and low across the hips.



To reduce the risk of injury, make sure children sit where they can be properly restrained.



Never let a passenger hold a child on his or her lap while your vehicle is moving. The passenger cannot protect the child from injury in a crash.



All occupants of your vehicle, including the driver, should always properly wear their safety belts, even when an airbag supplemental restraint system is provided.



It is extremely dangerous to ride in a cargo area, inside or outside of a vehicle. In a crash, people riding in these areas are more likely to be seriously injured or killed. Do not allow people to ride in any area of your vehicle that is not equipped with seats and safety belts. Be sure everyone in your vehicle is in a seat and using a safety belt properly.



In a rollover crash, an unbelted person is significantly more likely to die than a person wearing a safety belt.



Each seating position in your vehicle has a specific safety belt assembly which is made up of one buckle and one tongue that are designed to be used as a pair. 1) Use the shoulder belt on the outside shoulder only. Never wear the shoulder belt under the arm. 2) Never swing the safety belt around your neck over the inside shoulder. 3) Never use a single belt for more than one person.



When possible, all children 12 years old and under should be properly restrained in a rear seating position.

### WARNINGS



Safety belts and seats can become hot in a vehicle that has been closed up in sunny weather; they could burn a small child. Check seat covers and buckles before you place a child anywhere near them.



Front and rear seat occupants, including pregnant women, should wear safety belts for optimum protection in an accident.

All seating positions in this vehicle have lap and shoulder safety belts. All occupants of the vehicle should always properly wear their safety belts, even when an airbag supplemental restraint system is provided.

The safety belt system consists of:

- lap and shoulder safety belts
- shoulder safety belt with automatic locking mode, (except driver safety belt)
- height adjuster at the front outboard seating positions
- retractor and anchor pretensioner at the front outboard seating positions
- belt tension sensor at the front outboard passenger seating position



- safety belt warning light and chime



- crash sensors and monitoring system with readiness indicator.

# Safety Belts

The safety belt pretensioners are designed to activate in frontal, near-frontal and side crashes, and in rollovers. The safety belt pretensioners on the retractor and anchor at the front seating positions are designed to tighten the safety belts firmly against the occupant's body when activated. This helps increase the effectiveness of the safety belts. In frontal crashes, the safety belt pretensioners can be activated alone or, if the crash is of sufficient severity, together with the front airbags.

## FASTENING THE SAFETY BELTS

The front outboard and rear safety restraints in the vehicle are combination lap and shoulder belts.



1. Insert the belt tongue into the proper buckle (the buckle closest to the direction the tongue is coming from) until you hear a snap and feel it latch. Make sure the tongue is securely fastened in the buckle.

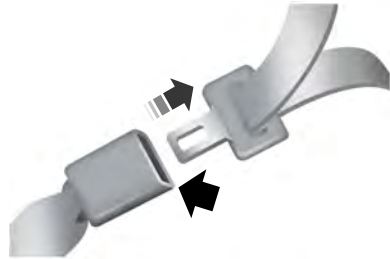

2. To unfasten, press the release button and remove the tongue from the buckle.



When in use, the rear safety belts should be placed in the belt guides on the outboard seatbacks.

## Using Safety Belts During Pregnancy

### WARNING



Always ride and drive with your seatback upright and the safety belt properly fastened. The lap portion of the safety belt should fit snug and be positioned low across the hips. The shoulder portion of the safety belt should be positioned across the chest. Pregnant women should also follow this practice. See the following figure.

# Safety Belts

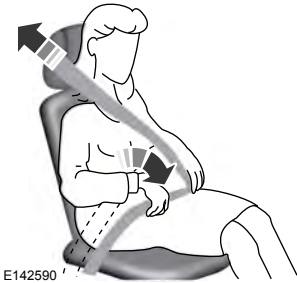

Pregnant women should always wear their safety belt. The lap belt portion of a combination lap and shoulder belt should be positioned low across the hips below the belly and worn as tight as comfort will allow. The shoulder belt should be positioned to cross the middle of the shoulder and the center of the chest.

## Safety Belt Locking Modes

### WARNINGS



After any vehicle crash, the safety belt system at all passenger seating positions must be checked by an authorized dealer to verify that the automatic locking retractor feature for child seats is still functioning properly. In addition, all safety belts should be checked for proper function.



Belt and retractor assembly must be replaced if the safety belt assembly automatic locking retractor feature or any other safety belt function is not operating properly when checked by an authorized dealer. Failure to replace the belt and retractor assembly could increase the risk of injury in crashes.

All safety restraints in the vehicle are combination lap and shoulder belts. The driver safety belt has the first type of locking mode, and the front outboard passenger and rear seat safety belts have both types of locking modes described as follows:

### Vehicle Sensitive Mode

This is the normal retractor mode, which allows free shoulder belt length adjustment to your movements and locking in response to vehicle movement. For example, if the driver brakes suddenly or turns a corner sharply, or the vehicle receives an impact of about 5 mph (8 km/h) or more, the combination safety belts will lock to help reduce forward movement of the driver and passengers.

In addition, the retractor is designed to lock if the webbing is pulled out too quickly. If this occurs, let the belt retract slightly and pull webbing out again in a slow and controlled manner.

### Automatic Locking Mode

In this mode, the shoulder belt is automatically pre-locked. The belt will still retract to remove any slack in the shoulder belt. The automatic locking mode is not available on the driver safety belt.

### When to Use the Automatic Locking Mode

This mode should be used any time a child safety seat, except a booster, is installed in passenger front or rear seating positions. Children 12 years old and under should be properly restrained in a rear seating position whenever possible. See **Child Safety** (page 15).



# Safety Belts

## How to Use the Automatic Locking Mode



E142591

1. Buckle the combination lap and shoulder belt.
2. Grasp the shoulder portion and pull downward until the entire belt is pulled out.

Allow the belt to retract. As the belt retracts, you will hear a clicking sound. This indicates the safety belt is now in the automatic locking mode.

## How to Disengage the Automatic Locking Mode

Unbuckle the combination lap and shoulder belt and allow it to retract completely to disengage the automatic locking mode and activate the vehicle sensitive (emergency) locking mode.

## Safety Belt Extension Assembly

### WARNING



Do not use extensions to change the fit of the shoulder belt across the torso.

If the safety belt is too short when fully extended, a safety belt extension assembly can be obtained from an authorized dealer.

Use only extensions manufactured by the same supplier as the safety belt. Manufacturer identification is on a label located either at the end of the webbing or on the retractor behind the trim. Also, use the safety belt extension only if the safety belt is too short for you when fully extended.

## SAFETY BELT HEIGHT ADJUSTMENT

### WARNING



Position the safety belt height adjusters so that the belt rests across the middle of your shoulder. Failure to adjust the safety belt correctly could reduce the effectiveness of the safety belt and increase the risk of injury in a crash.



E87511

To adjust the shoulder belt height, squeeze the button and slide the height adjuster up or down. Release the button and pull down on the height adjuster to make sure it is locked in place.

# Safety Belts

## SAFETY BELT WARNING LAMP AND INDICATOR CHIME



This lamp illuminates and an audible warning will sound if the driver's safety belt has not been fastened when the vehicle's ignition is turned on.

### Conditions of operation

If...	Then...
The driver's safety belt is not buckled before the ignition switch is turned to the on position...	The safety belt warning light illuminates 1-2 minutes and the warning chime sounds 4-8 seconds.
The driver's safety belt is buckled while the indicator light is illuminated and the warning chime is sounding...	The safety belt warning light and warning chime turn off.
The driver's safety belt is buckled before the ignition switch is turned to the on position...	The safety belt warning light and indicator chime remain off.

## SAFETY BELT MINDER

### Belt-Minder™

This feature supplements the safety belt warning function by providing additional reminders that intermittently sound a tone and illuminate the safety belt warning light when you are in the driver seat or you have a front seat passenger and a safety belt is unbuckled.

The system uses information from the front passenger sensing system to determine if a front seat passenger is present and therefore potentially in need of a warning. To avoid activating the Belt-Minder feature for objects you place in the front passenger seat, only the front seat passengers receive warnings as determined by the front passenger sensing system.

If the Belt-Minder warnings expire (warnings for about five minutes) for one passenger (driver or front passenger), the other passenger can still cause the Belt-Minder feature to turn on.

# Safety Belts

If...	Then...
You and the front seat passenger buckle your safety belts before you switch the ignition on or less than 1-2 minutes elapse after you switch the ignition on...	The Belt-Minder feature will not activate.
You or the front seat passenger do not buckle your safety belts before your vehicle reaches at least 6 mph (9.7 km/h) and 1-2 minutes elapse after you switch the ignition on...	The Belt-Minder feature activates, the safety belt warning light illuminates and a warning tone sounds for 6 seconds every 25 seconds, repeating for about 5 minutes or until you and the front seat passenger buckle your safety belts.
The safety belt for the driver or front passenger is unbuckled for about 1 minute while the vehicle is traveling at least 6 mph (9.7 km/h) and more than 1-2 minutes elapse after you switch the ignition on...	The Belt-Minder feature activates, the safety belt warning light illuminates and a warning tone sounds for 6 seconds every 25 seconds, repeating for about 5 minutes or until you and the front seat passenger buckle your safety belts.

## Deactivating and Activating the Belt-Minder Feature

### WARNING



While the system allows you to deactivate it, this system is designed to improve your chances of being safely belted and surviving an accident. We recommend you leave the system activated for yourself and others who may use the vehicle.

**Note:** *The driver and front passenger warnings switch on and off independently. When you perform this procedure for one seating position, do not buckle the other position as this will terminate the process.*

Read Steps 1 - 4 thoroughly before proceeding with the programming procedure.

Before following the procedure, make sure that:

- The parking brake is set.
  - The transmission is in park (P).
  - The ignition is off.
  - The driver and front passenger safety belts are unbuckled.
1. Switch the ignition on. Do not start the vehicle.
  2. Wait until the safety belt warning light turns off (about one minute). After Step 2, wait an additional five seconds before proceeding with Step 3. Once you start Step 3, you must complete the procedure within 60 seconds.
  3. For the seating position being disabled, buckle then unbuckle the safety belt three times at a moderate speed, ending in the unbuckled state. After Step 3, the safety belt warning light turns on.

# Safety Belts

---

4. While the safety belt warning light is on, buckle and then unbuckle the safety belt. After Step 4, the safety belt warning light flashes for confirmation.
  - This will switch the feature off for that seating position if it is currently on.
  - This will switch the feature on for that seating position if it is currently off.

## CHILD RESTRAINT AND SAFETY BELT MAINTENANCE

Inspect the vehicle safety belts and child safety seat systems periodically to make sure they work properly and are not damaged. Inspect the vehicle and child seat safety belts to make sure there are no nicks, tears or cuts. Replace if necessary. All vehicle safety belt assemblies, including retractors, buckles, front safety belt buckle assemblies, buckle support assemblies (slide bar-if equipped), shoulder belt height adjusters (if equipped), shoulder belt guide on seat back (if equipped), child safety seat LATCH and tether anchors, and attaching hardware, should be inspected after a crash. Read the child restraint manufacturer's instructions for additional inspection and maintenance information specific to the child restraint.

Ford Motor Company recommends that all safety belt assemblies in use in vehicles involved in a crash be replaced. However, if the crash was minor and an authorized dealer finds that the belts do not show damage and continue to operate properly, they do not need to be replaced. Safety belt assemblies not in use during a crash should also be inspected and replaced if either damage or improper operation is noted.

Properly care for safety belts. See **Vehicle Care** (page 236).

# Personal Safety System™

---

The Personal Safety System provides an improved overall level of frontal crash protection to front seat occupants and is designed to help further reduce the risk of airbag-related injuries. The system is able to analyze different occupant conditions and crash severity before activating the appropriate safety devices to help better protect a range of occupants in a variety of frontal crash situations.

The Vehicle Personal Safety System consists of:

- Driver and passenger dual-stage airbag supplemental restraints.
- Front seat outboard safety belts with pretensioners, energy management retractors and safety belt usage sensors.
- Driver seat position sensor.
- Front passenger sensing system.
- Passenger airbag off and on indicator lamp.
- Front crash severity sensors.
- Restraints control module with impact and safing sensors.
- Restraint system warning light and backup tone.
- The electrical wiring for the airbags, crash sensors, safety belt pretensioners, front safety belt usage sensors, driver seat position sensor, front passenger sensing system and indicator lights.

## How Does the Personal Safety System Work?

The Personal Safety System can adapt the deployment strategy of the safety devices according to crash severity and occupant conditions. A collection of crash and occupant sensors provides information to the restraints control module. During a crash, the restraints control module may deploy the safety belt pretensioners, one or both stages of the dual-stage airbags based on crash severity and occupant conditions.

# Supplementary Restraints System

## PRINCIPLE OF OPERATION

### WARNINGS

 Airbags do not inflate slowly or gently, and the risk of injury from a deploying airbag is the greatest close to the trim covering the airbag module.

 All occupants of your vehicle, including the driver, should always properly wear their safety belts, even when an airbag supplemental restraint system is provided. Failure to properly wear your safety belt could seriously increase the risk of injury or death.

 Always transport children 12 years old and under in the back seat and always properly use appropriate child restraints. Failure to follow this could seriously increase the risk of injury or death.

 Never place your arm over the airbag module as a deploying airbag can result in serious arm fractures or other injuries.

 Airbags can kill or injure a child in a child seat. Never place a rear-facing child seat in front of an active airbag. If you must use a forward-facing child seat in the front seat, move the seat upon which the child seat is installed all the way back.

 Do not attempt to service, repair, or modify the airbag supplemental restraint systems or its fuses as you could be seriously injured or killed. Contact your authorized dealer as soon as possible.

 Several airbag system components get hot after inflation. Do not touch them after inflation as this may result in serious injury.

 If the airbag has deployed, the airbag will not function again and must be replaced immediately. If the airbag is not replaced, the unrepaired area will increase the risk of injury in a crash.

The airbags are a supplemental restraint system and are designed to work with the safety belts to help protect the driver and right front passenger from certain upper body injuries. Airbags do not inflate slowly; there is a risk of injury from a deploying airbag.

**Note:** *You will hear a loud bang and see a cloud of harmless powdery residue if an airbag deploys. This is normal.*

The airbags inflate and deflate rapidly upon activation. After airbag deployment, it is normal to notice a smoke-like, powdery residue or smell the burnt propellant. This may consist of cornstarch, talcum powder (to lubricate the bag) or sodium compounds (for example, baking soda) that result from the combustion process that inflates the airbag. Small amounts of sodium hydroxide may be present which may irritate the skin and eyes, but none of the residue is toxic.

While the system is designed to help reduce serious injuries, contact with a deploying airbag may also cause abrasions or swelling. Temporary hearing loss is also a possibility as a result of the noise associated with a deploying airbag. Because airbags must inflate rapidly and with considerable force, there is the risk of death or serious injuries such as fractures, facial and eye injuries or internal injuries, particularly to occupants who are not properly restrained or are otherwise out of position at the time of airbag deployment. Thus, it is extremely important that occupants be properly restrained as far away from the airbag module as possible while maintaining vehicle control.

Routine maintenance of the airbags is not required.

# Supplementary Restraints System

## DRIVER AND PASSENGER AIRBAGS

### WARNINGS



Never place your arm or any objects over an airbag module. Placing your arm over a deploying airbag can result in serious arm fractures or other injuries. Objects placed on or over the airbag inflation area may cause those objects to be propelled by the airbag into your face and torso causing serious injury.



Airbags can kill or injure a child in a child seat. Never place a rear-facing child seat in front of an active airbag. If you must use a forward-facing child seat in the front seat, move the seat upon which the child seat is installed all the way back.

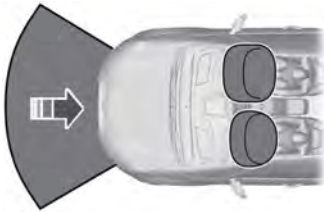

E151127

The driver and front passenger airbags will deploy during significant frontal and near frontal crashes.

The driver and passenger front airbag system consists of:

- Driver and passenger airbag modules.
- Front passenger sensing system.



• Crash sensors and monitoring system with readiness indicator. See **Crash Sensors and Airbag**

**Indicator** (page 42).

## Proper Driver and Front Passenger Seating Adjustment

### WARNING



National Highway Traffic Safety Administration (NHTSA) recommends a minimum distance of at least 10 inches (25 centimeters) between an occupant's chest and the driver airbag module.

To properly position yourself away from the airbag:

- Move your seat to the rear as far as you can while still reaching the pedals comfortably.
- Recline the seat slightly (one or two degrees) from the upright position.

After all occupants have adjusted their seats and put on safety belts, it is very important that they continue to sit properly. A properly seated occupant sits upright, leaning against the seat back, and centered on the seat cushion, with their feet comfortably extended on the floor. Sitting improperly can increase the chance of injury in a crash event. For example, if an occupant slouches, lies down, turns sideways, sits forward, leans forward or sideways, or puts one or both feet up, the chance of injury during a crash is greatly increased.

## Children and Airbags

### WARNING



Airbags can kill or injure a child in a child seat. Never place a rear-facing child seat in front of an active airbag. If you must use a forward-facing child seat in the front seat, move the seat upon which the child seat is installed all the way back.

# Supplementary Restraints System



E142846

Children must always be properly restrained. Accident statistics suggest that children are safer when properly restrained in the rear seating positions than in the front seating position. Failure to follow these instructions may increase the risk of injury in a crash.

## FRONT PASSENGER SENSING SYSTEM

### WARNINGS



Even with Advanced Restraints Systems, children 12 and under should be properly restrained in a rear seating position. Failure to follow this could seriously increase the risk of injury or death.



Sitting improperly out of position or with the seatback reclined too far can take off weight from the seat cushion and affect the decision of the front passenger sensing system, resulting in serious injury or death in a crash.



Always sit upright against your seatback, with your feet on the floor.



Any alteration or modification to the front passenger seat may affect the performance of the front passenger sensing system which could seriously increase the risk of injury or death.

This system works with sensors that are part of the front passenger seat and safety belt to detect the presence of a properly-seated occupant and determine if the front passenger frontal airbag should be enabled (may inflate) or not.

### Type 1



E190688

### Type 2



E183107

The front passenger sensing system uses a passenger airbag off indicator which will illuminate and stay lit to remind you that the front passenger frontal airbag is disabled. The indicator lamp is located in the center stack of the instrument panel.

**Note:** When the ignition is first turned on, the passenger airbag off light will illuminate for a short period of time to confirm it is functional.



# Supplementary Restraints System

The front passenger sensing system is designed to disable (will not inflate) the front passenger frontal airbag when the front passenger seat is unoccupied, or a rear facing infant seat, a forward-facing child restraint, or a booster seat is detected. Even with this technology, parents are **strongly** encouraged to always properly restrain children in the rear seat. The sensor also turns off the passenger front airbag and seat-mounted side airbag when the passenger seat is empty.

- When the front passenger sensing system disables (will not inflate) the front passenger frontal airbag, the passenger airbag status indicator will illuminate and stay lit to remind you that the front passenger frontal airbag is disabled.
- If the child restraint has been installed and the passenger airbag status indicator does not illuminate, then turn the vehicle off, remove the child restraint from the vehicle and reinstall the restraint following the child restraint manufacturer's instructions.

The front passenger sensing system is designed to enable (may inflate) the front passenger frontal airbag anytime the system senses that a person of adult size is sitting properly in the front passenger seat.

- When the front passenger sensing system enables the front passenger frontal airbag (may inflate), the passenger airbag status indicator will not illuminate.

If a person of adult size is sitting in the front passenger seat, but the passenger airbag status indicator lamp is lit, it is possible that the person is not sitting properly in the seat. If this happens:

- Turn the vehicle off and ask the person to place the seatback in the full upright position.
- Have the person sit upright in the seat, centered on the seat cushion, with the person's legs comfortably extended.
- Restart the vehicle and have the person remain in this position for about two minutes. This will allow the system to detect that person and enable the passenger's frontal airbag.
- If the passenger airbag status indicator lamp remains lit even after this, the person should be advised to ride in the rear seat.

Occupant	Passenger airbag status indicator	Passenger airbag
Empty	Unlit	Disabled
Child	Lit	Disabled
Adult	Unlit	Enabled

**Note:** When the passenger airbag status indicator lamp is illuminated, the passenger side airbag (seat mounted) may be disabled to avoid the risk of airbag deployment injuries.

# Supplementary Restraints System

After all occupants have adjusted their seats and put on safety belts, it is very important that they continue to sit properly. A properly seated occupant sits upright, leaning against the seatback, and centered on the seat cushion, with their feet comfortably extended on the floor. Sitting improperly can increase the chance of injury in a crash event. For example, if an occupant slouches, lies down, turns sideways, sits forward, leans forward or sideways, or puts one or both feet up, the chance of injury during a crash is greatly increased.

If you think that the status of the passenger airbag off indicator lamp is incorrect, check for the following:

- Objects lodged underneath the seat.
- Objects between the seat cushion and the center console.
- Objects hanging off the seatback.
- Objects stowed in the seatback map pocket.
- Objects placed on the occupant's lap.
- Cargo interference with the seat
- Other passengers pushing or pulling on the seat.
- Rear passenger feet and knees resting or pushing on the seat.

The conditions listed above may cause the weight of a properly seated occupant to be incorrectly interpreted by the passenger sensing system. The person in the front passenger seat may appear heavier or lighter due to the conditions described in the list above.



Make sure the front passenger sensing system is operating properly. See **Crash Sensors and Airbag Indicator** (page 42).

**If the airbag readiness lamp is lit, do the following:**

The driver or adult passengers should check for objects that lodged underneath the front passenger seat, or cargo interfering with the seat.

If there are lodged objects, or cargo is interfering with the seat, take the following steps to remove the obstruction:

- Pull the vehicle over.
- Turn the vehicle off.
- Driver or adult passengers should check for any objects lodged underneath the front passenger seat or cargo interfering with the seat.
- Remove the obstruction(s) (if found).
- Restart the vehicle.
- Wait at least two minutes and verify that the airbag readiness lamp is no longer illuminated.
- If the airbag readiness lamp remains illuminated, this may or may not be a problem due to the front passenger sensing system.

Do not attempt to repair or service the system. Take your vehicle immediately to an authorized dealer.

If it is necessary to modify an advanced front airbag system to accommodate a person with disabilities, contact your authorized dealer.

## SIDE AIRBAGS

### WARNINGS



Do not place objects or mount equipment on or near the airbag cover, on the side of the seatbacks (of the front seats), or in front seat areas that may come into contact with a deploying airbag. Failure to follow these instructions may increase the risk of personal injury in the event of a crash.

# Supplementary Restraints System

## WARNINGS



Do not use accessory seat covers. The use of accessory seat covers may prevent the deployment of the side airbags and increase the risk of injury in an accident.



Do not lean your head on the door. The side airbag could injure you as it deploys from the side of the seatback.



Do not attempt to service, repair, or modify the airbag, its fuses or the seat cover on a seat containing an airbag as you could be seriously injured or killed. Contact your authorized dealer as soon as possible.



If the side airbag has deployed, the airbag will not function again. The side airbag system (including the seat) must be inspected and serviced by an authorized dealer. If the airbag is not replaced, the unrepaired area will increase the risk of injury in a crash.

The side airbags are located on the outboard side of the seatbacks of the front seats. In certain sideways crashes, the airbag on the side affected by the crash will be inflated. The airbag was designed to inflate between the door panel and occupant to further enhance the protection provided occupants in side impact crashes.



E152533

The system consists of the following:

- A label or embossed side panel indicating that side airbags are fitted to your vehicle.
- Side airbags located inside the driver and front passenger seatbacks.
- Front passenger sensing system.



Crash sensors and monitoring system with readiness indicator. See **Crash Sensors and Airbag Indicator** (page 42).

**Note:** *The passenger sensing system will deactivate the passenger seat-mounted side airbag if it detects an empty passenger seat.*

The design and development of the side airbag system included recommended testing procedures that were developed by a group of automotive safety experts known as the Side Airbag Technical Working Group. These recommended testing procedures help reduce the risk of injuries related to the deployment of side airbags.

## DRIVER KNEE AIRBAG

A driver's knee airbag is located under the instrument panel. During a crash, the restraints control module may activate the driver's knee airbag based on crash severity and occupant conditions. Under certain crash and occupant conditions, the driver's knee airbag may deploy but the driver's front airbag may not activate. As with front and side airbags, it is important to be properly seated and restrained to reduce the risk of death or serious injury.





Make sure the knee airbag is operating properly. See **Crash Sensors and Airbag Indicator** (page 42).

# Supplementary Restraints System

## SAFETY CANOPY™

### WARNINGS

 Do not place objects or mount equipment on or near the headliner at the siderail that may come into contact with a deploying curtain airbag. Failure to follow these instructions may increase the risk of personal injury in the event of a crash.

 Do not lean your head on the door. The curtain airbag could injure you as it deploys from the headliner.

 Do not attempt to service, repair, or modify the curtain airbags, its fuses, the A, B, or C pillar trim, or the headliner on a vehicle containing curtain airbags as you could be seriously injured or killed. Contact your authorized dealer as soon as possible.

 All occupants of your vehicle including the driver should always wear their safety belts even when an airbag supplemental restraint system and curtain airbag is provided. Failure to properly wear your safety belt could seriously increase the risk of injury or death.

 To reduce risk of injury, do not obstruct or place objects in the deployment path of the curtain airbag.

 If the curtain airbags have deployed, the curtain airbags will not function again. The curtain airbags (including the A, B and C pillar trim and headliner) must be inspected and serviced by an authorized dealer. If the curtain airbag is not replaced, the unrepaired area will increase the risk of injury in a crash.

The Safety Canopy will deploy during significant side crashes or when a certain likelihood of a rollover event is detected by the rollover sensor. The Safety Canopy is mounted to the roof side-rail sheet metal, behind the headliner, above each row of seats. In certain sideways crashes or rollover events, the Safety Canopy will be activated, regardless of which seats are occupied. The Safety Canopy is designed to inflate between the side window area and occupants to further enhance protection provided in side impact crashes and rollover events.

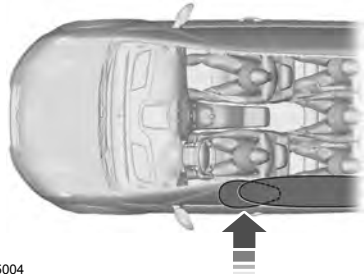

E75004

The system consists of the following:

- Safety canopy curtain airbags located above the trim panels over the front and rear side windows identified by a label or wording on the headliner or roof-pillar trim.
- A flexible headliner which opens above the side doors to allow air curtain deployment
-  Crash sensors and monitoring system with a readiness indicator. See **Crash Sensors and Airbag Indicator** (page 42).

# Supplementary Restraints System

Children 12 years old and under should always be properly restrained in the rear seats. The Safety Canopy will not interfere with children restrained using a properly installed child or booster seat because it is designed to inflate downward from the headliner above the doors along the side window opening.

The design and development of the Safety Canopy included recommended testing procedures that were developed by a group of automotive safety experts known as the Side Airbag Technical Working Group. These recommended testing procedures help reduce the risk of injuries related to the deployment of side airbags (including the Safety Canopy).

## CRASH SENSORS AND AIRBAG INDICATOR

### WARNING



Modifying or adding equipment to the front end of your vehicle (including frame, bumper, front end body structure and tow hooks) may affect the performance of the airbag system, increasing the risk of injury. Do not modify the front end of your vehicle.

Your vehicle has a collection of crash and occupant sensors which provide information to the restraints control module which deploys (activates) the front safety belt pretensioners, driver airbag, passenger airbag, seat mounted side airbags, and the Safety Canopy. Based on the type of accident (frontal impact, side impact or rollover) the restraints control module will deploy the appropriate safety devices.

The restraints control module also monitors the readiness of the above safety devices plus the crash and occupant sensors. A warning indicator light in the instrument cluster indicates the readiness of the safety system. If this warning indicator light is not functioning and there is another fault within the system, the message cluster may display an airbag failure warning. See **Information Displays** (page 91). You will hear five tones that repeat periodically until you repair the problem, the warning indicator light or both. Routine maintenance of the airbag is not required.

A difficulty with the system is indicated by one or more of the following:



- The readiness light will not illuminate immediately after the ignition is turned on.
- The readiness light will either flash or stay lit.
- A series of five beeps will be heard. The tone pattern will repeat periodically until the problem, the light or both are repaired.

If any of these things happen, even intermittently, have the supplemental restraint system serviced at an authorized dealer immediately. Unless serviced, the system may not function properly in the event of a crash.

The safety belt pretensioners and the airbag supplemental restraint system is designed to activate when your vehicle sustains frontal or sideways deceleration sufficient to cause the restraints control module to deploy a safety device or when a certain likelihood of a rollover event is detected by the rollover sensor.

# Supplementary Restraints System

---

The fact that the safety belt pretensioners or airbags did not activate for both front seat occupants in a crash does not mean that something is wrong with the system. Rather, it means the restraints control module determined the accident conditions (for example, crash severity, belt usage) were not appropriate to activate these safety devices.

- The design of the front airbags is to activate only in frontal and near-frontal crashes (not rollovers, side impacts or rear impacts) unless the crash causes sufficient frontal deceleration.
- The design of the safety belt pretensioners is to activate in frontal, near-frontal and side crashes, and in rollovers.
- The design of the side airbags is to inflate in certain side impact crashes. Side airbags may activate in other types of crashes if your vehicle experiences sufficient sideways motion or deformation.
- The design of the Safety Canopy is to inflate in certain side impact crashes or rollover events. The Safety Canopy may activate in other types of crashes if your vehicle experiences sufficient sideways motion or deformation, or a certain likelihood of rollover.

## **AIRBAG DISPOSAL**

Contact your authorized dealer as soon as possible. Airbags must be disposed of by qualified personnel.

# Keys and Remote Controls

## GENERAL INFORMATION ON RADIO FREQUENCIES

This device complies with Part 15 of the FCC Rules and with Industry Canada license-exempt RSS standard(s). Operation is subject to the following two conditions: (1) This device may not cause harmful interference, and (2) This device must accept any interference received, including interference that may cause undesired operation.

**Note:** *Changes or modifications not expressly approved by the party responsible for compliance could void the user's authority to operate the equipment. The term IC before the radio certification number only signifies that Industry Canada technical specifications were met.*

The typical operating range for your transmitter is approximately 33 ft (10 m). Vehicles with the remote start feature will have a greater range.

One of the following could cause a decrease in operating range:

- Weather conditions.
- Nearby radio towers.
- Structures around the vehicle.
- Other vehicles parked next to your vehicle.

The radio frequency used by your remote control can also be used by other radio transmitters, for example amateur radios, medical equipment, wireless headphones, wireless remote controls, cell phones, battery chargers and alarm systems. If the frequencies are jammed, you will not be able to use your remote control. You can lock and unlock the doors with the key.

**Note:** *Make sure to lock your vehicle before leaving it unattended.*

**Note:** *If you are in range, the remote control will operate if you press any button unintentionally.*

## Intelligent Access (If Equipped)

The system uses a radio frequency signal to communicate with your vehicle and authorize your vehicle to unlock when one of the following conditions are met:

- You activate the front exterior door handle switch.
- You press the luggage compartment button.
- You press a button on the transmitter.

If excessive radio frequency interference is present in the area or if the transmitter battery is low, you may need to mechanically unlock your door. You can use the mechanical key blade in your intelligent access key to open the driver door in this situation. See **Remote Control** (page 44).

## REMOTE CONTROL

### Integrated Keyhead Transmitters (If Equipped)

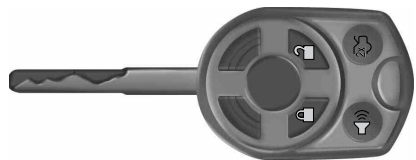

E142585

Use the key blade to start your vehicle and unlock or lock the driver door from outside your vehicle. The transmitter portion functions as the remote control.

# Keys and Remote Controls



E138615

**Note:** Your vehicle's keys came with a security label that provides important vehicle key cut information. Keep the label in a safe place for future reference.

## Intelligent Access Key (If Equipped)

### Type 1



E162192

### Type 2



E138616

Your intelligent access keys operate the power locks and the remote start system. The key must be in your vehicle to activate the push-button start system.

## Mechanical Key Blade

The intelligent access key also contains a removable mechanical key blade that you can use to unlock the driver door.

### Type 1



E87964

To release the mechanical key blade:

1. Press and hold the push buttons on the edges of the transmitter to release the cover. Carefully remove the cover.
2. Remove the key blade.

### Type 2



E142431

Slide the release on the back of the transmitter to release the key blade, then pull the blade out.



# Keys and Remote Controls



E138618

**Note:** Your vehicle's back-up keys came with a security tag that provides important vehicle key cut information. Keep the tag in a safe place for future reference.

## Replacing the Battery

**Note:** Refer to local regulations when disposing of transmitter batteries.

**Note:** Do not wipe off any grease on the battery terminals or on the back surface of the circuit board.

**Note:** Replacing the battery does not delete the transmitter from the vehicle. The transmitter should operate normally.

The remote control uses one coin-type three-volt lithium battery CR2032 or equivalent.

## Integrated Keyhead Transmitter



E138619

1. Twist a thin coin in the slot of the transmitter near the key ring to remove the battery cover.
2. Remove the old battery.

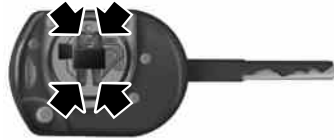

E138620

3. Insert the new battery. Refer to the instructions inside the transmitter for the correct orientation of the battery. Press the battery down to make sure it is fully in the housing.
4. Snap the battery cover back onto the transmitter.

## Intelligent Access Key (Type 1)



E87964

1. Press and hold the buttons on the edges to release the cover. Carefully remove the cover.
2. Remove the key blade.

# Keys and Remote Controls



E105362

3. Twist the screwdriver in the position shown to start separating the two halves of the remote control.



E119190

4. Twist the screwdriver in the position shown to separate the two halves of the remote control.



E125860

**Note:** Do not touch the battery contacts or the printed circuit board with the screwdriver.

5. Carefully remove the battery with the screwdriver.
6. Install a new battery with the + facing downward.
7. Assemble the two halves of the remote control.
8. Install the key blade.

## Intelligent Access Key (Type 2)

1. Remove the backup key from the transmitter.



E142432

2. Twist a thin coin under the tab hidden behind the backup key head to remove the battery cover. Do not use the backup key to remove the cover or you could damage the intelligent access key.



E138622

# Keys and Remote Controls

3. Remove the old battery.
4. Insert a new battery with the **+** facing downward. Press the battery down to make sure it is fully in the housing.
5. Snap the battery cover back onto the transmitter and install the backup key.

## Car Finder

Press the lock button on the key twice within three seconds. The horn sounds and the turn signals flash. We recommend you use this method to locate your vehicle, rather than using the panic alarm.

**Note:** *If locking was not successful or if any door or the liftgate is open, or if the hood is open on vehicles with a perimeter alarm or remote start, the horn does sound twice and the lamp does not flash.*

## Sounding a Panic Alarm (If Equipped)

**Note:** *The panic alarm only operates when the ignition is off.*



Press the button to activate the alarm. Press the button again or switch the ignition on to deactivate it.

## Remote Start (If Equipped)

### WARNING



To avoid exhaust fumes, do not use remote start if your vehicle is parked indoors or areas that are not well ventilated.

**Note:** *Do not use remote start if your vehicle is low on fuel.*



The remote start button is on the transmitter.

This feature allows you to start your vehicle from outside the vehicle. The transmitter has an extended operating range.

Vehicles with automatic climate control can be configured to operate when the vehicle is remote started. See **Automatic Climate Control** (page 107).

Many states and provinces have restrictions for the use of remote start. Check your local and state or provincial laws for specific requirements regarding remote start systems.

The remote start system does not work if any of the following occur:

- The ignition is on.
- The alarm system triggers.
- You disable the feature.
- The hood is open.
- The transmission is not in **P**.
- The vehicle battery voltage is too low.
- The powertrain fault indicator was on the last time your vehicle was driven.

## Remote Starting the Vehicle

**Note:** *You must press each button within three seconds of each other. If you do not follow this sequence, your vehicle does not remote start, the exterior lamps do not flash twice, and the horn does not sound.*

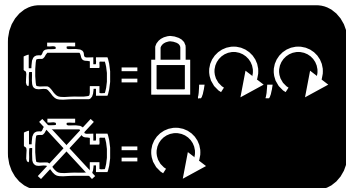

E138626

The label on your transmitter details the starting procedure.

To remote start your vehicle:

# Keys and Remote Controls

1. Press the lock button to lock all the doors.
2. Press the remote start button twice. The exterior lamps flash twice.

The horn sounds if the system fails to start, unless quiet start is on. Quiet start runs the blower fan at a slower speed to reduce noise. You can switch it on or off in the information display. See (page 91).

**Note:** *If you remote start your vehicle with an integrated keyhead transmitter, you must switch the ignition on before driving your vehicle. If you remote start your vehicle with an intelligent access transmitter, you must press the **START/STOP** button on the instrument panel once while applying the brake pedal before driving your vehicle.*

The power windows do not work during remote start and the radio does not turn on automatically.

The parking lamps remain on and the vehicle runs for 5, 10, or 15 minutes, depending on the setting.

## **Extending the Vehicle Run Time**

Repeat Steps 1 and 2 with the vehicle still running to extend the run time for another remote start duration. If the duration is set to last 10 minutes, the duration extends by another 10 minutes. For example, if the vehicle had been running from the first remote start for five minutes, the vehicle continues to run now for a total of 20 minutes. You can extend the remote start up to a maximum of 30 minutes.

Wait at least five seconds before remote starting after a vehicle shutdown.

## **Turning the Vehicle Off After Remote Starting**



Press the button once. The parking lamps turns off.

You may have to be closer to the vehicle than when starting due to ground reflection and the added noise of the running vehicle.

You can disable or enable the remote start system through the information display. See (page 91).

## **REPLACING A LOST KEY OR REMOTE CONTROL**

Replacement keys or remote controls can be purchased from an authorized dealer. Authorized dealers can program remote controls for your vehicle. See **Passive Anti-Theft System** (page 65).

To re-program the passive anti-theft system see an authorized dealer.

## PRINCIPLE OF OPERATION

MyKey allows you to program keys with restricted driving modes to promote good driving habits. All but one of the keys programmed to the vehicle can be activated with these restricted modes.

Any keys that have not been programmed are referred to as administrator keys or admin keys. These can be used to:

- Create a MyKey.
- Program configurable MyKey settings.
- Clear all MyKey features.

When you have programmed a MyKey, you can access the following information using the information display:

- How many admin keys and MyKeys are programmed to your vehicle.
- The total distance your vehicle has traveled using a MyKey.

**Note:** All MyKeys are programmed to the same settings. You cannot program them individually.

**Note:** For vehicles with push-button start, when both a MyKey and an admin remote transmitter are present, the admin remote transmitter will be recognized by the vehicle while switching the ignition on to start the vehicle.

## Non-configurable Settings

The following settings cannot be changed by an admin key user:

- Seat belt reminder or Belt Minder. You cannot disable this feature. The audio system will mute when the front seat passengers' safety belts are not fastened.
- Early low fuel. The low-fuel warning activates earlier, giving the MyKey user more time to refuel.
- Driver assist features, if equipped on your vehicle, are forced on: parking aid, blind spot information system (BLIS) with cross traffic alert, lane departure warning and forward collision warning system or active city-stop.

## Configurable Settings

With an admin key, you can configure certain MyKey settings when you first create a MyKey and before you recycle the key or restart the vehicle. You can also change the settings afterward with an admin key.

- A vehicle speed limit can be set. Warnings will be shown in the display followed by an audible tone when your vehicle reaches the set speed. You cannot override the set speed by fully depressing the accelerator pedal or by setting cruise control.

### WARNING



Do not set MyKey maximum speed limit to a limit that will prevent the driver from maintaining a safe speed considering posted speed limits and prevailing road conditions. The driver is always responsible to drive in accordance with local laws and prevailing conditions. Failure to do so could result in accident or injury.

- Various vehicle speed minders can be set. Once you select a speed, it will be shown in the display, followed by an audible tone when the preselected vehicle speed is exceeded.
- Audio system maximum volume of 45%. A message will be shown in the display when you attempt to exceed the limited volume. Also, the speed-sensitive or compensated automatic volume control will be disabled.
- Always on setting. When this is selected, you will not be able to turn off Advance Trac or traction control (if your vehicle is equipped with this feature).

## CREATING A MYKEY

Use the information display to create a MyKey:

1. Insert the key you want to program into the ignition. If your vehicle is equipped with a push-button start, hold the intelligent access key next to the steering column. Details on the correct fob placement and position is in another chapter. See **Starting and Stopping the Engine** (page 127).
2. Switch the ignition on.
3. Access the main menu on the information display controls, and select **Settings** and then **MyKey** by pressing **OK** or the **>** button.
4. Press **OK** or the **>** button to select **Create MyKey**.
5. When prompted, hold the **OK** button until you see a message informing you to label this key as a MyKey. The key will be restricted at your vehicle's next start.

MyKey is successfully created. Make sure you label it so you can distinguish it from the admin keys.

You can also program configurable settings for the key(s). Refer to **Programming/Changing Configurable Settings**.

## Programming/Changing Configurable Settings

Use the information display to access your configurable MyKey settings:

1. Switch the ignition on using an admin key or fob.
2. Access the main menu on the information display controls, and select **Settings**, then **MyKey** by pressing **OK** or the **>** button.
3. Use the arrow buttons to get to a configurable feature.
4. Press **OK** or **>** to make a selection.

**Note:** *You can clear or change your MyKey settings at any time during the same key cycle as you created the MyKey. Once you have switched the engine off, however, you will need an admin key to change or clear your MyKey settings.*

## CLEARING ALL MYKEYS

You can clear or change your MyKey settings using the information display control on the steering wheel. See **Information Displays** (page 91).

Switch the ignition on using an admin key or fob.

# MyKey™

---

**To clear all MyKeys of all MyKey settings, press the left arrow button to access the main menu and scroll to:**

<b>Message</b>	<b>Action and Description</b>
Settings	Press the <b>OK</b> button.
MyKey	Press the <b>OK</b> button.
Clear MyKey	Press and hold the <b>OK</b> button until the following message displays.
All MyKeys Cleared	

**Note:** *When you clear your MyKeys, you remove all restrictions and return all MyKeys to their original admin key status.*

## CHECKING MYKEY SYSTEM STATUS

You can find information on programmed MyKey(s) using the information display control on the steering wheel. See **Information Displays** (page 91).

**To find information on programmed MyKey(s), press the left arrow button to access the main menu and scroll to:**

Message	Description
Settings	Press the <b>OK</b> button.
MyKey	Press the <b>OK</b> button.
<b>Select one of the following:</b>	
MyKey Dist.	Tracks the distance when drivers use a MyKey. The only way to delete the accumulated distance is by using an admin key to clear your MyKeys. If the distance does not accumulate as expected, then the intended user is not using the MyKey, or an admin key user recently cleared and then recreated a MyKey.
{0} MyKeys	Indicates the number of MyKeys programmed to your vehicle. Use this feature to detect how many MyKeys you have for your vehicle and determine when a MyKey has been deleted.
{0} Admin Keys	Indicates how many admin keys are programmed to your vehicle. Use this feature to determine how many unrestricted keys you have for your vehicle, and detect if an additional MyKey has been programmed.



## USING MYKEY WITH REMOTE START SYSTEMS

MyKey is not compatible with non

Ford-approved, aftermarket remote start systems. If you choose to install a remote start system, see an authorized dealer for a Ford-approved remote start system.

## MYKEY TROUBLESHOOTING

Condition	Potential Causes
I cannot create a MyKey.	<ul style="list-style-type: none"> <li>• The key or transmitter used to start the vehicle does not have admin privileges.</li> <li>• The key or transmitter used to start the vehicle is the only admin key (there always has to be at least one admin key).</li> <li>• Vehicles with keyless start: The keyless start transmitter is not placed in the backup position. See <b>Starting a Gasoline Engine</b> (page 128).</li> <li>• SecuriLock passive anti-theft system is disabled or in unlimited mode.</li> </ul>
I cannot program the configurable settings.	<ul style="list-style-type: none"> <li>• The key or transmitter used to start your vehicle does not have admin privileges.</li> <li>• No MyKeys are created. See <b>Creating a MyKey</b> (page 51).</li> </ul>
I cannot clear the MyKeys.	<ul style="list-style-type: none"> <li>• The key or transmitter used to start your vehicle does not have admin privileges.</li> <li>• No MyKeys are created. See <b>Creating a MyKey</b> (page 51).</li> </ul>
I lost the only admin key.	Purchase a new key from an authorized dealer.

# MyKey™

---

Condition	Potential Causes
I lost a key.	Program a spare key. See <b>Passive Anti-Theft System</b> (page 65).
MyKey distances do not accumulate.	<ul style="list-style-type: none"><li data-bbox="519 278 960 301">• The MyKey user is not using the MyKey.</li><li data-bbox="519 308 976 360">• An admin key holder cleared the MyKeys and created new MyKeys.</li><li data-bbox="519 368 875 390">• The key system has been reset.</li></ul>
No MyKey functions with the keyless entry transmitter.	<ul style="list-style-type: none"><li data-bbox="519 417 992 468">• An admin transmitter is present at vehicle start.</li><li data-bbox="519 476 971 528">• No MyKeys are created. See <b>Creating a MyKey</b> (page 51).</li></ul>

# Locks

## LOCKING AND UNLOCKING

You can use the power door lock control or the remote control to lock and unlock your vehicle.

### Power Door Locks

The power door lock control is on the driver and front passenger door panels.

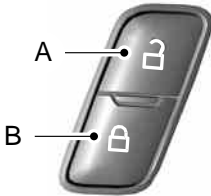

E162487

A Unlock

B Lock

### Door Lock Indicator

An LED on the instrument panel will light when you lock the doors. It is not a functional control.

## Remote Control

### Unlocking the Doors (Two-Stage Unlock)

#### Type 1



#### Type 2



Press the button to unlock the driver door.

Press the button again within three seconds to unlock all doors. The turn signals will flash.

Press and hold both the lock and unlock buttons on the remote control for four seconds to disable or enable two-stage unlocking. Disabling two-stage unlocking allows all vehicle doors to unlock with one press of the button. The turn signals will flash twice to indicate a change to the unlocking mode. The unlocking mode applies to the remote control and intelligent access.

Intelligent access at the driver door will unlock all doors when you disable two-stage unlocking.

## Locking the Doors

### Type 1



### Type 2



Press the button to lock all the doors. The turn signals will illuminate.

Press the button again within three seconds to confirm that all the doors are closed. The doors will lock again, the horn will sound and the turn signals will flash if all the doors and the luggage compartment are closed.

**Note:** *If locking was not successful or any door or the liftgate is open, or if the hood is open on vehicles with a perimeter alarm or remote start, the horn will sound twice and the lamps will not flash.*

## Liftgate

### WARNINGS



Make sure all persons are clear of the liftgate area before using the liftgate control.

# Locks

## WARNINGS



Make sure to close and latch the liftgate to prevent drawing exhaust fumes into your vehicle. This will also prevent passengers and cargo from falling out. If you must drive with the liftgate open, keep the vents or windows open so outside air comes into your vehicle. Failure to follow this warning could result in serious personal injury.

**Note:** Be careful when opening or closing the liftgate in a garage or other enclosed area to avoid damaging the liftgate.



Press twice within three seconds to:

- unlatch a manual liftgate
- open, close or stop the movement of a power liftgate. See **Power Liftgate** (page 61).

## Mechanical Key

Turn the top of the key toward the front of your vehicle once to lock all doors.

Turn the top of the key toward the rear of your vehicle once to unlock the driver door only.

## Locking the Doors Individually

If the power locks fail to operate, lock the doors individually using the key in the position shown.



E112203

### Left-Hand Side

Turn clockwise to lock.

### Right-Hand Side

Turn counterclockwise to lock.

## Opening a Rear Door from Inside

Pull the interior door release handle twice to unlock and open a rear door. The first pull unlocks the door and the second pull will unlatch the door.

## Activating Intelligent Access (if Equipped)

The intelligent access key must be within 3 feet (1 meter) of your vehicle.

## At the Front Doors

Pull a front exterior door handle to unlock and open the door. The unlock sensor is on the back of the handle. Make sure not to touch the lock sensor area on the front of the handle.

# Locks

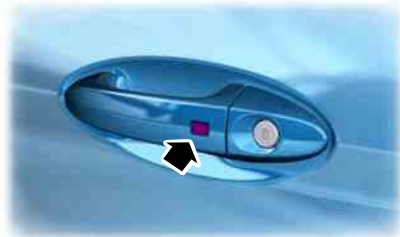

E87384

Press and hold the lock sensor area for about a second to lock your vehicle. To avoid unlocking the door inadvertently, make sure you only touch the lock sensor and not other areas of the door handle.

After locking the doors with the lock sensor, there is a brief delay before you can unlock your vehicle. This delay lets you pull the handle to make sure it locked.

**Note:** *Keep the door handle surface clean to avoid issues with operation.*

## At the Liftgate

Press the exterior liftgate release button on the top of the liftgate pull-cup handle.

## Smart Unlocks For Integrated Keyhead Transmitter

This feature helps to prevent you from locking yourself out of your vehicle if your key is still in the ignition.

When you open one of the front doors and lock your vehicle with the power door lock control, all the doors will lock then unlock if your key is still in the ignition.

You can still lock your vehicle with the key in the ignition by pressing the lock button on the transmitter even if the doors are not closed.

If both front doors are closed, you can lock your vehicle by any method, regardless of whether the key is in the ignition or not.

## Smart Unlocks For Intelligent Access Keys (If Equipped)

This feature helps to prevent you from unintentionally locking your intelligent access key inside your vehicle's passenger compartment or rear cargo area.

When you lock your vehicle using the power door lock control (with the door open, vehicle in park and ignition off), your vehicle will search for an intelligent access key in the passenger compartment after you close the door. If your vehicle finds a key, all of the doors will immediately unlock.

In order to override the smart unlock feature and intentionally lock the intelligent access key inside your vehicle, you can lock your vehicle after all doors are closed by pressing the lock button on another intelligent access key or touching the locking area on the handle with another intelligent access key in your hand.

When you open one of the front doors and lock your vehicle using the power door lock control, all doors will lock then unlock if the ignition is on.

## Autolock (If Equipped)

The autolock feature will lock all the doors when:

- all doors are closed
- the ignition is on,
- you shift into any gear putting your vehicle in motion, and
- your vehicle attains a speed greater than 4 mph (7 km/h).

# Locks

## Autounlock (If Equipped)

The autounlock feature will unlock all the doors when:

- the ignition is on, all the doors are closed, and your vehicle has been in motion at a speed greater than 4 mph (7 km/h);
- your vehicle comes to a stop and you switch the ignition off or to accessory; and
- you open the driver door within 10 minutes of the switching the ignition off or to accessory.

**Note:** *The doors will not autounlock if you electronically lock your vehicle after you switch the ignition off and before you open the driver door.*

## Enabling or Disabling Autolock and Autounlock

**Note:** *Your authorized dealer can perform this procedure, or you can do the procedure yourself.*

To enable or disable these features, do the following:

**Note:** *You will have 30 seconds to complete the procedure.*

1. Switch the ignition on.
2. Press the power door unlock button three times.
3. Switch the ignition off.
4. Press the power door unlock button three times.
5. Switch the ignition on. The horn will sound indicating your vehicle is in programming mode.

**Autolock:** Press the power door unlock button then the lock button. The horn will sound once if disabled or twice (one short and one long) if enabled.

**Autounlock:** Press the power door lock button then the unlock button. The horn will sound once if disabled or twice (one short and one long) if enabled.

After programming the feature, switch the ignition off. The horn will sound once indicating programming is complete.

**Note:** *You can enable or disable the autounlock feature independently of the autolock feature.*

## Illuminated Entry

The interior lamps and select exterior lamps will illuminate when you unlock the doors with the remote entry system.

The illuminated entry system will turn off the lights if:

- you start your vehicle,
- you press the remote control lock button, or
- after 25 seconds of illumination.

The lights will not turn off if:

- you turn them on with the lamp control, or
- any door is open.

## Illuminated Exit

The interior lamps and select exterior lamps will illuminate when all doors are closed and you switch the ignition off.

The lamps will turn off if all the doors remain closed and:

- 25 seconds elapse, or
- you lock your vehicle from the outside.

## Battery Saver

If you leave the courtesy lamps or dome lamps on and switch the ignition off, the battery saver shuts them off after some time.

# Locks

## Accessory Mode Battery Saver for Intelligent Access Keys (If Equipped)

If you leave the ignition on after leaving your vehicle, it will shut off 15 minutes after you close all of the doors.

## MANUAL LIFTGATE

### WARNINGS



It is extremely dangerous to ride in a cargo area, inside or outside of a vehicle. In a crash, people riding in these areas are more likely to be seriously injured or killed. Do not allow people to ride in any area of your vehicle that is not equipped with seats and safety belts. Be sure everyone in your vehicle is in a seat and using a safety belt properly. Failure to follow this warning could result in serious personal injury or death.



Make sure to close and latch the liftgate to prevent drawing exhaust fumes into your vehicle. This will also prevent passengers and cargo from falling out. If you must drive with the liftgate open, keep the vents or windows open so outside air comes into your vehicle. Failure to follow this warning could result in serious personal injury.

**Note:** Be careful when opening or closing the liftgate in a garage or other enclosed area to avoid damaging the liftgate.

**Note:** Do not hang anything, for example a bike rack, from the glass or liftgate. This could damage the liftgate and its components.

**Note:** Do not leave the liftgate open while driving. This could damage the liftgate and its components.

## Opening the Liftgate

### Manually

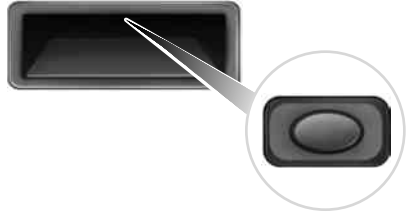

E138632

Press the button located in the top of the liftgate pull cup handle to unlatch the liftgate, and then pull on the outside handle.

### With the Remote Control



Press the button twice within three seconds to unlock the liftgate. Manually open the liftgate.

## Closing the Liftgate



E155976

A handle is located inside the liftgate to help with closing.

# Locks

## POWER LIFTGATE (If Equipped)

### WARNINGS



It is extremely dangerous to ride in a cargo area, inside or outside of a vehicle. In a crash, people riding in these areas are more likely to be seriously injured or killed. Do not allow people to ride in any area of your vehicle that is not equipped with seats and safety belts. Make sure everyone in your vehicle is in a seat and properly using a safety belt. Failure to follow this warning could result in serious personal injury or death.



Make sure to close and latch the liftgate to prevent drawing exhaust fumes into your vehicle. This will also prevent passengers and cargo from falling out. If you must drive with the liftgate open, keep the vents or windows open so outside air comes into your vehicle. Failure to follow this warning could result in serious personal injury.



Keep keys out of reach of children. Do not allow children to operate or play near an open or moving power liftgate. You should supervise the operation of the power liftgate at all times.

**Note:** Make sure that you close the liftgate before operating or moving your vehicle, especially in an enclosure, like a garage or a parking structure. This could damage the liftgate and its components.

**Note:** Do not hang anything, for example a bike rack, from the glass or liftgate. This could damage the liftgate and its components.

The liftgate only operates with the transmission in park (P).

Two warning tones sound as the liftgate begins to power close. Three short chimes indicate a problem with the open or close request, caused by:

- The ignition is on and the transmission is not in park (P).
- The battery voltage is below the minimum operating voltage.
- The vehicle speed is at or above 3 mph (5 km/h).

If the liftgate starts to close after it has fully opened, this indicates there may be excessive weight on the liftgate or a possible gas strut failure. A repetitive chime sounds and the liftgate closes under control. Remove any excessive weight from the liftgate. If the liftgate continues to close after opening, have the system checked by an authorized dealer.

## Opening and Closing the Liftgate

### WARNING



Make sure all persons are clear of the power liftgate area before using the power liftgate control.

**Note:** Be careful when opening or closing the liftgate in a garage or other enclosed area to avoid damaging the liftgate.

**Note:** Do not leave the liftgate open while driving. This could damage the liftgate and its components.

## From the Instrument Panel



Press the button on the instrument panel.

## With the Remote Control



Press the button twice within three seconds.



# Locks

## With the Outside Control Button

### Opening the Liftgate

1. Unlock the liftgate with the remote control or power door unlock control. If an intelligent access key is within 3 ft (1 m) of the liftgate, the liftgate unlocks when you press the liftgate release button.

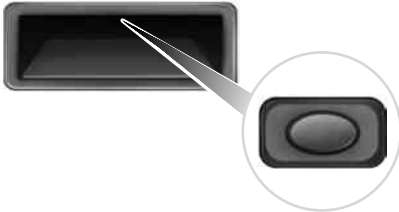

E138632

2. Press the control button located in the top of the liftgate pull-cup handle.

**Note:** Allow the power system to open the liftgate. Manually pushing or pulling the liftgate may activate the system's obstacle detection feature and stop the power operation or reverse its direction. Manually interfering with the liftgate motion may also replicate a gas strut failure.

### Closing the Liftgate

#### WARNING



Keep clear of the liftgate when activating the rear switch.



E138636

Press and release the liftgate control button.

### Stopping the Liftgate Movement

You can stop the liftgate movement by doing any of the following:

- Pressing the liftgate control button.
- Pressing the liftgate button on the remote control twice.
- Pressing the liftgate button on the instrument panel.
- Activating the obstacle detection feature.
- Moving your foot under and away from the center rear bumper in a single-kick motion.\*

\*This method only works for vehicles with the hands-free liftgate feature.

### Setting the Liftgate Open Height

1. Open the liftgate.
2. Stop the liftgate movement by pressing the control button on the liftgate when it reaches the desired height.

**Note:** Once the liftgate has stopped moving, you can also manually move it to the desired height.

# Locks

3. Press and hold the liftgate control button on the liftgate until you hear a chime, indicating programming is complete.

**Note:** You can only use the liftgate control button to program the height.

**Note:** You cannot program the height if the liftgate position is too low.

The new open liftgate height is recalled when the power liftgate is opened. To change the programmed height, repeat the above procedure. Once you open the power liftgate, you can manually move it to a different height.

**Note:** The system recalls the new programmed height until you reprogram it, even if you disconnect the battery.

When operating the power liftgate after you have programmed a lower height than fully open, you can fully open the liftgate by manually pushing it upward to the maximum open position.

## Obstacle Detection

### When Closing

The system stops when it detects an obstacle. Two short tones sound and the system reverses to open. Once you remove the obstacle, you can power close the liftgate.

**Note:** Entering your vehicle while the liftgate is closing can cause your vehicle to bounce and activate obstacle detection. To prevent this, let the power liftgate close completely before you enter your vehicle. Before driving off, check the instrument cluster for a liftgate or door ajar message or warning indicator. Failure to do this could result in unintentionally leaving the liftgate open while driving.

### When Opening

The system stops when it detects an obstacle and two short tones sound. Once you remove the obstacle, you can continue to operate the liftgate.

### Hands-Free Feature (If Equipped)

Make sure you have an intelligent access transmitter within 3 ft (1 m) of the liftgate.



E174120

1. Move your foot under and away from the rear bumper detection area in a single-kick motion. Do not move your foot sideways or the sensors may not detect the motion.
2. The liftgate powers open or close.

# Locks

---

**Note:** *Allow the power system to open the liftgate. Manually pushing or pulling the liftgate may activate the system's obstacle detection feature and stop the power operation or reverse its direction. Manually interfering with the liftgate motion may also replicate a gas strut failure.*

**Note:** *Splashing water may cause the hands-free liftgate to open. Keep the intelligent access key away from the rear bumper detection area when washing your vehicle.*

# Security

## PASSIVE ANTI-THEFT SYSTEM

### SecuriLock®

The system helps prevent your vehicle from starting unless you use a coded key programmed to your vehicle. Using the wrong key may prevent your vehicle from starting. A message may appear in the information display.

If you are unable to start your vehicle with a correctly coded key, a malfunction has happened. A message may appear in the information display.

**Note:** *The system is not compatible with non-Ford aftermarket remote start systems. Use of these systems may result in vehicle starting problems and a loss of security protection.*

**Note:** *Metallic objects, electronic devices or a second coded key on the same key chain may cause vehicle starting issues if they are too close to the key when starting your vehicle. Prevent these objects from touching the coded key while starting the engine. Switch the ignition off, move all objects on the key chain away from the coded key and restart your vehicle if a problem occurs.*

**Note:** *Do not leave a duplicate coded key in your vehicle. Always take your keys and lock all doors when leaving your vehicle.*

### Automatic Arming

Your vehicle arms immediately after you switch the ignition off.

### Automatic Disarming

Switching the ignition on with a coded key disarms your vehicle.

### Replacement Keys

**Note:** *Your vehicle comes equipped with two integrated keyhead transmitters or two intelligent access keys.*

The integrated keyhead transmitter functions as a programmed ignition key that operates all the locks and starts your vehicle, as well as a remote control.

The intelligent access key functions as a programmed key that operates the driver door lock and activates the intelligent access with push button start system, as well as a remote control.

If your programmed transmitters or standard SecuriLock coded keys (integrated keyhead transmitters only) are lost or stolen and you do not have an extra coded key, you will need to have your vehicle towed to an authorized dealer. You need to erase the key codes from your vehicle and program new coded keys.

Store an extra programmed key away from your vehicle in a safe place to help prevent any inconveniences. See your authorized dealer to purchase additional spare or replacement keys.

### Programming a Spare Integrated Keyhead Transmitter

**Note:** *You can program a maximum of eight coded keys to your vehicle. All eight can be integrated keyhead transmitters.*

You can program your own integrated keyhead transmitter or standard SecuriLock coded keys to your vehicle. This procedure will program both the vehicle immobilizer keycode and the remote entry portion of the remote control to your vehicle

Only use integrated keyhead transmitters or standard SecuriLock keys.

# Security

---

You must have two previously programmed coded keys and the new unprogrammed key readily accessible. See your authorized dealer to have the spare key programmed if two previously programmed coded keys are not available.

Read and understand the entire procedure before you begin.

1. Insert the first previously programmed coded key into the ignition.
2. Switch the ignition from off to on. Keep the ignition on for at least three seconds, but no more than 10 seconds.
3. Switch the ignition off and remove the first coded key from the ignition.
4. After three seconds but within 10 seconds of switching the ignition off, insert the second previously coded key into the ignition.
5. Switch the ignition from off to on. Keep the ignition on for at least three seconds, but no more than 10 seconds.
6. Switch the ignition off and remove the second previously programmed coded key from the ignition.
7. After three seconds but within 10 seconds of switching the ignition off and removing the previously programmed coded key, insert the new unprogrammed key into the ignition.
8. Switch the ignition from off to on. Keep the ignition on for at least six seconds.
9. Remove the newly programmed coded key from the ignition.

If the key has been successfully programmed it will start your vehicle and operate the remote entry system (if the new key is an integrated keyhead transmitter).

If programming was not successful, wait 10 seconds and repeat Steps 1 through 8. If you are still unsuccessful, take your vehicle to your authorized dealer.

## Programming a Spare Intelligent Access Key

See your authorized dealer to have additional keys programmed to your vehicle.

## ANTI-THEFT ALARM (If Equipped)

The system warns you of an unauthorized entry to your vehicle. It triggers if any door, the luggage compartment or the hood opens without using the key or remote control.

The direction indicators flash and the horn sounds if unauthorized entry is attempted while the alarm is armed.

Take all remote controls to an authorized dealer if there is any potential alarm problem with your vehicle.

### Arming the Alarm

The alarm is ready to arm when there is not a key in the ignition. Electronically lock the vehicle to arm the alarm.

### Disarming the Alarm

Disarm the alarm by any of the following actions:

- Unlock the doors or luggage compartment with the remote control or keyless entry keypad.
- Switch the ignition on or start the vehicle.
- Use a key in the driver's door to unlock the vehicle, then switch the ignition on within 12 seconds.

**Note:** *Pressing the panic button on the remote control will stop the horn and signal indicators, but will not disarm the system.*

# Steering Wheel

## ADJUSTING THE STEERING WHEEL

### WARNING



Do not adjust the steering wheel when your vehicle is moving.

**Note:** Make sure that you are sitting in the correct position. See **Sitting in the Correct Position** (page 112).



E95178

1. Unlock the steering column.
2. Adjust the steering wheel to the desired position.



E95179

3. Lock the steering column.

## AUDIO CONTROL (If Equipped)

Select the required source on the audio unit.

You can operate the following functions with the control:

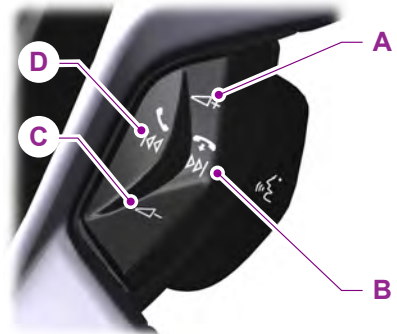

E129463

- A Volume up.
- B Seek up or next.

# Steering Wheel

- C Volume down.
- D Seek down or previous.

## Seek, Next or Previous

Press the seek button to:

- Tune the radio to the next or previous stored preset.
- Play the next or the previous track.

Press and hold the seek button to:

- Tune the radio to the next station up or down the frequency band.
- Seek through a track.

## VOICE CONTROL (If Equipped)



E129464

Pull the control to select or deselect voice control.

## CRUISE CONTROL



E142437

See **Cruise Control** (page 175).

## INFORMATION DISPLAY CONTROL



E130248

See **Information Displays** (page 91).

# Steering Wheel

---

## Multimedia Controls



E145434

Use the arrows on the right side of the steering wheel to navigate through the information display menus. Press **OK** to make a selection.



# Wipers and Washers

## WINDSHIELD WIPERS

**Note:** Fully defrost the windshield before switching on the windshield wipers.

**Note:** Make sure the windshield wipers are switched off before entering a car wash.

**Note:** Clean the windshield and wiper blades if they begin to leave streaks or smears. If that does not resolve the issue, install new wiper blades.

**Note:** Do not operate the wipers on a dry windshield. This may scratch the glass, damage the wiper blades or cause the wiper motor to burn out. Always use the windshield washers before wiping a dry windshield.

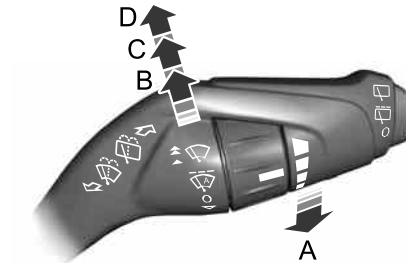

E168040

- A Single wipe
- B Intermittent wipe
- C Normal wipe
- D High speed wipe

## Intermittent Wipe

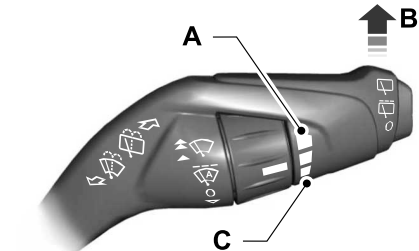

E168041

- A Short wipe interval
- B Intermittent wipe
- C Long wipe interval

Use the rotary control to adjust the intermittent wipe interval.

## Speed dependent wipers (if equipped)

When your vehicle speed increases, the interval between wipes will decrease.

## AUTOWIPERS (If Equipped)

**Note:** Fully defrost the windshield before switching on the windshield wipers.

**Note:** Make sure you switch off the windshield wipers before entering a car wash.

**Note:** Clean the windshield and wiper blades if they begin to leave streaks or smears. If that does not resolve the issue, install new wiper blades.

**Note:** If you switch on the autolamps with the autowipers, the low beam headlamps will turn on automatically when the rain sensor turns on the windshield wipers continuously.

# Wipers and Washers

**Note:** During wet or winter driving conditions with ice, snow or a salty road mist, inconsistent or unexpected wiping or smearing may occur.

In these conditions, you can do the following:

- Lower the sensitivity of the autowipers to reduce the amount of smearing.
- Switch to normal or high-speed wipe.
- Switch the autowipers off.

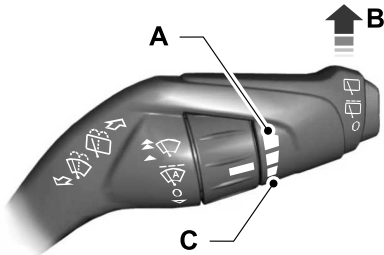

E168041

- A High sensitivity
- B On
- C Low sensitivity

The autowipers feature uses a rain sensor that is located in the area around the interior rear view mirror. The rain sensor monitors the amount of moisture on the windshield and automatically turns the wipers on. It will adjust the wiper speed by the amount of moisture that the sensor detects on the windshield.

Use the rotary control to adjust the sensitivity of the rain sensor. Set the control to low sensitivity, and the wipers will turn on when the rain sensor detects a large amount of moisture on the windshield. Set the control to high sensitivity, and the wipers will turn on when the rain sensor detects a small amount of moisture on the windshield.

Keep the outside of the windshield clean. The rain sensor is very sensitive. Dirt or debris around the interior rear view mirror area will affect the autowipers' performance. For example, the autowipers may turn on if dirt, mist or insects hit the windshield.

## REAR WINDOW WIPER AND WASHERS

### Rear Window Wiper



E168043

- A Intermittent wipe
- B Low-speed wipe
- C Off

Press the top of the button at the end of the lever to switch on the intermittent wiper. Press the button again to switch on low-speed wipe. Press the bottom of the button to switch the wiper off, or to change the wiper speed from low-speed to intermittent.

When you shift into R (Reverse), the rear wiper will turn on to intermittent if the front wipers are activated.

# Wipers and Washers

---

## Rear Window Washer

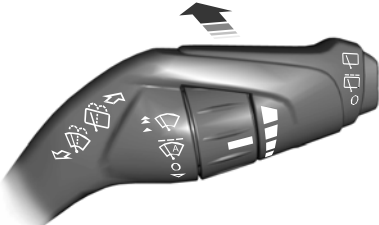

E168044

To use the rear washer function, push the lever away from you. When you release the lever, the wiper will operate for a short time.

# Lighting

## LIGHTING CONTROL



E142449

- A Off
- B Parking lamps, instrument panel lamps, license plate lamps and tail lamps
- C Headlamps

## High Beams



E162679

Push the lever forward to switch the high beams on.

Push the lever forward again or pull the lever toward you to switch the high beams off.

## Headlamp Flasher



E162680

Pull the lever toward you slightly and release it to flash the headlamps.

## AUTOLAMPS (If Equipped)

### WARNING



The autolamps switch position may not activate the headlamps in all low visibility conditions, such as daytime fog. Always ensure that your headlamps are switched to auto or on, as appropriate, during all low visibility conditions. Failure to do so may result in a collision.



E142451

When the lighting control is in the autolamps position, the headlamps automatically turn on in low light situations or when the wipers activate.

# Lighting

If equipped, the following also activate when the lighting control is in the autolamps position and you switch them on in the information display:

- Configurable daytime running lamps.
- Automatic high beam control.
- Adaptive headlamp control.

The headlamps remain on for a period of time after you switch the ignition off. Use the information display controls to adjust the period of time that the headlamps remain on. See **Information Displays** (page 91).

**Note:** *With the headlamps in the autolamps position, you cannot switch the high beam headlamps on until the autolamps system turns the low beam headlamps on.*

## Windshield Wiper Activated Headlamps

The windshield wiper activated headlamps turn on within 10 seconds when you switch the windshield wipers on and the lighting control is in the autolamps position. They turn off approximately 60 seconds after you switch the windshield wipers off.

The headlamps will not turn on by wiper activation:

- During a mist wipe.
- When the wipers are on to clear washer fluid during a wash condition.
- If the wipers are in intermittent mode.

**Note:** *If you switch autolamps and autowipers on, the headlamps will automatically turn on when the windshield wipers continuously operate.*

## INSTRUMENT LIGHTING DIMMER

**Note:** *If you disconnect the battery or it becomes discharged, the illuminated components will switch to the maximum setting.*

### Vehicles With Front Fog Lamps



E132712

Press repeatedly or press and hold until the desired level is reached.

# Lighting

## Vehicles Without Front Fog Lamps



E165366

- A Press repeatedly or press and hold to dim.
- B Press repeatedly or press and hold to brighten.

## HEADLAMP EXIT DELAY

After you switch the ignition off, you can switch the headlamps on by pulling the direction indicator lever toward you. You will hear a short tone. The headlamps will switch off automatically after three minutes with any door open or 30 seconds after the last door has been closed. You can cancel this feature by pulling the direction indicator toward you again or switching the ignition on.

## DAYTIME RUNNING LAMPS (If

Equipped)

### WARNING



The daytime running lamps system does not activate the rear lamps and may not provide adequate lighting during low visibility driving conditions. Also, the autolamps switch position may not activate the headlamps in all low visibility conditions, such as daytime fog. Make sure the headlamps are switched to auto or on, as appropriate, during all low visibility conditions. Failure to do so may result in a crash.

### Type 1 - Conventional (Non-Configurable)

The daytime running lamps turn on when:

1. The ignition is switched to the on position.
2. The transmission is not in park (P) for vehicles with automatic transmissions or the parking brake is released for vehicles with manual transmissions.
3. The lighting control is in the off, parking lamp or autolamps positions.
4. The headlamps are off.

### Type 2 - Configurable

Switch the daytime running lamps on or off using the information display controls. See **Information Displays** (page 91).

The daytime running lamps turn on when:

1. They are switched on in the information display. See **Information Displays** (page 91).
2. The ignition is switched to the on position.

# Lighting

3. The transmission is not in park (P) for vehicles with automatic transmissions or the parking brake is released for vehicles with manual transmissions.
4. The lighting control is in the autolamps position.
5. The headlamps are off.

The other lighting control switch positions do not activate the daytime running lamps, and you can use them to temporarily override autolamp control.

When switched off in the information display, the daytime running lamps are off in all lighting control switch positions.

## FRONT FOG LAMPS



E142453

Press the control to switch the fog lamps on or off.

You can switch the fog lamps on when the lighting control is in any position except Off and the high beams are not on.

## DIRECTION INDICATORS



E162681

Push the lever up or down to use the direction indicators.

**Note:** Tap the lever up or down to make the direction indicators flash three times to indicate a lane change.

## INTERIOR LAMPS

The lamps will switch on when one of the following conditions have been met:

- You open any door.
- You press a remote control button.
- You press switch B on the front interior lamp.

### Front Interior Lamp (If Equipped)

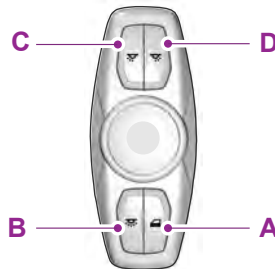

E161163

# Lighting



(A) Door function switch. Press this switch to disable the interior lamps. The door function indicator lamp will illuminate yellow with lamps disabled. Press the switch again to turn interior lamps back on. The indicator lamp will illuminate blue.



(B) All lamps on and off switch.



(C) Passenger individual lamp on and off switch.



(D) Driver individual lamp on and off switch.

## Front Interior Lamp - With Panorama Roof (If Equipped)

### Driver Side Lamp

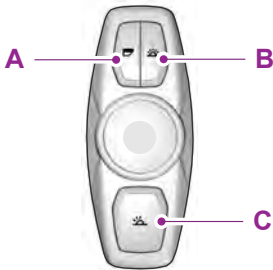

E142454



(A) Door function switch. Press this switch to disable the interior lamps. The door function indicator lamp will illuminate yellow with lamps disabled. Press the switch again to turn interior lamps back on. The indicator lamp will illuminate blue.



(B) All lamps on and off switch.



(C) Individual lamp on and off switch.

## Passenger Side Lamp



E142455



(A) Individual lamp on and off switch.

## Rear Interior Lamp (If Equipped)

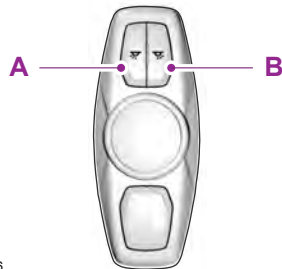

E190496



(A) Passenger side lamp on and off switch.



(B) Driver side lamp on and off switch.

## AMBIENT LIGHTING (If Equipped)

The ambient lighting system illuminates the interior with a choice of several colors. The ambient lighting control is located in the overhead console.



# Lighting

---

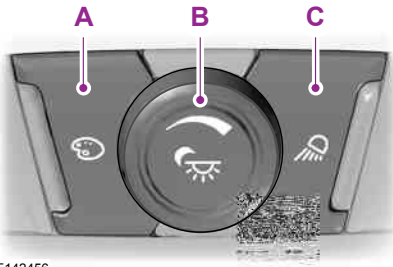

E142456

- A Color palette
- B Control knob
- C Search mode

Rotate B past the first detent to switch on and adjust to the desired brightness.

Press A to cycle through the color choices.

Press C to switch on all interior lamps and the ambient lighting. Press C again to switch off the interior lamps and return the ambient lighting to the previously selected color.

The ambient lighting will switch on when the following conditions have been met:

- you switch the ignition on
- you switch the headlamps on

The ambient lighting will remain on until you switch the ignition off and one of the following conditions have been met:

- you lock your vehicle
- the accessory delay timer expires.

# Windows and Mirrors

## POWER WINDOWS

### WARNINGS



Do not leave children unattended in your vehicle and do not let them play with the power windows. They may seriously injure themselves.



When closing the power windows, you should verify they are free of obstructions and make sure that children and pets are not in the proximity of the window openings.



E70848

**Note:** You may hear a pulsing noise when just one of the windows is open. Lower the opposite window slightly to reduce this noise.

Press the switch to open the window.

Lift the switch to close the window.

### One-Touch Down

Press the switch fully and release it. Press again or lift it to stop the window.

### One-Touch Up

Lift the switch fully and release it. Press or lift it again to stop the window.

## Window Lock



E70850

Press the control to lock or unlock the rear window controls. It illuminates when you lock the rear window controls.

### Bounce-Back (If Equipped)

The window will stop automatically while closing. It will reverse some distance if there is an obstacle in the way.

### Overriding the Bounce-Back Feature

#### WARNING



When you override the bounce-back feature the window will not reverse if it detects an obstacle. Take care when closing the windows to avoid personal injury or damage to your vehicle.

Proceed as follows to override this protection feature when there is a resistance, for example in winter:

1. Close the window twice until it reaches the point of resistance and let it reverse.

# Windows and Mirrors

---

2. Close the window a third time to the point of resistance. The bounce-back feature is now disabled and you can close the window manually. The window will go past the point of resistance and you can close it fully.

See an authorized dealer as soon as possible if the window does not close after the third attempt.

## Resetting the Bounce-Back Feature

### WARNING



The bounce-back feature remains turned off until you reset the memory.

---

If you have disconnected the battery, you must reset the bounce-back memory separately for each window.

1. Lift and hold the switch until the window is fully closed.
2. Release the switch.
3. Lift the switch again for one more second.
4. Press and hold the switch until the window is fully open.
5. Release the switch.
6. Lift and hold the switch until the window is fully closed.
7. Open the window and then try to close it automatically.
8. Reset and repeat the procedure if the window does not close automatically.

## Accessory Delay (If Equipped)

You can use the window switches for several minutes after you switch the ignition off or until you open either front door.

## GLOBAL OPENING

You can use the remote control to operate the windows with the ignition off.

**Note:** *To operate this feature, accessory delay must not be active.*

## Opening the Windows

You can use the global opening feature to open the windows only for a short time after you unlock your vehicle by using the remote control.

To use the global opening feature:

1. Press and release the remote control unlock button.
2. Press the remote control unlock button again and hold it for approximately three seconds. Release the control when the windows begin to open.
3. Press the lock or unlock button on your remote control to stop the window opening function.

**Note:** *Contact an authorized Ford dealer to deactivate this feature.*

## EXTERIOR MIRRORS

### Power Exterior Mirrors

#### WARNING



Do not adjust the mirrors when your vehicle is moving.

---

# Windows and Mirrors

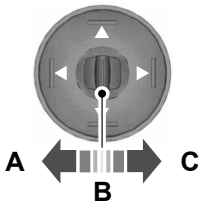

E70846

- A Left-hand mirror
- B Off
- C Right-hand mirror

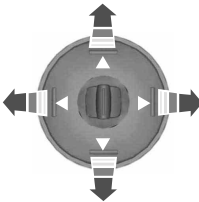

E70847

Press the arrows to adjust the mirror.

## Fold-Away Exterior Mirrors

Push the mirror toward the door window glass. Make sure that you fully engage the mirror in its support when returning it to its original position.

## Signal Indicator Mirrors

The outer portion of the appropriate mirror housing blinks when you activate the turn signal.

## Heated Exterior Mirrors (If Equipped)

See **Heated Windows and Mirrors** (page 110).

## Integrated Blind Spot Mirrors

### WARNING



Objects in the blind spot mirror are closer than they appear.

Blind spot mirrors have an integrated convex mirror built into the upper outboard corner of the exterior mirrors. They are designed to increase your visibility along the side of your vehicle.

Check the main mirror first before a lane change, then check the blind spot mirror. If no vehicles are present in the blind spot mirror and the traffic in the adjacent lane is at a safe distance, signal that you intend to change lanes. Glance over your shoulder to verify traffic is clear and carefully change lanes.

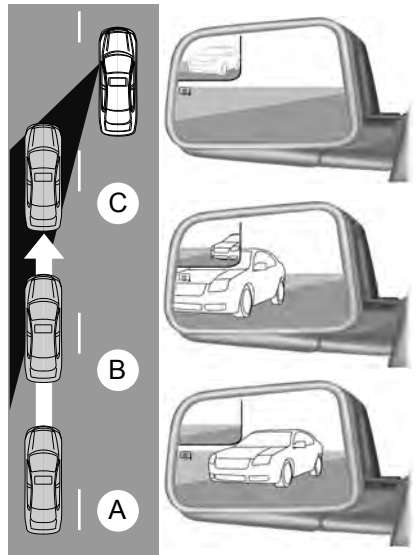

E138665

# Windows and Mirrors

The image of the approaching vehicle is small and near the inboard edge of the main mirror when it is at a distance. The image becomes larger and begins to move outboard across the main mirror as the vehicle approaches (A). The image will transition from the main mirror and begin to appear in the blind spot mirror as the vehicle approaches (B). The vehicle will transition to your peripheral field of view as it leaves the blind spot mirror (C).

## INTERIOR MIRROR

### WARNING



Do not adjust the mirror when your vehicle is moving.

**Note:** Do not clean the housing or glass of any mirror with harsh abrasives, fuel or other petroleum or ammonia-based cleaning products.

You can adjust the interior mirror to your preference. Some mirrors also have a second pivot point. This lets you move the mirror head up or down and from side to side.

Pull the tab below the mirror toward you to reduce glare at night.

### Auto-Dimming Mirror (If Equipped)

**Note:** Do not block the sensors on the front and back of the mirror. Mirror performance may be affected. A rear center passenger or raised rear center head restraint may also block light from reaching the sensor.

The mirror will dim automatically to reduce glare when bright lights are detected from behind your vehicle. It will automatically return to normal reflection when you select reverse gear to make sure you have a clear view when backing up.

## SUN VISORS

### Illuminated Vanity Mirror (If Equipped)

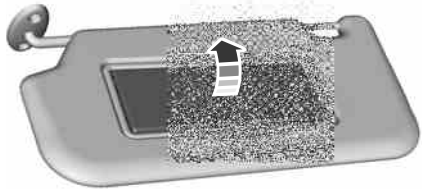

E162197

Lift the cover to switch the lamp on.

## SUN SHADES (If Equipped)

### WARNINGS



Do not let children play with the sun shade or leave them unattended in the vehicle. They may seriously hurt themselves.



When closing the sun shade, you should verify that it is free of obstructions and make sure that children and pets are not in the proximity of the sunshade.

The control is located in the overhead console.

The sun shade has a one-touch open and close feature. To stop motion during one-touch operation, press the control a second time.

# Windows and Mirrors

## Opening and Closing the Sun Shade



E138668

Fully press and release the front of the control to open the sun shade.

Fully press and release the rear of the control to close the sun shade.

### Bounce-Back

The sun shade will stop automatically while closing. It will reverse some distance if there is an obstacle in the way.

### Sun Shade Relearning

#### WARNING



The bounce-back function is not active during this procedure. Make sure that there are no obstacles in the way of the moving sun shade.

**Note:** You must start the relearning process within 30 seconds of switching the ignition on.

In case the sun shade no longer opens or closes properly, follow this relearning procedure:

1. Press the front of the control to the first action point twice and release it within two seconds.
2. Press the rear of the control to the first action point twice and release it within two seconds.
3. Press and hold the front of the control to the first action point, until the sun shade fully opens.

4. Press and hold the rear of the control to the first action point, until the sun shade fully closes.

If you do not complete Step 2 within 15 seconds of Step 1, the relearning function ends. Switch the ignition off, wait for another 30 seconds and then switch the ignition back on again. Start the procedure again from the beginning.

Confirm that relearning was successful by opening and closing the sun shade.

# Instrument Cluster

## GAUGES

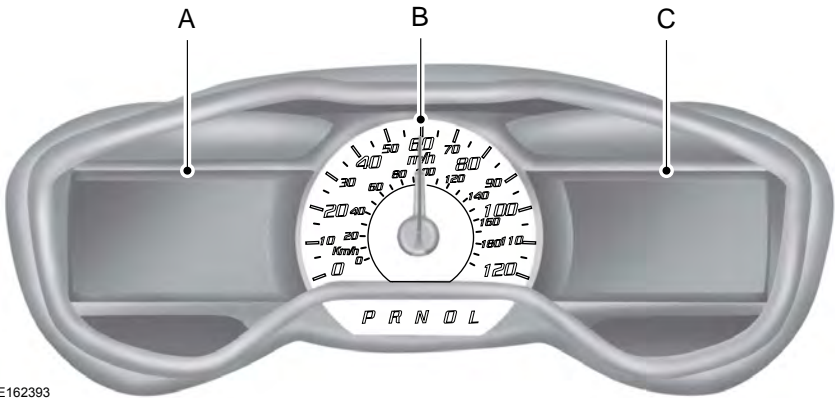

E162393

- A Left Information Display
- B Speedometer
- C Right Information Display

### Left Information Display

#### Odometer

Located in the bottom of the information display Registers the accumulated distance your vehicle has traveled.

#### Battery Gauge:

**Note:** For Energi vehicles there are two versions of the battery gauge. When your vehicle is in hybrid mode, a simple battery graphic displays your battery information. When your vehicle is in plug-in power mode, an enhanced battery graphic displays your battery information.

The high voltage battery gauge provides Charge Fill (State of Charge), Charge Assist, Regen Active and Electric Range (Energi only) information.

#### Charge Fill (Hybrid Mode)

The fill level, or State of Charge indicates the amount of energy stored in the high voltage battery as a percent of total energy capacity. The level will increase or decrease as the battery charges and discharges during normal operation.

#### Charge Fill (Energi Plug-in Power Mode)

The fill level indicates the amount of energy stored in the high voltage battery which is available for Plug-in Power Mode. A full fill represents the total amount of energy you can get from an external charge (plugging your vehicle in). When the fill reaches empty your vehicle will automatically enter Hybrid Mode.

# Instrument Cluster

## Charge Assist

The up and down arrows provide information about the energy going into and out of the high voltage battery. The up arrow above the battery indicates battery charging such as from regenerative braking. The down arrow below the battery indicates battery discharging to provide power for propulsion or vehicle accessories.

## Regen Active

A circular arrow symbol appears in the center of the battery gauge when energy is being recaptured through the regenerative braking system.

This feature can be switched on or off in the information displays settings menu. See **General Information** (page 91).

## Fuel Gauge:

**Note:** *The fuel gauge may vary slightly when your vehicle is moving or on a gradient.*

Switch the ignition on. The fuel gauge will indicate approximately how much fuel is left in the fuel tank. The arrow adjacent to the fuel pump symbol indicates on which side of your vehicle the fuel filler door is located.

The needle should move toward F when you refuel your vehicle. If the needle points to E after adding fuel, this indicates your vehicle needs service soon.

After refueling some variability in needle position is normal:

- It may take a short time for the needle to reach F after leaving the gas station. This is normal and depends upon the slope of pavement at the gas station.
- The fuel amount dispensed into the tank is a little less or more than the gauge indicated. This is normal and depends upon the slope of pavement at the gas station.
- If the gas station nozzle shuts off before the tank is full, try a different gas pump nozzle.

## Low Fuel Reminder

A low fuel reminder triggers when the fuel gauge needle is at 1/16th.

## Variations:

Driving type (fuel economy conditions)	Fuel gauge position	Distance-to-empty
Highway driving	1/16th	35 miles to 80 miles (56 km to 129 km)
Severe duty driving (trailer towing, extended idle)	1/16th	35 miles (56km)

## Vehicle Settings and Personalization

### Display/Trip

See **General Information** (page 91).

### Information

See **General Information** (page 91).

### Settings

See **General Information** (page 91).



# Instrument Cluster

---

## Brake Coach Display:

The Brake Coach appears after the vehicle has come to a stop. It coaches you to brake in a manner which maximizes the amount of energy returned through the regenerative braking system. The percent displayed is an indication of the regenerative braking efficiency with 100% representing the maximum amount of energy recovery.

This feature can be switched on or off in the information displays settings menu. See **General Information** (page 91).

## Trip Summary:

Trip Summary displays upon shutting off your vehicle. The information is cumulative over the last trip. A new trip begins each time you start your vehicle (when the Ready to Drive message comes on). Corresponding trip efficiency leaves appear on the right information display.

- Distance - Displays the total distance traveled, distance traveled on battery power only (EV distance) and Regen distance. Regen distance is the estimated range gained from energy recaptured through regenerative braking.
- Energy Use - Displays the average fuel economy. In addition for Energi, displays the total electrical energy used while in Plug-in Power Mode in kilowatt hours (kWh).
- Brake Score - The percent displayed is an indication of the regenerative braking efficiency for the trip.

## Right Information Display

### Entertainment

See **General Information** (page 336).

### Phone

See **General Information** (page 336).

## Navigation or Compass

See **General Information** (page 336).

## Fuel Economy

See **General Information** (page 91).

## Vehicle Range

Vehicle range indicates the estimated distance your vehicle will travel with the energy currently onboard.

- For Energi vehicles the range is the total of the range available in Hybrid Mode fueled by gasoline, plus the electric range available in Plug-in Power Mode.
- For Hybrid vehicles the range shown is the estimated distance to empty based on the fuel remaining in the tank.

Changes in driving pattern and climate control use will cause the value to vary.

## Trip Efficiency Leaves

Trip Efficiency Leaves display upon shutting off your vehicle. The number of leaves represent the average for the last trip. A new trip begins each time you start your vehicle (when the Ready to Drive message comes on). Corresponding Trip Summary data displays on the left information display.

## WARNING LAMPS AND INDICATORS

The following warning lamps and indicators will alert you to a vehicle condition that may become serious. Some lamps will light when you start your vehicle to make sure they work. If any lamps remain on after starting your vehicle, refer to the respective system warning lamp for further information.

# Instrument Cluster

**Note:** Some warning indicators appear in the information display and function the same as a warning lamp but do not display when you start your vehicle.

## Anti-Lock Braking System



If it lights when you are driving, this indicates a malfunction. You will continue to have normal braking (without anti-lock braking system) unless the brake system warning lamp also lights. Have the system checked by an authorized dealer.

## Battery



If it lights while driving, this indicates a malfunction. Switch off all unnecessary electrical equipment and have the system checked by an authorized dealer immediately.

## Brake System



Lights when you engage the parking brake with the ignition on.

If it lights when you are driving, check that you do not have the parking brake engaged. If you do not have the parking brake engaged, this indicates low brake fluid level or a brake system malfunction. Have the system checked immediately by an authorized dealer.

### WARNING



Driving your vehicle with the warning lamp on is dangerous. A significant decrease in braking performance may occur. It will take you longer to stop your vehicle. Have your vehicle checked by your authorized dealer immediately. Driving extended distances with the parking brake engaged can cause brake failure and the risk of personal injury.

## Cruise Control (If Equipped)



Lights when you switch on this feature.

## Direction Indicator



Lights when you switch on the left or right direction indicator or hazard warning flasher. If the indicators stay on or flash faster, check for a burned out bulb. See **Changing a Bulb** (page 227).

## Door Ajar



Displays when the ignition is on and any door is not completely closed.

## Engine and Motor Coolant Temperature



Lights when the engine or motor coolant temperature is high. Stop the vehicle as soon as possible, switch off the engine and let cool.

## Engine Oil



If it lights with the engine running or while you are driving, this indicates a malfunction. Stop your vehicle as soon as it is safe to do so and switch off the engine. Check the engine oil level. See **Engine Oil Check** (page 217).

**Note:** Do not resume your journey if it lights despite the level being correct. Have the system checked by an authorized dealer immediately.

## EV Now



Lights when you select this feature on. See **Hybrid Electric Vehicle** (page 132).

# Instrument Cluster

## EV Later



Lights when you select this feature on. See **Hybrid Electric Vehicle** (page 132).

## Fasten Safety Belt



It will light and a tone will sound to remind you to fasten your safety belt. See **Safety Belt**

**Minder** (page 31).

## Front Airbag



If it fails to light when you start your vehicle, continues to flash or remains on, this indicates a malfunction. Have the system checked by an authorized dealer.

## Front Fog Lamps (If Equipped)



Lights when you switch the front fog lamps on.

## High Beam



Lights when you switch the high beam headlamps on. It will flash when you use the headlamp flasher.

## Liftgate Ajar



Lights when the liftgate is not completely closed.

## Low Battery (If Equipped)



Lights when the battery level is low. You may also see a message suggesting you reduce your usage of the climate system.

## Low Fuel Level



Lights when the fuel level is low or the fuel tank is nearly empty. Refuel as soon as possible.

## Low Tire Pressure Warning



Lights when your tire pressure is low. If the lamp remains on with the engine running or when driving, check your tire pressure as soon as possible.

It also lights momentarily when you switch on the ignition to confirm the lamp is functional. If it does not light when you switch on the ignition, or begins to flash at any time, have the system checked by an authorized dealer.

## Overdrive Cancel and Grade Assist (If Equipped)



Lights when the overdrive function in the transmission turns off and the grade assist turns on.

## Parking Lamps



Lights when you switch the parking lamps on.

## Powertrain Fault



Lights when the system detects a powertrain or high-voltage charge system fault. If the indicator stays on or continues to come on, contact an authorized dealer as soon as possible.

# Instrument Cluster

**Note:** If your vehicle detects certain faults, it will not allow you to operate the accelerator pedal. If this happens, press the brake pedal and release it. This will activate limp home vehicle operation. In limp home vehicle operation, your vehicle will accelerate in a controlled manner up to a maximum speed of 35 mph (56 km/h) on a flat surface. If you apply the brake pedal or move the transmission to neutral (N) you can override your vehicle's acceleration.

## Ready to Drive



Lights after your switch your vehicle on and it is ready to drive. A corresponding message may display stating ready to drive.

## Service Engine Soon



If the service engine soon indicator light stays on after you switch on the engine, this indicates that the On-Board Diagnostics system (OBD) has detected a malfunction of the vehicle emissions control system. Refer to On-Board diagnostics (OBD) in the Fuel and Refueling chapter for more information about having your vehicle serviced. See **Emission Control System** (page 146).

If the light is blinking, engine misfire is occurring which could damage your catalytic converter. Drive in a moderate fashion (avoid heavy acceleration and deceleration) and have your vehicle serviced immediately.

### WARNING



Under engine misfire conditions, excessive exhaust temperatures could damage the catalytic converter, the fuel system, interior floor coverings or other vehicle components, possibly causing a fire. Have an authorized dealer service your vehicle immediately.

The service engine soon indicator lights when you first switch on the ignition prior to engine start to check the bulb and to indicate whether the vehicle is ready for Inspection and Maintenance testing.

Normally, the service engine soon light will stay on until you switch on the engine, then turn itself off if no malfunctions are present. However, if after 15 seconds the service engine soon light blinks eight times, it means that the vehicle is not ready for Inspection and Maintenance testing. See **Emission Control System** (page 146).

## Stability Control



Lights when the system is active. If it remains on or does not light when you switch the ignition on, this indicates a malfunction. During a malfunction, the system will turn off. Have the system checked by an authorized dealer immediately. See **Using Stability Control** (page 165).

## Stability Control Off



Lights when you switch the system off. It will go out when you switch the system back on or when you switch the ignition off. See **Using Stability Control** (page 165).

## Stop Safely



Indicates an electrical component fault or failure that will cause the vehicle to shutdown or enter into a limited operating mode. A message may also display.

## Vehicle Plugged in (If Equipped)



Lights after you plug in your vehicle. A corresponding message may display after attempting to start the vehicle.

# Instrument Cluster

---

## AUDIBLE WARNINGS AND INDICATORS

### Key in Ignition Warning Chime

Sounds when you open the driver's door and you have left the key in the ignition.

### Engine On Warning Chime

A warning chime will sound when any door is opened if the vehicle exceeds a relatively low speed.

### Keyless Warning Alert *(If Equipped)*

Sounds the horn twice when you exit the vehicle and the keyless vehicle is in RUN, indicating the vehicle is still on.

### Headlamps On Warning Chime

Sounds when you remove the key from the ignition and open the driver's door and you have left the headlamps or parking lamps on.

### Parking Brake On Warning Chime

Sounds when you have left the parking brake on and drive your vehicle. If the warning chime remains on after you have released the parking brake, have the system checked by your authorized dealer immediately.

### Automatic Transmission Warning Chime

Sounds when you have not moved the transmission selector lever to position **P**. A message will be shown in the display.

# Information Displays

## GENERAL INFORMATION

### WARNING



Driving while distracted can result in loss of vehicle control, crash and injury. We strongly recommend that you use extreme caution when using any device that may take your focus off the road. Your primary responsibility is the safe operation of your vehicle. We recommend against the use of any hand-held device while driving and encourage the use of voice-operated systems when possible. Make sure you are aware of all applicable local laws that may affect the use of electronic devices while driving

Various systems on your vehicle can be controlled using the information display controls on the steering wheel. Corresponding information is displayed in the information display.

## Left Information Display Controls

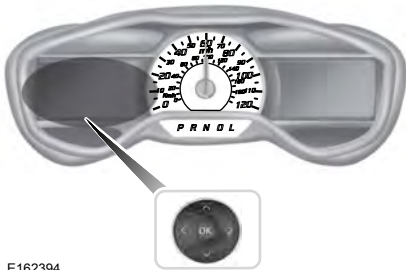

E162394

- Press the up and down arrow buttons to scroll through and highlight the options within a menu.
- Press the right arrow button to enter a sub-menu.
- Press the left arrow button to exit a menu.
- Press and hold the left arrow button at any time to return to the main menu display (escape button).
- Press the **OK** button to choose and confirm settings or messages.

## Main menu

From the main menu bar on the left side of the information display, you can choose from the following categories:



Display/Trip



Information



Settings

Scroll up or down to highlight one of the categories, and then press the right arrow key or **OK** to enter into that category. Press the left arrow key as needed to exit back to the main menu.

## Display/Trip



Use the up or down arrow buttons to choose between the following display options.

**Note:** *The cluster will remember the menu level 2 state when you change the key state from the RUN to the OFF position.*

# Information Displays

Display/Trip			
Menu level 2	Menu level 3	Menu level 4	Menu level 5
Engage (Split Power + Avg Fuel Economy + Battery Gauge + Fuel Gauge)	Help	—	—
Empower (Power (with engine on/off threshold) + Avg Fuel Economy + Battery Gauge + Fuel Gauge)	Help	—	—
MyView (MyView + Battery Gauge + Fuel Gauge)	Change MyView	Vehicle Range	Vehicle Range
		Average Fuel	Average Fuel
		Split Power	Instantaneous Fuel
		Power + Threshold	Coolant Temp
		Tach rpm x 1000 + Avg Fuel	Accessory Power
		Accessory Power	Trip 1
		Trip 1	Trip 2
		Trip 2	Fuel History
		Fuel History	Coach
		Coach	Blank
		Blank	—
—	—		

# Information Displays

Display/Trip			
	Help	—	—
<b>Energy Use (Energy only)</b> Auto EV (consumption gauge + climate power gauge + battery gauge + fuel gauge) EV Now (consumption gauge with budget cup + climate power gauge + engine enable + battery gauge + fuel gauge) EV Later (consumption gauge + climate power gauge + battery gauge + fuel gauge)	Help	—	—
Trip 1 & 2: Trip Data + Battery Gauge + Fuel Gauge	Help	—	—

## Engage

Engage provides separate gauges for engine power and high voltage battery power in kilowatts (kW). The engine power gauge fill is white and the high voltage battery power gauge fill is blue. You can also see an instantaneous fuel economy gauge. When your vehicle is operating on battery power only, you will see EV displayed and the gauges will appear in blue.

## Empower

Empower provides a power demand gauge in kilowatts (kW) which includes an engine on or off threshold.

- When your vehicle is operating with battery power only (below the threshold), you will see EV displayed and the gauge fill is blue.
- When your vehicle is operating with both the engine and the high voltage battery providing power the gauge fill is white.
- When power demand surpasses the amber indicator, this level of demand and associated fuel economy displays in amber.
- When the engine is on, reducing power demand to less than the threshold will allow the engine to turn off.

You can also see an instantaneous fuel economy gauge.



# Information Displays

---

**Note:** You can reset your average fuel economy by pressing and holding the **OK** button on the left hand steering wheel controls.

## MyView

You can choose what to display in this view. Selecting **Change MyView** in the options menu allows you to scroll through two columns of content choices.

- Press the up or down arrow to view content.
- Press **OK** to save your selected content.
- You must select content in both columns before you can save your new MyView.

Unique content available in MyView:

- **Vehicle Range (Energi vehicles only)** – Indicates the estimated distance your vehicle will travel with the energy currently onboard. Separately displays range available in Hybrid Mode fueled by gasoline, electric range available in Plug-in Power Mode, and total range. Total range is also shown on the bottom of the right information display. Changes in driving pattern and climate control use will cause the values to vary.
- **Accessory Power**— Indicates electrical power demands from your vehicle's accessory systems. Accessories use power but do not contribute to propelling your vehicle. The gauge separately displays power demand in kilowatts (kW) for climate and other accessories. Climate includes the power being used by high voltage climate control components such as the electric A/C compressor and the electric heater (Energi vehicles only). Other includes all power being used by the low voltage accessories (cabin fans, headlights, heated seats, etc.).
- **Coolant Temp** – Indicates engine coolant temperature. At normal operating temperature, the level indicator will be white and will be in the normal range (between H and C). If the engine coolant temperature exceeds the normal range, the level indicator will change to red to indicate that the engine is overheating. Stop your vehicle as soon as safely possible, turn your vehicle off and let the engine cool.

# Information Displays

- Tach rpm x 1000 — When the gasoline engine is running, the tachometer gauge displays the engine speed in revolutions per minute (RPM). When your vehicle is operating on battery power only with the engine off, EV displays and the tachometer is greyed out.

**Note:** *The trip data, and average fuel economy cannot be reset in MyView.*

## Energy Use (Energi only)

Energy Use provides an estimated available electric range, a energy use gauge and a climate power gauge in addition to fuel level and battery display. When you select EV Now operation this screen will automatically be shown. You can press **OK** to enable the engine when viewing this screen during EV Now operation. See **Hybrid Electric Vehicle** (page 132).

## Electric Range:

Electric range is the estimated distance you can travel in Plug-in Power Mode with the engine off. This is based on the amount of energy available in the high voltage battery and your average energy usage while driving.

The amount of energy in the battery refers to the energy gained from charging the battery while plugged in.

Energy usage is affected by:

- Mild or aggressive acceleration or braking.
- Your vehicle speed.
- Your use of accessories such as climate control.
- The ambient temperature and other weather conditions.
- City or highway driving.
- Road grades.

**Note:** *It is normal for your electric range estimate to vary from charge to charge due to changes in average energy usage.*

## Energy Use Gauge:

Your current energy use is the white line that moves up and down in the gauge. A higher line means you are using more energy (lower is better). Your energy use includes input from the accelerator pedal as well as the accessories, such as climate control.

When operating in EV Now a blue cup shape is shown around the gauge. This represents the maximum energy usage you can maintain in order to achieve the estimated electric range when EV Now mode began. Keep your current energy use mostly within the cup while driving and you should achieve your electric range estimate.

## Climate Power Gauge:

Indicates high voltage electrical power demand from you vehicle's high voltage climate control components including the electric A/C compressor and the electric heater. These components use power but do not contribute to propelling your vehicle. The gauge displays power demand in kilowatts (kW).

## Trip 1 & 2

Provides trip odometer, trip average fuel economy and trip timer.

Distance traveled on battery power only with the engine off is shown in blue next to total trip distance.

For Energi vehicles total plug-in electricity used in kilowatt hours (kWh) is shown in blue next to trip average fuel economy.

# Information Displays

## Info



In this mode, you can view different vehicle system information and perform a system check.

Information	
Tutorial	Displays a number of different system tutorials. Use the up/down arrows to scroll through the tutorials. Then press OK to view.
MyKey	MyKeys (Number of MyKeys programmed)
	MyKey Miles (km) (Distance traveled using a programmed MyKey)
	Admin Keys (Number of admin keys)
System Check	All active warnings will display first if applicable. The system check menu may appear different based upon equipment options and current vehicle status. Use the up/down arrow buttons to scroll through the list.

## Settings



In this mode, you can configure different driver setting choices.

**Note:** Some items are optional and may not appear.

**Note:** Some MyKey items will only appear if a MyKey is set.

Settings				
Menu level 2	Menu level 3	Menu level 4	Menu level 5	Menu level 6
Driver Assist	Traction Control	On or Off		—
	ECO Cruise	On or Off		—
	Hill Start Assist	On or Off		—
	EV + Mode	On or Off		—
	Rear Park Aid	On or Off		—
	Tire Monitor	Hold OK to Reset		

## Information Displays

<b>Settings</b>					
Vehicle	Lighting	Auto Light Rain	On or Off		
		Daytime Lights	On or Off		
		Home Light	Select time interval		
	Remote Start	Climate Control	Heater – A/C	Auto or Last Settings	
			Front Defrost	Auto or Off	
			Rear Defrost	Auto or Off	
			Driver Seat	Auto or Off	
			Passenger Seat	Auto or Off	
		Duration	5, 10 or 15 minutes		
		Quiet Start	On or Off		
	System	Enable or Disable			
Tire Mobility Kit	Select number of years	—			
MyKey	Create MyKey	Hold OK to Create MyKey	—		
	Traction Control	Always On or User Selectable	—		
	Max Speed	Choose desired speed or off	—		
	Speed Minder	Choose desired speed or off	—		
	Volume Limiter	On or Off	—		
	Clear MyKeys	Hold OK to Clear All MyKeys	—		

# Information Displays

Settings			
Display	Language	Select the desired language	—
	Units	Distance	Select the desired units of measure
		Temperature	Fahrenheit (°F) or Celsius (°C)
	Brake Coach Display	On or Off	—
	Regen Active	On or Off	—
	Charge Assist	On or Off	—
	Driving History	Hold OK to Reset	—

## Right Information Display Controls

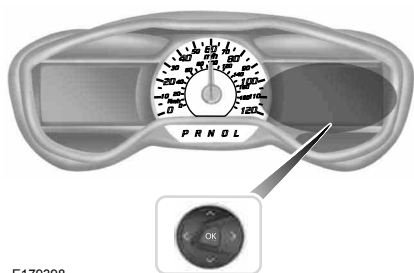

E179398

- Press the up and down arrow buttons to scroll through and highlight the options within a menu.
- Press the right arrow button to enter a sub-menu.
- Press the left arrow button to exit a menu.
- Press the **OK** button to choose and confirm your selection.

## Main menu

From the main menu bar on the right side of the information display, you can choose from the following categories:

### Entertainment

See **General Information** (page 336).

### Phone

See **General Information** (page 336).

### Navigation or Compass

See **General Information** (page 336).

### Fuel Economy

Use the up or down arrow buttons to choose between the following display options.

**Note:** The information display will remember the menu level 2 state when you change the individual key state from the RUN to the OFF position.

# Information Displays

Fuel Economy			
Menu level 2	Menu level 3	Menu level 4	Menu level 5
Efficiency Leaves	Help	—	—
Fuel History (Instantaneous Fuel Economy + Fuel Economy History + Avg Fuel Economy)	Duration	5, 10 or 30 minutes	—
	Help	—	—
Coach	Help	—	—

## Efficiency Leaves

Efficiency leaves indicate short term driving efficiency measured over the last few minutes. The more leaves and vines that appear on the display, the better your fuel economy. Leaves and vines will occasionally appear and disappear to indicate a change in your driving efficiency.

## Fuel History

From left to right this view includes an instantaneous fuel economy gauge, historical fuel economy data and average fuel economy. The historical data represents an average over time intervals of either 1, 2 or 6 minutes, with the leftmost interval being the most recent. Shown at the bottom of the view is the total time duration for the 5 intervals. You can select total duration in the options menu. Intervals shown in grey color are from the previous drive. The blue horizontal line represents the average fuel economy value shown to the right.

**Note:** Hold **OK** to reset average fuel economy.

## Coach

This view provides a comparison of your recent acceleration, braking and cruising behavior, then recommends the most efficient use of energy under present conditions. The horizontal bars fill from left to right with best behavior and appear blue when at least half full. When the bars are less than half full, the color is amber, suggesting that you need a change in your driving behavior to achieve better energy efficiency.

**Note:** *Fuel Economy will be impacted by your use of brakes, accelerator and accessories, as well as environmental conditions such as hills and weather.*

**Note:** *Fuel economy is not always a measure of appropriate driving behavior. For example, when driving uphill and maintaining an appropriate speed, your instant fuel economy may not be good (losing leaves) but the Coach may show a blue bar for Acceleration and Cruising.*

## Common Displays

Both Average fuel economy and an instantaneous fuel economy gauge are included in Engage, Empower and MyView (if selected) on the left information display. They are also included in Fuel History on the right information display.

# Information Displays

## Average Fuel Economy

Average Fuel Economy is continuously averaged since the last reset. You can reset your average fuel economy by pressing and holding the **OK** button on the corresponding steering wheel controls. For Energi vehicles both Hybrid and Plug-in Power mode operation will be included in the calculation.

**Note:** Average fuel economy cannot be reset in MyView.

## Instantaneous Fuel Economy

If your instantaneous fuel economy is greater than the maximum value displayed, a + sign will be shown next to the maximum scale number. When your vehicle is operating on battery power only, EV will display and the gauge fill will show in blue.

## INFORMATION MESSAGES

**Note:** Depending on the vehicle options equipped with your vehicle, not all of the messages display or are available. Certain messages may be abbreviated or shortened depending upon which cluster type you have.

## AdvanceTrac®

Message	Action
Service AdvanceTrac	Displayed when the system has detected a condition that requires service. Contact your authorized dealer as soon as possible.

## Alarm

Message	Action
To Stop Alarm, Start Vehicle	Displays when the alarm has been triggered due to unauthorized entry. See <b>Anti-Theft Alarm</b> (page 66).



E130248

Press the OK button to acknowledge and remove some messages from the information display. Other messages are removed automatically after a short time.

Certain messages need to be confirmed before you can access the menus.

# Information Displays

## Battery and Charging System (High Voltage)

Message	Action
Is Vehicle Plugged-In?	Your vehicle needs confirmation it is unplugged before allowing a start. You must make sure your vehicle is unplugged and you respond to the message prompt before starting your vehicle.
Ready to Drive	Your vehicle is ready to drive.
Unplug Prior to Starting Vehicle	Your vehicle detects it is still plugged in and you attempt to start it.
EV Now Not Available	EV Now is unavailable.
Press OK to Enable Engine	You can press OK to enable the engine temporarily for increased performance when in EV Now mode.
EV Now Battery Powered	You selected EV Now mode with the EV button.
EV Later XX% Plug-in Energy Reserved	You selected EV Later mode with the EV button.
Auto EV Normal Operation	You selected Auto EV mode with the EV button.
Engine Enabled due to Defrost Setting	Your vehicle enables the engine due to the climate control defrost setting. This is normal operation.
Engine Enabled for System Performance	Your vehicle enables the engine for system performance. This is normal operation.

## Doors

Message	Action
X Door Ajar	Displays when the door(s) listed is not completely closed and the vehicle is moving.
	Displays when the door(s) listed is not completely closed.
Liftgate Ajar	Displays when the liftgate is not completely closed.



# Information Displays

## Fuel

Message	Action
Fuel Level Low	An early reminder of a low fuel condition.
Fuel Freshness	EV functionality is disabled and the engine is running to maintain fuel freshness. See <b>Fuel Quality</b> (page 139).
Fuel Door Opening	Wait for up to 15 seconds while the fuel system depressurizes.
Fuel Door Open	The fuel system has finished depressurizing and you can begin to refuel.
Close Fuel Door	A reminder to close the fuel door.
Refuel Error See Manual	There is an error in attempting to refill your vehicle.

## Hill Start Assist

Message	Action
Hill Start Assist Not Available	Displays when hill start assist is not available. Contact your authorized dealer. See <b>Hill Start Assist</b> (page 161).
Hill Start Assist Active	Displays when hill start assist is active.
Hill Start Assist OFF	Displays when hill start assist is off.

## Keys and Intelligent Access

Message	Action
Starting System Fault	This message is displayed when there is a problem with your vehicle's starting system. See your authorized dealer for service.
Key Inside Vehicle	Displays to remind you that the key is in the luggage compartment. See <b>Keyless Starting</b> (page 127).
Key Not Inside Car	Displays if the key is not detected by the system. See <b>Keyless Starting</b> (page 127).
No Key Detected	Displayed if the key is not detected by the system. See <b>Keyless Starting</b> (page 127).
Restart Now or Key is Needed	Displayed when the start/stop button is pressed to shut off the engine and a Intelligent Access Key is not detected inside the vehicle.

## Information Displays

Message	Action
Accessory Power Active	Displayed when the vehicle is in the Accessory ignition state.
Press Brake to Start	Displayed as a reminder to press the brake while starting the vehicle.
Press Brake + Start Button	Displayed as a reminder to apply the brake and push the start button to start the vehicle.
Place Key in Backup Slot	Displayed as needed by the system for proper function.
Key Programmed x Keys Total	Displayed during spare key programming, when an intelligent access key is programmed to the system.
Max Number of Keys Learned	Displayed during spare key programming when the maximum number of keys have been programmed.
Could Not Program Integrated Key	Displayed when an attempt is made to program a spare key using two existing MyKeys.

## Maintenance

Message	Action
LOW Engine Oil Pressure	Stop the vehicle as soon as safely possible, turn off the engine. Check the oil level. If the warning stays on or continues to come on with your engine running, contact your authorized dealer as soon as possible.
Change Engine Oil Soon	Displayed when the engine oil life remaining is 10% or less. See <b>Engine Oil Check</b> (page 217).
Oil Change Required	Displayed when the oil life left reaches 0%. See <b>Engine Oil Check</b> (page 217).
Brake Fluid Level LOW	Indicates the brake fluid level is low and the brake system should be inspected immediately. See <b>Brake Fluid Check</b> (page 222).
Check Brake System	Displays when the brake system needs servicing. Stop the vehicle in a safe place. Contact your authorized dealer.
Engine Coolant Overtemperature	Displays when the engine coolant temperature is excessively high.
Motor Coolant Overtemperature	Displays when the motor coolant temperature is excessively high.

## Information Displays

Message	Action
Service Tire Mobility Kit	Displayed when the kit needs service. See your authorized dealer.
See Manual	Informs the driver that the powertrain needs service due to a powertrain malfunction.
Engine On Due to Low Use Normal Operation	Displays when EV functionality is disabled and the engine is running to maintain oil quality. See <b>Hybrid Electric Vehicle</b> (page 132).

### MyKey

Message	Action
MyKey Not Created	Displayed during key programming when MyKey cannot be programmed.
MyKey Active Drive Safely	Displays when MyKey is active.
Near Vehicle Top Speed	Displays when a MyKey is in use and the MyKey speed limit is on and the vehicle speed is approaching 80 mph (130 km/h).
Vehicle at Top Speed of MyKey Setting	Displays when a MyKey is in use and the MyKey speed limit is reached.
Check Speed Drive Safely	Displays when MyKey is active.
Buckle Up to Unmute Audio	Displays when a MyKey is in use and Belt-Minder is activated.
Traction Control On - MyKey Setting	Displays when a MyKey is in use and Traction control is activated.
MyKey Park Aid Cannot Be Deactivated	Displays when a MyKey is in use and park aid is activated.

# Information Displays

## Park Aid

Message	Action
Check Park Aid	Displays when the system has detected a condition that requires service. Contact your authorized dealer. See <b>Parking Aid</b> (page 166).
Rear Park Aid On Off	Displays the park aid status.
Check Rear Park Aid	Displays when the system has detected a condition that requires attention. See <b>Parking Aid</b> (page 166).
Check Front Park Aid	Displays when the system has detected a condition that requires attention. See <b>Parking Aid</b> (page 166).
Park Aid Malfunction	Displays when the system has detected a condition that requires service. Contact your authorized dealer. See <b>Parking Aid</b> (page 166).

## Park Brake

Message	Action
Park Brake Engaged	Displays when the parking brake is set, the engine is running and the vehicle is driven more than 3 mph (5 km/h). If the warning stays on after the parking brake is released, contact your authorized dealer.

## Power Steering

Message	Action
Steering malfunction Service now	The power steering system has detected a condition that requires service. See your authorized dealer.
Steering malfunction Stop safely	The power steering system is not working. Stop the vehicle a safe place. Contact your authorized dealer.

## Remote Start

Message	Action
Remote Start Active	Displayed when the remote start system is active.

# Information Displays

## Tire Pressure Monitoring System

Message	Action
Low Tire Pressure	Displays when one or more tires on your vehicle have low tire pressure. See <b>Tire Pressure Monitoring System</b> (page 270).
Tire Pressure Monitor Fault	Displays when the tire pressure monitoring system is malfunctioning. If the warning stays on or continues to come on, contact your authorized dealer. See <b>Tire Pressure Monitoring System</b> (page 270).
Tire Pressure Sensor Fault	Displayed when a tire pressure sensor is malfunctioning, or your spare tire is in use. For more information on how the system operates under these conditions, see <b>Tire Pressure Monitoring System</b> (page 270). If the warning stays on or continues to come on, contact your authorized dealer as soon as possible.

## Transmission

Message	Action
Shift to Park	Displays as a reminder to shift into park.

# Climate Control

## AUTOMATIC CLIMATE CONTROL

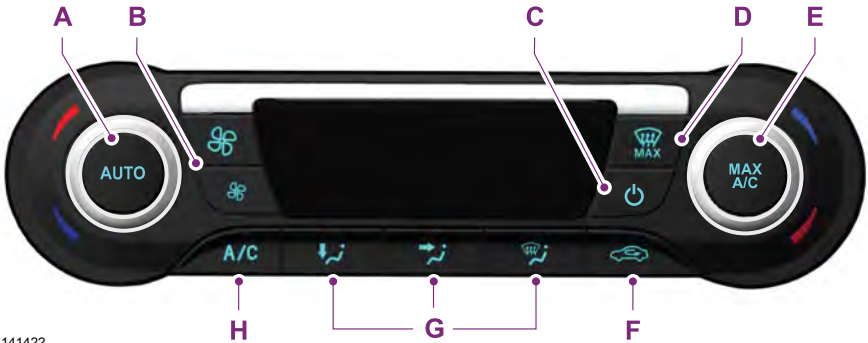

E141422

- A **AUTO:** Press the button to switch on automatic operation. Select the desired temperature using the temperature control. The system adjusts fan speed, air distribution, air conditioning operation, and selects outside air or recirculated air to heat or cool the vehicle in order to maintain the desired temperature.
- B **Fan speed control:** Adjust the volume of air circulated in the vehicle.
- C **Power:** Press the button to switch the system on and off. When the system is off, it prevents outside air from entering the vehicle.
- D **MAX Defrost:** Press the button to switch on defrost. Outside air flows through the windshield vents, air conditioning automatically turns on, and fan automatically adjusts to the highest speed. You can also use this setting to defrost and clear the windshield of a thin covering of ice. The heated rear window also automatically turns on when you select maximum defrost.  
**Note:** To prevent window fogging, you cannot select recirculated air when maximum defrost is on.
- E **MAX A/C:** Press the button to maximize cooling. Recirculated air flows through the instrument panel vents, air conditioning automatically turns on, and the fan automatically adjusts to the highest speed.
- F **Recirculated air:** Press the button to switch between outside air and recirculated air. When you select recirculated air, the air currently in the passenger compartment recirculates. This may reduce the time needed to cool the interior (when used with **A/C**) and may reduce unwanted odors from entering your vehicle.

# Climate Control

**Note:** Recirculated air may turn off automatically (or be prevented from turning on) in all airflow modes except **MAX A/C** to reduce risk of fogging. Recirculated air may also turn on and off automatically in **Panel** or **Panel and Floor** airflow modes during hot weather in order to improve cooling efficiency.

G **Air distribution control:** Adjust the control to turn airflow from the windshield, instrument panel, or footwell vents on or off. You can distribute air through any combination of these vents.

H **A/C:** Press the button to turn air conditioning compressor on or off. Use air conditioning with recirculated air to improve cooling performance and efficiency.

**Note:** In certain conditions (for example, maximum defrost), the air conditioning compressor may continue to operate even though the air conditioning is switched off.

## Temperature Control



E133115

You can set the temperature between 60°F (15.5°C) and 85°F (29.5°C) in steps of 1°F (0.5°C). In position **LO**, 59°F (15°C), the system switches to permanent cooling. In position **HI**, 86°F (30°C), the system switches to permanent heating.

### Single Zone Temperature Control

In this mode, the climate control system links the temperature settings for both the driver's side and passenger's side. If you adjust the setting using the rotary control on the driver's side, the system adjusts the temperature to the same setting on the passenger's side.

### Dual Zone Temperature Control

Select a temperature for the passenger's side using the rotary control on the passenger's side. Single zone temperature control automatically switches off. The temperature on the driver's side remains unchanged. You can now adjust the driver's side and passenger's side temperatures independently. The display shows the temperature settings for each side.

### Switching Back to Single Zone Temperature Control

Press and hold the **AUTO** button. The passenger side temperature is adjusted to the driver side temperature setting.

## HINTS ON CONTROLLING THE INTERIOR CLIMATE

### General Hints

**Note:** *Prolonged use of recirculated air may cause the windows to fog up.*

**Note:** *You may feel a small amount of air from the footwell air vents regardless of the air distribution setting.*

# Climate Control

---

**Note:** To reduce humidity build-up inside your vehicle, do not drive with the system switched off or with recirculated air always switched on.

**Note:** Do not place objects under the front seats as this may interfere with the airflow to the rear seats.

**Note:** Remove any snow, ice or leaves from the air intake area at the base of the windshield.

**Note:** To improve the time to reach comfort in hot weather, drive with the windows slightly open for 2-3 minutes after start-up or until your vehicle airs out.

In mild weather, you can improve your fuel economy when using the climate control system by using outside air instead of air conditioning.

- Turn the temperature control knob(s) so the interior temperature is set to 60°F (15.5°C).
- Set the air distribution to panel or floor (or both).
- Press **A/C** to turn the air conditioning off.
- Press the recirculated air button so fresh air enters the vehicle.
- Press the small fan button until the fan is at its lowest setting.

## Automatic Climate Control

**Note:** Adjusting the settings when your vehicle interior is extremely hot or cold is not necessary. The system automatically adjusts to heat or cool the cabin to your selected temperature as quickly as possible. For the system to function efficiently, the instrument panel and side air vents should be fully open.

**Note:** If you select **AUTO** during cold outside temperatures, the system directs airflow to the windshield and side window vents. In addition, the fan may run at a slower speed until the engine warms up.

**Note:** If you select **AUTO** during hot outside temperatures, or when the inside of the vehicle is hot, the system automatically uses recirculated air to maximize interior cooling. When the interior reaches the selected temperature, the system automatically switches to using outside air.

## Heating the Interior Quickly

1. Press the **AUTO** button.
2. Adjust the temperature control to the desired setting.

## Recommended Settings for Heating

1. Press the **AUTO** button.
2. Adjust the temperature control to the desired setting. Use 72°F (22°C) as a starting point, then adjust the setting as necessary.

## Cooling the Interior Quickly

Press the **MAX A/C** button.

## Recommended Settings for Cooling

1. Press the **AUTO** button.
2. Adjust the temperature control to the desired setting. Use 72°F (22°C) as a starting point, then adjust the setting as necessary.

## Side Window Defogging in Cold Weather

1. Press the defrost and panel buttons.
2. Select **A/C**.
3. Adjust the temperature control to maintain comfort. Use 72°F (22°C) as a starting point, then adjust the setting as necessary.
4. Set the fan to the highest speed.
5. Direct the outer instrument panel air vents toward the side windows.



# Climate Control

- To increase the airflow to the outer instrument panel vents, close the air vents in the middle of the instrument panel and in the rear of the center console.

## HEATED WINDOWS AND MIRRORS

### Heated Rear Window



The heated rear window button is below the climate control unit.

Press the button to clear the heated rear window of thin ice and fog. The heated rear window automatically turns off after a short period of time. Start the engine before you switch the heated rear window on.

**Note:** Do not use razor blades or other sharp objects to clean or remove decals from the inside of the heated rear window. The vehicle warranty does not cover damage caused to the heated rear window grid lines.

### Heated Exterior Mirrors (If Equipped)



When you switch the heated rear window on, the heated exterior mirrors automatically turn on.

**Note:** Do not remove ice from the mirrors with a scraper or adjust the mirror glass when it is frozen in place.

**Note:** Do not clean the mirror housing or glass with harsh abrasives, fuel or other petroleum-based cleaning products.

## CABIN AIR FILTER

Your vehicle is equipped with a cabin air filter, which gives you and your passengers the following benefits:

- It improves your driving comfort by reducing particle concentration.
- It improves the interior compartment cleanliness.
- It protects the climate control components from particle deposits.

Your cabin air filter is located under the instrument panel in the passenger footwell area.

**Note:** Make sure you have a cabin air filter installed at all times. This prevents foreign objects from entering the system. Running the system without a filter in place could result in degradation or damage to the system.

Replace the filter at regular intervals. See **Maintenance** (page 213).

For additional cabin air filter information, or to replace the filter, see an authorized dealer.

## REMOTE START (If Equipped)

The remote start feature allows you to pre-condition the interior of your vehicle. The climate control system works to achieve comfort according to your previous settings.

**Note:** You cannot adjust the system during remote start operation.

Turn the ignition on to return the system to its previous settings. You can now make adjustments normally, but you need to turn certain vehicle-dependent features back on, such as:

- Heated seats.
- Cooled seats.

# Climate Control

---

- Heated steering wheel.
- Heated mirrors.
- Heated rear window.

You can adjust the default remote start settings using the information display controls. See **Information Displays** (page 91).

## **Automatic Settings**

In hot weather, the system is set to 72°F (22°C). The cooled seats are set to high (if available, and selected to AUTO in the information display).

In moderate weather, the system either heats or cools (based on previous settings). The rear defroster, heated mirrors and heated seats do not automatically turn on.

In cold weather, the system is set to 72°F (22°C). The heated seats are set to high (if available, and selected to AUTO in the information display). The rear defroster and heated mirrors automatically turn on.

# Seats

## SITTING IN THE CORRECT POSITION

### WARNINGS



Sitting improperly, out of position or with the seatback reclined too far can take weight off the seat cushion and affect the decision of the passenger sensing system, resulting in serious injury or death in the event of a crash. Always sit upright against your seat back, with your feet on the floor.



Do not recline the seatback as this can cause the occupant to slide under the safety belt, resulting in serious injury in the event of a crash.



Do not place objects higher than the seatback to reduce the risk of serious injury in the event of a crash or during heavy braking.

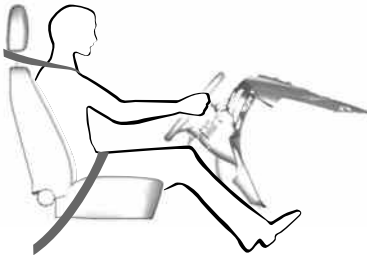

E68595

When you use them properly, the seat, head restraint, safety belt and airbags will provide optimum protection in the event of a crash.

We recommend that you follow these guidelines:

- Sit in an upright position with the base of your spine as far back as possible.
- Do not recline the seatback more than 30 degrees.
- Adjust the head restraint so that the top of it is level with the top of your head and as far forward as possible. Make sure that you remain comfortable.
- Keep sufficient distance between yourself and the steering wheel. We recommend a minimum of 10 in (25 cm) between your breastbone and the airbag cover.
- Hold the steering wheel with your arms slightly bent.
- Bend your legs slightly so that you can press the pedals fully.
- Position the shoulder strap of the safety belt over the center of your shoulder and position the lap strap tightly across your hips.

Make sure that your driving position is comfortable and that you can maintain full control of your vehicle.

## HEAD RESTRAINTS

### WARNINGS



Fully adjust the head restraint before you sit in or operate your vehicle. This will help minimize the risk of neck injury in the event of a crash. Do not adjust the head restraint when your vehicle is moving.



The head restraint is a safety device. Whenever possible it should be installed and properly adjusted when the seat is occupied. An improperly adjusted head restraint may not adequately protect an occupant during an impact from the rear.

# Seats

## WARNINGS



Install the head restraint properly to help minimize the risk of neck injury in the event of a crash.

**Note:** Adjust the seatback to an upright driving position before adjusting the head restraint. Adjust the head restraint so that the top of it is level with the top of your head and as far forward as possible. Make sure that you remain comfortable. If you are extremely tall, adjust the head restraint to its highest position.

### Front seat head restraint

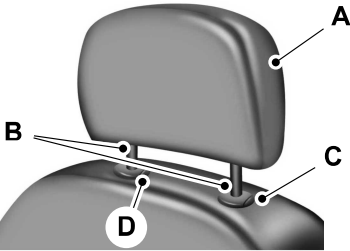

E138642

### Rear center seat head restraint

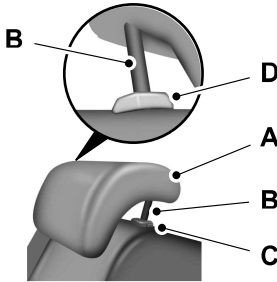

E138645

The head restraints consist of:

- A An energy absorbing head restraint.
- B Two steel stems.

- C Guide sleeve adjust and unlock button.
- D Guide sleeve unlock and remove button.

## Adjusting the Head Restraint

### Raising the Head Restraint

Pull the head restraint up.

### Lowering the Head Restraint

1. Press and hold button C.
2. Push the head restraint down.

### Removing the Head Restraint

1. Pull the head restraint up until it reaches its highest position.
2. Press and hold buttons C and D.
3. Pull the head restraint up.

### Installing the Head Restraint

Align the steel stems into the guide sleeves and push the head restraint down until it locks.

### Rear Seat Outboard Head Restraints

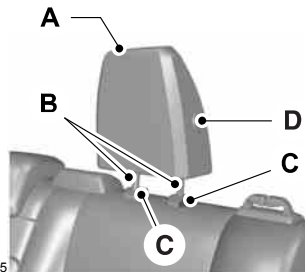

E162605

# Seats

The head restraints consist of:

- A An energy absorbing head restraint.
- B Two steel stems.
- C Guide sleeve unlock and remove button.
- D Fold button.

## Removing the Head Restraint

1. Press and hold buttons C.
2. Pull the head restraint up.

## Installing the Head Restraint

Align the steel stems into the guide sleeves and push the head restraint down until it locks.

## Folding the Head Restraint

1. Press and hold button D.
2. Pull it back up to reset.

## Tilting Head Restraints

The front head restraints tilt for extra comfort. To tilt the head restraint, do the following:



E144727

1. Adjust the seatback to an upright driving or riding position.
2. Pivot the head restraint forward toward your head to the desired position.

After the head restraint reaches the forward-most tilt position, pivot it forward again to release it to the rearward, un-tilted position.

## MANUAL SEATS

### WARNING



To reduce the risk of injury, do not adjust the driver's seat or seatback when your vehicle is moving.

## Moving the Seat Backward and Forward



E162375

# Seats

## WARNING



Rock the seat backward and forward after releasing the lever to make sure that it is fully engaged.

## Adjusting the Height of the Driver's Seat

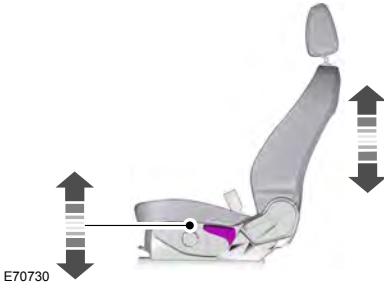

## Recline Adjustment

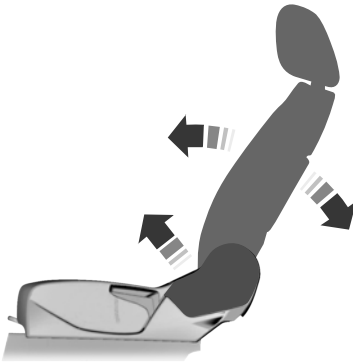

## WARNING



Do not place cargo or any objects behind the seatback before returning it to the original position. Pull on the seatback to make sure that it has fully latched after returning the seatback to its original position. An unlatched seat may become dangerous if you stop suddenly or have a crash.

## Lumbar Adjustment (If Equipped)



## POWER SEATS (If Equipped)

### WARNINGS



Do not adjust the driver's seat or seatback when your vehicle is moving. Adjusting your seatback while your vehicle is in motion may cause loss of control of your vehicle.



Do not place cargo or any objects behind the seatback before returning it to the original position.

# Seats

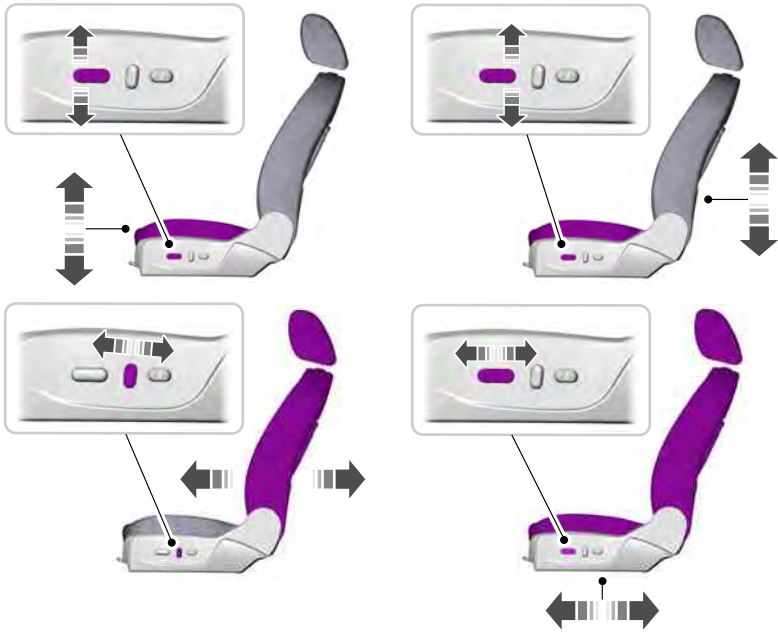

E138647

## Power Lumbar (If Equipped)



E138648

# Seats

## REAR SEATS



E155554

### Folding the Seatback

1. With the seat empty, press the button on the outboard side of each rear outboard headrest to fold them. Make sure the rear center headrest is in the full down position.
2. Pull the lever up on the outboard side of the seat to fold the seat.

### Unfolding the Seatback

Rotate the seatback upward until the seatback latches to return the seat to the upright position.

## HEATED SEATS (If Equipped)

### WARNING

 People who are unable to feel pain to their skin because of advanced age, chronic illness, diabetes, spinal cord injury, medication, alcohol use, exhaustion or other physical conditions, must exercise care when using the heated seat. The heated seat may cause burns even at low temperatures, especially if used for long periods of time. Do not place anything on the seat that insulates against heat, such as a blanket or cushion. This may cause the heated seat to overheat. Do not puncture the seat with pins, needles or other pointed objects. This may damage the heating element which may cause the heated seat to overheat. An overheated seat may cause serious personal injury.

Do not do the following:

- Place heavy objects on the seat.
- Operate the heated seat if water or any other liquid is spilled on the seat. Allow the seat to dry thoroughly.
- Operate the heated seats unless the engine is running. Doing so can cause the battery to lose charge.

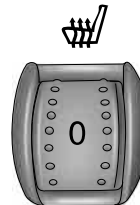

E138653

Adjust the control to the desired heat setting.



# Seats

---

## REAR SEAT ARMREST (If Equipped)



E138656

Fold the armrest down to use the armrest and cupholder.

# Universal Garage Door Opener (If Equipped)

## HomeLink Wireless Control System

### WARNINGS



Make sure that the garage door and security device are free from obstruction when you are programming. Do not program the system with the vehicle in the garage.



Do not use the system with any garage door opener that does not have the safety stop and reverse feature as required by U.S. Federal Safety Standards (this includes any garage door opener manufactured before April 1, 1982). A garage door opener which cannot detect an object, signaling the door to stop and reverse, does not meet current federal safety standards. Using a garage door opener without these features increases the risk of serious injury or death.

**Note:** Make sure you keep the original remote control transmitter for use in other vehicles as well as for future system programming.

**Note:** We recommend that upon the sale or lease termination of your vehicle, you erase the programmed function buttons for security reasons. See **Erasing the Function Button Codes**.

**Note:** You can program a maximum of three devices. To change or replace any of the three devices after it has been initially programmed, you must first erase the current settings. See **Erasing the Function Button Codes**.



E142657

The universal garage door opener replaces the common hand-held garage door opener with a three-button transmitter that is integrated into the driver's sun visor.

The system includes two primary features, a garage door opener and a platform for remote activation of devices within the home. As well as being programmed for garage doors, the system transmitter can be programmed to operate entry gate operators, security systems, entry door locks and home or office lighting.

Additional system information can be found online at [www.homelink.com](http://www.homelink.com), [www.youtube.com/HomeLinkGentex](http://www.youtube.com/HomeLinkGentex) or by calling the toll-free help line on 1-800-355-3515.

### In-Vehicle Programming

This process is to program your hand-held transmitter and your in-vehicle HomeLink transmitter.

**Note:** The programming steps below assume you will be programming HomeLink that was not previously programmed.

**Note:** Put a new battery in the hand-held transmitter. This will ensure quicker training and accurate transmission of the radio-frequency signal.

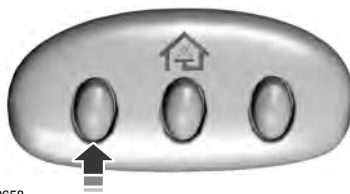

E142658

1. With your vehicle parked outside of the garage, turn your ignition to the **on** position, but do not start your vehicle.

## Universal Garage Door Opener (If Equipped)

2. Hold your hand-held garage door transmitter 2–6 in (5–14 cm) away from the HomeLink button you want to program.
3. Using both hands, simultaneously, press and hold the desired HomeLink button and the hand-held transmitter button. DO NOT release either one until the HomeLink indicator light flashes slowly and then rapidly. When the indicator light flashes rapidly, both buttons may be released. The rapid flashing indicates successful training.

**Note:** You may need to use a different method if you live in Canada or have difficulties programming your gate operator or garage door opener. See **Gate Operator / Canadian Programming**.

4. Press and hold the HomeLink button you programmed for two seconds, then release. You may need to do this twice to activate the door. If your garage door does not operate, watch the HomeLink indicator light.

**If the indicator light stays on, the programming is complete. No further action is needed.**

If the indicator light flashes rapidly for 2 seconds and then turns to a constant light, the HomeLink button is not programmed yet. See **Programming Your Garage Door Opener Motor**.

To program additional buttons, repeat Steps 1 – 4.

For questions or comments, please contact HomeLink at [www.homelink.com](http://www.homelink.com), [www.youtube.com/HomeLinkGentex](http://www.youtube.com/HomeLinkGentex) or 1-800-355-3515.

### Programming Your Garage Door Opener Motor

**Note:** You may need a ladder to reach the unit and you may need to remove the cover or lamp lens on your garage door opener.



E142659

1. Press the learn button on the garage door opener motor and then you have 30 seconds to complete the next two steps.
2. Return to your vehicle.

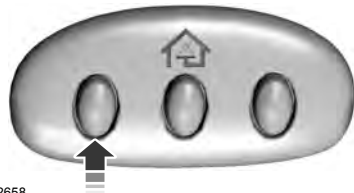

E142658

3. Press and hold the function button you want to program for 2 seconds, then release. Repeat this step. Depending on your brand of garage door opener, you may need to repeat this sequence a third time.

### Gate Operator / Canadian Programming

Canadian radio-frequency laws require transmitter signals to “time-out” (or quit) after several seconds of transmission – which may not be long enough for HomeLink to pick up the signal during programming. Similar to this Canadian law, some U.S. gate operators are designed to “time-out” in the same manner.

**Note:** If programming a garage door opener or gate operator, it is advised to unplug the device during the “cycling” process to prevent possible overheating.

# Universal Garage Door Opener (If Equipped)

1. Press and hold the HomeLink button while you press and release, **every two seconds**, your hand-held transmitter until the HomeLink indicator light changes from a slow to a rapidly blinking light.
2. Release both the HomeLink and hand-held transmitter buttons.
3. Continue programming HomeLink. See **In-Vehicle Programming**.

## Erasing the Function Button Codes

**Note:** You cannot erase individual buttons.

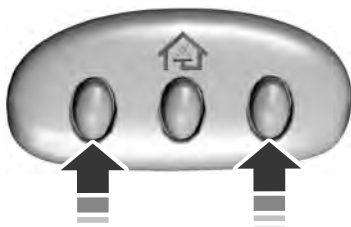

E142660

1. Press and hold the outer two function buttons simultaneously for approximately 20 seconds until the indicator lights above the buttons flash rapidly.
2. When the indicator lights flash, release the buttons. The codes for all buttons are erased.

## Reprogramming a Single Button

To program a device to a previously trained button, follow these steps:

1. Press and hold the desired button. Do NOT release the button.
2. The indicator light will begin to flash after 20 seconds. Without releasing the button, follow Step 1 in the Programming section.

For questions or comments, contact HomeLink at [www.homelink.com](http://www.homelink.com), [www.youtube.com/HomeLinkGenex](http://www.youtube.com/HomeLinkGenex) or 1-800-355-3515.

## Programming to a Genie Intellicode 2 Garage Door Opener

**Note:** The Genie Intellicode 2 transmitter must already be programmed to operate with the garage door opener.

**Note:** To program HomeLink to the transmitter you must first put the transmitter into programming mode.

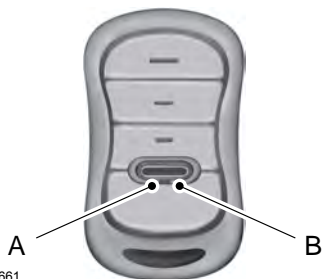

E142661

- A. Red indicator light
- B. Green indicator light

1. Press and hold one of the buttons on the hand-held transmitter for 10 seconds. The indicator light will change from green to red and green.
2. Press the same button twice to confirm the change to programming mode. If done properly the indicator light will appear red.
3. Hold the transmitter within 1–3 inches (2–8 centimeters) of the button on the visor you want to program.

## Universal Garage Door Opener (If Equipped)

4. Press and hold both the programmed Genie button on the hand-held transmitter and the button you want to program. The indicator light on the visor will flash rapidly when the programming is successful.

**Note:** *The Genie transmitter will transmit for up to 30 seconds. If HomeLink does not program within 30 seconds the Genie transmitter will need to be pressed again. If the Genie transmitter indicator light displays green and red, release the button until the indicator light turns off before pressing the button again.*

Once HomeLink has been programmed successfully, the Genie transmitter must be changed out of program mode. To do this:

1. Press and hold the previously programmed Genie button on the hand-held transmitter for 10 seconds. The indicator light will change from red to red and green.
2. Press the same button twice to confirm the change. If done correctly the indicator light will turn green.

### Programming HomeLink to the Genie Intellicode Garage Door Opener Motor

**Note:** *You may need a ladder to access the garage door opener motor.*

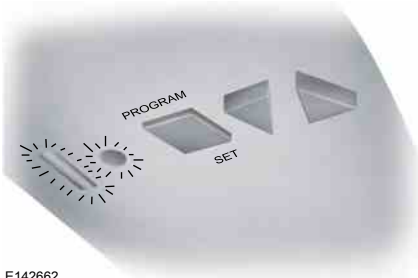

E142662

1. Press and hold the program button on the garage door opener motor until both blue indicator lights turn on.
2. Release the program button. Only the smaller round indicator light should be on.
3. Press and release the program button. The larger purple indicator light will flash.

**Note:** *The next two steps must be completed in 30 seconds.*

4. Press and release the Genie Intellicode 2 hand-held transmitter's previously programmed button. Both indicator lights on the garage door opener motor unit should now flash purple.
5. Press and hold the previously programmed button on the visor for 2 seconds. Repeat this step up to 3 times until the garage door moves.

Programming is now complete.

### Clearing a HomeLink Device

To erase programming from the three HomeLink buttons press and hold the two outer HomeLink buttons until the indicator light begins to flash. The indicator light will begin flashing in 10 to 20 seconds, at which time both buttons should be released. Programming has now been erased, and the indicator light should blink slowly to indicate the device is in train mode when any of the three HomeLink buttons are pressed.

# Universal Garage Door Opener (If Equipped)

---

## **FCC and RSS-210 Industry Canada Compliance**

This device complies with Part 15 of the FCC Rules and with RSS-210 of Industry Canada. Operation is subject to the following two conditions: (1) this device may not cause harmful interference, and (2) this device must accept any interference received, including interference that may cause undesired operation.

Changes or modifications to your device not expressly approved by the party responsible for compliance can void the user's authority to operate the equipment.

# Auxiliary Power Points

## 12-volt DC power point

### WARNING



Do not plug optional electrical accessories into the cigar lighter socket (if equipped). Improper use of the lighter can cause damage not covered by your warranty, and can result in fire or serious injury.

**Note:** *If used when the vehicle is not running, the battery will discharge. There may be insufficient power to restart your vehicle.*

**Note:** *Do not insert objects other than an accessory plug into the power point. This will damage the outlet and blow the fuse.*

**Note:** *Do not hang any type of accessory or accessory bracket from the plug.*

**Note:** *Do not use the power point over the vehicle capacity of 12 volt DC 180 watts or a fuse may blow.*

**Note:** *Do not use the power point for operating a cigar lighter element.*

**Note:** *Improper use of the power point can cause damage not covered by your warranty.*

**Note:** *Always keep the power point caps closed when not in use.*

Run the vehicle for full capacity use of the power point. To prevent the battery from being discharged:

- Do not use the power point longer than necessary when the vehicle is not running.
- Do not leave devices plugged in overnight or when the vehicle is parked for extended periods.

## Locations

Power points may be found:

- on the front of the center console
- inside the center console storage bin
- in the luggage compartment.

## 110-volt AC power point (If Equipped)

### WARNING



Do not keep electrical devices plugged in the power point whenever the device is not in use. Do not use any extension cord with the 110-volt AC power point, since it will defeat the safety protection design. Doing so may cause the power point to overload due to powering multiple devices that can reach beyond the 150-watt load limit and could result in fire or serious injury.

**Note:** *The power point will turn off when the ignition is switched off or the battery voltage drops below 11 volts.*

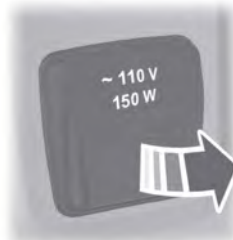

E143941

The power point is used for powering electrical devices that require up to 150 watts. It is located on the rear of the center console.

# Auxiliary Power Points

---

When the indicator light, located on the power point, is:

- on — the power point is working, the ignition is on and a device is plugged in.
- off — the power point is off, the ignition is off or no device is plugged in.
- flashing — the power point is in fault mode.

The power point temporarily turns off power if the 150-watt limit is exceeded. It can also switch to a fault mode when it is overloaded, overheated or has shorted. Unplug your device and switch the ignition off then on for overloading and shorting conditions. Let the system cool off, then turn the ignition off then on for an overheating condition.

The power point is not designed for electric devices such as:

- Cathode-ray, tube-type televisions
- Motor loads, such as vacuum cleaners, electric saws and other electric power tools, compressor-driven refrigerators, etc.
- Measuring devices, which process precise data, such as medical equipment, measuring equipment, etc.
- Other appliances requiring an extremely stable power supply: microcomputer-controlled electric blankets, touch-sensor lamps, etc.



# Storage Compartments

---

## CENTER CONSOLE

Stow items in the cup holder carefully as items may become loose during hard braking, acceleration or crashes, including hot drinks which may spill.

Available console features include:



E142433

- A Cup holder.
- B Storage compartment with auxiliary power point, auxiliary input jack, USB port and media hub.
- C Auxiliary power point.

## OVERHEAD CONSOLE



E131605

Press near the rear edge of the door to open it.

# Starting and Stopping the Engine

## GENERAL INFORMATION

### WARNINGS



Extended idling at high engine speeds can produce very high temperatures in the engine and exhaust system, creating the risk of fire or other damage.



Do not park, idle or drive your vehicle on dry grass or other dry ground cover. The emission system heats up the engine compartment and exhaust system, creating the risk of fire.



Do not start the vehicle in a closed garage or in other enclosed areas. Exhaust fumes can be toxic. Always open the garage door before you start the vehicle.



If you smell exhaust fumes inside your vehicle, have your vehicle checked by an authorized dealer immediately. Do not drive your vehicle if you smell exhaust fumes.

If you disconnect the battery, your vehicle may exhibit some unusual driving characteristics for approximately 5 miles (8 kilometers) after you reconnect it. This is because the engine management system must realign itself with the engine. You can disregard any unusual driving characteristics during this period.

The powertrain control system meets all Canadian interference-causing equipment standard requirements regulating the impulse electrical field or radio noise.

When you start the vehicle, avoid pressing the accelerator pedal before and during operation. Only use the accelerator pedal when you have difficulty starting the vehicle.

## IGNITION SWITCH



E72128

**0** (off) - The ignition is off.

**Note:** When you switch the ignition off and leave your vehicle, do not leave your key in the ignition. This could cause your vehicle battery to lose charge.

**I** (accessory) - Allows the electrical accessories, such as the radio, to operate while the engine is not running.

**Note:** Do not leave the ignition key in this position for too long. This could cause your vehicle battery to lose charge.

**II** (on) - All electrical circuits are operational and the warning lamps and indicators illuminate.

**III** (start) - starts the vehicle into Ready to Drive mode (indicated by the green "Ready to Drive" icon on the instrument cluster).

## KEYLESS STARTING (If Equipped)

**Note:** The keyless starting system may not function if the key is close to metal objects or electronic devices such as cellular phones.

**Note:** A valid key must be located inside your vehicle to switch the ignition on and start the vehicle.

# Starting and Stopping the Engine

## Ignition Modes

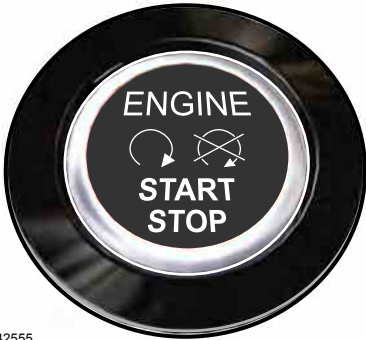

E142555

The keyless starting system has three modes:

- **Off:** Turns the ignition off.
  - Without applying the brake pedal, press and release the button once when the ignition is in the on mode, or when the vehicle is on but not moving.
- **On:** All electrical circuits are operational and the warning lamps and indicators illuminate.
  - Without applying the brake pedal, press and release the button once.
- **Start:** Starts the vehicle into Ready to Drive mode (indicated by the green "Ready to Drive" icon on the instrument cluster). The engine may not start when the vehicle starts.
  - Press the brake pedal, and then press the button until the vehicle turns on.

## STARTING A GASOLINE ENGINE

When the engine starts for the first time on your drive, the idle speed increases, this helps to warm up the engine. If the engine idle speed does not slow down automatically, have your vehicle checked by an authorized dealer.

Before starting the vehicle, check the following:

- Make sure all occupants have fastened their safety belts.
- Make sure the headlamps and electrical accessories are off.
- Make sure the parking brake is on.
- Move the transmission selector lever to position **P**.
- Turn the ignition key to position **II**. If your vehicle is equipped with a keyless ignition, see the following instructions.

### Vehicles with an Ignition Key

**Note:** *Do not touch the accelerator pedal.*

1. Fully press the brake pedal.
2. Turn the key to position **III** to start the vehicle. Release the key when the vehicle starts.

**Note:** *Cranking may last for up to 15 seconds, or until the vehicle starts.*

**Note:** *If you cannot start the vehicle on the first try, wait for a short period and try again.*

### Vehicles with Keyless Start

**Note:** *Do not touch the accelerator pedal.*

1. Fully press the brake pedal.
2. Press the button.

# Starting and Stopping the Engine

**Note:** The green ready indicator illuminates letting you know that the vehicle is ready for driving. Since your vehicle is equipped with a silent key start, the engine may not start at the time of the vehicle start. See **Hybrid Electric Vehicle** (page 132).

The system does not function if:

- The key frequencies are jammed.
- The key battery has no charge.

If you are unable to start the vehicle, do the following:

## 3-button remote



E145988

## 5-button remote



E142874

1. Hold the key next to the steering column as shown.

2. With the key in this position, you can use the start button to switch the ignition on and start your vehicle.

## Fast Restart

The fast restart feature allows you to restart the vehicle within 20 seconds of switching it off, even if a valid key is not present.

Within 20 seconds of switching the vehicle off, press the brake pedal and press the button. After 20 seconds have expired, you can no longer restart the vehicle without the key present inside your vehicle.

Once the vehicle has started, it remains running until you press the button, even if the system does not detect a valid key. If you open and close a door while the vehicle is running, the system searches for a valid key. You cannot restart the vehicle if the system does not detect a valid key within 20 seconds.

## Switching Off the Vehicle When It Is Stationary

### Vehicles with an Ignition Key

1. Move the transmission selector lever to position **P**.
2. Turn the key to position **O**.
3. Apply the parking brake.

### Vehicles with Keyless Start

1. Move the transmission selector lever to position **P**.
2. Press the button once.
3. Apply the parking brake.

**Note:** This switches off the ignition, all electrical circuits, warning lamps and indicators.

# Starting and Stopping the Engine

## Switching Off the Vehicle When It Is Moving

### WARNING



Switching off the engine when the vehicle is still moving will result in a loss of brake and steering assistance. The steering will not lock, but higher effort will be required. When the ignition is switched off, some electrical circuits, including air bags, warning lamps and indicators may also be off. If the ignition was turned off accidentally, you can shift into neutral (N) and re-start the engine.

## Vehicles with an Ignition Key

1. Move the transmission selector lever to position **N** and use the brakes to bring your vehicle to a safe stop.
2. When your vehicle has stopped, move the transmission selector lever to position **P** and turn the key to position **O**.
3. Apply the parking brake.

## Vehicles with Keyless Start

1. Move the transmission selector lever to position **N** and use the brakes to bring your vehicle to a safe stop.
2. When your vehicle has stopped, move the transmission selector lever to position **P**.
3. Press and hold the button for one second, or press it three times within two seconds.
4. Apply the parking brake.

## Guarding Against Exhaust Fumes

### WARNING



If you smell exhaust fumes inside your vehicle, have your vehicle checked by your authorized dealer immediately. Do not drive your vehicle if you smell exhaust fumes. Carbon monoxide is present in exhaust fumes. Take precautions to avoid its dangerous effects.

## Important Ventilating Information

If you stop your vehicle and leave it idling for long periods, we recommend that you do one of the following:

- Open the windows at least 1 in (2.5 cm).
- Set your climate control to outside air.

## ENGINE BLOCK HEATER (if

Equipped)

### WARNINGS



Failure to follow engine block heater instructions could result in property damage or serious personal injury.



Do not use your heater with ungrounded electrical systems or two-pronged adapters. There is a risk of electrical shock.



Do not fully close the hood, or allow it to drop under its own weight when using the engine block heater. This could damage the power cable and may cause an electrical short resulting in fire, injury and property damage.

**Note:** *The heater is most effective when outdoor temperatures are below 0°F (-18°C).*

# Starting and Stopping the Engine

---

The heater acts as a starting aid by warming the engine coolant. This allows the climate control system to respond quickly. The equipment includes a heater element (installed in the engine block) and a wire harness. You can connect the system to a grounded 120-volt AC electrical source.

We recommend that you do the following for a safe and correct operation:

- Use a 16-gauge outdoor extension cord that is product certified by Underwriter's Laboratory (UL) or Canadian Standards Association (CSA). This extension cord must be suitable for use outdoors, in cold temperatures, and be clearly marked Suitable for Use with Outdoor Appliances. Do not use an indoor extension cord outdoors. This could result in an electric shock or become a fire hazard.
- Use as short an extension cord as possible.
- Do not use multiple extension cords.
- Make sure that when in operation, the extension cord plug and heater cord plug connections are free and clear of water. This could cause an electric shock or fire.
- Make sure your vehicle is parked in a clean area, clear of combustibles.
- Make sure the heater, heater cord and extension cord are firmly connected.
- Check for heat anywhere in the electrical hookup once the system has been operating for approximately 30 minutes.

- Make sure the system is unplugged and properly stowed before starting and driving your vehicle. Make sure the protective cover seals the prongs of the block heater cord plug when not in use.
- Make sure the heater system is checked for proper operation before winter.

## Using the Engine Block Heater

Make sure the receptacle terminals are clean and dry prior to use. Clean them with a dry cloth if necessary.

The heater uses 0.4 to 1.0 kilowatt-hours of energy per hour of use. The system does not have a thermostat. It achieves maximum temperature after approximately three hours of operation. Using the heater longer than three hours does not improve system performance and unnecessarily uses electricity.

# Unique Driving Characteristics

## HYBRID ELECTRIC VEHICLE

### Plug-in Power Mode and Hybrid Mode (C-MAX Energi Only)

You must plug in your C-MAX Energi vehicle regularly for optimal use of the high voltage battery's extended range capability. Charging your vehicle adds electrical energy. This energy is used to propel the vehicle in plug-in power mode. You can view your estimated electric range on the Energy Use screen on the left-hand information display. You can also configure MyView to include detailed vehicle range information. See **Gauges** (page 84). The system maximizes the use of electric-only operation in plug-in power mode. System conditions may require engine operation; however, the system uses plug-in power whenever possible.

When your plug-in power is depleted, the powertrain system will automatically switch to hybrid mode. Your battery gauge will transition to a simple battery graphic upon entering hybrid mode. Hybrid mode uses both the gasoline engine and electric motor to power your vehicle and maximize fuel economy as with C-MAX Hybrid.

### EV Modes (C-MAX Energi Only)

**EV** Your vehicle contains selectable EV modes through the EV button located on the center of the instrument panel, below the climate controls.

These modes are available when the vehicle can run under high voltage battery power. With the vehicle in driving mode, you can change EV modes with each press of the EV button. The current mode will be displayed in the left-hand instrument cluster screen.

### Auto EV

**AUTO** This mode provides an automatic use of high voltage battery power during the drive, staying in electric mode when possible and running the engine when needed. This mode will be the only one available if the plug-in power has been depleted.

### EV Now

**EV** This mode provides an electric only driving experience. The left-hand information display will change to an Energy Use screen that supplies EV specific tools and functions.

The vehicle may accelerate more slowly and the top speed may be lower than in Auto mode. Your engine may be enabled at any time by using one of the following methods:

1. Press the OK button on the left 5-way steering wheel control while viewing the Energy Use screen. The vehicle will enable the engine as needed, and will automatically return to EV Now after eight seconds or when the engine is no longer needed.
2. Press the accelerator pedal fully. A pop up message stating **Press OK to Enable Engine** will appear. Press OK on the left-hand steering wheel button to activate as needed. The message will disappear if you release the accelerator pedal.
3. Press the EV button. This will change the mode to EV Later and permit engine operation.

The vehicle may automatically enter Engine Enabled mode if system conditions require it. A message **Engine Enabled for System Performance** will display if this occurs. This is normal function, and your vehicle will return to EV Now when possible.

## Unique Driving Characteristics

The vehicle may enter Enable Engine mode if the climate control is in a defrost mode and the outside temperature is cold. A message **Engine Enabled Due to Defrost** will display if this occurs. If defrost is not needed, select a different climate control mode to permit EV Now.

When you enable EV Now, a blue EV icon displays in the left-hand information display. If the vehicle is in the Engine Enabled mode, the EV icon will be yellow.

EV Now will automatically exit when the Plug in power has been depleted.

### EV Later

 This mode saves most of the high voltage battery plug in power for future use (for example, your initial drive is at high speeds on open roads, but later your drive will be at low speeds in an urban area where plug-in power usage is most efficient). Your vehicle will run the engine as needed and keep most of the high voltage battery plug in power for later use in Auto Mode or EV Now mode.

When you enable EV Later, a white EV Later icon appears on the left-hand information display.

The EV Later mode will automatically reset to EV Auto mode when you power the vehicle off. You may press the EV button twice during the next drive to return to EV Later mode, if desired.

### Hybrid Vehicle Operation

This hybrid vehicle combines electric and gasoline propulsion to provide breakthrough performance and improved efficiency. Familiarizing yourself with these unique characteristics will provide an optimal driving experience from your new vehicle.

**Note:** *You may notice higher engine speeds upon start-up. This temporary condition is normal and necessary to heat up the cabin and minimize emissions.*



**Starting:** When you start your vehicle, a green ready indicator light will appear in the lower right portion of the instrument cluster and a ready to drive message will appear in the middle of the left cluster screen, letting you know that the vehicle is ready for driving.

The engine may not start because this vehicle is equipped with silent key start. This fuel saving feature allows your vehicle to be ready-to-drive without requiring the gas engine to be running. This indicator will remain on while the vehicle is on, whether the engine is running or not to indicate the vehicle is capable of movement (using its electric motor, engine, or both). Typically, the engine will not start unless the vehicle is cold, a climate control change is requested, or the accelerator is pressed.

**Driving:** The gas engine automatically starts and stops to provide power when needed and to save fuel when not needed. While coasting at low speeds, coming to a stop, or standing, the gas engine normally shuts down and the vehicle operates in electric-only mode. Conditions that may cause the engine to start up or remain running include:

- Considerable vehicle acceleration.
- Vehicle speed above 85 mph (137 km/h) However, the maximum speed for electric-only operation may be lower while driving in hot temperatures or on hilly terrain.
- Ascending a hill.
- Charge level of high voltage battery is low.



# Unique Driving Characteristics

---

- Very high or low outside temperature (to provide system cooling or heating). For C-MAX Energi vehicles, climate control demands by passengers may not directly cause the engine to run. This only occurs when the high voltage battery charge is low, or if the outside temperature is cold enough to require the engine to provide additional heat for the cabin.
- Engine not warm enough to provide passenger requested cabin temperature.

**Stopping:** The gas engine may shut off to conserve fuel as you come to a stop. Restarting the vehicle is not required. Simply step on the accelerator when you are ready to drive.

**Transmission Operation:** Due to the technologically advanced, electronically-controlled continuously variable transaxle, you will not feel shift changes like those of a non-hybrid vehicle.

**Note:** *Since engine speed is controlled by the transmission, it may seem elevated at times. This is normal hybrid operation and helps deliver fuel efficiency and performance.*

**Neutral:** It is not recommended to idle the vehicle in neutral (N) for an extended period of time because this will discharge your high voltage battery and decrease fuel economy. The engine will not start or stop, and cannot provide power to the hybrid system in neutral (N).

**Low:** Low (L) is designed to mimic the enhanced engine braking available in non-hybrid vehicles. Low gear will produce high engine speeds to provide necessary engine braking. This is normal and will not damage your vehicle. In low gear, the gas engine will remain on more often than in drive (D).

**Reverse:** In reverse (R), vehicle speed is limited to 22 mph (35 km/h).

## Unique Hybrid Operating Characteristics

Your vehicle behaves differently compared to a non-hybrid. Here is a description of the major differences:

**Battery:** Your hybrid is equipped with a high voltage battery. A cool battery maintains battery life and provides the best possible performance. Your hybrid high voltage battery may periodically re-condition itself to maintain maximum efficiency. You may notice slight changes in driveability during this process, but it is an important part of your hybrid's high voltage battery optimization features.

The high voltage battery is cooled by cabin air drawn from vent holes in the trim panels behind the rear seats. Avoid placing objects at the vent holes that block airflow to the high voltage battery.

**Engine:** The engine speed in your hybrid is not directly tied to your vehicle speed. Your vehicle's engine and transmission are designed to deliver the power you need at the most efficient engine speed. During heavy accelerations, your hybrid may reach high engine speeds (up to 6000 RPM).

In prolonged mountainous driving, you may see the engine speed changing without your input. This is intentional and maintains the battery charge level. You may also notice during extended downhill driving that your engine continues to run instead of shutting off.

During this engine braking, the engine stays on, but it is not using any fuel. You may also hear a slight whine or whistle when operating your vehicle. This is the normal operation of the electric generator in the hybrid system.

# Unique Driving Characteristics

---

During certain events (such as vehicle servicing) your low voltage 12-volt battery may become disconnected or disabled. Once the battery is reconnected and after driving the vehicle, the engine may continue to operate for three to five seconds after the key is turned to off. This is a normal condition.

**Braking:** Your hybrid is equipped with standard hydraulic braking and regenerative braking. Regenerative braking is performed by your transmission and it captures brake energy and stores it in your high voltage battery.

## Driving to Optimize Fuel Economy

**Note:** *Having your engine running is not always an indication of inefficiency. In some cases, it is actually more efficient than driving in electric mode.*

Your fuel economy should improve throughout your hybrid's break-in period. As with any vehicle, your driving habits and accessory usage can significantly impact your fuel economy. For best results, keep in mind these tips:

- Keep the tires properly inflated and only use the recommended size.
- Aggressive driving increases the amount of energy required to move your vehicle. In general, you can achieve better fuel economy with mild to moderate acceleration and deceleration. Moderate braking is particularly important since it allows you to maximize the energy captured by the regenerative braking system.

### Additional Tips:

- Do not carry extra loads.
- Be mindful of adding external accessories that may increase aerodynamic drag.
- Observe posted speed limits.

- Perform all scheduled maintenance.
- There is no need to wait for your engine to warm up. The vehicle is ready to drive immediately after starting.

## EV+ Mode (C-MAX Energi Only)

Your vehicle will recognize your frequent destinations and allow for more EV driving as you approach them. For example, when nearing your home it should be easier to stay in electric mode. The EV indicator will display EV+ when this mode is active. You should see this approximately 1/8 mile (200 meters) from a frequent destination. See **Information Displays** (page 91).

**Note:** *Frequent destinations are learned by your vehicle after two to four weeks of use. You can clear these destinations with a Driving History reset through the Settings menu.*

**Note:** *You can switch the EV+ feature on or off through the Driver Assist section of the Settings menu.*

## Low Engine Use (If Equipped)

The low engine use mode is equipped on Energi models only. The low engine use mode will activate automatically when you drive your vehicle with limited engine use. The mode will maintain proper engine lubrication at sufficient temperature. If your vehicle is in low engine use mode when you start the vehicle, a message will appear in the information display. When your vehicle is in low engine use mode, your vehicle will automatically run the engine as necessary. If you select the EV Now mode while the vehicle is in the low engine use mode, EV Now mode will be suspended for as long as you are in low engine use mode. The low engine use mode will resume the next time you start your vehicle and will automatically stop when no longer needed.

# Unique Driving Characteristics

**Note:** Cold temperatures will affect the engine warm up time and the low engine use mode may operate more frequently.

**Note:** An oil change is not required but gives you the option of not running a low engine use cycle. Resetting the oil life monitoring system will suspend the low engine use mode.

## Frequently Asked Questions

Question	Answer
What are the series of clicks from the cargo area when I first turn the key in the ignition?	The high voltage battery is electrically isolated from the rest of the vehicle when the key is off. When you switch the key on, high voltage contactors inside the battery are closed to make the electricity available to the motor and generator and enable the vehicle to drive. The clicks are the sound of these contactors as they close and open during start up and shut down.
Why does the engine sometimes start at key-on?	The vehicle's computer will determine if an engine start is required at key-on. Silent key start will start the engine if it is necessary for cabin heating, windshield defrost, or if the outside temperature is low. (For C-MAX Energi vehicles, the engine may not be required to operate these functions.)
Why does it take a long time before the engine shuts down?	There are several reasons the engine stays on for an extended amount of time when you first start it. One common reason is to make sure that the emissions components are warm enough to minimize tailpipe emissions. As the climate gets cooler, this engine-on time is extended.
Why does my engine never shut down above 85 mph (137 km/h)?	The engine is required to turn on above this speed to protect the transmission hardware.
Why does my engine stay on when it is extremely cold outside?	In order to make sure that the climate control system can begin heating the cabin or defrosting the windshield as soon as a driver requests it, the engine coolant temperature has to be kept sufficiently hot. Keeping the engine on is required to maintain the correct coolant temperature.

## Unique Driving Characteristics

Question	Answer
Why does my engine rev up so high sometimes when I accelerate?	Your vehicle's engine and transmission are designed to deliver the power you need at the most efficient engine speed. This may be higher than expected during heavy accelerations, and may fluctuate when driving at a steady speed. These are characteristics of the Atkinson engine cycle and the transmission technology that help maximize your hybrid's fuel economy.
What is the fan noise I hear from the rear of my hybrid?	The fan noise comes from a fan located next to the high voltage battery pack. This fan turns on when the battery requires cooling air. The fan speed, and associated noise level, will change according to the amount of cooling required to maintain good performance. Maintaining the battery temperature at optimal conditions also prolongs the useful life of the battery and helps to achieve better fuel economy.
What is the engine oil change service interval?	Change the engine oil every 10000 miles (16000 kilometers) or once per year under normal operating conditions.
Can I put E15 or E85 in my vehicle, and how will it affect my fuel economy?	Your hybrid vehicle can use E15 (15% ethanol, 85% gasoline) fuel, but you may notice slightly reduced fuel economy because ethanol contains less energy per gallon than gasoline. Your hybrid vehicle is not designed to use E85 (85% ethanol).
How long will my high voltage battery last? Does it need maintenance?	The high voltage battery system is designed to last the life of the vehicle and requires no maintenance.
Can you charge the battery with a plug into an A/C outlet?	There are no provisions for charging the high voltage battery from a power supply external to the vehicle. (For C-MAX Energi vehicles, the vehicle can be plugged into a 110-volt outlet with charge cord provided.)
Can I tow the hybrid behind my motor home with all four wheels down?	Yes. Your hybrid vehicle can be flat towed without modification. See <b>Towing</b> (page 186).

# Fuel and Refueling

## SAFETY PRECAUTIONS

### WARNINGS



Do not overfill the fuel tank. The pressure in an overfilled tank may cause leakage and lead to fuel spray and fire.



The fuel system may be under pressure. If you hear a hissing sound near the fuel filler door (Easy Fuel capless fuel system), do not refuel until the sound stops. Otherwise, fuel may spray out, which could cause serious personal injury.



Automotive fuels can cause serious injury or death if misused or mishandled.



Flow of fuel through a fuel pump nozzle can produce static electricity. This can cause a fire if you are filling an ungrounded fuel container.



Fuel ethanol and gasoline may contain benzene, which is a cancer-causing agent.



When refueling always shut the engine off and never allow sparks or open flames near the filler neck.

Never smoke or use a cell phone while refueling. Fuel vapor is extremely hazardous under certain conditions. Avoid inhaling excess fumes.

Observe the following guidelines when handling automotive fuel:

- Extinguish all smoking materials and any open flames before refueling your vehicle.
- Always turn off the vehicle before refueling.
- Automotive fuels can be harmful or fatal if swallowed. Fuel such as gasoline is highly toxic and if swallowed can cause death or permanent injury. If fuel is swallowed, call a physician immediately, even if no symptoms are immediately apparent. The toxic effects of fuel may not be visible for hours.
- Avoid inhaling fuel vapors. Inhaling too much fuel vapor of any kind can lead to eye and respiratory tract irritation. In severe cases, excessive or prolonged breathing of fuel vapor can cause serious illness and permanent injury.
- Avoid getting fuel liquid in your eyes. If fuel is splashed in the eyes, remove contact lenses (if worn), flush with water for 15 minutes and seek medical attention. Failure to seek proper medical attention could lead to permanent injury.
- Fuels can also be harmful if absorbed through the skin. If fuel is splashed on the skin, clothing or both, promptly remove contaminated clothing and wash skin thoroughly with soap and water. Repeated or prolonged skin contact with fuel liquid or vapor causes skin irritation.
- Be particularly careful if you are taking "Antabuse" or other forms of disulfiram for the treatment of alcoholism. Breathing gasoline vapors, or skin contact could cause an adverse reaction. In sensitive individuals, serious personal injury or sickness may result. If fuel is splashed on the skin, promptly wash skin thoroughly with soap and water. Consult a physician immediately if you experience an adverse reaction.

# Fuel and Refueling

## FUEL QUALITY

**Note:** *Your warranty will not cover any vehicle damage, powertrain damage, loss of vehicle performance or repairs to your vehicle, caused by the use of fuel not recommended.*

### Choosing the Right Fuel

Use only UNLEADED gasoline or UNLEADED gasoline blended with a maximum of 15% ethanol in your gasoline vehicle. If your vehicle is a Flex Fuel Vehicle (FFV), it will have a yellow bezel placed over the fuel fill inlet.

Do not use:

- Fuels containing more than 15% ethanol or E-85 fuel.
- Fuels containing methanol.
- Fuels containing metallic based additives, including manganese-based compounds.
- Fuels containing the octane booster additive, methylcyclopentadienyl manganese tricarbonyl (MMT).
- Prohibited by law, you cannot use leaded fuel.

**Note:** *Use of any fuel other than the recommended fuel can cause powertrain damage, impair the emission control system or cause loss of vehicle performance. Any damage to your vehicle that is caused by the use of fuel not recommended will not be covered under warranty.*

## Octane Recommendations

We recommend regular unleaded gasoline with a pump (R+M)/2 octane rating of 87. Some stations offer fuels posted as regular with an octane rating below 87, particularly in high altitude areas. We do not recommend fuels with an octane rating below 87. Premium fuel will provide improved performance and is recommended for severe duty usage such as trailer tow.

### Fuel Freshness Mode (Energy Vehicles Only)

This feature helps keep the fuel system functional and the fuel fresh.

If you mainly operate your vehicle in plug-in power mode using electricity from plugging in without refueling, the gasoline in the fuel tank will become stale due to aging over an extended period. Stale gasoline can damage the engine and fuel system.

Your vehicle will automatically operate in fuel freshness mode if you do not refill your vehicle with fresh fuel within an 18-month period. The design of fuel freshness mode protects your vehicle from potential engine and fuel system damage caused by using stale fuel.

**Note:** *If you do not add new fuel during an 18-month period, fuel freshness mode will consume fuel until you have about 1 gal (3.8 L) in the tank.*

During fuel freshness mode:

- The information display screen will indicate that fuel freshness mode is active.
- The vehicle will only run in hybrid mode. EV Now will not be available.
- Most of the plug-in power will be stored until fuel freshness mode is completed.

# Fuel and Refueling

**Note:** EV Now can resume if less than 1 gal (3.8 L) of fuel is left in the tank.

**Note:** In most cases, when the fuel level is below one-quarter tank, refueling the vehicle will end fuel freshness mode and then EV Now will become available. Refueling after consuming a full tank in fuel freshness mode will end the mode.

**Note:** The recommendation is that you use a fuel stabilizer if you consume less than a full tank of fuel during an 18-month period.

## RUNNING OUT OF FUEL

Avoid running out of fuel because this situation may have an adverse effect on powertrain components.

If you have run out of fuel:

- You may need to cycle the ignition from off to on several times after refueling to allow the fuel system to pump the fuel from the tank to the engine. On restarting, cranking time will take a few seconds longer than normal. With keyless ignition, just start the engine. Crank time will be longer than usual.
- Normally, adding 1 gallon (3.8 liters) of fuel is enough to restart the engine. If the vehicle is out of fuel and on a steep grade, more than 1 gallon (3.8 liters) may be required.
- The service engine soon indicator may come on. For more information on the service engine soon indicator, See **Symbols Glossary** (page 7).

## Refilling With a Portable Fuel Container

### WARNINGS

 Do not insert the nozzle of portable fuel containers or aftermarket funnels into the capless fuel system. This could damage the fuel system and its seal, and may cause fuel to run onto the ground instead of filling the tank, which could result in serious personal injury.

 Do not try to pry open or push open the capless fuel system with foreign objects. This could damage the fuel system and its seal and cause injury to you or others.

**Note:** Do not use aftermarket funnels; they will not work with the capless fuel system and can damage it. The included funnel has been specially designed to work safely with your vehicle.

When filling the vehicle's fuel tank from a portable fuel container, use the funnel included with the vehicle.



E162448

In C-MAX vehicles, the funnel is located in the rear of the vehicle inside the load compartment.

# Fuel and Refueling



E162449

In C-MAX Energi vehicles the funnel is located in the rear of the vehicle, inside storage compartment

1. Locate the portable funnel that comes with your vehicle.



E142668

2. Slowly insert the funnel into the capless fuel system.



E145428











3. Fill the vehicle with fuel from the portable fuel container.

**Note:** For C-MAX Energi vehicles, press the fuel button located on the instrument panel before performing step 3.

4. When done, clean the funnel or properly dispose of it. Extra funnels can be purchased from your authorized dealer if you choose to dispose of the funnel.

## REFUELING

### WARNINGS

-  Fuel vapor burns violently and a fuel fire can cause severe injuries.
-  Read and follow all the instructions on the pump island.
-  Switch off your vehicle when you are refueling.
-  Do not smoke if you are near fuel or refueling your vehicle.
-  Keep sparks, flames and smoking materials away from fuel.
-  Stay outside your vehicle and do not leave the fuel pump unattended when refueling your vehicle. This is against the law in some places.
-  Keep children away from the fuel pump and never let children pump fuel.
-  Do not use personal electronic devices while refueling.
-  Wait at least 10 seconds before removing the fuel pump nozzle to allow any residual fuel to drain into the fuel tank.
-  Stop refueling after the fuel pump nozzle automatically shuts off for the second time. Failure to follow this will fill the expansion space in the fuel tank and could lead to fuel overflowing.
-  Do not remove the fuel pump nozzle from its fully inserted position when refueling.



# Fuel and Refueling

Use the following guidelines to avoid electrostatic charge build-up when filling an ungrounded fuel container:

- Place an approved fuel container on the ground.
- Do not fill a fuel container while it is in the vehicle (including the cargo area).
- Keep the fuel pump nozzle in contact with the fuel container while filling.
- Do not use a device that would hold the fuel pump handle in the fill position.

## Easy Fuel™ Capless Fuel System (Non-Energi Vehicles)

### WARNING

 The fuel system may be under pressure. If you hear a hissing sound near the fuel filler door, do not refuel until the sound stops. Otherwise, fuel may spray out, which could cause serious personal injury.

When fueling your vehicle:

1. Put the vehicle in park (P) and switch the ignition off.
2. Open the fuel filler door.



E156032

3. Slowly insert the fuel filler nozzle fully into the fuel system, and leave the nozzle fully inserted until pumping is complete. Hold the handle higher during insertion for easier access.

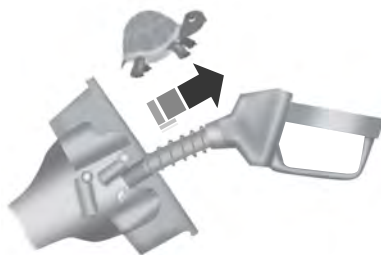

E154765

4. Once pumping is complete, slowly remove the fuel filler nozzle. Allow approximately five to ten seconds after pumping fuel before removing the fuel filler nozzle. This allows residual fuel to drain back into the fuel tank and not spill onto the vehicle.

**Note:** A fuel spill concern may occur if the fuel tank overfills. Do not overfill the tank to the point that the fuel is able to bypass the fuel filler nozzle. The overfilled fuel may run down the drain located below and in front of the fuel filler door.

If the fuel fill inlet was not properly closed, a service engine warning lamp may appear on the instrument cluster.

At the next opportunity, do the following:

1. Safely pull off the road.
2. Put the vehicle in park (P) and switch the ignition off.
3. Open the fuel filler door and remove any visible debris from the fuel fill opening.
4. Insert the fuel fill nozzle or the fuel fill funnel provided with the vehicle several times to dislodge any debris and allow the inlet to close properly.

## Fuel and Refueling

If this action corrects the problem, the message may not reset immediately. It may take several driving cycles for the message to turn off. A driving cycle consists of an engine start-up (after four or more hours with the engine off) followed by city or highway driving. Continuing to drive with the message on may cause the service engine soon lamp to turn on as well.

### Easy Fuel™ Capless System (Energi Vehicles Only)

#### WARNING



The fuel system may be under pressure. If you hear a hissing sound near the fuel filler door, do not refuel until the sound stops. Otherwise, fuel may spray out, which could cause serious personal injury.

**Note:** *Your vehicle features a locking fuel door and an auto-sealing feature that locks the fuel tank refueling valve. Before you can refuel your vehicle, you must first press the button located on the center console. Pressing this button will unlock the fuel tank refueling valve allowing the fuel filler door to open so that you can insert the fuel filler nozzle into the fuel inlet. This could take up to fifteen seconds before the fuel filler door pops open allowing the insertion of the fuel filler nozzle.*

When fueling your vehicle:

1. Put the vehicle in park (P) and switch the ignition off.
2. Press the fuel button located on the center console.



E145428

3. Wait up to fifteen seconds before opening the fuel filler door. During this time, a **Fuel Door Opening** message will appear in the information display screen.
4. When the door is open, a **Fuel Door Open** message will appear in the information display, indicating that your vehicle is ready to refuel. The vehicle will remain ready to refuel for approximately 20 minutes. If more than 20 minutes is required, you will need to press the refueling button again. You may experience the fuel pump turning off if you do not press the refuel button again.
5. Open the fuel filler door.

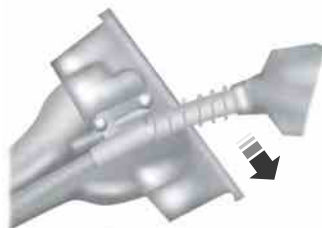

E156032

6. Slowly insert the fuel filler nozzle fully into the fuel system and leave the nozzle fully inserted until pumping is complete. Hold the handle higher while inserting for easier access.

# Fuel and Refueling

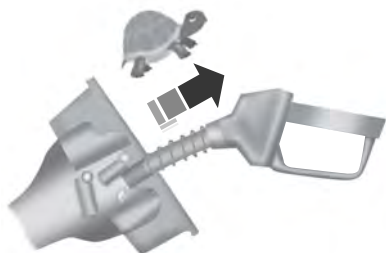

E154765

7. After pumping fuel, slowly remove the fuel filler nozzle. Allow approximately five to ten seconds after pumping fuel before removing the fuel filler nozzle. This allows residual fuel to drain back into the fuel tank and not spill onto the vehicle.
8. Close the fuel door fully until it clicks shut. This permits the fuel system to properly function.

**Note:** A fuel spill concern may occur if the fuel tank overfills. Do not overfill the tank to the point that the fuel is able to bypass the fuel filler nozzle. The overfilled fuel may run down the drain located below and in front of the fuel filler door.

If the fuel fill inlet was not properly closed, a service engine warning lamp may appear on the instrument cluster.

At the next opportunity, do the following:

1. Safely pull off the road.
2. Put the vehicle in park (P) and switch the ignition off.
3. Open the fuel filler door and remove any visible debris from the fuel fill opening.
4. Insert the fuel fill nozzle or the fuel fill funnel, provided with the vehicle, several times to dislodge any debris and allow the inlet to close properly.

If this action corrects the problem, the message may not reset immediately. It may take several driving cycles for the message to turn off. A driving cycle consists of an engine start-up (after four or more hours with the engine off) followed by city or highway driving. Continuing to drive with the message on may cause the service engine soon lamp to turn on as well.

## Using the manual override lever

### WARNING



The fuel system may be under pressure. Insert the fuel nozzle slowly. If you hear a hissing sound near the fuel filler door, do not refuel until the sound stops. Otherwise, fuel may spray out, which could cause serious personal injury.

**Note:** The vehicle must be in park (P) when using the manual override feature.

The manual override lever is located inside of the luggage compartment on the right rear side panel.

When using the fuel door manual override to access the fuel fill inlet:

1. Switch the ignition on prior to using the manual override.
2. Remove the panel located in luggage compartment on the right rear area of the vehicle hatch.

# Fuel and Refueling

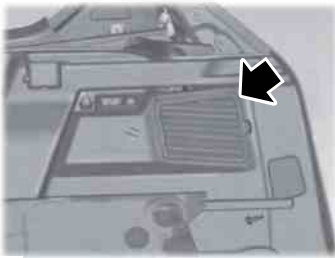

E162486

3. Locate the manual override mechanism.

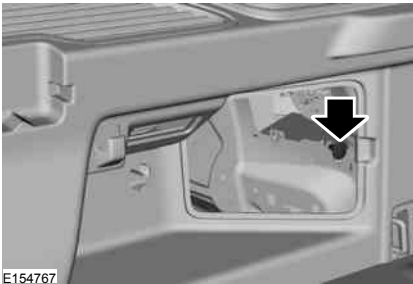

E154767

4. Pull the manual override mechanism.

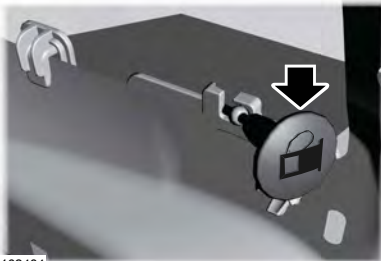

E162484

5. Key off and complete refueling within 20 minutes. If more than 20 minutes is required, close fuel door and repeat the procedure.

This will enable you to refuel without any issue.

**Note:** A fuel spill concern may occur if the fuel tank overfills. Do not overfill the tank to the point that the fuel is able to bypass the fuel filler nozzle. The overfilled fuel may run down the drain located below and in front of the fuel filler door.

If the fuel fill inlet was not properly closed, a service engine warning lamp may appear on the instrument cluster. At the next opportunity, do the following:

1. Safely pull off the road.
2. Put the vehicle in park (P) and turn the ignition off.
3. Open the fuel filler door and remove any visible debris from the fuel fill opening.
4. Insert either the fuel fill nozzle or the fuel fill funnel provided with the vehicle several times to allow the inlet to close properly. This will dislodge any debris preventing the inlet from sealing.

If this action corrects the problem, the message may not reset immediately. It may take several driving cycles for the message to turn off. A driving cycle consists of an engine start-up (after four or more hours with the engine off) followed by city and highway driving. Continuing to drive with the message on may cause the service engine soon lamp to turn on as well.

## FUEL CONSUMPTION

**Note:** The amount of usable fuel in the empty reserve varies and should not be relied upon to increase driving range. When refueling your vehicle after the fuel gauge indicates empty, you might not be able to refuel the full amount of the advertised capacity of the fuel tank due to the empty reserve still present in the tank.

# Fuel and Refueling

Empty reserve is the amount of fuel remaining in the tank after the fuel gauge indicates empty. Do not rely on this fuel for driving. The usable capacity of the fuel tank is the amount of fuel that can be put into the tank after the gauge indicates empty. The advertised capacity is the total fuel tank size – it is the combined usable capacity plus the empty reserve.

## Filling the Tank

For consistent results when filling the fuel tank:

- Turn the ignition off before fueling; an inaccurate reading results if the engine is left running.
- Use the same fill rate (low-medium-high) each time the tank is filled.
- Allow no more than two automatic click-offs when filling.

Results are most accurate when the filling method is consistent.

## Calculating Fuel Economy

Do not measure fuel economy during the first 1000 miles (1600 kilometers) of driving (this is your engine's break-in period); a more accurate measurement is obtained after 2000 miles - 3000 miles (3200 kilometers - 4800 kilometers). Also, fuel expense, frequency of fill ups or fuel gauge readings are not accurate ways to measure fuel economy.

1. Fill the fuel tank completely and record the initial odometer reading.
2. Each time you fill the tank, record the amount of fuel added.
3. After at least three to five tank fill ups, fill the fuel tank and record the current odometer reading.
4. Subtract your initial odometer reading from the current odometer reading.

5. Calculate fuel economy by dividing miles traveled by gallons used (For Metric: Multiply liters used by 100, then divide by kilometers traveled).

Keep a record for at least one month and record the type of driving (city or highway). This provides an accurate estimate of the vehicle's fuel economy under current driving conditions. Additionally, keeping records during summer and winter show how temperature impacts fuel economy. In general, lower temperatures mean lower fuel economy.

## EMISSION CONTROL SYSTEM

### WARNINGS



Do not park, idle, or drive your vehicle in dry grass or other dry ground cover. The emission system heats up the engine compartment and exhaust system, which can start a fire.



Exhaust leaks may result in entry of harmful and potentially lethal fumes into the passenger compartment. If you smell exhaust fumes inside your vehicle, have your dealer inspect your vehicle immediately. Do not drive if you smell exhaust fumes.

Your vehicle is equipped with various emission control components and a catalytic converter that will enable your vehicle to comply with applicable exhaust emission standards.

To make sure that the catalytic converter and other emission control components continue to work properly:

- Use only the specified fuel listed.
- Avoid running out of fuel.

# Fuel and Refueling

- Do not turn off the ignition while your vehicle is moving, especially at high speeds.
- Have the items listed in scheduled maintenance information performed according to the specified schedule.

The scheduled maintenance items listed in scheduled maintenance information are essential to the life and performance of your vehicle and to its emissions system.

If you use anything other than Ford, Motorcraft or Ford-authorized parts for maintenance replacements or for service of components affecting emission control, such non-Ford parts should be equivalent to genuine Ford Motor Company parts in performance and durability.

Illumination of the service engine soon indicator, charging system warning light or the temperature warning light, fluid leaks, strange odors, smoke or loss of engine power could indicate that the emission control system is not working properly.

An improperly operating or damaged exhaust system may allow exhaust to enter the vehicle. Have a damaged or improperly operating exhaust system inspected and repaired immediately.

Do not make any unauthorized changes to your vehicle or engine. By law, vehicle owners and anyone who manufactures, repairs, services, sells, leases, trades vehicles, or supervises a fleet of vehicles are not permitted to intentionally remove an emission control device or prevent it from working. Information about your vehicle's emission system is on the Vehicle Emission Control Information Decal located on or near the engine. This decal also lists engine displacement.

Please consult your warranty information for complete details.

## On-Board Diagnostics (OBD-II)

Your vehicle has a computer known as the on-board diagnostics system (OBD-II) that monitors the engine's emission control system. The system protects the environment by making sure that your vehicle continues to meet government emission standards. The OBD-II system also assists a service technician in properly servicing your vehicle.



When the service engine soon indicator illuminates, the OBD-II system has detected a malfunction. Temporary malfunctions may cause the service engine soon indicator to illuminate. Examples are:

1. Your vehicle has run out of fuel—the engine may misfire or run poorly.
2. Poor fuel quality or water in the fuel—the engine may misfire or run poorly.
3. The fuel fill inlet may not have closed properly. See **Refueling** (page 141).
4. Driving through deep water—the electrical system may be wet.

You can correct these temporary malfunctions by filling the fuel tank with good quality fuel, properly closing the fuel fill inlet or letting the electrical system dry out. After three driving cycles without these or any other temporary malfunctions present, the service engine soon indicator should stay off the next time you start the engine. A driving cycle consists of a cold engine startup followed by mixed city and highway driving. No additional vehicle service is required.

# Fuel and Refueling

If the service engine soon indicator remains on, have your vehicle serviced at the first available opportunity. Although some malfunctions detected by the OBD-II may not have symptoms that are apparent, continued driving with the service engine soon indicator on can result in increased emissions, lower fuel economy, reduced engine and transmission smoothness and lead to more costly repairs.

## Readiness for Inspection and Maintenance (I/M) Testing

Some state and provincial and local governments may have Inspection/Maintenance (I/M) programs to inspect the emission control equipment on your vehicle. Failure to pass this inspection could prevent you from getting a vehicle registration.



If the service engine soon indicator is on or the bulb does not work, your vehicle may need service. See On-Board Diagnostics.

Your vehicle may not pass the I/M test if the service engine soon indicator is on or not working properly (bulb is burned out), or if the OBD-II system has determined that some of the emission control systems have not been properly checked. In this case, the vehicle is not ready for I/M testing.

If the vehicle's engine or transmission has just been serviced, or the battery has recently run down or been replaced, the OBD-II system may indicate that the vehicle is not ready for I/M testing. To determine if the vehicle is ready for I/M testing, turn the ignition key to the on position for 15 seconds without cranking the engine. If the service engine soon indicator blinks eight times, it means that the vehicle is not ready for I/M testing; if the service engine soon indicator stays on solid, it means that your vehicle is ready for I/M testing.

The OBD-II system checks the emission control system during normal driving. A complete check may take several days.

If the vehicle is not ready for I/M testing, you can perform the following driving cycle consisting of mixed city and highway driving:

1. 15 minutes of steady driving on an expressway or highway followed by 20 minutes of stop-and-go driving with at least four 30-second idle periods.
2. Allow your vehicle to sit for at least eight hours with the ignition off. Then, start the vehicle and complete the above driving cycle. The vehicle must warm up to its normal operating temperature. Once started, do not turn off the vehicle until the above driving cycle is complete.

If the vehicle is still not ready for I/M testing, you need to repeat the above driving cycle.

# High Voltage Battery

## GENERAL INFORMATION

### WARNING



Have the battery pack serviced only by an authorized electric vehicle technician. Improper handling can result in personal injury or death.

**Note:** *The high-voltage battery does not require regular service maintenance.*

Your vehicle consists of various high-voltage components and wiring. All of the high-voltage power flows through specific wiring assemblies labeled as such or covered with a solid orange convolute, orange striped tape or both. Do not come in contact with these components.

The high-voltage battery system is a high-voltage, lithium-ion battery system. The pack is located in the rear cargo area. The high-voltage battery system uses an air cooled system to regulate the high-voltage battery temperature and help maximize high-voltage battery life.



E163462

**Note:** *The high-voltage battery is equipped with air vents in the package tray that help to regulate its temperature. It is important to keep these openings free of obstructions. Do not block the flow of cabin air to this area.*

## HIGH-VOLTAGE SERVICE DISCONNECT

The high-voltage service disconnect turns off power from the high-voltage battery.

**Note:** *There is a disconnect circuit in your vehicle. Disconnecting the circuit will automatically disable the high-voltage battery.*

To disable the battery and stop all high-voltage electric activity in the vehicle you can access high-voltage disconnect circuit. To do this, you must unplug the circuit from the circuit port connected to the battery.



# High Voltage Battery

**Note:** The service disconnect has an outer lever to aid in the proper seating of the service disconnect lever. Remove this to disconnect the high-voltage service disconnect.

The high-voltage service disconnect is located behind the rear fold down seats.

Service disconnect location for non-Energi vehicles.

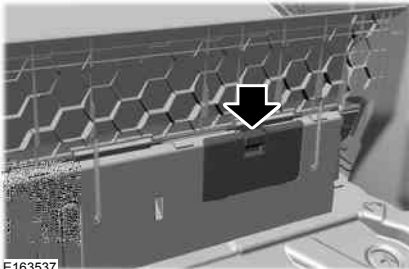

Service disconnect location for Energi vehicles.

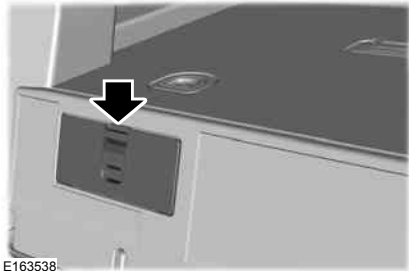

## Disabling the High-Voltage Battery

1. Fold down the rear seats and remove the cover panel.
2. Locate the access door and remove the plastic cover.



E171514

3. Pull the outer cover off to expose the service disconnect lever.

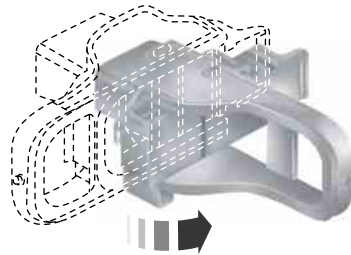

E147234

4. Slide the handle on the service disconnect outboard to the right. For Energi vehicles, slide the handle outboard and to the left.

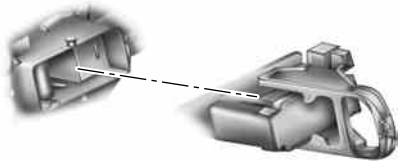

E146133

5. Pull the handle toward you and remove the service disconnect from the vehicle to disable the high-voltage battery.

# High Voltage Battery

## Reactivating the High-Voltage Battery

**Note:** If you have manually disconnected your high-voltage shut off circuit, you will need to reconnect the circuit before you can reactivate it. The system will detect if the electrical system is safe and turn on automatically.

## CHARGING THE HIGH VOLTAGE BATTERY

### WARNINGS



Do not use the 120 volt convenience cord with an extension cord, two-prong adapter, surge protector, timer or other adapter.



In Canada, do not use the 120 volt convenience cord in commercial garages.



This equipment has arcing or sparking parts, do not expose to flammable vapors. Position this equipment at least 18 in (45 cm) above the floor.



The AC wall plug must fit firmly into the AC outlet. If the connection feels loose, worn or the AC outlet is damaged, please have a qualified electrician replace the AC outlet. Using a convenience cord with a worn outlet may cause burns, property damage and increase the risk of electric shock.

## Charging Equipment



E78097

Your vehicle is equipped with a standard 120 volt convenience cord located in the floor compartment behind the driver seat.

**Note:** The 120 volt convenience cord allows you to charge the high voltage battery using a standard 120 volt household outlet. It takes approximately seven hours to completely charge an empty battery using the standard 120 volt convenience cord.

We recommend upgrading to the optional 240 volt charging station for faster more efficient charging. It takes approximately 2.5 hours to completely charge an empty battery using a 240 volt charging station.

Your electrical source must meet certain requirements for the high voltage batteries to charge:

- The AC outlet must be a three-prong 110–120 volt AC outlet that is properly grounded, 15–20 amps (or greater), and in good condition.
- You must use a dedicated line, which means you cannot have other appliances connected to the same circuit.

**Note:** If you do not have a dedicated circuit, contact a licensed professional electrician for proper installation.

# High Voltage Battery

Make sure that the 120 volt convenience cord is completely unwound before charging. Always plug the cord into the AC outlet before connecting the charging coupler into the charge port on your vehicle.

## 120 Volt Convenience Cord

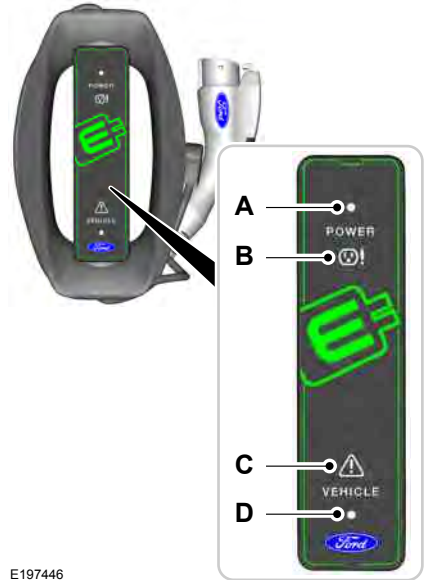

E197446

- A. Power.
- B. Check outlet (if equipped).
- C. Fault.
- D. Vehicle.

**Note:** When the convenience cord is plugged into an outlet, use the following table to determine your vehicle charge status. If the **POWER** indicator light is off after plugging in the convenience cord, use a different outlet.

## High Voltage Battery

Convenience Cord LED Indicators			Status
Check Outlet (If Equipped)	Fault	Vehicle	
Off	Off	Off	The convenience cord is not connected to your vehicle.
Off	Off	On	The convenience cord is connected, but your vehicle is not charging.
Off	Off	Blink	Your vehicle is charging.
Off	Blink	Off	Ground Fault Circuit Interrupter (GFCI) Fault Detected. The convenience cord is retrying to charge.
Off	On	Off	Ground Fault Circuit Interrupter (GFCI) Fault Detected. The convenience cord has exhausted its retry attempts. Your vehicle is not charging, or there is an internal fault in the charging equipment.
Blink	Off	Off	The convenience cord detected a high temperature at the AC plug and is waiting for the AC plug to return to a normal operating temperature.*
Blink	Off	On	The convenience cord detected a high temperature at the AC plug. The AC plug has returned to a normal operating temperature. Your vehicle is ready to charge at a reduced current.*
Blink	Off	Blink	The convenience cord detected a high temperature at the AC plug. The AC plug has returned to a normal operating temperature. Your vehicle is charging at a reduced current.*
Blink	On	Off	The convenience cord detected a high temperature at the AC plug. Your vehicle is not charging. The convenience cord has exhausted its retry attempts.*

\*Have the outlet checked by a qualified electrician and make sure the AC plug fits firmly into the outlet. Contact an authorized EV certified dealer if problem persists.

# High Voltage Battery

## Charge Port

The charge port is located between the front left-hand side door and the front left-hand side wheel well. Press the indentation on the charge port door to open and close it.

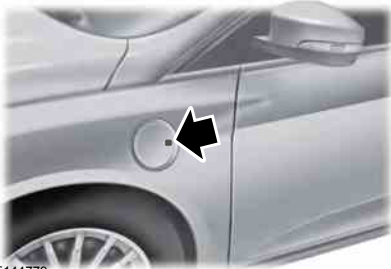

E144779

**Note:** Do not force the charge port door open or closed. Forcing the door open or closed damages the charge port.

You can modify the light ring illumination settings. The light ring located around the charge port indicates the charge status of the high voltage battery in your vehicle. Divided into four quadrants, the charge port light ring displays the state of charge in 25 percent increments.

You can press the unlock button on your key fob to view the charge status of your vehicle. Based on which quadrants light, you can determine the current state of charge. If the charge is below 25 percent, the light ring does not light. Do not forget to press the lock button on your key fob to re-lock your vehicle.

The light ring also displays the current state of charge when opening the doors.

The cord acknowledgment feature activates when you initiate a charge cycle. The four light quadrants each individually flash in a clockwise motion, starting with the top right-hand side light and ending with the top left-hand side, two times confirming that the system detects the charging coupler.

## Charging

**Note:** Your vehicle must be in park (P) to charge.

To charge your high voltage battery:

1. Put your vehicle in park (P) and switch off your vehicle.
2. Press the indentation on the charge port door to open it.
3. Plug the charging coupler into the charge port on your vehicle. Make sure the button clicks confirming you have completely engaged the coupler.



E144780

4. Verify that the cord acknowledgment feature activates. The cord acknowledgment feature activates when you initiate a charge cycle.
5. If using a 240 volt charging station, follow the instructions on the charge station to begin the charging process.

# High Voltage Battery

The light ring located around the charge port indicates the charge status of the high voltage battery in your vehicle:

- When the top right-hand side quadrant is pulsing, the charge is between 0-25 percent.
- When the top right-hand side quadrant is on and the bottom right-hand quadrant is pulsing, the charge is between 25-50 percent.
- When both right-hand side quadrants are on and the bottom left-hand side quadrant is pulsing, the charge is between 50-75 percent.
- When three quadrants are on and the top left-hand side quadrant is pulsing, the charge is between 75-100 percent.
- When all the lights on the light ring are on, the charge is complete.

**Note:** *The light ring will turn off one minute after reaching a full charge.*

## Locking the Charging Coupler

**Note:** *To lock the charging coupler, you need a padlock or a combination lock with a shackle diameter of 0.2 (5 mm) or less. Also, the straight portion of the shackle must be 1.0 (25.4 mm) or longer.*

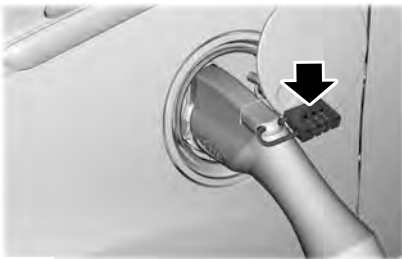

1. Insert the lock through the hole in the charging coupler button.
2. Lock the padlock or combination lock.

## Waiting to Charge

When you select Value Charge, charging may not begin upon plugging in. The vehicle may delay charging to take advantage of off-peak electricity rates. The vehicle will optimize the charge schedule to be complete by the next GO Time.

When waiting to charge (not actively charging), the light ring will indicate the present state of charge of the high voltage battery as follows:

- When the top right quadrant light is off, the charge is between 0-25 percent.
- When the top right quadrant light is on and the bottom right quadrant is off, the charge is between 25-50 percent.
- When both right side quadrant lights are on and the bottom left quadrant is off, the charge is between 50-75 percent.
- When three quadrant lights are on and the top left quadrant is off, the charge is between 75-100 percent.
- When all lights on the entire ring are on, the charge is 100 percent.

**Note:** *When the vehicle is waiting to charge, the light ring will turn off one minute after displaying the present state of charge. When the vehicle automatically begins charging, the light ring will turn on and display how far along the charge is per the section above.*

**Note:** *If the system detects a vehicle charging system fault at any point in a charge cycle, the entire light ring will flash continuously for one minute and then turn off. If this happens, unplug the charging coupler and then plug it back into the charge port receptacle. If the problem persists, contact an authorized dealer.*

You can modify the light ring lighting conditions by using the touchscreen system.

# High Voltage Battery

## Disconnecting the Charging Coupler

**Note:** Do not pull the wall plug from the wall while the vehicle is charging. Doing so may damage the outlet and the cord.

1. Remove the lock from the charging coupler button.
2. Press the button on the charging coupler.
3. While holding the button, remove the charging coupler from the charge port receptacle on your vehicle.

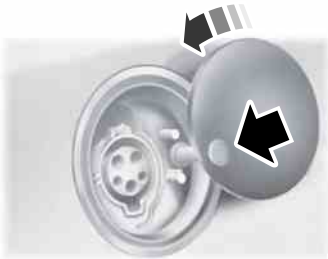

E144781

4. Close the charge port door by pressing the indentation on the charge port door. Continue pressing the indentation while the door rotates counterclockwise and closes.

## HIGH VOLTAGE BATTERY CUT-OFF SWITCH

The high-voltage shut off operation shuts off power from the high-voltage battery after a collision, or if your vehicle receives a substantial physical jolt.

To reactivate your vehicle after either event, perform the following steps:

1. Turn the ignition off.
2. Turn the ignition on.

3. If your vehicle is not powered after this sequence, repeat steps 1 and 2 up to two more times.

For vehicles equipped with a push button start system:

1. Press the **START/STOP** button to turn ignition off.
2. Press the brake pedal and press the **START/STOP** button.
3. If your vehicle is not powered after this sequence, repeat steps 1 and 2 up to two more times.

**Note:** During this process, your vehicle will detect if the electrical system is safe and reactivate. Once your vehicle determines the electrical system safe, you can start your vehicle as you would normally by either turning the ignition key or by pressing the brake in combination with the **START/STOP** button.

**Note:** In the event your vehicle does not reactivate after the third key cycle, contact an authorized dealer.

# Transmission

## AUTOMATIC TRANSMISSION

### WARNINGS



Always set the parking brake fully and make sure the gearshift is latched in park (P). Turn the ignition to the off position and remove the key whenever you leave your vehicle.



Do not apply the brake pedal and accelerator pedal simultaneously. Applying both pedals simultaneously for more than three seconds will limit engine rpm, which may result in difficulty maintaining speed in traffic and could lead to serious injury.

**Note:** Do not leave your vehicle with the transmission in neutral (N). Leaving your vehicle with the transmission in neutral (N) will drain the battery and you may not be able to start your vehicle.

## Automatic Transmission

### Putting your vehicle in gear:

1. Fully press down the brake pedal.
2. Move the gearshift lever to the desired gear.
3. Come to a complete stop.
4. Move the gearshift lever and securely latch it in park (P).



E144820

### Park (P)

This position locks the transmission and prevents the front wheels from turning. Come to a complete stop before putting your vehicle into and out of park (P).

### Reverse (R)

With the gearshift lever in reverse (R), your vehicle will move backward. Always come to a complete stop before shifting into and out of reverse (R).

### Neutral (N)

With the gearshift lever in neutral (N), your vehicle can be started and is free to roll. Hold the brake pedal down while in this position.

### Drive (D)

Drive (D) is the normal driving position for the best fuel economy.

### Low (L)

- Provides maximum engine braking.
- The transmission may be shifted into low (L) at any vehicle speed.
- Is not intended for use under extended or normal driving conditions and results in lower fuel economy.

### Grade assist:

Press the transmission control switch on the side of the gearshift lever to activate grade assist.



# Transmission



E146092

- Provides additional grade braking with a combination of engine motoring and high-voltage battery charging to help maintain vehicle speed when descending a grade.
- As your vehicle determines the amount of engine motoring and high-voltage battery charging, you may notice the engine speed increasing and decreasing to help maintain your vehicle speed when descending a grade.
- The grade assist lamp in the instrument cluster is illuminated.



The grade assist lamp will appear in the instrument cluster when grade assist is turned on.

Press the transmission control switch again to return to normal drive (D).

## Brake-Shift Interlock

### WARNINGS



Do not drive your vehicle until you verify that the brake lamps are working.



When doing this procedure, you will be taking your vehicle out of park which means your vehicle can roll freely. To avoid unwanted vehicle movement, always fully set the parking brake prior to doing this procedure. Use wheel chocks if appropriate.

### WARNINGS



If the parking brake is fully released, but the brake warning lamp remains illuminated, the brakes may not be working properly. See your authorized dealer.

**Note:** See your authorized dealer as soon as possible if this procedure is used.

**Note:** For some markets this feature will be disabled.

Use the brake shift interlock lever to move the gearshift lever from the park position in the event of an electrical malfunction or if your vehicle has a dead battery.

Apply the parking brake and turn the ignition off before performing this procedure.

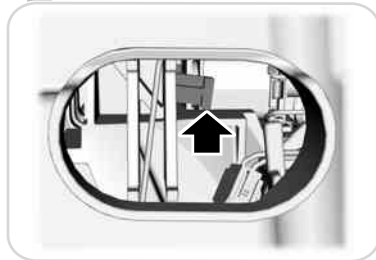
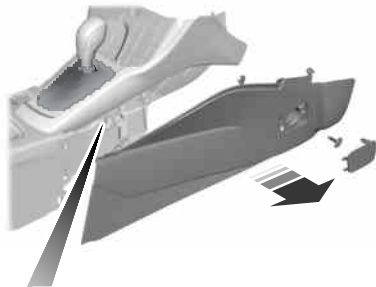

E162619

1. Remove the side panel on the right side of the gearshift lever.

# Transmission

---

2. Locate the access hole.
3. Insert the screwdriver (or similar tool) into the access hole and press the lever forward while pulling the gearshift lever out of the park (P) position and into the neutral (N) position.
4. Remove the tool and reinstall the panel.
5. Start your vehicle and release the parking brake.

## **If Your Vehicle Gets Stuck In Mud or Snow**

**Note:** *Do not rock your vehicle if the engine is not at normal operating temperature or damage to the transmission may occur.*

**Note:** *Do not rock your vehicle for more than a minute or damage to the transmission and tires may occur, or the engine may overheat.*

If your vehicle gets stuck in mud or snow, it may be rocked out by shifting between forward and reverse gears, stopping between shifts in a steady pattern. Press lightly on the accelerator in each gear.

# Brakes

## GENERAL INFORMATION

**Note:** Occasional brake noise is normal. If a metal-to-metal, continuous grinding or continuous squeal sound is present, the brake linings may be worn-out. Have the system checked by an authorized dealer. If the vehicle has continuous vibration or shudder in the steering wheel while braking, have it checked by an authorized dealer.

**Note:** Brake dust may accumulate on the wheels, even under normal driving conditions. Some dust is inevitable as the brakes wear and does not contribute to brake noise. See **Cleaning the Alloy Wheels** (page 240).



See **Warning Lamps and Indicators** (page 86).

Wet brakes result in reduced braking efficiency. Gently press the brake pedal a few times when driving from a car wash or standing water to dry the brakes.

## Brake Over Accelerator

In the event the accelerator pedal becomes stuck or entrapped, apply steady and firm pressure to the brake pedal to slow the vehicle and reduce engine power. If you experience this condition, apply the brakes and bring your vehicle to a safe stop. Move the transmission to park (P), switch the engine off and apply the parking brake. Inspect the accelerator pedal for any interference. If none are found and the condition persists, have your vehicle towed to the nearest authorized dealer.

## Brake Assist

Brake assist detects when you brake heavily by measuring the rate at which you press the brake pedal. It provides maximum braking efficiency as long as you press the pedal. Brake assist can reduce stopping distances in critical situations.

## Anti-lock Brake System

This system helps you maintain steering control during emergency stops by keeping the brakes from locking.



This lamp momentarily illuminates when you turn the ignition on. If the light does not illuminate during start up, remains on or flashes, the system may be disabled. Have the system checked by an authorized dealer. If the anti-lock brake system is disabled, normal braking is still effective.



If the brake warning lamp illuminates when you release the parking brake, have the system checked by an authorized dealer.

## Regenerative Braking System

This feature is used to simulate the engine braking of an internal combustion engine and assist the standard brake system while recovering some of the energy of motion and storing it in the battery to improve the range of your vehicle. The standard brake system is designed to fully stop the car if regenerative braking is not available. During regenerative braking, the motor is spun as a generator to create electrical current. This recharges the battery and slows the vehicle. In effect, once the accelerator pedal is released, the motor changes from an energy user to an energy producer.

When the accelerator pedal is released or the brake pedal is applied, the brake controller automatically detects the amount of deceleration requested and optimizes how much of the deceleration will be produced by regenerative braking. The remaining portion is generated by

# Brakes

standard friction braking. When the battery is almost fully charged, the amount of regenerative braking is limited to avoid overcharging, and the requested deceleration is produced by standard friction braking alone.

Regenerative braking does not take the place of the standard friction brakes; it only assists them. Regenerative braking has also been designed to interact with the anti-lock brake system. Regenerative braking is disabled when the anti-lock brake system is activated or the battery is fully charged.

## HINTS ON DRIVING WITH ANTI-LOCK BRAKES

**Note:** *When the system is operating, the brake pedal will pulse and may travel further. Maintain pressure on the brake pedal. You may also hear a noise from the system. This is normal.*

The anti-lock braking system will not eliminate the risks when:

- You drive too closely to the vehicle in front of you.
- Your vehicle is hydroplaning.
- You take corners too fast.
- The road surface is poor.

## PARKING BRAKE

### WARNING



Always set the parking brake fully and make sure you shift the gearshift lever to park (P). Switch the ignition off and remove the key whenever you leave your vehicle.

**Note:** *Do not press the release button while pulling the lever up.*

To apply the parking brake:

1. Press the foot brake pedal firmly.
2. Pull the parking brake lever up to its fullest extent.

**Note:** *If you park your vehicle on a hill and facing uphill, shift the gearshift lever to park (P) and turn the steering wheel away from the curb.*

**Note:** *If you park your vehicle on a hill and facing downhill, shift the gearshift lever to park (P) and turn the steering wheel toward the curb.*

To release the parking brake:

1. Press the brake pedal firmly.
2. Pull the lever up slightly.
3. Press the release button and push the lever down.

## HILL START ASSIST

### WARNINGS



The system does not replace the parking brake. When you leave your vehicle, always apply the parking brake. Failure to leave your vehicle securely parked may lead to a crash or injury. See **Parking Brake** (page 161).



You must remain in your vehicle when the system turns on. At all times, you are responsible for controlling your vehicle, supervising the system and intervening, if required. Failure to take care may result in the loss of control of your vehicle, serious personal injury or death.



The system will turn off if a malfunction is apparent or if you rev the engine excessively. Failure to take care may result in the loss of control of your vehicle, serious personal injury or death.

# Brakes

---

The system makes it easier to pull away when your vehicle is on a slope without the need to use the parking brake.

When the system is active, your vehicle remains stationary on the slope for two to three seconds after you release the brake pedal. This allows time to move your foot from the brake to the accelerator pedal. The system releases the brakes automatically once the engine has developed sufficient drive to prevent your vehicle from rolling down the slope. This is an advantage when pulling away on a slope, for example from a car park ramp, traffic lights or when reversing uphill into a parking space.

**Note:** *The system only functions when you bring your vehicle to a complete standstill in an uphill gear (for example, drive when facing uphill or reverse when facing downhill).*

**Note:** *There is no warning light to indicate the system is either on or off.*

## Using Hill Start Assist

1. Press the brake pedal to bring your vehicle to a complete standstill. Keep the brake pedal pressed.
2. If the sensors detect that your vehicle is on a slope, the system activates automatically.
3. When you remove your foot from the brake pedal, your vehicle remains on the slope without rolling away for about two to three seconds. This hold time automatically extends if you are in the process of driving off.
4. Drive off in the normal manner. The system releases the brakes automatically.

**Note:** *When you remove your foot from the brake pedal and press the pedal again when the system is active, you will experience significantly reduced brake pedal travel. This is normal.*

## Switching the System On and Off

### Vehicles with Manual Transmission

You can switch this feature on or off in the information display. The system remembers the last setting when you start your vehicle.

### Vehicles with Automatic Transmission

You cannot turn the system on or off. When you switch the ignition on, the system automatically turns on.

# Traction Control

## PRINCIPLE OF OPERATION

The traction control system helps avoid drive wheel spin and loss of traction.

If your vehicle begins to slide, the system applies the brakes to individual wheels and, when needed, reduces engine power at the same time. If the wheels spin when accelerating on slippery or loose surfaces, the system reduces engine power in order to increase traction.

## USING TRACTION CONTROL

In certain situations for example, stuck in snow or mud, turning the traction control off may be beneficial as this allows the wheels to spin with full engine power. Depending on the type of system you have on your vehicle, you can either turn the system off using the information display or by pressing the button.

### Switching the System Off Using the Information Display Controls

(If Equipped)

Your vehicle comes with this feature already enabled. If required, you can switch this feature off using the information display controls. See **General Information** (page 91).

### Switching the System Off Using a Switch (If Equipped)

The button is located in the instrument panel.

Press the button. You will see a message in conjunction with an illuminated icon in the display. Press the button again to return the system to normal mode.

When you switch the traction control system off, stability control remains fully active.

## System Indicator Lights and Messages

### WARNING



If a failure has been detected within the AdvanceTrac system, the stability control light will illuminate steadily. Verify that the AdvanceTrac system was not manually disabled through the information display. If the stability control light still illuminates steadily, have the system serviced by an authorized dealer immediately. Operating your vehicle with AdvanceTrac disabled could lead to an increased risk of loss of vehicle control, vehicle rollover, personal injury and death.



The stability control light temporarily illuminates on engine start-up and flashes when a driving condition activates the stability system.



The stability control off light temporarily illuminates on engine start-up and stays on when you turn the traction control system off.

When you turn the traction control system off or on, a message appears in the information display showing system status.

# Stability Control

## PRINCIPLE OF OPERATION

### WARNINGS



Vehicle modifications involving braking system, aftermarket roof racks, suspension, steering system, tire construction and wheel and tire size may change the handling characteristics of your vehicle and may adversely affect the performance of the AdvanceTrac system. In addition, installing any stereo loudspeakers may interfere with and adversely affect the AdvanceTrac system. Install any aftermarket stereo loudspeaker as far as possible from the front center console, the tunnel, and the front seats in order to minimize the risk of interfering with the AdvanceTrac sensors. Reducing the effectiveness of the AdvanceTrac system could lead to an increased risk of loss of vehicle control, vehicle rollover, personal injury and death.



Remember that even advanced technology cannot defy the laws of physics. It's always possible to lose control of a vehicle due to inappropriate driver input for the conditions. Aggressive driving on any road condition can cause you to lose control of your vehicle increasing the risk of personal injury or property damage. Activation of the AdvanceTrac system is an indication that at least some of the tires have exceeded their ability to grip the road; this could reduce the operator's ability to control the vehicle potentially resulting in a loss of vehicle control, vehicle rollover, personal injury and death. If your AdvanceTrac system activates, **SLOW DOWN**.

The AdvanceTrac with Roll Stability Control system helps you keep control of your vehicle when on a slippery surface. The electronic stability control portion of the system helps avoid skids and lateral slides and roll stability control helps avoid a vehicle rollover. The traction control system helps avoid drive wheel spin and loss of traction. See **Using Traction Control** (page 163).

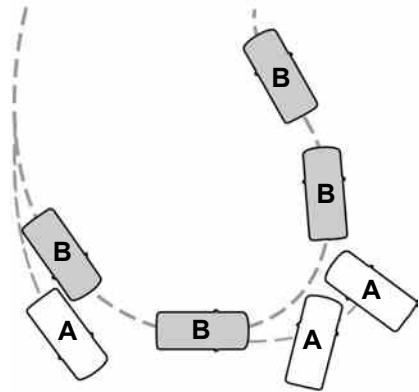

E72903

- A Vehicle without AdvanceTrac with RSC skidding off its intended route.
- B Vehicle with AdvanceTrac with RSC maintaining control on a slippery surface.

# Stability Control

---

## USING STABILITY CONTROL

### **AdvanceTrac® with Roll Stability Control™ (RSC®)**

The system automatically activates when you start your vehicle. The AdvanceTrac with RSC system cannot be completely turned off, but the electronic stability control and roll stability control portions of the system are disabled when the transmission is in position **R**. You can turn off the traction control portion of the system independently. See **Using Traction Control** (page 163).



# Parking Aids

## PARKING AID (If Equipped)

### WARNINGS



To help avoid personal injury, please read and understand the limitations of the system as contained in this section. Sensing is only an aid for some (generally large and fixed) objects when moving in reverse on a flat surface at parking speeds. Traffic control systems, inclement weather, air brakes, and external motors and fans may also affect the function of the sensing system; this may include reduced performance or a false activation.



To help avoid personal injury, always use caution when in reverse (R) and when using the sensing system.



This system is not designed to prevent contact with small or moving objects. The system is designed to provide a warning to assist the driver in detecting large stationary objects to avoid damaging the vehicle. The system may not detect smaller objects, particularly those close to the ground.



Certain add-on devices such as large trailer hitches, bike or surfboard racks and any device that may block the normal detection zone of the system, may create false beeps.

**Note:** *Keep the sensors, located on the bumper or fascia, free from snow, ice and large accumulations of dirt. If the sensors are covered, the system's accuracy can be affected. Do not clean the sensors with sharp objects.*

**Note:** *If your vehicle sustains damage to the bumper or fascia, leaving it misaligned or bent, the sensing zone may be altered causing inaccurate measurement of obstacles or false alarms.*

**Note:** *If your vehicle is equipped with MyKey, it is possible to prevent turning the sensing system off. See MyKey™ (page 50).*

The sensing system warns the driver of obstacles within a certain range of the bumper area. The system turns on automatically whenever the ignition is switched on.

When receiving a detection warning, the radio volume is reduced to a predetermined level. After the warning goes away, the radio volume returns to the previous level.

### Rear Sensing System

The rear sensors are only active when the transmission is in reverse (R). As the vehicle moves closer to the obstacle, the rate of the audible warning increases. When the obstacle is fewer than 12 in (30 cm) away, the warning sounds continuously. If a stationary or receding object is detected farther than 12 in (30 cm) from the side of the vehicle, the tone sounds for only three seconds. Once the system detects an object approaching, the warning sounds again.

# Parking Aids



E130178

- A Coverage area of up to 6 feet (1.8 meters) from the rear bumper. There is decreased coverage area at the outer corners of the bumper.

The system detects certain objects while the transmission is in reverse (R):

- and moving toward a stationary object at a speed of 3 mph (5 km/h) or less.
- but not moving, and a moving object is approaching the rear of the vehicle at a speed of 3 mph (5 km/h) or less.

The system can be switched off through the information display. If a fault is present in the system, a warning message appears in the information display and does not allow the driver to switch the faulted system on.

## Front Sensing System

The front sensors are active when the gearshift is in any position other than park (P) or neutral (N) and the vehicle speed is below 6 mph (10 km/h).

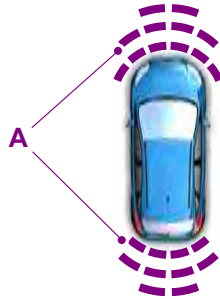

E130382

- A Coverage area of up to 27 inches (70 centimeters) from the front of the vehicle and about 14 inches (35 centimeters) to the side of the front end of the vehicle. Refer to the reverse sensing section for details on coverage area.

The system sounds an audible warning when obstacles are near either bumper in the following manner:

- Objects detected by the front sensors are indicated by a high-pitched tone from the front radio speakers.
- Objects detected by the rear sensors are indicated by a lower pitched tone from the rear radio speakers.
- The sensing system reports the obstacle which is closest to the front or rear of the vehicle. For example, if an obstacle is 24 in (60 cm) from the front of the vehicle and, at the same time, an obstacle is only 16 in (40 cm) from the rear of the vehicle, the lower pitched tone sounds.
- An alternating warning sounds from the front and rear if there are objects at both bumpers that are closer than 10 in (25 cm).

# Parking Aids

For specific information on the reverse sensing portion of the system, refer to that section.

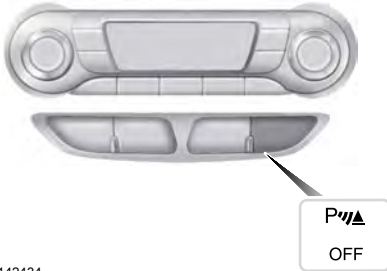

E142434

Press the button to switch the system off. It remains off for the entire ignition cycle. The system can also be switched off through the information display.

## ACTIVE PARK ASSIST (If Equipped)

### WARNING



This system is designed to be a supplementary park aid. It may not work in all conditions and is not intended to replace the driver's attention and judgment. The driver is responsible for avoiding hazards and maintaining a safe distance and speed, even when the system is in use.

**Note:** The driver is always responsible for controlling the vehicle, supervising the system and intervening if required.

The system detects an available parallel parking space and automatically steers the vehicle into the space (hands-free) while you control the accelerator, gearshift and brakes. The system visually and audibly instructs you to park the vehicle.

The system may not function correctly if something passes between the front bumper and the parking space (i.e. a pedestrian or cyclist) or if the edge of the neighboring parked vehicle is high from the ground (i.e. a bus, tow truck or flatbed truck).

**Note:** The sensors may not detect objects in heavy rain or other conditions that cause disruptive reflections.

**Note:** The sensors may not detect objects with surfaces that absorb ultrasonic waves.

**Note:** After a tire change the system will go through a relearning procedure. During this time the system performance may deteriorate.

The system should not be used if:

- a foreign object (i.e. bike rack or trailer) is attached to the front or rear of the vehicle or at another location close to the sensors.
- an overhanging object (i.e. surfboard) is attached to the roof.
- the front bumper or side sensors are damaged (i.e. in a collision) or obstructed by a foreign object (i.e. front bumper cover).
- a mini-spare tire is in use.

## Using Active Park Assist

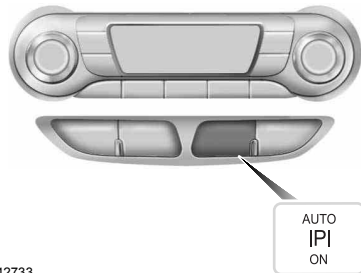

E142733

# Parking Aids

Press the button. The touch screen displays a message and a corresponding graphic to indicate it's searching for a parking space. Use the turn signal to indicate which side of the vehicle you want

the system to search on.

**Note:** *If the turn signal is not on, the system automatically searches on the vehicle's passenger side.*

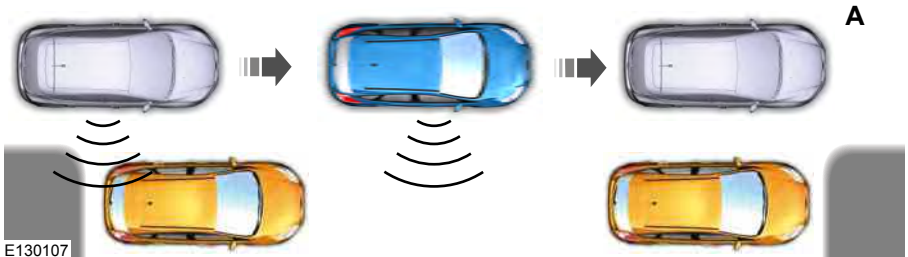

When a suitable space is found, the touch screen displays a message and a chime sounds. Slow down and stop at approximately position (A), then follow the instructions on the touch screen.

**Note:** *You must observe that the selected space remains clear of obstructions at all times in the maneuver.*

**Note:** *Vehicles with overhanging loads (e.g. a bus or a truck), street furniture and other items may not be detected by active park assist. You must make sure the selected space is suitable for parking.*

**Note:** *The vehicle should be driven as parallel to other vehicles as possible while passing a parking space.*

**Note:** *The system always offers the last detected parking space (i.e. if the vehicle detects multiple spaces while you are driving, it offers the last one).*

**Note:** *If driven above approximately 20 mph (35 km/h), the touch screen shows a message to alert you to reduce vehicle speed.*

## Automatic Steering into Parking Space

**Note:** *If vehicle speed exceeds 6 mph (10 km/h), the system switches off and you need to take full control of the vehicle.*

**Note:** *If a maneuver is interrupted before completion, the system switches off. The steering wheel position will not indicate the actual position of the steering and you have to full take control of the vehicle.*

With your hands off the wheel (and nothing obstructing its movement) and the transmission in R (Reverse), the vehicle steers itself as instructions to safely move the vehicle back and forward in the space are displayed in the touch screen. While reversing, the touch screen displays a message instructing you to check your surroundings (for safety reasons) and to back-up slowly, accompanied by a corresponding graphic.

# Parking Aids



E130108

When you think the vehicle has enough space in front and behind it, or you hear a solid tone from the parking aid, bring the vehicle to a complete stop.



E130109

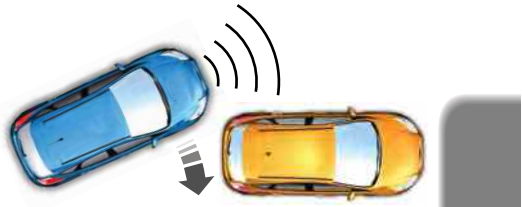

When automatic steering is finished, the touch screen displays a message indicating that the active park assist process is done. The driver is responsible for checking the parking job and making any necessary corrections before putting the transmission in P (Park).

## Deactivating the Park Assist Feature

The system can be deactivated manually by:

- pressing the active park assist button
- grabbing the steering wheel
- driving above approximately 20 mph (35 km/h) for 30 seconds during an active park search

- driving above 6 mph (10 km/h) during automatic steering
- turning off the traction control system.

Certain vehicle conditions can also deactivate the system, such as:

- Traction control has activated on a slippery or loose surface.
- There is an anti-lock brake system activation or failure.
- Any door (except the driver's) opens.
- Something touches the steering wheel.

If a problem occurs with the system, a warning message is displayed, followed by a chime. Occasional system messages may occur in normal operation. For recurring or frequent system faults, contact an authorized dealer to have your vehicle serviced.

# Parking Aids

## Troubleshooting the System

<b>The system does not look for a space</b>
The traction control system may be off
Any door (except the driver's) may not be completely closed

<b>The system does not offer a particular space</b>
Something may be contacting the front bumper or side sensors
There is not enough room on both sides of the vehicle in order to park
There is not enough space for the parking maneuver on the opposite side of the parking space
The vehicle is farther than 6.5 ft (2 m) from the parking space
The vehicle is closer than 16 in. (40 cm) from neighboring parked vehicles
The transmission is in R (Reverse); the vehicle must be moving forward to detect a parking space

<b>The system does not position the vehicle where I want in the space</b>
The vehicle is rolling in the opposite direction of the transmission (i.e. rolling forward when R [Reverse] is selected)
The transmission is in R (Reverse); the vehicle must be moving forward to detect a parking space
An irregular curb along the parking space prevents the system from aligning the vehicle properly
Vehicles or objects bordering the space may not be positioned correctly
The vehicle was pulled too far past the parking space. The system performs best when you drive the same distance past the parking space
The tires may not be installed or maintained correctly (i.e. not inflated correctly, improper size, or of different sizes)
A repair or alteration has changed detection capabilities

# Parking Aids

## The system does not position the vehicle where I want in the space

A parked vehicle has a high attachment (i.e. salt sprayer, snowplow, moving truck bed, etc.)

The parking space length or position of parked objects changed after your vehicle passed

The temperature around your vehicle changes quickly (i.e. driving from a heated garage into the cold, or after leaving a car wash)

## REAR VIEW CAMERA (If Equipped)

### WARNINGS



The rear view camera system is a reverse aid supplement device that still requires the driver to use it in conjunction with the interior and exterior mirrors for maximum coverage.



Objects that are close to either corner of the bumper or under the bumper, might not be seen on the screen due to the limited coverage of the camera system.



Back up as slow as possible since higher speeds might limit your reaction time to stop your vehicle.



Use caution when using the rear video camera and the liftgate is ajar. If the liftgate is ajar, the camera will be out of position and the video image may be incorrect. All guidelines have been removed when the liftgate is ajar.



Use caution when turning camera features on or off while in reverse (R). Make sure your vehicle is not moving.

The rear view camera system provides a video image of the area behind your vehicle.

During operation, lines appear in the display which represent your vehicle's path and proximity to objects behind your vehicle.



E162528

The camera is located on the liftgate.

## Using the Rear View Camera System

The rear view camera system displays what is behind your vehicle when you place the transmission in reverse (R).

# Parking Aids

The system uses three types of guides to help you see what is behind your vehicle:

- Active guidelines: Show the intended path of your vehicle when reversing.
- Fixed guidelines: Show the actual path your vehicle is moving in while reversing in a straight line. This can be helpful when backing into a parking space or aligning your vehicle with another object behind you.
- Centerline: Helps align the center of your vehicle with an object (for example, a trailer).

**Note:** If the transmission is in reverse (R) and the luggage compartment is ajar, no rear view camera features are displayed.

**Note:** If the image comes on while the transmission is not in reverse (R), have the system inspected by your authorized dealer.

**Note:** When towing, the camera only sees what is being towed behind your vehicle. This might not provide adequate coverage as it usually provides in normal operation and some objects might not be seen. In some vehicles, the guidelines may disappear once the trailer tow connector is engaged.

**Note:** The camera may not operate correctly under the following conditions:

- Nighttime or dark areas if one or both reverse lamps are not operating.
- The camera's view is obstructed by mud, water or debris. Clean the lens with a soft, lint-free cloth and non-abrasive cleaner.
- The rear of your vehicle is hit or damaged, causing the camera to become misaligned.

To access any of the rear view camera system settings, make the following selections in the touch screen when the transmission is not in reverse (R):

- Menu > Vehicle > Rear View Camera

After changing a system setting, the touch screen shows a preview of the selected features.

## Camera Guidelines

**Note:** Fixed guidelines are only available when the transmission is in reverse (R).

**Note:** The centerline is only available if Active or Fixed guidelines are on.

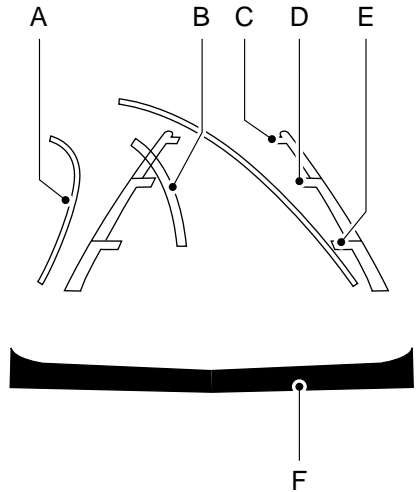

E142436

- A Active guidelines
- B Centerline
- C Fixed guideline: Green zone
- D Fixed guideline: Yellow zone
- E Fixed guideline: Red zone
- F Rear bumper



# Parking Aids

---

Active guidelines are only shown with fixed guidelines. To use active guidelines, turn the steering wheel to point the guidelines toward an intended path. If the steering wheel position is changed while reversing, your vehicle might deviate from the original intended path.

The fixed and active guidelines fade in and out depending on the steering wheel position. The active guidelines are not shown when the steering wheel position is straight.

Always use caution while reversing.

Objects in the red zone are closest to your vehicle and objects in the green zone are farther away. Objects are getting closer to your vehicle as they move from the green zone to the yellow or red zones. Use the side view mirrors and rear view mirror to get better coverage on both sides and rear of your vehicle.

## Enhanced Park Aids

**Note:** *Enhanced park aids is only available when the transmission is in reverse (R).*

**Note:** *The reverse sensing system is not effective at speeds above 7 mph (12 km/h) and may not detect certain angular or moving objects.*

The system uses red, yellow and green highlights which appear on top of the video image when an object is detected by the reverse sensing system. The alert highlights the closest object detected.

Selectable settings for this feature are ON and OFF.

## Manual Zoom

### WARNING



When manual zoom is on, the full area behind your vehicle is not shown. Be aware of your surroundings when using the manual zoom feature.

---

**Note:** *Manual zoom is only available when the transmission is in reverse (R).*

**Note:** *When manual zoom is enabled, only the centerline is shown.*

This allows you to get a closer view of an object behind your vehicle. The zoomed image keeps the bumper in the image to provide a reference. The zoom is only active while the transmission is in reverse (R). When the transmission is shifted out of reverse (R), the feature automatically turns off and must be reset when it is used again.

Selectable settings for this feature are + and -. The default setting for the manual zoom is OFF.

## Rear Camera Delay (If Equipped)

When you shift the transmission out of reverse (R) and into any gear while the rear camera delay is active, the camera image displays until:

- Your vehicle speed sufficiently increases.
- You shift your vehicle into park (P).

Selectable settings for this feature are ON and OFF. The default setting for the rear camera delay is OFF.

# Cruise Control

## PRINCIPLE OF OPERATION

Cruise control lets you maintain a set speed without keeping your foot on the accelerator pedal. You can use cruise control when your vehicle speed is greater than 20 mph (30 km/h).

## USING CRUISE CONTROL

### WARNINGS



Do not use cruise control in heavy traffic, on winding roads or when the road surface is slippery. This could result in loss of vehicle control, serious injury or death.



When you are going downhill, your vehicle speed may increase above the set speed. The system will not apply the brakes. Change down a gear to assist the system in maintaining the set speed. Failure to do so could result in loss of vehicle control, serious injury or death.

**Note:** Cruise control will disengage if your vehicle speed decreases more than 10 mph (16 km/h) below your set speed while driving uphill.



E142437

The cruise controls are located on the steering wheel.

## Switching Cruise Control On

Press and release **ON**.



The indicator will display in the instrument cluster.

## Setting a Speed

1. Accelerate to the desired speed.
2. Press and release **SET+**.
3. Take your foot off the accelerator pedal.

## Changing the Set Speed

- Press and hold **SET+** or **SET-**. Release the control when you reach the desired speed.
- Press and release **SET+** or **SET-**. The set speed will change in approximately 1 mph (2 km/h) increments.
- Press the accelerator or brake pedal until you reach the desired speed. Press and release **SET+**.

**Note:** When you are going downhill while using cruise control, your battery charging system and engine work together to help maintain your set speed. Engine noise may increase or decrease under these conditions.

## Canceling the Set Speed

Pull **CAN** toward you and release, or tap the brake pedal. The set speed will not be erased.

## Resuming the Set Speed

Pull **RES** toward you and release.

**Note:** When you are going downhill while using cruise control, your battery charging system and engine work together to help maintain your set speed. Engine noise may increase or decrease under these conditions.

# Cruise Control

---

## Switching Cruise Control Off

**Note:** *You will erase the set speed if you switch the system off.*

Press and release **OFF** or switch the ignition off.

## ECO Cruise Control

This feature saves vehicle energy by relaxing acceleration compared to standard cruise control. For example, your vehicle may temporarily lose speed when going uphill. **ECO** will appear in the information display when ECO cruise control is activated. It can be switched on or off in the information display. See (page 91).

# Driving Aids

---

## STEERING

### Electric Power Steering

#### WARNING



The electric power steering system has diagnostic checks that continuously monitor the system. If a fault is detected, a message displays in the information display. Stop your vehicle as soon as it is safe to do so. Switch the ignition off. After at least 10 seconds, switch the ignition on and watch the information display for a steering system warning message. If a steering system warning message returns, have the system checked by an authorized dealer.

---

Your vehicle has an electric power steering system. There is no fluid reservoir. No maintenance is required.

If your vehicle loses electrical power while you are driving, electric power steering assistance is lost. The steering system still operates and you can steer your vehicle manually. Manually steering your vehicle requires more effort.

Extreme continuous steering may increase the effort required for you to steer your vehicle. This increased effort prevents overheating and permanent damage to the steering system. You do not lose the ability to steer your vehicle manually. Typical steering and driving maneuvers allow the system to cool and return to normal operation.

### Steering Tips

If the steering wanders or pulls, check for:

- Correct tire pressures.
- Uneven tire wear.
- Loose or worn suspension components.

- Loose or worn steering components.
- Improper vehicle alignment.

**Note:** *A high crown in the road or high crosswinds may also make the steering seem to wander or pull.*

### Adaptive Learning

The electronic power steering system adaptive learning helps correct road irregularities and improves overall handling and steering feel. It communicates with the brake system to help operate advanced stability control and accident avoidance systems. Additionally, whenever the battery is disconnected or a new battery installed, you must drive your vehicle a short distance before the system relearns the strategy and reactivates all systems.

# Load Carrying

## REAR UNDER FLOOR STORAGE





E162198

The under floor storage compartments are located behind the front seats. Lift the handle to unlatch the lid.

## LUGGAGE COVERS

### WARNINGS

 Make sure that the posts are properly latched in mounting features. The cover may cause injury in a sudden stop or accident if it is not securely installed.

 Do not place any objects on the cargo area shade. They may obstruct your vision or strike occupants of your vehicle in a sudden stop or crash.

Use the cargo shade to cover items in the cargo area of your vehicle.

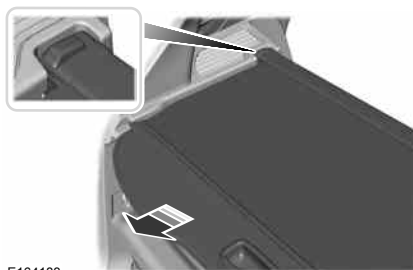

E164183

Insert the ends of the cargo shade into the mounting features located behind the rear seat on the rear trim panels to install the cargo shade.

To operate the cargo shade:

1. Pull the rear edge of the cargo shade rearward.
2. Secure both ends of the support rod into the retention slots located on the rear quarter trim panels.

## Removing the Shade



E162195

Press the release lever on each side forward, and then lift the shade out of the mounting feature. You will see a red mark when the lever is unlatched.

# Load Carrying

## LOAD LIMIT

### Vehicle Loading - with and without a Trailer

This section will guide you in the proper loading of your vehicle, trailer or both, to keep your loaded vehicle weight within its design rating capability, with or without a trailer. Properly loading your vehicle will provide maximum return of vehicle design performance. Before loading your vehicle, familiarize yourself with

the following terms for determining your vehicle's weight ratings, with or without a trailer, from the vehicle's Tire Label or Safety Compliance Certification Label:

**Base Curb Weight** - is the weight of the vehicle including full fluids and all standard equipment. It does not include passengers, cargo, or optional equipment.

**Vehicle Curb Weight** - is the weight of your new vehicle when you picked it up from your authorized dealer plus any aftermarket equipment.

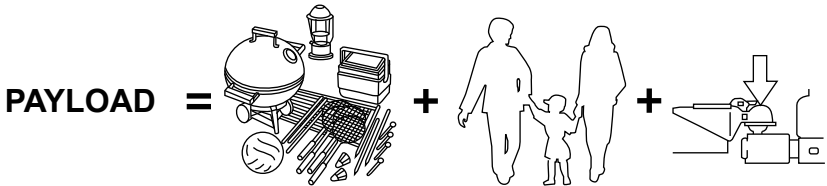

E143816

**Payload** - is the combined weight of cargo and passengers that the vehicle is carrying. The maximum payload for your vehicle can be found on the Tire Label on the B-Pillar or the edge of the driver door (vehicles exported outside the US and Canada may not have a Tire Label). Look for **“THE COMBINED WEIGHT OF OCCUPANTS AND CARGO SHOULD NEVER EXCEED XXX**

**kg OR XXX lb.”** for maximum payload. The payload listed on the Tire Label is the maximum payload for the vehicle as built by the assembly plant. If you install any aftermarket or authorized-dealer installed equipment on the vehicle, you must subtract the weight of the equipment from the payload listed on the Tire Label in order to determine the new payload.

# Load Carrying

## WARNING



The appropriate loading capacity of your vehicle can be limited either by volume capacity (how much space is available) or by payload capacity (how much weight the vehicle should carry). Once you have reached the maximum payload of your vehicle, do not add more cargo, even if there is space available. Overloading or improperly loading your vehicle can contribute to loss of vehicle control and vehicle rollover.

### Example only:



### TIRE AND LOADING INFORMATION

SEATING CAPACITY	TOTAL 5	FRONT 2	REAR 3
------------------	---------	---------	--------

The combined weight of occupants and cargo should never exceed : **XXX kg or XXX lbs.**

TIRE	SIZE	COLD TIRE PRESSURE	SEE OWNERS MANUAL FOR ADDITIONAL INFORMATION
FRONT	LT225/75R 16.5E	200 KPA, 29 PSI	
REAR	LT225/75R 16.5E	200 KPA, 29 PSI	
SPARE	T145/80D16 P225/60R17	420 KPA, 60 PSI 200 KPA, 29 PSI	

(XXX) XX-XXXX-XXXX



E142516



### TIRE AND LOADING INFORMATION RENSEIGNEMENTS SUR LES PNEUS ET LE CHARGEMENT

SEATING CAPACITY NOMBRE DE PLACES	TOTAL 5	FRONT AVANT 2	REAR ARRIERE 3
--------------------------------------	---------	------------------	-------------------

The combined weight of occupants and cargo should never exceed 492 kg or 1085 lbs.  
Le poids total des occupants et du chargement ne doit jamais dépasser 492 kg ou 1085 lb.

TIRE PNEU	SIZE DIMENSIONS	COLD TIRE PRESSURE PRESSION DES PNEUS A FROID	SEE OWNER'S MANUAL FOR ADDITIONAL INFORMATION  VOIR LE MANUEL DE L'USAGER POUR PLUS DE RENSEIGNEMENTS
FRONT AVANT	P235/70R16	240 KPA, 35 PSI	
REAR ARRIERE	P235/70R16	240 KPA, 35 PSI	
SPARE DE SECOURS	T145/90R17	415 KPA, 60 PSI	

(XXX) XX-XXXX-XXXX



E142517

# Load Carrying

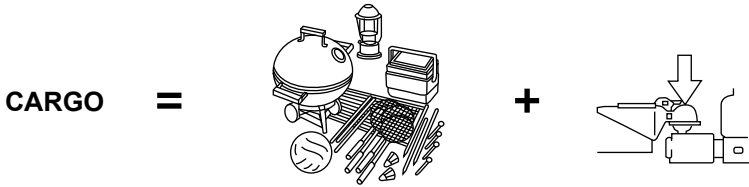

E143817

**Cargo Weight** - includes all weight added to the Base Curb Weight, including cargo and optional equipment. When towing, trailer tongue load or king pin weight is also part of cargo weight.

**GAW (Gross Axle Weight)** - is the total weight placed on each axle (front and rear) including vehicle curb weight and all payload.

**GAWR (Gross Axle Weight Rating)** - is the maximum allowable weight that can be carried by a single axle (front or rear). These numbers are shown on the Safety Compliance Certification Label. The label shall be affixed to either the door hinge pillar, door-latch post, or the door edge that meets the door-latch post, next to the driver's seating position. **The total load on each axle must never exceed its Gross Axle Weight Rating.**

**Note:** For trailer towing information refer to the *RV and Trailer Towing Guide* available at an authorized dealer.

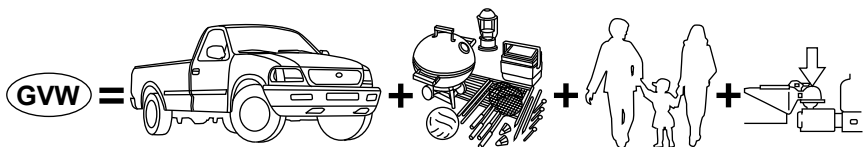

E143818



# Load Carrying

**GVW (Gross Vehicle Weight)** - is the Vehicle Curb Weight, plus cargo, plus passengers.



**GVWR (Gross Vehicle Weight Rating)** - is the maximum allowable weight of the fully loaded vehicle (including all options, equipment, passengers and cargo). It is shown on the

**Example only:**

Safety Compliance Certification Label. The label shall be affixed to either the door hinge pillar, door-latch post, or the door edge that meets the door-latch post, next to the driver's seating position. **The Gross Vehicle Weight must never exceed the Gross Vehicle Weight Rating.**

<b>MFD. BY FORD MOTOR CO.</b>					
DATE: XX/XX	GVWR: XXXXLB/ XXXXXKG				
FRONT GAWR: XXXXL	WITH XXXXKG		REAR GAWR: XXXXLB		
XXXXXX	TIRES: XXXX/XXXXXX	WITH XXXX/XXXXXX		TIRES	
XXXXXX	RIMS: XXXX	WITH XXXX		RIMS	
AT XXX kPa/XX PSI COLD	AT XXX kPa/XX PSI COLD				
THIS VEHICLE CONFORMS TO ALL APPLICABLE FEDERAL MOTOR VEHICLE SAFETY STANDARDS IN EFFECT ON THE DATE OF MANUFACTURE SHOWN ABOVE.					
VIN: XXXXXXXXXXXXXXXXX					XXXXX
TYPE: XXX					XXXXX
					
EXT. PNT: XX	RC: XX		DSO:		
WB: X	INT: TR	TI: PS	TR: X	AXLE: X	TR: SPR: XXXXX
XXX	XX	X	XX	X	XX XXX
XXXXXXXXXXXXXXXX XXX XXXX-XXXXXX-XX					

E142523

<b>MFD. BY FORD MOTOR CO.</b>					
DATE: xx/xx	GVWR/PNBV: xxxxx LB/xxxxx KG				
	FRONT GAWR/PNBE AV /		REAR GAWR/PNBE AR		
	xxxx/xxxxx B		xxxxx KG/xxxxx LB		
WITH/AVEC TIRES/PNEUS					
xxxx/xxxxx		RIMS/JANTES xxx,xxx			
xxxx/xxxxx					
xxxx,xxx					
AT/AVEC PSI/PSI		COLD/A FROID		xxx/xx	
/JUMEELES					
VIN: XXXXXXXXXXXXXXXXX		COMPLIES: xxx/xxx-xxx			
TYPE: XXX/XXXX					
					
EXT. PNT:	WB:	INT:	TI:	PS:	TR:
XX	X	TR	X	AXLE:	TR:
	XX		X	XX	X
				SPR:	XXXXX
					XXX
XXXXXXXXXXXXXXXX XXX XXXX-XXXXXX-XX					

E142524

# Load Carrying

## WARNING



Exceeding the Safety Compliance Certification Label vehicle weight rating limits could result in substandard vehicle handling or performance, engine, transmission and/or structural damage, serious damage to the vehicle, loss of control and personal injury.

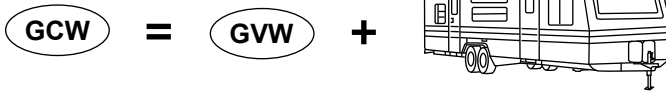

E143819

### **GCW (Gross Combined Weight)**

- is the Gross Vehicle Weight plus the weight of the fully loaded trailer.

### **GCWR (Gross Combined Weight Rating)**

- is the maximum allowable weight of the vehicle and the loaded trailer, including all cargo and passengers, that the vehicle can handle without risking damage. (Important: The towing vehicle's braking system is rated for operation at Gross Vehicle Weight Rating, not at Gross Combined Weight Rating.)

Separate functional brakes should be used for safe control of towed vehicles and for trailers where the Gross Combined Weight of the

towing vehicle plus the trailer exceed the Gross Vehicle Weight Rating of the towing vehicle. **The Gross Combined Weight must never exceed the Gross Combined Weight Rating.**

### **Maximum Loaded Trailer Weight**

- is the highest possible weight of a fully loaded trailer the vehicle can tow. It assumes a vehicle with mandatory options, driver and front passenger weight (150 pounds [68 kilograms] each), no cargo weight (internal or external) and a tongue load of 10–15% (conventional trailer) or king pin weight of 15–25% (fifth wheel trailer). Consult an authorized dealer (or the RV and Trailer Towing Guide available at an authorized dealer) for more detailed information.

# Load Carrying

**Tongue Load or Fifth Wheel King Pin Weight** - refers to the amount of the weight that a trailer pushes down on a trailer hitch.

**Examples:** For a 5000 pound (2268 kilogram) conventional trailer, multiply 5000 by 0.10 and 0.15 to obtain a proper tongue load range of 500 to 750 pounds (227 to 340 kilograms). For an 11500 pound (5216 kilogram) fifth wheel trailer, multiply by 0.15 and 0.25 to obtain a proper king pin load range of 1725 to 2875 pounds (782 to 1304 kilograms).

## WARNINGS



Do not exceed the GVWR or the GAWR specified on the Safety Compliance Certification Label.



Do not use replacement tires with lower load carrying capacities than the original tires because they may lower the vehicle's GVWR and GAWR limitations. Replacement tires with a higher limit than the original tires do not increase the GVWR and GAWR limitations.



Exceeding any vehicle weight rating limitation could result in serious damage to the vehicle and/or personal injury.

## Steps for determining the correct load limit:

1. Locate the statement "The combined weight of occupants and cargo should never exceed XXX kg or XXX lb." on your vehicle's placard.
2. Determine the combined weight of the driver and passengers that will be riding in your vehicle.
3. Subtract the combined weight of the driver and passengers from XXX kg or XXX lb.
4. The resulting figure equals the available amount of cargo and luggage load capacity. For example, if the "XXX" amount equals 1,400 lb. and there will be five 150 lb. passengers in your vehicle, the amount of available cargo and luggage load capacity is 650 lb.  $(1400 - 750 (5 \times 150) = 650 \text{ lb.})$
5. Determine the combined weight of luggage and cargo being loaded on the vehicle. That weight may not safely exceed the available cargo and luggage load capacity calculated in Step 4.
6. If your vehicle will be towing a trailer, load from your trailer will be transferred to your vehicle. Consult this manual to determine how this reduces the available cargo and luggage load capacity of your vehicle.

The following gives you a few examples on how to calculate the available amount of cargo and luggage load capacity:

\*Suppose your vehicle has a 1400-pound (635-kilogram) cargo and luggage capacity. You decide to go golfing. Is there enough load capacity to carry you, four of your friends and all the golf bags? You and four friends average 220 pounds (99 kilograms) each and the golf bags weigh approximately 30 pounds (13.5 kilograms) each. The calculation would be:  $1400 - (5 \times 220) - (5 \times 30) = 1400 - 1100 - 150 = 150$  pounds. Yes, you have enough load capacity in your

## Load Carrying

---

vehicle to transport four friends and your golf bags. In metric units, the calculation would be:  $635 \text{ kilograms} - (5 \times 99 \text{ kilograms}) - (5 \times 13.5 \text{ kilograms}) = 635 - 495 - 67.5 = 72.5 \text{ kilograms}$ .

\*Suppose your vehicle has a 1400-pound (635-kilogram) cargo and luggage capacity. You and one of your friends decide to pick up cement from the local home improvement store to finish that patio you have been planning for the past two years. Measuring the inside of the vehicle with the rear seat folded down, you have room for twelve 100-pound (45-kilogram) bags of cement. Do you have enough load capacity to transport the cement to your home? If you and your friend each weigh 220 pounds (99 kilograms), the calculation would be:  $1400 - (2 \times 220) - (12 \times 100) = 1400 - 440 - 1200 = -240 \text{ pounds}$ . No, you do not have enough cargo capacity to carry that much weight. In metric units, the calculation would be:  $635 \text{ kilograms} - (2 \times 99 \text{ kilograms}) - (12 \times 45 \text{ kilograms}) = 635 - 198 - 540 = -103 \text{ kilograms}$ . You will need to reduce the load weight by at least 240 pounds (104 kilograms). If you remove three 100-pound (45-kilogram) cement bags, then the load calculation would be:  $1400 - (2 \times 220) - (9 \times 100) = 1400 - 440 -$

$900 = 60 \text{ pounds}$ . Now you have the load capacity to transport the cement and your friend home. In metric units, the calculation would be:  $635 \text{ kilograms} - (2 \times 99 \text{ kilograms}) - (9 \times 45 \text{ kilograms}) = 635 - 198 - 405 = 32 \text{ kilograms}$ .

The above calculations also assume that the loads are positioned in your vehicle in a manner that does not overload the Front or the Rear Gross Axle Weight Rating specified for your vehicle on the Safety Compliance Certification Label. The label shall be affixed to either the door hinge pillar, door-latch post, or the door edge that meets the door-latch post, next to the driver's seating position.

# Towing

## TOWING A TRAILER

### WARNING

 Your vehicle is not approved for trailer towing. Never tow a trailer with your vehicle.

## TRANSPORTING THE VEHICLE

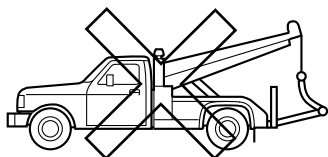
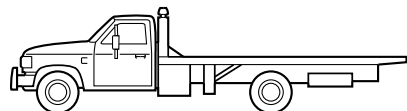
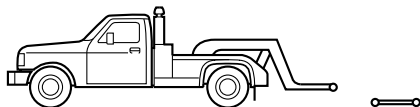

E143886

If you need to have your vehicle towed, contact a professional towing service or, if you are a member of a roadside assistance program, your roadside assistance service provider.

We recommend the use of a wheel lift and dollies or flatbed equipment to tow your vehicle. Do not tow with a slingbelt. Ford Motor Company has not approved a slingbelt towing procedure. Vehicle damage may occur if towed incorrectly, or by any other means.

Ford Motor Company produces a towing manual for all authorized tow truck operators. Have your tow truck operator refer to this manual for proper hook-up and towing procedures for your vehicle.

The front wheels (drive wheels) must be on a tow dolly when towing your vehicle from the rear using wheel lift equipment. This prevents damage to the transmission.

We recommend placing the rear wheels on a tow dolly when towing your vehicle from the front using wheel lift equipment. This prevents damage to the rear fascia.

## TOWING THE VEHICLE ON FOUR WHEELS

### Emergency Towing

#### WARNING

 If your vehicle has a steering wheel lock make sure the ignition is in the accessory or on position when being towed.

If your vehicle becomes inoperable (without access to wheel dollies, car-hauling trailer, or flatbed transport vehicle), it can be flat-towed (all wheels on the ground, regardless of the powertrain and transmission configuration) under the following conditions:

- Tow only in the forward direction.
- The transmission in position **N**. If you cannot move the transmission into **N**, you may need to override it. See **Automatic Transmission** (page 157).

# Towing

- Maximum speed is 35 mph (56 km/h).
- Maximum distance is 50 miles (80 kilometers).

## Recreational Towing

**Note:** Put your climate control system in recirculated air mode to prevent exhaust fumes from entering the vehicle. See **Climate Control** (page 107).

Follow these guidelines if you have a need for recreational (RV) towing. An example of recreational towing would be towing your vehicle behind a motorhome. We designed these guidelines to prevent damage to your transmission.

You can tow your vehicle with all four wheels on the ground or with the front wheels off the ground by using a tow dolly. If you are using a tow dolly follow the instructions specified by the equipment provider.

If you tow your vehicle with all four wheels on the ground:

- Tow only in the forward direction.
- Release the parking brake.

## Vehicles with Push Button Start

1. Start the vehicle by pressing the brake pedal, and then pressing the ENGINE START/STOP button until the vehicle starts.
2. Press the brake pedal and shift the transmission into position **N**.
3. Turn the vehicle off by pressing the ENGINE START/STOP button once. (Trip Summary appears in the left instrument cluster screen when the vehicle is off.)

**Note:** You can remove the key fob from the vehicle while towing.

## Vehicles with Ignition Key

1. Start the vehicle by pressing the brake pedal, and then turning the ignition key until the vehicle starts.
2. Press the brake pedal and shift the transmission into position **N**.
3. Turn the vehicle off by turning the ignition key past the accessory position. The key position is between the accessory and off positions. See **Ignition Switch** (page 127). (Trip Summary appears in the left instrument cluster screen when the vehicle is off.)

**Note:** If your vehicle is equipped with an ignition key, you cannot remove the key from the ignition cylinder when the transmission is in position **N** and the vehicle is off.

## All Vehicles

- Do not exceed 70 mph (113 km/h).
- Place the transmission in position **P**, start the vehicle, and allow the engine to run for one minute at the beginning of each day (you may need to press the accelerator pedal in order to start the engine). After allowing the vehicle to run, place the transmission back into position **N** and the ignition in the off position.

**Note:** A **SHIFT TO PARK** or **TRANSMISSION NOT IN PARK** message may appear in the information display when the transmission is in position **N** and the ignition is in the off position.

# Driving Hints

---

## BREAKING-IN

You need to break in new tires for approximately 300 miles (480 kilometers). During this time, your vehicle may exhibit some unusual driving characteristics. The engine also needs to break in. Avoid hard accelerations and driving too fast for the first 1000 miles (1600 kilometers). If possible, avoid carrying heavy loads up steep grades during the break-in period.

## ECONOMICAL DRIVING

Your fuel economy depends on:

- How you drive your vehicle.
- How you maintain your vehicle.
- The conditions you drive your vehicle in.

You may improve your fuel economy by keeping these in mind:

- Drive your vehicle at reasonable speeds. Traveling at 65 mph (105 km/h) uses about 15% less fuel than traveling at 75 mph (121 km/h).
- Drive at steady speeds without stopping.
- Anticipate stops. Slowing down your vehicle may eliminate the need to stop.
- Keep the tires properly inflated and use only the recommended size.
- Switch off the heater if you do not need it. When you have the heater on, keep it at the lowest blower and temperature setting necessary to be comfortable.
- When it is cold outside, park in a sunny location or a climate-controlled environment. This may save fuel by reducing the energy needed to heat the cabin.

- Switch off the air conditioning if you do not need it. When you have the air conditioning on, keep it at the lowest blower and highest temperature setting necessary to be comfortable.
- When it is hot or sunny outside, parking in a shaded or climate-controlled environment will save fuel by reducing the energy needed to cool the cabin.
- For the C-MAX Energi, use preconditioning to improve your fuel economy. See **High Voltage Battery** (page 149).
- Switch off the heated seats if you are not using them.
- Switch off the defroster when you no longer need it for visibility.
- For the C-MAX Energi, plug in and recharge the high voltage battery whenever possible.
- Use ECO Cruise Control, especially in hilly terrain. For information on enabling eco-cruise, See **Cruise Control** (page 175).
- Shift into low gear (L) when enhanced engine braking is needed. Otherwise, use drive gear (D) shift position.
- Combine errands and minimize stop-and-go driving. A warmed up engine works more efficiently. When running errands, go to the farthest destination first and then work your way back home.
- Close the windows for high-speed driving.
- Use the recommended engine oil. See **Capacities and Specifications** (page 275).

# Driving Hints

- Perform all regularly scheduled maintenance. See **Scheduled Maintenance** (page 420).
- Use the coach and brake coach display to get feedback on your economical drive style. For more information, See **Information Displays** (page 91).

Avoid these actions because they reduce your fuel economy:

- Avoid sudden or hard accelerations and decelerations. Accelerate and slow down in a smooth, moderate fashion.
- Avoid revving the engine before switching off your vehicle.
- Avoid long idle periods.
- Do not warm up your vehicle on cold mornings.
- Do not rest your foot on the brake pedal while driving.
- Avoid carrying unnecessary weight. Approximately 1 mile per gallon (0.4 kilometers per liter) is lost for every 400 lb (180 kg) of weight carried.
- Avoid adding accessories that increase aerodynamic drag to your vehicle such as bug deflectors, car top carriers and ski or bike racks.
- Avoid driving with the wheels out of alignment.

Things to keep in mind when you refuel your vehicle:

- Fuel generates fewer vapors when it is cool and dark outside. Refuel your vehicle in the early morning or late evening.
- Use the recommended octane-rated fuel. Using fuel below the recommended rating will lower your fuel economy.

## DRIVING THROUGH WATER

### WARNING



Do not drive through flowing or deep water as you may lose control of your vehicle.

**Note:** *Driving through standing water can cause vehicle damage.*

**Note:** *Engine damage can occur if water enters the air filter.*

Before driving through standing water, check the depth. Never drive through water that is higher than the bottom of the front rocker area of your vehicle.

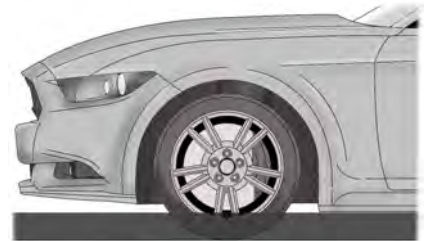

E176360

When driving through standing water, drive very slowly and do not stop your vehicle. Your brake performance and traction may be limited. After driving through water and as soon as it is safe to do so:

- Lightly press the brake pedal to dry the brakes and to check that they work.
- Check that the horn works.
- Check that the exterior lights work.
- Turn the steering wheel to check that the steering power assist works.





# Driving Hints

## FLOOR MATS

### WARNINGS

 Always use floor mats that are designed to fit the foot well of your vehicle. Only use floor mats that leave the pedal area unobstructed. Only use floor mats that are firmly secured to retention posts so that they cannot slip out of position and interfere with the pedals or impair safe operation of your vehicle in other ways.

 Pedals that cannot move freely can cause loss of vehicle control and increase the risk of serious personal injury.

 Always make sure that the floor mats are properly attached to the retention posts in the carpet that are supplied with your vehicle. Floor mats must be properly secured to both retention posts to make sure mats do not shift out of position.

 Never place floor mats or any other covering in the vehicle foot well that cannot be properly secured to prevent them from moving and interfering with the pedals or the ability to control the vehicle.

 Never place floor mats or any other covering on top of already installed floor mats. Floor mats should always rest on top of vehicle carpeting surface and not another floor mat or other covering. Additional floor mats or any other covering will reduce the pedal clearance and potentially interfere with pedal operation.

 Check attachment of floor mats on a regular basis. Always properly reinstall and secure floor mats that have been removed for cleaning or replacement.

### WARNINGS

 Always make sure that objects cannot fall into the driver foot well while the vehicle is moving. Objects that are loose can become trapped under the pedals causing a loss of vehicle control.

 Failure to properly follow floor mat installation or attachment instructions can potentially cause interference with pedal operation causing a loss of vehicle control.



E142666

To install floor mats, position the floor mat so that the eyelet is over the retention post and press down to lock in.

To remove the floor mat, reverse the installation procedure.

# Roadside Emergencies

## ROADSIDE ASSISTANCE

### Vehicles Sold in the United States: Getting Roadside Assistance

To fully assist you should you have a vehicle concern, Ford Motor Company offers a complimentary roadside assistance program. This program is separate from the New Vehicle Limited Warranty. The service is available:

- 24 hours a day, seven days a week.
- For the coverage period listed on the Roadside Assistance Card included in your Owner's Manual portfolio.

Roadside Assistance covers:

- A flat tire change with a good spare, if provided with the vehicle (except vehicles supplied with a tire inflation kit).
- Battery jump start.
- Lock-out assistance (key replacement cost is the customer's responsibility).
- Fuel delivery — independent service contractors, if not prohibited by state, local or municipal law, shall deliver up to 2 gal (7.6 L) of gasoline or 5 gal (18.9 L) of diesel fuel to a disabled vehicle. Roadside Assistance limits fuel delivery service to two no-charge occurrences within a 12-month period.
- Winch out — available within 100 ft (30.5 m) of a paved or county maintained road, no recoveries.
- Towing — independent service contractors, if not prohibited by state, local or municipal law, shall tow Ford eligible vehicles to an authorized dealer within 35 mi (56 km) of the disablement location or to the nearest

authorized dealer. If a member requests a tow to an authorized dealer that is more than 35 mi (56 km) from the disablement location, the member shall be responsible for any mileage costs in excess of 35 mi (56 km).

Roadside Assistance includes up to \$200 for a towed trailer if the disabled eligible vehicle requires service at the nearest authorized dealer. If the towing vehicle is operational but the trailer is not, then the trailer does not qualify for any roadside services.

### Vehicles Sold in the United States: Using Roadside Assistance

Complete the roadside assistance identification card and place it in your wallet for quick reference. This card is in the owner's information portfolio in the glove compartment.

United States Ford vehicle customers who require Roadside Assistance, call 1-800-241-3673.

If you need to arrange roadside assistance for yourself, Ford Motor Company reimburses a reasonable amount for towing to the nearest dealership within 35 mi (56 km). To obtain reimbursement information, United States Ford vehicle customers call 1-800-241-3673. Customers need to submit their original receipts.

### Vehicles Sold in Canada: Getting Roadside Assistance

Canadian customers who require roadside assistance, call 1-800-665-2006.

### Vehicles Sold in Canada: Using Roadside Assistance

For your convenience, you may complete the roadside assistance identification card found in the centerfold of your warranty guide and retain for future reference.

# Roadside Emergencies

Canadian roadside coverage and benefits may differ from the U.S. coverage. If you require more information, please refer to the coverage section of your warranty guide, call us in Canada at 1-800-665-2006, or visit our website at [www.ford.ca](http://www.ford.ca).

Sykes Assistance Services Corporation administers the Roadside Assistance program. You must receive covered services in Canada or the continental United States. Coverage extends to vehicles that use public, non-seasonal, annually traveled roadways. Roadside Assistance coverage does not extend to vehicles involved in cross-country driving, logging, autocross and any other form of off-road use. Well maintained roads and surfaces help ensure safe travel for the supplier, and allow their representatives to perform service as per the standard operating procedures.

## In Remote Locations

If our supplier cannot take your vehicle by road to the nearest authorized dealership, transportation by rail or water may be necessary. The program covers a tow to the dock or rail terminal and also to the dealership at the end of the trip.

For rail or water transportation, however, contact your authorized dealer to confirm if you are eligible for additional coverage before you authorize or pay for the service.

Call Ford Roadside Assistance at 1-800-665-2006 for additional information.

## HAZARD WARNING FLASHERS

**Note:** *If used when the vehicle is not running, the battery will lose charge. There may be insufficient power to restart your vehicle.*



The hazard warning button is located on the instrument panel. Use it when your vehicle is creating a safety hazard for other motorists.

- Press the button to turn on the hazard warning function, and the front and rear direction indicators will flash.
- Press the button again to turn them off.

## FUEL SHUTOFF

### WARNING



Failure to inspect and, if necessary, repair fuel leaks after a collision may increase the risk of fire and serious injury. Ford Motor Company recommends that the fuel system be inspected by an authorized dealer after any collision.

In the event of a moderate to severe collision, this vehicle has a fuel pump shut-off feature that stops the flow of fuel to the engine. Not every impact will cause a shut-off.

Should your vehicle shut off after a collision, you may restart your vehicle.

For vehicles equipped with a key system:

1. Switch off the ignition.
2. Switch on the ignition.
3. Check the information display for the Ready to Drive light as the gasoline engine may not start, but the electric motor may be running. If you do not see the Ready to Drive light, repeat Steps 1 and 2 up to two more times.

For vehicles equipped with a push button start system:

1. Press the push button start to switch off the ignition.

# Roadside Emergencies

---

2. Press the brake pedal and press the push button start to switch on the ignition.
3. Check the information display for the Ready to Drive light as the gasoline engine may not start, but the electric motor may be running. If you do not see the Ready to Drive light, repeat Steps 1 and 2 up to two more times.

**Note:** When you try to restart your vehicle after a fuel shutoff, the vehicle makes sure that the electrical system is safe to restart. Once your vehicle determines that the electrical system is safe, then the vehicle will allow you to restart.

**Note:** In the event that your vehicle does not restart after your third attempt, contact an authorized dealer.

## JUMP STARTING THE VEHICLE

### WARNINGS



The gases around the battery can explode if exposed to flames, sparks or lit cigarettes. An explosion could result in injury or vehicle damage.



Batteries contain sulfuric acid which can burn skin, eyes and clothing, if contacted.

---

Do not attempt to push-start your automatic transmission vehicle. Automatic transmissions do not have push-start capability. Attempting to push-start a vehicle with an automatic transmission may cause transmission damage.

### Preparing Your Vehicle

**Note:** Use only a 12-volt supply to start your vehicle.

**Note:** Do not disconnect the battery of the disabled vehicle as this could damage the vehicle's electrical system.

1. Park the booster vehicle close to the hood of the disabled vehicle making sure the two vehicles do not touch. Set the parking brake on both vehicles and stay clear of the engine cooling fan and other moving parts.
2. Check all battery terminals and remove any excessive corrosion before you attach the battery cables. Ensure that vent caps are tight and level.
3. Turn the heater fan on in both vehicles to protect from any electrical surges. Turn all other accessories off.

### Connecting the Jumper Cables

Your vehicle has a 12-volt battery that has two prongs accessible from under the hood. Your vehicle can be jumped the same way conventional vehicles can by using these prongs. The illustration below shows the two connector prongs used for jump-starting your vehicle.

# Roadside Emergencies

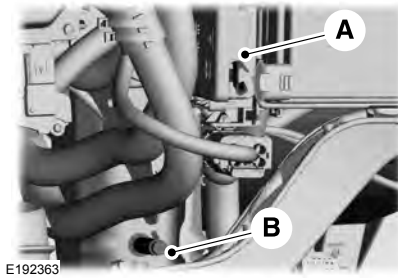

- A. Positive prong (+)
- B. Negative prong (-)

**Note:** In the illustration, the vehicle on the bottom is used to designate the assisting (boosting) battery.

**Note:** Remove the red cap from the positive prong (A) on your vehicle before connecting the cables.

1. Connect the positive (+) jumper cable to the positive (+) prong (A) of the discharged battery.
2. Connect the other end of the positive (+) cable to the positive (+) terminal of the assisting battery.
3. Connect the negative (-) cable to the negative (-) terminal of the assisting battery.
4. Make the final connection of the negative (-) cable to the negative (-) prong (B) of your vehicle.

**Note:** Do not attach the negative (-) cable to fuel lines, engine rocker covers, the intake manifold or electrical components. These items should not be considered grounding points.

## WARNING

 Never connect the negative end of the cable to the negative (-) terminal of the discharged battery. A spark may cause an explosion of the gases that surround the battery. Always use the negative prong as a grounding point.

Make sure that the cables are clear of fan blades, belts, the moving parts of both engines, or any fuel delivery system parts.

## Jump Starting

1. Start the booster vehicle and press the accelerator pedal moderately.

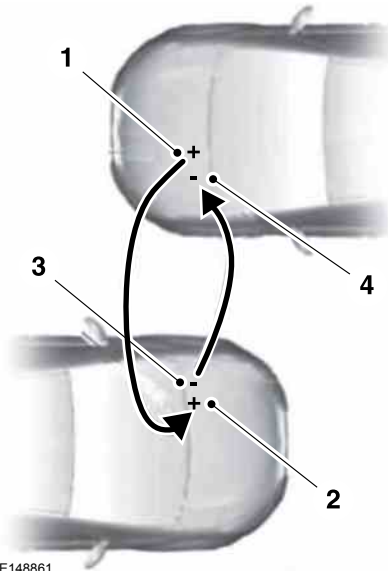

# Roadside Emergencies

2. Start the disabled vehicle. Check the instrument cluster for the Ready to Drive light as the gasoline engine may not start, but the electric motor may be running.
3. Once you start the disabled vehicle, run both vehicles for an additional three minutes before disconnecting the jumper cables.

## Removing the Jumper Cables

Remove the jumper cables in the reverse order that they were connected.

**Note:** *In the illustration, the vehicle on the bottom is used to designate the assisting (boosting) battery.*

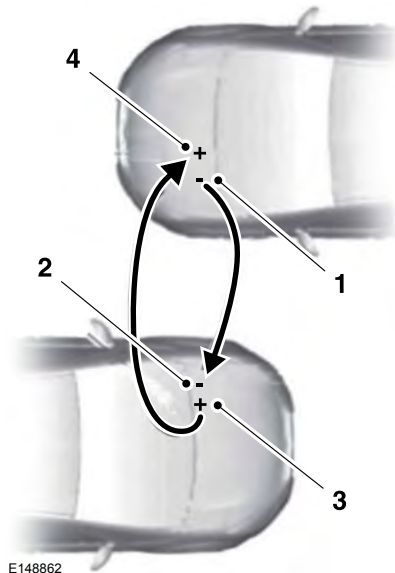

1. Remove the jumper cable from the negative prong.

2. Remove the jumper cable on the negative (-) terminal of the booster vehicle's battery.
3. Remove the jumper cable from the positive (+) terminal of the booster vehicle's battery.
4. Remove the jumper cable from the positive (+) prong of the disabled vehicle's battery.

After disconnecting the jumper cables, let the disabled vehicle sit in Ready to Drive mode for several minutes to charge the 12V battery. The disabled vehicle can charge the 12V battery even if the gasoline engine may be off. The 12V battery will receive power from the high-voltage battery instead.

## COLLISION, DAMAGE OR FIRE EVENT

### Guidance for Ford Motor Company Electric and Hybrid-Electric Vehicles Equipped With High Voltage Batteries

#### (Vehicle Owner/Operator/General Public) Electric and Hybrid-Electric Vehicle Considerations

#### In the event of damage or fire involving an electric vehicle (EV) or hybrid-electric vehicle (HEV):

- Always assume the high-voltage battery and associated components are energized and fully charged.
- Exposed electrical components, wires and high-voltage batteries present potential high-voltage shock hazards.

# Roadside Emergencies

---

- Venting/off-gassing high-voltage battery vapors are potentially toxic and flammable.
- Physical damage to the vehicle or high-voltage battery may result in immediate or delayed release of toxic, flammable gases and fire.

## Vehicle Information and General Safety Practices

- Know the make and model of your vehicle.
- Review the owner's manual and become familiar with your vehicle's safety information and recommended safety practices.
- Do not attempt to repair damaged electric and hybrid-electric vehicles yourself. Contact an authorized Ford Dealer or vehicle manufacturer representative for service.

## Crashes

A crash or impact significant enough to require an emergency response for conventional vehicles would also require the same response for an electric or hybrid-electric vehicle.

### *If possible*

- Move your car to a safe, nearby location and remain on the scene.
- Roll down the windows before shutting your vehicle off.
- Place your vehicle in Park, set the parking brake, turn off the vehicle, activate the hazard lights, and move your key(s) at least 16 feet (5 meters) away from the vehicle.

## Always

- Call 911 if assistance is needed and advise that an electric or hybrid-electric vehicle is involved.
- Do not touch exposed electrical components or the engine compartment, as a shock hazard may exist.
- Avoid contact with leaking fluids and gases, and remain out of the way of oncoming traffic until emergency responders arrive.
- When emergency responders arrive, tell them that the vehicle involved is an electric vehicle or hybrid vehicle.

## Fires

As with any vehicle, call 911 immediately if you see sparks, smoke or flames coming from the vehicle.

- Exit the vehicle immediately.
- Advise 911 that an electric or hybrid-electric vehicle is involved.
- As with any vehicle fire, do not inhale smoke, vapors or gas from the vehicle, as they may be hazardous.
- Remain a safe distance from the vehicle and try to stay clear of the smoke.
- Stay out of the roadway and stay out of the way of any oncoming traffic while awaiting the arrival of emergency responders.

## Post-Incident

- Do not store a severely damaged vehicle with a lithium-ion battery inside a structure or within 50 feet (15 meters) of any structure or vehicle.
- Make sure that passenger and cargo compartments remain ventilated (i.e. open window, door or trunk).

# Roadside Emergencies

---

- For vehicles in the United States, notify Ford Motor Company 1-800-392-3673 (then follow the prompts on the voice response menu), an authorized Ford dealer or service center as soon as possible as there may be other steps to secure and discharge the high-voltage battery.
- For vehicles in Canada, notify Ford Motor Company 1-800-565-3673 (then follow the prompts on the voice response menu), an authorized Ford dealer or service center as soon as possible as there may be other steps to secure and discharge the high-voltage battery.
- Call 911 if you observe leaking fluids, sparks, smoke or flames, or hear gurgling or bubbling from the high-voltage battery.

## **POST-CRASH ALERT SYSTEM**

The system flashes the direction indicators and sounds the horn (intermittently) in the event of a serious impact that deploys an airbag (front, side, side curtain or Safety Canopy) or the safety belt pretensioners.

The horn and indicators will turn off when:

- You press the hazard control button.
- You press the panic button on the remote entry transmitter (if equipped).
- Your vehicle runs out of power.



# Customer Assistance

---

## GETTING THE SERVICES YOU NEED

Warranty repairs to your vehicle must be performed by an authorized dealer. While any authorized dealer handling your vehicle line will provide warranty service, we recommend you return to your selling authorized dealer who wants to ensure your continued satisfaction.

Please note that certain warranty repairs require special training and equipment, so not all authorized dealers are authorized to perform all warranty repairs. This means that, depending on the warranty repair needed, you may have to take your vehicle to another authorized dealer.

A reasonable time must be allowed to perform a repair after taking your vehicle to the authorized dealer. Repairs will be made using Ford or Motorcraft® parts, or remanufactured or other parts that are authorized by Ford.

### Away From Home

If you are away from home when your vehicle needs service, contact the Ford Customer Relationship Center or use the online resources listed below to find the nearest authorized dealer.

In the United States:

#### Mailing address

Ford Motor Company  
Customer Relationship Center  
P.O. Box 6248  
Dearborn, MI 48121

#### Telephone

1-800-392-3673 (FORD)  
(TDD for the hearing impaired:  
1-800-232-5952)

#### Online

Additional information and resources are available online at [www.fordowner.com](http://www.fordowner.com)

These are some of the items that can be found online:

- U.S. dealer locator by Dealer Name, City/State or Zip Code.
- Owner Manuals.
- Maintenance Schedules.
- Recalls.
- Ford Extended Service Plans.
- Ford Genuine Accessories.
- Service specials and promotions.

In Canada:

#### Mailing address

Customer Relationship Centre  
Ford Motor Company of Canada, Limited  
P.O. Box 2000  
Oakville, Ontario L6K 0C8

#### Telephone

1-800-565-3673 (FORD)

#### Online

[www.ford.ca](http://www.ford.ca)

#### Twitter

@FordServiceCA (English Canada)  
@FordServiceQC (Quebec)

#### Additional Assistance

If you have questions or concerns, or are unsatisfied with the service you are receiving, follow these steps:

1. Contact your Sales Representative or Service Advisor at your selling/servicing authorized dealer.
2. If your inquiry or concern remains unresolved, contact the Sales Manager, Service Manager or Customer Relations Manager.
3. If you require assistance or clarification on Ford Motor Company policies, please contact the Ford Customer Relationship Center.

# Customer Assistance

---

In order to help us serve you better, please have the following information available when contacting a Customer Relationship Center:

- Vehicle Identification Number.
- Your telephone number (home and business).
- The name of the authorized dealer and city where located.
- The vehicle's current odometer reading.

In some states, you must directly notify Ford in writing before pursuing remedies under your state's warranty laws. Ford is also allowed a final repair attempt in some states.

In the United States, a warranty dispute must be submitted to the BBB AUTO LINE before taking action under the Magnuson-Moss Warranty Act, or to the extent allowed by state law, before pursuing replacement or repurchase remedies provided by certain state laws. This dispute handling procedure is not required prior to enforcing state created rights or other rights which are independent of the Magnuson-Moss Warranty Act or state replacement or repurchase laws.

## IN CALIFORNIA (U.S. ONLY)

California Civil Code Section 1793.2(d) requires that, if a manufacturer or its representative is unable to repair a motor vehicle to conform to the vehicle's applicable express warranty after a reasonable number of attempts, the manufacturer shall be required to either replace the vehicle with one substantially identical or repurchase the vehicle and reimburse the buyer in an amount equal to the actual price paid or payable by the consumer (less a reasonable allowance for consumer use). The consumer has the right to choose whether to receive a refund or replacement vehicle.

California Civil Code Section 1793.22(b) presumes that the manufacturer has had a reasonable number of attempts to conform the vehicle to its applicable express warranties if, within the first 18 months of ownership of a new vehicle or the first 18000 miles (29 000 km), whichever occurs first:

1. Two or more repair attempts are made on the same non-conformity likely to cause death or serious bodily injury OR
2. Four or more repair attempts are made on the same nonconformity (a defect or condition that substantially impairs the use, value or safety of the vehicle) OR
3. The vehicle is out of service for repair of nonconformities for a total of more than 30 calendar days (not necessarily all at one time).

In the case of 1 or 2 above, the consumer must also notify the manufacturer of the need for the repair of the nonconformity at the following address:

Ford Motor Company  
16800 Executive Plaza Drive  
Mail Drop 3NE-B  
Dearborn, MI 48126

You are required to submit your warranty dispute to BBB AUTO LINE before asserting in court any rights or remedies conferred by California Civil Code Section 1793.22(b). You are also required to use BBB AUTO LINE before exercising rights or seeking remedies created by the Federal Magnuson-Moss Warranty Act, 15 U.S.C. sec. 2301 et seq. If you choose to seek redress by pursuing rights and remedies not created by California Civil Code Section 1793.22(b) or the Magnuson-Moss Warranty Act, resort to BBB AUTO LINE is not required by those statutes.

## Customer Assistance

---

### **THE BETTER BUSINESS BUREAU (BBB) AUTO LINE PROGRAM (U.S. ONLY)**

Your satisfaction is important to Ford Motor Company and to your dealer. If a warranty concern has not been resolved using the three-step procedure outlined earlier in this chapter in the Getting the Services you need section, you may be eligible to participate in the BBB AUTO LINE program.

The BBB AUTO LINE program consists of two parts – mediation and arbitration. During mediation, a representative of the BBB will contact both you and Ford Motor Company to explore options for settlement of the claim. If an agreement is not reached during mediation or you do not want to participate in mediation, and if your claim is eligible, you may participate in the arbitration process. An arbitration hearing will be scheduled so that you can present your case in an informal setting before an impartial person. The arbitrator will consider the testimony provided and make a decision after the hearing.

Disputes submitted to the BBB AUTO LINE program are usually decided within forty days after you file your claim with the BBB. You are not bound by the decision, and may reject the decision and proceed to court where all findings of the BBB Auto Line dispute, and decision, are admissible in the court action. Should you choose to accept the BBB AUTO LINE decision, Ford is then bound by the decision, and must comply with the decision within 30 days of receipt of your acceptance letter.

**BBB AUTO LINE Application:** Using the information provided below, please call or write to request a program application. You will be asked for your name and address, general information about your new vehicle, information about your warranty concerns, and any steps you have

already taken to try to resolve them. A Customer Claim Form will be mailed that will need to be completed, signed and returned to the BBB along with proof of ownership. Upon receipt, the BBB will review the claim for eligibility under the Program Summary Guidelines.

**You can get more information by calling BBB AUTO LINE at 1-800-955-5100, or writing to:**

**BBB AUTO LINE  
3033 Wilson Boulevard, Suite 600  
Arlington, Virginia 22201**

BBB AUTO LINE applications can also be requested by calling the Ford Motor Company Customer Relationship Center at 1-800-392-3673.

**Note:** *Ford Motor Company reserves the right to change eligibility limitations, modify procedures, or to discontinue this process at any time without notice and without obligation.*

### **UTILIZING THE MEDIATION/ARBITRATION PROGRAM (CANADA ONLY)**

For vehicles delivered to authorized Canadian dealers. In those cases where you continue to feel that the efforts by Ford of Canada and the authorized dealer to resolve a factory-related vehicle service concern have been unsatisfactory, Ford of Canada participates in an impartial third party mediation/arbitration program administered by the Canadian Motor Vehicle Arbitration Plan (CAMVAP).

The CAMVAP program is a straight forward and relatively speedy alternative to resolve a disagreement when all other efforts to produce a settlement have failed. This procedure is without cost to you and is designed to eliminate the need for lengthy and expensive legal proceedings.

# Customer Assistance

---

In the CAMVAP program, impartial third-party arbitrators conduct hearings at mutually convenient times and places in an informal environment. These impartial arbitrators review the positions of the parties, make decisions and, when appropriate, render awards to resolve disputes. CAMVAP decisions are fast, fair, and final as the arbitrator's award is binding on both you and Ford of Canada.

CAMVAP services are available in all Canadian territories and provinces. For more information, without charge or obligation, call your CAMVAP Provincial Administrator directly at 1-800-207-0685 or visit [www.camvap.ca](http://www.camvap.ca).

## GETTING ASSISTANCE OUTSIDE THE U.S. AND CANADA

Before exporting your vehicle to a foreign country, contact the appropriate foreign embassy or consulate. These officials can inform you of local vehicle registration regulations and where to find unleaded fuel.

If you cannot find unleaded fuel or can only get fuel with an anti-knock index lower than is recommended for your vehicle, contact our Customer Relationship Center.

The use of leaded fuel in your vehicle without proper conversion may damage the effectiveness of your emission control system and may cause engine knocking or serious engine damage. Ford Motor Company or Ford of Canada is not responsible for any damage caused by use of improper fuel. Using leaded fuel may also result in difficulty importing your vehicle back into the United States.

If your vehicle must be serviced while you are traveling or living in Asia-Pacific Region, Sub-Saharan Africa, U.S. Virgin Islands, Central America, the Caribbean, and Israel, contact the nearest authorized dealer. If the authorized dealer cannot help you, contact:

FORD MOTOR COMPANY  
Customer Relationship Center  
1555 Fairlane Drive  
Fairlane Business Park #3  
Allen Park, Michigan 48101  
U.S.A.  
Telephone: (313) 594-4857  
Fax: (313) 390-0804  
Email: [expcac@ford.com](mailto:expcac@ford.com)

For customers in Guam, the Commonwealth of the Northern Mariana Islands (CNMI), America Samoa, and the U.S. Virgin Islands, please feel free to call our Toll-Free Number: (800) 841-FORD (3673).

If your vehicle must be serviced while you are traveling or living in Puerto Rico, contact the nearest authorized dealer. If the authorized dealer cannot help you, contact:

FORD MOTOR COMPANY  
Customer Relationship Center  
1555 Fairlane Drive  
Fairlane Business Park #3  
Allen Park, Michigan 48101  
U.S.A.  
Telephone: (800) 841-FORD (3673)  
FAX: (313) 390-0804  
Email: [prcac@ford.com](mailto:prcac@ford.com)  
[www.ford.com.pr](http://www.ford.com.pr)

If your vehicle must be serviced while you are traveling or living in the Middle East, contact the nearest authorized dealer. If the authorized dealer cannot help you, contact:

# Customer Assistance

---

FORD MOTOR COMPANY  
Customer Relationship Center  
1555 Fairlane Drive  
Fairlane Business Park #3  
Allen Park, Michigan 48101  
U.S.A.

**Ford:** 80004443673

**Lincoln:** 80004441067

**If calling from the UAE:** 80004441066

**If calling from the Kingdom of Saudi**

**Arabia:** 8008443673

**If calling from Kuwait:** 22280384

FAX: +971 4 3327266

Email: [menacac@ford.com](mailto:menacac@ford.com)

[www.me.ford.com](http://www.me.ford.com)

If you buy your vehicle in North America and then relocate to any of the above locations, register your vehicle identification number (VIN) and new address with Ford Motor Company Export Operations & Global Growth Initiatives by emailing **expcac@ford.com**.

If you are in another foreign country, contact the nearest authorized dealer. In the event your inquiry is unresolved, communicate your concern with the dealership's Sales Manager, Service Manager or Customer Relations Manager. If you require additional assistance or clarification, please contact the respective Customer Relationship Center as previously listed.

**Customers in the U.S. should call  
1-800-392-3673.**

## ORDERING ADDITIONAL OWNER'S LITERATURE

To order the publications in this portfolio, contact Helm, Incorporated at:

HELM, INCORPORATED

47911 Halyard Drive

Plymouth, Michigan 48170

Attention: Customer Service

Or to order a free publication catalog, call toll free: 1-800-782-4356

Monday-Friday 8:00 a.m. - 6:00 p.m. EST

Helm, Incorporated can also be reached by their website:

[www.helminc.com](http://www.helminc.com)

(Items in this catalog may be purchased by credit card, check or money order.)

## Obtaining a French Owner's Manual

French Owner's Manual can be obtained from your authorized dealer or by contacting Helm, Incorporated using the contact information listed previously in this section.

## REPORTING SAFETY DEFECTS (U.S. ONLY)



E142557

If you believe that your vehicle has a defect which could cause a crash or could cause injury or death, you should immediately inform the National Highway Traffic Safety Administration (NHTSA) in addition to notifying Ford Motor Company.

## Customer Assistance

---

If NHTSA receives similar complaints, it may open an investigation, and if it finds that a safety defect exists in a group of vehicles, it may order a recall and remedy campaign. However, NHTSA cannot become involved in individual problems between you, your dealer, or Ford Motor Company.

To contact NHTSA, you may call the Vehicle Safety Hotline toll-free at 1-888-327-4236 (TTY: 1-800-424-9153); go to <http://www.safercar.gov>; or write to:

Administrator

1200 New Jersey Avenue,  
Southeast

Washington, D.C. 20590

You can also obtain other information about motor vehicle safety from <http://www.safercar.gov>.

### **REPORTING SAFETY DEFECTS (CANADA ONLY)**

If you believe that your vehicle has a defect which could cause a crash or could cause injury or death, you should immediately inform Transport Canada.

<b>Transport Canada Contact Information</b>	
Website	<a href="http://www.tc.gc.ca/eng/roadsafety/menu.htm">http://www.tc.gc.ca/eng/roadsafety/menu.htm</a>
Phone	1-800-333-0510

# Fuses

## FUSE SPECIFICATION CHART

### Pre-Fuse Box

Your vehicle has a pre-fuse box attached to the power distribution box. There is a second pre-fuse box attached to the 12-volt battery terminal in the rear of your vehicle. They contain high-current fuses. If you need to replace one of these fuses, see an authorized dealer.

### Power Distribution Box

#### WARNINGS



Always disconnect the battery before servicing high current fuses.

#### WARNINGS



To reduce risk of electrical shock, always replace the cover to the power distribution box before reconnecting the battery or refilling fluid reservoirs.

The power distribution box is located in the engine compartment. It has high-current fuses that protect your vehicle's main electrical systems from overloads.

If you disconnect and reconnect the battery, you will need to reset some features. See **Changing the 12V Battery** (page 223).

Lift the release lever at the rear of the cover to remove it.

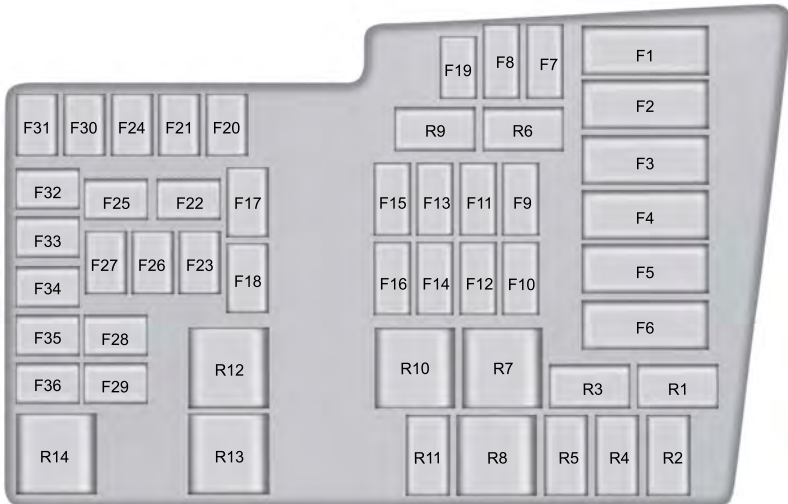

E162196

# Fuses

Fuse or relay number	Fuse amp rating	Protected components
F1	50A Midi	Cooling fan module.
F2	50A Midi	Electric water pump.
F3	50A Midi	Body control module supply 1.
F4	50A Midi	Body control module supply 2.
F5	—	Not used.
F6	—	Not used.
F7	40A**	Anti-lock brake system pump.
F8	30A**	Anti-lock brake system valve.
F9	40A**	Vacuum pump.
F10	40A**	Heater blower motor.
F11	30A**	Engine management.
F12	—	Not used.
F13	25A**	Powertrain control module relay.
F14	20A**	Rear wiper.
F15	30A**	Body control module KL30 supply.
F16	20A**	Body control module 15 feed.
F17	20A**	Transmission oil pump (C-MAX Energi).
F18	20A**	Front wiper motor.
F19	5A*	Anti-lock brake system and electronic stability program module.
F20	15A*	Horn.
F21	5A*	Stop light switch.
F22	5A*	Vacuum pump monitoring.
F23	5A*	Engine control module 15. Powertrain control module 15. Transmission oil pump 15.
F24	5A*	Relay coils. Light switch module.



# Fuses

Fuse or relay number	Fuse amp rating	Protected components
F25	10A*	Motor electronic cooling pump.
F26	5A*	Electronic power assist steering module 15.
F27	5A*	Mass air flow sensor.
F28	15A*	Powertrain control module.
F29	10A*	Electronic air conditioning compressor. Positive temperature coefficient heater.
F30	10A*	Engine control module. Powertrain control module.
F31	5A*	Charge port light ring (C-MAX Energi).
F32	20A*	Vehicle power 2.
F33	15A*	Vehicle power 4.
F34	10A*	Injectors.
F35	10A*	Vehicle power 3.
F36	20A*	Vehicle power 1.
R1	—	Not used.
R2	Micro relay	Horn.
R3	Micro relay	Hybrid powertrain control.
R4	Micro relay	Front wiper.
R5	—	Not used.
R6	Micro relay	Front and rear wiper high-low.
R7	Power relay	Vacuum pump.
R8	Power relay	Ignition feed.
R9	—	Not used.
R10	Mini relay	Vacuum pump sensor.
R11	—	Not used.
R12	Power relay	Cooling fan.

# Fuses

Fuse or relay number	Fuse amp rating	Protected components
R13	Mini relay	Heater blower.
R14	Mini relay	Engine control relay.

\*Mini fuses \*\*Cartridge fuses

## Passenger Compartment Fuse Panel

The fuse panel is located on the right-hand side below the glove box. You may need to remove a trim panel to access it.

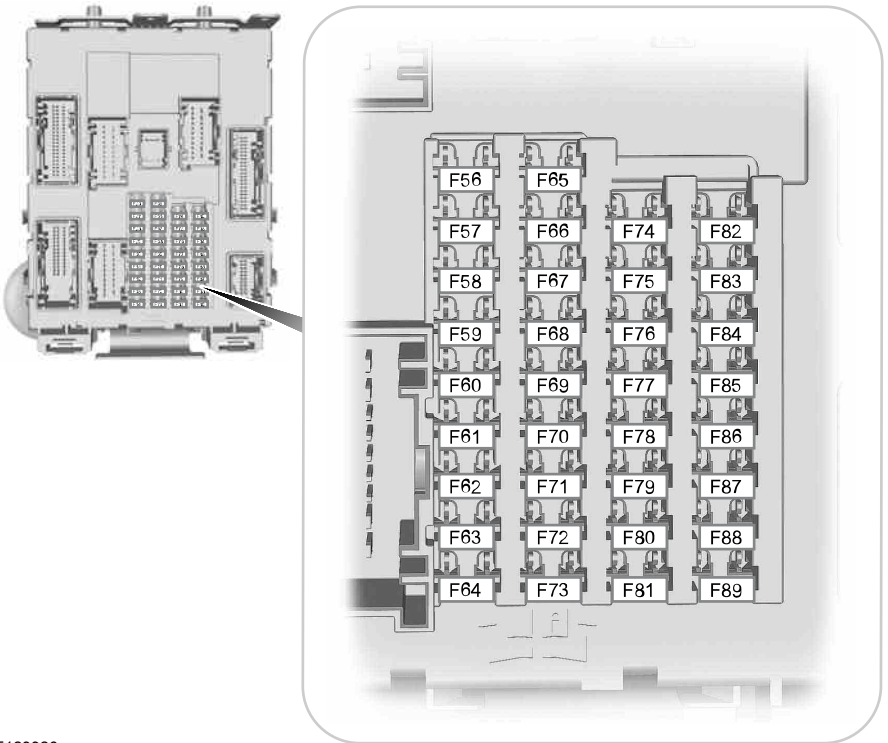

E129926

## Fuses

Fuse or relay number	Fuse amp rating	Protected components
F56	20A	Fuel pump supply.
F57	—	Not used.
F58	5A	Not used (spare).
F59	5A	Passive anti-theft system.
F60	10A	Interior light. Driver door switch pack. Glove box illumination. Overhead console switch bank.
F61	20A	Cigar lighter. Second row power point.
F62	5A	Autowiper module. Autodimming rear view mirror.
F63	10A	Not used (spare).
F64	—	Not used.
F65	10A	Liftgate release.
F66	20A	Driver door unlock supply.
F67	7.5A	Cell phone passport (C-MAX Energi). Multi-function display. GPS module. Sync.
F68	15A	Not used (spare).
F69	5A	Instrument cluster.
F70	20A	Central lock and unlock supply.
F71	7.5A	Climate control module.
F72	7.5A	Steering wheel module.
F73	7.5A	Data link connector. OBD II supply.
F74	15A	Headlamp supply.
F75	15A	Fog lamp supply.
F76	10A	Reversing lamp supply.

# Fuses

Fuse or relay number	Fuse amp rating	Protected components
F77	20A	Washer pump.
F78	5A	Ignition switch, Start button.
F79	15A	Radio. Hazard light switch.
F80	20A	Not used (spare).
F81	5A	Power sun shade. Remote receiver antenna.
F82	20A	Washer pump ground.
F83	20A	Central locking ground.
F84	20A	Drive door unlock ground.
F85	7.5A	Electronic 15 feed.
F86	10A	Restraints control module. Passenger air bag deactivation indicator.
F87	15A	Not used (spare).
F88	25A	Not used (spare).
F89	—	Not used.

## Luggage Compartment Fuse Panel

The fuse panel is located in the luggage compartment behind the left side wheel well. Remove the fuse panel cover to gain access to the fuses.

# Fuses

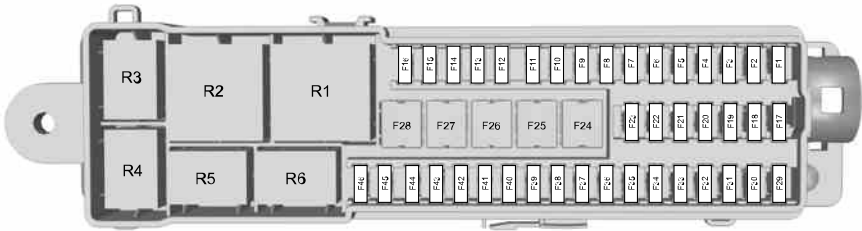

E129927

Fuse or relay number	Fuse amp rating	Protected components
F1	5A	Hands-free liftgate entry module.
F2	10A	Keyless vehicle module.
F3	5A	Keyless vehicle door handles.
F4	25A	Door control unit front left.
F5	25A	Door control unit front right.
F6	25A	Door control unit rear left.
F7	25A	Door control unit rear right.
F8	—	Not used.
F9	25A	Driver seat motor.
F10	25A	Heated rear window.
F11	5A	Ignition relay.
F12	15A	Battery electronics control module.
F13	—	Not used.
F14	10A	Charger (C-MAX Energi).
F15	—	Not used.
F16	—	Not used.
F17	10A	Battery electronics control module.
F18	15A	Battery electronics control module — fan.

## Fuses

Fuse or relay number	Fuse amp rating	Protected components
F19	15A	Charger fan (C-MAX Energi).
F20	—	Not used.
F21	15A	Smart datalink connector.
F22	10A	Active noise cancellation.
F23	—	Not used.
F24	30A	DC/AC power converter.
F25	25A	Power liftgate.
F26	40A	AC/DC charger (C-MAX Energi).
F27	20A	Luggage compartment outlet.
F28	—	Not used.
F29	—	Not used.
F30	5A	Parking aid module.
F31	5A	Rear view camera.
F32	5A	DC/AC power converter.
F33	—	Not used.
F34	20A	Driver seat heater.
F35	20A	Passenger seat heater.
F36	—	Not used.
F37	20A	Power sun shade.
F38	—	Not used.
F39	—	Not used.
F40	—	Not used.
F41	—	Not used.
F42	—	Not used.
F43	—	Not used.
F44	—	Not used.
F45	5A	Humidity sensor.

# Fuses

Fuse or relay number	Fuse amp rating	Protected components
F46	10A	Fuel system.
R1	Power relay	Rear 15 relay.
R2	Mini relay	Heated rear window.
R3	Micro relay	Fuel door (C-MAX Energi).
R4	—	Not used.
R5	—	Not used.
R6	Micro relay	Rear wiper.

## CHANGING A FUSE

### Fuses

#### WARNING



You must replace a failed fuse with one that has the specified amperage rating. If you use a fuse with a higher amperage rating, you may cause severe wire damage and may start a fire.

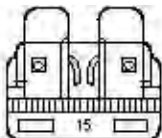

E142430

A fuse may fail if electrical components in the vehicle are not properly working. A broken wire inside the fuse indicates a failed fuse. Check the appropriate fuses before replacing any electrical components.

# Maintenance

## GENERAL INFORMATION

Have your vehicle serviced regularly to help maintain its roadworthiness and resale value. There is a large network of authorized dealers that are there to help you with their professional servicing expertise. We believe that their specially trained technicians are best qualified to service your vehicle properly and expertly. They are supported by a wide range of highly specialized tools developed specifically for servicing your vehicle.

To help you service your vehicle, we provide scheduled maintenance information which makes tracking routine service easy. See **Scheduled Maintenance** (page 420).

If your vehicle requires professional service, an authorized dealer can provide the necessary parts and service. Check your warranty information to find out which parts and services are covered.

Use only recommended fuels, lubricants, fluids and service parts conforming to specifications. Motorcraft® parts are designed and built to provide the best performance in your vehicle.

## Precautions

- Do not work on a hot engine.
- Make sure that nothing gets caught in moving parts.
- Do not work on a vehicle with the engine running in an enclosed space, unless you are sure you have enough ventilation.
- Keep all open flames and other burning material (such as cigarettes) away from the battery and all fuel related parts.

## Working with the Engine Off

1. Set the parking brake and shift to park (P).
2. Switch off the engine.
3. Block the wheels.

## Working with the Engine On

### WARNING



To reduce the risk of vehicle damage and/or personal burn injuries, do not start your engine with the air cleaner removed and do not remove it while the engine is running.

1. Set the parking brake and shift to park (P).
2. Block the wheels

## OPENING AND CLOSING THE HOOD

### Opening the Hood



E142457

1. Inside the vehicle, pull the hood release handle located under the left-hand side of the instrument panel.
2. Slightly lift the hood.
3. Release the hood latch by pushing the secondary release lever to your left-hand side.



# Maintenance



E87786

4. Open the hood. Support the hood with the strut.

## Closing the Hood

1. Remove the hood strut from the catch and secure it correctly after use.

2. Lower the hood and allow it to drop under its own weight for the last 8-12 in (20-30 cm).

**Note:** Make sure that the hood is correctly closed.

## UNDER HOOD OVERVIEW - HYBRID ELECTRIC VEHICLE (HEV)

### WARNING



The inverter system controller contains various high-voltage components that can cause serious bodily harm or death. The inverter system controller is not serviceable and should never be touched, probed, or tampered with.

**Note:** Do not attempt to service any of the high-voltage components or wiring. For easier identification, the high-voltage wiring insulation is color coated orange.

# Maintenance

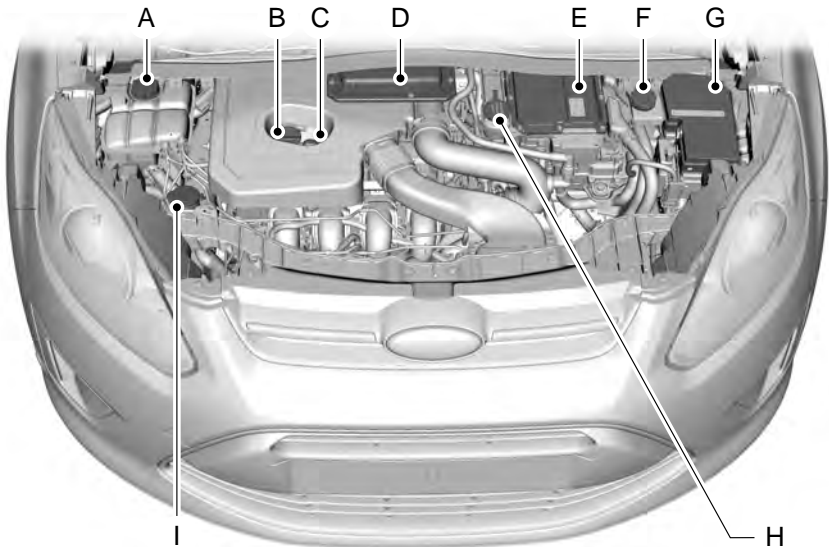

E162485

- A Engine coolant reservoir cap. See **Engine Coolant Check** (page 218).
- B Engine oil filler cap. See **Engine Oil Check** (page 217).
- C Engine oil dipstick. See **Engine Oil Dipstick** (page 217).
- D Engine air filter cover. See **Changing the Engine Air Filter** (page 233).
- E Inverter system controller.
- F Brake fluid reservoir cap. See **Brake Fluid Check** (page 222).
- G Power distribution box. See **Fuses** (page 204).
- H Inverter system controller coolant reservoir cap.
- I Windshield washer fluid reservoir cap. See **Washer Fluid Check** (page 222).

# Maintenance

## UNDER HOOD OVERVIEW - PLUG-IN HYBRID ELECTRIC VEHICLE (PHEV)

**Note:** Do not attempt to service any of the high-voltage components or wiring. For easier identification, the high-voltage wiring insulation is color coated orange.

### WARNING



The inverter system controller contains various high-voltage components that can cause serious bodily harm or death. The inverter system controller is not serviceable and should never be touched, probed, or tampered with.

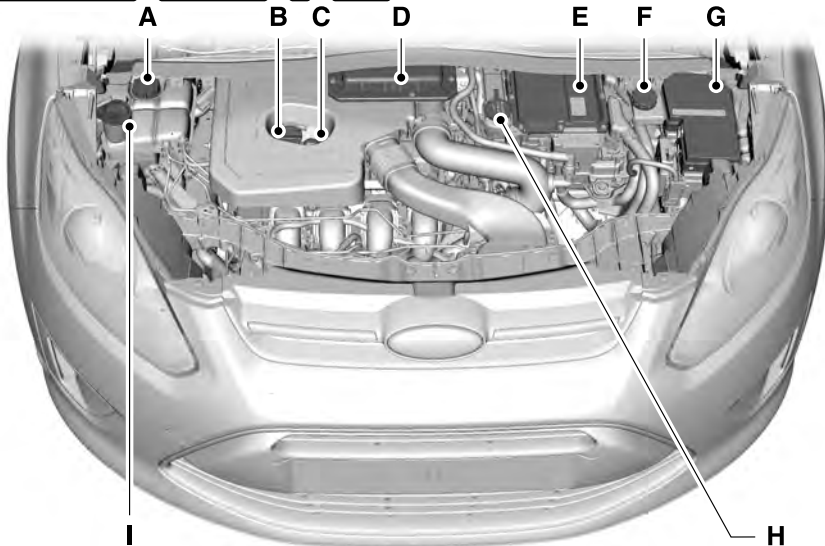

E190353

- A Engine coolant reservoir cap. See **Engine Coolant Check** (page 218).
- B Engine oil filler cap. See **Engine Oil Check** (page 217).
- C Engine oil dipstick. See **Engine Oil Dipstick** (page 217).
- D Engine air filter cover. See **Changing the Engine Air Filter** (page 233).
- E Inverter system controller.
- F Brake fluid reservoir cap. See **Brake Fluid Check** (page 222).

# Maintenance

- G Power distribution box. See **Fuses** (page 204).
- H Inverter system controller coolant reservoir cap.
- I Windshield washer fluid reservoir cap. See **Washer Fluid Check** (page 222).

## ENGINE OIL DIPSTICK

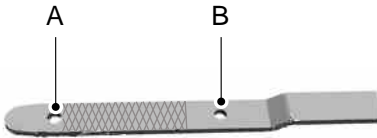

E169062

- A MIN
- B MAX

## ENGINE OIL CHECK

Check the level before starting the engine and make sure that the level is between the MIN and the MAX marks.

1. Make sure that your vehicle is on level ground.
2. Switch the engine off and wait 10 minutes for the oil to drain into the oil pan.
3. Remove the dipstick and wipe it with a clean, lint-free cloth. Replace the dipstick and remove it again to check the oil level.

If the oil level is at the minimum mark, add oil immediately.

## Adding Engine Oil

**Note:** Do not remove the filler cap when the engine is running.

**Note:** Do not add oil further than the MAX mark. Oil levels above the MAX mark may cause engine damage.



E142732

Only use oils certified for gasoline engines by the American Petroleum Institute (API). An oil with this trademark symbol conforms to the current engine and emission system protection standards and fuel economy requirements of the International Lubricants Specification Advisory Council (ILSAC), comprised of U.S. and Japanese automobile manufacturers.

1. Remove the filler cap.
2. Add engine oil that meets the Ford specifications. See **Capacities and Specifications** (page 275).
3. Wipe off any spilled oil.
4. Replace the filler cap. Turn it until you feel a strong resistance.

# Maintenance

## Low Engine Use (If Equipped)

The low engine use mode is equipped on Energi models only. The low engine use mode keeps the engine oil quality in good condition when you drive your vehicle with limited engine use. If your vehicle is in low engine use mode when you start the vehicle, a message appears in the information display. When your vehicle is in low engine use mode, your vehicle runs the engine as necessary.

Selecting EV Now mode when your vehicle is in the low engine use mode suspends the low engine use mode for as long as you continue driving your vehicle. The low engine use mode resumes the next time you start your vehicle.

Changing the engine oil and resetting the oil life monitoring system suspends the low engine use mode.

## ENGINE COOLANT CHECK

### WARNINGS



Do not add engine coolant when the engine is hot. Steam and scalding liquids released from a hot cooling system can burn you badly. Also, you can be burned if you spill coolant on hot engine parts.



Do not put engine coolant in the windshield washer fluid container. If sprayed on the windshield, engine coolant could make it difficult to see through the windshield.



To reduce the risk of personal injury, make sure the engine is cool before unscrewing the coolant pressure relief cap. The cooling system is under pressure; steam and hot liquid can come out forcefully when the cap is loosened slightly.



Do not add coolant further than the **MAX** mark.

## Engine Coolant and Inverter System Controller Coolant

Your vehicle has two separate cooling systems. One is for cooling the engine and one is for cooling the inverter system controller that is specific to the hybrid operating system. The two systems operate similarly, with the inverter system controller cooling system generally operating at a lower temperature and pressure.

## Checking the Engine Coolant

When the engine is cold, check the concentration and level of the engine coolant at the intervals listed in the scheduled maintenance information. See **Scheduled Maintenance** (page 420).

**Note:** Make sure that the level is between the **MIN** and **MAX** marks on the engine coolant reservoir.

**Note:** Coolant expands when it is hot. The level may extend beyond the **MAX** mark.

**Note:** If the level is at the **MIN** mark, below the **MIN** mark, or empty, add prediluted coolant immediately. See **Adding Engine Coolant** in this chapter.

Maintain coolant concentration within 48% to 50%, which equates to a freeze point between -30°F (-34°C) and -34°F (-37°C).

**Note:** For best results, coolant concentration should be tested with a refractometer such as Robinair® Coolant and Battery Refractometer 75240. We do not recommend the use of hydrometers or coolant test strips for measuring coolant concentrations.

**Note:** Automotive fluids are not interchangeable. Do not use engine coolant or antifreeze or windshield washer fluid outside of its specified function and vehicle location.

# Maintenance

---

## Checking the Inverter System Controller Coolant

When the engine is cold, check the concentration and level of the inverter system controller coolant at the intervals listed in the scheduled maintenance information. See **Scheduled Maintenance** (page 420).

**Note:** Make sure that the level is between the MIN and MAX marks on the inverter system controller coolant reservoir.

**Note:** Coolant expands when it is hot. The level may extend beyond the MAX mark.

**Note:** If the level is at the MIN mark, below the MIN mark, or empty, add prediluted coolant immediately. See **Adding Inverter System Controller Coolant** in this chapter.

Maintain coolant concentration within 48% to 50%, which equates to a freeze point between -30°F (-34°C) and -34°F (-37°C).

**Note:** For best results, coolant concentration should be tested with a refractometer such as Robinair® Coolant and Battery Refractometer 75240. We do not recommend the use of hydrometers or coolant test strips for measuring coolant concentrations.

**Note:** Automotive fluids are not interchangeable. Do not use engine coolant or antifreeze or windshield washer fluid outside of its specified function and vehicle location.

## Adding Coolant

**Note:** Do not use stop leak pellets, cooling system sealants, or additives as they can cause damage to the cooling or heating systems. This damage would not be covered under your vehicle's warranty.

**Note:** During normal vehicle operation, the coolant may change color from orange to pink or light red. As long as the coolant is clear and uncontaminated, this color change does not indicate the coolant has degraded nor does it require the coolant to be drained, the system to be flushed, or the coolant to be replaced.

**Note:** It is very important to use prediluted coolant meeting the Ford specification in order to avoid plugging the small coolant passageways. Use of concentrated coolant and water may cause coolant passageway plugging and void the warranty. See **Capacities and Specifications** (page 275).

- Do not mix different colors or types of coolant in your vehicle. Make sure the correct coolant is used. Mixing of coolants may harm your cooling system. The use of an improper coolant may harm the engine, inverter system controller, and cooling system components and may void the warranty.
- In case of emergency, a large amount of water without engine coolant may be added to the engine cooling system in order to reach a vehicle service location. In this instance, the engine cooling system must be drained, chemically cleaned with Motorcraft Premium Cooling System Flush, and refilled with prediluted engine coolant as soon as possible. Water alone (without engine coolant) can cause engine damage from corrosion, overheating, or freezing. DO NOT use this method for the inverter system controller cooling system. The inverter system controller cooling system operates close to ambient temperature, and is susceptible to freezing in any subfreezing environment in the absence of coolant.

# Maintenance

---

- Do not use alcohol, methanol, brine or any engine coolants mixed with alcohol or methanol antifreeze (coolant). Alcohol and other liquids can cause engine damage from overheating or freezing.
- Do not add extra inhibitors or additives to the coolant. These can be harmful and compromise the corrosion protection of the engine coolant.

## Adding Engine Coolant

1. Unscrew the engine coolant reservoir cap slowly. Any pressure will escape as you unscrew the cap.
2. Use a funnel to add prediluted engine coolant to the engine coolant reservoir. Make sure that the level is between the MIN and MAX marks on the engine coolant reservoir. Use prediluted engine coolant meeting the Ford specification. See **Capacities and Specifications** (page 275).
3. Close the engine coolant reservoir cap.

Whenever you add coolant, check the coolant level in the engine coolant reservoir the next few times you drive the vehicle. If necessary, add enough prediluted engine coolant to bring the engine coolant level to the proper level.

## Adding Inverter System Controller Coolant

1. Open the inverter system controller coolant reservoir cap.
2. Use a funnel to add prediluted coolant to the inverter system controller coolant reservoir. Make sure that the level is between the MIN and MAX marks on the inverter system controller coolant reservoir. Use prediluted coolant meeting the Ford specification. See **Capacities and Specifications** (page 275).

3. Close the inverter system controller coolant reservoir cap.

Whenever you add coolant, check the coolant level in the inverter system controller coolant reservoir the next few times you drive the vehicle. If necessary, add enough prediluted coolant to bring the inverter system controller coolant level to the proper level.

## Recycled Engine Coolant

Ford Motor Company does not recommend the use of recycled engine coolant since a Ford-approved recycling process is not yet available.

Used engine coolant should be disposed of in an appropriate manner. Follow your community's regulations and standards for recycling and disposing of automotive fluids.

## Severe Climates

If you drive in extremely cold climates:

- It may be necessary to have an authorized Ford dealer increase the coolant concentration above 50%.
- A coolant concentration of 60% will provide improved freeze point protection. Engine coolant concentrations above 60% will decrease the overheat protection characteristics of the engine coolant and may cause engine damage.

If you drive in extremely hot climates:

- It may be necessary to have an authorized Ford dealer decrease the coolant concentration to 40%.
- A coolant concentration of 40% will provide improved overheat protection. Engine coolant concentrations below 40% will decrease the freeze and corrosion protection characteristics of the engine coolant and may cause engine damage.

# Maintenance

Vehicles driven year-round in non-extreme climates should use prediluted coolant meeting the Ford specification for optimum cooling system and engine protection.

## What You Should Know About Fail-Safe Cooling

If the engine coolant supply is depleted, this feature allows the vehicle to be driven temporarily before incremental component damage is incurred. The “fail-safe” distance depends on ambient temperatures, vehicle load and terrain.

### How Fail-Safe Cooling Works

If the engine begins to overheat, the engine coolant temperature gauge will move to the red (hot) area and:



The coolant temperature warning light will illuminate.



The service engine soon indicator will illuminate.

If the engine reaches a preset over-temperature condition, the engine will automatically switch to alternating cylinder operation. Each disabled cylinder acts as an air pump and cools the engine.

When this occurs the vehicle will still operate. However:

- The engine power will be limited.
- The air conditioning system will be disabled.

Continued operation will increase the engine temperature and the engine will completely shut down, causing steering and braking effort to increase.

Once the engine temperature cools, the engine can be re-started. Take your vehicle to an authorized dealer as soon as possible to minimize engine damage.

## When Fail-Safe Mode Is Activated

### WARNINGS



Fail-safe mode is for use during emergencies only. Operate your vehicle in fail-safe mode only as long as necessary to bring your vehicle to rest in a safe location and seek immediate repairs. When in fail-safe mode, your vehicle will have limited power, will not be able to maintain high-speed operation, and may completely shut down without warning, potentially losing engine power, power steering assist, and power brake assist, which may increase the possibility of a crash resulting in serious injury.



Never remove the coolant reservoir cap while the engine is running or hot.

**Note:** *Driving the vehicle without repairing the engine problem increases the chance of engine damage. Take your vehicle to an authorized dealer as soon as possible.*

You have limited engine power when in the fail-safe mode, so drive the vehicle with caution. The vehicle will not be able to maintain high-speed operation and the engine will run rough. Remember that the engine is capable of completely shutting down automatically to prevent engine damage, therefore:

1. Pull off the road as soon as safely possible and turn off the engine.
2. Arrange for the vehicle to be taken to an authorized dealer.
3. If this is not possible, wait a short period for the engine to cool.
4. Check the coolant level and replenish if low.
5. Re-start the engine and take your vehicle to an authorized dealer.



# Maintenance

---

## AUTOMATIC TRANSMISSION FLUID CHECK

If required, have an authorized dealer check and change the transmission fluid at the correct service interval. See **Scheduled Maintenance** (page 420).

The automatic transmission does not have a transmission fluid dipstick. Your transmission does not consume fluid.

An authorized dealer should check the fluid:

- If the transmission is not working properly.
- If you notice signs of fluid leakage.

Do not use supplemental transmission fluid additives, treatments or cleaning agents. The use of these materials may affect transmission operation and result in damage to internal transmission components.

## BRAKE FLUID CHECK

Fluid levels between the MIN and MAX lines are within the normal operating range; there is no need to add fluid. If the fluid levels are outside of the normal operating range, the performance of the system could be compromised; seek service from your authorized dealer immediately.

## POWER STEERING FLUID CHECK

Your vehicle is equipped with an electric power steering (EPS) system. There is no fluid reservoir to check or fill.

## WASHER FLUID CHECK

### WARNING



If you operate your vehicle in temperatures below 40°F (5°C), use washer fluid with antifreeze protection. Failure to use washer fluid with antifreeze protection in cold weather could result in impaired windshield vision and increase the risk of injury or accident.

**Note:** *The front and rear washer systems are supplied from the same reservoir.*

Add fluid to fill the reservoir if the level is low. Only use a washer fluid that meets Ford specifications. See **Capacities and Specifications** (page 275).

State or local regulations on volatile organic compounds may restrict the use of methanol, a common windshield washer antifreeze additive. Washer fluids containing non-methanol antifreeze agents should be used only if they provide cold weather protection without damaging the vehicle's paint finish, wiper blades or washer system.

## FUEL FILTER

Your vehicle is equipped with a lifetime fuel filter that is integrated with the fuel tank. Regular maintenance or replacement is not needed.

# Maintenance

## CHANGING THE 12V BATTERY

### WARNINGS



Batteries normally produce explosive gases which can cause personal injury. Therefore, do not allow flames, sparks or lighted substances to come near the battery. When working near the battery, always shield your face and protect your eyes. Always provide correct ventilation.



When lifting a plastic-cased battery, excessive pressure on the end walls could cause acid to flow through the vent caps, resulting in personal injury and damage to the vehicle or battery. Lift the battery with a battery carrier or with your hands on opposite corners.



Keep batteries out of reach of children. Batteries contain sulfuric acid. Avoid contact with skin, eyes or clothing. Shield your eyes when working near the battery to protect against possible splashing of acid solution. In case of acid contact with skin or eyes, flush immediately with water for a minimum of 15 minutes and get prompt medical attention. If acid is swallowed, call a physician immediately.



Battery posts, terminals and related accessories contain lead and lead compounds. Wash hands after handling.

Your vehicle has a Motorcraft® maintenance-free battery which normally does not require additional water during its life of service.

**Note:** *If your vehicle's battery has a cover or shield, make sure it is reinstalled after the battery has been cleaned or replaced.*

**Note:** *See an authorized dealer for low voltage battery access, testing, or replacement.*

When a low voltage battery replacement is necessary, see an authorized dealer to replace the low voltage battery with a Ford recommended replacement low voltage battery that matches the electrical requirements of the vehicle.

To ensure proper operation of the battery management system (BMS), do not allow a technician to connect any electrical device ground connection directly to the low voltage battery negative post. A connection at the low voltage battery negative post can cause inaccurate measurements of the battery condition and potential incorrect system operation.

**Note:** *If a person adds electrical or electronic accessories or components to the vehicle, the accessories or components may adversely affect the low voltage battery performance and durability and may also affect the performance of other electrical systems in the vehicle.*

For longer, trouble-free operation, keep the top of the battery clean and dry. Also, make certain the battery cables are always tightly fastened to the battery terminals.

If you see any corrosion on the battery or terminals, remove the cables from the terminals and clean with a wire brush. You can neutralize the acid with a solution of baking soda and water.

When a battery replacement is required, the battery should only be replaced with a Ford recommended replacement battery that matches the electrical requirements of the vehicle.

Because your vehicle's engine is electronically-controlled by a computer, some engine control settings are maintained by power from the low voltage battery. Some engine computer settings, like the idle trim and fuel trim strategy, optimize the driveability and performance of the engine. Some other computer settings, like the clock and radio station

# Maintenance

presets, are also maintained in memory by power from the low voltage battery. When a technician disconnects and connects the low voltage battery, these settings are erased. Complete the following procedure in order to restore the settings:

1. With the vehicle at a complete stop, set the parking brake.
2. Shift into park (P).
3. Switch off all accessories.
4. Fully press the brake pedal and start the vehicle.
5. Run the engine until it reaches normal operating temperature. While the engine is warming up, complete the following: Reset the clock. See **Audio System** (page 282). Reset the power windows bounce-back feature. See **Windows and Mirrors** (page 79). Reset the radio station presets. See **Audio System** (page 282).
6. Allow the engine to idle for at least one minute. If the engine turns off, press the accelerator pedal to start the engine.
7. While the engine is running, press the brake pedal and shift into neutral (N).
8. Allow the engine to run for at least one minute by pressing on the accelerator pedal.
9. Drive the vehicle at least 12 mi (20 km) to completely relearn the idle and fuel trim strategy.

**Note:** If you do not allow the engine to relearn the idle and fuel trim strategy, the idle quality of your vehicle may be adversely affected until the engine computer eventually relearns the idle trim and fuel trim strategy.

Make sure that you dispose of old batteries in an environmentally friendly way. Seek advice from your local authority about recycling old batteries.

## CHECKING THE WIPER BLADES



E142463

Run the tip of your fingers over the edge of the blade to check for roughness.

Clean the wiper blades with washer fluid or water applied with a soft sponge or cloth.

## CHANGING THE WIPER BLADES

**Note:** Use the service position in winter to provide easier access to the front wiper blades for freeing them from snow and ice. The front wipers will not return to their normal position as soon as you switch on the ignition. The front wipers will stay in the service position when you switch the ignition on or start the engine. Switch on the front wipers to any mode, then switch off the front wipers to bring the front wipers back to the park position.

**Note:** The windshield wiper blades are different in length. If you install wiper blades of the wrong length, the wipers may not work correctly. If equipped with autowipers, the rain sensor may not work correctly.

**Note:** Make sure that the wiper blade locks into place. Lower the wiper arm and blade back to the windshield. The wiper arms will automatically return to their normal position when the ignition is turned on.

**Note:** Replace wiper blades at least once per year for optimum performance.

# Maintenance

**Note:** Poor wiper quality can be improved by cleaning the wiper blades and the windshield

## Setting the Front Wipers in the Service Position

1. Make sure that the outside of the windshield is free from snow and ice.
2. Switch on the ignition.



E162733

3. Switch off the ignition and within three seconds, pull the wiper lever toward you. Hold the lever in until wipers have moved to the service position.

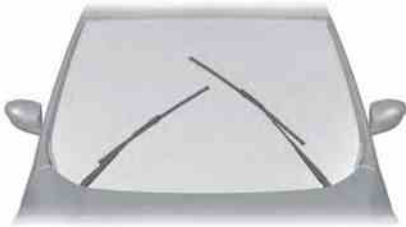

E162532

4. Release the lever when the wipers have moved to the service position.

## Changing the Front Wiper Blades

1. Pull the wiper blade and arm away from the glass.

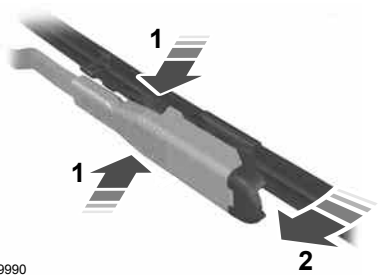

E129990

2. Press the locking buttons together.
3. Rotate and remove the wiper blade.
4. Install in the reverse order.

**Note:** Make sure that the wiper blade locks into place.

## Changing the Rear Window Wiper Blade

1. Lift the wiper arm.

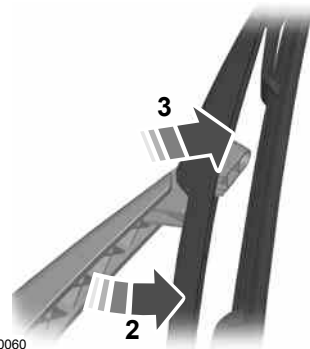

E130060

2. Slightly rotate the wiper blade from the wiper arm
3. Disengage the wiper blade from the wiper arm.
4. Remove the wiper blade.
5. Install in the reverse order.

# Maintenance

**Note:** Make sure that the wiper blade locks into place.

## ADJUSTING THE HEADLAMPS

### Vertical Aim Adjustment

The headlamps on your vehicle are properly aimed at the assembly plant. If your vehicle has been in an accident, the alignment of your headlamps should be checked by your authorized dealer.

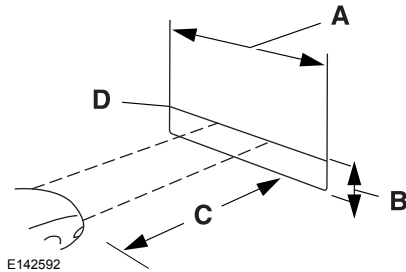

E142592

- A 8 feet (2.4 meters)
- B Center height of lamp to ground
- C 25 feet (7.6 meters)
- D Horizontal reference line

1. Park the vehicle directly in front of a wall or screen on a level surface, approximately 25 feet (7.6 meters) away.

**Note:** To see a clearer light pattern for adjusting, you may want to block the light from one headlamp while adjusting the other.

2. Measure the height of the headlamp bulb center from the ground and mark an 8 foot (2.4 meter) horizontal reference line on the vertical wall or screen at this height.

3. Turn on the low beam headlamps to illuminate the wall or screen and open the hood.



E142465

4. On the wall or screen you will observe a flat zone of high intensity light located at the top of the right hand portion of the beam pattern. If the top edge of the high intensity light zone is not at the horizontal reference line, the headlamp will need to be adjusted.



E142467

5. Locate the vertical adjuster on each headlamp. Using a Phillips #2 screwdriver, turn the adjuster either clockwise or counterclockwise in order to aim the headlamp. The horizontal edge of the brighter light should touch the horizontal reference line.
6. Close the hood and turn off the lamps.

# Maintenance

## Horizontal Aim Adjustment

Horizontal aim is not required for this vehicle and is non-adjustable.

## REMOVING A HEADLAMP



E142468

1. Make sure the headlamp control is in the off position and open the hood.
2. Remove the two screws from the headlamp assembly.
3. Carefully pull the headlamp assembly as far as possible towards the front of the vehicle to disengage it from the lower fixing point.
4. Carefully lift the outer side of the headlamp and remove it.
5. Disconnect the electrical connector.

## CHANGING A BULB

### Lamp Assembly Condensation

Exterior lamps are vented to accommodate normal changes in pressure. Condensation can be a natural by-product of this design. When moist air enters the lamp assembly through the vents, there is a possibility that condensation can occur when the temperature is cold. When

normal condensation occurs, a thin film of mist can form on the interior of the lens. The thin mist eventually clears and exits through the vents during normal operation. Clearing time may take as long as 48 hours under dry weather conditions.

Examples of acceptable condensation are:

- Presence of thin mist (no streaks, drip marks or droplets).
- Fine mist covers less than 50% of the lens.

Examples of unacceptable moisture (usually caused by a lamp water leak) are:

- Water puddle inside the lamp.
- Large water droplets, drip marks or streaks present on the interior of the lens.

Take your vehicle to a dealer for service if any of the above conditions of unacceptable moisture are present.

## Replacing Headlamp Bulbs

### WARNING



Handle a halogen headlamp bulb carefully and keep out of children's reach. Grasp the bulb by only its plastic base and do not touch the glass. The oil from your hand could cause the bulb to break the next time the headlamps are operated.

**Note:** *If the bulb is accidentally touched, it should be cleaned with rubbing alcohol before being used.*

# Maintenance

## Locating the headlamp bulbs:

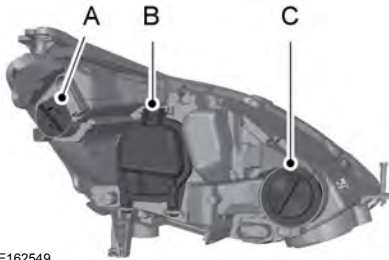

E162549

- A Direction indicator lamp.
- B Low beam headlamp.
- C High beam headlamp.

## Replacing the High Beam Headlamp Bulb:



E162550

1. Remove the headlamp assembly.
2. Remove service cap.
3. Disconnect the electrical connector.
4. Remove bulb from the headlamp assembly by turning it counterclockwise, then pull it straight out.

## Replacing the Low Beam Headlamp Bulb:

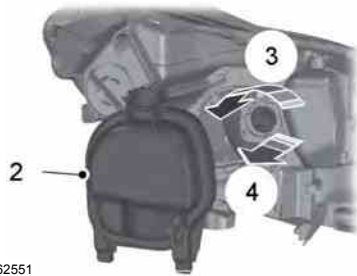

E162551

1. Remove the headlamp assembly.
2. Remove service cap.
3. Disconnect the electrical connector.
4. Remove bulb from the headlamp assembly by turning it counterclockwise, then pull it straight out.

Install the new bulbs in reverse order.

## Replacing Side Marker Bulbs:

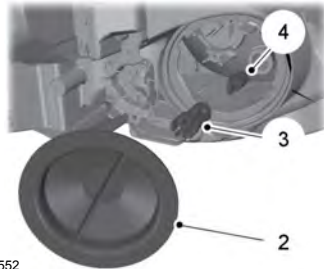

E162552

1. Remove the headlamp assembly.
2. Remove service cap.
3. Remove the bulb holder.
4. Remove bulb from the headlamp assembly.

Install the new bulb in reverse order.

# Maintenance

## Replacing Fog, Park and Direction Indicator Bulbs

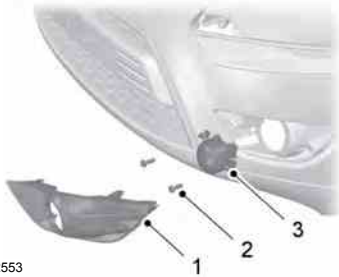

E162553

**Note:** You cannot separate the fog lamp bulb from the bulb holder.

1. Remove the fog lamp cover.
2. Remove the 2 screws.
3. Remove the lamp.

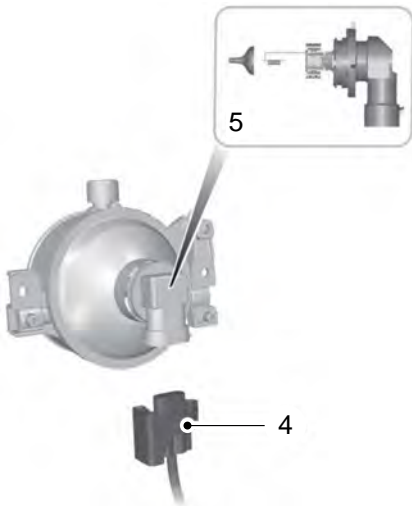

E162554

4. Disconnect the electrical connector.

5. Turn the bulb holder counterclockwise and remove it.
6. Install the new bulb in reverse order.

## Replacing Tail, Brake and Direction Indicator Bulbs



E162555

1. Make sure the headlamp control is in the off position.
2. Open the liftgate.
3. Remove the trim panel cover.



E162556

4. Disconnect the electrical connector.
5. Remove the wing nut.
6. Gently pull the lamp assembly away from the vehicle.



# Maintenance

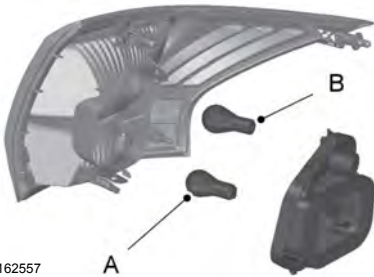

E162557

7. Remove the bulb holder.
8. Gently press the bulb into the bulb holder, then turn the bulb counterclockwise and remove the bulb. (A) Taillamp and brake lamp. (B) Direction indicator lamp.

Install the new bulb in reverse order.

## Replacing Reverse Lamp and Tail Lamp Bulbs



E162558

1. Make sure the lighting control is in the off position.
2. Open the liftgate.
3. Remove the trim panel cover.



E162559

4. Remove the wing nut.
5. Gently pull the lamp assembly away from the vehicle.

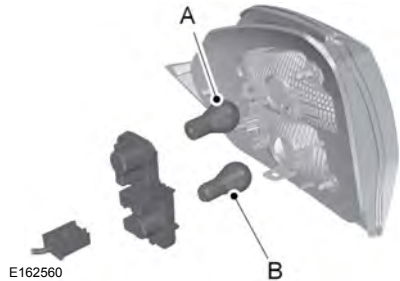

E162560

6. Disconnect the electrical connector.
7. Remove the bulb holder.
8. Gently press the bulb into the bulb holder, turn the bulb counterclockwise, and remove the bulb. (A) Reverse lamp. (B) Tail lamp.
9. Install the new bulb in reverse order.

# Maintenance

## Replacing License Plate Lamp Bulb

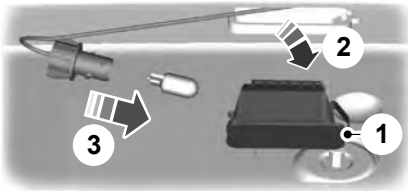

E72789

1. Carefully release the spring clip.
2. Remove the lamp.
3. Remove the bulb.

Reverse steps to reinstall bulb.

## Replacing the Center High Mounted Brake Lamp Bulbs



E162562

1. Open the liftgate.
2. Detach the clips above the inboard side of the rear window.



E162563

3. Insert a suitable tool into the holes.
4. Carefully pull the lamp towards the front of the vehicle in order to release the spring clips.



E162564

5. Gently pull the lamp assembly away from the vehicle.
6. Remove the bulb holder.
7. Remove the bulb.

## BULB SPECIFICATION CHART

Replacement bulbs are specified in the chart below. Headlamp bulbs must be marked with an authorized "D.O.T." for North America to ensure lamp performance, light brightness and pattern and safe visibility. The correct bulbs will not damage the lamp assembly or void the lamp assembly warranty and will provide quality bulb burn time.

# Maintenance

---

<b>Function</b>	<b>Trade number</b>
Headlamps high beam (Halogen)	9005LL
Headlamp low beam (Halogen)	H11LL
Sidemarker - front	168
Park lamp - front	194
Turn lamp - front	W21W
Fog lamps	H10 (9145)
Tail/brake lamp	3157K
Turn lamp - rear	T20
Backup lamp	921
License plate lamp	W5W
* High-mount brake lamp	W5W
* Interior lamps	LED

\* To replace these lamps - see your authorized dealer.

To replace all instrument panel lights - see your authorized dealer

# Maintenance

## CHANGING THE ENGINE AIR FILTER

### WARNING



To reduce the risk of vehicle damage and/or personal burn injuries do not start your engine with the air cleaner removed and do not remove it while the engine is running.

**Note:** Failure to re-install the air cleaner assembly properly by fully seating on the mounting studs in five places and securing with the two bolts may result in air cleaner assembly dislodgement from engine and damage to the air cleaner assembly and other engine components. Therefore we recommend that the air filter be serviced at a Ford dealer.

**Note:** When changing the air filter element, use only the air filter element listed. See **Capacities and Specifications** (page 275).

**Note:** Change the air filter element at the proper interval.

**Note:** Failure to use the correct air filter element may result in severe engine damage. The customer warranty may be void for any damage to the engine if the correct air filter element is not used.

## Identifying Air Filter Element Components

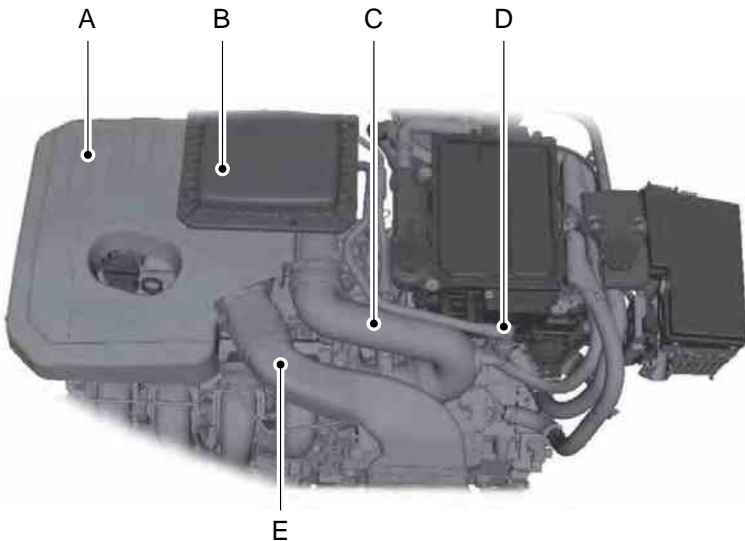

E162533

# Maintenance

- A. Air cleaner assembly
- B. Air cleaner cover
- C. Air cleaner outlet tube
- D. Positive crankcase ventilation (PCV) tube
- E. Air cleaner intake tube

## Removing the Engine Air Filter Element

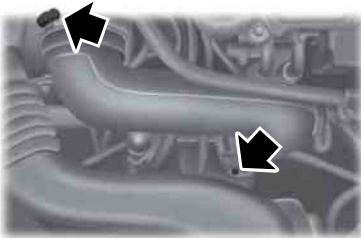

E162534

1. Loosen the hose clamps for air cleaner outlet tube (C). Disconnect the tube from the air cleaner assembly (A).
2. Release the tabs and disconnect the PCV tube (D) from the air cleaner outlet tube (C) and remove the tube.
3. Disconnect the air cleaner intake tube (E) from the air cleaner assembly (A).



E162535

4. Remove the bolts from each side of the air cleaner assembly (A) as shown with arrows.

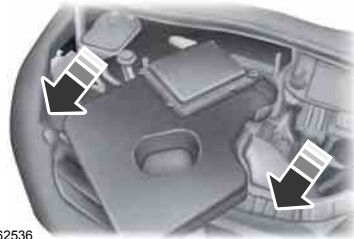

E162536

5. Lift the air cleaner assembly (A) from the mounting studs, then rotate and pull it towards the front of the vehicle.



E162537

6. Loosen the 5 bolts from the air cleaner cover (B).
7. Remove the air cleaner cover (B) from the air cleaner assembly (A).

## Installing the Engine Air Filter Element

**Note:** Clean the inside of the air filter assembly before installing a new air filter.

# Maintenance

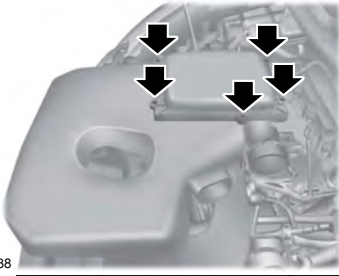

E162538

1. Install the new engine air filter into the engine air cleaner assembly.
2. Install the air cleaner cover (B) and tighten the 5 bolts.

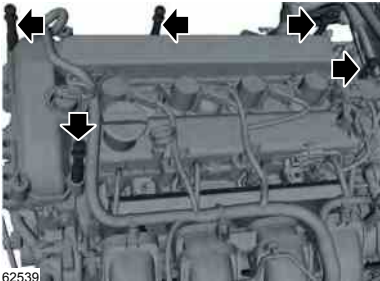

E162539

3. Position the air cleaner assembly (A) onto the engine and make sure the assembly is aligned with the studs.



E162540

4. Install and tighten the bolts to each side of the air cleaner assembly (A) as shown with arrows.



E162541

5. Connect the PCV tube (D) to the air cleaner outlet tube (C).
6. Connect the air cleaner intake tube (E) to the air cleaner assembly (A).

# Vehicle Care

## GENERAL INFORMATION

Your Ford or Lincoln authorized dealer has many quality products available to clean your vehicle and protect its finishes.

## CLEANING PRODUCTS

For best results, use the following products or products of equivalent quality:

- Motorcraft Bug and Tar Remover (ZC-42)
- Motorcraft Custom Bright Metal Cleaner (ZC-15)
- Motorcraft Detail Wash (ZC-3-A)
- Motorcraft Dusting Cloth (ZC-24)
- Motorcraft Engine Shampoo and Degreaser (U.S. only) (ZC-20)
- Motorcraft Engine Shampoo (Canada only) (CXC-66-A)
- Motorcraft Multi-Purpose Cleaner (Canada only) (CXC-101)
- Motorcraft Premium Glass Cleaner (Canada only) (CXC-100)
- Motorcraft Premium Quality Windshield Washer Fluid (Canada only) [CXC-37-(A, B, D or F)]
- Motorcraft Premium Windshield Wash Concentrate with Bitterant (U.S. only) (ZC-32-B2)
- Motorcraft Professional Strength Carpet & Upholstery Cleaner (ZC-54)
- Motorcraft Premium Leather and Vinyl Cleaner (ZC-56)
- Motorcraft Spot and Stain Remover (U.S. only) (ZC-14)
- Motorcraft Ultra-Clear Spray Glass Cleaner (ZC-23)
- Motorcraft Wheel and Tire Cleaner (ZC-37-A)

## CLEANING THE EXTERIOR

Wash your vehicle regularly with cool or lukewarm water and a neutral pH shampoo, we recommend Motorcraft Detail Wash.

- Never use strong household detergents or soap, for example dish washing or laundry liquid. These products can discolor and spot painted surfaces.
- Never wash your vehicle when is hot to the touch, or during strong or direct sunlight.
- Dry your vehicle with a chamois or soft terry cloth towel to eliminate water spotting.
- Immediately remove fuel spillages, bird droppings, insect deposits and road tar. These may cause damage to your vehicle's paintwork or trim over time. We recommend Motorcraft Bug and Tar Remover.
- Remove any exterior accessories, for example antennas, before entering a car wash.

**Note:** *Suntan lotions and insect repellents can damage painted surfaces. If these substances come in contact with your vehicle, wash the affected area as soon as possible.*

## Exterior Chrome Parts

- Apply a high quality-cleaning product to bumpers and other chrome parts. Follow the manufacturer's instructions. We recommend Motorcraft Custom Bright Metal Cleaner.
- Do not apply the cleaning product to hot surfaces. Do not leave the cleaning product on chrome surfaces longer than the time recommended.
- Using other non-recommended cleaners can result in severe and permanent cosmetic damage.

# Vehicle Care

---

**Note:** *Never use abrasive materials, for example steel wool or plastic pads as they can scratch the chrome surface.*

**Note:** *Do not use chrome cleaner, metal cleaner or polish on wheels or wheel covers.*

## Exterior Plastic Parts

For routine cleaning we recommend Motorcraft Detail Wash. If tar or grease spots are present, we recommend Motorcraft Bug and Tar Remover.

## Stripes or Graphics (If Equipped)

Do not use a commercial or high-pressure sprayer on the surface or edge of stripes and graphics. This can damage them and cause the edges to peel away from the vehicle surface.

## Underbody

Flush the complete underside of your vehicle frequently. Keep body and door drain holes free of debris or foreign material.

## WAXING

Regular waxing is necessary to protect your car's paint from the elements. We recommend that you wash and wax the painted surface once or twice a year.

When washing and waxing, park your vehicle in a shaded area out of direct sunlight. Always wash your vehicle before applying wax.

- Use a quality wax that does not contain abrasives.
- Follow the manufacturer's instructions to apply and remove the wax.
- Apply a small amount of wax in a back-and-forth motion, not in circles.

- Do not allow wax to come in contact with any non-body (low-gloss black) colored trim. The wax will discolor or stain the parts over time.
  - Roof racks.
  - Bumpers.
  - Grained door handles.
  - Side moldings.
  - Mirror housings.
  - Windshield cowl area.
- Do not apply wax to glass areas.
- After waxing, your car's paint should feel smooth, and be free of streaks and smudges.

## CLEANING THE ENGINE

Engines are more efficient when they are clean because grease and dirt buildup keep the engine warmer than normal.

When washing:

- Take care when using a power washer to clean the engine. The high-pressure fluid could penetrate the sealed parts and cause damage.
- Do not spray a hot engine with cold water to avoid cracking the engine block or other engine components.
- Spray Motorcraft Engine Shampoo and Degreaser on all parts that require cleaning and pressure rinse clean. In Canada, use Motorcraft Engine Shampoo.
- Never wash or rinse the engine while it is hot or running; water in the running engine may cause internal damage.



# Vehicle Care

- Never wash or rinse any ignition coil, spark plug wire or spark plug well, or the area in and around these locations.
- Cover the battery, power distribution box, and air filter assembly to prevent water damage when cleaning the engine.

## CLEANING THE WINDOWS AND WIPER BLADES

Car wash chemicals and environmental fallout can result in windshield and wiper blade contamination. Dirty windshield and wipers will result in poor windshield wiper operation. Keep the windshield and wiper blades clean to maintain windshield wiper performance.

To clean the windshield and wiper blades:

- Clean the windshield with a non-abrasive glass cleaner. When cleaning the interior of the windshield, avoid getting any glass cleaner on the instrument panel or door panels. Wipe any glass cleaner off these surfaces immediately.
- For windshields contaminated with tree sap, chemicals, wax or bugs, clean the entire windshield using steel wool (no greater than 0000 grade) in a circular motion and rinse with water.
- Clean the wiper blades with isopropyl rubbing alcohol or windshield washer concentrate.

**Note:** *Do not use razor blades or other sharp objects to clean or remove decals from the inside of the heated rear window. The vehicle warranty does not cover damage caused to the heated rear window grid lines.*

## CLEANING THE INTERIOR

### WARNINGS



Do not use cleaning solvents, bleach or dye on the vehicle's safety belts, as these actions may weaken the belt webbing.



On vehicles equipped with seat-mounted airbags, do not use chemical solvents or strong detergents. Such products could contaminate the side airbag system and affect performance of the side airbag in a collision.

For fabric, carpets, cloth seats, safety belts and seats equipped with side airbags:

- Remove dust and loose dirt with a vacuum cleaner.
- Remove light stains and soil with Motorcraft Professional Strength Carpet & Upholstery Cleaner.
- If grease or tar is present on the material, spot-clean the area first with Motorcraft Spot and Stain Remover. In Canada, use Motorcraft Multi-Purpose Cleaner.
- If a ring forms on the fabric after spot cleaning, clean the entire area immediately (but do not oversaturate) or the ring will set.
- Do not use household cleaning products or glass cleaners, which can stain and discolor the fabric and affect the flame retardant abilities of the seat materials.

# Vehicle Care

## CLEANING THE INSTRUMENT PANEL AND INSTRUMENT CLUSTER LENS

### WARNING



Do not use chemical solvents or strong detergents when cleaning the steering wheel or instrument panel to avoid contamination of the airbag system.

**Note:** Follow the same procedure as cleaning leather seats for cleaning leather instrument panels and leather interior trim surfaces. See **Cleaning Leather Seats** (page 239).

Clean the instrument panel and cluster lens with a clean, damp and soft cloth, then use a clean, dry and soft cloth to dry these areas.

- Avoid cleaners or polishes that increase the gloss of the upper portion of the instrument panel. The dull finish in this area helps protect you from undesirable windshield reflection.
- Do not use any household cleaning products or glass cleaners as these may damage the finish of the instrument panel, interior trim and cluster lens.
- Wash or wipe your hands clean if you have been in contact with certain products such as insect repellent and suntan lotion to avoid possible damage to the interior painted surfaces.
- Do not allow air fresheners and hand sanitizers to spill onto interior surfaces. If a spill occurs, wipe off immediately. Your warranty may not cover these damages.

If a staining liquid like coffee or juice has been spilled on the instrument panel or on interior trim surfaces:

1. Wipe up spilled liquid using a clean, soft cloth as quickly as possible.
2. Use Motorcraft Premium Leather and Vinyl Cleaner or a commercially available leather cleaning product for automotive interiors. Test any cleaner or stain remover on an inconspicuous area.
3. Alternatively, wipe the surface with a clean, soft cloth and a mild soap and water solution. Dry the area with a clean, soft cloth.
4. If necessary, apply more soap and water solution or cleaning product to a clean, soft cloth and press it onto the soiled area. Allow this to set at room temperature for 30 minutes.
5. Remove the soaked cloth, then with a clean, damp cloth, use a rubbing motion for 60 seconds on the soiled area.
6. Dry the area with a clean, soft cloth.

## CLEANING LEATHER SEATS (if

### Equipped)

**Note:** Follow the same procedure as cleaning leather seats for cleaning leather instrument panels and leather interior trim surfaces.

For routine cleaning, wipe the surface with a soft, damp cloth and a mild soap and water solution. Dry the area with a clean, soft cloth.

For cleaning and removing stains such as dye transfer, use Motorcraft Premium Leather and Vinyl Cleaner or a commercially available leather cleaning product for automotive interiors.

**Note:** Test any cleaner or stain remover on an inconspicuous area.

# Vehicle Care

---

You should:

- Remove dust and loose dirt with a vacuum cleaner.
- Clean and treat spills and stains as soon as possible.

Do not use the following products as these may damage the leather:

- Oil and petroleum or silicone-based leather conditioners.
- Household cleaners.
- Alcohol solutions.
- Solvents or cleaners intended specifically for rubber, vinyl and plastics.

## REPAIRING MINOR PAINT DAMAGE

Authorized dealers have touch-up paint to match your vehicle's color. Your vehicle color code is printed on a sticker on the front, left-hand side door jamb. Take your color code to your authorized dealer to make sure you get the correct color.

Before repairing minor paint damage, use a cleaner such as Motorcraft Bug and Tar Remover to remove particles such as bird droppings, tree sap, insect deposits, tar spots, road salt and industrial fallout.

Always read the instructions before using cleaning products.

## CLEANING THE ALLOY WHEELS (If Equipped)

**Note:** Do not apply a cleaning chemical to warm or hot wheel rims and covers.

**Note:** Some automatic car washes may cause damage to the finish on your wheel rims and covers.

**Note:** Industrial-strength or heavy-duty cleaners in combination with brush agitation to remove brake dust and dirt, could wear away the clear coat finish over a period time.

**Note:** Do not use hydrofluoric acid-based or high caustic-based wheel cleaners, steel wool, fuels or strong household detergents.

**Note:** If you intend parking your vehicle for an extended period after cleaning the wheels with a wheel cleaner, drive your vehicle for a few minutes before doing so. This will reduce the risk of increased corrosion of the brake discs.

Alloy wheels and wheel covers are coated with a clear coat paint finish. To maintain their condition we recommend that you:

- Clean the wheels weekly using Motorcraft Wheel and Tire Cleaner. Apply using manufacturer's instructions.
- Use a sponge to remove heavy deposits of dirt and brake dust accumulation.
- Rinse thoroughly with a strong stream of water when you have completed the cleaning process.
- To remove tar and grease, use Motorcraft Bug and Tar Remover.

## VEHICLE STORAGE

If you plan on storing your vehicle for 30 days or more, read the following maintenance recommendations to make sure your vehicle stays in good operating condition.

We engineer and test all motor vehicles and their components for reliable, regular driving. Under various conditions, long-term storage may lead to degraded engine performance or failure unless you use specific precautions to preserve engine components.

# Vehicle Care

---

## General

- Store all vehicles in a dry, ventilated place.
- Protect from sunlight, if possible.
- If you store vehicles outside, they require regular maintenance to protect against rust and damage.

## Body

- Wash your vehicle thoroughly to remove dirt, grease, oil, tar or mud from exterior surfaces, rear-wheel housing and the underside of front fenders.
- Periodically wash your vehicle if you store it in exposed locations.
- Touch-up exposed or primed metal to prevent rust.
- Cover chrome and stainless steel parts with a thick coat of auto wax to prevent discoloration. Re-wax as necessary when you wash your vehicle.
- Lubricate all hood, door and luggage compartment hinges and latches with a light grade oil.
- Cover interior trim to prevent fading.
- Keep all rubber parts free from oil and solvents.

## Engine

- Change the engine oil and filter prior to storage because used engine oil contains contaminants which may cause engine damage.
- Start the engine every 15 days for a minimum of 15 minutes. Run at fast idle with the climate controls set to defrost until the engine reaches normal operating temperature.

- With your foot on the brake, shift through all the gears while the engine is running.
- We recommend that you change the engine oil before you use your vehicle again.

## Fuel System

- Fill the fuel tank with high-quality fuel until the first automatic shutoff of the fuel pump nozzle.

## Cooling System

- Protect against freezing temperatures.
- When removing your vehicle from storage, check coolant fluid level. Confirm that there are no cooling system leaks and that fluid is at the recommended level.

## 12V Battery

- Check and recharge as necessary. Keep connections clean.
- If storing your vehicle for more than 30 days without recharging the battery, we recommend that you disconnect the battery cables to maintain battery charge for quick starting.

**Note:** *It is necessary to reset memory features if you disconnect the battery cables.*

# Vehicle Care

---

We recommend the following options for your plug-in vehicle:

- Leave your vehicle plugged in. The 12V battery maintains power if left plugged in. However, this periodically uses electricity from the household outlet.
- Connect a battery charger to your 12V battery and leave it on a continuous, slow charge.
- Disconnect the 12V battery. If your 12V battery is located in the luggage compartment, do not fully shut the luggage compartment after disconnecting the 12V battery. Only leave the luggage compartment open if your vehicle is stored in a locked location.

## Brakes

- Make sure the brakes and parking brake release fully.

## Tires

- Maintain recommended air pressure.

## Miscellaneous

- Make sure you cover all linkages, cables, levers and pins under your vehicle with grease to prevent rust.
- Move vehicles at least 25 ft (7.5 m) every 15 days to lubricate working parts and prevent corrosion.

## Removing Vehicle From Storage

When your vehicle is ready to come out of storage, do the following:

- Wash your vehicle to remove any dirt or grease film build-up on window surfaces.
- Check windshield wipers for any deterioration.

- Check under the hood for any foreign material that may have collected during storage such as mice or squirrel nests.
- Check the exhaust for any foreign material that may have collected during storage.
- Check tire pressures and set tire inflation per the Tire Label.
- Check brake pedal operation. Drive your vehicle 15 ft (4.5 m) back and forth to remove rust build-up.
- Check fluid levels (including coolant and gas) to make sure there are no leaks, and fluids are at recommended levels.
- If you remove the 12-volt battery, clean the cable ends and inspect.

Contact an authorized dealer if you have any concerns or issues.

# Wheels and Tires

## TEMPORARY MOBILITY KIT

### (Type 1)

**Note:** You should use the temporary mobility kit sealant compound in the canister for one tire only. See your Ford authorized dealer for additional replacement sealant canisters.



E164703

The kit is located under the front-row passenger seat. Loosen the Velcro strap to access the kit.

The kit consists of an air compressor to reinflate the tire and a sealing compound in a canister that will effectively seal most punctures caused by nails or similar objects. This kit will provide a temporary seal allowing you to drive your vehicle up to 120 miles (200 kilometers) at a maximum speed of 50 mph (80 km/h).

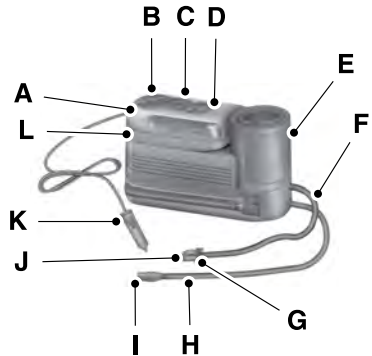

E144618

- A Air compressor (inside)
- B Diverter knob
- C On and off button
- D Air pressure gauge
- E Sealant bottle and canister
- F Sealant filling clear tube
- G Sealant tube - tire valve connector
- H Yellow cap tool
- I Air compressor hose
- J Air hose-tire valve connector
- K Accessory power plug
- L Casing and housing

# Wheels and Tires

## General Information

### WARNING



Failure to follow these guidelines could result in an increased risk of loss of vehicle control, injury or death.

**Note:** Do not use the kit to repair a severely damaged tire, damaged from driving the vehicle with a tire that has insufficient air pressure. You can only use the kit to seal punctured areas located within the tire tread.

Do not attempt to repair punctures larger than 1.4 inch (6.4 millimeters) or damage to the tire's sidewall. The tire may not completely seal.

Loss of air pressure may adversely affect tire performance. For this reason:

**Note:** Do not drive the vehicle above 50 mph (80 km/h).

**Note:** Do not drive further than 120 miles (200 kilometers). Drive only to the closest Ford Motor Company authorized dealer or tire repair shop to have your tire inspected.

- Drive carefully and avoid abrupt steering maneuvers.
- Periodically monitor tire inflation pressure in the affected tire; if the tire is losing pressure, have the vehicle towed.
- Read the information in the Tips for Use of the Kit section to make sure of safe operation of the kit and your vehicle.

## Tips for Use of the Kit

Read the following list of tips to make sure of safe operation of the kit:

- Before operating the kit, make sure your vehicle is safely off the road and away from moving traffic. Turn on the hazard lights.
- Always set the parking brake to make sure the vehicle does not move unexpectedly.
- Do not remove any foreign objects, such as nails or screws, from the tire.
- When using the kit, leave the engine running (only if the vehicle is outdoors or in a well-ventilated area) so the compressor does not drain the vehicle's battery.
- Do not allow the compressor to operate continuously for more than 15 minutes; this will help prevent the compressor from overheating.
- Never leave the kit unattended when it is operating.
- Sealant compound contains latex. Make sure that you use the non-latex gloves provided to avoid an allergic reaction.
- Keep the kit away from children.
- Only use the kit when the ambient temperature is between -22°F (-30°C) and 158°F (70°C).
- Only use the sealing compound before the use by date. The use by date is on the lower right hand corner of the label located on the sealant canister (bottle). Check the use by date regularly and replace the canister after four years.
- Do not store the kit unsecured inside the passenger compartment of the vehicle as it may cause injury during a sudden stop or crash. Always store the kit in its original location.
- After sealant use, you must replace the tire pressure monitoring system sensor and valve stem on the wheel by an authorized Ford dealer.

# Wheels and Tires

- When inflating a tire or other objects, use the black air hose only. Do not use the transparent hose, which is designed for sealant application only.
- Operating the kit could cause an electrical disturbance in radio, CD, and DVD player operation.

## What to Do When a Tire Is Punctured

Repair a tire puncture within the tread area of the tire in two stages with the kit.

- In the first stage, you will re-inflate the tire with a sealing compound and air. After the tire has been re-inflated, drive the vehicle a short distance (about 4 miles [6 kilometers]) to distribute the sealant in the tire.
- In the second stage, check the tire pressure and adjust, if necessary, to the vehicle's tire inflation pressure.

## First Stage: Reinflating the Tire with Sealing Compound and Air

### WARNINGS

 Do not stand directly over the kit while inflating the tire. If you notice any unusual bulges or deformations in the tire's sidewall during inflation, stop and call roadside assistance.

 If the tire does not inflate to the recommended tire pressure within 15 minutes, stop and call roadside assistance.

Preparation: Park the vehicle in a safe, level and secure area, away from moving traffic. Turn the hazard lights on. Apply the parking brake and turn the engine off. Inspect the flat tire for visible damage.

Sealant compound contains latex. To avoid any allergic reactions, use the non-latex gloves located in the accessory box on the underside of the kit housing.

Do not remove any foreign object that has pierced the tire. If a puncture is located in the tire sidewall, stop and call roadside assistance.

1. Remove the valve cap from the tire valve.
2. Unwrap the clear tube from the compressor housing.
3. Remove the tube cap and fasten the metal connector of the tube to the tire valve, turning clockwise. Make sure you fasten the connection tightly.



E144619

4. Plug the power cable into the 12-volt power point in the vehicle.
5. Remove the warning sticker found on the canister, and place it on the top of the instrument panel or the center of the dash.
6. Start the vehicle only if the vehicle is outdoors or in a well-ventilated area.

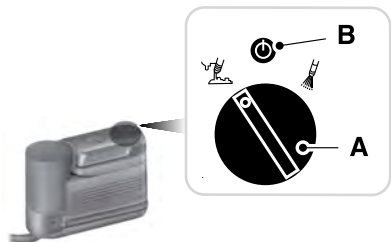

E144924



# Wheels and Tires

7. Push and turn dial (A) counterclockwise to the sealant position. Turn on the kit by pressing the on and off button (B).



E144621

8. Inflate the tire to the pressure listed on the tire label located on the driver's door or the door jamb area. When you first add the sealing compound into the tire, the air pressure gauge reading on the compressor unit may indicate a higher value; this is normal and should be no reason for concern. The pressure will drop after about 30 seconds of operation. You have to check the tire pressure with the compressor in the OFF position to get the correct tire pressure reading.
9. When you reach the recommended tire pressure, turn off the kit by pressing the on button; disconnect the kit from the tire valve and the power point. Re-install the valve cap on the tire valve, place the tube cap on the metal connector, and return the kit to the stowage area
10. Immediately and cautiously, drive the vehicle 4 miles (6 kilometers) to distribute the sealant evenly inside the tire. Do not exceed 50 mph (80 km/h).
11. After 4 miles (6 kilometers), stop and check the tire pressure. See Second stage: Checking tire pressure.

**Note:** *If you experience any unusual vibration, ride disturbance or noise while driving, reduce your speed until you can safely pull off to the side of the road to call for roadside assistance.*

**Note:** *Do not proceed to the second stage of this operation.*

## Second Stage: Checking Tire Pressure

### WARNINGS



If you are proceeding from the First stage: Re-inflating the tire with sealing compound and air section and have injected sealant in the tire and the pressure is below 20 psi (1.4 bar), stop and call roadside assistance. If tire pressure is above 20 psi (1.4 bar), continue to the next step.



The power plug may get hot after use and you should handle it carefully while unplugging.

Check the air pressure of your tires as follows:

1. Remove the valve cap from the tire valve.
2. Unhook the black hose from the side of the compressor and fasten firmly on the valve stem by turning clockwise.
3. Push and turn the dial clockwise to the air position. Turn on the kit by pressing the on button.

# Wheels and Tires

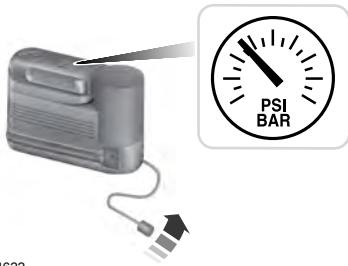

E144622

4. Adjust the tire to the recommended inflation pressure from the tire label located on the driver's door or door jamb area. You have to check the tire pressure with the compressor in the OFF position to get the correct tire pressure reading.
5. Turn the compressor off by pressing the off button.
6. Unplug the hoses, re-install the valve cap on the tire and return the kit to the stowage area.

## What to Do after the Tire has Been Sealed

After using the kit to seal your tire, replace the sealant canister and clear tube (hose). Obtain and replace the sealing compound and spare parts at an authorized Ford Motor Company dealership or tire dealer. You can dispose empty sealant bottles at home. However, liquid residue from the sealing compound should be disposed by your local Ford Motor Company dealership or tire dealer, or in accordance with local waste disposal regulations.

**Note:** After you use the sealing compound, the maximum vehicle speed is 50 mph (80 km/h) and the maximum driving distance is 120 miles (200 kilometers). Inspect the sealed tire immediately.

**Note:** After you use the sealant, an authorized Ford dealer must replace the tire pressure monitoring system sensor and the valve stem on the wheel.

Check the tire pressure any time within the 120 miles (200 kilometers) by performing the procedure from Second stage: Checking tire pressure listed previously.

## Removal of the Sealant Canister from the Kit



E144623

1. Unwrap the clear tube from the compressor housing.



E144624

2. Locate the yellow cap at the end of the clear tube.

# Wheels and Tires



E144625

3. Using the yellow cap tool, press the tab located on the kit compressor housing while pulling up on the sealant canister.

## Installation of the Sealant Canister to the Kit

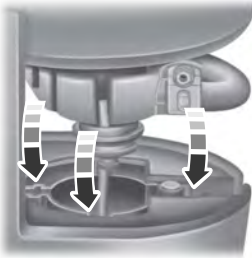

E144626

1. Align the sealant canister with the kit housing.



E161567

2. Once aligned, seat the sealant canister by lightly pushing down until you hear an audible click.



E144628

3. Wrap the clear tube around the compressor housing.

**Note:** *If you experience any difficulties with the removal or installation of the sealant canister, consult your Ford Motor Company authorized dealer for assistance.*

**Use By / Utiliser avant:**

E144629

Be sure to check the sealant compound's use by date regularly. The use by date is on the lower right hand corner of the label located on the sealant canister (bottle). You should replace the sealant canister after four years.

## (Type 2)

**Note:** *The temporary mobility kit contains enough sealant compound in the canister for one tire repair only. See an authorized Ford dealer for replacement sealant canisters.*

# Wheels and Tires

The kit is located under the front-row passenger seat. Loosen the Velcro strap to access the kit.

The kit consists of an air compressor to reinflate the tire and a canister of sealing compound that will effectively seal most punctures caused by nails or similar objects. This kit provides a temporary tire repair, allowing you to drive your vehicle up to 120 mi (200 km) at a maximum speed of 50 mph (80 km/h) to reach a tire service location.

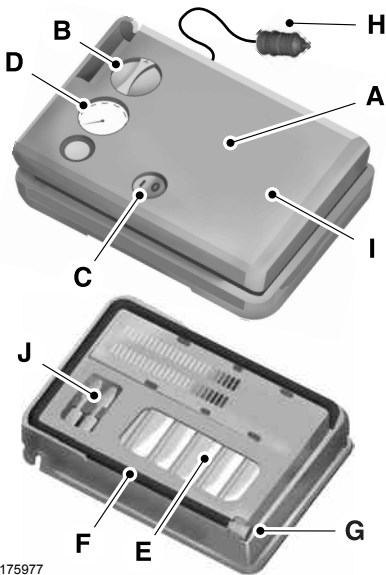

E175977

- A Air compressor (inside).
- B Selector switch.
- C On and off button.
- D Air pressure gauge.
- E Sealant bottle and canister.
- F Dual purpose hose: air and repair.

- G Tire valve connector.
- H Accessory power plug.
- I Casing and housing.
- J Bike/raft/sports ball adapters.

## General Information

### WARNING



Failure to follow these guidelines could result in an increased risk of loss of vehicle control, injury or death.

**Note:** Do not use the kit if you have severely damaged a tire. Only seal punctures located within the tire tread with the kit.

Do not attempt to repair punctures larger than ¼ inch (6 millimeters) or damage to the tire's sidewall. The tire may not completely seal.

Loss of air pressure may adversely affect tire performance. For this reason:

**Note:** Do not drive the vehicle above 50 mph (80 km/h).

**Note:** Do not drive further than 120 mi (200 km). Drive only to the closest authorized Ford dealer or tire repair shop to have your tire inspected.

- Drive carefully and avoid abrupt steering maneuvers.
- Periodically monitor tire inflation pressure in the affected tire; if the tire is losing pressure, have the vehicle towed.
- Read the information in the Tips for Use of the Kit section to make sure safe operation of the kit and your vehicle.

## Tips for Use of the Kit

To ensure safe operation of the kit:

# Wheels and Tires

- Read all instructions and cautions fully.
- Before operating the kit, make sure your vehicle is safely off the road and away from moving traffic. Switch on the hazard lights.
- Always set the parking brake to make sure the vehicle does not move unexpectedly.
- Do not remove any foreign objects, such as nails or screws, from the tire.
- When using the kit, leave the engine running (only if the vehicle is outdoors or in a well-ventilated area) so the compressor does not drain the vehicle's battery.
- Do not allow the compressor to operate continuously for more than 15 minutes. This will help prevent the compressor from overheating.
- Never leave the kit unattended during operation.
- Sealant compound contains latex. Those with latex sensitivities should use appropriate precautions to avoid an allergic reaction.
- Keep the kit away from children.
- Only use the kit when the ambient temperature is between -22°F (-30°C) and 158°F (70°C).
- Only use the sealing compound before the use-by date. The use-by date is on a label on the sealant canister, which you can see through the rectangular viewing window on the bottom of the compressor. Check the use-by date regularly and replace the canister after four years of non-use.
- Do not store the kit unsecured inside the passenger compartment of the vehicle as it may cause injury during a sudden stop or crash. Always store the kit in its original location.
- After sealant use, an authorized Ford dealer must replace the tire pressure monitoring system sensor and valve stem on the wheel.
- Operating the kit could cause an electrical disturbance in radio, CD and DVD player operation.



\* When inflation only is required for a tire or other objects, the selector must be in the Air position.

## What to Do When a Tire Is Punctured

Repair a tire puncture within the tire's tread area in two stages with the kit.

- In the first stage, inflate the tire with a sealing compound and air. After you inflate the tire, you will need to drive the vehicle a short distance (about 4 miles [6 kilometers]) to distribute the sealant in the tire.
- In the second stage, check the tire pressure and adjust, if necessary, to the vehicle's specified tire inflation pressure.

## First Stage: Inflating the Tire with Sealing Compound and Air

### WARNINGS



Do not stand directly over the kit while inflating the tire. If you notice any unusual bulges or deformations in the tire's sidewall during inflation, stop and call roadside assistance.



If the tire does not inflate to the recommended tire pressure within 15 minutes, stop and call roadside assistance.



Do not run the engine during kit operation unless the vehicle is outdoors or in a well-ventilated area.

# Wheels and Tires

Preparation: Park the vehicle in a safe, level and secure area, away from moving traffic.

Switch the hazard lights on. Apply the parking brake and switch the engine off. Inspect the flat tire for visible damage.

Sealant compound contains latex. Use appropriate precautions to avoid any allergic reactions.

Do not remove any foreign object that has pierced the tire. If a puncture is located in the tire sidewall, stop and call roadside assistance.

1. Remove the valve cap from the tire valve.
2. Unwrap the dual purpose hose (black tube) from the back of the compressor housing.
3. Fasten the hose to the tire valve by turning the connector clockwise. Tighten the connection securely.

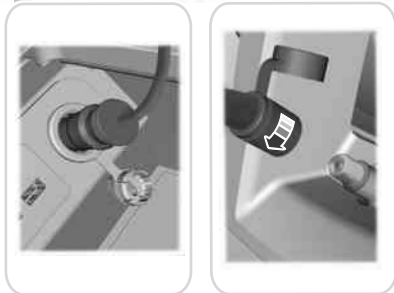
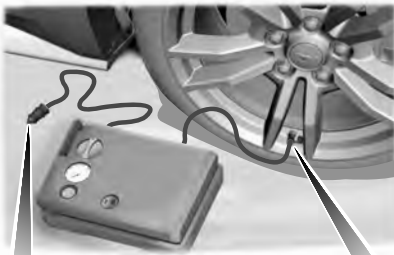

E175979

4. Plug the power cable into the 12-volt power point in the vehicle.
5. Remove the warning sticker found on the canister and place it on the top of the instrument panel or the center of the dash.
6. Start the vehicle and leave the engine running so the compressor does not drain the vehicle's battery.



E175981

7. Turn dial (A) clockwise to the sealant position. Switch the kit on by pressing the on/off button (B).
8. Inflate the tire to the pressure listed on the tire label located on the driver door or the door jamb area. The initial air pressure gauge reading may indicate a value higher than the label pressure while you pump the sealing compound into the tire. This is normal and should be no reason for concern. The pressure

# Wheels and Tires

gauge reading will indicate the tire inflation pressure after about 30 seconds of operation. You should check the final tire pressure with the compressor turned OFF in order to get an accurate pressure reading.

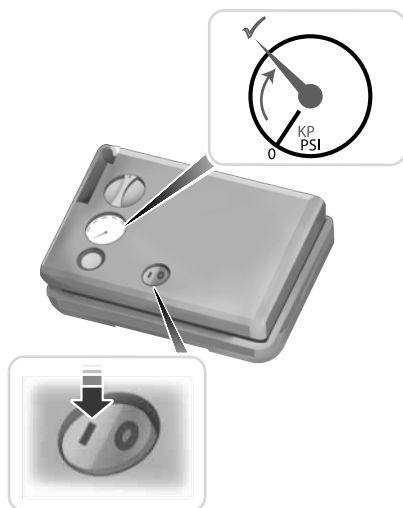



**Note:** If you experience any unusual vibration, ride disturbance or noise while driving, reduce your speed until you can safely pull off to the side of the road to call for roadside assistance.

**Note:** Do not proceed to the second stage of this operation.

## Second Stage: Checking Tire Pressure

### WARNINGS

 If you are proceeding from the First stage: Re-inflating the tire with sealing compound and air section and have injected sealant in the tire and the pressure is below 20 psi (1.4 bar), stop and call roadside assistance. If tire pressure is above 20 psi (1.4 bar), continue to the next step.

 The power plug may get hot after use and should be handled carefully while unplugging.

Check the air pressure of your tires as follows:



E175983

1. Remove the valve cap from the tire valve.
2. Firmly screw the air compressor hose onto the valve stem by turning clockwise.
3. Push and turn the dial clockwise to the air position.

E175982

9. When the tire reaches the recommended tire pressure, switch off the kit, unplug the power cable, and disconnect the hose from the tire valve. Re-install the valve cap on the tire valve and return the kit to the stowage area.
10. Immediately and cautiously, drive the vehicle 4 miles (6 kilometers) to distribute the sealant evenly inside the tire. Do not exceed 50 mph (80 km/h).
11. After 4 miles (6 kilometers), stop and check the tire pressure. See Second Stage: Checking Tire Pressure.

# Wheels and Tires

4. If required, switch on the compressor and adjust the tire to the recommended inflation pressure shown on the tire label located on the driver's door or door jamb area. You should check the tire pressure with the compressor turned OFF in order to get an accurate pressure reading.
5. Unplug the hoses, re-install the valve cap on the tire and return the kit to the stowage area.

## What to Do After the Tire has Been Sealed

After using the kit to seal your tire, replace the sealant canister and clear tube (hose). Obtain and replace the sealing compound and spare parts at an authorized Ford Motor Company dealership or tire dealer. You can dispose empty sealant bottles at home. However, return the liquid residue from the sealing compound to an authorized dealer or tire dealer for disposal, or in accordance with local waste disposal regulations.

**Note:** After you use the sealing compound, the maximum vehicle speed is 50 mph (80 km/h) and the maximum driving distance is 120 mi (200 km). Inspect the sealed tire immediately.

Check the tire pressure any time within the 120 mi (200 km) by performing the steps listed previously in the Second Stage: Checking Tire Pressure procedure.

## Removal of the Sealant Canister from the Kit

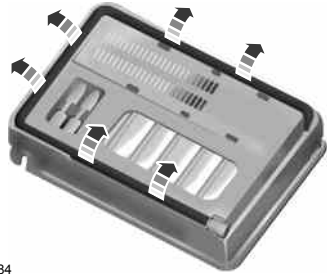

E175984

1. Unwrap the dual purpose hose (black tube) from the compressor housing.



E175985

2. Unwrap the power cord.



E175986

3. Remove the back cover.



# Wheels and Tires



E175987

4. Rotate the sealant canister up 90 degrees and pull away from casing/housing to remove.

## Installation of the Sealant Canister to the Kit

1. With the canister held perpendicular to the housing, insert the canister nozzle into the connector and push until seated.
2. Rotate the canister 90 degrees down into the housing/casing.



E175988

3. Snap the back cover back into place.

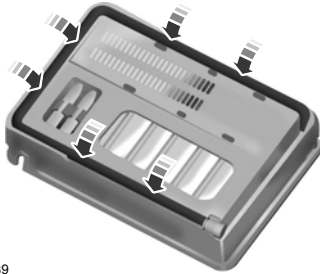

E175989

4. Wrap the dual purpose hose (black tube) around the channel on the bottom of the housing/casing.



E175990

5. Wrap the power cord around the housing and stow the accessory power plug into its storage area.

**Note:** *If you experience any difficulties when you remove or install the sealant canister, contact your authorized Ford dealer for assistance.*

Make sure you check the sealant compound's use-by date regularly. The use-by date is on a label located on the sealant canister, which you can see through the rectangular viewing window on the bottom of the kit. Replace the sealant canister after four years of non-use.

# Wheels and Tires

## TIRE CARE

### Information About Uniform Tire Quality Grading



E142542

Tire Quality Grades apply to new pneumatic passenger car tires. The Tire Quality Grades can be found where applicable on the tire sidewall between tread shoulder and maximum section width. For example: **Treadwear 200 Traction AA Temperature A.**

These Tire Quality Grades are determined by standards that the United States Department of Transportation has set.

Tire Quality Grades apply to new pneumatic passenger car tires. They do not apply to deep tread, winter-type snow tires, space-saver or temporary use spare tires, light truck or LT type tires, tires with nominal rim diameters of 10 to 12 inches or limited production tires as defined in Title 49 Code of Federal Regulations Part 575.104 (c)(2).

## U.S. Department of Transportation Tire quality grades:

The U.S. Department of Transportation requires Ford Motor Company to give you the following information about tire grades exactly as the government has written it.

### Treadwear

The treadwear grade is a comparative rating based on the wear rate of the tire when tested under controlled conditions on a specified government test course. For example, a tire graded 150 would wear 1 ½ times as well on the government course as a tire graded 100. The relative performance of tires depends upon the actual conditions of their use, however, and may depart significantly from the norm due to variations in driving habits, service practices, and differences in road characteristics and climate.

### Traction AA A B C

#### WARNING



The traction grade assigned to this tire is based on straight-ahead braking traction tests, and does not include acceleration, cornering, hydroplaning or peak traction characteristics.

# Wheels and Tires

The traction grades, from highest to lowest are AA, A, B, and C. The grades represent the tire's ability to stop on wet pavement as measured under controlled conditions on specified government test surfaces of asphalt and concrete. A tire marked C may have poor traction performance.

## Temperature A B C

### WARNING



The temperature grade for this tire is established for a tire that is properly inflated and not overloaded. Excessive speed, underinflation, or excessive loading, either separately or in combination, can cause heat buildup and possible tire failure.

The temperature grades are A (the highest), B and C, representing the tire's resistance to the generation of heat and its ability to dissipate heat when tested under controlled conditions on a specified indoor laboratory test wheel. Sustained high temperature can cause the material of the tire to degenerate and reduce tire life, and excessive temperature can lead to sudden tire failure. The grade C corresponds to a level of performance which all passenger car tires must meet under the

Federal Motor Vehicle Safety Standard No. 139. Grades B and A represent higher levels of performance on the laboratory test wheel than the minimum required by law.

## Glossary of Tire Terminology

\***Tire label:** A label showing the original equipment tire sizes, recommended inflation pressure and the maximum weight the vehicle can carry.

\***Tire Identification Number (TIN):** A number on the sidewall of each tire providing information about the tire brand and manufacturing plant, tire size and date of manufacture. Also referred to as DOT code.

\***Inflation pressure:** A measure of the amount of air in a tire.

\***Standard load:** A class of P-metric or Metric tires designed to carry a maximum load at set pressure. For example: for P-metric tires 35 psi (2.4 bar) or 36 psi (2.5 bar) depending on tire size and for Metric tires 36 psi (2.5 bar). Increasing the inflation pressure beyond this pressure will not increase the tire's load-carrying capability.

\***Extra load:** A class of P-metric or Metric tires designed to carry a heavier maximum load at 42 psi (2.9 bar). Increasing the inflation pressure beyond this pressure will not increase the tire's load-carrying capability.

# Wheels and Tires

\***kPa:** Kilopascal, a metric unit of air pressure.

\***PSI:** Pounds per square inch, a standard unit of air pressure.

\***Cold tire pressure:** The tire pressure when the vehicle has been stationary and out of direct sunlight for an hour or more and prior to the vehicle being driven for 1 mile (1.6 kilometers).

\***Recommended inflation pressure:** The cold inflation pressure found on the Safety Compliance Certification Label (affixed to either the door hinge pillar, door-latch post, or the door edge that meets the door-latch post, next to the driver's seating position) or Tire Label located on the B-Pillar or the edge of the driver's door.

\***B-pillar:** The structural member at the side of the vehicle behind the front door

\***Bead area of the tire:** Area of the tire next to the rim.

\***Sidewall of the tire:** Area between the bead area and the tread.

\***Tread area of the tire:** Area of the perimeter of the tire that contacts the road when mounted on the vehicle.

\***Rim:** The metal support (wheel) for a tire or a tire and tube assembly upon which the tire beads are seated.

## Information Contained on the Tire Sidewall

Both United States and Canada Federal regulations require tire manufacturers to place standardized information on the sidewall of all tires. This information identifies and describes the fundamental characteristics of the tire and also provides a U.S. DOT Tire Identification Number for safety standard certification and in case of a recall.

## Information on P Type Tires

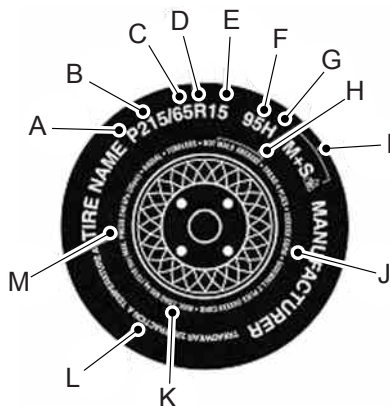

E142543

P215/65R15 95H is an example of a tire size, load index and speed rating. The definitions of these items are listed below. (Note that the tire size, load index and speed rating for your vehicle may be different from this example.)

## Wheels and Tires

A. **P:** Indicates a tire, designated by the Tire and Rim Association, that may be used for service on cars, sport utility vehicles, minivans and light trucks. **Note:** If your tire size does not begin with a letter this may mean it is designated by either the European Tire and Rim Technical Organization or the Japan Tire Manufacturing Association.

B. **215:** Indicates the nominal width of the tire in millimeters from sidewall edge to sidewall edge. In general, the larger the number, the wider the tire.

C. **65:** Indicates the aspect ratio which gives the tire's ratio of height to width.

D. **R:** Indicates a radial type tire.

E. **15:** Indicates the wheel or rim diameter in inches. If you change your wheel size, you will have to purchase new tires to match the new wheel diameter.

F. **95:** Indicates the tire's load index. It is an index that relates to how much weight a tire can carry. You may find this information in your owner's manual. If not, contact a local tire dealer.

**Note:** *You may not find this information on all tires because it is not required by federal law.*

G. **H:** Indicates the tire's speed rating. The speed rating denotes the speed at which a tire is designed to be driven for extended periods of time under a standard condition of load and inflation pressure. The tires on your vehicle may operate at different conditions for load and inflation pressure. These speed ratings may need to be adjusted for the difference in conditions. The ratings range from 81 mph (130 km/h) to 186 mph (299 km/h). These ratings are listed in the following chart.

**Note:** *You may not find this information on all tires because it is not required by federal law.*

Letter rating	Speed rating
M	81 mph (130 km/h)
N	87 mph (140 km/h)
Q	99 mph (159 km/h)
R	106 mph (171 km/h)
S	112 mph (180 km/h)
T	118 mph (190 km/h)
U	124 mph (200 km/h)
H	130 mph (210 km/h)
V	149 mph (240 km/h)

# Wheels and Tires

Letter rating	Speed rating
W	168 mph (270 km/h)
Y	186 mph (299 km/h)

**Note:** For tires with a maximum speed capability over 149 mph (240 km/h), tire manufacturers sometimes use the letters ZR. For those with a maximum speed capability over 186 mph (299 km/h), tire manufacturers always use the letters ZR.

**H. U.S. DOT Tire Identification Number (TIN):** This begins with the letters DOT and indicates that the tire meets all federal standards. The next two numbers or letters are the plant code designating where it was manufactured, the next two are the tire size code and the last four numbers represent the week and year the tire was built. For example, the numbers 317 mean the 31st week of 1997. After 2000 the numbers go to four digits. For example, 2501 means the 25th week of 2001. The numbers in between are identification codes used for traceability. This information is used to contact customers if a tire defect requires a recall.

**I. M+S or M/S:** Mud and Snow, or  
**AT:** All Terrain, or  
**AS:** All Season.

**J. Tire Ply Composition and Material Used:** Indicates the number of plies or the number of layers of rubber-coated fabric in the tire tread and sidewall. Tire manufacturers also must indicate the ply materials in the tire and the sidewall, which include steel, nylon, polyester, and others.

**K. Maximum Load:** Indicates the maximum load in kilograms and pounds that can be carried by the tire. See the Safety Compliance Certification Label (affixed to either the door hinge pillar, door-latch post, or the door edge that meets the door-latch post, next to the driver's seating position), for the correct tire pressure for your vehicle.

**L. Treadwear, Traction and Temperature Grades:**

**\*Treadwear** The treadwear grade is a comparative rating based on the wear rate of the tire when tested under controlled conditions on a specified government test course. For example, a tire graded 150 would wear one and one-half times as well on the government course as a tire graded 100.

# Wheels and Tires

**\*Traction:** The traction grades, from highest to lowest are AA, A, B, and C. The grades represent the tire's ability to stop on wet pavement as measured under controlled conditions on specified government test surfaces of asphalt and concrete. A tire marked C may have poor traction performance.

**\*Temperature:** The temperature grades are A (the highest), B and C, representing the tire's resistance to the generation of heat and its ability to dissipate heat when tested under controlled conditions on a specified indoor laboratory test wheel.

## M. Maximum Inflation Pressure:

Indicates the tire manufacturer's maximum permissible pressure, or the pressure at which the maximum load can be carried by the tire. This pressure is normally higher than the vehicle manufacturer's recommended cold inflation pressure, which can be found on the Safety Compliance Certification Label (affixed to either the door hinge pillar, door-latch post, or the door edge that meets the door-latch post, next to the driver's seating position), or Tire Label which is located on the B-Pillar or the edge of the driver's door. The cold inflation pressure should never be set lower than the recommended pressure on the vehicle label.

The tire suppliers may have additional markings, notes or warnings such as standard load or radial tubeless.

## Additional Information Contained on the Tire Sidewall for LT Type Tires

**Note:** *Tire Quality Grades do not apply to this type of tire.*

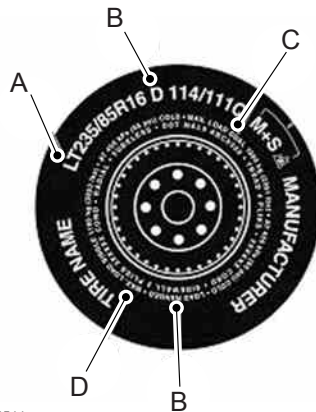

E142544

LT type tires have some additional information beyond those of P type tires. These differences are described below.

**A. LT:** Indicates a tire, designated by the Tire and Rim Association, that is intended for service on light trucks.

**B. Load Range and Load Inflation Limits:** Indicates the tire's load-carrying capabilities and its inflation limits.

# Wheels and Tires

**C. Maximum Load Dual lb (kg) at psi (kPa) cold:** Indicates the maximum load and tire pressure when the tire is used as a dual, defined as four tires on the rear axle (a total of six or more tires on the vehicle).

**D. Maximum Load Single lb (kg) at psi (kPa) cold:** Indicates the maximum load and tire pressure when the tire is used as a single, defined as two tires (total) on the rear axle.

## Information on T Type Tires

T145/80D16 is an example of a tire size.

**Note:** *The temporary tire size for your vehicle may be different from this example. Tire Quality Grades do not apply to this type of tire.*

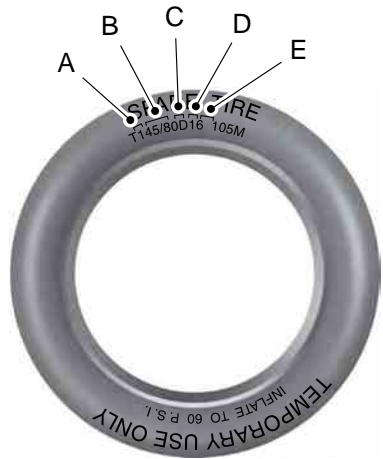

E142545

T type tires have some additional information beyond those of P type tires. These differences are described below.

**A. T:** Indicates a type of tire, designated by the Tire and Rim Association, that is intended for temporary service on cars, sport-utility vehicles, minivans and light trucks.

**B. 145:** Indicates the nominal width of the tire in millimeters from sidewall edge to sidewall edge. In general, the larger the number, the wider the tire.



# Wheels and Tires

---

**C. 80:** Indicates the aspect ratio, which gives the tire's ratio of height to width. Numbers of 70 or lower indicate a short sidewall.

**D. D:** Indicates a diagonal type tire.

**R:** Indicates a radial type tire.

**E. 16:** Indicates the wheel or rim diameter in inches. If you change your wheel size, you will have to purchase new tires to match the new wheel diameter.

## Location of the Tire Label

You will find a Tire Label containing tire inflation pressure by tire size and other important information located on the B-Pillar or the edge of the driver's door.

## Inflating Your Tires

Safe operation of your vehicle requires that your tires are properly inflated. Remember that a tire can lose up to half of its air pressure without appearing flat.

Every day before you drive, check your tires. If one looks lower than the others, use a tire gauge to check pressure of all tires and adjust if required.

At least once a month and before long trips, inspect each tire and check the tire pressure with a tire gauge (including spare, if equipped). Inflate all tires to the inflation pressure recommended by Ford Motor Company.

You are strongly urged to buy a reliable tire pressure gauge, as automatic service station gauges may be inaccurate. Ford recommends the use of a digital or dial-type tire pressure gauge rather than a stick-type tire pressure gauge.

Use the recommended cold inflation pressure for optimum tire performance and wear. Under-inflation or over-inflation may cause uneven treadwear patterns

## WARNING



Under-inflation is the most common cause of tire failures and may result in severe tire cracking, tread separation or blowout, with unexpected loss of vehicle control and increased risk of injury. Under-inflation increases sidewall flexing and rolling resistance, resulting in heat buildup and internal damage to the tire. It also may result in unnecessary tire stress, irregular wear, loss of vehicle control and accidents. A tire can lose up to half of its air pressure and not appear to be flat!

Always inflate your tires to the Ford recommended inflation pressure even if it is less than the maximum inflation pressure information found on the tire. The Ford recommended tire inflation pressure is found on the Safety Compliance Certification Label

## Wheels and Tires

---

(affixed to either the door hinge pillar, door-latch post, or the door edge that meets the door-latch post, next to the driver's seating position), or Tire Label which is located on the B-Pillar or the edge of the driver's door. Failure to follow the tire pressure recommendations can cause uneven treadwear patterns and adversely affect the way your vehicle handles

**Maximum Inflation Pressure** is the tire manufacturer's maximum permissible pressure and the pressure at which the maximum load can be carried by the tire. This pressure is normally higher than the manufacturer's recommended cold inflation pressure, which can be found on the Safety Compliance Certification Label (affixed to either the door hinge pillar, door-latch post, or the door edge that meets the door-latch post, next to the driver's seating position), or Tire Label which is located on the B-Pillar or the edge of the driver's door. The cold inflation pressure should never be set lower than the recommended pressure on the Safety Compliance Certification Label or Tire Label.

When weather temperature changes occur, tire inflation pressures also change. A 10°F (6°C) temperature drop can cause a corresponding drop of 1 psi (7 kPa) in inflation pressure. Check your tire pressures frequently and adjust them to the proper pressure which can be found on the Safety Compliance Certification Label or Tire Label.

To check the pressure in your tire(s):

1. Make sure the tires are cool, meaning they are not hot from driving even a mile.

**Note:** *If you are checking tire pressure when the tire is hot, (for example, driven more than 1 mile [1.6 kilometers], never bleed or reduce air pressure. The tires are hot from driving and it is normal for pressures to increase above recommended cold pressures. A hot tire at or below recommended cold inflation pressure could be significantly under-inflated.*

**Note:** *If you have to drive a distance to get air for your tire(s), check and record the tire pressure first and add the appropriate air pressure when you get to the pump. It is normal for tires to heat up and the air pressure inside to go up as you drive.*

2. Remove the cap from the valve on one tire, then firmly press the tire gauge onto the valve and measure the pressure.

# Wheels and Tires

---

3. Add enough air to reach the recommended air pressure.

**Note:** *If you overfill the tire, release air by pressing on the metal stem in the center of the valve. Then recheck the pressure with your tire gauge.*

4. Replace the valve cap.

5. Repeat this procedure for each tire, including the spare.

**Note:** *Some spare tires operate at a higher inflation pressure than the other tires. For T type mini-spare tires, see the Dissimilar Spare Wheel and Tire Assembly section. Store and maintain at 60 psi (4.15 bar). For full-size and dissimilar spare tires, see the Dissimilar Spare Wheel and Tire Assembly Information section. Store and maintain at the higher of the front and rear inflation pressure as shown on the Tire Label.*

6. Visually inspect the tires to make sure there are no nails or other objects embedded that could poke a hole in the tire and cause an air leak.

7. Check the sidewalls to make sure there are no gouges, cuts or bulges.

## Inspecting Your Tires and Wheel Valve Stems

Periodically inspect the tire treads for uneven or excessive wear and remove objects such as stones, nails or glass that may be wedged in the tread grooves. Check the tire and valve stems for holes, cracks, or cuts that may permit air leakage and repair or replace the tire and replace the valve stem. Inspect the tire sidewalls for cracking, cuts, bruises and other signs of damage or excessive wear. If internal damage to the tire is suspected, have the tire demounted and inspected in case it needs to be repaired or replaced. For your safety, tires that are damaged or show signs of excessive wear should not be used because they are more likely to blow out or fail.

Improper or inadequate vehicle maintenance can cause tires to wear abnormally. Inspect all your tires, including the spare, frequently, and replace them if one or more of the following conditions exist:

# Wheels and Tires

## Tire Wear



E142546

When the tread is worn down to one sixteenth of an inch (2 millimeters), tires must be replaced to help prevent your vehicle from skidding and hydroplaning. Built-in treadwear indicators, or wear bars, which look like narrow strips of smooth rubber across the tread will appear on the tire when the tread is worn down to one sixteenth of an inch (2 millimeters)

When the tire tread wears down to the same height as these wear bars, the tire is worn out and must be replaced.

## Damage

Periodically inspect the tire treads and sidewalls for damage (such as bulges in the tread or sidewalls, cracks in the tread groove and separation in the tread or sidewall). If damage is observed

or suspected have the tire inspected by a tire professional. Tires can be damaged during off-road use, so inspection after off-road use is also recommended.

## Age

### WARNING



Tires degrade over time depending on many factors such as weather, storage conditions, and conditions of use (such as load, speed, inflation pressure) the tires experience throughout their lives.

In general, tires should be replaced after six years regardless of tread wear. However, heat caused by hot climates or frequent high loading conditions can accelerate the aging process and may require tires to be replaced more frequently.

You should replace your spare tire when you replace the road tires or after six years due to aging even if it has not been used.

## U.S. DOT Tire Identification Number

Both United States and Canada Federal regulations require tire manufacturers to place standardized information on the sidewall of all tires. This information identifies and

# Wheels and Tires

describes the fundamental characteristics of the tire and also provides a U.S. DOT Tire Identification Number for safety standard certification and in case of a recall.

This begins with the letters DOT and indicates that the tire meets all federal standards. The next two numbers or letters are the plant code designating where it was manufactured, the next two are the tire size code and the last four numbers represent the week and year the tire was built. For example, the numbers 317 mean the 31st week of 1997. After 2000 the numbers go to four digits. For example, 2501 means the 25th week of 2001. The numbers in between are identification codes used for traceability. This information is used to contact customers if a tire defect requires a recall.

## Tire Replacement Requirements

Your vehicle is equipped with tires designed to provide a safe ride and handling capability.

### WARNINGS



Only use replacement tires and wheels that are the same size, load index, speed rating and type (such as P-metric versus LT-metric or all-season versus all-terrain) as those originally provided by Ford. The recommended tire and wheel size

### WARNINGS

may be found on either the Safety Compliance Certification Label (affixed to either the door hinge pillar, door-latch post, or the door edge that meets the door-latch post, next to the driver's seating position), or the Tire Label which is located on the B-Pillar or edge of the driver's door. If this information is not found on these labels then you should contact your authorized dealer as soon as possible. Use of any tire or wheel not recommended by Ford can affect the safety and performance of your vehicle, which could result in an increased risk of loss of vehicle control, vehicle rollover, personal injury and death. Additionally the use of non-recommended tires and wheels could cause steering, suspension, axle, transfer case or power transfer unit failure. If you have questions regarding tire replacement, contact your authorized dealer as soon as possible.



To reduce the risk of serious injury, when mounting replacement tires and wheels, you should not exceed the maximum pressure indicated on the sidewall of the tire to set the beads without additional precautions listed below. If the beads do not seat at the maximum pressure indicated, re-lubricate and try again

# Wheels and Tires

---

## WARNINGS

When inflating the tire for mounting pressures up to 20 psi (1.38 bar) greater than the maximum pressure on the tire sidewall, the following precautions must be taken to protect the person mounting the tire:

1. Make sure that you have the correct tire and wheel size.
2. Lubricate the tire bead and wheel bead seat area again.
3. Stand at a minimum of 12 feet (3.66 meters) away from the wheel and tire assembly.
4. Use both eye and ear protection.

For a mounting pressure more than 20 psi (1.38 bar) greater than the maximum pressure, a Ford dealer or other tire service professional should do the mounting.

Always inflate steel carcass tires with a remote air fill with the person inflating standing at a minimum of 12 feet (3.66 meters) away from the wheel and tire assembly

---

**Important:** Remember to replace the wheel valve stems when the road tires are replaced on your vehicle

The two front tires or two rear tires should generally be replaced as a pair.

The tire pressure sensors mounted in the wheels (originally installed on your vehicle) are not designed to be used in aftermarket wheels.

The use of wheels or tires not recommended by Ford Motor Company may affect the operation of your tire pressure monitoring system.

If the tire pressure monitoring system indicator is flashing, the system is malfunctioning. Your replacement tire might be incompatible with your tire pressure monitoring system, or some component of the system may be damaged.

## Safety Practices

### WARNINGS



If your vehicle is stuck in snow, mud or sand, do not rapidly spin the tires. Spinning the tires can tear the tire and cause an explosion. A tire can explode in as little as three to five seconds.



Do not spin the wheels at over 35 mph (56 km/h). The tires may fail and injure a passenger or bystander.

---

# Wheels and Tires

---

## **Driving habits have a great deal to do with your tire mileage and safety.**

- \*Observe posted speed limits
- \*Avoid fast starts, stops and turns
- \*Avoid potholes and objects on the road
- \*Do not run over curbs or hit the tire against a curb when parking

## **Highway Hazards**

No matter how carefully you drive there's always the possibility that you may eventually have a flat tire on the highway. Drive slowly to the closest safe area out of traffic. This may further damage the flat tire, but your safety is more important.

If you feel a sudden vibration or ride disturbance while driving, or you suspect your tire or vehicle has been damaged, immediately reduce your speed. Drive with caution until you can safely pull off the road. Stop and inspect the tires for damage. If you cannot detect a cause, have the vehicle towed to the nearest repair facility or tire dealer to have the vehicle inspected.

## **Tire and Wheel Alignment**

A bad jolt from hitting a curb or pothole can cause the front end of your vehicle to become misaligned or cause damage to your tires. If your vehicle seems to pull to one side when you're driving, the wheels may be out of alignment. Have an authorized dealer check the wheel alignment periodically.

Wheel misalignment in the front or the rear can cause uneven and rapid treadwear of your tires and should be corrected by an authorized dealer. Front-wheel drive vehicles and those with an independent rear suspension may require alignment of all four wheels.

The tires should also be balanced periodically. An unbalanced tire and wheel assembly may result in irregular tire wear.

## **Tire Rotation**

**Note:** *If your tires show uneven wear ask an authorized dealer to check for and correct any wheel misalignment, tire imbalance or mechanical problem involved before tire rotation.*

# Wheels and Tires

**Note:** Your vehicle may be equipped with a dissimilar spare wheel and tire assembly. A dissimilar spare wheel and tire assembly is defined as a spare wheel and tire assembly that is different in brand, size or appearance from the road tires and wheels. If you have a dissimilar spare wheel and tire assembly it is intended for temporary use only and should not be used in a tire rotation.

**Note:** After having your tires rotated, inflation pressure must be checked and adjusted to the vehicle requirements.

Rotating your tires at the recommended interval (as indicated in the scheduled maintenance information) will help your tires wear more evenly, providing better tire performance and longer tire life.

Front-wheel drive vehicles (front tires on the left side of the diagram)

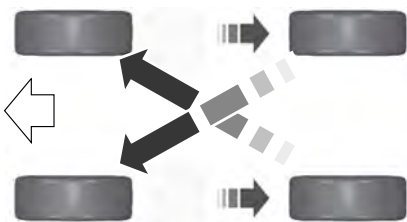

E142547

## Non-directional tires

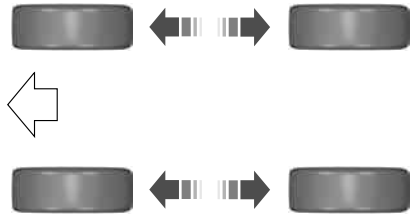

E70415

## Directional tires

Sometimes irregular tire wear can be corrected by rotating the tires.

## USING SNOW CHAINS

### WARNING



Snow tires must be the same size, load index, speed rating as those originally provided by Ford. Use of any tire or wheel not recommended by Ford can affect the safety and performance of your vehicle, which could result in an increased risk of loss of vehicle control, vehicle rollover, personal injury and death. Additionally, the use of non-recommended tires and wheels could cause steering, suspension, axle, transfer case or power transfer unit failure.

The tires on your vehicle have all-weather treads to provide traction in rain and snow. Snow chains have not been approved for use on your vehicle.

Consult your authorized dealer for information on other Ford Motor Company approved methods of traction control.



# Wheels and Tires

## TIRE PRESSURE MONITORING SYSTEM

### WARNING



The tire pressure monitoring system is not a substitute for manually checking tire pressure. The tire pressure should be checked periodically (at least monthly) using a tire gauge, see *Inflating your tires* in this chapter. Failure to properly maintain your tire pressure could increase the risk of tire failure, loss of control, vehicle rollover and personal injury.



Each tire, including the spare (if provided), should be checked monthly when cold and inflated to the inflation pressure recommended by the vehicle manufacturer on the vehicle placard or tire inflation pressure label. (If your vehicle has tires of a different size than the size indicated on the vehicle placard or tire inflation pressure label, you should determine the proper tire inflation pressure for those tires.)

As an added safety feature, your vehicle has been equipped with a Tire Pressure Monitoring System (TPMS) that illuminates a low tire pressure telltale when one or more of your tires is significantly under-inflated. Accordingly, when the low tire pressure telltale illuminates, you should stop and check your tires as soon as possible, and inflate them to the proper pressure. Driving on a significantly under-inflated tire causes the tire to overheat and can lead to tire failure. Under-inflation also reduces fuel efficiency and tire tread life, and may affect the vehicle's handling and stopping ability.

Please note that the TPMS is not a substitute for proper tire maintenance, and it is the driver's responsibility to maintain correct tire pressure, even if under-inflation has not reached the level to trigger illumination of the TPMS low tire pressure telltale.

Your vehicle has also been equipped with a TPMS malfunction indicator to indicate when the system is not operating properly. The TPMS malfunction indicator is combined with the low tire pressure telltale. When the system detects a malfunction, the telltale will flash for approximately one minute and then remain continuously illuminated. This sequence will continue upon subsequent vehicle start-ups as long as the malfunction exists.

When the malfunction indicator is illuminated, the system may not be able to detect or signal low tire pressure as intended. TPMS malfunctions may occur for a variety of reasons, including the installation of replacement or alternate tires or wheels on the vehicle that prevent the TPMS from functioning properly. Always check the TPMS malfunction telltale after replacing one or more tires or wheels on your vehicle to ensure that the replacement or alternate tires and wheels allow the TPMS to continue to function properly.

The tire pressure monitoring system complies with part 15 of the FCC rules and with RSS-210 of Industry Canada. Operation is subject to the following two conditions: (1) This device may not cause harmful interference, and (2) This device must accept any interference received, including interference that may cause undesired operation.

# Wheels and Tires

## Changing Tires With a Tire Pressure Monitoring System



E142549

**Note:** Each road tire is equipped with a tire pressure sensor located inside the wheel and tire assembly cavity. The pressure sensor is attached to the valve stem. The pressure sensor is covered by the tire and is not visible unless the tire is removed. Take care when changing the tire to avoid damaging the sensor

You should always have your tires serviced by an authorized dealer.

Check the tire pressure periodically (at least monthly) using an accurate tire gauge. See *Inflating Your Tires* in this chapter.

## Understanding Your Tire Pressure Monitoring System

The tire pressure monitoring system measures pressure in your four road tires and sends the tire pressure readings to your vehicle. The low tire pressure warning light will turn on if the tire pressure is significantly low. Once the light is illuminated, your tires are under-inflated and need to be inflated to the manufacturer's recommended tire pressure. Even if the light turns on and a short time later turns off, your tire pressure still needs to be checked.

### When Your Temporary Spare Tire is Installed

When one of your road tires needs to be replaced with the temporary spare, the system will continue to identify an issue to remind you that the damaged road wheel and tire assembly needs to be repaired and put back on your vehicle.

To restore the full function of the tire pressure monitoring system, have the damaged road wheel and tire assembly repaired and remounted on your vehicle.

### When You Believe Your System is Not Operating Properly

The main function of the tire pressure monitoring system is to warn you when your tires need air. It can also warn you in the event the system is no longer capable of functioning as intended. See the following chart for information concerning your tire pressure monitoring system:

# Wheels and Tires

Low tire pressure warning light	Possible cause	Customer action required
Solid warning light	Tire(s) under-inflated	Make sure tires are at the proper pressure. See <b>Inflating your tires</b> in this chapter. After inflating your tires to the manufacturer's recommended pressure as shown on the Tire Label (located on the edge of driver's door or the B-Pillar), the vehicle must be driven for at least two minutes over 20 mph (32 km/h) before the light turns off.
	Spare tire in use	Repair the damaged road wheel and tire assembly and reinstall it on the vehicle to restore system function. For a description on how the system functions, see <b>When your temporary spare tire is installed</b> in this section.
	TPMS malfunction	If the tires are properly inflated and the spare tire is not in use but the light remains on, contact your authorized dealer as soon as possible.
Flashing warning light	Spare tire in use	Repair the damaged road wheel and tire assembly and reinstall it on the vehicle to restore system function. For a description on how the system functions, see <b>When your temporary spare tire is installed</b> in this section.
	TPMS malfunction	If the tires are properly inflated and the spare tire is not in use but the light remains on, contact your authorized dealer as soon as possible.

## When Inflating Your Tires

When putting air into your tires (such as at a gas station or in your garage), the tire pressure monitoring system may not respond immediately to the air added to your tires.

It may take up to two minutes of driving over 20 mph (32 km/h) for the light to turn off after you have filled your tires to the recommended inflation pressure

# Wheels and Tires

## How Temperature Affects Your Tire Pressure

The tire pressure monitoring system monitors tire pressure in each pneumatic tire. While driving in a normal manner, a typical passenger tire inflation pressure may increase about 2 to 4 psi (14 to 28 kPa) from a cold start situation. If the vehicle is stationary overnight with the outside temperature significantly lower than the daytime temperature, the tire pressure may decrease about 3 psi (21 kPa) for a drop of 30°F (17°C) in ambient temperature. This lower pressure value

may be detected by the tire pressure monitoring system as being significantly lower than the recommended inflation pressure and activate the system warning light for low tire pressure. If the low tire pressure warning light is on, visually check each tire to verify that no tire is flat. If one or more tires are flat, repair as necessary. Check the air pressure in the road tires. If any tire is under-inflated, carefully drive the vehicle to the nearest location where air can be added to the tires. Inflate all the tires to the recommended inflation pressure.

## TECHNICAL SPECIFICATIONS

### Wheel Lug Nut Torque Specifications

#### WARNING



When a wheel is installed, always remove any corrosion, dirt or foreign materials present on the mounting surfaces of the wheel or the surface of the wheel hub, brake drum or brake disc that contacts the wheel. Make sure that any fasteners that attach the rotor to the hub are secured so they do not interfere with the mounting surfaces of the wheel. Installing wheels without correct metal-to-metal contact at the wheel mounting surfaces can cause the wheel nuts to loosen and the wheel to come off while your vehicle is in motion, resulting in loss of control.

Bolt size	lb-ft (Nm)*
M12 x 1.5	100 (135)

\*Torque specifications are for nut and bolt threads free of dirt and rust. Use only Ford recommended replacement fasteners.

Retighten the lug nuts to the specified torque within 100 miles (160 kilometers) after any wheel disturbance (such as tire rotation, changing a flat tire, wheel removal).

# Wheels and Tires

---



E145950

A Wheel pilot bore

Inspect the wheel pilot bore and mounting surface prior to installation. Remove any visible corrosion or loose particles.

# Capacities and Specifications

---

## ENGINE SPECIFICATIONS

<b>Engine</b>	<b>2.0L ATK iVCT Engine</b>
Cubic inches	122
Required fuel	Minimum 87 octane
Firing order	1-3-4-2
Ignition system	Coil on plug (COP)
Compression ratio	12.3:1
Spark plug gap	0.051 in. $\pm$ 0.002 in. (1.3 mm $\pm$ 0.05 mm)

# Capacities and Specifications

---

## MOTORCRAFT PARTS

<b>Component</b>	<b>2.0L ATK iVCT engine</b>
Air filter element	FA-1911
Oil filter	FL-910-S
Low-Voltage Battery	BXT-67R
Spark plugs	SP-530
Cabin air filter	FP70
Windshield wiper blade	WW-29 (driver side) WW-25 (passenger side)
Rear wiper blade	WW-12

We recommend Motorcraft replacement parts available at your Ford dealer or at [fordparts.com](http://fordparts.com) for scheduled maintenance. These parts meet or exceed Ford Motor Company's specifications and are engineered for your vehicle. Use of other parts may impact vehicle performance, emissions and durability. Your warranty may be void for any damage related to use of other parts.

If a Motorcraft oil filter is not available, use an oil filter that meets industry performance specification SAE/USCAR-36.

For spark plug replacement, contact an authorized dealer. Replace the spark plugs at the appropriate intervals.

# Capacities and Specifications

## VEHICLE IDENTIFICATION NUMBER

The vehicle identification number is located on the left-hand side of the instrument panel.

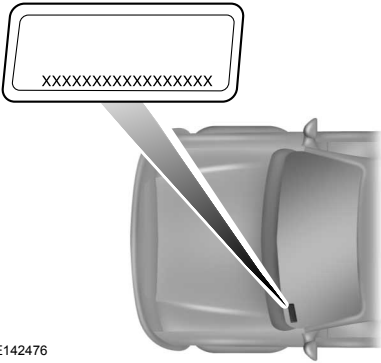

E142476

Please note that in the graphic, XXXX is representative of your vehicle identification number.

The Vehicle Identification Number contains the following information:

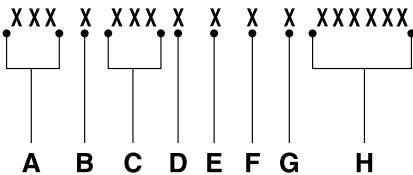

E142477

- A World manufacturer identifier
- B Brake system, Gross Vehicle Weight Rating, Restraint Devices and their locations

- C Make, vehicle line, series, body type
- D Engine type
- E Check digit
- F Model year
- G Assembly plant
- H Production sequence number

## VEHICLE CERTIFICATION LABEL

<b>MFD. BY FORD MOTOR CO.</b>			
DATE: XX/XX	GVWR: XXXX KG ( XXXX LB)		
FRONT GAWR: XXXX KG ( XXXX LB)	WITH REAR GAWR: XXXX KG ( XXXX LB)	WITH	
XXXXXXXXXXXXXXXXXX	TIRES XXXXXXXXXXXXXXXX	TIRES	
XXXXXX	RIMS XXXXXXX	RIMS	
AT XXXX kPa/ XXX PSI COLD	AT XXXX kPa/ XXX PSI COLD		
THIS VEHICLE CONFORMS TO ALL APPLICABLE FEDERAL MOTOR VEHICLE SAFETY AND THEFT PREVENTION STANDARDS IN EFFECT ON THE DATE OF MANUFACTURE SHOWN ABOVE.			
VIN: XXXXXXXXXXXXXXXXX		XXXXX	
TYPE: XXXX		XXXXX	
EXT PNT: XX	RC: XX	DSO: XXXX	
WB INT TR	T TP/PS TR	AXLE TR	SPR XXXX
XXX XX	XXX X	XX X	XXXX XXXX
	XXXXXXXXXXXX	XXX	XXXX-XXXXXX-XX

E167469

The National Highway Traffic Safety Administration Regulations require that a Safety Compliance Certification Label be affixed to a vehicle and prescribe where the Safety Compliance Certification Label may be located. The Safety Compliance Certification Label shall be affixed to either the door hinge pillar, the door latch post, or the edge of the door near the door latch, next to the driver's seating position.



# Capacities and Specifications

## TRANSMISSION CODE DESIGNATION

The transmission code is on the Safety Compliance Certification Label. The following table shows the transmission code along with the transmission description.

**MFD. BY FORD MOTOR CO.**

DATE: XX/XX      GVWR: XXXXXLB/ XXXXXKG  
 FRONT GAWR: XXXXL      REAR GAWR: XXXXLB  
 XXXXKG      WITH      XXXXKG      WITH  
 XXXX/XXXXXXXXX      TIRES:      XXXX/XXXXXXXXX      TIRES  
 XXXX.XX      RIMS:      XXXX.XX      RIMS  
 AT XXX kPa/XX      PSI COLD      AT XXX kPa/XX      PSI COLD

THIS VEHICLE CONFORMS TO ALL APPLICABLE FEDERAL MOTOR VEHICLE SAFETY STANDARDS IN EFFECT ON THE DATE OF MANUFACTURE SHOWN ABOVE.

VIN: XXXXXXXXXXXXXXXXXXXX      XXXXX  
 TYPE: XXX      XXXXX



EXT PNT: XX      RC: XX      DSO: \_\_\_\_\_  
 WB<sup>1</sup>      INT TR<sup>1</sup>      TP/PS<sup>1</sup>      R<sup>1</sup>      AXLE<sup>1</sup>      TR      SPR      XXXXX  
 XXX      XX      X      XX      X      XX      XXX

XXXXXXXXXXXXX      XXX      XXXX-XXXXXX-XX

E142806

Description	Code
Electronic continuously variable transmission (HF35 eCVT)	J

# Capacities and Specifications

## Capacities

### WARNING



The air conditioning refrigerant system contains refrigerant R-134a under high pressure. Opening the air conditioning refrigerant system can cause personal injury. Have the air conditioning refrigerant system serviced only by qualified personnel.

Item	Capacity
Engine oil	4.5 qt (4.3 L)
Engine coolant	8.2 qt (7.8 L)
Engine coolant (Energi vehicles)	8.8 qt (8.3 L)
Inverter system controller coolant	1.1 qt (1 L)
Brake fluid	Between MIN and MAX on brake fluid reservoir
Automatic transmission fluid <sup>1</sup>	4.8 qt (4.5 L)
Windshield washer fluid	Fill as required
Fuel tank	13.5 gal (51.1 L)
Fuel tank (Energi vehicles)	14 gal (53 L)
A/C Refrigerant	1.63 lb (0.74 kg)
A/C Refrigerant Compressor Oil	5.2 fl oz (153.8 ml)

<sup>1</sup>Approximate dry fill capacity. Actual amount may vary during fluid changes.

## Specifications

### Materials

Name	Specification
Motor oil: Motorcraft SAE 0W-20 Synthetic Blend Motor Oil XO-5W30-QSP	WSS-M2C947-A
Engine coolant (U.S.): Motorcraft Orange Antifreeze/Coolant Prediluted VC-3DIL-B	WSS-M97B44-D2
Engine coolant (Canada):	WSS-M97B44-D2

## Capacities and Specifications

Name	Specification
Motorcraft Orange Antifreeze/Coolant Prediluted CVC-3DIL-B	
Brake fluid: Motorcraft DOT 4 Low Viscosity (LV) High Performance Motor Vehicle Brake Fluid PM-20	WSS-M6C65-A2
Automatic transmission fluid (U.S.): Motorcraft MERCON LV Automatic Transmission Fluid XT-10-QLVC	WSS-M2C938-A MERCON LV
Automatic transmission fluid (Canada): Motorcraft MERCON LV Automatic Transmission Fluid CXT-10-LV12	WSS-M2C938-A MERCON LV
Windshield washer fluid (U.S.): Motorcraft Premium Windshield Wash Concentrate with Bitterant ZC-32-B2	WSS-M14P19-A
Windshield washer fluid (Canada): Motorcraft Premium Quality Windshield Washer Fluid CXC-37-(A, B, D, F)	WSS-M14P19-A
A/C refrigerant (U.S.): Motorcraft R-134a Refrigerant YN-19	WSH-M17B19-A
A/C refrigerant (Canada): Motorcraft R-134a Refrigerant CYN-16-R	WSH-M17B19-A
A/C refrigerant compressor oil: Motorcraft Electric A/C Compressor Oil YN-32	—
Multi-purpose grease: Motorcraft Multi-Purpose Grease Spray XL-5	ESB-MIC93-B
Lock cylinders (U.S.): Penetrating and Lock Lubricant XL-1	--
Lock cylinders (Canada): Penetrating Fluid CXC-51-A	--

# Capacities and Specifications

---

If you use oil and fluids that do not meet the defined specification and viscosity grade, this may lead to:

- Component damage which is not covered by the vehicle warranty.
- Longer engine cranking periods.
- Increased emission levels.
- Reduced engine performance.
- Reduced fuel economy.
- Degraded brake performance.

Only use fluid that meets Ford specifications. Motor oils of the recommended viscosity grade that meet API SN requirements and display the API Certification Mark for gasoline engines are also acceptable. Do not use oil labeled with API SN service category unless the label also displays the API certification mark.



E142732

An oil that displays this symbol conforms to current engine, emission system and fuel economy performance standards of the International Lubricant Standardization and Approval Committee (ILSAC).

Do not use supplemental engine oil additives because they are unnecessary and could lead to engine damage that may not be covered by your vehicle warranty.

**Note:** Ford recommends using DOT 4 Low Viscosity (LV) High Performance Brake Fluid or equivalent meeting WSS-M6C65-A2. Use of any fluid other than the recommended fluid may cause degraded brake performance and not meet the Ford performance standards. Keep brake fluid clean and dry. Contamination with dirt, water, petroleum products or other materials may result in brake system damage and possible failure.

**Note:** Automatic transmissions that require MERCON LV transmission fluid should only use MERCON LV transmission fluid. The use of any other fluid may cause transmission damage.

# Audio System

## GENERAL INFORMATION

### Radio Frequencies and Reception Factors

AM and FM frequencies are established by the Federal Communications Commission (FCC) and the Canadian Radio and Telecommunications Commission (CRTC). Those frequencies are:

- AM: 530, 540-1700, 1710 kHz
- FM: 87.9-107.7, 107.9 MHz

Radio Reception Factors	
<b>Distance and strength</b>	The further you travel from an AM or FM station, the weaker the signal and the weaker the reception.
<b>Terrain</b>	Hills, mountains, tall buildings, bridges, tunnels, freeway overpasses, parking garages, dense tree foliage and thunderstorms can interfere with the reception.
<b>Station overload</b>	When you pass a ground-based broadcast repeating tower, a stronger signal may overtake a weaker one and result in the audio system muting.

### CD and CD Player Information

**Note:** CD units play commercially pressed 4.75-inch (12 centimeter) audio compact discs only. Due to technical incompatibility, certain recordable and re-recordable compact discs may not function correctly when used in Ford CD players.

**Note:** Do not insert CDs with homemade paper (adhesive) labels into the CD player as the label may peel and cause the CD to become jammed. You should use a permanent felt tip marker rather than adhesive labels on your homemade CDs. Ballpoint pens may damage CDs. Please contact an authorized dealer for further information.

**Note:** Do not use any irregularly shaped discs or discs with a scratch protection film attached.

Always handle discs by their edges only. Clean the disc with an approved CD cleaner only. Wipe it from the center of the disc toward the edge. Do not clean in a circular motion.

Do not expose discs to direct sunlight or heat sources for extended periods.

### MP3 Track and Folder Structure

Audio systems capable of recognizing and playing MP3 individual tracks and folder structures work as follows:

- There are two different modes for MP3 disc playback: MP3 track mode (system default) and MP3 folder mode.
- MP3 track mode ignores any folder structure on the MP3 disc. The player numbers each MP3 track on the disc (noted by the .mp3 file extension) from T001 to a maximum of T255. The maximum number of playable MP3 files may be less depending on the structure of the CD and exact model of radio present.

# Audio System

---

- MP3 folder mode represents a folder structure consisting of one level of folders. The CD player numbers all MP3 tracks on the disc (noted by the .mp3 file extension) and all folders containing MP3 files, from F001 (folder) T001 (track) to F253 T255.
- Creating discs with only one level of folders helps with navigation through the disc files.

If you are burning your own MP3 discs, it is important to understand how the system reads the structures you create. While various files may be present, (files with extensions other than mp3), only files with the .mp3 extension are played; other files are ignored by the system. This enables you to use the same MP3 disc for a variety of tasks on your work computer, home computer and your in-vehicle system.

In track mode, the system displays and plays the structure as if it were only one level deep (all .mp3 files play, regardless of being in a specific folder). In folder mode, the system only plays the .mp3 files in the current folder.

## AUDIO UNIT - VEHICLES WITH: AM/FM/CD/SYNC

### WARNING



Driving while distracted can result in loss of vehicle control, crash and injury. We strongly recommend that you use extreme caution when using any device that may take your focus off the road. Your primary responsibility is the safe operation of your vehicle. We recommend against the use of any hand-held device while driving and encourage the use of voice-operated systems when possible. Make sure you are aware of all applicable local laws that may affect the use of electronic devices while driving.

---

**Note:** *You can operate your audio system for up to one hour after you switch off the ignition. Press the **ON/OFF** control to operate the system with the ignition turned off. The system automatically turns off after one hour.*

# Audio System

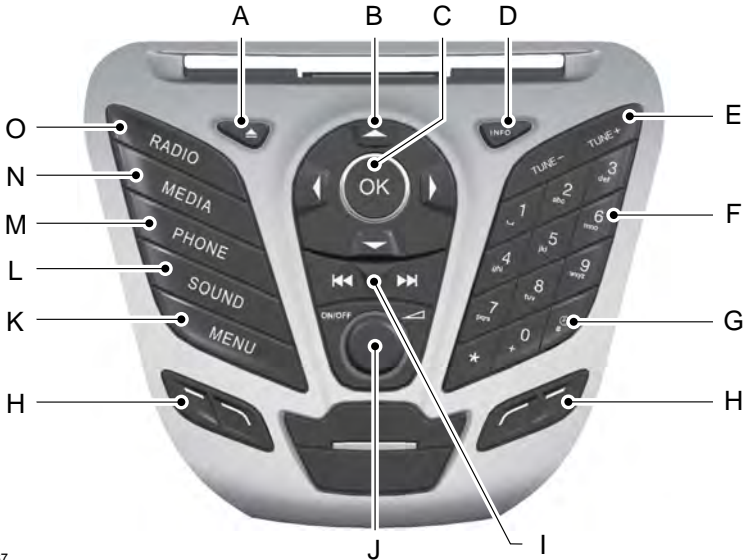

E162867

- A **Eject:** Press this button to eject a CD.
- B **Cursor arrows:** Press these buttons to scroll through on-screen audio system choices.
- C **OK:** Press this button to confirm menu selections.
- D **INFO:** Press this button to access any available radio or CD information.
- E **TUNE - and TUNE +:** Press these buttons to manually search the frequency band.
- F **Number block:** In radio mode, store your favorite radio stations. To store a radio station, tune to the station, then press and hold a preset button until sound returns. In CD mode, select a track. In phone mode, enter a phone number.
- G **Clock:** Push to access clock settings. You can also set the clock by pressing the **MENU** button and scrolling to Clock Settings.
- H **Function buttons:** Select different functions of the audio system depending on which mode you are in (such as Radio mode or CD mode).
- I **Seek:** Press and release these buttons to go to the previous or next preset radio station or disc track. Press and hold these buttons to fast forward to the previous or next strong radio station, memory preset or through the current disc track.

# Audio System

---

- J **ON/OFF:** Press this button to switch the system off and on. Turn to adjust the volume.
- K **MENU:** Press this button to access different audio system features. See **Menu Structure** later in this section.
- L **SOUND:** Press this button to access settings for Treble, Middle, Bass, Fade and Balance. Use the up and down arrow buttons to select the various settings. When you make your selection, press the left and right arrow buttons to change the settings. Press **OK** to set or press **MENU** to exit. Sound settings can be set for each audio source independently.
- M **PHONE:** Press this button to access the phone features of the SYNC system. See **SYNC™** (page 297).
- N **MEDIA:** Press this button to switch between listening to a CD and the SYNC-Media menu. To change the SYNC-Media device (such as switching from a device plugged into the USB port to a Bluetooth audio device), press **MENU** and scroll to Select Source.
- O **RADIO:** Press this button to listen to the radio or change radio frequencies. Press the function buttons below the radio screen to select different radio functions.

## AUDIO UNIT - VEHICLES WITH: PREMIUM AM/FM/CD

### WARNING



Driving while distracted can result in loss of vehicle control, crash and injury. We strongly recommend that you use extreme caution when using any device that may take your focus off the road. Your primary responsibility is the safe operation of your vehicle. We recommend against the use of any hand-held device while driving and encourage the use of voice-operated systems when possible. Make sure you are aware of all applicable local laws that may affect the use of electronic devices while driving.

---

**Note:** The CD slot is directly above the touchscreen.

**Note:** The MyFord Touch system controls most of the audio features. See **MyFord Touch™** (page 336).



# Audio System

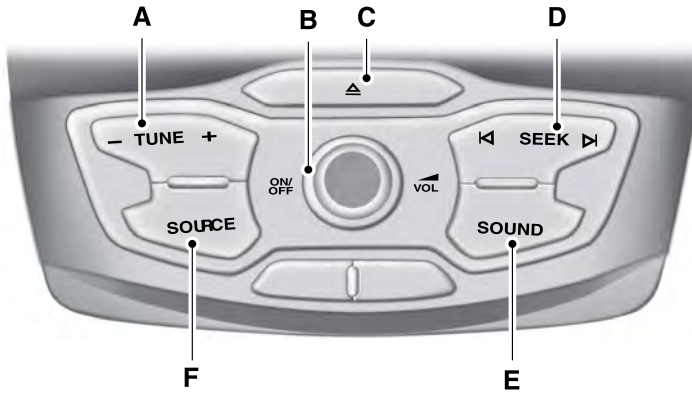

E143843

- A **- TUNE +:** Press this button to manually search through the radio frequency band.
- B **ON/OFF and VOL:** Press this button to switch the audio system off and on. Turn to adjust the volume.
- C **Eject:** Press this button to eject a CD.
- D **SEEK:** Press this button to go to the next station up or down the radio frequency band or the next or previous track on a CD.
- E **SOUND:** Press this button to adjust the sound settings for Bass, Treble, Balance and Fade.
- F **SOURCE:** Press this button to access different audio modes, such as AM, FM and A/V Input.

# Audio System

## AUDIO UNIT - VEHICLES WITH: SONY AM/FM/CD

### WARNING



Driving while distracted can result in loss of vehicle control, crash and injury. We strongly recommend that you use extreme caution when using any device that may take your focus off the road. Your primary responsibility is the safe operation of your vehicle. We recommend against the use of any hand-held device while driving and encourage the use of voice-operated systems when possible. Make sure you are aware of all applicable local laws that may affect the use of electronic devices while driving.

**Note:** The CD slot is directly above the touchscreen.

**Note:** The MyFord Touch system controls most of the audio features. See **Entertainment** (page 354).

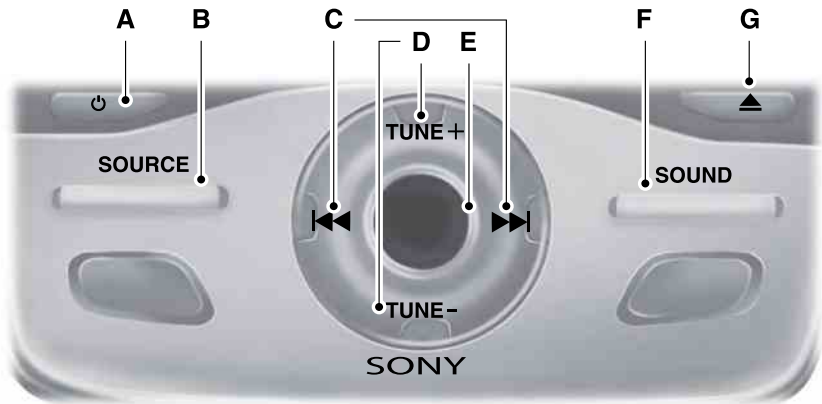

E143844

- A **Power:** Press this button to switch the system off and on.
- B **SOURCE:** Press this button to access different audio modes, such as AM, FM and A/V Input.
- C **Seek, Reverse and Fast Forward:** In radio mode, select a frequency band and press these buttons. The system stops at the first station it finds in that direction. In SIRIUS mode, press these buttons to select the previous or next channel. If a specific category is selected (such as Jazz, Rock or News), use these buttons to find the previous or next channel in the selected category. In CD mode, press these buttons to select the previous or next track.

# Audio System

- D **- TUNE +:** In radio mode, press these buttons to manually search through the radio frequency band. In SIRIUS mode, press these buttons to find the next or previous available satellite radio station.
- E **Volume:** Turn this control to adjust the volume.
- F **SOUND:** Press this button to access settings for Treble, Midrange, Bass, Balance or Fade.
- G **Eject:** Press this button to eject a CD.

## Menu Structure

**Note:** Depending on your system, some options may appear slightly different.

Press **MENU**.

Press the up and down arrow buttons to scroll through the options.

Press the right arrow to enter a menu.  
Press the left arrow to exit a menu.

Press **OK** to confirm a selection.

<b>Radio</b>	
Manual tune	Use the left and right arrows to go up or down the frequency band.
Scan	Select for a brief sampling of all available channels.
AST	Select to store the six strongest local stations on the AM 2 and FM 2 frequency bands.
PTY/Set Category	Select to have the system search by certain music categories (such as Rock, Pop or Country).
RBDS/RDS	Select to view additional broadcast data, if available. This feature defaults to off. RBDS must be on for you to set a category.

<b>SIRIUS</b>	
Scan	Select for a brief sampling of all available channels.
Show ESN	Select to view your satellite radio electronic serial number (ESN). You will need this number when communicating with Sirius to activate, modify or track your account.
Channel Guide	Select to view available satellite radio channels. Press <b>OK</b> to open a list of the following options for this channel: Tune Channel, Skip Channel or Lock Channel. Once you skip or lock a channel, you can only access it by pressing Direct and entering the channel number. Locking or unlocking a channel requires your PIN.

# Audio System

<b>SIRIUS</b>	
Set Category	Select to view channel categories (such as Pop, Rock or News). If you select a category, seek and scan functions only stop on channels in that category.
Alerts	Select to turn off or turn on alerts for songs, artists or teams. The system alerts you when the selection is playing on another channel. Save up to 20 alerts.
Unlock All Stations	Use your PIN to unlock previously locked stations.
Skip No stations	Use to restore any channels you previously skipped.
Parental Lock (PIN)	Select to create a PIN, which allows you to lock or unlock channels. Your initial PIN is 1234.

<b>Audio Settings</b>	
Spd. Comp. Vol.	Automatically adjusts the volume to compensate for speed and wind noise. You can set the system between 0 and +7.
Sound	Select to adjust settings for Treble, Midrange, Bass, Fade or Balance.
Occupancy Mode	Select to optimize sound quality for the chosen seating position.
RBDS/RDS Text	Select to view additional broadcast data, if available. This feature defaults to off. RBDS must be on for you to set a category.
DSP	Choose between STEREO SURROUND mode and STEREO mode.

<b>CD Settings</b>	
Scan All	Select to scan all disc selections.
Scan Folder	Select to scan all music in the current MP3 folder.
CD Compression	Select to bring soft and loud passages together for a more consistent listening level.

# Audio System

---

Clock Settings	
Set Time	Select to set the time.
Set Date	Select to set the calendar date.
24h Mode	Select to view clock time in a 12-hour mode or 24-hour mode.

Display Settings	
Dimming	Select to change display brightness.
Language	Select to display the language in English, French or Spanish.
Temp. setting	Select to display the outside temperature in Fahrenheit or Celsius.

## DIGITAL RADIO

**Note:** *HD Radio broadcasts are not available in all markets.*

HD Radio technology is the digital evolution of analog AM/FM radio. Your system has a special receiver that allows it to receive digital broadcasts (where available) in addition to the analog broadcasts, it already receives. Digital broadcasts provide a better sound quality than analog broadcasts with free, crystal-clear audio and no static or distortion. For more information, and a guide to available stations and programming, please visit [www.hdradio.com](http://www.hdradio.com).

When HD Radio is on and you tune to a station broadcasting HD Radio technology, you may notice the HD Radio logo on your screen. When this logo is available, you may also see Title and Artist fields on-screen.

The multicast indicator appears in FM mode (only) if the current station is broadcasting multiple digital broadcasts. The highlighted numbers signify available digital channels where new or different content is available. HD1 signifies the main programming status and is available in analog and digital broadcasts. Other multicast stations (HD2 through HD7) are only available digitally.

# Audio System

When HD Radio broadcasts are active, you can access the following functions:

- **Scan** allows you to hear a brief sampling of all available stations. This feature still works when HD Radio reception is on, although it does not scan for HD2-HD7 channels. You may see the HD logo appear if the station has a digital broadcast.

- **Memory presets** allow you to save an active channel as a memory preset. Touch and hold a memory preset slot until the sound returns. There is a brief mute while the radio saves the station. Sound returns when finished. When switching to an HD2 or HD3 memory preset, the sound mutes before the digital audio plays, because the system has to reacquire the digital signal.

**Note:** *As with any saved radio station, you cannot access the saved station if your vehicle is outside the station's reception area.*

## HD Radio Reception and Station Troubleshooting

Potential reception issues	
Reception area	If you are listening to a multicast station and you are on the fringe of the reception area, the station may mute due to weak signal strength.
	If you are listening to HD1, the system switches back to the analog broadcast until the digital broadcast is available again. However, if you are listening to any of the possible HD2-HD7 multicast channels, the station mutes and stays muted unless it is able to connect to the digital signal again.
Station blending	When the system first receives a station (aside from HD2-HD7 multicast stations), it first plays the station in the analog version. Once the receiver verifies the station is an HD Radio station, it shifts to the digital version. Depending on the station quality, you may hear a slight sound change when the station changes from analog to digital. Blending is the shift from analog to digital sound or digital back to analog sound.

In order to provide the best possible experience, use the contact form to report any station issues found while listening to a station broadcasting with HD Radio technology. Independent entities own and operate each station. These stations are responsible for ensuring all audio streams and data fields are accurate.

# Audio System

Potential station issues		
Issues	Cause	Action
Echo, stutter, skip or repeat in audio. Increase or decrease in audio volume.	This is poor time alignment by the radio broadcaster.	No action required. This is a broadcast issue.
Sound fading or blending in and out.	The radio is shifting between analog and digital audio.	No action required. The reception issue may clear up as you continue to drive.
There is an audio mute delay when selecting HD2 or HD3, multicast preset or <b>Direct Tune</b> .	The digital multicast is not available until the HD Radio broadcast is decoded. Once decoded, the audio is available.	No action required. This is normal behavior. Wait until the audio is available.
Cannot access HD2 or HD3 multicast channel when recalling a preset or from a direct tune.	The previously stored multicast preset or direct tune is not available in your current reception area.	No action required. The station is not available in your current location.
Text information does not match currently playing audio.	Data service issue by the radio broadcaster.	Fill out the station issue form at website listed below.*
There is no text information shown for currently selected frequency.	Data service issue by the radio broadcaster.	Fill out the station issue form at website listed below.*
HD2-HD7 stations not found when <b>Scan</b> is pressed.	Pressing <b>Scan</b> disables HD2-HD7 channel search.	No action required. This is normal behavior.

\* [http://www.ibiquity.com/automotive/report\\_radio\\_station\\_experiences](http://www.ibiquity.com/automotive/report_radio_station_experiences)

HD Radio Technology manufactured under license from iBiquity Digital Corp. U.S. and foreign patents. HD Radio and the HD and HD Radio logos are proprietary trademarks of iBiquity Digital Corp. Ford Motor Company and iBiquity Digital Corp. are not responsible for the content sent using HD Radio technology. Content may be changed, added or deleted at any time at the station owner's discretion.

## SATELLITE RADIO (If Equipped)

SIRIUS® broadcasts a variety of music, news, sports, weather, traffic and entertainment satellite radio channels. For more information and a complete list of SIRIUS satellite radio channels, visit [www.siriusxm.com](http://www.siriusxm.com) in the United States, [www.siriusxm.ca](http://www.siriusxm.ca) in Canada, or call SIRIUS at 1-888-539-7474.

# Audio System

**Note:** This receiver includes the eCos real-time operating system. eCos is published under the eCos License.

## Satellite Radio Reception Factors

Potential satellite radio reception issues	
Antenna obstructions	For optimal reception performance, keep the antenna clear of snow and ice build-up and keep luggage and other material as far away from the antenna as possible.
Terrain	Hills, mountains, tall buildings, bridges, tunnels, freeway overpasses, parking garages, dense tree foliage and thunderstorms can interfere with your reception.
Station overload	When you pass a ground-based broadcast-repeating tower, a stronger signal may overtake a weaker one and the audio system may mute.
Satellite radio signal interference	Your display may show ACQUIRING . . . to indicate the interference and the audio system may mute.

## SIRIUS® Satellite Radio Service

**Note:** SIRIUS reserves the unrestricted right to change, rearrange, add or delete programming including canceling, moving or adding particular channels, and its prices, at any time, with or without notice to you. Ford Motor Company shall not be responsible for any such programming changes.



E142593

SIRIUS satellite radio is a subscription-based satellite radio service that broadcasts a variety of music, sports, news, weather, traffic and entertainment programming. Your factory-installed SIRIUS satellite radio system includes hardware and a limited subscription term, which begins on the date of sale or lease of your vehicle. See an authorized dealer for availability.

For more information on extended subscription terms (a service fee is required), the online media player and a complete list of SIRIUS satellite radio channels, and other features, please visit [www.siriusxm.com](http://www.siriusxm.com) in the United States, [www.siriusxm.ca](http://www.siriusxm.ca) in Canada, or call SIRIUS at 1-888-539-7474.

## Satellite Radio Electronic Serial Number (ESN)

You need your ESN to activate, modify or track your satellite radio account. When in satellite radio mode, tune to channel 0.



# Audio System

## Troubleshooting

Message	Condition	Action
Acquiring...	Radio requires more than two seconds to produce audio for the selected channel.	No action required. This message should disappear shortly.
Satellite antenna fault SIRIUS system failure	There is an internal module or system failure present.	If this message does not clear shortly, or with an ignition key cycle, your receiver may have a fault. See an authorized dealer for service.
Invalid Channel	The channel is no longer available.	Tune to another channel or choose another preset.
Unsubscribed Channel	Your subscription does not include this channel.	Contact SIRIUS at 1-888-539-7474 to subscribe to the channel, or tune to another channel.
No Signal	The signal is lost from the SIRIUS satellite or SIRIUS tower to your vehicle antenna.	The signal is blocked. When you move into an open area, the signal should return.
Updating...	Update of channel programming in progress.	No action required. The process may take up to three minutes.
Questions? Call 1-888-539-7474	Your satellite service is no longer available.	Contact SIRIUS at 1-888-539-7474 to resolve subscription issues.
None found Check Channel Guide	All the channels in the selected category are either skipped or locked.	Use the channel guide to turn off the Lock or Skip function on that station.
Subscription Updated	SIRIUS has updated the channels available for your vehicle.	No action required.

# Audio System

## AUDIO INPUT JACK

### WARNINGS



Driving while distracted can result in loss of vehicle control, crash and injury. We strongly recommend that you use extreme caution when using any device that may take your focus off the road. Your primary responsibility is the safe operation of your vehicle. We recommend against the use of any hand-held device while driving and encourage the use of voice-operated systems when possible. Make sure you are aware of all applicable local laws that may affect the use of electronic devices while driving.



Do not connect or adjust the settings on your portable music player when your vehicle is moving.



Do not place your portable music player on the instrument panel. Hard objects may become projectiles in a crash or sudden stop, which may increase the risk of serious injury.



E149149

The audio input jack allows you to connect and play music from a portable music player through your vehicle speakers. You can use any portable music player designed for use with headphones.

Your audio extension cable must have male 1/8th-inch (3.5 millimeter) connectors at each end.

1. Switch off the radio and portable music player. Apply the parking brake and shift the transmission into park (**P**) for automatic transmission or first gear for manual transmission. Switch the ignition off.
2. Plug the extension cable from the portable music player into the audio input jack.
3. Switch the radio on. Select either a tuned FM station or a CD.
4. Adjust the volume as desired.
5. Switch your portable music player on and adjust its volume to half its maximum level.
6. Press **AUX** or **MEDIA** until **LINE** or **LINE IN** appears in the display. You should hear music from your device even if it is low.
7. Adjust the volume on your portable music player until it reaches the volume level of the FM station or CD. Do this by switching back and forth between the AUX and FM or CD controls.

## USB PORT (If Equipped)



E142604

The USB port allows you to plug in media playing devices, memory sticks and charge devices (if supported). See **SYNCTM** (page 297).

# Audio System

---

## **MEDIA HUB (If Equipped)**

The media hub is located in the center console and has the following features:

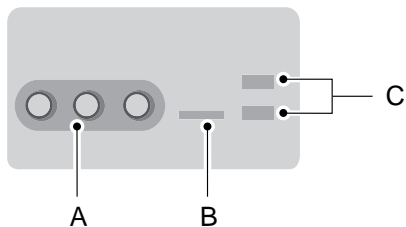

E142605

- A A/V inputs
- B SD card slot
- C USB ports

## GENERAL INFORMATION

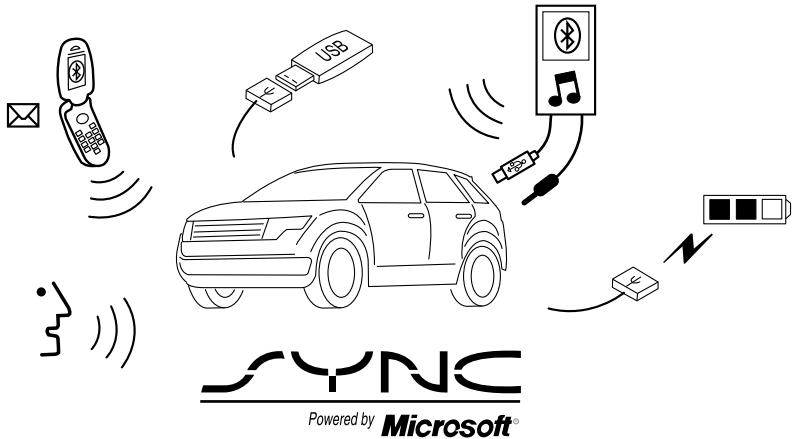

E142598

SYNC is an in-vehicle communications system that works with your Bluetooth-enabled cellular phone and portable media player. This allows you to:

- Make and receive calls.
- Access and play music from your portable music player.
- Use 911 Assist, Vehicle Health Report and SYNC Services (Traffic, Directions & Information).\*
- Use applications, such as Pandora and Stitcher, via SYNC AppLink.\*\*
- Access phonebook contacts and music using voice commands.
- Stream music from your connected phone.
- Text message.

- Use the advanced voice recognition system.
- Charge your USB device (if your device supports this).

\*These features are not available in all markets and may require activation.

\*\*Available AppLink enabled apps vary by market.

Make sure that you review your device's manual before using it with SYNC.

### Support

The SYNC support team is available to help you with any questions you cannot answer on your own.

Monday-Saturday, 8:30am-9:00pm EST.

Sunday, 10:30am-7:30pm EST.

In the United States, call 1-800-392-3673.

In Canada, call 1-800-565-3673.

Times are subject to change due to holidays.

## SYNC Owner Account

Why do I need a SYNC owner account?

- Required to activate Vehicle Health Report and to view the reports online.
- Required to activate the subscription-based SYNC Services and to personalize your Saved Points and Favorites.
- Essential for keeping up with the latest software downloads available for SYNC.
- Access to customer support for any questions you may have.

## Driving Restrictions

For your safety, certain features are speed-dependent and restricted when your vehicle is traveling over 3 mi (5 km).

## Safety Information

### WARNING



Driving while distracted can result in loss of vehicle control, crash and injury. We strongly recommend that you use extreme caution when using any device that may take your focus off the road. Your primary responsibility is the safe operation of your vehicle. We recommend against the use of any hand-held device while driving and encourage the use of voice-operated systems when possible. Make sure you are aware of all applicable local laws that may affect the use of electronic devices while driving.

---

When using SYNC:

- Do not operate playing devices if the power cords or cables are broken, split or damaged. Place cords and cables out of the way, so they do not interfere with the operation of pedals, seats, compartments or safe driving abilities.
- Do not leave playing devices in your vehicle during extreme conditions as it could cause them damage. See your device's manual for further information.
- Do not attempt to service or repair the system. See an authorized dealer.

## Privacy Information

When a cellular phone is connected to SYNC, the system creates a profile within your vehicle that is linked to that cellular phone. This profile is created in order to offer you more cellular features and to operate more efficiently. Among other things, this profile may contain data about your cellular phone book, text messages (read and unread), and call history, including history of calls when your cellular phone was not connected to the system. In addition, if you connect a media device, the system creates and retains an index of supported media content. The system also records a short development log of approximately 10 minutes of all recent system activity. The log profile and other system data may be used to improve the system and help diagnose any problems that may occur.

The cellular profile, media device index, and development log will remain in the vehicle unless you delete them and are generally accessible only in the vehicle when the cellular phone or media player is connected. If you no longer plan to use the system or the vehicle, we recommend you perform a Master Reset to erase all stored information.

System data cannot be accessed without special equipment and access to the vehicle's SYNC module. Ford Motor Company and Ford of Canada will not access the system data for any purpose other than as described absent consent, a court order, or where required by law enforcement, other government authorities, or other third parties acting with lawful authority. Other parties may seek to access the information independently of Ford Motor Company and Ford of Canada. For further privacy information, see the sections on 911 Assist, Vehicle Health Report, and Traffic, Directions and Information.

## USING VOICE RECOGNITION

This system helps you control many features using voice commands. This allows you to keep your hands on the wheel and focus on what is in front of you.

### Initiating a Voice Session



Push the voice icon. A tone sounds and Listening appears in the display. Say any of the following:

Say	If You Want To
"Bluetooth audio"	Stream audio from your phone.
"Cancel"	Cancel the requested action.
"Line in"	Access the device connected to the auxiliary input jack.
"Mobile apps" *	Access mobile applications.
"Phone"	Make calls.
"Services" *	Access the SYNC Services portal.
"SYNC"	Return to the main menu.
"USB"	Access the device connected to your USB port.
"Vehicle health report" *	Run a vehicle health report.
"Voice settings"	Adjust the level of voice interaction and feedback.
"Help"	Hear a list of voice commands available in the current mode.

\* This is an optional feature and available in the United States only.

## System Interaction and Feedback

The system provides feedback through audible tones, prompts, questions and spoken confirmations depending on the situation and the chosen level of interaction (voice settings). You can customize the voice recognition system to provide more or less instruction and feedback.

The default setting is to a higher level of interaction in order to help you learn to use the system. You can change these settings at any time.

### Adjusting the Interaction Level



Push the voice icon. Say "Voice settings" when prompted, then any of the following:

When you say:	The system:
"Interaction mode standard"	Provides more detailed interaction and guidance.
"Interaction mode advanced"	Provides less audible interaction and more tone prompts.

The system defaults to the standard interaction mode.

Confirmation prompts are short questions the system asks when it is not sure of your request or when there are multiple possible responses to your request. For example, the system may ask "Phone, is that correct?". If turned off, the system simply makes a best guess as to what you requested and may ask you to confirm settings.

When you say:	The system:
"Confirmation prompts off"	Makes a best guess from the command; you may still occasionally be asked to confirm settings.
"Confirmation prompts on"	Clarifies your voice command with a short question.

The system creates candidate lists when it has the same confidence level of several options based on your voice command. When turned on, it may prompt you with as many as four possibilities for clarification.

For example, say "Say 1 after the tone to call John Doe at home. Say 2 after the tone to call Johnny Doe on mobile. Say 3 after the tone to call Jane Doe at home." You could also say "Say 1 after the tone to play John Doe, Say 2 after the tone to play Johnny Doe."

<b>When you say:</b>	<b>The system:</b>
"Media candidate lists off"	Makes a best guess from the media candidate list. You may still occasionally be asked questions.
"Media candidate lists on"	Clarifies your voice command for media candidates.
"Phone candidate lists off"	Makes a best guess from the phone candidate list. You may still occasionally be asked questions.
"Phone candidate lists on"	Clarifies your voice command for phone candidates

## Helpful Hints

- Make sure the interior of your vehicle is as quiet as possible. Wind noise from open windows and road vibrations may prevent the system from correctly recognizing spoken commands.
- After pressing the voice icon, wait until after the tone sounds and Listening appears before saying a command. Any command spoken before this does not register with the system.
- Speak naturally, without long pauses between words.
- At any time, you can interrupt the system while it is speaking by pressing the voice icon.

## USING SYNC™ WITH YOUR PHONE

Hands-free calling is one of the main features of SYNC. While the system supports a variety of features, many are dependent on your cellular phone's functionality. At a minimum, most cellular phones with Bluetooth wireless technology support the following functions:

- Answering an incoming call.
- Ending a call.
- Using privacy mode.
- Dialing a number.
- Redialing.
- Call waiting notification.
- Caller ID.

Other features, such as text messaging using Bluetooth and automatic phonebook download, are phone-dependent features. To check your phone's compatibility, see your phone's manual and visit [www.SYNCMYRide.com](http://www.SYNCMYRide.com).



## Pairing a Phone for the First Time

**Note:** SYNC can support downloading up to approximately 1000 entries per Bluetooth-enabled cellular phone.

**Note:** Make sure to switch on the ignition and the radio. Put the transmission in position **P**.

**Note:** To scroll through the menus, press the up and down arrows on your audio system.

Wirelessly pairing your phone with SYNC allows you to make and receive hands-free calls.

1. Press the phone button. When the display indicates there is no phone paired, press **OK**.
2. When **Find SYNC** appears in the display, press **OK**.
3. Put your phone into Bluetooth discovery mode. See your device's manual if necessary.
4. When prompted on your phone's display, enter the six-digit PIN provided by SYNC in the radio display. The display indicates when the pairing is successful.

Depending on your phone's capability and your market, the system may prompt you with questions, such as setting the current phone as the primary phone (the phone SYNC automatically tries to connect with first upon vehicle start-up) and downloading your phonebook.

## Pairing Subsequent Phones

**Note:** Make sure to switch on the ignition and the radio. Put the transmission in position **P**.

**Note:** To scroll through the menus, press the up and down arrows on your audio system.

1. Press the phone button, and then scroll to System Settings. Press **OK**.
2. Scroll to Bluetooth Devices. Press **OK**.
3. Scroll to Add Bluetooth Device. Press **OK**.
4. When **Find SYNC** appears in the display, press **OK**.
5. Put your phone into Bluetooth discovery mode. See your phone's manual if necessary.
6. When prompted on your phone's display, enter the six-digit PIN provided by SYNC in the radio display. The display indicates when the pairing is successful.

The system then prompts with questions, such as if you would like to set the current phone as the primary phone (the phone SYNC automatically tries to connect with first upon vehicle start-up) and download your phone book.

## Phone Voice Commands

<b>"PHONE"</b>
"Call <name>" <sup>1,2</sup>
"Call <name> at home" <sup>1,2</sup>
"Call <name> at work" <sup>1,2</sup>
"Call <name> in office" <sup>1,2</sup>
"Call <name> on mobile OR cell" <sup>1,2</sup>
"Call <name> on other" <sup>1,2</sup>
"Call history incoming" <sup>2</sup>
"Call history missed" <sup>2</sup>
"Call history outgoing" <sup>2</sup>

"PHONE"
"Connections" <sup>1,2</sup>
"Dial" <sup>1,3</sup>
"Go to privacy"
"Hold"
"Join"
"Menu" <sup>1,2,4</sup>
"Phone book <name>" <sup>1,2</sup>
"Phone book <name> at home" <sup>1,2</sup>
"Phone book <name> at office" <sup>1,2</sup>
"Phone book <name> at work" <sup>1,2</sup>
"Phone book <name> on mobile OR cell" <sup>1,2</sup>
"Phone book <name> on other" <sup>1,2</sup>

<sup>1</sup> These commands do not require you to say "Phone" first.

<sup>2</sup> These commands are not available until phone information is completely downloaded using Bluetooth.

<sup>3</sup> See **Dial** table below.

<sup>4</sup> See **Menu** table below.

**Phone book commands:** When you ask SYNC to access things such as a phonebook name or number, the requested information appears in the display to view. Press the phone button and say, "Call" to call the contact.

"DIAL"
"411 (four-one-one)", "911" (nine-one-one)
"700" (seven hundred)
"800" (eight hundred)
"900" (nine hundred)
"Pound" (#)
"Number <0-9>"
"Asterisk" (*)
"Clear" (deletes all entered digits)
"Delete" (deletes one digit)
"Plus"
"Star"

**Note:** To exit dial mode, press and hold the phone button or press **MENU** to go to the phone menu.

"MENU"
"(Phone) connections"
"(Phone) settings (message) notification off"
"(Phone) settings (message) notification on"
"(Phone) settings (set) phone ringer"
"(Phone) settings (set) ringer 1"
"(Phone) settings (set) ringer 2"
"(Phone) settings (set) ringer 3"
"(Phone) settings (set) ringer off"
"Battery"
"Phone name"

<b>"MENU"</b>
"Signal"
"Text message inbox"

Words in ( ) are optional and do not have to be spoken for the system to understand the command.

## Making Calls

Press the voice icon and when prompted say:

1. Say "Call <name>" or "Dial", then the desired number.
2. When the system confirms the number, say, "Dial" again to initiate the call.

To erase the last spoken digit, say, "Delete" or press the left arrow button. To erase all spoken digits, say "Clear" or press and hold the left arrow button.

To end the call, press and hold the phone button.

## Receiving Calls

When receiving a call, you can:

- Answer the call by pressing the phone button.
- Reject the call by pressing and holding the phone button.
- Ignore the call by doing nothing.

## Phone Options during an Active Call

During an active call, you have more menu features that become available, such as putting a call on hold or joining calls. Use the arrow buttons to scroll through the menu options.

1. Press **MENU** during an active call.
2. After selecting Active Call Menu, press **OK**.
3. Scroll to cycle through the following options:

<b>When you select:</b>	<b>You can:</b>
Mute Call?	Mute the call.
Privacy	Switch a call from an active hands-free environment to your cellular phone for a more private conversation. Press <b>OK</b> when <b>Privacy on/off</b> appears. (The display indicates In Privacy and the system transfers your call.)
Call Hold	Put an active call on hold. Press <b>OK</b> when <b>Hold on/off</b> appears. To answer another call at this time, press the phone button.
Enter Tones	Enter "tones", such as numbers for passwords. Scroll until the desired number appears in the display, then press <b>OK</b> ; a tone sounds as confirmation. Repeat as necessary.
Join Calls	Join two separate calls. (SYNC supports a maximum of three callers on a multiparty call or conference call.) 1. Press the phone button.

When you select:	You can:
	2. Access the desired contact through SYNC or use voice commands to place the second call. Once actively in the second call, press <b>MENU</b> . 3. Scroll to Join Calls, and press <b>OK</b> . Press <b>OK</b> again when <b>Join Calls?</b> appears.
Phonebook	Access your phonebook contacts. 1. Press <b>OK</b> to select, and then scroll through your phonebook contacts. 2. Press <b>OK</b> again when the desired selection appears in the display. 3. Press the phone button.
Call History	Access your call history log. 1. Press <b>OK</b> to select, then scroll through your call history options (incoming, outgoing or missed). 2. Press <b>OK</b> when the desired selection appears in the display. 3. Press the phone button to call the selection.
Return	Exit the current menu.

## Accessing Features through the Phone Menu

SYNC's phone menu allows you to redial a number, access your call history and phonebook and sends text messages as well as access phone and system settings.

1. Press the phone button to enter the phone menu.
2. Scroll to cycle through:

When you select:	You can:
Phone Redial	Redial the last number called (if available). Press <b>OK</b> to select, and then press <b>OK</b> again to confirm.
Call History <sup>1</sup>	Access any previously dialed, received or missed calls after you connect your Bluetooth-enabled phone to SYNC. 1. Press <b>OK</b> to select. 2. Scroll to select from Call History Incoming, Call History Outgoing or Call History Missed. Press <b>OK</b> to make your selection. 3. Press <b>OK</b> or the phone button to call the desired selection.

# SYNC™

When you select:	You can:
	<p><b>Note:</b> The system attempts to automatically re-download your phonebook and call history each time your phone connects to SYNC (if the auto download feature is on and your Bluetooth-enabled cellular phone supports this feature).</p>
Phonebook <sup>1,2</sup>	<p>Access and call any contacts in your previously downloaded phonebook.</p> <ol style="list-style-type: none"> <li>1. Press <b>OK</b> to confirm and enter. If your phonebook has fewer than 255 listings, they appear alphabetically in flat file mode. If there are more than 255 entries, the system organizes them into alphabetical categories.</li> <li>2. Scroll until the desired contact appears, then press <b>OK</b>.</li> <li>3. Press <b>OK</b> or the phone button.</li> </ol>
Text Message <sup>1</sup>	Send, download and delete text messages.
Phone Settings <sup>1</sup>	View your phone's status, set ring tones, select your message notification, change phone book entries and automatically download your cellular phone among other features.
SYNC Services	Access the SYNC Services portal where you can request various types of information, for example traffic reports and directions <sup>3</sup> .
911 Assist	Automatically place an emergency call to a 911 operator following a crash <sup>4</sup> .
Vehicle Health Report	Create and receive a diagnostic report card on your vehicle <sup>3</sup> .
Mobile Apps	Interact with SYNC-capable mobile applications on your smartphone <sup>3</sup> .
System Settings	Access Bluetooth Devices menu listings (Add, Connect, Set as Primary, On and Off, Delete) as well as Advanced menu listings (prompts, languages, defaults, master reset, install application and system information).
Exit Phone Menu	Exit the phone menu by pressing OK.

<sup>1</sup> This is a phone-dependent feature.

<sup>2</sup> This is a phone-dependent and speed-dependent feature.

<sup>3</sup> This is an optional feature and available in the United States only.

## Text Messaging

**Note:** *This is a phone-dependent feature.*

SYNC allows you to receive, send, download and delete text messages. The system can also read incoming text messages to you so that you do not have to take your eyes off the road.

### Receiving a Text Message

**Note:** *This is a phone-dependent feature. Your phone must support downloading text messages using Bluetooth to receive incoming text messages.*

When a new message arrives, an audible tone sounds and the display indicates you have a new message. You have these options:

- Press the voice button, wait for the prompt and say "Read message" to have SYNC read the message to you.
- Press **OK** to receive and open the text message or do nothing and the message goes into your text message inbox. Press **OK** again and SYNC reads your message aloud as you are not able to view the message. You can then also choose to reply or forward the message.
- Press **OK** and scroll to choose between:
  - **Reply to Text Message:** Press **OK** to access and then scroll through the list of pre-defined messages to send.
  - **Forward Text Message:** Press **OK** to forward the message to anyone in your Phonebook or Call History. You can also choose Enter Number.

## Sending, Downloading and Deleting Your Text Messages

**Note:** *Forwarding a text message is a speed-dependent feature and is only available when your vehicle is traveling at 3 mph (5 km/h) or less.*

**Note:** *You can only have one recipient per text message.*

Text messaging is a phone-dependent feature. If your phone is compatible, SYNC allows you to receive, send, download and delete text messages.

1. Press the phone button.
2. Scroll to Text Message, and then press **OK**.

Scroll to select from the following options:

- **Send Text Message?** allows you to send a new text message based on a pre-defined set of 15 messages.
- **Download Unread Msgs** allows you to download your unread messages (only) to SYNC. To download the messages, press **OK** to select. The display indicates that it is downloading your messages. When it is complete, SYNC takes you to your inbox.
- **Delete All Messages?** allows you to delete current text messages from SYNC (not your phone). To delete the messages, press **OK** to select. The display indicates when it is finished deleting all your text messages. SYNC returns you to the text message menu.
- **Return** exits the current menu when you press **OK**.

If you select **Send Text Message?**:

1. Press **OK** to select. If the system detects your phone does not support this feature, **Unsupported** appears in the display and SYNC returns to the main menu.
2. Scroll to cycle through the message options in the following chart.

3. Press **OK** when the desired selection is in the display.
4. Enter the name of the recipient. Scroll to cycle through Phonebook or Call History entries. You can also select Enter Number to say the desired number.
5. Press **OK** to enter the desired menu and scroll to select the specific contact.
6. Press **OK** when the contact appears and press **OK** again to confirm when the system asks if you would like to send the message. The system sends each text message with the following signature: "This message was sent from my <Ford or Lincoln>".

Pre-defined text message options
No
Why?
Thanks
Where R you?
I need more directions
I love you
Too funny
Can't wait to see you
I'm stuck in traffic

Pre-defined text message options
Can't talk right now
Call me
Call U later
Be there in 10 minutes
Be there in 20 minutes
Yes

## Accessing Your Phone Settings

These are phone-dependent features. Your phone settings allow you to access and adjust features such as your ring tone, text message notification, modify your phonebook and set up automatic download.

1. Press the phone button.
2. Scroll to Phone Settings, and then press **OK**.
3. Scroll to select from the following options:

When you select:	You can:
Phone Status	See the provider, name, signal power, battery power and roaming status of your connected phone. Press <b>OK</b> to select and scroll to view the information. When done, press <b>OK</b> again to return to the phone status menu.
Set Ringer	Select which ring tone sounds during an incoming call (one of the system's or your phone's). <ol style="list-style-type: none"> <li>1. Press <b>OK</b> to select and scroll to hear Ringer 1, Ringer 2, Ringer 3 and Phone Ringer.</li> <li>2. Press <b>OK</b> to select.</li> </ol>

When you select:	You can:
	If your phone supports in-band ringing, your phone's ring tone plays when you choose Phone Ringer.
Message Notification	Have the option of hearing an audible tone to notify you when a text message arrives. 1. Press <b>OK</b> to select and scroll between Message Notification On and Message Notification Off. 2. Press <b>OK</b> to select.
Modify Phonebook	Modify the contents of your phonebook (such as add, delete or download). Press <b>OK</b> to choose between:
	Add Contacts: Press <b>OK</b> to add more contacts from your phone book. Push the desired contact(s) on your phone. See your phone's manual on how to push contacts.
	Delete Phonebook: Press <b>OK</b> to delete the current phone book and call history. When <b>Delete Phonebook</b> appears, press <b>OK</b> to confirm. SYNC takes you back to the Phone Settings menu.
Auto Download	Download Phonebook: Press <b>OK</b> to select, then and press <b>OK</b> again when <b>Confirm Download?</b> appears.
	Automatically download your phone book each time your phone connects to SYNC.* Press <b>OK</b> to select. When <b>Auto Download On?</b> appears, press <b>OK</b> to have your phonebook automatically downloaded each time.** Select Off if you do not want to download your phonebook every time your phone connects to SYNC. Your phonebook, call history and text messages can only be accessed when your specific phone is connected to SYNC.
Return	Exit the current menu.

\*Downloading times are phone-dependent and quantity-dependent.

\*\*When Auto Download is on, it automatically deletes any changes, additions or deletions saved since your last download.

## System Settings

This menu provides access to your Bluetooth Devices and Advanced menu features. Use the arrow buttons to scroll through the menu options.

## Bluetooth Devices

The Bluetooth Devices menu allows you to add, connect and delete devices, set a phone as primary as well as turn your Bluetooth feature on and off.



# SYNC™

1. Press the phone button to enter the phone menu
2. Scroll to System Settings. Press **OK**.
3. Scroll to Bluetooth Devices. Press **OK**.
4. Scroll to select from the following options:

If You Select	You Can
Add Bluetooth Device*	See <b>Using SYNC™ With Your Phone</b> (page 301).
Connect Bluetooth Device	Connect a previously paired Bluetooth-enabled phone.** 1. Press <b>OK</b> to select and view a list of previously paired phones. 2. Scroll until you find the desired device, and then press <b>OK</b> to connect the phone.
Set as Primary Phone?	Set a previously paired phone as your primary phone. Press <b>OK</b> to select and scroll to select the desired phone. Press <b>OK</b> to confirm. SYNC attempts to connect with the primary phone at every ignition cycle. When you select a phone as a primary phone, it appears first in the list and the system marks it with an asterisk.
Set Bluetooth	Turn the Bluetooth feature on and off. Press <b>OK</b> and scroll to toggle between On and Off. Make a selection, and then press <b>OK</b> . Setting Bluetooth to off disconnects all Bluetooth devices and turns off all Bluetooth features.
Delete Device	Delete a paired phone. Press <b>OK</b> and scroll to select the device. Press <b>OK</b> to confirm.
Delete All Devices	Delete all previously paired phones (and all information originally saved with those phones). Press <b>OK</b> to select.
Return	Exit the current menu.

\* This is a speed-dependent feature.

\*\*You can only connect one device at a time. When another phone is connected, the previous one is disconnected.

## Advanced

The Advanced menu allows you to access and set prompts, languages, defaults, perform a master reset, install an application and view system information.

1. Press the phone button to enter the phone menu
2. Scroll to System Settings. Press **OK**.
3. Scroll to Advanced. Press **OK**.
4. Scroll to select from the following options:

If you select:	You can:
Prompts	Get help from SYNC by using questions, helpful hints or asking you for a specific action. To turn these prompts on or off: 1. Press <b>OK</b> to select and scroll to select between On and Off. 2. Press <b>OK</b> when the desired selection appears in the display. SYNC takes you back to the Advanced menu.
Languages	Choose between English, Français and Español. Once selected, all of the radio displays and prompts are in the selected language. 1. Press <b>OK</b> to select and then scroll through the languages. 2. Press <b>OK</b> when the desired selection appears in the display. If you change the language setting, the display indicates that the system is updating. When complete, SYNC takes you back to the Advanced menu.
Factory Defaults	Return to the factory default settings. This selection does not erase your indexed information (phonebook, call history, text messages and paired devices). 1. Press <b>OK</b> to select and then press <b>OK</b> again when <b>Restore Defaults?</b> appears in the display. 2. Press <b>OK</b> to confirm.
Master Reset	Completely erase all information stored on SYNC (phonebook, call history, text messages and paired devices) and return to the factory default settings. Press <b>OK</b> to select. The display indicates when complete and SYNC takes you back to the Advanced menu.
Install Application?	Install applications you have downloaded. Press the <b>OK</b> button and scroll to select. Press the <b>OK</b> button to confirm.
Delete All Devices	Delete all previously paired phones (and all information originally saved with those phones). Press <b>OK</b> to select.

If you select:	You can:
System Info	Access the Auto Version number as well as the FDN number. Press <b>OK</b> to select.
MAP Profile	This is a Bluetooth component, which can further help your phone with the exchange of text messages.
Return	Exit the current menu.

## SYNC™ APPLICATIONS AND SERVICES (If Equipped)

In order for the following features to work, your cellular phone must be compatible with SYNC. To check your phone's compatibility, visit [www.SYNCMYRide.com](http://www.SYNCMYRide.com), [www.SYNCMYRide.ca](http://www.SYNCMYRide.ca) or [www.syncmaroute.ca](http://www.syncmaroute.ca)

- SYNC Services\*: Provides access to traffic, directions and information such as travel, horoscopes, stock prices and more.
- 911 Assist: Can alert 911 in the event of an emergency.
- Vehicle Health Report\*: Provides a diagnostic and maintenance report card of your vehicle.
- SYNC AppLink: Allows you to connect to and use certain applications such as Pandora and Stitcher (if your phone is compatible).

\*This is an optional feature and available in the United States only.

### 911 Assist (If Equipped)

#### WARNINGS



Unless the 911 Assist setting is set on before a crash, the system will not dial for help which could delay response time, potentially increasing the risk of serious injury or death after a crash.

#### WARNINGS



Do not wait for 911 Assist to make an emergency call if you can do it yourself. Dial emergency services immediately to avoid delayed response time which could increase the risk of serious injury or death after a crash. If you do not hear 911 Assist within five seconds of the crash, the system or phone may be damaged or non-functional.



Always place your phone in a secure location in your vehicle so it does not become a projectile or get damaged in a crash. Failure to do so may cause serious injury to someone or damage the phone which could prevent 911 Assist from working properly.

**Note:** The SYNC 911 Assist feature must be set on before the incident.

**Note:** Before setting this feature on, make sure that you read the 911 Assist Privacy Notice later in this section for important information.

**Note:** If any user turns 911 Assist on or off, that setting applies for all paired phones. If 911 Assist is turned off, either a voice message plays or a display message (or icon) comes on (or both) when your vehicle is started after a previously paired phone connects.

**Note:** *Every phone operates differently. While SYNC 911 Assist works with most cellular phones, some may have trouble using this feature.*

If a crash deploys an airbag (excluding knee airbags and rear inflatable safety belts [if equipped]) or activates the fuel pump shut-off, your SYNC-equipped vehicle may be able to contact emergency services by dialing 911 through a paired and connected Bluetooth-enabled phone. You can learn more about the 911 Assist feature, visit [www.SYNCMYride.com](http://www.SYNCMYride.com), [www.SYNCMYride.ca](http://www.SYNCMYride.ca) or [www.syncmaroute.ca](http://www.syncmaroute.ca).

See **Supplementary Restraints System** (page 35). Important information about airbag deployment is in this chapter.

See **Roadside Emergencies** (page 191). Important information about the fuel pump shut-off is in this chapter.

## Setting 911 Assist On or Off

1. Press the phone button to enter the phone menu.
2. Scroll to select 911 Assist.
3. Press **OK** to confirm and enter the 911 Assist menu.
4. Scroll to select between On or Off.
5. Press **OK** when the desired option appears in the radio display. **Set On** or **Set Off** appears in the display as confirmation.

Off selections include:

- Off with reminder: Provides a display and voice reminder at phone connection at vehicle start.
- Off without reminder: Provides a display reminder only without a voice reminder at phone connection.

To make sure that 911 Assist works properly:

- SYNC must be powered and working properly at the time of the incident and throughout feature activation and use.
- The 911 Assist feature must be set on before the incident.
- You must pair and connect a Bluetooth-enabled and compatible cell phone to SYNC.
- A connected Bluetooth-enabled phone must have the ability to make and maintain an outgoing call at the time of the incident.
- A connected Bluetooth-enabled phone must have adequate network coverage, battery power and signal strength.
- The vehicle must have battery power and be located in the U.S., Canada or in a territory in which 911 is the emergency number.

## In the Event of a Crash

Not all crashes will deploy an airbag or activate the fuel pump shut-off (the triggers for 911 Assist). If a connected cell phone sustains damage or loses its connection to SYNC during a crash, SYNC will search for and try to connect to a previously paired cell phone; SYNC will then attempt to call the emergency services.

Before making the call:

- SYNC provides a short window of time (about 10 seconds) to cancel the call. If you fail to cancel the call, SYNC attempts to dial 911.
- SYNC says the following, or a similar message: "SYNC will attempt to call 911, to cancel the call, press Cancel on your screen or press and hold the phone button on your steering wheel."

If you do not cancel the call, and SYNC makes a successful call, a pre-recorded message plays for the 911 operator, and then the occupant(s) in your vehicle is able to talk with the operator. Be prepared to provide your name, phone number and location immediately, because not all 911 systems are capable of receiving this information electronically.

### 911 Assist May Not Work If

- Your cellular phone or 911 Assist hardware sustains damage in a crash.
- The vehicle's battery or the SYNC system has no power.
- The phone(s) previously paired or connected to the system are thrown from your vehicle.

### 911 Assist Privacy Notice

When you turn on 911 Assist, it may disclose to emergency services that your vehicle has been in a crash involving the deployment of an airbag or activation of the fuel pump shut-off. Certain versions or updates to 911 Assist may also be capable of electronically or verbally disclosing to 911 operators your vehicle location or other details about your vehicle or crash to assist 911 operators to provide the most appropriate emergency services. If you do not want to disclose this information, do not turn the feature on.

## Vehicle Health Report

### WARNING



Always follow scheduled maintenance instructions, regularly inspect your vehicle, and seek repair for any damage or problem you suspect. Vehicle Health Report supplements, but cannot replace, normal maintenance and vehicle inspection. Vehicle Health Report only monitors certain systems electronically monitored by your vehicle and will not monitor or report the status of any other system, (such as brake lining wear). Failure to perform scheduled maintenance and regularly inspect your vehicle may result in vehicle damage and serious injury.

**Note:** This feature is only available in the United States.

**Note:** Your Vehicle Health Report feature requires activation before use. Visit [www.SYNCMyRide.com](http://www.SYNCMyRide.com) to register. There is no fee or subscription associated with Vehicle Health Report, but you must register to use this feature.

**Note:** This feature may not function properly if you have enabled caller ID blocking on your cellular phone. Before running a report, review the Vehicle Health Report Privacy Notice.

**Note:** In order to allow a break-in period for your vehicle, you may not be able to create a Vehicle Health Report until your vehicle odometer has reached 200 miles.

**Note:** Cellular phone and SMS charges may apply when making a report.

Register for Vehicle Health Report and set your report preferences at [www.SYNCMYride.com](http://www.SYNCMYride.com). After registering, you can request a Vehicle Health Report (inside your vehicle). Return to your account at [www.SYNCMYride.com](http://www.SYNCMYride.com) to view your report. You can also choose for SYNC to remind you automatically to run reports at specific mileage intervals.

The system allows you to check your vehicle's overall health in the form of a diagnostic report card. The Vehicle Health Report contains valuable information such as:

- Vehicle diagnostic information
- Scheduled maintenance

- Open recalls and Field Service Actions
- Items noted during vehicle inspections by an authorized dealer that still need servicing.

You can run a report (after your vehicle has been running a minimum of 60 seconds) by pressing the voice button and saying "Vehicle Health Report", or pressing the phone button.

To run a report using the phone button:

1. Press the phone button to enter phone menu.
2. Scroll to select Vehicle Health, and then press **OK**.
3. Scroll to select from the following options:

<b>Vehicle Health Report options</b>	
User Preferences: Press <b>OK</b> to select and enter the menu. Scroll to select from:	<p><b>Automatic Reports:</b> Press <b>OK</b> to and select On or Off. Select On to have SYNC automatically prompt you to run a health report at certain mileage intervals.*</p> <p><b>Mileage Intervals:</b> Press <b>OK</b>. Scroll to select between 5000, 7500 or 10000-mile intervals and press <b>OK</b> to make your selection.</p> <p><b>Return:</b> Press OK to exit the menu.</p>
Run Report?	Press <b>OK</b> for SYNC to run a health report of your vehicle's diagnostic systems and send the results to Ford where it combines with scheduled maintenance information, open recalls and other field service actions and vehicle inspection items that still need servicing from an authorized dealer.
Return	Exit the current menu.

\*You must first turn this feature on before you can select the desired mileage interval.

## Vehicle Health Report Privacy Notice

When you create a Vehicle Health Report, Ford Motor Company may collect your cellular phone number (to process your report request) and diagnostic information about your vehicle. Certain versions or updates to Vehicle Health Report may also collect more vehicle information. Ford may use your vehicle information it collects for any purpose. If you do not want to disclose your cellular phone number or vehicle information, do not run the feature or set up your Vehicle Health Report profile at [www.SYNCMYRide.com](http://www.SYNCMYRide.com). See [www.SYNCMYRide.com](http://www.SYNCMYRide.com) (Vehicle Health Report Terms and Conditions, and Privacy Statement) for more information.

## SYNC Services: Traffic, Directions & Information (TDI) (If Equipped, Unites States Only)

**Note:** SYNC Services varies by trim level and model year and may require a subscription. Traffic alerts and turn-by-turn directions available in select markets. Message and data rates may apply. Ford Motor Company reserves the right to change or discontinue this product service at any time without prior notification or incurring any future obligation.

**Note:** SYNC Services requires activation before use. Visit [www.SYNCMYRide.com](http://www.SYNCMYRide.com) to register and check your eligibility for complimentary services. Standard phone and message rates may apply. Subscription may be required. You must also have the active SYNC Services Bluetooth-enabled cellular phone paired and connected to the system in order to connect to, and use, SYNC Services. See **Using SYNC™ With Your Phone** (page 301).

**Note:** This feature does not function properly if you have enabled caller ID blocking on your cellular phone. Make sure your cellular phone is not blocking caller ID before using SYNC Services.

**Note:** The driver is ultimately responsible for the safe operation of the vehicle, and therefore, must evaluate whether it is safe to follow the suggested directions. Any navigation features provided are only an aid. Make your driving decisions based on your observations of local conditions and existing traffic regulations. Do not follow the route suggestions if doing so would result in an unsafe or illegal maneuver, place you in an unsafe situation, or if you would be directed into an area that you consider unsafe. Maps used by this system may be inaccurate because of errors, changes in roads, traffic conditions or driving conditions.

**Note:** When you connect, the service uses GPS technology and advanced vehicle sensors to collect your vehicle's current location, travel direction and speed to help provide you with the directions, traffic reports, or business searches you request. Further, to provide the services you request, for continuous improvement, the service may collect and record call details and voice communications. For more information, see SYNC Services Terms and Conditions at [www.SYNCMYRide.com](http://www.SYNCMYRide.com). If you do not want Ford or its service providers to collect your vehicle travel information or other information identified in the Terms and Conditions, do not subscribe or use the service.

SYNC Services uses advanced vehicle sensors, integrated GPS technology and comprehensive map and traffic data, to give you personalized traffic reports, precise turn-by-turn directions, business search, news, sports, weather and more. For a complete list of services, or to learn more, please visit [www.SYNCMYRide.com](http://www.SYNCMYRide.com).

## Connecting to SYNC Services Using Voice Commands

1. Press the voice button.

2. When prompted, say "Services". This initiates an outgoing call to SYNC Services using your paired and connected Bluetooth-enabled cellular phone.
3. Once you connect to the service, follow the voice prompts to request the desired service, such as Traffic or Directions. You can also say, "What are my choices?" to receive a list of available services from which to choose.
4. Say, "Services" to return to the Services main menu or for help, say, "Help".

## Connecting to SYNC Services Using the Phone Menu

1. Press the phone button to enter the phone menu.
2. Scroll to Services.
3. Press **OK** to confirm and enter the Services menu. The display indicates the system is connecting.
4. Press **OK**. SYNC initiates the call to the Services portal.
5. Once you connect to the service, follow the voice prompts to request the desired service, such as Traffic or Directions. You can also say, "What are my choices?" to receive a list of available services from which to choose.
6. Say, "Services" to return to the Services main menu or for help, say, "Help".

## Receiving Turn-by-Turn Directions

1. When connected to SYNC Services, say "Directions" or "Business search". To find the closest business or type of business to your current location, just say "Business search" and then "Search near me". If you need further

assistance in finding a location you can say "Operator" at any time within a Directions or Business search to speak with a live operator. The system may prompt you to speak with an operator when it has difficulty matching your voice request. The live operator can assist you by searching for businesses by name or by category, residential addresses by street address or by name or specific street intersections. Operator Assist is a feature of your SYNC Services subscription. For more information on Operator Assist, visit [www.SYNCMyRide.com/support](http://www.SYNCMyRide.com/support).

2. Follow the voice prompts to select your destination. Once you select your destination, the system uploads your current vehicle location, calculates a route based on current traffic conditions and sends it back to your vehicle. After the route download is complete, the phone call automatically ends. You then receive audible and visual driving instructions as you travel toward your destination.
3. While on an active route, you can select or say "Route summary" or "Route status" to view the Route Summary turn list or the Route Status ETA. You can also turn voice guidance on or off, cancel the route or update the route.

If you miss a turn, SYNC automatically asks if you want the route updated. Just say, "Yes" when prompted and the system sends a new route to your vehicle.

## Disconnecting from SYNC Services

1. Press and hold the phone button on the steering wheel.
2. Say "Goodbye" from the SYNC Services main menu.



SYNC Services quick tips	
Personalizing	You can personalize your Services feature to provide quicker access to your most used or favorite information. You can save address points such as work or home. You can also save favorite information like sports teams or a news category. You can learn more about personalization by logging onto <a href="http://www.SYNCMyRide.com">www.SYNCMyRide.com</a> .
Push to interrupt	Press the voice button at any time (while connected to SYNC Services) to interrupt a voice prompt or an audio clip (such as a sports report) and say your voice command.
Portable	Your subscription is associated with your Bluetooth-enabled cellular phone number, not your VIN (Vehicle Identification Number). You can pair and connect your phone to any vehicle equipped with SYNC Services and continue enjoying your personalized services. You can even access your account outside your vehicle. Just use the number on your phone's call history. Traffic and Directions features do not function properly but information services and the 411 connect and text message features are available.

## SYNC AppLink

**Note:** This feature is only available in the United States.

**Note:** You must pair and connect your smartphone to SYNC to access AppLink.

**Note:** iPhone users need to connect the phone to the USB port in order to start the application. We recommend you lock your iPhone after starting an application.

**Note:** The AppLink feature is not available if your vehicle is equipped with the MyFord Touch or MyLincoln Touch system.

**Note:** Depending on your display type, you can access AppLink from the media menu, the phone menu, or by using voice commands. Once an app is running through AppLink, you can control main features of the app through voice commands and steering wheel controls.

## To Access Using the Phone Menu

1. Press the phone button to access the SYNC phone menu on-screen.
2. Scroll to Mobile Apps and press OK to access a list of available applications.
3. Scroll through the list of available applications and press OK to select a particular app.
4. Once an app is running through SYNC, you can access an app's menu by pressing the **MENU** button to first access the SYNC menu.
5. Select "SYNC-Media" by pressing **OK**.
6. Scroll until "<App name> Menu" is displayed (such as, Pandora Menu), then press **OK**. From here, you can access an application's features, such as Thumbs up and Thumbs down. For more information, please visit [www.SYNCMyRide.com](http://www.SYNCMyRide.com).

## To Access Using the Media Menu

1. Press the **AUX** button on the center console.
2. Press **MENU** to access the SYNC menu.
3. Select "SYNC-Media" by pressing **OK**.
4. Scroll to Mobile Apps and press **OK** to access a list of available applications.
5. Scroll through the list of available applications and press **OK** to select a particular app.
6. Once an app is running through SYNC, you can access an app's menu by pressing the **MENU** button to first access the SYNC menu.
7. Select "SYNC-Media" by pressing **OK**.
8. Scroll until "<App name> Menu" is displayed (such as, Pandora Menu), then press **OK**. From here, you can access an application's features, such as Thumbs up and Thumbs down. For more information, please visit [www.SYNCMyRide.com](http://www.SYNCMyRide.com).

## To Access Using Voice Commands

1. Press the voice icon.
2. When prompted, say "Mobile Apps".
3. Say the name of the application after the tone.
4. The app should start. While an app is running through SYNC, you can press the voice button and speak commands specific to the app, such as "Play Station Quickmix". Say "Help" to discover available voice commands.

## USING SYNC™ WITH YOUR MEDIA PLAYER

You can access and play music from your digital music player over your vehicle's speaker system using the system's media menu or voice commands. You can also sort and play your music by specific categories, such as artist and album.

**Note:** *The system is capable of indexing up to 6,000 songs.*

SYNC is capable of hosting nearly any digital media player including: iPod®, Zune™, Plays from device players, and most USB drives. SYNC also supports audio formats, such as MP3, WMA, WAV and ACC.

## Connecting Your Digital Media Player to the USB Port

**Note:** *If your digital media player has a power switch, make sure you switch it on before plugging it in.*

## To Connect Using Voice Commands

1. Plug the device into the USB port.
2. Press the voice icon and when prompted, say "USB".
3. You can now play music by saying any of the appropriate voice commands. See the media voice commands.

## To Connect Using the System Menu

1. Plug the device into the USB port.
2. Press **AUX** and then **MENU** to enter the media menu.
3. Scroll to Select Source. Press **OK**.
4. Scroll to USB. Press **OK**.
5. Depending on how many digital media files are on your connected device, **Indexing** may appear in the radio display. When indexing is complete, the screen returns to the Play menu.

Press **OK** and scroll through selections of:

- Play All
- Albums
- Genres
- Playlists
- Tracks
- Explore USB
- Similar Music
- Return

## What's Playing?

At any time when a track is playing, you can press the voice icon and ask the system "What's playing?". The system reads the metadata tags (if populated) of the playing track to you.

## Media Voice Commands



Press the voice icon. When prompted, say "USB", then any of the following:

"USB"
"Autoplay off"
"Autoplay on"
"Connections"
"Pause"
"Play"
"Play album <name>" <sup>1,2</sup>
"Play all"
"Play artist <name>" <sup>1,2</sup>
"Play genre <name>" <sup>1,2</sup>
"Play next folder" <sup>3</sup>
"Play next track"

"USB"
"Play playlist <name>" <sup>1,2</sup>
"Play previous folder" <sup>3</sup>
"Play previous track"
"Play song <name>" <sup>1,2</sup>
"Play track <name>" <sup>1,2</sup>
"Refine album <name>" <sup>1,2</sup>
"Refine artist <name>" <sup>1,2</sup>
"Refine song <name>" <sup>1,2</sup>
"Refine track <name>" <sup>1,2</sup>
"Repeat off"
"Repeat on"
"Search album <name>" <sup>1,2</sup>
"Search artist <name>" <sup>1,2</sup>
"Search genre <name>" <sup>1,2</sup>
"Search song <name>" <sup>1,2</sup>
"Search track <name>" <sup>1,2</sup>
"Shuffle off"
"Shuffle on"

<b>"USB"</b>
"Similar music"
"What's playing?"

<sup>1</sup> <name> is a dynamic listing, meaning that it could be the name of anything, such as a group, artist or song.

<sup>2</sup> This voice command is not available until indexing is complete.

<sup>3</sup> This voice command is only available in folder mode.

<b>Voice command guide</b>	
"Autoplay"	Turn autoplay on to listen to music processed during indexing. Turn autoplay off to allow the indexing process to finish before the system plays any of your music.*
"Search genre" or "Play genre"	The system searches all the data from your indexed music and, if available, begins to play the chosen type of music. You can only play genres of music that are present in the GENRE metadata tags that you have on your digital media player.
"Similar music"	The system compiles a playlist and then plays music similar to what is currently playing from the USB port using indexed metadata information.
"Search" or "Play" artist, track or album	The system searches for specific artist, track or album information from the music indexed through the USB port.
"Refine"	This allows you to make your previous command more specific. For example, if you asked to search and play all music by a certain artist, you could then say, "Refine album" and choose a specific album from the list to view. If you then select Play, the system only plays music from that specific album.

\*Indexing times can vary from device to device and with regard to the number of songs the system needs to process.

Press the voice icon. When prompted, say, "Bluetooth audio", then any of the following:

<b>"BLUETOOTH AUDIO"</b>
"Connections"
"Pause"
"Play"
"Play next track"
"Play previous track"

## Media Menu Features

The media menu allows you to select your media source, how to play your music (such as by artist, genre, shuffle or repeat),

and also to add, connect or delete devices.

1. Press **AUX** and then **MENU** to enter the media menu.
2. Scroll to cycle through:

When you select:	You can:
Play Menu	Play your music by artist, album, genre, playlist, track, similar music or play all music. You can also choose to Explore USB to view the supported digital music files on your playing device.
Select Source	Select and play music from your USB port, auxiliary input jack (line in) or stream music from your Bluetooth-enabled phone.
	SYNC USB: Press <b>OK</b> to access music plugged into your USB port. You can also plug in devices to charge them (if supported by your device). Once connected, the system indexes any readable media files. <sup>1</sup>
	Bluetooth Audio: This is a phone-dependent feature that allows you to stream music playing on your Bluetooth-enabled phone. If supported by your device, you can press <b>SEEK</b> to play the previous or next track.
	SYNC Line In: Press <b>OK</b> to select and play music from your portable music player over your vehicle's speakers. <sup>2</sup>
Media Settings	Choose to shuffle or repeat your music and select your Autoplay settings. Once you turn these selections on, they remain on until you turn them off. Press <b>SEEK</b> to play the previous or next track. <sup>3</sup>
	Shuffle: Press <b>OK</b> to shuffle available media files in the current playlist. To shuffle all media tracks, you must select Play All in the play menu and then select Shuffle.
	Repeat: Press <b>OK</b> to repeat any song.
	Autoplay: Turn autoplay on to listen to music processed during indexing. Turn autoplay off to allow the indexing process to finish before the system plays any of your music. <sup>4</sup>
Mobile Apps	Interact with SYNC-capable mobile applications on your smartphone.

When you select:	You can:
System Settings	Access Bluetooth Device menu listings (Add, Connect, Set as Primary, On and Off, Delete) as well as Advanced menu listings (prompts, languages, defaults, master reset, install application and system information).
Exit Media Menu	Press <b>OK</b> to exit the media menu.

<sup>1</sup>The time required to complete this depends on the size of the media the system needs to index. If autoplay is on, you can listen to media processed during indexing. If autoplay is off, you cannot listen to music until the system finishes indexing media. SYNC is capable of indexing thousands of average size media and notifies you if it reaches the maximum indexing file size.

<sup>2</sup>If you have already connected a device to the USB port, you cannot access the line in feature. Some digital media players require both USB and line in ports to stream data and music separately.

<sup>3</sup>Some digital media players require both USB and line in ports to stream data and music separately

<sup>4</sup>Indexing times can vary from device to device and with regard to the number of songs the system needs to process.

## Accessing Your Play Menu

This menu allows you to select and play your media by artist, album, genre, playlist, track, similar music or even to explore what is on your USB device.

**Note:** *If your digital media player has a power switch, make sure you switch it on before plugging it in.*

1. Press **AUX** and then **MENU** to enter the media menu.
2. Scroll to Play. Press **OK**.

If there are no media files to access, the display indicates there is no media. If there are media files, you have the following options:

When you select:	You can:
Play All	Play all indexed media (tracks) from your playing device in flat file mode, one at a time in numerical order. Press <b>OK</b> to select. The first track title appears in the display.
Artists	Sort all indexed media by artist. Once selected, the system lists and then play all artists and tracks alphabetically. If there are fewer than 255 indexed artists, the system lists them alphabetically in flat file mode. If there are more than 255, the system categorizes them alphabetically.

When you select:	You can:
	1. Press <b>OK</b> to select. You can select to play All Artists or any indexed artist. 2. Scroll to choose the desired artist. Press <b>OK</b> .
Albums	Sort all indexed media by albums. If there are fewer than 255 indexed albums, the system lists them alphabetically in flat file mode. If there are more than 255, the system categorizes them alphabetically. 1. Press <b>OK</b> to enter the album menu and select from playing all albums or from any individual indexed album. 2. Scroll to choose the desired album. Press <b>OK</b> .
Genres	Sort indexed music by genre (category) type. SYNC lists the genres alphabetically in flat file mode. If there are more than 255, the system categorizes them alphabetically. 1. Press <b>OK</b> to select. 2. Scroll to select the desired genre. Press <b>OK</b> .
Playlists	Access your playlists (from formats, such as .ASX, .M3U, .WPL or .MTP). The system lists your playlists alphabetically in flat-file mode. If there are more than 255, the system categorizes them alphabetically. 1. Press <b>OK</b> to select. 2. Scroll to select the desired playlist. Press <b>OK</b> .
Tracks	Search for and play a specific indexed track. SYNC lists your tracks alphabetically in flat file mode. If there are more than 255, the system categorizes them alphabetically. 1. Press <b>OK</b> to select. 2. Scroll to select the desired track. Press <b>OK</b> .
Explore USB	Explore all supported digital media on your media device connected to the USB port. You can only view media content which is compatible with SYNC; other files saved are not visible. 1. Press <b>OK</b> to select. 2. Scroll to explore indexed media on your flash drive.
Similar Music*	Play music similar to what is currently playing from the USB port. The system uses the metadata information of each song to compile a playlist for you.

When you select:	You can:
	Press <b>OK</b> to select. The system creates a new list of similar songs and begins playing. This feature does not include tracks with incomplete metadata information.
Return	Exit the current menu.

\*With certain playing devices, if your metadata tags are not populated, the tracks are not available in voice recognition, play menu or similar music. However, if you place these tracks onto your playing device in "Mass Storage Device Mode", they are available in voice recognition, play menu browsing and similar music. The system places Unknown items into any unpopulated metadata tag.

## System Settings

### Bluetooth Devices

The Bluetooth Devices menu allows you to add, connect and delete a device as turn the Bluetooth feature on and off.

1. Press **AUX** and then **MENU** to enter the media menu.
2. Scroll to System Settings. Press **OK**.
3. Scroll to Bluetooth Devices. Press **OK**.

When you select:	You can:
Add Bluetooth Device*	Pair more devices to the system. 1. Press <b>OK</b> to select and press <b>OK</b> again when <b>Find SYNC</b> appears in the display. 2. Follow the directions in your phone's manual to put your phone into discovery mode. A six-digit PIN appears in the display. 3. When prompted on your phone's six-digit display, enter the PIN.
Connect Bluetooth Device	Connect a previously paired Bluetooth-enabled device. 1. Press <b>OK</b> to select and view a list of previously paired devices. 2. Scroll until you find the desired device, and then press <b>OK</b> to connect the device.
Set Bluetooth	Turn the Bluetooth feature on and off.** 1. Press <b>OK</b> and scroll to toggle between On and Off. 2. Make a selection, and then press <b>OK</b> .
Delete Device	Delete a paired media device. 1. Press <b>OK</b> and scroll to select the device. 2. Press <b>OK</b> to confirm.
Delete All Devices	Delete all previously paired devices.



# SYNC™

When you select:	You can:
	Press <b>OK</b> to select.
Return	Exit the current menu.

\*This is a speed-dependent feature.

\*\*Setting Bluetooth to off disconnects all Bluetooth devices and turns off all Bluetooth features.

## Advanced

The Advanced menu allows you to access and set prompts, languages, defaults and perform a master reset.

1. Press **AUX** and then **MENU** to enter the media menu.
2. Scroll to System Settings. Press **OK**.
3. Scroll to Advanced. Press **OK**.

When you select:	You can:
Prompts	Have SYNC guide you by asking questions, helpful hints or ask you for a specific action. 1. Press <b>OK</b> to select and scroll to select between on or off. 2. Press <b>OK</b> when the desired selection appears in the display. SYNC takes you back to the Advanced menu.
Languages	Choose from English, Français or Español. The displays and prompts are in the selected language. 1. Press <b>OK</b> to select and then scroll through the languages. 2. Press <b>OK</b> when the desired selection appears in the display. 3. If you change the language setting, the display indicates that the system is updating. When complete, SYNC takes you back to the Advanced menu.
Factory Defaults	Return to the factory default settings. This selection does not erase your indexed information (phonebook, call history, text messages and paired devices). 1. Press <b>OK</b> to select. 2. Press <b>OK</b> again when <b>Restore Defaults?</b> appears in the display. 3. Press <b>OK</b> to confirm.

# SYNC™

<b>When you select:</b>	<b>You can:</b>
Master Reset	Completely erase all information stored on SYNC (all phonebook, call history, text messages and all paired devices) and return to the factory default settings.
Application	Download new software applications (if available) and then load the desired applications through your USB port. See the web site for more information.
Return	Exit the current menu.

## SYNC™ TROUBLESHOOTING

Your SYNC system is easy to use. However, should questions arise, see the tables below.

Use the website at any time to check your phone's compatibility, register your account and set preferences as well as access a customer representative via an online chat (during certain hours). Visit [www.SYNCMYRide.com](http://www.SYNCMYRide.com), [www.SYNCMYRide.ca](http://www.SYNCMYRide.ca) or [www.syncmaroute.ca](http://www.syncmaroute.ca) for more information.

<b>Phone issues</b>		
<b>Issue</b>	<b>Possible cause(s)</b>	<b>Possible solution(s)</b>
There is excessive background noise during a phone call.	The audio control settings on your phone may be affecting SYNC performance.	Review your phone's manual about audio adjustments.
During a call, I can hear the other person but they cannot hear me.	This may be a possible phone malfunction.	Try turning off the device, resetting the device, removing the device's battery, then trying again.
SYNC is not able to download my phonebook.	This is a phone-dependent feature. This may be a possible phone malfunction.	Go to the website to review your phone's compatibility. Try turning off the device, resetting the device or removing the device's battery, then trying again. Try pushing your phonebook contacts to SYNC by using the Add Contacts feature. Use the SYNCmyphone feature available on the website.

# SYNC™

<b>Phone issues</b>		
<b>Issue</b>	<b>Possible cause(s)</b>	<b>Possible solution(s)</b>
The system says Phonebook Downloaded but the phonebook in SYNC is empty or missing contacts.	This may be a limitation on your phone's capability.	Try pushing your phonebook contacts to SYNC by using the Add Contacts feature. If the missing contacts are stored on your SIM card, try moving them to the device memory. Remove any pictures or special ring tones associated with the missing contact. Depending upon your phone, you may have to grant SYNC permission to access your phonebook contacts. Make sure to confirm when prompted by your phone during the phonebook download.
I am having trouble connecting my phone to SYNC.	This is a phone-dependent feature. This may be a possible phone malfunction.	Go to the website to review your phone's compatibility. Try turning off the device, resetting the device or removing the device's battery, then trying again. Try deleting your device from SYNC, deleting SYNC from your device and trying again. Check the security and auto accept and prompt always settings relative to the SYNC Bluetooth connection on your phone. Update your device's firmware. Turn off the Auto phonebook download setting.
Text messaging is not working on SYNC.	This is a phone-dependent feature.	Go to the website to review your phone's compatibility.

# SYNC™

<b>Phone issues</b>		
<b>Issue</b>	<b>Possible cause(s)</b>	<b>Possible solution(s)</b>
	This may be a possible phone malfunction.	Try turning off the device, resetting the device or removing the device's battery, then trying again.

<b>USB and media issues</b>		
<b>Issue</b>	<b>Possible cause(s)</b>	<b>Possible solution(s)</b>
I am having trouble connecting my device.	This may be a possible device malfunction.	Try turning off the device, resetting the device, removing the device's battery, then trying again. Make sure you are using the manufacturer's cable. Make sure you insert the USB cable correctly into the device and the USB port. Make sure that the device does not have an auto-install program or active security settings.
SYNC does not recognize my device when I turn on the car.	This is a device limitation.	Make sure you are not leaving the device in your vehicle during very hot or cold temperatures.
Bluetooth audio does not stream.	This is a phone-dependent feature. The device is not connected.	Review the device compatibility chart on the SYNC website to confirm your phone supports the Bluetooth audio streaming function. Make sure you correctly connect the device to SYNC, and that you have pressed play on your device.
SYNC does not recognize music that is on my device.	Your music files may not contain the correct artist, song title, album or genre information.	Make sure that all song details are populated.

<b>USB and media issues</b>		
<b>Issue</b>	<b>Possible cause(s)</b>	<b>Possible solution(s)</b>
	The file may be corrupted. The song may have copy-right protection, which does not allow it to play.	Some devices require you to change the USB settings from mass storage to MTP class.

<b>Vehicle Health Report and Services (Traffic, Directions and Information) issues</b>		
<b>Issue</b>	<b>Possible cause(s)</b>	<b>Possible solution(s)</b>
I received a text that I did not activate Vehicle Health Report.	You did not activate your account on the website. You may have the wrong VIN (vehicle identification number) listed.	This is a free feature, but you must first register online to use it. Make sure that your VIN is correctly listed in your account.
I am unable to retrieve the report on the website, or I receive a system error.	The preferred dealer information did not load correctly.	When you register your account, you must choose a preferred dealer. If it already lists a dealer, try selecting another dealer and logging out. Log back in, change it back to your preferred dealer, and retrieve the report.
I am unable to submit a report.	This could be due to your phone's compatibility. Bad signal strength. You did not register your phone correctly on the website.	Update your cellular number in your account on the website. Make sure you have full signal strength and that your Bluetooth volume level has been turned up. Make sure the currently connected phone is registered on your SYNCMyRide account. Try deleting your phone and performing a clean pairing.
I heard a commercial when I tried to use Traffic, Directions and Information.	You did not activate this phone for this service. Your phone has ID blocker active.	This is a free feature, but you must first register online to use it.

# SYNC™

## Vehicle Health Report and Services (Traffic, Directions and Information) issues

Issue	Possible cause(s)	Possible solution(s)
		<p>Turn off ID blocker on your phone as the system recognizes you by your phone number.</p> <p>Make sure the currently connected phone is the same one that is registered on your SYNCMyRide account.</p>

## Voice command issues

Issue	Possible cause(s)	Possible solution(s)
<p>SYNC does not understand what I am saying.</p>	<p>You may be using the wrong voice commands.</p> <p>You may be speaking too soon or at the wrong time.</p>	<p>Review the phone voice commands and the media voice commands at the beginning of their respective sections.</p> <p>After pressing the voice icon, wait until after the tone sounds and Listening appears before saying a command. Any command spoken before this does not register with the system.</p>
<p>SYNC does not understand the name of a song or artist.</p>	<p>You may be using the wrong voice commands.</p> <p>You may be saying the name differently than the way you saved it.</p> <p>The system may not be reading the name the same way you are saying it.</p>	<p>Review the media voice commands at the beginning of the media section.</p> <p>Say the song or artist exactly as listed. If you say "Play Artist Prince", the system does not play music by Prince and the Revolution or Prince and the New Power Generation.</p> <p>Make sure you are saying the complete title, such as "California remix featuring Jennifer Nettles".</p>

# SYNC™

<b>Voice command issues</b>		
<b>Issue</b>	<b>Possible cause(s)</b>	<b>Possible solution(s)</b>
		<p>If the song titles are in all CAPS, you have to spell them. LOLA requires you to say "L-O-L-A".</p> <p>Do not use special characters in the title. The system does not recognize them.</p>
<p>SYNC does not understand or is calling the wrong contact when I want to make a call.</p>	<p>You may be using the wrong voice commands.</p> <p>You may be saying the name differently than the way you saved it.</p> <p>The system may not be reading the name the same way you are saying it.</p> <p>Contacts in your phonebook may be very short and similar, or they may contain special characters.</p> <p>Your phonebook contacts may be in CAPS.</p>	<p>Review the Phone voice commands at the beginning of the phone section.</p> <p>Make sure you are saying the contacts exactly as they are listed. For example, if you save a contact as Joe Wilson, say "Call Joe Wilson".</p> <p>Using the SYNC phone menu, open the phonebook and scroll to the name SYNC is having trouble understanding. SYNC will read the name to you, giving you some idea of the pronunciation SYNC is expecting.</p> <p>The system works better if you list full names, such as "Joe Wilson" rather than "Joe".</p> <p>Do not use special characters, such as 123 or ICE, as the system does not recognize them.</p> <p>If a contact is in CAPS, you have to spell it. JAKE requires you to say "Call J-A-K-E".</p>

# SYNC™

<b>AppLink issues</b>		
<b>Issue</b>	<b>Possible cause(s)</b>	<b>Possible solution(s)</b>
AppLink Mobile Applications: When I select "Find New Apps," SYNC does not find any applications.	An AppLink capable phone is not connected to SYNC.	Ensure you have a compatible smartphone; an Android with OS 2.3 or higher or an iPhone 3GS or newer with iOS 5.0 or higher. Additionally, ensure your phone is paired and connected to SYNC in order to find AppLink-capable apps on your device. iPhone users must also connect to SYNC's USB port with an Apple USB cable.
My phone is connected, but I still cannot find any apps.	AppLink-enabled apps are not installed and running on your mobile device.	Ensure you have downloaded and installed the latest version of the app from your phone's app store. Ensure the app is running on your phone. Some apps require you to register or login on the app on the phone before using them with AppLink. Also, some may have a "Ford SYNC" setting, so check the app's settings menu on the phone.
My phone is connected, my app(s) are running, but I still cannot find any apps.	Sometime apps do not properly close and re-open their connection to SYNC, over ignition cycles, for example.	Closing and restarting apps may help SYNC find the application if you cannot discover it inside the vehicle. On an Android device, if apps have an "Exit" or 'Quit' option, select that then restart the app. If the app does not have that option, you can also manually "Force Close" the app by going to the phone's settings



# SYNC™

<b>AppLink issues</b>		
<b>Issue</b>	<b>Possible cause(s)</b>	<b>Possible solution(s)</b>
		<p>menu, selecting 'Apps.' then finding the particular app and choosing 'Force stop.' Don't forget to restart the app afterwards, then select "Find New Apps" on SYNC.</p> <p>On an iPhone with iOS7+, to force close an app, double tap the home button then swipe up on the app to close it. Tab the home button again, then select the app again to restart it. After a few seconds, the app should then appear in SYNC's Mobile App's Menu.</p>
<p>My Android phone is connected, my app(s) are running, I restarted them, but I still cannot find any apps.</p>	<p>There is a bluetooth bug on some older versions of the Android OS that may cause apps that were found on your previous vehicle drive to not be found again if you have not turned off bluetooth.</p>	<p>Reset the Bluetooth on your phone by turning it off and then turning Bluetooth back on. If you are in your vehicle, SYNC should be able to automatically re-connect to your phone if you press the "Phone" button.</p>

# SYNC™

<b>AppLink issues</b>		
<b>Issue</b>	<b>Possible cause(s)</b>	<b>Possible solution(s)</b>
My iPhone phone is connected, my app is running, I restarted the app but I still cannot find it on SYNC.	The USB connection to SYNC may need to be reset.	Unplug the USB cable from the phone, wait a moment, and plug the USB cable back in to the phone. After a few seconds, the app should appear in SYNC's Mobile Apps Menu. If not, "Force Close" the application and restart it.
I have an Android phone. I found and started my media app on SYNC, but there is no sound or the sound is very low.	The bluetooth volume on the phone may be low.	Try increasing the Bluetooth volume of the device by using the device's volume control buttons which are most often found on the side of the device.
I can only see some of the AppLink apps running on my phone listed in SYNC's Mobile Apps Menu.	Some Android devices have a limited number of bluetooth ports apps can use to connect. If you have more AppLink apps on your phone than the number of available Bluetooth ports, you will not see all of your apps listed in SYNC's mobile apps menu.	Force close or uninstall the apps you do not want SYNC to find. If the app has a "Ford SYNC" setting, disable that setting in the app's settings menu on the phone.

# MyFord Touch™ (If Equipped)

## GENERAL INFORMATION

### WARNING



Driving while distracted can result in loss of vehicle control, crash and injury. We strongly recommend that you use extreme caution when using any device that may take your focus off the road. Your primary responsibility is the safe operation of your vehicle. We recommend against the use of any hand-held device while driving and encourage the use of voice-operated systems when possible. Make sure you are aware of all applicable local laws that may affect the use of electronic devices while driving.

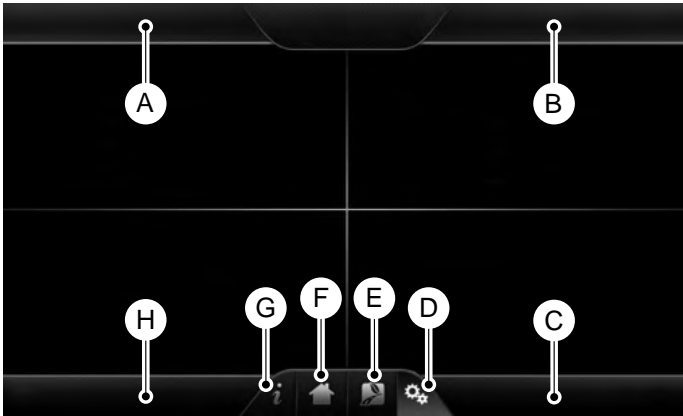

E161890

- A Phone
- B Navigation (or Information if your vehicle is not equipped with Navigation)
- C Climate
- D Settings
- E EV Information
- F Home
- G Information
- H Entertainment

# MyFord Touch™ (If Equipped)

This system uses a four-corner strategy to provide quick access to several vehicle features and settings. The touchscreen provides easy interaction with your cellular phone, multimedia, climate control and navigation system. The corners display any active modes within those menus, such as phone status or the climate temperature.

**Note:** *Some features are not available while your vehicle is moving.*

**Note:** *Your system is equipped with a feature that allows you to access and control audio features for 30 minutes after you switch the ignition off (and no doors open).*

## PHONE

Press to select any of the following:

- Phone
- Quick Dial
- Phonebook
- History
- Messaging
- Settings

## NAVIGATION

Press to select any of the following:

- My Home
- Favorites
- Previous Destinations
- Point of Interest
- Emergency
- Street Address
- Intersection
- City Center
- Map
- Edit Route
- Cancel Route

## CLIMATE

Press to select any of the following:

- Driver Settings
- Recirculated Air
- Auto
- Dual
- Passenger Settings
- A/C
- Defrost



## SETTINGS

Press to select any of the following:

- Clock
- Display
- Sound
- Vehicle
- Settings
- Help



## EV Information

Press to access features specific to your hybrid or plug-in hybrid electric vehicle.



## HOME

Press to access your home screen. Depending on your vehicle's option package and software, your screens may vary in appearance from the descriptions in this section. Your features may also be limited depending on your market. Check with an authorized dealer for availability.



## INFORMATION

Press to select any of the following:

- Services
- Travel Link
- Alerts

# MyFord Touch™ (If Equipped)

---

- Calendar
- Apps

## ENTERTAINMENT

Press to select any of the following:

- AM
- FM
- SIRIUS
- CD
- USB
- BT Stereo
- SD Card
- A/V In

## Using the Audio Controls

Depending on your vehicle and option package, you may also have these controls on your bezel:

- **Power:** Switch the media or climate features off and on.
- **VOL:** Control the volume of playing media.
- **Climate:** Control the temperature, fan speed and climate control settings."
- **Seek and Tune buttons:** Use as you normally would in media modes.
- **Eject:** Eject a CD from the entertainment system.
- **SOURCE:** Press repeatedly to see all available media modes
- **SOUND:** Press to access the Sound menu where you can adjust settings such as: Bass, Treble, Midrange, Balance and Fade, DSP (Digital Signal Processing), Occupancy Mode and Speed Compensated Volume. (Your vehicle may not have all of these sound options.)

## Using the Touchscreen

- Make sure your hands are clean and dry.
- Press firmly on the center of a control graphic or menu item.
- Keep metal objects or other conductive material away from the surface of the touchscreen.

## Cleaning the Touchscreen Display

Use a clean, soft cloth such as one used for cleaning glasses. If dirt or fingerprints are still visible, apply a small amount of alcohol to the cloth. Do not pour or spray alcohol onto the display. Do not use detergent or any type of solvent to clean the display.

## Support

The SYNC support team is available to help you with any questions you are not able to answer on your own.

Monday-Saturday, 8:30am-9:00pm EST.

Sunday, 10:30am-7:30pm EST.

In the United States, call: 1-800-392-3673.

In Canada, call: 1-800-565-3673.

Times are subject to change due to holidays.

## Safety Information

### WARNING



Driving while distracted can result in loss of vehicle control, crash and injury. We strongly recommend that you use extreme caution when using any device that may take your focus off the road. Your primary responsibility is the safe operation of your vehicle. We recommend against the use of any hand-held device while driving and encourage the use of voice-operated systems when possible. Make sure you are aware of all applicable local laws that may affect the use of electronic devices while driving.

- Do not attempt to service or repair the system. See an authorized dealer.
- Do not operate playing devices if the power cords or cables are broken, split or damaged. Place cords and cables out of the way, so they do not interfere with the operation of pedals, seats, compartments or safe driving abilities.

- Do not leave playing devices in your vehicle during extreme conditions as it could cause them damage. See your device's user guide for further information.
- For your safety, some SYNC functions are speed-dependent. Their use is limited to when your vehicle is traveling at speeds under 3 mph (5 km/h).

Make sure that you review your device's manual before using it with SYNC.

### Speed-restricted Features

Some features of this system may be too difficult to use while your vehicle is moving so they are restricted from use unless your vehicle is stationary.

- Screens crowded with information, such as Point of Interest reviews and ratings, SIRIUS Travel Link sports scores, movie times or ski conditions.
- Any action that requires you to use a keyboard is restricted, such as entering a navigation destination or editing information.
- All lists are limited so the user can view fewer entries (such as phone contacts or recent phone call entries).

See the following chart for more specific examples.

Restricted features	
Cellular Phone	Pairing a Bluetooth phone
	Adding phonebook contacts or uploading phonebook contacts (from a USB)
	List entries are limited for phone contacts and recent phone call entries
System Functionality	Editing the keypad code
	Enabling Valet Mode

## MyFord Touch™ (If Equipped)

<b>Restricted features</b>	
	Editing settings while the rear view camera or active park assist are active
Wi-Fi and Wireless	Editing wireless settings
	Editing the list of wireless networks
Videos, Photos and Graphics	Playing video
	Editing the screen's wallpaper or adding new wallpaper
Text Messages	Composing text messages
	Viewing received text messages
	Editing preset text messages
Navigation	Using the keyboard to enter a destination
	Demo navigation route
	Adding or editing Address Book entries or Avoid Areas

### Privacy Information

When you connect a cellular phone to SYNC, the system creates a profile within your vehicle that links to that cellular phone. This profile helps in offering you more cellular features and operating more efficiently. Among other things, this profile may contain data about your cellular phone book, text messages (read and unread), and call history, including history of calls when your cell phone was not connected to the system. In addition, if you connect a media device, the system creates and retains an index of supported media content. The system also records a short development log of approximately 10 minutes of all recent system activity. The log profile and other system data may be used to improve the system and help diagnose any problems that may occur.

The cellular profile, media device index, and development log remain in your vehicle unless you delete them and are generally accessible only in your vehicle when the cellular phone or media player is connected. If you no longer plan to use the system or your vehicle, we recommend you perform a Master Reset to erase all stored information.

System data cannot be accessed without special equipment and access to your vehicle's SYNC module. Ford Motor Company and Ford of Canada do not access the system data for any purpose other than as described absent consent, a court order, or where required by law enforcement, other government authorities, or other third parties acting with lawful authority. Other parties may seek to access the information independently of Ford Motor Company and Ford of Canada. For further privacy information, see the sections on 911 Assist, Vehicle Health Report, and Traffic, Directions and Information.

## MyFord Touch™ (If Equipped)

### Accessing and Adjusting Modes Through Your Right Vehicle Information Display



E145459

The display is located on the right side of your instrument cluster (A). You can use your steering wheel controls to view and make minor adjustments to active modes without taking your hands off the wheel. For example:

- In Entertainment mode, you can view what is now playing, change the audio source, select memory presets and make some adjustments.
- In Phone mode, you can accept or reject an incoming call.
- If your vehicle is equipped with Navigation, you can view the current route or activate a route.
- In Efficiency Leaves mode, you can learn how your vehicle informs you of your driving efficiency. Press **OK** to exit the menu.



E130248

Use the **OK** and arrow buttons on the right side of your steering wheel to scroll through the available modes:

The selection menu expands and different options appear.

- Press the up and down arrows to scroll through the modes.
- Press the right arrow to enter the mode.



# MyFord Touch™ (If Equipped)

- Press the left or right arrows to make adjustments within the chosen mode.
- Press **OK** to confirm your selection.

**Note:** *If your vehicle is not equipped with Navigation, Compass appears in the display instead of Navigation. If you press the right arrow to go into the Compass menu, you can see the compass graphic. The compass displays the direction in which the vehicle is traveling, not true direction (for example, if the vehicle is traveling west, the middle of the compass graphic displays west; north displays to the left of west though its true direction is to the right of west).*

## Using Voice Recognition

This system helps you control many features using voice commands. This allows you to keep your hands on the wheel and focus on what is in front of you. The system provides feedback through audible tones, prompts, questions and spoken confirmations depending on the situation and the chosen level of interaction (voice settings).

The system also asks short questions (confirmation prompts) when it is not sure of your request or when there are multiple possible responses to your request.

When using voice commands, words and icons may appear in the lower left status bar indicating the status of the voice session (such as Listening, Success, Failed, Paused or Try Again).

## How to Use Voice Commands with Your System



Press the voice icon. After the tone, speak your command clearly.

These commands can be said at any time during a voice session
"Cancel"
"Exit"
"Go back"
"List of commands"
"Main menu"
"Next page"
"Previous page"
"What can I say?"
"Help"

## What Can I Say?

To access the available voice commands for the current session, do one of the following:

- During a voice session, press the Help icon (🗉) in the lower left status bar of the screen.
- Say, "What can I say?" for an on-screen listing of the possible voice commands associated with your current voice session.
- Press the voice icon. After the tone, say, "Help" to hear a list of possible voice commands.

## Helpful Hints

- Make sure the interior of your vehicle is as quiet as possible. Wind noise from open windows and road vibrations may prevent the system from correctly recognizing spoken commands.
- After pressing the voice icon, wait until after the tone sounds and Listening appears before saying a command. Any command spoken prior to this does not register with the system.

# MyFord Touch™ (If Equipped)

- Speak naturally, without long pauses between words.
- At any time, you can interrupt the system while it is speaking by pressing the voice icon.

## Accessing a List of Available Commands

- If you use the touchscreen, press the Settings icon > **Help** > **Voice Command List**.
- If you use the steering wheel control, press the voice icon. After the tone, speak your command clearly.

Available voice commands
"Audio list of commands"
"Bluetooth audio list of commands"
"Browse list of commands"
"CD list of commands"
"Climate control list of commands"
"List of commands"
"Navigation list of commands" *
"Phone list of commands"
"Radio list of commands"
"SD card list of commands"
"Sirius satellite list of commands" **
"Travel link list of commands" *
"USB list of commands"
"Voice instructions list of commands"

Available voice commands
"Voice settings list of commands"
"Help"

\* This command is only available when your vehicle is equipped with the navigation system, and the navigation system SD card is in the card slot.

\*\* This command is only available when you have an active SIRIUS satellite radio subscription.

## Voice Settings

Voice settings allow you to customize the level of system interaction, help and feedback. The system defaults to standard interaction that uses candidate lists and confirmation prompts as these provide the highest level of guidance and feedback.

- **Interaction Mode:** Novice mode provides detailed interaction and guidance while the advanced mode has less audible interaction and more tone prompts.
- **Confirmation Prompts:** The system uses these short questions to confirm your voice request. If turned off, the system simply makes a best guess as to what you requested. The system may still occasionally ask you to confirm settings.
- **Phone and Media Candidate Lists:** Candidate lists are lists of possible results from your voice commands. The system creates these lists when it has the same confidence level of several options based on your voice command.

To access these settings using the touchscreen:

1. Press the Settings icon > **Settings** > **Voice Control**.
2. Select from:

# MyFord Touch™ (If Equipped)

- Interaction Mode
- Confirmation Prompts
- Media Candidate Lists
- Phone Candidate Lists
- Voice Control Volume.

To access these settings using voice commands:

1. Press the voice icon. Wait for the prompt "Please say a command". Another tone sounds to let you know the system is listening.
2. Say any of the following commands:

Voice settings using voice commands
"Confirmation prompts off"
"Confirmation prompts on"
"Interaction mode advanced"
"Interaction mode novice"

Voice settings using voice commands
"Media candidate lists off"
"Media candidate lists on"
"Phone candidate lists off"
"Phone candidate lists on"
"Help"

### ***Using Voice Commands with the Touchscreen Options***

Your voice system has a dual mode feature which allows you to switch between using voice commands and making on-screen selections. This is available only when the system displays a list of candidates generated during a voice session. For example, when entering in a street address or trying to call a contact from the phone you paired to the system.

## SETTINGS



E161968

- A Clock
- B Display
- C Sound
- D Vehicle
- E Settings
- F Help



Under this menu, you can set your clock, access and adjust the display, sound and vehicle settings as well as access settings for specific modes or the help feature.

## Clock

**Note:** You cannot manually set the date. Your vehicle's GPS does this for you.

**Note:** If the battery has been disconnected, your vehicle needs to acquire a GPS signal to update the clock. Once your vehicle acquires the signal, it may take a few minutes for the update to display the correct time.



1. Press the Settings icon > **Clock**.
2. Press **+** and **-** to adjust the time.

From this screen, you can also make other adjustments such as 12-hour or 24-hour mode, activate GPS time synchronization and have the system automatically update new time zones.

You can also turn the outside air temperature display off and on. It appears at the top center of the touchscreen, next to the time and date.

The system automatically saves any updates you make to the settings.

## Display

You can adjust the touchscreen display through the touchscreen or by pressing the voice button on your steering wheel controls and when prompted, say, "Display settings".



Press the Settings icon > **Display**, to access and make adjustments using the touchscreen.

- **Brightness** allows you to make the screen display brighter or dimmer.
- **Auto DIM**, when set to **On**, lets you use the Auto Dim Manual Offset feature. When set to **Off**, screen brightness does not change.
- **Mode** allows you to set the screen to a certain brightness or have the system automatically change based on the outside light level, or turn the display off.
  - If you select **AUTO** or **NIGHT**, you have the options of turning the display's Auto Dim feature on or off and changing the Auto Dim Manual Offset feature.

# MyFord Touch™ (If Equipped)

- **Auto Dim Manual Offset** allows you to adjust screen dimming as the outside lighting conditions change from day to night. This feature also allows you to adjust screen brightness using the instrument panel dimming control.
- **Edit Wallpaper**
  - You can have your touchscreen display the default photo or upload your own.

## Uploading Photos for Your Home Screen Wallpaper

**Note:** You cannot load photos directly from your camera. You must access the photos either from your USB mass storage device or from an SD card.

**Note:** Photographs with extremely large dimensions (such as 2048 x 1536) may not be compatible and appear as a blank (black) image on the display.

Your system allows you to upload and view up to 32 photos.



To access, press the Settings icon > **Display** > **Edit Wallpaper**, and then follow the system prompts to upload your photographs.

Only the photograph(s), which meets the following conditions, display:

- Compatible file formats are as follows: .jpg, .gif, .png, .bmp
- Each file must be 1.5 MB or less.
- Recommended dimensions: 800 x 384

## Sound



Press the Settings icon > **Sound**, then select from the following:

<b>Sound settings</b>
Bass
Midrange
Treble
Set Balance and Fade
DSP*
Occupancy Mode*
Speed Compensated Volume

\* Your vehicle may not have this sound setting.

## Vehicle



Press the Settings icon > **Vehicle**, then select from the following:

- Vehicle Health Report
- Camera Settings
- Enable Valet Mode
- Charge Port Light Ring.

## Vehicle Health Report (If Equipped, US Only)

Turn **Automatic Reminders** on and off and set the mileage interval at which you would like to receive the reports. Press **?** for more information on these selections.

When done making your selections, press **Run Vehicle Health Report Now** if you want your report.

You can find more information on Vehicle Health Report in this chapter. See **Information** (page 388).

## Camera Settings

This menu allows you to access settings for your rear view camera.



Press the Settings icon > **Vehicle** > **Camera Settings**, then select from the following settings:

- Enhanced Park Aids
- Rear Camera Delay

You can find more information on the rear view camera in another chapter. See **Rear View Camera** (page 172).

## Enable Valet Mode

Valet mode allows you to lock the system. No information is accessible until the system is unlocked with the correct PIN. You can create your own four-digit PIN to lock and unlock the system.



1. Press the Settings icon > **Vehicle** > **Enable Valet Mode**.
2. Enter a four-digit pin twice, as prompted.

After you press **Continue**, the system locks until you enter the PIN again.

**Note:** *If the system locks, and you need to reset the PIN, enter 3681 and the system unlocks.*

## Charge Point Light Ring



Press the Settings icon > **Vehicle** > **Charge Point Light Ring**, then select from the

following:

Charge point light ring	
On	Illuminates when plugging in, opening doors, pressing the unlock button on your remote, and while charging.
Off	Does not illuminate.
Limited	<b>Cord Acknowledgement:</b> Illuminates when plugging in.
	<b>Charge Status:</b> Illuminates when opening doors or pressing the unlock button on your remote.

**Note:** *Details on the charge port light ring functions are in another chapter. See **High Voltage Battery** (page 149).*

## Settings

Access and adjust system settings, voice features, as well as phone, navigation and wireless settings.

## System



Press the Settings icon > **Settings** > **System**, then select from the following:

## MyFord Touch™ (If Equipped)

System	
Language	Select to have the touchscreen display in English, Spanish or French.
Distance	Select to display units in kilometers or miles.
Temperature	Select to display units in Celsius or Fahrenheit.
System Prompt Volume	Adjust the volume of voice prompts from the system.
Touch Screen Button Beep	Select to have the system beep to confirm choices made through the touchscreen.
Touch Panel Button Beep	Select to have the system beep to confirm button choices made through the climate or audio system.
Keyboard Layout	Have the touchscreen keyboard display in QWERTY or ABC format.
Install Applications	Install any downloaded applications or view the current software licenses.
Master Reset	Select to restore factory defaults. This erases all personal settings and personal data.

### Voice Control



Press the Settings icon > **Settings** > **Voice Control**, then select from the following:

Voice control	
Interaction Mode	Standard interaction mode provides more detailed interaction and guidance. Advanced mode has less audible interaction and more tone prompts.
Confirmation Prompts	Have the system ask you short questions if it has not clearly heard or understood your request.*
Media Candidate Lists	Candidate lists are possible results from your voice commands. The system simply makes a best guess at your request with these turned off.

## MyFord Touch™ (If Equipped)

Voice control	
Phone Candidate Lists	Candidate lists are possible results from your voice commands. The system simply makes a best guess at your request with these turned off.
Voice Control Volume	This allows you to adjust the system's voice volume level.

\* Even with confirmation prompts turned off, the system may occasionally ask you to confirm settings

### Media Player



Press the Settings icon > **Settings** > **Media Player**, then select from the following:

Media player	
Autoplay	When this feature is on, the system automatically switches to the media source upon initial connection. This allows you to listen to music during the indexing process. When this feature is off, the system does not automatically switch to the inserted media source.
Bluetooth Devices	Select to connect, disconnect, add or delete a device. You can also set a device as your favorite so that the system automatically attempts to connect to that device at every ignition cycle.
Index Bluetooth Audio Devices	When this feature is on, the system automatically indexes media on your connected Bluetooth device.
Gracenote Database Info	This allows you to view the version level of the Gracenote Database.
Gracenote Management	With this feature on, the Gracenote Database supplies metadata information for your music files. This overrides information from your device. This feature defaults to off.
Cover Art Priority	With this feature on, the Gracenote Database supplies cover art for your music files. This overrides any art from your device. This feature defaults to Media Player.

### Navigation



Press the Settings icon > **Settings** > **Navigation**, then select from the following:



## MyFord Touch™ (If Equipped)

Navigation	
Map Preferences	Turn breadcrumbs on and off.
	Have the system display your turn list top to bottom or bottom to top.
	Turn the Parking POI notification on and off.
Route Preferences	Choose to have the system display the Shortest, Fastest or most Ecological route first. If you set <b>Always Use Preferred Route to Yes</b> , the system uses the selected route type to calculate only one route to the desired destination. <b>Always Use Preferred Route</b> bypasses route selection in destination programming. The system only calculates one route based on the preferred route setting. <b>Eco Time Penalty</b> allows you to select a low, medium or high cost for the calculated Eco Route. The higher the setting, the longer the time allotment is for the route.
	Have the system avoid freeways.
	Have the system avoid tollroads.
	Have the system avoid ferries or car trains.
	Have the system use HOV (high-occupancy vehicle) lanes.
Navigation Preferences	Have the system use guidance prompts.
	Have the system automatically fill-in State/Province information.
Traffic Preferences	Have the system avoid traffic problems automatically.
	Turn traffic alert notifications on or off.
	Have the system display accident icons.
	Have the system display traffic jam icons.
	Have the system display closed roads.
	Have the system display areas where difficult driving conditions may occur.
	Have the system display areas where snow and ice on the road may occur.
	Have the system display any smog alerts.
	Have the system display weather warnings.

## MyFord Touch™ (If Equipped)

Navigation	
	Have the system display where there may be reduced visibility.
	Have the system turn on your radio for traffic announcements.
Avoid Areas	Enter specific areas that you would like to avoid on planned navigation routes.

### Phone



Press the Settings icon > **Settings** > **Phone**, then select from the following:

Phone	
Bluetooth Devices	Connect, disconnect, add or delete a device, as well as save it as a favorite.
Bluetooth	Turn Bluetooth on and off.
Do Not Disturb	Have all calls go directly to your voice mail and not ring inside your vehicle. With this feature turned on, text message notifications are also suppressed and do not ring inside your vehicle.
911 Assist	Turn on or turn off the 911 Assist feature. See <b>Information</b> (page 388).
Phone Ringer	Select the type of notification for phone calls - ring tone, beep, text to speech, or have it be silent.
Text Message Notification	Select the type of notification for text messages - alert tone, beep, text to speech, or have it be silent.
Internet Data Connection	If compatible with your phone, you can adjust your internet data connection. Select to make your connection profile with the personal area network or to turn off your connection. You can also choose to adjust your settings or have the system always connect, never connect when roaming or query on connect. Press <b>?</b> for more information.
Manage Phonebook	Access features, such as automatic phonebook download, re-download your phonebook, add contacts from your phone as well as delete or upload your phonebook.
Roaming Warning	Have the system alert you when in Roaming mode.

# MyFord Touch™ (If Equipped)

## Wireless & Internet

Your system has a Wi-Fi feature that creates a wireless network within your vehicle, thereby allowing other devices (such as personal computers or phones) in your vehicle to speak to each other, share files or play games. Using this Wi-Fi

feature, everyone in your vehicle can also access the internet if you have a USB mobile broadband connection inside your vehicle, your phone supports personal area networking or if you park outside a wireless hotspot.



Press the Settings icon > **Settings** > **Wireless & Internet**, then select from the following:

<b>Wi-Fi</b>	
Wi-Fi Settings	<p><b>Wi-Fi Network (Client) Mode</b> turns the Wi-Fi feature on and off in your vehicle. Make sure you turn it on for connectivity purposes.</p>
	<p><b>Choose a Wireless Network</b> allows you to use a previously stored wireless network. You can categorize by alphabetical listing, priority and signal strength. You can also choose to search for a network, connect to a network, disconnect from a network, receive more information, prioritize a network or delete a network.</p>
	<p><b>Gateway (Access Point) Mode</b> makes SYNC an access point for a phone or a computer when turned on. This forms the local area network within your vehicle for things, such as game playing, file transfer and internet browsing. Press ? for more information.</p>
	<p><b>Gateway (Access Point) Settings</b> allows you to view and change settings for using SYNC as the internet gateway.</p>
	<p><b>Gateway (Access Point) Device List</b> allows you to view recent connections to your Wi-Fi system.</p>

## MyFord Touch™ (If Equipped)

Wi-Fi	
USB Mobile Broadband	Instead of using Wi-Fi, your system can also use a USB mobile broadband connection to access the internet. (You must turn on your mobile broadband device on your personal computer before connecting it to the system.) This screen allows you to set up what is your typical area for your USB mobile broadband connection. (USB mobile broadband settings may not display if the device is already on.) You can select the following: Country, Carrier, Phone Number, User Name and Password.
Bluetooth Settings	Shows you the currently paired devices as well as giving you your typical Bluetooth options to connect, disconnect, set as favorite, delete and add device. Bluetooth is a registered trademark of the Bluetooth SIG.
Prioritize Connection Methods	Choose your connection methods and change them as needed. You can select to Change Order and have the system either always attempt to connect using a USB mobile broadband or using Wi-Fi.



E142626

The Wi-Fi CERTIFIED Logo is a certification mark of the Wi-Fi Alliance.

### Help



Press the Settings icon > **Help**, then select from the following:

Help	
System Information	Touchscreen system serial number
	Your vehicle identification number (VIN)
	Touchscreen system software version
	Navigation system version
	Map database version
	Sirius satellite radio ESN
	Gracenote Database Information and Library version
Software Licenses	View the licenses for any software and applications installed on your system.

# MyFord Touch™ (If Equipped)

Help	
Driving Restrictions	Certain features are not accessible when your vehicle is moving.
911 Assist	Turn on and turn off the 911 Assist feature. See <b>Information</b> (page 388).
	<b>In Case of Emergency (ICE) Quick Dial:</b> allows you to save up to two numbers as ICE contacts for quick access if there is an emergency. Select <b>Edit</b> to access your phonebook and then select the desired contacts. The numbers then appear as options on this screen for the ICE 1 and ICE 2 buttons. The ICE contacts you select appear at the end of the 911 Assist call process.
Voice Command List	View categorized lists of voice commands.

To access Help using the voice commands, press the voice button, then, after the tone, say "Help". The system provides allowable voice commands for the current mode.

## ENTERTAINMENT



E161892

- A AM 1 and AM AST.
- B FM 1, FM 2 and FM AST.

# MyFord Touch™ (If Equipped)

- C SIRIUS.
- D CD.
- E USB.
- F Touch this button to scroll down for more options, such as SD Card, BT Stereo and A/V In.
- G These buttons change with the media mode you are in.
- H Radio memory presets and CD controls.

**Note:** Some features may not be available in your area. Contact an authorized dealer for more information.

You can access these options using the touchscreen or voice commands.

## Browsing Device Content

When listening to audio on a device, you can browse through other devices without having to change sources. For example, if you are currently listening to audio on an SD card, you can browse all the artists that are stored on your USB device.



Press the voice icon on the steering wheel. When prompted, you can say:

"BROWSE" within devices
"Browse"
"Browse <league> games"
"Browse <Sirius category> channels"
"Browse SD card"
"Browse Sirius channel guide"

"BROWSE" within devices
"Browse USB"
"Help"

\* If you only say, "Browse", you can then say any commands in the following chart.

\*\* This command is only usable if you have an active subscription to SIRIUS satellite radio.

"BROWSE"
"<League> Games"
"<Sirius category> channels"
"SD card"
"Sirius Channel Guide"
"USB"
"Help"

\* This command is only usable if you have an active subscription to SIRIUS satellite radio.

\*\* For more commands in SD card or USB mode, see the "SD Card and USB Port" section of this chapter.

## MyFord Touch™ (If Equipped)

Your voice system allows you to change audio sources with a simple voice command. For example, if you are listening to music on a USB device, then want to switch to a satellite radio channel, simply press the voice button on the steering wheel controls and say the name of the SIRIUS station (such as, "the Highway"). The following voice commands are available at the top level of the voice session no matter which current audio source you are listening to (such as a USB device or SIRIUS satellite radio).

**Note:** *This is only available when your MyFord Touch system language is set to North American English.*

Sample commands
"<87.9-107.9>"
"<530-1710>"
"<Channel name>"
"AM <530-1710>"
"FM <87.9-107.9>"
"Play [album] <name>"
"Play [artist] <name>"
"Play [genre] <name>"
"Play [playlist] <name>"
"Play [song] <name>"
"Play <name>"
"Play <name (song or album)> by <artist name>"

Sample commands
"Sirius <0-223>"
"Sports games"

\* This command is only usable if you have an active subscription to SIRIUS satellite radio.

\*\* The commands that have [ ] around the word means that the word is optional. For example, if you say, "Play Metallica", this is the same as the voice command, "Play [artist] <name>"

### AM/FM Radio



Touch the **AM** or **FM** tab to listen to the radio.

To change between AM and FM presets, just touch the **AM** or **FM** tab.

### Memory Presets

Save a station by pressing and holding one of the memory preset areas. There is a brief mute while the radio saves the station. Sound returns when finished.

### HD Radio

Touch this button to switch HD Radio on. The light on the button illuminates when the feature is on. HD Radio allows you to receive radio broadcasts digitally, where available, providing free, crystal-clear sound. See HD Radio information later in this chapter.

### Scan

Touch this button to go to the next strong AM or FM radio station. The light on the button illuminates when the feature is on.

## Options

### Sound Settings

Touch this button to adjust settings for:

- Bass.
- Midrange.
- Treble.
- Balance and Fade.
- DSP (Digital Signal Processing).
- Occupancy Mode.
- Speed Compensated Volume.

**Note:** *Your vehicle may not have all of these sound settings.*

### Set PTY for Seek/Scan

This allows you to select a category of music you would like to search for. You can then choose to either seek or scan for the stations playing that category.

### RDS Text Display

This allows you to view the information broadcast by FM stations.

### AST

AST (Autostore) allows you to have the system automatically store the six strongest stations in your current location.

### TAG Button

This feature is available when HD Radio is on, and allows you to tag a song to download later. When you select On, **TAG** appears on-screen when HD Radio is active. You can touch **TAG** to save the information of the song that is playing. When you plug in your portable music player, the information transfers, if supported by your device. When you connect to iTunes, the tags appear to remind you of the songs you would like to download. See HD Radio information later in this chapter.

## Direct Tune

Touch this button to manually enter the desired station number. Touch **Enter** when you are done.

## HD Radio™ Information (If Available)

**Note:** *HD Radio broadcasts are not available in all markets.*

HD Radio technology is the digital evolution of analog AM/FM radio. Your system has a special receiver that allows it to receive digital broadcasts (where available) in addition to the analog broadcasts it already receives. Digital broadcasts provide a better sound quality than analog broadcasts with free, crystal-clear audio and no static or distortion. For more information and a guide to available stations and programming, please visit [www.hdradio.com](http://www.hdradio.com).

When HD Radio is on and you tune to a station broadcasting HD Radio technology, you may notice the following indicators on your screen:



E142616

The HD Radio logo either blinks when acquiring a digital station and then stays solid when digital audio is playing, or is grey when acquiring a digital station and then changes to orange when digital audio is playing. When this logo is available, you may also see Title and Artist fields on-screen.



## MyFord Touch™ (if Equipped)

---

The multicast indicator appears in FM mode (only) if the current station is broadcasting multiple digital broadcasts. The highlighted numbers signify available digital channels where new or different content is available. HD1 signifies the main programming status and is available in analog and digital broadcasts. Other multicast stations (HD2 through HD7) are only available digitally.

**TAG** allows you to save a song to download later when you are on an acquired HD Radio station and the feature is on. To switch the feature on and use it:

1. Press **AM** or **FM** > **Options** > **TAG** > **On**.
2. When you hear a song you like, touch **TAG**.
3. The system automatically saves the song's information and transfers it to your portable music player (if supported) when you connect it to the system. The system automatically transfers the tag to your player (if already connected) and a pop-up confirms the transfer.

4. When you access iTunes with your portable music player, the tags appear to you as a reminder. The system allows you to tag up to approximately 100 songs. For a list of devices that support tagging, see [www.SYNCMYRide.com](http://www.SYNCMYRide.com), [www.SYNCMYRide.ca](http://www.SYNCMYRide.ca) or [www.syncmaroute.ca](http://www.syncmaroute.ca).

When HD Radio broadcasts are active, you can access the following functions:

- **Scan** allows you to hear a brief sampling of all available stations. This feature still works when HD Radio reception is on, although it does not scan for HD2-HD7 channels. You may see the HD logo appear if the station has a digital broadcast.
- **Memory presets** allow you to save an active channel as a memory preset. Touch and hold a memory preset slot until the sound returns. There is a brief mute while the radio saves the station. Sound returns when finished. When switching to an HD2 or HD3 memory preset, the sound mutes before the digital audio plays, because the system has to reacquire the digital signal.

**Note:** *As with any saved radio station, you cannot access the saved station if your vehicle is outside the station's reception area.*

## MyFord Touch™ (If Equipped)

### HD Radio Reception and Station Troubleshooting

Potential reception issues	
Reception area	If you are listening to a multicast station and you are on the fringe of the reception area, the station may mute due to weak signal strength.
	If you are listening to HD1, the system switches back to the analog broadcast until the digital broadcast is available again. However, if you are listening to any of the possible HD2-HD7 multicast channels, the station mutes and stays muted unless it is able to connect to the digital signal again.
Station blending	When the system first receives a station (aside from HD2-HD7 multicast stations), it first plays the station in the analog version. Once the receiver verifies the station is an HD Radio station, it shifts to the digital version. Depending on the station quality, you may hear a slight sound change when the station changes from analog to digital. Blending is the shift from analog to digital sound or digital back to analog sound.

In order to provide the best possible experience, use the contact form to report any station issues found while listening to a station broadcasting with HD Radio technology. Independent entities own and operate each station. These stations are responsible for ensuring all audio streams and data fields are accurate.

Potential station issues		
Issues	Cause	Action
Echo, stutter, skip or repeat in audio.	This is poor time alignment by the radio broadcaster.	No action required. This is a broadcast issue.
Increase or decrease in audio volume.		
Sound fading or blending in and out.	The radio is shifting between analog and digital audio.	No action required. The reception issue may clear up as you continue to drive.

# MyFord Touch™ (If Equipped)

Potential station issues		
Issues	Cause	Action
There is an audio mute delay when selecting HD2 or HD3, multicast preset or <b>Direct Tune</b> .	The digital multicast is not available until the HD Radio broadcast is decoded. Once decoded, the audio is available.	No action required. This is normal behavior. Wait until the audio is available.
Cannot access HD2 or HD3 multicast channel when recalling a preset or from a direct tune.	The previously stored multicast preset or direct tune is not available in your current reception area.	No action required. The station is not available in your current location.
Text information does not match currently playing audio.	Data service issue by the radio broadcaster.	Fill out the station issue form at the website listed below.*
There is no text information shown for currently selected frequency.	Data service issue by the radio broadcaster.	Fill out the station issue form at the website listed below.*
HD2-HD7 stations not found when <b>Scan</b> is pressed.	Pressing <b>Scan</b> disables HD2-HD7 channel search.	No action required. This is normal behavior.
* <a href="http://www.ibequity.com/automotive/report_radio_station_experiences">http://www.ibequity.com/automotive/report_radio_station_experiences</a>		

HD Radio Technology is under license iBiquity Digital Corp. U.S. and foreign patents manufacture. HD Radio and the HD and HD Radio logos are proprietary trademarks of iBiquity Digital Corp. Ford Motor Company and iBiquity Digital Corp. are not responsible for the content sent using HD Radio technology. Content may be changed, added or deleted at any time at the station owner's discretion.

## Radio Voice Commands



If you are listening to the radio, press the voice button on the steering wheel controls. When prompted, say any of the following commands.

If you are not listening to the radio, press the voice button and, after the tone, say "Radio", then any of the following commands.

<b>"RADIO"</b>
"<87.9-107.9>"
"<87.9-107.9> HD" <sup>1</sup>
"<530-1710>"
"AM"
"AM <530-1710>"
"AM autosest"
"AM autosest preset <#>"

## MyFord Touch™ (If Equipped)

"RADIO"
"AM preset <#>"
"Browse" <sup>2</sup>
"FM"
"FM <87.9-107.9>"
"FM <87.9-107.9> HD <#>" <sup>1</sup>
"FM autotset"
"FM autotset preset <#>"
"FM preset <#>"
"FM 1"
"FM 1 preset <#>"
"FM 2"
"FM 2 preset <#>"
"HD <#>" <sup>1</sup>
"Preset <#>"
"Radio off"
"Radio on"
"Set PTY"
"Tune" <sup>3</sup>
"Help"

<sup>1</sup> If available.

<sup>2</sup> If you have said "Browse", see the "Browse" chart later in this section.

<sup>3</sup> If you have said "Tune", see the following "Tune" chart.

"TUNE"
"<530-1710>"
"<87.9-107.9>"
"<87.9-107.9> HD <#>"*
"AM"
"AM <530-1710>"
"AM autotset"
"AM autotset preset <#>"
"AM preset <#>"
"FM"
"FM <87.9-107.9>"
"FM <87.9-107.9> HD <#>"*
"FM autotset"
"FM autotset preset <#>"
"FM preset <#>"
"FM 1"
"FM 1 preset <#>"
"FM 2"
"FM 2 preset <#>"
"HD <#>"*
"Preset <#>"
"Help"

\* If available.

### SIRIUS® Satellite Radio (If Activated)



Press the lower left-hand corner of the touchscreen, and then select the **SIRIUS** tab.

# MyFord Touch™ (If Equipped)

## Memory Presets

Save a channel by pressing and holding one of the memory preset areas. There is a brief mute while the radio saves the channel. Sound returns when finished.

## ALERT

Save the current song, artist, or team as a favorite. The system alerts you when it plays again on any channel.

## Replay

Replay audio on the current channel. You can replay approximately 45 minutes of audio as long as you have remained tuned to the current station. Changing stations erases the previous audio.

While in replay mode:

- Press and release the seek buttons to hear the previous or next song.
- Press and hold the seek buttons to reverse or fast forward in the current track.
- Press play or pause to play or pause the audio.
- Press **Replay** to return to live audio if you have been using the feature to replay audio.

## Scan

Touch this button to hear a brief sampling of channels.

## Options

Touch this button to view and adjust various media settings.

## Sound Settings

Touch this button to adjust settings for:

- Bass.
- Midrange.
- Treble.

- Balance and Fade.
- DSP (Digital Signal Processing).
- Occupancy Mode.
- Speed Compensated Volume.

**Note:** *Your vehicle may not have all of these sound settings.*

## Set Category for Seek/Scan

This allows you to select a category of music you would like to search for. You can then choose to either seek or scan for the stations playing that category.

## Parental Lockout

This allows you to lock and unlock channels, change or reset your PIN, or unlock all channels. To use this feature, you need your initial PIN, which is 1234.

## Artist/Title/Team Alerts

This feature allows you to select Artists, Titles and Teams that you would like the system to alert you to when they are playing on other channels. Press Edit Alerts to delete or switch off alerts. You can also set all alerts to on or off. When an alert appears on the screen, you can choose to Tune to the channel, to Cancel the alert or to Disable Alerts. If you are listening to a sporting event, you can save your favorite teams so that the system can alert you when they are playing on a satellite radio channel.

**Note:** *SIRIUS does not support the Alert feature on all channels. Ford Motor Company shall not be responsible for Alert feature variation.*

## Electronic Serial Number (ESN)

You need your ESN to activate, modify or track your satellite radio account. The ESN is on the System Information Screen (SR ESN:XXXXXXXXXXXX). To access your ESN, touch the bottom left-hand corner of the touchscreen. Touch **SIRIUS > Options**.

## Direct Tune

Touch this button to manually enter the desired satellite channel number. Touch **Enter** when you are done.

## Browse

Touch this button to view a list of all available stations. Scroll to see more categories. Touch the station you want to listen to.

Touch **Skip** if you want to skip this channel.

Touch **Lock** if you do not want anyone to listen to this channel.

Touch **Title** or **Artist** to see song and artists on other stations.

## SIRIUS Satellite Radio Information

**Note:** SIRIUS reserves the unrestricted right to change, rearrange, add or delete programming, including canceling, moving or adding particular channels, and its prices, at any time, with or without notice to you. Ford Motor Company shall not be responsible for any such programming changes.



E142593

SIRIUS satellite radio is a subscription-based satellite radio service that broadcasts a variety of music, sports, news, weather, traffic and entertainment programming. Your factory-installed SIRIUS satellite radio system includes hardware and a limited subscription term that begins on the date of sale or lease of your vehicle. See an authorized dealer for availability.

For more information on extended subscription terms (a service fee is required), the online media player, and a list of SIRIUS satellite radio channels and other features, please visit [www.siriusxm.com](http://www.siriusxm.com) in the United States, [www.sirius.ca](http://www.sirius.ca) in Canada, or call SIRIUS at 1-888-539-7474.

**Note:** This receiver includes the eCos real-time operating system. The eCos License publishes eCos.

## MyFord Touch™ (If Equipped)

### **SIRIUS Satellite Radio Reception Factors and Troubleshooting**

<b>Potential reception issues</b>	
Antenna obstructions	For optimal reception performance, keep the antenna clear of snow and ice build-up and keep luggage and other materials as far away from the antenna as possible.
Terrain	Hills, mountains, tall buildings, bridges, tunnels, freeway overpasses, parking garages, dense tree foliage and thunderstorms can interfere with your reception.
Station overload	When you pass a ground-based broadcast-repeating tower, a stronger signal may overtake a weaker one and the audio system may mute.
Satellite radio signal interference	Your display may show ACQUIRING... to indicate the interference and the audio system may mute.

<b>Troubleshooting tips</b>		
<b>Radio display</b>	<b>Cause</b>	<b>Action</b>
Acquiring...	Radio requires more than two seconds to produce audio for the selected channel.	No action required. This message should disappear shortly.
Sat Fault/SIRIUS System Failure.	There is an internal module or system failure present.	If this message does not clear shortly, or with an ignition key cycle, your receiver may have a fault. See an authorized dealer for service.
Invalid Channel.	The channel is no longer available.	Tune to another channel or choose another preset.
Unsubscribed Channel.	Your subscription does not include this channel.	Contact SIRIUS at 1-888-539-7474 to subscribe to the channel, or tune to another channel.
No Signal.	The signal is lost from the SIRIUS satellite or SIRIUS tower to your vehicle antenna.	The signal is blocked. When you move into an open area, the signal should return.

## MyFord Touch™ (If Equipped)

<b>Troubleshooting tips</b>		
<b>Radio display</b>	<b>Cause</b>	<b>Action</b>
Updating.	Update of channel programming in progress.	No action required. The process may take up to three minutes.
Call SIRIUS 1-888-539-7474.	Your satellite service is no longer available.	Contact SIRIUS at 1-888-539-7474 to resolve subscription issues.
None found. Check Channel Guide.	All the channels in the selected category are either skipped or locked.	Use the channel guide to switch off the Lock or Skip function on that station.
Subscription Updated.	SIRIUS has updated the channels available for your vehicle.	No action required.

### **SIRIUS Satellite Radio Voice Commands**



If you are listening to SIRIUS satellite radio, press the voice button on the steering wheel controls. When prompted, say any of the following commands.

If you are not listening to SIRIUS satellite radio, press the voice button and, after the tone, say "SIRIUS", then any of the following commands.

<b>"SIRIUS"</b>
"<Channel name>"
"Preset <#>"
"SAT"
"SAT preset <#>"
"SAT 1"
"SAT 1 Preset <#>"
"SAT 2"

<b>"SIRIUS"</b>
"SAT 2 preset <#>"
"SAT 3"
"SAT 3 preset <#>"
"Sirius <0-223>"
"Sirius off"
"Sirius on"
"Sports game"
"Tune"
"Help"

\* If you have said "Sports game", see the following "Sports game" chart.

\*\* If you have said "Tune", see the following "Tune" chart.



# MyFord Touch™ (If Equipped)

<b>"SPORTS GAME"</b>
"Tune to the <college name> game"
"Tune to the <team city> game"
"Tune to the <team city> <team name> game"
"Tune to the <team name> game"
"Help"

<b>"TUNE"</b>
"<Channel Name>"
"Preset <#>"
"SAT"
"SAT 1"
"SAT 1 preset <#>"
"SAT 2"
"SAT 2 preset <#>"
"SAT 3"
"SAT 3 preset <#>"
"Sirius <0-223>"
"Help"

## CD



Press the lower left-hand corner of the touchscreen, and then select the **CD** tab.

You can also advance and reverse the current track or current folder, if applicable.

## Repeat

Touch this button to repeat the currently playing track, all tracks on the disc or switch the feature off if already on.

## Shuffle

Touch this button to play the tracks or entire albums in random order, or switch the feature off if already on.

## Scan

Touch this button to hear a brief sampling of all available tracks.

## More Info

Touch this button to see disc information.

## Options

### Sound Settings

Touch this button to adjust settings for:

- Bass.
- Midrange.
- Treble.
- Balance and Fade.
- DSP (Digital Signal Processing).
- Occupancy Mode.
- Speed Compensated Volume.

**Note:** *Your vehicle may not have all of these sound settings.*

### Compression

Touch this button to switch the compression feature on and off.

## Browse

Touch this button to look through all available CD tracks.

## CD Voice Commands



If you are listening to a CD, press the voice button on the steering wheel controls. When prompted, say any of the following commands.

If you are not listening to a CD, press the voice button and, after the tone, say "CD", then any of the following commands.

## MyFord Touch™ (If Equipped)

"CD"
"Pause"
"Play"
"Play next track"
"Play previous track"
"Play track <1-512>"
"Repeat"
"Repeat folder"*
"Repeat off"
"Repeat track"
"Shuffle"
"Shuffle CD"*
"Shuffle folder"*
"Shuffle off"
"Help"

\*This applies to WMA or MP3 files only.

### SD Card Slot and USB Port

#### SD Card

**Note:** Your SD card slot is spring-loaded. To remove the SD card, press the card in and the system ejects it. Do not attempt to pull the card to remove it as this could cause damage.

**Note:** The navigation system also uses this card slot. See **Navigation** (page 401).

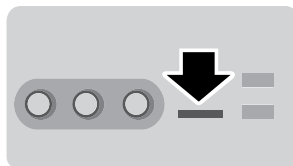

E142619

The SD card slot is located either in the center console or behind a small access door in the instrument panel. To access and play music from your device, press the lower left-hand corner of the touchscreen, and then select **SD Card** from the list on the left-hand side of the screen.



E142620

SD logo is a trademark of SD-3C, LLC.

# MyFord Touch™ (If Equipped)

## USB Port

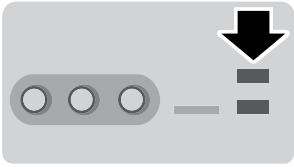

E142621

The USB ports are located either in the center console or behind a small access door in the instrument panel. To access and play music from your device, press the lower left-hand corner of the touchscreen.

This feature allows you to plug in media playing devices, memory sticks, flash drives or thumb drives, and charge devices if they support this feature.

In order to playback video from your iPod or iPhone, you must have a special combination USB/RCA composite video cable (which you can buy from Apple). When you connect the cable to your iPod or iPhone, plug the other end into both the RCA jacks and the USB port.

## Playing Music from Your Device

**Note:** *The system is capable of indexing up to 30000 songs.*



Insert your device and select the **SD Card** or **USB** tab once the system recognizes it. You can then select from the following options:

## Repeat

This feature replays the currently playing song or album.

## Shuffle

Touch this button to play music on the selected album or folder in random order.

## Similar Music

This feature allows you to choose music similar to what is currently playing.

## More Info

Touch this button to see disc information such as current track, artist name, album and genre.

## Options

Touch this button to view and adjust various media settings.

**Sound Settings** allows you to adjust settings for:

- Bass.
- Midrange.
- Treble.
- Balance and Fade.
- DSP (Digital Signal Processing).
- Occupancy Mode.
- Speed Compensated Volume.

**Note:** *Your vehicle may not have all of these sound settings.*

**Media Player Settings** allows you to select more settings, which is under Media Player. See **Settings** (page 344).

**Device Information** displays software and firmware information about the currently connected media device.

**Update Media Index** indexes your device when you connect it for the first time and each time the content changes (such as adding or removing tracks) to make sure you have the latest voice commands available for all media on the device.

# MyFord Touch™ (If Equipped)

## Browse

This feature allows you to view the contents of the device. It also allows you to search by categories, such as genre, artist or album.

If you want to view song information such as Title, Artist, File, Folder, Album and Genre, touch the on-screen album art.

You can also touch **What's Playing** to hear how the system pronounces the current band and song. This can be helpful when using voice commands to make sure the system correctly plays your request.

## Playing Video from Your Device

To access and play video from your device, your vehicle's transmission must be in position **P** with the ignition in accessory mode. See **Starting and Stopping the Engine** (page 127).

## SD Card and USB Voice Commands



If you are listening to a USB device or an SD card, press the voice button on the steering wheel controls. When prompted, say any of the following commands.

If you are not listening to a USB device or an SD card, press the voice button and, after the tone, say "USB" or "SD card", then any of the following commands.

"USB" or "SD CARD"
"Browse"
"Next"
"Pause"
"Play"
"Play album <name>"
"Play all"

"USB" or "SD CARD"
"Play artist <name>"
"Play audiobook <name>"
"Play author <name>"
"Play composer <name>"
"Play folder <name>"
"Play genre <name>"
"Play movie <name>"**
"Play music video <name>"**
"Play playlist <name>"
"Play podcast <name>"
"Play podcast episode <name>"
"Play similar music"
"Play song <name>"
"Play TV show <name>"**
"Play TV show episode <name>"**
"Play video <name>"**
"Play video podcast <name>"**
"Play video podcast episode <name>"**
"Play video playlist <name>"**
"Previous"
"Repeat all"
"Repeat off"
"Repeat on"
"Shuffle"
"Shuffle album"

# MyFord Touch™ (If Equipped)

"USB" or "SD CARD"
"Shuffle off"
"What's this?"
"Help"

\* If you have said you would like to browse your USB or SD card, the system prompts you to specify what you would like to browse. When prompted, see the following "Browse" chart.

\*\* These commands are only available in USB mode and are device-dependent.

"BROWSE"
"Album <name>"
"All albums"
"All artists"
"All audiobooks"
"All authors"
"All composers"
"All folders"
"All genres"
"All movies"*
"All music videos"*
"All playlists"
"All podcasts"
"All songs"
"All TV shows"*
"All video playlists"*
"All video podcasts"*

"BROWSE"
"All videos"*
"Artist <name>"
"Audiobook <name>"
"Author <name>"
"Composer <name>"
"Folder <name>"
"Genre <name>"
"Playlist <name>"
"Podcast <name>"
"TV show <name>"*
"Video <name>"*
"Video playlist <name>"*
"Video podcast <name>"*
"Help"

\* This command is only available in USB mode and is device-dependent.

## Supported Media Players, Formats and Metadata Information

SYNC is capable of hosting nearly any digital media player, including iPod, Zune™, plays from device players, and most USB drives. Supported audio formats include MP3, WMA, WAV and AAC.

It is also able to organize your indexed media from your playing device by metadata tags. Metadata tags, which are descriptive software identifiers embedded in the media files, provide information about the file.

# MyFord Touch™ (If Equipped)

If your indexed media files contain no information embedded in these metadata tags, SYNC may classify the empty metadata tags as **Unknown**.

In order to playback video from your iPod or iPhone, you must have a special combination USB/RCA composite video cable (which you can buy from Apple). When you connect the cable to your iPod or iPhone, plug the other end into both the RCA jacks and the USB port.

## Bluetooth Audio

Your system allows you to stream audio over your vehicle's speakers from your connected, Bluetooth-enabled cellular phone.



To access, press the lower left-hand corner on the touchscreen, then select the **BT Stereo** tab.

## Bluetooth Audio Voice Commands



If you are listening to a Bluetooth audio device, press the voice button on the steering wheel control. When prompted, say "Next song", "Pause", "Play" or "Previous song".

If you are not listening to a Bluetooth audio device, press the voice button and, after the tone, say "Next song", "Pause", "Play" or "Previous song".

## A/V Inputs

### WARNINGS



Driving while distracted can result in loss of vehicle control, crash and injury. We strongly recommend that you use extreme caution when using any device that may take your focus off the road. Your primary responsibility is the safe operation of your vehicle. We recommend

### WARNINGS

against the use of any handheld device while driving and encourage the use of voice-operated systems when possible. Make sure you are aware of all applicable local laws that may affect the use of electronic devices while driving.



For safety reasons, do not connect or adjust the settings on your portable music player while your vehicle is moving.



Store the portable music player in a secure location, such as the center console or the glove box, when your vehicle is moving. Hard objects may become projectiles in a crash or sudden stop, which may increase the risk of serious injury. The audio extension cable must be long enough to allow the portable music player to be safely stored while your vehicle is moving.

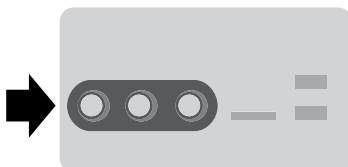

E142622

Your A/V inputs allow you to connect an auxiliary audio/video source (such as a gaming system or a personal camcorder) by connecting RCA cords (not included) to these input jacks. The jacks are yellow, red and white and are located either behind a small access door on the instrument panel or in your center console.

## MyFord Touch™ (If Equipped)

You can also use the A/V inputs as an auxiliary input jack to play music from your portable music player over your vehicle's speakers. Plug in your 1/8 inch (3.5 millimeter) RCA adapter into the two left A/V input jacks (red and white).

Press the lower left-hand corner of the touchscreen, and then select **A/V In**.

To use the auxiliary input jack feature, make sure that your portable music player is designed for use with headphones and that it is fully charged. You also need an audio extension cable with stereo male 1/8 inch (3.5 millimeter) connectors at one end and a RCA jack at the other.

1. Switch off the vehicle, radio and portable music player. Set the parking brake and put the transmission in position **P**.
2. Attach one end of the audio extension cable to the headphone output of your player and the other end into the adapter in one of the two left-hand A/V input jacks (white or red) inside the center console.
3. Press the lower left-hand corner on the touchscreen. Select either a tuned FM station or a CD (if there is a CD already loaded into the system).
4. Adjust the volume as desired.
5. Switch the portable music player on and adjust the volume to half the maximum.
6. Press the lower left-hand corner on the touchscreen. Select the **A/V In** tab. (You should hear audio from your portable music player although it may be low.)

7. Adjust the sound on your portable music player until it reaches the level of the FM station or CD by switching back and forth between the controls.

In order to playback video from your iPod or iPhone, you must have a special combination USB/RCA composite video cable (which you can buy from Apple). When you connect the cable to your iPod or iPhone, plug the other end into both the RCA jacks and the USB port.

### Troubleshooting

- Do not connect the audio input jack to a line level output. The jack only works correctly with devices that have a headphone output with a volume control.
- Do not set the portable music player's volume level higher than is necessary to match the volume of the CD or FM radio as this causes distortion and reduces sound quality.
- If the music sounds distorted at lower listening levels, turn the portable music player volume down. If the problem persists, replace or recharge the batteries in the portable media player.
- Control the portable media player in the same manner when used with headphones, as the auxiliary input jack does not provide control (such as Play or Pause) over the attached portable media player.

## PHONE

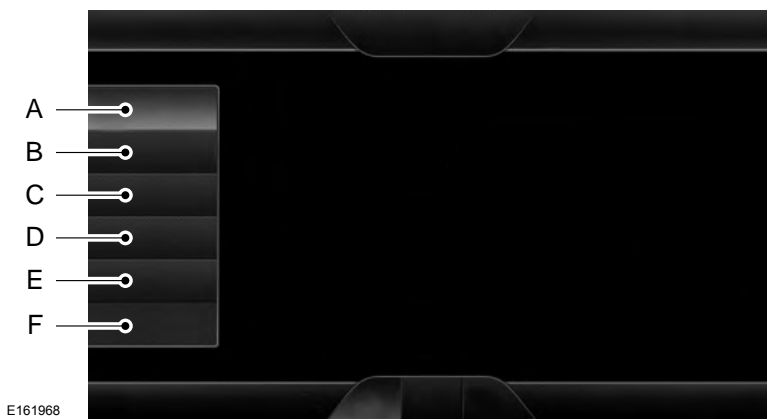

E161968

- A Phone
- B Quick Dial
- C Phonebook
- D History
- E Messaging
- F Settings

Hands-free calling is one of the main features of SYNC. Once you pair your phone, you can access many options using the touchscreen or voice commands. While the system supports a variety of features, many are dependent on your cellular phone's functionality.

At a minimum, most cellular phones with Bluetooth wireless technology support the following functions:

- Answering an incoming call.
- Ending a call.
- Using privacy mode.
- Dialing a number.

- Redialing.
- Call waiting notification.
- Caller ID.

Other features, such as text messaging using Bluetooth and automatic phonebook download, are phone-dependent features. To check your phone's compatibility, see your phone's user manual and visit [www.SYNCMYride.com](http://www.SYNCMYride.com), [www.SYNCMYride.ca](http://www.SYNCMYride.ca) or [www.syncmaroute.ca](http://www.syncmaroute.ca).



## Pairing Your Phone for the First Time

### WARNING



Driving while distracted can result in loss of vehicle control, crash and injury. We strongly recommend that you use extreme caution when using any device that may take your focus off the road. Your primary responsibility is the safe operation of your vehicle. We recommend against the use of any handheld device while driving and encourage the use of voice-operated systems when possible. Make sure you are aware of all applicable local laws that may affect the use of electronic devices while driving.

The first thing you must do to use the phone features of SYNC is to pair your Bluetooth-enabled cellular phone with SYNC. This allows you to use your phone in a hands-free manner.

**Note:** Put the transmission in park (P). Switch on your vehicle ignition and the radio.

1. Touch **Add Phone** in the upper left corner of the touchscreen. **Find SYNC** appears on the screen, and instructs you to begin the pairing process from your device.
2. Make sure that Bluetooth is set to **On** and that your cellular phone is in the proper mode. See your phone's manual if necessary.

**Note:** Select **SYNC**, and a six-digit PIN appears on your device.

3. If prompted to enter a PIN on your device, it does not support Secure Simple Pairing. To pair, enter the PIN displayed on the touchscreen. Skip the next step.
4. When prompted on your phone's display, confirm that the PIN provided by SYNC matches the PIN displayed on your cellular phone.

5. The display indicates when the pairing is successful.

SYNC may prompt you with more phone options. For more information on your phone's capability, see your phone's manual and visit the website.

## Pairing Subsequent Phones

**Note:** Put the transmission in park (P). Switch on your vehicle ignition and the radio.

1. Press the **Phone** corner of the touchscreen > **Settings** > **BT Devices** > **Add Device**.
2. Make sure that Bluetooth is set to **On** and that your cellular phone is in the proper mode. See your phone's manual if necessary.

**Note:** Select **SYNC**, and a six-digit PIN appears on your device.

3. If prompted to enter a PIN on your device, it does not support Secure Simple Pairing. To pair, enter the PIN displayed on the touchscreen. Skip the next step.
4. When prompted on your phone's display, confirm that the PIN provided by SYNC matches the PIN displayed on your cellular phone.
5. The display indicates when the pairing is successful.

SYNC may prompt you with more phone options. For more information on your phone's capability, see your phone's manual and visit the website.

## Making Calls



Press the voice button on your steering wheel controls. When prompted, say, "Call <name>" or say "Dial", then the desired number.



To end the call or exit phone mode, press this phone button.

## Receiving Calls

During an incoming call, an audible tone sounds. Call information appears in the display if it is available.



Accept the call by pressing **Accept** on the touchscreen or by pressing this phone button on your steering wheel controls.



Reject the call by pressing **Reject** on the touchscreen or by pressing this phone button on your steering wheel controls.

Ignore the call by doing nothing. SYNC logs it as a missed call.

## Phone Menu Options

Press the top left corner on your touchscreen to select from the following options:

### Phone

Touch this button to access the on-screen numerical pad to enter a number and place a call. During an active call, you can also choose to:

- Mute the call.
- Put the call on hold.
- Turn on the privacy feature.
- Join two calls.
- End the call.

### Quick Dial

Set up favorite contacts from your phonebook or history folder.

### Phonebook

Touch this button to access and call any contacts in your previously downloaded phone book. The system places the entries in alphabetical categories summarized at the top of the screen.

To switch on contact picture settings, if your device supports this feature, press **Phone > Settings > Manage Phonebook > Download photos from Phonebook > On**.

### History

After you connect your Bluetooth-enabled phone to SYNC, you can access any previously dialed, received or missed calls. You can also choose to save these to your Favorites or to Quick Dial.

**Note:** *This is a phone-dependent feature. If your phone does not support downloading call history using Bluetooth, SYNC keeps track of calls made with the SYNC system.*

### Messaging

Send text messages using your touchscreen. See **Text messaging** later in this section.

### Settings

Touch this button to access various phone settings, such as turning Bluetooth on and off, managing your phonebook and more. See **Phone settings** later in this section.

### Text Messaging

**Note:** *Downloading and sending text messages using Bluetooth are phone-dependent features.*

**Note:** *Certain features in text messaging are speed-dependent and not available when your vehicle is traveling at speeds over 3 mph (5 km/h).*

**Note:** *SYNC does not download read text messages from your phone.*

You can send and receive text messages using Bluetooth, read them aloud and translate text messaging acronyms, such as LOL.

1. Touch the top left corner of the display to access the **Phone** menu.

# MyFord Touch™ (If Equipped)

2. Select **Messaging**.
3. Choose from the following:
  - Listen (speaker icon).
  - Dial.
  - Send Text.
  - View.
  - Delete.

## Composing a Text Message

**Note:** *This is a speed-dependent feature. It is unavailable when your vehicle is traveling at speeds over 3 mph (5 km/h).*

**Note:** *Downloading and sending text messages using Bluetooth are phone-dependent features.*

1. Touch the top left corner of the display to access the **Phone** menu.
2. Touch **Messaging > Send Text**.
3. Enter a phone number or choose from your phonebook.
4. You can select from the following options:
  - **Send**, which sends the message as it is.
  - **Edit Text**, which allows you to customize the pre-defined message or create a message on your own.

You can then preview the message, verify the recipient as well as update the message list.

Text message options
I'll call you back in a few minutes.
I just left, I'll be there soon.
Can you give me a call?
I'm on my way.
I'm running a few minutes late.

Text message options
I'm ahead of schedule, so I'll be there early.
I'm outside.
I'll call you when I get there.
OK
Yes
No
Thanks
Stuck in traffic.
Call me later.
LOL

## Receiving a Text Message

**Note:** *If you select **View** and your vehicle is traveling over 3 mph (5 km/h), the system offers to read the message to you instead of allowing you to view it while driving.*

When a new message arrives, an audible tone sounds and the screen displays a pop-up with the caller name and ID, if supported by your phone. You can press:

- **View** to view the text message.
- **Listen** for SYNC to read the message to you.
- **Dial** to call the contact.
- **Ignore** to exit the screen.

## Phone Settings

Press **Phone > Settings**.

## Bluetooth Devices

Touch this tab to connect, disconnect, add or delete a device, as well as save it as a favorite.

# MyFord Touch™ (If Equipped)

## Bluetooth

Touch this tab to turn Bluetooth off or on.

## Do Not Disturb

Touch this tab if you want all calls to go directly to your voice mail and not ring in the vehicle. When this feature is on, text message notifications do not ring inside the cabin either.

## 911 Assist

Turn on or turn off the 911 Assist feature. See **Information** (page 388).

## Phone Ringer

Select the ring tone you want to hear when you receive a call. Choose from possible system ring tones, your currently paired phone's ring tone, a beep, text-to-speech or a silent notification.

## Text Message Notification

Select a text message notification, if supported by your phone. Choose from possible system alert tones, text-to-speech or silent.

## Internet Data Connection

If your phone is compatible, use this screen to adjust your internet data connection. Select to make your connection profile with the personal area network or to switch off your connection. You can also choose to adjust your settings or have the system always connect, never connect when roaming or query on connect. Press **?** for more information.

## Manage Phonebook

Touch this button to access features such as automatic phonebook download, re-download your phonebook, add contacts from your phone as well as delete or upload your phonebook.

## Roaming Warning

Touch this button to have the system alert you when your phone is in roaming mode.

## Phone Voice Commands



Press the voice button on the steering wheel controls. When prompted, say any of the following commands:

<b>"PHONE"</b>
"Call"
"Call <name>"
"Call <name> at home"
"Call <name> at work"
"Call <name> on cell"
"Call <name> on other"
"Call voicemail"
"Dial"
"Do not disturb off"
"Do not disturb on"
"Forward text messages"
"Go to hands free"
"Hold call off"
"Hold on"
"Join calls"
"Listen to text message <#>"
"Listen to text messages"
"Messages"
"Mute call"

# MyFord Touch™ (If Equipped)

"PHONE"
"Pair phone"
"Privacy on"
"Read text message"
"Reply to text messages"
"Turn ringer off"
"Turn ringer on"
"Unmute call"
"Help"

"MESSAGES"
"Call"
"Forward text messages"
"Listen to text message <#>"
"Listen to text messages"
"Reply to text messages"
"Help"

\* This command is only available during an active call.

\*\* If you say "Messages", see the following "Messages" chart for additional commands.



Your system has special electric vehicle screens, which display power flow and charge settings. To access these screens, press the EV Info button.



E169382

- A Settings
- B Power

# MyFord Touch™ (If Equipped)

---

## Settings (Energi Only)

This screen allows you to set up the charging convenience features.

**Note:** You can also set up the charging convenience features using MyFord Mobile over the internet or smartphone application. For more information on MyFord Mobile, and to set up your MyFord Mobile account, visit [www.myfordmobile.com](http://www.myfordmobile.com).

To improve the charging experience, your vehicle has the following convenience features:

- **Value Charge:** Your vehicle schedules its charging time for when the utility rates are lowest. Contact your utility company to see what rates are available.
- **Charge Now:** Your vehicle starts charging immediately after you connect the charging plug.
- **GO Time:** Setting GO Times allows you to control charging schedules and cabin conditioning settings so your vehicle is ready to drive when you are. By setting a GO Time, your vehicle can use your value charge settings to minimize your electricity costs but still prioritize getting a full charge before your GO Time. A calendar view allows you to program two GO Times per day for each day of the week.

**Note:** Remember, you must plug in your vehicle for My GO Time to work.

- **Cabin Conditioning:** Get the most miles out of every charge by conditioning your vehicle while it is plugged in. Set the cabin temperature when you set your GO Time in order to use energy from your home (or charging station) instead of from your vehicle's battery.

## MyFord Touch™ (If Equipped)

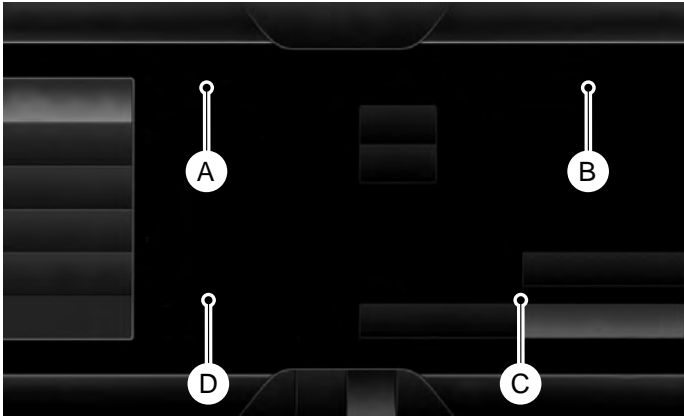

E161966

- A **My GO Time summary** displays the next GO Time and cabin temperature setting.
- B **Estimated charge time limits** displays the estimated minimum and maximum times to fully charge the high-voltage battery and the battery's present state of charge as a percentage of total capacity.
- C **Charge profile and mode** displays the charging profile and charging mode for the vehicle's present location.
- D **Charging status and actual times** displays charging status with the charging start time, end time, and duration.

### My GO Time Summary

#### GO Time

This is the time and date of your next set drive time. Your vehicle automatically schedules charging and cabin conditioning to finish by this time.

#### Temperature

This is the chosen cabin conditioning setting for this GO Time.

#### Skip

This cancels the cabin conditioning for the present GO Time. Once you touch Skip, the GO Time and Temperature grey out, and the LED illuminates on the Skip button. Touch the button again to turn on the cabin conditioning. This feature allows you to ignore the present GO Time without having to delete it or having to turn off the entire schedule (see **GO Time Schedule** later in this section). After the present GO Time passes, the Skip feature resets.

#### Edit

This accesses your GO Time Schedule (see **GO Time Schedule** later in this section).

## MyFord Touch™ (If Equipped)

The system also alerts you to any conflicts by highlighting areas of the screen in yellow. If your battery cannot have a full charge by the scheduled drive time, the system highlights your next GO Time and Charge Complete time and a message

**Charge at GO Time: under 100%** appears. This is normal; the vehicle is informing you of the conflicting situation. This notification only displays when the gearshift selector lever is in position **P**.

**Note:** *Charging occurs as soon as you plug the vehicle in. The system limits cabin conditioning to 15 minutes before your GO Time.*

To eliminate the conflict notification immediately or to prevent a conflict in the future, try the following:

- Change the present GO Time to occur later.
- Plug the vehicle into a 240V charging station instead of the 120V convenience cord. Higher power charging yields shorter charge times.
- Plug the vehicle in sooner.

### Estimated Charge Time Limits

#### Battery

This shows you the battery's current charge displayed as a percentage. A reading of 100% means the battery has a full charge. A reading of 0% indicates the battery has no plug-in energy left.

#### To fully charge

**240V** is the estimated minimum charging time from the present high-voltage battery level to full charge (100%). This represents the shortest amount of time you should expect the high-voltage battery to recharge under ideal conditions. Ideal conditions include a 240V charging station and a minimum 30A service and high-voltage battery at a moderate temperature.

**Note:** *This charging time is only an estimate. It is normal for your actual charge duration to be longer.*

**Note:** *Some charging stations use lower voltage (208V), which result in longer charge times.*

**120V** is the estimated maximum charging time from the present high-voltage battery level to full charge (100%). This represents the longest amount of time you should expect the high-voltage battery to recharge under normal conditions. Normal conditions include a 120V convenience cord and 12A service.

**Note:** *This charging time is only an estimate. It is possible for your actual charge duration to be longer. This occurs when the AC line voltage is low and may indicate your electrical source is not meeting certain requirements. See **Charging the High Voltage Battery** (page 151).*

### Value Charge Profile and Mode

#### Value Charge Profile Name

This is the name of the presently detected Value Charge Profile. The system detects a customer defined value charge profile when the vehicle is within approximately 300 feet (100 meters) of the GPS location registered for the profile. If the vehicle is close to more than one charge profile, it chooses the closest. When the vehicle is not at a defined profile, it uses the **Default Value** charge profile. The system normally displays **Default Profile** while you are driving because the vehicle is typically between defined value charge profiles.

#### Edit

Touch this button to access your Value Charge profiles settings screen (see **Value Charge Profiles** later in this section).



## **Charge Now**

Touch this button if you want your vehicle to immediately charge when plugged in at this profile location. This button illuminates when Charge Now is the charge mode selected for the presently detected charge profile.

## **Value Charge**

Touch this button if you want to take advantage of off-peak electricity rates. The vehicle optimizes the charge schedule to be complete by the next GO Time. This button illuminates when Value Charge is the charge mode selected for the presently detected charge profile.

## **Charging Status and Actual Times**

This is the status of the charging system, which includes the charging plug, high-voltage battery and charger.

## **Next Charge**

This means the vehicle is unplugged. Charge Start and Complete information is for the present vehicle location.

## **Waiting to Charge**

This means you plugged the vehicle in and it is ready to charge. Typical of Value Charge mode, the vehicle may not start charging right away because it is set to charge at times with lower utility costs.

## **Charging**

This means the high-voltage battery is charging.

## **Charged**

This informs you that the high-voltage battery is fully charged and not currently scheduled for further charging.

## **Charge Fault**

This alerts you that a fault is present and is preventing the high-voltage battery from charging. Inspect the charge plug connection, charge cord and charging station.

## **Start**

This is the scheduled start time of charging.

- **At Plug In:** When the vehicle is in Charge Now mode, and unplugged, the message At Plug In appears, indicating the vehicle immediately starts charging once you plug it in. Once you plug it in, the system shows the actual charge start time.
- **Scheduled Charge Start Time:** When the vehicle is in Value Charge mode, the system displays the scheduled charge start time (for example, 8:00 PM). Once charging starts, the system continues to display the actual charge start time.

## **Complete**

This is the estimated time of charge completion.

- **Charge Now Duration:** When the vehicle is in Charge Now mode, and unplugged, the system displays the charging duration in hours. Once you plug in the vehicle, the value shows the estimated time to finish charging.
- **Scheduled Charge Complete Time:** When the vehicle is in Value Charge mode, the system displays the estimated charge complete time. It is normal for the estimated complete time to change while charging. The vehicle keeps charging until the high-voltage battery is fully charged.

## GO Time Schedule

Touch the **Edit** button in the My GO Time section of the Settings screen to see the GO Time Schedule.

### On

This turns on the GO Time schedule.

### Off

This turns off the GO Time schedule. This also turns off the cabin conditioning function. Use this mode to prevent using energy for cabin preconditioning when you leave your vehicle plugged in and don't plan to use it for a while, such as when on vacation.

**Note:** *If you choose to perform Value Charging with the schedule off, the vehicle schedules charging to finish at the lowest cost within 24 hours of plugging the vehicle in.*

## GO Time 1 and GO Time 2

This displays the GO Time day-of-week and time. The blue highlighted GO Time is the present GO Time which the vehicle is using for charge scheduling and cabin conditioning. You can schedule two GO Time events per day for each day of the week.

- **GO Time** allows you to edit the GO Time and cabin conditioning temperature.
- **--:--** indicates that you can add a GO Time to this slot.

**Note:** *If you set GO Time 2 to occur before GO Time 1, a message pops up alerting you. You need to go back to the previous screen and change the times so GO Time 1 occurs before GO Time 2.*

## GO Time and Cabin Conditioning

This screen allows you to enter or change the GO Time and cabin conditioning temperature.

### Time (+ and -)

These change the hours and minutes of your GO Time. The minutes change in increments of five. You can also change the settings for AM and PM by touching those buttons.

### Cabin Conditioning (+ and -)

These change the setting for your selected cabin conditioning temperature for this GO Time event. You can select from four settings:

- 65°F (18.5°C)
- 72°F (22.0°C)
- 85°F (29.5°C)
- Off.

**Note:** *Cabin conditioning can perform differently depending on if you plug into a 120V convenience cord or 240V charging station. The power available for conditioning is limited to the charging station power available.*

**Note:** *Your vehicle may not always reach the set cabin temperature due to charging and ambient temperature conditions. This is normal operation.*

### Clear

Touching this button erases the GO Time and cabin conditioning temperature.

### Save

Touching this button stores the GO Time and temperature settings.

**Note:** *If you select a GO Time, but choose **Off** for the temperature setting, the vehicle schedules charging to be complete by your GO Time and does not condition the cabin.*

**Note:** Make sure you save your settings before returning to the previous screen. If you do not touch **Save**, your settings are not stored in the system.

## Value Charge Profiles

Touch the **Edit** button next to the profile name on the Settings screen to see the value charge profiles.

### Default

This displays the charging mode and off-peak times for your Default Value Charge profile. The system displays off-peak times for weekdays; the remaining hours of the day are considered peak time. The system displays similar off-peak times for weekend days.

- **Charge Now** if you want your vehicle to immediately charge when you plug it in at this profile location.
- **Value Charge** if you want to take advantage of off-peak electricity rates. The vehicle optimizes the charge schedule to be complete by the next GO Time.
- **Edit** to access your Default Value Charge Profile settings screen (see Default Value Charge Profile later in this section).

### Customer Defined Value Charge Profiles

Once you create profile names, this section displays the Value Charge Profile names and current Charge Mode for specific locations. You can set up and edit these profiles using the MyFord Mobile internet or smartphone application. You can program up to nine unique charge profiles.

## Default Value Charge Profile

### Weekday and Weekend

Touch the **Edit** button to set the off-peak charge times. Set the Weekday times and Weekend time (by touching the **Weekday** and **Weekend** buttons), then touch **Save**. The system does not store your settings until you make selections for both Weekday and Weekend. If you touch the back arrow button to return to the previous screen without saving your settings, the system does not store them and you need to enter them again.

### Start and Finish

These buttons display the times, which you can modify, using the following:

- **+** and **-** allow you to change the hours of your start and finish times.
- **AM** and **PM** allow you to change the time of your start and finish time. This setting is viewable in 12-hour mode.

### 240V and 120V

These represent the voltage service the default profile is using. The system uses this selection to calculate estimated charge times.

### Clear

Touching this button erases the Default Value Charge preferences.

### Save All

Touching this button stores your Default Value Charge preferences

**Note:** Make sure you save your settings before returning to the previous screen. If you do not touch **Save**, your settings are not stored in the system.

## Power

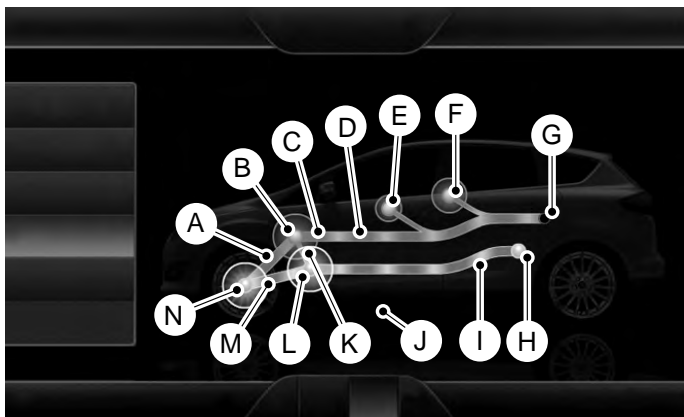

E169381

- A **Motor-to-wheel flow** shows the direction of power flow between the wheels and the electric motor.
- B **Electric Motor** represents the hybrid electric motor. The higher the motor power is, the larger the circle around this node. Any time the vehicle is ready to be driven, the motor node illuminates.
- C **Battery-to-motor flow**<sup>1</sup> shows the direction of power flow between the high-voltage battery and the electric motor. Flow toward the motor indicates the battery is providing power to accelerate the vehicle (discharging the battery). Flow toward the battery indicates the electric motor is providing power to the battery (charging the battery).
- D **Plug (Energi only)** appears when you plug your vehicle into the wall. When charging the high voltage battery from the wall, you can see flow from the plug to the battery on the screen.
- E **Other**<sup>2</sup> includes all power usage from the low voltage accessories such as the climate control fan, headlights and heated seats. The higher the power usage is from these accessories, the larger the circle around the node. This node illuminates anytime the vehicle is on since there is always some low level power in use.
- F **Climate**<sup>2,3</sup> includes the power usage from the high-voltage climate control components such as the electric A/C compressor and the electric heater (Energi only). The higher the power usage is from these components, the larger the circle around this node.

## MyFord Touch™ (If Equipped)

---

- G **High voltage battery power** represents your high-voltage battery. A circle illuminates around the node when the high-voltage battery is receiving power from regenerative braking, engine charging or external charging (when you plug it in). The higher the power going into the high-voltage battery, the larger the circle around this node.
- H **Fuel** represents the fuel tank in the vehicle.
- I **Fuel-to-engine flow** shows flow from the fuel tank to the engine when the engine is on and using fuel (there are some cases where the engine is on, but not using any fuel). When the engine is on, but not using fuel, the engine node is active, but the fuel flow path is off. An example of this is when your foot is off the accelerator pedal and the vehicle is traveling at a high speed.
- J **Engine On due to** provides you with the reason(s) the gasoline engine is on. When the gasoline engine is off, this display does not appear. **Engine On due to** reasons displayed by the system are in a chart following this list.
- K **Motor-to-engine flow** shows the direction of power flow between the engine and the electric motor. The direction indicates if the engine is providing power to the high-voltage electrical system, or if the high-voltage electrical system is providing power to control or start the engine.
- L **Engine power** represents the gasoline engine. It illuminates only when the gasoline engine is on. The higher the engine power is, the larger the circle around this node.
- M **Engine-to-wheels flow** shows the direction of the power flow between the engine and the wheels.
- N **Drive power** represents the power going to the wheels. The higher the wheel power is, the larger the circle around this node. When the engine is off, drive power is shown in blue. When the engine is on, drive power is shown in grey.

<sup>1</sup>The battery-to-motor flow includes battery power the vehicle is using for acceleration. It does not include energy the vehicle is using for accessories (such as air conditioning, headlights and radio). This screen displays accessories and climate usage separately.

<sup>2</sup>**Accessories** indicates electrical power demands from your vehicle's accessory systems. Accessories use power but do not contribute to making the vehicle move. The power flow displays power usage from the climate control system and other accessories separately.

<sup>3</sup>The climate control system may determine A/C is necessary even when you turn it off. In this case, you may see some climate power when the A/C is off.

## MyFord Touch™ (If Equipped)

<b>Engine On due to</b>	
Heater Setting	The engine is on because of the heater setting. Reduce or turn off the heater setting to return to electric mode.
High Speed	The engine is on because the vehicle speed exceeds the level for electric mode operation. Reduce the speed to return to electric mode.
Acceleration	The engine is on when applying pressure to the accelerator pedal or switching on the speed control. Reduce pressure on the accelerator pedal or switch off the speed control to return to full electric mode.
Neutral Gear	The engine is on because the vehicle is in neutral gear. Shift out of neutral gear to return to electric mode.
Low Gear	The engine is on because the vehicle is in low gear. Shift out of low gear to return to electric mode.
Battery Charging	The engine is on to charge the high-voltage battery. The vehicle returns to electric mode once the battery is charged.
Oil Maintenance (Energi Only)	The engine is on to maintain engine oil quality. The vehicle returns to electric mode when engine oil maintenance is complete.
Batt Temperature (Energi Only)	The engine is on due to high or low high-voltage battery temperature. This is a normal operating condition. The vehicle returns to electric mode automatically when possible.
Normal Operation	The engine is on to optimize vehicle operation. The vehicle returns to electric mode when possible.

### **Status**

This indicates which mode is active within the vehicle system.

### **Hybrid Drive**

The electric motor and gasoline engine are powering vehicle.

# MyFord Touch™ (If Equipped)

## **Charging HV Battery**

The hybrid system is storing power in the high-voltage battery.

## **Idle**

The vehicle is either at rest, or sharing very little power between the electric system parts.

## **Electric Drive**

The vehicle is driving in electric mode (the power is coming from the electric motor). The gasoline engine is off in this mode.

## **Charge Complete (Energi only)**

The high-voltage battery charging from the wall is complete.

## **Privacy Notice for GPS Mapping with MyFord® Mobile in the United States and Canada**

MyFord Mobile allows for GPS mapping when a vehicle is registered to a MyFord Mobile account. To remove the vehicle from the account, thereby removing GPS mapping ability, a Master Reset can be performed in the vehicle. See **Settings** (page 344).

Prior to transferring ownership of a vehicle, owners may choose to execute a Master Reset or Factory Reset (completed via the MyFord Mobile website). Either method will remove the vehicle from all MyFord Mobile accounts.

It is recommended that new owners conduct a Master Reset upon taking possession of the vehicle to remove it from any existing MyFord Mobile accounts. The new owner can activate a MyFord Mobile account by going to [www.myfordmobile.com](http://www.myfordmobile.com) and following the registration process.

## **INFORMATION**



E188418

- A SYNC Services
- B Sirius Travel Link
- C Alerts
- D Calendar
- E SYNC Applications
- F Where Am I?



If your vehicle is equipped with Navigation, press the **Information** button to access these features. If your vehicle is not equipped with Navigation, press the corner of the touchscreen with the green tab.

### SYNC Services (If Equipped, United States Only)

**Note:** SYNC Services varies by trim level and model year and may require a subscription. Traffic alerts and turn-by-turn directions available in select markets. Message and data rates may apply. Ford Motor Company reserves the right to change or discontinue this product service at any time without prior notification or incurring any future obligation.

**Note:** SYNC Services requires activation before use. Visit [www.SYNCMyRide.com](http://www.SYNCMyRide.com) to register and check your eligibility for complimentary services. Standard phone and message rates may apply. Subscription may be required. You must also have the active SYNC Services Bluetooth-enabled cellular phone paired and connected to the system in order to connect to, and use, SYNC Services. See **Phone** (page 373).

**Note:** This feature does not function properly if you have enabled caller ID blocking on your cellular phone. Make sure your cellular phone is not blocking caller ID before using SYNC Services.

**Note:** The driver is ultimately responsible for the safe operation of the vehicle, and therefore, must evaluate whether it is safe to follow the suggested directions. Any navigation features provided are only an aid. Make your driving decisions based on your observations of local conditions and existing traffic regulations. Do not follow the route suggestions if doing so would result in an unsafe or illegal maneuver, if you would be placed in an unsafe situation, or if you would be directed into an area that you consider unsafe. Maps used by this system may be inaccurate because of errors, changes in roads, traffic conditions or driving conditions.

**Note:** When you connect, the service uses GPS technology and advanced vehicle sensors to collect your vehicle's current location, travel direction and speed to help provide you with the directions, traffic reports, or business searches you request. Further, to provide the services you request, for continuous improvement, the service may collect and record call details and voice communications. For more information, see SYNC Services Terms and Conditions at [www.SYNCMyRide.com](http://www.SYNCMyRide.com). If you do not want Ford or its service providers to collect your vehicle travel information or other information identified in the Terms and Conditions, do not subscribe or use the service.



## MyFord Touch™ (If Equipped)

SYNC Services uses advanced vehicle sensors, integrated GPS technology and comprehensive map and traffic data, to give you personalized traffic reports, precise turn-by-turn directions, business search, news, sports, weather and more. For a complete list of services, or to learn more, please visit [www.SYNCMyRide.com](http://www.SYNCMyRide.com).

### Connecting to SYNC Services Using Voice Commands



1. Press the voice button.
2. When prompted, say "Services". This initiates an outgoing call to SYNC Services using your paired and connected Bluetooth-enabled cellular phone.
3. Once you connect to the service, follow the voice prompts to request the desired service, such as "Traffic" or "Directions". You can also say, "What are my choices?" to receive a list of available services from which to choose.
4. Say, "Services" to return to the Services main menu or for help, say, "Help".

### Connecting to SYNC Services Using the Touchscreen



If your vehicle is equipped with Navigation, press the **Information** button.

If your vehicle is not equipped with Navigation, press the green tab on your touchscreen.

1. Select **Connect to Services** to initiate an outgoing call to SYNC Services using your phone.

2. Once connected, follow the voice prompts to request your desired Service, such as "Traffic" or "Directions". You can also say, "What are my choices?" to receive a list of available services from which to choose.
3. Say, "Services" to return to the Services main menu or for help, say, "Help".

### Receiving Turn-by-Turn Directions

1. When connected to SYNC Services, say "Directions" or "Business search". To find the closest business or type of business to your current location, just say "Business search" and then "Search near me". If you need further assistance in finding a location you can say "Operator" at any time within a Directions or Business search to speak with a live operator. The system may prompt you to speak with an operator when it has difficulty matching your voice request. The live operator can assist you by searching for businesses by name or by category, residential addresses by street address or by name or specific street intersections. Operator Assist is a feature of your SYNC Services subscription. For more information on Operator Assist, visit [www.SYNCMyRide.com/support](http://www.SYNCMyRide.com/support).
2. Follow the voice prompts to select your Destination. After the route download is finished, the phone call automatically ends.

## MyFord Touch™ (If Equipped)

If your vehicle is not equipped with Navigation:

- Turn-by-turn directions appear in the information display, in the status bar of your touchscreen system and on the SYNC Services screen. You also receive driving instructions from audible prompts.
- When on an active route, you can select **Route Summary** or **Route Status** using the touchscreen controls or voice commands to view the **Route Summary Turn List** or the **Route Status ETA**. You can also turn voice guidance on or off, cancel the route or update the route.

If you miss a turn, SYNC automatically asks if you want the route updated. Just say, "Yes" when prompted and the system delivers a new route to your vehicle.

If your vehicle is equipped with Navigation, SYNC Services downloads your requested destination to the navigation system. The navigation system then calculates the route and provides driving instructions. See **Navigation** (page 401).

### Disconnecting from SYNC Services

1. Press and hold the hang-up phone button on the steering wheel.
2. Say "Good-bye" from the SYNC Services main menu.

### SYNC Services quick tips

Personalizing	You can personalize your Services feature to provide quicker access to your most used or favorite information. You can save address points, such as work or home. You can also save favorite information like sports teams, such as Detroit Lions, or a news category. You can learn more about personalization by logging onto <a href="http://www.SYNCMyRide.com">www.SYNCMyRide.com</a> .
Push to interrupt	Press the voice button at any time (while connected to SYNC Services) to interrupt a voice prompt or an audio clip (such as a sports report) and say your voice command.
Portable	Your subscription is associated with your Bluetooth-enabled cellular phone number, not your VIN (Vehicle Identification Number). You can pair and connect your phone to any vehicle equipped with SYNC Services and continue enjoying your personalized services.

### SYNC Services Voice Commands



When a route has been downloaded (non-navigation systems), press the voice button on the steering wheel controls. When prompted, say any of the following commands:

<b>"SERVICES"</b>
"Cancel route"
"Navigation voice off"
"Navigation voice on"
"Next turn"

## MyFord Touch™ (If Equipped)

<b>"SERVICES"</b>
"Route status"
"Route summary"
"Services"
"Update route"
"Help"

### Sirius Travel Link (If Equipped)

#### WARNING



Driving while distracted can result in loss of vehicle control, crash and injury. We strongly recommend that you use extreme caution when using any device that may take your focus off the road. Your primary responsibility is the safe operation of your vehicle. We recommend against the use of any handheld device while driving and encourage the use of voice-operated systems when possible. Make sure you are aware of all applicable local laws that may affect the use of electronic devices while driving.

**Note:** In order to use Sirius Travel Link, your vehicle must be equipped with navigation and your navigation SD card must be in the SD card slot.

**Note:** This feature is only available in the United States.

**Note:** A paid subscription is required to access and use these features. Go to [www.siriusxm.com/travellink](http://www.siriusxm.com/travellink) for more information.

**Note:** Visit [www.siriusxm.com/traffic](http://www.siriusxm.com/traffic) and click on Coverage map and details for a complete listing of all traffic areas covered by Sirius Travel Link.

**Note:** Neither Sirius nor Ford is responsible for any errors or inaccuracies in the Sirius Travel Link services or its use in vehicles.

When you subscribe to Sirius Travel Link, it can help you locate the best gas prices, find movie listings, get current traffic alerts, view the current weather map, get accurate ski conditions and see scores to current sports games.



If your vehicle is equipped with Navigation, touch the I (Information) button to access these features. If your vehicle is not equipped with Navigation, touch the corner of the touchscreen with the green tab.

### Traffic On Route and Traffic Nearby

Touch these buttons to identify traffic incidents on your route, nearby your vehicle's current location or near any of your favorite places, if programmed.

### Fuel Prices

Touch this button to view fuel prices at stations close to your vehicle's location or on an active navigation route.

### Movie Listings

Touch this button to view nearby movie theaters and their show times, if available.

### Weather

Touch this button to view the nearby weather, current weather, or the five day forecast for the chosen area. Select **Map** to see the weather map, which can show storms, radar information, charts and winds. Select **Area** to select from a listing of weather locations.

### Sports Info

Touch this button to view scores and schedules from a variety of sports. You can also save up to 10 favorite teams for easier access. The score automatically refreshes when a game is in progress.

# MyFord Touch™ (If Equipped)

## Ski Conditions

Touch this button to view ski conditions for a specific area.

## Sirius Travel Link Voice Commands



Press the voice button on the steering wheel controls. When prompted, say any of the following commands:

"SIRIUS TRAVEL LINK"
"5-day weather forecast"
"Fuel prices"
"Movie listings"
"Sports headlines"
"Sports schedules"
"Sports scores"
"Traffic"
"Weather"
"Weather map"
"Help"

\* If you say "Sports headlines", "Sports schedules" or "Sports scores", you can then say any of the commands in the following chart.

Sports-related commands
"Baseball"
"College basketball"
"College football"
"Golf"
"MLS"

Sports-related commands
"My teams"
"NBA"
"NFL"
"NHL"
"WNBA"
"Help"

Additional sports-related voice commands
"Baseball headlines"
"Baseball schedule"
"Baseball scores"
"College basketball headlines"
"College basketball schedule"
"College basketball scores"
"College football headlines"
"College football schedule"
"College football scores"
"Golf headlines"
"Golf leaderboard"
"Golf schedule"
"MLS headlines"
"MLS schedule"
"MLS scores"
"Motor sports headlines"
"Motor sports order"
"Motor sports schedule"
"My team headlines"

# MyFord Touch™ (If Equipped)

Additional sports-related voice commands
"My teams schedule"
"My teams scores"
"NBA headlines"
"NBA schedule"
"NBA scores"
"NFL headlines"
"NFL schedule"
"NFL scores"
"NHL headlines"
"NHL schedule"
"NHL scores"
"WNBA headlines"
"WNBA schedule"
"WNBA scores"
"Help"

## Alerts

 If your vehicle is equipped with Navigation, touch the I (Information) button to access these features. If your vehicle is not equipped with Navigation, touch the corner of the touchscreen with the green tab.

Press **Alerts**, and then choose from any of the following services:

- **View** the complete message.
- **Delete** the message.
- **Delete All** messages.

This screen displays any system messages (such as an SD card fault).

**Note:** The system alerts you to any messages by turning the information icon yellow. After you read or delete the messages, the icon returns to white.

## Calendar

 If your vehicle is equipped with Navigation, touch the I (Information) button to access these features. If your vehicle is not equipped with Navigation, touch the corner of the touchscreen with the green tab.

Press **Calendar**. You can view the current calendar by day, week or month.

## 911 Assist (If Equipped)

### WARNINGS

 Unless the 911 Assist setting is set on before a crash, the system will not dial for help, which could delay response time, potentially increasing the risk of serious injury or death after a crash.

 Do not wait for 911 Assist to make an emergency call if you can do it yourself. Dial emergency services immediately to avoid delayed response time, which could increase the risk of serious injury or death after a crash. If you do not hear 911 Assist within five seconds of the crash, the system or phone may be damaged or non-functional.

 Always place your phone in a secure location in your vehicle so it does not become a projectile or damaged in a crash. Failure to do so may cause serious injury to someone or damage the phone, which could prevent 911 Assist from working properly.

**Note:** The SYNC 911 Assist feature must be set on prior to the incident.

# MyFord Touch™ (If Equipped)

**Note:** Before setting this feature on, make sure that you read the 911 Assist Privacy Notice later in this section for important information.

**Note:** If any user turns 911 Assist on or off, that setting applies for all paired phones. If 911 Assist is turned off, either a voice message plays or a display message (or icon) comes on (or both) when your vehicle is started after a previously paired phone connects.

**Note:** Every phone operates differently. While SYNC 911 Assist works with most cellular phones, some may have trouble using this feature.

If a crash deploys an airbag, excluding knee airbags and rear inflatable safety belts where fitted or activates the fuel pump shut-off, your SYNC-equipped vehicle may be able to contact emergency services by dialing 911 through a paired and connected Bluetooth-enabled phone. You can learn more about the 911 Assist feature, visit [www.SYNCMyRide.com](http://www.SYNCMyRide.com), [www.SYNCMyRide.ca](http://www.SYNCMyRide.ca) or [www.syncmaroute.ca](http://www.syncmaroute.ca).

See **Supplementary Restraints System** (page 35). Important information regarding airbag deployment is in this chapter.

See **Roadside Emergencies** (page 191). Important information regarding the fuel pump shut-off is in this chapter.

## Setting 911 Assist On

 If your vehicle is equipped with Navigation, touch the i (Information) button to access these features. If your vehicle is not equipped with Navigation, touch the corner of the touchscreen with the green tab.

Touch **Apps > 911 Assist**, then select **On**.



You can also access 911 Assist by:

- Pressing the Settings icon > **Settings > Phone > 911 Assist**, or
- Pressing the Settings icon > **Help > 911 Assist**.

To make sure that 911 Assist works properly:

- SYNC must be powered and working properly at the time of the incident and throughout feature activation and use.
- The 911 Assist feature must be set on prior to the incident.
- You must pair and connect a Bluetooth-enabled and compatible phone to SYNC.
- A connected Bluetooth-enabled phone must have the ability to make and maintain an outgoing call at the time of the incident.
- A connected Bluetooth-enabled phone must have adequate network coverage, battery power and signal strength.
- The vehicle must have battery power and be located in the United States, Canada or in a territory in which 911 is the emergency number.

## In the Event of a Crash

Not all crashes deploy an airbag or activate the fuel pump shut-off (which would trigger 911 Assist); however, SYNC tries to contact emergency services if 911 Assist triggers. If a connected phone sustains damage or loses connection to SYNC, SYNC searches for, and tries to connect to, any available previously paired phone and tries to make the call to 911.

Before making the call:

- SYNC provides a short window of time (approximately 10 seconds) to cancel the call. If you fail to cancel the call, SYNC attempts to dial 911.
- SYNC says the following, or a similar message: "SYNC will attempt to call 911, to cancel the call, press Cancel on your screen or press and hold the phone button on your steering wheel."

If you do not cancel the call, and SYNC makes a successful call, a pre-recorded message plays for the 911 operator, and then the occupant(s) in your vehicle is able to talk with the operator. Be prepared to provide your name, phone number and location immediately, because not all 911 systems are capable of receiving this information electronically.

## 911 Assist May Not Work If:

- Your cellular phone or 911 Assist hardware sustains damage in a crash.
- The vehicle's battery or the SYNC system has no power.
- The phone(s) previously paired or connected to the system are thrown from the vehicle.

## 911 Assist Privacy Notice

When you turn on 911 Assist, it may disclose to emergency services that your vehicle has been in a crash involving the deployment of an airbag or activation of the fuel pump shut-off. Certain versions or updates to 911 Assist may also be capable of electronically or verbally disclosing to 911 operators your vehicle location or other details about your vehicle or crash to assist 911 operators to provide the most appropriate emergency services. If you do not want to disclose this information, do not turn the feature on.

## Vehicle Health Report (If Equipped, United States Only)

### WARNING



Always follow scheduled maintenance instructions, regularly inspect your vehicle, and seek repair for any damage or problem you suspect. Vehicle Health Report supplements, but cannot replace, normal maintenance and vehicle inspection. Vehicle Health Report only monitors certain systems electronically monitored by your vehicle and will not monitor or report the status of any other system, (such as brake lining wear). Failure to perform scheduled maintenance and regularly inspect your vehicle may result in vehicle damage and serious injury.

**Note:** *Your Vehicle Health Report feature requires activation prior to use. Visit [www.SYNCMYride.com](http://www.SYNCMYride.com) to register. There is no fee or subscription associated with Vehicle Health Report, but you must register to use this feature.*

**Note:** *This feature may not function properly if you have enabled caller ID blocking on your cellular phone. Before running a report, review the Vehicle Health Report Privacy Notice.*

**Note:** *In order to allow a break-in period for your vehicle, you may not be able to create a Vehicle Health Report until your vehicle odometer has reached 200 miles.*

**Note:** *Cellular phone and SMS charges may apply when making a report.*

# MyFord Touch™ (If Equipped)

Register for Vehicle Health Report and set your report preferences at [www.SYNCMYride.com](http://www.SYNCMYride.com). After registering, you can request a Vehicle Health Report (inside your vehicle). Return to your account at [www.SYNCMYride.com](http://www.SYNCMYride.com) to view your report. You can also choose for SYNC to remind you automatically to run reports at specific mileage intervals. Cellular phone airtime usage may apply when reporting.

The system allows you to check your vehicle's overall health in the form of a diagnostic report card. The Vehicle Health Report contains valuable information, for example:

- Vehicle diagnostic information.
- Scheduled maintenance.
- Open recalls and Field Service Actions.
- Items noted during vehicle inspections by your authorized dealer that still need servicing.

## Making a Report



If you want to run a report by using the touchscreen, touch **Apps > Vehicle Health Report**.



To run a report by voice command, press the voice button on the steering wheel and, when prompted, say "Vehicle health report".

## Vehicle Health Report Privacy Notice

When you create a Vehicle Health Report, Ford Motor Company may collect your cellular phone number (to process your report request) and diagnostic information about your vehicle. Certain versions or updates to Vehicle Health Report may also collect more vehicle information. Ford may use your vehicle information it collects for any purpose. If you do not want to disclose your cellular phone number or vehicle information, do not run the feature or set up your Vehicle Health Report profile at [www.SYNCMYride.com](http://www.SYNCMYride.com). See [www.SYNCMYride.com](http://www.SYNCMYride.com) (Vehicle Health Report Terms and Conditions, and Privacy Statement) for more information.

## Where Am I? (If Equipped)

For vehicle location and information touch **Help > Where Am I?**

This allows you to view your vehicle's current location, if your vehicle is equipped with navigation. If your vehicle is not equipped with navigation, you do not see this button.

## CLIMATE



Press the lower right corner on the touchscreen to access your climate control features. Depending on your vehicle line and option package, your climate screen may look different from the screen shown here.



## MyFord Touch™ (If Equipped)

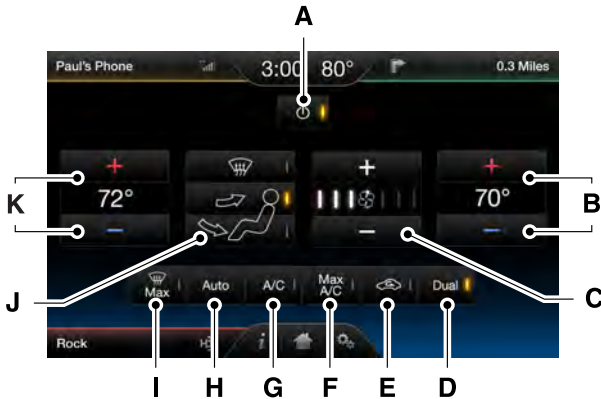

E185678

- A **Power:** Touch to switch the system off and on. Outside air cannot enter your vehicle when you switch off the system.
- B **Passenger settings:** Touch + or – to adjust the temperature.
- C **Fan speed:** Touch + or - to adjust fan speed.
- D **DUAL:** Touch to switch on the passenger temperature control.
- E **Recirculated air:** Touch to turn the recirculated air on or off which may reduce the amount of time needed to cool down the interior and help reduce odors from reaching the interior. Recirculated air also engages automatically when MAX A/C or MAX defrost is selected and may be engaged manually in any airflow mode except defrost. It may also turn off in all airflow modes except MAX A/C and MAX defrost to reduce fog potential.
- F **MAX A/C:** Touch to cool your vehicle with recirculated air. Touch again for normal A/C operation. MAX A/C distributes air through instrument panel vents and may help reduce odors from entering your vehicle. MAX A/C is more economical and efficient than normal A/C mode.
- G **A/C:** Touch to turn the air conditioning on or off. Use A/C with recirculated air to improve cooling performance and efficiency. A/C engages automatically in MAX A/C, defrost and footwell/defrost.
- H **AUTO:** Touch to engage automatic operation, then set the temperature using the temperature control. The system automatically controls fan speed, airflow distribution, A/C on or off and the use of fresh or recirculated air.

## MyFord Touch™ (If Equipped)

- I **MAX Defrost:** Distributes outside air through the windshield air vents and automatically switches the air conditioning on. The fan is set to the highest speed and the temperature to HI. When the air distribution is set in this position, you are unable to select recirculated air or manually adjust the fan speed and temperature control.
- J **Manual airflow distribution controls:Footwell and Defrost:** Distributes air through the windshield defroster vents, demister vents, floor vents and rear seat floor vents, and provides outside air to reduce window fogging. **Panel:** Distributes air through the instrument panel vents. **Panel and Floor:** Distributes air through the instrument panel vents, demister vents, floor vents and rear seat floor vents. **Floor:** Distributes air through the demister vents, floor vents and rear seat floor vents. **Defrost:** Touch to clear the windshield of fog and thin ice. Touch again to return to the previous airflow selection. When on, defrost provides outside air to reduce window fogging and distributes air through the windshield defroster vents and demister vents.
- K **Driver settings:** Touch + or – adjust the temperature.

### Climate Control Voice Commands



Press the voice button on the steering wheel controls. When prompted, say any of the following commands:

Climate Control Commands
"Climate automatic"
"Climate off"
"Climate on"
"Climate temperature <15.5-29.5> degrees"
"Climate temperature <60-85> degrees"
"Help"

There are additional climate control commands but in order to access them, you have to say "Climate" first. When the system is ready to listen, you may say any of the following commands:

## MyFord Touch™ (If Equipped)

<b>"CLIMATE"</b>	
"A/C off"	"Off"
"A/C on"	"On"
"Automatic"	"Panel floor on"
"Defrost off"	"Panel on"
"Defrost on"	"Panel off"
"Dual off"	"Recirc off"
"Floor on"	"Recirc on"
"Fan decrease"	"Temperature"
"Fan increase"	"Temperature <15.5-29.5> degrees"
"Floor off"	"Temperature <60-85> degrees"
"Floor windshield panel on"	"Temperature decrease"
"MAX A/C off"	"Temperature high"
"MAX A/C on"	"Temperature increase"
"Max defrost off"	"Temperature low"
"Max defrost on"	"Windshield floor on"
"Max fan"	"Windshield panel on"
"Min fan"	"Help"

\* If you say "Temperature", you can then say any of the commands in the following chart.

<b>"TEMPERATURE"</b>
"<15.5-29.5> degrees"
"<60-85> degrees"
"High"
"Low"
"Help"

## NAVIGATION

**Note:** The navigation SD card must be in the SD card slot to operate the navigation system. If you need a replacement SD card, see an authorized dealer.

**Note:** The SD card slot is spring-loaded. To remove the SD card, just push the card in and release it. Do not attempt to pull the card out to remove it; this could cause damage.

Your navigation system is comprised of two main features, destination mode and map mode.

To set a destination, press the green corner of your touchscreen, then the **Dest** button when it appears. See **Setting a destination** later in this chapter.

To view the navigation map and your vehicle's current location, touch the green bar in the upper right hand corner of the touchscreen, or, press **Dest**, then **Map**. See **Map mode** later in this chapter.

### Setting a Destination

Press the green corner of your touchscreen, then the **Dest** button when it appears. Choose any of the following:

Destination
My Home
Favorites
Previous Destinations
Point of Interest
Emergency
Street Address
Intersection
City Center

Destination
Map
Edit Route
Cancel Route

1. Enter the necessary information into the highlighted text fields (in any order). For address destination entry, the **Go!** button appears once you enter all the necessary information. Pressing the **Go!** button makes the address location appear on the map. If you choose **Previous Destination**, the last 20 destinations you have selected appear.
2. Select **Set as Dest** to make this your destination. You can also choose to set this as a waypoint (have the system route to this point on the way to your current destination) or save it as a favorite. The system considers any **Avoid Areas** selections in its route calculation.
3. Choose from up to three different types of routes, and then select **Start Route**.
  - Fastest: Uses the fastest moving roads possible.
  - Shortest: Uses the shortest distance possible.
  - Eco Route: Uses the most fuel-efficient route.

You can cancel the route or have the system demo the route for you. Select **Route Prefs** to set route preferences like avoiding freeways, tollroads, ferries and car trains as well as to use or not use high-occupancy vehicle lanes. (High-occupancy vehicle lanes are also known as carpool or diamond lanes. People who ride in buses, vanpools or carpools use these lanes.)

# MyFord Touch™ (if Equipped)

**Note:** If your vehicle is on a recognized road and you do not press the **Start Route** button, the system defaults to the Fastest Route option and begins guidance.

During route guidance, you can press the talking bubble icon that appears in the upper right navigation corner (green bar) if you want the system to repeat route guidance information. When the system repeats the last guidance instruction, it updates the distance to the next guidance instruction, since it detects when the vehicle is moving.

## Point of Interest (POI) Categories

Main categories
Food/Drink & Dining
Travel & Transportation
Financial
Emergency
Community
Health & Medicine
Automotive
Shopping

Main categories
Entertainment & Arts
Recreation & Sports
Government
Domestic Services

Subcategories
Restaurant
Golf
Parking
Home & Garden
Personal Care Services
Auto Dealership
Govt Office
Public Transit
Education

To expand these listings, press the + in front of the listing.

The system also allows you to sort alphabetically, by distance or by cityseekr listings (if available).

## Range Rings and Charge Points (Energi Only)



E161378

Shaded rings appear on the map when you are driving in EV Now mode. The inner ring with no shading indicates a safe range you can travel using plug-in power only. The lightly shaded outer band reflects areas you may or may not be able to reach while in EV Now mode. If your destination is within this band, your vehicle may operate in Auto EV mode, running the engine as needed. The darker shaded area, beyond the rings, is not likely reachable using only the vehicle's available plug-in energy.

The rings represent approximate ranges. Actual route distances, road grades, vehicle speed, accessory usage and other conditions affect how far your vehicle can travel in EV Now mode before recharging.

You can turn off the rings in the Settings menu. Press the Settings icon >

**Navigation > Map Preferences.**

You can turn the charge point POIs on and off. Touch the map, use the buttons at the bottom of the screen and then select the POI icon. The icons only appear at a map scale of 5 miles (8 kilometers) and lower.

## cityseekr

**Note:** *cityseekr* point of interest (POI) information is limited to approximately 912 cities (881 in the United States, 20 in Canada and 11 in Mexico).



E142634

cityseekr, when available, is a service that provides more information about certain points of interest such as restaurants, hotels and attractions.

When you have selected a point of interest, the location and information appear, such as address and phone number. If cityseekr lists the point of interest, more information is available, such as a brief description, check-in and checkout times or restaurant hours.

# MyFord Touch™ (If Equipped)

Press **More Information** for a longer review, a list of services and facilities, the average room or meal price as well as the website. This screen displays the point of interest icon such as:



Hotel



Coffeehouse



Food & Drink



Nightlife



Attraction



This icon appears when your selection exists in multiple categories within the system.

When you are viewing more information for hotels, cityseekr also tells you if the hotel has certain services and facilities using icons, such as:

- Restaurant.
- Business center.
- Handicap facilities.
- Laundry.
- Refrigerator.
- 24 hour room service.
- Fitness center.
- Internet access.

- Pool.
- Wi-fi.

For restaurants, cityseekr can provide information such as star rating, average cost, review, handicap access, hours of operation and website address.

For hotels, cityseekr can provide information such as star rating, price category, review, check-in and checkout times, hotel service icons and website address.

## Setting Your Navigation Preferences

Select settings for the system to take into account when planning your route.



Press the Settings icon > **Settings > Navigation.**

## Map Preferences

### Breadcrumbs

Display your vehicle's previously traveled route with white dots. Turn this feature **ON** or **OFF**.

### Turn List Format

Have the system display your turn list **Top to Bottom** or **Bottom to Top**.

### Parking POI Notification

Set the automatic parking point of interest notification. Turn this feature **ON** or **OFF**. When parking point of interest notification is on, the icons display on the map when you get close to your destination. This may not be very useful in dense areas, and may clutter the map when other points of interest display.

## Route Preferences

### Preferred Route

Choose to have the system display the Shortest, Fastest or most Ecological route first. If you set **Always Use Preferred Route** to **Yes**, the system uses the selected route type to calculate only one route to the desired destination.

### Always Use Preferred Route

Bypass route selection in destination programming. The system only calculates one route based on preferred route setting.

### Eco Time Penalty

Select a low, medium or high cost for the calculated Eco Route. The higher the setting, the longer the time allotment is for the route.

### Avoid

These features allow you to choose to have the system avoid freeways, toll roads, ferries and car trains when planning your route. Turn these features **ON** or **OFF**.

### Use HOV Lanes

Have the system use high-occupancy vehicle lanes, if available, when planning your route.

## Navigation Preferences

### Guidance Prompts

Have the system use **Voice & Tones** or **Tone Only** on your programmed route.

### Auto - Fill State/Province

Have the system automatically fill in the state and province based on the information already entered into the system. Turn this feature **ON** or **OFF**.

## Traffic Preferences

### Avoid Traffic Problems

Choose how you want the system to handle traffic problems along your route.

- **Automatic:** Have the system reroute you to avoid traffic incidents that develop and impact the current route. The system does not provide a traffic alert notification.
- **Manual:** Have the system always provide a traffic alert notification for traffic incidents along the planned route. You have a choice to accept or ignore the notification before making the route deviation.

### Traffic Alert Notification

Have the system display traffic alert notifications.

Other traffic alert features allow you to turn on certain, or all, traffic icons on the map such as road work, incident, accidents and closed roads. Scroll down to view all the different types of alerts. Turn these features **ON** or **OFF**.

### Avoid Areas

Choose areas which you want the system to avoid when calculating a route for you.

Press **Add** to program an entry. Once you make a selection, the system tries to avoid the area(s) if possible for all routes. To delete a selection, choose the listing on the screen. When the screen changes to **Avoid Areas Edit**, you can press **Delete** at the bottom right of the screen.

### Map Mode

Press the green bar in the upper right area of the touchscreen to view map mode. Map mode shows advanced viewing comprised of both 2D city maps as well as 3D landmarks (when available).



## MyFord Touch™ (If Equipped)

2D city maps show detailed outlines of buildings, visible land use and land elements and detailed railway infrastructure for the most essential cities around the globe. These maps also contain features, such as town blocks, building footprints and railways.

3D landmarks appear as clear, visible objects that are typically recognizable and have a certain tourist value. The 3D landmarks appear in 3D map mode only. Coverage varies, and improves with updated map releases.



E174016

Change the appearance of the map display by repeatedly pressing the arrow button in the upper left corner of the screen. It toggles between three different map modes: Heading up, North up, and 3D.



**Heading up (2D map)** always shows the direction of forward travel to be upward on the screen.

This view is available for map scales up to 2.5 miles (4 kilometers). The system remembers this setting for larger map scales, but shows the map in North up only. If the scale returns below this level, the system restores Heading up.



**North up (2D map)** always shows the northern direction to be upward on the screen.



**3D map mode** provides an elevated perspective of the map. This viewing angle can be adjusted and the map can be rotated 180 degrees by touching the map twice, and then dragging your finger along the shaded bar with arrows at the bottom of the map.

**View** switches between full map, street list and exit view in route guidance.

**Menu** displays a pop-up box that allows direct access to navigation settings, View/Edit Route, SIRIUS Travel Link, Guidance Mute and Cancel Route.



Press the speaker button on the map to mute route guidance. When the light on the button illuminates, the feature is on. The speaker button appears on the map only when route guidance is active.



Re-center the map by pressing this icon whenever you scroll the map away from your vehicle's current location.

### Auto Zoom

Press the green bar to access map mode, then select the **+** or **-** zoom button to bring up the zoom level and Auto buttons on the touchscreen. When you press **Auto**, Auto Zoom turns on and **Auto** displays in the bottom left corner of the screen in the map scale. The map zoom level then synchronizes with vehicle speed. The slower your vehicle is traveling, the farther in the map zooms in; the faster your vehicle is traveling, the farther the map zooms out. To turn the feature off, just press the **+** or **-** button again.

In 3D mode, rotate the map view by swiping your finger across the shaded bar with the arrows.

# MyFord Touch™ (If Equipped)

The ETA box under the zoom buttons appears when a route is active and displays the distance and time to your destination. If the button is pressed, a pop up appears with the destination listed (and waypoint if applicable) along with mileage and time to destination. You may also select to have either the estimated time to reach your destination or your estimated arrival time.

## Map Icons



**Vehicle mark** shows the current location of your vehicle. It stays in the center of the map display, except when in scroll mode.



**Scroll cursor** allows you to scroll the map; the fixed icon is in the center of the screen. The map position closest to the cursor is in a window on the top center part of the screen.



**Address book entry default icon(s)** indicates the location on the map of an address book entry.

This is the default symbol shown after the entry has been stored to the Address Book by any method other than the map. You can select from any of the 22 icons available. You can use each icon more than once.



**Home** indicates the location on the map currently stored as the home position. You can only save one address from the Address

Book as your Home entry. You cannot change this icon.



**POI (Point Of Interest) icons** indicate locations of any point of interest categories you choose to display on the map. You can

choose to display three point of interest categories on the map at one time.



**Starting point** indicates the starting point of a planned route.



**Waypoint** indicates the location of a waypoint on the map. The number inside the circle is different for each waypoint and represents the position of the waypoint in the route list.



**Destination symbol** indicates the ending point of a planned route.



**Next maneuver point** indicates the location of the next turn on the planned route.



**No GPS symbol** indicates that insufficient GPS satellite signals are available for accurate map positioning. This icon may display under normal operation in an area with poor GPS access.

## Quick-touch Buttons

When in map mode, touch anywhere on the map display to access the following options:

### Set as Dest

Touch this button to select a scrolled location on the map as your destination. You may scroll the map by pressing your index finger on the map display. When you reach the desired location, simply let go and then touch **Set as Dest**.

### Set as Waypoint

Touch this button to set the current location as a waypoint.

### Save to Favorites

Touch this button to save the current location to your favorites.

# MyFord Touch™ (If Equipped)

## POI Icons

Touch this button to select icons to display on the map. You can select up to three icons to display on the map at the same time. Turn these **ON** or **OFF**.

## Cancel Route

Touch this button to cancel the active route.

## View/Edit Route

Access these features when a route is active:

- View Route.
- Edit Destination/Waypoints.
- Edit Turn List.
- Detour.
- Edit Route Preferences.
- Edit Traffic Preferences.
- Cancel Route.

Nokia is the digital map provider for the navigation application. If you find map data errors, you may report them directly to Nokia by going to <http://mapreporter.navteq.com>. Nokia evaluates all reported map errors and responds with the result of their investigation by e-mail.

## Navigation Map Updates

Annual navigation map updates are available for purchase through your dealership, by calling 1-866-4NAVTEQ (1-866-462-8837) (in Mexico, call 01-800-557-5539) or going to [www.navigation.com/sync](http://www.navigation.com/sync). You need to specify the make and model of your vehicle to determine if there is an update available.

## Navigation Voice Commands



When in navigation mode, press the voice button on the steering wheel controls. After the tone, say any of the following commands:

Navigation system voice commands
"Cancel next waypoint" <sup>1</sup>
"Cancel route" <sup>1</sup>
"Destination" <sup>2</sup>
"Destination <nametag>"
"Destination <POI category>"
"Destination favorites"
"Destination home"
"Destination intersection"
"Destination nearest <POI category>"
"Destination nearest POI"
"Destination play nametags"
"Destination POI"
"Destination POI category"
"Destination previous destination"
"Destination street address"
"Detour" <sup>1</sup>
"Navigation" <sup>3</sup>
"Navigation voice volume decrease"
"Navigation voice volume increase"
"Repeat instruction" <sup>1</sup>
"Show 3D"

# MyFord Touch™ (If Equipped)

Navigation system voice commands
"Show heading up"
"Show map"
"Show north up"
"Show route" <sup>1</sup>
"Show turn list" <sup>1</sup>
"Voice guidance off"
"Voice guidance on"
"Where am I?"
"Zoom in"
"Zoom out"
"Help"

<sup>1</sup> These commands are only available when a navigation route is active.

<sup>2</sup> If you say "Destination", you can then say any command in the following "Destination" chart.

<sup>3</sup> If you say "Navigation", you can then say any command in the following "Navigation" chart.

"DESTINATION"
"<nametag>"
"<POI category>"
"Favorites"
"Home"
"Intersection"
"Nearest <POI category>"
"Nearest POI"
"Play nametags"

"DESTINATION"
"POI category"
"Previous destination"
"Street address"
"Help"

"NAVIGATION"
"Destination"
"Zoom city"
"Zoom country"
"Zoom minimum"
"Zoom maximum"
"Zoom province"
"Zoom state"
"Zoom street"
"Zoom to <distance>"
"Help"

\* If you say "Destination", you can then say any command in the "Destination" chart.

## One-shot Destination Street Address

When you say either "Navigation destination street address" or "Destination street address", the system asks you to say the full address. The system displays an example on-screen. You can then speak the address naturally, such as "One two three four Main Street, Anytown".

## MYFORD TOUCH™ TROUBLESHOOTING

Your SYNC system is easy to use. However, should questions arise, see the tables below.

Use the website at any time to check your phone's compatibility, register your account and set preferences as well as access a customer representative via an online chat (during certain hours). For more information visit:

Websites
www.SYNCMyRide.com
www.SYNCMyRide.ca
www.syncmaroute.ca

Phone issues		
Issue	Possible cause(s)	Possible solution(s)
There is excessive background noise during a phone call.	The audio control settings on your phone may be affecting SYNC performance.	Review your phone's manual about audio adjustments.
During a call, I can hear the other person but they cannot hear me.	This may be a possible phone malfunction.	Try turning off the device, resetting the device, removing the device's battery, then trying again.
SYNC is not able to download my phonebook.	This is a phone-dependent feature. This may be a possible phone malfunction.	Go to the website to review your phone's compatibility. Try turning off the device, resetting the device or removing the device's battery, then trying again. Try pushing your phonebook contacts to SYNC. See <b>Phone</b> (page 373). Use the SYNCmyphone feature available on the website.
The system says that the phonebook has downloaded but the phonebook in SYNC is empty or missing contacts.	This may be a limitation on your phone's capability.	Try pushing your phonebook contacts to SYNC. See <b>Phone</b> (page 373). If the missing contacts are stored on your SIM card, try moving them to the device memory.

## MyFord Touch™ (If Equipped)

<b>Phone issues</b>		
<b>Issue</b>	<b>Possible cause(s)</b>	<b>Possible solution(s)</b>
		<p>Remove any pictures or special ring tones associated with the missing contact.</p> <p>Depending upon your phone, you may have to grant SYNC permission to access your phonebook contacts. Make sure to confirm when prompted by your phone during the phonebook download.</p>
I am having trouble connecting my phone to SYNC.	<p>This is a phone-dependent feature.</p> <p>This may be a possible phone malfunction.</p>	<p>Go to the website to review your phone's compatibility.</p> <p>Try turning off the device, resetting the device or removing the device's battery, then trying again.</p> <p>Try deleting your device from SYNC, deleting SYNC from your device and trying again.</p> <p>Check the security and auto accept and prompt always settings relative to the SYNC Bluetooth connection on your phone.</p> <p>Update your device's firmware.</p> <p>Turn off the Auto phonebook download setting.</p> <p>You can also preform the MyFord Touch reset procedure.</p>
Text messaging is not working on SYNC.	<p>This is a phone-dependent feature.</p> <p>This may be a possible phone malfunction.</p>	<p>Go to the website to review your phone's compatibility.</p> <p>Try turning off the device, resetting the device or removing the device's battery, then trying again.</p>

## MyFord Touch™ (If Equipped)

<b>USB and media issues</b>		
<b>Issue</b>	<b>Possible cause(s)</b>	<b>Possible solution(s)</b>
I am having trouble connecting my device.	This may be a possible device malfunction.	Try turning off the device, resetting the device, removing the device's battery, then trying again. Make sure you are using the manufacturer's cable. Make sure you insert the USB cable correctly into the device and the USB port. Make sure that the device does not have an auto-install program or active security settings.
SYNC does not recognize my device when I turn on the car.	This is a device limitation.	Make sure you are not leaving the device in your vehicle during very hot or cold temperatures.
Bluetooth audio does not stream.	This is a phone-dependent feature. The device is not connected.	Review the device compatibility chart on the SYNC website to confirm your phone supports the Bluetooth audio streaming function. Make sure you correctly connect the device to SYNC, and that you have pressed play on your device. You can also preform the MyFord Touch reset procedure.
SYNC does not recognize music that is on my device.	Your music files may not contain the correct artist, song title, album or genre information. The file may be corrupted. The song may have copyright protection, which does not allow it to play.	Make sure that all song details are populated. Some devices require you to change the USB settings from mass storage to MTP class.

## MyFord Touch™ (If Equipped)

<b>Vehicle Health Report and Services (Traffic, Directions and Information) issues</b>		
<b>Issue</b>	<b>Possible cause(s)</b>	<b>Possible solution(s)</b>
I received a text that I did not activate Vehicle Health Report.	You did not activate your account on the website. You may have the wrong VIN (vehicle identification number) listed.	This is a free feature, but you must first register online to use it. Make sure that your VIN is correctly listed in your account.
I am unable to retrieve the report on the website, or I receive a system error.	The preferred dealer information did not load correctly.	When you register your account, you must choose a preferred dealer. If it already lists a dealer, try selecting another dealer and logging out. Log back in, change it back to your preferred dealer, and retrieve the report.
I am unable to submit a report.	This could be due to your phone's compatibility. Bad signal strength. You did not register your phone correctly on the website.	Update your cellular number in your account on the website. Make sure you have full signal strength and that your Bluetooth volume level has been turned up. Make sure the currently connected phone is registered on your SYNCMyRide account. Try deleting your phone and performing a clean pairing.
I heard a commercial when I tried to use Traffic, Directions and Information.	You did not activate this phone for this service. Your phone has ID blocker active.	This is a free feature, but you must first register online to use it. Turn off ID blocker on your phone as the system recognizes you by your phone number. Make sure the currently connected phone is the same one that is registered on your SYNCMyRide account.



## MyFord Touch™ (If Equipped)

<b>Voice command issues</b>		
<b>Issue</b>	<b>Possible cause(s)</b>	<b>Possible solution(s)</b>
SYNC does not understand what I am saying.	You may be using the wrong voice commands. You may be speaking too soon or at the wrong time.	Review the phone voice commands and the media voice commands at the beginning of their respective sections. After pressing the voice icon, wait until the system prompts you to begin saying a command. Any command spoken before this does not register with the system.
SYNC does not understand the name of a song or artist.	You may be using the wrong voice commands. You may be saying the name differently than the way you saved it. The system may not be reading the name the same way you are saying it.	Review the media voice commands at the beginning of the media section. Say the song or artist exactly as listed. If you say "Play Artist Prince", the system does not play music by Prince and the Revolution or Prince and the New Power Generation. Make sure you are saying the complete title, such as "California remix featuring Jennifer Nettles". If the song titles are in all CAPS, you have to spell them. LOLA requires you to say "L-O-L-A". Do not use special characters in the title. The system does not recognize them.
SYNC does not understand or is calling the wrong contact when I want to make a call.	You may be using the wrong voice commands. You may be saying the name differently than the way you saved it. The system may not be reading the name the same way you are saying it.	Review the Phone voice commands at the beginning of the phone section. Make sure you are saying the contacts exactly as they are listed. For example, if you save a contact as Joe Wilson, say "Call Joe Wilson".

## MyFord Touch™ (If Equipped)

<b>Voice command issues</b>		
<b>Issue</b>	<b>Possible cause(s)</b>	<b>Possible solution(s)</b>
	Contacts in your phonebook may be very short and similar, or they may contain special characters. Your phonebook contacts may be in CAPS.	Using the SYNC phone menu, open the phonebook and scroll to the name SYNC is having trouble understanding. SYNC will read the name to you, giving you some idea of the pronunciation SYNC is expecting. The system works better if you list full names, such as "Joe Wilson" rather than "Joe". Do not use special characters, such as 123 or ICE, as the system does not recognize them. If a contact is in CAPS, you have to spell it. JAKE requires you to say "Call J-A-K-E".

### **Touchscreen System Reset**

The touchscreen system has a system reset feature that can be performed if the function of a SYNC feature is lost. This reset is intended to restore functionality and will not erase any information previously stored in the system (such as paired devices, phonebook, call history, text messages, or user settings). To perform a System Reset, press and hold the Seek Up (>>) button while pressing and holding the Radio Power button. After approximately 5 seconds the screen will go black. Allow a 1-2 minutes for the system reset to complete. You may then resume using the SYNC system.

# Accessories

---

**For a complete listing of the accessories that are available for your vehicle, please contact your authorized dealer or visit our online store at:**

Web Address
<a href="http://www.Accessories.Ford.com">www.Accessories.Ford.com</a>

**You can also visit:**

Web Address
<a href="http://www.Ford.ca">www.Ford.ca</a>

Ford Motor Company will repair or replace any properly authorized dealer-installed Ford Genuine Accessory found to be defective in factory-supplied materials or workmanship during the warranty period, as well as any component damaged by the defective accessories. Ford Motor Company will warrant your accessory through the warranty that provides the greatest benefit:

- 24 months, unlimited mileage.
- The remainder of your new vehicle limited warranty.

Contact an authorized dealer for details and a copy of the warranty.

## Exterior style

- Hood deflector\*.
- Side window deflectors.
- Splash guards.
- Custom graphics\*.

## Interior style

- Floor mats.
- Accent lighting.
- Cargo area protector.

## Lifestyle

- Ash cup or smoker's packages.
- Soft cargo organizers.
- Cargo net\*.
- Roof racks and carriers\*.

## Peace of mind

- Keyless entry keypad.
- Remote start.
- Vehicle security systems.
- Wheel locks.
- Bumper-mounted parking assist system\*.
- Rear bumper protector.
- Car covers.
- Charge cord storage bag\*.

\*Ford Licensed Accessory. The accessory manufacturer designs, develops and therefore warrants Ford Licensed Accessories, and does not design or test these accessories to Ford Motor Company engineering requirements. Contact an authorized Ford dealer for the manufacturer's limited warranty details, and request a copy of the Ford Licensed Accessories product limited warranty from the accessory manufacturer.

# Accessories

---

For maximum vehicle performance, keep the following information in mind when adding accessories or equipment to your vehicle:

- When adding accessories, equipment, passengers and luggage to your vehicle, do not exceed the total weight capacity of the vehicle or of the front or rear axle (GVWR or GAWR as indicated on the Safety Compliance Certification label). Ask an authorized dealer for specific weight information.
- The Federal Communications Commission (FCC) and Canadian Radio Telecommunications Commission (CRTC) regulate the use of mobile communications systems that are equipped with radio transmitters, for example, two-way radios, telephones and theft alarms. Any such equipment installed in your vehicle should comply with Federal Communications Commission (FCC) and Canadian Radio Telecommunications Commission (CRTC) regulations and should be installed only by an authorized dealer.
- Mobile communications systems may harm the operation of your vehicle, particularly if their manufacturer did not design them specifically for automotive use.
- If you or an authorized Ford dealer add any non-Ford electrical or electronic accessories or components to your vehicle, you may adversely affect battery performance and durability. In addition, you may also adversely affect the performance of other electrical systems in the vehicle.

# Extended Service Plan (ESP)

---

PROTECT YOURSELF FROM THE RISING COST OF VEHICLE REPAIRS WITH A FORD EXTENDED SERVICE PLAN.

## **SERVICE PLANS (U.S. Only)**

More than 32 million Ford owners have discovered the powerful protection of Ford Extended Service Plan. It is the extended service plan backed by Ford Motor Company, and provides peace of mind protection beyond the New Vehicle Limited Warranty coverage.

### **Ford ESP Can Quickly Pay for Itself**

One service bill – the cost of parts and labor – can easily exceed the price of your Ford Extended Service Plan. With Ford ESP you minimize your risk for unexpected repair bills and rising repair costs.

### **Up to 1,000+ Covered Vehicle Components**

There are four core Extended Service Plans with different levels of coverage. Ask your authorized dealer for details.

1. PremiumCARE - Our most comprehensive coverage. With over 1,000 covered components, this plan is so complete that we generally only discuss what's not covered.
2. ExtraCARE - Covers 113 components, and includes many high-tech items.
3. BaseCARE - Covers 84 components.
4. PowertrainCARE - Covers 29 critical components.

Ford Extended Service Plan is honored by all authorized Ford dealers in the U.S., Canada and Mexico. It is the extended service plan authorized and backed by Ford Motor Company.

That means you get:

- Reliable, quality service at any Ford or Lincoln dealership
- Repairs performed by factory trained technicians, using genuine parts

### **Rental Car Reimbursement**

#### ***1st day Rental Benefit***

You take advantage of replacement transportation if your vehicle is at your authorized dealer for same day covered repairs.

#### ***Extended Rental Benefits***

If your vehicle is kept overnight for covered repairs, you are eligible for rental car coverage, including bumper to bumper warranty repairs, and Field Service Actions.

### **Roadside Assistance**

Exclusive 24/7 roadside assistance, including:

- Towing, flat-tire change and battery jump starts
- Out of fuel and lock-out assistance.
- Travel expense reimbursement for lodging, meals and rental car.
- Destination assistance for taxi, shuttle, rental car coverage and emergency transportation.

### **Transferable Coverage**

If you sell your vehicle before your Ford Extended Service Plan coverage expires, you can transfer any remaining coverage to the new owner. Whenever you sell your vehicle, prospective buyers may have a higher degree of confidence that vehicle was properly maintained with Ford ESP, thereby improving resale value.

# Extended Service Plan (ESP)

---

## Avoid the Rising Cost of Properly Maintaining Your Vehicle!

Ford Extended Service Plan also offers a Premium Maintenance Plan that covers all scheduled maintenance, and selected wear items. The coverage is prepaid, so you never have to worry about affording your vehicle's maintenance. It covers regular checkups, routine inspections, preventive care and replacement of select items that require periodic attention for normal wear:

- Windshield wiper blades.
- Spark plugs.
- The clutch disc.
- Brake pads and linings.
- Shock absorbers.
- Struts.
- Engine Belts.
- Engine coolant hoses, clamps and o-rings.
- Diesel exhaust fluid replenishment.

## Interest Free Finance Options Available

Take advantage of our interest free installment payment plan. Just a 10% down payment will provide you with an affordable, no interest, no fee payment program allowing you all the security and benefits Ford ESP has to offer while paying over time. You are pre-approved with no credit checks, no hassles! To learn more, call our Ford ESP specialists at 800-367-3377.

Ford ESP  
P.O. Box 321067  
Detroit, MI 48232

## SERVICE PLANS (CANADA ONLY)

You can get more protection for your vehicle by purchasing a Ford Extended Service Plan. Ford Extended Service Plan is the only service contract backed by Ford Motor Company of Canada, Limited. Depending on the plan you purchase, Ford Extended Service Plan provides benefits such as:

- Rental reimbursement.
- Coverage for certain maintenance and wear items.
- Protection against repair costs after your New Vehicle Limited Warranty Coverage expires.
- Roadside Assistance benefits.

There are several Ford Extended Service Plans available in various time, distance and deductible combinations. Each plan is tailored to fit your own driving needs, including reimbursement for towing and rental. When you purchase Ford Extended Service Plan, you receive added peace-of-mind protection throughout Canada, the United States and Mexico, provided by a network of participating authorized Ford Motor Company dealers.

**Note:** *Repairs performed outside of Canada, the United States and Mexico are not eligible for Ford Extended Service Plan coverage.*

This information is subject to change. For more information, visit your local Ford of Canada dealer or [www.ford.ca](http://www.ford.ca) to find the Ford Extended Service Plan that is right for you.

# Scheduled Maintenance

---

## GENERAL MAINTENANCE INFORMATION

### Why Maintain Your Vehicle?

Carefully following the maintenance schedule helps protect against major repair expenses resulting from neglect or inadequate maintenance and may help to increase the value of your vehicle when you sell or trade it. Keep all receipts for completed maintenance with your vehicle.

We have established regular maintenance intervals for your vehicle based upon rigorous testing. It is important that you have your vehicle serviced at the proper times. These intervals serve two purposes; one is to maintain the reliability of your vehicle and the second is to keep your cost of owning your vehicle down.

It is your responsibility to have all scheduled maintenance performed and to make sure that the materials used meet the specifications identified in this owner's manual. See **Capacities and Specifications** (page 275).

Failure to perform scheduled maintenance invalidates warranty coverage on parts affected by the lack of maintenance.

### Why Maintain Your Vehicle at Your Dealership?

#### Factory-Trained Technicians

Service technicians participate in extensive factory-sponsored certification training to help them become experts on the operation of your vehicle. Ask your dealership about the training and certification their technicians have received.

### Genuine Ford and Motorcraft® Replacement Parts

Dealerships stock Ford, Motorcraft and Ford-authorized branded re-manufactured replacement parts. These parts meet or exceed our specifications. Parts installed at your dealership carry a nationwide 24-month or unlimited mile (kilometer) parts and labor limited warranty.

If you do not use Ford authorized parts they may not meet our specifications and depending on the part, it could affect emissions compliance.

### Convenience

Many dealerships have extended evening and Saturday hours to make your service visit more convenient and they offer one stop shopping. They can perform any services that are required on your vehicle, from general maintenance to collision repairs.

**Note:** *Not all dealers have extended hours or body shops. Please contact your dealer for details.*

### Protecting Your Investment

Maintenance is an investment that pays dividends in the form of improved reliability, durability and resale value. To maintain the proper performance of your vehicle and its emission control systems, make sure you have scheduled maintenance performed at the designated intervals.

### C-MAX Full Hybrid

Your vehicle is equipped with an information display, which indicates the proper oil change interval. This interval may be up to one year or 10000 miles (16000 kilometers).

# Scheduled Maintenance

---

When **ENGINE OIL CHANGE DUE** or **OIL CHANGE REQUIRED** appears in the information display, it is time for an oil change. Make sure you perform the oil change within two weeks or 500 miles (800 kilometers) of the **ENGINE OIL CHANGE DUE** or **OIL CHANGE REQUIRED** message appearing. Make sure you reset the oil monitoring system after each oil change.

If your information display resets prematurely, becomes inoperative or the vehicle battery becomes discharged or disconnected, the oil monitoring system resets to 100% oil life. You should change your engine oil one year or 10000 miles (16000 kilometers) from the previous oil change. Never exceed one year or 10000 miles (16000 kilometers) between oil change intervals.

## C-MAX Energi Plug-in Hybrid

Your vehicle is equipped with the Intelligent Oil-Life Monitor system, which displays a message in the information display at the proper oil change interval. This interval may be up to two years or 20000 miles (32000 kilometers).

When **ENGINE OIL CHANGE DUE** or **OIL CHANGE REQUIRED** appears in the information display, it is time for an oil change. Make sure you perform the oil change within two weeks or 500 miles (800 kilometers) of the **ENGINE OIL CHANGE DUE** or **OIL CHANGE REQUIRED** message appearing. Make sure you reset the Intelligent Oil-Life Monitor after each oil change.

If your information display resets prematurely or becomes inoperative, you should perform the oil change interval at six months or 5000 miles (8000 kilometers) from your last oil change. Never exceed two years or 20000 miles (32000 kilometers) between oil change intervals.

## All Vehicles

Your vehicle is very sophisticated and built with multiple, complex, performance systems. Every manufacturer develops these systems using different specifications and performance features. That is why it is important to rely upon your dealership to properly diagnose and repair your vehicle.

Ford Motor Company has recommended maintenance intervals for various parts and component systems based upon engineering testing. Ford Motor Company relies upon this testing to determine the most appropriate mileage for replacement of oils and fluids to protect your vehicle at the lowest overall cost to you and recommends against maintenance schedules that deviate from the scheduled maintenance information.

We strongly recommend the use of only genuine Ford, Motorcraft or Ford-authorized re-manufactured replacement parts engineered for your vehicle.

## Additives and Chemicals

This owner's manual and the Ford Workshop Manual list the recommended additives and chemicals for your vehicle. We do not recommend using chemicals or additives not approved by us as part of your vehicle's normal maintenance. Please consult your warranty information.



# Scheduled Maintenance

## Oils, Fluids and Flushing

In many cases, fluid discoloration is a normal operating characteristic and, by itself, does not necessarily indicate a concern or that the fluid needs to be changed. However, a qualified expert, such as the factory-trained technicians at your dealership, should inspect discolored fluids that also show signs of overheating or foreign material contamination immediately.

Make sure to change your vehicle's oils and fluids at the specified intervals or in conjunction with a repair. Flushing is a viable way to change fluid for many vehicle sub-systems during scheduled maintenance. It is critical that systems are flushed only with new fluid that is the same as that required to fill and operate the system or using a Ford-approved flushing chemical.

## Owner Checks and Services

Make sure you perform the following basic maintenance checks and inspections every month or at six-month intervals.

<b>Check every month</b>
Engine oil level.
Function of all interior and exterior lights.
Tires (including spare) for wear and proper pressure.
Windshield washer fluid level.

<b>Check every six months</b>
Battery connections. Clean if necessary.
Body and door drain holes for obstructions. Clean if necessary.
Cooling system fluid level and coolant strength.
Door weatherstrips for wear. Lubricate if necessary.
Hinges, latches and outside locks for proper operation. Lubricate if necessary.
Parking brake for proper operation.
Safety belts and seat latches for wear and function.
Safety warning lamps (brake, ABS, airbag and safety belt) for operation.
Washer spray and wiper operation. Clean or replace blades as necessary.

# Scheduled Maintenance

## Check Every 12 Months (C-MAX Energi Plug-in Hybrid Only)

Inspect the engine oil filter for signs of damage such as rust, paint blistering, scratches or dents. If any of these conditions are present, replace the filter. See **Normal Scheduled Maintenance** (page 424).

## Multi-point Inspection

In order to keep your vehicle running right, it is important to have the systems on your vehicle checked regularly. This can help identify potential issues and prevent major problems. We recommend having the following multi-point inspection performed at every scheduled maintenance interval to help make sure your vehicle keeps running great.

Multi-point inspection	
Accessory drive belt(s)	Hazard warning system operation
Battery performance	Horn operation
Engine air filter	Radiator, cooler, heater and A/C hoses
Exhaust system	Suspension components for leaks or damage
Exterior lamps operation	Steering and linkage
Fluid levels*; fill if necessary	Tires for wear and proper pressure**
For oil and fluid leaks	Windshield for cracks, chips or pits
Half-shaft dust boots	Washer spray and wiper operation

\* Brake, coolant recovery reservoir, automatic transmission and window washer

\*\* If your vehicle is equipped with a temporary mobility kit, check the tire sealant expiration Use By date on the canister. Replace as needed.

Be sure to ask your dealership service advisor or technician about the multi-point vehicle inspection. It is a comprehensive way to perform a thorough inspection of your vehicle. Your checklist gives you immediate feedback on the overall condition of your vehicle.

# Scheduled Maintenance

## NORMAL SCHEDULED MAINTENANCE

### Intelligent Oil-Life Monitor™ (If Equipped)

Your vehicle is equipped with an Intelligent Oil-Life Monitor that determines when you should change the engine oil based on how your vehicle is used. By using several important factors in its calculations, the monitor helps reduce the cost of owning your vehicle and reduces environmental

waste at the same time.

This means you do not have to remember to change the oil on a mileage-based schedule. Your vehicle lets you know when an oil change is due by displaying a message in the information display.

The following table provides examples of vehicle use and its impact on oil change intervals. It is a guideline only. Actual oil change intervals depend on several factors and generally decrease with severity of use.

When to expect the message prompting you to change your oil	
Miles (kilometers)	Vehicle use and example
7500-10000 (12000-16000)	<b>Normal</b>
	Normal commuting with highway driving No, or moderate, load or towing Flat to moderately hilly roads No extended idling
5000-7499 (8000-11999)	<b>Severe</b>
	Moderate to heavy load or towing Mountainous or off-road conditions Extended idling Extended hot or cold operation
3000-4999 (4000-7999)	<b>Extreme</b>
	Maximum load or towing Extreme hot or cold operation

## Normal Maintenance Intervals

At every oil change interval as indicated by the information display. <sup>1,2</sup>
Change engine oil and filter. <sup>3</sup>
Inspect automatic transmission fluid level. Consult dealer for requirements.
Inspect brake pads, rotors, hoses and parking brake.

# Scheduled Maintenance

<b>At every oil change interval as indicated by the information display.<sup>1,2</sup></b>
Inspect engine cooling system and motor/electronics cooling system strength and hoses.
Inspect exhaust system and heat shields.
Inspect half-shaft boots.
Inspect steering linkage, ball joints, suspension and tie-rod ends.
Inspect wheels and related components for abnormal noise, wear, looseness or drag.

<sup>1</sup> Do not exceed two years or 20000 miles (32000 kilometers) between service intervals.

<sup>2</sup> Perform multi-point inspection (recommended).

<sup>3</sup> Reset the Intelligent Oil-Life Monitor system after engine oil and filter changes. See **Engine Oil Check** (page 217).

<b>Other maintenance items*</b>	
Every 20000 miles (32000 km)	Replace cabin air filter.
Every 30000 miles (48000 km)	Replace engine air filter.
At 100000 miles (160000 km)	Change engine coolant and motor/electronics coolant.**
Every 100000 miles (160000 km)	Replace spark plugs.
Every 150000 miles (240000 km)	Change automatic transmission fluid.

\* Perform these maintenance items within 3000 miles (4800 kilometers) of the last engine oil and filter change. Do not exceed the designated distance for the interval.

\*\* Initial replacement at six years or 100000 miles (160000 kilometers), then every three years or 50000 miles (80000 kilometers).

# Scheduled Maintenance

## SPECIAL OPERATING CONDITIONS SCHEDULED MAINTENANCE

If you operate your vehicle **primarily** in any of the following conditions, you need to perform extra maintenance as indicated. If you operate your vehicle **occasionally** under any of these conditions, it is not necessary to perform the extra maintenance. For specific recommendations, see your dealership service advisor or technician.

Perform the services shown in the following tables when specified or within 3000 miles (4800 kilometers) of the message appearing in the information display prompting you to change your oil.

- **Example 1:** The message comes on at 28751 miles (46270 kilometers). Perform the 30000-mile (48000 kilometer) automatic transmission fluid replacement.
- **Example 2:** The message has **not** come on, but the odometer reads 30000 miles (48000 kilometers) (for example, the Intelligent Oil-Life Monitor was reset at 25000 miles [40000 kilometers]). Perform the engine air filter replacement.

<b>Extensive idling or low-speed driving for long distances</b>	
As required	Change engine oil and filter every 12 months or 10000 miles (16000 km) unless otherwise indicated by the information display. Perform services listed in the Normal Scheduled Maintenance chart.*
Inspect frequently, service as required	Replace cabin air filter.
	Replace engine air filter.
Every 60000 miles (96000 km)	Replace spark plugs.

\*Reset the Intelligent Oil-Life Monitor after engine oil and filter changes. See **Engine Oil Check** (page 217).

<b>Operating in dusty or sandy conditions (such as unpaved or dusty roads)</b>	
Inspect frequently, service as required	Replace cabin air filter.
	Replace engine air filter.
Every 5000 miles (8000 km)	Inspect the wheels and related components for abnormal noise, wear, looseness or drag.
	Rotate tires, inspect tires for wear and measure tread depth.

# Scheduled Maintenance

Operating in dusty or sandy conditions (such as unpaved or dusty roads)	
Every 5000 miles (8000 km) or six months	Change engine oil and filter.*
	Perform multi-point inspection.

\*Reset the Intelligent Oil-Life Monitor after engine oil and filter changes. See **Engine Oil Check** (page 217).

## Exceptions

There are several exceptions to the Normal Schedule:

### Axle Maintenance

Change the axle fluid anytime an axle is submerged in water.

### California Fuel Filter Replacement

If you register your vehicle in California, the California Air Resources Board has determined that the failure to perform this maintenance item does not nullify the emission warranty or limit recall liability before the completion of your vehicle's useful life. Ford Motor Company, however, urges you to have all recommended maintenance services performed at the specified intervals and to record all vehicle service.

## Hot Climate Oil Change Intervals

Vehicles operating in the Middle East, North Africa, Sub-Saharan Africa or locations with similar climates using an American Petroleum Institute (API) Certified for Gasoline Engines (Certification mark) oil of SM or SN quality, the normal oil change interval is 3100 miles (5000 kilometers).

If the available API SM or SN oils are not available, then the oil change interval is 1800 miles (3000 kilometers).

## Engine Air Filter and Cabin Air Filter Replacement

The life of the engine air filter and cabin air filter is dependent on exposure to dusty and dirty conditions. Vehicles operated in these conditions require frequent inspection and replacement of the engine air filter and cabin air filter.

# Scheduled Maintenance

## SCHEDULED MAINTENANCE RECORD

<input type="radio"/> Repair Order #:	<p>Dealer stamp</p>
<input type="radio"/> Distance:	
<input type="radio"/> Engine hours (optional):	
<input type="radio"/> Multi-point inspection (recommended): <input type="checkbox"/>	
<input type="radio"/> Signature:	

<input type="radio"/> Repair Order #:	<p>Dealer stamp</p>
<input type="radio"/> Distance:	
<input type="radio"/> Engine hours (optional):	
<input type="radio"/> Multi-point inspection (recommended): <input type="checkbox"/>	
<input type="radio"/> Signature:	

# Scheduled Maintenance

<input type="radio"/> Repair Order #:	<p>Dealer stamp</p>
<input type="radio"/> Distance:	
<input type="radio"/> Engine hours (optional):	
<input type="radio"/> Multi-point inspection (recommended): <input type="checkbox"/>	
<input type="radio"/> Signature:	

<input type="radio"/> Repair Order #:	<p>Dealer stamp</p>
<input type="radio"/> Distance:	
<input type="radio"/> Engine hours (optional):	
<input type="radio"/> Multi-point inspection (recommended): <input type="checkbox"/>	
<input type="radio"/> Signature:	

<input type="radio"/> Repair Order #:	<p>Dealer stamp</p>
<input type="radio"/> Distance:	
<input type="radio"/> Engine hours (optional):	
<input type="radio"/> Multi-point inspection (recommended): <input type="checkbox"/>	
<input type="radio"/> Signature:	



# Scheduled Maintenance

<input type="radio"/> Repair Order #:	<p>Dealer stamp</p>
<input type="radio"/> Distance:	
<input type="radio"/> Engine hours (optional):	
<input type="radio"/> Multi-point inspection (recommended): <input type="checkbox"/>	
<input type="radio"/> Signature:	

<input type="radio"/> Repair Order #:	<p>Dealer stamp</p>
<input type="radio"/> Distance:	
<input type="radio"/> Engine hours (optional):	
<input type="radio"/> Multi-point inspection (recommended): <input type="checkbox"/>	
<input type="radio"/> Signature:	

<input type="radio"/> Repair Order #:	<p>Dealer stamp</p>
<input type="radio"/> Distance:	
<input type="radio"/> Engine hours (optional):	
<input type="radio"/> Multi-point inspection (recommended): <input type="checkbox"/>	
<input type="radio"/> Signature:	

# Scheduled Maintenance

<input type="radio"/> Repair Order #:	<p>Dealer stamp</p>
<input type="radio"/> Distance:	
<input type="radio"/> Engine hours (optional):	
<input type="radio"/> Multi-point inspection (recommended): <input type="checkbox"/>	
<input type="radio"/> Signature:	

<input type="radio"/> Repair Order #:	<p>Dealer stamp</p>
<input type="radio"/> Distance:	
<input type="radio"/> Engine hours (optional):	
<input type="radio"/> Multi-point inspection (recommended): <input type="checkbox"/>	
<input type="radio"/> Signature:	

<input type="radio"/> Repair Order #:	<p>Dealer stamp</p>
<input type="radio"/> Distance:	
<input type="radio"/> Engine hours (optional):	
<input type="radio"/> Multi-point inspection (recommended): <input type="checkbox"/>	
<input type="radio"/> Signature:	

# Scheduled Maintenance

<input type="radio"/> Repair Order #:	<p>Dealer stamp</p>
<input type="radio"/> Distance:	
<input type="radio"/> Engine hours (optional):	
<input type="radio"/> Multi-point inspection (recommended): <input type="checkbox"/>	
<input type="radio"/> Signature:	

<input type="radio"/> Repair Order #:	<p>Dealer stamp</p>
<input type="radio"/> Distance:	
<input type="radio"/> Engine hours (optional):	
<input type="radio"/> Multi-point inspection (recommended): <input type="checkbox"/>	
<input type="radio"/> Signature:	

<input type="radio"/> Repair Order #:	<p>Dealer stamp</p>
<input type="radio"/> Distance:	
<input type="radio"/> Engine hours (optional):	
<input type="radio"/> Multi-point inspection (recommended): <input type="checkbox"/>	
<input type="radio"/> Signature:	

# Scheduled Maintenance

<input type="radio"/> Repair Order #:	<p>Dealer stamp</p>
<input type="radio"/> Distance:	
<input type="radio"/> Engine hours (optional):	
<input type="radio"/> Multi-point inspection (recommended): <input type="checkbox"/>	
<input type="radio"/> Signature:	

<input type="radio"/> Repair Order #:	<p>Dealer stamp</p>
<input type="radio"/> Distance:	
<input type="radio"/> Engine hours (optional):	
<input type="radio"/> Multi-point inspection (recommended): <input type="checkbox"/>	
<input type="radio"/> Signature:	

<input type="radio"/> Repair Order #:	<p>Dealer stamp</p>
<input type="radio"/> Distance:	
<input type="radio"/> Engine hours (optional):	
<input type="radio"/> Multi-point inspection (recommended): <input type="checkbox"/>	
<input type="radio"/> Signature:	

# Scheduled Maintenance

<input type="radio"/> Repair Order #:	<p>Dealer stamp</p>
<input type="radio"/> Distance:	
<input type="radio"/> Engine hours (optional):	
<input type="radio"/> Multi-point inspection (recommended): <input type="checkbox"/>	
<input type="radio"/> Signature:	

<input type="radio"/> Repair Order #:	<p>Dealer stamp</p>
<input type="radio"/> Distance:	
<input type="radio"/> Engine hours (optional):	
<input type="radio"/> Multi-point inspection (recommended): <input type="checkbox"/>	
<input type="radio"/> Signature:	

<input type="radio"/> Repair Order #:	<p>Dealer stamp</p>
<input type="radio"/> Distance:	
<input type="radio"/> Engine hours (optional):	
<input type="radio"/> Multi-point inspection (recommended): <input type="checkbox"/>	
<input type="radio"/> Signature:	

# Appendices

---

## END USER LICENSE AGREEMENT

### SYNC End User License Agreement (EULA)

- You have acquired a device ("DEVICE") that includes software licensed by Ford Motor Company and its affiliates ("FORD MOTOR COMPANY") from an affiliate of Microsoft Corporation ("MS"). Those installed software products of MS origin, as well as associated media, printed materials, and "online" or electronic documentation ("MS SOFTWARE") are protected by international intellectual property laws and treaties. The MS SOFTWARE is licensed, not sold. All rights reserved.
- The MS SOFTWARE may interface with and/or communicate with, or may be later upgraded to interface with and/or communicate with additional software and/or systems provided by FORD MOTOR COMPANY. The additional software and systems of FORD MOTOR COMPANY origin, as well as associated media, printed materials, and "online" or electronic documentation ("FORD SOFTWARE") are protected by international intellectual property laws and treaties. The FORD SOFTWARE is licensed, not sold. All rights reserved.

- The MS SOFTWARE and/or FORD SOFTWARE may interface with and/or communicate with, or may be later upgraded to interface with and/or communicate with additional software and/or systems provided by third party software and service suppliers. The additional software and services of third party origin, as well as associated media, printed materials, and "online" or electronic documentation ("THIRD PARTY SOFTWARE") are protected by international intellectual property laws and treaties. The THIRD PARTY SOFTWARE is licensed, not sold. All rights reserved.
- The MS SOFTWARE, FORD SOFTWARE and THIRD PARTY SOFTWARE hereinafter collectively and individually will be referred to as "SOFTWARE".

**IF YOU DO NOT AGREE TO THIS END USER LICENSE AGREEMENT ("EULA") DO NOT USE THE DEVICE OR COPY THE SOFTWARE. ANY USE OF THE SOFTWARE, INCLUDING BUT NOT LIMITED TO USE ON THE DEVICE, WILL CONSTITUTE YOUR AGREEMENT TO THIS EULA (OR RATIFICATION OF ANY PREVIOUS CONSENT).**

**GRANT OF SOFTWARE LICENSE:** This EULA grants you the following license:

- You may use the SOFTWARE as installed on the DEVICE and as otherwise interfacing with systems and/or services provide by or through FORD MOTOR COMPANY or its third party software and service providers.

# Appendices

---

## Description of Other Rights and Limitations

- **Speech Recognition:** If the SOFTWARE includes speech recognition component(s), you should understand that speech recognition is an inherently statistical process and that recognition errors are inherent in the process. Neither FORD MOTOR COMPANY nor its suppliers shall be liable for any damages arising out of errors in the speech recognition process.
- **Limitations on Reverse Engineering, Decompilation and Disassembly:** You may not reverse engineer, decompile, or disassemble nor permit others to reverse engineer, decompile or disassemble the SOFTWARE, except and only to the extent that such activity is expressly permitted by applicable law notwithstanding this limitation.
- **Limitations on Distributing, Copying, Modifying and Creating Derivative Works:** You may not distribute, copy, make modifications to or create derivative works based on the SOFTWARE, except and only to the extent that such activity is expressly permitted by applicable law notwithstanding this limitation.
- **Single EULA:** The end user documentation for the DEVICE and related systems and services may contain multiple EULAs, such as multiple translations and/or multiple media versions (e.g., in the user documentation and in the software). Even if you receive multiple EULAs, you are licensed to use only one (1) copy of the SOFTWARE.
- **SOFTWARE Transfer:** You may permanently transfer your rights under this EULA only as part of a sale or transfer of the DEVICE, provided you retain no copies, you transfer all of the SOFTWARE (including all component parts, the media and printed materials, any upgrades, and, if applicable, the Certificate(s) of Authenticity), and the recipient agrees to the terms of this EULA. If the SOFTWARE is an upgrade, any transfer must include all prior versions of the SOFTWARE.
- **Termination:** Without prejudice to any other rights, FORD MOTOR COMPANY or MS may terminate this EULA if you fail to comply with the terms and conditions of this EULA.
- **Security Updates/Digital Rights Management:** Content owners use the WMDRM technology included in your DEVICE to protect their intellectual property, included copyrighted content. Portions of the SOFTWARE on your DEVICE use WMDRM software to access WMDRM-protected content. If the WMDRM software fails to protect the content, content owners may ask Microsoft to revoke the SOFTWARE's ability to use WMDRM to play or copy protected content. This action does not affect unprotected content. When your DEVICE downloads licenses for protected content, you agree that Microsoft may include a revocation list with the licenses. Content owners may require you to upgrade the SOFTWARE on your DEVICE to access their content. If you decline an upgrade, you will not be able to access content that requires the upgrade.

# Appendices

---

- **Consent to Use of Data:** You agree that MS, Microsoft Corporation, FORD MOTOR COMPANY, third party software and systems suppliers, their affiliates and/or their designated agent may collect and use technical information gathered in any manner as part of product support services related to the SOFTWARE or related services. MS, Microsoft Corporation, FORD MOTOR COMPANY, third party software and services suppliers, their affiliates and/or their designated agent may use this information solely to improve their products or to provide customized services or technologies to you. MS, Microsoft Corporation, FORD MOTOR COMPANY, third party software and systems suppliers, their affiliates and/or their designated agent may disclose this information to others, but not in a form that personally identifies you.
- **Internet-Based Services Components:** The SOFTWARE may contain components that enable and facilitate the use of certain Internet-based services. You acknowledge and agree that MS, Microsoft Corporation, FORD MOTOR COMPANY, third party software and service suppliers, their affiliates and/or their designated agent may automatically check the version of the SOFTWARE and/or its components that you are utilizing and may provide upgrades or supplements to the SOFTWARE that may be automatically downloaded to your DEVICE.
- **Additional Software/Services:** The SOFTWARE may permit FORD MOTOR COMPANY, third party software and service suppliers, MS, Microsoft Corporation, their affiliates and/or their designated agent to provide or make available to you SOFTWARE updates,

supplements, add-on components, or Internet-based services components of the SOFTWARE after the date you obtain your initial copy of the SOFTWARE ("Supplemental Components").

If FORD MOTOR COMPANY or third party software and services suppliers provide or make available to you Supplemental Components and no other EULA terms are provided along with the Supplemental Components, then the terms of this EULA shall apply.

If MS, Microsoft Corporation, their affiliates and/or their designated agent make available Supplemental Components, and no other EULA terms are provided, then the terms of this EULA shall apply, except that the MS, Microsoft Corporation or affiliate entity providing the Supplemental Component(s) shall be the licensor of the Supplemental Component(s).

FORD MOTOR COMPANY, MS, Microsoft Corporation, their affiliates and/or their designated agent reserve the right to discontinue without liability any Internet-based services provided to you or made available to you through the use of the SOFTWARE.



# Appendices

---

- **Links to Third Party Sites:** The MS SOFTWARE may provide you with the ability to link to third party sites through the use of the SOFTWARE. The third party sites are not under the control of MS, Microsoft Corporation, their affiliates and/or their designated agent. Neither MS nor Microsoft Corporation nor their affiliates nor their designated agent are responsible for (i) the contents of any third party sites, any links contained in third party sites, or any changes or updates to third party sites, or (ii) webcasting or any other form of transmission received from any third party sites. If the SOFTWARE provides links to third party sites, those links are provided to you only as a convenience, and the inclusion of any link does not imply an endorsement of the third party site by MS, Microsoft Corporation, their affiliates and/or their designated agent.
- **Obligation to Drive Responsibly:** You recognize your obligation to drive responsibly and keep attention on the road. You will read and abide with the DEVICE operating instructions particularly as they pertain to safety and assumes any risk associated with the use of the DEVICE.

## **UPGRADES AND RECOVERY MEDIA:**

If the SOFTWARE is provided by FORD MOTOR COMPANY separate from the DEVICE on media such as a ROM chip, CD ROM disk(s) or via web download or other means, and is labeled "For Upgrade Purposes Only" or "For Recovery Purposes Only" you may install one (1) copy of such SOFTWARE onto the DEVICE as a replacement copy for the existing SOFTWARE, and use it in accordance with this EULA, including any additional EULA terms accompanying the upgrade SOFTWARE.

## **INTELLECTUAL PROPERTY RIGHTS:**

All title and intellectual property rights in and to the SOFTWARE (including but not limited to any images, photographs, animations, video, audio, music, text and "applets" incorporated into the SOFTWARE), the accompanying printed materials, and any copies of the SOFTWARE, are owned by MS, Microsoft Corporation, FORD MOTOR COMPANY, or their affiliates or suppliers. The SOFTWARE is licensed, not sold. You may not copy the printed materials accompanying the SOFTWARE. All title and intellectual property rights in and to the content which may be accessed through use of the SOFTWARE is the property of the respective content owner and may be protected by applicable copyright or other intellectual property laws and treaties. This EULA grants you no rights to use such content. All rights not specifically granted under this EULA are reserved by MS, Microsoft Corporation, FORD MOTOR COMPANY, third party software and service providers, their affiliates and suppliers. Use of any on-line services which may be accessed through the SOFTWARE may be governed by the respective terms of use relating to such services. If this SOFTWARE contains documentation that is provided only in electronic form, you may print one copy of such electronic documentation.

**EXPORT RESTRICTIONS:** You acknowledge that the SOFTWARE is subject to U.S. and European Union export jurisdiction. You agree to comply with all applicable international and national laws that apply to the SOFTWARE, including the U.S. Export Administration Regulations, as well as end-user, end-use and destination restrictions issued by U.S. and other governments. For additional information, see <http://www.microsoft.com/exporting/>.

# Appendices

---

**TRADEMARKS:** This EULA does not grant you any rights in connection with any trademarks or service marks of FORD MOTOR COMPANY, MS, Microsoft Corporation, third party software or service providers, their affiliates or suppliers.

**PRODUCT SUPPORT:** Product support for the SOFTWARE is not provided by MS, its parent corporation Microsoft Corporation, or their affiliates or subsidiaries. For product support, please refer to FORD MOTOR COMPANY instructions provided in the documentation for the DEVICE. Should you have any questions concerning this EULA, or if you desire to contact FORD MOTOR COMPANY for any other reason, please refer to the address provided in the documentation for the DEVICE.

**No Liability for Certain Damages:** EXCEPT AS PROHIBITED BY LAW, FORD MOTOR COMPANY, ANY THIRD PARTY SOFTWARE OR SERVICES SUPPLIERS, MS, MICROSOFT CORPORATION AND THEIR AFFILIATES SHALL HAVE NO LIABILITY FOR ANY INDIRECT, SPECIAL, CONSEQUENTIAL OR INCIDENTAL DAMAGES ARISING FROM OR IN CONNECTION WITH THE USE OR PERFORMANCE OF THE SOFTWARE. THIS LIMITATION SHALL APPLY EVEN IF ANY REMEDY FAILS OF ITS ESSENTIAL PURPOSE. IN NO EVENT SHALL MS, MICROSOFT CORPORATION AND/OR THEIR AFFILIATES BE LIABLE FOR ANY AMOUNT IN EXCESS OF U.S. TWO HUNDRED FIFTY DOLLARS (U.S. \$250.00).

- THERE ARE NO WARRANTIES OTHER THAN THOSE THAT MAY EXPRESSLY BE PROVIDED FOR YOUR NEW VEHICLE.

## **Adobe**

Contains Adobe® [Flash® Player] or [AIR®] technology by Adobe Systems Incorporated. This [Licensee Product] contains [Adobe® Flash® Player] [Adobe® AIR®] software under license from Adobe Systems Incorporated, Copyright ©1995-2009 Adobe Macromedia Software LLC. All rights reserved. Adobe, Flash and AIR are trademarks of Adobe Systems Incorporated.

## **End User Notice**

### **Microsoft® Windows® Mobile for Automotive Important Safety Information**

This system Ford SYNC contains software that is licensed to Manufacturer FORD MOTOR COMPANY by an affiliate of Microsoft Corporation pursuant to a license agreement. Any removal, reproduction, reverse engineering or other unauthorized use of the software from this system in violation of the license agreement is strictly prohibited and may subject you to legal action.

**Read and follow instructions:** Before using your Windows Automotive- based system, read and follow all instructions and safety information provided in this end user manual ("User's Guide"). Not following precautions found in this User's Guide can lead to an accident or other serious consequences.

**Keep User's Guide in vehicle:** When kept in the vehicle, the User's Guide will be a ready reference for you and other users unfamiliar with the Windows Automotive-based system. Please make certain that before using the system for the first time, all persons have access to the User's Guide and read its instructions and safety information carefully.

# Appendices

---

## WARNING



Operating certain parts of this system while driving can distract your attention away from the road, and possibly cause an accident or other serious consequences. Do not change system settings or enter data non-verbally (using your hands) while driving. Stop the vehicle in a safe and legal manner before attempting these operations. This is important since while setting up or changing some functions you might be required to distract your attention away from the road and remove your hands from the wheel.

---

### General Operation

**Voice Command Control:** Functions within the Windows Automotive-based system may be accomplished using only voice commands. Using voice commands while driving allows you to operate the system without removing your hands from the wheel.

**Prolonged Views of Screen:** Do not access any function requiring a prolonged view of the screen while you are driving. Pull over in a safe and legal manner before attempting to access a function of the system requiring prolonged attention. Even occasional short scans to the screen may be hazardous if your attention has been diverted away from your driving task at a critical time.

**Volume Setting:** Do not raise the volume excessively. Keep the volume at a level where you can still hear outside traffic and emergency signals while driving. Driving while unable to hear these sounds could cause an accident.

### Use of Speech Recognition Functions:

Speech recognition software is inherently a statistical process which is subject to errors. It is your responsibility to monitor any speech recognition functions included in the system and address any errors.

**Navigation Features:** Any navigation features included in the system are intended to provide turn by turn instructions to get you to a desired destination. Please make certain all persons using this system carefully read and follow instructions and safety information fully.

**Distraction Hazard:** Any navigation features may require manual (non-verbal) setup. Attempting to perform such set-up or insert data while driving can seriously distract your attention and could cause an accident or other serious consequences. Stop the vehicle in a safe and legal manner before attempting these operations.

**Let Your Judgment Prevail:** Any navigation features are provided only as an aid. Make your driving decisions based on your observations of local conditions and existing traffic regulations. Any such feature is not a substitute for your personal judgment. Any route suggestions made by this system should never replace any local traffic regulations or your personal judgment or knowledge of safe driving practices.

**Route Safety:** Do not follow the route suggestions if doing so would result in an unsafe or illegal maneuver, if you would be placed in an unsafe situation, or if you would be directed into an area that you consider unsafe. The driver is ultimately responsible for the safe operation of the vehicle and therefore, must evaluate whether it is safe to follow the suggested directions.

# Appendices

---

**Potential Map Inaccuracy:** Maps used by this system may be inaccurate because of changes in roads, traffic controls or driving conditions. Always use good judgment and common sense when following the suggested routes.

**Emergency Services:** Do not rely on any navigation features included in the system to route you to emergency services. Ask local authorities or an emergency services operator for these locations. Not all emergency services such as police, fire stations, hospitals and clinics are likely to be contained in the map database for such navigation features.

## **Telenav Software End User License Agreement**

Please read these terms and conditions carefully before you use the Telenav Software. Your use of the Telenav Software indicates that you accept these terms and conditions. If you do not accept these terms and conditions, do not break the seal of the package, launch, or otherwise use the Telenav Software.

These terms and conditions represent the agreement ("Agreement") between you and Telenav, Inc. ("Telenav") with respect to the Telenav Software (including upgrades, modifications, or additions thereto) (collectively "Telenav Software"). All references herein to "you" and "your" means you, your employees, agents, and contractors, and any other entity on whose behalf you accept these terms and conditions, all of whom shall also be bound by this Agreement. Additionally, all of your account information, as well as other payment and personal information provided by you to Telenav (directly or through the use of the Telenav Software, is subject to Telenav's privacy policy located at <http://www.telenav.com>.

Telenav may revise this Agreement and the privacy policy at any time, with or without notice to you. You agree to visit <http://www.telenav.com> from time to time to review the then current version of this Agreement and of the privacy policy.

## **1. Safe and Lawful Use**

You acknowledge that devoting attention to the Telenav Software may pose a risk of injury or death to you and others in situations that otherwise require your undivided attention, and you therefore agree to comply with the following when using the Telenav Software: (a) observe all traffic laws and otherwise drive safely; (b) use your own personal judgment while driving. If you feel that a route suggested by the Telenav Software instructs you to perform an unsafe or illegal maneuver, places you in an unsafe situation, or directs you into an area that you consider to be unsafe, do not follow such instructions; (c) do not input destinations, or otherwise manipulate the Telenav Software, unless your vehicle is stationary and parked; (d) do not use the Telenav Software for any illegal, unauthorized, unintended, unsafe, hazardous, or unlawful purposes, or in any manner inconsistent with this Agreement; (e) arrange all GPS and wireless devices and cables necessary for use of the Telenav Software in a secure manner in your vehicle so that they will not interfere with your driving and will not prevent the operation of any safety device (such as an airbag).

You agree to indemnify and hold Telenav harmless against all claims resulting from any dangerous or otherwise inappropriate use of the Telenav Software in any moving vehicle, including as a result of your failure to comply with the directions above.

# Appendices

---

## 2. Account Information

You agree: (a) when registering the Telenav Software, to provide Telenav with true, accurate, current, and complete information about yourself, and (b) to inform Telenav promptly of any changes to such information, and to keep it true, accurate, current and complete.

## 3. Software License

Subject to your compliance with the terms of this Agreement, Telenav hereby grants to you a personal, non-exclusive, non-transferable license (except as expressly permitted below in connection with your permanent transfer of the Telenav Software license), without the right to sublicense, to use the Telenav Software (in object code form only) in order to access and use the Telenav Software. This license shall terminate upon any termination or expiration of this Agreement. You agree that you will use the Telenav Software only for your personal business or leisure purposes, and not to provide commercial navigation services to other parties.

### 3.1 License Limitations

You agree not to do any of the following: (a) reverse engineer, decompile, disassemble, translate, modify, alter or otherwise change the Telenav Software or any part thereof; (b) attempt to derive the source code, audio library or structure of the Telenav Software without the prior express written consent of Telenav; (c) remove from the Telenav Software, or alter, any of Telenav's or its suppliers' trademarks, trade names, logos, patent or copyright notices, or other notices or markings; (d) distribute, sublicense or otherwise transfer the Telenav Software to others, except as part of your permanent transfer of the Telenav Software; or (e) use the Telenav Software in any manner that (i) infringes the intellectual property

or proprietary rights, rights of publicity or privacy or other rights of any party, (ii) violates any law, statute, ordinance or regulation, including but not limited to laws and regulations related to spamming, privacy, consumer and child protection, obscenity or defamation, or (iii) is harmful, threatening, abusive, harassing, tortuous, defamatory, vulgar, obscene, libelous, or otherwise objectionable; and (f) lease, rent out, or otherwise permit unauthorized access by third parties to the Telenav Software without advanced written permission of Telenav.

## 4. Disclaimers

To the fullest extent permissible pursuant to applicable law, in no event will Telenav, its licensors and suppliers, or agents or employees of any of the foregoing, be liable for any decision made or action taken by you or anyone else in reliance on the information provided by the Telenav Software. Telenav also does not warrant the accuracy of the map or other data used for the Telenav Software. Such data may not always reflect reality due to, among other things, road closures, construction, weather, new roads and other changing conditions. You are responsible for the entire risk arising out of your use of the Telenav Software. For example but without limitation, you agree not to rely on the Telenav Software for critical navigation in areas where the well-being or survival of you or others is dependent on the accuracy of navigation, as the maps or functionality of the Telenav Software are not intended to support such high risk applications, especially in more remote geographical areas.

TELENAV EXPRESSLY DISCLAIMS AND EXCLUDES ALL WARRANTIES IN CONNECTION WITH THE TELENNAV SOFTWARE, WHETHER STATUTORY, EXPRESS OR IMPLIED, INCLUDING ALL WARRANTIES WHICH MAY ARISE FROM

# Appendices

---

COURSE OF DEALING, CUSTOM OR TRADE AND INCLUDING, BUT NOT LIMITED TO, THE IMPLIED WARRANTIES OF MERCHANTABILITY, FITNESS FOR A PARTICULAR PURPOSE AND NON-INFRINGEMENT OF THIRD PARTY RIGHTS WITH RESPECT TO THE TELENAV SOFTWARE. Certain jurisdictions do not permit the disclaimer of certain warranties, so this limitation may not apply to you.

## **5. Limitation of Liability**

TO THE EXTENT PERMITTED UNDER APPLICABLE LAW, UNDER NO CIRCUMSTANCES SHALL TELENAV OR ITS LICENSORS AND SUPPLIERS BE LIABLE TO YOU OR TO ANY THIRD PARTY FOR ANY INDIRECT, INCIDENTAL, CONSEQUENTIAL, SPECIAL OR EXEMPLARY DAMAGES (INCLUDING IN EACH CASE, BUT NOT LIMITED TO, DAMAGES FOR THE INABILITY TO USE THE EQUIPMENT OR ACCESS DATA, LOSS OF DATA, LOSS OF BUSINESS, LOSS OF PROFITS, BUSINESS INTERRUPTION OR THE LIKE) ARISING OUT OF THE USE OF OR INABILITY TO USE THE TELENAV SOFTWARE, EVEN IF TELENAV HAS BEEN ADVISED OF THE POSSIBILITY OF SUCH DAMAGES.

NOTWITHSTANDING ANY DAMAGES THAT YOU MIGHT INCUR FOR ANY REASON WHATSOEVER (INCLUDING, WITHOUT LIMITATION, ALL DAMAGES REFERENCED HEREIN AND ALL DIRECT OR GENERAL DAMAGES IN CONTRACT, TORT (INCLUDING NEGLIGENCE) OR OTHERWISE), THE ENTIRE LIABILITY OF TELENAV AND OF ALL OF TELENAV'S SUPPLIERS SHALL BE LIMITED TO THE AMOUNT ACTUALLY PAID BY YOU FOR THE TELENAV SOFTWARE. SOME

STATES AND/OR JURISDICTIONS DO NOT ALLOW THE EXCLUSION OR LIMITATION OF INCIDENTAL OR CONSEQUENTIAL DAMAGES, SO THE ABOVE LIMITATIONS OR EXCLUSIONS MAY NOT APPLY TO YOU.

## **6. Arbitration and Governing Law**

You agree that any dispute, claim or controversy arising out of or relating to this Agreement or the Telenav Software shall be settled by independent arbitration involving a neutral arbitrator and administered by the American Arbitration Association in the County of Santa Clara, California. The arbitrator shall apply the Commercial Arbitration Rules of the American Arbitration Association, and the judgment upon the award rendered by the arbitrator may be entered by any court having jurisdiction. Note that there is no judge or jury in an arbitration proceeding and the decision of the arbitrator shall be binding upon both parties. You expressly agree to waive your right to a jury trial.

This Agreement and performance hereunder will be governed by and construed in accordance with the laws of the State of California, without giving effect to its conflict of laws provisions. To the extent judicial action is necessary in connection with the binding arbitration, both Telenav and you agree to submit to the exclusive jurisdiction of the courts of the County of Santa Clara, California. The United Nations Convention on Contracts for the International Sale of Goods shall not apply.

## **7. Assignment**

You may not resell, assign, or transfer this Agreement or any of your rights or obligations, except in totality, in connection with your permanent transfer of the Telenav Software, and expressly conditioned upon the new user of the Telenav Software agreeing to be bound by

# Appendices

---

the terms and conditions of this Agreement. Any such sale, assignment or transfer that is not expressly permitted under this paragraph will result in immediate termination of this Agreement, without liability to Telenav, in which case you and all other parties shall immediately cease all use of the Telenav Software. Notwithstanding the foregoing, Telenav may assign this Agreement to any other party at any time without notice, provided the assignee remains bound by this Agreement.

## **8. Miscellaneous**

### **8.1**

This Agreement constitutes the entire agreement between Telenav and you with respect to the subject matter hereof.

### **8.2**

Except for the limited licenses expressly granted in this Agreement, Telenav retains all right, title and interest in and to the Telenav Software, including without limitation all related intellectual property rights. No licenses or other rights which are not expressly granted in this Agreement are intended to, or shall be, granted or conferred by implication, statute, inducement, estoppel or otherwise, and Telenav and its suppliers and licensors hereby reserve all of their respective rights other than the licenses explicitly granted in this Agreement.

### **8.3**

By using the Telenav Software, you consent to receive from Telenav all communications, including notices, agreements, legally required disclosures or other information in connection with the Telenav Software (collectively, "Notices") electronically. Telenav may provide such

Notices by posting them on Telenav's Website or by downloading such Notices to your wireless device. If you desire to withdraw your consent to receive Notices electronically, you must discontinue your use of the Telenav Software.

### **8.4**

Telenav's or your failure to require performance of any provision shall not affect that party's right to require performance at any time thereafter, nor shall a waiver of any breach or default of this Agreement constitute a waiver of any subsequent breach or default or a waiver of the provision itself.

### **8.5**

If any provision herein is held unenforceable, then such provision will be modified to reflect the intention of the parties, and the remaining provisions of this Agreement will remain in full force and effect.

### **8.6**

The headings in this Agreement are for convenience of reference only, will not be deemed to be a part of this Agreement, and will not be referred to in connection with the construction or interpretation of this Agreement. As used in this Agreement, the words "include" and "including," and variations thereof, will not be deemed to be terms of limitation, but rather will be deemed to be followed by the words "without limitation."

## **9. Other Vendors Terms and Conditions**

The Telenav Software utilizes map and other data licensed to Telenav by third party vendors for the benefit of you and other end users. This Agreement includes end-user terms applicable to these companies (included at the end of this

# Appendices

---

Agreement), and thus your use of the Telenav Software is also subject to such terms. You agree to comply with the following additional terms and conditions, which are applicable to Telenav's third party vendor licensors:

## **9.1 End User Terms Required by HERE North America, LLC**

The data ("Data") is provided for your personal, internal use only and not for resale. It is protected by copyright, and is subject to the following terms and conditions which are agreed to by you, on the one hand, and Telenav ("Telenav") and its licensors (including their licensors and suppliers) on the other hand.

© 2013 HERE. All rights reserved.

The Data for areas of Canada includes information taken with permission from Canadian authorities, including: © Her Majesty the Queen in Right of Canada, © Queen's Printer for Ontario, © Canada Post Corporation, GeoBase®, © Department of Natural Resources Canada.

HERE holds a non-exclusive license from the United States Postal Service® to publish and sell ZIP+4® information.

©United States Postal Service® 2014. Prices are not established, controlled or approved by the United States Postal Service®. The following trademarks and registrations are owned by the USPS: United States Postal Service, USPS, and ZIP+4.

The Data for Mexico includes certain data from Instituto Nacional de Estadística y Geografía.

## **TERMS AND CONDITIONS**

## **9.2 End User Terms Required by NAV2 (Shanghai) Co., Ltd**

The data ("Data") is provided for your personal, internal use only and not for resale. It is protected by copyright, and is subject to the following terms and conditions which are agreed to by you, on the one hand, and NAV2 (Shanghai) Co., Ltd ("NAV2") and its licensors (including their licensors and suppliers) on the other hand.

© 20xx. All rights reserved.

### ***Permitted Use.***

You agree to use this Data together with the Telenav Software solely for the internal business and personal purposes for which you were licensed, and not for service bureau, time-sharing or other similar purposes. Accordingly, but subject to the restrictions set forth in the following paragraphs, you agree not to otherwise reproduce, copy, modify, decompile, disassemble, create any derivative works of, or reverse engineer any portion of this Data, and may not transfer or distribute it in any form, for any purpose, except to the extent permitted by mandatory laws.

### ***Restrictions.***

Except where you have been specifically licensed to do so by Telenav, and without limiting the preceding paragraph, you may not use this Data (a) with any products, systems, or applications installed or otherwise connected to or in communication with vehicles, capable of vehicle navigation, positioning, dispatch, real time route guidance, fleet management or similar applications; or (b) with or in communication with any



# Appendices

---

positioning devices or any mobile or wireless-connected electronic or computer devices, including without limitation cellular phones, palmtop and handheld computers, pagers, and personal digital assistants or PDAs.

## **Warning.**

The Data may contain inaccurate or incomplete information due to the passage of time, changing circumstances, sources used and the nature of collecting comprehensive geographic data, any of which may lead to incorrect results.

## **No Warranty.**

This Data is provided to you "as is," and you agree to use it at your own risk. Telenav and its licensors (and their licensors and suppliers) make no guarantees, representations or warranties of any kind, express or implied, arising by law or otherwise, including but not limited to, content, quality, accuracy, completeness, effectiveness, reliability, fitness for a particular purpose, usefulness, use or results to be obtained from this Data, or that the Data or server will be uninterrupted or error-free.

## **Disclaimer of Warranty:**

TELENAV AND ITS LICENSORS (INCLUDING THEIR LICENSORS AND SUPPLIERS) DISCLAIM ANY WARRANTIES, EXPRESS OR IMPLIED, OF QUALITY, PERFORMANCE, MERCHANTABILITY, FITNESS FOR A PARTICULAR PURPOSE OR NON-INFRINGEMENT. Some States, Territories and Countries do not allow certain warranty exclusions, so to that extent the above exclusion may not apply to you.

## **Disclaimer of Liability:**

TELENAV AND ITS LICENSORS (INCLUDING THEIR LICENSORS AND SUPPLIERS) SHALL NOT BE LIABLE TO YOU: IN RESPECT OF ANY CLAIM, DEMAND OR ACTION, IRRESPECTIVE OF THE NATURE OF THE CAUSE OF THE CLAIM, DEMAND OR ACTION ALLEGING ANY LOSS, INJURY OR DAMAGES, DIRECT OR INDIRECT, WHICH MAY RESULT FROM THE USE OR POSSESSION OF THE INFORMATION; OR FOR ANY LOSS OF PROFIT, REVENUE, CONTRACTS OR SAVINGS, OR ANY OTHER DIRECT, INDIRECT, INCIDENTAL, SPECIAL OR CONSEQUENTIAL DAMAGES ARISING OUT OF YOUR USE OF OR INABILITY TO USE THIS INFORMATION, ANY DEFECT IN THE INFORMATION, OR THE BREACH OF THESE TERMS OR CONDITIONS, WHETHER IN AN ACTION IN CONTRACT OR TORT OR BASED ON A WARRANTY, EVEN IF TELENAV OR ITS LICENSORS HAVE BEEN ADVISED OF THE POSSIBILITY OF SUCH DAMAGES. Some States, Territories and Countries do not allow certain liability exclusions or damages limitations, so to that extent the above may not apply to you.

## **Export Control.**

You shall not export from anywhere any part of the Data or any direct product thereof except in compliance with, and with all licenses and approvals required under, applicable export laws, rules and regulations, including but not limited to the laws, rules and regulations administered by the Office of Foreign Assets Control of the U.S. Department of Commerce and the Bureau of Industry and Security of the U.S. Department of Commerce. To the extent

# Appendices

that any such export laws, rules or regulations prohibit HERE from complying with any of its obligations hereunder to deliver or distribute Data, such failure shall be excused and shall not constitute a breach of this Agreement.

## **Entire Agreement.**

These terms and conditions constitute the entire agreement between Telenav (and its licensors, including their licensors and suppliers) and you pertaining to the subject matter hereof, and supersedes in their entirety any and all written or oral agreements previously existing between us with respect to such subject matter.

## **Governing Law.**

The above terms and conditions shall be governed by the laws of the State of Illinois [insert "Netherlands" where European HERE Data is used], without giving effect to (i) its conflict of laws provisions, or (ii) the United Nations Convention for Contracts for the International Sale of Goods, which is explicitly excluded. You agree to submit to the jurisdiction of the State of Illinois [insert "The Netherlands" where European HERE Data is used] for any and all disputes, claims and actions arising from or in connection with the Data provided to you hereunder.

## **Government End Users.**

If the Data is being acquired by or on behalf of the United States government or any other entity seeking or applying rights similar to those customarily claimed by the United States government, this Data is a "commercial item" as that term is defined at 48 C.F.R. ("FAR") 2.101, is licensed in accordance with these End-User Terms, and each copy of Data delivered or otherwise furnished shall be marked and embedded as appropriate with the following "Notice of Use," and shall be treated in accordance with such Notice:

### **NOTICE OF USE**

CONTRACTOR (MANUFACTURER/  
SUPPLIER) NAME: HERE

CONTRACTOR (MANUFACTURER/  
SUPPLIER) ADDRESS: c/o Nokia, 425  
West Randolph Street, Chicago, Illinois  
60606

This Data is a commercial item as defined in FAR 2.101 and is subject to these End-User Terms under which this Data was provided.

© 1987 – 2014 HERE – All rights reserved.

If the Contracting Officer, federal government agency, or any federal official refuses to use the legend provided herein, the Contracting Officer, federal government agency, or any federal official must notify HERE prior to seeking additional or alternative rights in the Data.

### I. US/Canada Territory

A. United States Data. The End-User Terms for any Application containing Data for the United States shall contain the following notices:

"HERE holds a non-exclusive license from the United States Postal Service® to publish and sell ZIP+4® information."

"©United States Postal Service® 20XX. Prices are not established, controlled or approved by the United States Postal Service®. The following trademarks and registrations are owned by the USPS: United States Postal Service, USPS, and ZIP+4."

## Appendices

---

B. Canada Data. The following provisions apply to the Data for Canada, which may include or reflect data from third party licensors (“Third Party Data”), including Her Majesty the Queen in Right of Canada (“Her Majesty”), Canada Post Corporation (“Canada Post”) and the Department of Natural Resources of Canada (“NRCan”):

1. Disclaimer and Limitation: Client agrees that its use of the Third Party Data is subject to the following provisions:

a. Disclaimer: The Third Party Data is licensed on an “as is” basis. The licensors of such data, including Her Majesty, Canada Post and NRCan, make no guarantees, representations or warranties respecting such data, either express or implied, arising by law or otherwise, including but not limited to, effectiveness, completeness, accuracy or fitness for a particular purpose.

b. Limitation on Liability: The Third Party Data licensors, including Her Majesty, Canada Post and NRCan, shall not be liable: (i) in respect of any claim, demand or action, irrespective of the nature of the cause of the claim, demand or action alleging any loss, injury or damages, direct or indirect, which may result from the use or possession of such Data; or (ii) in any way for loss of revenues or contracts, or any other consequential loss of any kind resulting from any defect in the Data.

2. Copyright Notice: In connection with each copy of all or any portion of the Data for the Territory of Canada, Client shall affix in a conspicuous manner the following copyright notice on at least one of: (i) the label for the storage media of the copy; (ii) the packaging for the copy; or (iii) other materials packaged with the copy, such as user manuals or end user license agreements: “This data includes information taken with permission from Canadian authorities, including © Her Majesty the Queen in Right of Canada, © Queen’s Printer for Ontario, © Canada Post Corporation, GeoBase®, © The Department of Natural Resources Canada. All rights reserved.”

3. End-User Terms: Except as otherwise agreed by the parties, in connection with the provision of any portion of the Data for the Territory of Canada to End-Users as may be authorized under the Agreement, Client shall provide such End-Users, in a reasonably conspicuous manner, with terms (set forth with other end user terms required to be provided under the Agreement, or as otherwise may be provided, by Client) which shall include the following provisions on behalf of the Third Party Data licensors, including Her Majesty, Canada Post and NRCan:

The Data may include or reflect data of licensors, including Her Majesty the Queen in the Right of Canada (“Her Majesty”), Canada Post Corporation (“Canada Post”) and the Department of Natural Resources Canada (“NRCan”). Such data is licensed on an “as is” basis. The licensors, including Her Majesty, Canada Post and NRCan, make no guarantees, representations or warranties respecting such data,

# Appendices

---

either express or implied, arising by law or otherwise, including but not limited to, effectiveness, completeness, accuracy or fitness for a particular purpose. The licensors, including Her Majesty, Canada Post and NRCan, shall not be liable in respect of any claim, demand or action, irrespective of the nature of the cause of the claim, demand or action alleging any loss, injury or damages, direct or indirect, which may result from the use or possession of the data or the Data. The licensors, including Her Majesty, Canada Post and NRCan, shall not be liable in any way for loss of revenues or contracts, or any other consequential loss of any kind resulting from any defect in the data or the Data.

End User shall indemnify and save harmless the licensors, including Her Majesty, Canada Post and NRCan, and their officers, employees and agents from and against any claim, demand or action, irrespective of the nature of the cause of the claim, demand or action, alleging loss, costs, expenses, damages or injuries (including injuries resulting in death) arising out of the use or possession of the data or the Data.

4. Additional Provisions: The terms contained in this Section are in addition to all of the rights and obligations of the parties under the Agreement. To the extent that any of the provisions of this Section are inconsistent with, or conflict with, any other provisions of the Agreement, the provisions of this Section shall prevail.

II. Mexico. The following provision applies to the Data for Mexico, which includes certain data from the Instituto Nacional de Estadística y Geografía (“INEGI”):

A. Any and all copies of the Data and/or packaging containing Data for Mexico shall contain the following notice: “Fuente: INEGI (Instituto Nacional de Estadística y Geografía)”

III. Latin America Territory

A. Third Party Notices. Any and all copies of the Data and/or packaging relating thereto shall include the respective Third Party Notices set forth below and used as described below corresponding to the Territory (or portion thereof) included in such copy:

Territory Notice

Ecuador “INSTITUTO GEOGRAFICO MILITAR DEL ECUADOR AUTORIZACION N° IGM-2011-01- PCO-01 DEL 25 DE ENERO DE 2011”  
“source: © IGN 2009 - BD TOPO ®”

Guadeloupe,  
French  
Guiana  
and  
Martinique  
Mexico

“Fuente: INEGI (Instituto Nacional de Estadística y Geografía)”

IV. Middle East Territory

# Appendices

---

A. Third Party Notices. Any and all copies of the Data and/or packaging relating thereto shall include the respective Third Party Notices set forth below and used as described below corresponding to the Territory (or portion thereof) included in such copy:

Country Notice

Jordan “© Royal Jordanian Geographic Centre”. The foregoing notice requirement for Jordan Data is a material term of the Agreement. If Client or any of its permitted sublicensees (if any) fail to meet such requirement, HERE shall have the right to terminate Client’s license with respect to the Jordan Data.

B. Jordan Data. Client and its permitted sublicensees (if any) are restricted from licensing and/or otherwise distributing HERE’s database for the country of Jordan (“Jordan Data”) for use in Enterprise Applications to (i) non-Jordanian entities for use of the Jordan Data solely in Jordan or (ii) Jordan-based customers. In addition, Client, its permitted sublicensees (if any) and End-Users are restricted from using the Jordan Data in Enterprise Applications if such party is (i) a non-Jordanian entity using the Jordan Data solely in Jordan or (ii) a Jordan-based customer. For purposes of the foregoing, “Enterprise Applications” shall mean Geomarketing applications, GIS applications, mobile business asset management applications, call center applications, telematics applications, public organization Internet applications or for providing geocoding services.

## V. Europe Territory

### A. Use of Certain Traffic Codes in Europe

1. General Restrictions Applicable to Traffic Codes. Client acknowledges and agrees that in certain countries of the Europe Territory, Client will need to obtain rights directly from third party RDS-TMC code providers to receive and use the Traffic Codes in the Data and to deliver to End-Users Transactions in any way derived from or based on such Traffic Codes. For such countries, HERE shall deliver the Data incorporating Traffic Codes to Client only after receiving certification from Client of its having obtained such rights.

2. Display of Third Party Rights Legends for Belgium. Client shall, for each Transaction that uses Traffic Codes for Belgium, provide the following notice to the End-User: “Traffic Codes for Belgium are provided by the Ministerie van de Vlaamse Gemeenschap and the Ministère de l’Équipement et des Transports.”

B. Paper Maps. With respect to any license granted to Client relating to making, selling or distributing paper maps (i.e., a map fixed on a paper or paper-like medium): (a) such license with respect to Data for the Territory of Great Britain is conditioned on Client’s entering into and complying with a separate written agreement with the Ordnance Survey (“OS”) to create and sell paper maps, Client’s paying to the OS any and all applicable paper map royalties, and Client’s complying with the OS copyright notice requirements; (b) such license for selling or otherwise distributing for charge with respect to Data for the Territory of Czech Republic

# Appendices

is conditioned on Client's obtaining prior written consent from Kartografie a.s.; (c) such license for selling or distributing with respect to Data for the Territory of Switzerland is conditioned on Client's obtaining a permit from Bundesamt für Landestopografie of Switzerland; (d) Client is restricted from using Data for the Territory of France to create paper maps with a scale between 1:5,000 and 1:250,000; and (e) Client is restricted from using any Data to create, sell or distribute paper maps that are the same or substantially similar, in terms of data content and specific use of color, symbols and scale, to paper maps published by the European national mapping agencies, including without limitation, Landervermessungämter of Germany, Topografische Dienst of the Netherlands, Nationaal Geografisch Instituut of Belgium, Bundesamt für Landestopografie of Switzerland, Bundesamt für Eich-und Vermessungswesen of Austria, and the National Land Survey of Sweden.

C. OS Enforcement. Without limiting Section IV(B) above, with respect to Data for the Territory of Great Britain, Client acknowledges and agrees that the Ordnance Survey ("OS") may bring a direct action against Client to enforce compliance with the OS copyright notice (see Section IV(D) below) and paper map requirements (see Section IV(B) above) contained in this Agreement.

D. Third Party Notices. Any and all copies of the Data and/or packaging relating thereto shall include the respective Third Party Notices set forth below and used as described below corresponding to the Territory (or portion thereof) included in such copy:

Country(ies) Notice

Austria	"© Bundesamt für Eich- und Vermessungswesen"
Croatia Cyprus, Estonia, Latvia, Lithuania, Moldova, Poland, Slovenia and/or Ukraine	"© EuroGeographics"
France	"source: © IGN 2009 – BD TOPO ®"
Germany	"Die Grundlegendaten wurden mit Genehmigung der zuständigen Behörden entnommen"
Great Britain	"Contains Ordnance Survey data © Crown copyright and database right 2010 Contains Royal Mail data © Royal Mail copyright and database right 2010"
Greece	"Copyright Geomatics Ltd."
Hungary	"Copyright © 2003; Top-Map Ltd."
Italy	"La Banca Dati Italiana è stata prodotta usando quale riferimento anche cartografia numerica ed al tratto prodotta e fornita dalla Regione Toscana."
Norway	"Copyright © 2000; Norwegian Mapping Authority"
Portugal	"Source: IgeoE – Portugal"
Spain	"Información geográfica propiedad del CNIG"

# Appendices

---

Sweden “Based upon electronic data  
© National Land Survey  
Sweden.”

Switzer- “Topografische Grundlage: ©  
land Bundesamt für Landestopo-  
graphie.

E. Respective Country Distribution. Client acknowledges that HERE has not received approvals to distribute map data for the following countries in such respective countries: Albania, Belarus, Kyrgyzstan, Moldova and Uzbekistan. HERE may update such list from time to time. The license rights granted to Client under this TL with respect to the Data for such countries are contingent upon Client’s compliance with all applicable laws and regulations, including, without limitation, any required licenses or approvals to distribute the Application incorporating such Data in such respective countries.

## VI. Australia Territory

A. Third Party Notices. Any and all copies of the Data and/or packaging relating thereto shall include the respective Third Party Notices set forth below and used as described below corresponding to the Territory (or portion thereof) included in such copy:

Copyright. Based on data provided under license from PSMA Australia Limited ([www.pasma.com.au](http://www.pasma.com.au)).

Product incorporates data which is © 20XX Telstra Corporation Limited, GM Holden Limited, Intelomatics Australia Pty Ltd and Continental Pty Ltd.

B. Third Party Notices for Australia. In addition to the foregoing, the End-User Terms for any Application containing RDS-TMC Traffic Codes for Australia shall contain the following notice: “Product incorporates traffic location codes which is © 20XX Telstra Corporation Limited and its licensors.”

## VII. China Territory

### *Personal Use Only*

You agree to use this Data together with [insert name of Client Application] for the solely personal, non-commercial purposes for which you were licensed, and not for service bureau, time-sharing or other similar purposes. Accordingly, but subject to the restrictions set forth in the following paragraphs, you may copy this Data only as necessary for your personal use to (i) view it, and (ii) save it, provided that you do not remove any copyright notices that appear and do not modify the Data in any way. You agree not to otherwise reproduce, copy, modify, decompile, disassemble or reverse engineer any portion of this Data, and may not transfer or distribute it in any form, for any purpose, except to the extent permitted by mandatory laws.

### *Restrictions*

Except where you have been specifically licensed to do so by NAV2 , and without limiting the preceding paragraph, you may not (a) use this Data with any products, systems, or applications installed or otherwise connected to or in communication with vehicles, capable of vehicle navigation, positioning, dispatch, real time route guidance, fleet management or similar applications; or (b)

# Appendices

---

with or in communication with any positioning devices or any mobile or wireless-connected electronic or computer devices, including without limitation cellular phones, palmtop and handheld computers, pagers, and personal digital assistants or PDAs. You agree to cease using this Data if you fail to comply with these terms and conditions.

## **Limited Warranty**

NAV2 warrants that (a) the Data will perform substantially in accordance with the accompanying written materials for a period of ninety (90) days from the date of receipt, and (b) any support services provided by NAV2 shall be substantially as described in applicable written materials provided to you by NAV2, and NAV2's support engineers will make commercially reasonable efforts to solve any problem issues.

## **rigCustomer Remedies**

NAV2 and its suppliers' entire liability and your exclusive remedy shall be, at NAV2's sole discretion, either (a) return of the price paid, if any, or (b) repair or replacement of the Data that do not meet NAV2's Limited Warranty and that are returned to NAV2 with a copy of your receipt. This Limited Warranty is void if failure of the Data has resulted from accident, abuse, or misapplication. Any replacement Data will be warranted for the remainder of the original warranty period or thirty (30) days, whichever is longer. Neither these remedies nor any product support services offered by NAV2 are available without proof of purchase from an authorized international source.

## **No Other Warranty:**

EXCEPT FOR THE LIMITED WARRANTY SET FORTH ABOVE AND TO THE EXTENT PERMITTED BY APPLICABLE LAW, NAV2 AND ITS LICENSORS (INCLUDING THEIR LICENSORS AND SUPPLIERS) DISCLAIM ANY WARRANTIES, EXPRESS OR IMPLIED, OF QUALITY, PERFORMANCE, MERCHANTABILITY, FITNESS FOR A PARTICULAR PURPOSE, OWNERSHIP OR NON-INFRINGEMENT. Certain warranty exclusions may not be permitted under applicable law, so to that extent the above exclusion may not apply to you.

## **Limited Liability:**

TO THE EXTENT PERMITTED BY APPLICABLE LAW, NAV2 AND ITS LICENSORS (INCLUDING THEIR LICENSORS AND SUPPLIERS) SHALL NOT BE LIABLE TO YOU: IN RESPECT OF ANY CLAIM, DEMAND OR ACTION, IRRESPECTIVE OF THE NATURE OF THE CAUSE OF THE CLAIM, DEMAND OR ACTION ALLEGING ANY LOSS, INJURY OR DAMAGES, DIRECT OR INDIRECT, WHICH MAY RESULT FROM THE USE OR POSSESSION OF THE INFORMATION; OR FOR ANY LOSS OF PROFIT, REVENUE, CONTRACTS OR SAVINGS, OR ANY OTHER DIRECT, INDIRECT, INCIDENTAL, SPECIAL OR CONSEQUENTIAL DAMAGES ARISING OUT OF YOUR USE OF OR INABILITY TO USE THIS INFORMATION, ANY DEFECT IN THE INFORMATION, OR THE BREACH OF THESE TERMS OR CONDITIONS, WHETHER IN AN ACTION IN CONTRACT OR TORT OR BASED ON A WARRANTY, EVEN IF NAV2 OR ITS LICENSORS HAVE BEEN ADVISED OF THE POSSIBILITY OF SUCH DAMAGES. UNDER NO CIRCUMSTANCES SHALL NAV2'S OR ITS SUPPLIERS' LIABILITY HEREUNDER EXCEED THE PRICE PAID. Certain liability exclusions may not be permitted under applicable law, so to that extent the above exclusion may not apply to you.



# Appendices

---

## **Export Control**

You agree not to export to anywhere any part of the Data provided to you or any direct product thereof except in compliance with, and with all licenses and approvals required under, applicable export laws, rules and regulations.

## **IP Protection**

The Data are owned by NAV2 or its suppliers and are protected by applicable copyright and other intellectual property law and treaties. The Data are provided solely on the basis of a license to use, not sale.

## **Entire Agreement**

These terms and conditions constitute the entire agreement between NAV2 (and its licensors, including their licensors and suppliers) and you pertaining to the subject matter hereof, and supersedes in their entirety any and all written or oral agreements previously existing between us with respect to such subject matter.

## **Governing Law.**

The above terms and conditions shall be governed by the laws of the People's Republic of China, without giving effect to (i) its conflict of laws provisions, or (ii) the United Nations Convention for Contracts for the International Sale of Goods, which is explicitly excluded. Any dispute arising from or in connection with the Data provided to you hereunder shall be submitted to the Shanghai International Economic and Trade Arbitration Commission for arbitration.

## **Gracenote® Copyright**

CD and music-related data from Gracenote, Inc., copyright© 2000-2007 Gracenote. Gracenote Software, copyright © 2000-2007 Gracenote. This product and service may practice one or more of the following U.S. Patents #5,987,525, #6,061,680, #6,154,773, #6,161,132, #6,230,192, #6,230,207, #6,240,459, #6,330,593 and other patents issued or pending. Some services supplied under license from Open Globe, Inc. for U.S. Patent: #6,304,523.

Gracenote and CDDB are registered trademarks of Gracenote. The Gracenote logo and logotype, and the "Powered by Gracenote™" logo are trademarks of Gracenote.

## **Gracenote® End User License Agreement (EULA)**

This device contains software from Gracenote, Inc. of 2000 Powell Street Emeryville, California 94608 ("Gracenote").

The software from Gracenote (the "Gracenote Software") enables this device to do disc and music file identification and obtain music-related information, including name, artist, track, and title information ("Gracenote Data") from online servers ("Gracenote Servers"), and to perform other functions. You may use Gracenote Data only by means of the intended End User functions of this device.

This device may contain content belonging to Gracenote's providers. If so, all of the restrictions set forth herein with respect to Gracenote Data shall also apply to such content and such content providers shall be entitled to all of the benefits and protections set forth herein that are available to Gracenote.

## Appendices

---

You agree that you will use the content from Gracenote ("Gracenote Content"), Gracenote Data, the Gracenote Software, and Gracenote Servers for your own personal, non-commercial use only. You agree not to assign, copy, transfer or transmit the Gracenote Content, Gracenote Software or any Gracenote Data (except in a Tag associated with a music file) to any third party. YOU AGREE NOT TO USE OR EXPLOIT GRACENOTE CONTENT, GRACENOTE DATA, THE GRACENOTE SOFTWARE, OR GRACENOTE SERVERS, EXCEPT AS EXPRESSLY PERMITTED HEREIN.

You agree that your non-exclusive licenses to use the Gracenote Content, Gracenote Data, the Gracenote Software, and Gracenote Servers will terminate if you violate these restrictions. If your licenses terminate, you agree to cease any and all use of the Gracenote Content, Gracenote Data, the Gracenote Software, and Gracenote Servers. Gracenote, respectively, reserve all rights in Gracenote Data, the Gracenote Software, and the Gracenote Servers and Gracenote Content, including all ownership rights. Under no circumstances will either Gracenote become liable for any payment to you for any information that you provide, including any copyrighted material or music file information. You agree that Gracenote may enforce its respective rights, collectively or separately, under this agreement against you, directly in each company's own name.

Gracenote uses a unique identifier to track queries for statistical purposes. The purpose of a randomly assigned numeric identifier is to allow Gracenote to count queries without knowing anything about who you are. For more information, see the web page at [www.gracenote.com](http://www.gracenote.com) for the Gracenote Privacy Policy.

THE GRACENOTE SOFTWARE, EACH ITEM OF GRACENOTE DATA AND THE GRACENOTE CONTENT ARE LICENSED TO YOU "AS IS". NEITHER GRACENOTE MAKES ANY REPRESENTATIONS OR WARRANTIES, EXPRESS OR IMPLIED, REGARDING THE ACCURACY OF ANY GRACENOTE DATA FROM THE GRACENOTE SERVERS OR GRACENOTE CONTENT. GRACENOTE COLLECTIVELY AND SEPARATELY RESERVE THE RIGHT TO DELETE DATA AND/OR CONTENT FROM THE COMPANIES' RESPECTIVE SERVERS OR, IN THE CASE OF GRACENOTE, CHANGE DATA CATEGORIES FOR ANY CAUSE THAT GRACENOTE DEEMS SUFFICIENT. NO WARRANTY IS MADE THAT EITHER GRACENOTE CONTENT OR THE GRACENOTE SOFTWARE OR GRACENOTE SERVERS ARE ERROR-FREE OR THAT THE FUNCTIONING OF THE GRACENOTE SOFTWARE OR GRACENOTE SERVERS WILL BE UNINTERRUPTED. GRACENOTE IS NOT OBLIGATED TO PROVIDE YOU WITH ANY ENHANCED OR ADDITIONAL DATA TYPES THAT GRACENOTE MAY CHOOSE TO PROVIDE IN THE FUTURE AND IS FREE TO DISCONTINUE ITS ONLINE SERVICES AT ANY TIME. GRACENOTE DISCLAIMS ALL WARRANTIES EXPRESS OR IMPLIED, INCLUDING, BUT NOT LIMITED TO, IMPLIED WARRANTIES OF MERCHANTABILITY, FITNESS FOR A PARTICULAR PURPOSE, TITLE, AND NON-INFRINGEMENT. NEITHER GRACENOTE WARRANTS THE RESULTS THAT WILL BE OBTAINED BY YOUR USE OF THE GRACENOTE SOFTWARE OR ANY GRACENOTE SERVER. IN NO CASE WILL GRACENOTE BE LIABLE FOR ANY CONSEQUENTIAL OR INCIDENTAL DAMAGES OR FOR ANY LOST PROFITS OR LOST REVENUES FOR ANY REASON WHATSOEVER.

© Gracenote 2007.

# Appendices

---

## **Vehicle with SYNC only United States and Mexico**

FCC ID: KMHSG1G1

IC: 1422A-SG1G1

### **Mexico**

Model: KMHSG1P1

NOM-121-SCT1-2009

The operation of this equipment is subject to the following two conditions: (1) This equipment or device may not cause harmful interference, and (2) this equipment or device must accept any interference, including interference that may cause undesired operation.

## **Vehicle with SYNC with Touchscreen/My Touch**

FCC ID: KMHSYNGG2

IC: 1422A-SYNGG2

This device complies with Part 15 of the FCC Rules and with RSS-210 of Industry Canada. Operation is subject to the following two conditions: (1) This device may not cause harmful interference, and (2) this device must accept any interference received, including interference that may cause undesired operation.

### **WARNING**



Changes or modifications not expressly approved by the party responsible for compliance could void the user's authority to operate the equipment. The term "IC" before the radio certification number only signifies that Industry Canada technical specifications were met.

---

The antenna used for this transmitter must not be co-located or operating in conjunction with any other antenna or transmitter.

# Index

## A

- A/C
    - See: Climate Control.....107
  - About This Manual.....7
  - ABS
    - See: Brakes.....160
  - ABS driving hints
    - See: Hints on Driving With Anti-Lock Brakes.....161
  - Accessories.....416
    - Exterior style.....416
    - Interior style.....416
    - Lifestyle.....416
    - Peace of mind.....416
  - Accessories
    - See: Replacement Parts Recommendation.....11
  - Active Park Assist.....168
    - Automatic Steering into Parking Space.....169
    - Deactivating the Park Assist Feature.....170
    - Troubleshooting the System.....171
    - Using Active Park Assist.....168
  - Adjusting the Headlamps.....226
    - Horizontal Aim Adjustment.....227
    - Vertical Aim Adjustment.....226
  - Adjusting the Steering Wheel.....67
  - Airbag Disposal.....43
  - Air Conditioning
    - See: Climate Control.....107
  - Alarm
    - See: Anti-Theft Alarm.....66
  - Ambient Lighting.....77
  - Anti-Theft Alarm.....66
    - Arming the Alarm.....66
    - Disarming the Alarm.....66
  - Appendices.....435
  - Audible Warnings and Indicators.....90
    - Automatic Transmission Warning Chime.....90
    - Engine On Warning Chime.....90
    - Headlamps On Warning Chime.....90
    - Key in Ignition Warning Chime.....90
    - Keyless Warning Alert.....90
    - Parking Brake On Warning Chime.....90
  - Audio Control.....67
    - Seek, Next or Previous.....68
  - Audio Input Jack.....295
  - Audio System.....282
    - General Information.....282
  - Audio Unit - Vehicles With: AM/FM/CD/SYNC.....283
  - Audio Unit - Vehicles With: Premium AM/FM/CD.....285
  - Audio Unit - Vehicles With: Sony AM/FM/CD.....287
    - Menu Structure.....288
  - Autolamps.....73
    - Windshield Wiper Activated Headlamps.....74
  - Automatic Climate Control.....107
    - Temperature Control.....108
  - Automatic Transmission.....157
    - Automatic Transmission.....157
    - Brake-Shift Interlock.....158
    - If Your Vehicle Gets Stuck In Mud or Snow.....159
  - Automatic Transmission Fluid Check.....222
  - Autowipers.....70
  - Auxiliary Power Points.....124
    - 110-volt AC power point.....124
    - 12-volt DC power point.....124
    - Locations.....124
- ## B
- Bonnet Lock
    - See: Opening and Closing the Hood.....213
  - Booster Seats.....22
    - Types of Booster Seats.....23
  - Brake Fluid Check.....222
  - Brakes.....160
    - General Information.....160
  - Breaking-In.....188
  - Bulb Specification Chart.....231
- ## C
- Cabin Air Filter.....110
  - California Proposition 65.....11
  - Capacities and Specifications.....279
    - Specifications.....279
  - Car Wash
    - See: Cleaning the Exterior.....236

# Index

Center Console.....	126	Cleaning the Alloy Wheels.....	240
Changing a Bulb.....	227	Cleaning the Engine.....	237
Lamp Assembly Condensation.....	227	Cleaning the Exterior.....	236
Replacing Fog, Park and Direction Indicator Bulbs.....	229	Exterior Chrome Parts.....	236
Replacing Headlamp Bulbs.....	227	Exterior Plastic Parts.....	237
Replacing License Plate Lamp Bulb.....	231	Stripes or Graphics.....	237
Replacing Reverse Lamp and Tail Lamp Bulbs.....	230	Underbody.....	237
Replacing Tail, Brake and Direction Indicator Bulbs.....	229	Cleaning the Instrument Panel and Instrument Cluster Lens.....	239
Replacing the Center High Mounted Brake Lamp Bulbs.....	231	Cleaning the Interior.....	238
Changing a Fuse.....	212	Cleaning the Windows and Wiper Blades.....	238
Fuses.....	212	Clearing All MyKeys.....	51
Changing the 12V Battery.....	223	Climate.....	397
Changing the Engine Air Filter.....	233	Climate Control Voice Commands.....	399
Identifying Air Filter Element Components.....	233	Climate Control.....	107
Installing the Engine Air Filter Element.....	234	Collision, Damage or Fire Event.....	195
Removing the Engine Air Filter Element.....	234	Guidance for Ford Motor Company Electric and Hybrid-Electric Vehicles Equipped With High Voltage Batteries.....	195
Changing the Wiper Blades.....	224	Coolant Check See: Engine Coolant Check.....	218
Changing the Front Wiper Blades.....	225	Crash Sensors and Airbag Indicator.....	42
Changing the Rear Window Wiper Blade.....	225	Creating a MyKey.....	51
Setting the Front Wipers in the Service Position.....	225	Programming/Changing Configurable Settings.....	51
Charging the High Voltage Battery.....	151	Cruise Control.....	68
Charge Port.....	154	Principle of Operation.....	175
Charging.....	154	Cruise control See: Using Cruise Control.....	175
Charging Equipment.....	151	Customer Assistance.....	198
Disconnecting the Charging Coupler.....	156		
Locking the Charging Coupler.....	155	<b>D</b>	
Waiting to Charge.....	155	Data Recording.....	9
Checking MyKey System Status.....	53	Event Data Recording.....	9
Checking the Wiper Blades.....	224	Service Data Recording.....	9
Child Restraint and Safety Belt Maintenance.....	33	Daytime Running Lamps.....	75
Child Safety.....	15	Type 1 - Conventional (Non-Configurable).....	75
General Information.....	15	Type 2 - Configurable.....	75
Child Safety Locks.....	25	Digital Radio.....	290
Left-Hand Side.....	26	HD Radio Reception and Station Troubleshooting.....	291
Right-Hand Side.....	26	Direction Indicators.....	76
Child Seat Positioning.....	24		
Cleaning Leather Seats.....	239		
Cleaning Products.....	236		

# Index

Driver and Passenger Airbags.....	36	Entertainment.....	354
Children and Airbags.....	36	A/V Inputs.....	371
Proper Driver and Front Passenger Seating Adjustment.....	36	AM/FM Radio.....	356
Driver Knee Airbag.....	40	Bluetooth Audio.....	371
Driving Aids.....	177	Browsing Device Content.....	355
Driving Hints.....	188	CD.....	366
Driving Through Water.....	189	SD Card Slot and USB Port.....	367
DRL		SIRIUS® Satellite Radio (If Activated).....	361
See: Daytime Running Lamps.....	75	Supported Media Players, Formats and Metadata Information.....	370
<b>E</b>		Environment.....	14
Economical Driving.....	188	Event Data Recording	
Electric Vehicle Information.....	378	See: Data Recording.....	9
Power.....	385	Export Unique Options.....	13
Settings (Energi Only).....	379	Extended Service Plan (ESP).....	418
Emission Control System.....	146	SERVICE PLANS (CANADA ONLY).....	419
On-Board Diagnostics (OBD-II).....	147	SERVICE PLANS (U.S. Only).....	418
Readiness for Inspection and Maintenance (I/M) Testing.....	148	Exterior Mirrors.....	80
End User License Agreement.....	435	Fold-Away Exterior Mirrors.....	81
SYNC End User License Agreement (EULA).....	435	Heated Exterior Mirrors.....	81
Engine Block Heater.....	130	Integrated Blind Spot Mirrors.....	81
Using the Engine Block Heater.....	131	Power Exterior Mirrors.....	80
Engine Coolant Check.....	218	Signal Indicator Mirrors.....	81
Adding Coolant.....	219	<b>F</b>	
Adding Engine Coolant.....	220	Fastening the Safety Belts.....	28
Adding Inverter System Controller Coolant.....	220	Safety Belt Extension Assembly.....	30
Checking the Engine Coolant.....	218	Safety Belt Locking Modes.....	29
Checking the Inverter System Controller Coolant.....	219	Using Safety Belts During Pregnancy.....	28
Engine Coolant and Inverter System Controller Coolant.....	218	Flat Tire Inflation	
Recycled Engine Coolant.....	220	See: Temporary Mobility Kit.....	243
Severe Climates.....	220	Floor Mats.....	190
What You Should Know About Fail-Safe Cooling.....	221	Fog Lamps - Front	
Engine Immobilizer		See: Front Fog Lamps.....	76
See: Passive Anti-Theft System.....	65	Ford Credit.....	11
Engine Oil Check.....	217	(U.S. Only).....	11
Adding Engine Oil.....	217	Front Fog Lamps.....	76
Low Engine Use.....	218	Front Passenger Sensing System.....	37
Engine Oil Dipstick.....	217	Fuel and Refueling.....	138
Engine Specifications.....	275	Fuel Consumption.....	145
		Calculating Fuel Economy.....	146
		Filling the Tank.....	146
		Fuel Filter.....	222

# Index

Fuel Quality.....	139	Heated Windows and Mirrors.....	110
Choosing the Right Fuel.....	139	Heated Exterior Mirrors.....	110
Fuel Freshness Mode (Energi Vehicles Only).....	139	Heated Rear Window.....	110
Octane Recommendations.....	139	Heating.....	
Fuel Shutoff.....	192	See: Climate Control.....	107
Fuses.....	204	HEV.....	
Fuse Specification Chart.....	204	See: Hybrid Electric Vehicle.....	132
Luggage Compartment Fuse Panel.....	209	High Voltage Battery Cut-Off Switch.....	156
Passenger Compartment Fuse Panel.....	207	High Voltage Battery.....	149
Power Distribution Box.....	204	General Information.....	149
Pre-Fuse Box.....	204	Hill Start Assist.....	161
		Switching the System On and Off.....	162
		Using Hill Start Assist.....	162
<b>G</b>		Hints on Controlling the Interior.....	
Garage Door Opener.....		Climate.....	108
See: Universal Garage Door Opener.....	119	Cooling the Interior Quickly.....	109
Gauges.....	84	General Hints.....	108
Left Information Display.....	84	Heating the Interior Quickly.....	109
Right Information Display.....	86	Recommended Settings for Cooling .....	109
General Information on Radio.....		Recommended Settings for Heating.....	109
Frequencies.....	44	Side Window Defogging in Cold Weather.....	109
Intelligent Access.....	44	Hints on Driving With Anti-Lock Brakes.....	161
General Maintenance Information.....	420	Hood Lock.....	
Multi-point Inspection.....	423	See: Opening and Closing the Hood.....	213
Owner Checks and Services.....	422	Hybrid Electric Vehicle.....	132
Protecting Your Investment.....	420	Hybrid Vehicle Operation.....	133
Why Maintain Your Vehicle?.....	420	Plug-in Power Mode and Hybrid Mode (C-MAX Energi Only).....	132
Why Maintain Your Vehicle at Your Dealership?.....	420		
Getting Assistance Outside the U.S. and Canada.....	201	<b>I</b>	
Getting the Services You Need.....	198	Ignition Switch.....	127
Away From Home.....	198	In California (U.S. Only).....	199
Global Opening.....	80	Information Display Control.....	68
Opening the Windows.....	80	Multimedia Controls.....	69
		Information Displays.....	91
		General Information.....	91
<b>H</b>			
Handbrake.....			
See: Parking Brake.....	161		
Hazard Warning Flashers.....	192		
Headlamp Exit Delay.....	75		
Head Restraints.....	112		
Adjusting the Head Restraint.....	113		
Heated Seats.....	117		

# Index

Information.....	388
911 Assist.....	394
Alerts.....	394
Calendar.....	394
Sirius Travel Link.....	392
SYNC Services (If Equipped, United States Only).....	389
Vehicle Health Report (If Equipped, United States Only).....	396
Where Am I?.....	397
Information Messages.....	100
AdvanceTrac®.....	100
Alarm.....	100
Battery and Charging System (High Voltage).....	101
Doors.....	101
Fuel.....	102
Hill Start Assist.....	102
Keys and Intelligent Access.....	102
Maintenance.....	103
MyKey.....	104
Park Aid.....	105
Park Brake.....	105
Power Steering.....	105
Remote Start.....	105
Tire Pressure Monitoring System.....	106
Transmission.....	106
Installing Child Seats.....	16
Child Seats.....	16
Using Lap and Shoulder Belts.....	17
Using Lower Anchors and Tethers for Children (LATCH).....	19
Using Tether Straps.....	21
Instrument Cluster.....	84
Instrument Lighting Dimmer.....	74
Vehicles With Front Fog Lamps.....	74
Vehicles Without Front Fog Lamps.....	75
Interior Lamps.....	76
Front Interior Lamp.....	76
Front Interior Lamp - With Panorama Roof.....	77
Rear Interior Lamp.....	77
Interior Mirror.....	82
Auto-Dimming Mirror.....	82
Introduction.....	7

## J

Jump Starting the Vehicle.....	193
Connecting the Jumper Cables.....	193
Jump Starting.....	194
Preparing Your Vehicle.....	193
Removing the Jumper Cables.....	195

## K

Keyless Starting.....	127
Ignition Modes.....	128
Keys and Remote Controls.....	44

## L

Lighting Control.....	73
Headlamp Flasher.....	73
High Beams.....	73
Lighting.....	73
Load Carrying.....	178
Load Limit.....	179
Vehicle Loading - with and without a Trailer.....	179
Locking and Unlocking.....	56
Activating Intelligent Access.....	57
Autolock.....	58
Battery Saver.....	59
Illuminated Entry.....	59
Illuminated Exit.....	59
Mechanical Key.....	57
Opening a Rear Door from Inside.....	57
Power Door Locks.....	56
Remote Control.....	56
Smart Unlocks For Integrated Keyhead Transmitter.....	58
Smart Unlocks For Intelligent Access Keys.....	58
Locks.....	56
Luggage Covers.....	178
Removing the Shade.....	178

## M

Maintenance.....	213
General Information.....	213



# Index

Manual Liftgate.....	60
Closing the Liftgate.....	60
Opening the Liftgate.....	60
Manual Seats.....	114
Adjusting the Height of the Driver's Seat.....	115
Lumbar Adjustment (If Equipped).....	115
Moving the Seat Backward and Forward.....	114
Recline Adjustment.....	115
Media Hub.....	296
Message Center See: Information Displays.....	91
Mirrors See: Heated Windows and Mirrors.....	110
See: Windows and Mirrors.....	79
Mobile Communications Equipment.....	13
Motorcraft Parts.....	276
MyFord Touch™.....	336
General Information.....	336
MyFord Touch™ Troubleshooting.....	410
MyKey Troubleshooting.....	54
MyKey™.....	50
Principle of Operation.....	50

## N

Navigation.....	401
cityseekr.....	403
Map Mode.....	405
Navigation Map Updates.....	408
Navigation Voice Commands.....	408
Point of Interest (POI) Categories.....	402
Quick-touch Buttons.....	407
Setting a Destination.....	401
Setting Your Navigation Preferences.....	404
Normal Scheduled Maintenance.....	424
Intelligent Oil-Life Monitor™.....	424
Normal Maintenance Intervals.....	424

## O

Oil Check See: Engine Oil Check.....	217
Opening and Closing the Hood.....	213
Closing the Hood.....	214
Opening the Hood.....	213

Ordering Additional Owner's Literature.....	202
Obtaining a French Owner's Manual.....	202
Overhead Console.....	126

## P

Parking Aid.....	166
Front Sensing System.....	167
Rear Sensing System.....	166
Parking Aids.....	166
Parking Brake.....	161
Passive Anti-Theft System.....	65
SecuriLock®.....	65
PATS See: Passive Anti-Theft System.....	65
Perchlorate.....	11
Personal Safety System™.....	34
How Does the Personal Safety System Work?.....	34
Phone.....	373
Making Calls.....	374
Pairing Subsequent Phones.....	374
Pairing Your Phone for the First Time.....	374
Phone Menu Options.....	375
Phone Settings.....	376
Phone Voice Commands.....	377
Receiving Calls.....	375
Text Messaging.....	375
Post-Crash Alert System.....	197
Power Door Locks See: Locking and Unlocking.....	56
Power Liftgate.....	61
Hands-Free Feature.....	63
Obstacle Detection.....	63
Opening and Closing the Liftgate.....	61
Setting the Liftgate Open Height.....	62
Stopping the Liftgate Movement.....	62
Power Seats.....	115
Power Lumbar.....	116
Power Steering Fluid Check.....	222
Power Windows.....	79
Accessory Delay.....	80
Bounce-Back.....	79
One-Touch Down.....	79
One-Touch Up.....	79
Window Lock.....	79
Protecting the Environment.....	14

# Index

## R

Rear Seat Armrest.....	118
Rear Seats.....	117
Folding the Seatback .....	117
Unfolding the Seatback.....	117
Rear Under Floor Storage.....	178
Rear View Camera.....	172
Using the Rear View Camera System.....	172
Rear View Camera	
See: Rear View Camera.....	172
Rear Window Wiper and Washers.....	71
Rear Window Washer.....	72
Rear Window Wiper.....	71
Refueling.....	141
Easy Fuel™ Capless Fuel System (Non-Energi Vehicles).....	142
Easy Fuel™ Capless System (Energi Vehicles Only).....	143
Remote Control.....	44
Car Finder.....	48
Integrated Keyhead Transmitters .....	44
Intelligent Access Key.....	45
Remote Start (If Equipped).....	48
Replacing the Battery.....	46
Sounding a Panic Alarm.....	48
Remote Start.....	110
Automatic Settings.....	111
Removing a Headlamp.....	227
Repairing Minor Paint Damage.....	240
Replacement Parts	
Recommendation.....	11
Collision Repairs.....	11
Scheduled Maintenance and Mechanical Repairs.....	11
Warranty on Replacement Parts.....	12
Replacing a Lost Key or Remote Control.....	49
Reporting Safety Defects (Canada Only).....	203
Reporting Safety Defects (U.S. Only).....	202

Roadside Assistance.....	191
Vehicles Sold in Canada: Getting Roadside Assistance.....	191
Vehicles Sold in Canada: Using Roadside Assistance.....	191
Vehicles Sold in the United States: Getting Roadside Assistance.....	191
Vehicles Sold in the United States: Using Roadside Assistance.....	191
Roadside Emergencies.....	191
Running-In	
See: Breaking-In.....	188
Running Out of Fuel.....	140
Refilling With a Portable Fuel Container.....	140

## S

Safety Belt Height Adjustment.....	30
Safety Belt Minder.....	31
Belt-Minder™.....	31
Safety Belts.....	27
Principle of Operation.....	27
Safety Belt Warning Lamp and Indicator Chime.....	31
Conditions of operation.....	31
Safety Canopy™.....	41
Safety Precautions.....	138
Satellite Radio.....	292
Satellite Radio Electronic Serial Number (ESN).....	293
Satellite Radio Reception Factors.....	293
SIRIUS® Satellite Radio Service.....	293
Troubleshooting.....	294
Scheduled Maintenance Record.....	428
Scheduled Maintenance.....	420
Seats.....	112
Security.....	65
Settings.....	344
Clock.....	345
Display.....	345
Settings.....	347
Sound.....	346
Vehicle.....	346
Side Airbags.....	39
Sitting in the Correct Position.....	112
Snow Chains	
See: Using Snow Chains.....	269

# Index

Special Notices.....	12	SYNC™.....	297
New Vehicle Limited Warranty.....	12	General Information.....	297
Notice to Owners of Pickup Trucks and Utility Type Vehicles.....	12	SYNC™ Troubleshooting.....	327
On-board Diagnostics (OBD-II).....	12	<b>T</b>	
Special Instructions.....	12	Tailgate	
Using Your Vehicle as an Ambulance.....	12	See: Manual Liftgate.....	60
Using Your Vehicle With a Snowplow.....	12	See: Power Liftgate.....	61
Special Operating Conditions Scheduled Maintenance.....	426	Technical Specifications	
Exceptions.....	427	See: Capacities and Specifications.....	275
Speed Control		Temporary Mobility Kit.....	243
See: Cruise Control.....	175	(Type 2).....	248
Stability Control.....	164	First Stage: Inflating the Tire with Sealing Compound and Air.....	250
Principle of Operation.....	164	First Stage: Reinflating the Tire with Sealing Compound and Air.....	245
Starter Switch		General Information.....	244
See: Ignition Switch.....	127	Second Stage: Checking Tire Pressure.....	246
Starting a Gasoline Engine.....	128	Tips for Use of the Kit.....	244
Guarding Against Exhaust Fumes.....	130	What to Do after the Tire has Been Sealed.....	247
Important Ventilating Information.....	130	What to Do After the Tire has Been Sealed.....	253
Switching Off the Vehicle When It Is Moving.....	130	What to Do When a Tire Is Punctured.....	245
Switching Off the Vehicle When It Is Stationary.....	129	The Better Business Bureau (BBB) Auto Line Program (U.S. Only).....	200
Vehicles with an Ignition Key.....	128	Tire Care.....	255
Vehicles with Keyless Start.....	128	Glossary of Tire Terminology.....	256
Starting and Stopping the Engine.....	127	Information About Uniform Tire Quality Grading.....	255
General Information.....	127	Information Contained on the Tire Sidewall.....	257
Steering.....	177	Temperature A B C.....	256
Electric Power Steering.....	177	Traction AA A B C.....	255
Steering Wheel.....	67	Treadwear.....	255
Storage Compartments.....	126	Tire Inflation When Punctured	
Sun Shades.....	82	See: Temporary Mobility Kit.....	243
Bounce-Back.....	83	Tire Pressure Monitoring System.....	270
Opening and Closing the Sun Shade.....	83	Changing Tires With a Tire Pressure Monitoring System.....	271
Sun Shade Relearning.....	83	Understanding Your Tire Pressure Monitoring System.....	271
Sun Visors.....	82	Tire Repair Kit	
Illuminated Vanity Mirror.....	82	See: Temporary Mobility Kit.....	243
Supplementary Restraints System.....	35		
Principle of Operation.....	35		
Symbols Glossary.....	7		
SYNC™ Applications and Services.....	312		
911 Assist.....	312		
SYNC AppLink.....	318		
SYNC Services: Traffic, Directions & Information (TDI) (If Equipped, Unites States Only).....	316		
Vehicle Health Report.....	314		

# Index

Tires	
See: Wheels and Tires.....	243
Towing a Trailer.....	186
Towing the Vehicle on Four	
Wheels.....	186
Emergency Towing.....	186
Recreational Towing.....	187
Towing.....	186
Traction Control.....	163
Principle of Operation.....	163
Transmission Code Designation.....	278
Transmission.....	157
Transmission	
See: Transmission.....	157
Transporting the Vehicle.....	186
<b>U</b>	
Under Hood Overview - Hybrid Electric Vehicle (HEV).....	214
Under Hood Overview - Plug-In Hybrid Electric Vehicle (PHEV).....	216
Unique Driving Characteristics.....	132
Universal Garage Door Opener.....	119
HomeLink Wireless Control System.....	119
USB Port.....	295
Using Cruise Control.....	175
ECO Cruise Control.....	176
Switching Cruise Control Off.....	176
Switching Cruise Control On.....	175
Using MyKey With Remote Start Systems.....	54
Using Snow Chains.....	269
Using Stability Control.....	165
AdvanceTrac® with Roll Stability Control™ (RSC®).....	165
Using SYNC™ With Your Media Player.....	319
Accessing Your Play Menu.....	323
Connecting Your Digital Media Player to the USB Port.....	319
Media Menu Features.....	322
Media Voice Commands.....	320
System Settings.....	325
What's Playing?.....	320
Using SYNC™ With Your Phone.....	301
Accessing Features through the Phone Menu.....	305
Accessing Your Phone Settings.....	308
Making Calls.....	304
Pairing a Phone for the First Time.....	302
Pairing Subsequent Phones.....	302
Phone Options during an Active Call.....	304
Phone Voice Commands.....	302
Receiving Calls.....	304
System Settings.....	309
Text Messaging.....	307
Using Traction Control.....	163
Switching the System Off Using a Switch.....	163
Switching the System Off Using the Information Display Controls.....	163
System Indicator Lights and Messages.....	163
Using Voice Recognition.....	299
Initiating a Voice Session.....	299
System Interaction and Feedback.....	300
Utilizing the Mediation/Arbitration Program (Canada Only).....	200
<b>V</b>	
Vehicle Care.....	236
General Information.....	236
Vehicle Certification Label.....	277
Vehicle Identification Number.....	277
Vehicle Storage.....	240
12V Battery.....	241
Body.....	241
Brakes.....	242
Cooling System.....	241
Engine.....	241
Fuel System.....	241
General.....	241
Miscellaneous.....	242
Removing Vehicle From Storage.....	242
Tires.....	242
Ventilation	
See: Climate Control.....	107
VIN	
See: Vehicle Identification Number.....	277
Voice Control.....	68

# Index

---

## W

Warning Lamps and Indicators.....	86
Anti-Lock Braking System.....	87
Battery.....	87
Brake System.....	87
Cruise Control.....	87
Direction Indicator.....	87
Door Ajar.....	87
Engine and Motor Coolant Temperature.....	87
Engine Oil.....	87
EV Later.....	88
EV Now.....	87
Fasten Safety Belt.....	88
Front Airbag.....	88
Front Fog Lamps.....	88
High Beam.....	88
Liftgate Ajar.....	88
Low Battery.....	88
Low Fuel Level.....	88
Low Tire Pressure Warning.....	88
Overdrive Cancel and Grade Assist.....	88
Parking Lamps.....	88
Powertrain Fault.....	88
Ready to Drive.....	89
Service Engine Soon.....	89
Stability Control.....	89
Stability Control Off.....	89
Stop Safely.....	89
Vehicle Plugged in.....	89
Washer Fluid Check.....	222
Washers	
See: Cleaning the Exterior.....	236
See: Wipers and Washers.....	70
Waxing.....	237
Wheels and Tires.....	243
Technical Specifications.....	273
Windows and Mirrors.....	79
Windshield Wipers.....	70
Intermittent Wipe.....	70
Speed dependent wipers (if equipped).....	70
Wipers and Washers.....	70
Wrecker Towing	
See: Transporting the Vehicle.....	186