

# 2011 GMC Terrain Owner Manual

|                                      |      |   |      |                                    |      |
|--------------------------------------|------|---|------|------------------------------------|------|
| <b>In Brief</b> .....                | 1-1  | <b>Storage</b> .....                            | 4-1  | <b>Climate Controls</b> .....      | 8-1  |
| Instrument Panel .....               | 1-2  | Storage Compartments .....                      | 4-1  | Climate Control Systems .....      | 8-1  |
| Initial Drive Information .....      | 1-4  | Additional Storage Features .....               | 4-2  | Air Vents .....                    | 8-5  |
| Vehicle Features .....               | 1-18 | Roof Rack System .....                          | 4-2  | Maintenance .....                  | 8-6  |
| Performance and<br>Maintenance ..... | 1-23 | <b>Instruments and Controls</b> .....           | 5-1  | <b>Driving and Operating</b> ..... | 9-1  |
| <b>Keys, Doors and Windows</b> ..... | 2-1  | Controls .....                                  | 5-2  | Driving Information .....          | 9-2  |
| Keys and Locks .....                 | 2-2  | Warning Lights, Gauges, and<br>Indicators ..... | 5-7  | Starting and Operating .....       | 9-26 |
| Doors .....                          | 2-8  | Information Displays .....                      | 5-20 | Engine Exhaust .....               | 9-32 |
| Vehicle Security .....               | 2-12 | Vehicle Messages .....                          | 5-24 | Automatic Transmission .....       | 9-34 |
| Exterior Mirrors .....               | 2-14 | Vehicle Personalization .....                   | 5-30 | Drive Systems .....                | 9-37 |
| Interior Mirrors .....               | 2-15 | <b>Lighting</b> .....                           | 6-1  | Brakes .....                       | 9-37 |
| Windows .....                        | 2-16 | Exterior Lighting .....                         | 6-1  | Ride Control Systems .....         | 9-39 |
| Roof .....                           | 2-18 | Interior Lighting .....                         | 6-4  | Cruise Control .....               | 9-42 |
| <b>Seats and Restraints</b> .....    | 3-1  | Lighting Features .....                         | 6-5  | Object Detection Systems .....     | 9-45 |
| Head Restraints .....                | 3-2  | <b>Infotainment System</b> .....                | 7-1  | Fuel .....                         | 9-52 |
| Front Seats .....                    | 3-3  | Introduction .....                              | 7-1  | Towing .....                       | 9-57 |
| Rear Seats .....                     | 3-9  | Radio .....                                     | 7-11 | Conversions and<br>Add-Ons .....   | 9-64 |
| Safety Belts .....                   | 3-10 | Audio Players .....                             | 7-19 |                                    |      |
| Airbag System .....                  | 3-26 | Rear Seat Infotainment .....                    | 7-33 |                                    |      |
| Child Restraints .....               | 3-40 | Phone .....                                     | 7-45 |                                    |      |

# 2011 GMC Terrain Owner Manual

---

|                           |       |                                    |      |                                   |       |
|---------------------------|-------|------------------------------------|------|-----------------------------------|-------|
| <b>Vehicle Care</b> ..... | 10-1  | <b>Service and Maintenance</b> ... | 11-1 | <b>Customer Information</b> ..... | 13-1  |
| General Information ..... | 10-2  | General Information .....          | 11-1 | Customer Information .....        | 13-1  |
| Vehicle Checks .....      | 10-4  | Scheduled Maintenance .....        | 11-2 | Reporting Safety Defects ....     | 13-15 |
| Headlamp Aiming .....     | 10-31 | Recommended Fluids,                |      | Vehicle Data Recording and        |       |
| Bulb Replacement .....    | 10-33 | Lubricants, and Parts .....        | 11-6 | Privacy .....                     | 13-16 |
| Electrical System .....   | 10-39 | Maintenance Records .....          | 11-9 | <b>Index</b> .....                | i-1   |
| Wheels and Tires .....    | 10-45 | <b>Technical Data</b> .....        | 12-1 |                                   |       |
| Jump Starting .....       | 10-75 | Vehicle Identification .....       | 12-1 |                                   |       |
| Towing .....              | 10-79 | Vehicle Data .....                 | 12-2 |                                   |       |
| Appearance Care .....     | 10-82 |                                    |      |                                   |       |



The names, logos, emblems, slogans, vehicle model names, and vehicle body designs appearing in this manual including, but not limited to, GM, the GM logo, GMC, the GMC Truck Emblem, and TERRAIN are trademarks and/or service marks of General Motors LLC, its subsidiaries, affiliates, or licensors.

This manual describes features that may or may not be on your specific vehicle either because they are options that you did not purchase or due to changes subsequent to the printing of this owner manual.

Litho in U.S.A.  
Part No. 20781753 B Second Printing

Please refer to the purchase documentation relating to your specific vehicle to confirm each of the features found on your vehicle. For vehicles first sold in Canada, substitute the name "General Motors of Canada Limited" for GMC Motor Division wherever it appears in this manual.

Keep this manual in the vehicle for quick reference.



Manufactured under license under U.S. Patent #'s: 5,451,942; 5,956,674; 5,974,380; 5,978,762; 6,487,535 & other U.S. and worldwide patents issued & pending. DTS and the Symbol are

registered trademarks and DTS Digital Surround and the DTS logos are trademarks of DTS, Inc. Product includes software. All Rights Reserved.



Manufactured under license from Dolby® Laboratories. Dolby and the double-D symbol are registered trademarks of Dolby Laboratories.



This product incorporates copyright protection technology that is protected by U.S. patents and other intellectual property rights. Use of this copyright protection technology must be authorized by Macrovision, and is intended for home and other limited viewing uses only unless otherwise authorized by Macrovision. Reverse engineering or disassembly is prohibited.



"Made for iPod" means that an electronic accessory has been designed to connect specifically to iPod and has been certified by

the developer to meet Apple performance standards. Apple is not responsible for the operation of this device or its compliance with safety and regulatory standards.

iPod, iPod classic, iPod nano, and iPod touch are trademarks of Apple Inc., registered in the U.S. and other countries.

## Canadian Vehicle Owners

### Propriétaires Canadiens

A French language copy of this manual can be obtained from your dealer or from:

On peut obtenir un exemplaire de ce guide en français auprès du concessionnaire ou à l'adresse suivante:

Helm, Incorporated  
P.O. Box 07130  
Detroit, MI 48207

1-800-551-4123  
Numéro de poste 6438 de  
langue française  
[www.helminc.com](http://www.helminc.com)

## Using this Manual

To quickly locate information about the vehicle, use the Index in the back of the manual. It is an alphabetical list of what is in the manual and the page number where it can be found.

## Danger, Warnings, and Cautions

Warning messages found on vehicle labels and in this manual describe hazards and what to do to avoid or reduce them.

**Danger** indicates a hazard with a high level of risk which will result in serious injury or death.

**Warning** or **Caution** indicates a hazard that could result in injury or death.

**⚠ WARNING**

These mean there is something that could hurt you or other people.

**Notice:** This means there is something that could result in property or vehicle damage. This would not be covered by the vehicle's warranty.



A circle with a slash through it is a safety symbol which means "Do Not," "Do not do this," or "Do not let this happen."

**Symbols**













The vehicle has components and labels that use symbols instead of text. Symbols are shown along with the text describing the operation or information relating to a specific component, control, message, gauge, or indicator.

 : This symbol is shown when you need to see your owner manual for additional instructions or information.

 : This symbol is shown when you need to see a service manual for additional instructions or information.

**Vehicle Symbol Chart**

Here are some additional symbols that may be found on the vehicle and what they mean. For more information on the symbol, refer to the Index.

-  : Airbag Readiness Light
-  : Air Conditioning
-  : Antilock Brake System (ABS)
-  : Brake System Warning Light
-  : Charging System
-  : Cruise Control
-  : Engine Coolant Temperature
-  : Exterior Lamps
-  : Fog Lamps
-  : Fuel Gauge
-  : Fuses
-  : Headlamp High/Low-Beam Changer

## vi Introduction

---

 : LATCH System Child Restraints

 : Malfunction Indicator Lamp

 : Oil Pressure

 : OnStar®

 : Power

 : Remote Vehicle Start

 : Safety Belt Reminders

 : Steering Wheel Controls

 : Tire Pressure Monitor

 : Traction Control

 : Windshield Washer Fluid

## In Brief

### Instrument Panel

Instrument Panel ..... 1-2

### Initial Drive Information

Initial Drive Information ..... 1-4

Remote Keyless Entry (RKE)  
System ..... 1-4

Remote Vehicle Start ..... 1-5

Door Locks ..... 1-5

Liftgate ..... 1-6

Windows ..... 1-7

Seat Adjustment ..... 1-7

Memory Features ..... 1-9

Heated Seats ..... 1-10

Head Restraint

Adjustment ..... 1-11

Safety Belts ..... 1-11

Sensing System for  
Passenger Airbag ..... 1-11

Mirror Adjustment ..... 1-12

Steering Wheel  
Adjustment ..... 1-12

Interior Lighting ..... 1-13

Exterior Lighting ..... 1-13

Windshield Wiper/Washer .... 1-14

Climate Controls ..... 1-15

Parking Brake ..... 1-16

Transmission ..... 1-17

### Vehicle Features

Radio(s) ..... 1-18

Satellite Radio ..... 1-19

Portable Audio Devices ..... 1-19

Bluetooth® ..... 1-19

Steering Wheel Controls .... 1-20

Cruise Control ..... 1-20

Navigation System ..... 1-21

### Driver Information

Center (DIC) ..... 1-21

Vehicle Personalization ..... 1-21

### Rear Vision

Camera (RVC) ..... 1-22

Ultrasonic Parking Assist .... 1-22

Roof Rack System ..... 1-22

Power Outlets ..... 1-23

### Performance and Maintenance

#### Traction Control

System (TCS) ..... 1-23

StabiliTrak® System ..... 1-23

Tire Pressure Monitor ..... 1-24

Engine Oil Life System ..... 1-24

Fuel E85 (85% Ethanol) .... 1-24

#### Driving for Better Fuel

Economy ..... 1-25

#### Roadside Assistance

Program ..... 1-25

OnStar® ..... 1-26

## Instrument Panel

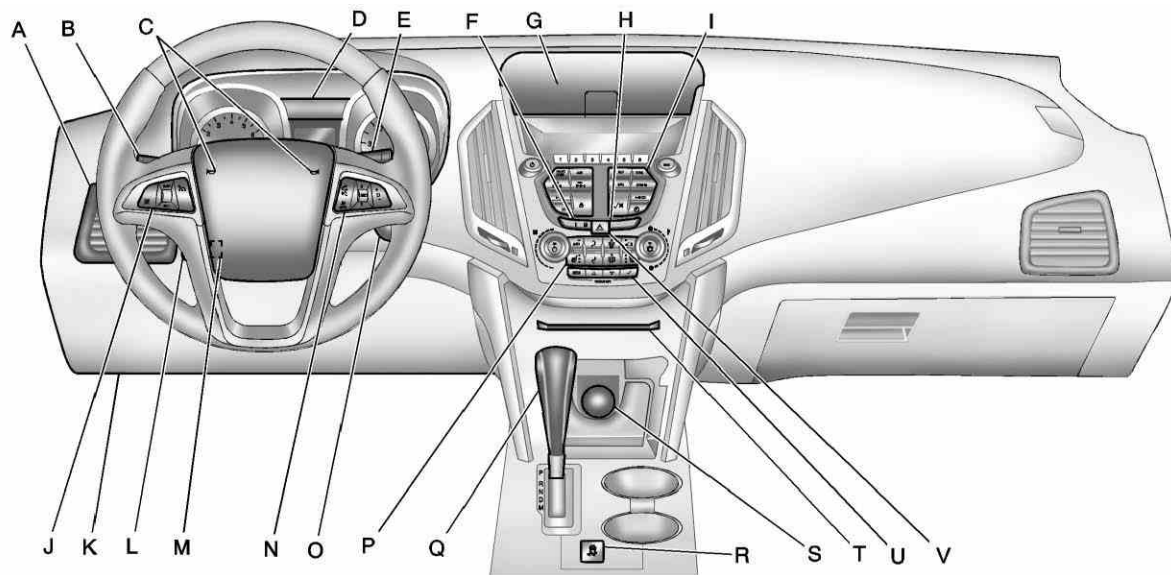



- 
- A. *Air Vents on page 8-5.*
  - B. *Turn and Lane-Change Lever. See Turn and Lane-Change Signals on page 6-3. Exterior Lamp Controls on page 6-1. Fog Lamps on page 6-4.*
  - C. *Horn on page 5-3.*
  - D. *Instrument Cluster on page 5-8.*
  - E. *Windshield Wiper/Washer on page 5-3. Rear Window Wiper/Washer on page 5-4.*
  - F. *Power Door Locks on page 2-7.*
  - G. *Instrument Panel Storage on page 4-1.*
  - H. *Safety Locks on page 2-8.*
  - I. *Infotainment on page 7-1. Navigation System (If Equipped). See Navigation System Manual.*
  - J. *Cruise Control on page 9-42.*
  - K. *Data Link Connector (DLC) (Out of View). See Malfunction Indicator Lamp on page 5-13.*
  - L. *Instrument Panel Illumination Control on page 6-4.*
  - M. *Steering Wheel Adjustment on page 5-2.*
  - N. *Steering Wheel Controls on page 5-2.*
  - O. *Ignition Positions on page 9-27.*
  - P. *Climate Control Systems on page 8-1 (If Equipped). Automatic Climate Control System on page 8-3 (If Equipped).*
  - Q. *Shift Lever. See Automatic Transmission on page 9-34.*
  - R. *StabiliTrak<sup>®</sup> System on page 9-41.*
  - S. *Power Outlets on page 5-6.*
  - T. *CD/DVD Player Slot. See CD Player on page 7-19 or CD/DVD Player on page 7-21.*
  - U. *Driver Information Center (DIC) Buttons. See Driver Information Center (DIC) on page 5-20.*
  - V. *Hazard Warning Flashers on page 6-3.*

### Initial Drive Information

This section provides a brief overview about some of the important features that may or may not be on your specific vehicle.

For more detailed information, refer to each of the features which can be found later in this owner manual.

### Remote Keyless Entry (RKE) System

The Remote Keyless Entry (RKE) transmitter will work up to 60 m (195 ft) away from the vehicle.





Press this button to extend the key. The key can be used for the ignition and all locks.



 : Press to unlock the driver door or all doors.

 : Press to lock all doors.

Lock and unlock feedback can be personalized.

 : For vehicles with the power liftgate, press and hold until the liftgate begins to move to open the liftgate.

For vehicles without the power liftgate, first press , then press and hold  to unlock the liftgate.



 : Press and release to locate the vehicle. Press and hold for at least two seconds to sound the panic alarm. Press  again to cancel the panic alarm.

See *Keys* on page 2-2 and *Remote Keyless Entry (RKE) System Operation* on page 2-3.

## Remote Vehicle Start

With this feature the engine can be started from outside of the vehicle.

### Starting the Vehicle

1. Press  on the Remote Keyless Entry transmitter.
2. Press and hold  for about two seconds. The turn signal lamps will briefly flash to confirm the vehicle has been started. The parking lamps will turn on and remain on as long as the engine is running. The vehicle's doors will be locked.
3. The key must be inserted and turned to ON/RUN before driving.

The engine will shut off after 10 minutes unless a time extension is done or the key is inserted and turned to ON/RUN.

## Canceling a Remote Start

To cancel a remote start, do one of the following:

- Press  until the parking lamps turn off.
- Turn on the hazard warning flashers.
- Insert the key and turn it to ON/RUN and then back to LOCK/OFF.

See *Remote Vehicle Start* on page 2-5.

## Door Locks

To lock or unlock a door, use the Remote Keyless Entry (RKE) transmitter from outside the vehicle.

From inside the vehicle with the doors locked, pull once on the door handle to unlock it, and a second time to open it or use the power door lock switch.

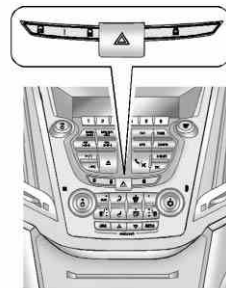

The power door lock switches are on the instrument panel.

 : Press to unlock the doors.

 : Press to lock the doors. See *Door Locks* on page 2-6.

 : Press for Safety Locks. See *Safety Locks* on page 2-8.

## Liftgate

### Manual Liftgate Operation

Unlock the vehicle before opening the liftgate.

Press the touchpad located in the handle of the liftgate, above the license plate, and lift up to open.

Do not press the touchpad while closing the liftgate. This will cause the liftgate to be unlatched.

### Power Liftgate Operation

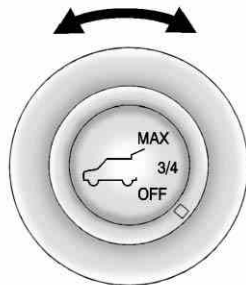

On vehicles with a power liftgate, the switch is on the overhead console. The vehicle must be in P (Park) to use the power feature. The taillamps flash when the power liftgate moves.

**Notice:** If you open the liftgate without checking for overhead obstructions such as a garage door, you could damage the liftgate or the liftgate glass. Always check to make sure the area above and behind the liftgate is clear before opening it.

Choose the power liftgate mode by turning the dial on the switch to either the 3/4 or MAX position. Press the button to open or close the liftgate.

See *Liftgate (Manual)* on page 2-8 or *Liftgate (Power)* on page 2-9.

## Windows

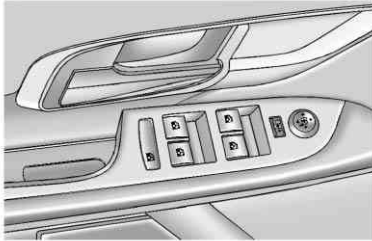

The power window controls are on each of the side doors.

The driver door also has switches that control the passenger and rear windows.

Operate the switch for the window by pressing to open and pulling to close.

Pushing or pulling the switch part of the way will open or close the window as long as the switch is operated.

See *Power Windows* on page 2-17.

## Seat Adjustment

### Four-Way Power Driver Seat

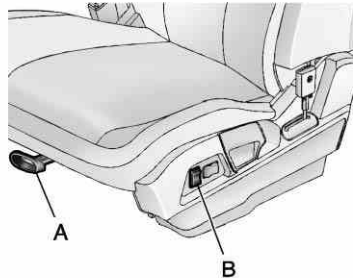

- A. Seat Position Handle
- B. Height Adjustment Control

To adjust the seat:

- Move the seat forward or rearward using the handle under the front of the seat cushion (A). See *Seat Adjustment* on page 3-3.
- Raise or lower the entire seat by moving the control (B) up or down.

See *Power Seat Adjustment* on page 3-3 for more information.

### Eight-Way Power Driver Seat

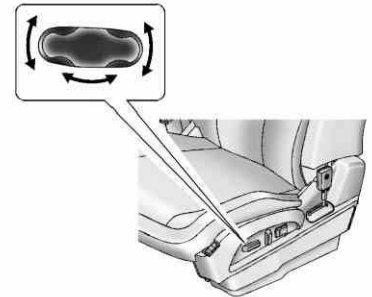

To adjust a power seat, if equipped:

- Move the seat forward or rearward by sliding the control forward or rearward.
- Raise or lower the front or rear part of the seat cushion by moving the front or rear of the control up or down.
- Raise or lower the entire seat by moving the entire control up or down.

## 1-8 In Brief

---

See *Power Seat Adjustment* on page 3-3 for more information.

### Lumbar Adjustment

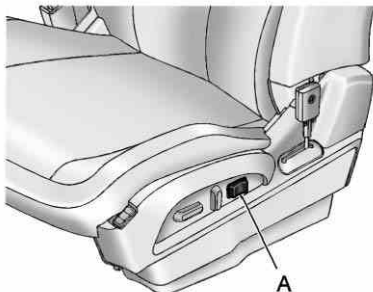

#### Eight-Way Power Seat Shown, Four-Way Similar

##### A. Lumbar Switch

If available, press and hold the front or rear of the switch (A) to increase or decrease lumbar support. Release the switch when the seatback reaches the desired level of lumbar support.

See *Lumbar Adjustment* on page 3-6 for more information.

### Reclining Seatbacks

#### Manual Reclining Seatbacks

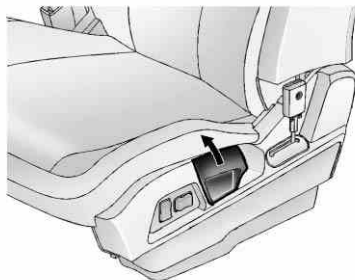

To recline a manual seatback:

1. Lift the lever.
2. Move the seatback to the desired position, and then release the lever to lock the seatback in place.

3. Push and pull on the seatback to make sure it is locked.

To return the seatback to the upright position:

1. Lift the lever fully without applying pressure to the seatback, and the seatback will return to the upright position.
2. Push and pull on the seatback to make sure it is locked.

## Power Reclining Seatbacks

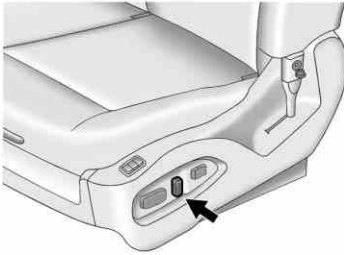

To adjust a power seatback, if available:

- Tilt the top of the control rearward to recline.
- Tilt the top of the control forward to raise.

## Memory Features

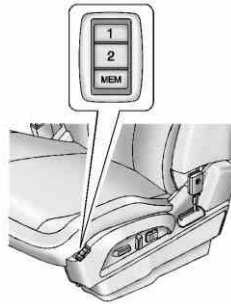

On vehicles with the memory feature, the “1” and “2” buttons on the outboard side of the driver seat are used to manually save and recall the driver seat and outside mirror positions. These manually stored positions are referred to as Button Memory positions.

The vehicle will also automatically save driver seat and outside mirror positions to the current driver Remote Keyless Entry (RKE) transmitter when the ignition is turned off. These automatically stored positions are referred to as RKE Memory positions.

### Storing Button Memory Positions

To save positions into Button Memory:

1. Adjust the driver seat, seatback recliner, and both outside mirrors to the desired driving positions.
2. Press and release the MEM (Memory) button.
3. Press “1” until a beep sounds.
4. Repeat Steps 1 through 3 for a second driver using “2.”

To recall the manually saved Button Memory positions, press and hold “1” or “2.” The driver seat and outside mirrors move to the positions stored to those buttons when pressed. Releasing “1” or “2” before the stored positions are reached stops the recall.

To automatically recall RKE Memory positions, unlock the driver door with the RKE transmitter and open the driver door. If the driver door is already open, pressing the RKE transmitter  button will also activate the RKE Memory recall. The driver seat and outside mirrors will move to the previously saved RKE Memory positions.

See “Memory Seat and Mirrors” under *Power Seat Adjustment on page 3-3* for more information.

### Easy Exit Driver Seat

This feature moves the seat rearward allowing the driver more room to exit the vehicle.

To activate, turn the ignition off and open the driver door. If the driver door is already open, turning the ignition off will activate the easy exit driver seat.

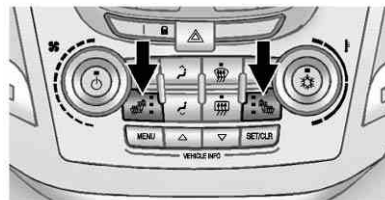

This feature can be turned on or off using the vehicle personalization menu. See “Easy Exit Driver Seat” under *Vehicle Personalization on page 5-30* for more information.

## Heated Seats



### Uplevel Climate Control System Shown, Base Similar

If available, the buttons are near the climate controls. To operate, the ignition must be in ON/RUN.

Press  or  to heat the driver or passenger seat cushion and seatback.

Indicator lights on the button show the temperature setting.

See *Heated Front Seats on page 3-8*.



## Head Restraint Adjustment

Do not drive until the head restraints for all occupants are installed and adjusted properly.

To achieve a comfortable seating position, change the seatback recline angle as little as necessary while keeping the seat and the head restraint height in the proper position.

For more information see *Head Restraints* on page 3-2 and *Seat Adjustment* on page 3-3.

## Safety Belts



Refer to the following sections for important information on how to use safety belts properly.

- *Safety Belts* on page 3-10.
- *How to Wear Safety Belts Properly* on page 3-14.
- *Lap-Shoulder Belt* on page 3-20.
- *Lower Anchors and Tethers for Children (LATCH System)* on page 3-49.

## Sensing System for Passenger Airbag



### United States



### Canada

The passenger sensing system will turn off the right front passenger frontal airbag under certain conditions. The driver airbag, seat-mounted side impact airbags, and roof-rail airbags are not affected by the passenger sensing system.

The passenger airbag status indicator will be visible on the overhead console when the vehicle is started. See *Passenger Sensing System* on page 3-33 for more information.

### Mirror Adjustment

#### Exterior

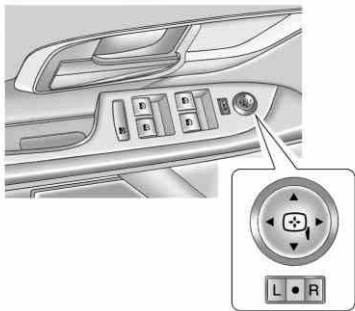

Controls for the outside power mirrors are on the driver door.

To adjust the mirrors:

1. Move the selector switch to L (left) or R (right) to choose the driver or passenger mirror.
2. Press the arrows on the control pad to move each mirror in the desired direction.
3. Return the selector switch to the middle position.

See *Power Mirrors* on page 2-14.

#### Interior

Vehicles with an automatic dimming inside rearview mirror can automatically reduce the glare from the headlamps of the vehicle behind you. The dimming feature comes on and the indicator light comes on each time the vehicle is started.

See *Automatic Dimming Rearview Mirror* on page 2-15.

### Steering Wheel Adjustment

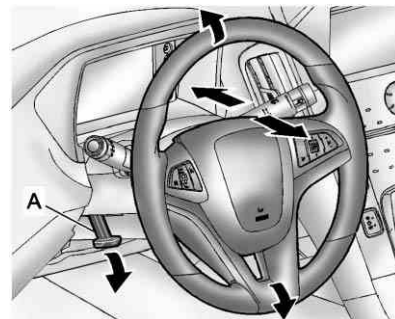

To adjust the steering wheel:

1. Pull the lever (A) down.
2. Move the steering wheel up or down.

- Pull or push the steering wheel closer or away from you.
- Pull the lever (A) up to lock the steering wheel in place.

Do not adjust the steering wheel while driving.

## Interior Lighting

### Reading Lamps

These lamps are located on the overhead console. These lamps come on automatically when any door is opened.

For manual operation, press the button next to each lamp to turn it on or off.

### Center Dome Lamps

There are front and rear dome lamps.

The dome lamp controls are located in the overhead console. To change the settings, press the following:

 : Turns the lamp off, even when a door is open.

 : The lamps come on automatically when a door is opened.

 : Turns the dome lamps on.

The dome lamps can also be turned on and off by pressing the buttons next to the lamps.

For more information on interior lighting, See *Instrument Panel Illumination Control* on page 6-4.

## Exterior Lighting





The exterior lamp control is located on the turn signal/lane change lever.

 : Turn to operate the exterior lamps.

 : Turns the exterior lamps off.

**AUTO:** Turns the exterior lamps on and off automatically depending on the exterior light.

 : Turns on the parking lamps, together with the sidemarkers lamps, taillamps, license plate lamps, and instrument panel lights.

 : Turns on the headlamps, together with the parking lamps, sidemarkers lamps, taillamps, license plate lamps, and instrument panel lights.

## 1-14 In Brief

For more information, see:

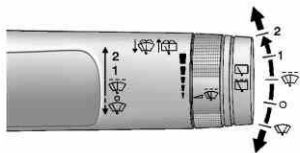

- *Exterior Lamp Controls on page 6-1.*
- *Daytime Running Lamps (DRL) on page 6-2.*
- *Fog Lamps on page 6-4.*

### Windshield Wiper/Washer





The windshield wiper/washer lever is located on the right side of the steering column.

Move the lever to one of the following positions:

 : Use for a single wipe, move the lever to  and then release. The wipers stop after one wipe.

 : Use to turn the wipers off.

 : For adjustable interval wipes. Turn the  band up for more frequent wipes or down for less frequent wipes.

**1:** Use for slow wipes.

**2:** Use for fast wipes.

### Windshield Washer

Pull the lever toward you to spray washer fluid on the windshield. The spray continues until the lever is released.

### Rear Window Wiper/Washer

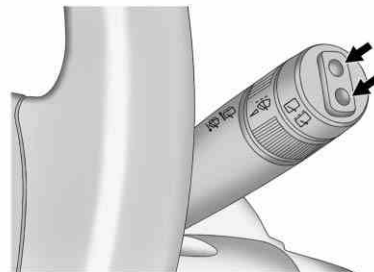

The rear wiper controls are on the end of the windshield wiper lever.

Press the upper or lower portion of the button to control the rear wiper and rear wiper delay.

The system turns off when the button is returned to the middle position.

 : For continuous rear window wipes.

 : To set a delay between wipes.

 : Push the windshield wiper lever forward to spray washer fluid on the rear window. The lever returns to its starting position when released.

See *Windshield Wiper/Washer* on page 5-3 and *Rear Window Wiper/Washer* on page 5-4.

## Climate Controls

The vehicle's heating, cooling, defrosting, and ventilation can be controlled with these systems.

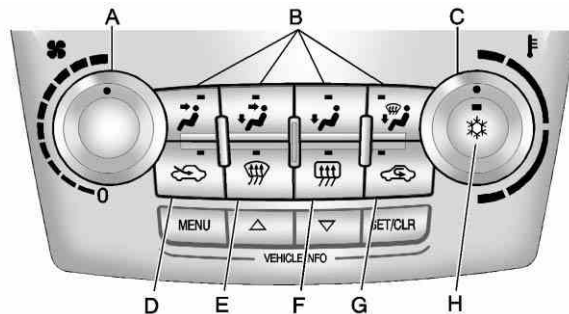

### Climate Control System

- |                               |                         |
|-------------------------------|-------------------------|
| A. Fan Control                | E. Defrost              |
| B. Air Delivery Mode Controls | F. Rear Window Defogger |
| C. Temperature Control        | G. Recirculation        |
| D. Outside Air                | H. Air Conditioning     |

### Automatic Climate Control System

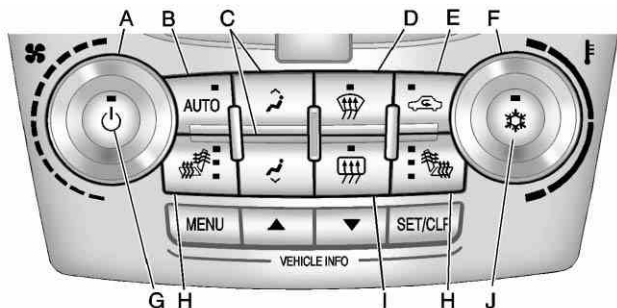

- A. Fan Control
- B. AUTO (Automatic Operation)
- C. Air Delivery Mode Controls
- D. Defrost
- E. Recirculation
- F. Temperature Control
- G. Power

- H. Driver and Passenger Heated Seats
- I. Rear Window Defogger
- J. Air Conditioning

See *Climate Control Systems on page 8-1* (If Equipped) or *Automatic Climate Control System on page 8-3* (If Equipped).

### Parking Brake

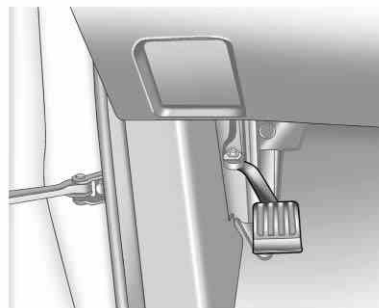

To set the parking brake, hold the regular brake pedal down, then push the parking brake pedal down.

If the ignition is on, the brake system warning light will come on. See *Brake System Warning Light on page 5-15*.

To release the parking brake, hold the regular brake pedal down, then push down momentarily on the parking brake pedal until you feel the pedal release. Slowly pull your foot up off the park brake pedal.

See *Parking Brake* on page 9-38.

## Transmission

### Electronic Range Select (ERS) Mode

ERS or manual mode allows for the selection of the range of gear positions. Use this mode when driving down hill or towing a trailer to limit the top gear and vehicle speed.

To use this feature:

1. Move the shift lever to M (Manual Mode).
2. Press the plus/minus button on the shift lever, to increase or decrease the gear range available.

See *Manual Mode* on page 9-35 for more information.

### Fuel Economy Mode

Vehicles with a 2.4L engine have a Fuel Economy Mode. When engaged, fuel economy mode can improve the vehicle's fuel economy.

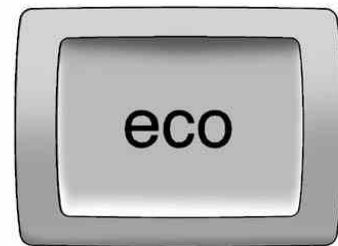

Press the “eco” (economy) button by the shift lever to turn this feature on or off. The “eco” light in the instrument cluster will come on when engaged, and a Driver Information Center (DIC) message “ECO MODE ON” displays. See *Fuel Economy Mode* on page 9-36.

## Vehicle Features

### Radio(s)

**VOL/** : Press to turn the system on and off. Turn to increase or decrease the volume.

**RADIO/BAND:** Press to choose between FM, AM, or XM™, if equipped.

**TUNE** /|l: Turn to select radio stations.

Press to show play or pause track.

**SEEK** : Press to seek the previous station or track.

**SEEK** : Press to seek the next station or track.

 **BACK** or **BACK**  (**depending on system**): Press to exit or move backwards in a menu.

**Buttons 1 - 6:** Press to save and select favorite stations

For more information about these and other radio features, see *Operation* on page 7-7.

### Storing a Favorite Station

Stations from all bands can be stored in the favorite lists in any order. Up to six stations can be stored in each favorite page and the number of available favorite pages can be set.

To store the station to a position in the list, press the corresponding numeric button 1-6 until the station can be heard again.

For more information, see “Storing a Station as a Favorite” in *AM-FM Radio* on page 7-11.

### Setting the Clock

The vehicle has a digital and an analog clock.

For detailed instructions on setting either clock, see *Clock (With Date Display)* on page 5-5 or *Clock (Without Date Display)* on page 5-6.

### Turning the Digital Clock On or Off

1. Press the CONFIG button.
2. Select Time and Date Settings.
3. Select Clock Displayed.
4. Press the MENU/SEL button to turn the clock on or off.

### Setting the Time and Date

1. Press the CONFIG button.
2. Select Time and Date Settings.
3. Select Set Time or Set Date.
4. Turn the MENU/SEL knob to adjust the highlighted value.
5. Press the MENU/SEL knob to select the next value.
6. To save the time or date and return to the Time and Date Settings menu, press the BACK button at any time or press the MENU/SEL knob after adjusting the minutes or year.



### Setting the 12/24 Hour Format

1. Press the CONFIG button.
2. Select Time and Date Settings.
3. Highlight 12/24 Hour Format.
4. Press the MENU/SEL button to select the 12 hour or 24 hour display format.

### Setting the Month & Day Format

1. Press the CONFIG button.
2. Select Time and Date Settings.
3. Highlight Month & Day Format.
4. Press the MENU/SEL knob to select MM/DD (month/day) or DD/MM (day/month).

### Setting the Auto Time Adjust (If Equipped)

1. Press the CONFIG button.
2. Select Time and Date Settings.
3. Highlight Auto Time Adjust.
4. Press the MENU/SEL knob to turn Auto Time Adjust on or off.

## Satellite Radio

Vehicles with an XM™ Satellite Radio tuner and a valid XM Satellite Radio subscription can receive XM programming.

### XM Satellite Radio Service

XM is a satellite radio service based in the 48 contiguous United States and 10 Canadian provinces. XM Satellite Radio has a wide variety of programming and commercial-free music, coast to coast, and in digital-quality sound. A fee is required to receive the XM service.

For more information refer to:

- [www.xmradio.com](http://www.xmradio.com) or call 1-800-929-2100 (U.S.).
- [www.xmradio.ca](http://www.xmradio.ca) or call 1-877-438-9677 (Canada).

For more information, see *Satellite Radio* on page 7-14.

## Portable Audio Devices

Some vehicles have a 3.5 mm (1/8 in) auxiliary input and a USB port located in the center console. External devices such as iPods®, laptop computers, MP3 players, CD changers, and USB storage devices may be connected, depending on the audio system.

For more information, see *Auxiliary Devices (Radio with CD)* on page 7-28 or *Auxiliary Devices (Radio with CD/DVD/MEM)* on page 7-31.

## Bluetooth®

The Bluetooth system allows users with a Bluetooth-enabled cell phone to make and receive hands-free calls using the vehicle audio system, microphone, and controls.

The Bluetooth-enabled cell phone must be paired with the in-vehicle Bluetooth system before it can be used in the vehicle. Not all phones will support all functions.

See *Bluetooth (Overview)* on page 7-45 or *Bluetooth (Infotainment Controls)* on page 7-46 or *Bluetooth (Voice Recognition)* on page 7-51.



### Steering Wheel Controls



Some audio steering wheel controls can be adjusted at the steering wheel.

 : Press to interact with the available Bluetooth or OnStar systems.

 : Press to silence the vehicle speakers only. Press again to turn the sound on. For vehicles with OnStar or Bluetooth systems, press to reject an incoming call, or end a current call.

 **SRC**  : Press to select an audio source.

Toggle up or down to select the next or previous favorite radio station, CD, or MP3 track.

**+**  **-**: Press + to increase the volume; press - to decrease the volume.

For more information, see *Steering Wheel Controls* on page 5-2.

### Cruise Control

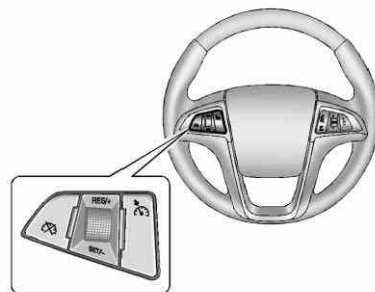

 : Press to turn the cruise control system on and off.

 : Press to disengage cruise control without erasing the set speed from memory.

**RES/+**: Move the thumbwheel up to make the vehicle resume to a previously set speed or to accelerate.

**SET/-** : Move the thumbwheel down toward SET/- to set a speed and activate cruise control, or to make the vehicle decelerate.

See *Cruise Control* on page 9-42.

## Navigation System

If the vehicle has a navigation system, there is a separate Navigation System Manual that includes information on the radio, audio players, and navigation system.

The navigation system provides detailed maps of most major freeways and roads. After a destination has been set, the system provides turn-by-turn instructions for reaching the destination. In addition, the system can help locate a variety of points of interest (POIs), such as banks, airports, restaurants, and more.

See the navigation system manual for more information.

## Driver Information Center (DIC)

The DIC display is located in the center of the instrument panel cluster. It shows the status of many vehicle systems.

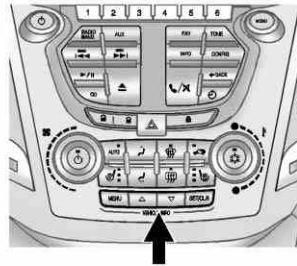

The DIC buttons are located below the climate control system.

**MENU**: Press this button to get to the Trip/Fuel Menu and the Vehicle Information Menu.

$\triangle$   $\nabla$  : Use these buttons to scroll through the items in each menu. A small marker will move along the page as you scroll through the items. This shows where each page is in the menu.

**SET/CLR**: Use this button to set or clear the menu item when it is displayed.

For more information, see *Driver Information Center (DIC)* on page 5-20.

## Vehicle Personalization

Some vehicle features can be programmed by using the audio system controls. These features include:

- Climate and Air Quality
- Comfort and Convenience
- Collision/Detection Systems
- Language
- Lighting

- Power Door Locks
- Remote Lock/Unlock/Start
- Return to Factory Settings

See *Vehicle Personalization on page 5-30*.

### Rear Vision Camera (RVC)

If available, the rear vision camera displays a view of the area behind the vehicle when the vehicle is shifted into R (Reverse). The display will appear on either the inside rearview mirror or navigation screen, if equipped.

To clean the camera lens, located above the license plate, rinse it with water and wipe it with a soft cloth.

See *Rear Vision Camera (RVC) on page 9-47*.

### Ultrasonic Parking Assist

If available, Ultrasonic Rear Parking Assist (URPA) uses sensors on the rear bumper to detect objects while parking the vehicle. URPA comes on automatically when the shift lever is moved into R (Reverse) and operates at speeds less than 8 km/h (5 mph). URPA uses audio beeps to provide distance and system information.

Keep the sensors on the vehicle's rear bumper clean to ensure proper operation.

The URPA system can be turned on and off using the infotainment system controls. See *Vehicle Personalization on page 5-30* for more information.

See *Ultrasonic Parking Assist on page 9-45* for more information.

### Roof Rack System

The roof rack cross rails can be locked in four positions along the roof rack side rails. Lift the lever to release and move the cross rail. Push the lever down to completely engage into the side rail holes. Slide the cross rails back and forth until the lock pins engage in the holes and a click is heard.

When the roof rack is not in use, lock one cross rail at the furthest forward position and lock the other cross rail at the furthest rearward position to reduce wind noise. See *Roof Rack System on page 4-2*.

## Power Outlets

The accessory power outlets can be used to connect electrical equipment, such as a cell phone or MP3 player.

There are four accessory power outlets in the following locations: below the CD slot, inside the center console storage, on the rear of the center console storage, and in the rear cargo compartment.



To use the outlets, remove the cover and close when not in use.

See *Power Outlets on page 5-6*.

## Performance and Maintenance

### Traction Control System (TCS)





The traction control system limits wheel spin. The system is on when the vehicle is started.

- To turn off traction control, press and release  located on the console.  illuminates and the appropriate DIC message displays. See *Vehicle Messages on page 5-24*.
- Press and release  again to turn traction control back on.

For more information, see *Traction Control System (TCS) on page 9-39*.

### StabiliTrak<sup>®</sup> System

The StabiliTrak system assists with directional control of the vehicle in difficult driving conditions. The system is on when the vehicle is started.

- To turn off both Traction Control and StabiliTrak, press and hold  until  and  illuminate and the appropriate DIC message displays. See *Vehicle Messages on page 5-24*.
- Press  again to turn on both systems.

For more information, see *StabiliTrak<sup>®</sup> System on page 9-41*.

## Tire Pressure Monitor

This vehicle may have a Tire Pressure Monitor System (TPMS).



The TPMS warning light alerts you to a significant loss in pressure of one of the vehicle's tires. If the warning light comes on, stop as soon as possible and inflate the tires to the recommended pressure shown on the Tire and Loading Information label. See *Vehicle Load Limits* on page 9-21. The warning light will remain on until the tire pressure is corrected.

During cooler conditions, the low tire pressure warning light may appear when the vehicle is first started and then turn off. This may be an early

indicator that the tire pressures are getting low and the tires need to be inflated to the proper pressure.

The TPMS does not replace normal monthly tire maintenance. It is the driver's responsibility to maintain correct tire pressures.

See *Tire Pressure Monitor System* on page 10-52.

## Engine Oil Life System

The engine oil life system calculates engine oil life based on vehicle use and displays the CHANGE ENGINE OIL SOON message when it is time to change the engine oil and filter. The oil life system should be reset to 100% only following an oil change.

### Resetting the Oil Life System

1. Turn the ignition to ON/RUN, with the engine off.
2. Press the DIC MENU button to display the Vehicle Information menu.

3. Press either the up or down arrows to view REMAINING OIL LIFE.

4. Press the SET/CLR button until 100% is displayed.

5. Turn the key to LOCK/OFF.

Or:

1. Turn the ignition to ON/RUN with the engine off.
2. Fully press and release the accelerator pedal three times within five seconds.

See *Engine Oil Life System* on page 10-14.

## Fuel E85 (85% Ethanol)

Vehicles that have a FlexFuel badge and a yellow fuel cap can use either unleaded gasoline or ethanol fuel containing up to 85% ethanol (E85). See *Fuel E85 (85% Ethanol)* on page 9-54. For all other vehicles, use only the unleaded gasoline described under *Recommended Fuel* on page 9-52.

## Driving for Better Fuel Economy

Driving habits can affect fuel mileage. Here are some driving tips to get the best fuel economy possible.

- Avoid fast starts and accelerate smoothly.
- Brake gradually and avoid abrupt stops.
- Avoid idling the engine for long periods of time.
- When road and weather conditions are appropriate, use cruise control.
- Always follow posted speed limits or drive more slowly when conditions require.
- Keep vehicle tires properly inflated.
- Combine several trips into a single trip.

- Replace the vehicle's tires with the same TPC Spec number molded into the tire's sidewall near the size.
- Follow recommended scheduled maintenance.

## Roadside Assistance Program

U.S.: **1-800-GMC-8782**  
(1-800-462-8782)

TTY Users (U.S.): **1-888-889-2438**

Canada: **1-800-268-6800**

Mexico: **01-800-466-0801**

As the owner of a new GMC, you are automatically enrolled in the Roadside Assistance program.

See *Roadside Assistance Program (U.S. and Canada)* on page 13-7 or *Roadside Assistance Program (Mexico)* on page 13-9 for more information.

## Roadside Assistance and OnStar (U.S. and Canada)

If you have an active OnStar subscription, press the  button and the current GPS location will be sent to an OnStar advisor who will assess your problem, contact Roadside Assistance, and relay your exact location to get the help you need.

## Online Owner Center (U.S. and Canada)

The Online Owner Center is a complimentary service that includes online service reminders, vehicle maintenance tips, online owner manual, special privileges, and more.

Sign up today at:  
**www.gmcownercenter.com** (U.S.)  
or **www.gm.ca** (Canada).

## OnStar®





For vehicles with an active OnStar subscription, OnStar uses several innovative technologies and live Advisors to provide a wide range of safety, security, navigation, diagnostics, and calling services.

### Automatic Crash Response

In a crash, built-in sensors can automatically alert an OnStar Advisor who is immediately connected to the vehicle to see if you need help.

### How OnStar Service Works

 : Push this blue button to connect to a specially trained OnStar Advisor to verify your account information and to answer questions.

 : Push this red emergency button to get priority help from specially trained OnStar Emergency Advisors.

 : Push this button for hands-free, voice-activated calling and to give voice commands for Hands-Free Calling and Turn-by-Turn Navigation.

Automatic Crash Response, Emergency Services, Crisis Assist, Stolen Vehicle Assistance, Vehicle Diagnostics, Remote Door Unlock, Roadside Assistance, Turn-by-Turn Navigation, and Hands-Free Calling are available on most vehicles. Not all OnStar services are available on all vehicles. For more information, see the OnStar Owner's Guide; visit [www.onstar.com](http://www.onstar.com) (U.S.) or [www.onstar.ca](http://www.onstar.ca) (Canada); contact OnStar at 1-888-4-ONSTAR (1-888-466-7827) or TTY 1-877-248-2080; or push the  button to speak with an OnStar Advisor 24 hours a day, 7 days a week.

For a full description of OnStar services and system limitations, see the OnStar Owner's Guide in the glove box.

OnStar service is subject to the OnStar Terms and Conditions included in the OnStar Glove Box Kit.

OnStar service requires wireless communication networks and the Global Positioning System (GPS) satellite network. Not all OnStar services are available everywhere or on all vehicles at all times.

OnStar service can't work unless the vehicle is in a place where OnStar has an agreement with a wireless service provider for service in that area, and the wireless service provider has coverage, network capacity, reception, and technology compatible with OnStar service. Service involving location information about the vehicle can't work unless GPS signals are available, unobstructed, and compatible with the OnStar



hardware. The vehicle has to have a working electrical system and adequate battery power for the OnStar equipment to operate. OnStar service may not work if the OnStar equipment isn't properly installed or you haven't maintained it and the vehicle is in good working order and in compliance with all government regulations. If you try to add, connect, or modify any equipment or software in the vehicle, OnStar service may not work. Other problems OnStar can't control may prevent service to you, such as hills, tall buildings, tunnels, weather, electrical system design and architecture of the vehicle, damage to important parts of the vehicle in a crash, or wireless phone network congestion or jamming.

See *Radio Frequency Statement on page 13-18* for information regarding Part 15 of the Federal Communications Commission (FCC) rules and Industry Canada Standards RSS-210/220/310.



### **OnStar Steering Wheel Controls**

This vehicle may have a Talk/Mute button that can be used to interact with OnStar Hands-Free calling. See *Steering Wheel Controls on page 5-2* for more information.

On some vehicles, the Talk button can be used to dial numbers into voice mail systems, or to dial phone extensions. See the OnStar Owner's Guide for more information.

### **Your Responsibility**

Increase the volume of the radio if the OnStar Advisor cannot be heard.

If the light next to the OnStar buttons is red, the system may not be functioning properly. Push the  button and request a vehicle diagnostic check. If the light appears clear (no light appears), your OnStar subscription has expired and all services have been deactivated. Push the  button to confirm that the OnStar equipment is active.



# Keys, Doors and Windows

## Keys and Locks

|  |     |
|--|-----|
| Keys .....   | 2-2 |
| Remote Keyless Entry (RKE)<br>System .....           | 2-3 |
| Remote Keyless Entry (RKE)<br>System Operation ..... | 2-3 |
| Remote Vehicle Start .....                           | 2-5 |
| Door Locks .....                                     | 2-6 |
| Power Door Locks .....                               | 2-7 |
| Safety Locks .....                                   | 2-8 |

## Doors

|                         |     |
|-------------------------|-----|
| Liftgate (Manual) ..... | 2-8 |
| Liftgate (Power) .....  | 2-9 |

## Vehicle Security

|                               |      |
|-------------------------------|------|
| Vehicle Security .....        | 2-12 |
| Anti-Theft Alarm System ..... | 2-12 |
| Immobilizer .....             | 2-13 |
| Immobilizer Operation .....   | 2-13 |

## Exterior Mirrors

|                         |      |
|-------------------------|------|
| Convex Mirrors .....    | 2-14 |
| Power Mirrors .....     | 2-14 |
| Heated Mirrors .....    | 2-15 |
| Park Tilt Mirrors ..... | 2-15 |

## Interior Mirrors

|  |      |
|--|------|
| Automatic Dimming Rearview<br>Mirror ..... | 2-15 |
|--|------|

## Windows

|                     |      |
|---------------------|------|
| Windows .....       | 2-16 |
| Power Windows ..... | 2-17 |
| Sun Visors .....    | 2-18 |

## Roof

|               |      |
|---------------|------|
| Sunroof ..... | 2-18 |
|---------------|------|

### Keys and Locks

#### Keys

##### WARNING

Leaving children in a vehicle with the ignition key is dangerous for many reasons. Children or others could be badly injured or even killed. They could operate the power windows or other controls or even make the vehicle move. The windows will function with the keys in the ignition and children could be seriously injured or killed if caught in the path of a closing window. Do not leave the keys in a vehicle with children.



The key that is part of the Remote Keyless Entry (RKE) transmitter can be used for the ignition and all locks.



Press the button on the RKE transmitter to extend the key. Press the button and the key blade to retract the key.

See your dealer if a new key is needed.

**Notice:** If the keys get locked in the vehicle, it may have to be damaged to get them out. Always carry a spare key.

If you are locked out of the vehicle, see *Roadside Assistance Program (U.S. and Canada)* on page 13-7 or *Roadside Assistance Program (Mexico)* on page 13-9.

## Remote Keyless Entry (RKE) System

See *Radio Frequency Statement on page 13-18* for information regarding Part 15 of the Federal Communications Commission (FCC) rules and Industry Canada Standards RSS-210/220/310.

If there is a decrease in the RKE operating range:

- Check the distance. The transmitter may be too far from the vehicle.
- Check the location. Other vehicles or objects may be blocking the signal.
- Check the transmitter's battery. See "Battery Replacement" later in this section.
- If the transmitter is still not working correctly, see your dealer or a qualified technician for service.

## Remote Keyless Entry (RKE) System Operation

The Remote Keyless Entry (RKE) transmitter will work up to 60 m (195 ft) away from the vehicle.

There are other conditions which can affect the performance of the transmitter. See *Remote Keyless Entry (RKE) System on page 2-3*.



### RKE Without Remote Start Shown

The following may be available:

**🔒 (Lock):** Press to lock all doors. The turn signal indicators may flash and/or the horn may sound to

indicate locking. See "Remote Lock Feedback" under *Vehicle Personalization on page 5-30*. If a passenger door is open when **🔒** is pressed, all doors lock. If the driver door is open when **🔒** is pressed, all doors lock except the driver door. These settings can be modified. See "Unlocked Door Anti Lock Out" under *Vehicle Personalization on page 5-30*.

Pressing **🔒** may also arm the theft-deterrent system. See *Anti-Theft Alarm System on page 2-12*.



**🔓 (Unlock):** Press to unlock the driver door or all doors. See "Remote Door Unlock" under *Vehicle Personalization on page 5-30*. The turn signal indicators flash to indicate unlocking has occurred. For more information see "Remote Unlock Light Feedback" under *Vehicle Personalization on page 5-30*.

## 2-4 Keys, Doors and Windows



---



Pressing  may also disarm the theft-deterrent system. See *Anti-Theft Alarm System on page 2-12*.

### (Remote Liftgate Release):

First press , then press and hold  to unlock the liftgate. For vehicles with the power liftgate, press and hold  until the liftgate begins to move to open the liftgate.

### (Vehicle Locator/Panic

**Alarm):** Press and release one time to locate the vehicle. The exterior lamps flash and the horn chirps. Press and hold  for at least two seconds to sound the panic alarm. The horn sounds and the turn signals flash until  is pressed again or the key is placed in the ignition and turned to ON/RUN.

 (Remote Vehicle Start): For vehicles with this feature, first press  then press and hold  to start the engine from outside the vehicle using the RKE transmitter. See *Remote Vehicle Start on page 2-5* for additional information.

### Programming Transmitters to the Vehicle

Only RKE transmitters programmed to this vehicle will work. If a transmitter is lost or stolen, a replacement can be purchased and programmed through your dealer. When the replacement transmitter is programmed to this vehicle, all remaining transmitters must also be reprogrammed. Any lost or stolen transmitters will no longer work once the new transmitter is programmed.

### Battery Replacement

Replace the battery if the REPLACE BATTERY IN REMOTE KEY message displays in the DIC. See “Replace Battery in Remote Key” under *Key and Lock Messages on page 5-27*.

The battery is not rechargeable. To replace the battery:

1. Push the button on the transmitter to extend the key.
2. Remove the battery cover by prying with a finger.
3. Remove the battery by pushing on the battery and sliding it toward the keyblade.
4. Insert the new battery, positive side facing up. Push the battery down until it is held in place. Replace with a CR2032 or equivalent battery.
5. Snap the battery cover back on to the transmitter.

## Remote Vehicle Start

The vehicle may have this feature that allows you to start the engine from outside the vehicle.

### (Remote Vehicle Start):

This button will be on the RKE transmitter if the vehicle has remote start.



Vehicles with an automatic climate control system will default to a heating or cooling mode depending on the outside temperature during a remote start. Once the key is turned to ON/RUN, the system will turn on at the setting the vehicle was last set to. If the vehicle has heated seats, they may come on during a remote start. See *Heated Front Seats* on page 3-8 for more information.

Laws in some local communities may restrict the use of remote starters. For example, some laws require a person using remote start to have the vehicle in view. Check local regulations for any requirements.

There are other conditions which can affect the performance of the transmitter. See *Remote Keyless Entry (RKE) System* on page 2-3 for additional information.

### Starting the Engine Using Remote Start

To start the engine using the remote start feature:

1. Press  on the RKE transmitter.
2. Press and hold  for about two seconds. The turn signal lamps will briefly flash to confirm the vehicle has been started. The parking lamps will turn on and remain on as long as the engine is running. The vehicle's doors will be locked.
3. The key must be inserted and turned to ON/RUN before driving.

The engine will shut off after 10 minutes unless a time extension is done or the key is inserted and turned to ON/RUN.

### Extending Engine Run Time

For a 10-minute extension, repeat Steps 1 and 2 while the engine is still running. The remote start can be extended once.

When the remote start is extended, the second 10 minutes will start immediately.

For example, if the engine has been running for 5 minutes, and 10 minutes are added, the engine will run for a total of 15 minutes.

A maximum of two remote starts or remote start attempts are allowed between ignition cycles.

The vehicle's ignition switch must be turned to ON/RUN and then back to LOCK/OFF using the key, before the remote start procedure can be used again.

## 2-6 Keys, Doors and Windows

### Shutting the Engine Off After a Remote Start

To shut off the engine:

- Press **Q** until the parking lamps turn off.
- Turn on the hazard warning flashers.
- Insert the key and turn it to ON/RUN and then back to LOCK/OFF.

### Conditions in Which Remote Start Will Not Work

The remote vehicle start feature will not operate if:

- The key is in the ignition.
- The hood or doors are not closed.
- The hazard warning flashers are on.

- There is an emission control system malfunction.
- The engine coolant temperature is too high.
- The oil pressure is low.
- Two remote vehicle starts have already been used.
- The vehicle is not in P (Park).

### Remote Start Ready

If the vehicle does not have the remote vehicle start feature, it may have the remote start ready feature. This feature allows your dealer to add the manufacturer's remote vehicle start feature. See your dealer to add the manufacturer's remote vehicle start feature to the vehicle.

## Door Locks



Unlocked doors can be dangerous.

- Passengers, especially children, can easily open the doors and fall out of a moving vehicle. The chance of being thrown out of the vehicle in a crash is increased if the doors are not locked. So, all passengers should wear safety belts properly and the doors should be locked whenever the vehicle is driven.
- Young children who get into unlocked vehicles may be unable to get out. A child can be overcome by extreme heat and can suffer permanent injuries or even death from heat stroke. Always lock the vehicle whenever leaving it.

(Continued)



**WARNING (Continued)**

- Outsiders can easily enter through an unlocked door when slowing or stopping the vehicle. Lock the doors to help prevent this from happening.

To lock or unlock a door from the outside of the vehicle, use the Remote Keyless Entry (RKE) transmitter. Pull the handle once from the inside to unlock the door, and a second time to open it.

**Power Door Locks**

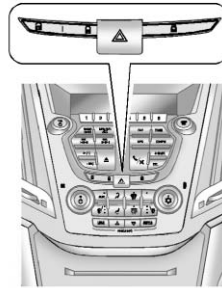

The power door lock switches are on the instrument panel.

**U (Unlock):** Press to unlock the doors.

**L (Lock):** Press to lock the doors.

When locking the doors with the power lock switch and a door or the liftgate is open, the doors will lock five seconds after the last door is closed. Three chimes sound to signal that the delayed locking feature is in use.

Pressing the power lock switch twice or **L** on the RKE transmitter twice will override the delayed locking feature and immediately lock all the doors.

This feature will not operate if the key is in the ignition.

This feature can be programmed. See “Delayed Door Lock” under *Vehicle Personalization* on page 5-30.

### Safety Locks

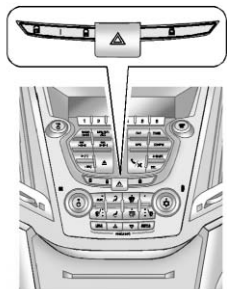

Rear door safety locks prevent passengers from opening the rear doors from inside the vehicle.

Press  to activate the safety locks. When activated, the LED light in the switch changes to amber.

Pressing the button again deactivates the safety locks.

### Doors

#### Liftgate (Manual)

##### WARNING

Exhaust gases can enter the vehicle if it is driven with the liftgate, trunk/hatch open, or with any objects that pass through the seal between the body and the trunk/hatch or liftgate. Engine exhaust contains Carbon Monoxide (CO) which cannot be seen or smelled. It can cause unconsciousness and even death.

If the vehicle must be driven with the liftgate, or trunk/hatch open:

- Close all of the windows.
- Fully open the air outlets on or under the instrument panel.

(Continued)

##### WARNING (Continued)

- Adjust the Climate Control system to a setting that brings in only outside air and set the fan speed to the highest setting. See Climate Control System in the Index.

For more information about carbon monoxide, see *Engine Exhaust* on page 9-32.

**Notice:** If you open the liftgate without checking for overhead obstructions such as a garage door, you could damage the liftgate or the liftgate glass. Always check to make sure the area above and behind the liftgate is clear before opening it.

Unlock the vehicle before opening the liftgate.

Press the touchpad located in the handle of the liftgate, above the license plate, and lift up to open.

Do not press the touchpad while closing the liftgate. This will cause the liftgate to be unlatched.

Always close the liftgate before driving.

## Liftgate (Power)

### Power Liftgate Operation

 **WARNING**

Exhaust gases can enter the vehicle if it is driven with the liftgate, trunk/hatch open, or with any objects that pass through the seal between the body and the trunk/hatch or liftgate. Engine exhaust contains carbon monoxide (CO) which cannot be seen or smelled. It can cause unconsciousness and even death.

(Continued)

**WARNING (Continued)**

If the vehicle must be driven with the liftgate, or trunk/hatch open:

- Close all of the windows.
- Fully open the air outlets on or under the instrument panel.
- Adjust the Climate Control system to a setting that brings in only outside air and set the fan speed to the highest setting. See Climate Control Systems in the Index.
- If the vehicle is equipped with a power liftgate, disable the power liftgate function.

For more information about carbon monoxide, see *Engine Exhaust* on page 9-32.

On vehicles with a power liftgate, the switch is on the overhead console. The vehicle must be in P (Park) to use the power feature. The taillamps flash when the power liftgate moves.

 **WARNING**

You or others could be injured if caught in the path of the power liftgate. Make sure there is no one in the way of the liftgate as it is opening and closing.

**Notice:** If you open the liftgate without checking for overhead obstructions such as a garage door, you could damage the liftgate or the liftgate glass. Always check to make sure the area above and behind the liftgate is clear before opening it.

The power liftgate has three modes of operation. Mode selection is controlled by the interior mode switch.

## 2-10 Keys, Doors and Windows

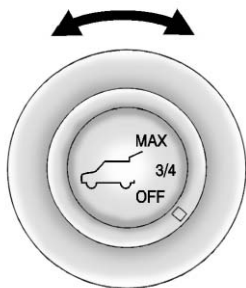

Choose the power liftgate mode by turning the dial on the switch until the indicator lines up with the desired position. The vehicle must be in P (Park).

The three modes are:

**MAX:** The liftgate power opens to the full open height.



**3/4:** The liftgate power opens to a reduced open height that can be set by the vehicle operator. Use this setting to prevent the liftgate from opening into overhead obstructions

such as a garage door or roof mounted cargo during power operation. The liftgate can still be fully opened manually.

**OFF:** The liftgate only operates manually in this position.

Manual operation of a liftgate that also has power operation requires more effort than a standard manual liftgate.

In either the MAX or the 3/4 mode, the liftgate can be power opened and closed by:

- First pressing  and then pressing and holding  on the Remote Keyless Entry (RKE) transmitter until the liftgate starts moving. See *Remote Keyless Entry (RKE) System Operation* on page 2-3.
- Pressing the power liftgate button in the center of the mode switch on the overhead console, with the driver door unlocked.

- Pressing the touchpad switch on the liftgate outside handle, with all doors unlocked, to open the liftgate.

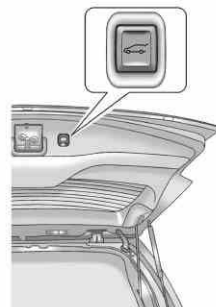

Press and release  on the liftgate adjacent to the latch to close the liftgate.

Pressing any button, or the touchpad switch, while the liftgate is moving stops it. Pressing the button or RKE switch again reverses the direction. The touchpad switch will stop the liftgate from moving.

There is a minimum distance that the power liftgate must already be open for the system to hold it open. If movement is stopped below that minimum, the liftgate closes.

Do not force the liftgate open or closed during a power cycle.

The power liftgate may be temporarily disabled under extreme temperatures or low battery conditions. If this occurs, the liftgate can still be operated manually.

If you shift the transmission out of P (Park) while the power function is in progress, the liftgate power function will continue to completion. If you shift the transmission out of P (Park) and accelerate before the power liftgate latch is closed, the liftgate may reverse to the open position. Cargo could fall out of the vehicle. Always make sure the power liftgate is closed and latched before you drive away.

If you power open the liftgate and the liftgate support struts have lost pressure, the turn signals flash and a chime sounds. The liftgate stays open temporarily, then slowly closes. See your dealer for service before using the liftgate.

### **Obstacle Detection Features**

If the liftgate encounters an obstacle during a power open or close cycle, a warning chime will sound and the liftgate will automatically reverse direction to the full closed or open position. After removing the obstruction, the power liftgate operation can be used again.

If the liftgate encounters multiple obstacles on the same power cycle, the power function will deactivate. The MANUALLY CLOSE POWER LIFTGATE warning message in the Driver Information Center (DIC) will display. After removing the obstructions, the liftgate will resume normal power operation.

Pinch sensors are located on the side edges of the liftgate. If an object is caught between the liftgate and the body and presses against this sensor, the liftgate will reverse direction and open fully. The liftgate will remain open until it is activated again or closed manually.

### **Power Liftgate 3/4 Mode**

To program the liftgate opening height:

1. Turn the liftgate switch to either the MAX, or the 3/4 mode position and power open the liftgate.
2. Stop the liftgate movement at the desired height by pressing any liftgate switch. Manually adjust the liftgate position if required.
3. Press and hold the button on the liftgate adjacent to the latch until the turn signals flash and a beep sounds to indicate that the new setting is recorded.

## 2-12 Keys, Doors and Windows

---

When power opened with the 3/4 mode selected, the liftgate stops at the new set position.

If you do not hear the audible and visual feedback when setting the intermediate stop position, you are attempting to set the height below the 3/4 open height minimum (approximately 1.5 m or 5 ft). The liftgate cannot be set below that minimum and the new setting will not be recorded.

### Manual Operation of Power Liftgate

To change the liftgate to manual operation, turn the mode switch to the OFF position.

With the power liftgate disabled and all of the doors unlocked, the liftgate can be manually opened and closed. Manual operation of a liftgate that also has power operation requires more effort than a standard manual liftgate.

To open the liftgate, press the touchpad on the handle on the outside of the liftgate, and lift the gate open. To close the liftgate, use the pull cup to lower the liftgate and close. With the power liftgate disabled, the liftgate electric latch will still power latch once contact is made with the striker. Always close the liftgate before driving.

If the RKE button is pressed while power operation is disabled, the turn signals flash and the liftgate will not move.

The liftgate has an electric latch. If the battery is disconnected or has low voltage, the liftgate will not open. The liftgate will resume operation when the battery is reconnected and charged.

## Vehicle Security

This vehicle has theft-deterrent features; however, they do not make it impossible to steal.

### Anti-Theft Alarm System

This vehicle has an anti-theft alarm system.

#### Arming the System

To arm the system, do one of the following:

- Press  on the RKE transmitter.
- Lock the vehicle using the key in the driver door.

The alarm automatically arms after about 30 seconds. The security light, located on the instrument panel, flashes.

Press  on the RKE transmitter to open the liftgate without setting off the alarm. The system rearms when the liftgate is closed.

### Disarming the System

To disarm the system, do one of the following:

- Press  on the RKE transmitter.
- Turn the ignition to ON/RUN.
- Allow the alarm to time out after about 30 seconds and reset itself.

The alarm automatically disarms.

If the system is armed and any door is unlocked without pressing  on the RKE transmitter, the alarm sounds.

### How to Detect a Tamper Condition

If  is pressed and the horn sounds, an attempted break-in has occurred while the system was armed.

If the alarm has been activated, the THEFT ATTEMPTED message will appear on the DIC. See *Key and Lock Messages on page 5-27* for additional information.

### Immobilizer

See *Radio Frequency Statement on page 13-18* for information regarding Part 15 of the Federal Communications Commission (FCC) rules and Industry Canada Standards RSS-210/220/310.

### Immobilizer Operation

This vehicle has a passive theft-deterrent system.

The system does not have to be manually armed or disarmed.

The vehicle is automatically immobilized when the key is removed from the ignition.

The system is automatically disarmed when the vehicle is started with the correct key. The key uses a transponder that matches an immobilizer control unit in the vehicle and automatically disarms the system. Only an authorized key starts the vehicle. The vehicle may not start if the key is damaged.



The security light, located in the instrument panel cluster, comes on if there is a problem with arming or disarming the theft-deterrent system.

When trying to start the vehicle, the security light comes on briefly when the ignition is turned on.

## 2-14 Keys, Doors and Windows

If the engine does not start and the security light stays on, there is a problem with the system. Turn the ignition off and try again.

If the engine still does not start, and the key appears to be undamaged or the light continues to stay on, try another ignition key. If the engine does not start with the other key, the vehicle needs service. If the vehicle does start, the first key may be damaged. See your dealer who can service the theft-deterrent system and have a new key made.

Do not leave the key or device that disarms or deactivates the theft-deterrent system in the vehicle.

### Exterior Mirrors

#### Convex Mirrors

 **WARNING**

A convex mirror can make things, like other vehicles, look farther away than they really are. If you cut too sharply into the right lane, you could hit a vehicle on the right. Check the inside mirror or glance over your shoulder before changing lanes.

The passenger side mirror is convex shaped. A convex mirror's surface is curved so more can be seen from the driver seat.

### Power Mirrors

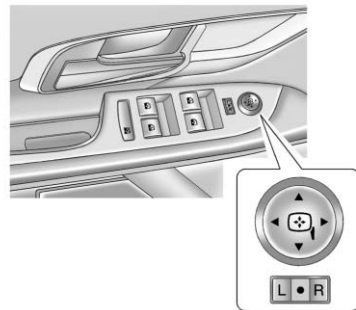

Controls for the outside power mirrors are on the driver door.

To adjust the mirrors:

1. Move the selector switch to L (left) or R (right) to choose the driver or passenger mirror.
2. Press the arrows on the control pad to move each mirror in the desired direction.
3. Return the selector switch to the middle position.



## Heated Mirrors

For vehicles with heated mirrors:

The heated outside rearview mirrors turn on when the rear window defogger is on and help to clear fog or frost from the surface of the mirrors.

 **(Rear Window Defogger):** This button is on the climate control panel.

See “Rear Window Defogger” under *Automatic Climate Control System* on page 8-3 for more information.

## Park Tilt Mirrors

If the vehicle is equipped with memory mirrors, there is an option to have the mirrors tilt down, when in R (Reverse), to more easily see the ground near the vehicle.

When the vehicle is shifted to R (Reverse), both the driver and passenger mirrors will tilt downward. They will return to their previous position when the vehicle is shifted out of R (Reverse), the ignition is turned to OFF, or the vehicle is left in R (Reverse) for an extended period of time.

This feature can be turned on or off. See *Vehicle Personalization* on page 5-30.

## Interior Mirrors

### Automatic Dimming Rearview Mirror

The vehicle may have an automatic dimming inside rearview mirror. Automatic dimming reduces the glare from the headlamps of the vehicle behind you. The dimming feature comes on and the indicator light comes on each time the vehicle is started.

 : Press to turn automatic dimming on or off.

If the vehicle has a rear vision camera (RVC) the  button for turning the automatic dimming feature on or off will not be available. See *Rear Vision Camera (RVC)* on page 9-47 for more information.

## 2-16 Keys, Doors and Windows

Vehicles with OnStar® have three additional control buttons located at the bottom of the mirror. See your dealer for more information on the system and how to subscribe to OnStar. See the OnStar Owner's Guide for more information about the services OnStar provides.

### Cleaning the Mirror

Do not spray glass cleaner directly on the mirror. Use a soft towel dampened with water.

## Windows

### WARNING

Leaving children, helpless adults, or pets in a vehicle with the windows closed is dangerous. They can be overcome by the extreme heat and suffer permanent injuries or even death from heat stroke. Never leave a child, a helpless adult, or a pet alone in a vehicle, especially with the windows closed in warm or hot weather.



The vehicle aerodynamics are designed to improve fuel economy performance. This may result in a pulsing sound when either rear window is down and the front windows are up. To reduce the sound, open either a front window or the sunroof (if equipped).

## Power Windows

### **WARNING**

Leaving children in a vehicle with the keys is dangerous for many reasons. Children or others could be badly injured or even killed. They could operate the power windows or other controls or even make the vehicle move. The windows will function and they could be seriously injured or killed if caught in the path of a closing window. Do not leave keys in a vehicle with children.

When there are children in the rear seat use the window lockout button to prevent unintentional operation of the windows.

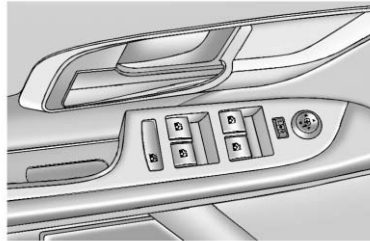

The power window controls are on each of the side doors.

The driver door also has switches that control the passenger and rear windows. The power windows work when the ignition is in ON/RUN or

ACC/ACCESSORY, or in Retained Accessory Power (RAP). See *Retained Accessory Power (RAP)* on page 9-30.

Press or pull on the switch to lower or raise the window.

### **Express Down Windows**

Windows that have the express-down feature allow the windows to be lowered without holding the switch. Press the window switch fully and release it to activate the express-down feature. The express mode can be canceled at any time by briefly pressing, or pulling the switch.

### Window Lockout

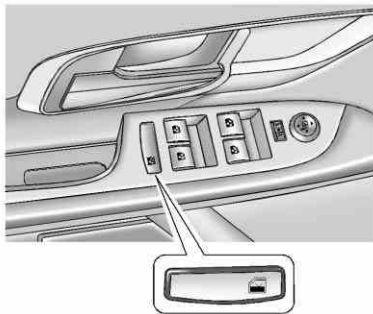

 **(Window Lockout):** The window lockout switch is on the driver door. This feature prevents the rear passenger windows from operating, except from the driver position. Press the switch to turn the lockout feature on or off. An indicator light shows the feature is on.

### Sun Visors

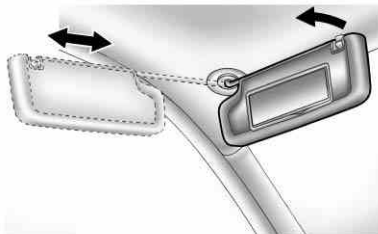

Pull the sun visor down to block glare. Detach the sun visor from the center mount to pivot to the side window, or to extend along the rod, if available.

### Roof

#### Sunroof

On vehicles with a sunroof, the switches used to operate it are on the headliner above the rearview mirror. The ignition must be in ON/RUN or ACC/ACCESSORY, or in Retained Accessory Power (RAP) to operate the sunroof. See *Ignition Positions* on page 9-27 and *Retained Accessory Power (RAP)* on page 9-30.

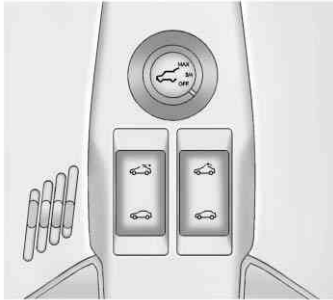

- Press and hold the front or rear of the driver side switch to open or close the sunroof. The sunshade automatically opens with the sunroof, but must be closed manually.
- Press and hold the rear of the passenger side switch to vent the sunroof. Press and hold the front of the switch to close.

### Express-open/Express-close

Press and release the front or rear of the driver side switch to express-open or express-close the sunroof.

### Anti-Pinch Feature

If an object is in the path of the sunroof when it is closing, the anti-pinch feature detects the object and stops the sunroof from closing at the point of the obstruction. The sunroof then returns to the full-open position.

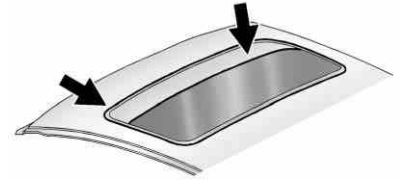

Dirt and debris may collect on the sunroof seal or in the track. This could cause an issue with sunroof operation, noise, or plugging the water drainage system. Periodically open the sunroof and remove any obstacles or loose debris. Wipe the sunroof seal and roof sealing area using a clean cloth, mild soap, and water. Do not remove grease from the sunroof.



## Seats and Restraints

### Head Restraints

Head Restraints ..... 3-2

### Front Seats

Seat Adjustment ..... 3-3  
 Power Seat Adjustment ..... 3-3  
 Lumbar Adjustment ..... 3-6  
 Reclining Seatbacks ..... 3-6  
 Heated Front Seats ..... 3-8

### Rear Seats

Rear Seats ..... 3-9

### Safety Belts

Safety Belts ..... 3-10  
 How to Wear Safety Belts Properly ..... 3-14  
 Lap-Shoulder Belt ..... 3-20

Safety Belt Use During Pregnancy ..... 3-24  
 Safety Belt Extender ..... 3-24  
 Safety System Check ..... 3-24  
 Safety Belt Care ..... 3-25  
 Replacing Safety Belt System Parts After a Crash ..... 3-25

### Airbag System

Airbag System ..... 3-26  
 Where Are the Airbags? .... 3-28  
 When Should an Airbag Inflate? ..... 3-29  
 What Makes an Airbag Inflate? ..... 3-31  
 How Does an Airbag Restrain? ..... 3-31  
 What Will You See After an Airbag Inflates? ..... 3-31  
 Passenger Sensing System ..... 3-33  
 Servicing the Airbag-Equipped Vehicle ..... 3-37

Adding Equipment to the Airbag-Equipped Vehicle ... 3-38  
 Airbag System Check ..... 3-39  
 Replacing Airbag System Parts After a Crash ..... 3-40

### Child Restraints

Older Children ..... 3-40  
 Infants and Young Children ..... 3-43  
 Child Restraint Systems .... 3-45  
 Where to Put the Restraint ... 3-47  
 Lower Anchors and Tethers for Children (LATCH System) ..... 3-49  
 Replacing LATCH System Parts After a Crash ..... 3-54  
 Securing Child Restraints (Rear Seat ) ..... 3-55  
 Securing Child Restraints (Front Passenger Seat) .... 3-57

## 3-2 Seats and Restraints

### Head Restraints

The vehicle's front and rear seats have head restraints in all outboard seating positions.

#### **WARNING**

With head restraints that are not installed and adjusted properly, there is a greater chance that occupants will suffer a neck/spinal injury in a crash. Do not drive until the head restraints for all occupants are installed and adjusted properly.



Adjust the head restraint so that the top of the restraint is at the same height as the top of the occupant's head. This position reduces the chance of a neck injury in a crash.

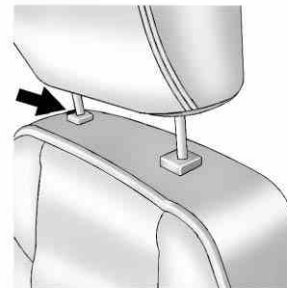

1. Pull the head restraint up to raise it. To lower the head restraint, press the release button, located on the head restraint post on the top of the seatback, while you push the head restraint down.
2. Push down on the head restraint after the button is released to make sure that it is locked in place.

The vehicle's rear seat head restraints are not adjustable.

The head restraints are not designed to be removed.



## Front Seats

### Seat Adjustment

#### WARNING

You can lose control of the vehicle if you try to adjust a manual driver seat while the vehicle is moving. The sudden movement could startle and confuse you, or make you push a pedal when you do not want to. Adjust the driver seat only when the vehicle is not moving.



To adjust a manual seat:

1. Pull the handle at the front of the seat cushion.
2. Move the seat forward or rearward to adjust the seat position.
3. Release the handle to stop the seat from moving.
4. Try to move the seat back and forth to be sure it is locked in place.

## Power Seat Adjustment

### Four-Way Power Driver Seat

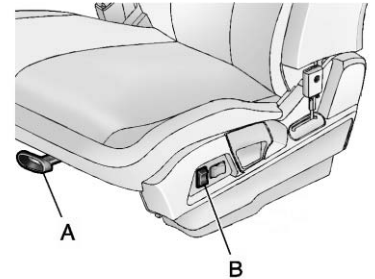

A. Seat Position Handle

B. Height Adjustment Control

To adjust a power seat, if equipped:

- Move the seat forward or rearward using the handle under the front of the seat cushion (A). See *Seat Adjustment* on page 3-3.
- Raise or lower the entire seat by moving the control (B) up or down.

## 3-4 Seats and Restraints

To adjust the seatback, see *Reclining Seatbacks on page 3-6*.

To adjust the lumbar support, see *Lumbar Adjustment on page 3-6*.

### Eight-Way Power Seats

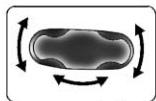

To adjust a power seat, if equipped:

- Move the seat forward or rearward by sliding the control forward or rearward.
- Raise or lower the front or rear part of the seat cushion by moving the front or rear of the control up or down.

- Raise or lower the entire seat by moving the entire control up or down.

To adjust the seatback, see *Reclining Seatbacks on page 3-6*.

To adjust the lumbar support, see *Lumbar Adjustment on page 3-6*.

### Memory Seat and Mirrors

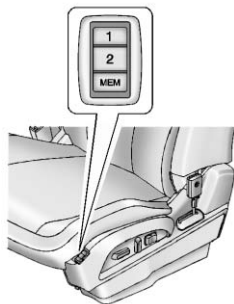

On vehicles with the memory feature, the “1” and “2” buttons on the outboard side of the driver seat are used to manually save and recall the driver seat and outside

mirror positions. These manually stored positions are referred to as Button Memory positions.

The vehicle will also automatically save driver seat and outside mirror positions to the current driver Remote Keyless Entry (RKE) transmitter when the ignition is turned off. These automatically stored positions are referred to as RKE Memory positions. See *Remote Keyless Entry (RKE) System Operation on page 2-3* for more information.

### Storing Button Memory Positions

To save positions into Button Memory:

1. Adjust the driver seat, seatback recliner, and both outside mirrors to the desired driving positions.
2. Press and release the MEM (Memory) button.
3. Press “1” until a beep sounds.
4. Repeat Steps 1 through 3 for a second driver using “2.”

### **Recalling Button Memory Positions**

To recall the manually saved Button Memory positions, press and hold “1” or “2.” The driver seat and outside mirrors move to the positions stored to those buttons when pressed. Releasing “1” or “2” before the stored positions are reached stops the recall.

If something has blocked the driver seat while recalling a memory position, the recall may stop. Remove the obstruction; then press and hold the appropriate manual control for the memory item that is not recalling for two seconds. Try recalling the memory position again by pressing the appropriate memory button. If the memory position is still not recalling, see your dealer for service.

### **Recalling RKE Memory Positions (Memory Remote Recall)**

The Memory Remote Recall feature can recall the driver seat and outside mirrors to previously stored RKE Memory positions when entering the vehicle.

Every time the ignition is turned off, the positions of the driver seat and outside mirrors are automatically stored to the RKE transmitter that was used to start the vehicle. These positions are called RKE Memory positions and may be different than the previously mentioned Button Memory positions saved to the “1” or “2” buttons. To automatically recall RKE Memory positions, unlock the driver door with the RKE transmitter and open the driver door. If the driver door is already open, pressing the RKE transmitter  button will also activate the RKE Memory recall. The driver seat and outside mirrors will move to the previously saved RKE Memory positions.

This feature is turned on or off using the vehicle personalization menu. See “Memory Remote Recall” under *Vehicle Personalization on page 5-30* for more information.

To stop recall movement, press any of the memory, power mirror, or power seat controls.

If something has blocked the driver seat while recalling a memory position, the recall may stop. Remove the obstruction; then press and hold the appropriate manual control for the memory item that is not recalling for two seconds. Try recalling the memory position again by opening the driver door and pressing the RKE  button. If the memory position is still not recalling, see your dealer for service.

## 3-6 Seats and Restraints

### Easy Exit Driver Seat

This feature moves the seat rearward allowing the driver more room to exit the vehicle.

To activate, turn the ignition off and open the driver door. If the driver door is already open, turning the ignition off will activate the easy exit driver seat.

This feature can be turned on or off using the vehicle personalization menu. See “Easy Exit Driver Seat” under *Vehicle Personalization on page 5-30* for more information.

To stop recall movement, press one of the memory or power seat controls.

If something has blocked the driver seat while recalling the exit position, the recall may stop. Remove the obstruction; then press and hold the power seat control rearward for two seconds. Try recalling the exit position again. If the exit position is still not recalling, see your dealer for service.

### Lumbar Adjustment

#### Power Lumbar

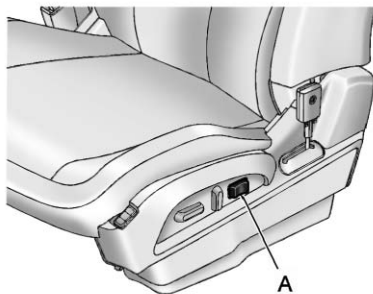

#### Eight-Way Power Seat Shown, Four-Way Similar

##### A. Lumbar Switch

If available, press and hold the front or rear of the switch (A) to increase or decrease lumbar support. Release the switch when the seatback reaches the desired level of lumbar support.

### Reclining Seatbacks

#### WARNING

Sitting in a reclined position when the vehicle is in motion can be dangerous. Even when buckled up, the safety belts cannot do their job when reclined like this.

The shoulder belt cannot do its job because it will not be against your body. Instead, it will be in front of you. In a crash, you could go into it, receiving neck or other injuries.

The lap belt cannot do its job either. In a crash, the belt could go up over your abdomen. The belt forces would be there, not at your pelvic bones. This could cause serious internal injuries.

(Continued)

**WARNING (Continued)**

For proper protection when the vehicle is in motion, have the seatback upright. Then sit well back in the seat and wear the safety belt properly.



Do not have a seatback reclined if the vehicle is moving.

**Manual Reclining Seatbacks**

**⚠ WARNING**

You can lose control of the vehicle if you try to adjust a manual driver seat while the vehicle is moving. The sudden movement could startle and confuse you, or make you push a pedal when you do not want to. Adjust the driver seat only when the vehicle is not moving.

**⚠ WARNING**

If either seatback is not locked, it could move forward in a sudden stop or crash. That could cause injury to the person sitting there. Always push and pull on the seatbacks to be sure they are locked.

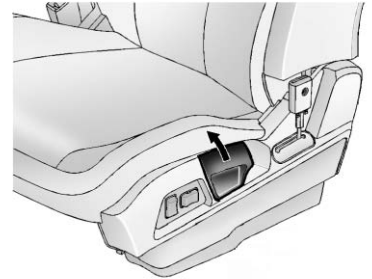

To recline a manual seatback:

1. Lift the lever.
2. Move the seatback to the desired position, and then release the lever to lock the seatback in place.
3. Push and pull on the seatback to make sure it is locked.

To return the seatback to the upright position:

1. Lift the lever fully without applying pressure to the seatback, and the seatback will return to the upright position.

## 3-8 Seats and Restraints

2. Push and pull on the seatback to make sure it is locked.

### Power Reclining Seatbacks

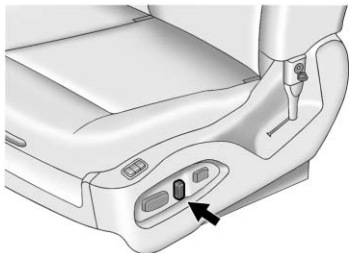

To adjust a power seatback, if available:

- Tilt the top of the control rearward to recline.
- Tilt the top of the control forward to raise.

### Heated Front Seats

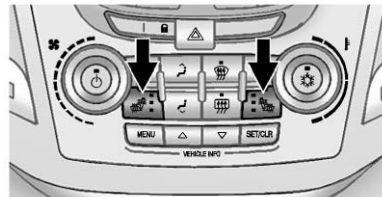

#### WARNING

If you cannot feel temperature change or pain to the skin, the seat heater may cause burns even at low temperatures. To reduce the risk of burns, people with such a condition should use care when using the seat heater, especially for long periods of time. Do not place anything on the seat that insulates against heat, such as a blanket, cushion, cover, or similar item. This may cause the seat heater to overheat. An overheated seat heater may cause a burn or may damage the seat.



#### Uplevel Climate Control System Shown, Base Similar

If available, the buttons are near the climate controls. To operate, the ignition must be in ON/RUN.

Press  or  to heat the driver or passenger seat cushion and seatback.

Press the button once for the highest setting. With each press of the button, the heated seat will change to the next lower setting, and then the off setting. Three lights indicate the highest setting, and one light indicates the lowest.

The passenger seat may take longer to heat up.

### Remote Start Heated Seats

When it is cold outside, the heated seats can be programmed to turn on automatically during a remote vehicle start. The heated seats will be canceled when the ignition is turned on. Press the heated seat button to use the heated seats after the vehicle is started.

The heated seat button lights will not turn on during a remote start.

The temperature of an unoccupied seat may be reduced.

To program the heated seat feature to enabled, see “Remote Start Auto Heat Seats” under *Vehicle Personalization on page 5-30* for more information.

## Rear Seats

### Split Folding Seatbacks

With this feature, either side of the rear seatback can be folded down for more cargo space.

#### WARNING

If either seatback is not locked, it could move forward in a sudden stop or crash. That could cause injury to the person sitting there. Always push and pull on the seatbacks to be sure they are locked.

#### WARNING

A safety belt that is improperly routed, not properly attached, or twisted will not provide the protection needed in a crash. The person wearing the belt could be

(Continued)

#### WARNING (Continued)

seriously injured. After raising the rear seatback, always check to be sure that the safety belts are properly routed and attached, and are not twisted.

To fold the seatback down:

**Notice:** Folding a rear seat with the safety belts still fastened may cause damage to the seat or the safety belts. Always unbuckle the safety belts and return them to their normal stowed position before folding a rear seat.

1. Unbuckle the rear safety belts and place the front seatbacks in the upright position. See *Reclining Seatbacks on page 3-6*.

## 3-10 Seats and Restraints

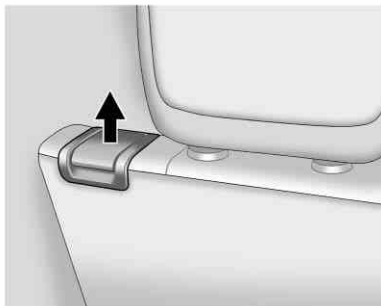

2. Lift the lever on the top of the seatback.
3. Fold the seatback forward.

The filler panel behind the seat will fold with the seatback to span the gap between the rear of the seat and the cargo area, creating a flat load floor. Do not lift the filler panel.

Keep the seatback in the upright, locked position when not in use.

To recline the seatback:

1. Lift and hold the lever on top of the seatback.
2. Tilt the seatback rearward, then release the lever when the seatback is in the desired position.

To slide the entire seat forward or rearward:

1. Lift and hold the release bar under the front of the seat cushion to unlock the seat.
2. Slide the seat to the desired position.
3. Release the bar.
4. Try to move the seat back and forth to ensure the seat is locked into place.

## Safety Belts

This section of the manual describes how to use safety belts properly. It also describes some things not to do with safety belts.

### **WARNING**

Do not let anyone ride where a safety belt cannot be worn properly. In a crash, if you or your passenger(s) are not wearing safety belts, the injuries can be much worse. You can hit things inside the vehicle harder or be ejected from the vehicle. You and your passenger(s) can be seriously injured or killed. In the same crash, you might not be, if you are buckled up. Always fasten your safety belt, and check that your passenger(s) are restrained properly too.



**⚠ WARNING**

It is extremely dangerous to ride in a cargo area, inside or outside of a vehicle. In a collision, people riding in these areas are more likely to be seriously injured or killed. Do not allow people to ride in any area of your vehicle that is not equipped with seats and safety belts. Be sure everyone in the vehicle is in a seat and using a safety belt properly.

This vehicle has indicators as a reminder to buckle the safety belts. See *Safety Belt Reminders on page 5-10* for additional information.

In most states and in all Canadian provinces, the law requires wearing safety belts. Here is why:

You never know if you will be in a crash. If you do have a crash, you do not know if it will be a serious one.

A few crashes are mild, and some crashes can be so serious that even buckled up, a person would not survive. But most crashes are in between. In many of them, people who buckle up can survive and sometimes walk away. Without safety belts they could have been badly hurt or killed.

After more than 40 years of safety belts in vehicles, the facts are clear. In most crashes buckling up does matter ... a lot!

**Why Safety Belts Work**

When you ride in or on anything, you go as fast as it goes.

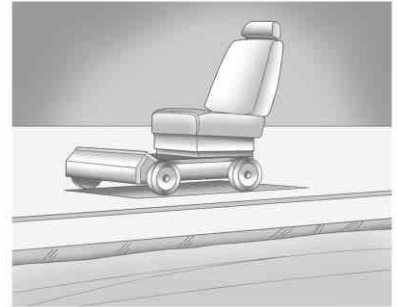

Take the simplest vehicle. Suppose it is just a seat on wheels.

## 3-12 Seats and Restraints

---

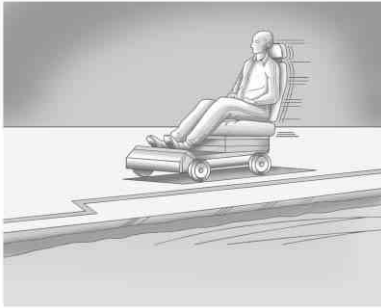

Put someone on it.

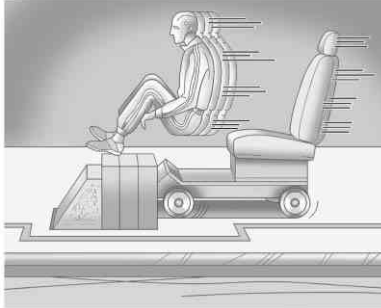

Get it up to speed. Then stop the vehicle. The rider does not stop.

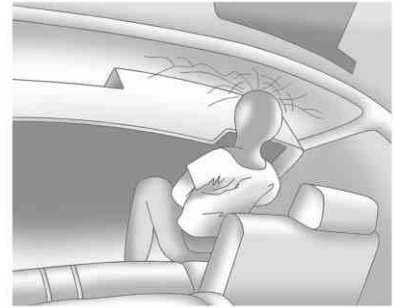

The person keeps going until stopped by something. In a real vehicle, it could be the windshield...

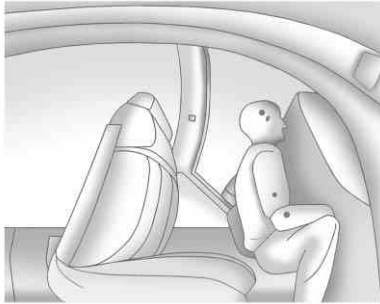

or the instrument panel...

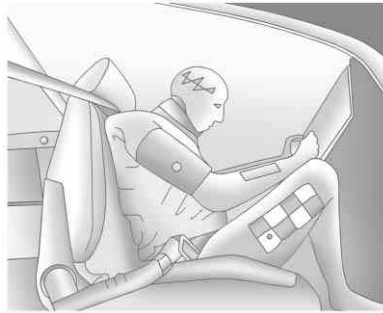

or the safety belts!

With safety belts, you slow down as the vehicle does. You get more time to stop. You stop over more distance, and your strongest bones take the forces. That is why safety belts make such good sense.

### Questions and Answers About Safety Belts

**Q: Will I be trapped in the vehicle after a crash if I am wearing a safety belt?**

**A:** You *could* be — whether you are wearing a safety belt or not. But your chance of being conscious during and after an accident, so you *can* unbuckle and get out, is *much* greater if you are belted. And you can unbuckle a safety belt, even if you are upside down.

**Q: If my vehicle has airbags, why should I have to wear safety belts?**

**A:** Airbags are supplemental systems only; so they work *with* safety belts — not instead of them. Whether or not an airbag is provided, all occupants still have to buckle up to get the most protection. That is true not only in frontal collisions, but especially in side and other collisions.

## 3-14 Seats and Restraints

**Q: If I am a good driver, and I never drive far from home, why should I wear safety belts?**

**A:** You may be an excellent driver, but if you are in a crash — even one that is not your fault — you and your passenger(s) can be hurt. Being a good driver does not protect you from things beyond your control, such as bad drivers.

Most accidents occur within 40 km (25 mi) of home. And the greatest number of serious injuries and deaths occur at speeds of less than 65 km/h (40 mph).

Safety belts are for everyone.

### How to Wear Safety Belts Properly

This section is only for people of adult size.

Be aware that there are special things to know about safety belts and children. And there are different rules for smaller children and infants. If a child will be riding in the vehicle, see *Older Children on page 3-40* or *Infants and Young Children on page 3-43*. Follow those rules for everyone's protection.

It is very important for all occupants to buckle up. Statistics show that unbelted people are hurt more often in crashes than those who are wearing safety belts.

Occupants who are not buckled up can be thrown out of the vehicle in a crash. And they can strike others in the vehicle who are wearing safety belts.

First, before you or your passenger(s) wear a safety belt, there is important information you should know.

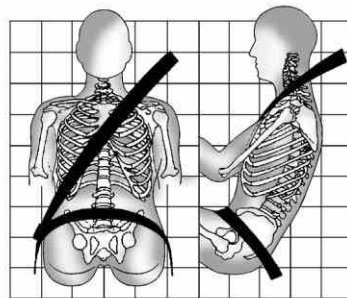

Sit up straight and always keep your feet on the floor in front of you. The lap part of the belt should be worn low and snug on the hips, just touching the thighs.

In a crash, this applies force to the strong pelvic bones and you would be less likely to slide under the lap belt. If you slid under it, the belt would apply force on your abdomen. This could cause serious or even fatal injuries. The shoulder belt should go over the shoulder and across the chest. These parts of the body are best able to take belt restraining forces.

The shoulder belt locks if there is a sudden stop or crash.

**Q: What is wrong with this?**

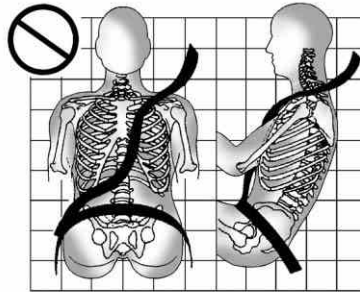

**A: The shoulder belt is too loose. It will not give as much protection this way.**

**⚠ WARNING**

You can be seriously hurt if the shoulder belt is too loose. In a crash, you would move forward too much, which could increase injury. The shoulder belt should fit snugly against your body.

## 3-16 Seats and Restraints

**Q:** What is wrong with this?

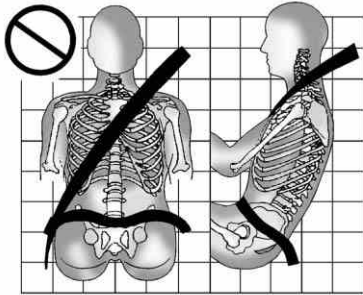

**A:** The lap belt is too loose. It will not give nearly as much protection this way.

### **WARNING**

You can be seriously hurt if the lap belt is too loose. In a crash, you could slide under the lap belt and apply force on your abdomen. This could cause serious or even fatal injuries. The lap belt should be worn low and snug on the hips, just touching the thighs.

**Q:** What is wrong with this?

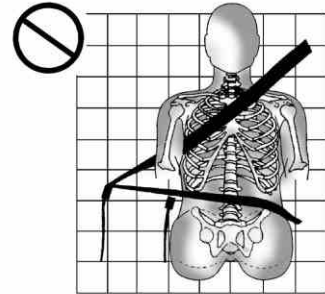

**A:** The belt is buckled in the wrong buckle.

**⚠ WARNING**

You can be seriously injured if the belt is buckled in the wrong place like this. In a crash, the belt would go up over your abdomen. The belt forces would be there, not on the pelvic bones. This could cause serious internal injuries. Always buckle the belt into the buckle nearest you.

**Q: What is wrong with this?**

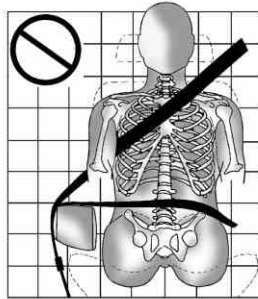

**A: The belt is over an armrest.**

**⚠ WARNING**

You can be seriously injured if the belt goes over an armrest like this. The belt would be much too high. In a crash, you can slide under the belt. The belt force would then be applied on the abdomen, not on the pelvic bones, and that could cause serious or fatal injuries. Be sure the belt goes under the armrests.

## 3-18 Seats and Restraints

**Q:** What is wrong with this?

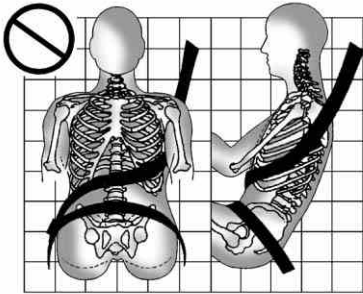

**A:** The shoulder belt is worn under the arm. It should be worn over the shoulder at all times.

### **WARNING**

You can be seriously injured if you wear the shoulder belt under your arm. In a crash, your body would move too far forward, which would increase the chance of head and neck injury. Also, the belt would apply too much force to the ribs, which are not as strong as shoulder bones. You could also severely injure internal organs like your liver or spleen. The shoulder belt should go over the shoulder and across the chest.

**Q:** What is wrong with this?

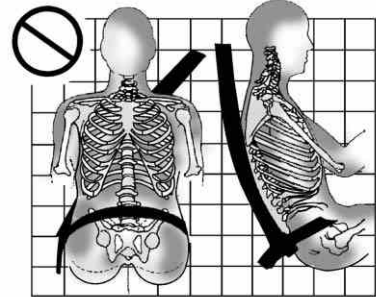

**A:** The belt is behind the body.



**⚠ WARNING**

You can be seriously injured by not wearing the lap-shoulder belt properly. In a crash, you would not be restrained by the shoulder belt. Your body could move too far forward increasing the chance of head and neck injury. You might also slide under the lap belt. The belt force would then be applied right on the abdomen. That could cause serious or fatal injuries. The shoulder belt should go over the shoulder and across the chest.

**Q: What is wrong with this?**

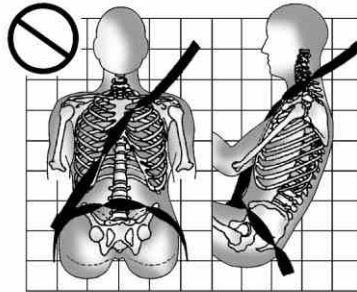

**A: The belt is twisted across the body.**

**⚠ WARNING**

You can be seriously injured by a twisted belt. In a crash, you would not have the full width of the belt to spread impact forces. If a belt is twisted, make it straight so it can work properly, or ask your dealer to fix it.

### Lap-Shoulder Belt

All seating positions in the vehicle have a lap-shoulder belt.

The following instructions explain how to wear a lap-shoulder belt properly.

1. Adjust the seat, if the seat is adjustable, so you can sit up straight. To see how, see “Seats” in the Index.
2. Pick up the latch plate and pull the belt across you. Do not let it get twisted.

The lap-shoulder belt may lock if you pull the belt across you very quickly. If this happens, let the belt go back slightly to unlock it. Then pull the belt across you more slowly.

If the shoulder portion of a passenger belt is pulled out all the way, the child restraint locking feature may be engaged. If this happens, let the belt go back all the way and start again.

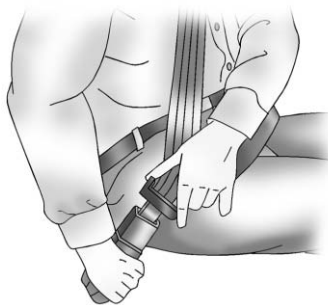

3. Push the latch plate into the buckle until it clicks.

Pull up on the latch plate to make sure it is secure. If the belt is not long enough, see *Safety Belt Extender* on page 3-24.

Position the release button on the buckle so that the safety belt could be quickly unbuckled if necessary.

4. If equipped with a shoulder belt height adjuster, move it to the height that is right for you. See “Shoulder Belt Height Adjuster” later in this section for instructions on use and important safety information.

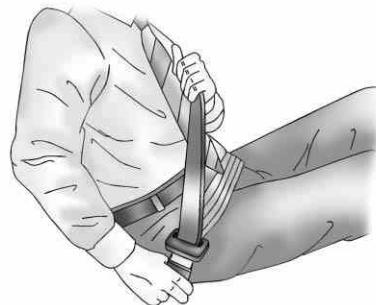

5. To make the lap part tight, pull up on the shoulder belt.

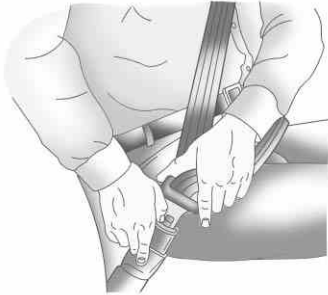

To unlatch the belt, push the button on the buckle.

Before a door is closed, be sure the safety belt is out of the way. If a door is slammed against a safety belt, damage can occur to both the safety belt and the vehicle.

### Shoulder Belt Height Adjuster

The vehicle has a shoulder belt height adjuster for the driver and right front passenger seating positions.

Adjust the height so the shoulder portion of the belt is on the shoulder and not falling off of it. The belt should be close to, but not contacting, the neck. Improper shoulder belt height adjustment could reduce the effectiveness of the safety belt in a crash. See *How to Wear Safety Belts Properly* on page 3-14.

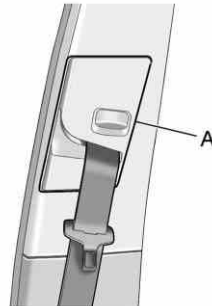

Move the height adjuster up to the desired position by pushing up on the height adjuster.

After the height adjuster is set to the desired position, try to move it down without pressing the release button (A) to make sure it has locked into position. Press the release button to lower the height adjuster.

### Safety Belt Pretensioners

This vehicle has safety belt pretensioners for front outboard occupants. Although the safety belt pretensioners cannot be seen, they are part of the safety belt assembly. They can help tighten the safety belts during the early stages of a moderate to severe frontal and near frontal crash if the threshold conditions for pretensioner activation are met. And, if the vehicle has side impact airbags, safety belt pretensioners can help tighten the safety belts in a side crash or a rollover event.

## 3-22 Seats and Restraints

Pretensioners work only once. If the pretensioners are activated in a crash, the pretensioners and possibly other parts of the safety belt system will need to be replaced. See *Replacing Safety Belt System Parts After a Crash* on page 3-25.

### Rear Safety Belt Comfort Guides

This vehicle may have rear shoulder belt comfort guides. If not, they are available through your dealer. The guides may provide added safety belt comfort for older children who have outgrown booster seats and for some adults. When installed and properly adjusted, the comfort guide positions the belt away from the neck and head.

There is one guide for each outside passenger position in the rear seat. Here is how to install a comfort guide to the safety belt:



1. Remove the guide from its storage pocket on the side of the seatback.

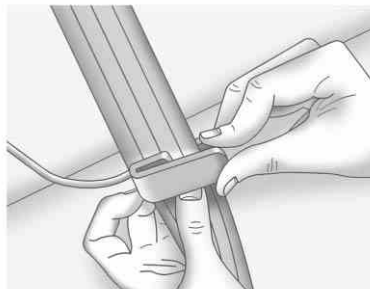

2. Place the guide over the belt, and insert the two edges of the belt into the slots of the guide.

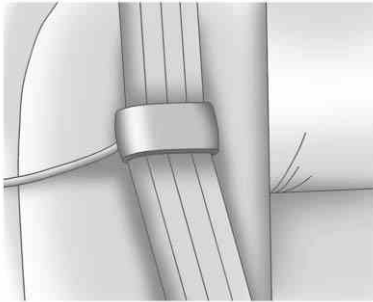

3. The belt should not be twisted and it should lie flat. The elastic cord must be under the belt and the guide on top.

**⚠ WARNING**

A safety belt that is not properly worn may not provide the protection needed in a crash. The person wearing the belt could be seriously injured. The shoulder belt should go over the shoulder and across the chest. These parts of the body are best able to take belt restraining forces.

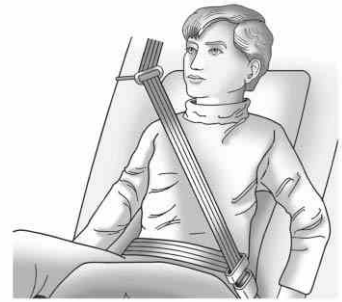

4. Buckle, position, and release the safety belt as described previously in this section. Make sure the shoulder portion of the belt is on the shoulder and not falling off of it. The belt should be close to, but not contacting, the neck.

To remove and store the comfort guide, squeeze the belt edges together so that the safety belt can be removed from the guide. Slide the guide back into its storage pocket located on the side of the seatback.

### Safety Belt Use During Pregnancy

Safety belts work for everyone, including pregnant women. Like all occupants, they are more likely to be seriously injured if they do not wear safety belts.



A pregnant woman should wear a lap-shoulder belt, and the lap portion should be worn as low as possible, below the rounding, throughout the pregnancy.

The best way to protect the fetus is to protect the mother. When a safety belt is worn properly, it is more likely that the fetus will not be hurt in a crash. For pregnant women, as for anyone, the key to making safety belts effective is wearing them properly.

### Safety Belt Extender

If the vehicle's safety belt will fasten around you, you should use it.

But if a safety belt is not long enough, your dealer will order you an extender. When you go in to order it, take the heaviest coat you will wear, so the extender will be long enough for you. To help avoid personal injury, do not let someone else use it, and use it only for the seat it is made to fit. The extender has been designed for adults. Never use it for securing child seats. To wear it, attach it to the regular safety belt. For more information, see the instruction sheet that comes with the extender.

### Safety System Check

Now and then, check that the safety belt reminder light, safety belts, buckles, latch plates, retractors, and anchorages are working properly. Look for any other loose or damaged safety belt system parts that might keep a safety belt system from doing its job. See your dealer to have it repaired. Torn or frayed safety belts may not protect you in a crash. They can rip apart under impact forces. If a belt is torn or frayed, get a new one right away.

Make sure the safety belt reminder light is working. See *Safety Belt Reminders on page 5-10* for more information.

Keep safety belts clean and dry. See *Safety Belt Care on page 3-25*.

## Safety Belt Care

Keep belts clean and dry.

 **WARNING**

Do not bleach or dye safety belts. It may severely weaken them. In a crash, they might not be able to provide adequate protection. Clean safety belts only with mild soap and lukewarm water.

## Replacing Safety Belt System Parts After a Crash

 **WARNING**

A crash can damage the safety belt system in the vehicle. A damaged safety belt system may not properly protect the person using it, resulting in serious injury or even death in a crash. To help make sure the safety belt systems are working properly after a crash, have them inspected and any necessary replacements made as soon as possible.

After a minor crash, replacement of safety belts may not be necessary. But the safety belt assemblies that were used during any crash may have been stressed or damaged. See your dealer to have the safety belt assemblies inspected or replaced.

New parts and repairs may be necessary even if the safety belt system was not being used at the time of the crash.

Have the safety belt pretensioners checked if the vehicle has been in a crash, or if the airbag readiness light stays on after you start the vehicle or while you are driving. See *Airbag Readiness Light* on page 5-11.

### Airbag System

The vehicle has the following airbags:

- A frontal airbag for the driver.
- A frontal airbag for the right front passenger.
- A seat-mounted side impact airbag for the driver.
- A seat-mounted side impact airbag for the right front passenger.
- A roof-rail airbag for the driver and the passenger seated directly behind the driver.
- A roof-rail airbag for the right front passenger and the passenger seated directly behind the right front passenger.

All of the airbags in the vehicle will have the word AIRBAG embossed in the trim or on an attached label near the deployment opening.

For frontal airbags, the word AIRBAG will appear on the middle part of the steering wheel for the driver and on the instrument panel for the right front passenger.

With seat-mounted side impact airbags, the word AIRBAG will appear on the side of the seatback closest to the door.

With roof-rail airbags, the word AIRBAG will appear along the trim.

Airbags are designed to supplement the protection provided by safety belts. Even though today's airbags are also designed to help reduce the risk of injury from the force of an inflating bag, all airbags must inflate very quickly to do their job.

Here are the most important things to know about the airbag system:

#### **WARNING**

You can be severely injured or killed in a crash if you are not wearing a safety belt — even if the vehicle has airbags. Airbags are designed to work with safety belts, but do not replace them. Also, airbags are not designed to deploy in every crash. In some crashes safety belts are the only restraint. See *When Should an Airbag Inflate?* on page 3-29.

Wearing a safety belt during a crash helps reduce your chance of hitting things inside the vehicle or being ejected from it. Airbags are “supplemental restraints” to the safety belts. Everyone in the vehicle should wear a safety belt properly — whether or not there is an airbag for that person.



**⚠ WARNING**

Airbags inflate with great force, faster than the blink of an eye. Anyone who is up against, or very close to, any airbag when it inflates can be seriously injured or killed. Do not sit unnecessarily close to any airbag, as you would be if you were sitting on the edge of the seat or leaning forward. Safety belts help keep you in position before and during a crash. Always wear a safety belt, even with airbags. The driver should sit as far back as possible while still maintaining control of the vehicle.

Occupants should not lean on or sleep against the door or side windows in seating positions with seat-mounted side impact airbags and/or roof-rail airbags.

**⚠ WARNING**

Children who are up against, or very close to, any airbag when it inflates can be seriously injured or killed. Airbags plus lap-shoulder belts offer protection for adults and older children, but not for young children and infants. Neither the vehicle's safety belt system nor its airbag system is designed for them. Young children and infants need the protection that a child restraint system can provide. Always secure children properly in the vehicle. To read how, see *Older Children on page 3-40* or *Infants and Young Children on page 3-43*.



There is an airbag readiness light on the instrument panel cluster, which shows the airbag symbol.

The system checks the airbag electrical system for malfunctions. The light tells you if there is an electrical problem. See *Airbag Readiness Light on page 5-11* for more information.

## Where Are the Airbags?



The driver frontal airbag is in the middle of the steering wheel.



The right front passenger frontal airbag is in the instrument panel on the passenger side.



**Driver Side Shown, Passenger Side Similar**

The seat-mounted side impact airbags for the driver and right front passenger are in the side of the seatbacks closest to the door.



### Driver Side Shown, Passenger Side Similar

The roof-rail airbags for the driver, right front passenger, and second row outboard passengers are in the ceiling above the side windows.

#### **WARNING**

If something is between an occupant and an airbag, the airbag might not inflate properly or it might force the object into that person causing severe injury

(Continued)

#### **WARNING (Continued)**

or even death. The path of an inflating airbag must be kept clear. Do not put anything between an occupant and an airbag, and do not attach or put anything on the steering wheel hub or on or near any other airbag covering.

Do not use seat accessories that block the inflation path of a seat-mounted side impact airbag.

Never secure anything to the roof of a vehicle with roof-rail airbags by routing a rope or tie down through any door or window opening. If you do, the path of an inflating roof-rail airbag will be blocked.

### When Should an Airbag Inflate?

Frontal airbags are designed to inflate in moderate to severe frontal or near-frontal crashes to help reduce the potential for severe injuries mainly to the driver's or right front passenger's head and chest. However, they are only designed to inflate if the impact exceeds a predetermined deployment threshold. Deployment thresholds are used to predict how severe a crash is likely to be in time for the airbags to inflate and help restrain the occupants.

Whether the frontal airbags will or should deploy is not based on how fast your vehicle is traveling. It depends largely on what you hit, the direction of the impact, and how quickly your vehicle slows down.

## 3-30 Seats and Restraints

---

Frontal airbags may inflate at different crash speeds. For example:

- If the vehicle hits a stationary object, the airbags could inflate at a different crash speed than if the vehicle hits a moving object.
- If the vehicle hits an object that deforms, the airbags could inflate at a different crash speed than if the vehicle hits an object that does not deform.
- If the vehicle hits a narrow object (like a pole), the airbags could inflate at a different crash speed than if the vehicle hits a wide object (like a wall).
- If the vehicle goes into an object at an angle, the airbags could inflate at a different crash speed than if the vehicle goes straight into the object.

Thresholds can also vary with specific vehicle design.

Frontal airbags are not intended to inflate during vehicle rollovers, rear impacts, or in many side impacts.

In addition, the vehicle has dual-stage frontal airbags. Dual-stage airbags adjust the restraint according to crash severity. The vehicle has electronic frontal sensors, which help the sensing system distinguish between a moderate frontal impact and a more severe frontal impact. For moderate frontal impacts, dual-stage airbags inflate at a level less than full deployment. For more severe frontal impacts, full deployment occurs.

The vehicle has seat-mounted side impact and roof-rail airbags. See *Airbag System on page 3-26*. Seat-mounted side impact and roof-rail airbags are intended to inflate in moderate to severe side crashes. In addition, these roof-rail airbags are intended to inflate during a rollover or in a severe frontal impact. Seat-mounted side impact and roof-rail airbags will inflate if the crash severity is above

the system's designed threshold level. The threshold level can vary with specific vehicle design.

Seat-mounted side impact airbags are not intended to inflate in frontal impacts, near-frontal impacts, rollovers, or rear impacts. Roof-rail airbags are not intended to inflate in rear impacts. A seat-mounted side impact airbag is intended to deploy on the side of the vehicle that is struck. Both roof-rail airbags will deploy when either side of the vehicle is struck, or if the sensing system predicts that the vehicle is about to roll over, or in a severe frontal impact.

In any particular crash, no one can say whether an airbag should have inflated simply because of the damage to a vehicle or because of what the repair costs were. For frontal airbags, inflation is determined by what the vehicle hits, the angle of the impact, and how quickly the vehicle slows down. For seat-mounted side impact and roof-rail airbags, deployment is

determined by the location and severity of the side impact. In a rollover event, roof-rail airbag deployment is determined by the direction of the roll.

## **What Makes an Airbag Inflate?**

In a deployment event, the sensing system sends an electrical signal triggering a release of gas from the inflator. Gas from the inflator fills the airbag causing the bag to break out of the cover and deploy. The inflator, the airbag, and related hardware are all part of the airbag module.

Frontal airbag modules are located inside the steering wheel and instrument panel. For vehicles with seat-mounted side impact airbags, there are airbag modules in the side of the front seatbacks closest to the door. For vehicles with roof-rail airbags, there are airbag modules in the ceiling of the vehicle, near the side windows that have occupant seating positions.

## **How Does an Airbag Restrain?**

In moderate to severe frontal or near frontal collisions, even belted occupants can contact the steering wheel or the instrument panel. In moderate to severe side collisions, even belted occupants can contact the inside of the vehicle.

Airbags supplement the protection provided by safety belts. Frontal airbags distribute the force of the impact more evenly over the occupant's upper body, stopping the occupant more gradually. Seat-mounted side impact and roof-rail airbags distribute the force of the impact more evenly over the occupant's upper body.

Rollover capable roof-rail airbags are designed to help contain the head and chest of occupants in the outboard seating positions in the first and second rows. The rollover capable roof-rail airbags are designed to help reduce the risk of

full or partial ejection in rollover events, although no system can prevent all such ejections.

But airbags would not help in many types of collisions, primarily because the occupant's motion is not toward those airbags. See *When Should an Airbag Inflate?* on page 3-29 for more information.

Airbags should never be regarded as anything more than a supplement to safety belts.

## **What Will You See After an Airbag Inflates?**

After the frontal airbags and seat-mounted side impact airbags inflate, they quickly deflate, so quickly that some people may not even realize an airbag inflated. Roof-rail airbags may still be at least partially inflated for some time after they deploy. Some components of the airbag module may be hot for several minutes. For location of the airbag modules, see *What Makes an Airbag Inflate?* on page 3-31.

## 3-32 Seats and Restraints

The parts of the airbag that come into contact with you may be warm, but not too hot to touch. There may be some smoke and dust coming from the vents in the deflated airbags. Airbag inflation does not prevent the driver from seeing out of the windshield or being able to steer the vehicle, nor does it prevent people from leaving the vehicle.

### **WARNING**

When an airbag inflates, there may be dust in the air. This dust could cause breathing problems for people with a history of asthma or other breathing trouble. To avoid this, everyone in the vehicle should get out as soon as it is safe to do so. If you have breathing problems but cannot get out of the vehicle after an airbag inflates, then get fresh air by opening a window or a door. If you experience breathing

(Continued)

### **WARNING (Continued)**

problems following an airbag deployment, you should seek medical attention.

The vehicle has a feature that may automatically unlock the doors, turn on the interior lamps, turn on the hazard warning flashers, and shut off the fuel system after the airbags inflate. You can lock the doors, turn off the interior lamps, and turn off the hazard warning flashers by using the controls for those features.

### **WARNING**

A crash severe enough to inflate the airbags may have also damaged important functions in the vehicle, such as the fuel system, brake and steering systems, etc. Even if the vehicle

(Continued)

### **WARNING (Continued)**

appears to be drivable after a moderate crash, there may be concealed damage that could make it difficult to safely operate the vehicle.

Use caution if you should attempt to restart the engine after a crash has occurred.

In many crashes severe enough to inflate the airbag, windshields are broken by vehicle deformation. Additional windshield breakage may also occur from the right front passenger airbag.

- Airbags are designed to inflate only once. After an airbag inflates, you will need some new parts for the airbag system. If you do not get them, the airbag system will not be there to help protect you in another crash. A new system will include airbag modules and possibly

other parts. The service manual for your vehicle covers the need to replace other parts.

- The vehicle has a crash sensing and diagnostic module which records information after a crash. See *Vehicle Data Recording and Privacy on page 13-16* and *Event Data Recorders on page 13-16*.
- Let only qualified technicians work on the airbag systems. Improper service can mean that an airbag system will not work properly. See your dealer for service.

## Passenger Sensing System

The vehicle has a passenger sensing system for the right front passenger position. The passenger airbag status indicator will be visible on the overhead console when the vehicle is started.



### United States



### Canada and Mexico

The words ON and OFF, or the symbol for on and off, are visible during the system check. If you are using remote start, if equipped, to start the vehicle from a distance, you may not see the system check. When the system check is complete, either the word ON or OFF, or the symbol for on or off, will be visible. See *Passenger Airbag Status Indicator on page 5-11*.

The passenger sensing system turns off the right front passenger frontal airbag under certain conditions. The driver airbag, seat-mounted side impact airbags and the roof-rail airbags are not affected by the passenger sensing system.

The passenger sensing system works with sensors that are part of the right front passenger seat. The sensors are designed to detect the presence of a properly-seated occupant and determine if the right front passenger frontal airbag should be enabled (may inflate) or not.

According to accident statistics, children are safer when properly secured in a rear seat in the correct child restraint for their weight and size.

## 3-34 Seats and Restraints

We recommend that children be secured in a rear seat, including: an infant or a child riding in a rear-facing child restraint; a child riding in a forward-facing child seat; an older child riding in a booster seat; and children, who are large enough, using safety belts.

A label on the sun visor says, "Never put a rear-facing child seat in the front." This is because the risk to the rear-facing child is so great, if the airbag deploys.

### **WARNING**

A child in a rear-facing child restraint can be seriously injured or killed if the right front passenger airbag inflates. This is because the back of the rear-facing child restraint would be very close to the inflating airbag. A child in a forward-facing child restraint can be seriously injured or killed if the right front

(Continued)

### **WARNING (Continued)**

passenger airbag inflates and the passenger seat is in a forward position.

Even if the passenger sensing system has turned off the right front passenger frontal airbag, no system is fail-safe. No one can guarantee that an airbag will not deploy under some unusual circumstance, even though the airbag is turned off.

Secure rear-facing child restraints in a rear seat, even if the airbag is off. If you secure a forward-facing child restraint in the right front seat, always move the front passenger seat as far back as it will go. It is better to secure the child restraint in a rear seat.

The passenger sensing system is designed to turn off the right front passenger frontal airbag if:

- The right front passenger seat is unoccupied.
- The system determines that an infant is present in a child restraint.
- A right front passenger takes his/her weight off of the seat for a period of time.
- Or, if there is a critical problem with the airbag system or the passenger sensing system.

When the passenger sensing system has turned off the right front passenger frontal airbag, the off indicator will light and stay lit to remind you that the airbag is off. See *Passenger Airbag Status Indicator* on page 5-11.



The passenger sensing system is designed to turn on (may inflate) the right front passenger frontal airbag anytime the system senses that a person of adult size is sitting properly in the right front passenger seat.

When the passenger sensing system has allowed the airbag to be enabled, the on indicator will light and stay lit to remind you that the airbag is active.

For some children, including children in child restraints, and for very small adults, the passenger sensing system may or may not turn off the right front passenger frontal airbag, depending upon the person's seating posture and body build. Everyone in the vehicle who has outgrown child restraints should wear a safety belt properly — whether or not there is an airbag for that person.

 **WARNING**

If the airbag readiness light ever comes on and stays on, it means that something may be wrong with the airbag system. To help avoid injury to yourself or others, have the vehicle serviced right away. See *Airbag Readiness Light* on page 5-11 for more information, including important safety information.

**If the On Indicator is Lit for a Child Restraint**

If a child restraint has been installed and the on indicator is lit:

1. Turn the vehicle off.
2. Remove the child restraint from the vehicle.

3. Remove any additional items from the seat such as blankets, cushions, seat covers, seat heaters, or seat massagers.
4. Reinstall the child restraint following the directions provided by the child restraint manufacturer and refer to *Securing Child Restraints (Rear Seat)* on page 3-55 or *Securing Child Restraints (Front Passenger Seat)* on page 3-57.
5. If, after reinstalling the child restraint and restarting the vehicle, the on indicator is still lit, turn the vehicle off. Then slightly recline the vehicle seatback and adjust the seat cushion, if adjustable, to make sure that the vehicle seatback is not pushing the child restraint into the seat cushion.

## 3-36 Seats and Restraints

Also make sure the child restraint is not trapped under the vehicle head restraint. If this happens, adjust the head restraint. See *Head Restraints on page 3-2*.

6. Restart the vehicle.

The passenger sensing system may or may not turn off the airbag for a child in a child restraint depending upon the child's seating posture and body build. It is better to secure the child restraint in a rear seat.

### If the Off Indicator is Lit for an Adult-Size Occupant



If a person of adult-size is sitting in the right front passenger seat, but the off indicator is lit, it could be because that person is not sitting properly in the seat. If this happens, use the following steps to allow the

system to detect that person and enable the right front passenger frontal airbag:

1. Turn the vehicle off.
2. Remove any additional material from the seat, such as blankets, cushions, seat covers, seat heaters, or seat massagers.
3. Place the seatback in the fully upright position.
4. Have the person sit upright in the seat, centered on the seat cushion, with legs comfortably extended.
5. Restart the vehicle and have the person remain in this position for two to three minutes after the on indicator is lit.

### Additional Factors Affecting System Operation

Safety belts help keep the passenger in position on the seat during vehicle maneuvers and braking, which helps the passenger sensing system maintain the passenger airbag status. See “Safety Belts” and “Child Restraints” in the Index for additional information about the importance of proper restraint use.

A thick layer of additional material, such as a blanket or cushion, or aftermarket equipment such as seat covers, seat heaters, and seat massagers can affect how well the passenger sensing system operates. We recommend that you not use seat covers or other aftermarket equipment except when approved by GM for your specific vehicle. See *Adding Equipment to the Airbag-Equipped Vehicle on page 3-38* for more information about modifications that can affect how the system operates.

A wet seat can affect the performance of the passenger sensing system. Here is how:

- The passenger sensing system may turn off the passenger airbag when liquid is soaked into the seat. If this happens, the off indicator will be lit, and the airbag readiness light on the instrument panel will also be lit.
- Liquid pooled on the seat that has not soaked in may make it more likely that the passenger sensing system will enable (turn on) the passenger airbag while a child restraint or child occupant is on the seat. If the passenger airbag is turned on, the on indicator will be lit.

If the passenger seat gets wet, dry the seat immediately. If the airbag readiness light is lit, do not install a child restraint or allow anyone to occupy the seat. See *Airbag Readiness Light on page 5-11* for important safety information.

The on indicator may be lit if an object, such as a briefcase, handbag, grocery bag, laptop or other electronic device, is put on an unoccupied seat. If this is not desired remove the object from the seat.

 **WARNING**

Stowing of articles under the passenger seat or between the passenger seat cushion and seatback may interfere with the proper operation of the passenger sensing system.

### Servicing the Airbag-Equipped Vehicle

Airbags affect how the vehicle should be serviced. There are parts of the airbag system in several places around the vehicle. Your dealer and the service manual have information about servicing the vehicle and the airbag system.

To purchase a service manual, see *Service Publications Ordering Information* on page 13-14.

### **WARNING**

For up to 10 seconds after the ignition is turned off and the battery is disconnected, an airbag can still inflate during improper service. You can be injured if you are close to an airbag when it inflates. Avoid yellow connectors. They are probably part of the airbag system. Be sure to follow proper service procedures, and make sure the person performing work for you is qualified to do so.

## Adding Equipment to the Airbag-Equipped Vehicle

**Q: Is there anything I might add to or change about the vehicle that could keep the airbags from working properly?**

**A:** Yes. If you add things that change the vehicle's frame, bumper system, height, front end or side sheet metal, they may keep the airbag system from working properly. Changing or moving any parts of the front seats, safety belts, the airbag sensing and diagnostic module, steering wheel, instrument panel, roof-rail airbag modules, ceiling headliner or pillar garnish trim, overhead console, front sensors, side impact sensors, rollover sensor module, or airbag wiring can affect the operation of the airbag system.

In addition, the vehicle has a passenger sensing system for the right front passenger position, which includes sensors that are part of the passenger seat. The passenger sensing system may not operate properly if the original seat trim is replaced with non-GM covers, upholstery or trim, or with GM covers, upholstery or trim designed for a different vehicle. Any object, such as an aftermarket seat heater or a comfort enhancing pad or device, installed under or on top of the seat fabric, could also interfere with the operation of the passenger sensing system. This could either prevent proper deployment of the passenger airbag(s) or prevent the passenger sensing system from properly turning off the passenger airbag(s). See *Passenger Sensing System* on page 3-33.

If you have questions, call Customer Assistance. The phone numbers and addresses for Customer Assistance are in Step Two of the Customer Satisfaction Procedure in this manual. See *Customer Satisfaction Procedure (U.S. and Canada)* on page 13-1 or *Customer Satisfaction Procedure (Mexico)* on page 13-3.

If the vehicle has rollover roof-rail airbags, see *Different Size Tires and Wheels* on page 10-61 for additional important information.

**Q: Because I have a disability, I have to get my vehicle modified. How can I find out whether this will affect my airbag system?**

**A:** If you have questions, call Customer Assistance. The phone numbers and addresses for Customer Assistance are in Step Two of the Customer Satisfaction Procedure in this manual. See *Customer Satisfaction Procedure (U.S. and Canada)* on page 13-1 or *Customer Satisfaction Procedure (Mexico)* on page 13-3.

In addition, your dealer and the service manual have information about the location of the airbag sensors, sensing and diagnostic module and airbag wiring.

## Airbag System Check

The airbag system does not need regularly scheduled maintenance or replacement. Make sure the airbag readiness light is working. See *Airbag Readiness Light* on page 5-11 for more information.

**Notice:** If an airbag covering is damaged, opened, or broken, the airbag may not work properly. Do not open or break the airbag coverings. If there are any opened or broken airbag covers, have the airbag covering and/or airbag module replaced. For the location of the airbag modules, see *What Makes an Airbag Inflate?* on page 3-31. See your dealer for service.

### Replacing Airbag System Parts After a Crash

#### **WARNING**

A crash can damage the airbag systems in the vehicle. A damaged airbag system may not work properly and may not protect you and your passenger(s) in a crash, resulting in serious injury or even death. To help make sure the airbag systems are working properly after a crash, have them inspected and any necessary replacements made as soon as possible.

If an airbag inflates, you will need to replace airbag system parts. See your dealer for service.

If the airbag readiness light stays on after the vehicle is started or comes on when you are driving, the airbag system may not work properly. Have the vehicle serviced right away. See *Airbag Readiness Light* on page 5-11 for more information.

### Child Restraints

#### Older Children



Older children who have outgrown booster seats should wear the vehicle safety belts.

The manufacturer's instructions that come with the booster seat state the weight and height limitations for that booster. Use a booster seat with a lap-shoulder belt until the child passes the fit test below:

- Sit all the way back on the seat. Do the knees bend at the seat edge? If yes, continue. If no, return to the booster seat.
- Buckle the lap-shoulder belt. Does the shoulder belt rest on the shoulder? If yes, continue. If no, try using the rear safety belt comfort guide. See “Rear Safety Belt Comfort Guides” under *Lap-Shoulder Belt on page 3-20* for more information. If the shoulder belt still does not rest on the shoulder, then return to the booster seat.

- Does the lap belt fit low and snug on the hips, touching the thighs? If yes, continue. If no, return to the booster seat.
- Can proper safety belt fit be maintained for the length of the trip? If yes, continue. If no, return to the booster seat.

**Q: What is the proper way to wear safety belts?**

**A:** An older child should wear a lap-shoulder belt and get the additional restraint a shoulder belt can provide. The shoulder belt should not cross the face or neck. The lap belt should fit snugly below the hips, just touching the top of the thighs.

This applies belt force to the child's pelvic bones in a crash. It should never be worn over the abdomen, which could cause severe or even fatal internal injuries in a crash.

Also see “Rear Safety Belt Comfort Guides” under *Lap-Shoulder Belt on page 3-20*.

According to accident statistics, children and infants are safer when properly restrained in a child restraint system or infant restraint system secured in a rear seating position.

## 3-42 Seats and Restraints

In a crash, children who are not buckled up can strike other people who are buckled up, or can be thrown out of the vehicle. Older children need to use safety belts properly.

### **WARNING**

Never do this.

Never allow two children to wear the same safety belt. The safety belt cannot properly spread the impact forces. In a crash, the two children can be crushed together and seriously injured. A safety belt must be used by only one person at a time.



### **WARNING**

Never do this.

Never allow a child to wear the safety belt with the shoulder belt behind their back. A child can be seriously injured by not wearing the lap-shoulder belt properly. In a crash, the child would not be restrained by the shoulder belt. The child could move too far forward increasing the chance of head and neck injury. The child

(Continued)

### **WARNING (Continued)**

might also slide under the lap belt. The belt force would then be applied right on the abdomen. That could cause serious or fatal injuries. The shoulder belt should go over the shoulder and across the chest.





## Infants and Young Children

Everyone in a vehicle needs protection! This includes infants and all other children. Neither the distance traveled nor the age and size of the traveler changes the need, for everyone, to use safety restraints. In fact, the law in every state in the United States and in every Canadian province says children up to some age must be restrained while in a vehicle.

### WARNING

Children can be seriously injured or strangled if a shoulder belt is wrapped around their neck and the safety belt continues to tighten. Never leave children unattended in a vehicle and never allow children to play with the safety belts.

Airbags plus lap-shoulder belts offer protection for adults and older children, but not for young children and infants. Neither the vehicle's safety belt system nor its airbag system is designed for them. Every time infants and young children ride in vehicles, they should have the protection provided by appropriate child restraints.

Children who are not restrained properly can strike other people, or can be thrown out of the vehicle.

### WARNING

Never do this.

Never hold an infant or a child while riding in a vehicle. Due to crash forces, an infant or a child will become so heavy it is not possible to hold it during a crash. For example, in a crash at only 40 km/h (25 mph), a 5.5 kg (12 lb) infant will suddenly become a

(Continued)

### WARNING (Continued)

110 kg (240 lb) force on a person's arms. An infant should be secured in an appropriate restraint.



### WARNING

Never do this.

Children who are up against, or very close to, any airbag when it inflates can be seriously injured or killed. Never put a rear-facing child restraint in the right front seat. Secure a rear-facing child restraint in a rear seat. It is also better to secure a forward-facing child restraint in a rear seat. If you must secure a forward-facing child restraint in the right front seat, always move the front passenger seat as far back as it will go.



#### **Q: What are the different types of add-on child restraints?**

**A:** Add-on child restraints, which are purchased by the vehicle owner, are available in four basic types. Selection of a particular restraint should take into consideration not only the child's weight, height, and age but also whether or not the restraint will be compatible with the motor vehicle in which it will be used.

For most basic types of child restraints, there are many different models available. When purchasing a child restraint, be sure it is designed to be used in a motor vehicle. If it is, the restraint will have a label saying that it meets federal motor vehicle safety standards.

The restraint manufacturer's instructions that come with the restraint state the weight and height limitations for a particular child restraint. In addition, there are many kinds of restraints available for children with special needs.

**⚠ WARNING**

To reduce the risk of neck and head injury during a crash, infants need complete support. This is because an infant's neck is not fully developed and its head weighs so much compared with the rest of its body. In a crash, an infant in a rear-facing child restraint settles into the restraint, so the crash forces can be distributed across the strongest part of an infant's body, the back and shoulders. Infants should always be secured in rear-facing child restraints.

**⚠ WARNING**

A young child's hip bones are still so small that the vehicle's regular safety belt may not remain low on the hip bones, as it should. Instead, it may settle up around the child's abdomen. In a crash, the belt would apply force on a body area that is unprotected by any bony structure. This alone could cause serious or fatal injuries. To reduce the risk of serious or fatal injuries during a crash, young children should always be secured in appropriate child restraints.

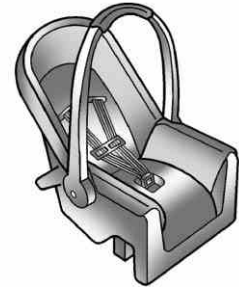
**Child Restraint Systems****(A) Rear-Facing Infant Seat**

A rear-facing infant seat (A) provides restraint with the seating surface against the back of the infant.

The harness system holds the infant in place and, in a crash, acts to keep the infant positioned in the restraint.



**(B) Forward-Facing Child Seat**

A forward-facing child seat (B) provides restraint for the child's body with the harness.

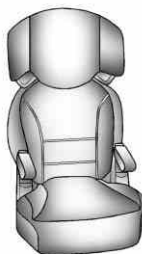
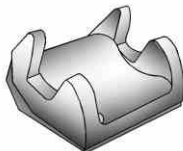

**(C) Booster Seats**

A booster seat (C) is a child restraint designed to improve the fit of the vehicle's safety belt system. A booster seat can also help a child to see out the window.

### Securing an Add-On Child Restraint in the Vehicle

**⚠ WARNING**

A child can be seriously injured or killed in a crash if the child restraint is not properly secured in the vehicle. Secure the child restraint properly in the vehicle using the vehicle safety belt or LATCH system, following the instructions that came with that child restraint and the instructions in this manual.

To help reduce the chance of injury, the child restraint must be secured in the vehicle. Child restraint systems must be secured in vehicle seats by lap belts or the lap belt portion of a lap-shoulder belt, or by the LATCH system. See *Lower Anchors and Tethers for Children (LATCH System)* on page 3-49 for more information.

Children can be endangered in a crash if the child restraint is not properly secured in the vehicle.

When securing an add-on child restraint, refer to the instructions that come with the restraint which may be on the restraint itself or in a booklet, or both, and to this manual. The child restraint instructions are important, so if they are not available, obtain a replacement copy from the manufacturer.

Keep in mind that an unsecured child restraint can move around in a collision or sudden stop and injure people in the vehicle. Be sure to properly secure any child restraint in the vehicle — even when no child is in it.

In some areas, Certified Child Passenger Safety Technicians (CPSTs) are available to inspect and demonstrate how to correctly use and install child restraints. In the U.S., refer to the National Highway Traffic Safety Administration (NHTSA) website to locate the nearest child safety seat inspection station. For CPST availability in Canada, check with Transport Canada or the Provincial Ministry of Transportation office.

### Securing the Child within the Child Restraint

 **WARNING**

A child can be seriously injured or killed in a crash if the child is not properly secured in the child restraint. Secure the child properly following the instructions that came with that child restraint.

### Where to Put the Restraint

According to accident statistics, children and infants are safer when properly restrained in a child restraint system or infant restraint system secured in a rear seating position.

We recommend that children and child restraints be secured in a rear seat, including: an infant or a child riding in a rear-facing child restraint; a child riding in a forward-facing child seat; an older child riding in a booster seat; and children, who are large enough, using safety belts.

## 3-48 Seats and Restraints

A label on your sun visor says, “Never put a rear-facing child seat in the front.” This is because the risk to the rear-facing child is so great, if the airbag deploys.

### **WARNING**

A child in a rear-facing child restraint can be seriously injured or killed if the right front passenger airbag inflates. This is because the back of the rear-facing child restraint would be very close to the inflating airbag. A child in a forward-facing child restraint can be seriously injured or killed if the right front passenger airbag inflates and the passenger seat is in a forward position.

Even if the passenger sensing system has turned off the right front passenger frontal airbag, no system is fail-safe. No one can guarantee that an airbag will not

(Continued)

### **WARNING (Continued)**

deploy under some unusual circumstance, even though it is turned off.

Secure rear-facing child restraints in a rear seat, even if the airbag is off. If you secure a forward-facing child restraint in the right front seat, always move the front passenger seat as far back as it will go. It is better to secure the child restraint in a rear seat.

See *Passenger Sensing System* on page 3-33 for additional information.

When securing a child restraint in a rear seating position, study the instructions that came with the child restraint to make sure it is compatible with this vehicle.

Child restraints and booster seats vary considerably in size, and some may fit in certain seating positions better than others. Always make sure the child restraint is properly secured.

Depending on where you place the child restraint and the size of the child restraint, you may not be able to access adjacent safety belt assemblies or LATCH anchors for additional passengers or child restraints. Adjacent seating positions should not be used if the child restraint prevents access to or interferes with the routing of the safety belt.

Wherever a child restraint is installed, be sure to secure the child restraint properly.

Keep in mind that an unsecured child restraint can move around in a collision or sudden stop and injure people in the vehicle. Be sure to properly secure any child restraint in your vehicle — even when no child is in it.

If you need to secure more than one child restraint in the rear seat, review the following illustrations. Depending on where you place the child restraint or the size of the child restraint, you may not be able to access certain safety belt assemblies or LATCH anchors for additional passengers or child restraints.

### Configurations for Use of Child Restraints

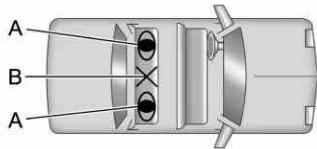

- A. Child restraint using LATCH
- B. Occupant prohibited

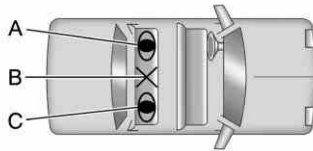

- A. Child restraint using LATCH
- B. Occupant prohibited
- C. Child restraint or occupant using safety belt

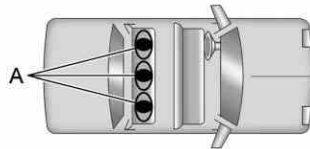

- A. Child restraint or occupant using safety belt

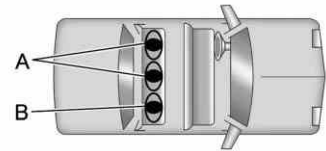

- A. Child restraint or occupant using safety belt
- B. Child restraint using LATCH

### Lower Anchors and Tethers for Children (LATCH System)

The LATCH system holds a child restraint during driving or in a crash. This system is designed to make installation of a child restraint easier. The LATCH system uses anchors in the vehicle and attachments on the child restraint that are made for use with the LATCH system.

## 3-50 Seats and Restraints

Make sure that a LATCH-compatible child restraint is properly installed using the anchors, or use the vehicle's safety belts to secure the restraint, following the instructions that came with that restraint, and also the instructions in this manual. When installing a child restraint with a top tether, you must also use either the lower anchors or the safety belts to properly secure the child restraint. A child restraint must never be installed using only the top tether and anchor.

In order to use the LATCH system in your vehicle, you need a child restraint that has LATCH attachments. The child restraint manufacturer will provide you with instructions on how to use the child restraint and its attachments. The following explains how to attach a child restraint with these attachments in your vehicle.

Not all vehicle seating positions or child restraints have lower anchors and attachments or top tether anchors and attachments.

### Lower Anchors

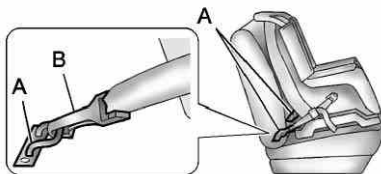

Lower anchors (A) are metal bars built into the vehicle. There are two lower anchors for each LATCH seating position that will accommodate a child restraint with lower attachments (B).

### Top Tether Anchor

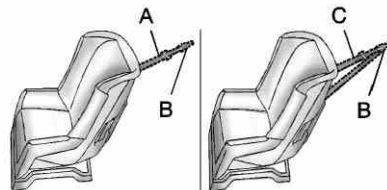

A top tether (A, C) anchors the top of the child restraint to the vehicle. A top tether anchor is built into the vehicle. The top tether attachment (B) on the child restraint connects to the top tether anchor in the vehicle in order to reduce the forward movement and rotation of the child restraint during driving or in a crash.



Your child restraint may have a single tether (A) or a dual tether (C). Either will have a single attachment (B) to secure the top tether to the anchor.

Some child restraints that have a top tether are designed for use with or without the top tether being attached. Others require the top tether always to be attached. In Canada, the law requires that forward-facing child restraints have a top tether, and that the tether be attached. Be sure to read and follow the instructions for your child restraint.

### Lower Anchor and Top Tether Anchor Locations

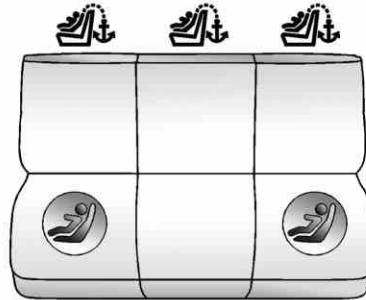

Rear Seat

 **(Top Tether Anchor):** Seating positions with top tether anchors.

 **(Lower Anchor):** Seating positions with two lower anchors.

The rear outboard seating positions have exposed metal anchors located in the crease between the seatback and the seat cushion.

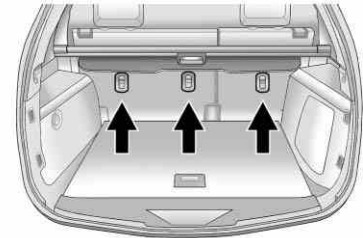

### Top Tether Anchors

The top tether anchors for each rear seating position are located on the back of the rear seatback. The rear compartment storage panel/cover might need to be adjusted to access the anchors. Be sure to use an anchor located on the same side of the vehicle as the seating position where the child restraint will be placed.

## 3-52 Seats and Restraints

Do not secure a child restraint in a position without a top tether anchor if a national or local law requires that the top tether be attached, or if the instructions that come with the child restraint say that the top tether must be attached.

According to accident statistics, children and infants are safer when properly restrained in a child restraint system or infant restraint system secured in a rear seating position. See *Where to Put the Restraint* on page 3-47 for additional information.

### Securing a Child Restraint Designed for the LATCH System

#### WARNING

If a LATCH-type child restraint is not attached to anchors, the child restraint will not be able to protect the child correctly. In a crash, the

(Continued)

#### WARNING (Continued)

child could be seriously injured or killed. Install a LATCH-type child restraint properly using the anchors, or use the vehicle safety belts to secure the restraint, following the instructions that came with the child restraint and the instructions in this manual.

#### WARNING

Do not attach more than one child restraint to a single anchor. Attaching more than one child restraint to a single anchor could cause the anchor or attachment to come loose or even break during a crash. A child or others could be injured. To reduce the risk of serious or fatal injuries during a crash, attach only one child restraint per anchor.

#### WARNING

Children can be seriously injured or strangled if a shoulder belt is wrapped around their neck and the safety belt continues to tighten. Buckle any unused safety belts behind the child restraint so children cannot reach them. Pull the shoulder belt all the way out of the retractor to set the lock, if the vehicle has one, after the child restraint has been installed.

**Notice:** Do not let the LATCH attachments rub against the vehicle's safety belts. This may damage these parts. If necessary, move buckled safety belts to avoid rubbing the LATCH attachments.

**Do not fold the empty rear seat with a safety belt buckled. This could damage the safety belt or the seat. Unbuckle and return the safety belt to its stowed position, before folding the seat.**

Make sure to attach the child restraint at the proper anchor location.

This system is designed to make installation of child restraints easier. When using lower anchors, do not use the vehicle's safety belts. Instead use the vehicle's anchors and child restraint attachments to secure the restraints. Some restraints also use another vehicle anchor to secure a top tether.

1. Attach and tighten the lower attachments to the lower anchors. If the child restraint does not have lower attachments or the desired seating position does not have lower anchors, secure the child

restraint with the top tether and the safety belts. Refer to the child restraint manufacturer instructions and the instructions in this manual.

- 1.1. Find the lower anchors for the desired seating position.
  - 1.2. Put the child restraint on the seat.
  - 1.3. Attach and tighten the lower attachments on the child restraint to the lower anchors.
2. If the child restraint manufacturer recommends that the top tether be attached, attach and tighten the top tether to the top tether anchor, if equipped. Refer to the child restraint instructions and the following steps:
    - 2.1. Find the top tether anchor.

- 2.2. Route, attach and tighten the top tether according to your child restraint instructions and the following instructions:

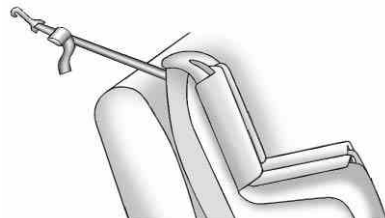

- If the position being used does not have a headrest or head restraint and a single tether is being used, route the tether over the seatback.

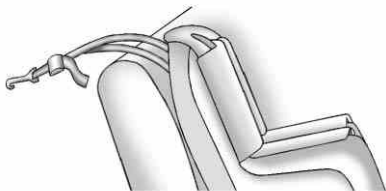

- If the position being used does not have a headrest or head restraint and a dual tether is being used, route the tether over the seatback.

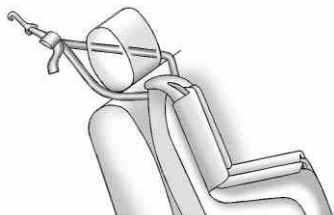

- If the position being used has a fixed headrest or head restraint and a dual

tether is being used, route the tether around the headrest or head restraint.

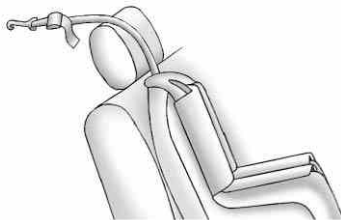

- If the position being used has a fixed headrest or head restraint and a single tether is being used, route the tether over the headrest or head restraint.
3. Before placing a child in the child restraint, make sure it is securely held in place. To check, grasp the child restraint at the LATCH path and attempt to move it side-to-side and back-and-forth. There should

be no more than 2.5 cm (1 in) of movement, for proper installation.

### Replacing LATCH System Parts After a Crash

#### WARNING

A crash can damage the LATCH system in the vehicle. A damaged LATCH system may not properly secure the child restraint, resulting in serious injury or even death in a crash. To help make sure the LATCH system is working properly after a crash, see your dealer to have the system inspected and any necessary replacements made as soon as possible.

If the vehicle has the LATCH system and it was being used during a crash, new LATCH system parts may be needed.

New parts and repairs may be necessary even if the LATCH system was not being used at the time of the crash.

## Securing Child Restraints (Rear Seat )

When securing a child restraint in a rear seating position, study the instructions that came with the child restraint to make sure it is compatible with this vehicle.

If the child restraint has the LATCH system, see *Lower Anchors and Tethers for Children (LATCH System)* on page 3-49 for how and where to install the child restraint using LATCH. If a child restraint is secured in the vehicle using a safety belt and it uses a top tether, see *Lower Anchors and Tethers for Children (LATCH System)* on page 3-49 for top tether anchor locations.

Do not secure a child seat in a position without a top tether anchor if a national or local law requires

that the top tether be anchored, or if the instructions that come with the child restraint say that the top strap must be anchored.

In Canada, the law requires that forward-facing child restraints have a top tether, and that the tether be attached.

If the child restraint does not have the LATCH system, you will be using the safety belt to secure the child restraint in this position. Be sure to follow the instructions that came with the child restraint. Secure the child in the child restraint when and as the instructions say.

If more than one child restraint needs to be installed in the rear seat, be sure to read *Where to Put the Restraint* on page 3-47.

1. Put the child restraint on the seat.
2. Pick up the latch plate, and run the lap and shoulder portions of the vehicle's safety

belt through or around the restraint. The child restraint instructions will show you how.



3. Push the latch plate into the buckle until it clicks.

Position the release button on the buckle so that the safety belt could be quickly unbuckled if necessary.

## 3-56 Seats and Restraints



4. Pull the shoulder belt all the way out of the retractor to set the lock. When the retractor lock is set, the belt can be tightened but not pulled out of the retractor.

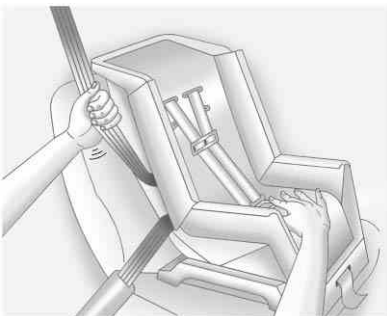

5. To tighten the belt, push down on the child restraint, pull the shoulder portion of the belt to tighten the lap portion of the belt, and feed the shoulder belt back into the retractor. When installing a forward-facing child restraint, it may be helpful to use your knee to push down on the child restraint as you tighten the belt.

Try to pull the belt out of the retractor to make sure the retractor is locked. If the retractor is not locked, repeat Steps 4 and 5.

6. If the child restraint has a top tether, follow the child restraint manufacturer's instructions regarding the use of the top tether. See *Lower Anchors and Tethers for Children (LATCH System)* on page 3-49 for more information.
7. Before placing a child in the child restraint, make sure it is securely held in place. To check, grasp the child restraint at the safety belt path and attempt to move it side to side and back and forth. When the child restraint is properly installed, there should be no more than 2.5 cm (1 in) of movement.

To remove the child restraint, unbuckle the vehicle safety belt and let it return to the stowed position. If the top tether is attached to a top tether anchor, disconnect it.

### Armrest Retaining Strap

**⚠ WARNING**

A rear center armrest that is not properly stowed and secured could fall forward during a sudden stop or collision. The armrest could contact an infant secured in a rear-facing child restraint in the center seat position. Fasten the retaining strap onto the stowed armrest before installing a rear-facing child restraint in the rear center seat position.



When new, the vehicle's glove box materials included an armrest retaining strap. Use it to secure the

center armrest before installing a rear-facing child restraint in the second row center seat position.

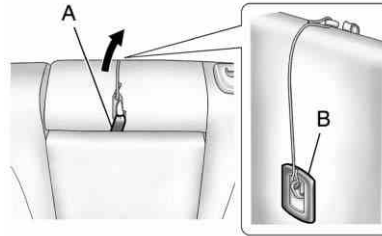

Stow the rear seat center armrest. Attach the retaining strap to the armrest loop (A) and to the center top tether anchor on the seatback (B). Make sure the retaining strap's clips are firmly attached.

Install the rear-facing child restraint using the child restraint manufacturer's instructions and the instructions described previously.

Remove the armrest retaining strap before installing a forward facing child restraint in the center seat position, as it may interfere with the attachment of the top tether to the top tether anchor on the seatback.

### Securing Child Restraints (Front Passenger Seat)

This vehicle has airbags. A rear seat is a safer place to secure a forward-facing child restraint. See *Where to Put the Restraint* on page 3-47.

In addition, the vehicle has a passenger sensing system which is designed to turn off the right front passenger frontal airbag under certain conditions. See *Passenger Sensing System* on page 3-33 and *Passenger Airbag Status Indicator* on page 5-11 for more information, including important safety information.

## 3-58 Seats and Restraints

A label on the sun visor says, “Never put a rear-facing child seat in the front.” This is because the risk to the rear-facing child is so great, if the airbag deploys.

### **WARNING**

A child in a rear-facing child restraint can be seriously injured or killed if the right front passenger airbag inflates. This is because the back of the rear-facing child restraint would be very close to the inflating airbag. A child in a forward-facing child restraint can be seriously injured or killed if the right front passenger airbag inflates and the passenger seat is in a forward position.

(Continued)

### **WARNING (Continued)**

Even if the passenger sensing system has turned off the right front passenger frontal airbag, no system is fail-safe. No one can guarantee that an airbag will not deploy under some unusual circumstance, even though it is turned off.

Secure rear-facing child restraints in a rear seat, even if the airbag is off. If you secure a forward-facing child restraint in the right front seat, always move the front passenger seat as far back as it will go. It is better to secure the child restraint in a rear seat.

See *Passenger Sensing System* on page 3-33 for additional information.

If the child restraint has the LATCH system, see *Lower Anchors and Tethers for Children (LATCH System)* on page 3-49 for how and where to install the child restraint using LATCH. If a child restraint is secured using a safety belt and it uses a top tether, see *Lower Anchors and Tethers for Children (LATCH System)* on page 3-49 for top tether anchor locations.

Do not secure a child seat in a position without a top tether anchor if a national or local law requires that the top tether be anchored, or if the instructions that come with the child restraint say that the top strap must be anchored.

In Canada, the law requires that forward-facing child restraints have a top tether, and that the tether be attached.



You will be using the lap-shoulder belt to secure the child restraint in this position. Follow the instructions that came with the child restraint.

1. Move the seat as far back as it will go before securing the forward-facing child restraint.

When the passenger sensing system has turned off the right front passenger frontal airbag and seat-mounted side impact airbag, the off indicator on the passenger airbag status indicator should light and stay lit when you start the vehicle. See *Passenger Airbag Status Indicator on page 5-11*.

2. Put the child restraint on the seat.
3. Pick up the latch plate, and run the lap and shoulder portions of the vehicle's safety belt through or around the restraint. The child restraint instructions will show you how.

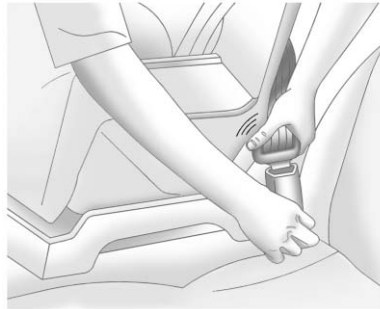

4. Push the latch plate into the buckle until it clicks.  
Position the release button on the buckle, so that the safety belt could be quickly unbuckled if necessary.



5. Pull the shoulder belt all the way out of the retractor to set the lock. When the retractor lock is set, the belt can be tightened but not pulled out of the retractor.

## 3-60 Seats and Restraints

---

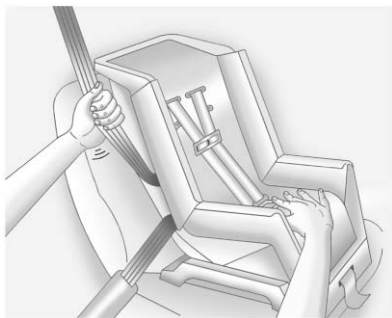

6. To tighten the belt, push down on the child restraint, pull the shoulder portion of the belt to tighten the lap portion of the belt, and feed the shoulder belt back into the retractor. When installing a forward-facing child restraint, it may be helpful to use your knee to push down on the child restraint as you tighten the belt.

Try to pull the belt out of the retractor to make sure the retractor is locked. If the retractor is not locked, repeat Steps 5 and 6.

If the vehicle does not have a rear seat and the child restraint has a top tether, follow the child restraint manufacturer's instructions regarding the use of the top tether. See *Lower Anchors and Tethers for Children (LATCH System)* on page 3-49 for more information.

7. Before placing a child in the child restraint, make sure it is securely held in place. To check, grasp the child restraint at the safety belt path and attempt to move it side to side and back and forth. When the child restraint is properly installed, there should be no more than 2.5 cm (1 in) of movement.

If the airbags are off, the off indicator in the passenger airbag status indicator will come on and stay on when the vehicle is started.

If a child restraint has been installed and the on indicator is lit, see "If the On Indicator is Lit for a Child Restraint" under *Passenger Sensing System* on page 3-33 for more information.

To remove the child restraint, unbuckle the vehicle safety belt and let it return to the stowed position.

## Storage

### Storage Compartments

|                          |     |
|--------------------------|-----|
| Instrument Panel Storage | 4-1 |
| Glove Box                | 4-1 |
| Cupholders               | 4-1 |
| Center Console Storage   | 4-1 |

### Additional Storage Features

|                 |     |
|-----------------|-----|
| Cargo Cover     | 4-2 |
| Cargo Tie-Downs | 4-2 |
| Convenience Net | 4-2 |

### Roof Rack System

|                  |     |
|------------------|-----|
| Roof Rack System | 4-2 |
|------------------|-----|

## Storage Compartments

### Instrument Panel Storage

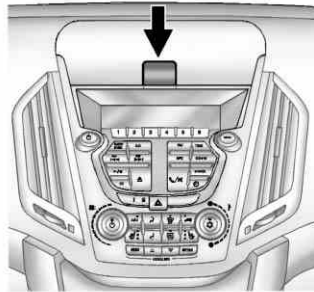

There may be a storage compartment on the instrument panel. Pull the handle to open.

### Glove Box

Open the glove box by lifting up on the lever.

## Cupholders

Two cupholders are in the center console. Cupholders may be located in the second row seat armrest. To access, pull the armrest down.

### Center Console Storage

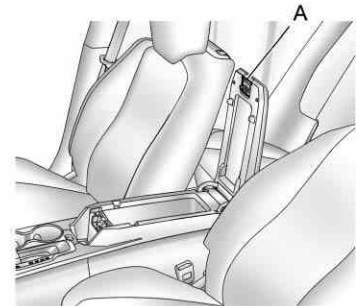

For vehicles with a center console storage, use the lever (A) on the front to open.

### Additional Storage Features

#### Cargo Cover

For vehicles with a cargo cover, use it to cover items in the rear of the vehicle.

To remove the cover from the vehicle, pull both ends toward each other. To reinstall, place each end of the cover in the holes behind the rear seat.

#### Cargo Tie-Downs

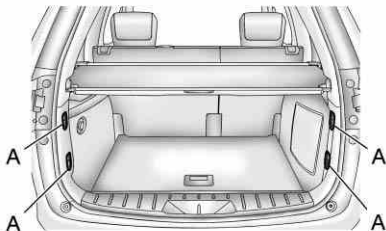

The vehicle may be equipped with four cargo tie downs (A) located in the rear compartment.

#### Convenience Net

This vehicle may have a convenience net located in the rear of the vehicle. Attach it to the cargo tie-downs for storing small loads.

Do not use the net to store heavy loads.

### Roof Rack System

#### WARNING

If something is carried on top of the vehicle that is longer or wider than the roof rack — like paneling, plywood, or a mattress — the wind can catch it while the vehicle is being driven. The item being carried could be violently torn off, and this could cause a collision and damage the vehicle. Never carry something longer or wider than the roof rack on top of the vehicle unless using a GM certified accessory carrier.

This vehicle may be equipped with a roof rack. For roof racks that do not have cross rails included, GM certified cross rails can be purchased as an accessory. See your dealer for additional information.

**Notice:** Loading cargo on the roof rack that weighs more than 100 kg (220 lbs) or hangs over the rear or sides of the vehicle may damage the vehicle. Load cargo so that it rests evenly between the crossrails, making sure to fasten cargo securely.

To prevent damage or loss of cargo when driving, check to make sure cross rails and cargo are securely fastened. Loading cargo on the roof rack will make the vehicle's center of gravity higher. Avoid high speeds, sudden starts, sharp turns, sudden braking, or abrupt maneuvers; otherwise it may result in loss of control. If driving for a long distance, on rough roads, or at high speeds, occasionally stop the vehicle to make sure the cargo remains in its place. Do not exceed the maximum vehicle capacity when loading the vehicle. For more information on vehicle capacity and loading, see *Vehicle Load Limits on page 9-21*.

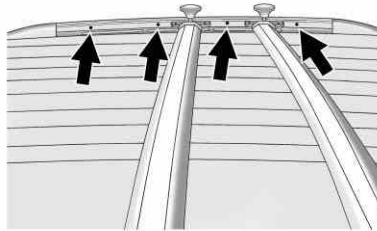

The roof rack cross rails can be locked in four positions along the roof rack side rails. These are the only positions that the cross rails will lock.

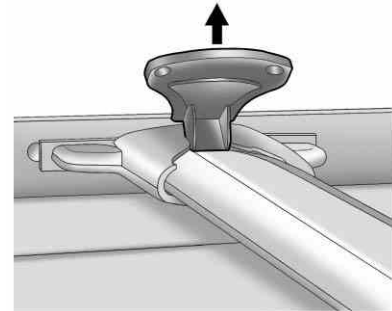

Lift the lever to release and move the cross rail.

Position the cross rail on both sides of the vehicle at the same time.

## 4-4 Storage

---

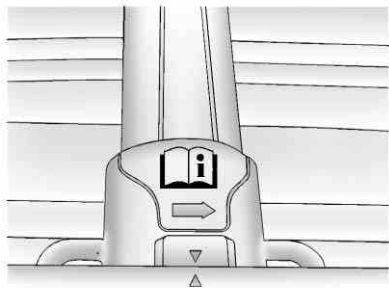

Push the lever down to completely engage into the side rail holes. If the lever is not tight, then the cross rail is not engaged in a side rail hole.

Slide the cross rails back and forth until the lock pins engage in the holes and a click is heard as the pins align and the cross rail locks.

Try sliding the cross rails forward and backward to ensure that they are correctly secured and that the levers stay tight to the cross rails.

Do not stand on the plastic lower body panels when loading cargo on the roof rack.

When the roof rack is not in use, lock one cross rail at the furthest forward position and lock the other cross rail at the furthest rearward position to reduce wind noise.

# Instruments and Controls

## Controls

- Steering Wheel Adjustment ... 5-2
- Steering Wheel Controls ..... 5-2
- Horn ..... 5-3
- Windshield Wiper/Washer ..... 5-3
- Rear Window Wiper/  
Washer ..... 5-4
- Compass ..... 5-4
- Clock (With Date Display) ..... 5-5
- Clock (Without Date  
Display) ..... 5-6
- Power Outlets ..... 5-6

## Warning Lights, Gauges, and Indicators

- Warning Lights, Gauges, and  
Indicators ..... 5-7
- Instrument Cluster ..... 5-8
- Speedometer ..... 5-9

- Odometer ..... 5-9
- Tachometer ..... 5-9
- Fuel Gauge ..... 5-9
- Engine Coolant Temperature  
Gauge ..... 5-10
- Safety Belt Reminders ..... 5-10
- Airbag Readiness Light ..... 5-11
- Passenger Airbag Status  
Indicator ..... 5-11
- Charging System Light ..... 5-12
- Malfunction  
Indicator Lamp ..... 5-13
- Brake System Warning  
Light ..... 5-15
- Antilock Brake System (ABS)  
Warning Light ..... 5-16
- Traction Off Light ..... 5-16
- StabiliTrak<sup>®</sup> OFF Light ..... 5-16
- Traction Control System  
(TCS)/StabiliTrak<sup>®</sup> Light .... 5-17
- Tire Pressure Light ..... 5-17
- Engine Oil Pressure Light .... 5-18
- Fuel Economy Light ..... 5-18
- Low Fuel Warning Light ..... 5-19

- Security Light ..... 5-19
- High-Beam On Light ..... 5-19
- Front Fog Lamp Light ..... 5-20
- Lamps On Reminder ..... 5-20
- Cruise Control Light ..... 5-20

## Information Displays

- Driver Information  
Center (DIC) ..... 5-20

## Vehicle Messages

- Vehicle Messages ..... 5-24
- Battery Voltage and Charging  
Messages ..... 5-24
- Brake System Messages .... 5-24
- Compass Messages ..... 5-24
- Cruise Control Messages .... 5-25
- Door Ajar Messages ..... 5-25
- Engine Cooling System  
Messages ..... 5-25
- Engine Oil Messages ..... 5-26
- Engine Power Messages .... 5-26
- Fuel System Messages ..... 5-27
- Key and Lock Messages ..... 5-27

## 5-2 Instruments and Controls

|   |      |
|---|------|
| Object Detection System<br>Messages ..... | 5-27 |
| Ride Control System<br>Messages .....     | 5-27 |
| Airbag System Messages ....               | 5-28 |
| Safety Belt Messages .....                | 5-28 |
| Anti-Theft Alarm System<br>Messages ..... | 5-28 |
| Service Vehicle Messages ...              | 5-28 |
| Tire Messages .....                       | 5-28 |
| Transmission Messages ....                | 5-29 |
| Vehicle Reminder<br>Messages .....        | 5-29 |

### Vehicle Personalization

|                               |      |
|-------------------------------|------|
| Vehicle Personalization ..... | 5-30 |
|-------------------------------|------|

## Controls

### Steering Wheel Adjustment

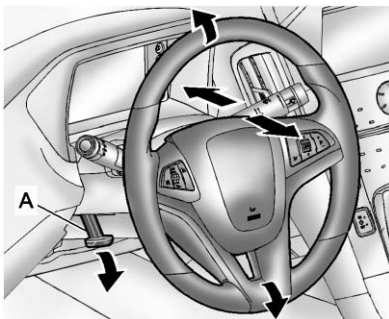

To adjust the steering wheel:

1. Pull the lever (A) down.
2. Move the steering wheel up or down.

3. Pull or push the steering wheel closer or away from you.
4. Pull the lever (A) up to lock the steering wheel in place.

Do not adjust the steering wheel while driving.

### Steering Wheel Controls



For vehicles with audio steering wheel controls, some audio controls can be adjusted at the steering wheel.



 **(Push to Talk):** For vehicles with a Bluetooth® or OnStar®, press to interact with those systems. See *Bluetooth (Overview) on page 7-45* or *Bluetooth (Infotainment Controls) on page 7-46* or *Bluetooth (Voice Recognition) on page 7-51* or the OnStar Owner's Guide for more information.

 **(Mute/End Call):** Press to reject an incoming call, or end a current call. Press to silence the vehicle speakers while using the infotainment system. Press again to turn the sound on.

 **(Toggle Switch):** Press to select an audio source.

Toggle up or down to select the next or previous favorite radio station or CD/MP3 track.

 **(Volume):** Press + or - to increase or decrease the volume.

## Horn

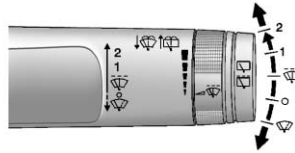

Press near the horn symbols or press on the steering wheel pad to sound the horn.

## Windshield Wiper/Washer





The windshield wiper/washer lever is located on the right side of the steering column.

Move the lever to one of the following positions:

 **(Mist):** Use for a single wipe, move the lever to  and then release. The wipers stop after one wipe.

 **(Off):** Use to turn the wipers off.

 **(Adjustable Interval Wipes):** For adjustable interval wipes. Turn the  band up for more frequent wipes or down for less frequent wipes.

**1 (Low Speed):** Use for slow wipes.

**2 (High Speed):** Use for fast wipes.

Clear snow and ice from the wiper blades before using them. If frozen to the windshield, carefully loosen or thaw them. Damaged wiper blades should be replaced. See *Wiper Blade Replacement on page 10-30*.

Heavy snow or ice can overload the wiper motor. A circuit breaker will stop the motor until it cools down.

## 5-4 Instruments and Controls

### Windshield Washer

Pull the lever toward you to spray washer fluid on the windshield. The spray continues until the lever is released. The wipers will run a few times. See *Washer Fluid* on page 10-23 for information on filling the windshield washer fluid reservoir.

#### **WARNING**

In freezing weather, do not use the washer until the windshield is warmed. Otherwise the washer fluid can form ice on the windshield, blocking your vision.

### Rear Window Wiper/Washer

The rear wiper controls are on the end of the windshield wiper lever.

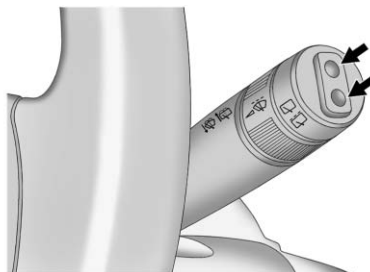

Press the upper or lower portion of the button to control the rear wiper and rear wiper delay.

The system turns off when the button is returned to the middle position.

 **(Rear Wiper):** For continuous rear window wipes.

 **(Rear Wiper Delay):** Sets a delay between wipes.

 **(Rear Washer):** Push the windshield wiper lever forward to spray washer fluid on the rear window. The lever returns to its starting position when released.

The windshield washer reservoir is used for the windshield and the rear window. Check the fluid level in the reservoir if either washer is not working. See *Washer Fluid* on page 10-23.

### Compass

The vehicle may have a compass display on the Driver Information Center (DIC). The compass receives its heading and other information from the Global Positioning System (GPS) antenna, StabiliTrak, and vehicle speed information.

Avoid covering the GPS antenna for long periods of time with objects that may interfere with the antenna's ability to receive a satellite signal.

See *Multi-Band Antenna* on page 7-18 for the location of the vehicle's antenna. The compass system is designed to operate for a certain number of miles or degrees of turn before needing a signal from the GPS satellites. When the compass display shows CAL, drive the vehicle for a short distance in an open area where it can receive a GPS signal. The compass system will automatically determine when a GPS signal is restored and provide a heading again. See *Compass Messages* on page 5-24 for more information on the messages that may be displayed for the compass.

## **Clock (With Date Display)**

The infotainment system controls, located on the instrument panel, are used to access the time and date settings through the menu system. See *Operation* on page 7-7 for information about how to use the menu system.

### **Setting the Time and Date**

1. Turn the infotainment system ON.
2. Press the CONFIG button and select Time and Date Settings.
3. Select Set Time or Set Date.
4. Turn the MENU/SEL knob to adjust the highlighted value.
5. Press the MENU/SEL knob to select the next value.
6. To save the time or date and return to the Time and Date Settings menu, press the ◀ BACK button at any time or press the MENU/SEL knob after adjusting the minutes or year.

### **Setting the 12/24 Hour Format**

1. Turn the infotainment system ON.
2. Press the CONFIG button and select Time and Date Settings.
3. Highlight 12/24 Hour Format.

4. Press the MENU/SEL knob to select the 12 hour or 24 hour display format.

### **Setting the Month and Day Format**

1. Turn the infotainment system ON.
2. Press the CONFIG button and select Time and Date Settings.
3. Highlight Month and Day Format.
4. Press the MENU/SEL knob to select MM/DD (month/day) or DD/MM (day/month).

### **Setting the Auto Time Adjust (If Equipped)**

1. Turn the infotainment system ON.
2. Press the CONFIG button and select Time and Date Settings.
3. Highlight Auto Time Adjust.
4. Press the MENU/SEL knob to turn Auto Time Adjust on or off.

## 5-6 Instruments and Controls

---

5. Press the MENU/SEL knob to select Time Zone, and then select the time zone.
6. Press the MENU/SEL knob to turn Daylight Savings on or off.

### Clock (Without Date Display)

The infotainment system controls, located on the instrument panel, are used to access the time and date settings through the menu system. See *Operation on page 7-7* for information about how to use the menu system.

#### Setting the Time

1. Turn the infotainment system ON.
2. Press the CONFIG button and select Time Settings, or press the ⌚ button.

3. Select Set Time.
4. Turn the MENU/SEL knob to adjust the highlighted value.
5. Press the MENU/SEL knob to select the next value.
6. To save the time and return to the Time Settings menu, press the ⬅ BACK button at any time or press the SELECT button after adjusting the minutes.

#### Setting the 12/24 Hour Format

1. Turn the infotainment system ON.
2. Press the CONFIG button and select Time Settings, or press the ⌚ button.
3. Highlight 12/24 Hour Format.
4. Press the MENU/SEL knob to select the 12 hour or 24 hour display format.

### Power Outlets

The accessory power outlets can be used to connect electrical equipment, such as a cell phone or MP3 player.

There are four accessory power outlets in the following locations: below the CD slot, inside the center console storage, on the rear of the center console storage, and in the rear cargo compartment.

To use the outlets, remove the cover and close when not in use.

**Notice:** Leaving electrical equipment plugged in for an extended period of time while the vehicle is off will drain the battery. Always unplug electrical equipment when not in use and do not plug in equipment that exceeds the maximum 20 ampere rating.

Certain accessory plugs may not be compatible with the accessory power outlets and could overload vehicle and adapter fuses. If a problem is experienced, see your dealer.

When adding electrical equipment, be sure to follow the installation instructions included with the equipment. See *Add-On Electrical Equipment* on page 9-64.

**Notice: Hanging heavy equipment from the power outlet can cause damage not covered by the vehicle warranty. The power outlets are designed for accessory power plugs only, such as cell phone charge cords.**

## Warning Lights, Gauges, and Indicators

Warning lights and gauges can signal that something is wrong before it becomes serious enough to cause an expensive repair or replacement. Paying attention to the warning lights and gauges could prevent injury.

Warning lights come on when there could be a problem with a vehicle function. Some warning lights come on briefly when the engine is started to indicate they are working.

Gauges can indicate when there could be a problem with a vehicle function. Often gauges and warning lights work together to indicate a problem with the vehicle.

When one of the warning lights comes on and stays on while driving, or when one of the gauges shows there may be a problem, check the section that explains what to do. Follow this manual's advice. Waiting to do repairs can be costly and even dangerous.

## 5-8 Instruments and Controls

---

### Instrument Cluster

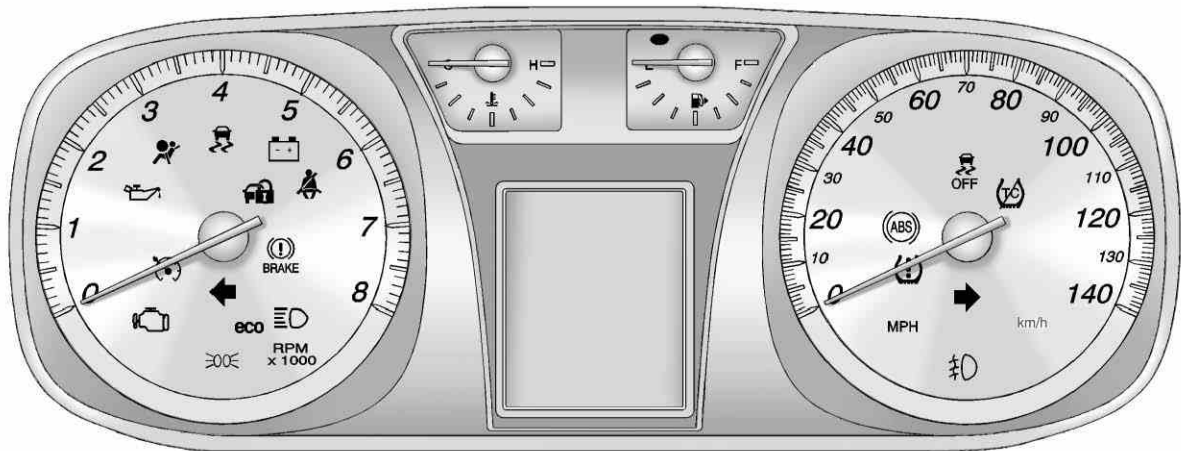

English Shown, Metric Similar

## Speedometer

The vehicle's speed can be selected to display on the Driver Information Center (DIC) and the speedometer in either kilometers per hour (km/h) or miles per hour (mph). Telltales on the speedometer indicate whether kilometers or miles were chosen. The DIC will show the vehicle's speed after the limit on the speedometer has been reached.

## Odometer

The odometer shows how far the vehicle has been driven, in either kilometers or miles.

This vehicle has a tamper-resistant odometer. The digital odometer will read 999,999 if it is turned back.

If the vehicle needs a new odometer installed, it must be set to the mileage total of the old odometer.

## Tachometer

The tachometer displays the engine speed in revolutions per minute (rpm).

## Fuel Gauge

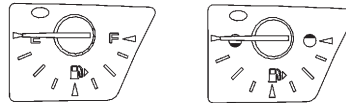

English

Metric

When the ignition is on, the fuel gauge shows about how much fuel the vehicle has left in the fuel tank.

An arrow on the fuel gauge indicates the side of the vehicle the fuel door is on.

The gauge will first indicate empty before the vehicle is out of fuel and the low fuel light comes on, but the vehicle's fuel tank should be filled soon.

Here are some situations that can occur with the fuel gauge. None of these indicate a problem with the fuel gauge.

- At the service station, the fuel pump shuts off before the gauge reads full.
- It takes a little more or less fuel to fill up than the gauge indicated. For example, the gauge may have indicated the tank was half full, but it actually took a little more or less than half the tank's capacity to fill the tank.
- The gauge moves a little while turning a corner or speeding up.
- The gauge takes a few seconds to stabilize after the ignition is turned on, and goes back to empty when the ignition is turned off.

### Engine Coolant Temperature Gauge

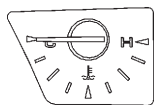

English

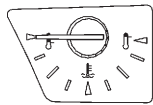

Metric

This gauge measures the temperature of the vehicle's engine.

If the indicator needle moves to the hot side of the gauge toward the colored line, the engine is too hot.

If the vehicle has been operated under normal driving conditions, pull off the road, stop the vehicle, and turn off the engine as soon as possible.

### Safety Belt Reminders

#### Driver Safety Belt Reminder Light

There is a driver safety belt reminder light on the instrument panel cluster.



When the engine is started this light and a chime come on and stay on for several seconds to remind drivers to fasten their safety belts. The light also begins to flash.

This cycle repeats if the driver remains unbuckled and the vehicle is moving.

If the driver safety belt is already buckled, neither the light nor chime comes on.

#### Passenger Safety Belt Reminder Light

The passenger safety belt reminder light is by the passenger airbag status indicator.



When the engine is started this light and the chime come on and stay on for several seconds to remind the passenger to fasten their safety belt. The light also begins to flash.

This cycle repeats if the passenger remains unbuckled and the vehicle is moving.

If the passenger safety belt is buckled, neither the chime nor the light comes on.

The front passenger safety belt warning light and chime may turn on if an object is put on the seat such



as a briefcase, handbag, grocery bag, laptop, or other electronic device. To turn off the warning light and/or chime, remove the object from the seat or buckle the safety belt.

## Airbag Readiness Light

This light shows if there is an electrical problem. The system check includes the airbag sensor, the pretensioners, the airbag modules, the wiring, and the crash sensing and diagnostic module. For more information on the airbag system, see *Airbag System on page 3-26*.



The airbag readiness light comes on and stays on for several seconds when the vehicle is started. Then the light goes out.

### WARNING

If the airbag readiness light stays on after the vehicle is started or comes on while driving, it means the airbag system might not be working properly. The airbags in the vehicle might not inflate in a crash, or they could even inflate without a crash. To help avoid injury, have the vehicle serviced right away.

## Passenger Airbag Status Indicator

The vehicle has a passenger sensing system. See *Passenger Sensing System on page 3-33* for important safety information. The overhead console has a passenger airbag status indicator.



### United States



### Canada and Mexico

When the vehicle is started, the passenger airbag status indicator will light ON and OFF, or the symbol for on and off, for several seconds as a system check. If you are using remote start, if equipped, to start the vehicle from a distance, you may not see the system check.

## 5-12 Instruments and Controls

Then, after several more seconds, the status indicator will light either ON or OFF, or either the on or off symbol to let you know the status of the right front passenger frontal airbag.

If the word ON or the on symbol is lit on the passenger airbag status indicator, it means that the right front passenger frontal airbag is enabled (may inflate).

If the word OFF or the off symbol is lit on the passenger airbag status indicator, it means that the passenger sensing system has turned off the right front passenger frontal airbag.

If, after several seconds, both status indicator lights remain on, or if there are no lights at all, there may be a problem with the lights or the passenger sensing system. See your dealer for service.

### **WARNING**

If the airbag readiness light ever comes on and stays on, it means that something may be wrong with the airbag system. To help avoid injury to yourself or others, have the vehicle serviced right away. See *Airbag Readiness Light* on page 5-11 for more information, including important safety information.

### **Charging System Light**



The charging system light comes on briefly when the ignition is turned on, but the engine is not running, as a check to show the light is working.

The light turns off when the engine is started. If it does not, have the vehicle serviced by your dealer.

If the light stays on, or comes on while driving, there may be a problem with the electrical charging system. Have it checked by your dealer. Driving while this light is on could drain the battery.

When this light comes on, the Driver Information Center (DIC) also displays a message.

See *Battery Voltage and Charging Messages* on page 5-24.

If a short distance must be driven with the light on, be sure to turn off all accessories, such as the radio and air conditioner.

## Malfunction Indicator Lamp

A computer system called OBD II (On-Board Diagnostics-Second Generation) monitors operation of the fuel, ignition, and emission control systems. It ensures that emissions are at acceptable levels for the life of the vehicle, helping to produce a cleaner environment.



This light should come on when the ignition is on, but the engine is not running, as a check to show it is working. If it does not, have the vehicle serviced by your dealer.

If the Malfunction Indicator Lamp comes on and stays on while the engine is running, this indicates that there is an OBD II problem and service is required.

Malfunctions often are indicated by the system before any problem is apparent. Being aware of the light can prevent more serious damage to the vehicle. This system assists the service technician in correctly diagnosing any malfunction.

**Notice:** If the vehicle is continually driven with this light on the emission controls might not work as well, the vehicle fuel economy might not be as good, and the engine might not run as smoothly. This could lead to costly repairs that might not be covered by the vehicle warranty.

**Notice:** Modifications made to the engine, transmission, exhaust, intake, or fuel system of the vehicle or the replacement of the original tires with other than those of the same Tire Performance Criteria (TPC) can affect the vehicle's emission controls and can cause this light to come on. Modifications to these systems could lead to costly repairs not covered by

the vehicle warranty. This could also result in a failure to pass a required Emission Inspection/Maintenance test. See *Accessories and Modifications on page 10-3*.

This light comes on during a malfunction in one of two ways:

**Light Flashing:** A misfire condition has been detected. A misfire increases vehicle emissions and could damage the emission control system on the vehicle. Diagnosis and service might be required.

To prevent more serious damage to the vehicle:

- Reduce vehicle speed.
- Avoid hard accelerations.
- Avoid steep uphill grades.
- If towing a trailer, reduce the amount of cargo being hauled as soon as it is possible.

## 5-14 Instruments and Controls

If the light continues to flash, when it is safe to do so, stop the vehicle. Find a safe place to park the vehicle. Turn the vehicle off, wait at least 10 seconds, and restart the engine. If the light is still flashing, follow the previous steps and see your dealer for service as soon as possible.

**Light On Steady:** An emission control system malfunction has been detected on the vehicle. Diagnosis and service might be required.

The following may correct an emission system malfunction:

- Make sure the fuel cap is fully installed. See *Filling the Tank* on page 9-55. The diagnostic system can determine if the fuel cap has been left off or improperly installed. A loose or missing fuel cap allows fuel to evaporate into the atmosphere. A few driving trips with the cap properly installed should turn the light off.

- Make sure the electrical system is not wet. The system could be wet if the vehicle was driven through a deep puddle of water. The condition is usually corrected when the electrical system dries out. A few driving trips should turn the light off.
- Make sure to fuel the vehicle with quality fuel. Poor fuel quality causes the engine not to run as efficiently as designed and can cause: stalling after start-up, stalling when the vehicle is changed into gear, misfiring, hesitation on acceleration, or stumbling on acceleration. These conditions might go away once the engine is warmed up.

If one or more of these conditions occurs, change the fuel brand used. It will require at least one full tank of the proper fuel to turn the light off.

See *Recommended Fuel* on page 9-52.

If none of the above have made the light turn off, your dealer can check the vehicle. The dealer has the proper test equipment and diagnostic tools to fix any mechanical or electrical problems that might have developed.

### Emissions Inspection and Maintenance Programs

Some local governments may have programs to inspect the on-vehicle emission control equipment. For the inspection, the emission system test equipment is connected to the vehicle's Data Link Connector (DLC).

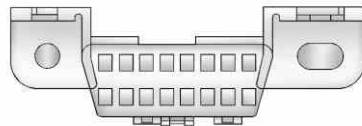

The DLC is under the instrument panel to the left of the steering wheel. See your dealer if assistance is needed.

The vehicle may not pass inspection if:

- The Malfunction Indicator Lamp is on with the engine running, or if the light does not come on when the ignition is turned to ON/RUN while the engine is off.
- The critical emission control systems have not been completely diagnosed by the system. This can happen if the battery has recently been replaced or if the battery has run down. The diagnostic system evaluates critical emission control systems during normal driving. This can take several days of routine driving. If this has been done and the vehicle still does not pass the inspection, your dealer can prepare the vehicle for inspection.

## Brake System Warning Light

The vehicle brake system consists of two hydraulic circuits. If one circuit is not working, the remaining circuit can still work to stop the vehicle. For normal braking performance, both circuits need to be working



BRAKE

English



Metric

The brake indicator light should come on briefly as the engine is started. If it does not come on have the vehicle serviced by your dealer.

When the ignition is on, the brake system warning light comes on when the parking brake is set. The light stays on if the parking brake does not fully release. If it stays on

after the parking brake is fully released, there is a brake problem. Have the brake system inspected immediately.

### WARNING

The brake system might not be working properly if the brake system warning light is on. Driving with the brake system warning light on can lead to a crash. If the light is still on after the vehicle has been pulled off the road and carefully stopped, have the vehicle towed for service.

If the light comes on while driving, a chime sounds. Pull off the road and stop. The pedal might be harder to push or go closer to the floor. It might also take longer to stop. If the light is still on, have the vehicle towed for service. See *Towing the Vehicle on page 10-79.*

## Antilock Brake System (ABS) Warning Light



For vehicles with the Antilock Brake System (ABS), this light comes on briefly when the engine is started.

If the light does not come on, have it fixed so it will be ready to warn if there is a problem.

If the ABS light comes on and stays on while driving, stop as soon as possible and turn the ignition off. Start the engine again to reset the system. If the light stays on after driving at a speed above 20 km/h (13 mph), see your dealer for service. A chime may also sound when the light comes on steady.

If the regular brake system warning light is not on, the vehicle still has brakes, but not antilock brakes. If the regular brake system warning light is also on, the vehicle does not have antilock brakes and there is a problem with the regular brakes. See *Brake System Warning Light* on page 5-15.

See *Brake System Messages* on page 5-24 for all brake-related DIC messages.

## Traction Off Light



This light comes on briefly while starting the engine. If it does not, have the vehicle serviced by your dealer. If the system is working normally, the indicator light then turns off.

The traction off light comes on when the Traction Control System (TCS) has been turned off by pressing and releasing the traction control button.

This light and the StabiliTrak Off light come on when StabiliTrak is turned off.

If the Traction Control System (TCS) is off, wheelspin is not limited. Adjust driving accordingly.

See *Traction Control System (TCS)* on page 9-39 and *StabiliTrak® System* on page 9-41 for more information.

## StabiliTrak® OFF Light



This light comes on when the StabiliTrak system is turned off. If the Traction Control System (TCS) is off, wheel spin is not limited.

If the StabiliTrak system is off, the system does not assist in controlling the vehicle. Turn on the TCS and the StabiliTrak system and the warning light turns off.

Check the DIC for applicable messages. See *Ride Control System Messages* on page 5-27 for more information.

See *Traction Control System (TCS)* on page 9-39 and *StabiliTrak® System* on page 9-41 for more information.

## Traction Control System (TCS)/StabiliTrak® Light



The StabiliTrak system or the Traction Control System (TCS) indicator/warning light come on briefly when the engine is started.

If the light does not come on, have the vehicle serviced by the dealer. If the system is working normally, the indicator light turns off.

If the light is on and not flashing, the TCS, and potentially the StabiliTrak system have been disabled. A DIC message may display. Check the DIC messages to determine which feature(s) is no longer functioning and whether the vehicle requires service.

If the indicator/warning light is on and flashing, the TCS and/or the StabiliTrak system is actively working.

See *StabiliTrak® System* on page 9-41 and *Traction Control System (TCS)* on page 9-39 for more information.

## Tire Pressure Light



For vehicles with the Tire Pressure Monitor System (TPMS), this light comes on briefly when the engine is started. It provides information about tire pressures and the TPMS.

### When the Light is On Steady

This indicates that one or more of the tires are significantly underinflated.

A tire pressure message can accompany the light. See *Tire Messages* on page 5-28 for more information. Stop as soon as possible, and inflate the tires to the pressure value shown on the Tire and Loading Information label. See *Tire Pressure* on page 10-51 for more information.

### When the Light Flashes First and Then is On Steady

This indicates that there may be a problem with the TPMS. The light flashes for about a minute and stays on steady for the remainder of the ignition cycle. This sequence repeats with every ignition cycle. See *Tire Pressure Monitor Operation* on page 10-54 for more information.

### Engine Oil Pressure Light

#### **WARNING**

Do not keep driving if the oil pressure is low. The engine can become so hot that it catches fire. Someone could be burned. Check the oil as soon as possible and have the vehicle serviced.

**Notice:** Lack of proper engine oil maintenance can damage the engine. The repairs would not be covered by the vehicle warranty. Always follow the maintenance schedule for changing engine oil.



The oil pressure light should come on briefly as the engine is started. If it does not come on have the vehicle serviced by your dealer.

If the light comes on and stays on, it means that oil is not flowing through the engine properly. The vehicle could be low on oil and might have some other system problem. See your dealer.

### Fuel Economy Light

# eco

For vehicles with the fuel economy mode light, it comes on when the eco (economy) switch, located on the center console near the shifter, is pressed. For vehicles with a Driver Information Center (DIC) an ECO MODE ON message displays. See *Fuel System Messages* on page 5-27 for more information. Press the switch again to turn off the light and exit the fuel saver mode.



## Low Fuel Warning Light

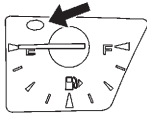

### English Shown, Metric Similar

This light comes on for a few seconds when the ignition is turned on as a check to indicate it is working. If it does not come on, have it fixed.

The low fuel warning light is a circle located on the fuel gauge. This light comes on and a chime sounds periodically when the vehicle is low on fuel. The light goes off when fuel is added to the fuel tank.

For vehicles with a Driver Information Center (DIC), see *Fuel System Messages on page 5-27* for more information.

## Security Light



The security light comes on briefly when the engine is started. If it does not have the vehicle serviced by your dealer.

This light comes on if there is a problem with the security system, or if the vehicle has been tampered with.

For more information, see *Vehicle Security on page 2-12*.

## High-Beam On Light



The high-beam on light comes on when the high-beam headlamps are in use.

See *Headlamp High/Low-Beam Changer on page 6-2* for more information.

## Front Fog Lamp Light



The front fog lamp light comes on when the fog lamps are in use.

The light goes out when the fog lamps are turned off. See *Fog Lamps* on page 6-4 for more information.

## Lamps On Reminder



For vehicles with the lamps on reminder light, it comes on when the lights are in use.

## Cruise Control Light



The cruise control light is white whenever the cruise control is set, and turns green when the cruise control is active.

The light turns off when the cruise control is turned off. See *Cruise Control* on page 9-42 for more information.

## Information Displays

### Driver Information Center (DIC)

The vehicle may have a Driver Information Center (DIC). It displays information about the vehicle and warning messages if there is a system problem detected. DIC messages display in the center of the instrument panel cluster. See *Vehicle Messages* on page 5-24 for more information.

The vehicle may also have features that can be customized through the controls on the radio. See *Vehicle Personalization* on page 5-30 for more information.

### DIC Operation and Displays

Use the DIC buttons located in the center of the instrument panel to access different displays. The DIC displays trip, fuel, vehicle system information, and warning messages.

It also shows the shift lever position, the odometer, and the direction the vehicle is driving.

### DIC Buttons

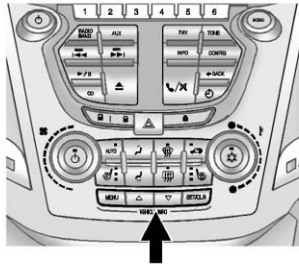

**MENU:** Press this button to get to the Trip/Fuel Menu and the Vehicle Information Menu.

△ ▽ : Use these buttons to scroll through the items in each menu. A small marker will move along the page as you scroll through the items. This shows where each page is in the menu.

**SET/CLR (Set/Clear):** Use this button to set or clear the menu item when it is displayed.

### Trip/Fuel Menu Items

Press the MENU button until Trip/Fuel Information Menu is displayed. Then press ▽ to scroll through the following menu items:

- Trip 1
- Trip 2
- Fuel Range
- Average Fuel Economy
- Instantaneous Fuel Economy
- Average Vehicle Speed
- Timer
- Digital Speedometer
- Turn-by-Turn
- Blank Display

### Trip 1 and Trip 2

This display shows the current distance traveled, in either kilometers (km) or miles (mi), since the last reset for the trip odometer. The trip odometer can be reset to zero by pressing SET/CLR while the trip odometer display is showing.

### Fuel Range

This display shows the approximate distance the vehicle can be driven without refueling. The fuel range estimate is based on an average of the vehicle's fuel economy over recent driving history and the amount of fuel remaining in the fuel tank. Fuel range cannot be reset.

## 5-22 Instruments and Controls

---

### **Average Fuel Economy**

This display shows the approximate average liters per 100 kilometers (L/100 km) or miles per gallon (mpg). This number is calculated based on the number of L/100 km (mpg) recorded since the last time this menu item was reset. The fuel economy can be reset by pressing SET/CLR while the Average Fuel Economy display is showing. The display may not reset to zero.

### **Instantaneous Fuel Economy**

This display shows the current fuel economy in either liters per 100 kilometers (L/100 km) or miles per gallon (mpg). This number reflects only the fuel economy that the vehicle has right now and changes frequently as driving conditions change. Unlike average economy, this display cannot be reset.

### **Average Vehicle Speed**

This display shows the average speed of the vehicle in kilometers per hour (km/h) or miles per hour (mph). This average is calculated based on the various vehicle speeds recorded since the last reset of this value. The average speed can be reset by pressing SET/CLR while the Average Vehicle Speed display is showing.

### **Timer**

This display can be used as a timer. To start the timer, press SET/CLR while Timer is displayed. The display will show the amount of time that has passed since the timer was last reset, not including time the ignition is off. Time will continue to be counted as long as the ignition is on, even if another display is being shown on the DIC. The timer will record up to 99 hours, 59 minutes and 59 seconds (99:59:59) after which the display will return to zero.

To stop the timer, press SET/CLR briefly while Timer is displayed. To reset the timer to zero, press and hold SET/CLR.

### **Digital Speedometer**

The speedometer shows how fast the vehicle is moving in either kilometers per hour (km/h) or miles per hour (mph). The speedometer cannot be reset.

### **Turn-by-Turn**

This display is used for the OnStar or Navigation System Turn-by-Turn guidance. See The OnStar Owner's Guide or the Navigation manual, if the vehicle has navigation, for more information.

### **Blank Display**

This display shows no information.

## Vehicle Information Menu Items

Press the MENU button until Vehicle Information Menu is displayed.

Then press ▽ to scroll through the following menu items:

- Unit
- Tire Pressure
- Remaining Oil Life
- Blank Display

### Unit

Press SET/CLR to enter the unit menu. Then press △ or ▽ to switch between METRIC or US when the Unit display is active. Press SET/CLR to confirm the setting. This will change the displays on the cluster and DIC to either metric or English (US) measurements.

### Tire Pressure

The display will show a vehicle with the approximate pressures of all four tires. Tire pressure is displayed in either kilopascal (kPa) or in pounds per square inch (psi).

See *Tire Pressure Monitor System on page 10-52* and *Tire Pressure Monitor Operation on page 10-54* for more information.

### Remaining Oil Life

This display shows an estimate of the oil's remaining useful life. If REMAINING OIL LIFE 99% is displayed, that means 99% of the current oil life remains.

When the remaining oil life is low, the CHANGE ENGINE OIL SOON message will appear on the display. See *Engine Oil Messages on page 5-26*. The oil should be changed as soon as possible. See *Engine Oil on page 10-10*. In addition to the engine oil life system monitoring the oil life, additional maintenance is recommended in

the Maintenance Schedule in this manual. See *Scheduled Maintenance on page 11-2* for more information.

Remember, the Oil Life display must be reset after each oil change. It will not reset itself. Also, be careful not to reset the Oil Life display accidentally at any time other than when the oil has just been changed. It cannot be reset accurately until the next oil change.

To reset the engine oil life system, press SET/CLR while the Oil Life display is active. The display will ask for confirmation of a reset.

Press △ or ▽ to select Yes or No. Then press SET/CLR to confirm the selection. See *Engine Oil Life System on page 10-14*.

### Blank Display

This display shows no information.

### Compass

The vehicle may have a compass in the Driver Information Center (DIC). See *Compass on page 5-4*.

### Vehicle Messages

Messages are displayed on the DIC to notify the driver that the status of the vehicle has changed and that some action may be needed by the driver to correct the condition. Multiple messages may appear one after another.

Some messages may not require immediate action, but you can press SET/CLR to acknowledge that you received the messages and to clear them from the display. Some messages cannot be cleared from the DIC display because they are more urgent. These messages require action before they can be cleared. You should take any messages that appear on the display seriously and remember that clearing the messages will only make the messages disappear, not correct the problem. You will find the possible messages that can be displayed and some information about them grouped by subject in the following information.

### Battery Voltage and Charging Messages

#### BATTERY SAVER ACTIVE

This message displays when the vehicle has detected that the battery voltage is dropping beyond a reasonable point. The battery saver system starts reducing certain features of the vehicle that you may be able to notice. At the point that features are disabled, this message is displayed. It means that the vehicle is trying to save the charge in the battery. Turn off unnecessary accessories to allow the battery to recharge.

#### LOW BATTERY

This message is displayed when the battery voltage is low. See *Battery on page 10-27* for more information.

### SERVICE BATTERY CHARGING SYSTEM

This message is displayed when there is a fault in the battery charging system. Take the vehicle to your dealer for service.

### Brake System Messages

#### BRAKE FLUID LOW

This message is displayed when the brake fluid level is low; see *Brake Fluid on page 10-25*.

#### RELEASE PARKING BRAKE

This message is displayed as a reminder that the parking brake is on. Release it before you attempt to drive.

### Compass Messages

#### CAL

This message is displayed when the compass needs to be calibrated. See *Compass on page 5-4*.

— — —

Three dashes will be displayed if the compass needs service. See your dealer for service.

## Cruise Control Messages

### APPLY BRAKE BEFORE CRUISE

If this message displays when attempting to activate cruise control, apply the brake pedal and try again.

### CRUISE SET TO XXX

This message displays when the cruise control is set and shows the speed it was set to. See *Cruise Control* on page 9-42 for more information.

## Door Ajar Messages

### DOOR OPEN

A door open symbol will be displayed on the DIC showing which door is open. If the vehicle has been shifted out of P (Park),

a DOOR OPEN message will also be displayed. Close the door completely.

### MANUALLY CLOSE THE POWER LIFTGATE

This message will display if the power liftgate encounters multiple obstacles on the same power cycle. After removing the obstructions, the liftgate will resume normal power operation.

### REAR ACCESS OPEN

This message will display along with a symbol when the liftgate is open. Close the liftgate completely.

## Engine Cooling System Messages

### A/C OFF DUE TO HIGH ENGINE TEMP

This message displays when the engine coolant becomes hotter than the normal operating temperature. To avoid added strain on a hot engine, the air conditioning

compressor automatically turns off. When the coolant temperature returns to normal, the air conditioning compressor turns back on. You can continue to drive the vehicle.

If this message continues to appear, have the system repaired by your dealer as soon as possible to avoid damage to the engine.

### COOLANT LEVEL LOW ADD COOLANT

This message will display if the coolant is low. See *Engine Coolant* on page 10-17.

### ENGINE OVERHEATED — IDLE ENGINE

This message displays when the engine coolant temperature is too hot. Stop and allow the vehicle to idle until it cools down.

### **ENGINE OVERHEATED — STOP ENGINE**

This message displays and a continuous chime sounds if the engine cooling system reaches unsafe temperatures for operation. Stop and turn off the vehicle as soon as it is safe to do so to avoid severe damage. This message clears when the engine has cooled to a safe operating temperature.

### **HIGH COOLANT TEMPERATURE**

This message displays if the coolant temperature is hot. See *Engine Overheating on page 10-21*.

### **Engine Oil Messages**

#### **CHANGE ENGINE OIL SOON**

This message displays when the engine oil needs to be changed. When you change the engine oil, be sure to reset the Oil Life System. See *Engine Oil Life System on*

*page 10-14 and Driver Information Center (DIC) on page 5-20* for information on how to reset the system. See *Engine Oil on page 10-10 and Scheduled Maintenance on page 11-2* for more information.

#### **ENGINE OIL HOT, IDLE ENGINE**

This message displays when the engine oil temperature is too hot. Stop and allow the vehicle to idle until it cools down.

#### **ENGINE OIL LOW — ADD OIL**

This message displays when the engine oil level is too low. Check the oil level. See *Engine Oil on page 10-10*.

#### **OIL PRESSURE LOW — STOP ENGINE**

This message displays if low oil pressure levels occur. Stop the vehicle as soon as safely possible and do not operate it until the cause of the low oil pressure has been

corrected. Check the oil as soon as possible and have the vehicle serviced by your dealer.

### **Engine Power Messages**

#### **ENGINE POWER IS REDUCED**

This message displays when the vehicle's engine power is reduced. Reduced engine power can affect the vehicle's ability to accelerate. If this message is on, but there is no reduction in performance, proceed to your destination. The performance may be reduced the next time the vehicle is driven. The vehicle may be driven at a reduced speed while this message is on, but maximum acceleration and speed may be reduced. Anytime this message stays on, the vehicle should be taken to your dealer for service as soon as possible.



## Fuel System Messages

### ECO MODE ON

On some models, this message displays when the fuel economy mode has been turned on by pressing the eco button near the shift lever. See *Fuel Economy Mode* on page 9-36 for more information.

### FUEL LEVEL LOW

This message displays when the vehicle is low on fuel. Refuel as soon as possible.

### TIGHTEN GAS CAP

This message displays when the fuel cap is not on tight. Tighten the fuel cap.

## Key and Lock Messages

### REPLACE BATTERY IN REMOTE KEY

This message displays when the battery in the Remote Keyless Entry (RKE) transmitter needs to be replaced.

## Object Detection System Messages

### PARK ASSIST OFF

This message is displayed when the park assist system has been turned off. See *Ultrasonic Parking Assist* on page 9-45.

### SERVICE PARK ASSIST

This message is displayed if there is a problem with the park assist system. Take the vehicle to your dealer for service.

## Ride Control System Messages

### ALL WHEEL DRIVE OFF

If your vehicle has the All-Wheel Drive (AWD) system, this message displays when the rear drive system is overheating. This message turns off when the rear drive system cools down. If the warning message stays on for a while, you need to reset the warning message. To reset the

warning message, turn the ignition off and then back on again. If the message stays on, see your dealer right away. See *All-Wheel Drive* on page 9-37 for more information.

### SERVICE ALL WHEEL DRIVE

If your vehicle has the All-Wheel Drive (AWD) system, this message displays if a problem occurs with this system. If this message appears, stop as soon as possible and turn off the vehicle. Restart the vehicle and check for the message on the DIC display. If the message is still displayed or appears again when you begin driving, the AWD system needs service. See your dealer.

### SERVICE TRACTION CONTROL

This message displays when there is a problem with the Traction Control System (TCS). See *Traction Control System (TCS)* on page 9-39.

### **SERVICE STABILITRAK**

This message displays if there is a problem with the StabiliTrak system. *StabiliTrak® System on page 9-41.*

### **STABILITRAK OFF**

This message displays when the StabiliTrak system is turned off. See *StabiliTrak® System on page 9-41* for more information.

### **TRACTION CONTROL OFF**

This message displays when the Traction Control System (TCS) is turned off. Adjust your driving accordingly.

### **TRACTION CONTROL ON**

This message displays when the Traction Control System (TCS) is first turned on. See *Traction Control System (TCS) on page 9-39* for more information.

## **Airbag System Messages**

### **SERVICE AIRBAG**

This message displays if there is a problem with the airbag system. Take the vehicle to your dealer for service.

## **Safety Belt Messages**

### **BUCKLE SEATBELT**

This message displays as a reminder when the safety belt is not buckled.

## **Anti-Theft Alarm System Messages**

### **THEFT ATTEMPTED**

This message displays if the vehicle detects a tamper condition.

## **Service Vehicle Messages**

### **SERVICE AC SYSTEM**

This message is displayed if there is a problem with the air conditioning system. Take the vehicle to your dealer for service.

### **SERVICE POWER STEERING**

This message is displayed if there is a problem with the power steering system. Take the vehicle to your dealer for service.

### **SERVICE VEHICLE SOON**

This message is displayed if there is a problem with the vehicle. Take the vehicle to your dealer for service.

## **Tire Messages**

### **SERVICE TIRE MONITOR SYSTEM**

This message displays if there is a problem with the Tire Pressure Monitor System (TPMS). See *Tire Pressure Monitor Operation on page 10-54* for more information.

**TIRE LEARNING ACTIVE**

This message displays when the system is learning new tires. See *Tire Pressure Monitor Operation on page 10-54* for more information.

**TIRE LOW ADD AIR TO TIRE**

This message displays when the pressure in one or more of the tires is low.

This message also displays LEFT FRONT, RIGHT FRONT, LEFT REAR, or RIGHT REAR to indicate the location of the low tire.

The low tire pressure warning light will also come on. See *Tire Pressure Light on page 5-17*.

If a tire pressure message appears on the DIC, stop as soon as you can. Inflate the tires by adding air until the tire pressure is equal to the values shown on the Tire and Loading Information label. See *Tires on page 10-45*, *Vehicle Load Limits on page 9-21*, and *Tire Pressure on page 10-51*.

You can receive more than one tire pressure message at a time. The DIC also shows the tire pressure values. See *Driver Information Center (DIC) on page 5-20*.

**Transmission Messages****SERVICE TRANSMISSION**

This message displays if there is a problem with the transmission. See your dealer.

**SHIFT TO PARK**

This message displays when the transmission needs to be shifted to P (Park). This may appear when attempting to remove the key if the vehicle is not in P (Park).

**TRANSMISSION HOT — IDLE ENGINE**

This message displays and a chime sounds if the transmission fluid in the vehicle gets hot. Driving with the transmission fluid temperature high can cause damage to the vehicle. Stop the vehicle and let it idle to

allow the transmission to cool. This message clears when the fluid temperature reaches a safe level.

**Vehicle Reminder Messages****ICE POSSIBLE DRIVE WITH CARE**

This message is displayed when ice conditions are possible.

**TURN WIPER CONTROL TO INTERMITTENT FIRST**

This message is displayed when attempting to adjust the intermittent wiper speed without intermittent selected on the wiper control. See *Windshield Wiper/Washer on page 5-3*.

### Vehicle Personalization

The audio system controls are used to access the personalization menus for customizing vehicle features.

**CONFIG (Configuration):** Press to access the Configuration Settings Menu.

**MENU/SEL Knob:** Press the center of this knob to enter the menus and select menu items. Turn the knob to scroll through the menus.

◀ **BACK:** Press to exit or move backwards in a menu.

#### Entering the Personalization Menus

1. Turn the infotainment system on and press the CONFIG button to access the Configuration Settings menu.
2. Turn the MENU/SEL knob to highlight Vehicle Settings.

3. Press the center of the MENU/SEL knob to select the Vehicle Settings menu.

The following list of menu items will be available:

- Climate and Air Quality
- Comfort and Convenience
- Collision/Detection Systems
- Languages
- Lighting
- Power Door Locks
- Remote Lock/Unlock/Start
- Return to Factory Settings

Turn the MENU/SEL knob to highlight the menu. Press the knob to select it. Each of the menus is detailed in the following information. All of the menus may not be available. Only those tied to the features on your vehicle will be shown.

### Climate and Air Quality

Select the Climate and Air Quality menu and the following will be displayed:

- Auto Fan Speed
- Air Conditioning Mode
- Remote Start Auto Heat Seats

#### Auto Fan Speed

This selection is available on vehicles with the Automatic Climate Control System. Choose from the following blower speed settings:

**High:** Increased speed.

**Low:** Reduced speed.

**Normal:** Moderate speed.

Press the MENU/SEL knob when Auto Fan Speed is highlighted. Turn the knob to highlight “High,” “Normal,” or “Low.” Press the knob to confirm the selection and go back to the last menu.

### **Air Conditioning Mode**

This will allow you to select whether or not the air conditioning comes on automatically the next time the vehicle is started. "On" means that the air conditioning will be on at start up, regardless of whether it was on or off the last time the vehicle was turned off. "Off" means the air conditioning will be off at the next start up, regardless of whether it was on or off the last time the vehicle was turned off. "Last Setting" means that when the vehicle is started, the air conditioning will resume whichever setting it was at the last time the vehicle was turned off.

Press the MENU/SEL knob when Air Conditioning Mode is highlighted. Turn the knob to highlight "On," "Off," or "Last Setting." Press the knob to confirm the selection and go back to the last menu.

### **Remote Start Auto Heat Seats**

When on, this feature will turn the heated seats on when using remote start on cold days.

Press the MENU/SEL knob when "Remote Start Auto Heat Seats" is highlighted to toggle between "On" or "Off." Press ◀ BACK to confirm the selection and go back to the last menu.

### **Comfort and Convenience**

Select the Comfort and Convenience menu and the following will be displayed:

- Easy Exit Driver Seat
- Chime Volume
- Reverse Tilt Mirror

### **Easy Exit Driver Seat**

When on, this feature will move the driver seat rearward upon turning the ignition off and the driver door opening. This may be performed to make it easier to exit the vehicle. See the "Easy Exit Driver Seat"

information under *Power Seat Adjustment on page 3-3* for more information.

This allows you to turn the easy exit seat feature on or off.

Press the MENU/SEL knob when "Easy Exit Driver Seat" is highlighted. Turn the knob to select "On" or "Off." Press the knob to confirm and go back to the last menu.

### **Chime Volume**

This allows the selection of the chime volume level.

Press the MENU/SEL knob when "Chime Volume" is highlighted. Turn the knob to select "Normal" or "High." Press the knob to confirm and go back to the last menu.

### **Reverse Tilt Mirror**

When on, both the driver and passenger mirrors will tilt downward when vehicle is shifted to R (Reverse) to improve visibility of the ground near the rear wheels.

## 5-32 Instruments and Controls

---

They will return to their previous driving position when the vehicle is shifted out of R (Reverse), the ignition is turned to OFF, or the vehicle is left in reverse. See *Park Tilt Mirrors on page 2-15* for more information.

This allows you to turn the park tilt mirrors feature on or off.

Press the MENU/SEL knob when "Reverse Tilt Mirror" is highlighted. Turn the knob to select "On" or "Off." Press the knob to confirm and go back to the last menu.

### Collision/Detection Systems

Select the Collision/Detection Systems menu and the following will be displayed:

- Park Assist

### Park Assist

This allows the Ultrasonic Parking Assist feature to be turned on or off.

Press the MENU/SEL knob when "Park Assist" is highlighted. Turn the knob to select "On," "Off," or "Tow Bar." Press the knob to confirm and go back to the last menu.

See *Ultrasonic Parking Assist on page 9-45* for more information

### Languages

Select the Languages menu and the following will be displayed:

- English
- French
- Spanish

Turn the MENU/SEL knob to select the language. Press the knob to confirm and go back to the last menu.

### Lighting

Select the Lighting menu and the following will be displayed:

- Vehicle Locator Lights
- Exit Lighting

### Vehicle Locator Lights

This allows the vehicle locator lights to be turned on or off.

Press the MENU/SEL knob when "Vehicle Locator Lights" is highlighted to toggle between "On" or "Off." Press ◀ BACK to confirm the selection and go back to the last menu.

### Exit Lighting

This allows the selection of how long the exterior lamps stay on when leaving the vehicle when it is dark outside.

Press the MENU/SEL knob when “Exit Lighting” is highlighted. Turn the knob to select “Off,” “30 Seconds,” “1 Minute,” or “2 Minutes.” Press the knob to confirm and go back to the last menu.

### Power Door Locks

Select Power Door Locks and the following will be displayed:

- Unlocked Door Anti Lock Out
- Auto Door Unlock
- Delayed Door Lock

#### Unlocked Door Anti Lock Out

When on, this feature will keep the driver door from locking when the door is open. If off is selected, the Delayed Door Lock menu will be available.

Press the MENU/SEL knob when “Unlocked Door Anti Lock Out” is highlighted to toggle between “On”

or “Off.” Press ◀ BACK to confirm the selection and go back to the last menu.

#### Auto Door Unlock

This allows selection of which of the doors will automatically unlock when the vehicle is shifted into P (Park).

Press the MENU/SEL knob when “Auto Door Unlock” is highlighted. Turn the knob to select “All Doors,” “Driver Door,” or “Off.” Press the knob to confirm and go back to the last menu.

#### Delayed Door Lock

When on, this feature will delay the locking of the doors. If you want to override the delay you can press the power door lock on the instrument panel.

Press the MENU/SEL knob when “Delayed Door Lock” is highlighted. Turn the knob to select “On” or “Off.” Press the knob to confirm and go back to the last menu.

### Remote Lock/Unlock/Start

Select Remote Lock/Unlock/Start and the following will be displayed:

- Remote Unlock Light Feedback
- Remote Lock Feedback
- Remote Door Unlock
- Memory Remote Recall

#### Remote Unlock Light Feedback

When on, the exterior lamps will flash when unlocking the vehicle with the RKE transmitter.

Press the MENU/SEL knob when “Remote Unlock Light Feedback” is highlighted. Turn the knob to select “Flash Lights” or “Off.” Press the knob to confirm and go back to the last menu.

## 5-34 Instruments and Controls

---

### Remote Lock Feedback

This allows selection of what type of feedback is given when unlocking the vehicle with the RKE transmitter.

Press the MENU/SEL knob when “Remote Lock Feedback” is highlighted. Turn the knob to select “Lights and Horn,” “Lights Only,” “Horn Only,” or “Off.” Press the knob to confirm and go back to the last menu.

### Remote Door Unlock

This allows selection of which doors will unlock when pressing the unlock button on the RKE transmitter.

Press the MENU/SEL knob when “Remote Door Unlock” is highlighted. Turn the knob to select “All Doors” or “Driver Door.” Press the knob to confirm and go back to the last menu.

### Memory Remote Recall

This allows the Memory Remote Recall feature to be turned on or off.

When on, this feature will recall the current driver's last seat, outside mirrors upon unlocking the driver door with the RKE, and opening that door. The current driver is identified when the RKE transmitter is used to unlock the driver door. See “Memory Remote Recall” under *Power Seat Adjustment* on page 3-3 for more information.

Memory Remote Recall is when the memorized settings will be recalled as you unlock the vehicle.

Press the MENU/SEL knob when “Memory Remote Recall” is highlighted to toggle between “On” or “Off.” Press ◀ BACK to confirm the selection and go back to the last menu.

### Return to Factory Settings

Select “Return to Factory Settings” to return all of the vehicle personalization to the default settings. Turn the knob to select “Yes” or “No.” Press the knob to confirm and go back to the last menu.



## Lighting

### Exterior Lighting

|   |     |
|---|-----|
| Exterior Lamp Controls .....            | 6-1 |
| Headlamp High/Low-Beam<br>Changer ..... | 6-2 |
| Flash-to-Pass .....                     | 6-2 |
| Daytime Running<br>Lamps (DRL) .....    | 6-2 |
| Automatic Headlamp<br>System .....      | 6-3 |
| Hazard Warning Flashers .....           | 6-3 |
| Turn and Lane-Change<br>Signals .....   | 6-3 |
| Fog Lamps .....                         | 6-4 |

### Interior Lighting

|  |     |
|--|-----|
| Instrument Panel Illumination<br>Control ..... | 6-4 |
| Dome Lamps .....                               | 6-4 |
| Reading Lamps .....                            | 6-5 |

### Lighting Features

|                               |     |
|-------------------------------|-----|
| Entry Lighting .....          | 6-5 |
| Battery Load Management ..... | 6-5 |

## Exterior Lighting

### Exterior Lamp Controls



The exterior lamp control is on the turn signal/lane change lever.

**☀️ (Exterior Lamp Control):** Operates the exterior lamps. Turn to one of the following positions:

**⏻ (Off):** Turns the exterior lamps off.

### **AUTO (Automatic Headlamps):**

Turns the exterior lamps on and off automatically depending on the exterior light.

**🅂 (Parking Lamps):** Turns on the parking lamps together with the following:

- Sidemarkers Lamps
- Taillamps
- License Plate Lamps
- Instrument Panel Lights

**☀️ (Headlamps):** Turns on the headlamps, together with the previously listed lamps and lights.

### Headlamp High/ Low-Beam Changer

 **Headlamp High/Low-Beam Changer:** Push the turn/lane change lever away from you to turn the high beams on.

Pull the lever toward you to return to low beams.



This indicator light turns on in the instrument panel cluster when the high-beam headlamps are on.

### Flash-to-Pass

The flash-to-pass feature works with the low beams or Daytime Running Lamps (DRL) on or off.

To flash the high beams, pull the turn signal/lane change lever all the way toward you, then release it.

### Daytime Running Lamps (DRL)

Daytime Running Lamps (DRL) system makes the low-beam headlamps come on at a reduced brightness in daylight when the following conditions are met:

- The ignition is on.
- The exterior lamp band is in the automatic position.
- The transmission is not in P (Park).

- The light sensor determines it is daytime.
- The parking brake is released.

Fully functional Daytime Running Lamps (DRL) are required on all vehicles first sold in Canada.

When the DRL are on the taillamps, sidemarker, instrument panel lights and other lamps will not be on. The instrument panel cluster will be lit.

When the exterior lamp band is turned to the headlamp position, the low-beam headlamps come on. The other lamps that come on with the headlamps will also come on.

To idle your vehicle with the DRL off, move the shift lever to P (Park). The DRL will stay off until the shift lever is moved out of the P (Park) position.

The regular headlamp system should be turned on when needed.

## Automatic Headlamp System

When it is dark enough outside, the headlamps come on automatically.

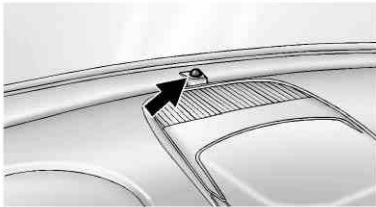

Do not cover the light sensor on top of the instrument panel or the headlamps will come on when they are not needed.

The system may also turn on the headlamps when driving through a parking garage or tunnel.

## Hazard Warning Flashers



**⚠ (Hazard Warning Flasher):** Press this button, on the center of the instrument panel, to make the front and rear turn signal lamps flash on and off. This warns others that you are having trouble.

Press **⚠** again to turn the flashers off.

## Turn and Lane-Change Signals

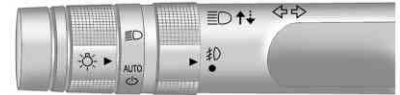

An arrow on the instrument panel cluster will flash in the direction of the turn or lane change.

Move the lever all the way up or down to signal a turn.

Raise or lower the lever until the arrow starts to flash to signal a lane change. Hold it there until the lane change is complete.

The lever returns to its starting position when it is released.

## 6-4 Lighting

If after signaling a turn or a lane change the arrows flash rapidly or do not come on, a signal bulb may be burned out.

Have the bulbs replaced. If the bulb is not burned out, check the fuse; see *Fuses on page 10-39* for more information.

### Fog Lamps

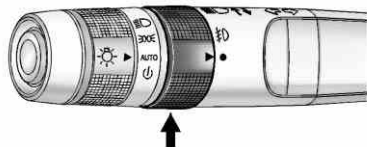

For vehicles with fog lamps, the control is located on the turn signal/lane change lever.

Use the fog lamps for better vision in foggy or misty conditions.

**(Fog Lamps):** Turn the fog lamp band on the lever to  and release it, to turn the fog lamps on or off. The band will return to its original position.

The parking lamps or low-beam headlamps must be on to use the fog lamps.

The fog lamps will go off whenever the high-beam headlamps are turned on. When the high-beam headlamps are turned off, the fog lamps will come on again.

Some localities have laws that require the headlamps to be on along with the fog lamps.

## Interior Lighting

### Instrument Panel Illumination Control

This control is located on the instrument panel, to the left of the steering column.

**(Instrument Panel Brightness):** Turn clockwise or counterclockwise to brighten or dim the lights.

### Dome Lamps

There are front and rear dome lamps.

The dome lamp controls are located in the overhead console. To change the settings, press the following:

**(Dome Lamp Override):** Turns the lamps off, even when a door is open.

 **(Door):** The lamps come on automatically when a door is opened.

 **(On):** Turns the dome lamps on.

The dome lamps can also be turned on and off by pressing the buttons next to the lamps.

## Reading Lamps

The reading lamps are located on the overhead console. These lamps come on automatically when any door is opened.

For manual operation, press the button next to each lamp to turn it on or off.

## Lighting Features

### Entry Lighting

The dome lamp, cargo lamp, and foot lamp inside the vehicle come on when any door is opened, if the dome lamp is in the door position. In addition, these lamps come on when the Remote Keyless Entry (RKE) unlock button is pressed. They stay on for 20 seconds or until a door is opened. After the door is opened and then closed, the light remains on for 20 seconds, or until the ignition is turned to ON/RUN.

### Battery Load Management

The vehicle has Electric Power Management (EPM) that estimates the battery's temperature and state of charge. It then adjusts the voltage for best performance and extended life of the battery.

When the battery's state of charge is low, the voltage is raised slightly to quickly bring the charge back up. When the state of charge is high, the voltage is lowered slightly to prevent overcharging. If the vehicle has a voltmeter gauge or a voltage display on the Driver Information Center (DIC), you may see the voltage move up or down. This is normal. If there is a problem, an alert will be displayed.

The battery can be discharged at idle if the electrical loads are very high. This is true for all vehicles. This is because the generator (alternator) may not be spinning fast enough at idle to produce all of the power needed for very high electrical loads.

A high electrical load occurs when several of the following are on, such as: headlamps, high beams, fog lamps, rear window defogger, climate control fan at high speed, heated seats, engine cooling fans, trailer loads, and loads plugged into accessory power outlets.

## 6-6 Lighting

---

EPM works to prevent excessive discharge of the battery. It does this by balancing the generator's output and the vehicle's electrical needs. It can increase engine idle speed to generate more power whenever needed. It can temporarily reduce the power demands of some accessories.

Normally, these actions occur in steps or levels, without being noticeable. In rare cases at the highest levels of corrective action, this action may be noticeable to the driver. If so, a DIC message might be displayed, such as BATTERY SAVER ACTIVE, BATTERY VOLTAGE LOW, or LOW BATTERY. If one of these messages displays, it is recommended that the driver reduce the electrical loads as much as possible. See *Driver Information Center (DIC)* on page 5-20.

# Infotainment System

## Introduction

|  |     |
|--|-----|
| Infotainment .....                         | 7-1 |
| Theft-Deterrent Feature .....              | 7-2 |
| Overview (Radio with CD) .....             | 7-3 |
| Overview (Radio with CD/<br>DVD/MEM) ..... | 7-5 |
| Operation .....                            | 7-7 |

## Radio

|                          |      |
|--------------------------|------|
| AM-FM Radio .....        | 7-11 |
| Satellite Radio .....    | 7-14 |
| Radio Reception .....    | 7-18 |
| Multi-Band Antenna ..... | 7-18 |

## Audio Players

|  |      |
|--|------|
| CD Player .....                                    | 7-19 |
| CD/DVD Player .....                                | 7-21 |
| Mass Storage<br>Media (MEM) .....                  | 7-24 |
| Auxiliary Devices (Radio<br>with CD) .....         | 7-28 |
| Auxiliary Devices (Radio with<br>CD/DVD/MEM) ..... | 7-31 |

## Rear Seat Infotainment

|   |      |
|---|------|
| Rear Seat Entertainment<br>(RSE) System ..... | 7-33 |
| Rear Seat Audio (RSA)<br>System .....         | 7-43 |

## Phone

|  |      |
|--|------|
| Bluetooth (Overview) .....                 | 7-45 |
| Bluetooth (Infotainment<br>Controls) ..... | 7-46 |
| Bluetooth (Voice<br>Recognition) .....     | 7-51 |

# Introduction

## Infotainment

Read the following pages to become familiar with the audio system's features.

### WARNING

Taking your eyes off the road for extended periods could cause a crash resulting in injury or death to you or others. Do not give extended attention to entertainment tasks while driving.

This system provides access to many audio and non-audio listings.

To minimize taking your eyes off the road while driving, do the following while the vehicle is parked:

- Become familiar with the operation and controls of the audio system.

## 7-2 Infotainment System

---

- Set up the tone, speaker adjustments, and preset radio stations.

For more information, see *Defensive Driving* on page 9-2.

This vehicle's infotainment system may be equipped with a noise reduction system which can work improperly if the audio amplifier, engine calibrations, exhaust system, microphones, radio, or speakers are modified or replaced. This could result in more noticeable engine noise at certain speeds.

**Notice:** Contact your dealer before adding any equipment.

**Adding audio or communication equipment could interfere with the operation of the engine, radio, or other systems, and could damage them. Follow federal rules covering mobile radio and telephone equipment.**

The vehicle has Retained Accessory Power (RAP). With RAP, the audio system can be played even after the ignition is turned off. See *Retained Accessory Power (RAP)* on page 9-30 for more information.

### Navigation System

For vehicles with a navigation system, see the separate navigation manual.



### Theft-Deterrent Feature

The theft-deterrent feature works by learning a portion of the Vehicle Identification Number (VIN) to the infotainment system. The infotainment system does not operate if it is stolen or moved to a different vehicle.

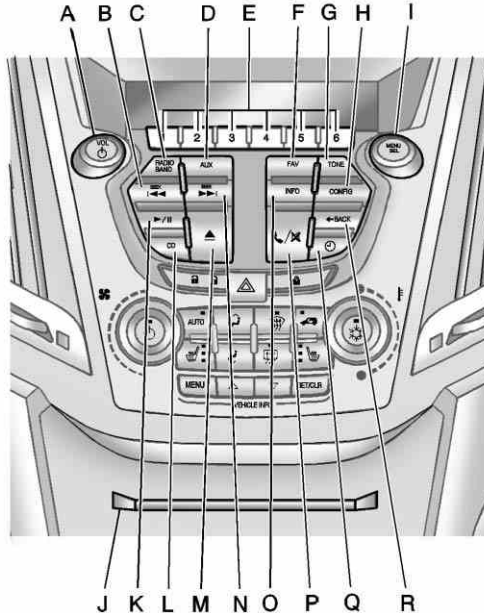

## Overview (Radio with CD)



- A. VOL/ 
- Turns the system on or off and adjusts the volume.
- B.  SEEK
- Radio: Seeks the previous station.
  - CD: Selects the previous track or rewinds within a track.
- C. RADIO/BAND
- Changes the band while listening to the radio.
  - Selects the radio when listening to a different audio source.
- D. AUX
- Selects a connected external audio source.
- E. Buttons 1 to 6
- Radio: Saves and selects favorite stations.

## 7-4 Infotainment System

---

### F. FAV

- Radio: Opens the favorites list.

### G. TONE

- Opens the tone menu.

### H. CONFIG

- Opens the settings menu.

### I. MENU/SEL

- Press: Opens the menus and selects menu items.
- Turn: Highlights menu items or sets values while in a menu. Manually selects radio stations while listening to the radio.

### J. CD Slot

- Insert a CD.

### K. ▶/||

- CD: Pauses the CD.

### L. CD

- Selects the CD player when listening to a different audio source.

### M. ▲ (CD Eject)

- Removes a disc from the CD slot.

### N. ▶▶ SEEK

- Radio: Seeks the next station.
- CD: Selects the next track or fast forwards within a track.

### O. INFO

- Radio: Shows available information about the current station.
- CD: Shows available information about the current track.

### P. ☎ / ✕

- Opens the phone main menu.
- Mutes the audio system.

### Q. ⌚

- Opens the clock menu.

### R. ◀ BACK

- Menu: Moves one level back.
- Character Input: Deletes the last character.

## Overview (Radio with CD/DVD/MEM)

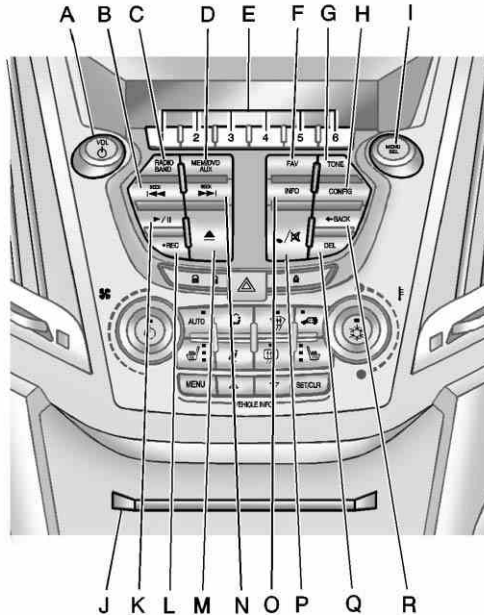

### A. VOL/

- Turns the system on or off and adjusts the volume.

### B. SEEK

- Radio: Seeks the previous station.
- CD/DVD: Selects the previous track or rewinds within a track.
- MEM: Selects the previous track or rewinds within a track.

### C. RADIO/BAND

- Changes the band while listening to the radio.
- Selects the radio when listening to a different audio source.

### D. MEM/DVD/AUX

- Selects MEM, CD/DVD, USB, or a connected front or rear auxillary audio source.

## 7-6 Infotainment System

---

### E. Buttons 1 to 6

- Radio: Saves and selects favorite stations.
- MEM: Saves and selects favorite tracks and playlists.

### F. FAV

- Radio: Opens the favorites list.
- MEM: Opens the favorites list.

### G. TONE

- Opens the tone menu.

### H. CONFIG

- Opens the settings menu.

### I. MENU/SEL

- Press: Opens menus and selects menu items.
- Turn: Highlights menu items or sets values while in a menu. Manually selects radio stations while listening to the radio.

### J. CD/DVD Slot

- Insert a disc.

### K. ▶/|| (Play/Pause)

- Radio: Pauses time shifted content.
- CD/DVD: Pauses CD/DVD-A and DVD-V playback. Stops DVD-V playback.
- MEM: Pauses MEM playback.

### L. ● REC

- CD/DVD: Records content from audio CDs and MP3/WMA CDs.
- AUX: Records content from USB mass storage devices.

### M. ▲ (CD Eject)

- Removes a disc from the CD/DVD slot.

### N. ►► SEEK

- Radio: Seeks the next station.
- CD/DVD: Selects the next track or fast forwards within a track.
- MEM: Selects the next track or fast forwards within a track.

### O. INFO

- Radio: Shows available information about the current station.
- CD/DVD: Shows available information about the current track.
- MEM: Shows available information about the current track.

### P. ☎ / 🔇 (Phone/Mute)

- Opens the phone main menu.
- Mutes the audio system.

Q. DEL

- MEM: Deletes the current track from MEM.

R. ◀ BACK

- Menu: Moves one level back.
- Character Input: Deletes the last character.

## Operation

### Controls

The infotainment system is operated by using the pushbuttons, multifunction knobs, display menus, and steering wheel controls, if equipped.

### Turning the System On or Off

**VOL/ ⏻ (Volume/Power):** Press to turn the system on and off.

### Automatic Switch-Off

If the infotainment system has been turned on after the ignition is turned off, the system will turn off automatically after 10 minutes.

### Volume Control

**VOL/ ⏻ (Volume/Power):** Turn to adjust the volume.

**🔇 / 🔇 (Mute):** For vehicles with OnStar, press and hold 🔇 / 🔇 to mute the infotainment system. Press and hold 🔇 / 🔇 again, or turn the VOL/ ⏻ knob to cancel mute.

For vehicles without OnStar, press 🔇 / 🔇 to mute the infotainment system.

Press 🔇 / 🔇 again, or turn the VOL/ ⏻ knob to cancel mute.

## Menu System

### Controls

The MENU/SEL knob and the ◀ BACK button are used to navigate the menu system.

### MENU/SEL (Menu/Select):

Press to:

- Enter the menu system.
- Select or activate the highlighted menu option.
- Confirm a set value.
- Turn a system setting on or off.

Turn to:

- Highlight a menu option.
- Select a value.

◀ **BACK:** Press to:

- Exit a menu.
- Return from a submenu screen to the previous menu screen.
- Delete the last character in a sequence.

## 7-8 Infotainment System

### Selecting a Menu Option

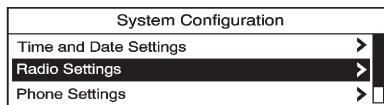

1. Turn the MENU/SEL knob to move the highlighted bar.
2. Press the MENU/SEL button to select the highlighted option.

### Submenus

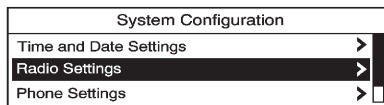

An arrow on the right-hand edge of the menu indicates that it has a submenu with other options.

### Activating a Setting

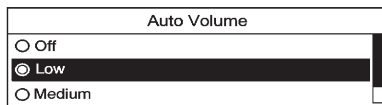

1. Turn the MENU/SEL knob to highlight the setting.
2. Press the MENU/SEL button to activate the setting.

### Setting a Value

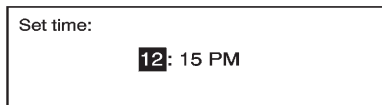

1. Turn the MENU/SEL knob to change the current value of the setting.
2. Press the MENU/SEL button to confirm the setting.

### Turning a Function On or Off

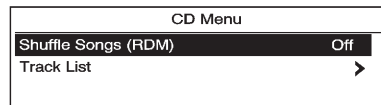

1. Turn the MENU/SEL knob to highlight the function.
2. Press the MENU/SEL button to turn the function on or off.

### Entering a Character Sequence

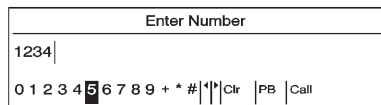

1. Turn the MENU/SEL knob to highlight the character.
2. Press the MENU/SEL button to select the character.

Press the **◀ BACK** button to delete the last character in the sequence or press and hold to delete the entire character sequence.

### Audio Settings

The audio settings can be set for each radio band and each audio player source.

To quickly reset an audio setting value to 0:

1. Press the TONE button.
2. Select the audio setting.
3. Press and hold the MENU/SEL button until the value changes to 0.

Press the **◀ BACK** button to go back to the Tone Settings menu.

### Adjusting the Treble, Midrange, and Bass

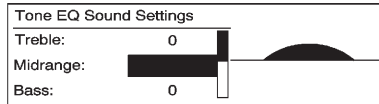

1. Press the TONE button.
2. Select Treble, Midrange, or Bass.
3. Select the value.

Press the **◀ BACK** button to go back to the Tone Settings menu.

### Adjusting the Fader and Balance

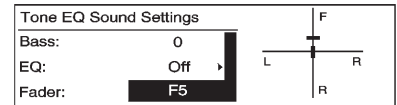

1. Press the TONE button.
2. Select Fader or Balance.
3. Select the value.

Press the **◀ BACK** button to go back to the Tone Settings menu.

## 7-10 Infotainment System

### Adjusting the EQ (Equalizer)

For vehicles that have an equalizer:



1. Press the TONE button.
2. Select EQ.
3. Select the setting.

Press the **←** BACK button to go back to the Tone Settings menu.

### System Settings

#### Configuring the Number of Favorite Pages

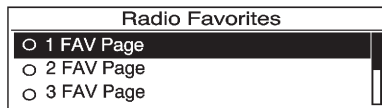

To configure the number of available favorite pages:

1. Press the CONFIG button.
2. Select Radio Settings.
3. Select Radio Favorites.
4. Select the number of available favorite pages.
5. Press the **←** BACK button to go back to the System Configuration menu.

### Auto Volume

The auto volume feature automatically adjusts the radio volume to compensate for road and wind noise as the vehicle speeds up or slows down, so that the volume level is consistent.

The level of volume compensation can be selected, or the auto volume feature can be turned off.

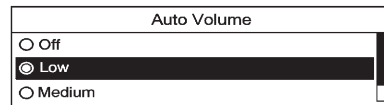

1. Press the CONFIG button.
2. Select Radio Settings.
3. Select Auto Volume.
4. Select the setting.
5. Press the **←** BACK button to go back to the System Configuration menu.



### Maximum Startup Volume

The maximum volume played when the Radio with CD is first turned on can be set.

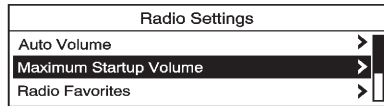

1. Press the CONFIG button.
2. Select Radio Settings.
3. Select Maximum Startup Volume.
4. Select the setting.
5. Press the ◀ BACK button to go back to the System Configuration menu.

## Radio

### AM-FM Radio

#### Control Buttons

The buttons used to control the radio are:

**RADIO/BAND:** Press to turn the radio on and choose between AM, FM, and XM™, if equipped.

**MENU/SEL:** Turn to manually search for stations.

**FAV:** Press to open the favorites list.

**▶▶ SEEK or ◀◀ SEEK:** Press to search for stations. Press and hold to fast forward and rewind time shifted data. See “Time Shifting (Radio with CD/DVD and MEM)” later in this section.

**▶/|| :** Press to pause and resume time shifted data. See “Time Shifting (Radio with CD/DVD and MEM)” later in this section.

**1 to 6:** Press to select preset stations.

### RDS (Radio Data System)

The radio may have RDS. The RDS feature is available for use only on FM stations that broadcast RDS information. This feature only works when the information from the radio station is available. In rare cases, a radio station could broadcast incorrect information that causes the radio features to work improperly. If this happens, contact the radio station.

While the radio is tuned to an FM-RDS station, the station name or call letters display.

## 7-12 Infotainment System

---

### Radio Menus

Radio menus are available for AM and FM.

Press the MENU/SEL knob to open the main radio menu for that band.

### Selecting a Band

Press the RADIO/BAND button to choose AM, FM, or XM™, if equipped. The last station that was playing starts playing again.

### Selecting a Station

#### Seek Tuning (Radio with CD)

If the radio station is not known:

Briefly press **◀◀** SEEK or **▶▶** SEEK, to automatically search for the next available station. If a station is not found, the radio switches to a more sensitive search level. If a station still is not found, the frequency that was last active begins to play.

If the radio station is known:

Press and hold **◀◀** SEEK or **▶▶** SEEK until the station on the display is reached, then release the button.

#### Seek Tuning (Radio with CD/DVD and MEM)

Briefly press **▶▶** SEEK or **◀◀** SEEK, to automatically search for the next available station. If a station is not found, the radio switches to a more sensitive search level. If a station still is not found, the frequency that was last active begins to play.

#### Manual Tuning

Turn the MENU/SEL knob to select the frequency on the display.

#### Favorites List

1. Press the MENU/SEL knob.
2. Select Favorites List.
3. Select the station.

### Station Lists

1. Press the MENU/SEL knob.
2. Select AM or FM Station List. All receivable stations in the current reception area are displayed. If a station list has not been created, an automatic station search is done.
3. Select the station.

### Category Lists

Most stations that broadcast an RDS program type code specify the type of programming transmitted. Some stations change the program type code depending on the content. The system stores the RDS stations sorted by program type in the FM category list.

To search for a programming type determined by station:

1. Press the MENU/SEL knob.
2. Select FM category list. A list of all programming types available displays.

3. Select the programming type.  
A list of stations that transmit programming of the selected type displays.

4. Select the station.

The category lists are updated when the station lists are updated.

### Updating Station & Category Lists

If stations stored in the station list can no longer be received:

1. Press the MENU/SEL knob.
2. Select Update AM or FM Station List, if the stations stored in the station list are no longer received. A station search will be completed and the first station in the updated list will play.

To cancel the station search, press the MENU/SEL knob.

### Storing a Station as a Favorite

Stations from all bands can be stored in any order in the favorite pages.

Up to six stations can be stored in each favorite page and the number of available favorite pages can be set.

### Storing a Station as a Favorite

To store the station to a position in the list, press the corresponding button 1 to 6 until a beep is heard.

### Retrieving Stations



Press the FAV button to open a favorite page or to switch to another favorite page. Briefly press one of the 1 to 6 buttons to retrieve the station.

### Time Shifting (Radio with CD/DVD and MEM)

The radio with MEM time shift feature can rewind 20 minutes of FM/AM content. While listening to the radio, the content from the current station is always being buffered.

Press  to pause the radio. The radio displays the time shift status bar. The status bar shows the amount of content stored in the buffer and the current pause point.

To resume playback from the current pause point, press  again. The radio is no longer live, but played from the time shift buffer. A status bar displays below the station number.

Press and hold  SEEK or  SEEK to fast forward or rewind through the time shift buffer. Hold  SEEK until the end of the recorded buffer resumes live playback.

## 7-14 Infotainment System

---

Press and release **◀◀ SEEK** or **▶▶ SEEK** to jump forward or back 30 seconds in the time shift buffer.

When the radio station is changed, the buffer is cleared and automatically restarted for the current station. Content from a previously tuned station is no longer available.

The time shift feature is not available while recording or with other sources of playback.

### Pausing AM/FM with the Vehicle Turned Off

If AM/FM is paused when the vehicle is turned off, the radio continues to buffer the current radio station for up to 20 minutes. If the vehicle is turned back on within 20 minutes, the radio resumes playback from the paused point.

### Satellite Radio

Vehicles with an XM™ Satellite Radio tuner and a valid XM Satellite Radio subscription can receive XM programming.

### XM Satellite Radio Service

XM is a satellite radio service based in the 48 contiguous United States and 10 Canadian provinces. XM Satellite Radio has a wide variety of programming and commercial-free music, coast-to-coast, and in digital-quality sound. If XM service needs to be reactivated, the radio will display “No Subscription Please Renew on channel XM1.” A service fee is required to receive the XM service. For more information, contact XM at [www.xmradio.com](http://www.xmradio.com) or call 1-800-929-2100 in the U.S. and [www.xmradio.ca](http://www.xmradio.ca) or call 1-877-438-9677 in Canada.

### Control Buttons

The buttons used to control the XM radio are:

**RADIO/BAND:** Press to turn the radio on and choose between AM, FM, and XM™, if equipped.

**◀◀ SEEK / ▶▶ SEEK:** Press to go to the previous or next station.

**FAV:** Press to open the favorites list.

**▶/|| :** Press to pause and resume time shifted data. See “Time Shifting (Radio with CD/DVD and MEM)” in this section.

**1 to 6:** Press to select preset stations.

**MENU/SEL:** Turn to select stations. Press to open the XM Satellite Radio menu.

## Selecting the XM Band

Press the RADIO/BAND button to choose between the AM, FM, and XM bands. The last channel played in that band begins to play when that band is selected.

## XM Categories

XM channels are organized in categories.

## Removing or Adding Categories

Channels in a category that have been removed can still be accessed by using the **◀◀ SEEK** or **▶▶ SEEK** buttons, or the MENU/SEL knob.

To add or remove categories:

1. Press the CONFIG button.
2. Select Radio Settings.
3. Select XM Categories.
4. Turn the MENU/SEL knob to highlight the category.
5. Press the MENU/SEL knob to remove or add the category.

## Selecting an XM Channel

XM channels can be selected by using **◀◀ SEEK**, **▶▶ SEEK**, the MENU/SEL knob, or the menu system.

### Selecting a Channel Using

#### **◀◀ SEEK** or **▶▶ SEEK** (Radio with CD)

- Press and release **◀◀ SEEK** or **▶▶ SEEK** to go to the previous or next channel.
- Press and hold **◀◀ SEEK** or **▶▶ SEEK** to scroll through the previous or next channel until the channel is reached.

### Selecting a Channel Using

#### **◀◀ SEEK** or **▶▶ SEEK** (Radio with CD/DVD and MEM)

Press and release **◀◀ SEEK** or **▶▶ SEEK** to go to the previous or next channel.

## Selecting a Channel Using the MENU/SEL Knob

To select an XM channel using the MENU/SEL knob:

Turn the MENU/SEL knob to highlight an XM channel. The channel is selected after a short delay.

To select a channel using the menu:

1. Turn the MENU/SEL knob and select Channel List.
2. Select the desired channel.

## Selecting a Channel Using the Menu System

1. Turn the MENU/SEL knob.
2. Select XM Category List.
3. Select the category.
4. Select the channel.

### Storing an XM Channel as a Favorite

Channels from all bands can be stored in any order in the favorite pages.

Up to six channels can be stored in each favorite page and the number of available favorite pages can be set.

### Storing a Channel as a Favorite

To store the channel to a position in the list, press and hold the corresponding 1 to 6 button until the channel can be heard again.

### Retrieving Channels



Press the FAV button to open a favorite page or to change to another favorite page. Briefly press one of the 1 to 6 buttons to retrieve the channel.



### Time Shifting (Radio with CD/DVD and MEM)

The radio with MEM time shift feature can rewind 20 minutes of XM content. While listening to the radio, the content from the current channel is always being buffered.

Press /|| to pause the radio. The radio displays the time shift status bar. The status bar shows the amount of content stored in the buffer and the current pause point.

To resume playback from the current pause point, press /|| again. The radio is no longer live, but played from the time shift buffer. A status bar displays below the channel number.

Press and hold  SEEK or  SEEK to fast forward or rewind through the time shift buffer. Hold  SEEK until the end of the recorded buffer resumes live playback.

Press and release  SEEK or  SEEK to go to the next or previous song in the time shift buffer.

When the channel is changed, the buffer is cleared and automatically restarted for the current channel. Content from a previously tuned station is no longer available.

The time shift feature is not available while recording or with other sources of playback.

### Pausing XM with the Vehicle Turned Off

If XM is paused when the vehicle is turned off, the radio continues to buffer the current radio station for up to 20 minutes. If the vehicle is turned back on within 20 minutes, the radio resumes playback from the paused point.

**XM Messages**

**XL (Explicit Language**

**Channels):** These channels, or any others, can be blocked by request, by calling 1-800-929-2100 in the U.S. and 1-877-438-9677 in Canada.

**XM Updating:** The encryption code in the receiver is being updated, no action is required. This process should take no longer than 30 seconds.

**Loading XM:** The audio system is acquiring and processing audio and text data; no action is needed. This message should disappear shortly.

**Channel Off Air:** This channel is not currently in service. Tune in to another channel.

**Channel Unauth:** This channel is blocked or cannot be received with your XM Subscription package.

**Channel Unavailable:** This previously assigned channel is no longer assigned. Tune to another station.

**No Artist Info:** The system is working properly. No artist information is available at this time on this channel.

**No Title Info:** The system is working properly. No song title information is available at this time on this channel.

**No CAT Info:** The system is working properly. No category information is available at this time on this channel.

**No Information:** The system is working properly. No text or informational messages are available at this time on this channel.

**No Subscription Please Renew:** XM subscription needs to be reactivated. Contact XM at [www.xmradio.com](http://www.xmradio.com) or call 1-800-929-2100 in the U.S. and [www.xmradio.ca](http://www.xmradio.ca) or call 1-877-438-9677 in Canada.

**No XM Signal:** The system is working properly. The vehicle may be in a location where the XM signal is being blocked. When the vehicle is moved into an open area, the signal should return.

**CAT Not Found:** The system is working properly. There are no channels available for the selected category.

**XM Radio ID:** If tuned to channel 0, this message alternates with the XM Radio 8-digit radio ID label. This label is needed to activate the service.

**Unknown:** If this message is received when tuned to channel 0, there could be a receiver fault. Consult with your dealer.

**Check Antenna:** If this message does not clear within a short period of time, the receiver could have a fault. Consult with your dealer.

**XM Not Available:** If this message does not clear within a short period of time, the receiver could have a fault. Consult with your dealer.

### Radio Reception

Frequency interference and static can occur during normal radio reception if items such as cell phone chargers, vehicle convenience accessories, and external electronic devices are plugged into the accessory power outlet. If there is interference or static, unplug the item from the accessory power outlet.

### FM

FM signals only reach about 16 to 65 km (10 to 40 mi). Although the radio has a built-in electronic circuit that automatically works to reduce interference, some static can occur, especially around tall buildings or hills, causing the sound to fade in and out.

### AM

The range for most AM stations is greater than for FM, especially at night. The longer range can cause station frequencies to interfere with each other. Static can occur when things like storms and power lines interfere with radio reception. When this happens, try reducing the treble on the radio.

### XM™ Satellite Radio Service

XM Satellite Radio Service gives digital radio reception from coast to coast in the 48 contiguous United States, and in Canada. Just as with FM, tall buildings or hills can interfere with satellite radio signals, causing the sound to fade in and out. In addition, traveling or standing under heavy foliage, bridges, garages, or tunnels may cause loss of the XM signal for a period of time.

### Cellular Phone Usage

Cellular phone usage can cause interference with the vehicle's radio.

### Multi-Band Antenna

The multi-band antenna is on the roof of the vehicle. The antenna is used for the AM-FM radio, OnStar, the XM Satellite Radio Service System, and GPS (Global Positioning System), if the vehicle has these features. Keep the antenna clear of obstructions for clear reception.



## Audio Players

### CD Player

The CD player can play audio CDs and MP3 CDs.

The CD player will not play 8 cm (3 in) CDs.

#### Care of CDs

Sound quality can be reduced due to disc quality, recording method, quality of the music recorded, and how the disc has been handled. Handle discs carefully and store them in their original cases or other protective cases away from direct sunlight and dust. If the bottom surface of a disc is damaged, the disc may not play properly or at all. Do not touch the bottom surface of a disc while handling it; this could damage the surface. Pick up discs by grasping the outer edges or the edge of the hole and the outer edge.

If the bottom surface of a disc is dirty, take a soft lint-free cloth, or dampen a clean soft cloth in a mild neutral detergent solution mixed with water, and clean it. Wipe the disc from the center to the outer edge.

#### Care of the CD Player

Do not add a label to a disc, as it could get caught in the CD player. If a label is needed, label the top of the recorded disc with a marking pen.

Do not use disc lens cleaners because they could contaminate the lens of the disc optics and damage the CD player.

**Notice:** If a label is added to a CD, more than one CD is inserted into the slot at a time, or an attempt is made to play scratched or damaged CDs, the CD player could be damaged. While using the CD player, use only CDs in good condition without any label,

load one CD at a time, and keep the CD player and the loading slot free of foreign materials, liquids, and debris.

#### Control Buttons

The buttons used to control the CD player are:

**CD:** Press to choose between the CD and AUX player.

**▶▶ SEEK or ◀◀ SEEK:** Press to select tracks or to fast forward or rewind within a track.

**INFO:** Press to display additional information about the CD that may be available.

**MENU/SEL:** Turn to select tracks.

**▲ (Eject):** Press to remove the CD.

**▶/|| :** Press to pause a CD or MP3 track; press again to resume playback.

### Inserting a CD

With the printed side facing up, insert a disc into the CD slot until it is drawn in.

### Removing a CD

Press the  button.

The disc is pushed out of the CD slot.

If the disc is not removed after it is ejected, it is pulled back in after a few seconds.



### Playing a CD or MP3 CD

Press the CD button. If there is a disc in the player it begins playing.

Information about the disc and current track is shown on the display depending on the data stored.

### Selecting a CD Track

Using the control buttons:

- Press  SEEK or  SEEK to select the previous or next track.
- Turn the MENU/SEL knob.



Using the CD Menu:

1. Press the MENU/SEL knob.
2. Select Tracks list.
3. Select the track.

### Playing Tracks in Random Order



Press the MENU/SEL knob and then set Shuffle Songs to On.

### Fast Forward and Rewind

Press and hold  SEEK or  SEEK to fast forward or rewind within the current track.

### Selecting an MP3 Track

Using the control buttons:

- Press  SEEK or  SEEK to select the previous or next track.
- Turn the MENU/SEL knob.

Using the CD Menu:

1. Press the MENU/SEL knob.
2. Select Playlists/Folders.
3. Select the playlist or folder.
4. Select the track.

### Searching for MP3 Tracks

The search feature may take some time to display the information after reading the disc due to the amount of information stored on the disc. FM automatically plays while the disc is being read.

Tracks can be searched by:

- Playlists
- Artists
- Albums
- Song Titles
- Genres
- Folder View

To search for tracks:

1. Press the MENU/SEL knob.
2. Select Search.

3. Select: Playlists, Artists, Albums, Song Titles, Genres, or Folder View.
4. Select the track.

## CD/DVD Player

The CD/DVD player can play CDs, DVD-As, MP3/WMA CDs, MP3/WMA DVDs, and DVD-Vs.

The CD/DVD player will not play 8 cm (3 in) discs.

### Care of CDs and DVDs

Sound quality can be reduced due to disc quality, recording method, quality of the music recorded, and how the disc has been handled. Handle discs carefully and store them in their original cases or other protective cases away from direct sunlight and dust. If the bottom surface of a disc is damaged, the disc may not play properly or at all. Do not touch the bottom surface of a disc while handling it; this could

damage the surface. Pick up discs by grasping the outer edges or the edge of the hole and the outer edge.

If the bottom surface of a disc is dirty, take a soft lint-free cloth, or dampen a clean soft cloth in a mild neutral detergent solution mixed with water, and clean it. Wipe the disc from the center to the outer edge.

### Care of the CD/DVD Player

Do not add a label to a disc, as it could get caught in the CD/DVD player. If a label is needed, label the top of the recorded disc with a marking pen.

Do not use disc lens cleaners because they could contaminate the lens of the disc optics and damage the CD/DVD player.

**Notice:** If a label is added to a CD, more than one CD is inserted into the slot at a time, or an attempt is made to play scratched or damaged CDs, the CD player could be damaged. While using

**the CD player, use only CDs in good condition without any label, load one CD at a time, and keep the CD player and the loading slot free of foreign materials, liquids, and debris.**

### Control Buttons

The buttons used to control the CD/DVD player are:

**MEM/DVD/AUX:** Press to choose between the MEM, CD/DVD, and AUX.

**▶▶ SEEK or ◀◀ SEEK:** Press to select tracks or to fast forward or rewind within a track.

**INFO:** Press to display additional information about the disc that may be available.

**MENU/SEL:** Turn to select tracks.

**▲ (Eject):** Press to remove a disc.

**▶/|| :** Press to pause a CD, DVD-A, or DVD-V; press again to resume playback. Press and hold to stop a DVD-V disc.

### Inserting a CD or DVD

With the printed side facing up, insert a disc into the slot until it is drawn in.

### Removing a CD or DVD

Press the ▲ button.

The disc is pushed out of the CD/DVD slot.

If the disc is not removed after it is ejected, it is pulled back in after a few seconds.

### Playing a CD or DVD-A Disc

Press the MEM/DVD/AUX button. If there is a disc in the player, it begins playing.

Information about the disc and current track is shown on the display depending on the data stored.

### Selecting CD or DVD-A Tracks

Using the control buttons:

- Press ◀◀ SEEK or ▶▶ SEEK to select the previous or next track.
- Turn the MENU/SEL knob.

Using the menu:

1. Press the MENU/SEL knob.
2. Select Tracks List.
3. Select the track.

### Pausing a CD or DVD-A Track

Press ▶/|| to pause a CD or DVD-A track. Press ▶/|| again to continue playing the track.

### Playing CD or DVD-A Tracks in Random Order

Press the MENU/SEL knob and then set Shuffle Songs to On.

### Fast Forward and Rewind

Press and hold ▶▶ SEEK or ◀◀ SEEK to fast forward or rewind within the current track.

### Playing an MP3 CD or DVD

Files that are not stored in folders are displayed in the root directory (disc).

The search rate increases if the MENU/SEL knob is continuously turned while searching in a list.

### Selecting an MP3 Track

Using the control buttons:

- Press ◀◀ SEEK or ▶▶ SEEK to select the previous or next track.
- Turn the MENU/SEL knob.

Using the CD or DVD Menu:

1. Press the MENU/SEL knob.
2. Select Folder List.
3. Select the folder.
4. Select the track.

### Searching for MP3s on a CD or DVD

It is normal for the search feature to take some time to display the information after reading the disc due to the amount of information stored on the disc. The infotainment system automatically switches to FM while the disc is being read.

Files that do not have any meta data stored in the ID3 tag display as Unknown.

Tracks can be searched for by:

- Playlists
- Artists
- Albums
- Song Titles
- Genres

The number of objects in each category is shown in parentheses after the category.

To search for tracks:

1. Press the MENU/SEL knob.
2. Select Search.
3. Select: Playlists, Artists, Albums, Song Titles, or Genres.
4. Select the track. The search rate increases if the menu MENU/SEL knob is continuously turned while searching in a list.

### Playing MP3 Tracks in Random Order

Press the MENU/SEL knob and then set Shuffle Songs to On.

### Recording an Audio or MP3 CD to MEM

See *Mass Storage Media (MEM)* on page 7-24 for more information.

### Playing a DVD-V

See *Rear Seat Entertainment (RSE) System* on page 7-33 for information about how to control a Video DVD using the wireless remote control.

### Selecting a Chapter

Using the control buttons:

- Press ◀◀ SEEK or ▶▶ SEEK to select the previous or next track.
- Turn the MENU/SEL knob.

Using DVD Menu:

1. Press the MENU/SEL knob.
2. Select Chapter List.
3. Select the chapter.

### Selecting a Title

1. Press the MENU/SEL knob.
2. Select Title List.
3. Select the title.

### Changing the Audio Stream

1. Press the MENU/SEL knob.
2. Select Audio Stream.
3. Select Change Audio Stream.
4. Press MENU/SEL to change the selection.
5. Select Cancel to exit the menu.

## 7-24 Infotainment System

---

### Pausing a DVD

1. Press the MENU/SEL knob.
2. Select Pause, to pause the disc.  
Select Pause to start playback.

### Navigating the DVD-V Disc Menu

Use the following actions to navigate the title menu on a DVD-V Disc.

- Select/Enter
- Cursor UP
- Cursor DOWN
- Cursor RIGHT
- Cursor LEFT
- Up Menu

Use the following actions to navigate the menu on a DVD-V Disc while playing chapters.

- Pause (Play)
- Chapter List
- Title List

- DVD/DVD
- DVD/AUX
- AUX/DVD
- AUX/AUX

To navigate the menu:

1. Press the MENU/SEL knob.
2. Select the action.

### Mass Storage Media (MEM)

Infotainment systems with MEM storage are able to record up to 1.1 GB (gigabyte) of music from Audio CDs, MP3/WMA/AAC discs, and USB storage devices. The MEM player can also time shift audio from AM, FM, and XM™ radio.

Music or content stored in MEM that you did not create, or have the right to distribute, must be deleted before the sale or end of the lease of the vehicle.

### Control Buttons

The buttons used to control the MEM player are:

**MEM/DVD/AUX:** Press to select the MEM player.

**▶▶ SEEK or ◀◀ SEEK:** Press to select tracks or to fast forward or rewind within a track.

**INFO:** Press to display additional information about the MEM track that may be available.

**▶/|| :** Press to pause the track currently playing; press again to resume playback.

**● REC:** Press to record music from a CD, DVD-A, or USB drive.

**FAV (Favorites):** Press to display MEM favorites.

**1-6:** Press to select a track or a stored playlist.

**MENU/SEL:** Turn to select tracks.

## Recording From Audio CDs

The infotainment system can record the current song playing or all songs from an audio CD to MEM. A status bar appears on the top of the display when the recording process starts and disappears when the process has ended. Copy protected CDs cannot be recorded to MEM.

## Recording to MEM

Press ● REC, then select Record Current Song or Record All Songs on Disc. If the track has started playing, the system will restart the track and begin recording from the beginning of the track. When the song recording is completed, the message Song Recorded to MEM displays, and there may be a slight pause.

Songs recorded to MEM are stored as the current date, disc, and track number.

## Re-recording a Previously Recorded Disc

If the disc or track has already been recorded to MEM, the message The Song(s) is Already Recorded displays.

## Stopping the Recording

Press the ● REC button while recording from an audio CD to display the stop recording option. Select Stop Recording Song to MEM.

## Renaming Recorded Discs

Discs that have been recorded to MEM can be renamed.

1. Press the MENU/SEL knob.
2. Select Rename Recorded Discs.
3. Select the disc.
4. Select Album or Artist to rename either one.
5. Use the menu knob to enter the character sequence. See *Operation on page 7-7* for more information.

## Recording From MP3/WMA Discs or USB Storage Devices

### USB Host Support

The USB connector uses the USB standards, 1.1 and 2.0.

### USB Supported Devices

- USB Flash Drives
- Portable USB Hard Drives

## Recording to MEM

Press ● REC, then select Record Current Song or Record Current Folder.

The information stored by MEM is titled according to the ID3 tag associated with it.

## Re-recording a Previously Recorded Disc

If the disc or track has already been recorded to MEM, the message The Song(s) is Already Recorded displays.

### Stopping the Recording

Press the ● REC button while recording from an MP3/WMA CD or USB storage device to display the stop recording option. Select Stop Recording Song to MEM.

### Deleting Tracks From MEM

Individual tracks and all tracks can be deleted from MEM.

To delete individual tracks, press and release the DEL button while the track is playing.

To delete all tracks from MEM, press and hold the DEL button while a track is playing.

### Playing From MEM

#### Playing Back a Previously Recorded CD

Turn the MENU/SEL knob to select a track if MEM is already playing from the previously recorded disc.

1. Select Recorded Disc List.
2. Select the disc.
3. Select the track.

#### Searching For a Track

Tracks can be searched for by:

- Playlists
- Artists
- Albums
- Song Titles
- Genres

The number of objects in each category is shown in parentheses after the category.

To search for tracks:

1. Press the MENU/SEL knob.
2. Select Search.
3. Select: Playlists, Artists, Albums, Song Titles, or Genres.
4. Select the track. The search rate increases if the MENU/SEL knob is continuously turned while searching in a list.

#### Shuffle Songs

Select the Shuffle Songs option from the MEM menu to randomly play back tracks stored in MEM.



## Configuring MEM Favorites

During MEM playback, press the FAV button to change between favorite categories. The favorite categories are:

- Playlists
- Artists
- Albums
- Genres

To remove MEM favorites categories:

1. Press the CONFIG button.
2. Select Radio Settings.
3. Select MEM Favorites.
4. Remove the check mark from the box to remove that MEM favorites category.

Replace the check mark to re-add the removed category.

## Saving MEM Tracks as Favorites

Favorites can be saved by pressing and holding one of the 1 to 6 buttons. Favorites can be stored according to the following list:

**Playlist:** Adds the currently playing track to the playlist selected.

**Artist:** Saves the artist associated with the currently playing track in the indicated favorites position.

**Album:** Saves the album associated with the currently playing track in the indicated favorites position.

**Genre:** Saves the genre associated with the currently playing track in the indicated favorites position.

## Creating Playlists

To create a playlist using tracks stored in MEM:

1. Select Playlist from the MEM favorites.
2. Select the track to be stored in the playlist.
3. Press and hold one of the 1 to 6 buttons until the track can be heard again to store the track.
4. Repeat Steps 1 through 3 to store additional tracks in the playlist.

### Auxiliary Devices (Radio with CD)

The auxiliary input allows portable devices to be connected using the 3.5 mm (1/8 in) input jack or the optional USB port.

Portable devices are controlled by using the menu system described in *Operation on page 7-7*.



The auxiliary input is located in the center console.

### 3.5 mm Auxiliary Input Jack

Playback of an audio device that is connected to the 3.5 mm auxiliary input jack can only be controlled using the controls on the device.

#### Adjusting the Volume

Turn the VOL/  knob to adjust the volume of the infotainment system after the volume level has been set on the portable audio device.

#### USB Port

For vehicles with a USB port, the following devices may be connected and controlled by the infotainment system.

- iPods<sup>®</sup>
- PlaysForSure Devices (PFD)
- USB Drives
- Zunes

Not all iPods, PFDs, USB Drives, and Zunes are compatible with the infotainment system.

### Connecting and Controlling an iPod<sup>®</sup>

Not all iPods can be controlled by the infotainment system.

#### Connecting an iPod

Connect the iPod to the USB port.

#### Searching For a Track

Tracks can be searched for by:

- Playlists
- Artists
- Albums
- Song Titles
- Podcasts
- Genres
- Audiobooks
- Composers

To search for tracks:

1. Press the MENU/SEL knob.
2. Select Search.

3. Select: Playlists, Artists, Albums, Song Titles, Podcasts, Genres, Audiobooks, or Composers.
4. Select the track.

**Shuffle**

Press the MENU/SEL knob and set Shuffle Songs (Random) to On or Off, then press the ◀ BACK button to return to the main screen.

**On:** Plays tracks in the current folder in random order.

**Off:** Plays tracks in the current folder in sequential order.

**Repeat**

Press the MENU/SEL knob and set Repeat to On or Off, then press the ◀ BACK button to return to the main screen.

**On:** Repeats the current track.

**Off:** Playback starts from the beginning of the current track after the last track finishes.

**Connecting and Controlling a PlaysForSure Device (PFD) or Zune™**

**Connecting a PFD or Zune**

Connect the PFD or Zune to the USB port.

**Searching For a Track**

Tracks can be searched for by:

- Playlists
- Artists
- Albums
- Song Titles
- Podcasts
- Genres

To search for tracks:

1. Press the MENU/SEL knob.
2. Select Search.
3. Select: Playlists, Artists, Albums, Song Titles, Podcasts, or Genres.
4. Select the track.

**Shuffle Functionality**

Press the MENU/SEL knob and set Shuffle Songs (Random) to On or Off.

**On:** Plays current tracks in random order.

**Off:** Plays current tracks in sequential order.

**Repeat Functionality**

Press the MENU/SEL knob and set Repeat to On or Off.

**Repeat On:** Repeats the current track.

**Repeat Off:** Playback starts from the beginning of the current track after the last track finishes.

**Connecting and Controlling a USB Drive**

The infotainment system can only play back .mp3 and .wma files from a USB drive.

Only the first 10,000 songs are recognized on the device.

## 7-30 Infotainment System

---

When a device is not supported, the message “No supported data found. You can safely disconnect the device” appears.

### Connecting a USB Drive

Connect the USB drive to the USB port.

### Searching For a Track

It is normal for the search feature to take some time to display the information after reading the disc due to the amount of information stored on the disc.

Files that do not have any meta data stored in the ID3 tag display as Unknown.

Tracks can be searched for by:

- Playlists\*
- Artists
- Albums
- Song Titles
- Genres
- Folder View

\*This only displays if a playlist is found on the device.

To search for tracks:

1. Press the MENU/SEL knob.
2. Select Search.
3. Select: Playlists, Artists, Albums, Song Titles, Genres, or Folder View.
4. Select the track.

### Shuffle Functionality

Press the MENU/SEL knob and set Shuffle Songs (Random) to On or Off.

**On:** Plays current tracks in random order.

**Off:** Plays current tracks in sequential order.

### Repeat Functionality

Press the MENU/SEL knob and set Repeat to On or Off.

**Repeat On:** Repeats the current track.

**Repeat Off:** Playback starts from the beginning of the current track after the last track finishes.

## Auxiliary Devices (Radio with CD/DVD/MEM)

The auxiliary input allows portable devices to be connected using the 3.5 mm (1/8 in) input jack or the optional USB port.

Portable devices are controlled by using the menu system described in *Operation on page 7-7*.

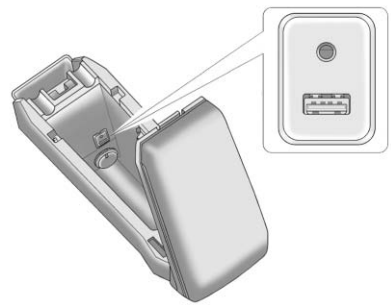

The auxiliary input is located in the center console.

## 3.5 mm Auxiliary Input Jack

Playback of an audio device that is connected to the 3.5 mm auxiliary input jack can only be controlled using the controls on the device.

### Adjusting the Volume

Turn the VOL/  knob to adjust the volume of the infotainment system after the volume level has been set on the portable audio device.

### USB Port

The following devices may be connected to the USB port and controlled by the infotainment system.

- iPods
- USB Mass Storage Devices

Not all iPod's or USB Mass Storage Devices are compatible with the infotainment system.

## Connecting and Controlling an iPod®



Not all iPods can be controlled by the infotainment system.

### Connecting an iPod

Connect the iPod to the USB port.

### Selecting a Track

Using the control buttons:

- Press  SEEK or  SEEK to select the previous or next track.
- Turn the MENU/SEL knob to select the track in the current submenu. The track will start to play.

### Playing Tracks in Random Order

Press the MENU/SEL knob and set Shuffle Songs to On or Off.

**Shuffle On:** Plays current tracks in random order.

**Shuffle Off:** Plays current tracks in sequential order.

### Searching for a Track

Tracks can be searched for by:

- Playlists
- Artists
- Albums
- Song Titles
- Genres
- Composers
- Audiobooks

The number of objects in each category is shown in parentheses after the category.

To search for tracks:

1. Press the MENU/SEL knob.
2. Select Search.
3. Select: Playlists, Artists, Albums, Song Titles, Genres, Composers, or Audiobooks.
4. Select the track. The search rate increases if the MENU/SEL knob is continuously turned while searching in a list.

### Connecting and Controlling a USB Drive

Files that are not stored in folders are displayed in the root directory (USB).

#### Connecting a USB Drive

Connect the USB drive to the USB port.

#### Disconnecting a USB Drive

A USB drive should be ejected from the USB port before disconnecting it. To eject a USB drive:

1. Press the MENU/SEL knob.
2. Select USB Eject.

#### Playing Tracks in Random Order

Press the MENU/SEL knob and then set Shuffle Songs to On.

### Selecting a Track

Using the control buttons:

- Press ◀◀ SEEK or ▶▶ SEEK to select the previous or next track.
- Turn the MENU/SEL knob to select a track in the current submenu. The track will start to play.

Selecting a track in a different folder:

1. Press the MENU/SEL knob.
2. Select Folder List.
3. Select the folder.
4. Select the track.

#### Searching for Tracks

It is normal for the search feature to take some time to display the information after reading the device due to the amount of information stored.

Files that do not have any meta data stored in the ID3 tag display as Unknown.

Tracks can be searched by:

- Playlists
- Artists
- Albums
- Song Titles
- Genres

The number of objects in each category is shown in parentheses after the category.

To search for tracks:

1. Press the MENU/SEL knob.
2. Select Search.
3. Select: Playlists, Artists, Albums, Song Titles, Genres, Composers, or Audiobooks.
4. Select the track. The search rate increases if the MENU/SEL knob is continuously turned while searching in a list.

**Recording Tracks to MEM**

See *Mass Storage Media (MEM)* on page 7-24 for more information.

**Rear Seat Infotainment**

**Rear Seat Entertainment (RSE) System**

The vehicle may have a DVD Rear Seat Entertainment (RSE) system. The RSE system works with the vehicle's infotainment system. The DVD player is part of the front radio. The RSE system includes a radio with a DVD player, two rear seat video display screens, audio/video jacks, two wireless headphones, and a remote control. See *CD/DVD Player* on page 7-21 or the separate navigation system manual for more information on the vehicle's DVD system.

**Before Driving**

The RSE is for rear seat passengers only. The driver cannot safely view the video screen while driving.

## 7-34 Infotainment System

In severe or extreme weather conditions, the RSE system may not work until the temperature is within the operating range. The operating range is above  $-20^{\circ}\text{C}$  ( $-4^{\circ}\text{F}$ ) and below  $60^{\circ}\text{C}$  ( $140^{\circ}\text{F}$ ). If the temperature is outside of this range, heat or cool the vehicle until it is within the operating range.

### Global Off

Depending on the infotainment system, the RSE system may have a Global Off feature. The Global Off feature disables all RSE system features. Press and hold the radio power button for more than three seconds for Global Off to disable the RSE features.

On some infotainment systems, the Global Off feature can be turned off by performing one of the following:

- Press and hold the radio power button for more than three seconds.
- Insert or eject any disc.
- Insert a DVD video disc.
- Press the remote control power button.
- Press the MEM/DVD/AUX button or  $\blacktriangleright/\parallel$  when a DVD video disc is in the player.
- Press the SRC button on the steering wheel when a DVD video disc is in the player.
- Cycle the ignition.

### Headphones

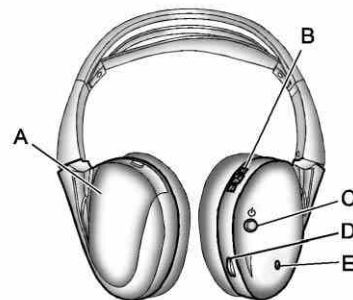

- A. Battery Cover
- B. Channel 1 or 2 Switch
- C. Power Button
- D. Volume Control
- E. Power Indicator Light

RSE includes two 2-channel wireless headphones. Channel 1 is dedicated to the DVD player, and Channel 2 is dedicated to any external auxiliary device connected



to the A/V jacks. The headphones are used to listen to various multi-media. The wireless headphones have an On/Off button, channel 1/2 switch, and a volume control. Turn the headphones off when not in use.

Push the On/Off button to turn on the headphones. A light on the headphones comes on. If the light does not come on, check the batteries. Intermittent sound or static can also indicate weak batteries. See "Battery Replacement" later in this section for more information.

Infrared transmitters are on the top of the left seatback video screen. The headphones shut off automatically to save the battery power if the RSE system is shut off or if the headphones are out of range of the transmitters for more than three minutes. Moving too far forward or stepping out of the vehicle can cause the headphones to lose the signal or have static.

To adjust the volume on the headphones, use the volume control.

For optimal audio performance, the headphones must be worn correctly. Headphones should be worn with the headband over the top of the head for best audio reception. The symbol L (Left) appears on the outside bottom edge of the ear cup and should be positioned on the left ear. The symbol R (Right) appears on the outside bottom edge of the ear cup and should be positioned on the right ear.

**Notice: Do not store the headphones in heat or direct sunlight. This could damage the headphones and repairs will not be covered by the warranty. Storage in extreme cold can weaken the batteries. Keep the headphones stored in a cool, dry place.**

If the foam ear pads attached to the headphones become worn or damaged, the pads can be replaced separately from the headphone set. To purchase replacement ear pads, call 1-888-293-3332, then prompt zero (0), or contact your dealer.

### **Battery Replacement**

To change the batteries:

1. Loosen the screw to the battery door located on the left side of the headphones.
2. Slide the battery door open.
3. Replace the two AAA batteries.
4. Replace the battery door and tighten the screw.

Remove the batteries if the headphones are not going to be used for a long period of time.

### Audio/Video (A/V) Jacks

If available, the A/V jacks are located on the rear of the floor console. They allow audio or video cables to be connected from an auxiliary device such as a camcorder or a video game system.

The A/V jacks are color coded:

- Yellow for video input.
- White for left audio input.
- Red for right audio input.

Power for auxiliary devices is not supplied by the radio system.

To use the auxiliary inputs of the RSE system:

1. Connect the auxiliary device cables to the A/V jacks.
2. Power on both the auxiliary device and the RSE video screen.

### Changing the Source on the Video Display Screens

The image from the auxiliary device can be switched between the video display screens.







To change the display:

1. Press the AUX button on the remote control to change the source of both video screens from the DVD player to the auxiliary device.
2. Press the AUX button a second time to change the left video screen source to the DVD player and the right video screen to the auxiliary device.
3. Press the AUX button a third time to change the left video screen source to the auxiliary device and the right video screen to the DVD player.

4. Press the AUX button a fourth time to change the source of both video screens to the DVD player.

### Changing the RSE Video Screen Settings

The screen display mode, brightness, and language can be changed from the setup menu using the remote control. To change a setting:

1. Press .
2. Use , , , , and  to select the settings.
3. Press  again to exit the setup menu.

## Audio Output

Audio from the DVD player or auxiliary inputs can be heard through the following:

- Wireless Headphones
- Vehicle Speakers

The RSE system transmits the audio signal to the wireless headphones if an audio signal is available. See “Headphones” earlier in this section for more information.

The front seat passengers are able to listen to playback from the A/V jacks through the vehicle speakers by selecting Rear A/V as the source on the radio.

## Video Screens

The video screens are located in the back of the driver and front passenger seats.

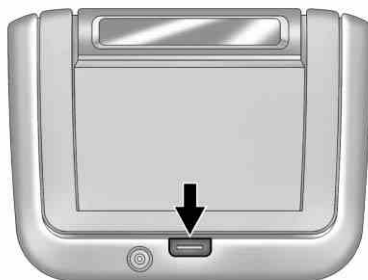

To use the video screen:

1. Push the release button located on the seatback console.
2. Move the screen to the desired viewing position.

Push the video screen down into its locked position when it is not in use. The screen turns off automatically.

Only the left RSE seatback console contains the infrared transmitters for the wireless headphones. They may be visible as eight illuminated LEDs. These LEDs are not on the right video screen. Both seatback consoles contain an infrared receiver for the remote control. They are located at the top of each console.

**Notice:** Avoid directly touching the video screen, as damage may occur. See “Cleaning the Video Screen” later in this section for more information.

## Video Screen Input Jack

Each video screen is equipped with a video input jack to allow video cables to be connected from an auxiliary device such as a camcorder or a video game system. This signal will override any video provided by the RSE system; either the DVD or auxiliary A/V jack source. The RSE system must be on for this input to operate.

### Remote Control



To use the remote control, aim it at the transmitter window at either seatback console and press the button. Direct sunlight or very bright light could affect the ability of the RSE transmitter to receive signals from the remote control. Check the batteries if the remote control does not seem to be working.

See “Battery Replacement” later in this section. Objects blocking the line of sight could also affect the function of the remote control.

If a CD, DVD, or MP3 disc is in the Radio DVD slot, the remote control  button can be used to turn on the video screen display and start the disc. The infotainment system can also turn on the video screen display. See *CD/DVD Player on page 7-21* or the separate navigation system manual for more information.

**Notice:** Storing the remote control in a hot area or in direct sunlight can damage it, and the repairs will not be covered by the warranty. Storage in extreme cold can weaken the batteries. Keep the remote control stored in a cool, dry place.

### Remote Control Buttons

 **(Power):** Press to turn the video screens on and off.

 **(Illumination):** Press to turn the remote control backlight on. The backlight times out after several seconds if no other button is pressed.

 **(Title):** Press to return to the main menu of the DVD. This function could vary for each disc.

 **(Main Menu):** Press to access the DVD menu. The DVD menu is different on every DVD. Use the navigation arrows to move the cursor. After making a selection press the enter button. This button only operates when using a DVD.

 **(Menu Navigation Arrows):** Use the arrow buttons to navigate through a menu.





 **(Enter):** Press to select the highlighted choice in any menu.

 **(Display Menu):** Press to adjust the brightness and screen display mode, and display the language menu.

 **(Return):** Press to exit the current active menu and return to the previous menu. This button operates only when the display menu or a DVD menu is active.



 **(Stop):** Press to stop playing, rewinding, or fast forwarding a DVD. Press twice to return to the beginning of the DVD.



 **(Play/Pause):** Press to start playing a DVD. Press to pause a DVD while it is playing. Press again to continue playing.

Depending on the infotainment system in the vehicle, DVD playback may be slowed down by pressing  then . Reverse slow play by pressing  then . Press  again to cancel slow play.

 **(Previous Track/Chapter):** Press to go to the start of the current track or chapter. Press again to go to the previous track or chapter. This button may not work when the DVD is playing the copyright information or the previews.

 **(Next Track/Chapter):** Press to go to the beginning of the next chapter or track. This button might not work when the DVD is playing the copyright information or the previews.

 **(Fast Reverse):** Press to quickly reverse the DVD or CD. To stop fast reversing a DVD video, press . To stop fast reversing a DVD audio or CD, release . This button might not work when the DVD is playing the copyright information or the previews.

 **(Fast Forward):** Press to fast forward the DVD or CD. To stop fast forwarding a DVD video, press . To stop fast forwarding a DVD audio or CD, release . This button might not work when the DVD is playing the copyright information or the previews.

 **(Audio):** Press to change audio tracks on DVDs that have this feature when the DVD is playing.

 **(Subtitles):** Press to turn ON/OFF subtitles and to move through subtitle options when a DVD is playing.

**AUX (Auxiliary):** Press to switch the video display between the DVD player and an auxiliary source.

## 7-40 Infotainment System

The AUX button also controls the source display between the left and right video screens as described in the table below:

| Aux Button Press         | Left Screen             | Right Screen            |
|--------------------------|-------------------------|-------------------------|
| Default State (No Press) | DVD Media               | DVD Media               |
| First Press              | Aux Video Source        | Aux Video Source        |
| Second Press             | DVD Media               | Aux Video Source        |
| Third Press              | Aux Video Source        | DVD Media               |
| Fourth Press             | Return to Default State | Return to Default State |

 **(Camera):** Press to change the camera angle on DVDs that have this feature when the DVD is playing.

 **(Clear) (If Available):** Press this button within three seconds after inputting a numeric selection, to clear all numeric inputs.

 **10 (Double Digit Entries) (If Available):** Press this button to select chapter or track numbers greater than 9. Press this button before inputting the number.

**1 through 0 (Numeric Keypad):** The numbered keypad provides the capability of direct chapter or track number selection.

### Replacing the Remote Control

If the remote control becomes lost or damaged, a new universal remote control can be purchased. Use a Toshiba® code set for replacement universal remote controls.

### Battery Replacement

To change the remote control batteries:

1. Slide back the rear cover on the remote control.
2. Replace the two batteries in the compartment.
3. Replace the battery cover.

Remove the batteries from the remote control if unused for an extended period of time.

### Tips and Troubleshooting Chart

| Problem   | Recommended Action   |
|---|--|
| No power.   | The ignition might not be turned to ON/RUN or ACC/ACCESSORY.   |
| The picture does not fill the screen. There are black borders on the top and bottom or on both sides or it looks stretched out. | Check the display mode settings in the setup menu by pressing the display menu button on the remote control.   |
| In auxiliary mode, the picture moves or scrolls.  | Check the auxiliary input connections at both devices.   |
| The remote control does not work.   | Check to make sure there is no obstruction between the remote control and the transmitter window.<br>Check the batteries to make sure they are not dead or installed incorrectly.                        |
| After stopping the player, I push Play but sometimes the DVD starts where I left off and sometimes at the beginning.            | If the Stop button was pressed one time, the DVD player resumes playing where the DVD was stopped. If the stop button was pressed two times the DVD player begins to play from the beginning of the DVD. |
| The auxiliary source is running but there is no picture or sound.   | Check that the RSE video screen is in the auxiliary source mode by pressing the AUX button on the remote control.<br>Check the auxiliary input connections at both devices.                              |

### Tips and Troubleshooting Chart (cont.)

| Problem  | Recommended Action  |
|--|---|
| Sometimes the wireless headphone audio cuts out or buzzes. | Check for obstructions, low batteries, reception range, and interference from cellular telephone towers or by using a cellular telephone in the vehicle.<br>Check that the headphones are on correctly using the L (left) and R (right) on the headphones.<br>Check that the headphones are positioned properly with the headband across the top of the head. |
| I lost the remote and/or the headphones.                   | See your dealer for assistance.   |
| The DVD is playing, but there is no picture or sound.      | Check that the RSE video screen is sourced to the DVD player by pressing the AUX button on the remote control.  |

#### DVD Display Error Messages

The DVD display error message depends on which radio the vehicle has. The video screen may display one of the following:

##### Disc Load/Eject Error or

**Mechanical Error:** There are disc load or eject problems.

##### Disc Format Error or Unknown

**Format:** The disc is inserted with the disc label wrong side up, or the disc is damaged.

##### Disc Region Error or Disc Error:

The disc is not from a correct region.

**No Disc Inserted:** No disc is present when the ▲ EJECT or MEM/DVD/AUX button is pressed on the radio.



### DVD Distortion

Video distortion can occur when operating cellular phones, scanners, CB radios, Global Position Systems (GPS)\*, two-way radios, mobile fax, or walkie talkies.

It might be necessary to turn off the DVD player when operating one of these devices in or near the vehicle.

\*Excludes the OnStar® System.

### Cleaning the RSE Seatback Console

Use only a clean cloth dampened with clean water to clean the RSE seatback console surface.

### Cleaning the Video Screen

Use only a clean cloth dampened with clean water. Use care when touching or cleaning the screen as damage could result.

### Rear Seat Audio (RSA) System

Vehicles with this feature allow the rear seat passengers to listen to and control any of the music sources: radio, CDs, DVDs, or other auxiliary sources. RSA can only control music sources that the front seat passengers are not listening to, except on radios where dual control is allowed.

RSA can function when the front radio is off.  displays on the infotainment system when RSA is on.

Audio can be heard through wired headphones (not included) plugged into the jacks on the RSA. If the vehicle has a Rear Seat Entertainment system with wireless headphones, audio can also be heard on Channel 2 of the wireless headphones.

To listen to a portable audio device through the RSA, attach the portable audio device to either the front or rear auxiliary input, if available. Turn the device on, then choose the front auxiliary input with the RSA SRCE button.

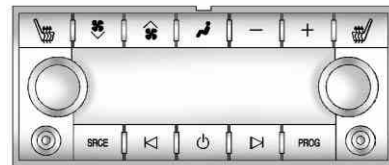

 **(Power):** Press to turn the RSA on or off.

**Volume:** Turn to increase or decrease the volume of the wired headphones. The left knob controls the left headphones and the right knob controls the right. Use the volume control on the headphones for wireless headphones.

## 7-44 Infotainment System

---

**SRCE (Source):** Press to select between the radio, CD, and if these features are available: DVD, front or rear auxiliary, HDD, USB. The front radio may override the rear selection as required.

**◀▶ (Seek):** While listening to the radio, press to go to the previous or to the next station and stay there. If the front seat passengers are listening to the radio, this function may be inactive on some radios.

Press and hold ◀ or ▶ until “Tune” displays. Continue to press ◀ or ▶ to tune to an individual station. Tune stays active until ◀ or ▶ has not been pressed for several seconds. If the front seat passengers are listening to the radio, this function may be inactive on some radios.

While listening to a disc, press ▶ to go to the next track or chapter on the disc. Press ◀ to go back to the start of the current track or chapter if more than 10 seconds have played. If the front seat passengers are listening to a disc, this function may be inactive on some radios. Press and hold ◀ or ▶ to fast reverse or fast forward.

When a DVD video menu is being displayed, press ◀ or ▶ to cursor up or down on the menu. Hold ◀ or ▶ to cursor left or right on the menu.

**PROG (Program):** Press to go to the next preset radio station or channel set on the main radio. If the front seat passengers are listening to the radio, this function may be inactive on some radios.

When a CD or DVD audio disc is playing, press PROG to go to the beginning of the disc or display disc info. If the front seat passengers are listening to a disc, this function may be inactive on some radios.

When a disc is playing in the CD or DVD changer, press and hold PROG to select the next disc, if multiple discs are loaded. If the front seat passengers are listening to a disc, this function may be inactive on some radios.

The PROG button may be used to access the menu of an MP3. Once in the menu, use ◀ or ▶ to make selections.

When a DVD video menu is displayed, press PROG, or press and hold PROG to perform the menu function, then press ENTER.

## Phone

### Bluetooth (Overview)

For vehicles equipped with Bluetooth capability, the system can interact with many cell phones, allowing:

- Placement and receipt of calls in a hands-free mode.
- Sharing of the cell phone's address book or contact list with the vehicle.

To minimize driver distraction, before driving, and with the vehicle parked:

- Become familiar with the features of the cell phone. Organize the phone book and contact lists clearly and delete duplicate or rarely used entries. If possible, program speed dial or other shortcuts.
- Review the controls and operation of the infotainment system.

- Pair cell phone(s) to the vehicle. The system may not work with all cell phones. See "Pairing a Phone" in this section for more information.
- If the cell phone has voice dialing capability, learn to use that feature to access the address book or contact list. See "Voice Pass-Thru" in this section for more information.
- See "Storing and Deleting Phone Numbers" in this section for more information.

#### WARNING

When using a cell phone, it can be distracting to look too long or too often at the screen of the phone or the infotainment (navigation) system. Taking your eyes off the road too long or too often could cause a crash resulting in injury or death. Focus your attention on driving.

Vehicles with a Bluetooth system can use a Bluetooth-capable cell phone with a Hands-Free Profile to make and receive phone calls. The infotainment system and voice recognition are used to control the system. The system can be used while the ignition is in ON/RUN or ACC/ACCESSORY. The range of the Bluetooth system can be up to 9.1 m (30 ft). Not all phones support all functions and not all phones work with the Bluetooth system. See [www.gm.com/bluetooth](http://www.gm.com/bluetooth) for more information about compatible phones.

### Bluetooth Controls

Use the buttons located on the infotainment system and the steering wheel to operate the Bluetooth system.

### Steering Wheel Controls

 (Push To Talk): Press to answer incoming calls, to confirm system information, and to start voice recognition.

 (Mute/End Call): Press to end a call, reject a call, or to cancel an operation.

### Infotainment System Controls

For information about how to navigate the menu system using the infotainment controls, see *Operation on page 7-7*.

 (Phone): Press to enter the Phone main menu.

### Voice Recognition

The voice recognition system uses commands to control the system and dial phone numbers.

**Noise:** The system may not recognize voice commands if there is too much background noise.

**When to Speak:** A tone sounds to indicate that the system is ready for a voice command. Wait for the tone and then speak.

**How to Speak:** Speak clearly in a calm and natural voice.

### Audio System

When using the Bluetooth system, sound comes through the vehicle's front audio system speakers and overrides the audio system. Use the VOL/  knob during a call to change the volume level. The adjusted volume level remains in memory for later calls. The system maintains a minimum volume level.

### Other Information

The Bluetooth<sup>®</sup> word mark and logos are owned by the Bluetooth<sup>®</sup> SIG, Inc. and any use of such marks by General Motors is under license. Other trademarks and trade names are those of their respective owners.

See *Radio Frequency Statement on page 13-18* for FCC information for Federal Communications Commission and Industry Canada information.

### Bluetooth (Infotainment Controls)

For information about how to navigate the menu system using the infotainment controls, see *Operation on page 7-7*.

### Pairing

A Bluetooth-enabled cell phone must be paired to the Bluetooth system first and then connected to the vehicle before it can be used. See the cell phone manufacturer user guide for Bluetooth functions before pairing the cell phone. If a Bluetooth phone is not connected, calls will be made using OnStar<sup>®</sup> Hands-Free Calling, if available. Refer to the OnStar Owner's Guide for more information.

A Bluetooth phone with MP3 capability can not be connected to the vehicle as a phone and an MP3 player at the same time.

The pairing process can be started by using the voice recognition system or the controls on the infotainment system.

Pairing Information:

- Up to five cell phones can be paired to the Bluetooth system.
- The pairing process is disabled when the vehicle is moving.
- The Bluetooth system links with the first available paired cell phone in the order the phone was paired.
- Only one paired cell phone can be connected to the Bluetooth system at a time.
- Pairing should only need to be completed once, unless changes to the pairing information have been made or the phone is deleted.

To link to a different paired phone, see “Linking to a Different Phone” later in this section.

### Pairing a Phone

1. Press the CONFIG button.
2. Select Phone Settings.
3. Select Bluetooth.
4. Select Pair Device (Phone).  
A four-digit Personal Identification Number (PIN) appears on the display.
5. Start the pairing process on the cell phone that will be paired to the vehicle. Reference the cell phone manufacturers user guide for information on this process.  
  
Locate the device named “Your Vehicle” in the list on the cell phone and follow the instructions on the cell phone to enter the PIN provided by the system.
6. The system prompts for a name for the phone and confirms the name provided. This name is used to indicate which phone is connected.

7. The system responds with “<Phone name> has been successfully paired” after the pairing process is complete.
8. Repeat Steps 1 through 7 to pair additional phones.

### Listing All Paired and Connected Phones

1. Press the CONFIG button.
2. Select Phone Settings.
3. Select Bluetooth.
4. Select Device List.

### Deleting a Paired Phone

1. Press the CONFIG button.
2. Select Phone Settings.
3. Select Bluetooth.
4. Select Device List.
5. Select the phone to delete and follow the on screen prompts.

### Linking to a Different Phone

To link to a different phone, the new phone must be in the vehicle and available to be connected to the Bluetooth system before the process is started.

1. Press the CONFIG button.
2. Select Phone Settings.
3. Select Bluetooth.
4. Select Device List.
5. Select the new phone to link to and follow the on screen prompts.

If delete is selected, the highlighted phone will be deleted.

### Making a Call Using Phone Book

For cell phones that support the phone book feature, the Bluetooth system can use the contacts stored on your cell phone to make calls. See your cell phone's owner's guide or contact your wireless provider to find out if this feature is supported by your phone.



When a cell phone supports the phone book feature, the Phone Book and Call Lists menus are automatically available.

The Phone Book menu allows you to access the phone book stored in the cell phone to make a call.



The Call Lists menu allows you to access the phone numbers from the Incoming Calls, Outgoing Calls, and Missed Calls menus on your cell phone to make a call.

### Radio with CD



To make a call using the Phone Book menu:

1. Press  /  twice.
2. Select Phone Book.
3. You can search through the list by selecting the letter group the phone book entry begins with, or press SELECT to scroll through the entire list of names/numbers in the phone book.
4. Select the name or number you want to call.



To make a call using the Call Lists menu:

1. Press  /  twice.
2. Select Call Lists.
3. Select the Incoming Calls, Outgoing Calls, or Missed Calls list.
4. Select the name or number you want to call.

### Radio with CD/DVD and MEM



1. Press  / .
2. Select Phone Book.
3. You can search through the list by selecting the letter group the phone book entry begins with, or press SELECT to scroll through the entire list of names/numbers in the phone book.
4. Select the name or number you want to call.

To make a call using the Call Lists menu:



1. Press  / .
2. Select Call Lists.
3. Select the Incoming Calls, Outgoing Calls, or Missed Calls list.
4. Select the name or number you want to call.

### Making a Call

#### Radio with CD

1. Press  /  twice.
2. Enter the character sequence. See “Entering a Character Sequence” in *Operation on page 7-7* for more information.
3. Select Call to start dialing the number.

#### Radio with CD/DVD and MEM

1. Press  / .
2. Select Enter number.
3. Enter the character sequence. See “Entering a Character Sequence” in *Operation on page 7-7* for more information.
4. Select Call to start dialing the number.

### Accepting or Declining a Call

When an incoming call is received, the infotainment system mutes and a ring tone is heard in the vehicle.

#### Accepting a Call

Press the MENU/SEL knob to “Answer” and press the MENU/SEL knob to accept the call.

#### Declining a Call

Press the MENU/SEL knob to “Decline” and press the MENU/SEL knob to decline the call.

#### Call Waiting

Call waiting must be supported on the Bluetooth phone and enabled by the wireless service carrier to work.

#### Accepting a Call

Press the MENU/SEL knob to “Answer” and press the MENU/SEL knob to accept the call.

### Declining a Call

Press the MENU/SEL knob to “Decline” and press the MENU/SEL knob to decline the call.

### Switching Between Calls (Call Waiting Calls Only)

To switch between calls:

1. Press the MENU/SEL knob.
2. Select Switch Call from the menu.

### Conference Calling

Conference calling and three-way calling must be supported on the Bluetooth phone and enabled by the wireless service carrier to work.

To start a conference while in a current call:

1. Press the MENU/SEL knob.
2. Select Enter Number.

3. Enter the character sequence then select Call. See “Entering a Character Sequence” in *Operation on page 7-7* for more information.
4. After the call has been placed, press the MENU/SEL knob and choose Merge Calls.
5. To add more callers to the conference call, repeat Steps 1 through 4. The number of callers that can be added are limited by your wireless service carrier.

### Ending a Call

Press the MENU/SEL knob and select Hang Up.

### Muting a Call

#### To Mute a Call

Press the MENU/SEL knob and select Mute Call.

### To Cancel Mute

Press the MENU/SEL knob and select Mute Call.

### Dual Tone Multi-Frequency (DTMF) Tones

The in-vehicle Bluetooth system can send numbers during a call. This is used when calling a menu-driven phone system.

1. Press the MENU/SEL knob and select Enter Number.
2. Enter the character sequence. See “Entering a Character Sequence” in *Operation on page 7-7* for more information.



## Bluetooth (Voice Recognition)

### Pairing

A Bluetooth cell phone must be paired to the Bluetooth system and then connected to the vehicle before it can be used. See the cell phone manufacturer's user guide for Bluetooth functions before pairing the cell phone. If a Bluetooth phone is not connected, calls will be made using OnStar® Hands-Free Calling, if available. Refer to the OnStar owner's guide for more information.

The pairing process can be started by using the voice recognition system or the controls on the infotainment system.



Pairing Information:

- Up to five cell phones can be paired to the Bluetooth system.
- The pairing process is disabled when the vehicle is moving.

- The Bluetooth system links with the first available paired cell phone in the order the phone was paired.
- Only one paired cell phone can be connected to the Bluetooth system at a time.
- Pairing only needs to be completed once, unless the pairing information changes or the phone is deleted.

To link to a different paired phone, see "Linking to a Different Phone" later in this section.

### Pairing a Phone

1. Press  / .
  - For vehicles without a navigation system, the system responds "Ready," followed by a tone.
  - For vehicles with a navigation system, the system responds with a tone. After the tone say

2. Say "Hands Free." The system responds "Ready," followed by a tone.
2. Say "Bluetooth." The system responds "Bluetooth ready," followed by a tone.
3. Say "Pair." The system responds with instructions and a four-digit Personal Identification Number (PIN). The PIN will be used in Step 4.
4. Start the pairing process on the cell phone that will be paired to the vehicle. Reference the cell phone manufacturer's user guide for information on this process.



Locate the device named "Your Vehicle" in the list on the cell phone and follow the instructions on the cell phone to enter the four-digit PIN number that was provided in Step 3.

## 7-52 Infotainment System

---

5. The system prompts for a name for the phone. This name will be used to indicate which phone is connected. The system confirms the name.
6. The system responds with "<Phone name> has been successfully paired" after the pairing process is complete.
7. Repeat Steps 1 through 7 for additional phones to be paired.



### Listing All Paired and Connected Phones

1. Press  / .

  - For vehicles without a navigation system, the system responds "Ready," followed by a tone.
  - For vehicles with a navigation system, the system responds with a tone. After the tone say "Hands Free." The system responds "Ready," followed by a tone.

2. Say "Bluetooth." The system responds "Bluetooth ready," followed by a tone.
3. Say "List." The system lists all paired Bluetooth devices. The system will respond "is connected" if a phone is connected to the vehicle.



### Deleting a Paired Phone

1. Press  / .

  - For vehicles without a navigation system, the system responds "Ready," followed by a tone.
  - For vehicles with a navigation system, the system responds with a tone. After the tone say "Hands Free." The system responds "Ready," followed by a tone.

2. Say "Bluetooth." The system responds "Bluetooth ready," followed by a tone.
3. Say "Delete." The system asks which phone to delete followed by a tone.
4. Say the name of the phone to be deleted. If the phone name is unknown, use the "List" command for a list of all paired phones. The system responds "Would you like to delete <phone name>? Yes or No," followed by a tone.
5. Say "Yes" to delete the phone. The system responds "OK, deleting <phone name>."

### Linking to a Different Phone

1. Press  / .

  - For vehicles without a navigation system, the system responds "Ready," followed by a tone.

- For vehicles with a navigation system, the system responds with a tone. After the tone say “Hands Free.” The system responds “Ready,” followed by a tone.
2. Say “Bluetooth.” The system responds “Bluetooth ready,” followed by a tone.
  3. Say “Change phone.” The system responds “Please wait while I search for other phones.”
    - If another phone is found, the response will be “<Phone name> is now connected.”
    - If another phone is not found, the original phone remains connected.

### Storing Name Tags



The system can store up to 30 phone numbers as name tags that are shared between the Bluetooth and OnStar systems.

The system uses the following commands to store and retrieve phone numbers:

- Store
- Digit Store
- Directory

### Using the Store Command

The store command allows a phone number to be stored without entering the digits individually.

1. Press  / .
  - For vehicles without a navigation system, the system responds “Ready,” followed by a tone.
  - For vehicles with a navigation system, the system responds with a tone. After the tone say “Hands Free.” The system responds “Ready,” followed by a tone.

2. Say “Store.” The system responds “Store, number please,” followed by a tone.
3. Say the complete phone number to be stored at once with no pauses.
  - If the system recognizes the number, the response is “OK, Storing.”
  - If the system does not recognize the phone number, the response is “Store <Phone number>. Please say yes or no.” If the number is correct, say “Yes.” If the number is not correct, say “No.” The system will ask for the number again.
4. After the system stores the phone number, it responds “Please say the name tag,” followed by a tone.



## 7-54 Infotainment System

---

5. Say a name tag for the phone number. The name tag is recorded and the system responds "About to store <name tag>. Does that sound OK?."
  - If the name tag does not sound correct, say "No" and repeat Step 5.
  - If the name tag sounds correct, say "Yes" and the name tag is stored. After the number is stored the system returns to the main menu.



### Using the Digit Store Command

The digit store command allows a phone number to be stored by entering the digits individually.

1. Press  / .
  - For vehicles without a navigation system, the system responds "Ready," followed by a tone.
- For vehicles with a navigation system, the system responds with a tone. After the tone say "Hands Free." The system responds "Ready," followed by a tone.
  2. Say "Digit Store." The system responds with "Please say the first digit to store," followed by a tone.
  3. Say the first digit to be stored. The system will repeat back the digit it heard followed by a tone. Continue entering digits until the number to be stored is complete.
    - If an unwanted number is recognized by the system, say "Clear" at any time to clear the last number.
    - To hear all of the numbers recognized by the system, say "Verify" at any time.
4. After the complete number has been entered, say "Store." The system responds "Please say the name tag," followed by a tone.
  5. Say a name tag for the phone number. The name tag is recorded and the system responds "About to store <name tag>. Does that sound OK?."
    - If the name tag does not sound correct, say "No" and repeat Step 5.
    - If the name tag sounds correct, say "Yes" and the name tag is stored. After the number is stored the system returns to the main menu.

### Using the Directory Command

The directory command lists all of the name tags stored by the system. To use the directory command:

1. Press  / .
  - For vehicles without a navigation system, the system responds “Ready,” followed by a tone.
  - For vehicles with a navigation system, the system responds with a tone. After the tone say “Hands Free.” The system responds “Ready,” followed by a tone.
2. Say “Directory.” The system responds “Directory” and lists all stored name tags. The system returns to the main menu when the list is complete.

### Deleting Name Tags



The system uses the following commands to delete name tags:

- Delete
- Delete all name tags

### Using the Delete Command

The delete command is used to delete specific name tags.

To delete name tags:



1. Press  / .
  - For vehicles without a navigation system, the system responds “Ready,” followed by a tone.
  - For vehicles with a navigation system, the system responds with a tone. After the tone say “Hands Free.” The system responds “Ready,” followed by a tone.

2. Say “Delete.” The system responds “Delete, please say the name tag,” followed by a tone.
3. Say the name tag to be deleted. The system responds “Would you like to delete, <name tag>? Please say yes or no.”
  - If the name tag is correct, say “Yes” to delete the name tag. The system responds with “OK, deleting <name tag>, returning to the main menu.”
  - If the name tag is incorrect, say “No.” The system responds with “No. OK, let's try again, please say the name tag.”

### Using the Delete All Name Tags Command

The Delete All Name Tags command deletes all stored phone book name tags and route name tags for OnStar, if stored.

To delete all name tags:

1. Press  / .

  - For vehicles without a navigation system, the system responds “Ready,” followed by a tone.
  - For vehicles with a navigation system, the system responds with a tone. After the tone say “Hands Free.” The system responds “Ready,” followed by a tone.

2. Say “Delete all name tags.” The system responds “You are about to delete all name tags stored in your phone directory and your route destination directory. Are you sure you want to do this? Please say yes or no.”



- Say “Yes” to delete all name tags.
- Say “No” to cancel the function and return to the main menu.

### Making a Call

Calls can be made using the following commands:



- Dial
- Digit Dial
- Call
- Re-dial

### Using the Dial Command

1. Press  / .
    - For vehicles without a navigation system, the system responds “Ready,” followed by a tone.
    - For vehicles with a navigation system, the system responds with a tone. After the tone say “Hands Free.” The system responds “Ready,” followed by a tone.
2. Say “Dial.” The system responds “Dial using <phone name>.” “Number please,” followed by a tone.
  3. Say the entire number without pausing.
    - If the system recognizes the number, it responds with “OK, Dialing” and dials the number.



- If the system does not recognize the number, it confirms the numbers followed by a tone. If the number is correct, say "Yes." The system responds "OK, Dialing" and dials the number. If the number is not correct, say "No." The system will ask for the number again.

### Using the Digit Dial Command

1. Press  / .
  - For vehicles without a navigation system, the system responds "Ready," followed by a tone.
  - For vehicles with a navigation system, the system responds with a tone. After the tone say "Hands Free." The system responds "Ready," followed by a tone.

2. Say "Digit Dial." The system responds "Digit dial using <phone name>, please say the first digit to dial," followed by a tone.
3. Say the digits to be dialed one at a time. The system repeats back the digit it heard followed by a tone.
4. Continue entering digits until the number to be dialed is complete. After the whole number has been entered, say "Dial." The system responds "OK, Dialing" and dials the number.
  - If an unwanted number is recognized by the system, say "Clear" at any time to clear the last number.
  - To hear all of the numbers recognized by the system, say "Verify" at any time.

### Using the Call Command

1. Press  / .
  - For vehicles without a navigation system, the system responds "Ready," followed by a tone.
  - For vehicles with a navigation system, the system responds with a tone. After the tone say "Hands Free." The system responds "Ready," followed by a tone.
2. Say "Call." The system responds "Call using <phone name>. Please say the name tag," followed by a tone.



## 7-58 Infotainment System

---

- Say the name tag of the person to call.
  - If the system recognizes the name tag it responds “OK, calling, <name tag>” and dials the number.
  - If the system does not recognize the name tag, it confirms the name tag followed by a tone. If the name tag is correct, say “Yes.” The system responds with “OK, calling, <name tag>” and dials the number. If the name tag is not correct, say “No.” The system will ask for the name tag again.

Once connected, the person called will be heard through the audio speakers.





### Using the Re-dial Command

- Press  / .
    - For vehicles without a navigation system, the system responds “Ready,” followed by a tone.
    - For vehicles with a navigation system, the system responds with a tone. After the tone say “Hands Free.” The system responds with “Ready,” followed by a tone.
- After the tone, say “Re-dial.” The system responds “Re-dial using <phone name>” and dials the last number called from the connected Bluetooth phone.

Once connected, the person called will be heard through the audio speakers.







### Receiving a Call

When an incoming call is received, the audio system mutes and a ring tone is heard in the vehicle.

- Press   to answer the call.
- Press  /  to ignore a call.

### Call Waiting





Call waiting must be supported on the Bluetooth phone and enabled by the wireless service carrier.

- Press   to answer an incoming call when another call is active. The original call is placed on hold.
- Press   again to return to the original call.
- To ignore the incoming call, no action is required.
- Press  /  to disconnect the current call and switch to the call on hold.



### Three-Way Calling

Three-way calling must be supported on the Bluetooth phone and enabled by the wireless service carrier.

1. While on a call, press  . The system responds with “Ready,” followed by a tone.
2. Say “Three-way call.” The system responds with “Three-way call, please say dial or call.”
3. Use the dial or call command to dial the number of the third party to be called.
4. Once the call is connected, press   to link all callers together.



### Ending a Call

Press  /  to end a call.



### Muting a Call

During a call, all sounds from inside the vehicle can be muted so that the person on the other end of the call cannot hear them.

#### To Mute a call

1. Press  . The system responds “Ready,” followed by a tone.
2. Say “Mute Call.” The system responds “Call muted.”

#### To Cancel Mute



1. Press  . The system responds “Ready,” followed by a tone.
2. After the tone, say “Mute Call.” The system responds “Resuming call.”

### Transferring a Call

Audio can be transferred between the in-vehicle Bluetooth system and the cell phone.



#### To Transfer Audio to the Cell Phone



During a call with the audio in the vehicle:

1. Press  . The system responds “Ready,” followed by a tone.
2. Say “Transfer Call.” The system responds “Transferring call” and the audio transfers to the cell phone.

### To Transfer Audio to the In-Vehicle Bluetooth System

The cell phone must be paired and connected with the Bluetooth system before a call can be transferred. The connection process can take up to two minutes after the ignition is turned to ON/RUN or ACC/ACCESSORY.



For vehicles without a navigation system, press   during a call with the audio on the cell phone. The audio transfers to the vehicle.

For vehicles with a navigation system, press   during a call with the audio on the cell phone. If the audio does not transfer to the vehicle, use the audio transfer feature on the cell phone. See the cell phone manufacturer's user guide for more information.

### Voice Pass-Thru

Voice pass-thru allows access to the voice recognition commands on the cell phone. See the cell phone manufacturer's user guide to see if the cell phone supports this feature.

To access contacts stored in the cell phone:

1. Press  / .



  - For vehicles without a navigation system, the system responds "Ready," followed by a tone.
  - For vehicles with a navigation system, the system responds with a tone. After the tone say "Hands Free." The system responds "Ready," followed by a tone.

2. Say "Bluetooth." The system responds "Bluetooth ready," followed by a tone.
3. Say "Voice." The system responds "OK, accessing <phone name>."
  - The cell phone's normal prompt messages will go through their cycle according to the phone's operating instructions.



### Dual Tone Multi-Frequency (DTMF) Tones

The in-vehicle Bluetooth system can send numbers and the numbers stored as name tags during a call. Use this feature when calling a menu-driven phone system. Account numbers can also be stored for use.

### **Sending a Number During a Call**

1. Press  . The system responds "Ready," followed by a tone.
2. Say "Dial." The system responds "Say a number to send tones," followed by a tone.
3. Say the number to send.
  - If the system recognizes the number, it responds "OK, Sending Number" and the dial tones are sent and the call continues.
  - If the system does not recognize the number, it responds "Dial Number, please say yes or no?," followed by a tone. If the number is correct, say "Yes." The system responds "OK, Sending Number" and the dial tones are sent and the call continues.

### **Sending a Stored Name Tag During a Call**

1. Press  . The system responds "Ready," followed by a tone.
2. Say "Send name tag." The system responds "Say a name tag to send tones," followed by a tone.
3. Say the name tag to send.
  - If the system recognizes the number, it responds "OK, Sending <name tag>" and the dial tones are sent and the call continues.
  - If the system does not recognize the name tag, it responds "Dial <name tag>, please say yes or no?," followed by a tone. If the name tag is correct, say "Yes." The system responds with "OK, Sending <name tag>" and the dial tones are sent and the call continues.

### **Clearing the System**

Unless information is deleted out of the in-vehicle Bluetooth system, it will be retained indefinitely. This includes all saved name tags in the phone book and phone pairing information. For information on how to delete this information, see the previous sections on Deleting a Paired Phone and Deleting Name Tags.



## Climate Controls

### Climate Control Systems

- Climate Control Systems ..... 8-1
- Automatic Climate Control System ..... 8-3

### Air Vents

- Air Vents ..... 8-5

### Maintenance

- Passenger Compartment Air Filter ..... 8-6

## Climate Control Systems

The vehicle's heating, cooling, defrosting, and ventilation can be controlled with this system.

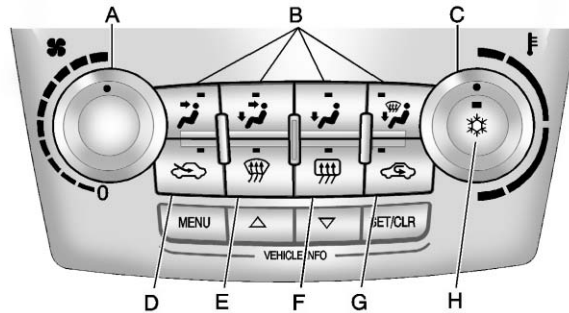

- A. Fan Control
- B. Air Delivery Mode Controls
- C. Temperature Control
- D. Outside Air
- E. Defrost
- F. Rear Window Defogger
- G. Recirculation

- H. Air Conditioning

**Fan Control:** Turn to increase or decrease the fan speed. Turn the knob completely to 0 to turn the fan off.

**Temperature Control:** Turn to increase or decrease the temperature.

## 8-2 Climate Controls

---

**Air Delivery Mode Control:** To change the current mode, select one of the following:

 **(Vent):** Air is directed to the instrument panel outlets.

 **(Bi-Level):** Air is directed to the instrument panel outlets and the floor outlets.

 **(Floor):** Air is directed to the floor outlets.

 **(Defog):** Clears the windows of fog or moisture. Air is directed to the windshield and floor outlets.

 **(Defrost):** Clears the windshield of fog or frost more quickly. Air is directed to the windshield and side window outlets.

For best results, clear all snow and ice from the windshield before defrosting.

Do not drive the vehicle until all the windows are clear.

### Air Conditioning

 **(Air Conditioning):** Press to turn the air conditioning on or off. If the fan is turned off or the outside temperature falls below freezing, the air conditioning will not work.

 **(Recirculation):** Press to turn on the recirculation. An indicator light comes on. Air is recirculated inside the vehicle. It helps to quickly cool the air inside the vehicle or prevent outside air and odors from entering. The air conditioning may come on under certain conditions.

 **(Outside Air):** Press to turn on the outside air. An indicator light comes on. Outside air is circulated throughout the vehicle.

### Rear Window Defogger

 **(Rear Defogger):** Press to turn the rear window defogger on or off. The rear window defogger turns off after about 10 minutes. It can also be turned off by turning the ignition to ACC/ACCESSORY or LOCK/OFF. If turned on again, it runs for about five minutes before turning off.

Do not drive the vehicle until all the windows are clear.

**Notice:** Do not use a razor blade or sharp object to clear the inside rear window. Do not adhere anything to the defogger grid lines in the rear glass. These actions may damage the rear defogger. Repairs would not be covered by your warranty.

## Automatic Climate Control System

The vehicle's heating, cooling, defrosting, and ventilation can be controlled with this system.

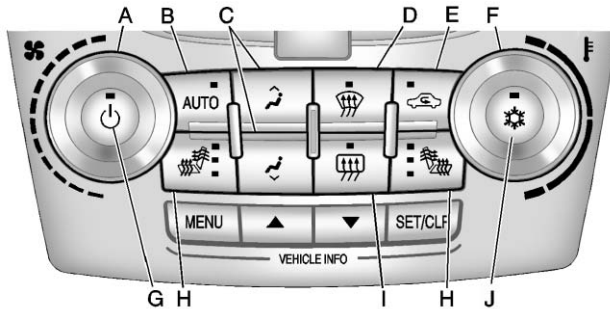

- |                               |                                      |
|-------------------------------|--------------------------------------|
| A. Fan Control                | G. Power                             |
| B. AUTO (Automatic Operation) | H. Driver and Passenger Heated Seats |
| C. Air Delivery Mode Controls | I. Rear Window Defogger              |
| D. Defrost                    | J. Air Conditioning                  |
| E. Recirculation              |                                      |
| F. Temperature Control        |                                      |

### Automatic Operation

The system automatically controls the fan speed, air delivery, air conditioning, and recirculation to heat or cool the vehicle to the selected temperature.

When the AUTO indicator light is on, the system is in full automatic operation.

To place the system in automatic mode:

1. Press AUTO.
2. Set the temperature. Allow the system time to stabilize. Then adjust the temperature as needed.

### Manual Operation

**⏻ (Power):** Press to turn the climate control system on or off.

**🌀 (Fan Control):** Turn to increase or decrease the fan speed. Adjusting the fan speed while in automatic mode places the fan under manual control.

## 8-4 Climate Controls

---

The AUTO indicator light turns off. The air delivery mode remains in automatic control.

**Temperature Control:** Turn to increase or decrease the temperature inside the vehicle.

 **(Air Delivery Mode Control):** Press mode up or mode down to cycle through the different air delivery modes. The current mode is shown on the display.

Select from the following:

 **(Vent):** Air is directed to the instrument panel outlets.

 **(Bi-Level):** Air is directed to the instrument panel outlets and the floor outlets.

 **(Floor):** Air is directed to the floor outlets.

 **(Defog):** Clears the windows of fog or moisture. Air is directed to the windshield and floor outlets.

 **(Defrost):** Clears the windshield of fog or frost more quickly. Air is directed to the windshield and side window outlets. Selecting defrost disables the automatic mode.

For best results, clear all snow and ice from the windshield before defrosting.

Do not drive the vehicle until all the windows are clear.

### Air Conditioning

 **(Air Conditioning):** Press to turn the air conditioning on or off. If the fan is turned off or the outside temperature falls below freezing, the air conditioning will not work. When in AUTO, the air conditioning will come on automatically as needed.

 **(Recirculation):** Press to turn on the recirculation. Press to alternate between recirculation and outside air, if the vehicle does not have a separate outside air button.

The indicator light turns on when recirculation is selected. Air is recirculated inside the vehicle. It helps quickly cool the air inside the vehicle or prevent outside air and odors from entering.

 **(Outside Air, If Equipped):** Press to turn on the outside air. An indicator light comes on. Outside air is circulated throughout the vehicle.

### Rear Window Defogger

 **(Rear Defogger):** Press to turn the rear window defogger on or off. The rear window defogger turns off after about 10 minutes. It can also be turned off by turning the ignition to ACC/ACCESSORY or LOCK/OFF. If turned on again, it runs for about five minutes before turning off.

Do not drive the vehicle until all the windows are clear.



**Notice:** Do not use a razor blade or sharp object to clear the inside rear window. Do not adhere anything to the defogger grid lines in the rear glass. These actions may damage the rear defogger. Repairs would not be covered by your warranty.

 (Driver and Passenger Heated Seats): For vehicles with heated seats, see *Heated Front Seats* on page 3-8.

**Remote Start Climate Control Operation:** For vehicles with the remote vehicle start feature, the climate control system may run when the vehicle is started remotely.

The system uses the driver's previous settings to heat or cool the inside of the vehicle. The front heated seats will turn on if it is cold outside. The heated seat indicator lights do not come on during a remote start. See *Remote Vehicle Start* on page 2-5.

### Sensors

The solar sensor, located on top of the instrument panel near the windshield, monitors the solar heat.

The climate control system uses the information to adjust the temperature, fan speed, recirculation, and air delivery mode.

Do not cover the solar sensor or the system will not work properly.

### Air Vents

Use the air outlets, located in the center and on the side of the instrument panel, to direct the airflow. Use the thumbwheels located near the center air outlets, to open or close off the airflow.

### Operation Tips

- Clear away any ice, snow, or leaves from air inlets at the base of the windshield that could block the flow of air into the vehicle.
- Keep the path under the front seats clear of objects to help circulate the air inside of the vehicle more effectively.
- Use of non-GM approved hood deflectors can adversely affect the performance of the system. Check with your dealer before adding equipment to the outside of the vehicle.

### Maintenance

#### Passenger Compartment Air Filter

The filter removes dust, pollen, and other airborne irritants from outside air that is pulled into the vehicle.

The filter should be replaced as part of routine scheduled maintenance. See *Scheduled Maintenance on page 11-2* for replacement intervals. To find out what type of filter to use, see *Maintenance Replacement Parts on page 11-8*.

The passenger compartment air filter can be accessed by removing the entire glove box.

1. Open the glove box completely and locate the stop tab on top of the glove box door.

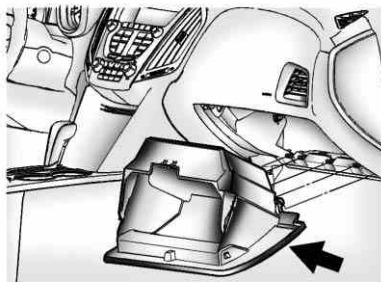

2. Push the stop tab upwards until the stop tab is under the instrument panel assembly and the glove box is released.
3. Unsnap the tabs beneath the glove box that connects it to the bottom of the instrument panel assembly.
4. Remove the glove box.
5. Locate the service door for the passenger compartment air filter.
6. Push the two tabs upwards and release the latches holding the service door. Lift the service door.

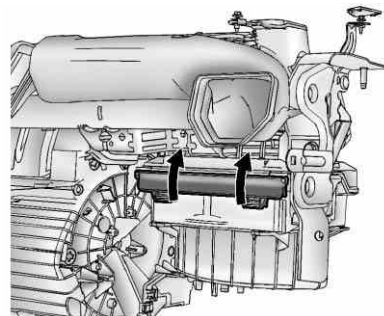

7. Remove the old air filter.
  8. Install the new air filter.
  9. Close the service door and latches.
  10. Re-install the glove box.
- See your dealer if additional assistance is needed.

# Driving and Operating

## Driving Information

|                               |      |
|-------------------------------|------|
| Defensive Driving .....       | 9-2  |
| Drunk Driving .....           | 9-2  |
| Control of a Vehicle .....    | 9-3  |
| Braking .....                 | 9-3  |
| Steering .....                | 9-4  |
| Off-Road Recovery .....       | 9-6  |
| Loss of Control .....         | 9-6  |
| Off-Road Driving .....        | 9-7  |
| Driving on Wet Roads .....    | 9-17 |
| Highway Hypnosis .....        | 9-18 |
| Hill and Mountain Roads ..... | 9-18 |
| Winter Driving .....          | 9-19 |
| If the Vehicle is Stuck ..... | 9-21 |
| Vehicle Load Limits .....     | 9-21 |

## Starting and Operating

|                            |      |
|----------------------------|------|
| New Vehicle Break-In ..... | 9-26 |
| Ignition Positions .....   | 9-27 |
| Starting the Engine .....  | 9-29 |

|   |      |
|---|------|
| Retained Accessory<br>Power (RAP) ..... | 9-30 |
| Engine Coolant Heater .....             | 9-30 |
| Shifting Into Park .....                | 9-31 |
| Shifting Out of Park .....              | 9-32 |
| Parking Over Things<br>That Burn .....  | 9-32 |

## Engine Exhaust

|   |      |
|---|------|
| Engine Exhaust .....                      | 9-32 |
| Running the Vehicle While<br>Parked ..... | 9-33 |

## Automatic Transmission

|                              |      |
|------------------------------|------|
| Automatic Transmission ..... | 9-34 |
| Manual Mode .....            | 9-35 |
| Fuel Economy Mode .....      | 9-36 |

## Drive Systems

|                       |      |
|-----------------------|------|
| All-Wheel Drive ..... | 9-37 |
|-----------------------|------|

## Brakes

|                                      |      |
|--------------------------------------|------|
| Antilock Brake<br>System (ABS) ..... | 9-37 |
| Parking Brake .....                  | 9-38 |
| Brake Assist .....                   | 9-39 |
| Hill Start Assist (HSA) .....        | 9-39 |

## Ride Control Systems

|  |      |
|--|------|
| Traction Control<br>System (TCS) ..... | 9-39 |
| StabiliTrak <sup>®</sup> System .....  | 9-41 |

## Cruise Control

|                      |      |
|----------------------|------|
| Cruise Control ..... | 9-42 |
|----------------------|------|

## Object Detection Systems

|                                   |      |
|-----------------------------------|------|
| Ultrasonic Parking Assist .....   | 9-45 |
| Rear Vision<br>Camera (RVC) ..... | 9-47 |

## Fuel

|   |      |
|---|------|
| Fuel .....  | 9-52 |
| Recommended Fuel .....                                  | 9-52 |
| Gasoline Specifications (U.S.<br>and Canada Only) ..... | 9-52 |
| California Fuel<br>Requirements .....                   | 9-53 |
| Fuels in Foreign Countries ...                          | 9-53 |
| Fuel Additives .....                                    | 9-53 |
| Fuel E85 (85% Ethanol) .....                            | 9-54 |
| Filling the Tank .....                                  | 9-55 |
| Filling a Portable Fuel<br>Container .....              | 9-57 |

## 9-2 Driving and Operating

### Towing

|   |      |
|---|------|
| General Towing Information .....              | 9-57 |
| Driving Characteristics and Towing Tips ..... | 9-58 |
| Trailer Towing .....                          | 9-61 |
| Towing Equipment .....                        | 9-63 |
| Trailer Sway Control (TSC) .....              | 9-64 |

### Conversions and Add-Ons

|                                   |      |
|-----------------------------------|------|
| Add-On Electrical Equipment ..... | 9-64 |
|-----------------------------------|------|

## Driving Information

### Defensive Driving

Defensive driving means “always expect the unexpected.” The first step in driving defensively is to wear the safety belt. See *Safety Belts on page 3-10*.

#### WARNING

Assume that other road users (pedestrians, bicyclists, and other drivers) are going to be careless and make mistakes. Anticipate what they might do and be ready. In addition:

- Allow enough following distance between you and the driver in front of you.
- Focus on the task of driving.

(Continued)

#### WARNING (Continued)

Driver distraction can cause collisions resulting in injury or possible death. These simple defensive driving techniques could save your life.

### Drunk Driving

#### WARNING

Drinking and then driving is very dangerous. Your reflexes, perceptions, attentiveness, and judgment can be affected by even a small amount of alcohol. You can have a serious — or even fatal — collision if you drive after drinking.

Do not drink and drive or ride with a driver who has been drinking. Ride home in a cab; or if you are with a group, designate a driver who will not drink.

Death and injury associated with drinking and driving is a global tragedy.

Alcohol affects four things that anyone needs to drive a vehicle: judgment, muscular coordination, vision, and attentiveness.

Police records show that almost 40 percent of all motor vehicle-related deaths involve alcohol. In most cases, these deaths are the result of someone who was drinking and driving. In recent years, more than 17,000 annual motor vehicle-related deaths have been associated with the use of alcohol, with about 250,000 people injured.

For persons under 21, it is against the law in every U.S. state to drink alcohol. There are good medical, psychological, and developmental reasons for these laws.

The obvious way to eliminate the leading highway safety problem is for people never to drink alcohol and then drive.

Medical research shows that alcohol in a person's system can make crash injuries worse, especially injuries to the brain, spinal cord, or heart. This means that when anyone who has been drinking — driver or passenger — is in a crash, that person's chance of being killed or permanently disabled is higher than if the person had not been drinking.

### **Control of a Vehicle**

The following three systems help to control the vehicle while driving — brakes, steering, and accelerator. At times, as when driving on snow or ice, it is easy to ask more of those control systems than the tires and road can provide. Meaning, you can lose control of the vehicle. See *StabiliTrak® System on page 9-41*.

Adding non-dealer accessories can affect vehicle performance. See *Accessories and Modifications on page 10-3*.

### **Braking**

See *Brake System Warning Light on page 5-15*.

Braking action involves perception time and reaction time. Deciding to push the brake pedal is perception time. Actually doing it is reaction time.

Average reaction time is about three-fourths of a second. But that is only an average. It might be less with one driver and as long as two or three seconds or more with another. Age, physical condition, alertness, coordination, and eyesight all play a part. So do alcohol, drugs, and frustration. But even in three-fourths of a second, a vehicle moving at 100 km/h (60 mph) travels 20 m (66 ft). That could be a lot of distance in an emergency, so keeping enough space between the vehicle and others is important.

## 9-4 Driving and Operating

---

And, of course, actual stopping distances vary greatly with the surface of the road, whether it is pavement or gravel; the condition of the road, whether it is wet, dry, or icy; tire tread; the condition of the brakes; the weight of the vehicle; and the amount of brake force applied.

Avoid needless heavy braking. Some people drive in spurts — heavy acceleration followed by heavy braking — rather than keeping pace with traffic. This is a mistake. The brakes might not have time to cool between hard stops. The brakes will wear out much faster with a lot of heavy braking. Keeping pace with the traffic and allowing realistic following distances eliminates a lot of unnecessary braking. That means better braking and longer brake life.

If the engine ever stops while the vehicle is being driven, brake normally but do not pump the brakes. If the brakes are pumped, the pedal could get harder to push down. If the engine stops, there will still be some power brake assist but it will be used when the brake is applied. Once the power assist is used up, it can take longer to stop and the brake pedal will be harder to push.

Adding non-dealer accessories can affect vehicle performance. See *Accessories and Modifications on page 10-3*.

### Steering

#### Electric Power Steering (2.4L L4 Engine)

If the engine stalls while driving, the power steering assist system will continue to operate until you are able to stop the vehicle. If power steering assist is lost because the

electric power steering system is not functioning, the vehicle can be steered but it will take more effort.

If you turn the steering wheel in either direction several times until it stops, or hold the steering wheel in the stopped position for an extended amount of time, you may notice a reduced amount of power steering assist. The normal amount of power steering assist should return shortly after a few normal steering movements.

The electric power steering system does not require regular maintenance. If you suspect steering system problems, such as abnormally high steering effort for a prolonged period of time, contact your dealer for service repairs.

### Hydraulic Power Steering (3.0L V6 Engine)

If power steering assist is lost because the engine stops or the power steering system is not functioning, the vehicle can be steered but it will take more effort.

### Steering Tips

It is important to take curves at a reasonable speed.

Traction in a curve depends on the condition of the tires and the road surface, the angle at which the curve is banked, and vehicle speed. While in a curve, speed is the one factor that can be controlled.

If there is a need to reduce speed, do it before entering the curve, while the front wheels are straight.

Try to adjust the speed so you can drive through the curve. Maintain a reasonable, steady speed. Wait to accelerate until out of the curve, and then accelerate gently into the straightaway.

### Steering in Emergencies

There are times when steering can be more effective than braking. For example, you come over a hill and find a truck stopped in your lane, or a car suddenly pulls out from nowhere, or a child darts out from between parked cars and stops right in front of you. These problems can be avoided by braking — if you can stop in time. But sometimes you cannot stop in time because there is no room. That is the time for evasive action — steering around the problem.

The vehicle can perform very well in emergencies like these. First apply the brakes. See *Braking on page 9-3*. It is better to remove as much speed as possible from a collision. Then steer around the problem, to the left or right depending on the space available.



An emergency like this requires close attention and a quick decision. If holding the steering wheel at the recommended 9 and 3 o'clock positions, it can be turned a full 180 degrees very quickly without removing either hand. But you have to act fast, steer quickly, and just as quickly straighten the wheel once you have avoided the object.

The fact that such emergency situations are always possible is a good reason to practice defensive driving at all times and wear safety belts properly.

### Off-Road Recovery

The vehicle's right wheels can drop off the edge of a road onto the shoulder while driving.

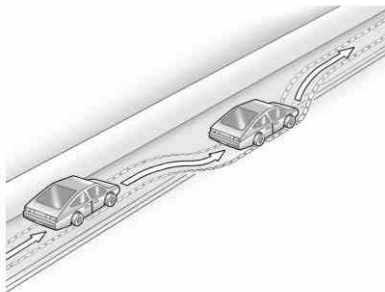

If the level of the shoulder is only slightly below the pavement, recovery should be fairly easy. Ease off the accelerator and then, if there is nothing in the way, steer so that the vehicle straddles the edge of the pavement. Turn the steering wheel 8 to 13 cm (3 to 5 in), about one-eighth turn, until the right front

tire contacts the pavement edge. Then turn the steering wheel to go straight down the roadway.

### Loss of Control

Let us review what driving experts say about what happens when the three control systems — brakes, steering, and acceleration — do not have enough friction where the tires meet the road to do what the driver has asked.

In any emergency, do not give up. Keep trying to steer and constantly seek an escape route or area of less danger.

### Skidding

In a skid, a driver can lose control of the vehicle. Defensive drivers avoid most skids by taking reasonable care suited to existing conditions, and by not overdriving those conditions. But skids are always possible.

The three types of skids correspond to the vehicle's three control systems. In the braking skid, the wheels are not rolling. In the steering or cornering skid, too much speed or steering in a curve causes tires to slip and lose cornering force. And in the acceleration skid, too much throttle causes the driving wheels to spin.

If the vehicle starts to slide, ease your foot off the accelerator pedal and quickly steer the way you want the vehicle to go. If you start steering quickly enough, the vehicle may straighten out. Always be ready for a second skid if it occurs.

Of course, traction is reduced when water, snow, ice, gravel, or other material is on the road. For safety, slow down and adjust your driving to these conditions. It is important to slow down on slippery surfaces because stopping distance is longer and vehicle control more limited.



While driving on a surface with reduced traction, try to avoid sudden steering, acceleration, or braking, including reducing vehicle speed by shifting to a lower gear. Any sudden changes could cause the tires to slide. You might not realize the surface is slippery until the vehicle is skidding. Learn to recognize warning clues — such as enough water, ice, or packed snow on the road to make a mirrored surface — and slow down when you have any doubt.

Remember: Antilock brakes help avoid only the braking skid.

## **Off-Road Driving**

Vehicles with all-wheel drive can be used for off-road driving. Vehicles without all-wheel drive should not be driven off-road except on a level, solid surface.

Many of the vehicle design features that help make the vehicle more responsive on paved roads during poor weather conditions also help make it better suited for off-road use than conventional passenger vehicles. The vehicle does not have features usually thought to be necessary for extended or severe off-road use such as special underbody shielding and transfer case low gear range.

The airbag system is designed to work properly under a wide range of conditions, including off-road usage. Always wear your safety belt and observe safe driving speeds, especially on rough terrain.

Drinking and driving can be very dangerous on any road and this is certainly true for off-road driving. At the very time you need special alertness and driving skills, your reflexes, perceptions, and judgment can be affected by even a small

amount of alcohol. You could have a serious — or even fatal — accident if you drink and drive or ride with a driver who has been drinking.

Off-roading can be great fun but has some definite hazards. The greatest of these is the terrain itself. When off-road driving, traffic lanes are not marked, curves are not banked, and there are no road signs. Surfaces can be slippery, rough, uphill, or downhill.

Avoid sharp turns and abrupt maneuvers. Failure to operate the vehicle correctly off-road could result in loss of vehicle control or vehicle rollover.

Off-roading involves some new skills. That is why it is very important that you read these driving tips and suggestions to help make off-road driving safer and more enjoyable.

## 9-8 Driving and Operating

### Before You Go Off-Road

- Have all necessary maintenance and service work done.
- Make sure there is enough fuel, that fluid levels are where they should be, and that the spare tire is fully inflated.
- Be sure to read all the information about all-wheel-drive vehicles in this manual.
- Make sure all underbody shields, if the vehicle has them, are properly attached.
- Know the local laws that apply to off-roading where you will be driving or check with law enforcement people in the area.
- Be sure to get the necessary permission if you will be on private land.

### Loading Your Vehicle for Off-Road Driving

#### WARNING

- Cargo on the load floor piled higher than the seatbacks can be thrown forward during a sudden stop. You or your passengers could be injured. Keep cargo below the top of the seatbacks.
- Unsecured cargo on the load floor can be tossed about when driving over rough terrain. You or your passengers can be struck by flying objects. Secure the cargo properly.
- Heavy loads on the roof raise the vehicle's center of gravity, making it more likely to roll over. You can be seriously or fatally injured if the vehicle rolls over. Put heavy loads inside the cargo area, not on

(Continued)

#### WARNING (Continued)

the roof. Keep cargo in the cargo area as far forward and low as possible.

There are some important things to remember about how to load your vehicle.

- The heaviest things should be on the floor, forward of the rear axle. Put heavier items as far forward as you can.
- Be sure the load is properly secured, so things are not tossed around.

You will find other important information under *Vehicle Load Limits* on page 9-21 and *Tires* on page 10-45.

## **Environmental Concerns**

Off-road driving can provide wholesome and satisfying recreation. However, it also raises environmental concerns. We recognize these concerns and urge every off-roader to follow these basic rules for protecting the environment:

- Always use established trails, roads, and areas that have been specially set aside for public off-road recreational driving and obey all posted regulations.
- Avoid any driving practice that could damage shrubs, flowers, trees, or grasses or disturb wildlife. This includes wheel-spinning, breaking down trees, or unnecessary driving through streams or over soft ground.
- Always carry a litter bag and make sure all refuse is removed from any campsite before leaving.

- Take extreme care with open fires (where permitted), camp stoves, and lanterns.
- Never park your vehicle over dry grass or other combustible materials that could catch fire from the heat of the vehicle's exhaust system.

## **Traveling to Remote Areas**

It makes sense to plan your trip, especially when going to a remote area. Know the terrain and plan your route. Get accurate maps of trails and terrain. Check to see if there are any blocked or closed roads.

It is also a good idea to travel with at least one other vehicle in case something happens to one of them.

For vehicles with a winch, be sure to read the winch instructions. In a remote area, a winch can be handy if you get stuck but you will want to know how to use it properly.

## **Getting Familiar with Off-Road Driving**

It is a good idea to practice in an area that is safe and close to home before you go into the wilderness. Off-roading requires some new and different skills.

Tune your senses to different kinds of signals. Your eyes need to constantly sweep the terrain for unexpected obstacles. Your ears need to listen for unusual tire or engine sounds. Use your arms, hands, feet, and body to respond to vibrations and vehicle bounce.

Controlling the vehicle is the key to successful off-road driving. One of the best ways to control the vehicle is to control the speed. At higher speeds:

- You approach things faster and have less time to react.
- There is less time to scan the terrain for obstacles.

## 9-10 Driving and Operating

- The vehicle has more bounce when driving over obstacles.
- More braking distance is needed, especially on an unpaved surface.

### WARNING

When you are driving off-road, bouncing and quick changes in direction can easily throw you out of position. This could cause you to lose control and crash. So, whether you are driving on or off the road, you and your passengers should wear safety belts.

### Scanning the Terrain

Off-road driving can take you over many different kinds of terrain. Be familiar with the terrain and its many different features.

**Surface Conditions:** Off-roading surfaces can be hard-packed dirt, gravel, rocks, grass, sand, mud,

snow, or ice. Each of these surfaces affects the vehicle's steering, acceleration, and braking in different ways. Depending on the surface, slipping, sliding, wheel spinning, delayed acceleration, poor traction, and longer braking distances can occur.

**Surface Obstacles:** Unseen or hidden obstacles can be hazardous. A rock, log, hole, rut, or bump can startle you if you are not prepared for them. Often these obstacles are hidden by grass, bushes, snow, or even the rise and fall of the terrain itself.

Some things to consider:

- Is the path ahead clear?
- Will the surface texture change abruptly up ahead?
- Does the travel take you uphill or downhill?
- Will you have to stop suddenly or change direction quickly?

When driving over obstacles or rough terrain, keep a firm grip on the steering wheel. Ruts, troughs, or other surface features can jerk the wheel out of your hands.

When driving over bumps, rocks, or other obstacles, the wheels can leave the ground. If this happens, even with one or two wheels, you cannot control the vehicle as well or at all.

Because you will be on an unpaved surface, it is especially important to avoid sudden acceleration, sudden turns, or sudden braking.

Off-roading requires a different kind of alertness from driving on paved roads and highways. There are no road signs, posted speed limits, or signal lights. Use good judgment about what is safe and what is not.

## Driving on Hills

Off-road driving often takes you up, down, or across a hill. Driving safely on hills requires good judgment and an understanding of what the vehicle can and cannot do. There are some hills that simply cannot be driven, no matter how well built the vehicle.

### **WARNING**

Many hills are simply too steep for any vehicle. If you drive up them, you will stall. If you drive down them, you cannot control your speed. If you drive across them, you will roll over. You could be seriously injured or killed. If you have any doubt about the steepness, do not drive the hill.

## Approaching a Hill

When you approach a hill, decide if it is too steep to climb, descend, or cross. Steepness can be hard to judge. On a very small hill, for example, there may be a smooth, constant incline with only a small change in elevation where you can easily see all the way to the top. On a large hill, the incline may get steeper as you near the top, but you might not see this because the crest of the hill is hidden by bushes, grass, or shrubs.

Consider this as you approach a hill:

- Is there a constant incline, or does the hill get sharply steeper in places?
- Is there good traction on the hillside, or will the surface cause tire slipping?

- Is there a straight path up or down the hill so you will not have to make turning maneuvers?
- Are there obstructions on the hill that can block your path, such as boulders, trees, logs, or ruts?
- What is beyond the hill? Is there a cliff, an embankment, a drop-off, a fence? Get out and walk the hill if you do not know. It is the smart way to find out.
- Is the hill simply too rough? Steep hills often have ruts, gullies, troughs, and exposed rocks because they are more susceptible to the effects of erosion.

## 9-12 Driving and Operating

---

### Driving Uphill

Once you decide it is safe to drive up the hill:

- Use a low gear and get a firm grip on the steering wheel.
- Get a smooth start up the hill and try to maintain speed. Not using more power than needed can avoid spinning the wheels or sliding.

#### **WARNING**

Turning or driving across steep hills can be dangerous. You could lose traction, slide sideways, and possibly roll over. You could be seriously injured or killed. When driving up hills, always try to go straight up.

- Try to drive straight up the hill if at all possible. If the path twists and turns, you might want to find another route.

- Ease up on the speed as you approach the top of the hill.
- Attach a flag to the vehicle to be more visible to approaching traffic on trails or hills.
- Sound the horn as you approach the top of the hill to let opposing traffic know you are there.
- Use headlamps even during the day to make the vehicle more visible to oncoming traffic.

#### **WARNING**

Driving to the top (crest) of a hill at full speed can cause an accident. There could be a drop-off, embankment, cliff, or even another vehicle. You could be seriously injured or killed. As you near the top of a hill, slow down and stay alert.

If the vehicle stalls, or is about to stall, and you cannot make it up the hill:

- Push the brake pedal to stop the vehicle and keep it from rolling backwards and apply the parking brake.
- If the engine is still running, shift the transmission to R (Reverse), release the parking brake, and slowly back down the hill in R (Reverse).
- If the engine has stopped running, you need to restart it. With the brake pedal pressed and the parking brake still applied, shift the transmission to P (Park) and restart the engine. Then, shift to R (Reverse), release the parking brake, and slowly back down the hill as straight as possible in R (Reverse).

- While backing down the hill, put your left hand on the steering wheel at the 12 o'clock position so you can tell if the wheels are straight and can maneuver as you back down. It is best to back down the hill with the wheels straight rather than in the left or right direction. Turning the wheel too far to the left or right will increase the possibility of a rollover.

Things not to do if the vehicle stalls, or is about to stall, when going up a hill:

- Never attempt to prevent a stall by shifting into N (Neutral) to rev-up the engine and regain forward momentum. This will not work. The vehicle can roll backward very quickly and could go out of control.

- Never try to turn around if about to stall when going up a hill. If the hill is steep enough to stall the vehicle, it is steep enough to cause it to roll over. If you cannot make it up the hill, back straight down the hill.

If, after stalling, you try to back down the hill and decide you just cannot do it, set the parking brake, put your transmission in P (Park), and turn off the engine. Leave the vehicle and go get some help. Exit on the uphill side and stay clear of the path the vehicle would take if it rolled downhill.

### Driving Downhill

When off-roading takes you downhill, consider:

- How steep is the downhill? Will I be able to maintain vehicle control?
- What is the surface like? Smooth? Rough? Slippery? Hard-packed dirt? Gravel?
- Are there hidden surface obstacles? Ruts? Logs? Boulders?
- What is at the bottom of the hill? Is there a hidden creek bank or even a river bottom with large rocks?

## 9-14 Driving and Operating

If you decide you can go down a hill safely, try to keep the vehicle headed straight down. Use a low gear so engine drag can help the brakes so they do not have to do all the work. Descend slowly, keeping the vehicle under control at all times.

### WARNING

Heavy braking when going down a hill can cause your brakes to overheat and fade. This could cause loss of control and a serious accident. Apply the brakes lightly when descending a hill and use a low gear to keep vehicle speed under control.

Things not to do when driving down a hill:

- When driving downhill, avoid turns that take you across the incline of the hill. A hill that is not too steep to drive down might be too steep to drive across. The vehicle could roll over.
- Never go downhill with the transmission in N (Neutral), called free-wheeling. The brakes will have to do all the work and could overheat and fade.

Vehicles are much more likely to stall when going uphill, but if it happens when going downhill:

1. Stop the vehicle by applying the regular brakes and apply the parking brake.
2. Shift to P (Park) and, while still braking, restart the engine.
3. Shift back to a low gear, release the parking brake, and drive straight down.
4. If the engine will not start, get out and get help.

### Driving Across an Incline

An off-road trail will probably go across the incline of a hill. To decide whether to try to drive across the incline, consider the following:

#### WARNING

Driving across an incline that is too steep will make your vehicle roll over. You could be seriously injured or killed. If you have any doubt about the steepness of the incline, do not drive across it. Find another route instead.

- A hill that can be driven straight up or down might be too steep to drive across. When going straight up or down a hill, the length of the wheel base — the distance from the front wheels to the rear wheels — reduces the likelihood the vehicle will tumble end over end. But when driving across an incline, the narrower track width — the distance



between the left and right wheels — might not prevent the vehicle from tilting and rolling over. Driving across an incline puts more weight on the downhill wheels which could cause a downhill slide or a rollover.

- Surface conditions can be a problem. Loose gravel, muddy spots, or even wet grass can cause the tires to slip sideways, downhill. If the vehicle slips sideways, it can hit something that will trip it — a rock, a rut, etc. — and roll over.
- Hidden obstacles can make the steepness of the incline even worse. If you drive across a rock with the uphill wheels, or if the downhill wheels drop into a rut or depression, the vehicle can tilt even more.

For these reasons, carefully consider whether to try to drive across an incline. Just because the trail goes across the incline does

not mean you have to drive it. The last vehicle to try it might have rolled over.

If you feel the vehicle starting to slide sideways, turn downhill. This should help straighten out the vehicle and prevent the side slipping. The best way to prevent this is to “walk the course” first, so you know what the surface is like before driving it.

### Stalling on an Incline

 **WARNING**

Getting out on the downhill (low) side of a vehicle stopped across an incline is dangerous. If the vehicle rolls over, you could be crushed or killed. Always get out on the uphill (high) side of the vehicle and stay well clear of the rollover path.

If the vehicle stalls when crossing an incline, be sure you, and any passengers, get out on the uphill side, even if the door there is harder to open. If you get out on the downhill side and the vehicle starts to roll over, you will be right in its path.

If you have to walk down the slope, stay out of the path the vehicle will take if it does roll over.

### Driving in Mud, Sand, Snow, or Ice

When you drive in mud, snow, or sand, the wheels do not get good traction. Acceleration is not as quick, turning is more difficult, and braking distances are longer.

It is best to use a low gear when in mud — the deeper the mud, the lower the gear. In really deep mud, keep the vehicle moving so it does not get stuck.

## 9-16 Driving and Operating

---

When driving on sand, wheel traction changes. On loosely packed sand, such as on beaches or sand dunes, the tires will tend to sink into the sand. This affects steering, accelerating, and braking. Drive at a reduced speed and avoid sharp turns or abrupt maneuvers.

Hard packed snow and ice offer the worst tire traction. On these surfaces, it is very easy to lose control. On wet ice, for example, the traction is so poor that you will have difficulty accelerating. And, if the vehicle does get moving, poor steering and difficult braking can cause it to slide out of control.

### WARNING

Driving on frozen lakes, ponds, or rivers can be dangerous. Underwater springs, currents under the ice, or sudden thaws can weaken the ice. Your vehicle could fall through the ice and you and your passengers could drown. Drive your vehicle on safe surfaces only.

### Driving in Water

### WARNING

Driving through rushing water can be dangerous. Deep water can sweep your vehicle downstream and you and your passengers could drown. If it is only shallow water, it can still wash away the ground from under your tires, and you could lose traction and roll the vehicle over. Do not drive through rushing water.

Heavy rain can mean flash flooding, and flood waters demand extreme caution.

Find out how deep the water is before driving through it. Do not try it if it is deep enough to cover the wheel hubs, axles, or exhaust pipe — you probably will not get through. Deep water can damage the axle and other vehicle parts.

If the water is not too deep, drive slowly through it. At faster speeds, water splashes on the ignition system and the vehicle can stall. Stalling can also occur if you get the tailpipe under water. If the tailpipe is under water, you will never be able to start the engine. When going through water, remember that when the brakes get wet, it might take longer to stop. See *Driving on Wet Roads* on page 9-17.

### After Off-Road Driving

Remove any brush or debris that has collected on the underbody, chassis, or under the hood. These accumulations can be a fire hazard.

After operation in mud or sand, have the brake linings cleaned and checked. These substances can cause glazing and uneven braking. Check the body structure, steering, suspension, wheels, tires, axles, and exhaust system for damage and check the fuel lines and cooling system for any leakage.

The vehicle requires more frequent service due to off-road use. Refer to the Maintenance Schedule for additional information.

### Driving on Wet Roads

Rain and wet roads can reduce vehicle traction and affect your ability to stop and accelerate. Always drive slower in these types of driving conditions and avoid driving through large puddles and deep-standing or flowing water.

#### **WARNING**

Wet brakes can cause crashes. They might not work as well in a quick stop and could cause pulling to one side. You could lose control of the vehicle.

After driving through a large puddle of water or a car/vehicle wash, lightly apply the brake pedal until the brakes work normally.

(Continued)

#### **WARNING (Continued)**

Flowing or rushing water creates strong forces. Driving through flowing water could cause the vehicle to be carried away. If this happens, you and other vehicle occupants could drown. Do not ignore police warnings and be very cautious about trying to drive through flowing water.

### Hydroplaning

Hydroplaning is dangerous. Water can build up under the vehicle's tires so they actually ride on the water. This can happen if the road is wet enough and you are going fast enough. When the vehicle is hydroplaning, it has little or no contact with the road.

There is no hard and fast rule about hydroplaning. The best advice is to slow down when the road is wet.

## 9-18 Driving and Operating

### Other Rainy Weather Tips

Besides slowing down, other wet weather driving tips include:

- Allow extra following distance.
- Pass with caution.
- Keep windshield wiping equipment in good shape.
- Keep the windshield washer fluid reservoir filled.
- Have good tires with proper tread depth. See *Tires on page 10-45*.
- Turn off cruise control.

### Highway Hypnosis

Always be alert and pay attention to your surroundings while driving. If you become tired or sleepy, find a safe place to park the vehicle and rest.

Other driving tips include:

- Keep the vehicle well ventilated.
- Keep interior temperature cool.
- Keep your eyes moving — scan the road ahead and to the sides.
- Check the rearview mirror and vehicle instruments often.

### Hill and Mountain Roads

Driving on steep hills or through mountains is different than driving on flat or rolling terrain. Tips for driving in these conditions include:

- Keep the vehicle serviced and in good shape.
- Check all fluid levels and brakes, tires, cooling system, and transmission.
- Shift to a lower gear when going down steep or long hills.

#### WARNING

If you do not shift down, the brakes could get so hot that they would not work well. You would then have poor braking or even none going down a hill. You could crash. Shift down to let the engine assist the brakes on a steep downhill slope.

#### WARNING

Coasting downhill in N (Neutral) or with the ignition off is dangerous. The brakes will have to do all the work of slowing down and they could get so hot that they would not work well. You would then have poor braking or even none going down a hill. You could crash. Always have the engine running and the vehicle in gear when going downhill.

- Stay in your own lane. Do not swing wide or cut across the center of the road. Drive at speeds that let you stay in your own lane.
- Top of hills: Be alert — something could be in your lane (stalled car, accident).
- Pay attention to special road signs (falling rocks area, winding roads, long grades, passing or no-passing zones) and take appropriate action.

## **Winter Driving**

### **Driving on Snow or Ice**

Drive carefully when there is snow or ice between the tires and the road, creating less traction or grip. Wet ice can occur at about 0°C (32°F) when freezing rain begins to fall, resulting in even less traction. Avoid driving on wet ice or in freezing rain until roads can be treated with salt or sand.

Drive with caution, whatever the condition. Accelerate gently so traction is not lost. Accelerating too quickly causes the wheels to spin and makes the surface under the tires slick, so there is even less traction.

Try not to break the fragile traction. If you accelerate too fast, the drive wheels will spin and polish the surface under the tires even more.

The *Antilock Brake System (ABS)* on page 9-37 improves vehicle stability during hard stops on slippery roads, but apply the brakes sooner than when on dry pavement.

Allow greater following distance on any slippery road and watch for slippery spots. Icy patches can occur on otherwise clear roads in shaded areas. The surface of a curve or an overpass can remain icy when the surrounding roads are clear. Avoid sudden steering maneuvers and braking while on ice.

Turn off cruise control on slippery surfaces.

### Blizzard Conditions

Being stuck in snow can be a serious situation. Stay with the vehicle unless there is help nearby. If possible, use the *Roadside Assistance Program (U.S. and Canada)* on page 13-7 or *Roadside Assistance Program (Mexico)* on page 13-9. To get help and keep everyone in the vehicle safe:

- Turn on the hazard warning flashers.
- Tie a red cloth to an outside mirror.

#### WARNING

Snow can trap engine exhaust under the vehicle. This may cause exhaust gases to get inside. Engine exhaust contains Carbon Monoxide (CO) which cannot be seen or smelled. It can cause unconsciousness and even death.

(Continued)

#### WARNING (Continued)

If the vehicle is stuck in the snow:

- Clear away snow from around the base of your vehicle, especially any that is blocking the exhaust pipe.
- Check again from time to time to be sure snow does not collect there.
- Open a window about 5 cm (2 in) on the side of the vehicle that is away from the wind to bring in fresh air.
- Fully open the air outlets on or under the instrument panel.
- Adjust the climate control system to a setting that circulates the air inside the vehicle and set the fan speed to the highest setting. See Climate Control System in the Index.

(Continued)

#### WARNING (Continued)

For more information about carbon monoxide, see *Engine Exhaust* on page 9-32.

Snow can trap exhaust gases under your vehicle. This can cause deadly CO (Carbon Monoxide) gas to get inside. CO could overcome you and kill you. You cannot see it or smell it, so you might not know it is in your vehicle. Clear away snow from around the base of your vehicle, especially any that is blocking the exhaust.

Run the engine for short periods only as needed to keep warm, but be careful.

To save fuel, run the engine for only short periods as needed to warm the vehicle and then shut the engine off and close the window most of the way to save heat.

Repeat this until help arrives but only when you feel really uncomfortable from the cold. Moving about to keep warm also helps.

If it takes some time for help to arrive, now and then when you run the engine, push the accelerator pedal slightly so the engine runs faster than the idle speed. This keeps the battery charged to restart the vehicle and to signal for help with the headlamps. Do this as little as possible to save fuel.

## If the Vehicle is Stuck

Slowly and cautiously spin the wheels to free the vehicle when stuck in sand, mud, ice, or snow.

If stuck too severely for the traction system to free the vehicle, turn the traction system off and use the rocking method. See *Traction Control System (TCS)* on page 9-39.

### WARNING

If the vehicle's tires spin at high speed, they can explode, and you or others could be injured. The vehicle can overheat, causing an engine compartment fire or other damage. Spin the wheels as little as possible and avoid going above 55 km/h (35 mph).

For information about using tire chains on the vehicle, see *Tire Chains* on page 10-65.

## Rocking the Vehicle to Get it Out

Turn the steering wheel left and right to clear the area around the front wheels. Turn off any traction system. Shift back and forth between R (Reverse) and a forward gear, spinning the wheels as little as possible. To prevent transmission

wear, wait until the wheels stop spinning before shifting gears. Release the accelerator pedal while shifting, and press lightly on the accelerator pedal when the transmission is in gear. Slowly spinning the wheels in the forward and reverse directions causes a rocking motion that could free the vehicle. If that does not get the vehicle out after a few tries, it might need to be towed out. If the vehicle does need to be towed out, see *Towing the Vehicle* on page 10-79.

## Vehicle Load Limits

It is very important to know how much weight the vehicle can carry. This weight is called the vehicle capacity weight and includes the weight of all occupants, cargo and all nonfactory-installed options.

## 9-22 Driving and Operating

Two labels on the vehicle show how much weight it may properly carry, the Tire and Loading Information label and the Certification label.

### WARNING

Do not load the vehicle any heavier than the Gross Vehicle Weight Rating (GVWR), or either the maximum front or rear Gross Axle Weight Rating (GAWR). This can cause systems to break and change the way the vehicle handles. This could cause loss of control and a crash. Overloading can also shorten the life of the vehicle.

### Tire and Loading Information Label

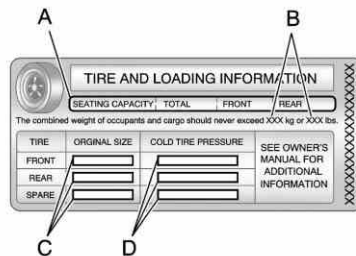

#### Label Example

A vehicle specific Tire and Loading Information label is attached to the vehicle's center pillar (B-pillar). With the driver's door open, you will find the label attached near the door lock post. The Tire and Loading Information label shows the

number of occupant seating positions (A), and the maximum vehicle capacity weight (B) in kilograms and pounds.

The Tire and Loading Information label also shows the tire size of the original equipment tires (C) and the recommended cold tire inflation pressures (D). For more information on tires and inflation see *Tires on page 10-45* and *Tire Pressure on page 10-51*.

There is also important loading information on the Certification label. It tells you the Gross Vehicle Weight Rating (GVWR) and the Gross Axle Weight Rating (GAWR) for the front and rear axle. See "Certification Label" later in this section.



### Steps for Determining Correct Load Limit

1. Locate the statement "The combined weight of occupants and cargo should never exceed XXX kg or XXX lbs" on your vehicle's placard.
2. Determine the combined weight of the driver and passengers that will be riding in your vehicle.
3. Subtract the combined weight of the driver and passengers from XXX kg or XXX lbs.
4. The resulting figure equals the available amount of cargo and luggage load capacity. For example, if the "XXX" amount equals 1400 lbs and there will be five 150 lb passengers in your vehicle,

the amount of available cargo and luggage load capacity is 650 lbs (1400 – 750 (5 x 150) = 650 lbs).

5. Determine the combined weight of luggage and cargo being loaded on the vehicle. That weight may not safely exceed the available cargo and luggage load capacity calculated in Step 4.
6. If your vehicle will be towing a trailer, the load from your trailer will be transferred to your vehicle. Consult this manual to determine how this reduces the available cargo and luggage load capacity of your vehicle.

See *Trailer Towing on page 9-61* for important information on towing a trailer, towing safety rules and trailering tips.



#### Example 1

- A. Vehicle Capacity Weight for Example 1 = 453 kg (1,000 lbs).
- B. Subtract Occupant Weight @ 68 kg (150 lbs) × 2 = 136 kg (300 lbs).
- C. Available Occupant and Cargo Weight = 317 kg (700 lbs).

## 9-24 Driving and Operating

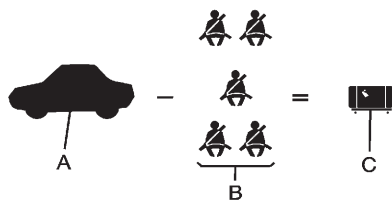

### Example 2

- A. Vehicle Capacity Weight for Example 2 = 453 kg (1,000 lbs).
- B. Subtract Occupant Weight @ 68 kg (150 lbs)  $\times$  5 = 340 kg (750 lbs).
- C. Available Cargo Weight = 113 kg (250 lbs).

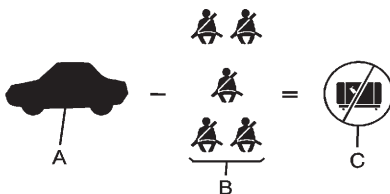

### Example 3

- A. Vehicle Capacity Weight for Example 3 = 453 kg (1,000 lbs).
- B. Subtract Occupant Weight @ 91 kg (200 lbs)  $\times$  5 = 453 kg (1,000 lbs).
- C. Available Cargo Weight = 0 kg (0 lbs).

Refer to the vehicle's Tire and Loading Information label for specific information about the

vehicle's capacity weight and seating positions. The combined weight of the driver, passengers, and cargo should never exceed the vehicle's capacity weight.

### Certification Label

|   |          |         |                    |
|---|----------|---------|--------------------|
| GVWR  | GAWR FRT | GAWR RR |                    |
| MODEL: _____ PAYLOAD = _____                        |          |         |                    |
| TIRE SIZE   | SPEED    | RIM     | COLD TIRE PRESSURE |
| FRT   |          |         |                    |
| RR  |          |         |                    |
| SPA   |          |         |                    |
| SEE OWNER'S MANUAL FOR ADDITIONAL INFORMATION _____ |          |         |                    |

### Label Example

A vehicle-specific Certification label is attached to the lower center pillar on the driver side of the vehicle or on the rear edge of the driver door.

The label shows the size of the vehicle's original tires and the inflation pressures needed to obtain the gross weight capacity of the vehicle. This is called Gross Vehicle Weight Rating (GVWR). The GVWR includes the weight of the vehicle, all occupants, fuel, and cargo.

The Certification/Tire label also tells you the maximum weights for the front and rear axles, called Gross Axle Weight Rating (GAWR). To find out the actual loads on the front and rear axles, you need to go to a weigh station and weigh the vehicle. Your dealer can help you with this. Be sure to spread out the load equally on both sides of the center line.

Never exceed the GVWR for the vehicle, or the GAWR for either the front or rear axle.

If the vehicle is carrying a heavy load, it should be spread out. See "Steps for Determining Correct Load Limit" earlier in this section.

 **WARNING**

Do not load the vehicle any heavier than the Gross Vehicle Weight Rating (GVWR), or either the maximum front or rear Gross Axle Weight Rating (GAWR). This can cause systems to break and change the way the vehicle handles. This could cause loss of control and a crash. Overloading can also shorten the life of the vehicle.

Your warranty does not cover parts or components that fail because of overloading.

The label will help you decide how much cargo and installed equipment your vehicle can carry.

Using heavier suspension components to get added durability might not change your weight ratings. Ask your dealer to help you load your vehicle the right way.

If you put things inside your vehicle – like suitcases, tools, packages, or anything else – they will go as fast as the vehicle goes. If you have to stop or turn quickly, or if there is a crash, they will keep going.

### **WARNING**

Things inside the vehicle can strike and injure people in a sudden stop or turn, or in a crash.

- Put things in the cargo area of the vehicle. In the cargo area, put them as far forward as possible. Try to spread the weight evenly.

(Continued)

### **WARNING (Continued)**

- Never stack heavier things, like suitcases, inside the vehicle so that some of them are above the tops of the seats.
- Do not leave an unsecured child restraint in the vehicle.
- Secure loose items in the vehicle.
- Do not leave a seat folded down unless needed.

## Starting and Operating

### New Vehicle Break-In

**Notice:** The vehicle does not need an elaborate break-in. But it will perform better in the long run if you follow these guidelines:

- Do not drive at any one constant speed, fast or slow, for the first 805 km (500 mi). Do not make full-throttle starts. Avoid downshifting to brake or slow the vehicle.
- During the first 1 000 km (600 mi), avoid using more than moderate acceleration in lower gears and avoid vehicle speeds above 110 km/h (68 mph).
- Between the first 1 000 km (600 mi) and 5 000 km (3,000 mi), heavy acceleration in lower gears can be used.

Vehicle speeds above 110 km/h (68 mph) should be limited to five minutes per use.

- Avoid making hard stops for the first 322 km (200 mi) or so. During this time the new brake linings are not yet broken in. Hard stops with new linings can mean premature wear and earlier replacement. Follow this breaking-in guideline every time you get new brake linings.
- Do not tow a trailer during break-in. See *Driving Characteristics and Towing Tips* on page 9-58 for the trailer towing capabilities of your vehicle and more information.

Following break-in, engine speed and load can be gradually increased.

## Ignition Positions

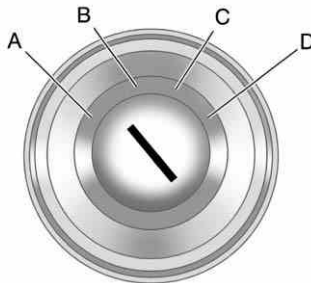

The ignition switch has four different positions.

**Notice:** Using a tool to force the key to turn in the ignition could cause damage to the switch or break the key. Use the correct key, make sure it is all the way in, and turn it only with your hand. If the key cannot be turned by hand, see your dealer.

The key must be fully extended to start the vehicle.

To shift out of P (Park), turn the ignition to ON/RUN and apply the brake pedal.

**A (STOPPING THE ENGINE/ LOCK/OFF):** When the vehicle is stopped, turn the ignition switch to LOCK/OFF to turn the engine off. Retained Accessory Power (RAP) will remain active. See *Retained Accessory Power (RAP)* on page 9-30.

This is the only position from which the key can be removed. This locks the steering wheel, ignition and automatic transmission.

Do not turn the engine off when the vehicle is moving. This will cause a loss of power assist in the brake and steering systems and disable the airbags.

## 9-28 Driving and Operating

In an emergency, if the vehicle must be shut off while driving:

1. Brake using a firm and steady pressure. Do not pump the brakes repeatedly. This may deplete power assist, requiring increased brake pedal force.
2. Shift the vehicle to N (Neutral). This can be done while the vehicle is moving. After shifting to N (Neutral), firmly apply the brakes and steer the vehicle to a safe location.
3. Come to a complete stop, shift to P (Park), and turn the ignition to LOCK/OFF. On vehicles with an automatic transmission, the shift lever must be in P (Park) to turn the ignition switch to the LOCK/OFF position.
4. Set the parking brake. See *Parking Brake on page 9-38*.

### WARNING

Turning off the vehicle while moving may cause loss of power assist in the brake and steering systems and disable the airbags. While driving, only shut the vehicle off in an emergency.

5. If the vehicle must be shut off while driving, turn the ignition to ACC/ACCESSORY.

The ignition switch can bind in the LOCK/OFF position with the wheels turned off center. If this happens, move the steering wheel from right to left while turning the key to ACC/ACCESSORY. If this does not work, then the vehicle needs service.

**B (ACC/ACCESSORY):** This position provides power to some of the electrical accessories. It unlocks the steering wheel and ignition. To move the key from

ACC/ACCESSORY to LOCK/OFF, push in the key and then turn it to LOCK/OFF.

**C (ON/RUN):** The ignition switch stays in this position when the engine is running. This position can be used to operate the electrical accessories, including the ventilation fan and 12-volt power outlets, as well as to display some warning and indicator lights. The transmission is also unlocked in this position on automatic transmission vehicles.

The battery could be drained if the key is left in the ACC/ACCESSORY or ON/RUN position with the engine off. The vehicle might not start if the battery is allowed to drain for an extended period of time.

**D (START):** This position starts the engine. When the engine starts, release the key. The ignition switch will return to ON/RUN for normal driving.

A warning tone sounds when the driver door is opened if the ignition is still in ACC/ACCESSORY and the key is in the ignition.

## Starting the Engine

Move the shift lever to P (Park) or N (Neutral). The engine will not start in any other position. To restart the vehicle when it is already moving, use N (Neutral) only.

**Notice: Do not try to shift to P (Park) if the vehicle is moving. If you do, you could damage the transmission. Shift to P (Park) only when the vehicle is stopped.**

### Starting Procedure

1. With your foot off the accelerator pedal, turn the ignition key to START. When the engine starts, let go of the key. The idle speed will go down as the engine warms. Do not race the engine immediately after starting it.

Operate the engine and transmission gently to allow the oil to warm up and lubricate all moving parts.

The vehicle has a Computer-Controlled Cranking System. This feature assists in starting the engine and protects components. If the ignition key is turned to the START position, and then released when the engine begins cranking, the engine will continue cranking for a few seconds or until the vehicle starts. If the engine does not start and the key is held in START for many seconds, cranking will be stopped after 15 seconds to prevent cranking motor damage. To prevent gear damage, this system also prevents cranking if the engine is already running. Engine cranking can be stopped by turning the ignition switch to ACC/ACCESSORY or LOCK/OFF.

**Notice: Cranking the engine for long periods of time, by returning the key to the START position immediately after cranking has ended, can overheat and damage the cranking motor, and drain the battery. Wait at least 15 seconds between each try, to let the cranking motor cool down.**

2. If the engine does not start after 5 to 10 seconds, especially in very cold weather (below  $-18^{\circ}\text{C}$  or  $0^{\circ}\text{F}$ ), it could be flooded with too much gasoline. Push the accelerator pedal all the way to the floor and hold it there as you hold the key in START for a maximum of 15 seconds. Wait at least 15 seconds between each try, to allow the cranking motor to cool. When the engine starts, let go of the key and accelerator. If the vehicle starts briefly but then stops again, repeat the procedure. This clears the extra gasoline from the engine.

## 9-30 Driving and Operating

Do not race the engine immediately after starting it. Operate the engine and transmission gently until the oil warms up and lubricates all moving parts.

**Notice:** The engine is designed to work with the electronics in the vehicle. If you add electrical parts or accessories, you could change the way the engine operates. Before adding electrical equipment, check with your dealer. If you do not, the engine might not perform properly. Any resulting damage would not be covered by the vehicle warranty.

### Retained Accessory Power (RAP)

These vehicle accessories can be used for up to 10 minutes after the engine is turned off:

- Audio System
- Power Windows
- Sunroof (if equipped)

Power to the audio system will continue to operate for up to 10 minutes or until the driver door is opened.

Power to the power windows and sunroof will continue to operate for up to 10 minutes or until any door is opened.

All these features will work when the key is in ON/RUN or ACC/ACCESSORY.

### Engine Coolant Heater

The engine coolant heater, if available, can help in cold weather conditions at or below  $-18^{\circ}\text{C}$  ( $0^{\circ}\text{F}$ ) for easier starting and better fuel economy during engine warm-up. Plug in the coolant heater at least four hours before starting the vehicle. An internal thermostat in the plug-end of the cord will prevent engine coolant heater operation at temperatures above  $-18^{\circ}\text{C}$  ( $0^{\circ}\text{F}$ ).

### To Use The Engine Coolant Heater

1. Turn off the engine.
2. Open the hood and unwrap the electrical cord.  
  
The electrical cord is located on the passenger side of the engine compartment, in front of the air cleaner.
3. Plug it into a normal, grounded 110-volt AC outlet.

#### WARNING

Plugging the cord into an ungrounded outlet could cause an electrical shock. Also, the wrong kind of extension cord could overheat and cause a fire. You could be seriously injured. Plug the cord into a properly grounded three-prong 110-volt AC outlet. If the cord will not reach, use a heavy-duty three-prong extension cord rated for at least 15 amps.



4. Before starting the engine, be sure to unplug and store the cord as it was before to keep it away from moving engine parts. If you do not it could be damaged.

The length of time the heater should remain plugged in depends on several factors. Ask a dealer in the area where you will be parking the vehicle for the best advice on this.

### Shifting Into Park

 **WARNING**

It can be dangerous to get out of the vehicle if the shift lever is not fully in P (Park) with the parking brake firmly set. The vehicle can roll. If you have left the engine running, the vehicle can move suddenly. You or others could be injured. To be sure the vehicle will not move, even when you are on fairly level ground, use the steps

(Continued)

**WARNING (Continued)**

that follow. If you are pulling a trailer, see *Driving Characteristics and Towing Tips* on page 9-58.

Use this procedure to shift into P (Park):

1. Hold the brake pedal down and set the parking brake.

See *Parking Brake* on page 9-38 for more information.

2. Hold the button on the shift lever and push the lever toward the front of the vehicle into P (Park).
3. Turn the ignition to LOCK/OFF.
4. Remove the key.

### Leaving the Vehicle With the Engine Running

 **WARNING**

It can be dangerous to leave the vehicle with the engine running. The vehicle could move suddenly if the shift lever is not fully in P (Park) with the parking brake firmly set. And, if you leave the vehicle with the engine running, it could overheat and even catch fire. You or others could be injured. Do not leave the vehicle with the engine running.

If you have to leave the vehicle with the engine running, the vehicle must be in P (Park) and the parking brake set.

Release the button and check that the shift lever cannot be moved out of P (Park).

### Torque Lock

Torque lock is when the weight of the vehicle puts too much force on the parking pawl in the transmission. This happens when parking on a hill and shifting the transmission into P (Park) is not done properly and then it is difficult to shift out of P (Park). To prevent torque lock, set the parking brake and then shift into P (Park). To find out how, see “Shifting Into Park” listed previously.

If torque lock does occur, the vehicle may need to be pushed uphill by another vehicle to relieve the parking pawl pressure, so you can shift out of P (Park).

### Shifting Out of Park

To shift out of P (Park):

1. Apply the brake pedal.
2. Turn the ignition to ON/RUN.
3. Press the shift lever button.
4. Move the shift lever.

If you still are unable to shift out of P (Park):

1. Fully release the shift lever button.
2. Hold the brake pedal down and press the shift lever button again.
3. Move the shift lever.

If you still cannot move the shift lever from P (Park), see your dealer for service.

### Parking Over Things That Burn

#### WARNING

Things that can burn could touch hot exhaust parts under the vehicle and ignite. Do not park over papers, leaves, dry grass, or other things that can burn.

### Engine Exhaust

#### WARNING

Engine exhaust contains carbon monoxide (CO) which cannot be seen or smelled. Exposure to CO can cause unconsciousness and even death.

Exhaust may enter the vehicle if:

- The vehicle idles in areas with poor ventilation (parking garages, tunnels, deep snow that may block underbody airflow or tail pipes).
- The exhaust smells or sounds strange or different.
- The exhaust system leaks due to corrosion or damage.
- The vehicle exhaust system has been modified, damaged or improperly repaired.

(Continued)

**WARNING (Continued)**

- There are holes or openings in the vehicle body from damage or after market modifications that are not completely sealed.

If unusual fumes are detected or if it is suspected that exhaust is coming into the vehicle:

- Drive it only with the windows completely down.
- Have the vehicle repaired immediately.

Never park the vehicle with the engine running in an enclosed area such as a garage or a building that has no fresh air ventilation.

**Running the Vehicle While Parked**

It is better not to park with the engine running. But if you ever have to, here are some things to know.

** WARNING**

Idling a vehicle in an enclosed area with poor ventilation is dangerous. Engine exhaust may enter the vehicle. Engine exhaust contains Carbon Monoxide (CO) which cannot be seen or smelled. It can cause unconsciousness and even death. Never run the engine in an enclosed area that has no fresh air ventilation. For more information, see *Engine Exhaust on page 9-32*.

** WARNING**

It can be dangerous to get out of the vehicle if the automatic transmission shift lever is not fully in P (Park) with the parking brake firmly set. The vehicle can roll. Do not leave the vehicle when the engine is running unless you have to. If you have left the engine running, the vehicle can move suddenly. You or others could be injured. To be sure the vehicle will not move, even when you are on fairly level ground, always set the parking brake and move the shift lever to P (Park).

Follow the proper steps to be sure the vehicle will not move. See *Shifting Into Park on page 9-31*.

If parking on a hill and pulling a trailer, see *Driving Characteristics and Towing Tips on page 9-58*.

## Automatic Transmission

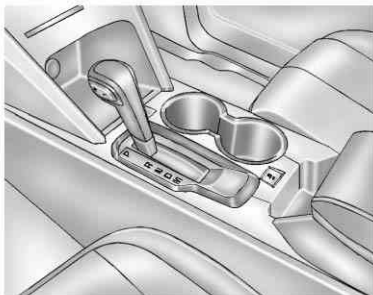

The automatic transmission shift lever is located on the console between the seats.

**P (Park):** This position locks the front wheels. Use P (Park) when starting the engine because the vehicle cannot move easily.

### WARNING

It is dangerous to get out of the vehicle if the shift lever is not fully in P (Park) with the parking brake firmly set. The vehicle can roll.

Do not leave the vehicle when the engine is running unless you have to. If you have left the engine running, the vehicle can move suddenly. You or others could be injured. To be sure the vehicle will not move, even when you are on fairly level ground, always set the parking brake and move the shift lever to P (Park). See *Shifting Into Park* on page 9-31. If you are pulling a trailer, see *Driving Characteristics and Towing Tips* on page 9-58.

The vehicle has an automatic transmission shift lock control system. You must fully apply the regular brake first and then press the shift lever button before shifting

from P (Park) when the ignition key is in ON/RUN. If you cannot shift out of P (Park), ease pressure on the shift lever, then push the shift lever all the way into P (Park) as you maintain brake application. Then press the shift lever button and move the shift lever into another gear. See *Shifting Out of Park* on page 9-32.

**R (Reverse):** Use this gear to back up.

**Notice:** Shifting to R (Reverse) while the vehicle is moving forward could damage the transmission. The repairs would not be covered by the vehicle warranty. Shift to R (Reverse) only after the vehicle is stopped.

To rock the vehicle back and forth to get out of snow, ice or sand without damaging the transmission, see *If the Vehicle is Stuck* on page 9-21.

**N (Neutral):** In this position the engine and transmission do not connect. Use N (Neutral) to restart a vehicle that is already moving.

 **WARNING**

Shifting into a drive gear while the engine is running at high speed is dangerous. Unless your foot is firmly on the brake pedal, the vehicle could move very rapidly. You could lose control and hit people or objects. Do not shift into a drive gear while the engine is running at high speed.

**Notice:** Shifting out of P (Park) or N (Neutral) with the engine running at high speed may damage the transmission. The repairs would not be covered by the vehicle warranty. Be sure the engine is not running at high speed when shifting the vehicle.

**D (Drive):** This position is for normal driving. It provides the best fuel economy. If you need more power for passing, and you are:

- Going less than 56 km/h (35 mph), push the accelerator pedal about halfway down.
- Going about 56 km/h (35 mph) or more, push the accelerator all the way down.

**Notice:** If the vehicle seems to accelerate slowly or not shift gears when you go faster, and you continue to drive the vehicle that way, you could damage the transmission. Have the vehicle serviced right away.

**M (Manual Mode):** Allows the driver to select the range of gear positions. See *Manual Mode on page 9-35*.

## Manual Mode

### Electronic Range Select (ERS) Mode

ERS or manual mode allows for the selection of the range of gear positions. Use this mode when driving downhill or towing a trailer to limit the top gear and vehicle speed. The shift position indicator within the Driver Information Center (DIC) will display a number next to the M indicating the highest available gear under manual mode and the driving conditions when manual mode was selected.

To use this feature:

1. Move the shift lever to M (Manual Mode).
2. Press the plus/minus button on the shift lever, to increase or decrease the gear range available.

When shifting to M (Manual Mode), the transmission will shift to a preset lower gear range. For this preset range, the highest gear available is displayed next to the M in the DIC. See *Driver Information Center (DIC) on page 5-20* for more information. All gears below that number are available to use. For example, when 4 (Fourth) is shown next to the M, 1 (First) through 4 (Fourth) gears are shifted automatically. To shift to 5 (Fifth) gear, press the + (Plus) button or shift into D (Drive).

M (Manual Mode) will prevent shifting to a lower gear range if the engine speed is too high. If vehicle speed is not reduced within the time allowed, the lower gear range shift will not be completed. Slow the vehicle, then press the - (Minus) button to the desired lower gear range.

While using the ERS, cruise control can be used.

### Fuel Economy Mode

Vehicles with a 2.4L engine have a Fuel Economy Mode. When engaged, fuel economy mode can improve the vehicle's fuel economy.

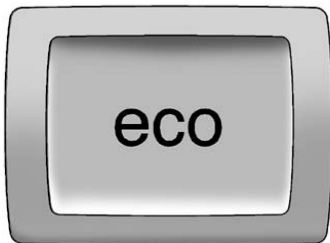

Press the "eco" (economy) button by the shift lever to turn this feature on or off. The "eco" light in the instrument cluster will come on when engaged. See *Fuel Economy Light on page 5-18*. A Driver Information Center (DIC) message

"ECO MODE ON" is also displayed. See *Fuel System Messages on page 5-27* for more information.

When Fuel Economy Mode is on:

- The transmission will upshift sooner and downshift later.
- The torque converter clutch will apply sooner and stay on longer.
- The gas pedal will be less sensitive.
- The vehicle's computer will more aggressively shut off fuel to the engine under deceleration.
- The engine idle speed will be lower.
- Driving performance is more conservative.

## Drive Systems

### All-Wheel Drive

Vehicles with this feature always send engine power to all four wheels. It is fully automatic, and adjusts itself as needed for road conditions.

When using a compact spare tire on an AWD vehicle, the system automatically detects the compact spare and disables AWD. To restore AWD operation and prevent excessive wear on the system, replace the compact spare with a full-size tire as soon as possible. See *Compact Spare Tire* on page 10-74 for more information.

## Brakes

### Antilock Brake System (ABS)

This vehicle has the Antilock Brake System (ABS), an advanced electronic braking system that helps prevent a braking skid.

When the engine is started and the vehicle begins to drive away, ABS checks itself. A momentary motor or clicking noise might be heard while this test is going on, and it might even be noticed that the brake pedal moves a little. This is normal.



If there is a problem with ABS, this warning light stays on. See *Antilock Brake System (ABS) Warning Light* on page 5-16.

If driving safely on a wet road and it becomes necessary to slam on the brakes and continue braking to avoid a sudden obstacle, a computer senses that the wheels are slowing down. If one of the wheels is about to stop rolling, the computer will separately work the brakes at each wheel.

ABS can change the brake pressure to each wheel, as required, faster than any driver could. This can help the driver steer around the obstacle while braking hard.

As the brakes are applied, the computer keeps receiving updates on wheel speed and controls braking pressure accordingly.

Remember: ABS does not change the time needed to get a foot up to the brake pedal or always decrease stopping distance. If you get too close to the vehicle in front of you, there will not be enough time to apply the brakes if that vehicle suddenly slows or stops. Always leave enough room up ahead to stop, even with ABS.

### Using ABS

Do not pump the brakes. Just hold the brake pedal down firmly and let ABS work. You might hear the ABS pump or motor operating and feel the brake pedal pulsate, but this is normal.

### Braking in Emergencies

ABS allows the driver to steer and brake at the same time. In many emergencies, steering can help more than even the very best braking.

### Parking Brake

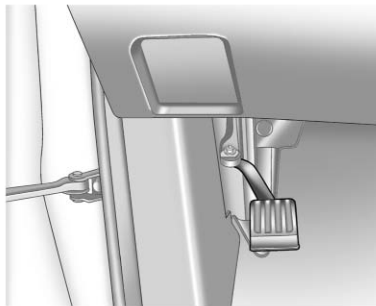

To set the parking brake, hold the regular brake pedal down, then push the parking brake pedal down.

If the ignition is on, the brake system warning light will come on. See *Brake System Warning Light* on page 5-15.

**Notice:** Driving with the parking brake on can overheat the brake system and cause premature wear or damage to brake system parts. Make sure that the parking brake is fully released and the brake warning light is off before driving.

To release the parking brake, hold the regular brake pedal down, then push down momentarily on the parking brake pedal until you feel the pedal release. Slowly pull your foot up off the park brake pedal. If the parking brake is not released when you begin to drive, the brake system warning light will be on and a chime will sound warning you that the parking brake is still on.

If you are towing a trailer and are parking on a hill, see *Driving Characteristics and Towing Tips* on page 9-58.



## Brake Assist

This vehicle has a brake assist feature designed to assist the driver in stopping or decreasing vehicle speed in emergency driving conditions. This feature uses the stability system hydraulic brake control module to supplement the power brake system under conditions where the driver has quickly and forcefully applied the brake pedal in an attempt to quickly stop or slow down the vehicle. The stability system hydraulic brake control module increases brake pressure at each corner of the vehicle until the ABS activates. Minor brake pedal pulsation or pedal movement during this time is normal and the driver should continue to apply the brake pedal as the driving situation dictates. The brake assist feature will automatically disengage when the brake pedal is released or brake pedal pressure is quickly decreased.

## Hill Start Assist (HSA)

This vehicle has a Hill Start Assist (HSA) feature, which may be useful when the vehicle is stopped on a grade. This feature is designed to prevent the vehicle from rolling, either forward or rearward, during vehicle drive off. After the driver completely stops and holds the vehicle in a complete standstill on a grade, HSA will be automatically activated. During the transition period between when the driver releases the brake pedal and starts to accelerate to drive off on a grade, HSA holds the braking pressure to ensure that there is no rolling. The brakes will automatically release when the accelerator pedal is applied within the two-second window. It will not activate if the vehicle is in a drive gear and facing downhill or if the vehicle is facing uphill and in R (Reverse).

## Ride Control Systems

### Traction Control System (TCS)

The vehicle has a Traction Control System (TCS) that limits wheel spin. On a front-wheel-drive vehicle, the system operates if it senses that one or both of the front wheels are spinning or beginning to lose traction. On an All-Wheel-Drive (AWD) vehicle, the system will operate if it senses that any of the wheels are spinning or beginning to lose traction. When this happens, the system brakes the spinning wheel(s) and/or reduces engine power to limit wheel spin.



The system may be heard or felt while it is working, but this is normal.

## 9-40 Driving and Operating

TCS is on whenever the vehicle is started. To limit wheel spin, especially in slippery road conditions, the system should always be left on. But, TCS can be turned off if needed.



 flashes to indicate that the traction control system is active.

If there is a problem detected with TCS, SERVICE TRACTION CONTROL and SERVICE STABILITRAK may be displayed on the Driver Information Center (DIC) and  will be on. See *Ride Control System Messages on page 5-27*. When this message is displayed and  comes on and

stays on, the vehicle is safe to drive but the system is not operational. Driving should be adjusted accordingly.

**Notice: Do not repeatedly brake or accelerate heavily when TCS is off. The vehicle's driveline could be damaged.**

If  comes on and stays on, reset the system by:

1. Stopping the vehicle.
2. Turning the engine off and waiting 15 seconds.
3. Starting the engine.

If  still comes on and stays on at a speed above 20 km/h (13 mph), see your dealer for service.



A chime may also sound when the light comes on steady.

The  is located on the console.



The TCS off light comes on and TRACTION CONTROL OFF is displayed on the Driver Information Center (DIC) to indicate that the traction control system has been turned off. See *Ride Control System Messages on page 5-27*.

TCS can be turned off by pressing and releasing .

When TCS is turned off,  comes on and the system will not limit wheel spin. Driving should be adjusted accordingly. Press and release  again to turn the system back on.

When TCS is turned off on AWD vehicles, the system may still make noise. This is normal and necessary with AWD hardware.

It may be necessary to turn the system off if the vehicle ever gets stuck in sand, mud, or snow and rocking the vehicle is required. See *If the Vehicle is Stuck on page 9-21* for more information. See also *Winter Driving on page 9-19* for information on using TCS when driving in snowy or icy conditions.

If cruise control is being used when TCS activates, cruise control will automatically disengage. Press the cruise control button to re-engage when road conditions allow. See *Cruise Control on page 9-42*.

Adding non-GM accessories can affect the vehicle's performance. See *Accessories and Modifications on page 10-3* for more information.

## StabiliTrak<sup>®</sup> System

The vehicle has a vehicle stability enhancement system called StabiliTrak. It is an advanced computer controlled system that assists with directional control of the vehicle in difficult driving conditions.

StabiliTrak activates when the computer senses a difference between the intended path and the direction the vehicle is actually traveling. StabiliTrak selectively applies braking pressure to the vehicle's brakes to help steer the vehicle in the intended direction.

StabiliTrak is on automatically whenever the vehicle is started. To assist with directional control of the vehicle, the system should always be left on.



When the stability control system activates, the Traction Control System (TCS)/StabiliTrak light will flash on the instrument panel. This also occurs when traction control is activated. A noise may be heard or vibration may be felt in the brake pedal. This is normal. Continue to steer the vehicle in the intended direction.

If there is a problem detected with StabiliTrak, SERVICE STABILITRAK is displayed on the Driver Information Center (DIC) and  will stay on. See *Vehicle Messages on page 5-24*.

## 9-42 Driving and Operating

When this message is displayed and/or  comes on and stays on, the vehicle is safe to drive but the system is not operational. Driving should be adjusted accordingly. See *Ride Control System Messages on page 5-27*.





If  comes on and stays on, reset the system by:

1. Stopping the vehicle.
2. Turning the engine off and waiting 15 seconds.
3. Starting the engine.

If  still comes on and stays on at a speed above 20 km/h (13 mph), see your dealer for service.



 is located on the console.

Both StabiliTrak and Traction Control can be turned off if needed by pressing and holding  until  and  come on the instrument panel. When StabiliTrak is turned off, the system will not assist with directional control of the vehicle or limit wheel spin. Driving should be adjusted accordingly. Press and release  again to turn the system back on.

If cruise control is being used when StabiliTrak activates, the cruise control will automatically disengage. Press the cruise control button to re-engage when road conditions allow. See *Cruise Control on page 9-42* for more information.

## Cruise Control

With cruise control, the vehicle can maintain a speed of about 40 km/h (25 mph) or more without keeping your foot on the accelerator. Cruise control does not work at speeds below 40 km/h (25 mph).

If the brakes are applied, the cruise control is disengaged.

If the vehicle has the StabiliTrak<sup>®</sup> system and begins to limit wheel spin while using cruise control, the cruise control automatically disengages. See *StabiliTrak<sup>®</sup> System on page 9-41* or *Traction Control System (TCS) on page 9-39*. When road conditions allow you to safely use it again, the cruise control can be turned back on.

**⚠ WARNING**

Cruise control can be dangerous where you cannot drive safely at a steady speed. So, do not use the cruise control on winding roads or in heavy traffic.

Cruise control can be dangerous on slippery roads. On such roads, fast changes in tire traction can cause excessive wheel slip, and you could lose control. Do not use cruise control on slippery roads.

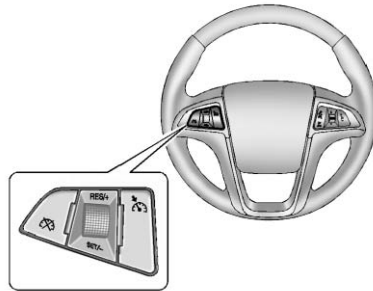

**⏻ (On/Off):** Press to turn the cruise control system on and off.

**⊗ (Cancel):** Press to disengage cruise control without erasing the set speed from memory.

**RES/+ (Resume/Accel):** Move the thumbwheel up toward RES/+ to make the vehicle resume to a previously set speed or to accelerate.

**SET/- (Set/Coast):** Move the thumbwheel down toward SET/- to set a speed and activate cruise control, or to make the vehicle decelerate.

**Setting Cruise Control**

If the cruise button is on when not in use, it could get bumped and go into cruise when not desired. Keep the cruise button turned off when cruise control is not being used.

1. Press .
2. Get to the speed desired.
3. Press the thumbwheel and release it. The desired set speed briefly appears in the Driver Information Center (DIC) display.
4. Take your foot off the accelerator pedal.

## 9-44 Driving and Operating

---

### Resuming a Set Speed

If the cruise control is set at a desired speed and then the brakes are applied, the cruise control is disengaged without erasing the set speed from memory.

Once the vehicle reaches about 40 km/h (25 mph) or more, move the thumbwheel up toward RES/+ briefly. The vehicle returns to the previous set speed and stays there.

### Increasing Speed While Using Cruise Control

If the cruise control system is already activated,

- Move the thumbwheel up toward RES/+ and hold it until the vehicle accelerates to the desired speed, and then release it.
- To increase the speed in small amounts, move the thumbwheel up toward RES/+ briefly and then release it. Each time this is done, the vehicle goes about 1.6 km/h (1 mph) faster.

### Reducing Speed While Using Cruise Control

If the cruise control system is already activated,

- Move the thumbwheel toward SET/- and hold until the desired lower speed is reached, then release it.
- To slow down in small amounts, move the thumbwheel toward SET/- briefly. Each time this is done, the vehicle goes about 1.6 km/h (1 mph) slower.

### Passing Another Vehicle While Using Cruise Control

Use the accelerator pedal to increase the vehicle speed. When you take your foot off the pedal, the vehicle will slow down to the previous set cruise speed.



### Using Cruise Control on Hills

How well the cruise control works on hills depends upon the vehicle speed, load, and the steepness of the hills. When going up steep hills,

you might have to step on the accelerator pedal to maintain the vehicle speed. When going downhill, you might have to brake or shift to a lower gear to maintain the vehicle's speed. When the brakes are applied the cruise control is disengaged.

### Ending Cruise Control

There are three ways to end cruise control:

- To disengage cruise control; step lightly on the brake pedal or clutch, the indicator light will go off.
- Press .
- To turn off the cruise control, press . The cruise control cannot be resumed.

### Erasing Speed Memory

The cruise control set speed is erased from memory if  is pressed or if the vehicle is turned off.

## Object Detection Systems

### Ultrasonic Parking Assist

For vehicles with the Ultrasonic Rear Parking Assist (URPA) system, it assists the driver with parking and avoiding objects while in R (Reverse). URPA operates at speeds less than 8 km/h (5 mph), and the sensors on the rear bumper detect objects up to 2.5 m (8 ft) behind the vehicle, and at least 20 cm (8 in) off the ground.

#### WARNING

The Ultrasonic Rear Parking Assist (URPA) system does not replace driver vision. It cannot detect:

- Objects that are below the bumper, underneath the vehicle, or too close or far from the vehicle.
- Children, pedestrians, bicyclists, or pets.

If you do not use proper care before and while backing, vehicle damage, injury, or death could occur. Even with URPA, always check behind the vehicle before backing up. While backing, be sure to look for objects and check the vehicle's mirrors.

### How the System Works

URPA comes on automatically when the shift lever is moved into R (Reverse). A single tone sounds to indicate the system is working.

URPA operates only at speeds less than 8 km/h (5 mph).

An obstacle is indicated by audible beeps. The interval between the beeps becomes shorter as the vehicle gets closer to the obstacle. When the distance is less than 30 cm (12 in) the beeping is continuous for 5 seconds.

To be detected, objects must be at least 20 cm (8 in) off the ground and below taillamp level. Objects must also be within 2.5 m (8 ft) from the rear bumper. The distance objects can be detected may be less during warmer or humid weather.

PARK ASSIST OFF displays on the Driver Information Center (DIC) to indicate that URPA is off. The message disappears after a short period of time.

See *Object Detection System Messages* on page 5-27 for URPA messages.

### Turning the System On and Off

The URPA system can be turned on and off using the infotainment system controls. See *Vehicle Personalization on page 5-30* for more information.

URPA defaults to the on setting each time the vehicle is started.

### When the System Does Not Seem to Work Properly

If the URPA system does not activate due to a temporary condition, the message PARK ASSIST OFF displays on the DIC. See *Driver Information Center (DIC) on page 5-20* for more information. This can occur under the following conditions:

- The driver has disabled the system.
- The ultrasonic sensors are not clean. Keep the vehicle's rear bumper free of mud, dirt, snow, ice, and slush. For cleaning instructions, see *Exterior Care on page 10-82*.
- The park assist sensors are covered by frost or ice, which can occur after washing the vehicle in cold weather. Keep the sensors free of frost or ice.
- A trailer was attached to the vehicle, or an object was hanging out of the trunk during the last drive cycle. Once the object is removed, URPA will return to normal operation.
- The vehicle's bumper is damaged. Take the vehicle to your dealer to repair the system.
- Other conditions may affect system performance, such as vibrations from a jackhammer or the compression of air brakes on a very large truck.



## Rear Vision Camera (RVC)

The vehicle may have a Rear Vision Camera (RVC) system. Read this entire section before using it.

The RVC can assist the driver when backing up by displaying a view of the area behind the vehicle.

### WARNING

The Rear Vision Camera (RVC) system does not replace driver vision. RVC does not:

- Detect objects that are outside the camera's field of view, below the bumper, or underneath the vehicle.
- Detect children, pedestrians, bicyclists, or pets.

(Continued)

### WARNING (Continued)

Do not back the vehicle by only looking at the RVC screen, or use the screen during longer, higher speed backing maneuvers or where there could be cross-traffic. Your judged distances using the screen will differ from actual distances.

If you do not use proper care before backing up, you could hit a vehicle, child, pedestrian, bicyclist, or pet, resulting in vehicle damage, injury, or death. Even though the vehicle has the RVC system, always check carefully before backing up by checking behind and around the vehicle.

## Vehicles Without a Navigation System

When the key is in the ON/RUN position and the driver shifts the vehicle into R (Reverse), the video image automatically appears in the inside rearview mirror. Once the driver shifts out of R (Reverse), the video image automatically disappears from the inside rearview mirror.

### Turning the Rear Vision Camera System Off or On

To turn off the RVC system, press and hold , located on the inside rearview mirror, until the left indicator light turns off. The RVC display is now disabled.

## 9-48 Driving and Operating

To turn the RVC system on again, press and hold  until the left indicator light illuminates. The RVC system display is now enabled and the display will appear in the mirror normally.

### Vehicles With a Navigation System

An image appears on the navigation screen with the message Check Surroundings for Safety when the vehicle is shifted into R (Reverse). The navigation screen goes to the previous screen after approximately 10 seconds once the vehicle is shifted out of R (Reverse).

To cancel the delay, do one of the following:

- Press a hard key on the navigation system.
- Shift into P (Park).
- Reach a vehicle speed of 8 km/h (5 mph).

### Turning the Rear Vision Camera System On or Off

To turn the rear vision camera system on or off:

1. Shift into P (Park).
2. Press the CONFIG button.
3. Select Display.

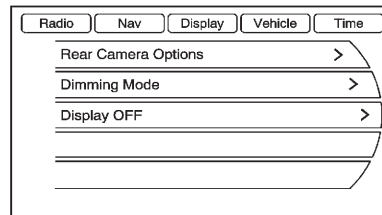

4. Select Rear Camera Options.
5. Select Camera. When a check mark appears next to the Camera option, then the RVC system is on.

## Symbols

The navigation system may have a feature that lets the driver view symbols on the navigation screen while using the RVC. The Ultrasonic Rear Park Assist (URPA) system must not be disabled to use the caution symbols. The error message Rear Parking Assist Symbols Unavailable may display if URPA has been disabled and the symbols have been turned on. See *Ultrasonic Parking Assist* on page 9-45.

The symbols appear and may cover an object when viewing the navigation screen when an object is detected by the URPA system.

To turn the symbols on or off:

1. Shift into P (Park).
2. Press the CONFIG button.
3. Select Display.
4. Select Rear Camera Options.
5. Select Symbols. When a check mark appears next to the Symbols option, symbols will appear.

## Guidelines

The RVC system has a guideline overlay that can help the driver align the vehicle when backing into a parking spot.

To turn the guidelines on or off:

1. Shift into P (Park).
2. Press the CONFIG button.
3. Select Display.
4. Select Rear Camera Options.
5. Select Guidelines. When a check mark appears next to the Guidelines option, guidelines will appear.

## Rear Vision Camera Error Messages

**SERVICE REAR VISION CAMERA SYSTEM:** This message can display on the navigation screen when the system is not receiving information it requires from other vehicle systems.

If any other problem occurs or if a problem persists, see your dealer.

## 9-50 Driving and Operating

### Rear Vision Camera Location

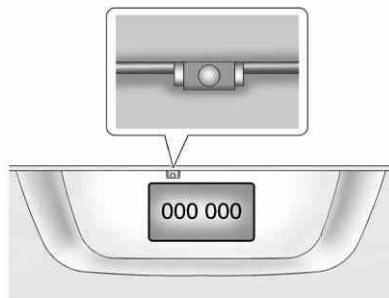

The camera is located above the license plate.

The area displayed by the camera is limited.

It does not display objects that are close to either corner or under the bumper and can vary depending on vehicle orientation or road conditions. The distance of the image that appears on the screen is different from the actual distance.

The following illustration shows the field of view that the camera provides.

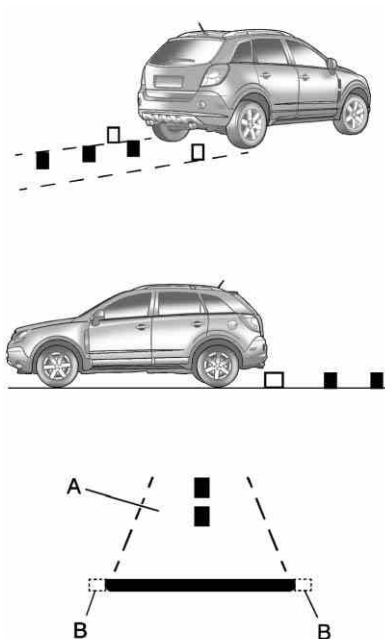

A. View displayed by the camera.

B. Corner of the rear bumper.

### When the System Does Not Seem To Work Properly

The RVC system may not work properly or display a clear image if:

- The RVC is turned off. See “Turning the Rear Vision Camera System On or Off” earlier in this section.
- It is dark.
- The sun or the beam of headlights is shining directly into the camera lens.
- Ice, snow, mud, or anything else builds up on the camera lens. Clean the lens, rinse it with water, and wipe it with a soft cloth.

- The back of the vehicle is in an accident, the position and mounting angle of the camera can change or the camera can be affected. Be sure to have the camera and its position and mounting angle checked at your dealer.

The RVC system display in the rearview mirror may turn off or not appear as expected due to one of the following conditions. If this occurs the left indicator light on the mirror will flash.

- A slow flash may indicate a loss of video signal, or no video signal present during the reverse cycle.
- A fast flash may indicate that the display has been on for the maximum allowable time during a reverse cycle, or the display has reached an over temperature limit.

The fast flash conditions are used to protect the video device from high temperature conditions. Once conditions return to normal the device will reset and the green indicator will stop flashing.

During any of these fault conditions, the display will be blank and the indicator will continue to flash as long as the vehicle is in R (Reverse) or until the conditions return to normal.

Pressing and holding  when the left indicator light is flashing will turn off the video display along with the left indicator light.

### Fuel

Use of the recommended fuel is an important part of the proper maintenance of this vehicle. To help keep the engine clean and maintain optimum vehicle performance, we recommend the use of gasoline advertised as TOP TIER Detergent Gasoline.

Look for the TOP TIER label on the fuel pump to ensure gasoline meets enhanced detergency standards developed by auto companies. A list of marketers providing TOP TIER Detergent Gasoline can be found at [www.toptiergas.com](http://www.toptiergas.com).



Vehicles that have a FlexFuel badge and a yellow fuel cap can use either unleaded gasoline or ethanol fuel containing up to 85% ethanol (E85). See *Fuel E85 (85% Ethanol)* on page 9-54. For all other vehicles, use only the unleaded gasoline described under *Recommended Fuel* on page 9-52.

### Recommended Fuel

Use regular unleaded gasoline with a posted octane rating of 87 or higher. If the octane rating is less than 87, an audible knocking noise, commonly referred to as spark knock, might be heard when driving. If this occurs, use a gasoline rated at 87 octane or higher as soon as possible. If heavy knocking is heard when using gasoline rated at 87 octane or higher, the engine needs service.

### Gasoline Specifications (U.S. and Canada Only)

At a minimum, gasoline should meet ASTM specification D 4814 in the United States or CAN/CGSB-3.5 or 3.511 in Canada. Some gasolines contain an octane-enhancing additive called methylcyclopentadienyl manganese tricarbonyl (MMT). We recommend

against the use of gasolines containing MMT. See *Fuel Additives* on page 9-53 for additional information.

## California Fuel Requirements

If the vehicle is certified to meet California Emissions Standards, it is designed to operate on fuels that meet California specifications. See the underhood emission control label. If this fuel is not available in states adopting California Emissions Standards, the vehicle will operate satisfactorily on fuels meeting federal specifications, but emission control system performance might be affected. The malfunction indicator lamp could turn on and the vehicle might fail a smog-check test. See *Malfunction Indicator Lamp* on page 5-13. If this occurs, return to your authorized dealer for diagnosis. If it is determined that the condition is caused by the type of fuel used, repairs might not be covered by the vehicle warranty.

## Fuels in Foreign Countries

Never use leaded gasoline or any other fuel not recommended in the previous text on fuel. Costly repairs caused by use of improper fuel would not be covered by the vehicle warranty.

To check the fuel availability, ask an auto club, or contact a major oil company that does business in the country where you will be driving.

## Fuel Additives

To provide cleaner air, all gasolines in the United States are now required to contain additives that help prevent engine and fuel system deposits from forming, allowing the emission control system to work properly. In most cases, nothing should have to be added to the fuel. However, some gasolines contain only the minimum amount of additive required to meet U.S. Environmental Protection Agency

regulations. To help keep fuel injectors and intake valves clean and avoid problems due to dirty injectors or valves, look for gasoline that is advertised as TOP TIER Detergent Gasoline. Look for the TOP TIER label on the fuel pump to ensure gasoline meets enhanced detergency standards developed by the auto companies. A list of marketers providing TOP TIER Detergent Gasoline can be found at [www.toptiergas.com](http://www.toptiergas.com).

For customers who do not use TOP TIER Detergent Gasoline regularly, one bottle of GM Fuel System Treatment PLUS, added to the fuel tank at every engine oil change, can help clean deposits from fuel injectors and intake valves. GM Fuel System Treatment PLUS is the only gasoline additive recommended by General Motors. It is available at your dealer.

Gasolines containing oxygenates, such as ethers and ethanol, and reformulated gasolines might be available in your area.

We recommend that you use these gasolines, if they comply with the specifications described earlier. However, E85 (85% ethanol) and other fuels containing more than 10% ethanol must not be used in vehicles that were not designed for those fuels.

**Notice:** This vehicle was not designed for fuel that contains methanol. Do not use fuel containing methanol. It can corrode metal parts in the fuel system and also damage plastic and rubber parts. That damage would not be covered under the vehicle warranty.

Some gasolines that are not reformulated for low emissions can contain an octane-enhancing additive called methylcyclopentadienyl manganese tricarbonyl (MMT); ask the attendant where you buy gasoline whether the fuel contains MMT. We recommend against the use of such gasolines. Fuels containing MMT can reduce spark plug life and affect emission

control system performance. The malfunction indicator lamp might turn on. If this occurs, return to your dealer for service.

### Fuel E85 (85% Ethanol)

Vehicles that have a FlexFuel badge and a yellow fuel cap can use either unleaded gasoline or ethanol fuel containing up to 85% ethanol (E85). For all other vehicles, use only the unleaded gasoline described under *Recommended Fuel on page 9-52*.

We encourage the use of E85 in vehicles that are designed to use it. The ethanol in E85 is a “renewable” fuel, meaning it is made from renewable sources such as corn and other crops.

Many service stations will not have an 85% ethanol fuel (E85) pump available. The U.S. Department of Energy has an alternative fuels website ([www.afdc.energy.gov/afdc/locator/stations/](http://www.afdc.energy.gov/afdc/locator/stations/)) that can help you find E85 fuel. Those stations that do have E85 should have a label

indicating ethanol content. Do not use the fuel if the ethanol content is greater than 85%.

At a minimum, E85 should meet ASTM Specification D 5798 or CGSB Specification 3.512. Filling the tank with fuel mixtures that do not meet ASTM or CGSB specifications can affect driveability and could cause the malfunction indicator lamp to come on. As the outside temperature approaches freezing, ethanol fuel distributors should supply winter grade ethanol, the same as with unleaded gasoline.

The starting characteristics of E85 fuel make it unsuitable for use when the ambient temperatures fall below  $-18^{\circ}\text{C}$  ( $0^{\circ}\text{F}$ ).

In the range of  $-18^{\circ}\text{C}$  ( $0^{\circ}\text{F}$ ) to  $0^{\circ}\text{C}$  ( $32^{\circ}\text{F}$ ), you may experience an increase in the time it takes for the engine to start.



It is best not to alternate repeatedly between gasoline and E85. If you do switch fuels, it is recommended that you add as much fuel as possible — do not add less than 11 L (3 gal) when refueling. You should drive the vehicle immediately after refueling for at least 11 km (7 mi) to allow the vehicle to adapt to the change in ethanol concentration.

E85 has less energy per liter (gallon) than gasoline, so you will need to refill the fuel tank more often when using E85 than when you are using gasoline. See *Filling the Tank* on page 9-55.

**Notice: Some additives are not compatible with E85 fuel and can harm the vehicle's fuel system. Do not add anything to E85. Damage caused by additives would not be covered by the vehicle warranty.**

**Notice: This vehicle was not designed for fuel that contains methanol. Do not use fuel**

**containing methanol. It can corrode metal parts in the fuel system and also damage plastic and rubber parts. That damage would not be covered under the vehicle warranty.**

## Filling the Tank

### WARNING

Fuel vapor burns violently and a fuel fire can cause bad injuries. To help avoid injuries to you and others, read and follow all the instructions on the fuel pump island. Turn off the engine when refueling. Do not smoke near fuel or when refueling the vehicle. Do not use cellular phones. Keep sparks, flames, and smoking materials away from fuel. Do not leave the fuel pump unattended when refueling the vehicle. This is against the law in some places. Do not re-enter the vehicle while

(Continued)

### WARNING (Continued)

pumping fuel. Keep children away from the fuel pump; never let children pump fuel.

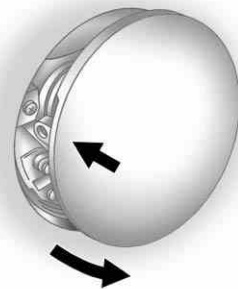

The tethered fuel cap is behind the fuel door on the vehicle's passenger side. To open the fuel door, push the rearward center edge in and release and the door will open. Turn the fuel cap counterclockwise to remove.

## 9-56 Driving and Operating

Do not release the cap too soon or it will spring back. Reinstall the cap by turning it clockwise until it clicks.

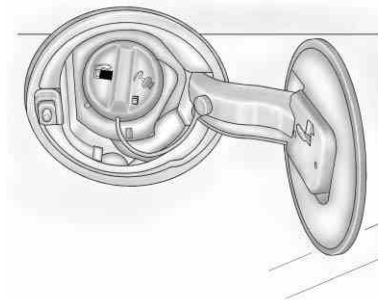

If the cap is not properly installed, the Malfunction Indicator Lamp will come on. See *Malfunction Indicator Lamp* on page 5-13 for more information.

### WARNING

Fuel can spray out on you if you open the fuel cap too quickly. If you spill fuel and then something ignites it, you could be badly burned. This spray can happen if the tank is nearly full, and is more likely in hot weather. Open the fuel cap slowly and wait for any hiss noise to stop. Then unscrew the cap all the way.

Do not top off or overfill the tank. Wait a few seconds before removing the nozzle. Clean fuel from painted surfaces as soon as possible. See *Exterior Care* on page 10-82.

### WARNING

If a fire starts while you are refueling, do not remove the nozzle. Shut off the flow of fuel by shutting off the pump or by notifying the station attendant. Leave the area immediately.

**Notice:** If a new fuel cap is needed, be sure to get the right type of cap from your dealer. The wrong type of fuel cap might not fit properly, might cause the malfunction indicator lamp to light, and could damage the fuel tank and emissions system. See *Malfunction Indicator Lamp* on page 5-13.

## Filling a Portable Fuel Container

### WARNING

Never fill a portable fuel container while it is in the vehicle. Static electricity discharge from the container can ignite the fuel vapor. You can be badly burned and the vehicle damaged if this occurs. To help avoid injury to you and others:

- Dispense fuel only into approved containers.
- Do not fill a container while it is inside a vehicle, in a vehicle's trunk, pickup bed, or on any surface other than the ground.

(Continued)

### WARNING (Continued)

- Bring the fill nozzle in contact with the inside of the fill opening before operating the nozzle. Contact should be maintained until the filling is complete.
- Do not smoke while pumping fuel.
- Do not use a cellular phone while pumping fuel.

## Towing

### General Towing Information

Only use towing equipment that has been designed for the vehicle. Contact your dealer or trailering dealer for assistance with preparing the vehicle for towing a trailer.

See the following trailer towing information in this section:

- For information on driving while towing a trailer, see "Driving Characteristics and Towing Tips."
- For maximum vehicle and trailer weights, see "Trailer Towing."
- For information on equipment to tow a trailer, see "Towing Equipment."

For information on towing a disabled vehicle, see *Towing the Vehicle* on page 10-79. For information on towing the vehicle behind another vehicle such as a motor home, see *Recreational Vehicle Towing* on page 10-79.

### Driving Characteristics and Towing Tips

#### **WARNING**

The driver can lose control when pulling a trailer if the correct equipment is not used or the vehicle is not driven properly. For example, if the trailer is too heavy, the brakes may not work well — or even at all. The driver and passengers could be seriously injured. The vehicle may also be damaged; the resulting repairs would not be covered by the vehicle warranty. Pull a trailer only if all the steps in this section

(Continued)

#### **WARNING (Continued)**

have been followed. Ask your dealer for advice and information about towing a trailer with the vehicle.

The vehicle can tow a trailer when equipped with the proper trailer towing equipment. For trailering capacity, see “Trailer Towing” following in this section. Trailering changes handling, acceleration, braking, durability and fuel economy. With the added weight, the engine, transmission, wheel assemblies and tires are forced to work harder and under greater loads. The trailer also adds wind resistance, increasing the pulling requirements. For safe trailering, correctly use the proper trailering equipment.

The following information has important trailering tips and rules for your safety and that of your passengers. Read this section carefully before pulling a trailer.

#### **Pulling a Trailer**

Here are some important points:

- There are many laws, including speed limit restrictions that apply to trailering. Check for legal requirements with state or provincial police.
- Do not tow a trailer at all during the first 1 600 km (1,000 miles) the new vehicle is driven. The engine, axle or other parts could be damaged.
- During the first 800 km (500 miles) that a trailer is towed, do not drive over 80 km/h (50 mph) and do not make starts at full throttle. This reduces wear on the vehicle.
- The vehicle can tow in D (Drive). Use a lower gear if the transmission shifts too often.

- Do not use the Fuel Saver Mode when towing.
- Obey speed limit restrictions. Do not drive faster than the maximum posted speed for trailers, or no more than 90 km/h (55 mph), to reduce wear on the vehicle.
- For vehicles with the Ultra Rear Parking Assist (URPA) system, turn the system off when towing a trailer. If the tow bar is installed while not towing a trailer, change the URPA system to the “Tow Bar” setting. See *Ultrasonic Parking Assist on page 9-45* for more information.

### Driving with a Trailer

Towing a trailer requires experience. Get familiar with handling and braking with the added trailer weight. The vehicle is now longer and not as responsive as the vehicle is by itself.

Check all trailer hitch parts and attachments, safety chains, electrical connectors, lamps, tires and mirror adjustments. If the trailer has electric brakes, start the vehicle and trailer moving and then apply the trailer brake controller by hand to be sure the brakes are working.

During the trip, check regularly to be sure that the load is secure, and the lamps and trailer brakes are working properly.

### Towing with a Stability Control System

When towing, the sound of the stability control system might be heard. The system is reacting to the vehicle movement caused by the trailer, which mainly occurs during cornering. This is normal when towing heavier trailers.

### Following Distance

Stay at least twice as far behind the vehicle ahead as you would when driving the vehicle without a trailer. This can help to avoid situations that require heavy braking and sudden turns.

### Passing

More passing distance is needed when towing a trailer. Because the rig is longer, it is necessary to go farther beyond the passed vehicle before returning to the lane.

### Backing Up

Hold the bottom of the steering wheel with one hand. To move the trailer to the left, move that hand to the left. To move the trailer to the right, move your hand to the right. Always back up slowly and, if possible, have someone guide you.

### Making Turns

**Notice:** Making very sharp turns while trailering could cause the trailer to come in contact with the vehicle. The vehicle could be damaged. Avoid making very sharp turns while trailering.

When turning with a trailer, make wider turns than normal so the trailer will not strike soft shoulders, curbs, road signs, trees or other objects. Use the turn signal well in advance and avoid jerky or sudden maneuvers.

### Turn Signals When Towing a Trailer

The turn signal indicators on the instrument panel flash whenever signaling a turn or lane change. Properly hooked up, the trailer lamps also flash, telling other drivers the vehicle is turning, changing lanes or stopping.

When towing a trailer, the arrows on the instrument panel flash for turns even if the bulbs on the trailer are burned out. Check occasionally to be sure the trailer bulbs are still working.

### Driving on Grades

Reduce speed and shift to a lower gear before starting down a long or steep downgrade. If the transmission is not shifted down, the brakes might have to be used so much that they would get hot and no longer work well.

The vehicle can tow in D (Drive). Use a lower gear if the transmission shifts too often.

When towing at high altitude on steep uphill grades, engine coolant will boil at a lower temperature than at normal altitudes. If the engine is turned off immediately after towing at high altitude on steep uphill grades, the vehicle may show signs

similar to engine overheating. To avoid this, let the engine run while parked, preferably on level ground, with the transmission in P (Park) for a few minutes before turning the engine off. If the overheat warning comes on, see *Engine Overheating* on page 10-21.

### Parking on Hills



Parking the vehicle on a hill with the trailer attached can be dangerous. If something goes wrong, the rig could start to move. People can be injured, and both the vehicle and the trailer can be damaged. When possible, always park the rig on a flat surface.

If parking the rig on a hill:

1. Press the brake pedal, but do not shift into P (Park) yet. Turn the wheels into the curb if facing downhill or into traffic if facing uphill.
2. Have someone place chocks under the trailer wheels.
3. When the wheel chocks are in place, release the brake pedal until the chocks absorb the load.
4. Reapply the brake pedal. Then apply the parking brake and shift into P (Park).
5. Release the brake pedal.

### **Leaving After Parking on a Hill**

1. Apply and hold the brake pedal.
2. Start the engine.
3. Shift into a gear.
4. Release the parking brake.
5. Let up on the brake pedal.

6. Drive slowly until the trailer is clear of the chocks.
7. Stop and have someone pick up and store the chocks.

### **Maintenance When Trailer Towing**

The vehicle needs service more often when pulling a trailer. See this manual's Maintenance Schedule or Index for more information.

Things that are especially important in trailer operation are automatic transmission fluid, engine oil, axle lubricant, belts, cooling system and brake system. Inspect these before and during the trip.

Check periodically to see that all hitch nuts and bolts are tight.

### **Engine Cooling When Trailer Towing**

The cooling system may temporarily overheat during severe operating conditions. See *Engine Overheating on page 10-21*.

### **Trailer Towing**

Before pulling a trailer, there are three important considerations that have to do with weight:

- The weight of the trailer
- The weight of the trailer tongue
- The total weight on the vehicle's tires

### **Weight of the Trailer**

How heavy can a trailer safely be?

Speed, altitude, road grades, outside temperature, special equipment, and the amount of tongue weight the vehicle can carry must be considered. See "Weight of the Trailer Tongue" later in this section for more information.

Maximum trailer weight is calculated assuming only the driver is in the tow vehicle and it has all the required trailering equipment. The weight of additional optional equipment, passengers and cargo in the tow vehicle must be subtracted from the maximum trailer weight.

## 9-62 Driving and Operating

Use the following chart to determine how much the vehicle can weigh, based upon the vehicle model and options.

| Vehicle        | Maximum Trailer Weight with Trailer Brakes† | GCWR*                |
|----------------|---|----------------------|
| L4 Engine, FWD | 680 kg (1,500 lbs)                          | 2 625 kg (5,787 lbs) |
| L4 Engine, AWD | 680 kg (1,500 lbs)                          | 2 700 kg (5,952 lbs) |
| V6 Engine, FWD | 1 588 kg (3,500 lbs)                        | 3 600 kg (7,937 lbs) |
| V6 Engine, AWD | 1 588 kg (3,500 lbs)                        | 3 700 kg (8,157 lbs) |

† For trailers without trailer brakes the maximum trailer weight is 454 kg (1,000 lbs). See *Towing Equipment* on page 9-63 for more information.

\*The Gross Combination Weight Rating (GCWR) is the total allowable weight of the completely loaded vehicle and trailer including any passengers, cargo, equipment and conversions. The GCWR for the vehicle should not be exceeded.

Ask your dealer for our trailering information or advice. See *Customer Assistance Offices (U.S. and Canada)* on page 13-4 or *Customer Assistance Offices (Mexico)* on page 13-5 for more information.

### Weight of the Trailer Tongue

The tongue load (A) of any trailer is an important weight to measure because it affects the total gross weight of the vehicle. The Gross Vehicle Weight (GVW) includes the curb weight of the vehicle, any cargo carried in it, and the people who will be riding in the vehicle. If there are a lot of options, equipment, passengers or cargo in the vehicle, it will reduce the tongue weight the vehicle can carry, which will also reduce the trailer weight the vehicle can tow. If towing a trailer, the tongue load must be added to the GVW because the vehicle will be carrying that weight, too. See *Vehicle Load Limits* on page 9-21.



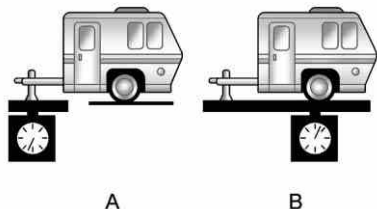

If a weight-carrying hitch or a weight-distributing hitch is being used, the trailer tongue (A) should weigh 10 to 15 percent of the total loaded trailer weight (B).

After loading the trailer, weigh the trailer and then the tongue, separately, to see if the weights are proper. If they are not, adjustments might be made by moving some items around in the trailer.

Trailer may be limited by the vehicle's ability to carry tongue weight. Tongue weight cannot cause the vehicle to exceed the GVWR (Gross Vehicle Weight Rating) or the RGAWR (Rear Gross Axle Weight Rating). The effect of additional weight may reduce the trailering capacity more than the total of the additional weight.

It is important that the vehicle does not exceed any of its ratings — GCWR, GVWR, RGAWR, Maximum Trailer Rating or Tongue Weight. The only way to be sure it is not exceeding any of these ratings is to weigh the vehicle and trailer.

### Total Weight on the Vehicle's Tires

Inflate the vehicle's tires to the upper limit for cold tires. These numbers can be found on the Certification label or see *Vehicle Load Limits* on page 9-21 for more information. Do not go over the GVW limit for the vehicle, or the GAWR, including the weight of the

trailer tongue. If using a weight distributing hitch, do not go over the rear axle limit before applying the weight distribution spring bars.

## Towing Equipment

### Hitches

Use the correct hitch equipment. See your dealer or a hitch dealer for assistance.

- The rear bumper on the vehicle is not intended for hitches. Do not attach rental hitches or other bumper-type hitches to it. Use only a frame-mounted hitch that does not attach to the bumper.
- Will any holes be made in the body of the vehicle when the trailer hitch is installed? If there are, seal the holes when the hitch is removed. If the holes are not sealed, dirt, water, and deadly carbon monoxide (CO) from the exhaust can get into the vehicle. See *Engine Exhaust* on page 9-32.

### Safety Chains

Always attach chains between the vehicle and the trailer. Cross the safety chains under the tongue of the trailer to help prevent the tongue from contacting the road if it becomes separated from the hitch. Leave enough slack so the rig can turn. Never allow safety chains to drag on the ground.

### Trailer Brakes

Does the trailer have its own brakes? Be sure to read and follow the instructions for the trailer brakes so they are installed, adjusted, and maintained properly.

Because the vehicle has antilock brakes, do not tap into the vehicle's brake system. If this is done, both brake systems will not work well, or at all.

### Trailer Sway Control (TSC)

The vehicle has a Trailer Sway Control (TSC) feature as part of the StabiliTrak system. If TSC detects that the trailer is swaying, the vehicle's brakes are automatically applied.



When TSC is applying the brakes, the TCS/StabiliTrak indicator light flashes to notify the driver to reduce speed. See *Traction Control System (TCS)/StabiliTrak® Light on page 5-17*. If the trailer continues to sway, StabiliTrak will reduce engine torque to help slow the vehicle.

TSC will not function if StabiliTrak is turned off.

### Conversions and Add-Ons

#### Add-On Electrical Equipment

**Notice:** Do not add anything electrical to the vehicle unless you check with your dealer first. Some electrical equipment can damage the vehicle and the damage would not be covered by the vehicle's warranty. Some add-on electrical equipment can keep other components from working as they should.

Add-on equipment can drain the vehicle's 12-volt battery, even if the vehicle is not operating.

The vehicle has an airbag system. Before attempting to add anything electrical to the vehicle, see *Servicing the Airbag-Equipped Vehicle on page 3-37* and *Adding Equipment to the Airbag-Equipped Vehicle on page 3-38*.

# Vehicle Care

## General Information

|                             |      |
|-----------------------------|------|
| General Information .....   | 10-2 |
| California                  |      |
| Proposition 65 Warning .... | 10-2 |
| California Perchlorate      |      |
| Materials Requirements .... | 10-3 |
| Accessories and             |      |
| Modifications .....         | 10-3 |

## Vehicle Checks

|                                |       |
|--------------------------------|-------|
| Doing Your Own                 |       |
| Service Work .....             | 10-4  |
| Hood .....                     | 10-5  |
| Engine Compartment             |       |
| Overview .....                 | 10-6  |
| Engine Cover .....             | 10-10 |
| Engine Oil .....               | 10-10 |
| Engine Oil Life System ....    | 10-14 |
| Automatic Transmission         |       |
| Fluid .....                    | 10-15 |
| Engine Air Cleaner/Filter .... | 10-15 |
| Cooling System .....           | 10-16 |
| Engine Coolant .....           | 10-17 |
| Engine Overheating .....       | 10-21 |

|                              |       |
|------------------------------|-------|
| Power Steering Fluid         |       |
| (2.4L L4 Engine) .....       | 10-23 |
| Power Steering Fluid         |       |
| (3.0L V6 Engine) .....       | 10-23 |
| Washer Fluid .....           | 10-23 |
| Brakes .....                 | 10-24 |
| Brake Fluid .....            | 10-25 |
| Battery .....                | 10-27 |
| All-Wheel Drive .....        | 10-27 |
| Starter Switch Check .....   | 10-28 |
| Automatic Transmission Shift |       |
| Lock Control Function        |       |
| Check .....                  | 10-28 |
| Ignition Transmission Lock   |       |
| Check .....                  | 10-29 |
| Park Brake and P (Park)      |       |
| Mechanism Check .....        | 10-29 |
| Wiper Blade                  |       |
| Replacement .....            | 10-30 |

## Headlamp Aiming

|                       |       |
|-----------------------|-------|
| Headlamp Aiming ..... | 10-31 |
|-----------------------|-------|

## Bulb Replacement

|                         |       |
|-------------------------|-------|
| Bulb Replacement .....  | 10-33 |
| Headlamps, Front Turn   |       |
| Signal, Sidemarker, and |       |
| Parking Lamps .....     | 10-34 |
| Fog Lamps .....         | 10-35 |

|                          |       |
|--------------------------|-------|
| Taillamps, Turn Signal,  |       |
| Sidemarker, Stoplamps,   |       |
| and Back-Up Lamps .....  | 10-35 |
| License Plate Lamp ..... | 10-38 |
| Replacement Bulbs .....  | 10-38 |

## Electrical System

|                         |       |
|-------------------------|-------|
| Fuses .....             | 10-39 |
| Engine Compartment Fuse |       |
| Block .....             | 10-40 |
| Instrument Panel Fuse   |       |
| Block .....             | 10-42 |

## Wheels and Tires

|                             |       |
|-----------------------------|-------|
| Tires .....                 | 10-45 |
| Tire Sidewall Labeling .... | 10-45 |
| Tire Designations .....     | 10-48 |
| Tire Terminology and        |       |
| Definitions .....           | 10-48 |
| Tire Pressure .....         | 10-51 |
| Tire Pressure Monitor       |       |
| System .....                | 10-52 |
| Tire Pressure Monitor       |       |
| Operation .....             | 10-54 |
| Tire Inspection .....       | 10-57 |
| Tire Rotation .....         | 10-57 |
| When It Is Time for New     |       |
| Tires .....                 | 10-58 |
| Buying New Tires .....      | 10-59 |

## 10-2 Vehicle Care

---

|   |       |
|---|-------|
| Different Size Tires and<br>Wheels .....  | 10-61 |
| Uniform Tire Quality<br>Grading .....     | 10-61 |
| Wheel Alignment and Tire<br>Balance ..... | 10-63 |
| Wheel Replacement .....                   | 10-63 |
| Tire Chains .....                         | 10-65 |
| If a Tire Goes Flat .....                 | 10-65 |
| Tire Changing .....                       | 10-67 |
| Compact Spare Tire .....                  | 10-74 |
| <b>Jump Starting</b>                      |       |
| Jump Starting .....                       | 10-75 |
| <b>Towing</b>                             |       |
| Towing the Vehicle .....                  | 10-79 |
| Recreational Vehicle<br>Towing .....      | 10-79 |
| <b>Appearance Care</b>                    |       |
| Exterior Care .....                       | 10-82 |
| Interior Care .....                       | 10-86 |
| Floor Mats .....                          | 10-89 |

### General Information

For service and parts needs, visit your dealer. You will receive genuine GM parts and GM-trained and supported service people.

Genuine GM parts have one of these marks:

***ACDelco.***

---

Genuine  | **Parts**

---

 | **Goodwrench.**

---

 | **Accessories**

### California Proposition 65 Warning

Most motor vehicles, including this one, contain and/or emit chemicals known to the State of California to cause cancer and birth defects or other reproductive harm. Engine exhaust, many parts and systems, many fluids, and some component wear by-products contain and/or emit these chemicals.

## California Perchlorate Materials Requirements

Certain types of automotive applications, such as airbag initiators, seat belt pretensioners, and lithium batteries contained in Remote Keyless Entry transmitters, may contain perchlorate materials. Special handling may be necessary. For additional information, see [www.dtsc.ca.gov/hazardouswaste/perchlorate](http://www.dtsc.ca.gov/hazardouswaste/perchlorate).

## Accessories and Modifications

Adding non-dealer accessories or making modifications to the vehicle can affect vehicle performance and safety, including such things as airbags, braking, stability, ride and handling, emissions systems, aerodynamics, durability, and electronic systems like antilock brakes, traction control, and stability control. These accessories or modifications could even cause malfunction or damage not covered by the vehicle warranty.

Damage to vehicle components resulting from modifications or the installation or use of non-GM certified parts, including control module or software modifications, is not covered under the terms of the vehicle warranty and may affect remaining warranty coverage for affected parts.

GM Accessories are designed to complement and function with other systems on the vehicle. Your GM dealer can accessorize the vehicle using genuine GM Accessories. When you go to your GM dealer and ask for GM Accessories, you will know that GM-trained and supported service technicians will perform the work using genuine GM Accessories.

Also, see *Adding Equipment to the Airbag-Equipped Vehicle* on page 3-38.

## Vehicle Checks

### Doing Your Own Service Work

 **WARNING**

You can be injured and the vehicle could be damaged if you try to do service work on a vehicle without knowing enough about it.

- Be sure you have sufficient knowledge, experience, the proper replacement parts, and tools before attempting any vehicle maintenance task.

(Continued)

**WARNING (Continued)**

- Be sure to use the proper nuts, bolts, and other fasteners. Metric and English fasteners can be easily confused. If the wrong fasteners are used, parts can later break or fall off. You could be hurt.

If doing some of your own service work, use the proper service manual. It tells you much more about how to service the vehicle than this manual can. To order the proper service manual, see *Service Publications Ordering Information on page 13-14*.

This vehicle has an airbag system. Before attempting to do your own service work, see *Servicing the Airbag-Equipped Vehicle on page 3-37*.

Keep a record with all parts receipts and list the mileage and the date of any service work performed. See *Maintenance Records on page 11-9*.

## Hood

To open the hood:

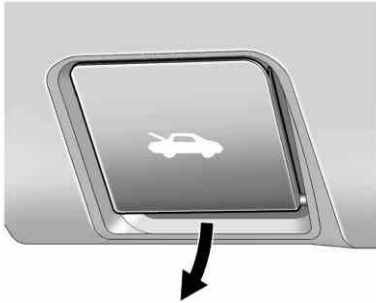

1. Pull the release handle located below the instrument panel to the left of the steering wheel.

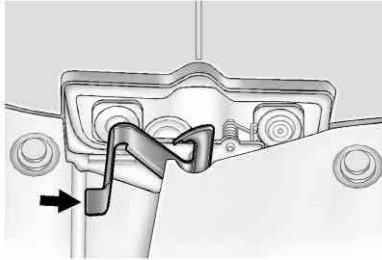

2. Move the secondary hood release lever to the right to release the striker. The lever is near the middle of the hood.
3. Lift the hood.

To close the hood:

1. Before closing the hood, be sure all the filler caps are on properly.
2. Lower the hood 30 cm (12 in) above the vehicle and release it so it fully latches. Check to make sure the hood is closed and repeat the process if necessary.

## Engine Compartment Overview

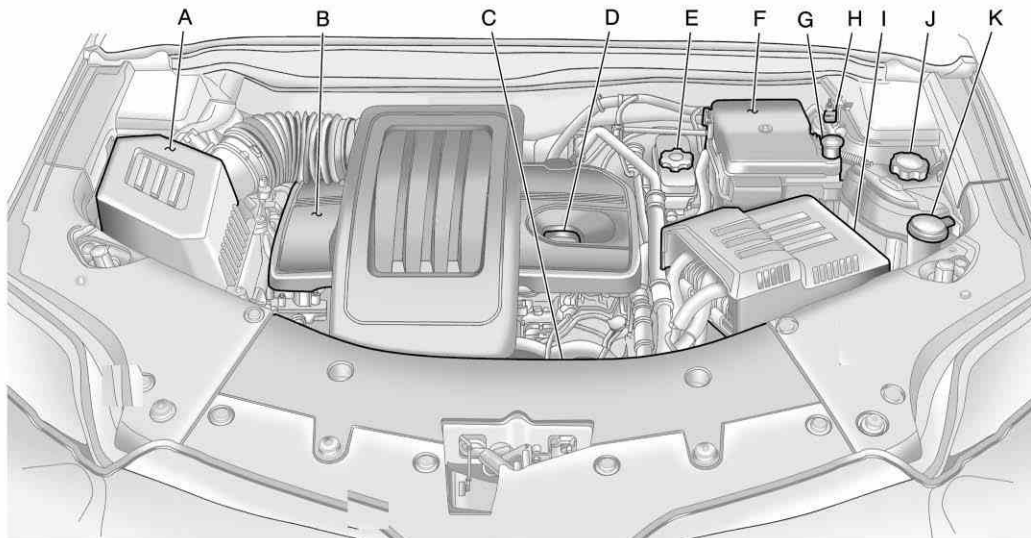

2.4 L L4 Engine



- A. *Engine Air Cleaner/Filter on page 10-15.*
- B. *Engine Cover on page 10-10.*
- C. *Engine Oil Dipstick (Out of View). See Engine Oil on page 10-10.*
- D. *Engine Oil Fill Cap. See Engine Oil on page 10-10.*
- E. *Brake Fluid Reservoir. See Brakes on page 10-24.*
- F. *Engine Compartment Fuse Block on page 10-40.*
- G. *Remote Positive (+) Terminal. See Jump Starting on page 10-75.*
- H. *Remote Negative (-) Terminal. See Jump Starting on page 10-75.*
- I. *Battery on page 10-27 (Out of View).*
- J. *Engine Coolant Surge Tank and Pressure Cap. See Engine Coolant on page 10-17.*
- K. *Windshield Washer Fluid Reservoir. See Washer Fluid on page 10-23.*

## 10-8 Vehicle Care

---

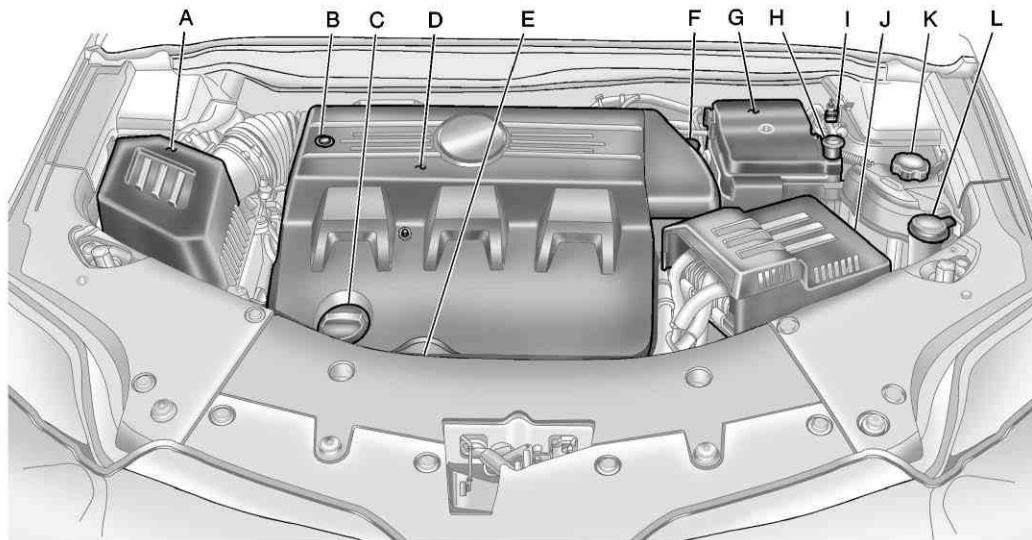

**3.0 L V6 Engine**

- A. *Engine Air Cleaner/Filter on page 10-15.*
- B. *Power Steering Fluid Reservoir (Under Engine Cover). See Power Steering Fluid (2.4L L4 Engine) on page 10-23 or Power Steering Fluid (3.0L V6 Engine) on page 10-23.*
- C. *Engine Oil Fill Cap. See Engine Oil on page 10-10.*
- D. *Engine Cover on page 10-10.*
- E. *Engine Oil Dipstick (Out of View). See Engine Oil on page 10-10.*
- F. *Brake Fluid Reservoir. See Brakes on page 10-24.*
- G. *Engine Compartment Fuse Block on page 10-40.*
- H. *Remote Positive (+) Terminal. See Jump Starting on page 10-75.*
- I. *Remote Negative (-) Terminal. See Jump Starting on page 10-75.*
- J. *Battery on page 10-27 (Out of View).*
- K. *Engine Coolant Surge Tank and Pressure Cap. See Engine Coolant on page 10-17.*
- L. *Windshield Washer Fluid Reservoir. See Washer Fluid on page 10-23.*

### Engine Cover

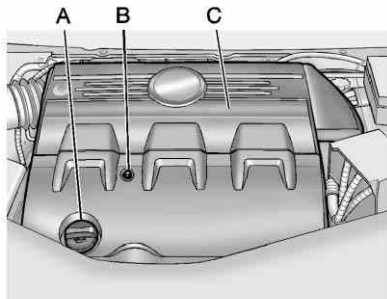

#### Engine Cover (3.0 L V6)

- A. Oil Fill Cap
- B. Engine Cover Bolt
- C. Engine Cover

To remove:

1. Remove the oil fill cap (A).
2. Remove the engine cover bolt (B).

3. Raise the engine cover (C) to release from the retainers.
4. Lift and remove the engine cover.
5. Reverse Steps 1 through 4 to reinstall engine cover.

### Engine Oil

To ensure proper engine performance and long life, careful attention must be paid to engine oil. Following these simple, but important steps will help protect your investment:

- Always use engine oil approved to the proper specification and of the proper viscosity grade. See “Selecting the Right Engine Oil” in this section.

- Check the engine oil level regularly and maintain the proper oil level. See “Checking Engine Oil” and “When to Add Engine Oil” in this section.
- Change the engine oil at the appropriate time. See *Engine Oil Life System on page 10-14*.
- Always dispose of engine oil properly. See “What to Do with Used Oil” in this section.

### Checking Engine Oil

It is a good idea to check the engine oil level at each fuel fill. In order to get an accurate reading, the vehicle must be on level ground. The engine oil dipstick handle is a yellow loop. See *Engine Compartment Overview on page 10-6* for the location of the engine oil dipstick.

Obtaining an accurate oil level reading is essential:

1. If the engine has been running recently, turn off the engine and allow several minutes for the oil to drain back into the oil pan. Checking the oil level too soon after engine shutoff will not provide an accurate oil level reading.
2. Pull out the dipstick and clean it with a paper towel or cloth, then push it back in all the way. Remove it again, keeping the tip down, and check the level.

### When to Add Engine Oil



L4 Engine



V6 Engine

If the oil is below the cross-hatched area at the tip of the dipstick, add 1 L (1 qt) of the recommended oil and then recheck the level. See “Selecting the Right Engine Oil” in this section for an explanation of what kind of oil to use. For engine oil crankcase capacity, see *Capacities and Specifications on page 12-2*.

**Notice:** Do not add too much oil. Oil levels above or below the acceptable operating range shown on the dipstick are harmful to the engine. If you find that you have an oil level above the operating range, i.e., the engine has so much oil that the oil level gets above the cross-hatched area that shows the proper operating range, the engine could be damaged. You should drain out the excess oil or limit driving of the vehicle and seek a service professional to remove the excess amount of oil.

See *Engine Compartment Overview on page 10-6* for the location of the engine oil fill cap.

Add enough oil to put the level somewhere in the proper operating range. Push the dipstick all the way back in when through.

### Selecting the Right Engine Oil

Selecting the right engine oil depends on both the proper oil specification and viscosity grade:

#### Specification

Use and ask for engine oils with the dexos™ certification mark. Oils meeting the requirements of the vehicle should have the dexos certification mark on the container. This certification mark indicates that the oil has been approved to the dexos specification.



This vehicle was filled at the factory with dexos-approved engine oil.

**Notice: Use only engine oil that is approved to the dexos specification or an equivalent engine oil of the appropriate viscosity grade. Engine oils approved to the dexos specification will show the dexos symbol on the container. Failure to use the recommended engine oil or equivalent can result in engine damage not covered by the vehicle warranty. If you are unsure whether the oil is approved to the dexos specification, ask your service provider.**

Use of Substitute Engine Oils if dexos is unavailable: In the event that dexos-approved engine oil is not available at an oil change or for maintaining proper oil level, you may use substitute engine oil displaying the API Starburst symbol and of SAE 5W-30 viscosity grade. Use of oils that do not meet the dexos specification, however, may result in reduced performance under certain circumstances.

#### Viscosity Grade

SAE 5W-30 is the best viscosity grade for the vehicle. Do not use other viscosity oils such as SAE 10W-30, 10W-40, or 20W-50.

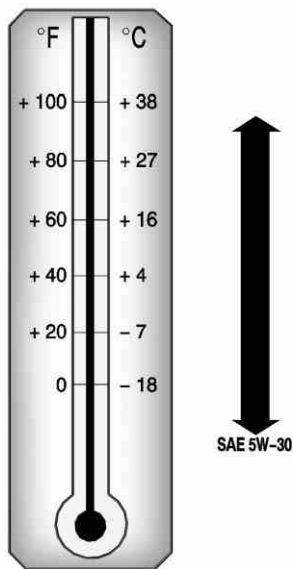

**Cold Temperature Operation:** In an area of extreme cold, where the temperature falls below  $-29^{\circ}\text{C}$  ( $-20^{\circ}\text{F}$ ), an SAE 0W-30 oil should

be used. An oil of this viscosity grade will provide easier cold starting for the engine at extremely low temperatures. When selecting an oil of the appropriate viscosity grade, be sure to always select an oil that meets the required specification, dexos. See “Specification” earlier in this section for more information.

### Engine Oil Additives/Engine Oil Flushes

Do not add anything to the oil. The recommended oils with the dexos specification and displaying the dexos certification mark are all that is needed for good performance and engine protection.

Engine oil system flushes are not recommended and could cause engine damage not covered by the vehicle warranty.

### What to Do with Used Oil

Used engine oil contains certain elements that can be unhealthy for your skin and could even cause cancer. Do not let used oil stay on your skin for very long. Clean your skin and nails with soap and water, or a good hand cleaner. Wash or properly dispose of clothing or rags containing used engine oil. See the manufacturer’s warnings about the use and disposal of oil products.

Used oil can be a threat to the environment. If you change your own oil, be sure to drain all the oil from the filter before disposal. Never dispose of oil by putting it in the trash or pouring it on the ground, into sewers, or into streams or bodies of water. Recycle it by taking it to a place that collects used oil.

### Engine Oil Life System

#### When to Change Engine Oil

This vehicle has a computer system that indicates when to change the engine oil and filter. This is based on engine revolutions and engine temperature, and not on mileage. Based on driving conditions, the mileage at which an oil change is indicated can vary considerably. For the oil life system to work properly, the system must be reset every time the oil is changed.

When the system has calculated that oil life has been diminished, it indicates that an oil change is necessary. A CHANGE ENGINE OIL SOON message comes on. See *Engine Oil Messages on page 5-26*. Change the oil as soon as possible within the next 1 000 km (600 mi). It is possible that, if driving under the best conditions, the oil life system might indicate that an oil change is not necessary for up to a year. The engine oil and filter must be changed at least once a year

and, at this time, the system must be reset. Your dealer has trained service people who will perform this work and reset the system. It is also important to check the oil regularly over the course of an oil drain interval and keep it at the proper level.

If the system is ever reset accidentally, the oil must be changed at 5 000 km (3,000 mi) since the last oil change. Remember to reset the oil life system whenever the oil is changed.

#### How to Reset the Engine Oil Life System

Reset the system whenever the engine oil is changed so that the system can calculate the next engine oil change. To reset the system:

1. Turn the ignition to ON/RUN, with the engine off.
2. Press the DIC MENU button to display the Vehicle Information menu.

3. Press either the up or down arrows to view REMAINING OIL LIFE.
4. Press the SET/CLR button until 100% is displayed.
5. Turn the key to LOCK/OFF.

Or:

1. Turn the ignition to ON/RUN with the engine off.
2. Fully press and release the accelerator pedal three times within five seconds.

The system is reset when the CHANGE ENGINE OIL SOON message goes off.

If the CHANGE ENGINE OIL SOON message comes back on when the vehicle is started, the engine oil life system has not been reset. Repeat the procedure.



## Automatic Transmission Fluid

### How to Check Automatic Transmission Fluid

It is not necessary to check the transmission fluid level. A transmission fluid leak is the only reason for fluid loss. If a leak occurs, take the vehicle to your dealer service department and have it repaired as soon as possible.

There is a special procedure for checking and changing the transmission fluid. Because this procedure is difficult, this should be done at your dealer service department. Contact your dealer for additional information or the procedure can be found in the service manual. To purchase a service manual, see *Service Publications Ordering Information* on page 13-14.

Change the fluid and filter at the intervals listed in *Scheduled Maintenance* on page 11-2, and be sure to use the fluid listed in *Recommended Fluids and Lubricants* on page 11-6.

### Engine Air Cleaner/Filter

See *Engine Compartment Overview* on page 10-6 for the location of the engine air cleaner/filter.

### When to Inspect the Engine Air Cleaner/Filter

Inspect or replace the air cleaner/filter at the scheduled maintenance intervals. See *Scheduled Maintenance* on page 11-2 for more information. If driving in dusty/dirty conditions, inspect the filter at each engine oil change.

### How to Inspect the Engine Air Cleaner/Filter

To inspect the air cleaner/filter, remove the filter from the vehicle and lightly shake the filter to release loose dust and dirt. If the filter remains covered with dirt, a new filter is required. Never use compressed air to clean the filter.

To inspect or replace the engine air cleaner/filter:

1. Open the hood. See *Hood* on page 10-5.
2. Locate the air filter housing on the passenger side of the engine compartment. See *Engine Compartment Overview* on page 10-6.

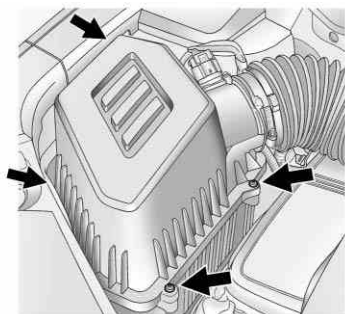

3. Remove the four air cleaner housing cover screws.
4. Pull straight up on the cover, and while holding the cover, remove the air cleaner filter.
5. Inspect or replace the air cleaner filter.

### How to Reinstall Engine Air Cleaner/Filter

1. Install the air cleaner filter into the air cleaner housing. The outer air cleaner filter seal must be fitted properly in the air cleaner housing.

2. Align the air cleaner housing cover tabs to the air cleaner housing.
3. Install the air cleaner housing cover using the four screws.

### WARNING

Operating the engine with the air cleaner/filter off can cause you or others to be burned. The air cleaner not only cleans the air; it helps to stop flames if the engine backfires. Use caution when working on the engine and do not drive with the air cleaner/filter off.

**Notice:** If the air cleaner/filter is off, dirt can easily get into the engine, which could damage it. Always have the air cleaner/filter in place when you are driving.

## Cooling System

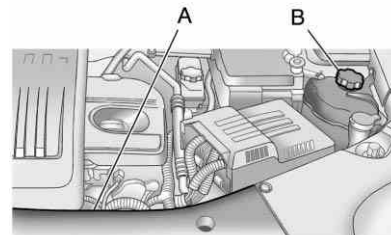

### 2.4 L L4 Engine

- A. Engine Cooling Fan (Out of View)
- B. Engine Coolant Surge Tank and Pressure Cap

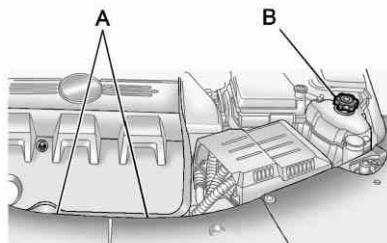

### 3.0 L V6 Engine

- A. Engine Cooling Fans (Out of View)
- B. Engine Coolant Surge Tank and Pressure Cap

#### **⚠ WARNING**

An electric engine cooling fan under the hood can start up even when the engine is not running and can cause injury. Keep hands, clothing, and tools away from any underhood electric fan.

If the coolant inside the coolant surge tank is boiling, do not do anything else until it cools down. The vehicle should be parked on a level surface.

The coolant level should be at the COLD FILL line. If it is not, the vehicle may have a leak at the radiator hoses, heater hoses, radiator, water pump, or somewhere else in the cooling system.

#### **⚠ WARNING**

Heater and radiator hoses, and other engine parts, can be very hot. Do not touch them. If you do, you can be burned.

Do not run the engine if there is a leak. If you run the engine, it could lose all coolant. That could cause an engine fire, and you could be burned. Get any leak fixed before you drive the vehicle.

If there seems to be no leak, with the engine on, check to see if the electric engine cooling fan is running. If the engine is overheating, the fan should be running. If it is not, the vehicle needs service. Turn off the engine.

**Notice:** Using coolant other than DEX-COOL<sup>®</sup> can cause premature engine, heater core, or radiator corrosion. In addition, the engine coolant could require changing sooner, at 50 000 km (30,000 mi) or 24 months, whichever occurs first. Any repairs would not be covered by the vehicle warranty. Always use DEX-COOL (silicate-free) coolant in the vehicle.

### Engine Coolant

The cooling system in the vehicle is filled with DEX-COOL<sup>®</sup> engine coolant. This coolant is designed to remain in the vehicle for 5 years or 240 000 km (150,000 mi), whichever occurs first.

The following explains the cooling system and how to check and add coolant when it is low. If there is a problem with engine overheating, see *Engine Overheating on page 10-21*.

### What to Use

#### **WARNING**

Adding only plain water or some other liquid to the cooling system can be dangerous. Plain water and other liquids, can boil before the proper coolant mixture will. The coolant warning system is set for the proper coolant mixture. With plain water or the wrong mixture, the engine could get too hot but you would not get the overheat warning. The engine could catch fire and you or others could be burned. Use a 50/50 mixture of clean, drinkable water and DEX-COOL coolant.

Use a 50/50 mixture of clean, drinkable water and DEX-COOL coolant. If using this mixture, nothing else needs to be added. This mixture:

- Gives freezing protection down to  $-37^{\circ}\text{C}$  ( $-34^{\circ}\text{F}$ ), outside temperature.
- Gives boiling protection up to  $129^{\circ}\text{C}$  ( $265^{\circ}\text{F}$ ), engine temperature.
- Protects against rust and corrosion.
- Will not damage aluminum parts.
- Helps keep the proper engine temperature.

**Notice:** If an improper coolant mixture is used, the engine could overheat and be badly damaged. The repair cost would not be covered by the vehicle warranty. Too much water in the mixture can freeze and crack the engine, radiator, heater core, and other parts.

Never dispose of engine coolant by putting it in the trash, pouring it on the ground, or into sewers, streams, or bodies of water.

Have the coolant changed by an authorized service center, familiar with legal requirements regarding used coolant disposal. This will help protect the environment and your health.

### Checking Coolant

The vehicle must be on a level surface when checking the coolant level.

Check to see if coolant is visible in the coolant surge tank. If the coolant inside the coolant surge tank is boiling, do not do anything else until it cools down. If coolant is visible but the coolant level is not at or above the COLD FILL line, add a 50/50 mixture of clean, drinkable water and DEX-COOL coolant at the coolant surge tank, but be sure the cooling system is cool before this is done. See *Cooling System on page 10-16* for more information.

The coolant surge tank is located in the engine compartment on the driver side of the vehicle. See *Engine Compartment Overview on page 10-6* for more information on location.

### How to Add Coolant to the Coolant Surge Tank

**Notice:** This vehicle has a specific coolant fill procedure. Failure to follow this procedure could cause the engine to overheat and be severely damaged.

If you have not found a problem yet, check to see if coolant is visible in the coolant surge tank. If coolant is visible but the coolant level is not at the COLD FILL line, add a 50/50 mixture of clean, drinkable water and DEX-COOL coolant at the coolant surge tank, but be sure

the cooling system, including the coolant surge tank pressure cap, is cool before you do it. See *Engine Overheating on page 10-21* for more information.

#### WARNING

Steam and scalding liquids from a hot cooling system can blow out and burn you badly. They are under pressure, and if you turn the coolant surge tank pressure cap — even a little — they can come out at high speed. Never turn the cap when the cooling system, including the coolant surge tank pressure cap, is hot. Wait for the cooling system and coolant surge tank pressure cap to cool if you ever have to turn the pressure cap.

#### WARNING

Adding only plain water or some other liquid to the cooling system can be dangerous. Plain water and other liquids, can boil before the proper coolant mixture will. The coolant warning system is set for the proper coolant mixture. With plain water or the wrong mixture, the engine could get too hot but you would not get the overheat warning. The engine could catch fire and you or others could be burned. Use a 50/50 mixture of clean, drinkable water and DEX-COOL coolant.

### WARNING

You can be burned if you spill coolant on hot engine parts. Coolant contains ethylene glycol and it will burn if the engine parts are hot enough. Do not spill coolant on a hot engine.

**Notice:** In cold weather, water can freeze and crack the engine, radiator, heater core and other parts. Use the recommended coolant and the proper coolant mixture.



1. Remove the coolant surge tank pressure cap when the cooling system, including the coolant surge tank pressure cap and upper radiator hose, is no longer hot.

Turn the pressure cap slowly counterclockwise about one-quarter of a turn. If you hear a hiss, wait for that to stop. This will allow any pressure still left to be vented out the discharge hose.

2. Keep turning the pressure cap slowly, and remove it.

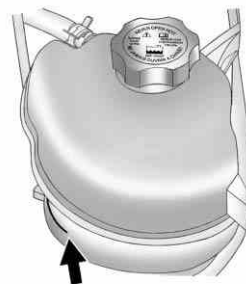

3. Fill the coolant surge tank with the proper DEX-COOL coolant mixture, to the COLD FILL line.
4. With the coolant surge tank pressure cap off, start the engine and let it run until the upper radiator hose can be felt getting hot. Watch out for the engine cooling fan.

By this time, the coolant level inside the coolant surge tank may be lower. If the level is lower, add more of the proper DEX-COOL coolant mixture to the coolant surge tank until the level reaches the COLD FILL line.

5. Replace the pressure cap. Be sure the pressure cap is hand-tight.

Check the level in the coolant surge tank when the cooling system has cooled down. If the coolant is not at the proper level, repeat Steps 1 through 3 and reinstall the pressure cap. If the coolant still is not at the proper level when the system cools down again, see your dealer.

## Engine Overheating

The vehicle has an indicator to warn of engine overheating. There is an engine coolant temperature warning light on the vehicle's instrument panel. See *Engine Coolant Temperature Gauge* on page 5-10.

The decision may be made not to lift the hood when this warning appears, but instead get service help right away. See *Roadside Assistance Program (U.S. and Canada)* on page 13-7 or *Roadside Assistance Program (Mexico)* on page 13-9.

If the decision to lift the hood is made, make sure the vehicle is parked on a level surface.

Then check to see if the engine cooling fan(s) are running. If the engine is overheating, the fan(s) should be running. If they are not, do not continue to run the engine and have the vehicle serviced.

**Notice: Engine damage from running the engine without coolant is not covered by the warranty.**

### If Steam is Coming from the Engine Compartment

 **WARNING**

Steam from an overheated engine can burn you badly, even if you just open the hood. Stay away from the engine if you see or hear steam coming from it. Just turn it off and get everyone away from the vehicle until it cools down. Wait until there is no sign of steam or coolant before you open the hood.

If you keep driving when the engine is overheated, the liquids in it can catch fire. You or others could be badly burned. Stop the engine if it overheats, and get out of the vehicle until the engine is cool.

### If No Steam is Coming from the Engine Compartment

If an engine overheat warning is displayed but no steam can be seen or heard, the problem may not be too serious. Sometimes the engine can get a little too hot when the vehicle:

- Climbs a long hill on a hot day.
- Stops after high-speed driving.
- Idles for long periods in traffic.
- Tows a trailer.

If the overheat warning is displayed with no sign of steam:

1. Turn the air conditioning off.
2. Turn the heater on to the highest temperature and to the highest fan speed. Open the windows as necessary.

3. In heavy traffic, let the engine idle in N (Neutral) while stopped. If it is safe to do so, pull off the road, shift to P (Park) or N (Neutral) and let the engine idle.

If the temperature overheat gauge is no longer in the overheat zone or an overheat warning no longer displays, the vehicle can be driven. Continue to drive the vehicle slowly for about 10 minutes. Keep a safe vehicle distance from the vehicle in front. If the warning does not come back on, continue to drive normally.

If the warning continues, pull over, stop, and park the vehicle right away.

If there is no sign of steam, idle the engine for three minutes while parked. If the warning is still displayed, turn off the engine until it cools down.



## Power Steering Fluid (2.4L L4 Engine)

The vehicle has electric power steering and does not use power steering fluid.

## Power Steering Fluid (3.0L V6 Engine)



The power steering fluid reservoir is located toward the rear of the engine compartment on the passenger side of the vehicle. See *Engine Compartment Overview on page 10-6* for reservoir location.

### When to Check Power Steering Fluid

The power steering fluid does not need to be checked unless there is a leak in the system or you hear an unusual noise. Have the system inspected and repaired if there is a fluid loss.

### How to Check Power Steering Fluid

To check the power steering fluid:

1. Turn the engine off and let it cool down.
2. Remove the engine cover. Refer to *Engine Cover on page 10-10*.
3. Wipe the cap and the top of the reservoir clean.
4. Unscrew the cap and wipe the dipstick with a clean rag.
5. Replace the cap and completely tighten it.
6. Remove the cap again and look at the fluid level on the dipstick.

The fluid level should be between MAX and MIN line at room temperature. If the fluid is on or below MIN line, add fluid.

### What to Use

To determine what kind of fluid to use, refer to *Recommended Fluids and Lubricants on page 11-6*. Always use the proper fluid.

**Notice:** Use of the incorrect fluid may damage the vehicle and the damages may not be covered by the vehicle's warranty. Always use the correct fluid listed in *Recommended Fluids and Lubricants on page 11-6*.

### Washer Fluid

#### What to Use

Read the manufacturer's instructions before refilling the windshield washer fluid. If operating the vehicle in an area where the temperature may fall below freezing, use a fluid that has sufficient protection against freezing.

### Adding Washer Fluid

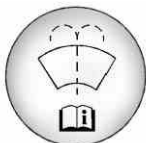

Open the cap with the washer symbol on it and add washer fluid until full. See *Engine Compartment Overview on page 10-6* for reservoir location.

#### Notice

- **When using concentrated washer fluid, follow the manufacturer's instructions for adding water.**
- **Do not mix water with ready-to-use washer fluid. Water can cause the solution to freeze and damage the washer fluid tank and other parts of the washer system. Also, water does not clean as well as washer fluid.**

- **Fill the washer fluid tank only three-quarters full when it is very cold. This allows for fluid expansion if freezing occurs, which could damage the tank if it is completely full.**
- **Do not use engine coolant (antifreeze) in the windshield washer. It can damage the windshield washer system and paint.**

### Brakes

This vehicle has disc brakes. Disc brake pads have built-in wear indicators that make a high-pitched warning sound when the brake pads are worn and new pads are needed. The sound can come and go or be heard all the time the vehicle is moving, except when applying the brake pedal firmly.

#### WARNING

The brake wear warning sound means that soon the brakes will not work well. That could lead to a crash. When the brake wear warning sound is heard, have the vehicle serviced.

**Notice: Continuing to drive with worn-out brake pads could result in costly brake repair.**

Some driving conditions or climates can cause a brake squeal when the brakes are first applied or lightly applied. This does not mean something is wrong with the brakes.

Properly torqued wheel nuts are necessary to help prevent brake pulsation. When tires are rotated, inspect brake pads for wear and evenly tighten wheel nuts in the proper sequence to torque specifications in *Capacities and Specifications on page 12-2*.

Brake linings should always be replaced as complete axle sets.

### **Brake Pedal Travel**

See your dealer if the brake pedal does not return to normal height, or if there is a rapid increase in pedal travel. This could be a sign that brake service might be required.

### **Brake Adjustment**

Every time the brakes are applied, with or without the vehicle moving, the brakes adjust for wear.

## **Replacing Brake System Parts**

The braking system on a vehicle is complex. Its many parts have to be of top quality and work well together if the vehicle is to have really good braking. The vehicle was designed and tested with top-quality brake parts. When parts of the braking system are replaced, be sure to get new, approved replacement parts. If this is not done, the brakes might not work properly. For example, installing disc brake pads that are wrong for the vehicle, can change the balance between the front and rear brakes — for the worse. The braking performance expected can change in many other ways if the wrong replacement brake parts are installed.

## **Brake Fluid**



The brake master cylinder reservoir is filled with DOT 3 brake fluid as indicated on the reservoir cap. See *Engine Compartment Overview on page 10-6* for the location of the reservoir.

There are only two reasons why the brake fluid level in the reservoir might go down:

- The brake fluid level goes down because of normal brake lining wear. When new linings are installed, the fluid level goes back up.

- A fluid leak in the brake hydraulic system can also cause a low fluid level. Have the brake hydraulic system fixed, since a leak means that sooner or later the brakes will not work well.

Do not top off the brake fluid. Adding fluid does not correct a leak. If fluid is added when the linings are worn, there will be too much fluid when new brake linings are installed. Add or remove brake fluid, as necessary, only when work is done on the brake hydraulic system.

### WARNING

If too much brake fluid is added, it can spill on the engine and burn, if the engine is hot enough. You or others could be burned, and the vehicle could be damaged. Add brake fluid only when work is done on the brake hydraulic system.

When the brake fluid falls to a low level, the brake warning light comes on. See *Brake System Warning Light* on page 5-15.

### What to Add

Use only new DOT 3 brake fluid from a sealed container. See *Recommended Fluids and Lubricants* on page 11-6.

Always clean the brake fluid reservoir cap and the area around the cap before removing it. This helps keep dirt from entering the reservoir.

### WARNING

With the wrong kind of fluid in the brake hydraulic system, the brakes might not work well. This could cause a crash. Always use the proper brake fluid.

### Notice

- Using the wrong fluid can badly damage brake hydraulic system parts. For example, just a few drops of mineral-based oil, such as engine oil, in the brake hydraulic system can damage brake hydraulic system parts so badly that they will have to be replaced. Do not let someone put in the wrong kind of fluid.
- If brake fluid is spilled on the vehicle's painted surfaces, the paint finish can be damaged. Be careful not to spill brake fluid on the vehicle. If you do, wash it off immediately.

## Battery

Refer to the replacement number on the original battery label when a new battery is needed.

**⚠ DANGER**

Battery posts, terminals, and related accessories contain lead and lead compounds, chemicals known to the State of California to cause cancer and reproductive harm. Wash hands after handling.

## Vehicle Storage

**⚠ WARNING**

Batteries have acid that can burn you and gas that can explode. You can be badly hurt if you are not careful. See *Jump Starting on page 10-75* for tips on working around a battery without getting hurt.

**Infrequent Usage:** Remove the black, negative (-) cable from the battery to keep the battery from running down.

**Extended Storage:** Remove the black, negative (-) cable from the battery or use a battery trickle charger.

## All-Wheel Drive

### Transfer Case

#### When to Check and Change Lubricant

Refer to the Maintenance Schedule to determine how often to check the lubricant and when to change it. See *Scheduled Maintenance on page 11-2*.

## How to Check Lubricant

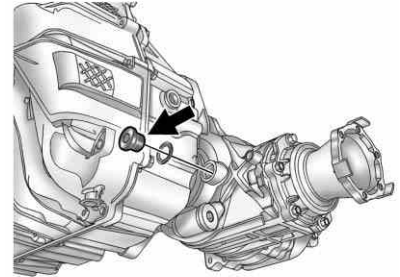

To get an accurate reading, the vehicle should be on a level surface.

If the level is below the bottom of the fill plug hole, the vehicle will need some lubricant added. Add enough lubricant to raise the level to the bottom of the fill plug hole. A fluid loss could indicate a problem; check and have it repaired, if needed.

### What to Use

Refer to *Recommended Fluids and Lubricants on page 11-6* to determine what kind of lubricant to use.

### Starter Switch Check

 **WARNING**

When you are doing this inspection, the vehicle could move suddenly. If the vehicle moves, you or others could be injured.

1. Before starting this check, be sure there is enough room around the vehicle.

2. Firmly apply both the parking brake and the regular brake. See *Parking Brake on page 9-38*.

Do not use the accelerator pedal, and be ready to turn off the engine immediately if it starts.

3. Try to start the engine in each gear. The vehicle should start only in P (Park) or N (Neutral). If the vehicle starts in any other position, contact your dealer for service.

### Automatic Transmission Shift Lock Control Function Check

 **WARNING**

When you are doing this inspection, the vehicle could move suddenly. If the vehicle moves, you or others could be injured.

1. Before starting this check, be sure there is enough room around the vehicle. It should be parked on a level surface.
2. Firmly apply the parking brake. See *Parking Brake on page 9-38*.

Be ready to apply the regular brake immediately if the vehicle begins to move.

3. With the engine off, turn the ignition on, but do not start the engine. Without applying the regular brake, try to move the shift lever out of P (Park) with normal effort. If the shift lever moves out of P (Park), contact your dealer for service.

### Ignition Transmission Lock Check

While parked, and with the parking brake set, try to turn the ignition to LOCK/OFF in each shift lever position.

- The ignition should turn to LOCK/OFF only when the shift lever is in P (Park).
- The ignition key should come out only in LOCK/OFF.

Contact your dealer if service is required.

### Park Brake and P (Park) Mechanism Check

 **WARNING**

When you are doing this check, the vehicle could begin to move. You or others could be injured and property could be damaged. Make sure there is room in front of the vehicle in case it begins to roll. Be ready to apply the regular brake at once should the vehicle begin to move.

Park on a fairly steep hill, with the vehicle facing downhill. Keeping your foot on the regular brake, set the parking brake.

- To check the parking brake's holding ability: With the engine running and the transmission in N (Neutral), slowly remove foot pressure from the regular brake pedal. Do this until the vehicle is held by the parking brake only.
- To check the P (Park) mechanism's holding ability: With the engine running, shift to P (Park). Then release the parking brake followed by the regular brake.

Contact your dealer if service is required.

### Wiper Blade Replacement

Windshield wiper blades should be inspected for wear and cracking. See *Scheduled Maintenance on page 11-2* for more information.

Replacement blades come in different types and are removed in different ways. For proper type and length, see *Maintenance Replacement Parts on page 11-8*.

**Notice:** Allowing the wiper blade arm to touch the windshield when no wiper blade is installed could damage the windshield. Any damage that occurs would not be covered by your warranty. Do not allow the wiper blade arm to touch the windshield.

#### Front Wiper Blade Replacement

To replace the front wiper blades:

1. Lift the wiper arm from the windshield until no further movement is possible.

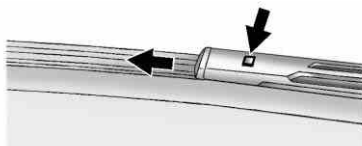

2. Press the square button on the top side, at the end of the wiper arm, and pull the wiper blade out of the end of the wiper arm.
3. Install the wiper blade connector by sliding into the end of the wiper arm until the square button on the wiper blade clicks into place with the wiper arm.
4. Place the wiper arm with the wiper blade in place back on the windshield.

#### Rear Wiper Blade Replacement

To replace the rear wiper blade:

1. Lift the wiper arm from the liftgate glass until no further movement is possible.

2. Hold the wiper arm at the tip with one hand and hold the wiper blade at the tip with the other hand.
3. Pull down on the wiper blade. The blade will pull away from the arm.

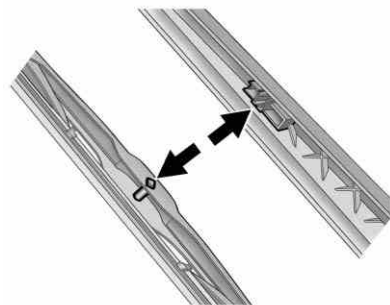

4. Place the wiper blade into the wiper arm aligning the blade attachment rivet with the arm attachment.



5. Align the wiper blade with the arm and hold both ends of the arm while gently squeezing until the blade snaps into place.

Do not apply excessive force during this operation.

Reposition the blade in the arm and repeat, if blade is not correctly positioned.

6. Place the wiper arm with the wiper blade attached back on the liftgate glass.

## Headlamp Aiming

The headlamp aiming system has been preset at the factory.

If the vehicle is damaged in an accident, the aim of the headlamps may be affected and adjustment may be necessary.

It is recommended that a dealer adjust the headlamps. To re-aim the headlamps yourself, use the following procedure.

The vehicle should be properly prepared as follows. The vehicle:

- Should be placed so the headlamps are 7.6 m (25 ft) from a light colored wall.
- Must have all four tires on a level surface which is level all the way to the wall.

- Should be placed so it is perpendicular to the wall or other flat surface.
- Should not have any snow, ice, or mud on it.
- Should be fully assembled and all other work stopped while headlamp aiming is being performed.
- Should be normally loaded with a full tank of fuel and one person or 75 kg (160 lbs) sitting in the driver's seat.
- Tires should be properly inflated.

Headlamp aiming is done with the vehicle's low-beam headlamps. The high-beam headlamps will be correctly aimed if the low-beam headlamps are aimed properly.

## 10-32 Vehicle Care

To adjust the vertical aim, do the following:

1. Open the hood. See *Hood* on page 10-5 for more information.

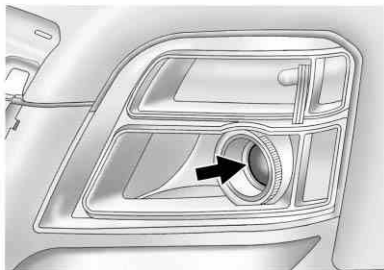

2. Locate the aim dot on the lens of the low-beam headlamp.
3. Measure the distance from the ground to the aim dot on the low-beam headlamp. Record the distance.

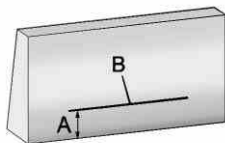

4. At the wall, measure from the ground upward (A) to the recorded distance from Step 3 and mark it.
5. Draw or tape a horizontal line (B) on the wall the width of the vehicle at the height of the mark in Step 4.

**Notice:** Do not cover a headlamp to improve beam cut-off when aiming. Covering a headlamp may cause excessive heat build-up which may cause damage to the headlamp.

6. Turn on the low-beam headlamps and place a piece of cardboard or equivalent in front of the headlamp not being adjusted. This allows only the beam of light from the headlamp being adjusted to be seen on the flat surface.

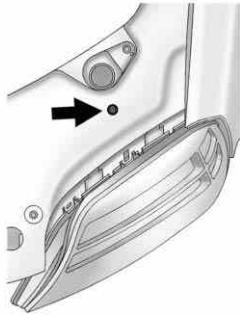

7. Locate the vertical headlamp aiming screws, which are under the hood near each headlamp assembly.
8. Turn the vertical aiming screw until the headlamp beam is aimed to the horizontal tape line. Turn it clockwise or counterclockwise to raise or lower the angle of the beam.

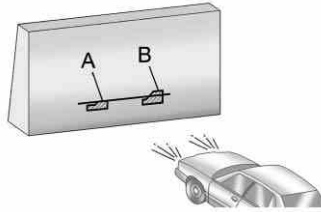

9. Make sure that the light from the headlamp is positioned at the bottom edge of the horizontal tape line. The lamp on the left (A) shows the correct headlamp aim. The lamp on the right (B) shows the incorrect headlamp aim.
10. Repeat Steps 7 through 9 for the opposite headlamp.

## Bulb Replacement

For the proper type of replacement bulbs, see *Replacement Bulbs on page 10-38*.

For any bulb changing procedure not listed in this section, contact your dealer.

## Headlamps, Front Turn Signal, Sidemarker, and Parking Lamps

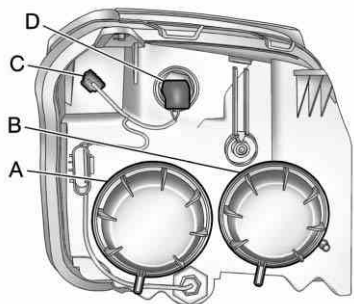

- A. Low-Beam Headlamp
- B. High-Beam headlamp
- C. Side Marker Lamp
- D. Park/Turn Signal Lamp

To replace one of these bulbs:

1. Turn the tire to reach the access port cap located in the front of wheel well cover.

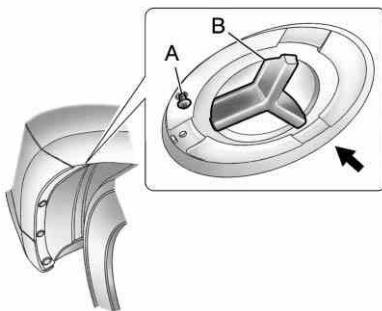

- A. Screw
- B. Access Port Cap

2. Remove the screw (A) and turn the access port cap (B) counterclockwise to remove.
3. If replacing a headlamp bulb, remove the dust cover cap from the back of the headlamp housing by turning the cap counterclockwise.
4. Turn the bulb socket counterclockwise to remove it from the lamp assembly.
5. Remove the bulb from the socket or disconnect the bulb assembly from the harness connector.
6. Install the new bulb.
7. Reinstall the bulb socket to the lamp assembly, turning clockwise.
8. Replace the dust cover cap on headlamps.
9. Reinstall the wheel well cover access port cap and secure by installing the screw.

## Fog Lamps

To replace one of these bulbs:

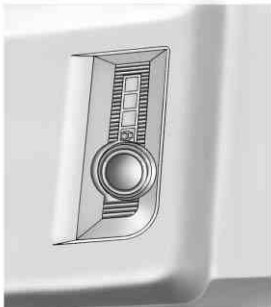

1. Locate the fog lamp assembly under the front facia.
2. Disconnect the bulb socket from the electrical connector, turn, and pull out the bulb assembly.
3. Remove the old bulb from the bulb socket and push the new bulb straight into the bulb socket until it connects.

4. Push the bulb socket into the fog lamp assembly and turn clockwise to lock it into place.
5. Reconnect the bulb socket to the electrical connector.

## Taillamps, Turn Signal, Sidemarker, Stoplamps, and Back-Up Lamps

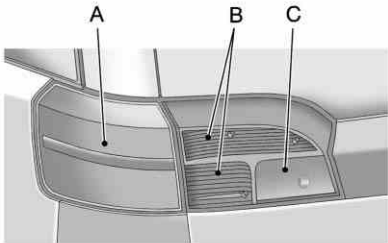

- A. Stop/Tail/Turn Signal/Sidemarker Lamp
- B. Auxiliary Taillamp
- C. Back-up Lamp

## Stop/Tail/Turn Signal/Sidemarker Lamp

To replace one of these lamps:

1. Open the liftgate. See *Liftgate (Manual)* on page 2-8 or *Liftgate (Power)* on page 2-9.

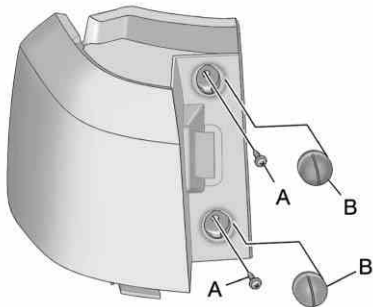

- A. Screw
  - B. Screw Cover
2. Remove the two screw covers (B) from the taillamp assembly.
  3. Remove the two screws (A) securing the taillamp assembly.

## 10-36 Vehicle Care

4. Pull the taillamp assembly out of the vehicle body.
5. Disconnect the lamp wiring harness.

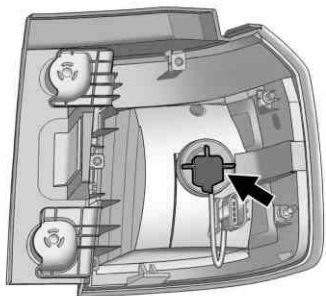

6. Turn the bulb socket counterclockwise and pull it out.
7. Pull the bulb straight out of the socket.
8. Install the new bulb.
9. Push the bulb socket in and turn it clockwise.
10. Reverse Steps 2 through 5 to reinstall the lamp assembly.

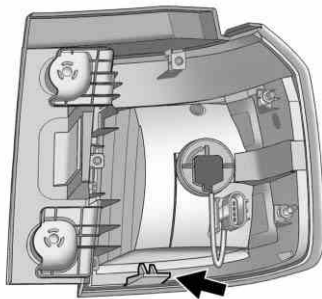

11. Verify that the taillamp assembly tab, located at the bottom of the taillamp assembly, is aligned to the fascia bracket before securing with screws.

### Auxiliary Taillamp

To replace one of these lamps:

1. Open the liftgate. See *Liftgate (Manual)* on page 2-8 or *Liftgate (Power)* on page 2-9.
2. Remove the interior trim access panel.

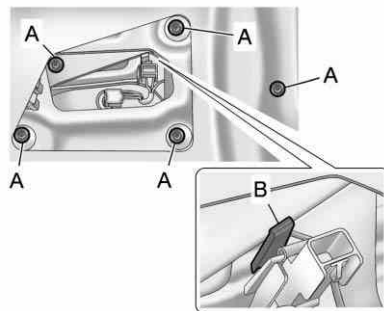

3. Remove the five attachment nuts (A) securing the taillamp assembly to the liftgate.
4. Disengage the retaining hook (B) and pull the taillamp assembly out of the vehicle liftgate.
5. Disconnect the lamp wiring harness.

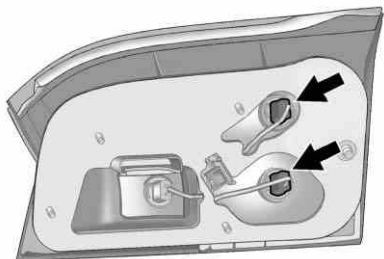

6. Turn the bulb socket counterclockwise and pull it out.
7. Pull the bulb straight out of the socket.
8. Install the new bulb.

9. Push the bulb socket in and turn it clockwise.
10. Reverse Steps 2 through 5 to reinstall lamp assembly.

### Back-Up Lamp

Removal of the lamp assembly is not required to replace the back-up lamp bulb.

To replace one of these lamps:

1. Open the liftgate. See *Liftgate (Manual)* on page 2-8 or *Liftgate (Power)* on page 2-9.
2. Remove the interior trim access panel.

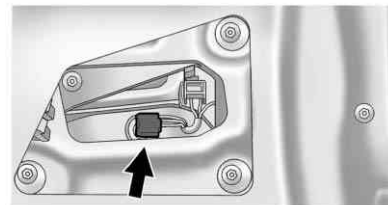

3. Turn the bulb socket counterclockwise and pull it out.
4. Pull the bulb straight out of the socket.
5. Install the new bulb.
6. Push the bulb socket in and turn it clockwise.
7. Reinstall the interior trim access panel.

## License Plate Lamp

To replace one of these bulbs:

1. Open the liftgate partway. See *Liftgate (Manual)* on page 2-8 or *Liftgate (Power)* on page 2-9.

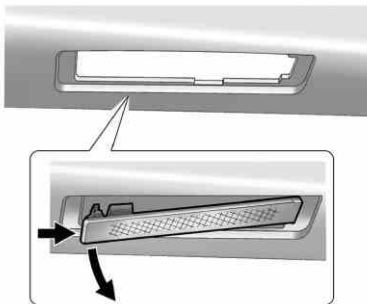

Passenger Side Shown, Driver Side Similar

2. Push the left end of the lamp assembly toward the right.
3. Pull the lamp assembly down to remove it from the liftgate.

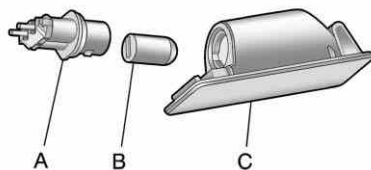

A. Bulb Socket

B. Bulb

C. Lamp Assembly

4. Turn the bulb socket (A) counterclockwise to remove it from the lamp assembly (C).
5. Pull the bulb (B) straight out of the bulb socket.

6. Push the replacement bulb straight into the bulb socket and turn the bulb socket clockwise to install into lamp assembly.
7. Turn the lamp assembly into the liftgate engaging the clip side first.
8. Push on the lamp side opposite the clip until the lamp assembly snaps into place.

## Replacement Bulbs

| Exterior Lamp      | Bulb Number |
|--------------------|-------------|
| Auxiliary Taillamp | 161LL       |
| Back-Up Lamp       | 921LL       |
| Fog Lamp           | H11         |
| Headlamp High Beam | HB3         |
| Headlamp Low Beam  | H11         |



| Exterior Lamp                                   | Bulb Number      |
|---|------------------|
| License Plate Lamp                              | 168LL<br>(W5WLL) |
| Parking Lamp/Turn Signal Front                  | 7444NA           |
| Sidemarkers Front                               | 194LL            |
| Taillamp/Turn Signal Lamp/Stop Lamp/Sidemarkers | 3057K            |

For replacement bulbs not listed here, contact your dealer.

## Electrical System

### Fuses

The wiring circuits in the vehicle are protected from short circuits by fuses. This greatly reduces the chance of damage caused by electrical problems.

Look at the silver-colored band inside the fuse. If the band is broken or melted, replace the fuse. Be sure to replace a bad fuse with a new one of the identical size and rating.

Replace a bad fuse with a new one of the identical size and rating.

If there is a problem on the road and a fuse needs to be replaced, the same amperage fuse can be borrowed. Choose some feature of the vehicle that is not needed to use and replace it as soon as possible.

There are two fuse blocks in the vehicle: one in the engine compartment and one in the instrument panel.

There is a fuse puller located in the engine compartment fuse block. See *Engine Compartment Fuse Block on page 10-40*. It can be used to easily remove fuses from the fuse block.

## Engine Compartment Fuse Block

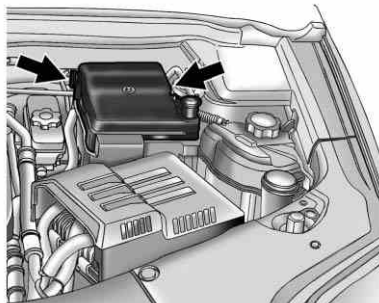

To remove the fuse block cover, squeeze the clips on the cover and lift it straight up. See *Engine Compartment Overview on page 10-6*.

**Notice:** Spilling liquid on any electrical component on the vehicle may damage it. Always keep the covers on any electrical component.

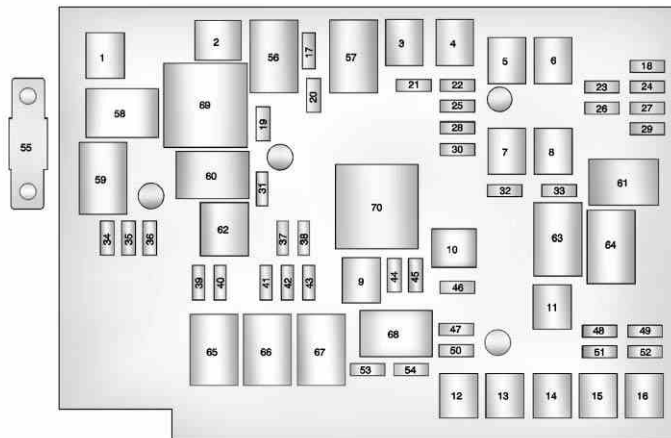

**Engine Compartment Fuse Block**

The vehicle may not be equipped with all of the fuses, relays, and features shown.

| J-Case Fuses | Usage      |
|--------------|------------|
| 1            | Cool Fan 1 |
| 2            | Cool Fan 2 |

| J-Case Fuses | Usage                 |
|--------------|-----------------------|
| 3            | Brake Booster         |
| 4            | Power Windows – Right |
| 5            | Memory Seat Module    |

| J-Case Fuses | Usage                         |
|--------------|-------------------------------|
| 6            | Power Seat – Left             |
| 7            | Instrument Panel Fuse Block 1 |
| 8            | Rear Defogger                 |
| 9            | Starter                       |
| 10           | AIR Pump Motor                |
| 11           | Instrument Panel Fuse Block 2 |
| 12           | Sunroof                       |
| 13           | Antilock Brake System Pump    |
| 14           | Instrument Panel Fuse Block 3 |
| 15           | Power Windows – Left          |
| 16           | Antilock Brake System Module  |

| Mini Fuses | Usage                                    |
|------------|--|
| 17         | Transmission Control Module Battery      |
| 18         | Trailer Parking Light                    |
| 19         | AIR Pump Solenoid                        |
| 20         | Engine Control Module Battery            |
| 21         | Canister Vent                            |
| 22         | Trailer Left Side (If Equipped)          |
| 23         | Lift Gate Module                         |
| 24         | Power Lumbar                             |
| 25         | Trailer Right Side (If Equipped)         |
| 26         | Rear Accessory Power Outlet              |
| 27         | Memory Mirror Module                     |
| 28         | Regulated Voltage Control Battery Sensor |

| Mini Fuses | Usage                                  |
|------------|--|
| 29         | Front Wiper                            |
| 30         | Rear Wiper                             |
| 31         | Air Conditioning Compressor            |
| 32         | Rear Latch                             |
| 33         | Heated Mirrors                         |
| 34         | Horn                                   |
| 35         | Right High-Beam Headlamp               |
| 36         | Left High-Beam Headlamp                |
| 37         | Ignition Even Coil                     |
| 38         | Ignition Odd Coil                      |
| 39         | Windshield Washer                      |
| 40         | Front Fog Lamps                        |
| 41         | Post Catalytic Converter Oxygen Sensor |
| 42         | Engine Control Module                  |

## 10-42 Vehicle Care

| Mini Fuses | Usage                                 |
|------------|---------------------------------------|
| 43         | Pre-Catalytic Converter Oxygen Sensor |
| 44         | Transmission Control Module           |
| 45         | Mirror                                |
| 46         | Chassis Control Module Ignition       |
| 47         | Spare                                 |
| 48         | Rear Drive Module                     |
| 49         | Lift Gate Module Logic                |
| 50         | Instrument Panel Fuse Block Ignition  |
| 51         | Heated Seat – Front                   |
| 52         | Chassis Control Module                |
| 53         | Engine Control Module                 |
| 54         | Rear Vision Camera                    |

| Midi Fuse | Usage                   |
|-----------|-------------------------|
| 55        | Electric Power Steering |

| Micro Relays | Usage                       |
|--------------|-----------------------------|
| 56           | AIR Pump Solenoid           |
| 57           | Brake Booster               |
| 58           | Cooling Fan Low             |
| 59           | Headlamp High Beam          |
| 60           | Cooling Fan Control         |
| 61           | Wiper On/Off Control        |
| 62           | Air Conditioning Compressor |
| 63           | Rear Defogger               |
| 64           | Wiper Speed                 |
| 65           | Fog Lamp                    |
| 66           | Engine Control              |
| 67           | Starter                     |
| 68           | Run/Crank                   |

| Mini Relays | Usage            |
|-------------|------------------|
| 69          | Cooling Fan High |
| 70          | AIR Pump Motor   |

### Instrument Panel Fuse Block

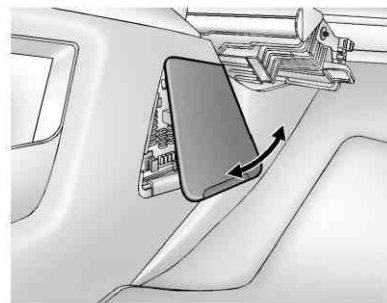

The instrument panel fuse block is located on the passenger side panel of the center console.

To access the fuses, open the fuse panel door from the passenger side by pulling it out.

To reinstall the door, insert the tabs on the top of the door into the console first, then push the door back into its original location.

The vehicle may not be equipped with all of the fuses, relays, and features shown.

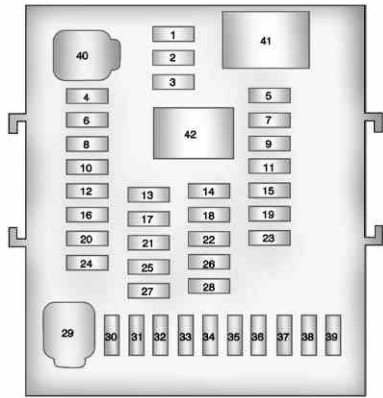

**Instrument Panel Fuse Block**

| Mini Fuses | Usage                                 |
|------------|---------------------------------------|
| 1          | Steering Wheel Dimming                |
| 2          | Spare                                 |
| 3          | Spare                                 |
| 4          | Body Control Module 1                 |
| 5          | Infotainment                          |
| 6          | Body Control Module 7                 |
| 7          | Noise Control Module                  |
| 8          | Body Control Module 4                 |
| 9          | Radio                                 |
| 10         | Special Equipment Order Battery       |
| 11         | Ultrasonic Rear Parking Assist Module |

## 10-44 Vehicle Care

| Mini Fuses | Usage   |
|------------|---|
| 12         | Heater, Ventilation and Air Conditioning Battery  |
| 13         | Auxiliary Power Front                             |
| 14         | Heater, Ventilation and Air Conditioning Ignition |
| 15         | Display   |
| 16         | Body Control Module 5                             |
| 17         | Auxiliary Power Rear                              |
| 18         | Instrument Panel Cluster Ignition                 |
| 19         | Personal Device Interface Module                  |
| 20         | Body Control Module 6                             |
| 21         | Special Equipment Order Retained Accessory Power  |

| Mini Fuses | Usage                                      |
|------------|--|
| 22         | Sensing and Diagnostic Module Ignition     |
| 23         | Spare                                      |
| 24         | Spare                                      |
| 25         | Transmission Gear Shift Position Indicator |
| 26         | Spare                                      |
| 27         | Spare                                      |
| 28         | Spare                                      |
| 30         | Body Control Module 3                      |
| 31         | Amplifier                                  |
| 32         | Discrete Logic Ignition Switch             |
| 33         | Communications Integration Module          |
| 34         | Body Control Module 2                      |

| Mini Fuses | Usage                                 |
|------------|---------------------------------------|
| 35         | Sensing and Diagnostic Module Battery |
| 36         | Data Link Connection                  |
| 37         | Instrument Panel Cluster Battery      |
| 38         | Passenger Sensing System Module       |
| 39         | Spare                                 |

| J-Case Fuses | Usage                 |
|--------------|-----------------------|
| 29           | Front Blower Motor    |
| 40           | Body Control Module 8 |

| Relays | Usage                          |
|--------|--------------------------------|
| 41     | Logistic Relay (If Equipped)   |
| 42     | Retained Accessory Power Relay |

## Wheels and Tires

### Tires

Every new GM vehicle has high-quality tires made by a leading tire manufacturer. See the warranty manual for information regarding the tire warranty and where to get service. For additional information refer to the tire manufacturer.



#### WARNING

- Poorly maintained and improperly used tires are dangerous.
- Overloading the tires can cause overheating as a result of too much flexing. There could be a blowout and a serious crash. See *Vehicle Load Limits on page 9-21*.

(Continued)

#### WARNING (Continued)

- Underinflated tires pose the same danger as overloaded tires. The resulting crash could cause serious injury. Check all tires frequently to maintain the recommended pressure. Tire pressure should be checked when the tires are cold.
- Overinflated tires are more likely to be cut, punctured, or broken by a sudden impact — such as when hitting a pothole. Keep tires at the recommended pressure.
- Worn or old tires can cause a crash. If the tread is badly worn, replace them.

(Continued)

#### WARNING (Continued)

- Replace any tires that have been damaged by impacts with potholes, curbs, etc.
- Improperly repaired tires can cause a crash. Only the dealer or an authorized tire service center should repair, replace, dismount, and mount the tires.
- Do not spin the tires in excess of 55 km/h (35 mph) on slippery surfaces such as snow, mud, ice, etc. Excessive spinning may cause the tires to explode.

### Tire Sidewall Labeling

Useful information about a tire is molded into its sidewall. The examples show a typical passenger vehicle tire and a compact spare tire sidewall.

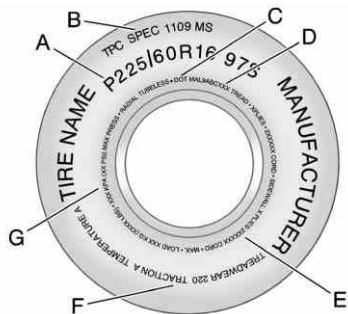

**Passenger (P-Metric) Tire Example**

**(A) Tire Size:** The tire size is a combination of letters and numbers used to define a particular tire's width, height, aspect ratio, construction type, and service description. See the "Tire Size" illustration later in this section for more detail.

**(B) TPC Spec (Tire Performance Criteria Specification):** Original equipment tires designed to GM's specific tire performance criteria have a TPC specification code molded onto the sidewall. GM's TPC specifications meet or exceed all federal safety guidelines.

**(C) DOT (Department of Transportation):** The Department of Transportation (DOT) code indicates that the tire is in compliance with the U.S. Department of Transportation Motor Vehicle Safety Standards.

**(D) Tire Identification Number (TIN):** The letters and numbers following the DOT (Department of Transportation) code are the Tire Identification Number (TIN). The TIN shows the manufacturer and plant code,

tire size, and date the tire was manufactured. The TIN is molded onto both sides of the tire, although only one side may have the date of manufacture.

**(E) Tire Ply Material:** The type of cord and number of plies in the sidewall and under the tread.

**(F) Uniform Tire Quality Grading (UTQG):** Tire manufacturers are required to grade tires based on three performance factors: treadwear, traction, and temperature resistance. For more information see *Uniform Tire Quality Grading on page 10-61*.

**(G) Maximum Cold Inflation Load Limit:** Maximum load that can be carried and the maximum pressure needed to support that load.



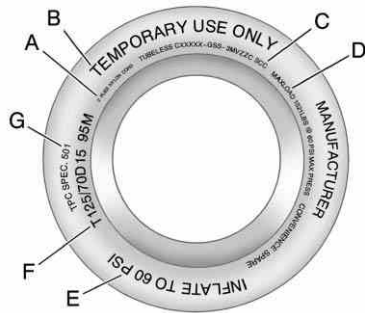

### Compact Spare Tire Example

**(A) Tire Ply Material:** The type of cord and number of plies in the sidewall and under the tread.

**(B) Temporary Use Only:** The compact spare tire or temporary use tire has a tread life of approximately 5 000 km (3,000 mi) and should not be driven at speeds over 105 km/h (65 mph). The compact spare tire is for emergency use when a

regular road tire has lost air and gone flat. If the vehicle has a compact spare tire, see *Compact Spare Tire* on page 10-74 and *If a Tire Goes Flat* on page 10-65.

### (C) Tire Identification Number (TIN):

The letters and numbers following the DOT (Department of Transportation) code is the Tire Identification Number (TIN). The TIN shows the manufacturer and plant code, tire size, and date the tire was manufactured. The TIN is molded onto both sides of the tire, although only one side may have the date of manufacture.

### (D) Maximum Cold Inflation

**Load Limit:** Maximum load that can be carried and the maximum pressure needed to support that load.

**(E) Tire Inflation:** The temporary use tire or compact spare tire should be inflated to 420 kPa (60 psi). For more information on tire pressure and inflation see *Tire Pressure* on page 10-51.

**(F) Tire Size:** A combination of letters and numbers define a tire's width, height, aspect ratio, construction type, and service description. The letter T as the first character in the tire size means the tire is for temporary use only.

### (G) TPC Spec (Tire Performance Criteria Specification):

Original equipment tires designed to GM's specific tire performance criteria have a TPC specification code molded onto the sidewall. GM's TPC specifications meet or exceed all federal safety guidelines.

## Tire Designations

### Tire Size

The following is an example of a typical passenger vehicle tire size.

P225/60R16 97S

The diagram shows the tire size designation 'P225/60R16 97S' with brackets and labels A through F pointing to specific parts of the code:

- A: Points to the letter 'P'.
- B: Points to the three-digit number '225'.
- C: Points to the two-digit number '60'.
- D: Points to the letter 'R'.
- E: Points to the two-digit number '16'.
- F: Points to the three-digit number '97'.

#### (A) Passenger (P-Metric) Tire:

The United States version of a metric tire sizing system. The letter P as the first character in the tire size means a passenger vehicle tire engineered to standards set by the U.S. Tire and Rim Association.

**(B) Tire Width:** The three-digit number indicates the tire section width in millimeters from sidewall to sidewall.

**(C) Aspect Ratio:** A two-digit number that indicates the tire height-to-width measurements. For example, if the tire size aspect ratio is 60, as shown in item C of the illustration, it would mean that the tire's sidewall is 60 percent as high as it is wide.

**(D) Construction Code:** A letter code is used to indicate the type of ply construction in the tire. The letter R means radial ply construction; the letter D means diagonal or bias ply construction; and the letter B means belted-bias ply construction.

**(E) Rim Diameter:** Diameter of the wheel in inches.

**(F) Service Description:** These characters represent the load index and speed rating of the tire. The load index represents the load carrying capacity a tire

is certified to carry. The speed rating is the maximum speed a tire is certified to carry a load.

## Tire Terminology and Definitions

**Air Pressure:** The amount of air inside the tire pressing outward on each square inch of the tire. Air pressure is expressed in kPa (kilopascal) or psi (pounds per square inch).

**Accessory Weight:** The combined weight of optional accessories. Some examples of optional accessories are automatic transmission, power steering, power brakes, power windows, power seats, and air conditioning.

**Aspect Ratio:** The relationship of a tire's height to its width.

**Belt:** A rubber coated layer of cords that is located between the plies and the tread. Cords may be made from steel or other reinforcing materials.

**Bead:** The tire bead contains steel wires wrapped by steel cords that hold the tire onto the rim.

**Bias Ply Tire:** A pneumatic tire in which the plies are laid at alternate angles less than 90 degrees to the centerline of the tread.

**Cold Tire Pressure:** The amount of air pressure in a tire, measured in kPa (kilopascal) or psi (pounds per square inch) before a tire has built up heat from driving. See *Tire Pressure on page 10-51*.

**Curb Weight:** The weight of a motor vehicle with standard and optional equipment including the

maximum capacity of fuel, oil, and coolant, but without passengers and cargo.

**DOT Markings:** A code molded into the sidewall of a tire signifying that the tire is in compliance with the U.S. Department of Transportation (DOT) Motor Vehicle Safety Standards. The DOT code includes the Tire Identification Number (TIN), an alphanumeric designator which can also identify the tire manufacturer, production plant, brand, and date of production.

**GVWR:** Gross Vehicle Weight Rating. See *Vehicle Load Limits on page 9-21*.

**GAWR FRT:** Gross Axle Weight Rating for the front axle. See *Vehicle Load Limits on page 9-21*.

**GAWR RR:** Gross Axle Weight Rating for the rear axle. See *Vehicle Load Limits on page 9-21*.

**Intended Outboard Sidewall:** The side of an asymmetrical tire, that must always face outward when mounted on a vehicle.

**Kilopascal (kPa):** The metric unit for air pressure.

**Light Truck (LT-Metric) Tire:** A tire used on light duty trucks and some multipurpose passenger vehicles.

**Load Index:** An assigned number ranging from 1 to 279 that corresponds to the load carrying capacity of a tire.

**Maximum Inflation Pressure:** The maximum air pressure to which a cold tire can be inflated. The maximum air pressure is molded onto the sidewall.

**Maximum Load Rating:** The load rating for a tire at the maximum permissible inflation pressure for that tire.

**Maximum Loaded Vehicle Weight:** The sum of curb weight, accessory weight, vehicle capacity weight, and production options weight.

**Normal Occupant Weight:** The number of occupants a vehicle is designed to seat multiplied by 68 kg (150 lbs). See *Vehicle Load Limits* on page 9-21.

**Occupant Distribution:** Designated seating positions.

**Outward Facing Sidewall:** The side of an asymmetrical tire that has a particular side that faces outward when mounted on a vehicle. The side of the tire that contains a whitewall, bears white lettering, or bears manufacturer, brand, and/or

model name molding that is higher or deeper than the same moldings on the other sidewall of the tire.

**Passenger (P-Metric) Tire:** A tire used on passenger cars and some light duty trucks and multipurpose vehicles.

**Recommended Inflation Pressure:** Vehicle manufacturer's recommended tire inflation pressure as shown on the tire placard. See *Tire Pressure* on page 10-51 and *Vehicle Load Limits* on page 9-21.

**Radial Ply Tire:** A pneumatic tire in which the ply cords that extend to the beads are laid at 90 degrees to the centerline of the tread.

**Rim:** A metal support for a tire and upon which the tire beads are seated.

**Sidewall:** The portion of a tire between the tread and the bead.

**Speed Rating:** An alphanumeric code assigned to a tire indicating the maximum speed at which a tire can operate.

**Traction:** The friction between the tire and the road surface. The amount of grip provided.

**Tread:** The portion of a tire that comes into contact with the road.

**Treadwear Indicators:** Narrow bands, sometimes called wear bars, that show across the tread of a tire when only 1.6 mm (1/16 in) of tread remains. See *When It Is Time for New Tires* on page 10-58.

**UTQGS (Uniform Tire Quality Grading Standards):** A tire information system that provides consumers with ratings for a tire's traction, temperature, and treadwear. Ratings are determined by tire manufacturers using government testing procedures. The ratings are molded into the sidewall of the tire. See *Uniform Tire Quality Grading on page 10-61*.

**Vehicle Capacity Weight:** The number of designated seating positions multiplied by 68 kg (150 lbs) plus the rated cargo load. See *Vehicle Load Limits on page 9-21*.

**Vehicle Maximum Load on the Tire:** Load on an individual tire due to curb weight, accessory weight, occupant weight, and cargo weight.

**Vehicle Placard:** A label permanently attached to a vehicle showing the vehicle capacity weight and the original equipment tire size and recommended inflation pressure. See "Tire and Loading Information Label" under *Vehicle Load Limits on page 9-21*.

## Tire Pressure

Tires need the correct amount of air pressure to operate effectively.

**Notice: Neither tire underinflation nor overinflation is good. Underinflated tires, or tires that do not have enough air, can result in:**

- **Tire overloading and over-heating which could lead to a blowout.**

- **Premature or irregular wear.**
- **Poor handling.**
- **Reduced fuel economy.**

**Overinflated tires, or tires that have too much air, can result in:**

- **Unusual wear.**
- **Poor handling.**
- **Rough ride.**
- **Needless damage from road hazards.**

The Tire and Loading Information label on the vehicle indicates the original equipment tires and the correct cold tire inflation pressures. The recommended pressure is the minimum air pressure needed to support the vehicle's maximum load carrying capacity.

For additional information regarding how much weight the vehicle can carry, and an example of the Tire and Loading Information label, see *Vehicle Load Limits on page 9-21*. How the vehicle is loaded affects vehicle handling and ride comfort. Never load the vehicle with more weight than it was designed to carry.

### **When to Check**

Check the tires once a month or more. Do not forget the compact spare tire, if the vehicle has one. The compact spare should be at 420 kPa (60 psi). For additional information regarding the compact spare tire, see *Compact Spare Tire on page 10-74*.

### **How to Check**

Use a good quality pocket-type gauge to check tire pressure. Proper tire inflation cannot be determined by looking at the tire. Check the tire inflation pressure when the tires are cold, meaning the vehicle has not been driven for at least three hours or no more than 1.6 km (1 mi).

Remove the valve cap from the tire valve stem. Press the tire gauge firmly onto the valve to get a pressure measurement. If the cold tire inflation pressure matches the recommended pressure on the Tire and Loading Information label, no further adjustment is necessary. If the inflation pressure is low, add air until the recommended pressure is reached. If the inflation pressure is high, press on the metal stem in the center of the tire valve to release air.

Re-check the tire pressure with the tire gauge.

Return the valve caps on the valve stems to prevent leaks and keep out dirt and moisture.

### **Tire Pressure Monitor System**

The Tire Pressure Monitor System (TPMS) uses radio and sensor technology to check tire pressure levels. The TPMS sensors monitor the air pressure in your tires and transmit tire pressure readings to a receiver located in the vehicle.

Each tire, including the spare (if provided), should be checked monthly when cold and inflated to the inflation pressure recommended by the vehicle manufacturer on the vehicle placard or tire inflation pressure label. (If your vehicle has tires of a different size than the size indicated on the vehicle placard or

tire inflation pressure label, you should determine the proper tire inflation pressure for those tires.)

As an added safety feature, your vehicle has been equipped with a tire pressure monitoring system (TPMS) that illuminates a low tire pressure telltale when one or more of your tires is significantly under-inflated.

Accordingly, when the low tire pressure telltale illuminates, you should stop and check your tires as soon as possible, and inflate them to the proper pressure. Driving on a significantly under-inflated tire causes the tire to overheat and can lead to tire failure. Under-inflation also reduces fuel efficiency and tire tread life, and may affect the vehicle's handling and stopping ability.

Please note that the TPMS is not a substitute for proper tire maintenance, and it is the driver's responsibility to maintain correct tire pressure, even if under-inflation has not reached the level to trigger illumination of the TPMS low tire pressure telltale.

Your vehicle has also been equipped with a TPMS malfunction indicator to indicate when the system is not operating properly. The TPMS malfunction indicator is combined with the low tire pressure telltale. When the system detects a malfunction, the telltale will flash for approximately one minute and then remain continuously illuminated. This sequence will continue upon subsequent vehicle start-ups as long as the malfunction exists.

When the malfunction indicator is illuminated, the system may not be able to detect or signal low tire pressure as intended. TPMS malfunctions may occur for a variety of reasons, including the installation of replacement or alternate tires or wheels on the vehicle that prevent the TPMS from functioning properly. Always check the TPMS malfunction telltale after replacing one or more tires or wheels on your vehicle to ensure that the replacement or alternate tires and wheels allow the TPMS to continue to function properly.

See *Tire Pressure Monitor Operation* on page 10-54 for additional information.

### Federal Communications Commission (FCC) and Industry Canada

See *Radio Frequency Statement on page 13-18* for information regarding Part 15 of the Federal Communications Commission (FCC) rules and Industry Canada Standards RSS-210/220/310.

### Tire Pressure Monitor Operation

This vehicle may have a Tire Pressure Monitor System (TPMS). The TPMS is designed to warn the driver when a low tire pressure condition exists. TPMS sensors are mounted onto each tire and wheel assembly, excluding the spare tire and wheel assembly. The TPMS sensors monitor the air pressure in the tires and transmits the tire pressure readings to a receiver located in the vehicle.



When a low tire pressure condition is detected, the TPMS illuminates the low tire pressure warning light located on the instrument cluster. If the warning light comes on, stop as soon as possible and inflate the tires to the recommended pressure shown on the tire loading information label. See *Vehicle Load Limits on page 9-21*.

A message to check the pressure in a specific tire displays in the Driver Information Center (DIC). The low tire pressure warning light and the DIC warning message come on at each ignition cycle until the tires are inflated to the correct inflation pressure. Using the DIC, tire pressure levels can be viewed.

For additional information and details about the DIC operation and displays see *Driver Information Center (DIC) on page 5-20*.

The low tire pressure warning light may come on in cool weather when the vehicle is first started, and then turn off as the vehicle is driven. This could be an early indicator that the air pressure is getting low and needs to be inflated to the proper pressure.

A Tire and Loading Information label shows the size of the original equipment tires and the correct inflation pressure for the tires when they are cold. See *Vehicle Load Limits on page 9-21*, for an example of the Tire and Loading Information label and its location. Also see *Tire Pressure on page 10-51*.



The TPMS can warn about a low tire pressure condition but it does not replace normal tire maintenance. See *Tire Inspection on page 10-57*, *Tire Rotation on page 10-57* and *Tires on page 10-45*.

**Notice:** Tire sealant materials are not all the same. A non-approved tire sealant could damage the TPMS sensors. TPMS sensor damage caused by using an incorrect tire sealant is not covered by the vehicle warranty. Always use only the GM-approved tire sealant available through your dealer or included in the vehicle.

### TPMS Malfunction Light and Message

The TPMS will not function properly if one or more of the TPMS sensors are missing or inoperable. When the system detects a malfunction, the low tire pressure warning light flashes for about one minute and then stays on for the remainder of

the ignition cycle. A DIC warning message also displays. The low tire pressure warning light and DIC warning message come on at each ignition cycle until the problem is corrected. Some of the conditions that can cause these to come on are:

- One of the road tires has been replaced with the spare tire. The spare tire does not have a TPMS sensor. The malfunction light and DIC message should go off after the road tire is replaced and the sensor matching process is performed successfully. See "TPMS Sensor Matching Process" later in this section.
- The TPMS sensor matching process was not done or not completed successfully after rotating the tires. The malfunction light and the DIC message should go off after successfully completing the

sensor matching process. See "TPMS Sensor Matching Process" later in this section

- One or more TPMS sensors are missing or damaged. The DIC message and the TPMS malfunction light should go off when the TPMS sensors are installed and the sensor matching process is performed successfully. See your dealer for service.
- Replacement tires or wheels do not match the original equipment tires or wheels. Tires and wheels other than those recommended could prevent the TPMS from functioning properly. See *Buying New Tires on page 10-59*.
- Operating electronic devices or being near facilities using radio wave frequencies similar to the TPMS could cause the TPMS sensors to malfunction.

If the TPMS is not functioning properly, it cannot detect or signal a low tire condition. See your dealer for service if the TPMS malfunction light and DIC message comes on and stays on.

### **TPMS Sensor Matching Process**

Each TPMS sensor has a unique identification code. The identification code needs to be matched to a new tire/wheel position after rotating the tires or replacing one or more of the TPMS sensors. The TPMS sensor matching process should also be performed after replacing a spare tire with a road tire containing the TPMS sensor. The malfunction light and the DIC message should go off at the next ignition cycle. The sensors are matched to the tire/wheel positions, using a TPMS relearn tool, in the following order: driver side front tire, passenger side front tire, passenger side rear tire,

and driver side rear. See your dealer for service or to purchase a relearn tool.

There are two minutes to match the first tire/wheel position, and five minutes overall to match all four tire/wheel positions. If it takes longer, the matching process stops and must be restarted.

The TPMS sensor matching process is:

1. Set the parking brake.
2. Turn the ignition to ON/RUN with the engine off.
3. Use the MENU button to select the Vehicle Information Menu in the Driver Information Center (DIC). Use the arrow keys to scroll to the Tire Pressure screen.
4. Press the SET/CLR button to begin the sensor matching process.

A message requesting acceptance of the process should display.

5. Press the SET/CLR button again to confirm the selection.

The horn sounds twice to signal the receiver is in relearn mode and the TIRE LEARNING ACTIVE message displays on the DIC screen.

6. Start with the driver side front tire.
7. Place the relearn tool against the tire sidewall, near the valve stem. Then press the button to activate the TPMS sensor. A horn chirp confirms that the sensor identification code has been matched to this tire and wheel position.
8. Proceed to the passenger side front tire, and repeat the procedure in Step 7.
9. Proceed to the passenger side rear tire, and repeat the procedure in Step 7.

10. Proceed to the driver side rear tire, and repeat the procedure in Step 7. The horn sounds two times to indicate the sensor identification code has been matched to the driver side rear tire, and the TPMS sensor matching process is no longer active. The TIRE LEARNING ACTIVE message on the DIC display screen goes off.
11. Turn the ignition to LOCK/OFF.
12. Set all four tires to the recommended air pressure level as indicated on the Tire and Loading Information label.

## Tire Inspection

We recommend that the tires, including the spare tire, if the vehicle has one, be inspected for signs of wear or damage at least once a month.

Replace the tire if:

- The indicators at three or more places around the tire can be seen.
- There is cord or fabric showing through the tire's rubber.
- The tread or sidewall is cracked, cut, or snagged deep enough to show cord or fabric.
- The tire has a bump, bulge, or split.
- The tire has a puncture, cut, or other damage that cannot be repaired well because of the size or location of the damage.

## Tire Rotation

Tires should be rotated every 12 000 km (7,500 mi). See *Scheduled Maintenance on page 11-2*.

Tires are rotated to achieve a uniform wear for all tires. The first rotation is the most important.

Any time unusual wear is noticed, rotate the tires as soon as possible and check the wheel alignment. Also check for damaged tires or wheels. Also check for damaged tires or wheels. See *When It Is Time for New Tires on page 10-58* and *Wheel Replacement on page 10-63*.

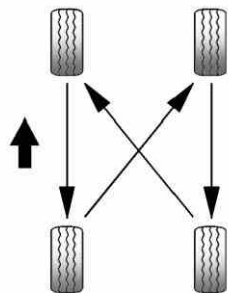

Use this rotation pattern when rotating the tires.

Do not include the compact spare tire in the tire rotation.

Adjust the front and rear tires to the recommended inflation pressure on the Tire and Loading Information label after the tires have been rotated. See *Tire Pressure* on page 10-51 and *Vehicle Load Limits* on page 9-21.

Reset the Tire Pressure Monitor System. See *Tire Pressure Monitor Operation* on page 10-54.

Make certain that all wheel nuts are properly tightened. See "Wheel Nut Torque" under *Capacities and Specifications* on page 12-2.

**⚠ WARNING**

Rust or dirt on a wheel, or on the parts to which it is fastened, can make wheel nuts become loose after time. The wheel could come off and cause an accident. When changing a wheel, remove any rust or dirt from places where the wheel attaches to the vehicle. In an emergency, a cloth or a paper towel can be used, however, use a scraper or wire brush later to remove all rust or dirt.

Lightly coat the center of the wheel hub with wheel bearing grease after a wheel change or tire rotation to prevent corrosion or rust build-up. Do not get grease on the flat wheel mounting surface or on the wheel nuts or bolts.

**When It Is Time for New Tires**

Factors such as maintenance, temperatures, driving speeds, vehicle loading, and road conditions affect the wear rate of the tires.

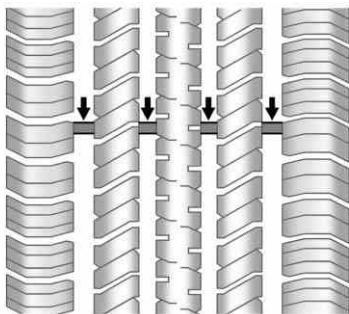

Treadwear indicators are one way to tell when it is time for new tires. Treadwear indicators appear when the tires have only 1.6 mm (1/16 in) or less of tread remaining. See *Tire Inspection* on page 10-57 and *Tire Rotation* on page 10-57 for more information.

The rubber in tires ages over time. This also applies for the spare tire, if the vehicle has one, even if it is never used. Multiple conditions including temperatures, loading conditions, and inflation pressure

maintenance affect how fast aging takes place. Tires will typically need to be replaced due to wear before they may need to be replaced due to age. Consult the tire manufacturer for more information on when tires should be replaced.

### Vehicle Storage

Tires age when stored normally mounted on a parked vehicle. Park a vehicle that will be stored for at least a month in a cool, dry, clean area away from direct sunlight to slow aging. This area should be free of grease, gasoline, or other substances that can deteriorate rubber.

Parking for an extended period can cause flat spots on the tires that may result in vibrations while driving. When storing a vehicle for at least a month, remove the tires or raise the vehicle to reduce the weight from the tires.

### Buying New Tires

GM has developed and matched specific tires for the vehicle. The original equipment tires installed were designed to meet General Motors Tire Performance Criteria Specification (TPC Spec) system rating. When replacement tires are needed, GM strongly recommends buying tires with the same TPC Spec rating.

GM's exclusive TPC Spec system considers over a dozen critical specifications that impact the overall performance of the vehicle, including brake system performance, ride and handling, traction control, and tire pressure monitoring performance. GM's TPC Spec number is molded onto the tire's sidewall near the tire size.

## 10-60 Vehicle Care

---

If the tires have an all-season tread design, the TPC Spec number will be followed by MS for mud and snow. See *Tire Sidewall Labeling on page 10-45* for additional information.

GM recommends replacing all the tires at the same time. Uniform tread depth on all tires will help to maintain the performance of the vehicle. Braking and handling performance may be adversely affected if all the tires are not replaced at the same time. See *Tire Inspection on page 10-57* and *Tire Rotation on page 10-57* for information on proper tire rotation.

### WARNING

Tires could explode during improper service. Attempting to mount or dismount a tire could cause injury or death. Only your dealer or authorized tire service center should mount or dismount the tires.

### WARNING

Mixing tires of different sizes, brands, or types may cause loss of control of the vehicle, resulting in a crash or other vehicle damage. Use the correct size, brand, and type of tires on all wheels.

### WARNING

Using bias-ply tires on the vehicle may cause the wheel rim flanges to develop cracks after many miles of driving. A tire and/or wheel could fail suddenly and cause a crash. Use only radial-ply tires with the wheels on the vehicle.

If the vehicle tires must be replaced with a tire that does not have a TPC Spec number, make sure they are the same size, load range, speed rating, and construction (radial) as the original tires.

Vehicles that have a tire pressure monitoring system could give an inaccurate low-pressure warning if non-TPC Spec rated tires are installed. See *Tire Pressure Monitor System on page 10-52*.

The Tire and Loading Information label indicates the original equipment tires on the vehicle. See *Vehicle Load Limits on page 9-21* for more information about the Tire and Loading Information label and its location on the vehicle.

## Different Size Tires and Wheels

If wheels or tires are installed that are a different size than the original equipment wheels and tires, vehicle performance, including its braking, ride and handling characteristics, stability, and resistance to rollover may be affected. If the vehicle has electronic systems such as antilock brakes, rollover airbags, traction control, and electronic stability control, the performance of these systems can also be affected.

### WARNING

If different sized wheels are used, there may not be an acceptable level of performance and safety if tires not recommended for those wheels are selected. This increases the chance of a crash and serious injury. Only use GM specific wheel and tire systems developed for the vehicle, and have them properly installed by a GM certified technician.

See *Buying New Tires on page 10-59* and *Accessories and Modifications on page 10-3* for additional information.

## Uniform Tire Quality Grading

Quality grades can be found where applicable on the tire sidewall between tread shoulder and maximum section width. For example:

### **Treadwear 200 Traction AA Temperature A**

The following information relates to the system developed by the United States National Highway Traffic Safety Administration (NHTSA), which grades tires by treadwear, traction, and temperature performance. This applies only to vehicles sold in the United States. The grades are molded on the sidewalls of most passenger car tires.

The Uniform Tire Quality Grading (UTQG) system does not apply to deep tread, winter-type snow tires, space-saver, or temporary use spare tires, tires with nominal rim diameters of 10 to 12 inches (25 to 30 cm), or to some limited-production tires.

While the tires available on General Motors passenger cars and light trucks may vary with respect to these grades, they must also conform to federal safety requirements and additional General Motors Tire Performance Criteria (TPC) standards.

All Passenger Car Tires Must Conform to Federal Safety Requirements In Addition To These Grades.

### **Treadwear**

The treadwear grade is a comparative rating based on the wear rate of the tire when tested under controlled conditions on a specified government test course. For example, a tire graded 150 would wear one and a half (1½) times as well on the government course as a tire graded 100. The relative performance of tires depends upon the actual conditions of their use, however, and may depart significantly from the norm due to variations in driving habits, service practices and differences in road characteristics and climate.

### **Traction – AA, A, B, C**

The traction grades, from highest to lowest, are AA, A, B, and C. Those grades represent the tire's ability to stop on wet pavement as measured under controlled conditions on specified government test surfaces of asphalt and concrete. A tire marked C may have poor traction performance. Warning: The traction grade assigned to this tire is based on straight-ahead braking traction tests, and does not include acceleration, cornering, hydroplaning, or peak traction characteristics.



### **Temperature – A, B, C**

The temperature grades are A (the highest), B, and C, representing the tire's resistance to the generation of heat and its ability to dissipate heat when tested under controlled conditions on a specified indoor laboratory test wheel.

Sustained high temperature can cause the material of the tire to degenerate and reduce tire life, and excessive temperature can lead to sudden tire failure. The grade C corresponds to a level of performance which all passenger car tires must meet under the Federal Motor Safety Standard No. 109. Grades B and A represent higher levels of performance on the laboratory test wheel than the minimum

required by law. Warning: The temperature grade for this tire is established for a tire that is properly inflated and not overloaded. Excessive speed, underinflation, or excessive loading, either separately or in combination, can cause heat buildup and possible tire failure.

### **Wheel Alignment and Tire Balance**

The tires and wheels were aligned and balanced at the factory to provide the longest tire life and best overall performance. Adjustments to wheel alignment and tire balancing will not be necessary on a regular basis. However, check the alignment if there is unusual tire wear or if the vehicle is pulling to one side or the other. If the vehicle

vibrates when driving on a smooth road, the tires and wheels might need to be rebalanced. See your dealer for proper diagnosis.

### **Wheel Replacement**

Replace any wheel that is bent, cracked, or badly rusted or corroded. If wheel nuts keep coming loose, the wheel, wheel bolts, and wheel nuts should be replaced. If the wheel leaks air, replace it. Some aluminum wheels can be repaired. See your dealer if any of these conditions exist.

Your dealer will know the kind of wheel that is needed.

Each new wheel should have the same load-carrying capacity, diameter, width, offset, and be mounted the same way as the one it replaces.

Replace wheels, wheel bolts, wheel nuts, or Tire Pressure Monitor System (TPMS) sensors with new GM original equipment parts.

### WARNING

Using the wrong replacement wheels, wheel bolts, or wheel nuts can be dangerous. It could affect the braking and handling of the vehicle. Tires can lose air, and cause loss of control, causing a crash. Always use the correct wheel, wheel bolts, and wheel nuts for replacement.

**Notice:** The wrong wheel can also cause problems with bearing life, brake cooling, speedometer or odometer calibration, headlamp aim, bumper height, vehicle ground clearance, and tire or tire chain clearance to the body and chassis.

*See If a Tire Goes Flat on page 10-65 for more information.*

### Used Replacement Wheels

#### WARNING

Replacing a wheel with a used one is dangerous. How it has been used or how far it has been driven may be unknown. It could fail suddenly and cause a crash. When replacing wheels, use a new GM original equipment wheel.

## Tire Chains

### WARNING

Do not use tire chains. There is not enough clearance. Tire chains used on a vehicle without the proper amount of clearance can cause damage to the brakes, suspension or other vehicle parts. The area damaged by the tire chains could cause you to lose control of the vehicle and you or others may be injured in a crash.

A Type S low-profile cable can be used only if the cable manufacturer recommends it for use on the vehicle, the tire size combination, and road conditions. Follow the manufacturer's instructions. To help avoid damage to the vehicle, drive slowly, readjust or remove the cable if it is contacting the vehicle and do not spin the vehicle's tires.

(Continued)

### WARNING (Continued)

Install the cables on the front tires only. Cables should not be installed on the spare tire or on the optional 19-inch tire.

## If a Tire Goes Flat

It is unusual for a tire to blowout while driving, especially if the tires are maintained properly. If air goes out of a tire, it is much more likely to leak out slowly. But if there ever is a blowout, here are a few tips about what to expect and what to do:

If a front tire fails, the flat tire creates a drag that pulls the vehicle toward that side. Take your foot off the accelerator pedal and grip the steering wheel firmly. Steer to maintain lane position, and then gently brake to a stop, well off the road, if possible.

A rear blowout, particularly on a curve, acts much like a skid and may require the same correction as used in a skid. Stop pressing the accelerator pedal and steer to straighten the vehicle. It may be very bumpy and noisy. Gently brake to a stop, well off the road, if possible.

### WARNING

Driving on a flat tire will cause permanent damage to the tire. Re-inflating a tire after it has been driven on while severely underinflated or flat may cause a blowout and a serious crash. Never attempt to re-inflate a tire that has been driven on while severely underinflated or flat. Have your dealer or an authorized tire service center repair or replace the flat tire as soon as possible.

**⚠ WARNING**

Lifting a vehicle and getting under it to do maintenance or repairs is dangerous without the appropriate safety equipment and training. If a jack is provided with the vehicle, it is designed only for changing a flat tire. If it is used for anything else, you or others could be badly injured or killed if the vehicle slips off the jack. If a jack is provided with the vehicle, only use it for changing a flat tire.

If a tire goes flat, avoid further tire and wheel damage by driving slowly to a level place, well off the road, if possible. Turn on the hazard warning flashers. See *Hazard Warning Flashers on page 6-3*.

**⚠ WARNING**

Changing a tire can be dangerous. The vehicle can slip off the jack and roll over or fall causing injury or death. Find a level place to change the tire. To help prevent the vehicle from moving:

1. Set the parking brake firmly.
2. Put an automatic transmission in P (Park) or a manual transmission in 1 (First) or R (Reverse).
3. Turn off the engine and do not restart while the vehicle is raised.
4. Do not allow passengers to remain in the vehicle.
5. Place wheel blocks on both sides of the tire at the opposite corner of the tire being changed.

When the vehicle has a flat tire (B), use the following example as a guide to assist in the placement of the wheel blocks (A).

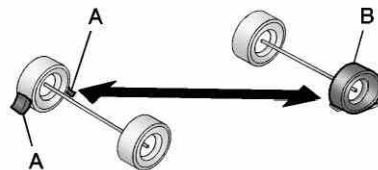

A. Wheel Block

B. Flat Tire

The following information explains how to repair or change a tire.

## Tire Changing

### Removing the Spare Tire and Tools

To access the spare tire and tools:

1. Open the liftgate. See *Liftgate (Manual)* on page 2-8 or *Liftgate (Power)* on page 2-9.
2. Lift the load floor up.

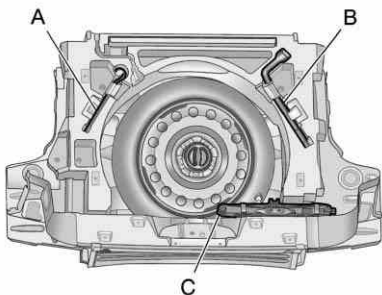

3. Remove the extension (A), wheel wrench (B) and jack (C). Place the tools next to the tire being changed.

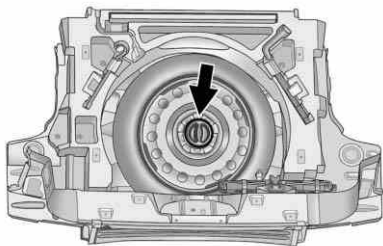

4. Turn the retainer nut counterclockwise and remove the spare tire.
5. Place the spare tire next to the tire being changed.

### Removing the Flat Tire and Installing the Spare Tire

1. Do a safety check before proceeding. See *If a Tire Goes Flat* on page 10-65 for more information.
2. For vehicles with wheel nut caps, turn the wheel wrench counterclockwise to loosen and remove them.

Do not try to remove plastic caps from the cover or center cap.

3. For vehicles with a wheel cover or center cap, pull the cover or center cap away from the wheel to remove it. Store the wheel cover in the cargo area until you have the flat tire repaired or replaced.

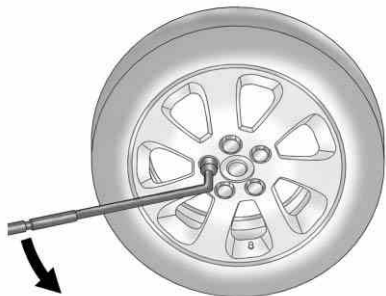

4. Turn the wheel wrench counterclockwise to loosen all the wheel nuts, but do not remove them yet.
5. Place the jack near the flat tire.

**Notice:** Make sure that the jack lift head is in the correct position or you may damage your vehicle. The repairs would not be covered by your warranty.

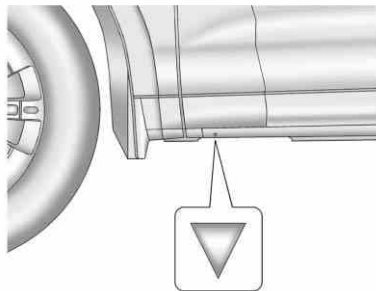

Front

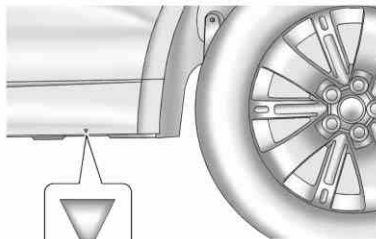

Rear

6. Position the jack lift head at the jack location nearest the flat tire. The location is indicated by a mark on the bottom edge of the front and rear door plastic molding. The jack must not be used in any other position.

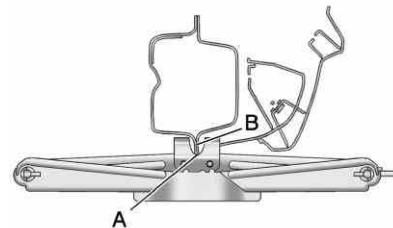

Place the jack notch (A) under the frame rail seam (B).

7. Put the compact spare tire near you.

**⚠ WARNING**

Getting under a vehicle when it is jacked up is dangerous. If the vehicle slips off the jack, you could be badly injured or killed. Never get under a vehicle when it is supported only by a jack.

**⚠ WARNING**

Raising the vehicle with the jack improperly positioned can damage the vehicle and even make the vehicle fall. To help avoid personal injury and vehicle damage, be sure to fit the jack lift head into the proper location before raising the vehicle.

**⚠ WARNING**

Lifting a vehicle and getting under it to do maintenance or repairs is dangerous without the appropriate safety equipment and training. If a jack is provided with the vehicle, it is designed only for changing a flat tire. If it is used for anything else, you or others could be badly injured or killed if the vehicle slips off the jack. If a jack is provided with the vehicle, only use it for changing a flat tire.

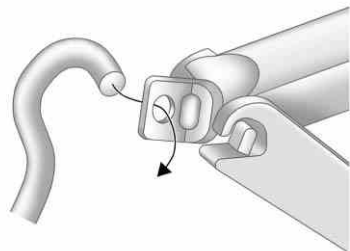

8. Fit the jack handle extension onto the jack by sliding the hook through the end of the jack.



9. Insert the other end of the jack handle into the wrench.

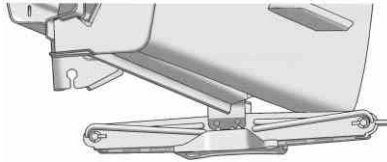

10. Place the jack under the vehicle.

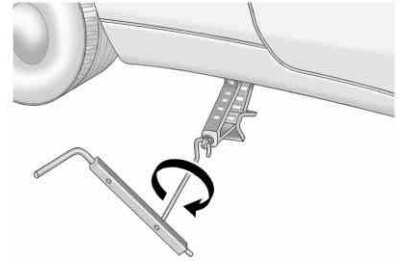

11. Raise the vehicle by turning the jack handle clockwise. Raise the vehicle far enough off the ground so there is enough room for the road tire to clear the ground.



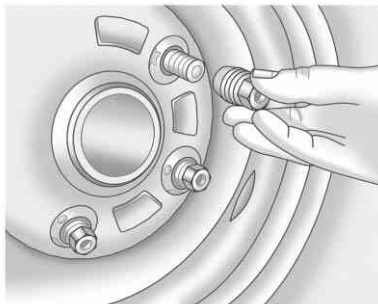

12. Remove all of the wheel nuts.
13. Remove the flat tire.

**⚠ WARNING**

Rust or dirt on a wheel, or on the parts to which it is fastened, can make wheel nuts become loose after time. The wheel could come off and cause an accident. When changing a wheel, remove any rust or dirt from places where the wheel attaches to the vehicle. In

(Continued)

**WARNING (Continued)**

an emergency, a cloth or a paper towel can be used, however, use a scraper or wire brush later to remove all rust or dirt.

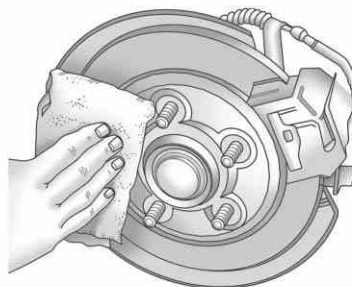

14. Remove any rust or dirt from the wheel bolts, mounting surfaces, and spare wheel.

15. Place the compact spare tire on the wheel-mounting surface.

**⚠ WARNING**

Never use oil or grease on bolts or nuts because the nuts might come loose. The vehicle's wheel could fall off, causing a crash.

16. Reinstall the wheel nuts. Tighten each nut by hand until the wheel is held against the hub.

- Lower the vehicle by turning the jack handle counterclockwise.

### WARNING

Wheel nuts that are improperly or incorrectly tightened can cause the wheels to become loose or come off. The wheel nuts should be tightened with a torque wrench to the proper torque specification after replacing. Follow the torque specification supplied by the aftermarket manufacturer when using accessory locking wheel nuts. See *Capacities and Specifications on page 12-2* for original equipment wheel nut torque specifications.

**Notice:** Improperly tightened wheel nuts can lead to brake pulsation and rotor damage. To avoid expensive brake repairs, evenly tighten the wheel nuts in the proper sequence and to the

proper torque specification. See *Capacities and Specifications on page 12-2* for the wheel nut torque specification.



- Tighten the wheel nuts firmly in a crisscross sequence, as shown.
- Lower the jack all the way and remove the jack from under the vehicle.
- Tighten the wheel nuts firmly with the wheel wrench.

When reinstalling the wheel cover or center cap on the full-size tire, tighten all five plastic caps hand snug with the aid of the wheel wrench and tighten them with the wheel wrench an additional one-quarter of a turn.

**Notice:** Wheel covers will not fit on the vehicle's compact spare. If you try to put a wheel cover on the compact spare, the cover or the spare could be damaged.

### Storing a Flat or Spare Tire and Tools

#### WARNING

Storing a jack, a tire, or other equipment in the passenger compartment of the vehicle could cause injury. In a sudden stop or collision, loose equipment could strike someone. Store all these in the proper place.

To store the flat tire:

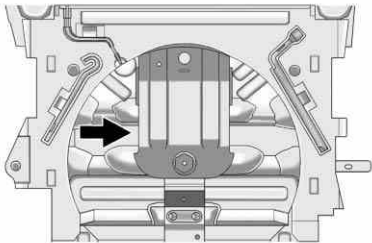

1. Remove the cable package. The cable is stored in a plastic bag under the compact spare tire.
2. Remove the small center cap by tapping the back of the cap with the extension of the shaft, if the vehicle has aluminum wheels.

3. Put the flat tire in the rear storage area with the valve stem pointing toward the rear of the vehicle.

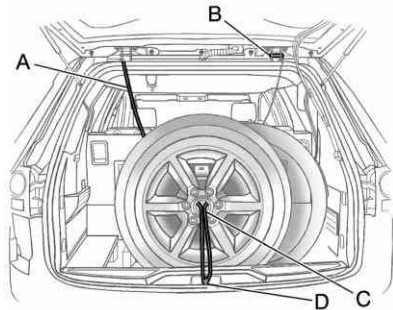

4. Pull the cable (A) through the door striker (D) then the center of the wheel (C).

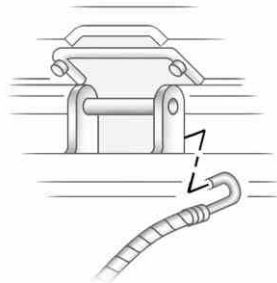

5. Hook the cable onto the outside portion of the liftgate hinges (B).
6. Hook the other end of the cable onto the outside portion of the liftgate hinge on the other side of the vehicle.
7. Pull on the cable to make sure it is secure.

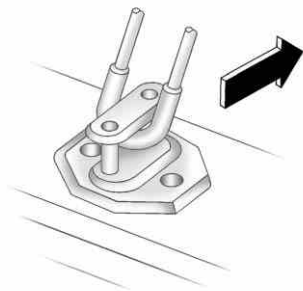

8. Make sure the metal tube is centered at the striker. Push the tube toward the front of the vehicle.
9. Close the liftgate and make sure it is latched properly.

The compact spare is for temporary use only. Replace the compact spare tire with a full-size tire as soon as you can.

### Compact Spare Tire

#### WARNING

Driving with more than one compact spare tire at a time could result in loss of braking and handling. This could lead to a crash and you or others could be injured. Use only one compact spare tire at a time.

If this vehicle has a compact spare tire, it was fully inflated when the vehicle was new; however, it can lose air after a time. Check the inflation pressure regularly. It should be 420 kPa (60 psi).

After installing the compact spare on the vehicle, stop as soon as possible and make sure the spare tire is correctly inflated. The compact spare is made to perform well at speeds up to 105 km/h (65 mph) for distances up to 5 000 km (3,000 mi), so you can finish your trip and have the full-size

tire repaired or replaced at your convenience. Of course, it is best to replace the spare with a full-size tire as soon as possible. The spare tire will last longer and be in good shape in case it is needed again.

**Notice:** When the compact spare is installed, do not take the vehicle through an automatic car wash with guide rails. The compact spare can get caught on the rails which can damage the tire, wheel and other parts of the vehicle.

Do not use the compact spare on other vehicles.

Do not mix the compact spare tire or wheel with other wheels or tires. They will not fit. Keep the spare tire and its wheel together.

**Notice:** Tire chains will not fit the compact spare. Using them can damage the vehicle and can damage the chains too. Do not use tire chains on the compact spare.

## Jump Starting

For more information about the vehicle battery, see *Battery* on page 10-27.

Jump starting can be used on vehicles with run-down batteries by using jumper cables and another vehicle.

### WARNING

Batteries can hurt you. They can be dangerous because:

- They contain acid that can burn you.
- They contain gas that can explode or ignite.
- They contain enough electricity to burn you.

If you do not follow these steps exactly, some or all of these things can hurt you.

### WARNING

Using an open flame near a battery can cause battery gas to explode. People have been hurt doing this, and some have been blinded. Use a flashlight if you need more light.

Be sure the battery has enough water. You do not need to add water to the battery installed in your new vehicle. But if a battery has filler caps, be sure the right amount of fluid is there. If it is low, add water to take care of that first. If you do not, explosive gas could be present.

(Continued)

### WARNING (Continued)

Battery fluid contains acid that can burn you. Do not get it on you. If you accidentally get it in your eyes or on your skin, flush the place with water and get medical help immediately.

Be sure to use the following steps to do it safely. Ignoring these steps could result in costly damage to the vehicle that would not be covered by the warranty.

Trying to start the vehicle by pushing or pulling it will not work, and it could damage the vehicle.

**Notice:** If the radio or other accessories are left on during the jump starting procedure, they could be damaged. The repairs would not be covered by the warranty. Always turn off the radio and other accessories when jump starting the vehicle.

**Notice:** If the jumper cables are connected or removed in the wrong order, electrical shorting may occur and damage the vehicle. The repairs would not be covered by the vehicle warranty. Always connect and remove the jumper cables in the correct order, making sure that the cables do not touch each other or other metal.

1. The vehicle used to jump start must have 12-volt battery with a negative ground.

**Notice:** Only use a vehicle that has a 12-volt system with a negative ground for jump starting. If the other vehicle does not have a 12-volt system with a negative ground, both vehicles can be damaged.

2. The vehicles should be close enough for the jumper cables to reach, but the vehicles should not be touching. Touching could cause grounding and possible electrical system damage.  
Put both vehicles in P (Park) and set the parking brake firmly.
3. Unplug accessories plugged into the cigarette lighter or the accessory power outlet. Turn off the radio and all lamps that are not needed. Turn off the ignition on both vehicles.

4. Locate the positive (+) and negative (-) terminals on both vehicles. Some vehicles have remote jump starting terminals.

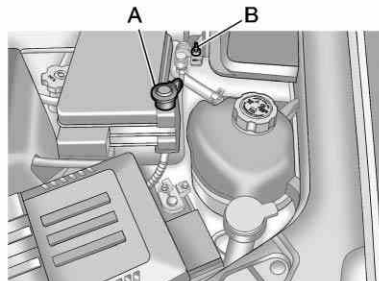

**⚠ WARNING**

An electric fan can start up even when the engine is not running and can injure you. Keep hands, clothing and tools away from any underhood electric fan.

- 5. The remote positive (+) terminal (A) is located on the underhood fuse block, on the driver side. Lift the red cap to uncover the terminal.  
  
The remote negative (-) terminal (B) is a stud behind the metal tab stamped with GND (-) near the driver side strut tower.
- 6. The jumper cables should be in good working condition with no loose or missing insulation. The vehicles could be damaged if they are not.

- 7. Connect the red positive (+) cable to the positive (+) terminal on the vehicle with the dead battery. Use a remote positive (+) terminal if the vehicle has one.
- 8. Do not let the other end touch metal. Connect it to the positive (+) terminal of the good battery. Use a remote positive (+) terminal if the vehicle has one.
- 9. Connect the black negative (-) cable to the negative (-) terminal of the good battery. Use a remote negative (-) terminal if the vehicle has one.

Do not let the other end touch anything until the next step. The other end of the negative (-) cable does not go to the dead battery. It goes to a heavy, unpainted metal engine part or to a remote negative (-) terminal on the vehicle with the dead battery.

- 10. Connect the other end of the negative (-) cable away from the dead battery, but not near engine parts that move.
- 11. Start the vehicle with the good battery and run the engine.
- 12. Press the unlock symbol on the remote keyless entry transmitter to disarm the security system, if equipped.

13. Try to start the vehicle that had the dead battery. If it will not start after a few tries, it needs service.

**Notice:** If the jumper cables are connected or removed in the wrong order, electrical shorting may occur and damage the vehicle. The repairs would not be covered by the vehicle warranty. Always connect and remove the jumper cables in the correct order, making sure that the cables do not touch each other or other metal.

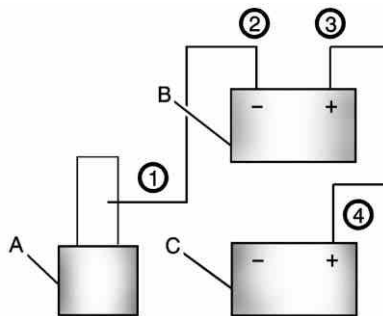

### Jumper Cable Removal

- Heavy, Unpainted Metal Engine Part or Remote Negative (-) Terminal
- Good Battery or Remote Positive (+) and Remote Negative (-) Terminals
- Dead Battery or Remote Positive (+) Terminal

To disconnect the jumper cables from both vehicles,

- Disconnect the black negative (-) cable from the vehicle that had the dead battery.
- Disconnect the black negative (-) cable from the vehicle with the good battery.
- Disconnect the red positive (+) cable from the vehicle with the good battery.
- Disconnect the red positive (+) cable from the other vehicle.
- Return the underhood fuse block cover to its original position, if applicable.



## Towing

### Towing the Vehicle

**Notice:** To avoid damage, the disabled vehicle should be towed with all four wheels off the ground. Care must be taken with vehicles that have low ground clearance and/or special equipment. Always flatbed on a car carrier.

Consult your dealer or a professional towing service if the disabled vehicle must be towed. See *Roadside Assistance Program (U.S. and Canada)* on page 13-7 or *Roadside Assistance Program (Mexico)* on page 13-9.

To tow the vehicle behind another vehicle for recreational purposes, such as behind a motor home, see "Recreational Vehicle Towing" in this section.

### Recreational Vehicle Towing

Recreational vehicle towing means towing the vehicle behind another vehicle – such as behind a motor home. The two most common types of recreational vehicle towing are known as dinghy towing and dolly towing. Dinghy towing is towing the vehicle with all four wheels on the ground. Dolly towing is towing the vehicle with two wheels on the ground and two wheels up on a device known as a dolly.

Here are some important things to consider before recreational vehicle towing:

- What is the towing capacity of the towing vehicle? Be sure to read the tow vehicle manufacturer's recommendations.
- What is the distance that will be travelled? Some vehicles have restrictions on how far and how long they can tow.
- Is the proper towing equipment going to be used? See your dealer or trailering professional for additional advice and equipment recommendations.
- Is the vehicle ready to be towed? Just as preparing the vehicle for a long trip, make sure the vehicle is prepared to be towed.

### Dinghy Towing

Front-wheel-drive and all-wheel-drive vehicles may be dinghy towed from the front. These vehicles can also be towed by placing them on a platform trailer with all four wheels off of the ground. For other towing options, see “Dolly Towing” following in this section.

For vehicles being dinghy towed, the vehicle should be run at the beginning of each day and at each RV fuel stop for about five minutes. This will ensure proper lubrication of transmission components.

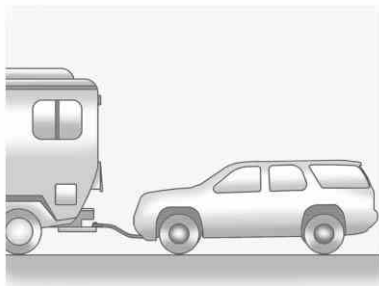

To tow the vehicle from the front with all four wheels on the ground:

1. Position the vehicle that will be towed and secure it to the towing vehicle.
2. Turn the ignition key to ON/RUN.
3. Shift the transmission to N (Neutral).
4. Turn the ignition key to ACC/ACCESSORY.
5. Turn all accessories off.

6. To prevent the battery from draining while the vehicle is being towed, remove fuse 32, the Discrete Logic Ignition Switch fuse, from the instrument panel fuse block and store it in a safe location. See *Instrument Panel Fuse Block* on page 10-42.

**Notice:** If the vehicle is towed without performing each of the steps listed under “Dinghy Towing,” the automatic transmission could be damaged. Be sure to follow all steps of the dinghy towing procedure prior to and after towing the vehicle.

**Notice:** If 105 km/h (65 mph) is exceeded while towing the vehicle, it could be damaged. Never exceed 105 km/h (65 mph) while towing the vehicle.

Once the destination has been reached:

1. Set the parking brake.
2. Shift the transmission to P (Park).
3. Turn the ignition key to LOCK/OFF.
4. Install fuse 32, the Discrete Logic Ignition Switch fuse. See *Instrument Panel Fuse Block on page 10-42*.
5. Start the engine and let it idle for more than three minutes before driving the vehicle.

**Notice: Too much or too little fluid can damage the transmission. Be sure that the transmission fluid is at the proper level before towing with all four wheels on the ground.**

**Notice: Do not tow a vehicle with the front drive wheels on the ground if one of the front tires is a compact spare tire. Towing with two different tire sizes on the front of the vehicle can cause severe damage to the transmission.**

### **Dolly Towing (All-Wheel-Drive Vehicles)**

All-wheel-drive vehicles should not be towed with two wheels on the ground. To properly tow these vehicles, they should be placed on a platform trailer with all four wheels off of the ground or dinghy towed from the front.

### **Dolly Towing (Front-Wheel-Drive Vehicles)**

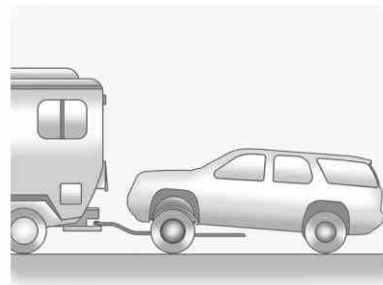

To tow the vehicle from the front with the rear wheels on the ground, do the following:

1. Put the front wheels on a dolly.
2. Move the shift lever to P (Park).
3. Set the parking brake.
4. Secure the vehicle to the dolly.

5. Follow the dolly manufacturer's instructions for preparing the vehicle and dolly for towing.
6. Release the parking brake.

### Towing the Vehicle From the Rear

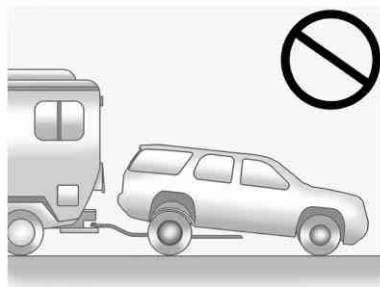
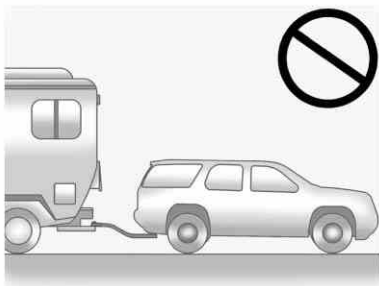

**Notice:** Towing the vehicle from the rear could damage it. Also, repairs would not be covered by the vehicle warranty. Never have the vehicle towed from the rear.

## Appearance Care

### Exterior Care

#### Cleaning Exterior Lamps/Lenses

Use only lukewarm or cold water, a soft cloth, and a car washing soap to clean exterior lamps and lenses. Follow instructions under "Washing the Vehicle" later in this section.

#### Finish Care

Occasional waxing or mild polishing of the vehicle by hand may be necessary to remove residue from the paint finish. Approved cleaning products can be obtained from your dealer.

If the vehicle has a basecoat/clearcoat paint finish, the clearcoat gives more depth and gloss to the colored basecoat. Always use waxes and polishes that are non-abrasive and made for a basecoat/clearcoat paint finish.

**Notice:** Machine compounding or aggressive polishing on a basecoat/clearcoat paint finish may damage it. Use only non-abrasive waxes and polishes that are made for a basecoat/clearcoat paint finish on the vehicle.

Foreign materials such as calcium chloride and other salts, ice melting agents, road oil and tar, tree sap, bird droppings, chemicals from industrial chimneys, etc., can damage the vehicle's finish if they remain on painted surfaces. Wash the vehicle as soon as possible. If necessary, use non-abrasive cleaners that are marked safe for painted surfaces to remove foreign matter.

Exterior painted surfaces are subject to aging, weather, and chemical fallout that can take their toll over a period of years. To keep the paint finish looking new, keep the vehicle garaged or covered whenever possible.

### Protecting Exterior Bright Metal Parts

Bright metal parts should be cleaned regularly to keep their luster. Wash with water or use chrome polish on chrome or stainless steel trim, if necessary.

Use special care with aluminum trim. To avoid damaging protective trim, never use auto or chrome polish, steam, or caustic soap to clean aluminum. A coating of wax, rubbed to high polish, is recommended for all bright metal parts.

### Washing the Vehicle

To preserve the vehicle's finish, keep it clean by washing it often.

Do not wash the vehicle in direct sunlight and use a car washing soap.

**Notice:** Do not use cleaning agents that are petroleum based or that contain acid or abrasives, as they can damage the paint, metal, or plastic on the vehicle.

Approved cleaning products can be obtained from your dealer. Follow all manufacturer directions regarding correct product usage, necessary safety precautions, and appropriate disposal of any vehicle care product. Certain cleaners contain chemicals that can damage the emblems or nameplates on the vehicle. Check the cleaning product label. If it states that it should not be used on plastic parts, do not use it on the vehicle or damage may occur and it would not be covered by the warranty.

Rinse the vehicle well, before washing and after, to remove all cleaning agents completely. If they are allowed to dry on the surface, they could stain.

Dry the finish with a soft, clean chamois or an all-cotton towel to avoid surface scratches and water spotting.

High pressure car washes could cause water to enter the vehicle. Avoid using high pressure washes closer than 30 cm (12 in) to the surface of the vehicle. Use of power washers exceeding 8,274 kPa (1,200 psi) can result in damage or removal of paint and decals.

**Notice:** Conveyor systems on some automatic car washes could damage the vehicle. There may not be enough clearance for the undercarriage. Check with the car wash manager before using the automatic car wash.

### Weatherstrips

Silicone grease on weatherstrips will make them last longer, seal better, and not stick or squeak. Apply silicone grease with a clean cloth. During very cold, damp weather frequent application may be required. See *Recommended Fluids and Lubricants* on page 11-6.

### Wheels and Trim — Aluminum or Chrome

The vehicle may have either aluminum or chrome-plated wheels.

Keep the wheels clean using a soft, clean cloth with mild soap and water. Rinse with clean water. After rinsing thoroughly, dry with a soft, clean towel. A wax may then be applied.

**Notice:** Chrome wheels and other chrome trim may be damaged if the vehicle is not washed after driving on roads that have been sprayed with magnesium, calcium or sodium chloride. These chlorides are used on roads for conditions such as ice and dust. Always wash the chrome with soap and water after exposure.

**Notice:** Do not use strong soaps, chemicals, abrasive polishes, cleaners, brushes, or cleaners that contain acid on aluminum or chrome-plated wheels, because the surface could be damaged.

The repairs would not be covered by the vehicle warranty. Use only approved cleaners on aluminum or chrome-plated wheels.

**Notice:** Never drive a vehicle that has aluminum or chrome-plated wheels through an automatic car wash that uses silicone carbide tire cleaning brushes, as this could cause damage. The repairs would not be covered by the vehicle warranty.

**Notice:** Driving the vehicle through an automatic car wash that has silicone carbide tire cleaning brushes, could damage the aluminum or chrome-plated wheels. The repairs would not be covered by the vehicle warranty. Never drive a vehicle that has aluminum or chrome-plated wheels through an automatic car wash that uses silicone carbide tire cleaning brushes.

## Windshield and Wiper Blades

Clean the outside of the windshield with glass cleaner.

Clean the rubber blades using a lint-free cloth or paper towel soaked with windshield washer fluid or a mild detergent. Wash the windshield thoroughly when cleaning the blades. Bugs, road grime, sap, and a buildup of vehicle wash/wax treatments may cause wiper streaking. Replace the wiper blades if they are worn or damaged.

Wipers can be damaged by:

- Extreme dusty conditions
- Sand and salt
- Heat and sun
- Snow and ice, without proper removal

## Tires

Use a stiff brush with tire cleaner to clean the tires.

**Notice: Using petroleum-based tire dressing products on the vehicle may damage the paint finish and/or tires. When applying a tire dressing, always wipe off any overspray from all painted surfaces on the vehicle.**

## Sheet Metal Damage

If the vehicle is damaged and requires sheet metal repair or replacement, make sure the body repair shop applies anti-corrosion material to parts repaired or replaced to restore corrosion protection.

Original manufacturer replacement parts will provide the corrosion protection while maintaining the vehicle warranty.

## Finish Damage

Any stone chips, fractures, or deep scratches in the finish should be repaired right away. Bare metal will corrode quickly and may develop into major repair expense.

Minor chips and scratches can be repaired with touch-up materials available from your dealer. Larger areas of finish damage can be corrected in your dealer's body and paint shop.

## Underbody Maintenance

Chemicals used for ice and snow removal and dust control can collect on the underbody. If these are not removed, corrosion and rust can develop on the underbody parts such as fuel lines, frame, floor pan, and exhaust system even though they have corrosion protection.

At least every spring, flush these materials from the underbody with plain water. Clean any areas where mud and debris can collect. Dirt packed in close areas of the frame should be loosened before being flushed. Your dealer or an underbody car washing system can do this.

### Chemical Paint Spotting

Some weather and atmospheric conditions can create a chemical fallout. Airborne pollutants can fall upon and attack painted surfaces on the vehicle. This damage can take two forms: blotchy, ring-shaped discolorations, and small, irregular dark spots etched into the paint surface.

### Interior Care

The interior will continue to look its best if it is cleaned often. Dust and dirt can accumulate on the upholstery and cause damage to the carpet, fabric, leather, and

plastic surfaces. Stains should be removed quickly as extreme heat could cause them to set rapidly.

Lighter colored interiors may require more frequent cleaning. Newspapers and garments that can transfer color to home furnishings can also transfer color to the interior.

Remove dust from small buttons and knobs with a small brush with soft bristles.

Your dealer has products for cleaning the interior. When cleaning the interior, only use cleaners specifically designed for the surfaces that are being cleaned. Permanent damage can result from using cleaners on surfaces for which they were not intended. Apply the cleaner directly to the cleaning cloth to prevent over-spray. Remove any accidental over-spray from other surfaces immediately.

**Notice:** Using abrasive cleaners when cleaning glass surfaces on the vehicle, could scratch the glass and/or cause damage to the rear window defogger. When cleaning the glass on the vehicle, use only a soft cloth and glass cleaner.

Cleaners can contain solvents that can become concentrated in the interior. Before using cleaners, read and adhere to all safety instructions on the label. While cleaning the interior, maintain adequate ventilation by opening the doors and windows.

Do not clean the interior using the following cleaners or techniques:

- Never use a knife or any other sharp object to remove a soil from any interior surface.
- Never use a stiff brush. It can cause damage.



- Never apply heavy pressure or rub aggressively with a cleaning cloth. Use of heavy pressure can damage the interior and does not improve the effectiveness of soil removal.
- Avoid laundry detergents or dishwashing soaps with degreasers. Using too much soap will leave a residue that leaves streaks and attracts dirt. For liquid cleaners, about 20 drops per 3.78 L (1 gal) of water is a good guide. Use only mild, neutral-pH soaps.
- Do not heavily saturate the upholstery while cleaning.
- Cleaners that contain solvents can damage the interior.

### Fabric/Carpet

Use a vacuum cleaner with a soft brush attachment to remove dust and loose dirt. A canister vacuum with rotating brushes in the nozzle may only be used on floor carpet and carpeted floor mats. For soils, always try to remove them first with plain water or club soda. Before cleaning, gently remove as much of the soil as possible using one of the following techniques:

- For liquids: gently blot the remaining soil with a paper towel. Allow the soil to absorb into the paper towel until no more can be removed.
- For solid dry soils: remove as much as possible and then vacuum.

To clean:

1. Saturate a lint-free, clean white cloth with water or club soda.
2. Remove excess moisture.

3. Start on the outside edge of the soil and gently rub toward the center. Continue cleaning, using a clean area of the cloth each time it becomes soiled.
4. Continue to gently rub the soiled area.
5. If the soil is not completely removed, use a mild soap solution and repeat the cleaning process with plain water.

If any of the soil remains, a commercial fabric cleaner or spot lifter may be necessary. Test a small hidden area for colorfastness before using a commercial upholstery cleaner or spot lifter. If the locally cleaned area gives any impression that a ring formation may result, clean the entire surface.

A paper towel can be used to blot excess moisture from the fabric or carpet after the cleaning process.

### Leather

Leather, and lighter colored leather in particular, will need more frequent cleaning to prevent the buildup of dust, dirt, and colors transferred from other items so that these do not become permanent stains.

To remove dust, a soft cloth dampened with water can be used. If a more thorough cleaning is necessary, a soft cloth dampened with a mild soap solution can be used. Your dealer has a GM approved leather cleaner available that provides superior cleaning performance when used regularly on finished automotive leathers. Allow the leather to dry naturally. Do not use heat, steam, spot lifters or spot removers, or shoe polish on leather. Many commercial leather cleaners and coatings that are sold to preserve and protect leather may permanently change the appearance and feel of the leather and are not recommended. Do not use silicone or wax-based products, or those containing organic solvents

to clean the interior because they can alter the appearance by increasing the gloss in a non-uniform manner.

### Instrument Panel, Vinyl, and Other Plastic Surfaces

To remove dust, a soft cloth dampened with water can be used. If a more thorough cleaning is necessary, a clean soft cloth dampened with a mild soap solution can be used to gently remove dust and dirt. Never use spot lifters or removers on plastic surfaces. Many commercial cleaners and coatings that are sold to preserve and protect soft plastic surfaces may permanently change the appearance and feel of the interior and are not recommended. Do not use silicone or wax-based products, or those containing organic solvents to clean the interior because they can alter the appearance by increasing the gloss in a non-uniform manner.

Some commercial products may increase gloss on the instrument panel. The increase in gloss may cause annoying reflections in the windshield and even make it difficult to see through the windshield under certain conditions.

**Notice:** Air fresheners contain solvents that may cause damage to plastics and painted surfaces. Follow the manufacturer's instructions when using air fresheners in the vehicle. If air freshener comes in contact with paint or a plastic surface, blot immediately with a soft cloth. Damage caused by using air fresheners would not be covered by the vehicle warranty.

## Care of Safety Belts

Keep belts clean and dry.

### WARNING

Do not bleach or dye safety belts. It may severely weaken them. In a crash, they might not be able to provide adequate protection. Clean safety belts only with mild soap and lukewarm water.

## Floor Mats

### WARNING

If a floor mat is the wrong size or is not properly installed, it can interfere with the accelerator pedal and/or brake pedal. Interference with the pedals can cause unintended acceleration and/or increased stopping distance which can cause a crash and injury. Make sure the floor mat does not interfere with the accelerator or brake pedal.

Use the following guidelines for proper floor mat usage.

- The original equipment floor mats were designed for your vehicle. If the floor mats need replacing, it is recommended that GM certified floor mats be purchased. Non-GM floor mats may not fit properly and may interfere with the accelerator or brake pedal. Always check that the floor mats do not interfere with the pedals.
- Use the floor mat with the correct side up. Do not turn it over.
- Do not place anything on top of the driver side floor mat.
- Use only a single floor mat on the driver side.
- Do not place one floor mat on top of another.

### Removing and Replacing the Floor Mat

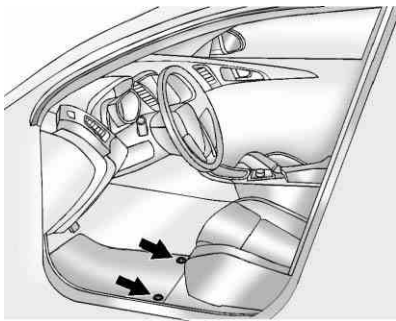

The driver side floor mat is held in place by two retainers.

1. Pull up on the rear of the floor mat to unlock each retainer and remove.
2. Reinstall by lining up the floor mat retainer openings over the carpet retainers and snap into position.
3. Make sure the floor mat is properly secured and verify that it does not interfere with the accelerator or brake pedal.

## Service and Maintenance

### General Information

General Information ..... 11-1

### Scheduled Maintenance

Scheduled Maintenance ..... 11-2

### Recommended Fluids, Lubricants, and Parts

Recommended Fluids and Lubricants ..... 11-6

Maintenance Replacement Parts ..... 11-8

### Maintenance Records

Maintenance Records ..... 11-9

## General Information

**Notice:** Maintenance intervals, checks, inspections, recommended fluids, and lubricants are necessary to keep this vehicle in good working condition. Damage caused by failure to follow scheduled maintenance might not be covered by the vehicle warranty.

As the vehicle owner, you are responsible for the scheduled maintenance in this section. We recommend having your dealer perform these services. Proper vehicle maintenance helps to keep the vehicle in good working condition, improves fuel economy, and reduces vehicle emissions for better air quality.

Because of all the different ways people use vehicles, maintenance needs vary. The vehicle might need more frequent checks and services. Please read the information under Scheduled Maintenance. To keep the vehicle in good condition, see your dealer.

The maintenance schedule is for vehicles that:

- Carry passengers and cargo within recommended limits on the Tire and Loading Information label. See *Vehicle Load Limits on page 9-21*.
- Are driven on reasonable road surfaces within legal driving limits.

## 11-2 Service and Maintenance

---

- Are driven off-road in the recommended manner. See *Off-Road Driving on page 9-7*.
- Use the recommended fuel. See *Recommended Fuel on page 9-52*.

### **WARNING**

Performing maintenance work can be dangerous. Some jobs can cause serious injury. Perform maintenance work only if you have the required know-how and the proper tools and equipment. If in doubt, see your dealer to have a qualified technician do the work. See *Doing Your Own Service Work on page 10-4*.

At your dealer, you can be certain that you will receive the highest level of service available. Your dealer has specially trained service technicians, uses genuine replacement parts, as well as, up-to-date tools and equipment to ensure fast and accurate diagnostics.

The proper replacement parts, fluids, and lubricants to use are listed in *Recommended Fluids and Lubricants on page 11-6* and *Maintenance Replacement Parts on page 11-8*. We recommend the use of genuine parts from your dealer.

### **Rotation of New Tires**

To maintain ride, handling, and performance of the vehicle, it is important that the first rotation service for new tires be performed. Tires should be rotated every 12 000 km/7,500 miles. See *Tire Rotation on page 10-57*.

## **Scheduled Maintenance**

### **When the Change Engine Oil Soon Message Displays**

Change engine oil and filter. See *Engine Oil on page 10-10*. An *Emission Control Service*.

When the CHANGE ENGINE OIL SOON message displays, service is required for the vehicle as soon as possible, within the next 1 000 km/600 miles. If driving under the best conditions, the engine oil life system might not indicate the need for vehicle service for more than a year. The engine oil and filter must be changed at least once a year and the oil life system must be reset. Your dealer has trained service technicians who will perform this work and reset the system.

If the engine oil life system is reset accidentally, service the vehicle within 5 000 km/3,000 miles since the last service. Reset the oil life system whenever the oil is changed. See *Engine Oil Life System* on page 10-14.

### Every Engine Oil Change

- Change engine oil and filter. Reset oil life system. See *Engine Oil* on page 10-10 and *Engine Oil Life System* on page 10-14. An *Emission Control Service*.
- Engine coolant level check. See *Engine Coolant* on page 10-17.
- Engine cooling system inspection. Visual inspection of hoses, pipes, fittings, and clamps and replacement, if needed.
- Windshield washer fluid level check. See *Washer Fluid* on page 10-23.

- Windshield wiper blade inspection for wear, cracking, or contamination and windshield and wiper blade cleaning, if contaminated. See *Exterior Care* on page 10-82. Worn or damaged wiper blade replacement. See *Wiper Blade Replacement* on page 10-30.
- Tire inflation pressures check. See *Tire Pressure* on page 10-51.
- Tire wear inspection. See *Tire Inspection* on page 10-57.
- Rotate tires if necessary. See *Tire Rotation* on page 10-57.
- Fluids visual leak check (or every 12 months, whichever occurs first). A leak in any system must be repaired and the fluid level checked.
- Engine air cleaner filter inspection. See *Engine Air Cleaner/Filter* on page 10-15.
- Brake system inspection (or every 12 months, whichever occurs first).
- Steering and suspension inspection. Visual inspection for damaged, loose, or missing parts or signs of wear.
- Body hinges and latches, key lock cylinders, folding seat hardware, and sunroof (if equipped) lubrication. See *Recommended Fluids and Lubricants* on page 11-6. More frequent lubrication may be required when the vehicle is exposed to a corrosive environment. Applying silicone grease on weatherstrips with a clean cloth makes them last longer, seal better, and not stick or squeak.
- Restraint system component check. See *Safety System Check* on page 3-24.

## 11-4 Service and Maintenance

---

- Fuel system inspection for damage or leaks.
- Exhaust system and nearby heat shields inspection for loose or damaged components.

### Additional Required Services

#### Every 12 000 km/7,500 Miles

- Rotate tires. Tires should be rotated every 12 000 km/7,500 miles. See *Tire Rotation on page 10-57*.

#### At Each Fuel Stop

- Engine oil level check. See *Engine Oil on page 10-10*.
- Engine coolant level check. See *Engine Coolant on page 10-17*.
- Windshield washer fluid level check. See *Washer Fluid on page 10-23*.

#### Once a Month

- Tire inflation check. See *Tire Pressure on page 10-51*.
- Tire wear inspection. See *Tire Inspection on page 10-57*.
- Sunroof track and seal inspection, if equipped. See *Sunroof on page 2-18*.

#### Once a Year

- See *Starter Switch Check on page 10-28*.
- See *Automatic Transmission Shift Lock Control Function Check on page 10-28*.
- See *Ignition Transmission Lock Check on page 10-29*.
- See *Park Brake and P (Park) Mechanism Check on page 10-29*.
- Accelerator pedal check for damage, high effort, or binding. Replace if needed.
- Underbody flushing service.

- Hood/Decklid/Liftgate/Liftglass Support Gas Strut Service: Visually inspect gas strut, if equipped, for signs of wear, cracks, or other damage. Check the hold open ability of the gas strut. Contact your dealer if service is required.

#### First Engine Oil Change After Every 40 000 km/25,000 Miles

- Passenger compartment air filter replacement (or every 24 months, whichever occurs first). More frequent replacement may be needed if you drive in areas with heavy traffic, areas with poor air quality, or areas with high dust levels. Replacement may also be needed if you notice reduced air flow, windows fogging up, or odors. Your dealer can help you determine when it is the right time to replace the filter.



**First Engine Oil Change After Every 80 000 km/50,000 Miles**

- Engine air cleaner filter replacement. See *Engine Air Cleaner/Filter on page 10-15*.
- Automatic transmission fluid change (severe service) for vehicles mainly driven in heavy city traffic in hot weather, in hilly or mountainous terrain, when frequently towing a trailer, or used for taxi, police, or delivery service. See *Automatic Transmission Fluid on page 10-15*.
- Transfer case fluid change (severe service) for vehicles mainly driven in hilly or mountainous terrain, when frequently towing a trailer, or used for taxi, police, or delivery service.

- Evaporative control system inspection. Check all fuel and vapor lines and hoses for proper hook-up, routing, and condition. Check that the purge valve, if the vehicle has one, works properly. Replace as needed. *An Emission Control Service. The U.S. Environmental Protection Agency or the California Air Resources Board has determined that the failure to perform this maintenance item will not nullify the emission warranty or limit recall liability prior to the completion of the vehicle's useful life. We, however, urge that all recommended maintenance services be performed at the indicated intervals and the maintenance be recorded.*

**First Engine Oil Change After Every 160 000 km/100,000 Miles**

- Automatic transmission fluid change (normal service). See *Automatic Transmission Fluid on page 10-15*.
- Transfer case fluid change (normal service).
- Spark plug replacement and spark plug wires inspection. *An Emission Control Service.*

**First Engine Oil Change After Every 240 000 km/150,000 Miles**

- Engine cooling system drain, flush, and refill (or every five years, whichever occurs first). See *Cooling System on page 10-16. An Emission Control Service.*
- Engine drive belts inspection for fraying, excessive cracks, or obvious damage (or every 10 years, whichever occurs first). Replace, if needed.

## Recommended Fluids, Lubricants, and Parts

### Recommended Fluids and Lubricants

| Usage  | Fluid/Lubricant  |
|--|--|
| Engine Oil   | The engine requires engine oil approved to the dexos specification. Oils meeting this specification can be identified with the dexos certification mark. Look for and use only an engine oil that displays the dexos certification mark of the proper viscosity grade. See <i>Engine Oil on page 10-10</i> . |
| Engine Coolant                                       | 50/50 mixture of clean, drinkable water and use only DEX-COOL Coolant. See <i>Engine Coolant on page 10-17</i> .   |
| Hydraulic Brake System                               | DOT 3 Hydraulic Brake Fluid (GM Part No. 88862806, in Canada 88862807).  |
| Windshield Washer                                    | Optikleen <sup>®</sup> Washer Solvent.   |
| Hydraulic Power Steering System<br>(V6 engines only) | DEXRON <sup>®</sup> -VI Automatic Transmission Fluid.  |
| Automatic Transmission                               | DEXRON <sup>®</sup> -VI Automatic Transmission Fluid.  |

| <b>Usage</b>  | <b>Fluid/Lubricant</b>  |
|---|---|
| Transfer Case (All-Wheel Drive)   | Transfer Case Fluid (GM Part No. 88861950, in Canada 88861951).   |
| Key Lock Cylinders  | Multi-Purpose Lubricant, Superlube (GM Part No. 12346241, in Canada 10953474).  |
| Hood Latch Assembly, Secondary Latch, Pivots, Spring Anchor, and Release Pawl | Lubriplate Lubricant Aerosol (GM Part No. 12346293, in Canada 992723) or lubricant meeting requirements of NLGI #2, Category LB or GC-LB. |
| Hood, Door, and Folding Seat Hinges   | Multi-Purpose Lubricant, Superlube (GM Part No. 12346241, in Canada 10953474).  |
| Power Liftgate Actuator Ball Joint  | Multi-Purpose Lubricant (GM Part No. 89021668, in Canada 89021674).   |
| Weatherstrip Conditioning   | Weatherstrip Lubricant (GM Part No. 3634770, in Canada 10953518) or Dielectric Silicone Grease (GM Part No. 12345579, in Canada 992887).  |

## 11-8 Service and Maintenance

---

### Maintenance Replacement Parts

Replacement parts identified below by name, part number, or specification can be obtained from your dealer.

| Part                                     | GM Part Number | ACDelco Part Number |
|--|----------------|---------------------|
| Engine Air Cleaner/Filter                | 25899727       | A3138C              |
| Engine Oil Filter                        |                |                     |
| 2.4L L4 Engine                           | 12605566       | PF457G              |
| 3.0L V6 Engine                           | 89017525       | PF63                |
| Passenger Compartment Air Filter Element | 20901295       | CF177               |
| Spark Plugs                              |                |                     |
| 2.4L L4 Engine                           | 12620540       | 41-108              |
| 3.0L V6 Engine                           | 12622561       | 41-109              |
| Wiper Blades                             |                |                     |
| Driver Side – 60 cm (23.6 in)            | 20794123       | —                   |
| Passenger Side – 42.5 cm (16.7 in)       | 20794124       | —                   |
| Rear – 32.5 cm (12.8 in)                 | 25788783       | —                   |











## Technical Data

### Vehicle Identification

|   |      |
|---|------|
| Vehicle Identification Number (VIN) ..... | 12-1 |
| Service Parts Identification Label .....  | 12-1 |

### Vehicle Data

|                                     |      |
|-------------------------------------|------|
| Capacities and Specifications ..... | 12-2 |
| Engine Drive Belt Routing ...       | 12-4 |

## Vehicle Identification

### Vehicle Identification Number (VIN)



This legal identifier is in the front corner of the instrument panel, on the left side of the vehicle. It can be seen through the windshield from outside. The VIN also appears on the Vehicle Certification and Service Parts labels and certificates of title and registration.

### Engine Identification

The eighth character in the VIN is the engine code. This code identifies the vehicle's engine, specifications, and replacement parts. See "Engine Specifications" under *Capacities and Specifications* on page 12-2 for the vehicle's engine code.

### Service Parts Identification Label

This label, on the inside of the glove box, has the following information:

- Vehicle Identification Number (VIN).
- Model designation.
- Paint information.
- Production options and special equipment.

Do not remove this label from the vehicle.

## Vehicle Data

### Capacities and Specifications

| Application                        | Capacities   |          |
|------------------------------------|--|----------|
|                                    | Metric   | English  |
| Air Conditioning Refrigerant R134a | For the air conditioning system refrigerant charge amount, see the refrigerant label located under the hood. See your dealer for more information. |          |
| Engine Cooling System              |  |          |
| 2.4L L4 Engine                     | 7.8 L  | 8.2 qt   |
| 3.0L V6 Engine                     | 10.2 L   | 10.8 qt  |
| Engine Oil with Filter             |  |          |
| 2.4L L4 Engine                     | 4.7 L  | 5.0 qt   |
| 3.0L V6 Engine                     | 5.7 L  | 6.0 qt   |
| Fuel Tank                          |  |          |
| 2.4L L4 Engine                     | 71.1 L   | 18.8 gal |
| 3.0L V6 Engine                     | 79.1 L   | 20.9 gal |

| Application  | Capacities |           |
|--|------------|-----------|
|  | Metric     | English   |
| Transmission Fluid (Drain and Refill)  |            |           |
| 2.4L L4 6-Speed Automatic*   | 8.5 L      | 9.0 qt    |
| 3.0L V6 6-Speed Automatic*   | 9.0 L      | 9.5 qt    |
| Wheel Nut Torque   | 190 N•m    | 140 lb ft |
| *See <i>Automatic Transmission Fluid</i> on page 10-15 for information on checking fluid level.  |            |           |
| All capacities are approximate. When adding, be sure to fill to the approximate level, as recommended in this manual. Recheck fluid level after filling. |            |           |

### Engine Specifications

| Engine  | VIN Code | Transmission | Spark Plug Gap    |
|---------|----------|--------------|-------------------|
| 2.4L L4 | C        | Automatic    | 0.9 mm (0.035 in) |
| 3.0L V6 | 5        | Automatic    | 1.1 mm (0.043 in) |

**Engine Drive Belt Routing**

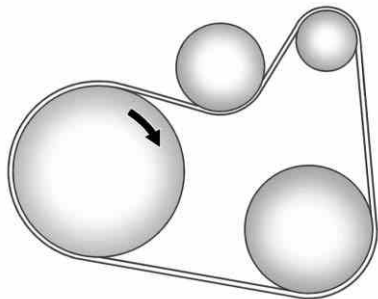

**2.4L L4 Engine**

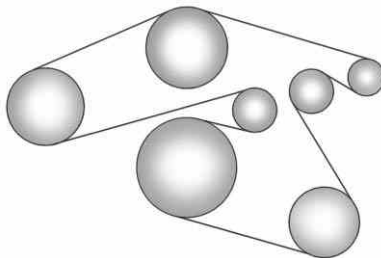

**3.0L V6 Engine**

## Customer Information

### Customer Information

|  |       |
|--|-------|
| Customer Satisfaction Procedure (U.S. and Canada) .....                    | 13-1  |
| Customer Satisfaction Procedure (Mexico) .....                             | 13-3  |
| Customer Assistance Offices (U.S. and Canada) .....                        | 13-4  |
| Customer Assistance Offices (Mexico) .....                                 | 13-5  |
| Customer Assistance for Text Telephone (TTY) Users (U.S. and Canada) ..... | 13-6  |
| Online Owner Center .....  | 13-6  |
| GM Mobility Reimbursement Program (U.S. and Canada) .....                  | 13-7  |
| Roadside Assistance Program (U.S. and Canada) .....                        | 13-7  |
| Roadside Assistance Program (Mexico) .....                                 | 13-9  |
| Scheduling Service Appointments (U.S. and Canada) .....                    | 13-10 |

|   |       |
|---|-------|
| Courtesy Transportation Program (U.S. and Canada) ..... | 13-10 |
| Collision Damage Repair (U.S. and Canada) .....         | 13-11 |
| Service Publications Ordering Information .....         | 13-14 |

### Reporting Safety Defects

|  |       |
|--|-------|
| Reporting Safety Defects to the United States Government ..... | 13-15 |
| Reporting Safety Defects to the Canadian Government .....      | 13-15 |
| Reporting Safety Defects to General Motors .....               | 13-16 |

### Vehicle Data Recording and Privacy

|   |       |
|---|-------|
| Vehicle Data Recording and Privacy .....    | 13-16 |
| Event Data Recorders .....                  | 13-16 |
| OnStar® .....                               | 13-17 |
| Navigation System .....                     | 13-17 |
| Radio Frequency Identification (RFID) ..... | 13-18 |
| Radio Frequency Statement .....             | 13-18 |

## Customer Information

### Customer Satisfaction Procedure (U.S. and Canada)

Your satisfaction and goodwill are important to the dealer and to GMC. Normally, any concerns with the sales transaction or the operation of the vehicle will be resolved by the dealer's sales or service departments. Sometimes, however, despite the best intentions of all concerned, misunderstandings can occur. If your concern has not been resolved to your satisfaction, the following steps should be taken:

**STEP ONE:** Discuss your concern with a member of dealership management. Normally, concerns can be quickly resolved at that level. If the matter has already been reviewed with the sales, service, or parts manager, contact the owner of the dealership or the general manager.

## 13-2 Customer Information

---

**STEP TWO:** If after contacting a member of dealership management, it appears your concern cannot be resolved by the dealership without further help, in the U.S., call 1-800-462-8782. In Canada, call General Motors of Canada Customer Communication at 1-800-263-3777 (English) or 1-800-263-7854 (French).

We encourage you to call the toll-free number in order to give your inquiry prompt attention. Have the following information available to give the Customer Assistance representative:

- Vehicle Identification Number (VIN). This is available from the vehicle registration or title, or the plate at the top left of the instrument panel and visible through the windshield.
- Dealership name and location.
- Vehicle delivery date and present mileage.

When contacting GMC, remember that your concern will likely be resolved at a dealer's facility. That is why we suggest following Step One first.

### **STEP THREE — U.S. Owners:**

Both General Motors and the dealer are committed to making sure you are completely satisfied with the new vehicle. However, if you continue to remain unsatisfied after following the procedure outlined in Steps One and Two, you can file with the Better Business Bureau (BBB) Auto Line<sup>®</sup> Program to enforce your rights.

The BBB Auto Line Program is an out-of-court program administered by the Council of Better Business Bureaus to settle automotive disputes regarding vehicle repairs or the interpretation of the New Vehicle Limited Warranty. Although you may be required to resort to this informal dispute resolution program prior to filling out a court action, use of the program is free of charge and your

case will generally be heard within 40 days. If you do not agree with the decision given in your case, you may reject it and proceed with any other venue for relief available to you.

You may contact the BBB Auto Line Program using the toll-free telephone number or write them at the following address:

BBB Auto Line Program  
Council of Better Business  
Bureaus, Inc.  
4200 Wilson Boulevard  
Suite 800  
Arlington, VA 22203-1838

Telephone: 1-800-955-5100  
[www.dr.bbb.org/goauto](http://www.dr.bbb.org/goauto)

This program is available in all 50 states and the District of Columbia. Eligibility is limited by vehicle age, mileage, and other factors. General Motors reserves the right to change eligibility limitations and/or discontinue its participation in this program.

**STEP THREE — Canadian**

**Owners:** In the event that you do not feel your concerns have been addressed after following the procedure outlined in Steps One and Two, General Motors of Canada Limited wants you to be aware of its participation in a no-charge Mediation/Arbitration Program. General Motors of Canada Limited has committed to binding arbitration of owner disputes involving factory-related vehicle service claims. The program provides for the review of the facts involved by an impartial third party arbiter, and may include an informal hearing before the arbiter. The program is designed so that the entire dispute settlement process, from the time you file your complaint to the final decision, should be completed in approximately 70 days. We believe our impartial program offers advantages over courts in most jurisdictions because it is informal, quick, and free of charge.

For further information concerning eligibility in the Canadian Motor Vehicle Arbitration Plan (CAMVAP), call toll-free 1-800-207-0685, or call the General Motors Customer Communication Centre, 1-800-263-3777 (English), 1-800-263-7854 (French), or write to:

Mediation/Arbitration Program  
c/o Customer Communication  
Centre  
General Motors of Canada Limited  
Mail Code: CA1-163-005  
1908 Colonel Sam Drive  
Oshawa, Ontario L1H 8P7  
Telephone: 1-800-955-5100

The inquiry should be accompanied by the Vehicle Identification Number (VIN).

**Customer Satisfaction  
Procedure (Mexico)**

Did you get the Warranty Extension Plan? This plan is recommended by General Motors to supplement the warranty included with the new vehicle purchase.

See your dealer for details.

**Customer Assistance  
Procedure**

Owner satisfaction and goodwill are very important to your dealer and General Motors.

Normally, any problem with the transaction, sale, or usage of the vehicle must be handled by your dealer sales or service departments.

## 13-4 Customer Information

---

However, we recognize that despite the good intentions of all parties involved, sometimes a misunderstanding may occur.

If you have a problem that has not been satisfactorily handled through the normal means, we suggest the following steps:

### STEP ONE

Explain your case to the dealer service agent, service manager, dealer sales agent, or sales manager, depending on your case.

Make sure that they have all necessary information. They are interested in your continual satisfaction.

### STEP TWO

If you are not satisfied, please contact the general manager or the dealership owner to ask for their help. If they are not able to resolve your case, ask them to contact the right people at General Motors for support, if needed.

### STEP THREE

If your case is not resolved in a reasonable amount of time by your dealer, please call the General Motors Customer Assistance Center (CAC) and provide the following information:

- Name
- Address
- Phone number
- Model year
- Brand
- Vehicle Identification Number (VIN)
- Mileage
- Delivery date
- Description of the problem
- Dealership name
- Dealership address

See *Customer Assistance Offices (U.S. and Canada)* on page 13-4 or *Customer Assistance Offices (Mexico)* on page 13-5 for more information.

## Customer Assistance Offices (U.S. and Canada)

GMC encourages customers to call the toll-free number for assistance. However, if a customer wishes to write or e-mail GMC, the letter should be addressed to:

### United States

GMC Customer Assistance Center  
P.O. Box 33172  
Detroit, MI 48232-5172

[www.GMC.com](http://www.GMC.com)

1-800-GMC-8782 (1-800-462-8782)  
1-800-462-8583 (For Text Telephone Devices (TTYs))  
Roadside Assistance:  
1-800-462-8782



From Puerto Rico:

1-800-496-9992 (English)  
1-800-496-9993 (Spanish)

From U.S. Virgin Islands:

1-800-496-9994

### **Canada**

General Motors of Canada Limited  
Customer Communication Centre,  
Mail Code: CA1-163-005  
1908 Colonel Sam Drive  
Oshawa, Ontario L1H 8P7  
www.gmc.ca

1-800-263-3777 (English)  
1-800-263-7854 (French)  
1-800-263-3830 (For Text  
Telephone Devices (TTYs))  
Roadside Assistance:  
1-800-268-6800

### **All Overseas Locations**

Please contact the local General  
Motors Business Unit.

### **Mexico, Central America and Caribbean Islands/Countries (Except Puerto Rico and U.S. Virgin Islands)**

General Motors de Mexico, S. de  
R.L. de C.V.  
Customer Assistance Center  
Av. Ejercito Nacional #843  
Col. Granada  
C.P. 11520, Mexico, D.F.

01-800-466-0801  
Long Distance: 011-52-53 29 0801

### **Customer Assistance Offices (Mexico)**

To contact the Customer Assistance  
Center (CAC), use the phone  
numbers listed in this section.  
Customer assistance is available  
Monday through Friday, 08:00 to  
20:00 hours, and Saturdays from  
08:00 to 15:00 hours.

All e-mail inquiries to the Customer  
Assistance Center (CAC) should be  
sent to: [cac.gmc@gm.com](mailto:cac.gmc@gm.com).

### **Mexico**

**From Mexico City**  
5329-0812

**From Other Mexico Locations**  
01-800-466-0812

**United States and Canada**  
1-866-466-8191

**Costa Rica**  
00-800-052-1005

**Guatemala**  
1-800-999-5252

**Panama**  
00-800-052-0001

**Dominican Republic**  
1-888-751-5301

**El Salvador**  
800-6273

**Honduras**  
800-0122-6101

### Customer Assistance for Text Telephone (TTY) Users (U.S. and Canada)

To assist customers who are deaf, hard of hearing, or speech impaired and who use Text Telephones (TTYs), GMC has TTY equipment available at its Customer Assistance Center. Any TTY user can communicate with GMC by dialing: 1-800-462-8583. TTY users in Canada can dial 1-800-263-3830.

### Online Owner Center

#### GMC Owner Center (U.S.) [www.gmcownercenter.com](http://www.gmcownercenter.com)

Information and services customized for your specific vehicle — all in one convenient place.

- Digital owner manual, warranty information, and more.
- Storage for online service and maintenance records.

- GMC dealer locator for service nationwide.
- Exclusive privileges and offers.
- Recall notices for your specific vehicle.
- OnStar and GM Cardmember Services Earnings summaries.

#### Other Helpful Links

GMC — [www.gmc.com](http://www.gmc.com)

GMC Merchandise —  
[www.gmccollection.com](http://www.gmccollection.com)

Help Center — [www.gmc.com/helpcenter](http://www.gmc.com/helpcenter)

- FAQ (Frequently Asked Questions)
- Contact Us

#### My GM Canada [www.gm.ca](http://www.gm.ca)

My GM Canada is a password-protected section of [www.gm.ca](http://www.gm.ca) where you can save information on GM vehicles, get personalized offers, and use handy tools and forms with greater ease.

Here are a few of the valuable tools and services you will have access to:

- My Showroom: Find and save information on vehicles and current offers in your area.
- My Dealers: Save details such as address and phone number for each of your preferred GM dealers.
- My Driveway: Access quick links to parts and service estimates, check trade-in values, or schedule a service appointment by adding the vehicles you own to your driveway profile.
- My Preferences: Manage your profile and use tools and forms with greater ease.

To sign up, visit the My GM.ca section within [www.gm.ca](http://www.gm.ca).

## GM Mobility Reimbursement Program (U.S. and Canada)



This program is available to qualified applicants for cost reimbursement of eligible aftermarket adaptive equipment required for the vehicle, such as hand controls or a wheelchair/scooter lift for the vehicle.

For more information on the limited offer, visit [www.gmmobility.com](http://www.gmmobility.com) or call the GM Mobility Assistance Center at 1-800-323-9935. Text Telephone (TTY) users, call 1-800-833-9935.

General Motors of Canada also has a Mobility Program. Call 1-800-GM-DRIVE (463-7483) for details. TTY users call 1-800-263-3830.

## Roadside Assistance Program (U.S. and Canada)

For U.S.-purchased vehicles, call **1-800-462-8782; (Text Telephone (TTY): 1-888-889-2438)**.

For Canadian-purchased vehicles, call **1-800-268-6800**.

Service is available 24 hours a day, 365 days a year.

### Calling for Assistance

When calling Roadside Assistance, have the following information ready:

- Your name, home address, and home telephone number
- Telephone number of your location

- Location of the vehicle
- Model, year, color, and license plate number of the vehicle
- Odometer reading, Vehicle Identification Number (VIN), and delivery date of the vehicle
- Description of the problem

### Coverage

Services are provided up to 5 years/160 000 km (100,000 miles), whichever comes first.

In the U.S., anyone driving the vehicle is covered. In Canada, a person driving the vehicle without permission from the owner is not covered.

Roadside Assistance is not a part of the New Vehicle Limited Warranty. GMC and General Motors of Canada Limited reserve the right to make any changes or discontinue the Roadside Assistance program at any time without notification.

## 13-8 Customer Information

---

GMC and General Motors of Canada Limited reserve the right to limit services or payment to an owner or driver if they decide the claims are made too often, or the same type of claim is made many times.

### Services Provided

- **Emergency Fuel Delivery:** Delivery of enough fuel for the vehicle to get to the nearest service station.
- **Lock-Out Service:** Service to unlock the vehicle if you are locked out. A remote unlock may be available if you have OnStar<sup>®</sup>. For security reasons, the driver must present identification before this service is given.

- **Emergency Tow From a Public Road or Highway:** Tow to the nearest GMC dealer for warranty service, or if the vehicle was in a crash and cannot be driven. Assistance is also given when the vehicle is stuck in the sand, mud, or snow.
- **Flat Tire Change:** Service to change a flat tire with the spare tire. The spare tire, if equipped, must be in good condition and properly inflated. It is the owner's responsibility for the repair or replacement of the tire if it is not covered by the warranty.
- **Battery Jump Start:** Service to jump start a dead battery.
- **Trip Routing Service:** Detailed maps of North America when requested either with the most direct route or the most scenic route. Additional travel information is also available. Allow three weeks for delivery.
- **Trip Interruption Benefits and Assistance:** If your trip is interrupted due to a warranty failure, incidental expenses may be reimbursed during the 5 years/(160 000 km) 100,000 miles Powertrain warranty period. Items considered are hotel, meals, and rental car.

### Services Not Included in Roadside Assistance

- Impound towing caused by violation of any laws.
- Legal fines.
- Mounting, dismounting, or changing of snow tires, chains, or other traction devices.
- Towing or services for vehicles driven on a non-public road or highway.

## Services Specific to Canadian-Purchased Vehicles

- **Fuel Delivery:** Reimbursement is approximately \$5 Canadian. Diesel fuel delivery may be restricted. Propane and other fuels are not provided through this service.
- **Lock-Out Service:** Vehicle registration is required.
- **Trip Routing Service:** Limit of six requests per year.
- **Trip Interruption Benefits and Assistance:** Must be over 250 kilometres from where your trip was started to qualify. General Motors of Canada Limited requires pre-authorization, original detailed receipts, and a copy

of the repair orders. Once authorization has been received, the Roadside Assistance advisor will help to make arrangements and explain how to receive payment.

- **Alternative Service:** If assistance cannot be provided right away, the Roadside Assistance advisor may give permission to get local emergency road service. You will receive payment, up to \$100, after sending the original receipt to Roadside Assistance. Mechanical failures may be covered, however any cost for parts and labor for repairs not covered by the warranty are the owner responsibility.

## Roadside Assistance Program (Mexico)

Roadside Assistance is available 24 hours a day, 365 days of the year.

For detailed information about Roadside Assistance, please see the brochure provided with your new vehicle or visit our website at: [www.gmc.com.mx](http://www.gmc.com.mx). Navigate the site and click on "Asistencia en el Camino." E-mail correspondence should be sent to: [asistencia.gmc@gm.com](mailto:asistencia.gmc@gm.com).

To contact Roadside Assistance by phone, use the following numbers:

### Mexico

01-800-466-0801

### United States

1-866-466-8902

### Canada

1-800-268-6800

### **Scheduling Service Appointments (U.S. and Canada)**

When the vehicle requires warranty service, contact the dealer and request an appointment. By scheduling a service appointment and advising the service consultant of your transportation needs, the dealer can help minimize your inconvenience.

If the vehicle cannot be scheduled into the service department immediately, keep driving it until it can be scheduled for service, unless, of course, the problem is safety related. If it is, please call the dealership, let them know this, and ask for instructions.

If the dealer requests you to bring the vehicle for service, you are urged to do so as early in the work day as possible to allow for the same day-repair.

### **Courtesy Transportation Program (U.S. and Canada)**

To enhance your ownership experience, we and our participating dealers are proud to offer Courtesy Transportation, a customer support program for vehicles with the Bumper-to-Bumper (Base Warranty Coverage period in Canada), extended powertrain, and/or hybrid-specific warranties in both the U.S. and Canada.

Several Courtesy Transportation options are available to assist in reducing inconvenience when warranty repairs are required.

Courtesy Transportation is not a part of the New Vehicle Limited Warranty. A separate booklet entitled "Warranty and Owner Assistance Information" furnished with each new vehicle provides detailed warranty coverage information.

### **Transportation Options**

Warranty service can generally be completed while you wait. However, if you are unable to wait, GM helps to minimize inconvenience by providing several transportation options. Depending on the circumstances, the dealer can offer one of the following:

#### **Shuttle Service**

Shuttle service is the preferred means of offering Courtesy Transportation. Dealers may provide shuttle service to get you to your destination with minimal interruption of your daily schedule. This includes one-way or round-trip shuttle service within reasonable time and distance parameters of the dealer's area.

### **Public Transportation or Fuel Reimbursement**

If the vehicle requires overnight warranty repairs, and public transportation is used instead of the dealer's shuttle service, the expense must be supported by original receipts and can only be up to the maximum amount allowed by GM for shuttle service. In addition, for U.S. customers, should you arrange transportation through a friend or relative, limited reimbursement for reasonable fuel expenses may be available. Claim amounts should reflect actual costs and be supported by original receipts. See the dealer for information regarding the allowance amounts for reimbursement of fuel or other transportation costs.

### **Courtesy Rental Vehicle**

The dealer may arrange to provide you with a courtesy rental vehicle or reimburse you for a rental vehicle that you obtain if the vehicle is kept for an overnight warranty repair.

Rental reimbursement will be limited and must be supported by original receipts. This requires that you sign and complete a rental agreement and meet state/provincial, local, and rental vehicle provider requirements. Requirements vary and may include minimum age requirements, insurance coverage, credit card, etc. You are responsible for fuel usage charges and may also be responsible for taxes, levies, usage fees, excessive mileage, or rental usage beyond the completion of the repair.

It may not be possible to provide a like vehicle as a courtesy rental.

### **Additional Program Information**

All program options, such as shuttle service, may not be available at every dealer. Please contact the dealer for specific information about availability. All Courtesy Transportation arrangements will be administered by appropriate dealer personnel.

*General Motors reserves the right to unilaterally modify, change, or discontinue Courtesy Transportation at any time and to resolve all questions of claim eligibility pursuant to the terms and conditions described herein at its sole discretion.*

### **Collision Damage Repair (U.S. and Canada)**

If the vehicle is involved in a collision and it is damaged, have the damage repaired by a qualified technician using the proper equipment and quality replacement parts. Poorly performed collision repairs diminish the vehicle resale value, and safety performance can be compromised in subsequent collisions.

### **Collision Parts**

Genuine GM Collision parts are new parts made with the same materials and construction methods as the parts with which the vehicle was originally built. Genuine GM Collision parts are the best choice to ensure that the vehicle's designed appearance, durability, and safety are preserved. The use of Genuine GM parts can help maintain the GM New Vehicle Limited Warranty.

Recycled original equipment parts may also be used for repair. These parts are typically removed from vehicles that were total losses in prior crashes. In most cases, the parts being recycled are from undamaged sections of the vehicle. A recycled original equipment GM part may be an acceptable choice to maintain the vehicle's originally designed appearance and safety performance; however, the history of these parts is not known. Such parts are not covered by the GM New

Vehicle Limited Warranty, and any related failures are not covered by that warranty.

Aftermarket collision parts are also available. These are made by companies other than GM and may not have been tested for the vehicle. As a result, these parts may fit poorly, exhibit premature durability/corrosion problems, and may not perform properly in subsequent collisions. Aftermarket parts are not covered by the GM New Vehicle Limited Warranty, and any vehicle failure related to such parts is not covered by that warranty.

### **Repair Facility**

GM also recommends that you choose a collision repair facility that meets your needs before you ever need collision repairs. The dealer may have a collision repair center with GM-trained technicians and state-of-the-art equipment, or be able to recommend a collision repair

center that has GM-trained technicians and comparable equipment.

### **Insuring The Vehicle**

Protect your investment in the GM vehicle with comprehensive and collision insurance coverage. There are significant differences in the quality of coverage afforded by various insurance policy terms. Many insurance policies provide reduced protection to the GM vehicle by limiting compensation for damage repairs by using aftermarket collision parts. Some insurance companies will not specify aftermarket collision parts. When purchasing insurance, we recommend that you ensure that the vehicle will be repaired with GM original equipment collision parts. If such insurance coverage is not available from your current insurance carrier, consider switching to another insurance carrier.



If the vehicle is leased, the leasing company may require you to have insurance that ensures repairs with Genuine GM Original Equipment Manufacturer (OEM) parts or Genuine Manufacturer replacement parts. Read the lease carefully, as you may be charged at the end of the lease for poor quality repairs.

### If a Crash Occurs

If there has been an injury, call emergency services for help. Do not leave the scene of a crash until all matters have been taken care of. Move the vehicle only if its position puts you in danger, or you are instructed to move it by a police officer.

Give only the necessary information to police and other parties involved in the crash.

For emergency towing see *Roadside Assistance Program (U.S. and Canada)* on page 13-7 or *Roadside Assistance Program (Mexico)* on page 13-9.

Gather the following information:

- Driver name, address, and telephone number.
- Driver license number.
- Owner name, address, and telephone number.
- Vehicle license plate number.
- Vehicle make, model, and model year.
- Vehicle Identification Number (VIN).
- Insurance company and policy number.
- General description of the damage to the other vehicle.

Choose a reputable repair facility that uses quality replacement parts. See “Collision Parts” earlier in this section.

If the airbag has inflated, see *What Will You See After an Airbag Inflates?* on page 3-31.

### Managing the Vehicle Damage Repair Process

In the event that the vehicle requires damage repairs, GM recommends that you take an active role in its repair. If you have a pre-determined repair facility of choice, take the vehicle there, or have it towed there. Specify to the facility that any required replacement collision parts be original equipment parts, either new Genuine GM parts or recycled original GM parts. Remember, recycled parts will not be covered by the GM vehicle warranty.

Insurance pays the bill for the repair, but you must live with the repair. Depending on your policy limits, your insurance company may initially value the repair using aftermarket parts. Discuss this with the repair professional, and insist on Genuine GM parts. Remember, if the vehicle is leased, you may be obligated to have the vehicle repaired with Genuine GM parts, even if your insurance coverage does not pay the full cost.

## 13-14 Customer Information

---

If another party's insurance company is paying for the repairs, you are not obligated to accept a repair valuation based on that insurance company's collision policy repair limits, as you have no contractual limits with that company. In such cases, you can have control of the repair and parts choices as long as the cost stays within reasonable limits.

### Service Publications Ordering Information

#### Service Manuals

Service Manuals have the diagnosis and repair information on the engines, transmission, axle, suspension, brakes, electrical, steering, body, etc.

#### Service Bulletins

Service Bulletins give additional technical service information needed to knowledgeable service General Motors cars and trucks.

Each bulletin contains instructions to assist in the diagnosis and service of the vehicle.

#### Owner Information

Owner publications are written specifically for owners and intended to provide basic operational information about the vehicle. The Owner Manual includes the Maintenance Schedule for all models.

In-Portfolio: Includes a Portfolio, Owner Manual, and Warranty Booklet.

RETAIL SELL PRICE:  
\$35.00 (U.S.) plus handling and shipping fees.

Without Portfolio: Owner Manual only.

RETAIL SELL PRICE:  
\$25.00 (U.S.) plus handling and shipping fees.

#### Current and Past Models

Technical Service Bulletins and Manuals are available for current and past model GM vehicles.

**ORDER TOLL FREE:**  
**1-800-551-4123 Monday - Friday**  
**8:00 AM - 6:00 PM Eastern Time**

For Credit Card Orders Only (VISA-MasterCard-Discover), visit Helm, Inc. at: [www.helminc.com](http://www.helminc.com).

Or write to:

Helm, Incorporated  
P.O. Box 07130  
Detroit, MI 48207

Prices are subject to change without notice and without incurring obligation. Allow ample time for delivery.

All listed prices are quoted in U.S. funds. Make checks payable in U.S. funds.

## Reporting Safety Defects

### Reporting Safety Defects to the United States Government

If you believe that your vehicle has a defect which could cause a crash or could cause injury or death, you should immediately inform the National Highway Traffic Safety Administration (NHTSA) in addition to notifying General Motors.

If NHTSA receives similar complaints, it may open an investigation, and if it finds that a safety defect exists in a group of vehicles, it may order a recall and remedy campaign.

However, NHTSA cannot become involved in individual problems between you, your dealer, or General Motors.

To contact NHTSA, you may call the Vehicle Safety Hotline toll-free at 1-888-327-4236 (TTY: 1-800-424-9153); go to <http://www.safercar.gov>; or write to:

Administrator, NHTSA  
1200 New Jersey Avenue, S.E.  
Washington, D.C. 20590

You can also obtain other information about motor vehicle safety from <http://www.safercar.gov>.

### Reporting Safety Defects to the Canadian Government

If you live in Canada, and you believe that the vehicle has a safety defect, notify Transport Canada immediately, and notify General Motors of Canada Limited. Call them at 1-800-333-0510 or write to:

Transport Canada  
Road Safety Branch  
2780 Sheffield Road  
Ottawa, Ontario K1B 3V9

### Reporting Safety Defects to General Motors

In addition to notifying NHTSA (or Transport Canada) in a situation like this, please notify General Motors.

Call 1-800-GMC-8782 (1-800-462-8782), or write:

GMC Customer Assistance Center  
P.O. Box 33172  
Detroit, MI 48232-5172

In Canada, call 1-800-263-3777 (English) or 1-800-263-7854 (French), or write:

General Motors of Canada Limited  
Customer Communication Centre,  
Mail Code: CA1-163-005  
1908 Colonel Sam Drive  
Oshawa, Ontario L1H 8P7

### Vehicle Data Recording and Privacy

This GM vehicle has a number of sophisticated computers that record information about the vehicle's performance and how it is driven. For example, the vehicle uses computer modules to monitor and control engine and transmission performance, to monitor the conditions for airbag deployment and deploy airbags in a crash, and, if so equipped, to provide antilock braking to help the driver control the vehicle. These modules may store data to help the dealer technician service the vehicle. Some modules may also store data about how you operate the vehicle, such as rate of fuel consumption or average speed. These modules may also retain the owner's personal preferences, such as radio pre-sets, seat positions, and temperature settings.

### Event Data Recorders

This vehicle has an Event Data Recorder (EDR). The main purpose of an EDR is to record, in certain crash or near crash-like situations, such as an airbag deployment or hitting a road obstacle, data that will assist in understanding how a vehicle's systems performed. The EDR is designed to record data related to vehicle dynamics and safety systems for a short period of time, typically 30 seconds or less. The EDR in this vehicle is designed to record such data as:

- How various systems in the vehicle were operating.
- Whether or not the driver and passenger safety belts were buckled/fastened.
- How far, if at all, the driver was pressing the accelerator and/or brake pedal.
- How fast the vehicle was traveling.

This data can help provide a better understanding of the circumstances in which crashes and injuries occur.

**Important:** EDR data is recorded by the vehicle only if a non-trivial crash situation occurs; no data is recorded by the EDR under normal driving conditions and no personal data (e.g., name, gender, age, and crash location) is recorded. However, other parties, such as law enforcement, could combine the EDR data with the type of personally identifying data routinely acquired during a crash investigation.

To read data recorded by an EDR, special equipment is required, and access to the vehicle or the EDR is needed. In addition to the vehicle manufacturer, other parties, such

as law enforcement, that have the special equipment, can read the information if they have access to the vehicle or the EDR.

GM will not access this data or share it with others except: with the consent of the vehicle owner or, if the vehicle is leased, with the consent of the lessee; in response to an official request by police or similar government office; as part of GM's defense of litigation through the discovery process; or, as required by law. Data that GM collects or receives may also be used for GM research needs or may be made available to others for research purposes, where a need is shown and the data is not tied to a specific vehicle or vehicle owner.

## OnStar®

If the vehicle is equipped with an active OnStar system, that system may also record data in crash or near crash-like situations. The OnStar Terms and Conditions provides information on data collection and use and is available in the OnStar glove box kit, at [www.onstar.com](http://www.onstar.com) (U.S.) or [www.onstar.ca](http://www.onstar.ca) (Canada), or by pressing the  button and speaking to an advisor.

## Navigation System

If the vehicle has a navigation system, use of the system may result in the storage of destinations, addresses, telephone numbers, and other trip information. Refer to the navigation system operating manual for information on stored data and for deletion instructions.

### Radio Frequency Identification (RFID)

RFID technology is used in some vehicles for functions such as tire pressure monitoring and ignition system security, as well as in connection with conveniences such as key fobs for remote door locking/unlocking and starting, and in-vehicle transmitters for garage door openers. RFID technology in GM vehicles does not use or record personal information or link with any other GM system containing personal information.

### Radio Frequency Statement

This vehicle has systems that operate on a radio frequency that comply with Part 15 of the Federal Communications Commission (FCC) rules and with Industry Canada Standards RSS-210/220/310.

Operation is subject to the following two conditions:

1. The device may not cause interference.
2. The device must accept any interference received, including interference that may cause undesired operation of the device.

Changes or modifications to any of these systems by other than an authorized service facility could void authorization to use this equipment.

## A

- Accessories and Modifications ..... 10-3
- Accessory Power ..... 9-30
- Add-On Electrical Equipment ..... 9-64
- Adjustments
  - Lumbar, Front Seats ..... 3-6
- Air Cleaner/Filter, Engine ..... 10-15
- Air Conditioning ..... 8-3
- Air Filter, Passenger Compartment ..... 8-6
- Air Vents ..... 8-5
- Airbag
  - Adding Equipment to the Vehicle ..... 3-38
- Airbag System
  - Check ..... 3-39
  - How Does an Airbag Restrain? ..... 3-31
  - Passenger Sensing System ..... 3-33
  - What Makes an Airbag Inflate? ..... 3-31
- Airbag System (cont.)
  - What Will You See After an Airbag Inflates? ..... 3-31
  - When Should an Airbag Inflate? ..... 3-29
  - Where Are the Airbags? ..... 3-28
- Airbags
  - Passenger Status Indicator ... 5-11
  - Readiness Light ..... 5-11
  - Servicing Airbag-Equipped Vehicles ..... 3-37
  - System Check ..... 3-26
- Alarm System
  - Anti-Theft ..... 2-12
- All-Wheel Drive ..... 9-37, 10-27
- AM-FM Radio ..... 7-11
- Antenna
  - Multi-Band ..... 7-18
- Anti-Theft
  - Alarm System ..... 2-12
  - Alarm System Messages ..... 5-28
- Antilock Brake System (ABS) ..... 9-37
- Warning Light ..... 5-16
- Appearance Care
  - Exterior ..... 10-82
  - Interior ..... 10-86
- Assistance Program, Roadside ..... 13-7, 13-9
- Audio Players ..... 7-19
  - CD ..... 7-19
  - CD/DVD ..... 7-21
- Audio System
  - Radio Reception ..... 7-18
  - Rear Seat (RSA) ..... 7-43
  - Theft-Deterrent Feature ..... 7-2
- Automatic
  - Climate Control System ..... 8-3
  - Headlamp System ..... 6-3
- Automatic Transmission ..... 9-34
  - Fluid ..... 10-15
  - Manual Mode ..... 9-35
  - Shift Lock Control Function Check ..... 10-28
- Auxiliary Devices ..... 7-28, 7-31

**B**

|  |                  |
|--|------------------|
| Battery .....                          | 10-27            |
| Jump Starting .....                    | 10-75            |
| Load Management .....                  | 6-5              |
| Voltage and Charging<br>Messages ..... | 5-24             |
| Blade Replacement, Wiper ...           | 10-30            |
| Bluetooth .....                        | 7-45, 7-46, 7-51 |
| Brake System Warning Light ...         | 5-15             |
| Brakes .....                           | 10-24            |
| Antilock .....                         | 9-37             |
| Assist .....                           | 9-39             |
| Fluid .....                            | 10-25            |
| Parking .....                          | 9-38             |
| System Messages .....                  | 5-24             |
| Braking .....                          | 9-3              |
| Break-In, New Vehicle .....            | 9-26             |
| Bulb Replacement .....                 | 10-38            |
| Fog Lamps .....                        | 6-4, 10-35       |
| Headlamp Aiming .....                  | 10-31            |
| Headlamps .....                        | 10-33            |

|   |       |
|---|-------|
| Bulb Replacement (cont.)  |       |
| Headlamps, Front Turn<br>Signal, Sidemarker, and<br>Parking Lamps .....     | 10-34 |
| License Plate Lamps .....   | 10-38 |
| Taillamps, Turn Signal,<br>Sidemarker, Stoplamps,<br>and Backup Lamps ..... | 10-35 |
| Buying New Tires .....  | 10-59 |

**C**

|   |          |
|---|----------|
| Calibration .....                           | 5-4      |
| California                                  |          |
| Fuel Requirements .....                     | 9-53     |
| Perchlorate Materials<br>Requirements ..... | 10-3     |
| Warning .....                               | 10-2     |
| Camera, Rear Vision .....                   | 9-47     |
| Canadian Vehicle Owners .....               | iv       |
| Capacities and<br>Specifications .....      | 12-2     |
| Carbon Monoxide                             |          |
| Engine Exhaust .....                        | 9-32     |
| Liftgate .....                              | 2-8, 2-9 |
| Winter Driving .....                        | 9-19     |

|   |            |
|---|------------|
| Cargo   |            |
| Cover .....                                     | 4-2        |
| Tie-Downs .....                                 | 4-2        |
| Cautions, Danger, and<br>Warnings .....         | iv         |
| CD Player .....                                 | 7-19       |
| CD/DVD Player .....                             | 7-21       |
| Center Console Storage .....                    | 4-1        |
| Chains, Tire .....                              | 10-65      |
| Charging System Light .....                     | 5-12       |
| Check   |            |
| Engine Light .....                              | 5-13       |
| Ignition<br>Transmission Lock .....             | 10-29      |
| Child Restraints                                |            |
| Infants and Young<br>Children .....             | 3-43       |
| Lower Anchors and<br>Tethers for Children ..... | 3-49       |
| Older Children .....                            | 3-40       |
| Securing .....                                  | 3-55, 3-57 |
| Systems .....                                   | 3-45       |
| Cleaning  |            |
| Exterior Care .....                             | 10-82      |
| Interior Care .....                             | 10-86      |



- Climate Control Systems ..... 8-1  
  Air Conditioning ..... 8-1  
  Automatic ..... 8-3  
  Heating ..... 8-1  
Clock ..... 5-5, 5-6  
Cluster, Instrument ..... 5-8  
Collision Damage Repair ..... 13-11  
Compact Spare Tire ..... 10-74  
Compass ..... 5-4  
  Messages ..... 5-24  
Control of a Vehicle ..... 9-3  
Convenience Net ..... 4-2  
Convex Mirrors ..... 2-14  
Coolant  
  Engine ..... 10-17  
  Engine Temperature  
    Gauge ..... 5-10  
Cooling System ..... 10-16  
  Engine Messages ..... 5-25  
Courtesy Transportation  
  Program ..... 13-10  
Cover  
  Cargo ..... 4-2  
  Engine ..... 10-10  
Cruise Control ..... 9-42  
  Light ..... 5-20  
  Messages ..... 5-25  
Cupholders ..... 4-1  
Customer Assistance ..... 13-6  
  Offices ..... 13-4, 13-5  
  Text Telephone (TTY)  
    Users ..... 13-6  
Customer Information  
  Service Publications  
    Ordering Information ..... 13-14  
Customer Satisfaction  
  Procedure ..... 13-1, 13-3
- D**
- Damage Repair, Collision ..... 13-11  
Danger, Warnings, and  
  Cautions ..... iv  
Data Recorders, Event ..... 13-16  
Daytime Running  
  Lamps (DRL) ..... 6-2  
Defensive Driving ..... 9-2  
Devices, Auxiliary ..... 7-28, 7-31  
Dome Lamps ..... 6-4  
Door  
  Ajjar Messages ..... 5-25  
  Locks ..... 2-6  
  Power Locks ..... 2-7  
Drive Belt Routing, Engine ..... 12-4  
Drive Systems  
  All-Wheel Drive ..... 9-37, 10-27  
Driver Information  
  Center (DIC) ..... 5-20  
Driving  
  Characteristics and  
    Towing Tips ..... 9-58  
  Defensive ..... 9-2  
  Drunk ..... 9-2  
  Highway Hypnosis ..... 9-18  
  Hill and Mountain Roads ..... 9-18  
  If the Vehicle is Stuck ..... 9-21  
  Loss of Control ..... 9-6  
  Off-Road ..... 9-7  
  Off-Road Recovery ..... 9-6  
  Vehicle Load Limits ..... 9-21  
  Wet Roads ..... 9-17  
  Winter ..... 9-19

|                         |      |
|-------------------------|------|
| Driving for Better Fuel |      |
| Economy .....           | 1-25 |
| DVD                     |      |
| Rear Seat Entertainment |      |
| System .....            | 7-33 |
| DVD/CD Player .....     | 7-21 |

**E**

|                            |       |
|----------------------------|-------|
| E85 Fuel .....             | 9-54  |
| ECO Button .....           | 9-36  |
| Economy Mode               |       |
| Fuel .....                 | 9-36  |
| Electrical Equipment,      |       |
| Add-On .....               | 9-64  |
| Electrical System          |       |
| Engine Compartment         |       |
| Fuse Block .....           | 10-40 |
| Fuses .....                | 10-39 |
| Instrument Panel Fuse      |       |
| Block .....                | 10-42 |
| Engine                     |       |
| Air Cleaner/Filter .....   | 10-15 |
| Check and Service Engine   |       |
| Soon Light .....           | 5-13  |
| Compartment Overview ..... | 10-6  |
| Coolant .....              | 10-17 |

|                               |       |
|-------------------------------|-------|
| Engine (cont.)                |       |
| Coolant Heater .....          | 9-30  |
| Coolant Temperature           |       |
| Gauge .....                   | 5-10  |
| Cooling System .....          | 10-16 |
| Cooling System Messages ..... | 5-25  |
| Cover .....                   | 10-10 |
| Drive Belt Routing .....      | 12-4  |
| Exhaust .....                 | 9-32  |
| Overheating .....             | 10-21 |
| Power Messages .....          | 5-26  |
| Pressure Light .....          | 5-18  |
| Running While Parked .....    | 9-33  |
| Starting .....                | 9-29  |
| Engine Oil                    |       |
| Life System .....             | 10-14 |
| Messages .....                | 5-26  |
| Entry Lighting .....          | 6-5   |
| Equipment, Towing .....       | 9-63  |
| Event Data Recorders .....    | 13-16 |
| Extender, Safety Belt .....   | 3-24  |
| Exterior Lamp Controls .....  | 6-1   |

**F**

|                                |            |
|--------------------------------|------------|
| Features                       |            |
| Memory .....                   | 1-9        |
| Filter,                        |            |
| Engine Air Cleaner .....       | 10-15      |
| Flash-to-Pass .....            | 6-2        |
| Flashers, Hazard Warning ..... | 6-3        |
| Flat Tire .....                | 10-65      |
| Changing .....                 | 10-67      |
| Floor Mats .....               | 10-89      |
| Fluid                          |            |
| Automatic Transmission .....   | 10-15      |
| Brakes .....                   | 10-25      |
| Power Steering .....           | 10-23      |
| Washer .....                   | 10-23      |
| Fog Lamps                      |            |
| Bulb Replacement .....         | 6-4, 10-35 |
| Front Fog Lamp                 |            |
| Light .....                    | 5-20       |
| Front Seats                    |            |
| Adjustment .....               | 3-3        |
| Heated .....                   | 3-8        |
| Fuel .....                     | 9-52       |
| Additives .....                | 9-53       |
| E85 (85% Ethanol) .....        | 9-54       |
| Economy Light .....            | 5-18       |

Fuel (cont.)  
 Filling a Portable Fuel  
     Container ..... 9-57  
 Filling the Tank ..... 9-55  
 Fuels in Foreign Countries .... 9-53  
 Gasoline Specifications ..... 9-52  
 Gauge ..... 5-9  
 Low Fuel Warning Light ..... 5-19  
     Recommended ..... 9-52  
     Requirements, California .... 9-53  
     System Messages ..... 5-27  
 Fuel Economy  
     Driving ..... 1-25  
 Fuel Economy Mode ..... 9-36  
 Fuses ..... 10-39  
     Engine Compartment  
         Fuse Block ..... 10-40  
     Instrument Panel Fuse  
         Block ..... 10-42

**G**

Gasoline  
     Specifications ..... 9-52  
 Gauges  
     Engine Coolant  
         Temperature ..... 5-10  
     Fuel ..... 5-9  
     Odometer ..... 5-9  
     Speedometer ..... 5-9  
     Tachometer ..... 5-9  
     Warning Lights and  
         Indicators ..... 5-7  
 General Information  
     Service and Maintenance .... 11-1  
     Towing ..... 9-57  
     Vehicle Care ..... 10-2  
 Glove Box ..... 4-1  
 GM Mobility Reimbursement  
     Program ..... 13-7

**H**

Hazard Warning Flashers ..... 6-3  
 Head Restraints ..... 3-2  
 Headlamps  
     Aiming ..... 10-31  
     Automatic ..... 6-3  
     Bulb Replacement ..... 10-33  
     Daytime Running  
         Lamps (DRL) ..... 6-2  
     Flash-to-Pass ..... 6-2  
     Headlamps, Front Turn  
         Signal, Sidemarker, and  
         Parking Lamps ..... 10-34  
     High-Beam On Light ..... 5-19  
     High/Low Beam Changer ..... 6-2  
     Lamps On Reminder ..... 5-20  
 Heated Front Seats ..... 3-8  
 Heated Mirrors ..... 2-15  
 Heater  
     Engine Coolant ..... 9-30  
 Heating and Air  
     Conditioning ..... 8-1, 8-3

|  |      |
|--|------|
| High-Beam On Light .....                   | 5-19 |
| Highway Hypnosis .....                     | 9-18 |
| Hill and Mountain Roads .....              | 9-18 |
| Hill Start Assist (HSA) .....              | 9-39 |
| Hood .....                                 | 10-5 |
| Horn .....                                 | 5-3  |
| How to Wear Safety Belts<br>Properly ..... | 3-14 |

**I**

|   |       |
|---|-------|
| Ignition Positions .....                        | 9-27  |
| Ignition Transmission Lock<br>Check .....       | 10-29 |
| Immobilizer .....                               | 2-13  |
| Infants and Young Children,<br>Restraints ..... | 3-43  |
| Infotainment .....                              | 7-1   |
| Instrument Cluster .....                        | 5-8   |
| Instrument Panel<br>Storage Area .....          | 4-1   |
| Introduction .....                              | iii   |

**J**

|                     |       |
|---------------------|-------|
| Jump Starting ..... | 10-75 |
|---------------------|-------|

**K**

|  |      |
|--|------|
| Key and Lock Messages .....                | 5-27 |
| Keyless Entry<br>Remote (RKE) System ..... | 2-3  |
| Keys .....                                 | 2-2  |

**L**

|  |          |
|--|----------|
| Labeling, Tire Sidewall .....                          | 10-45    |
| Lamps<br>Daytime Running (DRL) .....                   | 6-2      |
| Dome .....   | 6-4      |
| Exterior Controls .....                                | 6-1      |
| License Plate .....                                    | 10-38    |
| Malfunction Indicator .....                            | 5-13     |
| On Reminder .....                                      | 5-20     |
| Reading .....  | 6-5      |
| Lap-Shoulder Belt .....                                | 3-20     |
| LATCH System<br>Replacing Parts After a<br>Crash ..... | 3-54     |
| LATCH, Lower Anchors and<br>Tethers for Children ..... | 3-49     |
| Liftgate<br>Carbon Monoxide .....                      | 2-8, 2-9 |

|   |      |
|---|------|
| Light<br>StabiliTrak® OFF .....                     | 5-16 |
| Lighting<br>Entry .....                             | 6-5  |
| Illumination Control .....                          | 6-4  |
| Lights<br>Airbag Readiness .....                    | 5-11 |
| Antilock Brake System<br>(ABS) Warning .....        | 5-16 |
| Brake System Warning .....                          | 5-15 |
| Charging System .....                               | 5-12 |
| Cruise Control .....                                | 5-20 |
| Engine Oil Pressure .....                           | 5-18 |
| Flash-to-Pass .....                                 | 6-2  |
| Front Fog Lamp .....                                | 5-20 |
| Fuel Economy .....                                  | 5-18 |
| High-Beam On .....                                  | 5-19 |
| High/Low Beam Changer .....                         | 6-2  |
| Low Fuel Warning .....                              | 5-19 |
| Safety Belt Reminders .....                         | 5-10 |
| Security .....                                      | 5-19 |
| Tire Pressure .....                                 | 5-17 |
| Traction Control System<br>(TCS)/StabiliTrak® ..... | 5-17 |
| Traction Off .....                                  | 5-16 |

Locks  
 Door ..... 2-6  
 Power Door ..... 2-7  
 Safety ..... 2-8  
 Loss of Control ..... 9-6  
 Low Fuel Warning Light ..... 5-19  
 Lower Anchors and Tethers  
 for Children (LATCH  
 System) ..... 3-49  
 Lumbar Adjustment ..... 3-6  
 Front Seats ..... 3-6

**M**

Maintenance  
 Records ..... 11-9  
 Maintenance Schedule  
 Recommended Fluids and  
 Lubricants ..... 11-6  
 Scheduled Maintenance ..... 11-2  
 Malfunction Indicator Lamp ..... 5-13  
 Manual Mode ..... 9-35  
 Mass Storage Media (MEM) ... 7-24  
 Memory Features ..... 1-9

Messages  
 Airbag System ..... 5-28  
 Anti-Theft Alarm System ..... 5-28  
 Battery Voltage and  
 Charging ..... 5-24  
 Brake System ..... 5-24  
 Compass ..... 5-24  
 Door Ajar ..... 5-25  
 Engine Cooling System ..... 5-25  
 Engine Oil ..... 5-26  
 Engine Power ..... 5-26  
 Fuel System ..... 5-27  
 Key and Lock ..... 5-27  
 Object Detection System ..... 5-27  
 Ride Control System ..... 5-27  
 Safety Belt ..... 5-28  
 Service Vehicle ..... 5-28  
 Tire ..... 5-28  
 Transmission ..... 5-29  
 Vehicle ..... 5-24  
 Vehicle Reminder ..... 5-29

Mirrors  
 Automatic Dimming  
 Rearview ..... 2-15  
 Convex ..... 2-14  
 Heated ..... 2-15  
 Park Tilt ..... 2-15  
 Power ..... 2-14  
 Monitor System, Tire  
 Pressure ..... 10-52  
 Multi-Band Antenna ..... 7-18

**N**

Navigation  
 Vehicle Data Recording  
 and Privacy ..... 13-17  
 Net, Convenience ..... 4-2  
 New Vehicle Break-In ..... 9-26

**O**

Object Detection System  
 Messages ..... 5-27  
 Odometer ..... 5-9  
 Off-Road ..... 9-7  
 Driving ..... 9-7  
 Recovery ..... 9-6

Oil  
Engine ..... 10-10  
Engine Oil Life System ..... 10-14  
Messages ..... 5-26  
Pressure Light ..... 5-18  
Older Children, Restraints ..... 3-40  
Online Owner Center ..... 13-6  
OnStar® System ..... 1-26  
Operation, Infotainment  
System ..... 7-7  
Ordering  
Service Publications ..... 13-14  
Outlets  
Power ..... 5-6  
Overheating, Engine ..... 10-21  
Overview, Infotainment  
System ..... 7-3, 7-5

## **P**

Park  
Shifting Into ..... 9-31  
Shifting Out of ..... 9-32  
Park Tilt Mirrors ..... 2-15

Parking  
Assist, Ultrasonic ..... 9-45  
Brake ..... 9-38  
Brake and P (Park)  
Mechanism Check ..... 10-29  
Over Things That Burn ..... 9-32  
Passenger Airbag Status  
Indicator ..... 5-11  
Passenger Compartment Air  
Filter ..... 8-6  
Passenger Sensing System ... 3-33  
Perchlorate Materials  
Requirements, California ..... 10-3  
Personalization  
Vehicle ..... 5-30  
Phone  
Bluetooth ..... 7-45, 7-46, 7-51  
Power  
Door Locks ..... 2-7  
Mirrors ..... 2-14  
Outlets ..... 5-6  
Retained Accessory (RAP) ... 9-30  
Seat Adjustment ..... 3-3  
Steering Fluid ..... 10-23  
Windows ..... 2-17

Pregnancy, Using Safety  
Belts ..... 3-24  
Privacy  
Radio Frequency  
Identification (RFID) ..... 13-18  
Program  
Courtesy Transportation .... 13-10  
Proposition 65 Warning,  
California ..... 10-2

## **R**

Radio Frequency  
Identification (RFID) ..... 13-18  
Statement ..... 13-18  
Radios  
AM-FM Radio ..... 7-11  
CD/DVD Player ..... 7-21  
Reception ..... 7-18  
Satellite ..... 7-14  
Reading Lamps ..... 6-5  
Rear Seat Audio (RSA)  
System ..... 7-43  
Rear Seat Entertainment  
System ..... 7-33  
Rear Seat Audio (RSA) ..... 7-43  
Rear Seats ..... 3-9

Rear Vision Camera (RVC) . . . . 9-47  
 Rear Window Washer/Wiper . . . . 5-4  
 Rearview Mirror  
     Automatic Dimming . . . . . 2-15  
 Reclining Seatbacks . . . . . 3-6  
 Recommended  
     Fuel . . . . . 9-52  
 Recommended Fluids and  
     Lubricants . . . . . 11-6  
 Records  
     Maintenance . . . . . 11-9  
 Recreational Vehicle  
     Towing . . . . . 10-79  
 Reimbursement Program,  
     GM Mobility . . . . . 13-7  
 Remote Keyless Entry (RKE)  
     System . . . . . 2-3  
 Remote Vehicle Start . . . . . 2-5  
 Replacement Bulbs . . . . . 10-38  
 Replacement Parts  
     Airbags . . . . . 3-40  
     Maintenance . . . . . 11-8  
 Replacing Airbag System . . . . 3-40  
 Replacing LATCH System  
     Parts After a Crash . . . . . 3-54

Replacing Safety Belt  
     System Parts After a  
         Crash . . . . . 3-25  
 Reporting Safety Defects  
     Canadian Government . . . . 13-15  
     General Motors . . . . . 13-16  
     U.S. Government . . . . . 13-15  
 Restraints  
     Where to Put . . . . . 3-47  
 Retained Accessory  
     Power (RAP) . . . . . 9-30  
 Ride Control Systems  
     Messages . . . . . 5-27  
 Roads  
     Driving, Wet . . . . . 9-17  
 Roadside Assistance  
     Program . . . . . 13-7, 13-9  
 Roof  
     Sunroof . . . . . 2-18  
 Roof Rack System . . . . . 4-2  
 Rotation, Tires . . . . . 10-57  
 Routing, Engine Drive Belt . . . 12-4  
 Running the Vehicle While  
     Parked . . . . . 9-33

**S**

Safety Belts . . . . . 3-10  
     Care . . . . . 3-25  
     Extender . . . . . 3-24  
     How to Wear Safety Belts  
         Properly . . . . . 3-14  
     Lap-Shoulder Belt . . . . . 3-20  
     Messages . . . . . 5-28  
     Reminders . . . . . 5-10  
     Replacing After a Crash . . . . 3-25  
     Use During Pregnancy . . . . 3-24  
 Safety Defects Reporting  
     Canadian Government . . . . 13-15  
     General Motors . . . . . 13-16  
     U.S. Government . . . . . 13-15  
 Safety Locks . . . . . 2-8  
 Safety System Check . . . . . 3-24  
 Satellite Radio . . . . . 7-14  
 Scheduled Maintenance . . . . . 11-2  
 Scheduling Appointments . . . . 13-10  
 Seats  
     Adjustment, Front . . . . . 3-3  
     Head Restraints . . . . . 3-2  
     Heated Front . . . . . 3-8  
     Lumbar Adjustment, Front . . . 3-6

|                                    |            |  |
|------------------------------------|------------|--|
| Seats (cont.)                      |            |  |
| Power Adjustment, Front            | 3-3        |  |
| Rear                               | 3-9        |  |
| Reclining Seatbacks                | 3-6        |  |
| Securing Child                     |            |  |
| Restraints                         | 3-55, 3-57 |  |
| Security                           |            |  |
| Light                              | 5-19       |  |
| Vehicle                            | 2-12       |  |
| Service                            |            |  |
| Accessories and                    |            |  |
| Modifications                      | 10-3       |  |
| Doing Your Own Work                | 10-4       |  |
| Engine Soon Light                  | 5-13       |  |
| Maintenance Records                | 11-9       |  |
| Maintenance, General               |            |  |
| Information                        | 11-1       |  |
| Parts Identification Label         | 12-1       |  |
| Publications Ordering              |            |  |
| Information                        | 13-14      |  |
| Scheduling Appointments            | 13-10      |  |
| Vehicle Messages                   | 5-28       |  |
| Servicing the Airbag               | 3-37       |  |
| Shift Lock Control Function        |            |  |
| Check, Automatic                   |            |  |
| Transmission                       | 10-28      |  |
| Shifting                           |            |  |
| Into Park                          | 9-31       |  |
| Out of Park                        | 9-32       |  |
| Sidemarker                         |            |  |
| Bulb Replacement                   | 10-35      |  |
| Signals, Turn and                  |            |  |
| Lane-Change                        | 6-3        |  |
| Spare Tire                         |            |  |
| Compact                            | 10-74      |  |
| Specifications and                 |            |  |
| Capacities                         | 12-2       |  |
| Speedometer                        | 5-9        |  |
| StabiliTrak <sup>®</sup> OFF Light | 5-16       |  |
| StabiliTrak <sup>®</sup> System    | 9-41       |  |
| Start Assist, Hills                | 9-39       |  |
| Start Vehicle, Remote              | 2-5        |  |
| Starter Switch Check               | 10-28      |  |
| Starting the Engine                | 9-29       |  |
| Steering                           | 9-4        |  |
| Fluid, Power                       | 10-23      |  |
| Wheel Adjustment                   | 5-2        |  |
| Wheel Controls                     | 5-2        |  |
| Stoplamps and Back-Up Lamps        |            |  |
| Bulb Replacement                   | 10-35      |  |
| Storage                            |            |  |
| Mass Media (MEM)                   | 7-24       |  |
| Storage Areas                      |            |  |
| Cargo Cover                        | 4-2        |  |
| Center Console                     | 4-1        |  |
| Convenience Net                    | 4-2        |  |
| Glove Box                          | 4-1        |  |
| Instrument Panel                   | 4-1        |  |
| Roof Rack System                   | 4-2        |  |
| Stuck Vehicle                      | 9-21       |  |
| Sun Visors                         | 2-18       |  |
| Sunroof                            | 2-18       |  |
| Symbols                            | v          |  |
| System                             |            |  |
| Infotainment                       | 7-1        |  |
| Roof Rack                          | 4-2        |  |
| <b>T</b>                           |            |  |
| Tachometer                         | 5-9        |  |
| Taillamps                          |            |  |
| Bulb Replacement                   | 10-35      |  |
| Text Telephone (TTY) Users         | 13-6       |  |
| Theft-Deterrent Systems            | 2-13       |  |
| Immobilizer                        | 2-13       |  |
| Time                               | 5-5, 5-6   |  |



Tires  
 Buying New Tires ..... 10-59  
 Chains ..... 10-65  
 Changing ..... 10-67  
 Compact Spare ..... 10-74  
 Designations ..... 10-48  
 Different Size ..... 10-61  
 If a Tire Goes Flat ..... 10-65  
 Inflation Monitor System .... 10-54  
 Inspection ..... 10-57  
 Messages ..... 5-28  
 Pressure Light ..... 5-17  
 Pressure Monitor System ... 10-52  
 Rotation ..... 10-57  
 Sidewall Labeling ..... 10-45  
 Terminology and  
 Definitions ..... 10-48  
 Uniform Tire Quality  
 Grading ..... 10-61  
 Wheel Alignment and Tire  
 Balance ..... 10-63  
 Wheel Replacement ..... 10-63  
 When It Is Time for New  
 Tires ..... 10-58

Towing  
 Driving Characteristics ..... 9-58  
 Equipment ..... 9-63  
 General Information ..... 9-57  
 Recreational Vehicle ..... 10-79  
 Trailer ..... 9-61  
 Trailer Sway Control (TSC) ... 9-64  
 Vehicle ..... 10-79  
 Traction  
 Control System (TCS) ..... 9-39  
 Control System (TCS)/  
 StabiliTrak® Light ..... 5-17  
 Off Light ..... 5-16  
 Trailer  
 Sway Control (TSC) ..... 9-64  
 Trailer Towing ..... 9-61  
 Transmission  
 Automatic ..... 9-34  
 Fluid, Automatic ..... 10-15  
 Messages ..... 5-29  
 Transportation Program,  
 Courtesy ..... 13-10  
 Turn and Lane-Change  
 Signals ..... 6-3  
 Turn Signal  
 Bulb Replacement ..... 10-35

**U**

Ultrasonic Parking Assist ..... 9-45  
 Uniform Tire Quality  
 Grading ..... 10-61  
 Using this Manual ..... iv

**V**

Vehicle  
 Canadian Owners ..... iv  
 Control ..... 9-3  
 Identification  
 Number (VIN) ..... 12-1  
 Load Limits ..... 9-21  
 Messages ..... 5-24  
 Personalization ..... 5-30  
 Reminder Messages ..... 5-29  
 Remote Start ..... 2-5  
 Security ..... 2-12  
 Towing ..... 10-79  
 Vehicle Care  
 Tire Pressure ..... 10-51  
 Vehicle Identification  
 Service Parts Identification  
 Label ..... 12-1  
 Ventilation, Air ..... 8-5  
 Visors ..... 2-18

**W**

|                                 |       |
|---------------------------------|-------|
| Warning                         |       |
| Brake System Light .....        | 5-15  |
| Warning Lights, Gauges, and     |       |
| Indicators .....                | 5-7   |
| Warnings .....                  | iv    |
| Cautions and Danger .....       | iv    |
| Hazard Flashers .....           | 6-3   |
| Washer Fluid .....              | 10-23 |
| Wheels                          |       |
| Alignment and Tire              |       |
| Balance .....                   | 10-63 |
| Different Size .....            | 10-61 |
| Replacement .....               | 10-63 |
| When It Is Time for New         |       |
| Tires .....                     | 10-58 |
| Where to Put the Restraint .... | 3-47  |
| Windows .....                   | 2-16  |
| Power .....                     | 2-17  |
| Windshield                      |       |
| Wiper/Washer .....              | 5-3   |
| Winter                          |       |
| Driving .....                   | 9-19  |
| Wiper Blade Replacement ....    | 10-30 |
| Wipers                          |       |
| Rear Washer .....               | 5-4   |