

1994 Civic Coupe Online Reference Owner's Manual

Use these links (and links throughout this manual) to navigate through this reference.
For a printed owner's manual, click on authorized manuals or go to www.helminc.com.

Contents

Owner's Identification

Introduction	i
A Few Words About Safety	ii
Driver and Passenger Safety	3
Proper use and care of your car's seat belts, and Supplemental Restraint System.	
Instruments and Controls	27
Instrument panel indicator and gauge, and how to use dashboard and steering column controls.	
Comfort and Convenience Features	61
How to operate the climate control system, the audio system, and other convenience features.	
Before Driving	81
What gasoline to use, how to break-in your new car, and how to load luggage and other cargo.	
Driving	91
The proper way to start the engine, shift the transmission, and park, plus towing a trailer.	
Maintenance	107
The Maintenance Schedule shows you when you need to take your car to the dealer.	
Appearance Care	153
Tips on cleaning and protecting your car. Things to look for if your car ever needs body repairs.	
Taking Care of the Unexpected	161
This section covers several problems motorists sometimes experience, and how to handle them.	
Technical Information	183
ID numbers, dimensions, capacities, and technical information.	
Warranty and Customer Relations (U.S. and Canada)	197
A summary of the warranties covering your new Honda, and how to contact us.	
Authorized Manuals (U.S. only)	203
How to order manuals and other technical literature.	
Index	I

Gas Station Information

Information you need when you pull up to the fuel pump

Congratulations! Your selection of a 1994 Honda Civic was a wise investment. It will give you years of driving pleasure.

To enhance the enjoyment of your new car, take time to study this manual. In it, you will learn about your car's many conveniences and useful features. Following the service interval and maintenance recommendations will help keep your driving trouble-free while preserving your investment.

Keep this owner's manual in your car so you can refer to it at any time. Please make sure the manual stays with the car if you sell it. The next owner will find it just as helpful.

Several other booklets in the glove box explain the warranties that protect your Honda. We suggest you read them carefully so you understand the coverages and the responsibilities of ownership.

When your car needs scheduled maintenance, keep in mind that your Honda dealer's service staff is specially trained in the service and maintenance of the many systems unique to your Honda. Your Honda dealer is dedicated to your satisfaction and will be pleased to answer any questions and concerns.

Safety Messages

Your safety and the safety of others is very important. We have provided many important safety messages in this manual and on the vehicle. Please read these messages carefully.

A safety message alerts you to potential hazards that could hurt you or others. Each safety message is preceded by a safety alert symbol  and one of three words, **DANGER**, **WARNING** or **CAUTION**. These mean:

You WILL be KILLED or SERIOUSLY HURT if you don't follow instructions.

YOU CAN be KILLED or SERIOUSLY HURT if you don't follow instructions.

You CAN be HURT if you don't follow instructions.

Each safety message tells you what the hazard is, what can happen and what you can do to avoid or reduce injury.

You will also see another important symbol:

NOTICE

Your Honda or other property can be damaged if you don't follow instructions.

This section gives you important information about occupant protection. It shows how to use seat belts properly. It explains the Supplemental Restraint System that is standard in Civics. And it gives useful information about how to protect infants and children in your car.

Your Occupant Protection System	4
The Seat Belt System and How It Works	5
Why Wear Seat Belts	5
Important Safety Reminders .	5
Seat Belt System Components	6
Lap/Shoulder Belt	6
Lap Belt	6
Wearing Seat Belts Properly	7

Wearing a Lap/Shoulder Belt	7
Wearing the Lap Belt	9
Advice for Pregnant Women	10
Seat Belt Maintenance	10
Supplemental Restraint System	11
Important Safety Reminder .	12
How the Driver's Airbag Works	12
How the Passenger's Airbag Works	13
How the SRS Indicator Light Works	14
System Service	15
System Service Precautions	15
Additional Safety Information .	16
Seat-Back Position	16
Door Locks	16
Storing Cargo Safely	17
Driving With Pets	17
Child Safety	18
Where Should Children Sit? .	18

Important Safety Reminders	19
General Guidelines for Restraining Children Under 40 lb (18 kg)	19
Restraining an Infant Who Weighs Less Than 20 lb (9 kg)	20
Restraining a Child Who Weighs Between 20 and 40 lb (9 and 18 kg)	20
Restraining a Child Who Weighs Over 40 lb (18kg)	21
Using a Seat Belt Locking Clip	22
Using Child Restraints With Tethers	22
Storing a Child Seat	23
Alcohol and Drugs	24
Carbon Monoxide Hazard	25
Safety Labels	26

Your Occupant Protection System

Your Honda is equipped with seat belts and other features that work together to protect you and your passengers during a crash.

Seat belts are the most important part of your occupant protection system. When worn properly, seat belts can reduce the chance of serious injury or death in a crash.

For added protection during a severe frontal collision, your Honda has a Supplemental Restraint System (SRS) with a driver's airbag and an airbag for the front-seat passenger.

Two indicator lights are also part of your safety system. One reminds you to make sure you and your passengers wear your seat belts. The other alerts you to a possible problem with your supplemental restraint system (see page 14).

The seats, head restraints, and door locks also play a role in occupant safety. For example, reclining the seat-back can decrease the effectiveness of your seat belt. Head restraints can help protect your neck and head, especially during rear-end impacts. Door locks help keep your doors from being accidentally opened during a crash.

To get the maximum protection from your occupant protection system, check the following before you drive away:

- Everyone in the car is wearing a seat belt properly (see page 7).
- Infants or small children are properly secured in a child safety seat (see page 18).
- Both doors are closed and locked (see page 16).
- Seat-backs are upright (see page 16).
- There are no loose items that could be thrown around and hurt someone during a crash or sudden stop (see page 17).

By following these guidelines, you can reduce injuries to yourself and your passengers in many crash situations. Remember, however, that no safety system can prevent all injuries or deaths that can occur in severe crashes.

Why Wear Seat Belts

Wearing seat belts and wearing them properly is fundamental to your safety and the safety of your passengers.

During a crash or emergency stop, seat belts can help keep you from being thrown against the inside of the car, against other occupants, or out of the car.

Of course, seat belts cannot completely protect you in every crash. But, in most cases, seat belts reduce your chance of serious injury. They can even save your life. That is why many states and all Canadian provinces require you to wear seat belts.

Not wearing a seat belt increases the chance of being killed or seriously hurt in a crash.

Be sure you and your passengers always wear seat belts and wear them properly.

Important Safety Reminders

Seat belts are designed for adults and larger children. All infants and small children must be properly restrained in child safety seats (see page 18).

A pregnant woman needs to wear a seat belt to protect herself and her unborn child (see page 10).

Two people should never use the same seat belt. If they do, they could be very seriously injured in a crash.

Do not place the shoulder portion of a lap/shoulder belt under your arm or behind your back. This could increase the chance of serious injuries in a crash.

Do not put shoulder belt pads or other accessories on seat belts. They can reduce the effectiveness of the belts and increase the chance of injury.

The Seat Belt System and How It Works

Seat Belt System Components

Your Honda has seat belts in all five seating positions. The front seats and the outside positions of the rear seat have lap/shoulder belts. The center position of the rear seat has a lap belt.

Your seat belt system also includes a light on the instrument panel to remind you to fasten your seat belt and to make sure your passengers fasten theirs. This light comes on when you turn on the ignition if you have not fastened your seat belt. A beeper also sounds for several seconds (see page 30).

The following pages cover more about the seat belt components and how they work.

Lap/Shoulder Belt

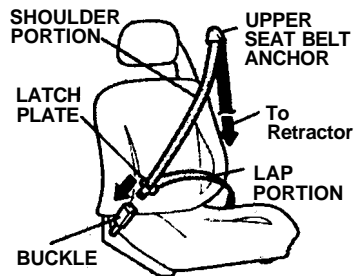

This style of seat belt has a single belt that goes over your shoulder, across your chest and across your hips.

Each lap/shoulder belt has an emergency locking retractor. In normal driving, the retractor lets you move freely in your seat while it keeps some tension on the belt. During a collision or sudden stop, the retractor automatically locks the belt to help restrain your body.

Lap Belt

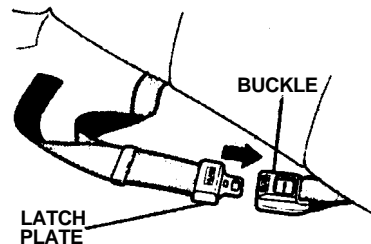

The lap belt has one manually adjusted belt that fits across the hips. It is similar to safety belts used in airplanes.

The Seat Belt System and How It Works

Wearing Seat Belts Properly

You can increase the effectiveness of your seat belts if you take a little time to read the following pages and make sure you know how to wear seat belts properly.

Not wearing a seat belt properly increases the chance of serious injury or death in a crash.

Be sure you and your passengers always wear seat belts and wear them properly.

Wearing a Lap/Shoulder Belt



Before putting on a front seat belt, be sure your seat is adjusted forward or backward to a good driving or riding position and the back of your seat is upright (see page 49).

1. Pull the latch plate across your body, and insert it into the buckle. Tug on the belt to make sure the latch is securely locked.
2. Check to see that the belt is not twisted.



3. Position the lap portion of the belt as low as possible across your hips, not across your stomach. This lets your strong pelvic bones take the force of a crash.

continued

The Seat Belt System and How It Works

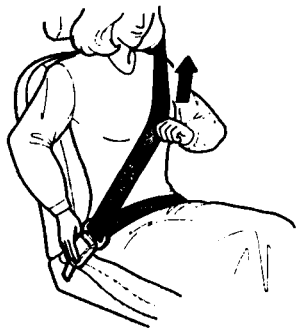

4. Pull up on the shoulder part of the belt to remove any slack. Make sure the belt goes over your collarbone and across your chest.

5. If the shoulder belt crosses your neck while you are sitting in one of the outside rear seating positions, you need to adjust your seating position. Move toward the center of the seat until the belt fits over your collarbone.

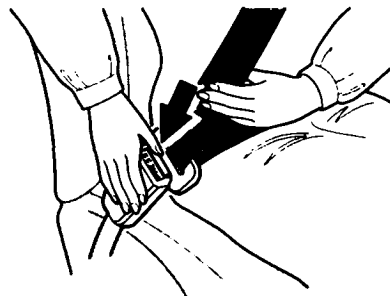

To unlatch the seat belt, push the red **PRESS** button on the buckle. Guide the belt across your body to the door pillar. If the belt doesn't retract easily, pull it out and check for twists or kinks.

The Seat Belt System and How It Works

Wearing the Lap Belt

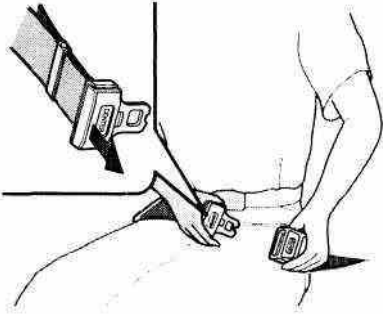

1. Pull the latch plate across your hips, and insert it into the buckle marked **CENTER**.

If the belt is too short, hold the latch plate at a right angle and pull to extend the belt. Insert the latch plate into the buckle.



2. Position the belt so it fits as low as possible across your hips and pelvic bones, not across your stomach. Pull the loose end of the belt to adjust for a snug but comfortable fit.

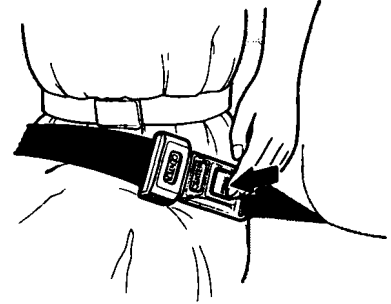

To unlatch the belt, push the red **PRESS** button on the buckle.

The Seat Belt System and How It Works

Advice for Pregnant Women

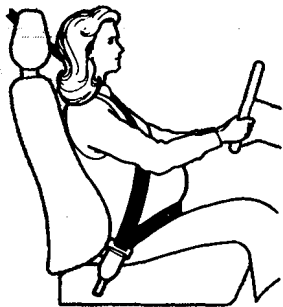

Protecting the mother is the best way to protect her unborn child. Therefore, a pregnant woman should wear a properly positioned seat belt whenever she drives or rides in a car.

If possible, use the lap/shoulder seat belt, remembering to keep the lap portion as low as possible (see page [7](#)).

Each time you have a check-up, ask your doctor if its okay for you to drive and how you should position a lap/shoulder seat belt.

Seat Belt Maintenance

For safety, you should check the condition of your seat belts regularly.

Pull out each belt fully and look for frays, cuts, burns and wear. Check to see that the latches work smoothly and the lap/shoulder belts retract easily. Any belt not in good condition or not working properly should be replaced.

If a seat belt is worn during a crash, have your dealer replace the belt and check the anchors for damage.

For information on how to clean your seat belts, see page [157](#).

Your Civic is equipped with a Supplemental Restraint System (SRS) to help protect your head and chest during a severe frontal collision. *This system does not replace your seat belt.* It supplements, or adds to, the protection offered by your seat belt.

Not wearing a seat belt increases the chance of serious injury or death in a crash, even if you have airbags.

Be sure you and your passengers always wear seat belts and wear them properly.

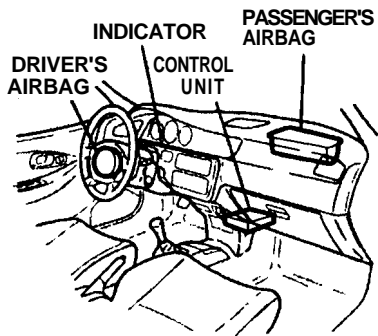

The main components in your SRS are:

- One airbag in the steering wheel for the driver and another in the dashboard for the front passenger.

- A diagnostic system that, when the ignition is ON (II), continually monitors the control unit (including sensors), airbag activator and all related wiring.
- An indicator light to warn you of a possible problem with the system.
- Emergency power backup in case your car's electrical system is disconnected in a crash.

Supplemental Restraint System

FRONTAL COLLISION RANGE

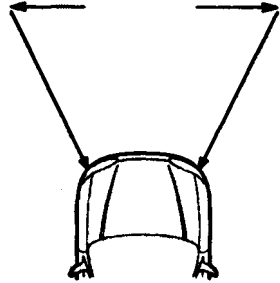

Important Safety Reminder

Even with an airbag, you need to wear a seat belt. The reasons are:

- Airbags only inflate in severe frontal collisions. They offer no protection in rear impacts, side impacts, rollovers or moderate frontal collisions.

- An airbag inflates and deflates very quickly. It cannot protect you during any additional impacts that can occur during a crash.
- A seat belt helps keep you in the proper position when an airbag inflates. An airbag opens with considerable force and can hurt you if you are not in the proper position.

How the Driver's Airbag Works

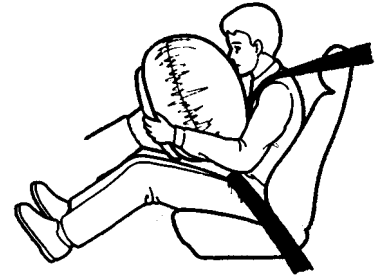

If you ever have a severe frontal collision, your airbag will instantly inflate to help protect your head and chest.

When the airbag inflates, you may hear a fairly loud noise and you might see smoke or powder. This is normal; it is caused by the inflation of the airbag.

To do its job, the airbag inflates with considerable force. So, while it can reduce serious injuries and even save your life, the airbag might cause some facial abrasions or other injuries. For this reason, you should always sit as far back from the steering wheel as comfortable while still maintaining control.

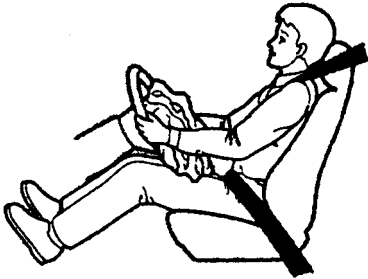

After the bag completely inflates, it immediately starts deflating so it won't interfere with your visibility, ability to steer, or ability to operate other controls.

The total time for inflating and deflation takes less than a fraction of a second. You may not even be aware that the airbag has been fully inflated.

The airbag is stored in the center of the steering wheel. For safety, do not attach any items to the steering wheel. They could interfere with the proper operation of the airbag. Or, if the airbag inflates, the items could be propelled inside the car and hurt someone.

How the Passenger's Airbag Works

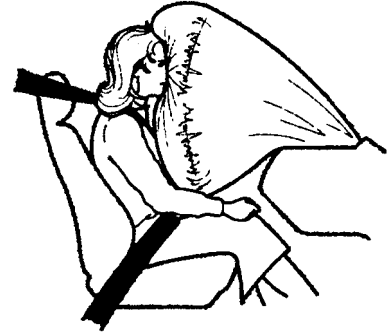

If you have a severe frontal collision, the passenger's airbag will inflate at the same time as the driver's airbag.

continued

Supplemental Restraint System

The airbag is quite large and inflates with considerable force. It can seriously hurt a front seat passenger who is not in the proper position and wearing the seat belt properly.

Front seat passengers should move the seat as far back as practical and sit well back in the seat.

If a toddler seat is used in the front passenger's seat, the vehicle seat should be moved as far back as possible. If the passenger bag inflates, it could seriously hurt a toddler who is not in the proper position or properly restrained.

Because of the airbag, we strongly recommend that you do not put an infant seat in the front passenger's seat. If the airbag inflates, it can dislodge the infant seat and seriously injure the infant.

The passenger's airbag is stored near the top of the dashboard, under a lid marked **SRS** (see page 11). Do not place any objects on top of this lid. If the airbag inflates, those objects can be propelled inside the car and possibly hurt someone.

SRS How the SRS Indicator Light Works

The purpose of the **SRS** light on your instrument panel is to alert you to a potential problem with your supplemental restraint system.

Have the system checked if:

- The light does not come on when you turn the ignition ON (II).
- The light stays on after the engine starts.
- The light comes on or flashes while you are driving.

System Service

Your supplemental restraint system is virtually maintenance-free. There are no parts you can safely service.

You must have the system serviced by an authorized Honda dealer:

- *If your airbags ever inflate.* The airbags and control unit must be replaced. Do not try to remove or discard the airbags by yourself. This must be done by a Honda dealer.
- *If the SRS indicator light alerts you of a problem.* Have the supplemental restraint system checked as soon as possible. Otherwise, your airbags might not inflate when you need them.
- *When the car is 10 years old* Have the dealer inspect the system. The production date is on the driver's doorjamb for your convenience.

System Service Precautions

Do not modify your steering wheel or any other part of the supplemental restraint system. Modifications could make the system ineffective.

Do not tamper with the system components or wiring. This could cause the airbags to inflate inadvertently, possibly injuring someone very seriously.

Tell anyone who works on your car that you have a supplemental restraint system. Failure to follow the procedures and precautions in the official Honda service manual could result in personal injury or damage to the system.

Scrapping an entire car that has uninflated airbags can be dangerous. Get assistance from a Honda dealer if your car must be scrapped.

If you sell your car, please be sure to tell the new owner that the car has a supplemental restraint system. Alert them to the information and precautions in this part of the Owner's Manual.

Additional Safety Information

The seat belts and airbags are obviously important parts of your occupant protection system.

In addition, you should know that sitting upright, locking the doors, and stowing things properly can also increase your safety and possibly even save your life.

Seat-Back Position

The seat-backs should be in an upright position for you and your passengers to get the most protection from the seat belts.

If you recline a seat-back, you reduce the protective capability of your seat belt. The farther a seat-back is reclined, the greater the risk that you will slide under the belt in a severe crash and be very seriously injured.

For information on how to adjust the seat-back, see page [49](#).

Door Locks

It is not safe to leave your car doors unlocked. A passenger, especially a child, could open a door and accidentally fall out. Also, there is a greater chance of being thrown out of the car during a crash when the doors are not locked.

Storing Cargo Safely

Before you drive, make sure you first securely store or tie down any items that could be thrown around the car and hurt someone or interfere with your ability to operate the controls.

Do not put any items on top of the rear shelf. They can block your view and they could be thrown about the car in a crash.

Be sure to keep compartment doors closed when the car is moving. If a front passenger hits the door of an open glove box, for example, he could injure his knees.

Driving With Pets

Loose pets can be a hazard while you are driving. An unrestrained pet can interfere with your ability to drive the car. In a crash or sudden stop, loose pets or cages can be thrown around inside the car and hurt you or your passengers. It is also for their safety that pets should be properly restrained in your car.

The recommended way to restrain a medium-sized or larger dog is with a special traveling harness. This harness can be secured to the rear seat with a seat belt. Travel harnesses are available at pet stores.

A small dog, cat, or other small animal will be safest in a pet carrier with rigid sides. Choose a style that allows you to secure it to the car's seat by routing a seat belt through the carrier's handle.

For further information, contact your veterinarian or local animal protection society.

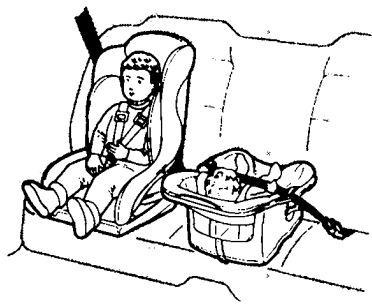

Children depend on adults to protect them. To help make sure we do, every state and Canadian province has laws requiring infants and young children to be properly restrained whenever they ride in a car.

An infant or child who is not properly restrained can be killed or seriously injured in a crash.

Be sure any child too small for seat belts is properly secured in a child restraint.

Where Should Children Sit?

According to accident statistics, children of all sizes and ages are safer when they are properly restrained in the rear seat rather than the front seat.

We recommend that, whenever possible, you secure your child's infant or toddler seat in the center position of the rear seat with the lap belt.

We strongly recommend that you do not put an infant seat in the front passenger seat. If the airbag inflates, it can hit the seat with great force. The infant seat can be dislodged and the baby seriously injured.

If a toddler seat is used in the front passenger's seat, the vehicle seat should be moved as far back as possible. If the passenger bag inflates, it could seriously hurt a toddler who is not in the proper position or properly restrained.

We also recommend that any child who is too large to use an infant or toddler seat ride in one of the outside positions of the rear seat. The child should then wear the lap/shoulder belt properly for protection.

Important Safety Reminders

Never hold a baby or child on your lap when riding in a car. If you are wearing your seat belt, the violent forces created during a crash will tear the child from your arms. The child could be seriously hurt or killed.

If you are holding a child and not wearing a seat belt in a crash, you could crush the child against the car's interior.

Never put your seat belt over yourself and a child. During a crash, the belt could press deep into the child causing serious internal injuries.

Two children should never use the same seat belt. If they do, they could be very seriously injured in a crash.

General Guidelines for Restraining Children Under 40 lb (18kg)

Use an approved child seat. The seat must meet Federal Motor Vehicle Safety Standard 213 (FMVSS-213) or Canadian Motor Vehicle Safety Standards. Look for the manufacturer's statement of compliance on the box and seat.

Use a seat of the right size. Make sure the seat fits your child. Check the seat's instructions and labels for height and weight limits,

Secure the child seat to the car. All approved child seats are designed to be secured in the car seat by the lap belt or the lap belt portion of a lap/shoulder belt. A child whose seat is not properly secured to the car can be endangered in a crash.

To properly route a seat belt through a child seat, follow the seat-maker's instructions. If you use a lap/shoulder belt, be sure you install a locking clip on the belt (see page 22).

Secure the child in the child seat. Make sure the infant or child is firmly secured to the child seat. Use the straps provided, and carefully follow the manufacturer's instructions.

Child Safety

Restraining an Infant Who Weighs Less Than 20lb(9kg)



An infant up to about 20 lb (9 kg) must be restrained in an infant seat or a convertible seat designed for a baby. Because infants of that size must ride in a reclining position, be sure the infant seat always faces the REAR of the car as shown.

We recommend that, whenever possible, you put the infant seat in the center position of the rear seat and secure it to the car with the lap belt.

We strongly recommend that you do not put an infant seat in the front passenger's seat. In a severe frontal collision, the inflating airbag can hit the infant seat with considerable force. The infant seat can be dislodged, causing serious injury to the infant.

If you decide to put an infant seat in an outside position of the rear seat, you must use a locking clip on the car's lap/shoulder belt (see page [22](#)).

Restraining a Child Who Weighs Between 20 and 40 lb (9 and 18 kg)

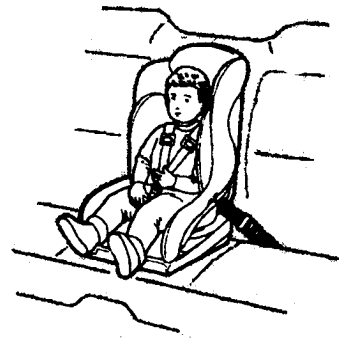

Toddler seats are designed for children who weigh between 20 and 40 lb (9 and 18 kg).

The preferred place to put a toddler seat is in the center position of the rear seat. Use the car's lap belt to secure the seat to the car.

If a toddler seat is used in the front passenger's seat, the vehicle seat should be moved as far back as possible. If the passenger bag inflates, it could seriously hurt a toddler who is not in the proper position or properly restrained.

If you decide to put a toddler seat in an outside position of the rear seat, you must use a locking clip on the car's lap/shoulder belt (see page 22).

Restraining a Child Who Weighs Over 40 lb (18 kg)

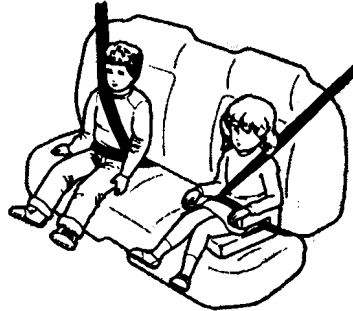

We recommend that, whenever possible, a child who has outgrown a toddler seat ride in one of the outside positions of the rear seat and use a lap/shoulder belt.

Put the lap/shoulder belt on your child and check its fit. The shoulder belt should fit over the collarbone and across the chest. The lap belt should sit low on your child's hips, not across the stomach.

If the shoulder belt crosses the neck, have your child move toward the center of the rear seat until the belt fits properly. If the belt still crosses the child's neck, you should use a booster seat.

Several styles of booster seats are available. We recommend a design that allows the child to use the car's lap/shoulder belt.

Whichever style you select, follow the booster seat manufacturer's instructions.

Child Safety

Using a Seat Belt Locking Clip

Always use a seat belt locking clip when you secure a child seat to your car with a lap/shoulder belt. This helps prevent the seat from shifting position or overturning.

A locking clip is usually included with the child seat. If you need a clip, contact the seat's manufacturer or a store that sells child restraints.

To install a locking clip, do the following:

1. Place the child restraint in the desired position. Route the lap/shoulder belt through the restraint according to the seat manufacturer's instructions.
2. Insert the latch plate into the buckle. Pull on the shoulder part of the belt to make sure there is no slack in the lap portion.

3. Tightly grasp the belt near the latch plate. Pinch both parts of the belt together so they won't slip through the latch plate. Unbuckle the seat belt.

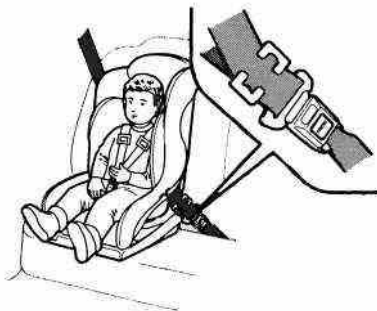

4. Install the locking clip as shown. Position the clip as close as possible to the latch plate.
5. Insert the latch plate into the buckle. Push and pull on the child seat to verify that it is

held firmly in place. If it is not, repeat these steps until the restraint is secure.

Using Child Restraints With Tethers

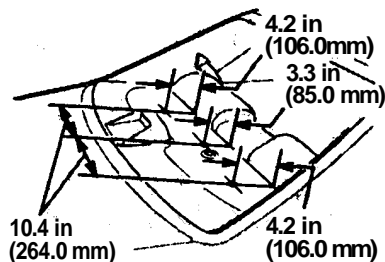

Your Honda has three attachment points for tether-style child seats. Use the dimensions in the above illustration to locate the attachment point you want to use.

Cut a 1/2 inch (12.7 mm) diameter hole in the rear shelf, then install the tether hardware that came with the child seat. Tighten the bolt to: 16 lb-ft (2.2 kg-m, 22 N.m).

If you are not sure how to install the bracket, have it installed by your authorized Honda dealer.

If you need an anchor plate and mounting hardware, you can obtain them by writing to:

American Honda Motor Co., Inc.
Consumer Affairs
1919 Torrance Blvd.
Torrance, CA 90501-2746

Canadian Cars

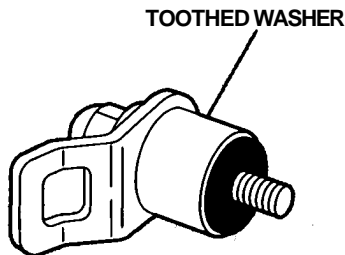

The anchor plate and mounting hardware for a top tether are supplied with the car. When installing, make sure the toothed washer is on the bottom of the bolt.

The supplied anchor plate is designed only for mounting a child restraint. Do not use it for any other purpose.

Storing a Child Seat

When you are not using an infant seat or other child restraint, either remove it or make sure it is properly secured so it cannot be thrown around the car during a crash.

Alcohol and Drugs

Driving a car requires your full attention and alertness. Traffic conditions change rapidly. You must be able to react just as rapidly. Alcohol or drugs directly affect your alertness and ability to react. Even prescription and non-prescription medicines can have this effect.

There are laws that deal with drunken driving. These laws define how much alcohol it takes in your system to be legally "drunk." However, your judgment and reaction time get worse with every drink - even the first one.

The safest thing you can do is never drink and drive. This can be done if you plan ahead. If you know you are going to be drinking, make plans to ride with a friend who will not be drinking.

What if you find that you've been drinking and cannot get a ride from a friend? Find alternative transportation. Call a taxi. Take a bus. Many communities have transportation services devoted to shuttling people who have been drinking.

If you have no choice but to drive, stop drinking and give yourself lots of time to sober up. Time is the only thing that can make you sober. Things like coffee or a cold shower don't speed up the process.

If you see friends trying to get behind the wheel after drinking, stop them. Drive them yourself or arrange other transportation. If you think you are interfering, remember that your interference will keep them from sharing the road with you.

Your car's exhaust contains carbon monoxide gas. You should have no problem with carbon monoxide entering the car in normal driving if you maintain your car properly. Have the exhaust system inspected for leaks whenever:

- The car is raised for an oil change.
- You notice a change in the sound of the exhaust.
- The car was in an accident that may have damaged the underside.



Carbon monoxide gas is toxic. Breathing it can cause unconsciousness and can even kill you.

Avoid any enclosed areas or activities that expose you to carbon monoxide.

High levels of carbon monoxide can collect rapidly in enclosed areas, such as a garage. Do not run the engine with the garage door closed. Even with the door open, run the engine only long enough to move the car out of the garage.

With the trunk lid open, air flow can pull exhaust gas into the trunk. This can get into your car's interior and create a hazardous condition. If you must drive with the trunk lid open, open all the windows and set the heating and cooling system as shown below.

If you must sit in your parked car, even in an unconfined area, with the engine running, adjust the heating and cooling system as follows:

1. Push the  button.
2. Select the  mode.
3. Turn the fan on high speed.
4. Set the temperature control to a comfortable setting.

Safety Labels

These labels are in the locations shown. They warn you of potential hazards that could cause serious injury. Read these labels carefully and don't remove them.

If a label comes off or becomes hard to read, contact your Honda dealer for a replacement.

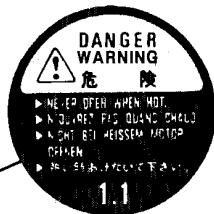
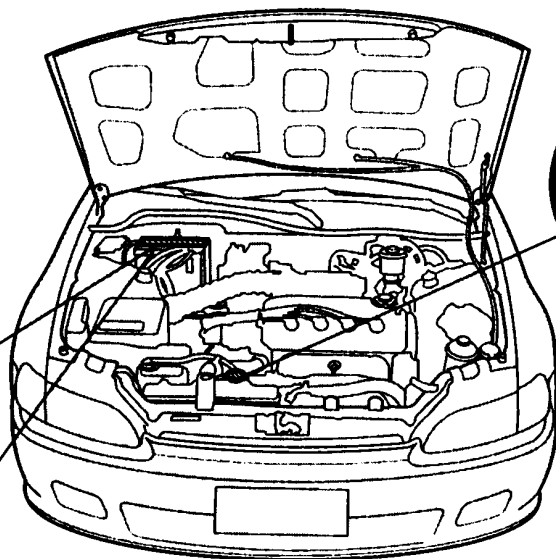

This section gives information about the controls and displays that contribute to the daily operation of your Honda. All the essential controls are within easy reach.

Control Locations	28	Keys and Locks	45
Indicator Lights	29	Keys	45
Gauges	34	Ignition Switch	46
Speedometer	34	Door Locks	47
Tachometer	34	Power Door Locks	47
Odometer	34	Trunk	48
Trip Meter	34	Seat Adjustments	49
Fuel Gauge	35	Front Seat Adjustments	49
Temperature Gauge	35	Folding Rear Seat	50
Controls Near the		Power Windows	51
Steering Wheel	36	Moonroof	52
Headlights	37	Sunshade	53
Daytime Running Lights	37	Mirrors	53
Instrument Panel Brightness	38	Parking Brake	55
Turn Signals	38	Glove Box	55
Windshield Wipers	39	Digital Clock	56
Windshield Washers	39	Beverage Holder	57
Hazard Warning	40	Vanity Mirror	57
Rear Window Defogger	40	Cigarette Lighter	58
Steering Wheel Adjustment	41	Ashtrays	58
Steering Wheel Controls	42	Interior Light	59
Cruise Control	42		
Horn	45		

Control Locations

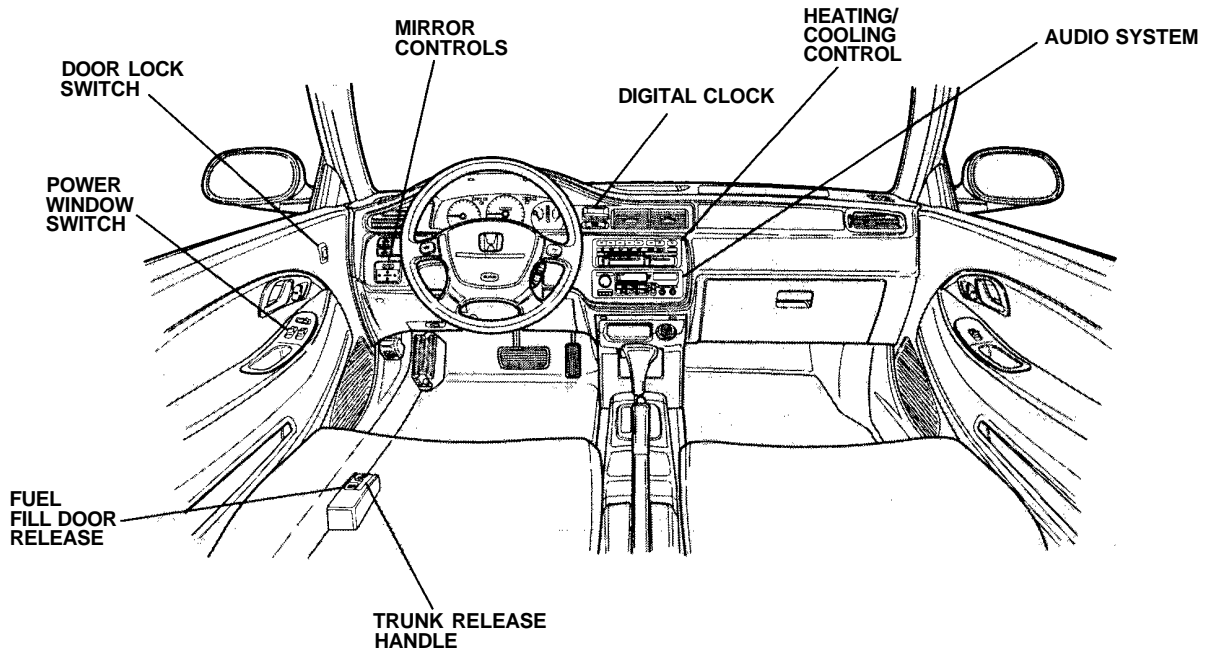

The instrument panel has many indicators to give you important information about your car.

Lamp Check

Many of the indicator lights come on when you turn the ignition switch ON (II), allowing you to see that they are working. The instrument panel should look like the illustration. If an indicator does not light during this test, it cannot alert you if that system develops a problem. Have the dealer check your car for burned-out bulbs or other problems.

* The U.S. EX with ABS option instrument panel is shown. Differences for the Canadian model are noted in the text.

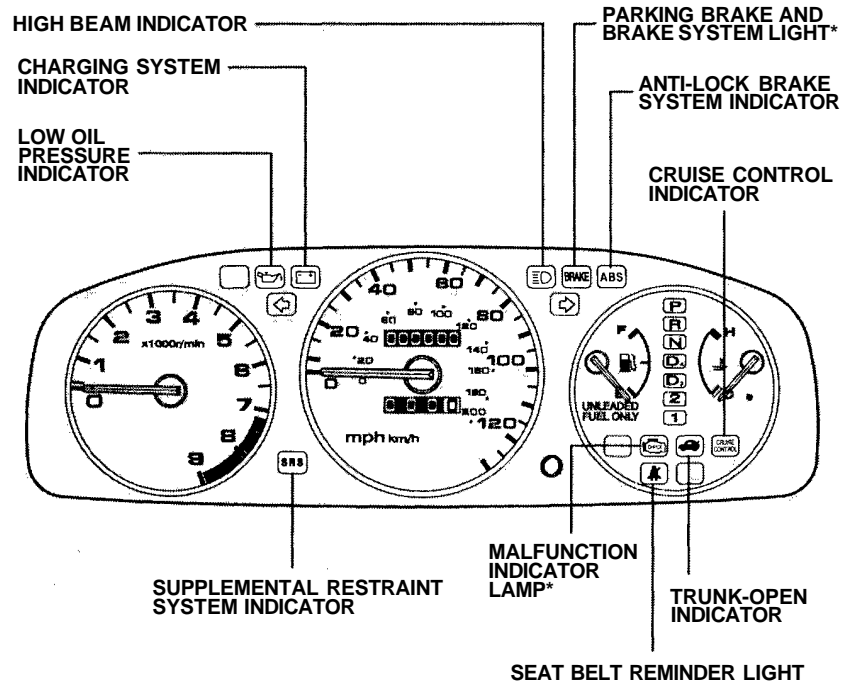

Automatic Transmission Shown

Indicator Lights

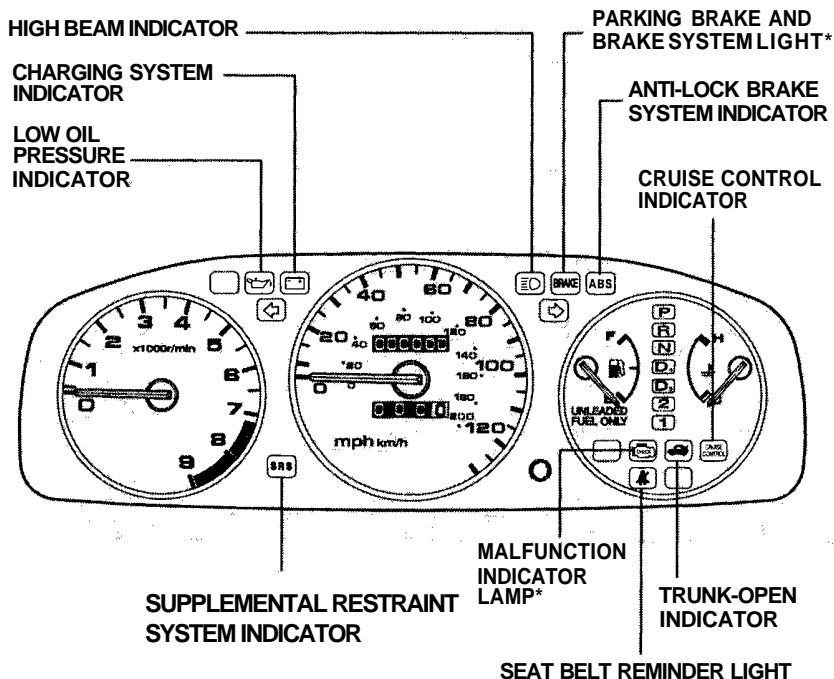

Automatic Transmission Shown



Seat Belt Reminder Light

This indicator lights when you turn the ignition ON (II). It is a reminder to you and your passengers to protect yourselves by fastening the seat belts. A beeper also sounds if you have not fastened your seat belt.

If you do not fasten your seat belt, the beeper will stop after a few seconds but the light stays on until you do. Both the light and the beeper stay off if you fasten your seat belt before turning on the ignition.

* The U.S. EX with ABS option instrument panel is shown. Differences for the Canadian model are noted in the text.



Charging System Indicator

This light indicates the battery is not being charged. It should come on when the ignition is ON (II), and go out after the engine starts. If this light comes on while driving, the battery is not being charged. Turn to page [174](#) for information about what to do.



Low Oil Pressure Indicator

This indicator lights when the oil pressure in the engine drops low enough to cause damage. It should light when the ignition is ON (II) and go out after the engine starts. If this light comes on when the engine is running, there is a possibility of serious engine damage. Safely pull to the side of the road and shut off the engine as soon as you can. Turn to page [173](#) for instructions and precautions on checking the engine.

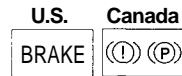

U.S.

Canada

Parking Brake and Brake System Indicator Light

This light has two functions:

1. It lights as a reminder that you have set the parking brake. Driving with the parking brake set can damage the brakes and tires. It will also cause the anti-lock brake system to turn off on cars with the ABS option. (See page [102](#)).
2. It can indicate the brake fluid level is low if it remains lit after you release the parking brake or comes on while driving. This is normally due to worn brake pads. Have your dealer check the braking system for worn pads or fluid leaks.

Indicator Lights

Supplemental Restraint System Indicator

The SRS light normally comes on for a few seconds when you turn the ignition ON (II). If it doesn't, or it stays on after the engine starts, something is wrong with the Supplemental Restraint System. It may also flash on and off to indicate a problem.

If you see any of these indications, the airbags may not work when needed in an accident. Take the car to your dealer promptly for diagnosis and service.

Anti-Lock Brake System (ABS) Indicator

On U.S. EX with option package (see page 188)

This light normally comes on when you turn the ignition ON (II) and goes off after the engine starts. If it comes on at any other time, there is a problem in the ABS. If this happens, stop the car in a safe place and turn off the engine. Reset the system by restarting the engine. Watch the ABS light. If it does not go off, or comes back on again while driving, take the car to your dealer to have it checked. With the light on, your car still has normal braking ability but no anti-lock.



U.S.: Malfunction Indicator Lamp



Canada: Check Engine Light

This light comes on for a few seconds when you turn the ignition switch ON (II). If it comes on at any other time, it indicates one of the engine's emissions control systems may have a problem. Turn to page 175 for information about what to do.



Trunk-Open Indicator

This light comes on if the trunk lid is not closed tightly.



Turn Signal and Hazard Warning Indicators

The left or right turn signal light blinks when you signal a lane change or turn. If the light does not blink or blinks rapidly, it usually means one of the turn signal bulbs is burned out (see page 146). Replace it as soon as possible, since other drivers cannot see that you are signaling.

When you turn on the Hazard Warning switch, both turn signal lights blink. All turn signals on the outside of the car should flash.



High Beam Indicator

This light comes on with the high beam headlights. See page 37 for information on the headlight controls.

Canada



Daytime Running Lights (DRL) Indicator

On Canadian models, this indicator comes on with reduced brightness when the Daytime Running Lights (DRL) are on. (See page 37).



Cruise Control Indicator

Only on cars equipped with cruise control system

This lights when you set the cruise control. See page 42 for information on operating the cruise control.

Shift Lever Position Indicator (Automatic Transmission only)

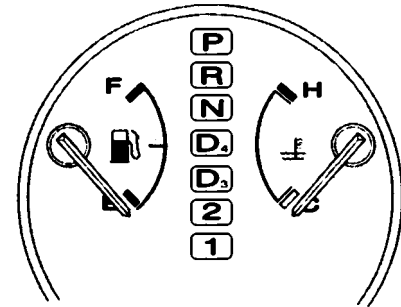

This indicator shows which shift position the lever is in.

Gauges

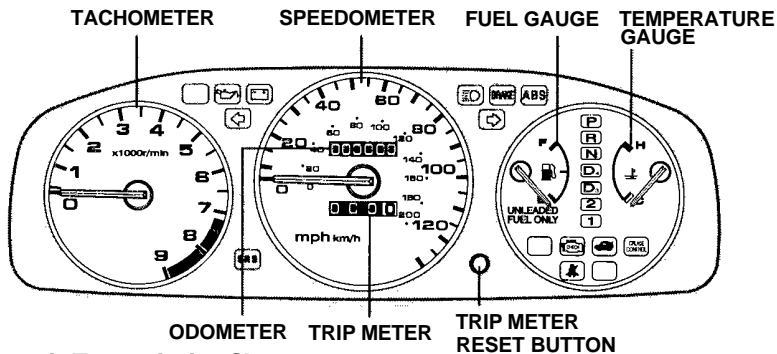

Automatic Transmission Shown

Speedometer

U.S. Models

This shows your speed in miles per hour. The smaller inner numbers are the speed in kilometers per hour.

Canadian Models

This shows your speed in kilometers per hour. The smaller inner numbers are the speed in miles per hour.

Tachometer

On U.S. EX and Canada Si models
The tachometer shows the engine speed in revolutions per minute (rpm). To protect the engine from damage, never drive with the tachometer needle in the red zone.

Odometer

The odometer shows the total distance your car has been driven. It measures miles in U.S. models and kilometers in Canadian models. It is illegal under federal law (in the U.S.) and provincial regulations (in Canada) to disconnect, reset, or alter the odometer with the intent to change the number of miles or kilometers indicated.

Trip Meter

This meter shows the number of miles (U.S.) or kilometers (Canada) driven since you last reset it. To reset it, push the trip meter reset button.

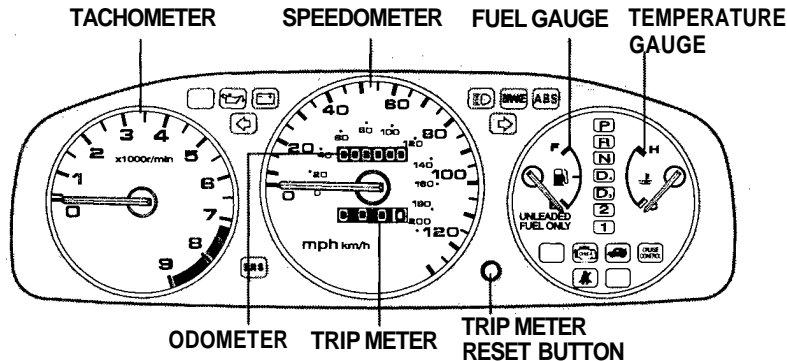

Automatic Transmission Shown

Fuel Gauge

This shows how much fuel you have. It is most accurate when the car is on level ground. It may show slightly more or less than the actual amount when you are driving on curvy or hilly roads.

The gauge stays at the same fuel level reading after you turn off the ignition. When you add fuel, the gauge slowly changes to the new reading after you turn the ignition back ON (II).

Temperature Gauge

This shows the temperature of the engine's coolant. During normal operation, the pointer should rise from the bottom white mark to about the middle of the gauge. In severe driving conditions, such as very hot weather or a long period of uphill driving, the pointer may rise to the upper white mark. If it reaches the red (Hot) mark, pull safely to the side of the road. Turn to page 120 for instructions and precautions on checking the engine's cooling system.

Controls Near the Steering Wheel

The two levers on the steering column contain controls for driving features you use most often. The left lever controls the turn signals, headlights, and high beams. The right lever controls the windshield wipers.

The rear window defogger switch is on the dashboard to the right of the steering column.

The controls under the left air vent are for the moonroof, mirrors, cruise control and instrument panel brightness.

The lever on the underside of the steering column allows you to tilt the steering wheel.

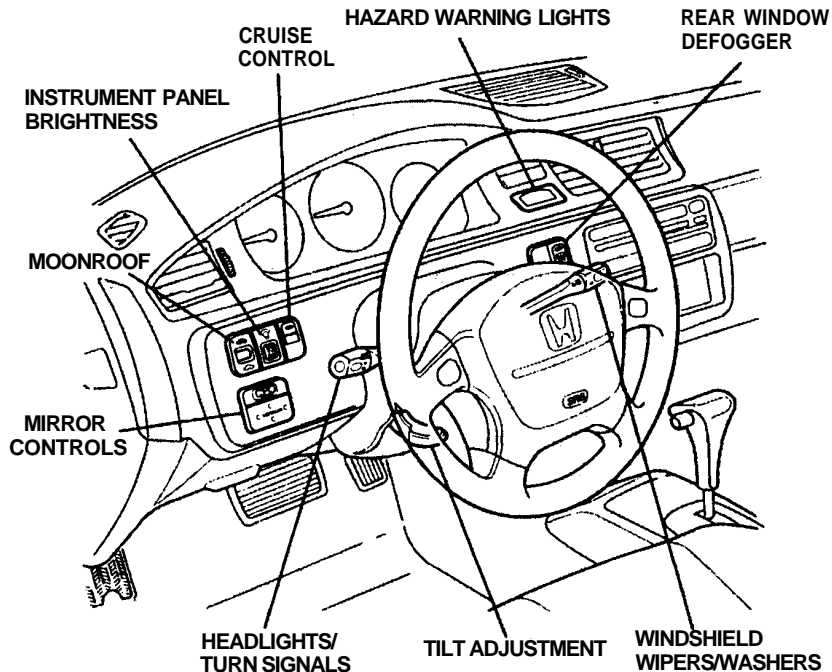

Headlights

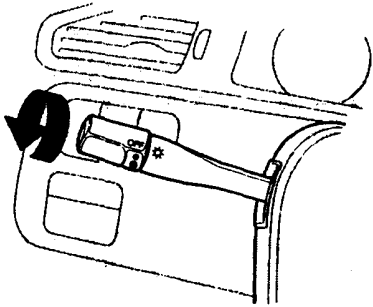

The rotating switch on the left lever controls the lights. Turning this switch to the first position "●" turns on the parking lights, tail lights, instrument panel lights, side-marker lights, and rear license plate lights. Turning the switch to the second position "●" turns on the headlights.

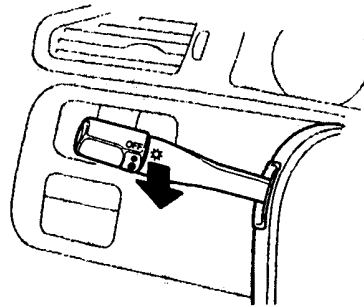

To change between low beams and high beams, pull the turn signal lever toward you until you hear a click, then let go. The high beam indicator will light (see page 33).

To flash the high beams, pull back and hold the turn signal lever. Release the lever and the high beams will go off.

The high beams will stay on for as long as you hold the lever, no matter what position the headlight switch is in.

Daytime Running Lights

Canadian Models

With the headlight switch off, the high beam headlights come on with reduced brightness when you turn the ignition switch to ON (II) and release the parking brake. They remain on until you turn the ignition off, even if you set the parking brake.

The headlights revert to normal operation when you turn them on with the switch.

Controls Near the Steering Wheel

Instrument Panel Brightness

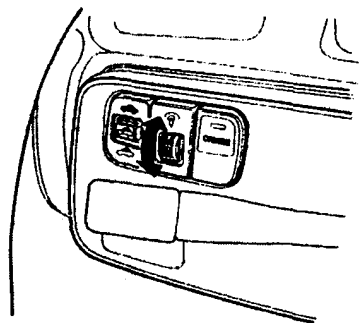

The dial on the dashboard to the left of the instrument panel controls the brightness of the instrument panel lights. Turn the dial to adjust the brightness.

Turn Signals

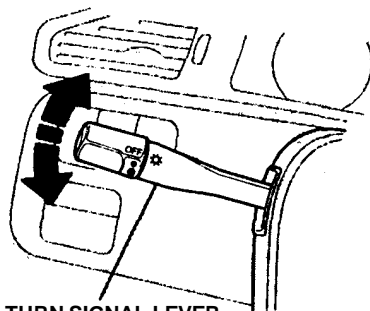

TURN SIGNAL LEVER

Signal a turn or lane change with this lever. Push down on the lever to signal a left turn, and up to signal a right turn. If you push it up or down all the way, the turn signal continues to blink even when you release the lever. It shuts off automatically as you complete the turn.

To signal a lane change, push lightly on the turn signal lever in the proper direction and hold it. The lever will return to the center position as soon as you release it.

Windshield Wipers

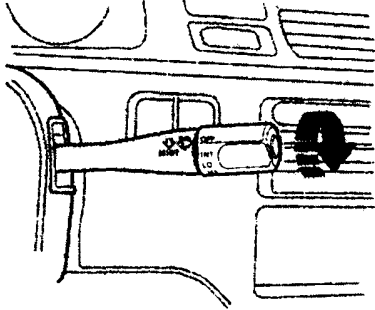

The right lever controls the windshield wipers and washers. The rotary switch at the end of the lever has three positions:

INT - intermittent
LO - low speed
HI - high speed

In intermittent, the wipers operate every few seconds. In low speed and high speed, the wipers run continuously.

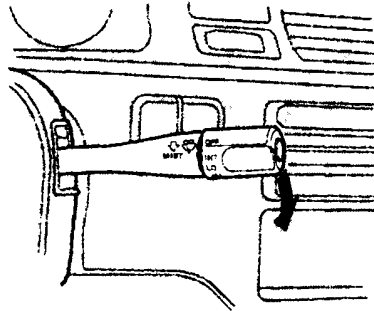

To operate the wipers in mist mode, push the control lever down. The wipers run at high speed until you release the lever. This gives you a quick way to clear the windshield.

Windshield Washers

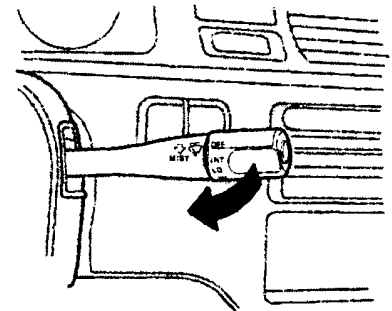

U.S. Models

To clean the windshield, pull the wiper control lever toward you. The washers spray until you release the lever.

Canadian Models

The wipers run at low speed while you're pulling the lever, then complete one more sweep of the windshield after you release it.

Controls Near the Steering Wheel

Hazard Warning

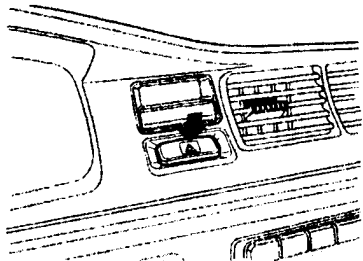

Push the red button under the clock to turn on the hazard warning lights (four-way flashers). This causes all four outside turn signals and both indicators in the instrument panel to flash. Use the hazard warning lights if you need to park in a dangerous area near heavy traffic, or if your car is disabled.

Rear Window Defogger

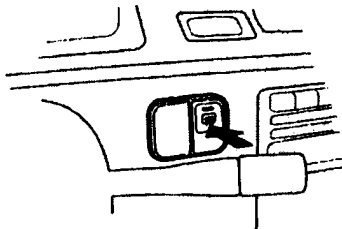

The rear window defogger will clear fog, frost, and thin ice from the window. Push the defogger button to turn it on and off. The light in the button lights to show the defogger is on. If you do not turn it off, the defogger will shut itself off after about 25 minutes. It also shuts off when you turn off the ignition. You have to turn it on again when you restart the car.

Make sure the rear window is clear and you have good visibility before starting to drive.

The defogger wires on the inside of the rear window can be accidentally damaged. When cleaning the glass, always wipe side to side.

Steering Wheel Adjustment

You can adjust the steering wheel height to suit your preference. Do this before you begin driving.

Adjusting the steering wheel position while driving may cause you to lose control of the car and be seriously injured in a crash.

Adjust the steering wheel when the car is stopped.

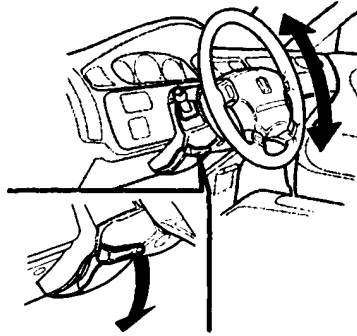

1. Adjust the seat so you are a comfortable distance from the pedals and can operate them safely.
2. The lever to tilt the steering wheel is under the steering column to the left. Push this lever all the way down.

3. Move the steering wheel up or down to the desired position. Position the wheel so you can see all the instrument panel gauges and warning lights. Push the lever up to lock the steering wheel in that position.
4. Make sure you have securely locked the steering wheel in place by trying to move it up and down.

Steering Wheel Controls

Cruise Control

Available only on EX in the U.S., and Si model in Canada

Cruise control allows you to maintain a set speed above 25 mph (40 km/h) without keeping your foot on the accelerator pedal. It is for cruising on straight, open highways. It is not recommended for conditions such as city driving, winding roads, slippery roads, heavy rain, or bad weather. You should have full control of the car under those conditions.

Improper use of the cruise control can lead to a crash.

Use the cruise control only when traveling on open highways in good weather.

NOTICE

The cruise control, as it operates, moves the accelerator pedal. You can damage your car's accelerator mechanism by resting your foot under the pedal and blocking the movement.

Using the Cruise Control

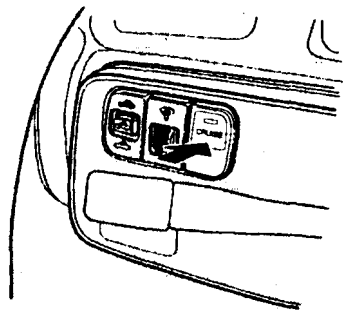

1. Push in the Cruise Control Master Switch to the left of the steering column. The indicator in the switch will light.
2. Accelerate to the desired cruising speed above 25 mph (40 km/h).

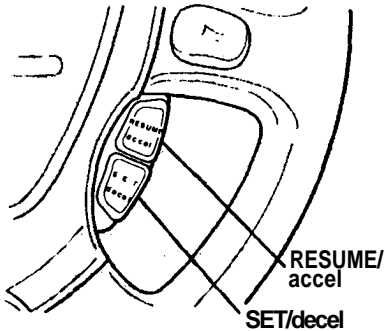

3. Press and hold the SET/decel button on the steering wheel until the CRUISE CONTROL light on the instrument panel comes on. This shows the system is now activated.

The set speed may vary slightly, particularly on hills.

Changing the Set Speed

You can increase the set cruising speed in either of two ways:

- Press and hold the RESUME/accel button. The car will accelerate slowly. When you reach the desired cruising speed, release the button.
- Push on the accelerator pedal. Accelerate to the desired cruising speed and press the SET/decel button.

You can decrease the set cruising speed in either of two ways:

- Press and hold the SET/decel button. The car will decelerate. Release the button when you reach the desired speed.

- Tap the brake or clutch pedal lightly with your foot. The CRUISE CONTROL light on the instrument panel will go out. When the car slows to the desired speed, press the SET/decel button. The car will then maintain the desired speed.

Even with the cruise control turned on, you can still use the accelerator pedal to speed up for passing. After completing the pass, take your foot off the accelerator pedal. The car will return to the set cruising speed.

Resting your foot on the brake or clutch pedal will cause the cruise control to cancel.

Steering Wheel Controls

Canceling the Cruise Control

Any of these actions cause the cruise control to cancel.

- Tap the brake or clutch pedal.
- Press the SET/decel and RESUME/accel buttons at the same time.
- Press the Cruise Control Master Switch.

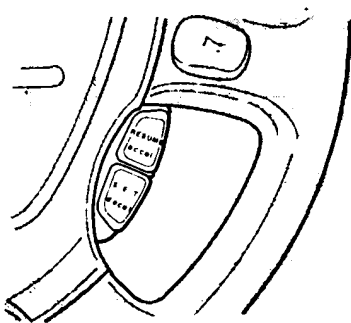

When you tap the brake or clutch pedal (manual transmission cars), or press the SET and RESUME buttons at the same time, the CRUISE CONTROL light on the instrument panel will go out and the car will begin to slow down. You can use the accelerator pedal in the normal way.

If you use the brake or clutch pedal to cancel cruise control, the system retains the previously set cruising speed. To return to that

speed, accelerate to above 25 mph (40 km/h) and press the RESUME/accel button until the CRUISE CONTROL light comes on. The car will accelerate to the same cruising speed as before.

If you cancel cruise control by pressing the SET and RESUME BUTTONS at the same time, the previously set cruising speed is erased. To use the cruise control, accelerate to the desired cruising speed and press the SET/decel button.

Pressing the Cruise Control Master Switch turns the system completely off and erases the previous cruising speed from memory. To use the system again, refer to **Using the Cruise Control**.

Steering Wheel Controls, Keys and Locks

Horn

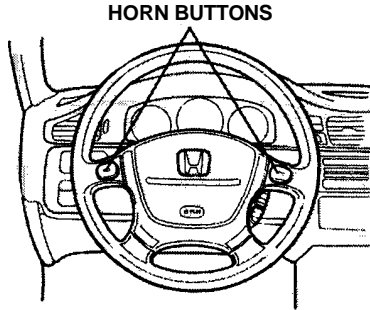

Press either of the buttons on the steering wheel spokes to sound the horn.

Keys

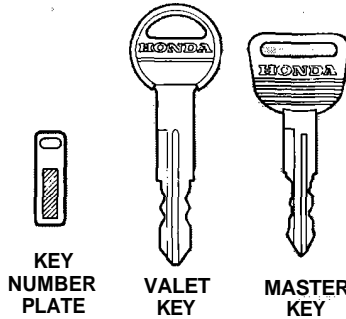

Your car comes with two kinds of keys: a master key and a valet key. The master key fits all locks on your car.

- Ignition
- Doors
- Trunk
- Trunk release handle
- Rear seat trunk access

The valet key only works the ignition and the door locks. You can keep the trunk, trunk release handle and rear seat trunk access locked when you leave your car and valet key at a parking facility. (See Trunk, page 48.)

You should have received a key number plate with your set of keys. You will need this number if you have to get a lost key replaced. Record this number and keep the plate in a safe place. When replacing keys, use only Honda-approved key blanks.

Keys and Locks

Ignition Switch

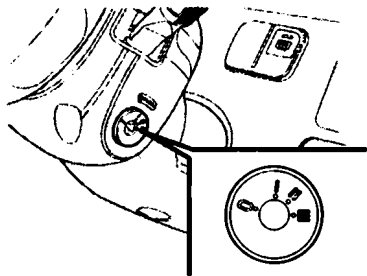

The ignition switch is on the right side of the steering column. It has four positions:

- LOCK (0)
- ACCESSORY (I)
- ON (II)
- START (III)

LOCK (0) — You can insert or remove the key only in this position. When you turn the key from LOCK to ACCESSORY, you may have to turn the steering wheel to release the anti-theft lock. To switch from ACCESSORY to LOCK, you must push the key in slightly as you turn it. If your car has an automatic transmission, it must also be in Park. The anti-theft lock will lock the steering column when you remove the key.

Removing the key from the ignition switch while driving locks the steering. This can cause you to lose control.

Remove the key from the ignition switch only when parked.

ACCESSORY (I) — In this position, you can operate the audio system and cigarette lighter.

ON (II) — This is the normal key position when driving. All features and accessories on the car are usable. Several of the lights on the instrument panel come on as a test when you turn the ignition switch from ACCESSORY to ON (see page 29).

START (III) — Use this position only to start the engine. The switch returns to ON when you let go of the key.

You will hear a reminder beeper if you open either front door with the key in the LOCK or ACCESSORY position. Remove the key to turn it off.

Door Locks

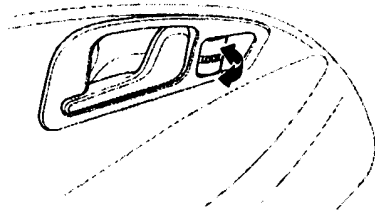

Each door has a lock tab next to the inside door handle. Push the tab forward to lock the door, and pull it backward to unlock.

To lock the passenger's door when getting out of the car, push the lock tab forward and close the door. To lock the driver's door, pull the outside door handle and push the lock tab forward. Release the handle; then, close the door.

Power Door Locks

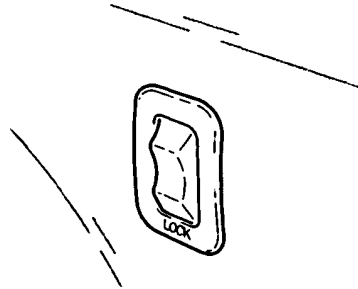

Available on U.S. EX model

This allows control of both door locks from the driver's door. Push the master door lock switch down to lock both doors and up to unlock them.

Both doors lock when you push the lock tab on the driver's door. Only the driver's door unlocks when you use the key or lock tab. To unlock the passenger's door, use the master door lock switch or the lock tab on each door.

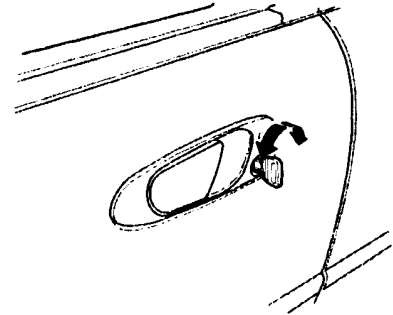

The doors can also be locked and unlocked from the outside with the key.

Keys and Locks

Trunk

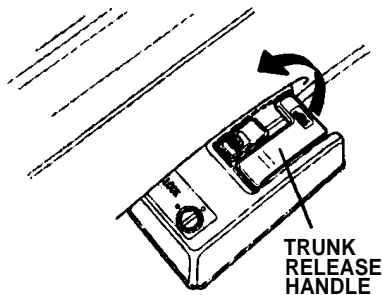

You can open the trunk in two ways:

- Pull the trunk release handle to the left of the driver's seat.
- Use the master key to open the trunk lock. The valet key does not work in this lock.

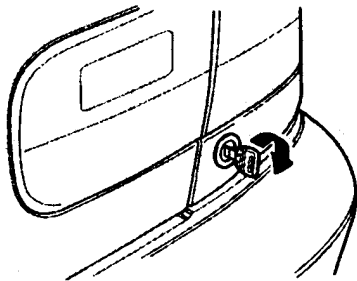

To close the trunk, press down on the trunk lid.

See page [90](#) for cargo loading and weight-limit information. Keep the trunk lid closed at all times while driving to avoid damaging the lid and getting exhaust gas in the interior. See Carbon Monoxide Hazard on page [25](#).

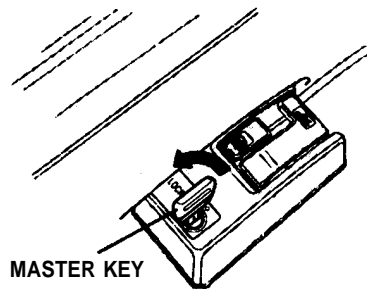

To protect items in the trunk when you need to give the key to someone else, lock the trunk release handle with the master key and give the other person the valet key.

Adjust the seat before you start driving.

Front Seat Adjustments

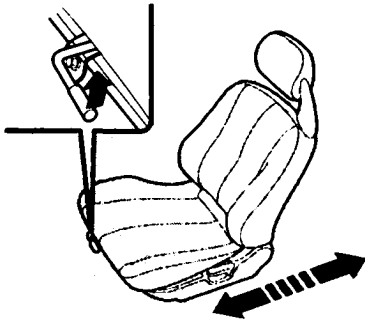

To adjust the seat forward and backward, pull up on the lever under the seat cushion's front edge. Move the seat to the desired position and release the lever. Try to move the seat to make sure it is locked in position.

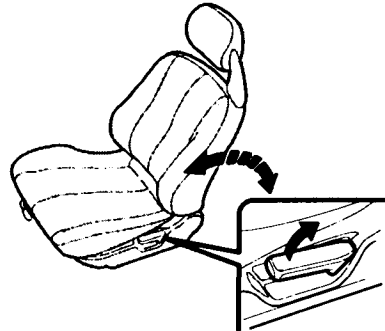

To change the angle of the seat-back, pull up on the lever on the outside of the seat bottom. Move the seat-back to the desired position and release the lever. Let the seat-back latch in the new position.

Reclining the seat-back can decrease the protection you get from your seat belt in a crash.

You can slide under the seat belt and be seriously injured.

Adjust the seat-back to an upright position and sit well back in the seat.

Folding Rear Seat

Rear Seat Access

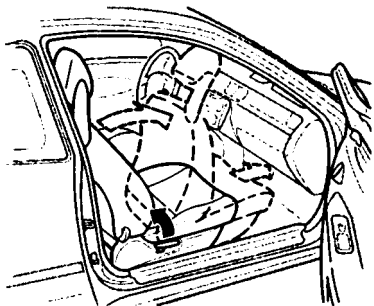

Passenger side only

To get in or out of the rear seat, pull up on the lever at the side of the front passenger's seat. The seat-back will fold down and the front passenger's seat will move forward.

The seat will lock in place when it is pushed back.

Folding Rear Seat

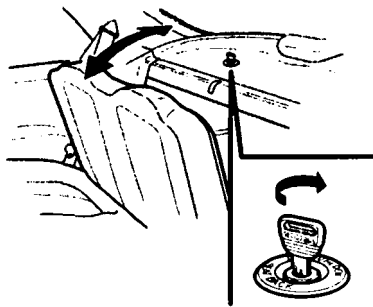

The back of the rear seat folds down, giving you direct access to the trunk. The seat-back can be released from inside the car or inside the trunk.

To fold down the seat-back from inside the car, insert the master key in the lock on the rear shelf. Turn the key clockwise, pull down the top of the seat-back; then, release the key.

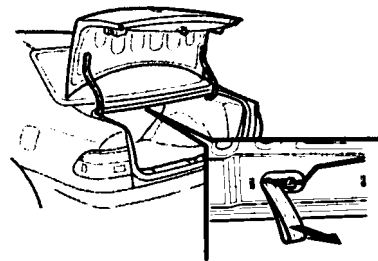

To release the seat-back from inside the trunk, pull the release loop under the rear shelf. Push the seat-back down; then, let go of the loop.

To lock the seat-back upright, push it firmly against the rear shelf. Make sure it is latched in place by pulling on the top of the seat.

Make sure all items in the trunk, or items extending through the opening into the back seat, are tied down. Loose items can fly forward and cause injury if you have to brake hard. See **Loading Cargo** on page 90.

Never drive with the seat-back folded down and the trunk lid open. See **Carbon Monoxide Hazard** on page 25.

Power Windows

On U.S. EX model

Your car's windows are electrically powered. Turn the ignition switch to ON (II) to raise or lower a window.

Each door has a switch that controls its window. To open the window, push the switch down and hold it. Release the switch when you want the window to stop. Close the window by pushing the switch up and holding it.

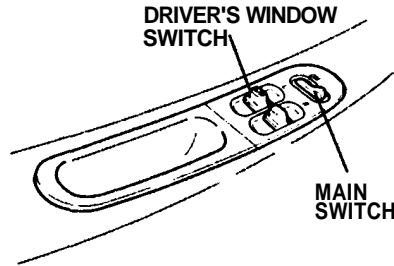

The driver's armrest has a master power window control panel. To open the passenger's window, push down on the appropriate switch and hold it down until the window reaches the desired position. To close the window, push up on the window switch. Release the switch when the window gets to the position you want.

The master control panel also contains these extra features:

AUTO - To open the driver's window fully, push the window switch firmly down and release it. The window automatically goes all the way down. To stop the window from going all the way down, push the window switch up briefly.

To open the driver's window only partially, push the window switch down lightly and hold it. The window will stop as soon as you release the switch.

The AUTO function only works to lower the driver's window. To raise the window, you must push the window switch up and hold it until the window reaches the desired position.

Power Windows, Moonroof

The MAIN switch controls power to the passenger's windows. With this switch off, the passenger's window cannot be raised or lowered. The MAIN switch does not affect the driver's window. Keep the MAIN switch off when you have children in the car so they do not injure themselves by operating the window unintentionally.

Closing a power window on a child's hands or fingers can cause serious injury.

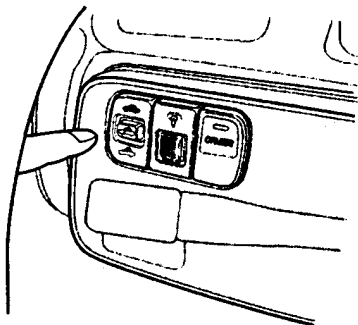

Make sure children are away from the windows before closing them.

Moonroof



Only on EX in the U.S. and Si model in Canada

Use the switches on the dashboard under the left vent to operate the moonroof. The ignition must be ON (II).

To lift the rear of the moonroof for ventilation, push the  button. To slide the moonroof back, push the  switch. Hold it until the moonroof reaches the

desired position, then release the switch.

To close the moonroof, press and hold the  switch.

Closing the moonroof on someone's hands or fingers can cause serious injury.

Make sure passengers are clear of the moonroof before closing it.

NOTICE

If you try to open the moonroof in below-freezing temperatures, or when it is covered with snow or ice, you can damage the moonroof panel or motor.

Sunshade

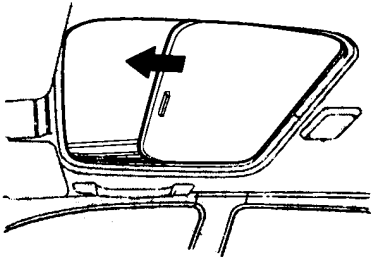

You can slide the sunshade to any position when the moonroof is closed. The sunshade slides open with the moonroof. You must close it manually.

Mirrors

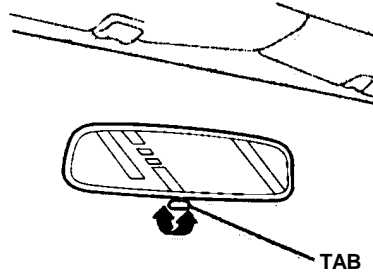

Keep the inside and outside mirrors clean and adjusted for best visibility. Be sure to adjust the mirrors before you start driving.

The inside mirror has day and night positions. The night position reduces glare from headlights behind you. Flip the tab on the bottom edge of the mirror to select the day or night position.

Manual Door Mirrors

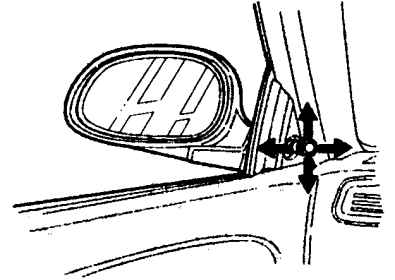

Only on DX models

The outside mirrors can be adjusted by moving the knob on the inside of the door.

Power Mirrors

Adjusting the Power Mirrors

SELECTOR SWITCH

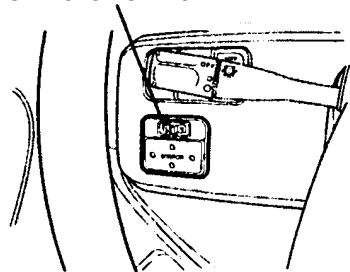

On the EX in the U.S. and Si in Canada

Adjust the outside mirrors with the adjustment switch on the left side of the dashboard:

1. Turn the ignition switch ON (II).
2. Move the selector switch to L (driver's side) or R (passenger's side).

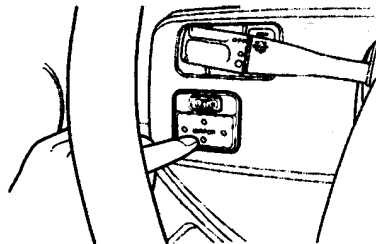

3. Push the appropriate edge of the adjustment switch to move the mirror right, left, up, or down.
4. When you finish, move the selector switch to the center (OFF) position. This turns off the adjustment switch so you can't move a mirror out of position by accidentally bumping it.

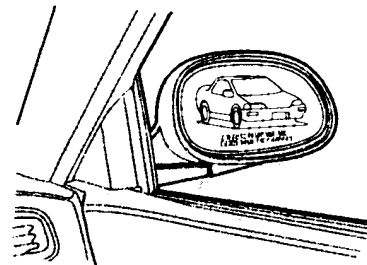

The outside mirror on the passenger's side has curved glass. Objects look farther away than they are. Use this mirror to get a "wide view." Don't use it to judge the distance of things behind you.

Parking Brake

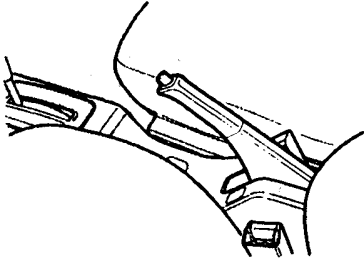

To apply the parking brake, pull the lever up fully. To release it, pull up slightly, push the button, and lower the lever. The parking brake light on the instrument panel should go out when the parking brake is fully released (see page 31).

NOTICE

Driving the car with the parking brake applied can damage the rear brakes and axles.

Glove Box

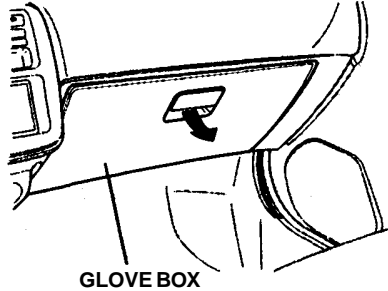

Open the glove box by pulling the handle. Close it with a firm push.

An open glove box can cause serious injury to your passenger in a crash, even if the passenger is wearing the seat belt.

Always keep the glove box closed while driving.

Digital Clock

Digital Clock

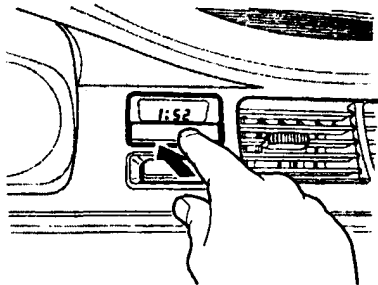

EX models in the U.S. and Si models in Canada

The digital clock displays the time with the ignition switch ON (II). To see the time with the ignition off, press and hold the wide button under the clock.

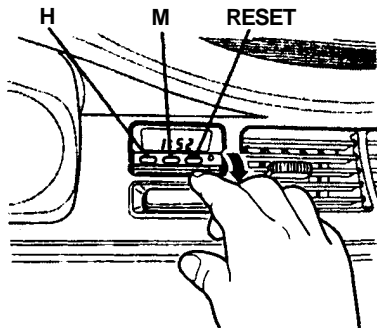

To set the clock:

1. Turn the ignition switch ON (II) to display the time.
2. Swing down the front cover of the wide button under the clock display. You will see H, M, and RESET buttons.

3. Press and hold the HOUR button until the hour advances to the desired time.
4. Press and hold the MIN. button until the numbers advance to the desired time.

You can use the RESET button to quickly set the time to the nearest hour. If the displayed time is before the half hour, pressing RESET sets the clock back to the previous hour. If the displayed time is after the half hour, pressing RESET sets the clock forward to the beginning of the next hour.

For example:

- 1:06 would RESET backward to 1:00.
- 1:52 would RESET forward to 2:00.

Beverage Holder

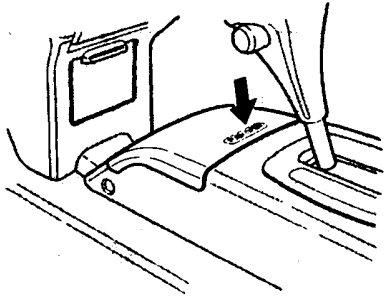

To open the beverage holder, push on the top. The beverage holder lid is spring-loaded and will pop open. To close it, push it down until it latches.

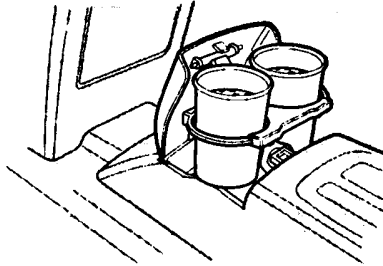

Use the beverage holder only when the car is parked. If you place cups in the holder while driving, the liquid may spill when you go over bumps or around corners.

Be careful when you are using the beverage holder. Spilled liquids can damage the upholstery, carpeting, and electrical components in the interior. If the liquid is very hot, it can scald you or your passengers.

Vanity Mirror

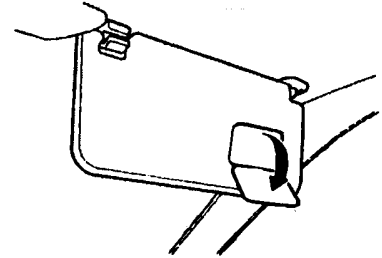

Only on EX in the U.S. and Si model in Canada

To use the vanity mirror, pull down the sun visor and swing down the cover.

Cigarette Lighter, Ashtrays

Cigarette Lighter

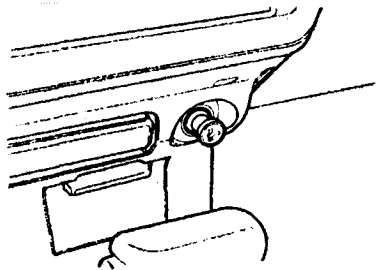

The ignition switch must be in ACCESSORY (I) or ON (II) for the cigarette lighter to work. To heat up the lighter, push it in. It will pop out when it is ready for use. Do not hold the lighter in while it is heating up, you could cause it to overheat.

Ashtrays

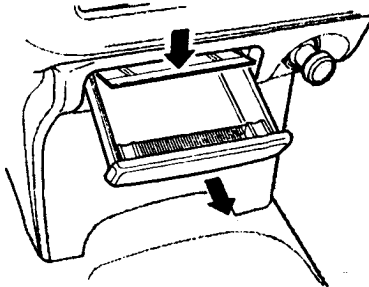

Open the front ashtray by pulling on the bottom edge. Push it in to close it.

To remove the ashtray for emptying, push down on the metal plate inside, then pull the ashtray out completely.

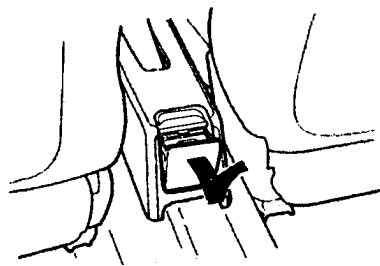

The rear ashtray is at the rear end of the center console. Open the ashtray by swinging the upper edge of the lid down. To remove the ashtray for emptying, open it then lift up and out.

NOTICE

Use the ashtray only for cigarettes, cigars and other smoking materials. To prevent a possible fire and damage to your car, don't put paper or other things that can burn in the ashtrays.

Interior Light

DOOR ACTIVATED

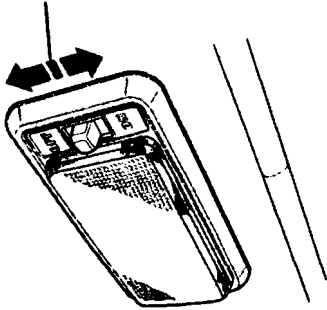

The interior light has a three-position switch. In the OFF (forward) position, the light does not come on. In the center position, the interior light comes on when you open either front door. In the ON (rearward) position, the interior light stays on continuously.

The heating/ventilation system in your car, when combined with the optional air conditioner, provides a comfortable driving environment in all weather conditions.

U.S. EX and Canada Si models

The standard audio system is very versatile. To get the most benefit from this system, read its description in this manual.

The anti-theft feature on your radio disables the system. To get the system working again you must enter a code number as described in this manual.

For other models

Refer to the operating instructions that came with the optional audio system you selected.

Heating and Cooling	62
What Each Control Does . . .	64
How to Use the System	65
Controlling Air	
Flow Direction	65
Ventilation	65
To Cool with A/C	66
To Heat	67
To Heat and Dehumidify with Air Conditioning . .	67
To Defog and Defrost . . .	68
To Turn Everything Off . .	68
Audio System	69
Operating the Radio	69
Presetting	70
Adjusting the Sound	71
Radio Frequencies	72
Operating the Cassette Player	73
Cassette Player Care	75
Operating the CD Player/Changer	76

Heating and Cooling

This system has full heating, ventilation, and air conditioning (optional) capabilities. You can adjust the system controls to mix these in various combinations. The air flows into the interior at three possible levels that you can select.

A Genuine Honda air conditioning system is available from your dealer. It meets Honda's high quality standards and is designed to fit your car. If you purchased your car without air conditioning, it can be installed at a later time. Please contact your dealer for more information.

CENTER VENT

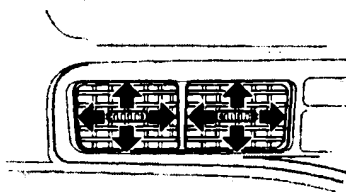

The direction of air flow from the vents in the center and each side of the dashboard is adjustable. Move the tab in the center of each vent up and down and side to side.

The side and upper vents can be opened and closed with the dials next to them.

SIDE VENT

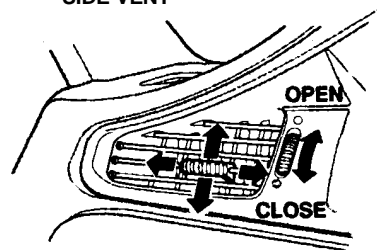

The heating and cooling system draws air through the exterior vents at the bottom of the windshield. Keep these vents clear of leaves and other debris.

UPPER VENT

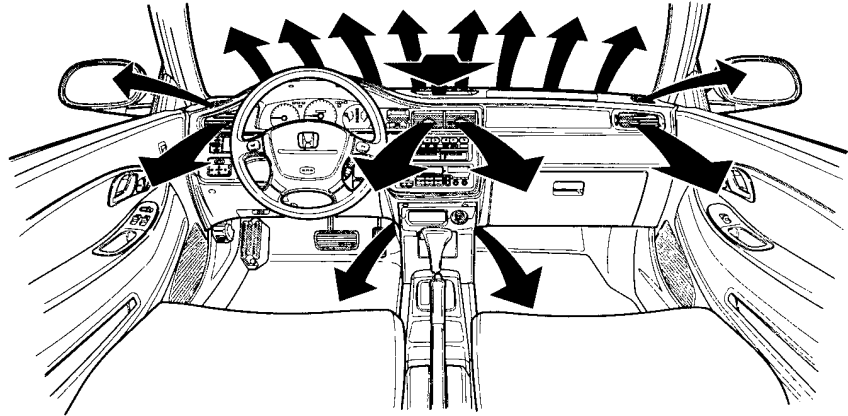
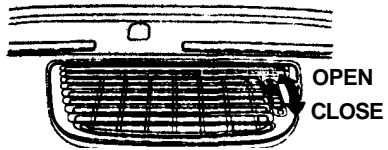

Heating and Cooling

What Each Control Does

Fan Control Lever

Sliding this lever to the right increases the fan speed, which increases air flow.

Temperature Control Lever

Sliding this lever to the right increases the temperature of air flowing through the system.

Mode Buttons

These buttons control the direction of air flow. The indicator light shows which button is controlling air flow.

Air Conditioning (A/C) Switch

This switch turns the air conditioner ON and OFF. The indicator in the switch lights when the A/C is ON.

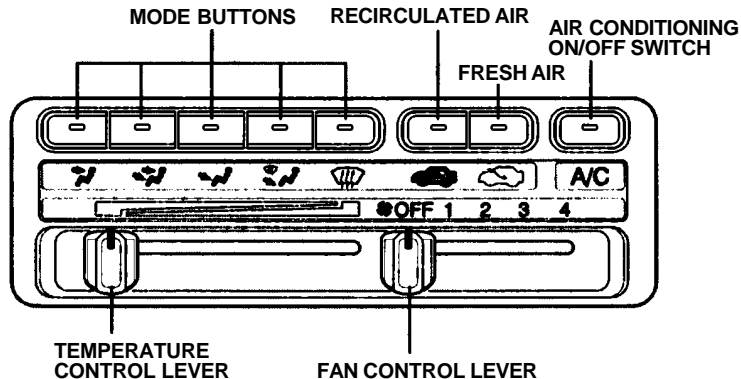



Fresh Air and Recirculation Buttons

These two buttons control the source of air going into the system. In Fresh Air mode, air comes from outside the car. In Recirculation mode, the interior air recycles through the system.

How to Use the System



This section covers the best way to use the system for ventilation, cooling, dehumidifying, defrosting and heating. In most cases, the mode and air source selections are only recommendations. You may prefer different settings.

Use  mode to heat or cool the interior more quickly, or to keep out smoke and dust. Leaving the system in recirculation mode with the air conditioning off can cause the windows to fog up. Switch to  mode as soon as the interior reaches a comfortable temperature or the outside smoky, dusty condition clears.

The engine must be running for the heater and air conditioning system to provide hot and cold air. The heater uses engine coolant to warm the air. If the engine is cold, it will be several minutes before you feel warm air circulating.

Air conditioning does not depend on engine temperature. It can produce cold air almost immediately.

Controlling Air Flow Direction

Air flows into the interior at three levels: Toward the floor , through the dash vents , and toward the windshield and side windows . You select the air flow level or combination of levels with the five mode buttons.

Ventilation

Your car has a flow-through ventilation system. Air enters the car through vents in front of the windshield. It circulates through the interior then exits through vents near the rear window. This system provides fresh air even when the car is standing still. To bring in outside air, press the  button. Set the fan at a comfortable speed.



continued

Heating and Cooling

To Cool with A/C

To operate the air conditioning system, press the air conditioning switch. Set the fan to the desired speed. You can also use the  mode button to direct air out of the dash and heater vents.

To cool the interior down rapidly after the car has been sitting in the sun:

1. Start the engine.
2. Turn on the A/C by pressing the switch.
3. Set the fan to maximum speed.
4. Open the windows partially. Select  and .

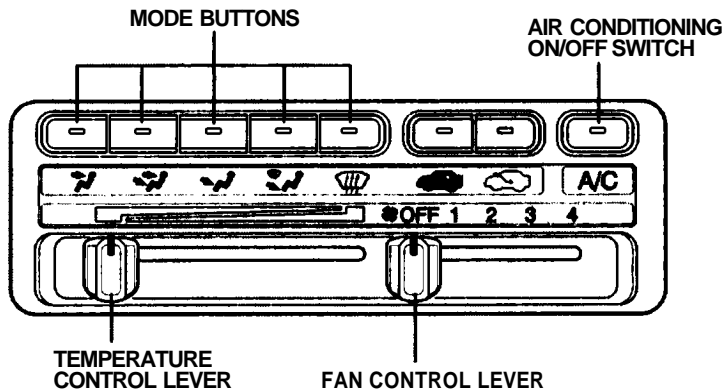



When the interior reaches a comfortable temperature, close the windows and set the system for cooling as described above.

The air conditioning places an extra load on the engine. Watch the coolant temperature gauge (see page 35) when using the A/C in heavy traffic or driving up long hills. If it moves near the red zone, turn off the air conditioning until the gauge reads normally.

To Heat

To warm the interior.

1. Start the engine.
2. Select  and .
3. Switch the fan to the desired speed.
4. Adjust the warmth of the air with the temperature control lever.

To Heat and Dehumidify with Air Conditioning

Air conditioning removes moisture from the air as it operates. When used in combination with the heater, it makes the interior warm and dry.

1. Switch the fan on.
2. Turn on the air conditioning.
3. Select  and press any desired mode button.

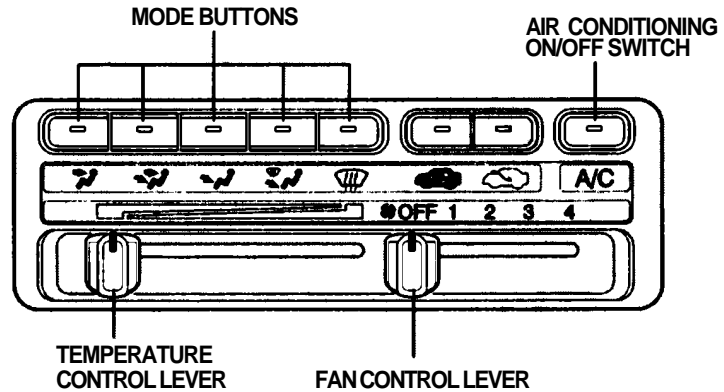



4. Adjust the temperature control lever so the mixture of heated and cooled air feels comfortable.

This setting is suitable for all driving conditions whenever the outside temperature is above 32°F (0°C).



Heating and Cooling

To Defog and Defrost

To remove fog from the inside of the windows:

1. Switch the fan on.
2. Turn on the air conditioning.
3. Select  and .
4. Adjust the temperature control lever so the airflow from the defroster vents feels warm.
5. Turn on the rear window defogger to help clear the rear window.

To remove exterior frost or ice from the windshield and side windows after the car has been sitting out in cold weather:

1. Start the engine.
2. Select  and .

3. Switch the fan and temperature controls to maximum.

To rapidly remove exterior frost or ice from the windshield (on very cold days), first select



. Once the windshield is clear, select  to avoid fogging the windows.

These settings direct all the air flow to the defroster vents at the base of the windshield and each front door window. The air flow will get warmer and clear the windows faster as the engine warms up. You can close the side vents with the dial beside each vent. This will send more warm air to the windshield defroster vents.

For safety, make sure you have clear view through all the windows before driving away.

To Turn Everything Off

To shut off the system temporarily, slide the fan speed and temperature control levers all the way to the left.

You should only shut the system completely off for the first few minutes of driving in cold weather, until the engine coolant warms up enough to operate the heater. Keep the fan on at all other times so stale air does not build up in the interior.

AM/FM/Cassette Stereo Audio System

U.S. EX and Canada Si

Your Honda audio system is easy to use and will give clear AM/FM reception. The preset buttons allow you to select six stations on AM and 12 stations on FM.

The anti-theft feature disables the system if it is disconnected from the car's battery. To get the system working again, you must enter a code number. See page 79.

The cassette system uses Dolby B* noise reduction to give excellent sound reproduction. The system also senses when a metal or a chromium dioxide (CrO₂) tape is being played and adjusts accordingly.

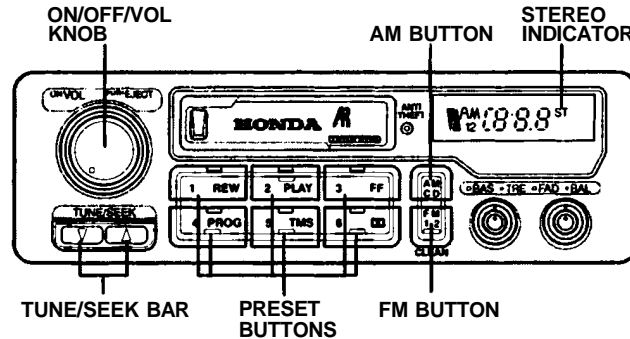

*Dolby noise reduction manufactured under license from Dolby Laboratories Licensing Corporation. "Dolby" and the  symbol are trademarks of Dolby Laboratories Licensing Corporation.

Operating the Radio

The ignition switch must be in ACCESSORY (I) or ON (II) to operate the audio system. Turn the system on by turning the ON/OFF/VOL knob clockwise. The radio comes on and displays the frequency of the station it was last tuned to.

Adjust the volume by turning the ON/OFF/VOL knob.

Audio System

Select the band you want to listen to by pressing the AM or FM1/FM2 button. You will see the selected band and the frequency in the display.

ST will be displayed next to the frequency if the station is broadcasting in FM stereo. The AM stereo feature is not available.

You can use any of three methods to find radio stations on the selected band: TUNE, SEEK, or the Preset buttons.

The TUNE function lets you find a desired frequency. Push the right side (▲) of the TUNE/SEEK bar to change to a higher frequency, and the left side (▼) of the bar to change to a lower frequency.

To change the frequency up or down a single increment, push and release the TUNE/SEEK bar.

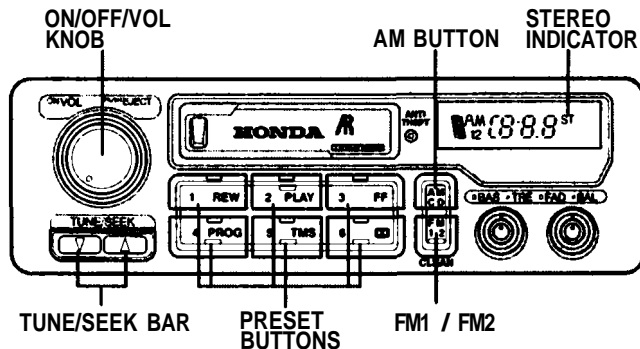

The SEEK function searches the band for a station with a strong signal. Depending on which way you push the TUNE/SEEK bar, the system searches up or down from the current frequency. Push the bar until you hear a beep, then release it. The system searches until it finds a station with a strong signal, then stops.

Presetting

The preset buttons allow you to store radio frequencies for later selection. Each button will store one frequency on the AM band, and two on the FM band. To store a frequency:

1. Select the desired band, AM or FM. FM1 and FM2 allow you to store two frequencies with each Preset button.

2. Use the TUNE or SEEK function to tune the radio to a desired station.
3. Pick the Preset button you want for that station. Press the button and hold it until you hear a beep. The light in the indicator will come on and the station selected will show in the display.
4. Repeat steps 1 to 3 to store a total of six stations on AM and 12 on FM.

Once that station's frequency is stored, simply press and release the proper Preset button to tune to it. If you want to change any Preset button's selection, store another frequency as described. The frequencies you preset will be lost if your car's battery goes dead or is disconnected.

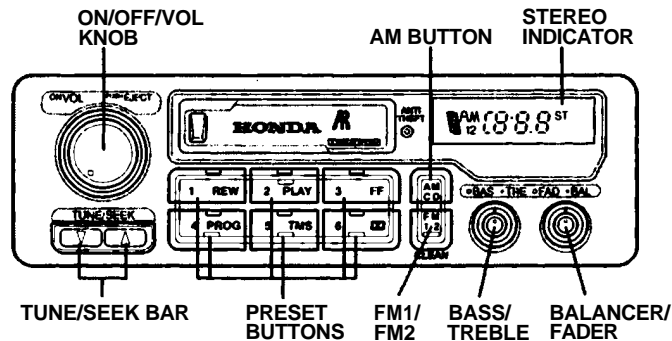

Adjusting the Sound

Use the Balance and Fader controls to adjust the sound "direction." The Balance control moves sound left to right. The Fader control moves it front to back.

To use either control, push on the knob to get it to pop out. Adjust the front-to-back sound to your liking with the outside ring.

Adjust the side-to-side sound balance with the knob. Push the knob back in when you are done.

Audio System

The illumination for the radio controls comes on with the instrument panel lights, even if the radio is off. You can use the Balance control to turn off the radio panel illumination even with the radio on. Push the control knob so it pops out, then pull it out slightly further. Check this control if the control panel lights do not come on with the instrument panel lights.

Use the Bass and Treble controls to adjust the tone quality to your liking. Push on the knob to get the controls to pop out. Adjust the bass level with the outer ring and the treble level with the knob. When finished, push the knobs back in so there is less chance of accidentally changing your settings.

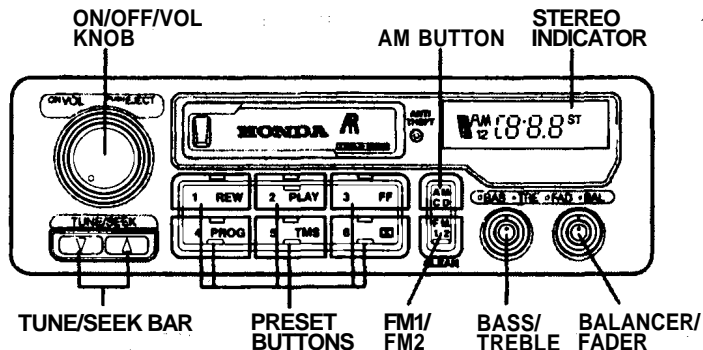

Radio Frequencies

Your Honda's radio can tune in all frequencies in both the AM and FM bands. Those bands cover these frequencies:

AM band
530 to 1710 kilohertz

FM band
87.7 to 107.9 megahertz

Radio stations on the AM band are assigned frequencies at least 10 kilohertz apart (530, 540, 550). Those on the FM band are assigned frequencies at least 0.2 megahertz apart (87.9, 88.1, 88.3).

Stations must use these exact frequencies. It is fairly common for stations to round-off the frequency in their advertising, so your radio will show a frequency of 100.9 even though the announcer may call the station "FM101."

Operating the Cassette Player

Turn the system ON. Insert the cassette into the slot with the tape opening to the right. Push the cassette in most of the way. The drive will pull it in the rest of the way and begin to play.

The ▲ or ▼ will light to show you which side of the cassette is playing. The ▲ indicates the side you inserted facing upward is now playing. To play the other side of the tape, press the PROG button.

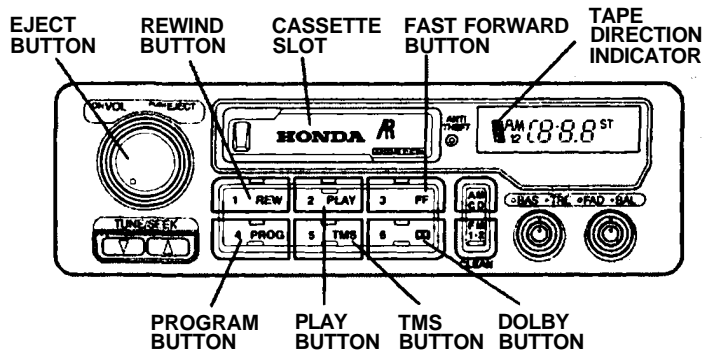

The system also has an auto-reverse feature. It will automatically reverse direction when it reaches the end of the cassette.

If the tape was recorded with Dolby "B" noise reduction, turn it on by pressing the button.

To remove the cassette from the drive, press the EJECT button. The system automatically ejects the cassette whenever you turn off the system or the ignition switch.

Audio System

Cassette Search Functions

Once a cassette is playing, you can use the FF, REW, or TMS function to look for desired songs or passages.

Press the REW button to rewind the cassette. Press the FF button to fast forward. The cassette will stop playing and will rewind or fast forward. To stop rewind or fast forward, press the PLAY button. If the system reaches the end of the cassette while in fast forward or rewind, it automatically stops that function, reverses direction, and begins to play.

The TMS function lets you skip to the beginning of a song or other passage.

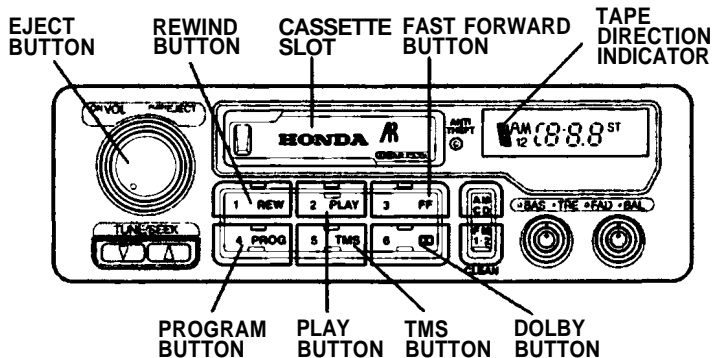

Press the TMS button and then the FF button or REW button. The tape will automatically advance to the beginning of the next song, or return to the beginning of the song just played. When the system senses a silent period on the tape, it goes back to PLAY mode.

The TMS function uses silent periods on the tape to find the end of a selection. This feature may not work satisfactorily on tapes that have almost no gap between songs, a high noise level between songs, or silent periods in the middle of songs.

Caring for Cassettes

Damaged cassettes can jam inside the drive or cause other problems. See page 76 for information on cassette care and protection.

Caring for the Cassette Player

The cassette drive picks up dirt and oxides whenever you play a tape. This builds up over time and causes the sound quality to degrade. To prevent this, you should clean the cassette drive after every 30 hours of use. Your Honda dealer has a cleaning kit available for this purpose.

After 30 hours of tape use, you will see CLEAN flashing for 5 seconds in the display when you insert a tape into the tape slot. If you are already regularly cleaning the tape drive at least every 30 hours, reset the indicator by pressing the FM1 button while the system is in the tape operation mode. Hold the button until you hear a beep and the CLEAN indicator goes out.

If you do not clean the cassette drive regularly, it may eventually become impossible to remove the deposits with a normal cleaning kit.

The cassette player automatically ejects cassettes that do not play normally. If it ejects a cassette before it begins to play, it is probably defective and should not be inserted again. You may have a cassette suddenly stop playing, reverse directions once or twice and then eject. This is normally an indication the tape is wound unevenly. It should play normally after being manually rewound.

Use 100-minute or shorter cassettes. Cassettes longer than 100 minutes use thinner tape that may break or jam the drive.

Audio System

Look at a cassette before you insert it. If the tape is loose, tighten it by turning one of the hubs with a pencil or your finger.

If the label is peeling off, do not put it in the player. It may cause the cassette to jam in the drive mechanism when you try to eject it.

Do not leave cassettes sitting where they are exposed to high heat or humidity, such as on top of the dashboard or in the player. If a cassette is exposed to extreme heat or cold, let it reach a moderate temperature before putting it in the player.

Operating the CD Player/Changer (Optional)

Your dealer has an in-dash Honda Compact Disc player or a trunk-mounted changer available for your car. The changer holds up to six discs, providing several hours of continuous programming. You operate the CD player and the changer with the same controls used for the radio.

Loading the CD Changer

Load the CDs in the magazine and load the magazine into the changer according to the instructions that came with the changer unit.

To operate the CD player or changer, the ignition key must be in the ACCESSORY (I) or ON (II). If you were listening to a cassette tape, eject it before listening to a CD.

CD Player

Insert the disc in the player. Push the CD button on the player, "CD" will show in the display and the disc will start to play.

CD Changer

Push the CD button on the radio, the display will show "CD" and the track last listened to will play. When that disc ends, the next disc in the magazine is loaded and played.

After disc 6 has completed the system will return to disc 1. To make your own disc selection, push one of the corresponding preset buttons. Your selection will appear in the display and start playing.

- If you try to select an empty slot in the magazine, the system will select and play the first track of the next disc in the magazine.

You can use the TUNE/SEEK bar while a disc is playing to select passages and change tracks. To move rapidly forward within a track, press and hold the ▲ side of the TUNE/SEEK bar. Press and hold the ▼ side to move rapidly backward within a track. You will hear a beep a half second after you press either side of the bar. Keep pressing the bar until you think the track has advanced or returned to the desired position. The disc will start playing when you release the bar.

If you press the ▲ side and release it before you hear a beep, the system will skip forward to the beginning of the next track on the CD. It will skip backward to the beginning of the current track if you press the ▼ side and release it.

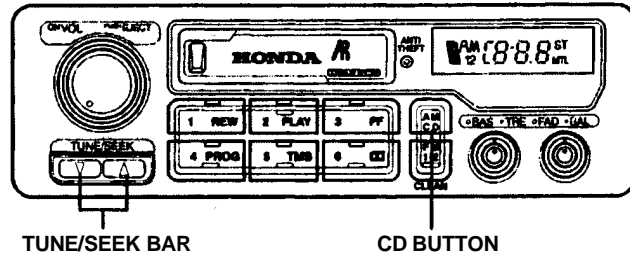

- If you change modes to radio or tape while a CD is playing, then change back to CD mode, the same disc and track will play.
- If you turn off the system while a CD is playing, either with the ON/OFF/VOL knob or by turning off the ignition, the system will begin playing the same disc and track when you turn it back on.

To return to the radio function, press the AM/FM button.

Audio System

CD Error Indications

If you see an error indication on the display, find the cause in the chart to the right. If you cannot clear the error indication, take the car to your Honda dealer.

Indication	Cause	Solution
<i>E - 01</i>	Disc-changer malfunction.	Consult Honda dealer.
<i>E - 02</i>	Disc is in changer mechanism.	Press the magazine eject button, and insert an empty magazine.
<i>E - 03</i> <i>E - 04</i> <i>E - 05</i>	Disc-changer malfunction.	If the code disappears within a few seconds, unit is OK. If it does not, consult your Honda dealer.
<i>E - 06</i>	Disc-changer malfunction.	Press the magazine eject button and pull out the magazine, check for error indication. Insert the magazine again. If the magazine can not be pulled out, consult your Honda dealer.
<i>E - 07</i>	CD magazine ejection impossible.	Press the magazine eject button. If the magazine does not eject, consult your Honda dealer.
<i>- - - H</i>	High temperature.	Will disappear when the temperature returns to normal.
<i>E - EE</i>	Misconnection or disconnection of CD changer.	See your Honda dealer.
<i>- - - -</i>	No CD magazine in the CD changer.	Insert CD magazine.

On U.S. EX and Canadian Si models

Your car's audio system will disable itself if it is disconnected from electrical power for any reason. To make it work again, the user must enter a specific five-digit code in the Preset buttons. Because there are hundreds of number combinations possible from five digits, making the system work without knowing the exact code is nearly impossible.

You should have received two copies of a card that lists your audio system's code number and serial number. It is best to store one of these cards in a safe place at home, and to keep the other in your wallet or purse. In addition, you should write the audio system's serial number in this Owner's Manual. If you should happen to lose both cards, you must obtain the code number by

having your Honda dealer contact American Honda. To do this, he will need the system's serial number.

If your car's battery is disconnected or goes dead, the audio system will disable itself. If this happens, you will see "Code" in the frequency display the next time you turn on the system. Use the Preset buttons to enter the five-digit code. If it is entered correctly, the radio will start playing.

If you make a mistake entering the code, do not start over or try to correct your mistake. Complete the five-digit sequence, then enter the correct code. You have three tries to enter the correct code. If you are unsuccessful in three attempts, you must then leave the system on for one hour before trying again.

You will have to store your favorite stations in the Preset buttons after the system begins working. Your original settings were lost when power was disconnected.

Before you begin driving your Honda, you should know what gasoline to use, and how to check the levels of important fluids. You also need to know how to properly stow luggage or packages. This section will help you. If you plan to add any accessories to your car, please read the information in this section first.

Break-in Period	82
Gasoline	82
Oxygenated Fuels	82
Driving in Foreign	
Countries	83
Service Station Procedures ...	84
Filling the Fuel Tank	84
Opening the Hood	85
Oil Check	86
Engine Coolant Check ..	87
Fuel Economy	88
Vehicle Condition	88
Driving Habits	88
Accessories	89
Loading Cargo	90

Break-in Period, Gasoline

Break-in Period

Help assure your car's future reliability and performance by paying extra attention to how you drive during the first 600 miles (1,000 km). During this period:

- Avoid full-throttle starts and rapid acceleration.
- If you need to add oil, use the engine oil recommended in this owner's manual.
- Avoid hard braking. New brakes need to be broken-in by moderate use for the first 200 miles (300 km).

You should follow these same recommendations with an overhauled or exchanged engine, or when the brakes are relined.

Gasoline

Your Honda is designed to operate most effectively on unleaded gasoline. Use an unleaded gasoline with a pump octane number of 86 or higher. Use of a lower octane gasoline can cause a persistent, heavy metallic rapping noise in the engine that can lead to mechanical damage.

Gasolines containing detergent additives designed to help prevent fuel system and engine deposits are recommended. Using gasoline containing lead will damage your car's emission controls. This contributes to air pollution and can void certain parts of your warranty.

Oxygenated Fuels

Some conventional gasolines are being blended with alcohol or an ether compound. These gasolines are collectively referred to as oxygenated fuels. To meet clean air standards, some areas of the United States and Canada use oxygenated fuels to help reduce emissions.

If you use an oxygenated fuel, be sure it is unleaded and meets the minimum octane rating requirement.

Before using an oxygenated fuel, try to confirm the fuel's contents. Some states/provinces require this information to be posted on the pump.

The following are the EPA-approved percentages of oxygenates:

ETHANOL (ethyl or grain alcohol)— You may use gasoline containing up to 10% ethanol by volume. Gasoline containing ethanol may be marketed under the name "Gasohol."

MTBE (Methyl Tertiary Butyl Ether)— You may use gasoline containing up to 15% MTBE by volume.

METHANOL (methyl or wood alcohol)— You may use gasoline containing up to 5% methanol by volume as long as it also contains cosolvents and corrosion inhibitors to protect the fuel system. Gasoline containing more than 5% methanol by volume may cause starting and/or performance problems. It may also damage metal, rubber, and plastic parts of your fuel system.

If you notice any undesirable operating symptoms, try another service station or switch to another brand of gasoline.

Fuel system damage or performance problems resulting from the use of an oxygenated fuel containing more than the percentages of oxygenates given previously are not covered under warranty.

Driving in Foreign Countries
Using any type of leaded gasoline in your Honda will affect performance and damage its emission controls. Unleaded gasoline may not be available in other countries. If you are planning to take your car outside the U.S. or Canada, write to Honda at the address shown for information about any modifications your car may need. Be sure to include the year and model of your car.

U.S. Owners:

American Honda Motor Co., Inc.
Consumer Affairs
1919 Torrance Blvd.
Torrance, CA 90501-2746

Canadian Owners:

Honda Canada Inc.
715 Milner Ave.
Scarborough, Ontario M1B 2K8

Service Station Procedures

Filling the Fuel Tank

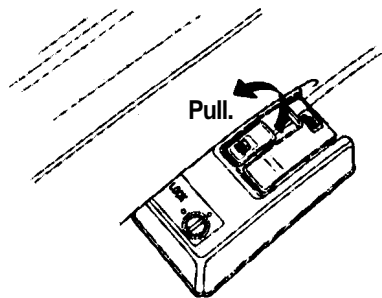

1. The fuel fill is on the driver's side of the car. Park with that side closest to the service station pumps.
2. Open the fuel fill door by pulling on the handle to the left of the driver's seat.

Handling gasoline improperly can cause it to ignite or explode, causing you to be seriously or fatally injured.

Always put out cigarettes and other smoking materials, and keep all sparks and open flames away when you are around gasoline.

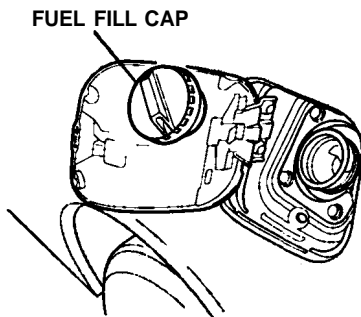

3. Remove the fuel fill cap slowly. You may hear a hissing sound as pressure inside the tank escapes.
4. Stop filling the tank after the gas pump automatically clicks off. Do not try to "top off" the tank, leave some room for the fuel to expand with temperature changes.
5. Screw the fuel fill cap back on, tighten it until it clicks.
6. Push the fuel fill door until it latches.

Opening the Hood



1. Shift to Park or Neutral and set the parking brake. Pull the hood release handle located under the left lower corner of the dashboard. The hood will pop up slightly.

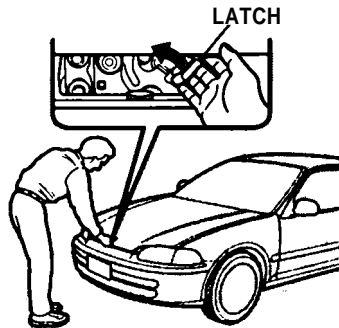

2. Standing in front of the car, put your fingers under the front edge of the hood to the right of center. Slide your hand to the left until you feel the hood latch handle. Push this handle to the left until it releases the hood. Lift the hood.

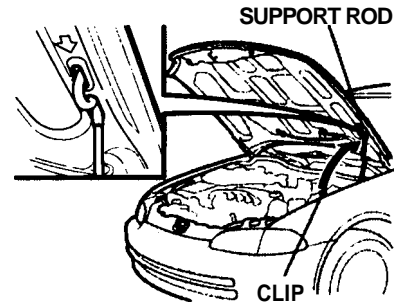

3. Pull the support rod out of its clip and insert the end into the hole on the left side of the hood.

To close the hood, lift it up slightly to remove the support rod from the hole. Put the support rod back into its holding clip. Lower the hood to about a foot above the fender, then let it drop.

Service Station Procedures

Oil Check

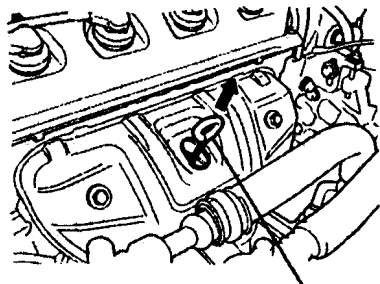

DIPSTICK

Check the engine oil level every time you fill the car with fuel. Wait at least two minutes after turning the engine off before you check the oil.

1. Remove the dipstick (orange handle).

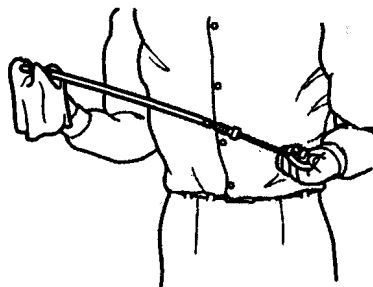

2. Wipe the dipstick with a clean cloth or paper towel.

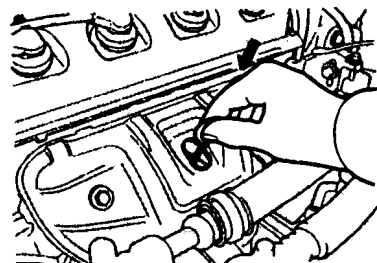

3. Insert it all the way back in its tube.

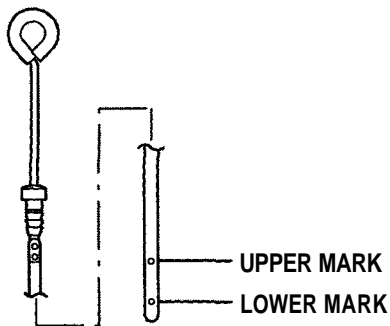

4. Remove it again and check the level. It should be between the upper and lower marks.
5. If it is near or below the lower mark, see page 115 for information on the proper oil and how to add it.

Engine Coolant Check

RESERVE TANK

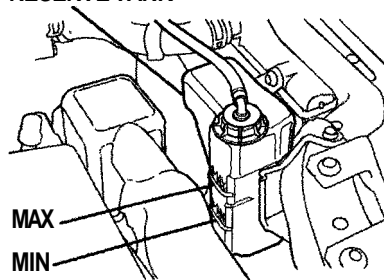

Look at the coolant level in the radiator reserve tank. Make sure it is between the MAX and MIN lines. If it is below the MIN line, see **Adding Coolant** on page 120 for information on adding the proper coolant.

Refer to **Periodic Checks** on page 113 for information on checking other items in your Honda.

Fuel Economy

The condition of your car and your driving habits are the two most important things that affect the fuel mileage you get.

Vehicle Condition

Always maintain your car according to the maintenance schedule. This will keep it in top operating condition.

An important part of that maintenance is the **Periodic Checks** (see page 113). For example an underinflated tire causes more "rolling resistance," which uses fuel. It also wears out faster, so check the tire pressure at least monthly. In winter the build-up of snow on your car's underside adds weight and rolling resistance. Frequent cleaning helps your fuel mileage and reduces the chance of corrosion.

Driving Habits

You can improve fuel economy by driving moderately. Rapid acceleration, cornering, and hard braking use more fuel. Always drive in the highest gear that allows the engine to run and accelerate smoothly. Maintain a constant speed while cruising, depending on traffic conditions. Every time you slow down and speed up, your car uses extra fuel. Use the cruise control, when appropriate, to increase fuel economy.

A cold engine uses more fuel than a warm engine. It is not necessary to "warm-up" a cold engine by letting it idle for a long time. You can drive away within 30 seconds, no matter how cold it is outside. The engine will warm up faster, and you get better fuel economy. To cut down on the number of "cold starts," try to combine several short trips into one.

Air conditioning puts an extra load on the engine which makes it use more fuel. Turn off the A/C to cut down on air conditioning use. Use the flow-through ventilation when the outside air temperature is moderate.

Your Honda dealer has many accessories available to personalize your car. Some of these are audio systems, alloy wheels, air conditioning, and color-coordinated carpet floor mats. All Genuine Honda Accessories have been approved by our engineers for installation and use on your car, and are covered by warranty.

Some non-Honda accessories you can buy in the "aftermarket" are designed for universal applications. Although they may fit your Honda, they may not be within factory specifications. For example, aftermarket wheels may not meet Honda's specifications for width and offset. They could cause suspension problems which would not be covered by your warranty. Improperly designed accessories can adversely affect your car's handling and stability.

Your car has several computer-controlled systems, including the SRS system, the anti-lock brake system, and the engine's fuel injection system. Strong electronic interference can affect their operation.

Electronic communications equipment, such as cellular telephones and two-way radios are regulated by the FCC (DOC in Canada) and should not interfere with your car's systems. Improper installation, or using electrical equipment not intended for mobile use may interfere with your car's operation. If you want to install a cellular telephone, other mobile communications equipment, or even add-on stereo amplifiers, please discuss it first with your Honda dealer.

In many cases, improper installation is the real cause of problems with aftermarket accessories. Have these accessories installed by qualified technicians who are familiar with your Honda. If possible, have your Honda dealer inspect the final installation.

Loading Cargo

The maximum load you can carry in your Honda is 850 lb (385 kg). It includes the total weight of all passengers and their belongings, and any accessories. This 850 lb (385 kg) figure is shown as the Vehicle Capacity Weight on the tire information label attached to the inside of the glove box.

To figure out how much cargo you can carry:

- Figure the total "occupant weight" you will be transporting. To do this, multiply the number of people (driver and all passengers) by 150 lb (70 kg).
- Subtract this number from the Vehicle Capacity Weight (850 lb/385 kg).

This final number is the total weight of cargo you can load in or on the car. With five occupants (driver and four passengers), the maximum recommended weight for cargo is 100 lb (45 kg).

Where you store this cargo, and how well you secure it are just as important as how much it weighs. Make sure you load cargo so it will not shift while driving. Items stored in the trunk should be placed as far forward as possible. You could store additional items on the floor behind the front seats. Make sure they cannot roll under the front seat and interfere with the pedals.

If you must carry large objects that prevent you from closing the trunk lid, be aware that exhaust gas can enter the interior. See Carbon Monoxide Hazard on page [25](#).

Never place items on the shelf behind the back seat. Those items can fly forward and injure you or your passengers if you brake hard or are involved in a collision.

This section gives you tips on starting the engine under various conditions and how to operate the 5-speed manual and automatic transmissions. It also includes important information on your car's braking system.

Preparing to Drive	92
Starting the Engine	93
5-Speed Manual Transmission	93
Automatic Transmission ...	93
Starting in Cold Weather at High Altitude	94
5-Speed Manual Transmission	95
Recommended Shift Points	96
Maximum Speeds	96
Automatic Transmission	97
Shift Lever Positions	97
Maximum Speeds	100
Shift Lock Release	100
The Braking System	101
Brake Wear Indicators	101
Brake System Design	102
Anti-Lock Brakes	102
Driving in Bad Weather	104
Towing a Trailer	105

Preparing to Drive

You should do the following checks and adjustments every day before you drive your car.

1. Make sure all windows, mirrors, and outside lights are clean and unobstructed. Remove frost, snow, or ice.
2. Check that the hood and trunk are fully closed.
3. Visually check the tires. If a tire looks low, use a gauge to check its pressure.
4. Check that any items you may be carrying with you inside are stored properly or fastened down securely.
5. Check the adjustment of the seat (see page 49).
6. Check the adjustment of the inside and outside mirrors (see pages 53 and 54).
7. Check the adjustment of the steering wheel (see page 41).
8. Make sure the doors are securely closed and locked.
9. Fasten your seat belt. Check that your passengers have fastened their seat belts (see page 7).
10. Turn the ignition ON (II). Check the indicator lights in the instrument panel.
11. Start the engine (see page 93).
12. Check the gauges and indicator lights in the instrument panel (see page 29).

5-Speed Manual Transmission

1. Apply the parking brake.
2. In cold weather, turn off all electrical accessories to reduce the drain on the battery.
3. Push the clutch pedal down all the way. START (III) does not function unless the clutch pedal is depressed.
4. Without touching the accelerator pedal, turn the ignition key to the START (III) position. If the engine does not start right away, do not hold the key in START (III) for more than 15 seconds at a time. Pause for at least 10 seconds before trying again.

5. If the engine does not start within 15 seconds, or starts but stalls right away, repeat step 4 with the accelerator pedal pressed half-way down. If the engine starts, release pressure on the accelerator pedal so the engine does not race.
6. If the engine still does not start, press the accelerator pedal all the way down and hold it there while starting in order to clear flooding. As before, keep the ignition key in the START (III) position for no more than 15 seconds. Return to step 5 if the engine does not start. If it starts, lift your foot off the accelerator pedal so the engine does not race.

Automatic Transmission

1. Apply the parking brake.
2. In cold weather, turn off all electrical accessories to reduce the drain on the battery.
3. Make sure the shift lever is in Park. Press on the brake pedal.
4. Without touching the accelerator pedal, turn the ignition key to the START (III) position. If the engine does not start right away, do not hold the key in START (III) for more than 15 seconds at a time. Pause for at least 10 seconds before trying again.

continued

Starting the Engine

5. If the engine does not start within 15 seconds, or starts but stalls right away, repeat step 4 with the accelerator pedal pressed half-way down. If the engine starts, release pressure on the accelerator pedal so the engine does not race.
6. If the engine still does not start, press the accelerator pedal all the way down and hold it there while starting in order to clear flooding. As before, keep the ignition key in the START (III) position for no more than 15 seconds. Return to step 5 if the engine does not start. If it starts, lift your foot off the accelerator pedal so the engine does not race.

Starting in Cold Weather at High Altitude (Above 8,000 feet/2,400 meters)

An engine is harder to start in cold weather. The thinner air found at high altitude above 8,000 feet (2,400 meters) adds to the problem. Use the following procedure:

1. Turn off all electrical accessories to reduce the drain on the battery.
2. Push the accelerator pedal half-way to the floor and hold it there while starting the engine. Do not hold the ignition key in START (III) for more than 15 seconds. When the engine starts, release the accelerator pedal gradually as the engine speeds up and smooths out.

3. If the engine fails to start in step 2, push the accelerator pedal to the floor and hold it there while you try to start the engine for no more than 15 seconds. If the engine does not start, return to step 2.

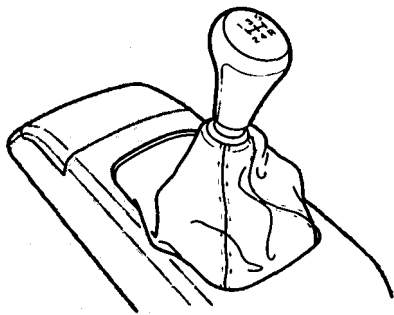

The manual transmission is synchronized in all forward gears for smooth operation. It has a lockout so you cannot shift directly from Fifth to Reverse. When shifting up or down, make sure you push the clutch pedal down all the way, shift to the next gear, and let the pedal up gradually. When you are not shifting, do not rest your foot on the clutch pedal. This can cause your clutch to wear out faster.

Come to a full stop before you shift into reverse. You can damage the transmission by trying to shift into reverse with the car moving. Depress the clutch pedal and pause for a few seconds before putting it in reverse, or shift into one of the forward gears for a moment. This stops the gears so they won't "grind."

You can get extra braking from the engine when slowing down by shifting to a lower gear. This extra braking can help you maintain a safe speed and prevent your brakes from overheating while going down a steep hill. Before downshifting, make sure engine speed will not go into the red zone in the lower gear. Refer to the Maximum Speeds chart.

Rapid slowing or speeding up can cause loss of control on slippery surfaces. If you crash, you can be injured.

Use extra care when driving on slippery surfaces.

5-Speed Manual Transmission

Recommended Shift Points

Drive in the highest gear that lets the engine run and accelerate smoothly. This will give you the best fuel economy and effective emissions control. The following shift points are recommended:

Shift up	Normal acceleration
1 st to 2 nd	15 mph (24 km/h)
2 nd to 3 rd	27 mph (43 km/h)
3 rd to 4 th	39 mph (62 km/h)
4 th to 5 th	53 mph (85 km/h)

Shift up	Cruise from acceleration
1 st to 2 nd	9 mph (14 km/h)
2 nd to 3 rd	20 mph (32 km/h)
3 rd to 4 th	33 mph (53 km/h)
4 th to 5 th	48 mph (77 km/h)

Maximum Speeds

The speeds in these tables are the maximums for the given gears. If you exceed these speeds, the engine speed will enter into the tachometer's red zone. If this occurs, you may feel the engine cut in and out. This is caused by a limiter in the engine's computer controls. The engine will run normally when you reduce the RPM below the red zone.

DX

Gear	Maximum speeds
1 st	32 mph (51 km/h)
2 nd	59 mph (95 km/h)
3 rd	88 mph (142 km/h)
4 th	112 mph (181 km/h)
5 th	Top speed

U.S.: EX, Canada: Si

Gear	Maximum speeds
1 st	34 mph (55 km/h)
2 nd	58 mph (94 km/h)
3 rd	89 mph (143 km/h)
4 th	Top speed
5 th	Top speed

Automatic Transmission

Your Honda's transmission has four forward speeds. It has a "lock-up" torque converter for better fuel economy. You may feel what seems like another shift when the converter locks.

Shift Lever Position Indicator

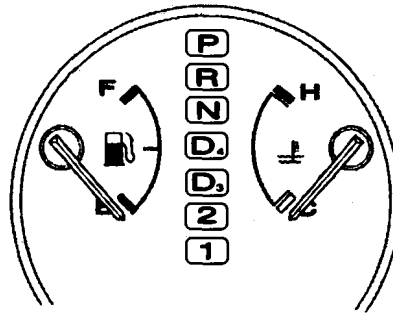

This display is on the instrument panel. It shows you the position of the shift lever.

Shift Lever Positions

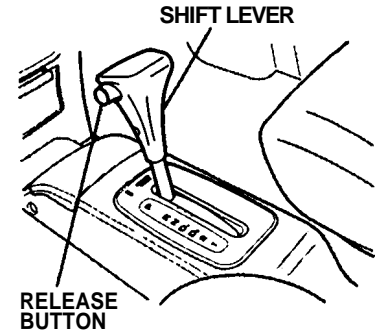

The shift lever has seven positions. It must be in Park or Neutral to start the engine. When you are stopped in D₄, D₃, 2, 1 or R, press firmly on the brake pedal and keep your foot off the accelerator pedal.

Automatic Transmission

To shift from:	Do this:
P to R	Press the brake pedal, and press the release button.
R to P N to R D ₃ to 2 2 to 1	Press the release button.
1 to 2 2 to D ₃ D ₃ to D ₄ D ₄ to N D ₄ to D ₃ N to D ₄ R to N	Move the lever.

Park (P) - This position mechanically locks the transmission. Use Park whenever you are turning off or starting the engine. To shift out of Park, you must press on the brake pedal and have your foot off the accelerator pedal. Press the release button on the side of the shift lever to move it.

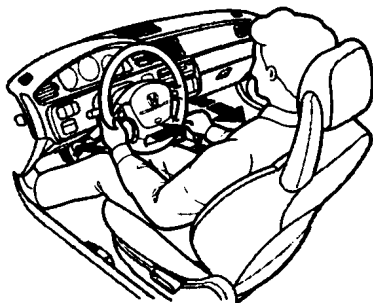

You must also press the release button to shift into Park. To avoid transmission damage, come to a complete stop before shifting into Park. The shift lever must be in Park before you can remove the key from the ignition switch.

If you have done all of the above and still cannot move the lever out of Park, see Shift Lock Release on page [100](#).

Reverse (R) — To shift to Reverse from Park, see the explanation under Park. To shift to Reverse from Neutral, come to a complete stop and then shift. Press the release button before shifting into Reverse from Neutral.

Neutral (N) — Use Neutral if you need to restart a stalled engine, or if it is necessary to stop briefly with the engine idling. Shift to Park position if you need to leave the car for any reason. Press on the brake pedal when you are moving the shift lever from Neutral to another gear.

Drive (D₄) — Use this position for your normal driving. The transmission automatically selects a suitable gear for your speed and acceleration. You may notice the transmission shifting up at higher speeds when the engine is cold. This helps the engine warm up faster.

Drive (D3) — This position is similar to D4, except only the first three gears are selected. Use D3 to provide engine braking when going down a steep hill. D3 can also keep the transmission from cycling between third and fourth gears in stop-and-go driving.

For faster acceleration when in D3 or D4, you can get the transmission to automatically downshift by pushing the accelerator pedal to the floor. The transmission will shift down one or two gears, depending on your speed.

Second (2) — To shift to Second, press the release button on the side of the shift lever. This position locks the transmission in second gear. It does not downshift

stop. Second gives you more power when climbing, and increased engine braking when going down steep hills. Use second gear when starting out on a slippery surface or in deep snow. It will help reduce wheel spin.

Whenever you move the shift lever to a lower gear, the transmission downshifts only if the engine's redline will not be exceeded in the lower gear.

First (1) — To shift from Second to First, press the release button on the side of the shift lever. With the lever in this position, the transmission locks in First gear. By upshifting and downshifting through 1, 2, D3, and D4, you can operate this transmission much like a manual transmission without a clutch pedal.

Automatic Transmission

Maximum Speeds

The speeds in these tables are the maximums for the given position. If you exceed these speeds, the engine speed will enter into the tachometer's red zone. If this occurs, you will feel the engine cut in and out. This is caused by a limiter in the engine's computer controls. The engine will run normally when you reduce the rpm below the red zone.

DX

Position	Maximum speeds
1	37 mph (60 km/h)
2	66 mph (106 km/h)
D ₃	99 mph (160 km/h)
D ₄	Top speed

U.S.: EX, Canada: Si

Position	Maximum speeds
1	42 mph (67 km/h)
2	75 mph (120 km/h)
D ₃	112 mph (180 km/h)
D ₄	Top speed

Shift Lock Release

This allows you to move the shift lever out of Park if the normal method of pushing on the brake pedal and pressing the release button does not work.

1. Set the Parking brake.
2. Remove the key from the ignition switch.
3. Insert the key in the Shift Lock Release slot next to the shift lever.
4. Push down on the key while you press the release button and

move the shift lever out of Park to Neutral.

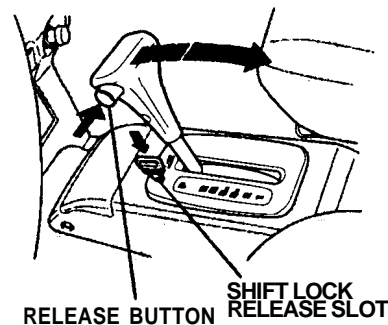

5. Remove the key from the Shift Lock Release slot. Return the key to the ignition switch, depress the brake pedal, and restart the engine.

If you need to use the Shift Lock Release, it could mean your car is developing a problem. Have the car checked by your Honda dealer.

All Civics are equipped with front disc brakes. The brakes on the rear wheels may be disc or drum, depending on the model. The braking system is power assisted to reduce the effort needed on the brake pedal.

Put your foot on the brake pedal only when you intend to brake. Resting your foot on the pedal keeps the brakes applied lightly, causing them to build up heat. Heat build up can reduce how well your brakes work. It also keeps your brake lights on all the time, confusing drivers behind you.

Constant application of the brakes when going down a long hill builds up heat and reduces their effectiveness. Use the engine to assist the brakes by downshifting to a lower gear and taking your foot off the accelerator pedal.

Check your brakes after driving through deep water. Apply the brakes moderately to see if they feel normal. If not, apply them gently and frequently until they do. Since a longer distance is needed to stop with wet brakes, be extra cautious and alert in your driving.

Brake Wear Indicators

The front disc brakes on all cars have audible brake wear indicators. They are also on the rear brakes of cars with ABS. When the brake pads need replacing, you will hear a distinctive metallic "screeching" sound when you apply the brakes. If you do not have the brake pads replaced, they will begin screeching all the time.

Your brakes may sometimes squeal or squeak when you apply them lightly. Do not confuse this with the brake wear indicators. They make a very audible "screeching."

The Braking System

Brake System Design

The hydraulic system that operates the brakes has two separate circuits. Each circuit works diagonally across the car (the left-front brake is connected with the right-rear brake, etc.). If one circuit should develop a problem, you will still have braking at two wheels.

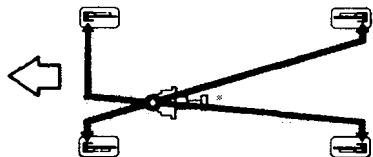

If this happens, you will notice that the brake pedal goes down much farther and you need to press on it much harder. A much longer distance will be needed to stop the car.

Slow the car by downshifting to a lower gear and removing your foot from the accelerator pedal. Pull to the side of the road as soon as it is safe. Because of the longer stopping distance needed, brake system failure is very hazardous. It is best to have your car towed, but if you must drive the car in this condition, be extremely cautious. Have your car repaired as soon as possible.

Anti-Lock Brakes

For U.S. EX with ABS option

Your car has an Anti-lock Brake System (ABS). ABS helps you to maintain steering control. It does this by helping prevent the wheels from locking up and skidding.

The ABS is always "ON." It requires no special effort or driving technique. You will feel a pulsation in the brake pedal when the ABS activates.

Activation varies with the amount of traction your tires have. On dry pavement, you will need to press on the brake pedal very hard before you feel the pedal pulsation that means the ABS has activated. However, you may feel the ABS activate immediately if you are trying to stop on snow or ice. Under all conditions, the ABS is helping to prevent the wheels from locking so you can retain

The Braking System

steering control. You should continue to press on the brake pedal with the same force.

You may feel a slight movement of the brake pedal just after you start the engine. This is the ABS working.

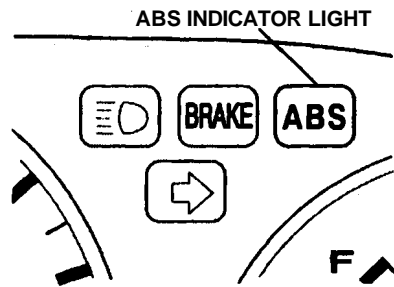

The ABS is self-checking. If anything goes wrong, the ABS indicator on the instrument panel comes on (see page 32). This means the Anti-lock function of the braking system has shut down. The brakes still work like a conventional system, providing normal stopping ability. You should have the dealer inspect your car as soon as possible.

The ABS works by comparing the speed of the wheels. When replacing tires, use the same size originally supplied with the car. Tire size and construction can affect wheel speed and may cause the system to work inconsistently.

A car with ABS may require a longer distance to stop on loose or uneven surfaces than an equivalent car without Anti-lock. The ABS cannot make up for road conditions or bad judgment. It is still your responsibility to drive at reasonable speeds for weather and traffic conditions, and to leave a margin of safety.

For a technical description of the ABS hardware, refer to page 188.

Driving in Bad Weather

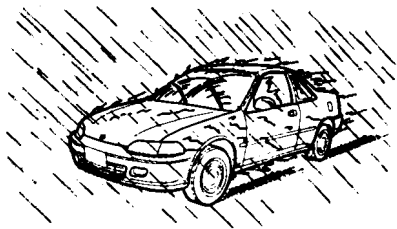

Rain, fog, and snow conditions require a different driving technique because of reduced traction and visibility. Keep your car well maintained and exercise greater caution when you need to drive in bad weather. The cruise control should not be used in these conditions.

Driving Technique— Always drive slower than you would in dry weather. It takes your car longer to react, even in conditions that may seem just barely damp. Apply smooth, even pressure to all the controls. Abrupt steering wheel movements or sudden, hard application of the brakes can cause loss of control in wet weather. Be extra cautious for the first few miles of driving while you adjust to the change in driving conditions. This is especially true in snow. A person can forget some snow driving techniques during the summer months. Practice is needed to relearn those skills.

Exercise extra caution when driving in rain after a long dry spell. After months of dry weather, the first rains bring oil to the surface of the roadway, making it slippery.

Visibility— Being able to see clearly in all directions and being visible to other drivers are important in all weather conditions. This is more difficult in bad weather. To be seen more clearly during daylight hours, turn on your headlights.

Inspect your windshield wipers and washers frequently. Keep the windshield washer reservoir full of the proper fluid. Have the windshield wiper blades replaced if they start to streak the windshield or leave parts unwiped. Use the defrosters and air conditioning to keep the windows from fogging up on the inside (see page [67](#)).

Traction — Check your tires frequently for wear and proper pressure. Both are important in preventing "hydroplaning" (loss of traction on a wet surface). In the winter, mount snow tires on all four wheels for the best handling.

Watch road conditions carefully, they can change from moment to moment. Wet leaves can be as slippery as ice. "Clear" roads can have patches of ice. Driving conditions can be very hazardous when the outside temperature is near freezing. The road surface can become covered with areas of water puddles mixed with areas of ice, so your traction can change without warning.

Be careful when downshifting. If traction is low, you can lock up the drive wheels for a moment and cause a skid.

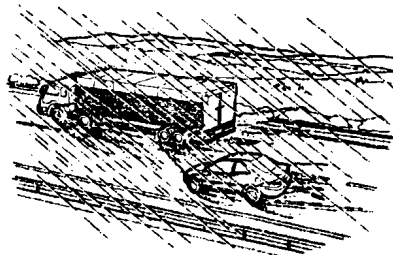

Be very cautious when passing, or being passed by, other vehicles. The spray from large vehicles reduces your visibility, and the wind buffeting can cause you to lose control.

Towing a Trailer

Your car is not designed to tow a trailer. Attempting to do so can void your warranties.

Regularly maintaining your Honda is the best way to protect your investment. You will be rewarded with safer, more economical, trouble-free driving. This section lists items that need to be checked regularly and explains how to check them. It also details some simple maintenance tasks you can do yourself. The maintenance schedules for normal and severe driving conditions show you when these things need to be done.

If you are interested in how to perform more complex maintenance on your Honda, you can purchase the Service Manual. See page 203 for information on how to obtain a copy, or see your Honda dealer.

Maintenance Schedule	108	Power Steering	129
Maintenance Record	111	Air Cleaner Element	130
Periodic Checks	113	Fuel Filter	131
Fluid Locations	114	Spark Plugs	131
Engine Oil	115	Replacement	131
Checking Engine Oil	115	Specifications	133
Adding Oil	115	Battery	133
Recommended Oil	116	Windshield Wipers	136
Additives	117	Air Conditioning	138
Oil and Filter Changes	117	Engine Belts	139
Cooling System	120	Tires	139
Checking the Engine		Inflation	139
Coolant Level	120	Inspection	141
Adding Engine Coolant	120	Maintenance	141
Replacing Coolant	121	Tire Rotation	142
Windshield Washers	124	Replacing Tires	
Transmission Oil	125	and Wheels	142
Automatic Transmission	125	Wheels and Tires	143
5-Speed Manual		Winter Driving	143
Transmission	126	Snow Tires	144
Brake and Clutch Fluid	127	Tire Chains	144
Brake System	127	Lights	145
Anti-Lock Brake System	128	Replacing Bulbs	145
Clutch System	128	Storing Your Car	151

Maintenance Schedule

The Required Maintenance Schedule specifies how often you should have your car serviced and what things need attention. It is essential that your car be serviced as scheduled to retain its high level of safety, dependability, and emission control performance.

The services and time or mileage intervals shown in the maintenance schedule assume you will use your car as normal transportation for passengers and their possessions. You should:

- Avoid exceeding your car's load limit. This puts excess strain on the engine, brakes, and many other parts of your car. The load limit is shown on the label in the glove box.
- Operate your car on reasonable roads within the legal speed limit.

- Drive your car regularly over a distance of several miles (kilometers).
- Always use unleaded gasoline with a pump octane number of 86 or higher.

Your authorized Honda dealer knows your car best, and can provide competent, efficient service. However, service at a dealer is not mandatory to keep your warranties in effect. Maintenance may be done by any qualified service facility or person who is skilled in this type of automotive service. Keep all the receipts as proof of completion, and have the person who does the work fill out the maintenance record on page 111. Check your warranty booklet for more information.

We recommend the use of Genuine Honda parts and fluids or their equivalent whenever you have maintenance done. These are the same high-quality items that went into your car when it was new, so you can be sure they fit and perform flawlessly.

U.S. Cars:
Maintenance, replacement or repair of emission control devices and systems may be done by any automotive repair establishment or individual using parts that are "certified" to EPA standards.

Vehicles sold in California have slightly different maintenance requirements. These are noted in the Required Maintenance Schedule. Other maintenance operations are required by California regulations, and condition the emission warranty.

Maintenance Schedule

R — Replace I — Inspect After inspection, clean, adjust, repair or replace if necessary.

Service at the interval listed x 1,000 miles (or km) or after that number of months, whichever comes first.	x 1,000 miles	7.5	15	22.5	30	37.5	45	52.5	60	67.5	75	82.5	90	97.5	105
	x 1,000 km	12	24	36	48	60	72	84	96	108	120	132	144	156	168
	months	6	12	18	24	30	36	42	48	54	60	66	72	78	84
Engine and Transmission															
<input type="checkbox"/> Air cleaner element					R				R				R		
Idle speed									I*1						
Positive crankcase ventilation valve									I						
Valve clearance			I		I		I		I		I		I		I
Fuel filter									R*1						
Fuel pipes, hoses, and connections					I*1				I*1				I*1		
Spark plugs					R				R				R		
Distributor ignition cap and rotor									I*1						
Ignition wires									I						
<input checked="" type="checkbox"/> Engine oil and oil filter		R	R	R	R	R	R	R	R	R	R	R	R	R	R
Alternator drive belt					I				I				I		
Cooling system hoses and connections					I*1				I*1				I*1		
• Engine coolant							R				R				R*2
Timing belt													R*3		
Water pump													I		
Three-way catalytic converter heat shield									I						
Exhaust pipe (before catalytic converter)					I*1				I*1				I*1		
Exhaust pipe and muffler (after catalytic converter)			I		I		I		I		I		I		I
Transmission oil					R				R				R		

- : Check oil and coolant level at each fuel stop.
- : Under severe driving conditions, service these items more often.

- *1: For cars sold in California, this service is recommended only; other areas, it is required.
- *2: Thereafter, replace every 2 years or 30,000 miles (48,000 km), whichever comes first.
- *3: This service is recommended only.
- *4: For cars with ABS.
- *5: For cars without ABS.

MAINTENANCE SCHEDULE

Maintenance Schedule

R — Replace I — Inspect After inspection, clean, adjust, repair or replace if necessary.

Service at the interval listed x 1,000 miles (or km) or after that number of months, whichever comes first.	x 1,000 miles	7.5	15	22.5	30	37.5	45	52.5	60	67.5	75	82.5	90	97.5	105	
	x 1,000 km	12	24	36	48	60	72	84	96	108	120	132	144	156	168	
	months	6	12	18	24	30	36	42	48	54	60	66	72	78	84	
Brakes																
Front brake pads		I	I	I	I	I	I	I	I	I	I	I	I	I	I	I
<input type="checkbox"/> Front brake discs and calipers			I		I		I		I		I		I		I	
Rear brake discs, calipers and pads *4			I		I		I		I		I		I		I	
Rear brake drums, wheel cylinders and linings *5					I				I				I			I
Brake hoses and lines			I		I				I				I			I
Parking brake			I		I				I				I			
Brake fluid (incl. anti-lock brake system)						R				R				R		
Anti-lock brake system operation *4					I				I				I			
Anti-lock brake system high pressure hose *4										R						
Steering and suspension, miscellaneous																
Front wheel alignment			I		I		I		I		I		I		I	
Steering operation, tie rod ends, steering gear box and boots			I		I				I				I			
<input type="checkbox"/> Power steering system			I		I		I		I		I		I		I	
Power steering pump belt					I				I				I			
Suspension mounting bolts			I		I		I		I		I		I		I	
Supplemental Restraint System	Inspect system 10 years after production (see page 15).															

Severe Driving Conditions:

Items marked [R] or an [I] in the chart indicate you will need some services more frequently in certain severe driving conditions.

The conditions are:

- Driving less than 5 miles (8 km) per trip, or, in freezing temperatures, driving less than 10 miles (16 km) per trip.
- Driving on rough or muddy roads, or de-iced roads.
- Driving in extremely dusty conditions.
- Extensive idling or driving long periods at slow speeds, such as a delivery vehicle.

The services are:

- Clean the air cleaner element every 15,000 miles (24,000 km) or 12 months and replace every 30,000 miles (48,000 km) or 24 months under conditions B or C.
- Replace engine oil and oil filter every 3,750 miles (6,000 km) or 3 months under conditions A, B, C, or D.
- Replace transmission oil every 15,000 miles (24,000 km) or 12 months under condition D.
- Inspect front brake discs and calipers, and rear brake discs, calipers and pads every 7,500 miles (12,000 km) or 6 months under conditions B, C, or D.
- Inspect the power steering system every 7,500 miles (12,000 km) or 6 months under conditions A, B, or C.

Required Maintenance Record

Have your servicing dealer record all Required Maintenance below. Keep receipts for all work done on your car.

7,500 Mi. 12,000 km (or 6 Mo.)	(Sign or Stamp)	Mi. (km)
		Date
15,000 Mi. 24,000 km (or 12 Mo.)	(Sign or Stamp)	Mi. (km)
		Date
22,500 Mi. 36,000 km (or 18 Mo.)	(Sign or Stamp)	Mi. (km)
		Date
30,000 Mi. 48,000 km (or 24 Mo.)	(Sign or Stamp)	Mi. (km)
		Date
37,500 Mi. 60,000 km (or 30 Mo.)	(Sign or Stamp)	Mi. (km)
		Date
45,000 Mi. 72,000 km (or 36 Mo.)	(Sign or Stamp)	Mi. (km)
		Date
52,500 Mi. 84,000 km (or 42 Mo.)	(Sign or Stamp)	Mi. (km)
		Date

60,000 Mi. 96,000 km (or 48 Mo.)	(Sign or Stamp)	Mi. (km)
		Date
67,500 Mi. 108,000 km (or 60 Mo.)	(Sign or Stamp)	Mi. (km)
		Date
75,000 Mi. 120,000 km (or 60 Mo.)	(Sign or Stamp)	Mi. (km)
		Date
82,500 Mi. 132,000 km (or 66 Mo.)	(Sign or Stamp)	Mi. (km)
		Date
90,000 Mi. 144,000 km (or 72 Mo.)	(Sign or Stamp)	Mi. (km)
		Date
97,500 Mi. 156,000 km (or 78 Mo.)	(Sign or Stamp)	Mi. (km)
		Date
105,000 Mi. 168,000 km (or 84 Mo.)	(Sign or Stamp)	Mi. (km)
		Date

Non-Scheduled Maintenance Record

Record additional maintenance for severe driving conditions or non-scheduled maintenance on this page (see page 108).

Maintenance Performed:	(Sign or Stamp)	Mi. (km)
		Date
Maintenance Performed:	(Sign or Stamp)	Mi. (km)
		Date
Maintenance Performed:	(Sign or Stamp)	Mi. (km)
		Date
Maintenance Performed:	(Sign or Stamp)	Mi. (km)
		Date
Maintenance Performed:	(Sign or Stamp)	Mi. (km)
		Date
Maintenance Performed:	(Sign or Stamp)	Mi. (km)
		Date

Maintenance Performed:	(Sign or Stamp)	Mi. (km)
		Date
Maintenance Performed:	(Sign or Stamp)	Mi. (km)
		Date
Maintenance Performed:	(Sign or Stamp)	Mi. (km)
		Date
Maintenance Performed:	(Sign or Stamp)	Mi. (km)
		Date
Maintenance Performed:	(Sign or Stamp)	Mi. (km)
		Date
Maintenance Performed:	(Sign or Stamp)	Mi. (km)
		Date

You should check the following items at the specified intervals. If you are unsure of how to perform any check, turn to the page given.

- Engine oil level — Check every time you fill the fuel tank. See page [86](#).
- Engine coolant level — Check the radiator reserve tank every time you fill the fuel tank. See page [87](#).
- Windshield washer fluid — Check the level in the reservoir monthly. If weather conditions cause you to use the washers frequently, check the reservoir each time you stop for fuel. See page [124](#).
- Automatic transmission — Check the fluid level monthly. See page [125](#).
- Brakes, clutch and power steering — Check the fluid level monthly. See pages [127](#) through [129](#).
- Tires — Check the tire pressure monthly. Examine the tread for wear and foreign objects. See page [141](#).
- Battery — Check its condition and the terminals for corrosion monthly. See page [133](#).
- Air conditioning — Check its operation weekly. See page [138](#).
- Lights — Check the operation of the headlights, parking lights, taillights, high-mount brake light, turn signals, brake lights, and license plate lights monthly. See page [145](#).

Fluid Locations

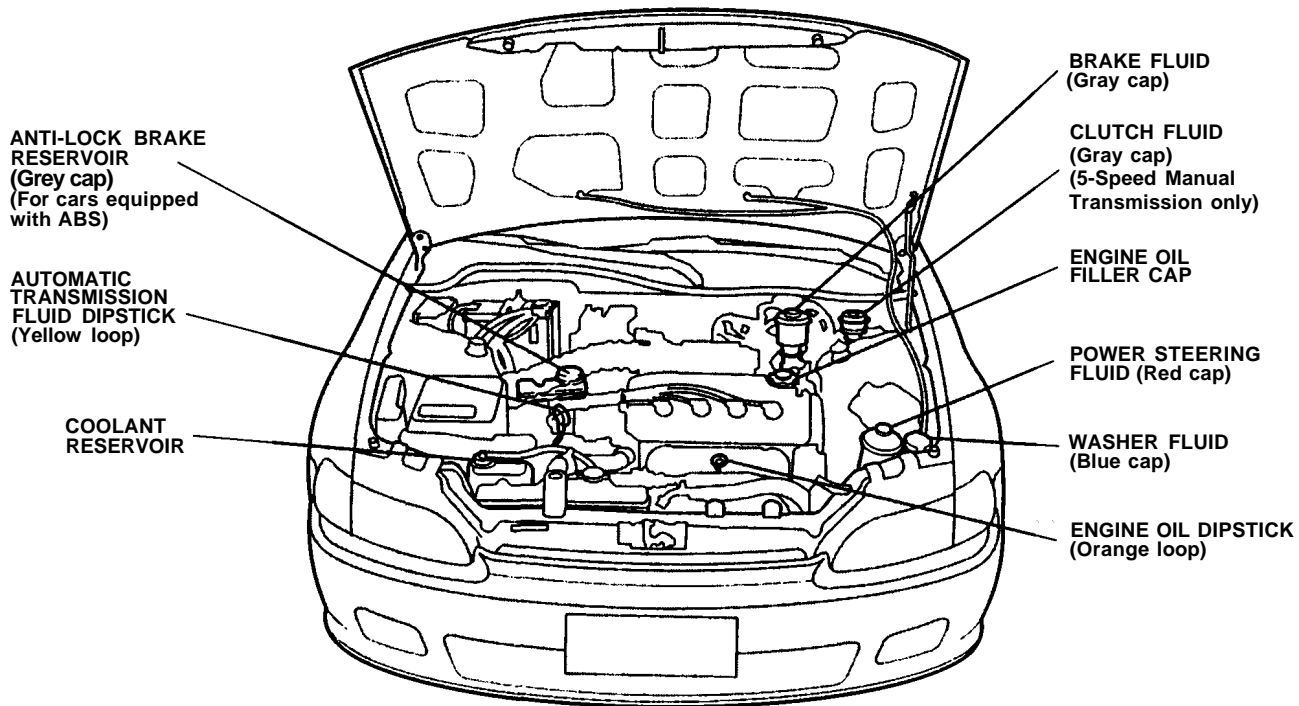

Checking Engine Oil

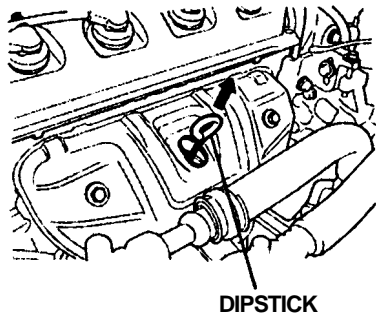

Check the engine oil a couple of minutes after shutting off the engine. This will allow the oil to drain down to the bottom of the engine. Make sure the car is parked on level ground.

1. Pull out the dipstick (orange loop) and wipe it with a cloth or paper towel.
2. Insert it all the way back in its tube.

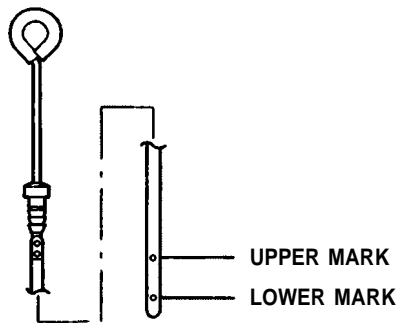

3. Pull it out again and look at the oil level at the end of the dipstick. If it is between the upper and lower marks, the level is correct. Add oil if the level is at or below the lower mark.

Adding Oil

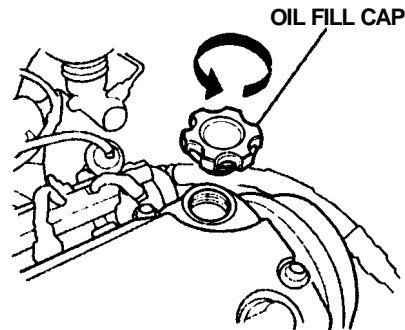

To add oil, unscrew and remove the engine oil fill cap on top of the valve cover. Pour in the oil, and replace the fill cap. Tighten it securely. Wait a few minutes and recheck the oil level. Do not fill above the upper mark; you could damage the engine.

Engine Oil

Recommended Oil

Oil is a major contributor to your engine's performance and longevity. Always use a premium-grade detergent oil.

You can determine an oil's SAE viscosity and Service Classification from the API Service label on the oil container.

A fuel-efficient oil is recommended for your Honda. This is shown on the API Service label by the words "Energy Conserving II." This oil is formulated to help your engine use less fuel.

The API Service label also tells you the service classification of the oil. Always use an oil that says "API Service SG or SH." This service rating may also include other designations, such as CD. These additional classifications are not a problem, as long as the

label also carries the SG or SH classification. An oil that is only classified SF is not recommended.

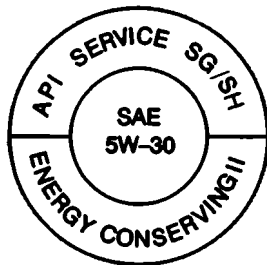

The oil container may also display the API Certification seal shown below. Make sure it says "For Gasoline Engines."



API CERTIFICATION SEAL

The SAE numbers tell you the oil's viscosity or weight. Select the oil for your car according to this chart:

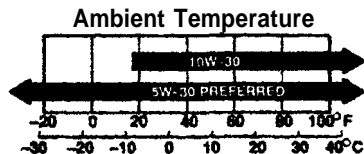

An oil with a viscosity of 5W-30 is preferred for improved fuel economy and year-round protection in your Honda. You may use a 10W-30 oil if the temperature in your area never goes below 20°F (-7°C).

Additives

Your Honda does not need any oil additives. Purchasing additives for the engine or transmission will not increase your car's performance or longevity. It only increases the cost of operating your car.

Oil and Filter Changes

Always change the oil and filter according to the time and distance (miles/kilometers) recommendations on the maintenance schedule. The oil and filter collect contaminants that can damage your engine if they are not removed regularly.

Changing the oil and filter requires special tools and access from underneath the car. The car should be raised on a service station-type hydraulic lift for this service. Unless you have the knowledge and proper

equipment, you should have this maintenance done by a skilled mechanic.

Repeated, prolonged exposure to used motor oil may cause skin cancer.

Wash your hands thoroughly with strong soap as soon as possible after handling used oil.

Engine Oil

1. Run the engine until it reaches normal operating temperature, then shut it off.

The oil, engine components and the exhaust system are hot and can burn you.

Use caution and wear protective clothing while working in the engine compartment.

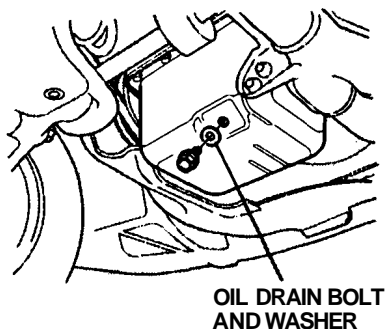

2. Open the hood and remove the oil fill cap. Remove the oil drain bolt and washer from the bottom of the engine. Drain the oil into an appropriate container.

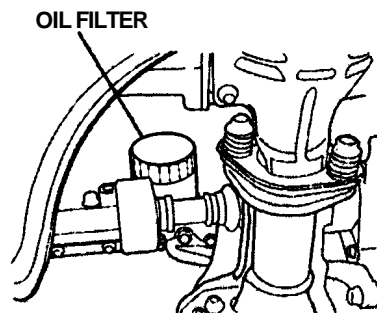

3. Remove the oil filter and let the remaining oil drain. A special wrench (available from your Honda dealer) is required to remove the filter.
4. Install a new oil filter according to the instructions that come with it.

- Put a new washer on the drain bolt, then reinstall the drain bolt. Tighten it to 40 N.m (4.0 kg-m, 29 lb-ft).
- Refill the engine with the recommended oil. Engine oil capacity (including filter): 3.5 U.S. qt (2.9 Imp. qt, 3.3ℓ).
- Replace the oil fill cap. Start the engine. The indicator light should go out within five seconds. If it does not, turn off the engine and inspect your work.
- Let the engine run for several minutes and check the drain bolt and washer, and oil filter for leaks.
- Turn off the engine, let it sit for several minutes, then check the oil level. If necessary, add oil to bring the level to the upper mark on the dipstick.

NOTICE

If you change your own oil, please dispose of the used oil properly. Put it in a sealed container and take it to a recycling center. Do not discard it in a waste bin or dump it on the ground.

The oil and filter should be changed every 6 months or 7,500 miles (12,000 km), whichever comes first. Under severe driving conditions, they should be changed every 3 months or 3,750 miles (6,000 km). See page 110 for a description of severe driving conditions.

Cooling System

Checking the Engine Coolant Level

RESERVE TANK

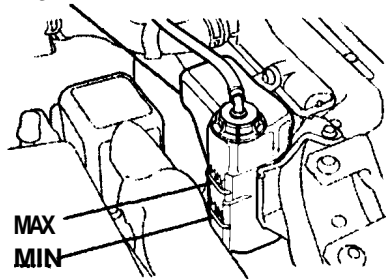

Check the level of the engine coolant by looking at the radiator reserve tank next to the air cleaner element box. If the level is at or below the MIN line, add coolant to bring it up to the MAX line. This coolant should always be a mixture of 50% antifreeze and 50% water. Never add straight antifreeze or plain water.

Always use Genuine Honda Antifreeze/Coolant. The cooling system contains many aluminum components that can corrode if an improper antifreeze is used. Some antifreeze, even though labeled as safe for aluminum parts, may not provide adequate protection.

Adding Engine Coolant

If the reserve tank is completely empty, you should also check the coolant level in the radiator.

Removing the radiator cap while the engine is hot can cause the coolant to spray out, seriously scalding you.

Always let the engine and radiator cool down before removing the radiator cap.

1. Make sure the engine and radiator are cool.

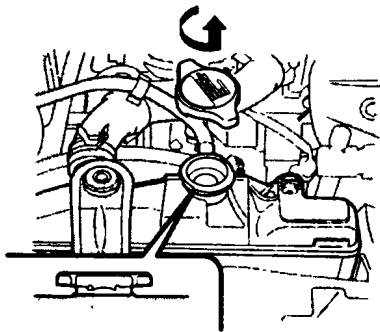

2. Turn the radiator cap counterclockwise, without pressing down on it, until it stops. This relieves any pressure remaining in the cooling system.
3. Remove the radiator cap by pushing down and turning counterclockwise.

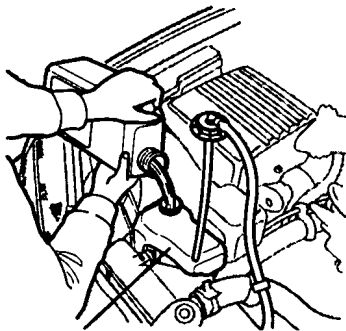

RESERVE TANK

4. The coolant level should be up to the base of the filler neck. Add coolant if it is low.
5. Put the radiator cap back on. Tighten it fully.
6. Pour coolant into the reserve tank. Fill it to halfway between the MAX and MIN marks. Put the cap back on the reserve tank.

Do not add any rust inhibitors or other additives to your car's cooling system. They may not be compatible with the coolant or engine components.

Replacing Engine Coolant

The cooling system should be completely drained and refilled with new coolant according to the time and mileage recommendations in the maintenance schedule. Only use the recommended antifreeze.

Draining the coolant requires access to the underside of the car. Unless you have the tools and knowledge, you should have this maintenance done by a skilled mechanic.

Cooling System

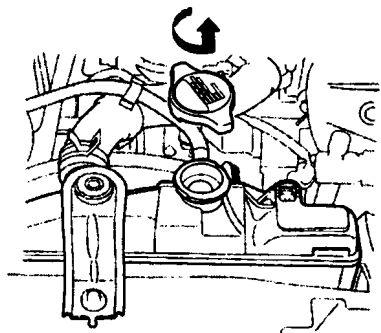

1. Slide the heater temperature control lever to maximum heat. Open the hood. Make sure the engine and radiator are cool to the touch.
2. Remove the radiator cap.

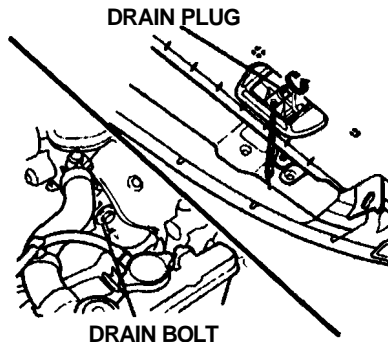

3. Loosen the drain plug in the bottom of the radiator. The coolant will drain through the splash guard. Remove the drain bolt from the engine block.

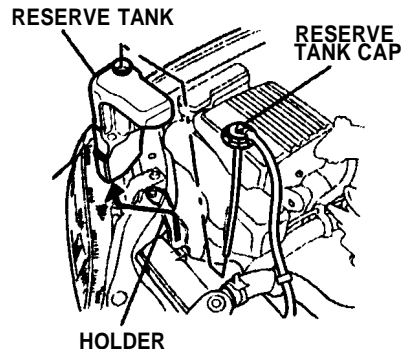

4. Remove the reserve tank from its holder by pulling it straight up. Drain the coolant, then put the tank back in its holder.
5. When the coolant stops draining, tighten the drain plug in the bottom of the radiator. Apply non-hardening sealant to the drain bolt threads and reinstall the bolt in the engine block. Tighten it securely.

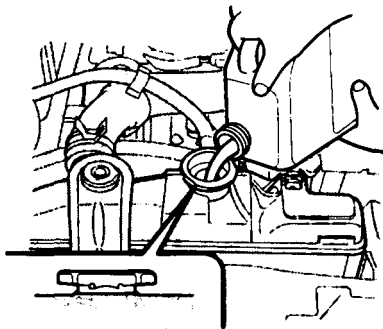

BLEEDER BOLT

6. Mix the recommended antifreeze with an equal amount of purified or distilled water in a clean container. The cooling system capacity is:

With 5-speed manual transmission:

0.95 U.S. gal (0.79 Imp. gal, 3.6ℓ)

With automatic transmission:

DX:

0.92 U.S. gal (0.77 Imp. gal, 3.5ℓ)

U.S.: EX, EX w/ABS option,

Canada: Si

1.00 U.S. gal (0.84 Imp. gal, 3.8ℓ)

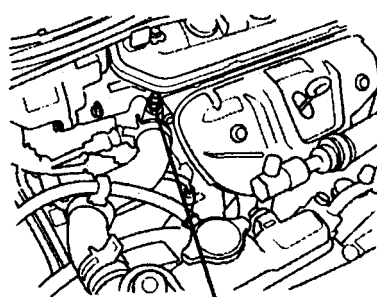

BLEEDER BOLT

7. Pour coolant into the radiator up to the base of the filler neck.
8. Loosen the bleeder bolt on top of the engine. Tighten it again when coolant comes out in a steady stream with no bubbles.
9. Refill the radiator to the base of the filler neck. Put the cap on the radiator, only tighten it to the first stop. Start the engine and let it run until it warms up (the radiator cooling fan comes on at least twice).

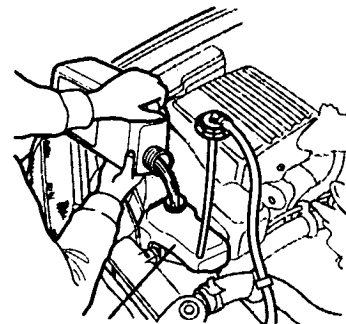

RESERVE TANK

10. Turn off the engine. Check the level in the radiator, add coolant if needed. Install the radiator cap, tighten it fully.
11. Fill the reserve tank to the MAX mark. Install the reserve tank cap.

Windshield Washers

Check the level in the windshield washer reservoir at least monthly during normal usage. In bad weather, when you use the washers often, check the level every time you stop for gas.

The windshield washer reservoir is located behind the left headlight. Check the reservoir's fluid level by removing the cap and looking inside.

Fill the reservoir with a good-quality windshield washer fluid. This increases the cleaning capability and prevents freezing in cold weather.

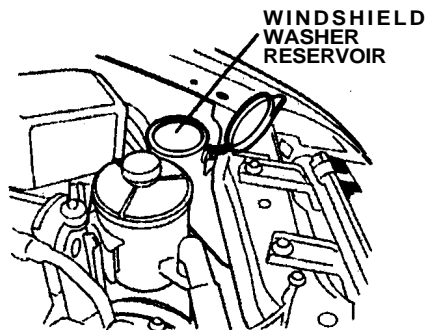

NOTICE

Do not use engine antifreeze or a vinegar/water solution in the windshield washer reservoir.

Antifreeze can damage your car's paint, while a vinegar/water solution can damage the windshield washer pump.

Use only commercially available windshield washer fluid.

Automatic Transmission

DIPSTICK

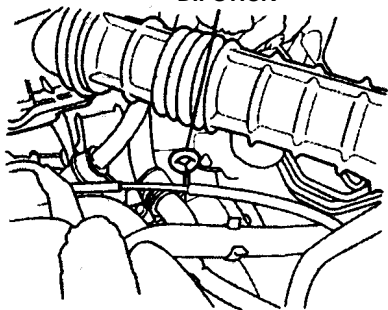

Check the fluid level with the engine at normal operating temperature.

1. Park the car on level ground. Shut off the engine.
2. Remove the dipstick (yellow loop) from the transmission and wipe it with a clean cloth.

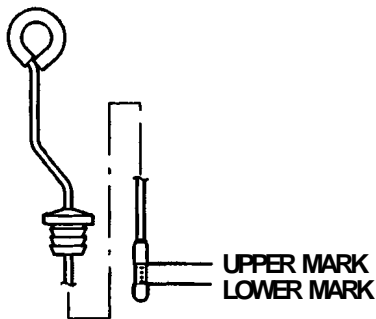

3. Insert the dipstick into the transmission.
4. Remove the dipstick and check the fluid level. It should be between the upper and lower marks.

5. If the level is below the lower mark, add fluid into the tube to bring it to the upper mark. Use Honda Premium Formula Automatic Transmission Fluid or an equivalent DEXRON® II Automatic Transmission Fluid (ATF) only.
6. Insert the dipstick all the way back in the transmission.

The transmission should be drained and refilled with new fluid every 24 months or 30,000 miles (48,000 km), whichever comes first.

Shorten this to every 12 months or 24,000 km (15,000 miles) under severe driving conditions (see page [110](#).)

Transmission Oil

5-Speed Manual Transmission

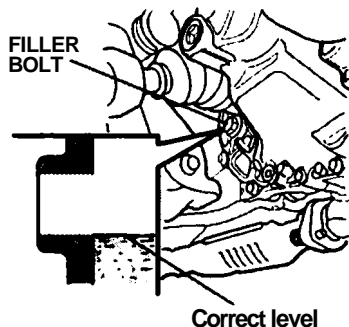

Check the oil level a couple of minutes after shutting off the engine. Make sure the car is on level ground. Remove the transmission filler bolt. The oil level should be up to the edge of the bolt hole. Feel inside the bolt hole with your finger. If you do not feel any oil, slowly add oil until it starts to run out of the hole. Reinstall the filler bolt and tighten it securely.

Only use an API Service SF or SG grade motor oil with a viscosity of SAE 10W-30 or 10W-40.

The transmission should be drained and refilled with new oil every 24 months or 30,000 miles (48,000 km), whichever comes first.

Shorten the service interval to every 12 months or 24,000 km (15,000 miles) under severe driving conditions (see page [110](#).)

Brake and Clutch Fluid

Check the fluid level in the reservoirs monthly. There are up to three reservoirs, depending on which model. They are:

- Brake fluid reservoir (all models).
- Clutch fluid reservoir (5-speed manual transmission only).
- ABS reservoir for cars with ABS option.

The brake fluid in the brake and anti-lock brake systems should be replaced every 2 years or 30,000 miles (48,000 km), whichever comes first.

Brake System

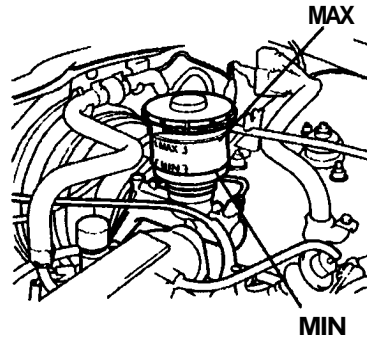

The fluid level should be between the MIN and MAX marks on the side of the reservoir. If the level is at or below the MIN mark, it is an indication that your brake system needs attention. Have the brake system inspected for leaks or worn brake pads.

If you add brake fluid to bring it up to the MAX mark, use Genuine Honda Brake Fluid or an equivalent from a sealed container that is marked DOT 3 or DOT 4 only. Brake fluid marked DOT 5 is not compatible with your car's braking system.

Brake and Clutch Fluid

Anti-Lock Brake System

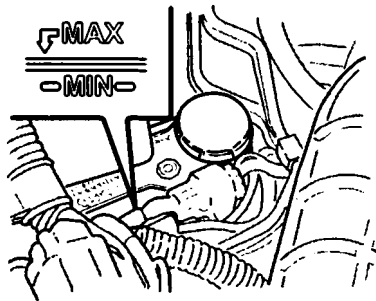

The fluid should be between the MIN and MAX marks on the side of the reservoir. If it is at or below the MIN mark, it may indicate a problem in the braking system. Have the dealer inspect your car.

If the fluid level is half an inch or more above the MAX mark, it may indicate a problem in the ABS. Have your dealer inspect the system as soon as possible.

If you add brake fluid to bring it up to the MAX mark, use the same DOT 3 or DOT 4 brake fluid from a sealed container specified for the brake system.

Clutch System

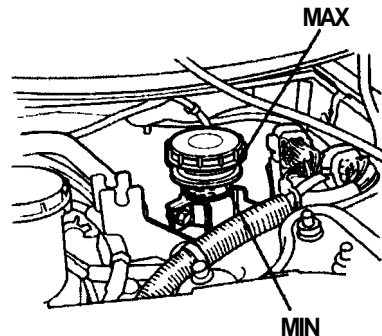

The fluid level should be between the MIN and MAX marks on the side of the reservoir. If it is not, add brake fluid to bring it up to that level. Use the same DOT 3 or DOT 4 brake fluid specified for the brake system.

Low fluid level can indicate a leak in the clutch system. Have this system inspected as soon as possible.

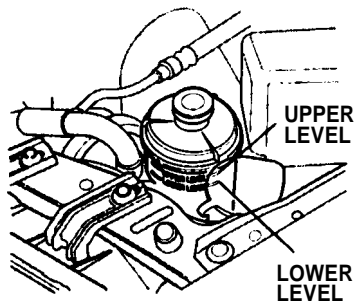

You should check the fluid level in the power steering reservoir monthly. Check the level when the engine is cold. Look at the side of the reservoir. The fluid should be between the UPPER LEVEL and LOWER LEVEL. If it is below the LOWER LEVEL, add power steering fluid to the UPPER LEVEL.

NOTICE

Using automatic transmission fluid or another brand of power steering fluid will damage the system. Use only Genuine Honda Power Steering Fluid-V.

A low power steering fluid level can indicate a leak in the system. Check the fluid level frequently and have the system inspected as soon as possible.

NOTICE

Turning the steering wheel to full left or right lock and holding it there can damage the power steering pump.

Air Cleaner Element

The air cleaner element should be replaced every 2 years or 30,000 miles (48,000 km), whichever comes first. Under severe driving conditions, it should be replaced every 12 months or 15,000 miles (24,000 km), whichever comes first.

Follow the replacement procedure for removal and reinstallation.

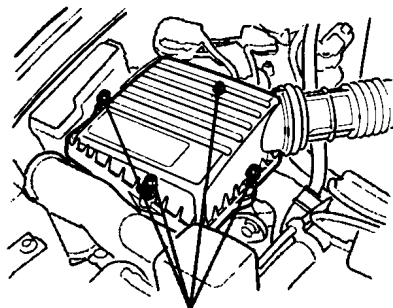

BOLTS

The air cleaner element is inside the air cleaner housing on the passenger's side of the engine compartment. To replace it:

1. Loosen the four bolts and remove the air cleaner housing cover.
2. Remove the old air cleaner element. Clean the inside of the housing with a damp rag.

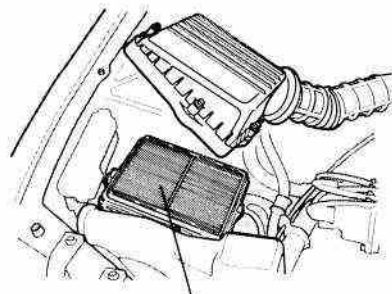

FILTER ELEMENT

3. Place the new air cleaner element in the housing.
4. Reinstall the housing cover, tighten the four bolts.

Fuel Filter

The fuel filter should be replaced every 4 years or 60,000 miles (96,000 km), whichever comes first.

Have a qualified technician change the fuel filter. Since the fuel system is under pressure, gasoline can spray out and create a hazard if all fuel line connections are not handled correctly.

The filter may require replacement sooner if you happen to buy one or more tankfuls of contaminated gasoline. Have the filter tested or replaced if you suspect it has been clogged by contaminants.

Spark Plugs

The original spark plugs in your car need to be replaced every 2 years or 48,000 km (30,000 miles), whichever comes first.

Replacement

SPARK PLUG CAP

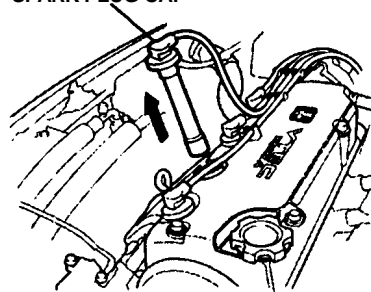

1. Clean up any dirt and oil that have collected around the spark plug caps.
2. Remove the spark plug cap by pulling it straight out.
3. Remove the spark plug, using a 16 mm (5/8 inch) spark plug socket.
4. Install the spark plug cap.

continued

Spark Plugs

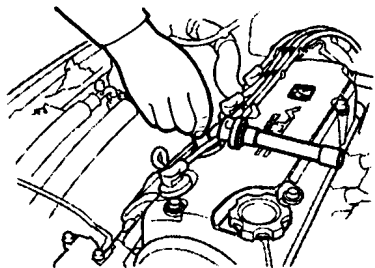

5. Put the new spark plug into the socket, then thread it into the hole. Screw it in by hand so you do not crosstread it.

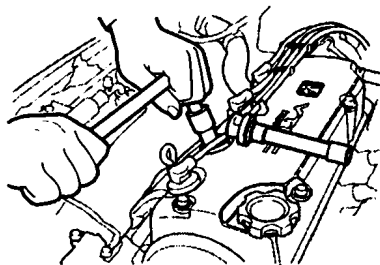

6. Torque the spark plug. (If you do not have a torque wrench, tighten the spark plug turn two-thirds after it contacts the cylinder head.) Tightening torque: 13 lb-ft (18 N.m, 1.8 kg-m).

NOTICE

Tighten the spark plugs carefully. A spark plug that is too loose can overheat and damage the engine. Overtightening can cause damage to the threads in the cylinder head.

7. Install the spark plug cap.
8. Repeat this procedure for the other three spark plugs.

Spark Plugs Specifications:

DX

Normal driving conditions

NGK: **ZFR5F-11**

Nippondenso: **KJ16CR-L11**

Hot climates, or continuous high speed driving

NGK: **ZFR6F-11**

Nippondenso: **KJ20CR-L11**

U.S.: EX, EX w/ABS option

Canada: Si

Normal driving conditions

NGK: **ZFR5J-11**

Nippondenso: **KJ16CR-L11**

Hot climates, or continuous high speed driving

NGK: **ZFR6J-11**

Nippondenso: **KJ20CR-L11**

Spark plug gap

0.04 in. (1.1 mm) $\begin{matrix} +0 \\ -0.1 \text{ mm} \end{matrix}$

Battery

Check the condition of your car's battery monthly. You should check for proper electrolyte level and corrosion on the terminals.

The battery gives off explosive hydrogen gas during normal operation. A spark or open flame can cause the battery to explode with enough force to kill or seriously hurt you.

Wear protective clothing and a face shield, or have a skilled mechanic do the battery maintenance.

The battery contains sulfuric acid (electrolyte), which is highly corrosive and poisonous.

Getting electrolyte in your eyes or on your skin can cause serious burns. Wear protective clothing and eye protection when working near the battery.

Swallowing electrolyte can cause fatal poisoning if immediate action is not taken.

KEEP OUT OF THE REACH OF CHILDREN.

Battery

Emergency Procedures

Eyes — Flush with water from a cup or other container for at least 15 minutes. (Water under pressure can damage the eye.) Immediately call a physician or 911.

Skin — Remove contaminated clothing. Flush the skin with large quantities of water. Call a physician immediately.

Swallowing — Drink water or milk. Call your local Poison Control Center or a physician immediately.

TEST INDICATOR WINDOW

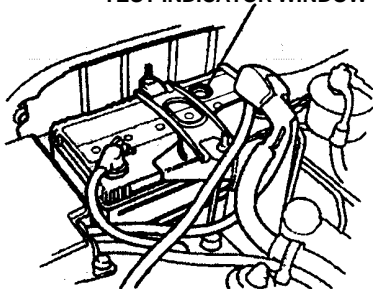

Check the battery condition by looking at the test indicator window on the battery.

The label on the battery explains the test indicator's colors.

Check the battery terminals for corrosion (a white or yellowish powder). To remove it, cover the terminals with a solution of baking soda and water. It will bubble up and turn brown. When this stops, wash it off with plain water. Dry off the battery with a cloth or paper towel. Coat the terminals with grease to help prevent future corrosion.

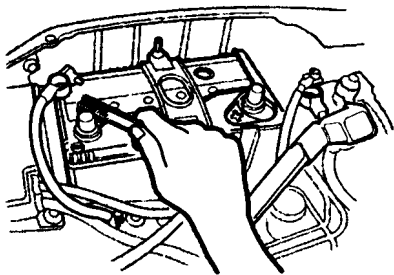

If the terminals are severely corroded, clean them with baking soda and water. Then use a wrench to loosen and remove the cables from the terminals. Always disconnect the negative (—) cable first and reconnect it last. Clean the battery terminals with a terminal cleaning tool or wire brush. Reconnect and tighten the cables, then coat the terminals with grease.

If you need to connect the battery to a charger, disconnect both cables to prevent damage to the car's electrical system.

If your car's battery is disconnected or goes dead, the audio system will disable itself. The next time you turn on the radio you will see "Code" in the frequency display. Use the Preset buttons to enter the five-digit code (see page 79).

NOTICE

Charging the battery with the cables connected can seriously damage your car's electronic controls. Detach the battery cables before connecting the battery to a charger.

Windshield Wipers

Check the condition of the windshield wiper blades at least every six months. Look for signs of cracking in the rubber, or areas that are getting hard. Replace the blades if you find these signs, or they leave streaks and unwiped areas when used.

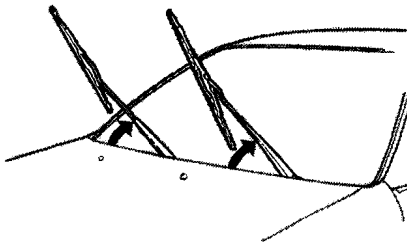

To replace:

1. Raise the wiper arm off the windshield.

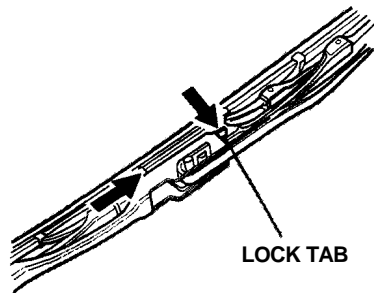

2. Disconnect the blade assembly from the wiper arm by pushing in the lock tab. Hold it in while you push the blade assembly toward the base of the arm.

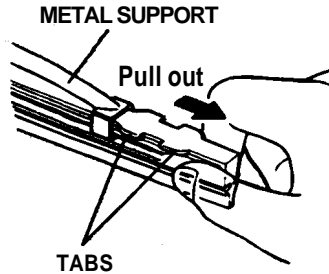

3. Remove the blade from its holder by grasping the tabbed end of the blade. Pull firmly until the tabs come out of the holder.

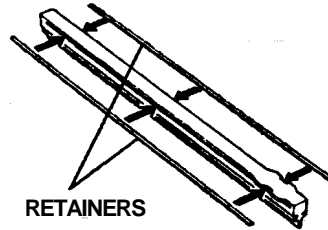

4. Examine the new wiper blades. If they have no plastic or metal reinforcement along the back edge, remove the metal reinforcement strips from the old wiper blade and install them in the slots along the edge of the new blade.
5. Slide the new wiper blade into the holder until the tabs lock.

6. Slide the blade assembly onto the wiper arm. Make sure it locks in place.
7. Lower the wiper arm down against the windshield.

Air Conditioning System (Optional)

Your car's air conditioning is a sealed system. Any major maintenance, such as recharging, should be done by a qualified technician. There are a couple of things you can do to make sure the air conditioning works efficiently.

AIR CONDITIONING
CONDENSER

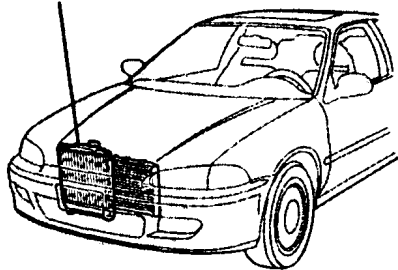

Periodically check the engine's radiator and air conditioning condenser for leaves, insects, and

dirt stuck to the front surface. These block the air flow and reduce cooling efficiency. Use a light spray from a hose or a soft brush to remove them.

NOTICE

The condenser and radiator fins bend easily. Only use a low-pressure spray or soft-bristle brush to clean them.

Run the air conditioning at least once a week during the cold weather months. Run it for at least 10 minutes while you are driving at a steady speed with the engine at normal operating temperature. This circulates the lubricating oil contained in the refrigerant.

If the air conditioning does not get as cold as before, have your dealer check the system. Recharge the system with Refrigerant HFC-134a (R-134a). See **Specifications** on page 187.

NOTICE

Whenever you have the air conditioning system serviced, make sure the service facility uses a refrigerant recycling system. This system captures the refrigerant for reuse. Releasing refrigerant into the atmosphere can damage the environment.

Engine Belts

ALTERNATOR BELT

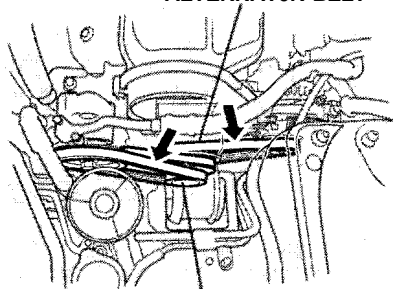

POWER STEERING BELT

Check the condition of the two engine belts. Examine the edges of each belt for cracks or fraying. Check the tension of each belt by pushing on it with your thumb midway between the pulleys.

The belts should have the following "play" or deflection.

Alternator belt:
0.28-0.41 in. (7.0-10.5 mm)

Power steering belt:
0.31-0.47 in. (8.0-12.0 mm)

If you see signs of wear or looseness, have your dealer adjust or replace the belts.

Tires

To safely operate your car, your tires must be the proper type and size, in good condition with adequate tread, and correctly inflated. The following pages give more detailed information on how and when to check air pressure, how to inspect your tires for damage, and what to do when your tires need to be replaced.

Using tires that are excessively worn or improperly inflated can cause a crash in which you can be seriously hurt or killed.

Follow all instructions in this owner's manual regarding tire inflation and maintenance.

Inflation

Keeping the tires properly-inflated provides the best combination of handling, tread life and riding comfort. Underinflated tires wear unevenly, adversely affect handling and fuel economy, and are more likely to fail from being overheated. Overinflated tires can make your car ride more harshly, are more prone to damage from road hazards, and wear unevenly.

Tires

We recommend that you visually check your tires every day and use a gauge to measure the air pressure at least once a month. If you think a tire might be low, check it immediately. Remember to check the spare tire at the same time you check all the other tires.

Check the pressure in the tires when they are cold. This means the car has been parked for at least three hours. If you have to drive the car before checking the tire pressure, the tires can still be considered "cold" if you drive less than one mile (1.6 km).

If you check the pressure when the tires are hot (the car has been driven several miles), you will see readings four to six PSI higher than the cold reading. This is normal. Do not let air out to match the specified cold pressure. The tire will be underinflated.

Recommended Tire Pressures for Normal Driving

The following chart shows the recommended cold tire pressures for most normal driving conditions and speeds. Tire pressures for high speed driving are shown on page 191.

DX

Tire Size	Cold Tire Pressure for Normal Driving
P175/70 R13 82S	32 psi (222 kPa, 2.2 kg/cm ²)

U.S.: EX, Canada: Si

Tire Size	Cold Tire Pressure for Normal Driving
P185/60 R14 82H	29 psi (200 kPa, 2.0 kg/cm ²)

The compact spare tire pressure is 60 psi (415 kPa, 4.15 kg/cm²)

TIRE INFORMATION LABEL
U. S. cars

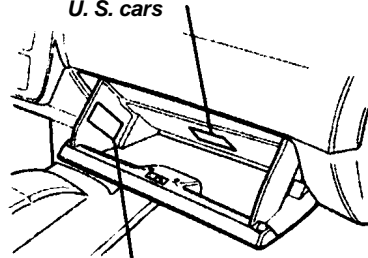

TIRE INFORMATION LABEL
Canada cars

These pressures are also given on the tire information label in the glove box.

You should get your own tire pressure gauge and use it whenever you check your tire pressures. This will make it easier for you to tell if a pressure loss is due to a tire problem and not due to a variation between gauges.

Tubeless tires have some ability to self-seal if they are punctured. However, because leakage is often very slow, you should look closely for punctures if a tire starts losing pressure.

Inspection

Every time you check inflation, you should also examine the tires for damage, foreign objects, and wear.

You should look for:

- Bumps or bulges in the tread or side of the tire. Replace the tire if you find either of these conditions.
- Cuts, splits, or cracks in the side of the tire. Replace the tire if you can see fabric or cord.
- Excessive tread wear.

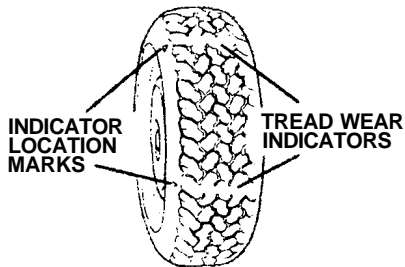

Your car's tires have wear indicators molded into the tread. When the tread wears down to that point, you will see a 1/2 inch (12.7 mm) wide band running across the tread. This shows there is less than 1/16 inch (1.6 mm) of tread left on the tire. A tire that is this worn gives very little traction on wet roads. You should replace the tire if you can see the tread wear indicator in three or more places around the tire.

Maintenance

In addition to proper inflation, correct wheel alignment helps to decrease tire wear. You should get your car's wheel alignment checked every 12 months or 15,000 miles (24,000 km).

The tires were properly balanced by the factory. They may need to be rebalanced at some time before they are worn out. Have your dealer check the tires if you feel a consistent vibration while driving. A tire should always be rebalanced if it is removed from the wheel for repair.

Tires

Make sure the installer balances the wheels when you have new tires installed. This increases riding comfort and tire life. Your car's original tires were dynamic or "spin" balanced at the factory. For best results, have the installer perform a dynamic balance.

NOTICE

Improper wheel weights can damage your car's aluminum wheels. Use only genuine Honda wheel weights for balancing.

Tire Rotation

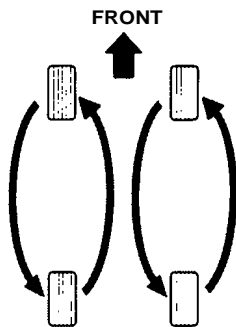

To help increase tire life and distribute wear more evenly, you should have the tires rotated every 7,500 miles (12,000 km). Move the tires to the positions shown in the chart each time they are rotated.

Replacing Tires and Wheels

The tires that came with your car were selected to match the performance capabilities of the car and provide the best combination of handling, ride comfort, and long life. You should replace them with radial tires of the same size, load range, and speed rating. Mixing radial and bias-ply or bias-belted tires on your car can reduce its braking ability, traction, and steering accuracy.

Installing improper tires on your car can affect handling and stability. This can cause a crash in which you can be seriously hurt or killed.

Always use the size and type of tires recommended in this owner's manual.

It is best to replace all four tires at the same time. If that is not possible or necessary, then replace the two front tires or the two rear tires as a pair. Replacing just one tire can seriously affect your car's handling.

If you ever need to replace a wheel, make sure the wheel's specifications match those of the original wheel that came on your car. Replacement wheels are available at your Honda dealer.

Wheels and Tires

Wheel:

(DX)

13 x 5J

(U.S.: EX, Canada: Si)

14x5J

Tire:

(DX)

P175/70 R13 82S

(U.S.: EX, Canada: Si)

P185/60 R14 82H

See *Tire Information* on page [190](#) for additional information about tire and wheel size designations. See page [191](#) for information about DOT Tire Quality Grading.

Winter Driving

Tires that are marked "M + S" or "All Season" on the sidewall have an all-weather tread design. They should be suitable for most winter driving conditions. Tires without these markings are designed for optimum traction in dry conditions. They may not provide adequate performance in winter driving. For the best performance in snowy or icy conditions, you should install snow tires or tire chains. They may be required by local laws under certain conditions.

Tires

Snow Tires

If you mount snow tires on your Honda, make sure they are radial tires of the same size and load range as the original tires. Mount snow tires on all four wheels to balance your car's handling in all weather conditions. Keep in mind the traction provided by snow tires on dry roads may not be as high as your car's original equipment tires. You should drive cautiously even when the roads are clear. Check with the tire dealer for maximum speed recommendations.

Tire Chains

Mount snow chains on your car when warranted by driving conditions or required by local laws. Make sure the chains are the correct size for your tires. Install them only on the front tires. If metal chains are used, they must be SAE class "S." Cable type traction devices can also be used.

When installing chains, follow the manufacturer's instructions and mount them as tightly as you can. Drive slowly with chains installed. If you hear the chains contacting the body or chassis, stop and tighten them. If they still make contact, slow down until it stops. Remove the chains as soon as you begin driving on cleared roads.

NOTICE

Chains of the wrong size or that are improperly installed can damage your car's brake lines, suspension, body, and wheels. Stop driving if you hear the chains hitting any part of the car.

Check the operation of your car's exterior lights at least once a month. A burned out bulb can create an unsafe condition by reducing your car's visibility and the ability to signal your intentions to other drivers. Check the following:

- Headlights (low and high beam)
- Parking lights
- Taillights
- Brake lights
- Turn signals
- Back-up lights
- Hazard light function
- License plate light
- Side marker lights
- Daytime running lights (Canada cars)

If you find any bulbs are burned out, replace them as soon as possible. Refer to the chart on page 187 to determine what type of replacement bulb is needed.

Replacing a Headlight Bulb

Your car has halogen headlight bulbs, one on each side. When replacing a bulb, handle it by its steel base and protect the glass from contact with your skin or hard objects. If you touch the glass, clean it with denatured alcohol and a clean cloth.

NOTICE

Halogen headlight bulbs get very hot when lit. Oil, perspiration, or a scratch on the glass can cause the bulb to overheat and shatter.

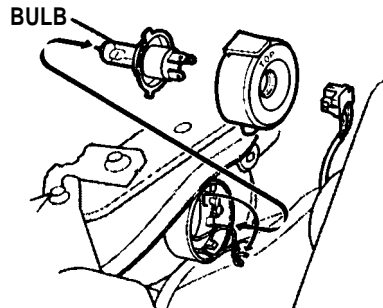

1. Open the hood. If you need to change the headlight bulb on the passenger's side, remove the air intake tube by pulling it straight up.

continued

Lights

2. Remove the electrical connector from the bulb by squeezing the connector to unlock the tab on each side. Pull the connector straight back.
3. Remove the rubber weather seal by pulling on the tab.
4. Unclip the end of the hold-down wire from its slot. Pivot it out of the way and remove the bulb.
5. Insert the new bulb into the hole, making sure the tabs are in their slots. Pivot the hold-down wire back in place and clip the end into the slot.
6. Push the rubber weather seal over the bulb. Make sure the tab is on the top.
7. Push the electrical connector onto the tabs of the new bulb. Turn on the headlights to test the new bulb.
8. (Passenger's side)
Reinstall the air intake tube.

Replacing the Front Side Marker/Turn Signal and Parking Light Bulb

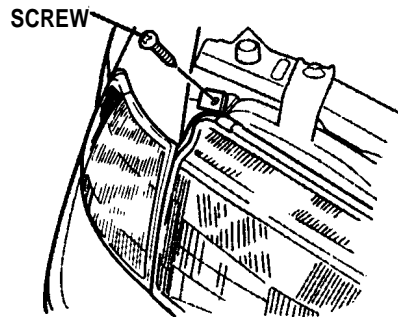

1. Use a Phillips® head screwdriver to remove the screw from the top of the fender.

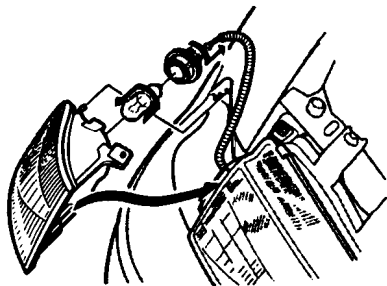

2. Move the side marker light assembly forward until it slides out of the body.
3. Turn the socket one-quarter turn counterclockwise to remove it from the lens.
4. Remove the bulb by pushing it in slightly and turning it counterclockwise.
5. Install the new bulb in the socket. Turn it clockwise to lock it in place.

6. Insert the socket back into the lens. Turn it clockwise to lock it in place.
7. Turn on the parking lights to make sure the new bulb works.
8. To reinstall the light assembly in the fender, line up the guide on the assembly with the metal tab next to the headlight and line up the fingers on the light assembly with the holes in the fender. Push the light assembly straight back.
9. Install the mounting screw and tighten it securely.

Replacing Rear Bulbs (in Fenders)

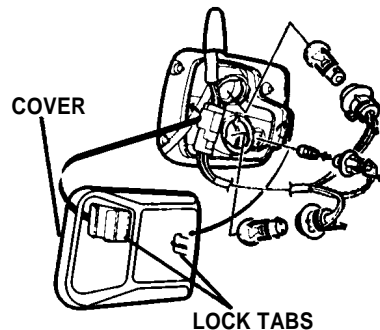

1. Open the trunk.
2. Remove the cover from the inside of the taillight assembly by pushing on the tab.
3. Determine which of the three bulbs is burned out: tail/stoplight, turn signal, or side marker. Remove the socket for that bulb by turning it counterclockwise.

Lights

- To remove either the tail/stoplight bulb or the turn signal bulb, push it in slightly and turn it counterclockwise. To remove the side marker bulb, pull it straight out of the socket.
- Install the new bulb in the socket. Insert the socket back in the taillight assembly and turn it clockwise to lock it in place.
- Test the new bulb. Reinstall the cover over the taillight assembly.

Replacing Rear Bulbs (in Trunk Lid)

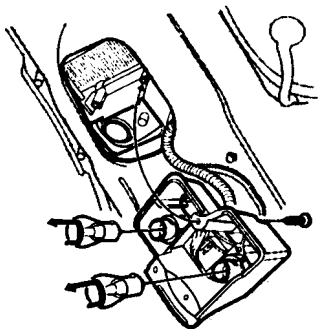

- Open the trunk.
- Remove the electrical connector from its hold-down clip by sliding it sideways toward the center of the car.

- Use a Phillips® head screwdriver to remove the two screws from the bulb holder. Remove the holder from the taillight assembly.
- Try the taillights and back-up lights to verify which bulb needs replacing. Remove that bulb from the socket by pushing it in slightly and turning it counterclockwise.
- Install the new bulb in the socket. Test it to make sure it works.
- Reinstall the bulb holder assembly. Install the two screws and tighten them securely.

High-Mount Brake Light

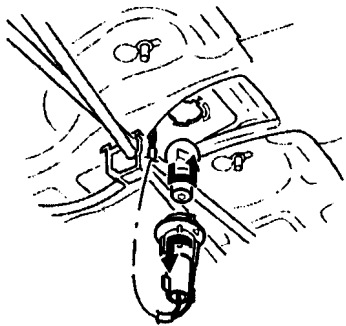

1. Open the trunk and remove the socket from the light assembly by turning it one-quarter turn counterclockwise.
2. Remove the bulb by turning it one-quarter turn counterclockwise.
3. Install the new bulb and reinstall the socket. Make sure the new bulb is working.

Replacing a Rear License Bulb

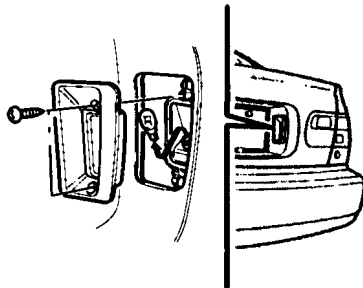

1. Remove the two screws and remove the lens.
2. Pull the bulb straight out of its socket. Push the new bulb in until it bottoms in the socket.
3. Turn on the parking lights and check that the new bulb is working.
4. Reinstall the lens. Reinstall the two screws and tighten them securely.

Replacing Interior and Trunk Light Bulbs

INTERIOR LIGHT

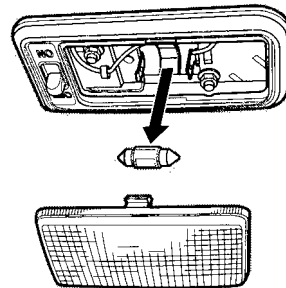

1. Remove the lens by carefully prying on the edge of the lens in the middle with a fingernail file or a small flat-tip screwdriver. Do not pry on the edge of the housing around the lens.

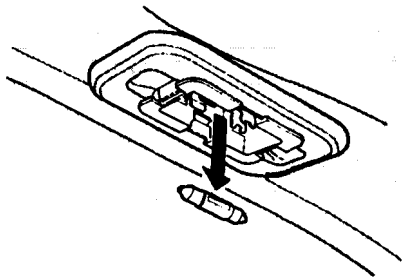

TRUNK LIGHT

2. Remove the bulb by pulling it straight out of its metal tabs.
3. Push the new bulb into the metal tabs.

If you need to park your car for an extended period (more than 1 month), there are several things you should do to prepare it for storage. Proper preparation helps prevent deterioration and makes it easier to get your car back on the road. It is best to store your car indoors if at all possible.

- Fill the fuel tank.
- Change the engine oil and filter (see page 115).
- Wash and dry the exterior completely.
- Clean the interior. Make sure the carpeting, floor mats, etc. are completely dry.
- Leave the parking brake off. Put the transmission in Reverse (5-speed manual) or Park (automatic).
- Block the rear wheels.

- If the car is to be stored for a longer period, it should be supported on jackstands so the tires are off the ground.
- Leave one window open slightly (if the car is being stored indoors).
- Disconnect the battery.
- Cover the car with a "breathable" car cover, one made from a porous material such as cotton. Nonporous materials, such as plastic sheeting, trap moisture which can damage the paint.
- If possible, run the engine for a while periodically (preferably once a month).
- Support the front and rear wiper blade arms with a folded towel or rag so they do not touch the windshield.

- To minimize the seal sticking, apply a silicone spray lubricant to all door and trunk seals. Also, apply a car body wax to the painted surfaces that mate with the door and trunk seals.

If you store your car for 12 months or longer, have your Honda dealer perform the inspections called for in the 24 months/30,000 miles (48,000 km) maintenance schedule as soon as you take it out of storage (see pages 108-110). The replacements called for in the maintenance schedule are not needed unless the car has actually reached that time or mileage.

Regular cleaning and polishing of your Honda helps to keep it "new" looking. This section gives you hints on how to clean and preserve your car's appearance: the paint, brightwork, wheels and interior. Also included are several things you can do to help prevent corrosion.

Exterior Care	154
Washing	154
Waxing	155
Touch-Up Paint.....	155
Interior Care	157
Carpeting	157
Fabric	157
Vinyl	157
Seat Belts	157
Windows	158
Air Fresheners	158
Corrosion Protection	158
Body Repairs	159

Exterior Care

Washing

Frequent washing helps preserve your car's beauty. Dirt and grit can scratch the paint, while tree sap and bird droppings can permanently ruin the finish.

Wash your car in a shady area, not in direct sunlight. If the car is parked in the sun, move it into the shade and let the exterior cool down before you start.

NOTICE

Chemical solvents and strong cleaners can damage the paint, metal and plastic on your car. Only use the solvents and cleaners recommended in this Owner's Manual.

- Rinse the car thoroughly with cool water to remove loose dirt.
 - Fill a bucket with cool water. Mix in a mild detergent, such as dishwashing liquid or a product made especially for car washing.
 - Wash the car, using the water and detergent solution and a soft-bristle brush, sponge or soft cloth. Start at the top and work your way down. Rinse frequently.
 - Check the body for road tar, tree sap, etc. Remove these stains with tar remover or turpentine. Rinse it off immediately so it does not harm the finish. Remember to re wax these areas, even if the rest of the car does not need waxing.
- When you have washed and rinsed the whole exterior, dry it with a chamois or soft towel. Letting it air-dry will cause dulling and water spots. As you dry the car, inspect it for chips and scratches that could allow corrosion to start. Repair them with touch-up paint (see page [155](#)).

Waxing

Always wash and dry the whole car before waxing it. You should wax your car, including the metal trim, whenever water sits on the surface in large patches. It should form into beads or droplets after waxing.

You should use a quality liquid or paste wax. Apply it according to the instructions on the container. In general, there are two types of products:

Waxes - A wax coats the finish and protects it from damage by exposure to sunlight, air pollution, etc. You should use a wax on your Honda when it is new.

Polishes - Polishes and cleaner/waxes can restore the shine to paint that has oxidized and lost some of its shine. They normally contain mild abrasives and solvents that remove the top layer of the finish. You should use a polish on your Honda if the finish does not have its original shine after using a wax.

Cleaning tar, insects, etc. with removers also takes off the wax. Remember to re wax those areas, even if the rest of the car does not need waxing.

Touch-Up Paint

Your dealer has touch-up paint to match your car's color. The color code is printed on a sticker on the driver's doorjamb. Take this code to your dealer so you are sure to get the correct color.

Exterior Care

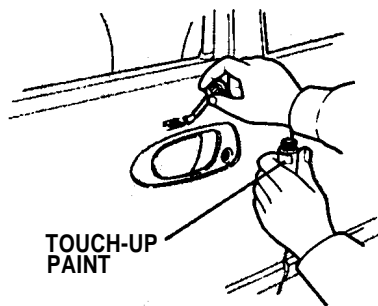

Inspect your car for chipped or scratched paint every time you wash it. Repair it as soon as possible to prevent corrosion. Use the touch-up paint on small chips and scratches. More extensive damage should be repaired by a professional.

Examine the chip or scratch closely before repairing it. If it does not go down to bare metal, clean it with soap and water and apply the touch-up paint. If it does go to the metal, apply a coat of primer first. After this dries, apply the touch-up paint. Build up the paint in the damaged area to the level of the surrounding paint. Several thin coats of paint are better than one thick coat.

Carpeting

Vacuum the carpeting frequently to remove dirt. Ground-in dirt will make the carpet wear out faster. Periodically shampoo the carpet to keep it looking new. Use one of the foam-type carpet cleaners on the market: Follow the instructions that come with the cleaner, applying it with a sponge or soft brush. Keep the carpeting as dry as possible by not adding water to the foam.

Fabric

Vacuum dirt and dust out of the material frequently. For general cleaning, use a solution of mild soap and lukewarm water, letting it air dry. To clean off stubborn spots, use a commercially available fabric cleaner. Test it on a hidden area of the fabric first, to make sure it does not bleach or stain the fabric. Follow the instructions that come with the cleaner.

Vinyl

Remove dirt and dust with a vacuum cleaner. Wipe the vinyl with a soft cloth dampened in a solution of mild soap and water. Use the same solution with a soft-bristle brush on more difficult spots. You can also use commercially available spray or foam-type vinyl cleaners.

Seat Belts

If your seat belts get dirty, you can use a soft brush to clean them with a mixture of mild soap and warm water. Do not use bleach, dye, or cleaning solvents. They can weaken the belt material. Let the belts air-dry before you use the car.

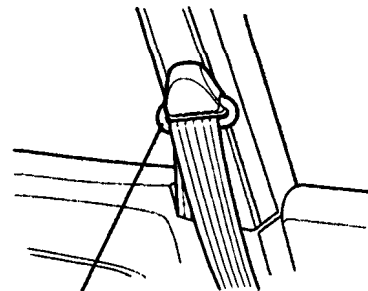

METAL LOOP

Dirt build-up in the metal loops of the seat belt anchors can cause the belts to retract slowly. Wipe the inside of the loops with a clean cloth dampened in mild soap and warm water or isopropyl alcohol.

Interior Care, Corrosion Protection

Windows

Clean the windows, inside and out, with a commercially available glass cleaner. You can also use a mixture of one part white vinegar to ten parts water. This will remove the haze that builds up on the inside of the windows. Use a soft cloth or paper towels to clean all glass and clear plastic surfaces.

NOTICE

The rear window defogger wires are bonded to the inside of the glass. Wiping vigorously up and down can dislodge and break the defogger wires. When cleaning the rear window, use gentle pressure and wipe side to side.

Air Fresheners

If you want to use an air freshener/deodorizer in the interior of your Civic, it is best to use a solid type. Some liquid air fresheners contain chemicals that may cause parts of the interior trim and fabric to crack or discolor.

If you use a liquid air freshener, make sure you fasten it securely so it does not spill as you drive.

Corrosion Protection

Two factors normally contribute to causing corrosion in your car:

1. Moisture trapped in body cavities. Dirt and road salt that collects in hollows on the underside of the car stays damp, promoting corrosion in that area.
2. Removal of paint and protective coatings from the exterior and underside of the car.

Many corrosion-preventive measures are built into your Honda. You can help keep your car from corroding by performing some simple periodic maintenance:

- Repair chips and scratches in the paint as soon as you discover them.
- Inspect and clean out the drain holes in the bottom of the doors and body.

- Check the floor coverings for dampness. Carpeting and floor mats may remain damp for a long time, especially in winter. This dampness can eventually cause the floor panels to corrode.
- Use a high-pressure spray to clean the underside of your car. This is especially important in areas that use road salt in winter. It is also a good idea in humid climates and areas subject to salt air. Cars with ABS have a sensor and wiring at each wheel. Be careful not to damage them.
- Have the corrosion-preventive coatings on the underside of your car inspected and repaired periodically.

Body Repairs

Body repairs can affect your car's resistance to corrosion. If your car needs repairs after a collision, pay close attention to the parts used in the repair and the quality of the work.

Make sure the repair facility uses genuine Honda replacement body parts. Some companies make sheetmetal pieces that seem to duplicate the original Honda body parts, but are actually inferior in fit, finish, and corrosion resistance. Once installed, they do not give the same high-quality appearance.

When reporting your collision to the insurance company, tell them you want genuine Honda parts used in the repair. Although most insurers recognize the quality of original parts, some may try to specify that the repairs be done with other available parts. You should investigate this before any repairs are begun.

Take your car to your authorized Honda dealer for inspection after the repairs are completed. He can make sure that quality materials were used, and that corrosion-preventive coatings were applied to all repaired and replaced parts.

This section covers the more common problems that motorists experience with their cars. It gives you information about how to safely evaluate the problem and what to do to correct it. If the problem has stranded you on the side of the road, you may be able to get going again. If not, you will also find instructions on getting your car towed.

Compact Spare Tire	162
Changing a Flat Tire	163
If Your Engine Won't Start	168
Nothing Happens	168
The Starter Operates Normally	169
Jump Starting	169
If Your Engine Overheats	171
Low Oil Pressure Indicator ...	173
Charging System Indicator ...	174
Malfunction Indicator Lamp (Check Engine Light)	175
Closing the Moonroof	176
Fuses	177
Checking and Replacing ...	178
Location	180
Towing	182

Compact Spare Tire

Your car has a compact spare tire that takes up less space. Use this spare tire as a temporary replacement only. Get your regular tire repaired or replaced and put back on your car as soon as you can.

Check the inflation of the compact spare tire every time you check the other tires. It should be inflated to:
60 psi (4.15 kg/cm², 415 kPa).

Follow these precautions whenever you are using the compact spare tire:

- Do not exceed 50 mph (80 km/h) under any circumstances.
- This tire gives a harsher ride and less traction on some road surfaces than the regular tire. Use greater caution while driving on this tire.
- Do not mount snow chains on the compact spare.
- The wheel of the compact spare tire is designed especially to fit your car. Do not use your spare tire on another car unless it is the same make and model.

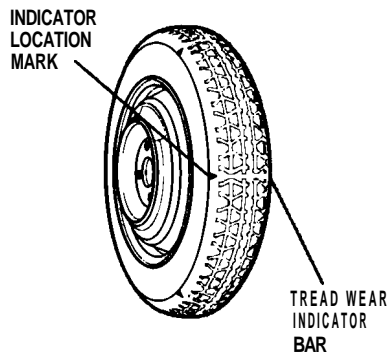

The compact spare tire has a shorter tread life than a regular tire. Replace it when you can see the tread wear indicator bars. The replacement should be the same size and design tire, mounted on the same wheel. The compact spare tire is not designed to be mounted on a regular wheel, and the compact wheel is not designed for mounting a regular tire.

If you have a flat tire while driving, stop in a safe place to change it. Stopping in traffic or on the shoulder of a busy road is dangerous. Drive slowly along the shoulder until you get to an exit or an area to stop that is far away from the traffic lanes.

The car can easily roll off the jack, seriously injuring anyone underneath.

Follow the directions for changing a tire exactly, and never get under the car when it is supported only by the jack.

1. Park the car on firm, level ground away from traffic. Turn on the hazard warning lights and turn the ignition to LOCK (0).

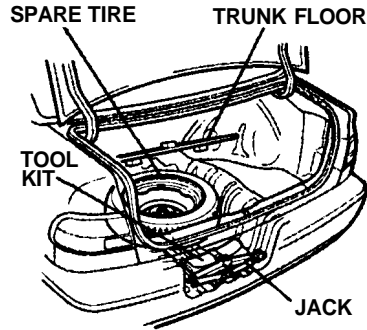

2. Put the transmission in Park (automatic) or Reverse (5-speed). Set the parking brake.
3. Open the trunk. Raise the trunk floor by lifting up on the back edge.
4. Take the tool kit out of the trunk.
5. Unscrew the wing bolt and take the spare tire out of the trunk.

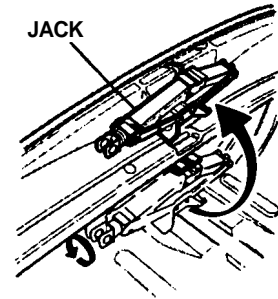

6. Turn the jack's end bracket counterclockwise to loosen it, then remove the jack.

continued

Changing a Flat Tire

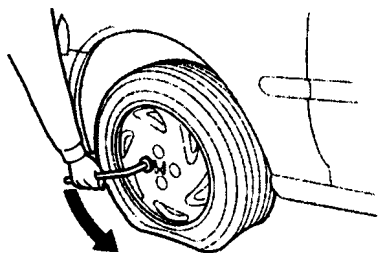

7. Loosen the four wheel nuts 1/2 turn with the wheel wrench.

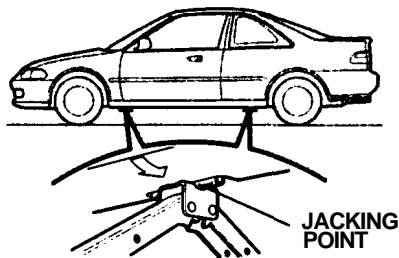

8. Locate the jacking point nearest the tire you need to change. It is pointed to by an arrow molded into the underside of the body. Place the jack under the jacking point. Turn the end bracket clockwise until the top of the jack contacts the jacking point. Make sure the jacking point tab is resting in the jack notch.

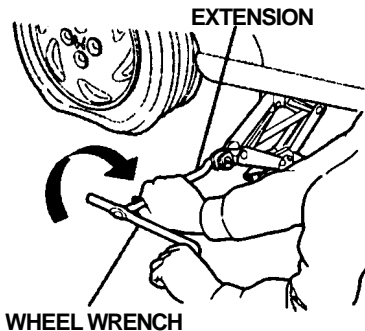

9. Use the extension and wheel wrench as shown to raise the car until the flat tire is off the ground.

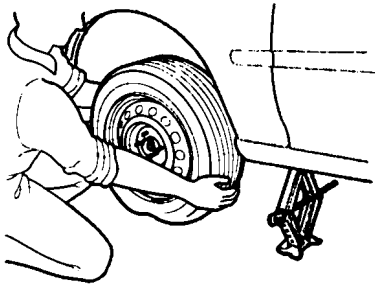

10. Remove the wheel nuts and flat tire. Temporarily place the flat tire on the ground.

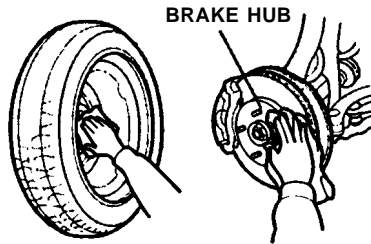

11. Before mounting the spare tire, wipe any dirt off the mounting surface of the wheel and hub with a cloth.

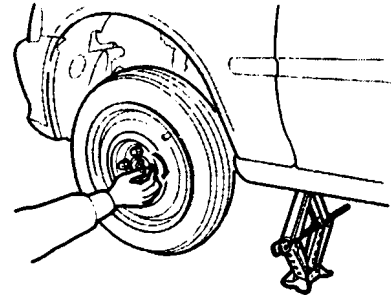

12. Put on the spare tire. Put the wheel nuts back on finger-tight, then tighten them in a crisscross pattern with the wheel wrench until the wheel is firmly against the hub. Do not try to tighten them fully.

continued

Changing a Flat Tire

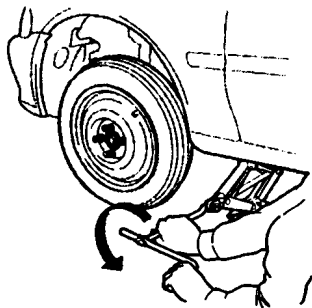

13. Lower the car to the ground and remove the jack.

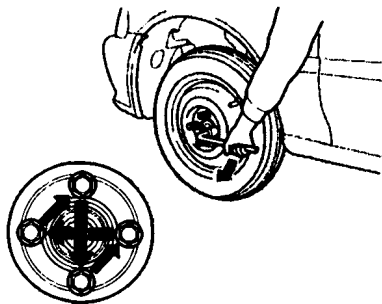

14. Tighten the wheel nuts securely in the same crisscross pattern. Have the wheel nut torque checked at the nearest automotive service facility. Tighten the wheel nuts to:
110 N.m (11 kg-m, 80 lb-ft).

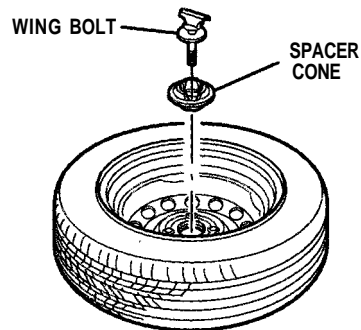

15. Remove the wheel cover or center cap. Place the flat tire face down in the trunk well.
16. Remove the spacer cone from the wing bolt, turn it over, and put it back on the bolt.
17. Secure the flat tire by screwing the wing bolt back into its hole.

18. Store the jack in the trunk with the end bracket on the right side. Turn the jack's end bracket to lock it in place. Store the tool kit.
19. Store the wheel cover or center cap in the trunk.

If Your Engine Won't Start

Diagnosing why your engine won't start falls into two areas, depending on what you hear when you turn the key to START (III):

- You hear nothing, or almost nothing. The engine's starter motor does not operate at all, or operates very slowly.
- You can hear the starter motor operating normally, but the engine does not start up and run.

Nothing Happens or the Starter Motor Operates Very Slowly

When you turn the ignition switch to START (III), you do not hear the normal noise of the engine trying to start. You may hear a clicking sound or series of clicks, or nothing at all. Check these things:

- Check the transmission interlock. If you have a 5-speed, the clutch pedal must be pushed all the way to the floor or the starter will not operate. With an automatic transmission, it must be in Park or Neutral.
- Turn the ignition switch to ON (II). Turn on the headlights and check their brightness. If the headlights are very dim or don't light at all, the battery is discharged. See Jump Starting on page [169](#).

- Turn the ignition switch to START (III). If the headlights do not dim, check the condition of the fuses. If the fuses are OK, there is probably something wrong with the electrical circuit for the ignition switch or starter motor. You will need a qualified technician to determine the problem. (See Towing on page [182](#).)

If the headlights dim noticeably or go out when you try to start the engine, either the battery is discharged or the connections are corroded. Check the condition of the battery and terminal connections (see page [134](#)). You can then try jump starting the car from a booster battery (see page [169](#)).

The Starter Operates Normally

In this case, the starter motor sounds normal when you turn the ignition switch to START (III), but the engine does not run.

- Are you using the proper starting procedure? Refer to Starting the Engine on page 93.
- Do you have gas? Turn the ignition switch to ON (II) for a minute and watch the fuel gauge.
- There may be an electrical problem, such as no power to the fuel pump. Check all the fuses (see page 177).

If you find nothing wrong, you will need a qualified technician to find the problem. See **Towing** on page 182.

Jump Starting

If your car's battery has run down, you may be able to start the engine by using a booster battery. Although this seems like a simple procedure, there are several precautions you should take. Follow the directions closely.

A battery can explode if you do not follow the correct procedure, seriously injuring anyone nearby.

Keep all sparks, open flames, and smoking materials away from the battery.

You cannot start a Honda with an automatic transmission by pushing or pulling it.

To jump start your car:

1. Open the hood and check the physical condition of the battery (see page 133). In very cold weather, check the condition of the electrolyte. If it seems slushy or like ice, do not try jump starting until it thaws.

NOTICE

If a battery sits in extreme cold, the electrolyte inside can freeze. Attempting to jump start with a frozen battery can cause it to rupture or explode.

2. Turn off all the electrical accessories: heater, A/C, stereo system, lights, etc. Put the transmission in Neutral or Park and set the parking brake.

continued

Jump Starting

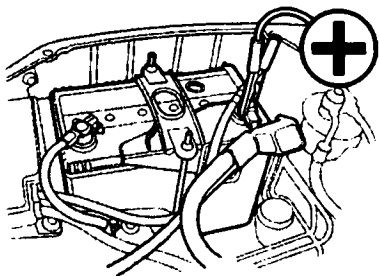

3. Connect one jumper cable to the positive (+) terminal on the booster battery. Connect the other end to the positive terminal on your Honda's battery.

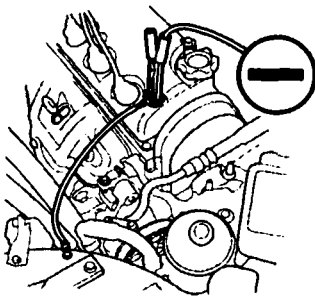

4. Connect the second jumper cable to the negative (-) terminal on the booster battery. Connect the other end to the grounding strap as shown. Do not connect this jumper cable to any other part of the engine.
5. If the booster battery is in another car, have an assistant start that car and run it at a fast idle.

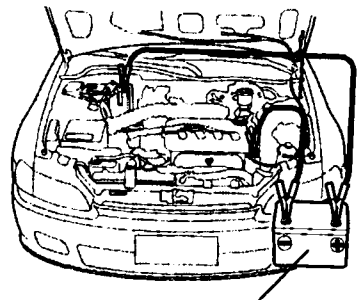

BOOSTER BATTERY

6. Start your car. If the starter motor still operates slowly, check the jumper cable connections to make sure they have good metal-to-metal contact.
7. Once your car is running, disconnect the negative cable from your car, then from the booster battery. Disconnect the positive cable from your car, then the booster battery.

The pointer of your car's temperature gauge should stay in the midrange under most conditions. It may go higher if you are driving up a long steep hill on a very hot day. If it climbs to the red mark, you should determine the reason.

NOTICE

Driving with the temperature gauge pointer at the red mark can cause serious damage to your engine.

Your car can overheat for several reasons, such as lack of coolant or a mechanical problem. The only indication may be the temperature gauge climbing to or above the red mark. Or you may see steam or spray coming from under the hood. In either case, you should take immediate action.

Steam and spray from an overheated engine can seriously scald you.

Do not open the hood if steam is coming out.

1. Safely pull to the side of the road. Put the transmission in Neutral or Park and set the parking brake. Turn off the climate control and all other accessories. Turn on the hazard warning indicators.
2. If you see steam and/or spray coming from under the hood, turn off the engine.
3. If you do not see steam or spray, leave the engine running and watch the temperature gauge. If the high

heat is due to overloading (climbing a long, steep hill on a hot day with the A/C running, for example), the engine should start to cool down almost immediately. If it does, wait until the temperature gauge comes down to the midpoint then continue driving.

4. If the temperature gauge stays at the red mark, turn off the engine.
5. Wait until you see no more sign: of steam or spray, then open the hood.

continued

If Your Engine Overheats

6. Look for any obvious coolant leaks, such as a split radiator hose. Everything is still extremely hot, so use caution. If you find a leak, it must be repaired before you continue driving (see **Towing** on page 182).

7. If you don't find an obvious leak, check the coolant level in the radiator reserve tank (see page 120). If the level is below the MIN mark, add coolant to half way between the MIN and MAX marks.

8. If there was no coolant in the reserve tank, you may also have to add coolant to the radiator.

Let the engine cool down until the pointer reaches the middle of the temperature gauge, or lower, before checking the radiator.

Removing the radiator cap while the engine is hot can cause the coolant to spray out, seriously scalding you.

Always let the engine and radiator cool down before removing the radiator cap.

9. Using gloves or a large heavy cloth, turn the radiator cap counterclockwise, without pushing down, to the first stop. This releases any remaining pressure in the cooling system. After the pressure releases, push down on the cap and turn it until it comes off.

10. Start the engine and set the heater control lever to maximum. Add coolant to the radiator up to the base of the fill neck. If you do not have

the proper coolant mixture available, you can add plain water. Remember to have the cooling system drained and refilled with the proper mixture as soon as you can.

11. Put the radiator cap back on tightly. Run the engine and watch the temperature gauge. If it goes back to the red mark, the engine needs repair. (See **Towing** on page 182.)

12. If the temperature stays normal, check the coolant level in the radiator reserve tank. If it has gone down, add coolant to the MAX mark. Put the cap back on tightly.

LOW OIL PRESSURE INDICATOR

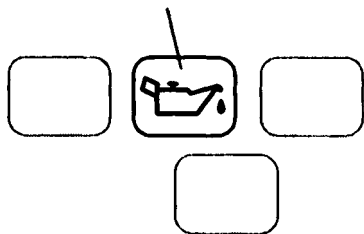

The low oil pressure indicator should never come on when the engine is running. If this indicator comes on with the engine running, take immediate action.

NOTICE

Running the engine with low oil pressure can cause serious mechanical damage almost immediately. Turn off the engine as soon as you can safely get the car stopped.

1. Safely pull off the road and shut off the engine.
2. Let the car sit for a minute. Open the hood and check the oil level (see page 115). Although oil level and oil pressure are not directly connected, an engine that is very low on oil can lose pressure during cornering and other driving maneuvers.
3. If necessary, add oil to bring the level back to the full mark on the dipstick (see page 115).
4. Start the engine and watch the oil pressure indicator. If the indicator does not go out within 10 seconds, turn off the engine. There is a mechanical problem that needs to be repaired before you can continue driving. (See **Towing** on page 182.)

Charging System Indicator

CHARGING SYSTEM INDICATOR

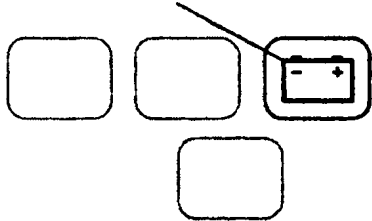

The charging system light should go out after the engine starts. If it comes on brightly with the engine running, the alternator is no longer charging the battery.

Immediately turn off all electrical accessories: radio, heater, A/C, rear defogger, cruise control, etc. Try not to use other electrically operated controls such as the power windows. Keep the engine running and take extra care not to stall it. Starting the engine will discharge the battery rapidly.

By eliminating as much of the electrical load as possible, you can drive several miles before the battery is too discharged to keep the engine running. Drive to a service station or garage where you can get technical assistance.

Malfunction Indicator Lamp, Check Engine Light

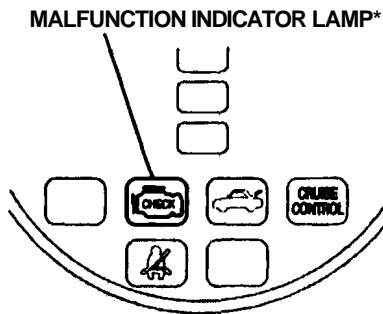

If this indicator comes on while driving, there is a problem with your engine or its emission control systems. Even though you may feel no difference in your car's performance, it can reduce your fuel economy and cause your car to put out excessive emissions. Continued operation may cause serious damage.

* The U.S. instrument panel is shown. Differences for the Canadian model are noted in the text.

If this indicator comes on safely pull off the road and turn off the engine. Restart the engine and watch the indicator. If it stays on, have your car checked by the dealer as soon as possible. Drive moderately until the dealer has inspected the problem. Avoid full-throttle acceleration and driving at high speed.

You should also have the dealer inspect your car if the indicator comes on frequently, even though it goes off when you follow the above procedure.

NOTICE

If you keep driving with the malfunction indicator lamp/check engine light on, you can damage your car's emission controls and engine. Those repairs may not be covered by your car's warranties.

Closing the Moonroof

If the electric motor will not close the moonroof, do the following:

1. Check the fuse for the moonroof motor (see page 177). If the fuse is blown, replace it with one of the same or lower rating.
2. Try closing the moonroof. If the new fuse blows immediately or the moonroof motor still does not operate, you can close the moonroof manually.
3. Get the tool kit out of the trunk.

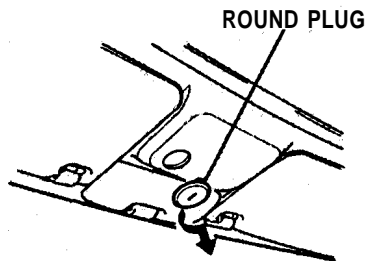

4. Use a screwdriver or coin to remove the round plug between the sun visors.

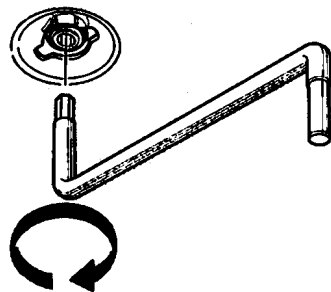

5. Insert the moonroof wrench into the socket behind this plug. Turn the wrench until the moonroof is fully closed.
6. Remove the wrench. Replace the round plug.

All the electrical circuits in your car have fuses to protect them from a short circuit or overload. These fuses are located in two or three fuse boxes.

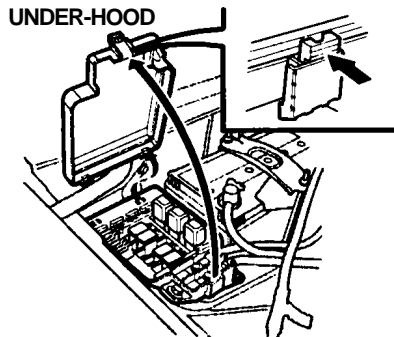

The under-hood fuse box is located in the engine compartment next to the battery. To open, push the tab as shown.

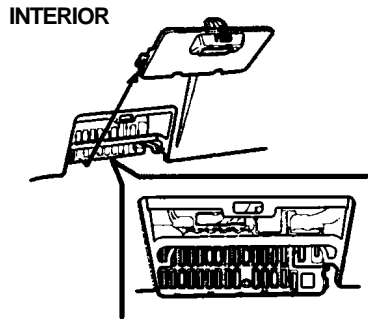

The interior fuse box is underneath the dashboard on the driver's side. Remove the fuse box lid by swinging the lid down and pulling it straight out of its hinges.

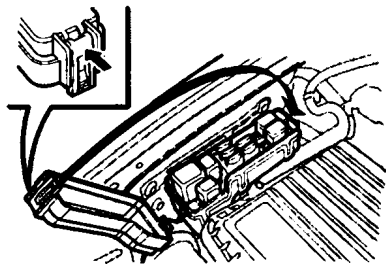

Cars equipped with ABS have a third fuse box for the ABS. It is in the front of the engine compartment on the passenger's side.

Checking and Replacing

If something electrical in your car stops working, the first thing you should check for is a blown fuse. Determine from the chart on the fuse box cover or inside the fuse box which fuse or fuses control that component. Check those fuses first, but check all the fuses before deciding that is not the cause. Replace any blown fuses and check the component's operation.

1. Turn the ignition switch to LOCK (0). Make sure the headlights and all other accessories are off.
2. Remove the cover from the fuse box.

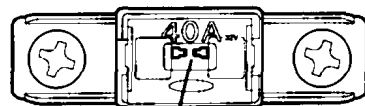

BLOWN

3. Check each of the large fuses in the underhood fuse box by looking through the top at the wire inside. Removing these fuses requires a Phillips® head screwdriver.

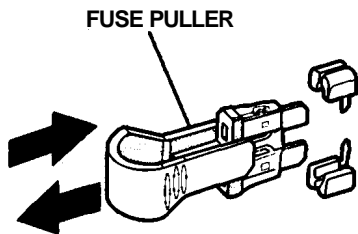

4. Check the smaller fuses in the under-hood fuse box and all the fuses in the interior fuse box by pulling out each fuse with the fuse puller provided in the interior fuse box.

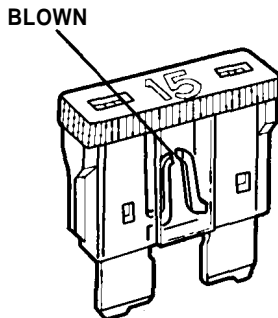

5. Look for a burned wire inside the fuse. If it is burned out, replace it with one of the spare fuses of the same rating or lower.

If you cannot drive the car without fixing the problem, and you do not have a spare fuse, take a fuse of the same rating or a lower rating from one of the other circuits. Make sure you can do without that circuit temporarily (such as the cigarette lighter or radio).

If you replace the burned out fuse with a spare fuse that has a lower rating, it might blow out again. This does not indicate anything wrong. Replace the fuse with one of the correct rating as soon as you can.

NOTICE

Replacing a fuse with one that has a higher rating greatly increases the chances of damaging the electrical system. If you do not have a replacement fuse with the proper rating for the circuit, install one with a lower rating.

6. If the replacement fuse of the same rating burns out in a short time, there is probably a serious electrical problem in your car. Leave the burned out fuse in that circuit and have your car checked by a qualified technician.

Fuses

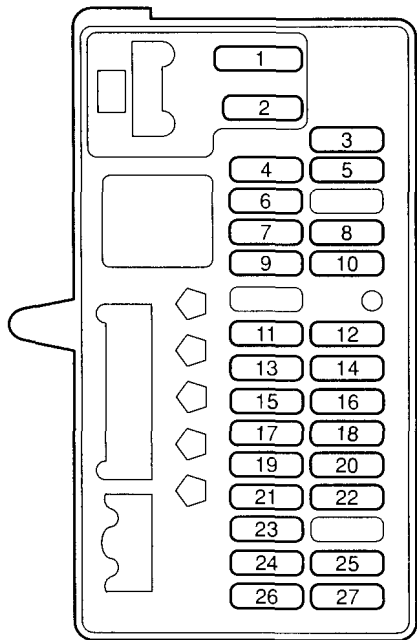

No.	Amps.	Circuits Protected
1	10A	S.R.S. *1
2	15A	ACG (S)
3	30A	Spare Fuse
4	20A	Spare Fuse
5	15A	Spare Fuse
6	15A	Radio, Cigarette Lighter
7	10A	Left Headlight Low Beam
8	10A	Left Headlight High Beam
9	10A	Right Headlight Low Beam
10	10A	Right Headlight High Beam
11	10A	Taillight, Instrument Panel Light, License Plate Light
12	20A	Front Left Power Window
13	7.5A	Starter Signal
14	20A	
15	10A	Daytime Running Light *2

No.	Amps.	Circuits Protected
16	20A	Power Door Lock
17	7.5A	Daytime Running Light *2
18	20A	Front Right Power Window
19	10A	Back-up Light
20	20A	
21	20A	Wiper, Washer, Power Window Relay, Moonroof Relay
22	7.5A	Interior Light
23	7.5A	Rear Defroster Relay, Heater Motor Relay, Cooling Fan Motor Relay
24	15A	ACG (S)*2
25	30A	Moonroof
26	10A	Spare Fuse
27	7.5A	Spare Fuse

*1 Optional for Canadian LX model

*2 On Canadian cars

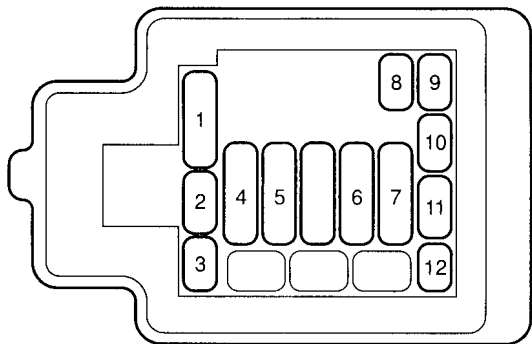

No.	Amps.	Circuits Protected
1	80A	Main Fuse Battery
2	20A	Stop, Horn
3	10A	Hazard
4	40A	Main Fuse Light
5	50A	Main Fuse Ignition
6	30A	Main Fuse Heater Motor
7	50A	Main Fuse Option
8	20A	Condenser Fan
9	15A	ECM
10	7.5A	Back Up
11	15A	Cooling Fan
12	30A	Main Fuse Rear Defroster

For cars equipped with ABS

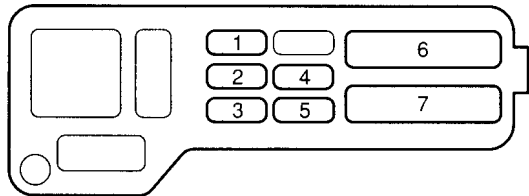

No.	Amps.	Circuits Protected
1	7.5A	ABS Clutch Monitor
2	7.5A	Motor Check
3	7.5A	ABS Clutch (Main)
4	15A	ABS + B2
5	20A	ABS + B1
6	50A	ABS Pump Motor
7	40A	ABS Clutch (Back up)

Towing

If your car needs to be towed, call a professional towing service or, if you belong to one, an organization that provides roadside assistance. Never tow your car behind another car with just a rope or chain. It is very dangerous.

Emergency Towing

There are three popular methods of towing a car:

Flat-Bed Equipment - The operator loads your car on the back of a truck. This is the best way of transporting your Honda.

Wheel Lift Equipment - The tow truck uses two pivoting arms that go under the tires (front or rear) and lift them off the ground. The other two wheels remain on the ground.

Sling-Type Equipment - The tow truck uses metal cables with hooks on the ends. These hooks go around parts of the frame or suspension and the cables lift that end of the car off the ground. Your car's suspension and body can be seriously damaged if this method of towing is attempted.

If your Honda cannot be transported by a flat-bed truck, it should be towed with the front wheels off the ground. If, due to damage, your car must be towed with the front wheels on the ground, do the following:

5-Speed Manual Transmission

- Release the parking brake.
- Shift the transmission to Neutral.

Automatic Transmission

- Release the parking brake.
- Start the engine.
- Shift to D4, then to N.
- Turn off the engine.

NOTICE

Improper towing preparation will damage the transmission. Follow the above procedure exactly. If you cannot shift the transmission or start the engine (automatic transmission), your car must be transported on a flat-bed.

- It is best to tow the car no farther than 50 miles (80 km), and keep the speed below 35 mph (55 km/h).

NOTICE

Trying to lift or tow your car by the bumpers will cause serious damage. The bumpers are not designed to support the car's weight.

The diagrams in this section give you the dimensions and capacities of your Honda and the locations of the identification numbers. The explanations of several electronic and mechanical systems on your Honda are for the more technically oriented owner.

Identification Numbers	184
Specifications	186
Anti-Lock Brake System	188
Supplemental Restraint System	189
Tire Information	190
Tire Size Designation	190
Wheel Size Designation ...	190
Tire Speed Ratings	190
Tire Pressure Adjustment for High Speed Driving ..	191
DOT Tire Quality Grading	
U.S. Cars	191
Traction	192
Temperature	192
Emission Controls	193
The Clean Air Act	193
Crankcase Emission Control System	193
Evaporative Emission Control System	193

Exhaust Emission Controls	194
PGM-FI System	194
Ignition Timing Control System	194
Three-Way Catalytic Converter	194
Replacement Parts	194
Three-Way Catalytic Converter	195

Identification Numbers

Your car has several identifying numbers located in various places.

The Vehicle Identification Number (VIN) is the 17-digit number your Honda dealer uses to register your car for warranty purposes. It is also necessary for licensing and insuring your car. The easiest place to find the VIN is on a plate fastened to the top of the dashboard. You can see it by looking through the windshield on the driver's side. It is also on the Certification label attached to the driver's doorjamb, and is stamped on the engine compartment bulkhead. The VIN is also provided in bar code on the Certification Label.

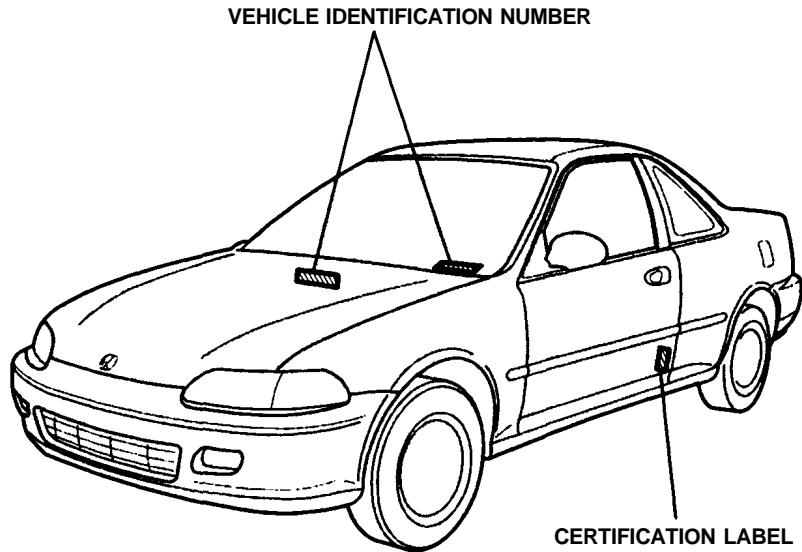

The Engine Number is stamped into the engine block.

The Transmission Number is on a label on top of the transmission.

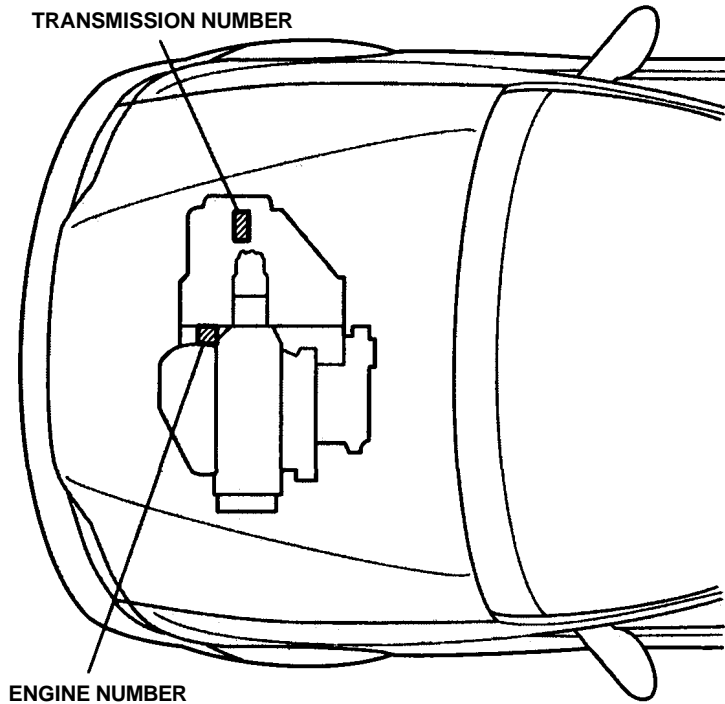

Specifications

Dimensions

Length	172.8 in (4,390 mm)	
Width	66.9 in (1,700 mm)	
Height	50.9 in (1,294 mm)	
Wheelbase	103.2 in (2,622 mm)	
Track	Front	58.1 in (1,475 mm)
	Rear	57.7 in (1,465 mm)

Weights

Gross vehicle weight rating	See the certification label attached to the driver's doorjamb.
-----------------------------	--

Engine

Type	Water cooled 4-stroke SOHC 4-cylinder gasoline engine
Bore x Stroke	2.95 x 3.33 in (75.0 x 84.5mm) *1 2.95 x 3.54 in (75.0 x 90.0mm) *2
Displacement	91.1 cu-in (1,493 cm ³) *1 97.0 cu-in (1,590 cm ³) *2
Compression ratio	9.2:1
Spark plugs	See spark plug maintenance section page 131.

*1 DX

*2 U.S.: EX, EX w/ABS option

Capacities

Fuel tank		Approx. 11.9 U.S. gal (45 ℓ, 9.9 Imp gal)
Radiator coolant	Change *1 5-Speed	0.95 U.S. gal (3.6 ℓ, 0.79 Imp gal)
	Automatic	0.92 U.S. gal (3.5 ℓ, 0.77 Imp gal)*2 1.00 U.S. gal (3.8 ℓ, 0.84 Imp gal)*3
	Total 5-Speed	1.19 U.S. gal (4.5 ℓ, 0.99 Imp gal)
	Automatic	1.16 U.S. gal (4.4 ℓ, 0.97 Imp gal)*2 1.24 U.S. gal (4.7 ℓ, 1.03 Imp gal)*3
Engine oil	Change *4 Incl. filter	3.5 U.S. qt (3.3 ℓ, 2.9 Imp qt)
	W/O filter	3.2 U.S. qt (3.0 ℓ, 2.6 Imp qt)
	Total	4.2 U.S. qt (4.0 ℓ, 3.5 Imp qt)
5-speed manual transmission oil	Change	1.9 U.S. qt (1.8 ℓ, 1.6 Imp qt)
	Total	2.0 U.S. qt (1.9 ℓ, 1.7 Imp qt)
Automatic transmission fluid	Change	2.9 U.S. qt (2.7 ℓ, 2.4 Imp qt)
	Total	6.1 U.S. qt (5.9 ℓ, 5.3 Imp qt)
Windshield washer reservoir	U.S. cars	2.6 U.S. qt (2.5 ℓ, 2.2 Imp qt)
	Canadian Cars	4.8 U.S. qt (4.5 ℓ, 4.0 Imp qt)

*1 Including the coolant in the reserve tank and that remaining in the engine. Reserve tank capacity: 0.4ℓ (0.11 U.S. gal, 0.09 Imp gal)

*2 DX

*3 U.S.: EX, EX w/ABS option, Canada: Si

*4 Excluding the oil remaining in the engine.

Specifications

Lights

Headlights (HI/LO)	12V – 60/55 W
Front turn signal/ side marker lights	12V – 43/3 CP (SAE 3497)
Rear turn signal lights	12V – 32CP (SAE1156)
Stop/Taillights	12V – 32/2CP (SAE 2057)
Rear side marker lights	12V – 3 CP (SAE 168)
Back-up lights	12V – 32 CP (SAE 1156)
High-mount brake light	12V – 45CP
License plate lights	12V – 8W
Interior light	12V – 8W
Trunk light	12V – 3.4W

Battery

Capacity	12V – 52AH/5HR
----------	----------------

Fuses

Interior	See the fuse label attached to the inside of the fuse box door under the dashboard.
Underhood	See the fuse box cover.

Alignment

Toe-in	Front	0.00 in (0.0 mm)
	Rear	0.08 in (2.0 mm)
Camber	Front	0°
	Rear	-0°20'
Caster	Front	1°10'

Tires

Size	Front/Rear	P175/70R13 82S *1 P185/60R14 82H *2
	Spare	T105/80D13 *1 T105/70D14 *2 T135/70D15 (For cars with ABS option)
Pressure	Front/Rear	32 psi (2.2 kg/cm ² , 220 kPa) *1 29 psi (2.0 kg/cm ² , 200 kPa) *2
	Spare	60 psi (4.15 kg/cm ² , 415 kPa)

Air Conditioning

Refrigerant Type	HFC-134a (R-134a)
Charge Quantity	17.6–19.4 oz. (500–550g)
Lubricant Type	SP10

*1 DX

*2 U.S.: EX,
Canada: Si

Anti-Lock Brake System

On U.S. EX with ABS option

The ABS works by measuring how fast the wheels are turning during braking and comparing their speed. If any wheel is rotating much slower than the others (on the verge of locking up and skidding), the system reduces hydraulic pressure to that wheel's brake caliper. When that wheel's speed matches the other wheels, the system applies normal hydraulic pressure. This can take place several times per second at each wheel. You feel the ABS working as rapid pulsations in the brake pedal.

Each wheel has a wheel speed sensor assembly. As the wheel rotates, the sensor sends electrical pulses to the ABS control unit. The pulse frequency varies with the wheel speed.

The electrical output of the ABS control unit is connected to the modulator/solenoid unit. During braking, the ABS control unit monitors the pulse frequencies from the four wheels. When the control unit detects a wheel locking up, it energizes the appropriate solenoid in the modulator/solenoid unit. There are three solenoids: one for each front wheel, and one for the rear wheels. The energized solenoid reduces hydraulic pressure to one side of a modulator valve. This, in turn, reduces hydraulic pressure in the brake line going to the affected wheel. When that wheel speeds up because of the reduced braking effort, the control unit de-energizes the solenoid. This builds hydraulic pressure on the modulator valve. The pressure increases in the hydraulic line to the wheel.

For the system to react quickly, the modulator/solenoid unit must have brake fluid under high pressure. This is supplied by a diaphragm-type accumulator that is pressurized by an electric pump. A pressure-sensing switch on the accumulator controls this pump.

The control unit also contains error detection circuitry. It monitors the operation of the wheel sensors, solenoids, pump, and electronics. If the control unit detects any faults, it shuts off power to the pump motor and solenoids. The light on the instrument panel comes on. The brakes then work like a conventional system without anti-lock capabilities.

The Honda Supplemental Restraint System (SRS) is standard on all Civic Coupes sold in the U.S. and Canada.

The SRS includes the steering wheel airbag assembly for the driver, a dashboard-mounted airbag assembly for the front seat passenger, and a control unit with sensors behind the center console.

The sensors are decelerometers, set to trigger in a severe frontal impact that generates more force than a 25 mile per hour crash into a parked vehicle of similar size. For the SRS to activate, both sensors must trigger. This duplication is to prevent accidental activation.

When the control unit receives trigger signals from both sensors, it sends voltage to the airbags. The control unit stores this charge in capacitors to ensure reliability even if a severe impact damages the car's battery or electrical connections.

The electrical charge sent to the airbag assembly ignites its propellant, which burns instantaneously. The gas produced by the burning propellant inflates the airbag instantly.

The airbags are vented so they stay inflated for only an instant and do not block the driver's vision. Smoke from the burned propellant comes out of the airbag and into the car's interior. This is normal and does not mean there is a fire. The airbags collapse onto the driver's and passenger's laps.

The airbags and control unit must be replaced after the system is activated. After use, your Honda dealer must check the complete Supplemental Restraint System and replace the airbag assemblies.

To ensure long-term reliability, the SRS uses gold-plated electrical connections throughout. Exposed components are sealed with epoxy. The control unit monitors the SRS circuitry whenever the ignition is ON (II). If the control unit senses any faults, it turns on the SRS indicator light on the instrument panel. Take the car to your Honda dealer to diagnose and repair the system as soon as possible.

The SRS needs no regular maintenance other than an inspection by your Honda dealer 10 years after manufacture.

Tire Information

Tire Size Designation

A tire's sidewall is marked with a tire size designation. You will need this information when selecting replacement tires for your car. The following explains what the letters and numbers in the tire size designation mean.

(Example tire size designation)
P175/65R1481H

P — Applicable vehicle type (tires marked with the prefix "P" are intended for use on passenger cars; however, not all tires have this marking).

175 — Tire width in millimeters.

65 — Aspect ratio. The tire's section height as a percentage of its width.

R — Tire construction code (Radial).

14 — Rim diameter in inches.

81 — Load Index, a numerical code associated with the maximum load the tire can carry.

H — Speed Rating Symbol. See the speed rating chart in this section for additional information.

Wheel Size Designation

Wheels are also marked with important information that you need if you ever have to replace one. The following explains what the letters and numbers in the wheel size designation mean.

(Example wheel size designation)
14 x 5J

14 — Rim diameter in inches.

5 — Rim width in inches.

J — Rim contour designation.

Tire Speed Ratings

The chart below shows many of the different speed ratings currently being used for passenger car tires. The speed rating symbol is part of the tire size designation on the sidewall of the tire. This symbol corresponds to that tire's designed maximum safe operating speed.

Speed Rating Symbol	Maximum Speed
S	112 mph (180 km/h)
T	118 mph (190 km/h)
H	130 mph (210 km/h)
V	149 mph (240 km/h)
Z	Above 149 mph (240 km/h)

Tire Pressure Adjustment for High Speed Driving

Honda strongly recommends that you not drive faster than posted speed limits and conditions allow. If you decide it is safe to drive at high speeds, be sure to adjust the cold tire pressures as shown below. If you do not adjust the tire pressure, excessive heat can build up and cause sudden tire failure.

DX

Tire Size	Cold Tire Pressure for Speeds Over 100 mph (160 km/h)
P175/70R13 82S	35 psi (240 kPa, 2.4 kg/cm ²)

U.S.: EX, Canada: Si

Tire Size	Cold Tire Pressure for Speeds Over 100 mph (160 km/h)
P185/60R14 82H	35 psi (240 kPa, 2.4 kg/cm ²)

Be sure to readjust the pressure for normal driving speeds. You should wait until the tires are cold before adjusting the tire pressure (see page 140).

DOT Tire Quality Grading (U.S. Cars)

The tires on your car meet all U.S. Federal Safety Requirements. All tires are also graded for treadwear, traction, and temperature performance according to Department of Transportation (DOT) standards. The following explains these gradings.

Treadwear

The treadwear grade is a comparative rating based on the wear rate of the tire when tested under controlled conditions on a specified government test course. For example, a tire graded 150 would wear one-and-one-half (1-1/2)

times as well on the government course as a tire graded 100. The relative performance of tires depends upon the actual conditions of their use, however, and may depart significantly from the norm due to variations in driving habits, service practices and differences in road characteristics and climate.

Tire Information

Traction

The traction grades, from highest to lowest, are A, B, and C, and they represent the tire's ability to stop on wet pavement as measured under controlled conditions on specified government test surfaces of asphalt and concrete. A tire marked C may have poor traction performance.

Warning: The traction grade assigned to this tire is based on braking (straight ahead) traction tests and does not include cornering (turning) traction.

Temperature

The temperature grades are A (the highest), B, and C, representing the tire's resistance to the generation of heat and its ability to dissipate heat when tested under controlled conditions on a specified indoor laboratory test wheel. Sustained high temperature can cause the material of the tire to degenerate and reduce tire life, and excessive temperature can lead to sudden tire failure. The grade C corresponds to a level of performance which all passenger car tires must meet under the Federal Motor Vehicle Safety Standard No. 109. Grades B and A represent higher levels of performance on the laboratory test wheel than the minimum required by law.

Warning: The temperature grade for this tire is established for a tire that is properly inflated and not overloaded. Excessive speed, underinflation, or excessive loading, either separately or in combination, can cause heat build-up and possible tire failure.

The burning of gasoline in your car's engine produces several by-products. Some of these are carbon monoxide (CO), oxides of nitrogen (NOx), and hydrocarbons (HC). Gasoline evaporating from the tank also produces hydrocarbons. Controlling the production of NOx, CO, and HC is important to the environment. Under certain conditions of sunlight and climate, NOx and HC react to form photochemical "smog." Carbon monoxide does not contribute to smog creation, but it is a poisonous gas.

The Clean Air Act

The Clean Air Act* sets standards for automobile emissions. It also requires that automobile manufacturers explain to owners how their emissions controls work and what to do to maintain them. This section summarizes how the emissions controls work. Scheduled maintenance is on page [108](#).

* In Canada, Honda vehicles comply with the Canadian Motor Vehicle Safety Standards (CMVSS) for Emissions valid at the time they are manufactured.

Crankcase Emission Control System

Your car has a Positive Crankcase Ventilation (PCV) System. This keeps gasses that build up in the engine's crankcase from going into the atmosphere. The PCV valve routes them from the crankcase back to the intake manifold. They are then drawn into the engine and burned.

Evaporative Emission Control System

As fuel evaporates in the fuel tank, an evaporative emission control canister filled with charcoal adsorb* the vapor. It is stored in this canister while the engine is off. After the engine is started and warmed up, the vapor is drawn into the engine and burned during driving.

Emissions Controls

Exhaust Emission Controls

The exhaust emission controls include three systems: PGM-FI, Ignition Timing Control, and Three-Way Catalytic Converter. These three systems work together to control the engine's combustion and minimize the amount of HC, CO, and NO_x that comes out the tailpipe. The exhaust emission control systems are separate from the crankcase and evaporative emission control systems.

PGM-FI System

The PGM-FI System uses a sequential multiport fuel injection. It has three sub-systems: Air Intake, Engine Control, and Fuel Control. The Engine Control Module (ECM) uses various sensors to determine how much air is going into the engine. It then controls how much fuel to inject under all operating conditions.

Ignition Timing Control System

This system constantly adjusts the ignition timing, reducing the amount of HC, CO and NO_x produced.

Three-Way Catalytic Converter

The Three-Way Catalytic Converter is in the exhaust system. Through chemical reactions, it converts HC, CO, and NO_x in the engine's exhaust to carbon dioxide (CO₂), dinitrogen (N₂), and water vapor.

Replacement Parts

The emissions control systems are designed and certified to work together in reducing emissions to levels that comply with the Clean Air Act. To make sure the emissions remain low, you should use only new Genuine Honda replacement parts or their equivalent for repairs. Using lower quality parts may increase the emissions from your car.

The emissions control systems are covered by warranties separate from the rest of your car. Read your warranty manual for more information.

The Three-Way Catalytic Converter contains precious metals that serve as catalysts, promoting chemical reactions to convert the exhaust gases without affecting the metals. The catalytic converter is referred to as a three-way catalyst, since it acts on HC, CO, and NOx. A replacement unit must be an original Honda part or its equivalent.

The Three-Way Catalytic Converter must operate at a high temperature for the chemical reactions to take place. It can set on fire any combustible materials that come near it. Park your car away from high grass, dry leaves, or other flammables.

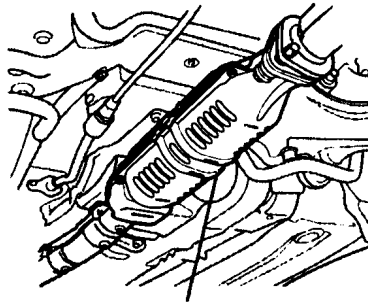

CATALYTIC CONVERTER

A defective catalytic converter contributes to air pollution, and can impair your engine's performance. Follow these guidelines to protect your car's catalytic converter.

- Always use unleaded gasoline. Even a small amount of leaded gasoline can contaminate the catalyst metals, making the converter ineffective.
- Keep the engine tuned-up.
- Have your car diagnosed and repaired if it is misfiring, back-firing, continuing to run after you turn off the engine, stalling, or otherwise not running properly.

Warranty Coverages	198
Customer Relations Information	199
Reporting Safety Defects	200
U.S. Zone Office Map	201
Canada Zone Office Map	202
Authorized Manuals	203

Warranty Coverages

U.S. Cars

Your new Honda is covered by these warranties:

New Car Limited Warranty —

Covers your new car, except for the battery, emissions control systems and accessories, against defects in materials and workmanship.

Emission Control Systems Defects Warranty and Emissions Performance Warranty —

These two warranties cover your car's emission control systems. Time, mileage, and coverage are conditional. Please read the warranty manual for exact information.

Original Equipment Battery Limited Warranty —

This warranty gives up to 100% credit toward a replacement battery.

Seat Belt Limited Warranty—

A seat belt that fails to function properly is covered for the useful life of the car.

Rust Perforation Limited Warranty—

All exterior body panels are covered for rust-through from the inside for the specified time period with no mileage limit.

Accessory Limited Warranty —

Genuine Honda Accessories are covered under this warranty. Time and mileage limits depend on the type of accessory and other factors. Please read your warranty manual for details.

Replacement Parts Limited Warranty—

Covers all Genuine Honda replacement parts against defects in materials and workmanship.

Replacement Battery Limited Warranty —

Provides prorated coverage for a replacement battery purchased from a Honda dealer.

Replacement Muffler Lifetime Limited Warranty —

Provides coverage for as long as the purchaser of the muffler owns the car.

Restrictions and exclusions apply to all these warranties. Please read the 1994 Honda Warranty booklet that came with your car for precise information on warranty coverages. Your Honda's original tires are covered by their manufacturer. Tire warranty information is in a separate booklet.

Canada Cars

Please refer to the 1994 Warranty and Maintenance Guide that came with your car.

Honda dealership personnel are trained professionals. They should be able to answer all your questions. If you encounter a problem that your dealership does not solve to your satisfaction, please discuss it with the dealership's management. The Service Manager or General Manager can help. Almost all problems are solved in this way.

If you are dissatisfied with the decision made by the dealership's management, contact your Honda Customer Relations Zone Office. Refer to the U.S. and Canada Zone Office maps on the following pages.

When you call or write, please give us this information:

- Vehicle Identification Number (see page [184](#)).
- Name and address of the dealer who services your car.
- Date of purchase.
- Mileage on your car.
- Your name, address, and telephone number.
- A detailed description of the problem.
- Name of the dealer who sold the car to you.

Reporting Safety Defects (U.S. Cars)

If you believe that your vehicle has a defect that could cause a crash or could cause injury or death, you should immediately inform the National Highway Traffic Safety Administration (NHTSA) in addition to notifying American Honda Motor Co., Inc.

If NHTSA receives similar complaints, it may open an investigation, and if it finds that a safety defect exists in a group of vehicles, it may order a recall and remedy campaign. However, NHTSA cannot become involved in individual problems between you, your dealer, or American Honda Motor Co., inc.

To contact NHTSA, you may either call the Auto Safety Hotline toll-free at (800) 424-9393 (or (202) 366-0123 in Washington D.C. area) or write to: NHTSA, U.S. Department of Transportation, Washington, D.C. 20590. You can also obtain other information about motor vehicle safety from the Hotline.

U.S. Zone Office Map

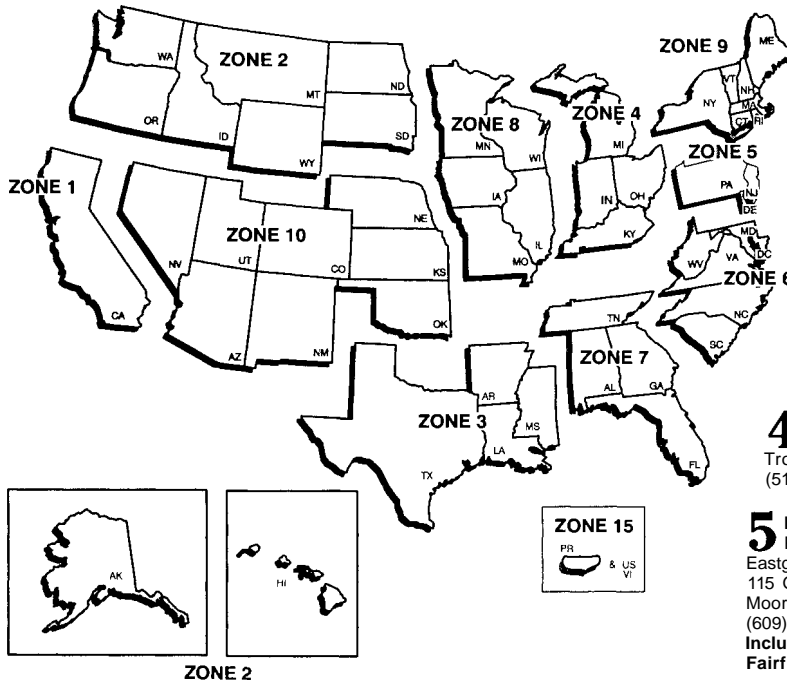

1 Western Zone
P.O. Box 2260
700 Van Ness Avenue
Torrance, California
90509-2260
(310)781-4565

2 Northwestern Zone
P.O. Box 20186
12439 N.E. Airport Way
Portland, Oregon 97220
(503) 256-0943
(also includes
Alaska and Hawaii)

3 South Central Zone
4529 Royal Lane
Irving, Texas 75063
(214)929-5481

4 Central Zone
101 South Stanfield Road
Troy, Ohio 45373
(513)332-6250

5 Northeastern Zone
P.O. Box 337
Eastgate Industrial Park
115 Gaither Drive
Moorestown, New Jersey 08057
(609) 235-5533
**Includes: NYC Metro area and
Fairfield County, CT area**

6 Mid-Atlantic Zone
902 Wind River Ln., Suite 200
Gaithersburg, Maryland 20878
(301) 990-2020

7 Southeastern Zone
1500 Morrison Parkway
Alpharetta, Georgia 30201
(404) 442-2045

8 North Central Zone
601 Campus Drive, Suite A-9
Arlington Heights, Illinois 60004
(708) 870-5600

9 New England Zone
555 Old County Road
Windsor Locks, Connecticut 06096
(203)623-3310
**See Zone 5 for: NYC Metro area
and Fairfield County, CT area**

10 West Central Zone
1600 South Abilene Street, Suite D
Aurora, Colorado 80012
(303) 696-3935

15 Puerto Rico and U.S. V.I.
Bella International
P.O. Box 190816
San Juan, PR 00919-0816
(809) 250-8070

The above addresses and telephone numbers are subject to change. If you cannot reach your Zone office, ask your Honda dealer for the current information.

Canada Zone Office Map



Western Zone
Honda Canada Inc.
13240 Worster Court
Richmond, B.C.
V6V 2B8
(604) 278-7121

Quebec Zone
Honda Canada Inc.
1750 rue Eiffel
Boucherville, Quebec
J4B 7W1
(514)655-6161

Central Zone
Honda Canada Inc.
126 Milner Avenue
Scarborough, Ontario
M1S 3R2
(416) 299-3400

Atlantic Zone
Honda Canada Inc.
800 Windmill Road
Dartmouth, N.S.
B3B 1L1
(902)468-4416

A

- ABS. *See* Anti-Lock Brakes
- Accessories, Installation 89
- ACCESSORY
 - (Ignition Key Position) 46
- Adding
 - Automatic Transmission
 - Fluid 125
 - Brake Fluid 127
 - Clutch Fluid 128
 - Engine Oil 115
 - Manual Transmission
 - Fluid 126
 - Power Steering Fluid 129
 - Radiator Coolant 120
 - Windshield Washer Fluid .. 124
- Additional Safety
 - Information 16
 - Door Locks 16
 - Driving With Pets 17
 - Seat-Back Position 16
 - Storing Cargo Safely 17
- Additives, Engine Oil 117
- Adjustments
 - Mirrors 38, 53
 - Seats 49
 - Steering Wheel 36, 41
- Air Cleaner Element 130
- Air Conditioning
 - Maintenance 138
 - Usage 66
- Air Filter. *See* Air Cleaner Element
- Air Outlets (Vents) 62
- Air Pressure, Tires 187, XIII
- Airbag (SRS) 12
- Alcohol and Drugs 24
- Alcohol in Gasoline 82
- Alternator Belt. *See* Engine Belts
- Anchor Plate, Child Seat 23
- Anti-Lock Brakes
 - Description 188
 - Indicator Light 32, 103
 - Operation 103
- Anti-Theft Steering
 - Column Lock 46
- Antifreeze 120
- Appearance Care 153
- Ashtrays 58
- Audio System 69
- Automatic Cruise Control 42
- Automatic Transmission 97
 - Capacity, Fluid 186
 - Checking Fluid Level 125
 - Shift Lever Position
 - Indicator 33
 - Shift Lever Positions 97
 - Shift Lock Release 100
 - Shifting 98

Index

B

Battery	133
Charging System	
Indicator	31
Jump Starting	169
Maintenance	133
Specifications	187
Before Driving	81
Belts, Seat	4
Beverage Holder	57
Body Repair	159
Brakes	
Anti-Lock Brake System	103
Break-in	82
Fluid	127
Light, Burned out	145
Parking	55
System Indicator	31
Wear Indicators	101
Braking System	102
Break-in, New Car	82

Brightness Control	
Instruments	38
Brights, Headlights	37
Bulb Replacement	
Back-up Lights	147
Brake Lights	147, 148
Front Parking Lights	146
Front Side Marker Lights	146
Headlights	145
High-Mount Brake Light	149
License Plate Lights	149
Rear Side Marker Lights	147
Specifications	187
Turn Signal Lights	146
Bulbs, Halogen	145

C

Cables, Jump Starting With	169
Capacities Chart	186
Carbon Monoxide Hazard	25
Cargo, Loading	90

Cassette Player	
Care	75
Operation	73
Catalytic Converter,	
Three-Way	195
CAUTION, Explanation of <i>Preface ii</i>	
Certification Label	184
Chains, Tire	144
Change Oil	
How to	118
When	109
Changing a Flat Tire	163
Changing Engine Coolant	121
Charging System Indicator	31
Charging System Light	174
Check Engine Light	
(Canada)	32

Checking		Cigarette Lighter	58	Instrument Panel	
Automatic Transmission		CLEAN light	75	Brightness	38
Fluid	125	Cleaner, Air	130	Rear Window Defogger	40
Battery Condition	133	Cleaning		Steering Wheel	
Brake Fluid	127	Exterior	154	Adjustment	41
Clutch Fluid	127	Interior	157	Turn Signals	38
Engine Belts	139	Seat Belts	157	Windshield Washers	39
Engine Coolant	120	Vinyl	157	Windshield Wipers	39
Engine Oil	115	Clock, Setting the	56	Controls, Instruments and	27
Fuses	178	Clutch Fluid	128	Coolant	
Manual Transmission		CO in the Exhaust	194	Adding	120
Fluid	126	Cold Weather, Starting in	94	Capacity	186
Power Steering Fluid	129	Compact Spare	162	Checking	120
Radiator Coolant	120	Consumer Information	199	Proper Solution	120
Tire Pressure	139	Control Locations	28	Temperature Gauge	35
Windshield Wipers	136	Controls Near the Steering		Corrosion Protection	158
Checklist, Before Driving	92	Wheel	36	Crankcase Emission Control	
Child Safety	18	Daytime Running Lights	37	System	193
Guidlines for Restraining		Hazard Warning	40	Cruise Control Operation	42
Infants/Children	19	Headlights	37	Cup Holder. See Beverage Holder	
Important Safety				Customer Relations	
Reminders	19			Information*	199
Where Should					
Children Sit	18				

Index

Customer Relations Office* .. 199

D

DANGER, Explanation of *Preface ii*

Dashboard 28

Daytime Running Lights 37

Dead Battery, What to Do 169

Defects, Reporting Safety 200

Defogger, Rear Window 40

Defrosting the Windows 68

DEXRON II Automatic

 Transmission Fluid 125

Dimensions 186

Dimming the Headlights 37

Dipstick

 Automatic Transmission .. 125

 Engine Oil 115

Directional Signals 33

Disabled, Towing Your Car If . 182

Disc Brake Wear Indicators .. 101

Disposal of Used Oil 119

Doors

 Locking and Unlocking 47

 Power Door Locks 47

DOT Tire Quality Grading 191

Downshifting, 5-Speed Manual

 Transmission 95

Driving

 Fuel Economy 88

 In Bad Weather 104

 In Foreign Countries 83

E

Economy, Fuel 88

Emergencies on the Road 161

 Battery, Jump Starting 169

 Changing a Flat Tire 163

Charging System

 Indicator 31

Check Engine Light

 (Canada) 32

Checking the Fuses 178

Malfunction Indicator Lamp

 (U.S.) 32

Manually Closing

 Moonroof 176

Oil Pressure Indicator 31

Overheated Engine 171

Emergency Brake 55

Emergency Flashers 33

Emissions Control 193

Engine

 Belts 139

 Check Light(Canada) 32

 Coolant Temperature

 Gauge 35

 Identification Number 185

 Malfunction Indicator Lamp

 (U.S.) 32

Oil	
Capacity	186, XIII
What Kind to Use	XIII
Oil Pressure Indicator	31
Overheating	172
Specifications	186
Ethanol in Gasoline	83
Evaporative Emission	
Controls	193
Exhaust Fumes	25
Expectant Mothers	
Use of Seat Belts by	10
Exterior, Cleaning the	154

F

Fabric, Cleaning	157
Fan, Interior	64
Features, Comfort and Convenience	61
Filling the Fuel Tank	84

Filters	
Air. See Air Cleaner Element	
Fuel	131
Oil	117
First Gear, Shifting	96
5-Speed Manual Transmission	
Checking Fluid Level	126
Shifting the	95, 96
Flashers, Hazard Warning	33
Flat Tire, Changing a	163
Fluids	
5-Speed Manual Transmission	126, XIII
Capacity	186
Automatic Transmission	125, XIII
Capacity	186, XIII
Brake	127
Clutch	128
Power Steering	129
Windshield Washer	124
Capacity	186

FM Stereo Radio Reception	69
Folding Rear Seat	50
Foreign Countries, Driving in	83
Four-Way Flashers	40
Front End, Towing by Emergency Wrecker	182
Fuel	
Fill Door and Cap	84
Filling the Fuel Tank	84
Filter	131
Gauge	35
Octane Requirement	82
Oxygenated	82
Tank, Capacity	186, XIII
Fuses, Checking the	178

G

Gas Mileage, Improving	88
Gas Station Procedures	84
Gasohol	82

Index

Gasoline	82, XIII
See also Fuel	
Filter	131
Gauge	35
Octane Requirement	XIII
Tank, Filling the	84
Gauges	
Engine Coolant Temperature	35
Fuel	35
Gearshift Lever Positions	
5-Speed Transmission	96
Automatic Transmission ..	97
Glass Cleaning	158
Glove Box	55

H

Halogen Headlight Bulbs	145
Hazard Warning Flashers	40
Headlights	37
Daytime Running Lights	37

High Beam Indicator	33
High Beams	37
Low Beams	37
Replacing Halogen Bulbs ..	145
Turning on	37
Heating and Cooling	62
High Altitude, Starting at	94
High-Low Beam Switch	33
Hood, Opening the	85
Horn	45
Hot Coolant, Warning About..	120
Hydroplaning	105

I

Identification Number Vehicle	184
If Your Car Has to Be Towed	182
Ignition Keys	45

Switch	46
Timing Control System	194
Indicator Lights, Instrument Panel	29
Infant Restraint	20
Inflation, Proper Tire	140
Inside Mirror	53
Inspection, Tire	139
Instrument Panel	28
Instrument Panel Brightness ..	38
Interior Cleaning	157
Interior Light	59
Introduction	<i>Preface i</i>

J

Jack, Tire	163
Jacking up the Car	164
Jump Starting	169

K

Keys 45

L

Label, Certification 184

Labels, Safety, Location of 26

Lane Change, Signaling 38

Lap Belt..... 9

Lap/Shoulder Belts 7

Leaking of Exhaust Into Car ... 25

Lighter, Cigarette 58

Lights

Bulb Replacement 145

Indicator 29

Parking 37

Turn Signal 38

Loading Cargo 90

LOCK (Ignition Key Position) .. 46

Locking Clip, Seat Belt 22

Locks

Anti-Theft Steering

Column 46

Fuel Filler Door..... 84

Power Door 47

Trunk 48

Low Coolant Level 120

Lower Gear

Downshifting to a 95

Lubricant Specifications

Chart 186

Luggage, Loading..... 90

M

Maintenance 107

Periodic Items 113

Record 111-112

Schedule 109-110

Malfunction Indicator Lamp

(U.S.)..... 32

Manually Closing Moonroof .. 176

Maximum Shift Speeds 96

Meters, Gauges 34

Methanol in Gasoline 83

Mirror, Vanity..... 57

Mirrors, Adjusting the 53

Moonroof

Closing Manually 176

Operation 52

N

Neutral Gear Position 98

New Vehicle Break-in 82

Normal Shift Speeds 96

NOTICE, Explanation of . *Preface ii*

Numbers, Identification 184

Index

O

- Occupant Protection System ... 4
- Octane Requirement
 - Gasoline 82, XIII
- Odometer 34
- Odometer, Trip 34
- Oil
 - Change, How to 118
 - Change, When to 109
 - Checking Engine 115
 - Pressure Indicator 31
 - Selecting Proper Viscosity
 - Chart 117
- ON (Ignition Key Position) 46
- Opening the Hood 85
- Opening the Trunk 48
- Outside Mirrors 53
- Overheating, Engine 171

P

- Panel Brightness Control 38
- Park Gear Position 98
- Parking Brake 55
- Parking Brake and Brake System
 - Light 31
- Parking Lights 37
- Parking Over Things
 - That Burn 195
- PGM-FI System 194
- Polishing and Waxing 155
- Power
 - Door Locks 47
 - Mirrors 54
 - Steering 129
 - Windows 51
- Power Steering Belt. See Engine Belts
- Pregnancy, Using Seat Belts ... 10
- Proper Seat Belt Usage 7

R

- Radiator Overheating 171
- Radio/Cassette Sound
 - System 69
- Rear End Towing 182
- Rear Lights
 - Bulb Replacement 147
- Rear Seat, Folding 50
- Rear View Mirror 53
- Rear Window Defogger 40
- Reclining the Seat-Backs 16
- Recommended Shift Speeds ... 96
- Replacement Information
 - Air Cleaner Element 130
 - Coolant 121
 - Engine Oil and Filter 117
 - Fuel Filter 131
 - Fuses 178
 - Light Bulbs 145
 - Schedule 109-110

Spark Plugs	131
Tires	142, XIII
Wiper Blades	136
Replacing Seat Belts	
After a Crash	10
Reporting Safety Defects*	200
Reserve Tank, Coolant	120
Restraint, Child	18
Reverse Gear Position	98
Rotation, Tire	142

S

Safety Belts	4
Safety Defects, Reporting* . . .	200
Safety Labels, Location of	26
Safety Messages	<i>Preface ii</i>

Seat Belts	
Advice for Pregnant	
Women	10
Child Seat Anchor Plate	23
Cleaning	157
Frayed or Torn	10
Locking Clip	22
Maintenance	10
Reminder Light	30
Replacement	10
System Components	6
Tether Attachment Points . .	22
Use During Pregnancy	10
Wearing a Lap/Shoulder Belt .	7
Wearing the Lap Belt	9
Seats, Adjusting the	49
Serial Number	184
Service Intervals	109
Service Manual	203
Service Station Procedures . . .	84
Setting the Clock	56

Shift Lever Position	
Indicator	33, 97
Shifting	
The 5-Speed Transmission . .	95
The Automatic	
Transmission	97, 98
Side Marker Lights	
Bulb Replacement in	146
Signaling Turns	38
Snow Chains	144
Snow Tires	144
Solvent-Type Cleaners	154
Sound System	69
Spare Tire	
Inflating	162
Inflating (Pressure)	XIII
Specifications	187, XIII
Spark Plugs	
Replacing	131
Specifications	133
Specifications Charts	186

Index

Speed Control	42
Speedometer	34
S R S	11
START	
(Ignition Key Position)	46
Starting the Engine	93
In Cold Weather at High Altitude	94
With a Dead Battery	169
Steam Coming From Engine ..	171
Steering Wheel	
Adjustment	41
Anti-Theft Column Lock	46
Steering Wheel Controls	
Cruise Control	42
Stereo Sound System	69
Storing Your Car	151
Sunshade (Moonroof)	53
Supplemental Restraint System	11

Service Precautions	15
Servicing	15
SRS Indicator	14, 32
System Components	11
Technical Description	189

T

Tachometer	34
Taillights	
Changing Bulbs in	147
Taking Care of the Unexpected	161
Tape Player	73
Technical Descriptions	
Anti-Lock Brake System ...	188
Emission Control Systems ..	193
Supplemental Restraint System	189
Three-Way Catalytic Converter	195
Tire Information	191

Temperature Gauge	35
Tether Attachment Points	22
Time, Setting the	56
Tire, How to Change a Flat ...	163
Tire Chains	144
Tires	139
See <i>also</i> label in glove box	
Air Pressure	187, XIII
Checking Wear	141
Compact Spare	162
DOT Tire Quality Grading ..	191
Inflation	139, XIII
Inspection	141
Replacing	142, XIII
Rotating	142
Snow	144
Specifications	186, XIII
Tools, Tire Changing	163
Torn Seat Belts	10
Towing	
A Trailer	105

Emergency Wrecker (Tow Truck)	182
Transmission	
Checking Fluid Level	
5-Speed Manual	
Transmission	126
Automatic	
Transmission	125
Fluid Selection	125
Identification Number	185
Shifting the	
5-Speed Manual	95
Shifting the Automatic	97
Treadwear	191
Trip Meter	34
Trunk-Open Indicator Light ...	32
Turn Signals	38

U

Underside, Cleaning	154
---------------------------	-----

Unexpected	
Taking Care of the	161
Uniform Tire Quality	
Grading	191
Unleaded Gasoline	82
Upholstery Cleaning	157
Used Oil	
How to Dispose of	119

V

Vanity Mirror	57
Vehicle Capacity Load	90
Vehicle Dimensions	186
Vehicle Identification	
Number	184
Vehicle Storage	151
Ventilation	65
VIN	184
Vinyl Cleaning	157

Viscosity, Oil	116
----------------------	-----

W

Warning BEEPERS	
Key in Ignition	46
Seat Belts	30
WARNING, Explanation of <i>Preface</i> <i>ii</i>	
Warning Labels, Location of ...	26
Warranty Coverages* ...	197, 198
Washer, Windshield	
Checking the Fluid Level ..	124
Checking the Fluid	
Capacity	186
Operation	39
Washing	154
Waxing and Polishing	155
Wheels	
Adjusting the Steering	41
Alignment and Balance	141
Compact Spare	162



Index

Wrench	164
Windows	
Cleaning	158
Operating the Power.	51
Rear, Defogger.	40
Windshield	
Cleaning	39
Defroster.	68
Wipers, Windshield	
Changing Blades.	136
Operation.	39
Worn Tires.	141
Wrecker	
Emergency Towing	182

*U.S. and Canada only

Gasoline

UNLEADED gasoline
Pump octane of 86 or higher

Fuel Tank Capacity

11.9 U.S. gal (45 l, 9.9 Imp gal)

Recommended Engine Oil

API SG or SH grade
"Energy Conserving II" oil
SAE 5W-30 viscosity

Engine Oil Capacity

including filter

3.5 U.S. qt (3.3 l, 2.9 Imp qt)

without filter

3.2 U.S. qt (3.0 l, 2.6 Imp qt)

Tire Pressure (measured cold):

DX: 32 psi (2.2 kg/cm², 220 kPa)

U.S.: EX, Canada: Si
29 psi (2.0 kg/cm², 200 kPa)

Spare Tire Pressure

60 psi (4.15 kg/cm², 415 kPa)

Tire Size (Front and Rear):

DX: P175/70R13 82S

U.S.: EX, Canada: Si
P185/60R14 82H

Spare Tire:

DX:T105/80D13

U.S.: EX, Canada: Si
T105/70D14

U.S.: EX with ABS option
T135/70 D 15

Other Tire Size Information

See label in the glove box.

5 Speed Manual Transmission Oil:

SAE 10W-30 or 10W-40 viscosity
API SF or SG grade recommended

Capacity:

1.9 U.S. qt (1.8 l, 1.6 Imp qt)

Automatic Transmission Fluid:

Honda Premium Formula
Automatic Transmission Fluid or
an equivalent DEXTRON® II type
Automatic Transmission Fluid
(ATF)

Capacity:

2.9 U.S. qt (2.7 l, 2.4 Imp qt)