

Congratulations! Your selection of a 2011 Honda Pilot was a wise investment. It will give you years of driving pleasure.

One of the best ways to enhance the enjoyment of your new vehicle is to read this manual. In it, you will learn how to operate its driving controls and convenience items. Afterwards, keep this owner's manual in your vehicle so you can refer to it at any time.

Several warranties protect your new vehicle. Read the warranty booklet thoroughly so you understand the coverages and are aware of your rights and responsibilities.

Maintaining your vehicle according to the maintenance information shown in the instrument panel helps to keep your driving trouble-free while it preserves your investment. When your vehicle needs maintenance, keep in mind that your dealer's staff is specially trained in servicing the many systems unique to your vehicle. Your dealer is dedicated to your satisfaction and will be pleased to answer any questions and concerns.

As you read this manual, you will find information that is preceded by a **NOTICE** symbol. This information is intended to help you avoid damage to your vehicle, other property, or the environment.

Introduction

California Proposition 65 Warning

WARNING: This product contains or emits chemicals known to the State of California to cause cancer and birth defects or other reproductive harm.

Event Data Recorders

This vehicle is equipped with one or more devices commonly referred to as event data recorders. These devices record front seat belt use, front passenger seat occupancy, airbag deployment data, and the failure of any airbag system component. This data belongs to the vehicle owner and may not be accessed by anyone else except as legally required or with the permission of the vehicle owner.

Service Diagnostic Recorders

This vehicle is equipped with service-related devices that record information about powertrain performance. The data can be used to verify emissions law requirements and/or help technicians diagnose and solve service problems. It may also be combined with data from other sources for research purposes, but it remains confidential.

Your safety, and the safety of others, is very important. And operating this vehicle safely is an important responsibility.

To help you make informed decisions about safety, we have provided operating procedures and other information on labels and in this manual. This information alerts you to potential hazards that could hurt you or others.

Of course, it is not practical or possible to warn you about all the hazards associated with operating or maintaining your vehicle. You must use your own good judgement.

You will find this important safety information in a variety of forms, including:

- **Safety Labels** — on the vehicle.
- **Safety Messages** — preceded by a safety alert symbol  and one of three signal words: **DANGER**, **WARNING**, or **CAUTION**.

These signal words mean:

 **DANGER**

You **WILL** be **KILLED** or **SERIOUSLY HURT** if you don't follow instructions.

 **WARNING**

You **CAN** be **KILLED** or **SERIOUSLY HURT** if you don't follow instructions.

 **CAUTION**

You **CAN** be **HURT** if you don't follow instructions.

- **Safety Headings** — such as Important Safety Reminders or Important Safety Precautions.
- **Safety Section** — such as Driver and Passenger Safety.
- **Instructions** — how to use this vehicle correctly and safely.

This entire book is filled with important safety information — please read it carefully.

Important Handling Information

Your Pilot has higher ground clearance than a passenger vehicle designed for use only on pavement. Higher ground clearance has many advantages for off-highway driving. It allows you to travel over bumps, obstacles, and rough terrain. It also provides good visibility so you can anticipate problems earlier.

These advantages come at some cost. Because your vehicle is taller and rides higher off the ground, it has a high center of gravity. This means your vehicle can tip or roll over if you make abrupt turns. Utility vehicles have a significantly higher rollover rate than other types of vehicles. In a rollover crash, an unbelted person is significantly more likely to die than a person wearing a seat belt. As a reminder, make sure you and your passengers always wear seat belts.

For information on how to reduce the risk of rollover, read “Driving Guidelines” on page [410](#) of this manual and the *Off-Highway Driving Guidelines* section on page [449](#). Failure to operate your vehicle correctly might result in loss of control, a crash, or rollover.

Owner's Identification Form

Your Vehicle at a Glance (main controls)	3
Driver and Passenger Safety (seat belts, SRS, and child protection)	5
Instruments and Controls (indicators, gauges, multi-information display, dashboard, and steering column)	65
Features (climate control, audio, steering wheel, rear entertainment, security, cruise control, and HomeLink®) ...	191
Before Driving (fuel, vehicle break-in, and cargo loading)	393
Driving (engine and transmission operation).....	409
Maintenance (information, fluid checking, minor services, and vehicle storage).....	453
Taking Care of the Unexpected (flat tire, jump starting, overheating, and fuses)	507
Technical Information (vehicle specifications, tires, and emissions controls).....	535
Warranty and Customer Relations (U.S. and Canada only) (warranty and contact information).....	553
Authorized Manuals (U.S. only) (how to order)	557
Index	I
Service Information Summary (fluid capacities and tire pressures)	

Overview of Contents

Contents

A convenient reference to the sections in this manual.

Your Vehicle at a Glance

A quick reference to the main controls in your vehicle.

Driver and Passenger Safety

Important information about the proper use and care of your vehicle's seat belts, an overview of the supplemental restraint system, and valuable information on how to protect children with child restraints.

Instruments and Controls

Explains the purpose of each instrument panel indicator and gauge, and how to use the controls on the dashboard and steering column.

Features

How to operate the climate control system, the audio system, rear entertainment system, and other convenience features.

Before Driving

What gasoline to use, how to break-in your new vehicle, and how to load luggage and other cargo.

Driving

The proper way to start the engine, shift the transmission, and park; plus what you need to know if you're planning to tow a trailer.

Maintenance

The maintenance information shows you when you need to take your vehicle to the dealer for maintenance service. There is also a list of things to check and instructions on how to check them.

Taking Care of the Unexpected

This section covers several problems motorists sometimes experience, and details how to handle them.

Technical Information

ID numbers, dimensions, capacities, and technical information.

Warranty and Customer Relations

(U.S. and Canada only)

A summary of the warranties covering your new vehicle, and how to contact us for any reason. Refer to your warranty manual for detailed information.

Authorized Manuals

(U.S. only)

How to order manuals and other technical literature.

Index

Service Information Summary

A summary of the information you need when you pull up to the fuel pump.

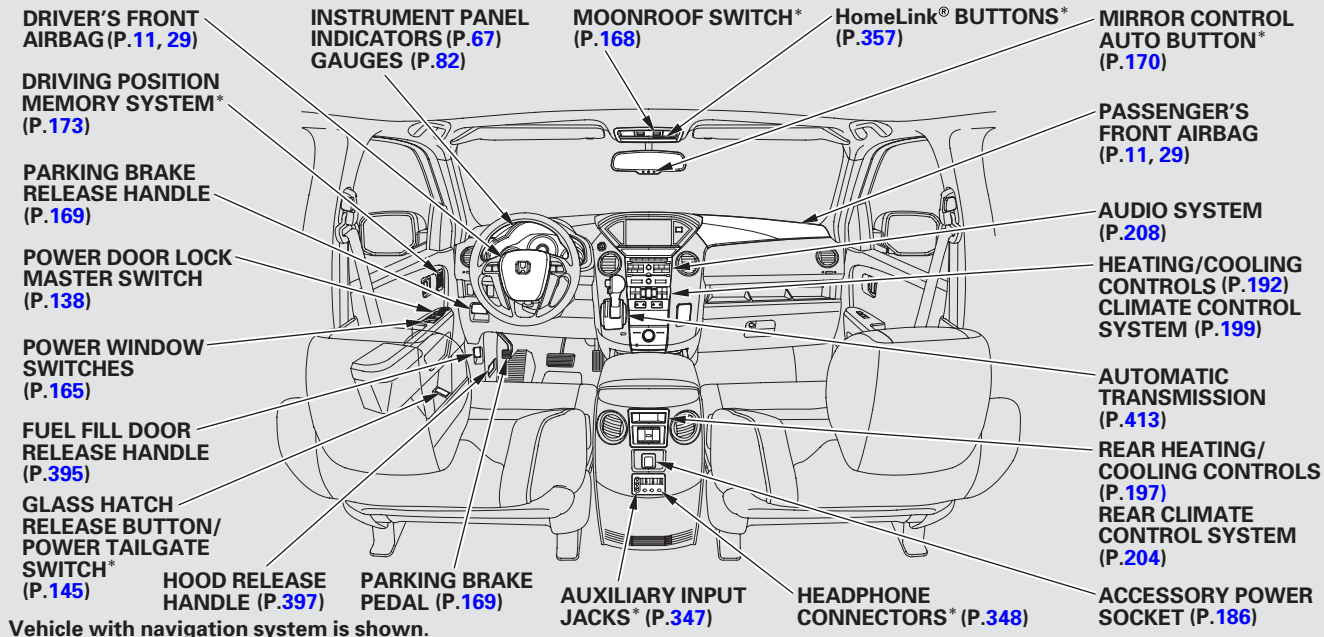

*: If equipped

CONTINUED

Your Vehicle at a Glance

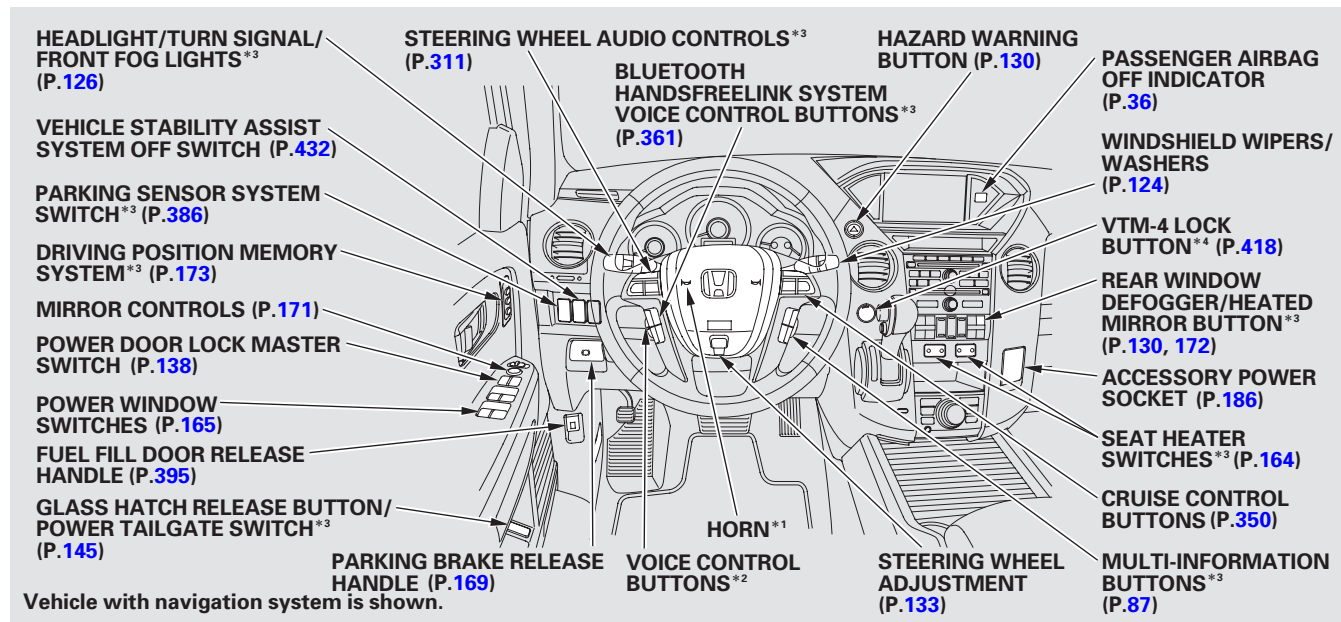

* 1 : To use the horn, press the center pad of the steering wheel.

* 2 : Only on vehicles equipped with navigation system. Refer to the navigation system manual.

* 3 : If equipped

* 4 : 4WD models only

This section gives you important information about how to protect yourself and your passengers. It shows you how to use seat belts. It explains how your airbags work. And it tells you how to properly restrain infants and children in your vehicle.

Important Safety Precautions	6
Your Vehicle's Safety Features.....	8
Seat Belts	9
Airbags	11
Protecting Adults and Teens.....	13
1. Close and Lock the Doors	13
2. Adjust the Front Seats	15
3. Adjust the Seat-Backs	16
4. Adjust the Head Restraints ...	16
5. Fasten and Position the Seat Belts	17
6. Maintain a Proper Sitting Position	19
Advice for Pregnant Women.....	20
Additional Safety Precautions....	21

Additional Information About Your Seat Belts	22
Seat Belt System Components...	22
Lap/Shoulder Belt	23
Automatic Seat Belt Tensioners.....	24
Seat Belt Maintenance	25
Additional Information About Your Airbags	26
Airbag System Components.....	26
How Your Front Airbags Work.....	29
How Your Side Airbags Work....	32
How Your Side Curtain Airbags Work.....	34
How the SRS Indicator Works...	35
How the Side Airbag Off Indicator Works.....	35
How the Passenger Airbag Off Indicator Works.....	36
Airbag Service	37
Additional Safety Precautions....	37
Protecting Children – General Guidelines.....	39
All Children Must Be Restrained	39

All Children Should Sit in a Back Seat	40
The Passenger's Front Airbag Can Pose Serious Risks	40
If You Must Drive with Several Children	42
If a Child Requires Close Attention	42
Additional Safety Precautions....	43
Protecting Infants and Small Children.....	44
Protecting Infants	44
Protecting Small Children	45
Selecting a Child Seat.....	47
Installing a Child Seat	48
With LATCH	49
With a Lap/Shoulder Belt	53
With a Tether	54
Protecting Larger Children	57
Checking Seat Belt Fit	57
Using a Booster Seat.....	58
When Can a Larger Child Sit in Front.....	59
Additional Safety Precautions....	60
Carbon Monoxide Hazard	61
Safety Labels	62

Important Safety Precautions

You'll find many safety recommendations throughout this section, and throughout this manual. The recommendations on this page are the ones we consider to be the most important.

Always Wear Your Seat Belt

A seat belt is your best protection in all types of collisions. Airbags are designed to supplement seat belts, not replace them. So even though your vehicle is equipped with airbags, make sure you and your passengers always wear your seat belts, and wear them properly (see page [17](#)).

Restrain All Children

Children age 12 and under should ride properly restrained in a back seat, not the front seat. Infants and small children should be restrained in a child seat. Larger children should use a booster seat and a lap/shoulder belt until they can use the belt properly without a booster seat (see pages [39](#) – [60](#)).

Be Aware of Airbag Hazards

While airbags can save lives, they can cause serious or fatal injuries to occupants who sit too close to them, or are not properly restrained. Infants, young children, and short adults are at the greatest risk. Be sure to follow all instructions and warnings in this manual.

Don't Drink and Drive

Alcohol and driving don't mix. Even one drink can reduce your ability to respond to changing conditions, and your reaction time gets worse with every additional drink. So don't drink and drive, and don't let your friends drink and drive, either.

Important Safety Precautions

Pay Appropriate Attention to the Task of Driving Safely

Engaging in mobile phone conversation or other activities that keep you from paying close attention to the road, other vehicles and pedestrians could lead to a crash. Remember, situations can change quickly, and only you can decide when it is safe to divert attention away from driving.

Control Your Speed

Excessive speed is a major factor in crash injuries and deaths. Generally, the higher the speed, the greater the risk, but serious injuries can also occur at lower speeds. Never drive faster than is safe for current conditions, regardless of the maximum speed posted.

Keep Your Vehicle in Safe Condition

Having a tire blowout or a mechanical failure can be extremely hazardous. To reduce the possibility of such problems, check your tire pressures and condition frequently, and perform all regularly scheduled maintenance (see page [496](#)).

Your Vehicle's Safety Features

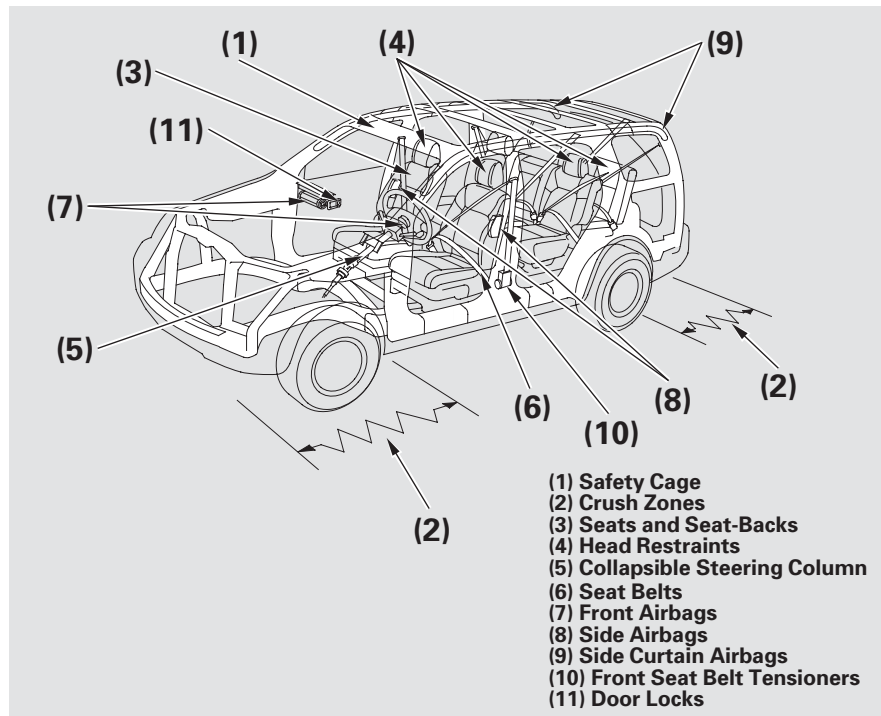

Your vehicle is equipped with many features that work together to protect you and your passengers during a crash.

Some features do not require any action on your part. These include a strong steel framework that forms a safety cage around the passenger compartment, front and rear crush zones, a collapsible steering column, and tensioners that tighten the front seat belts in a crash.

However, you and your passengers can't take full advantage of these features unless you remain sitting in the correct position and ***always wear your seat belts***. In fact, some safety features can contribute to injuries if they are not used properly.

The following pages explain how you can take an active role in protecting yourself and your passengers.

Your Vehicle's Safety Features

Seat Belts

Your vehicle is equipped with seat belts in all seating positions.

Your seat belt system also includes an indicator on the instrument panel and a beeper to remind you and your passengers to fasten your seat belts.

Why Wear Seat Belts

Seat belts are the single most effective safety device for adults and larger children. (Infants and smaller children must be properly restrained in child seats.)

Not wearing a seat belt properly increases the chance of serious injury or death in a crash, even though your vehicle has airbags.

In addition, most states and all Canadian provinces and territories require you to wear seat belts.

⚠ WARNING

Not wearing a seat belt properly increases the chance of serious injury or death in a crash, even though your vehicle has airbags.

Be sure you and your passengers always wear seat belts and wear them properly.

CONTINUED

Your Vehicle's Safety Features

When properly worn, seat belts:

- Keep you connected to the vehicle so you can take advantage of the vehicle's built-in safety features.
- Help protect you in almost every type of crash, including:
 - frontal impacts
 - side impacts
 - rear impacts
 - rollovers

- Help keep you from being thrown against the inside of the vehicle and against other occupants.
- Keep you from being thrown out of the vehicle.
- Help keep you in a good position should the airbags ever deploy. A good position reduces the risk of injury from an inflating airbag and allows you to get the best advantage from the airbag.

Of course, seat belts cannot completely protect you in every crash. But in most cases, seat belts can reduce your risk of serious injury.

What you should do: Always wear your seat belt, and make sure you wear it properly.

Your Vehicle's Safety Features

Airbags

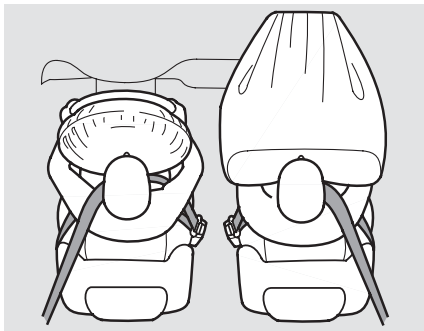

Your vehicle has a supplemental restraint system (SRS) with front airbags to help protect the heads and chests of the driver and a front seat passenger during a moderate to severe frontal collision (see page [29](#) for more information on how your front airbags work).

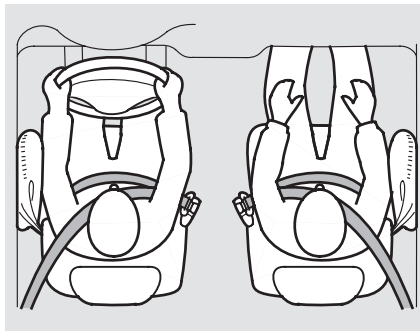

Your vehicle also has side airbags to help protect the upper torso of the driver or a front seat passenger during a moderate to severe side impact (see page [32](#) for more information on how your side airbags work).

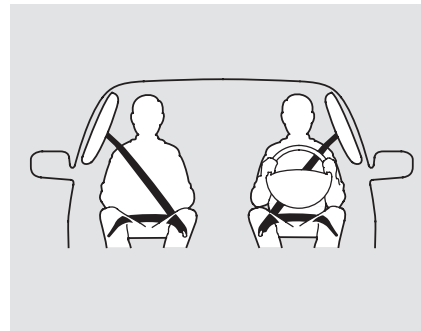

In addition, your vehicle has side curtain airbags to help protect the heads of the driver, front passenger, and passengers in the outer rear seating positions during a moderate to severe side impact or rollover (see page [34](#) for more information on how your side curtain airbags work).

CONTINUED

Your Vehicle's Safety Features

The most important things you need to know about your airbags are:

- ***Airbags do not replace seat belts.*** They are designed to supplement the seat belts.
- ***Airbags offer no protection in rear collisions, or minor frontal or side collisions.***
- ***Airbags can pose serious hazards.*** To do their job, airbags must inflate with tremendous force. So while airbags help save lives, they can cause minor injuries or more serious or even fatal injuries if occupants are not properly restrained or sitting properly.

What you should do: Always wear your seat belt properly, and sit upright and as far back from the steering wheel as possible while allowing full control of the vehicle. A front passenger should move their seat as far back from the dashboard as possible.

The rest of this section gives more detailed information about how you can maximize your safety.

Remember, however, that no safety system can prevent all injuries or deaths that can occur in a severe crash, even when seat belts are properly worn and the airbags deploy.

Introduction

The following pages provide instructions on how to properly protect the driver, adult passengers, and teenage children who are large enough and mature enough to drive or ride in the front.

See pages 39 – 60 for important guidelines on how to properly protect infants, small children, and larger children who ride in your vehicle.

1. Close and Lock the Doors

After everyone has entered the vehicle, be sure the doors and the tailgate are closed and locked.



Your vehicle has a door-open indicator on the instrument panel to indicate when any door is open.

On vehicles without navigation system

Your vehicle also has a tailgate, glass hatch, and door open indicator on the information display to indicate when the tailgate, the glass hatch, or a specific door is open. You will see the appropriate indicator(s) for each condition.

On vehicles with navigation system

Your vehicle also has a tailgate, glass hatch, and door open indicator on the multi-information display to indicate when the tailgate, the glass hatch, or a specific door is open. You will see the appropriate indicator(s) and message(s) for each condition.

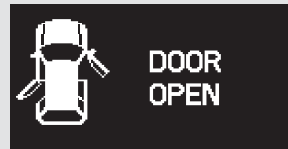

When one or more doors are open, the “DOOR OPEN” message will come on.

CONTINUED

Protecting Adults and Teens



When the glass hatch, the tailgate, or both glass hatch and tailgate are open, the “HATCH OPEN,” “TAILGATE OPEN,” or “HATCH & TAILGATE OPEN” message will come on.



When the glass hatch, tailgate, and one or more doors are open, the “DOOR, HATCH & TAILGATE OPEN” message will come on.

Locking the doors, the glass hatch, and the tailgate reduces the chance of someone being thrown out of the vehicle during a crash, and it helps prevent passengers from accidentally opening a door, the glass hatch, or the tailgate and falling out.

Locking the doors, the glass hatch and the tailgate also helps prevent an outsider from unexpectedly opening a door, the glass hatch, or the tailgate when you come to a stop.

On vehicles without navigation system
This vehicle has auto door locking/unlocking features. See page [139](#) for how to set them.

On vehicles with navigation system
This vehicle has auto door locking/unlocking features. See pages [116](#) and [117](#) for how to set them.

2. Adjust the Front Seats

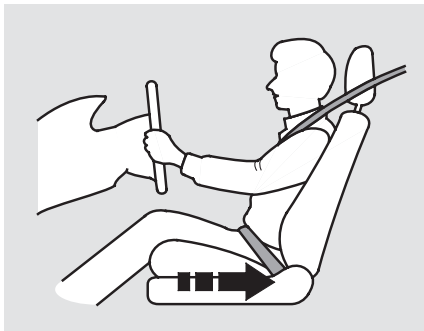

Adjust the driver's seat as far to the rear as possible while allowing you to maintain full control of the vehicle. Have a front passenger adjust their seat as far to the rear as possible.

If you sit too close to the steering wheel or dashboard, you can be seriously injured by an inflating front airbag, or by striking the steering wheel or dashboard.

The National Highway Traffic Safety Administration and Transport Canada recommend that drivers allow at least 10 inches (25 cm) between the center of the steering wheel and the chest. In addition to adjusting the seat, you can adjust the steering wheel up and down, and in and out (see page [133](#)).

If you cannot get far enough away from the steering wheel and still reach the controls, we recommend that you investigate whether some type of adaptive equipment may help.

⚠ WARNING

Sitting too close to a front airbag can result in serious injury or death if the front airbags inflate.

Always sit as far back from the front airbags as possible.

On vehicles with manual adjustable seats

Once your seat is adjusted correctly, rock it back and forth to make sure the seat is locked in position.

See page [154](#) for how to adjust a front seat (power adjustment) and page [155](#) for a manual adjustment.

Protecting Adults and Teens

3. Adjust the Seat-Backs

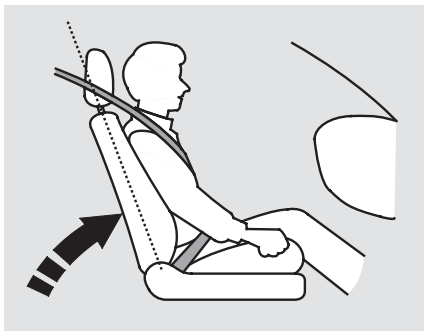

Adjust the driver's seat-back to a comfortable, upright position, leaving ample space between your chest and the airbag cover in the center of the steering wheel.

Passengers with adjustable seat-backs should also adjust their seat-back to a comfortable, upright position.

⚠ WARNING

Reclining the seat-back too far can result in serious injury or death in a crash.

Adjust the seat-back to an upright position, and sit well back in the seat.

Reclining a seat-back so that the shoulder part of the belt no longer rests against the occupant's chest reduces the protective capability of the belt. It also increases the chance of sliding under the belt in a crash and being seriously injured. The farther a seat-back is reclined, the greater the risk of injury.

See page [155](#) for how to adjust the manual adjustable seat-back, and page [154](#) for the power adjustable seat-back.

4. Adjust the Head Restraints

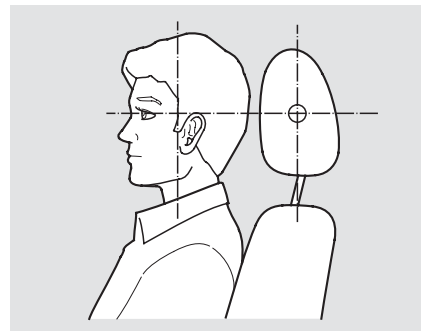

Adjust the driver's head restraint so the center of the back of your head rests against the center of the restraint.

Have passengers adjust their head restraints properly as well. Taller persons should adjust their restraint as high as possible.

⚠ WARNING

Improperly positioning head restraints reduces their effectiveness and you can be seriously injured in a crash.

Make sure head restraints are in place and positioned properly before driving.

Properly adjusted head restraints will help protect occupants from whiplash and other crash injuries.

See page [157](#) for how to adjust the head restraints and how the driver's and front passenger's active head restraints work.

5. Fasten and Position the Seat Belts

Insert the latch plate into the buckle, then tug on the belt to make sure the belt is securely latched. Check that the belt is not twisted, because a twisted belt can cause serious injuries in a crash.

The center seating position in the second row and all third row seats have a detachable seat belt that can be unlatched and retracted into the ceiling to allow the seats to be folded down. See page [162](#) for how to unlatch and relatch a belt.

Detachable seat belts should normally be latched whenever the seat-backs are in an upright position. See page [162](#) for how to unlatch a belt, and page [163](#) for how to relatch a belt.



Position the lap part of the belt as low as possible across your hips, then pull up on the shoulder part of the belt so the lap part fits snugly. This lets your strong pelvic bones take the force of a crash and reduces the chance of internal injuries.

CONTINUED

Protecting Adults and Teens

If necessary, pull up on the belt again to remove any slack, then check that the belt rests across the center of your chest and over your shoulder.

This spreads the forces of a crash over the strongest bones in your upper body.

⚠ WARNING

Improperly positioning the seat belts can cause serious injury or death in a crash.

Make sure all seat belts are properly positioned before driving.

If the seat belt touches or crosses your neck, or if it crosses your arm instead of your shoulder, you need to adjust the seat belt anchor height.

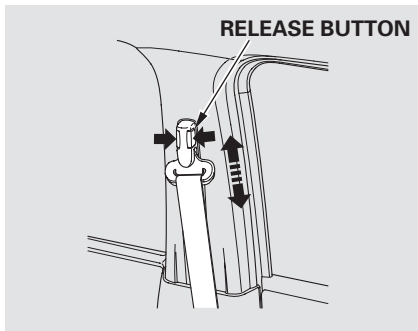

The front seats and second row seats have adjustable seat belt anchors. To adjust the height of an anchor, squeeze the two release buttons, and slide the anchor up or down as needed (it has four positions).

Never place the shoulder portion of a lap/shoulder belt under your arm or behind your back. This could cause very serious injuries in a crash.

If a seat belt does not seem to work properly, it may not protect the occupant in a crash.

No one should sit in a seat with an inoperative seat belt. Using a seat belt that is not working properly can result in serious injury or death. Have your dealer check the belt as soon as possible.

See page [22](#) for additional information about your seat belts and how to take care of them.

6. Maintain a Proper Sitting Position

After all occupants have adjusted their seats and head restraints, and put on their seat belts, it is very important that they continue to sit upright, well back in their seats, with their feet on the floor, until the vehicle is safely parked and the engine is off.

Sitting improperly can increase the chance of injury during a crash. For example, if an occupant slouches, lies down, turns sideways, sits forward, leans forward or sideways, or puts one or both feet up, the chance of injury during a crash is greatly increased.

In addition, an occupant who is out of position in the front seat can be seriously or fatally injured in a crash by striking interior parts of the vehicle or being struck by an inflating front airbag.

⚠ WARNING

Sitting improperly or out of position can result in serious injury or death in a crash.

Always sit upright, well back in the seat, with your feet on the floor.

Protecting Adults and Teens

Advice for Pregnant Women



If you are pregnant, the best way to protect yourself and your unborn child when driving or riding in a vehicle is to always wear a seat belt, and keep the lap part of the belt as low as possible across the hips.

When driving, remember to sit upright and adjust the seat as far back as possible while allowing full control of the vehicle. When riding as a front passenger, adjust the seat as far back as possible.

This will reduce the risk of injuries to both you and your unborn child that can be caused by a crash or an inflating front airbag.

Each time you have a checkup, ask your doctor if it's okay for you to drive.

Additional Safety Precautions

- **Never let passengers ride in the cargo area or on top of a folded-down back seat.** If they do, they could be very seriously injured in a crash.
- **Passengers should not stand up or change seats while the vehicle is moving.** A passenger who is not wearing a seat belt during a crash or emergency stop can be thrown against the inside of the vehicle, against other occupants, or out of the vehicle.
- **Two people should never use the same seat belt.** If they do, they could be very seriously injured in a crash.
- **Do not put any accessories on seat belts.** Devices intended to improve occupant comfort or reposition the shoulder part of a seat belt can reduce the protective capability of the belt and increase the chance of serious injury in a crash.
- **Do not place hard or sharp objects between yourself and a front airbag.** Carrying hard or sharp objects on your lap, or driving with a pipe or other sharp object in your mouth, can result in injuries if your front airbag inflates.
- **Keep your hands and arms away from the airbag covers.** If your hands or arms are close to an airbag cover, they could be injured if the airbag inflates.
- **Do not attach or place objects on the front airbag covers.** Objects on the covers marked “SRS AIRBAG” could interfere with the proper operation of the airbags or be propelled inside the vehicle and hurt someone if the airbags inflate.
- **Do not attach hard objects on or near a door.** If a side airbag or a side curtain airbag inflates, a cup holder or other hard object attached on or near the door could be propelled inside the vehicle and hurt someone.
- **Do not cover or replace front seat-back covers without consulting your dealer.** Improperly replacing or covering front seat-back covers can prevent your side airbags from inflating during a side impact.

Additional Information About Your Seat Belts

Seat Belt System Components

Your seat belt system includes lap/shoulder belts in all seating positions. The front seat belts are also equipped with automatic seat belt tensioners.

This system uses the same sensors as the front airbags to monitor whether the front seat belts are latched or unlatched, and how much weight is on the front passenger's seat (see pages [31](#) and [32](#)).



The seat belt system includes an indicator on the instrument panel and a beeper to remind you and your passengers to fasten your seat belts.

This system monitors the front seat belts. If you turn the ignition switch to the ON (II) position before your seat belt is fastened, the beeper will sound and the indicator will flash. If your seat belt is not fastened before the beeper stops, the indicator will stop flashing but remain on.

If a front passenger does not fasten their seat belt, the indicator will come on about 6 seconds after the ignition switch is turned to the ON (II) position.

If either the driver or a front passenger does not fasten their seat belt while driving, the beeper will sound and the indicator will flash again at regular intervals.

On vehicles with navigation system
You will also see a “FASTEN SEAT BELT” or “FASTEN PASSENGER SEAT BELT” message on the multi-information display (see page [95](#)).

When no one is sitting in the front passenger's seat, or a child or small adult is riding there, the indicator should not come on and the beeper should not sound.

Additional Information About Your Seat Belts

If the indicator comes on or the beeper sounds when the driver's seat belt is latched and there is no front seat passenger and no items on the front seat, something may be interfering with the monitoring system. Look for and remove:

- Any items under the front passenger's seat.
- Any object(s) hanging on the seat or in the seat-back pocket.
- Any object(s) touching the rear of the seat-back.

If no obstructions are found, have your vehicle checked by a dealer.

Lap/Shoulder Belt

The lap/shoulder belt goes over your shoulder, across your chest, and across your hips.

To fasten the belt, insert the latch plate into the buckle, then tug on the belt to make sure the buckle is latched (see page 17 for how to properly position the belt).

To unlock the belt, press the red PRESS button on the buckle. Guide the belt across your body so that it retracts completely. After exiting the vehicle, be sure the belt is out of the way and will not get closed in the door.

All seat belts have an emergency locking retractor. In normal driving, the retractor lets you move freely in your seat while it keeps some tension on the belt. During a collision or sudden stop, the retractor automatically locks the belt to help restrain your body.

The seat belts in all positions except the driver's have a lockable retractor that must be activated to secure a child seat (see page 53).

If the shoulder part of the belt is pulled all the way out, the lockable retractor will activate. The belt will retract, but it will not allow the passenger to move freely.

To deactivate the lockable retractor, unlatch the buckle and let the seat belt fully retract. To refasten the seat belt, pull it out only as far as needed.

CONTINUED

Additional Information About Your Seat Belts

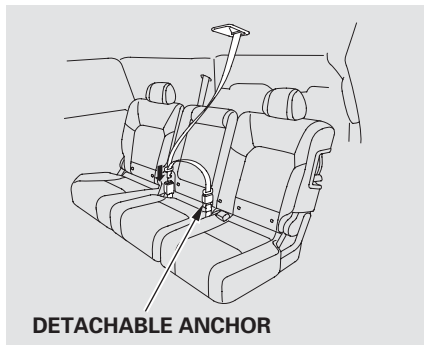

The lap/shoulder belts in the center seat of the second row and both of the third row seats are equipped with a detachable anchor that has two parts: a small latch plate and a buckle.

The detachable seat belt should normally be latched whenever the seat-backs are in an upright position. For more information about the detachable seat belt, see page [162](#).

Automatic Seat Belt Tensioners

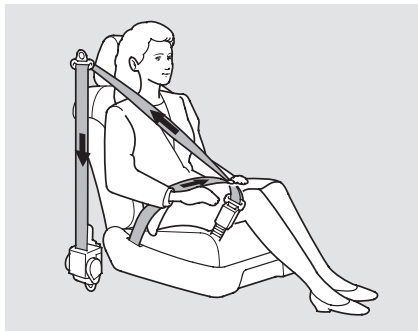

For added protection, the front seat belts are equipped with automatic seat belt tensioners. When activated, the tensioners immediately tighten the belts to help hold the driver and a front passenger in position.

The tensioners are designed to activate in any collision severe enough to cause the front airbags to deploy, or if a sensor detects your vehicle is about to roll over (see page [34](#)).

If a side curtain airbag deploys during a side impact, the tensioner on that side of the vehicle will also deploy.

The tensioners can also be activated during a collision in which the front airbags *do not* deploy. In this case, the airbags would not be needed, but the extra tension in the seat belt could be helpful.

When the tensioners are activated, the seat belts will remain tight until they are unbuckled.

Additional Information About Your Seat Belts

Seat Belt Maintenance

For safety, you should check the condition of your seat belts regularly.

Pull each belt out fully, and look for frays, cuts, burns, and wear. Check that the latches work smoothly and the belts retract easily. If a belt does not retract easily, cleaning the belt may correct the problem (see page 490). Any belt that is not in good condition or working properly will not provide good protection and should be replaced as soon as possible.

Honda provides a limited warranty on seat belts. See your *Honda Warranty Information* booklet for details.

If a seat belt is worn during a crash, it must be replaced by the dealer. A belt that has been worn during a crash may not provide the same level of protection in a subsequent crash.

The dealer should also inspect the anchors for damage and replace them if needed. If the automatic seat belt tensioners activate during a crash, they must be replaced.

WARNING

Not checking or maintaining seat belts can result in serious injury or death if the seat belts do not work properly when needed.

Check your seat belts regularly and have any problem corrected as soon as possible.

Additional Information About Your Airbags

Airbag System Components

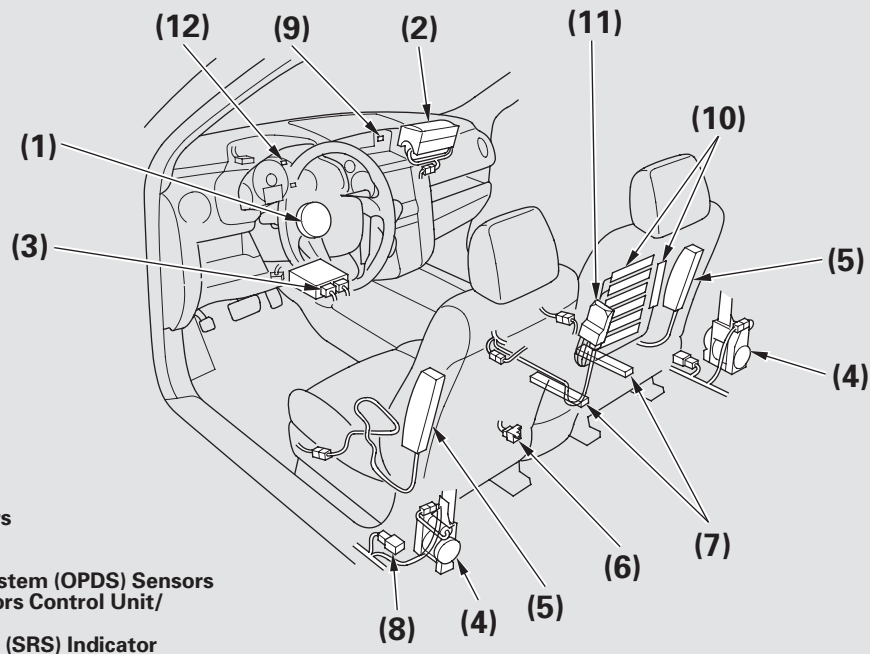

Additional Information About Your Airbags

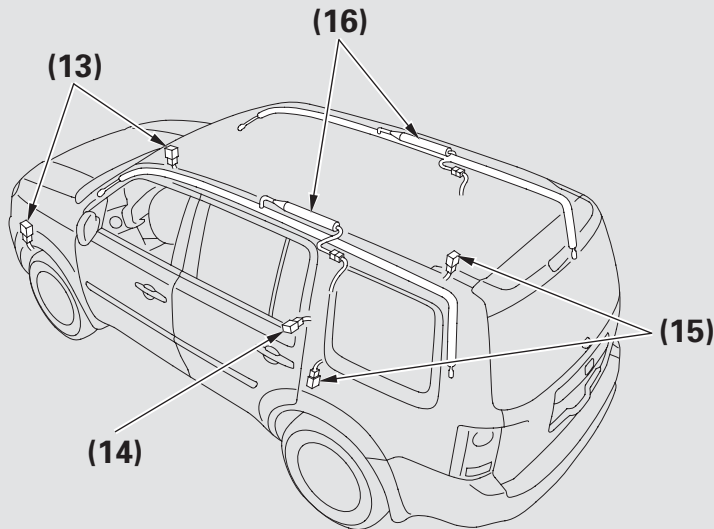

- (13) Front Impact Sensors
- (14) Rear Safing Sensor
- (15) Side Impact Sensors (Second)
- (16) Side Curtain Airbags

Your Airbag System includes:

- Two SRS (supplemental restraint system) front airbags. The driver's airbag is stored in the center of the steering wheel; the front passenger's airbag is stored in the dashboard. Both are marked "SRS AIRBAG" (see page 29).
- Two side airbags, one for the driver and one for a front passenger. The airbags are stored in the outer edges of the seat-backs. Both are marked "SIDE AIRBAG" (see page 32).
- Two side curtain airbags, one for each side of the vehicle. The airbags are stored in the ceiling above the side windows. The front and rear pillars are marked "SIDE CURTAIN AIRBAG" (see page 34).

CONTINUED

Additional Information About Your Airbags

- Automatic front seat belt tensioners (see page [24](#)).
- Sensors that can detect a moderate to severe front impact, side impact, or if your vehicle is about to rollover.
- Sensors that can detect whether a child is in the passenger's side airbag path and signal the control unit to turn the airbag off (see page [33](#)).
- Sensors that can detect whether the driver's seat belt and the front passenger's seat belt are latched or unlatched (see page [22](#)).
- A driver's seat position sensor that monitors the distance of the seat from the front airbag. If the seat is too far forward, the airbag will inflate with less force (see page [31](#)).
- Weight sensors that monitor the weight on the front passenger's seat. If the weight is about 65 lbs (29 kg) or less (the weight of an infant or small child), the passenger's front airbag will be turned off (see page [31](#)).
- A rollover sensor that can detect if your vehicle is about to roll over and signal the control unit to deploy both side curtain airbags and front seat belt tensioners (see page [34](#)).
- A sophisticated electronic system that continually monitors and records information about the sensors, the control unit, the airbag activators, the seat belt tensioners, and driver and front passenger seat belt use when the ignition switch is in the ON (II) position.
- An indicator on the instrument panel that alerts you to a possible problem with your airbag system components (see page [35](#)).
- An indicator on the instrument panel that alerts you that the passenger's side airbag has been turned off (see page [35](#)).
- An indicator on the dashboard that alerts you that the passenger's front airbag has been turned off (see page [36](#)).
- Emergency backup power in case your vehicle's electrical system is disconnected in a crash.

Additional Information About Your Airbags

How Your Front Airbags Work

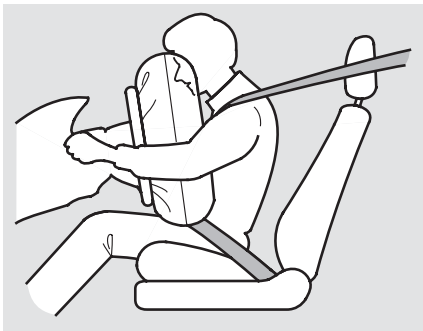

If you ever have a moderate to severe frontal collision, sensors will detect the vehicle's rapid deceleration.

If the rate of deceleration is high enough, the control unit will inflate the driver's and front passenger's airbags, at the time and with the force needed.

During a frontal crash, your seat belt restrains your lower body and torso, and the front airbag helps protect your head and chest.

Although both airbags normally inflate within a split second of each other, it is possible for only one airbag to deploy.

This can happen if the severity of a collision is at the margin, or threshold, that determines whether or not the airbags will deploy. In such cases, the seat belt will provide sufficient protection, and the supplemental protection offered by the airbag would be minimal.

Only the driver's airbag can deploy if there is no passenger in the front seat, or if the advanced airbag system has turned the passenger's airbag off (see page [36](#)).

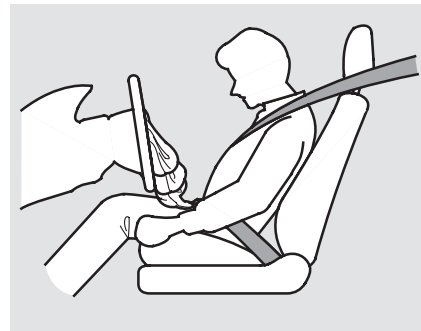

After inflating, the front airbags immediately deflate, so they won't interfere with the driver's visibility, or the ability to steer or operate other controls.

CONTINUED

Additional Information About Your Airbags

The total time for inflation and deflation is one-tenth of a second, so fast that most occupants are not aware that the airbags deployed until they see them lying in their laps.

After a crash, you may see what looks like smoke. This is actually powder from the airbag's surface. Although the powder is not harmful, people with respiratory problems may experience some temporary discomfort. If this occurs, get out of the vehicle as soon as it is safe to do so.

Dual-Stage Airbags

Your front airbags are dual-stage airbags. This means they have two inflation stages that can be ignited sequentially or simultaneously, depending on crash severity.

In a *more severe* crash, both stages will ignite simultaneously to provide the quickest and greatest protection.

In a *less severe* crash, one stage will ignite first, then the second stage will ignite a split second later. This provides longer airbag inflation time with a little less force.

Dual-Threshold Airbags

Your front airbags are also dual-threshold airbags. Airbags with this feature have two deployment thresholds that depend on whether sensors detect the occupant is wearing a seat belt or not.

If the occupant's belt is *not latched*, the airbag will deploy at a slightly lower threshold, because the occupant would need extra protection.

If the occupant's belt is *latched*, the airbag will inflate at a slightly higher threshold, when the airbag would be needed to supplement the protection provided by the seat belt.

Additional Information About Your Airbags

Advanced Airbags

Your front airbags are also advanced airbags. The main purpose of this feature is to help prevent airbag-caused injuries to short drivers and children or small-statured adults who ride in front.

For both advanced airbags to work properly:

- Occupants must sit upright and wear their seat belts properly.
- Do not spill any liquids on or under the seats, cover the sensors, or put any objects or metal items under the front seats.
- Objects placed or pushed under the front passenger's seat may cause the sensor to malfunction, increasing the risk of injury in a crash.

Failure to follow these instructions could damage the sensors or prevent them from working properly.

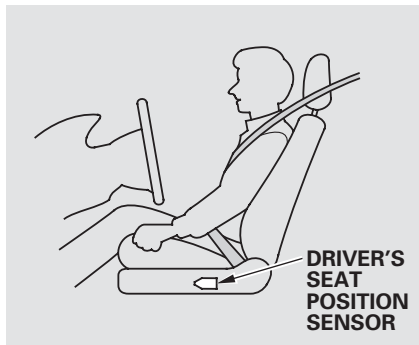

The driver's advanced front airbag system includes a seat position sensor under the seat. If the seat is too far forward, the airbag will inflate with less force, regardless of the severity of the impact.

If there is a problem with the sensor, the SRS indicator will come on, and the airbag will inflate in the normal manner regardless of the driver's seating position.

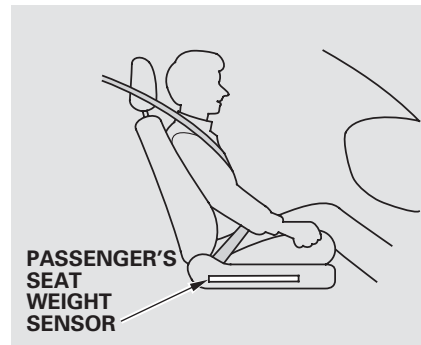

The passenger's advanced front airbag system has weight sensors under the seat. Although Honda does not encourage carrying an infant or small child in front, if the sensors detect the weight of an infant or small child (up to about 65 lbs or 29 kg), the system will automatically turn the passenger's front airbag off.

CONTINUED

Additional Information About Your Airbags

Be aware that objects placed on the passenger's seat can also cause the airbag to be turned off.

When the passenger airbag gets turned off by the weight sensors, a "passenger airbag off" indicator in the center of the dashboard comes on (see page 36).

If the weight sensors detect there is no passenger in the front seat, the airbag is automatically turned off. However, the passenger airbag off indicator in this situation will not come on.

To ensure that the passenger's advanced front airbag system will work properly, ***do not do anything that would increase or decrease the weight on the front passenger's seat.*** This includes:

- A second-row passenger pushing or pulling on the back of the front passenger's seat.

- Moving the front seat forcibly back against cargo on the seat or floor behind it.
- Hanging heavy items on the front passenger seat, or placing heavy items in the seat-back pocket.
- Moving the front passenger's seat or seat-back forcibly back against the folded right-side second-row seat.
- Second-row passengers should not wedge objects or intentionally force their feet under the front passenger seat.

Also, make sure the floor mat behind the front passenger's seat is hooked to the floor mat anchor (see page 491). If it is not, the mat may interfere with the proper operation of the sensors and operation of the seat.

How Your Side Airbags Work

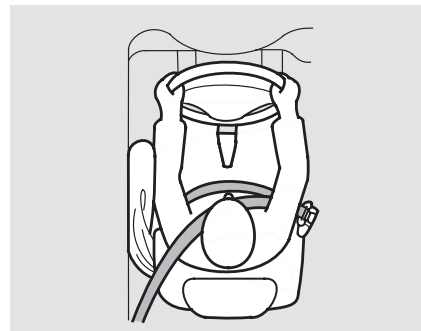

If you ever have a moderate to severe side impact, sensors will detect rapid acceleration and signal the control unit to instantly inflate either the driver's or the passenger's side airbag.

Additional Information About Your Airbags

Only one airbag will deploy during a side impact. If the impact is on the passenger's side, the passenger's side airbag will deploy even if there is no passenger.

To get the best protection from the side airbags, front seat occupants should wear their seat belts and sit upright and well back in their seats.

Side Airbag Cutoff System

Your vehicle has a side airbag cutoff system designed primarily to protect a child riding in the front passenger's seat.

Although Honda does not encourage children to ride in front, if the position sensors detect a child has leaned into the side airbag's deployment path, the airbag will shut off.

The side airbag may also shut off if a short adult leans sideways, or a larger adult slouches and leans sideways into the airbag's deployment path.

Objects placed on the front passenger seat can also cause the side airbag to be shut off.

If the side airbag off indicator comes on (see page 35), have the passenger sit upright. Once the passenger is out of the airbag's deployment path, the system will turn the airbag back on, and the indicator will go out.

There will be some delay between the moment the passenger moves into or out of the airbag deployment path and when the indicator comes on or goes off.

A front seat passenger should not use a cushion or another object as a backrest. It may prevent the cutoff system from working properly.

Additional Information About Your Airbags

How Your Side Curtain Airbags Work

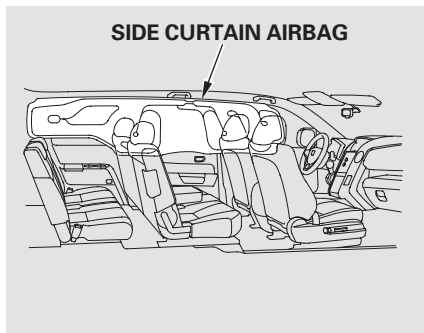

In a Side Impact

In a moderate to severe side impact, sensors will detect rapid acceleration and signal the control unit to instantly inflate the side curtain airbag and activate the seat belt tensioner on the driver's or the passenger's side of the vehicle.

If the impact is on the passenger's side, the passenger's side curtain airbag will inflate even if there are no occupants on that side of the vehicle.

In a Rollover

If the rollover sensor detects your vehicle is about to roll over, it signals the control unit, which immediately deploys both side curtain airbags and activates both front seat belt tensioners.

The airbag on the passenger's side will deploy, and the seat belt tensioner will activate, even if there are no passengers on that side of the vehicle.

To get the best protection from the side curtain airbags, occupants should wear their seat belts and sit upright and well back in their seats.

Additional Information About Your Airbags

How the SRS Indicator Works



The SRS indicator alerts you to a potential problem with your airbags or seat belt tensioners.

When you turn the ignition switch to the ON (II) position, this indicator comes on briefly then goes off. This tells you the system is working properly.

If the indicator comes on at any other time, or does not come on at all, you should have the system checked by your dealer. For example:

- If the SRS indicator does not come on after you turn the ignition switch to the ON (II) position.
- If the indicator stays on after the engine starts.
- If the indicator comes on or flashes on and off while you drive.

On vehicles with navigation system

You will also see a “CHECK AIRBAG SYSTEM” message on the multi-information display (see page 95).

If you see any of these indications, the airbags and seat belt tensioners may not work properly when you need them.

⚠ WARNING

Ignoring the SRS indicator can result in serious injury or death if the airbag systems or tensioners do not work properly.

Have your vehicle checked by a dealer as soon as possible if the SRS indicator alerts you to a possible problem.

How the Side Airbag Off Indicator Works



U.S.

Canada



This indicator alerts you that the passenger’s side airbag has been automatically shut off. It does **not** mean there is a problem with your side airbags.

When you turn the ignition switch to the ON (II) position, the indicator should come on briefly and then go off (see page 72). If it doesn’t come on, stays on, or comes on while driving without a passenger in the front seat, have the system checked.

On vehicles with navigation system

You will also see a “PASSENGER SIDE AIRBAG OFF” message on the multi-information display (see page 95).

Additional Information About Your Airbags

How the Passenger Airbag Off Indicator Works

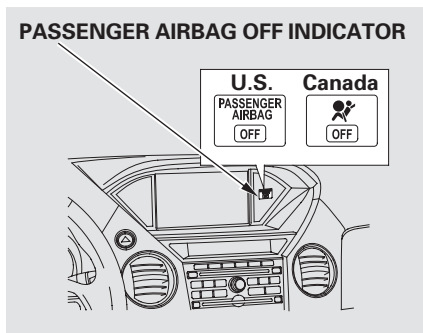

This indicator alerts you that the passenger's front airbag has been shut off because weight sensors detect about 65 lbs (29 kg) or less (the weight of an infant or small child) on the front passenger's seat. It does **not mean** there is a problem with the airbag.

Be aware that objects placed on the front seat can cause the indicator to come on.

If no weight is detected on the front seat, the airbag will be automatically shut off. However, the indicator will not come on.

The passenger airbag off indicator may come on and off repeatedly if the total weight on the seat is near the airbag cutoff threshold.

If an adult or teenage passenger is riding in front, move the seat as far to the rear as possible, and have the passenger sit upright and wear the seat belt properly.

If the indicator comes on with no front seat passenger and no objects on the seat, or with an adult riding there, something may be interfering with the weight sensors. Look for and remove:

- Any items under the front passenger's seat.
- Any object(s) hanging on the seat or in the seat-back pocket.
- Any object(s), such as a folded-down back seat, that are touching the rear of the seat-back.

If no obstructions are found, have your vehicle checked by a dealer as soon as possible.

Additional Information About Your Airbags

Airbag Service

Your airbag systems are virtually maintenance free, and there are no parts you can safely service.

However, you must have your vehicle serviced if:

- **An airbag ever inflates.** Any airbag that has deployed must be replaced along with the control unit and other related parts. Any seat belt tensioner that activates must also be replaced.

Do not try to remove or replace any airbag by yourself. This must be done by an authorized dealer or a knowledgeable body shop.

- **The SRS indicator alerts you to a problem.** Take your vehicle to an authorized dealer as soon as possible. If you ignore this indication, your airbags may not operate properly.

- **If your vehicle has a moderate to severe impact.** Even if your airbags do not inflate, your dealer should inspect the driver's seat position sensor, the front passenger's weight sensors, the front seat belt tensioners, and all seat belts and their anchors worn during a crash to make sure they are operating properly.

Additional Safety Precautions

- **Do not attempt to deactivate your airbags.** Together, airbags and seat belts provide the best protection.
- **Do not tamper with airbag components or wiring for any reason.** Tampering could cause the airbags to deploy, possibly causing very serious injury.
- **Do not expose the front passenger's seat-back to liquid.** If water or another liquid soaks into a seat-back, it can prevent the side airbag cutoff system from working properly.

CONTINUED

Additional Information About Your Airbags

- ***Do not remove or modify a front seat without consulting your dealer.*** This could make the driver's seat position sensor or the front passenger's weight sensors ineffective. If it is necessary to remove or modify a front seat to accommodate a person with disabilities, first contact Honda Automobile Customer Service at (800) 999-1009.

Protecting Children – General Guidelines

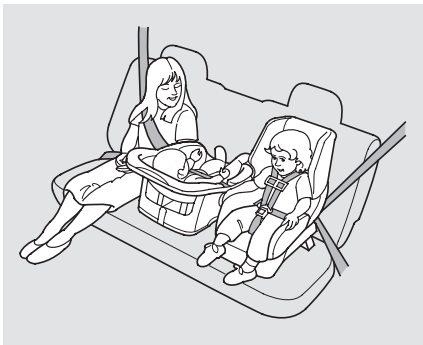

Children depend on adults to protect them. However, despite their best intentions, many adults do not know how to *properly* protect child passengers.

If you have children, or ever need to drive with a child in your vehicle, be sure to read this section. It begins with important general guidelines, then presents special information for infants, small children, and larger children.

All Children Must Be Restrained

Each year, many children are injured or killed in vehicle crashes because they are either unrestrained or not properly restrained. In fact, traffic collisions are the number one cause of death of children age 12 and under.

To reduce the number of child deaths and injuries, every state, Canadian province and territory requires that infants and children be properly restrained when they ride in a vehicle.

Infants and small children must be restrained in an approved child seat that is properly secured to the vehicle (see pages 44 – 56).

⚠ WARNING

Children who are unrestrained or improperly restrained can be seriously injured or killed in a crash.

Any child too small for a seat belt should be properly restrained in a child seat. A larger child should be properly restrained with a seat belt and use a booster seat if necessary.

Larger children must be restrained with a lap/shoulder belt and ride on a booster seat until the seat belt fits them properly (see pages 57 – 60).

Protecting Children – General Guidelines

All Children Should Sit in a Back Seat

According to crash statistics, children of all ages and sizes are safer when they are restrained in a back seat.

The National Highway Traffic Safety Administration and Transport Canada recommend that all children aged 12 and under be properly restrained in a back seat. Some states have laws restricting where children may ride.

Children who ride in the back are less likely to be injured by striking interior vehicle parts during a collision or hard braking. Also, children cannot be injured by an inflating front airbag when they ride in the back.

The Passenger's Front Airbag Can Pose Serious Risks

Front airbags have been designed to help protect adults in a moderate to severe frontal collision. To do this, the passenger's front airbag is quite large, and it can inflate with enough force to cause very serious injuries.

Even though your vehicle has an advanced front airbag system that automatically turns the passenger's front airbag off under certain circumstances (see page [36](#)), please follow these guidelines:

Infants

Never put a rear-facing child seat in the front seat of a vehicle equipped with a passenger's front airbag. If the airbag inflates, it can hit the back of the child seat with enough force to kill or very seriously injure an infant.

Small Children

Placing a forward-facing child seat in the front seat of a vehicle equipped with a passenger's front airbag can be hazardous. If the vehicle seat is too far forward, or the child's head is thrown forward during a collision, an inflating front airbag can strike the child with enough force to kill or very seriously injure a small child.

Larger Children

Children who have outgrown child seats are also at risk of being injured or killed by an inflating passenger's front airbag. Whenever possible, larger children should sit in the back seat, on a booster seat if needed, and be properly restrained with a seat belt. (See page [57](#) for important information about protecting larger children.)

Protecting Children – General Guidelines

To remind you of the passenger's front airbag hazards, and that children must be properly restrained in a back seat, your vehicle has warning labels on the dashboard (U.S. models) and on the front visors. Please read and follow the instructions on these labels.

U.S. Models

SUN VISORS



Canadian Models

SUN VISORS

CAUTION

TO AVOID SERIOUS INJURY:

- FOR MAXIMUM SAFETY PROTECTION IN ALL TYPES OF CRASHES, YOU MUST ALWAYS WEAR YOUR SAFETY BELT.
- DO NOT INSTALL REARWARD-FACING CHILD SEATS IN ANY FRONT PASSENGER SEAT POSITION.
- DO NOT SIT OR LEAN UNNECESSARILY CLOSE TO THE AIR BAG.
- DO NOT PLACE ANY OBJECTS OVER THE AIR BAG OR BETWEEN THE AIR BAG AND YOURSELF.
- SEE THE OWNER'S MANUAL FOR FURTHER INFORMATION AND EXPLANATIONS.

PRECAUTIONS:

- POUR PROFITER D'UNE PROTECTION MAXIMALE LORS D'UNE COLLISION BOUCLEZ TOUJOURS VOTRE CEINTURE DE SECURITE.
- N'INSTALLEZ JAMAIS UN SIEGE POUR ENFANTS FAISANT FACE A L'ARRIERE SUR LE SIEGE DU PASSAGER AVANT.
- NE VOUS APPUYEZ PAS ET NE VOUS ASSOYEZ PAS PRES DU COUSSIN GONFLABLE.
- NE DEPOSEZ AUCUN OBJET SUR LE COUSSIN GONFLABLE OU ENTRE LE COUSSIN GONFLABLE ET VOUS.
- LISEZ LE GUIDE UTILISATEUR POUR DE PLUS AMPLES RENSEIGNEMENTS.

DASHBOARD

This Vehicle is Equipped with Advanced Air Bags

Even with Advanced Air Bags

Children can be killed or seriously injured by the air bag. The back seat is the safest place for children. Never put a rear-facing child seat in the front. Always use seat belts and child restraints. See owner's manual for more information about air bags.

To be removed by owner only.

Protecting Children – General Guidelines

If You Must Drive with Several Children

Your vehicle has two rows of back seats where children can be properly restrained. If you ever have to carry a group of children, and a child must ride in front:

- Place the largest child in the front seat, provided the child is large enough to wear the lap/shoulder belt properly (see page [57](#)).
- Move the vehicle seat as far to the rear as possible (see page [15](#)).
- Have the child sit upright and well back in the seat (see page [19](#)).
- Make sure the seat belt is properly positioned and secured (see page [17](#)).

If a Child Requires Close Attention

Many parents say they prefer to put an infant or a small child in the front passenger seat so they can watch the child, or because the child requires attention.

Placing a child in the front seat exposes the child to hazards in a frontal collision, and paying close attention to a child distracts the driver from the important tasks of driving, placing both of you at risk.

If a child requires close physical attention or frequent visual contact, we strongly recommend that another adult ride with the child in a back seat. The back seat is far safer for a child than the front.

Protecting Children – General Guidelines

Additional Safety Precautions

- **Never hold an infant or child on your lap.** If you are not wearing a seat belt in a crash, you could be thrown forward and crush the child against the dashboard or a seat-back. If you are wearing a seat belt, the child can be torn from your arms and be seriously hurt or killed.
- **Never put a seat belt over yourself and a child.** During a crash, the belt could press deep into the child and cause serious or fatal injuries.
- **Use the childproof door locks to prevent children from opening the rear doors.** This can prevent children from accidentally falling out (see page 144).

- **Make sure any unused seat belt that a child can reach is buckled, the lockable retractor is activated, and the belt is fully retracted and locked.** If a child wraps a loose seat belt around their neck, they can be seriously or fatally injured. (See pages 53 and 54 for how to activate and deactivate the lockable retractor.)
- **Never let two children use the same seat belt.** If they do, they could be very seriously injured in a crash.
- **Do not leave children alone in a vehicle.** Leaving children without adult supervision is illegal in most states, Canadian provinces and territories, and can be very hazardous.

For example, infants and small children left in a vehicle on a hot day can die from heatstroke. A child left alone with the key in the ignition switch can accidentally set the vehicle in motion, possibly injuring themselves or others.

- **Lock all doors, the tailgate and the glass hatch when your vehicle is not in use.** Children who play in vehicles can accidentally get trapped inside. Teach your children not to play in or around vehicles.
- **Keep vehicle keys/remote transmitters out of the reach of children.** Even very young children learn how to unlock vehicle doors, turn on the ignition switch, and open the tailgate or the glass hatch, which can lead to accidental injury or death.

Protecting Infants and Small Children

Protecting Infants

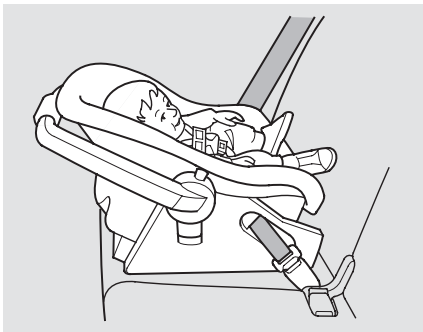

Child Seat Type

An infant must be properly restrained in a rear-facing, reclining child seat until the child reaches the seat maker's weight or height limit for the seat, and the child is at least one year old.

Only a rear-facing child seat provides proper support for a baby's head, neck, and back.

Two types of seats may be used: a seat designed exclusively for infants, or a convertible seat used in the rear-facing, reclining mode.

Do not put a rear-facing child seat in a forward-facing position. If placed facing forward, an infant could be very seriously injured during a frontal collision.

Rear-facing Child Seat Placement

A rear-facing child seat can be placed in any seating position in the back seat, but not in the front. ***Never put a rear-facing child seat in the front seat.***

If the passenger's front airbag inflates, it can hit the back of the child seat with enough force to kill or seriously injure an infant.

When properly installed in the second row, a rear-facing child seat may prevent the driver or a front passenger from moving their seat as far back as recommended, or from locking their seat-back in the desired position.

It could also interfere with proper operation of the passenger's advanced front airbag system.

Protecting Infants and Small Children

In any of these situations, we strongly recommend that you install the child seat directly behind the front passenger's seat, move the seat as far forward as needed, and leave it unoccupied. Or, you may wish to get a smaller rear-facing child seat.

⚠ WARNING

Placing a rear-facing child seat in the front seat can result in serious injury or death during a crash.

Always place a rear-facing child seat in the back seat, not the front.

Protecting Small Children

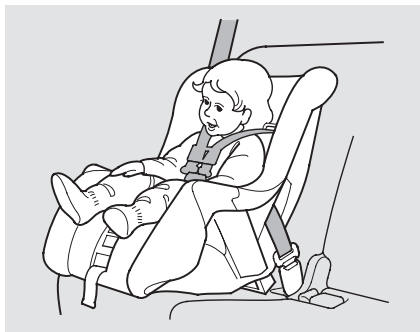

Child Seat Type

Many states, Canadian provinces and territories allow a child one year of age or older who also meets the minimum size and weight requirements to transition from a rear-facing child seat to a forward facing seat. Know the requirements where you are driving and follow the child seat instructions. Many experts recommend use of a rear-facing seat up to age two, if the child's height

and weight are appropriate for a rear-facing seat.

Of the different seats available, we recommend those that have a five-point harness system as shown.

We also recommend that a small child use the child seat until the child reaches the weight or height limit for the seat.

CONTINUED

Protecting Infants and Small Children

Child Seat Placement

We strongly recommend placing a forward-facing child seat in a back seat, not the front.

Placing a forward-facing child seat in the front seat of a vehicle equipped with a passenger's airbag can be hazardous. If the vehicle seat is too far forward, or the child's head is thrown forward during a collision, an inflating airbag can strike the child with enough force to cause very serious or fatal injuries.

Even with advanced front airbags that automatically turn the passenger's front airbag off (see page 36), a back seat is the safest place for a small child.

If it is necessary to put a forward-facing child seat in the front, move the vehicle seat as far to the rear as possible, be sure the child seat is firmly secured to the vehicle and the child is properly strapped in the seat.

⚠ WARNING

Placing a forward-facing child seat in the front seat can result in serious injury or death if the front airbag inflates.

If you must place a forward-facing child seat in front, move the vehicle seat as far back as possible, and properly restrain the child.

When buying a child seat, you need to choose either a conventional child seat, or one designed for use with the Lower Anchors and Tethers for Children (LATCH) system.

Conventional child seats must be secured to a vehicle with a seat belt, whereas LATCH-compatible seats are secured by attaching the seat to hardware built into the rear seating positions.

Since LATCH-compatible child seats are easier to install and reduce the possibility of improper installation, we recommend selecting this style.

In seating positions and vehicles not equipped with LATCH, a LATCH-compatible child seat can be installed using a seat belt.

Whatever type of seat you choose, to provide proper protection, a child seat should meet three requirements:

1. The child seat should meet Federal Motor Vehicle Safety Standard 213 or Canadian Motor Vehicle Safety Standard 213.

Look for FMVSS 213 or CMVSS 213 on the box.

2. The child seat should be of the proper type and size to fit the child.

Rear-facing for infants, forward-facing for small children.

3. The child seat should fit the vehicle seating position (or positions) where it will be used.

Before purchasing a conventional child seat, or using a previously purchased one, we recommend that you test the seat in the specific vehicle seating position or positions where the seat will be used.

Installing a Child Seat

After selecting a proper child seat and a good place to install the seat, there are three main steps in installing the seat:

1. Properly secure the child seat to the vehicle. All child seats must be secured to the vehicle with the lap part of a lap/shoulder belt or with the LATCH (Lower Anchors and Tethers for CHildren) system. A child whose seat is not properly secured to the vehicle can be endangered in a crash.

2. Make sure the child seat is firmly secured. After installing a child seat, push and pull the seat forward and from side-to-side to verify that it is secure.

A child seat secured with a seat belt should be installed as firmly as possible. However, it does not need to be “rock solid.” Some side-to-side movement can be expected and should not reduce the child seat’s effectiveness.

If the child seat is not secure, try installing it in a different seating position, or use a different style of child seat that can be firmly secured.

3. Secure the child in the child seat. Make sure the child is properly strapped in the child seat according to the child seat maker’s instructions. A child who is not properly secured in a child seat can be seriously injured in a crash.

The following pages provide guidelines on how to properly install a child seat. A forward-facing child seat is used in all examples, but the instructions are the same for rear-facing child seats.

Installing a Child Seat

Installing a Child Seat with LATCH

Your vehicle is equipped with LATCH (Lower Anchors and Tethers for CHildren) at each of the second row seats and the passenger's side third row seat.

The lower anchors are located between the seat-back and seat bottom, and are to be used only with a child seat designed for use with LATCH.

The location of each lower anchor is indicated by a small button above the anchor point.

You can find lower anchors in the slits in the seat-backs.

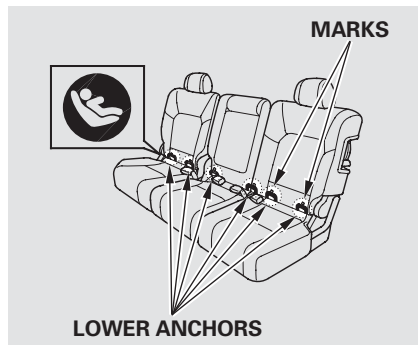

When you install a child seat in the second row seating position, use the lower anchors as shown in the illustration. You can install up to three child seats at a time with LATCH.

Do not attach two child seat connectors to a single lower anchor at a time.

Using the Outer LATCH

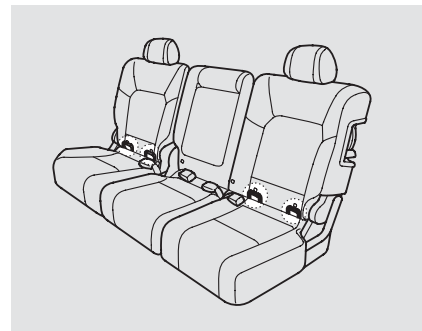

To install a LATCH-compatible child seat in either outer second row seat:

1. Move the seat belt buckle or tongue away from the lower anchors.
2. Make sure there are no objects near the anchors that could prevent a secure connection between the child seat and the anchors.

CONTINUED

Installing a Child Seat

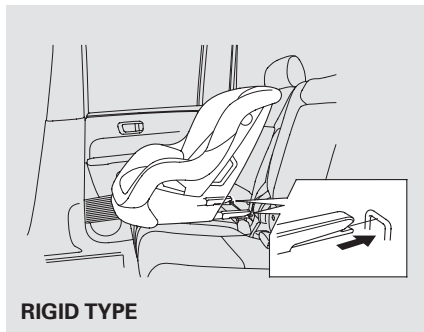

3. Place the child seat on the vehicle seat, then attach the seat to the lower anchors according to the child seat maker's instructions.

Some LATCH-compatible seats have a rigid-type connector as shown above.

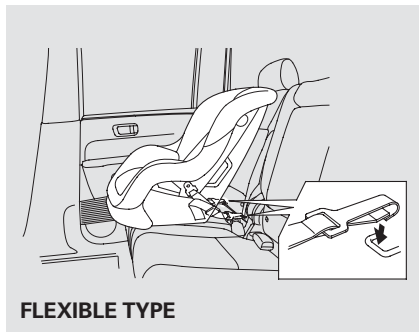

- Other LATCH-compatible seats have a flexible-type connector as shown above.
4. Whatever type you have, follow the child seat maker's instructions for adjusting or tightening the fit.

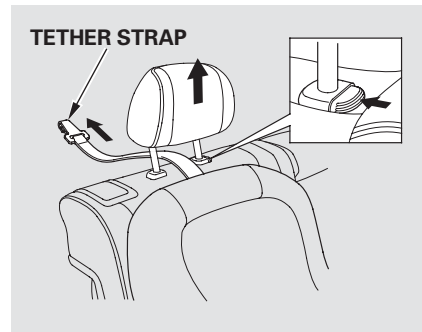

5. Lift the head restraint (see page [157](#)), then route the tether strap through the legs of the head restraint and over the seat-back, making sure the strap is not twisted.

Installing a Child Seat

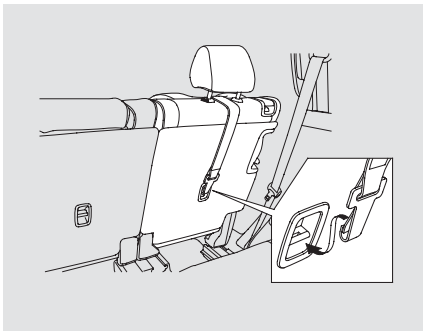

6. Attach the tether strap hook to the tether anchor, then tighten the strap as instructed by the child seat maker.
7. Push and pull the child seat forward and from side-to-side to verify that it is secure.

Using the Center LATCH

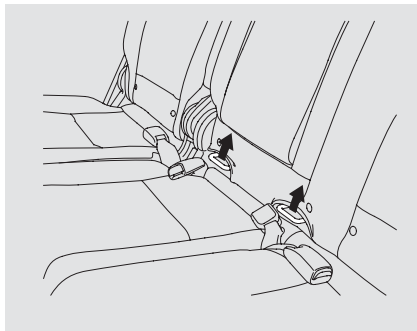

To install a LATCH-compatible child seat in the center seating position on the second row seat, use the center lower anchors as shown above.

1. Unlatch the detachable seat belt anchor latch and retract the seat belt all the way into the ceiling. Place the latch plate and anchor latch in their holding slots (see page [162](#)).

2. Follow step 1 through 4 as described previously to secure the child seat.
3. Lower the head restraint first. Route the tether strap over the head restraint and seat-back, then attach the tether strap hook to the anchor, making sure the strap is not twisted.
4. Push and pull the child seat forward and from side-to-side to verify that it is secure.

CONTINUED

Installing a Child Seat

To install a LATCH-compatible child seat in the passenger's side seating position of the third row:

1. Unlatch the detachable seat belt anchor latch and retract the seat belt all the way into the passenger's side panel. Place the latch plate and anchor latch in their holding slots (see page [163](#)).

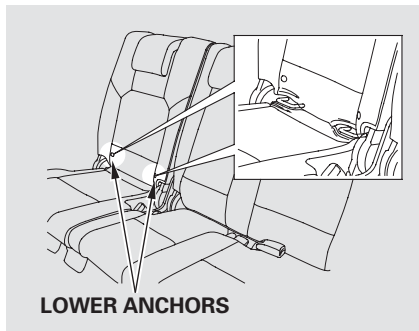

The location of each lower anchor is indicated by a small button above the anchor point.

You can find lower anchors in the slits in the seat-backs.

2. Follow steps 1 through 4 of the second row installation on pages [49](#) and [50](#).

3. Lower the head restraint first. Route the tether strap over the head restraint and seat-back, then attach the tether strap hook to the anchor, making sure the strap is not twisted.
4. Push and pull the child seat forward and from side-to-side to verify that it is secure.

Installing a Child Seat

Installing a Child Seat with a Lap/Shoulder Belt

When not using the LATCH system, all child seats must be secured to the vehicle with the lap part of a lap/shoulder belt.

In addition, the lap/shoulder belts in all seating positions except the driver's have a lockable retractor that must be activated to secure a child seat.

If you intend to install a child seat in the center seating position of the second row or in the third row, make sure the detachable seat belt is securely latched (see page [163](#)).



1. With the child seat in the desired seating position, route the belt through the child seat according to the seat maker's instructions, then insert the latch plate into the buckle and remove any slack from the lap portion of the belt.

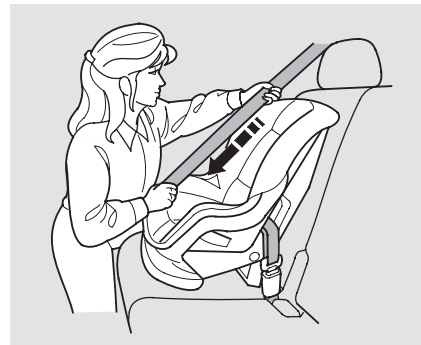

2. To activate the lockable retractor, slowly pull the shoulder part of the belt all the way out until it stops, then let the belt feed back into the retractor.

3. After the belt has retracted, tug on it. If the belt is locked, you will not be able to pull it out. If you can pull the belt out, it is not locked, and you will need to repeat these steps.

CONTINUED

Installing a Child Seat



4. After confirming that the belt is locked, grab the shoulder part of the belt near the buckle, and pull up to remove any slack from the lap part of the belt. Remember, if the lap part of the belt is not tight, the child seat will not be secure.

To remove slack, it may help to put weight on the child seat, or push on the back of the seat while pulling up on the belt.



5. Push and pull the child seat forward and from side-to-side to verify that it is secure enough to stay upright during normal driving maneuvers. If the child seat is not secure, unlatch the belt, allow it to retract fully, then repeat these steps.

To deactivate the lockable retractor and remove a child seat, unlatch the buckle, unrout the seat belt, and let the belt fully retract.

Installing a Child Seat with a Tether

A child seat with a tether can be installed in any seating position in the second or third row.

Since a tether can provide additional security to the lap/shoulder belt installation, we recommend using a tether whenever one is required or available.

Installing a Child Seat

Second Row Installation

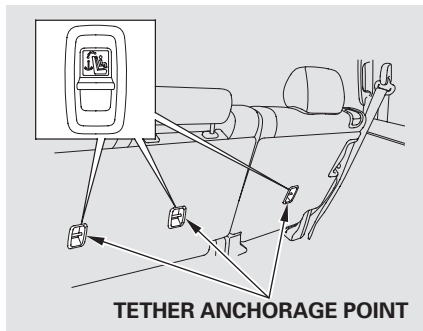

Each second row seat has a tether anchorage point behind the seat-back.

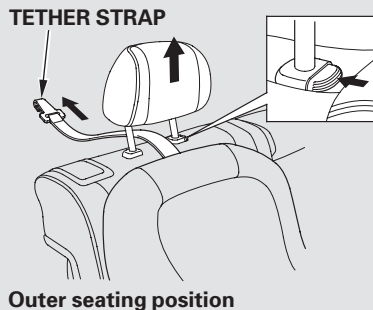

1. After properly securing the child seat (see page 53), lift the head restraint, then route the tether strap over the seat-back and through the head restraint legs.

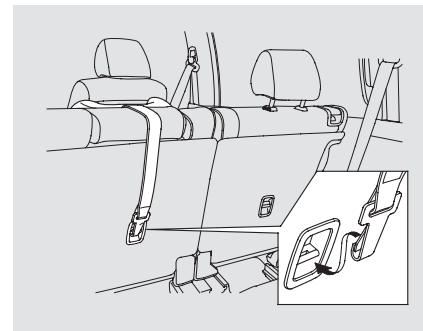

For the center seat, lower the head restraint, then route the tether strap over the head restraint and seat-back.

CONTINUED

Installing a Child Seat

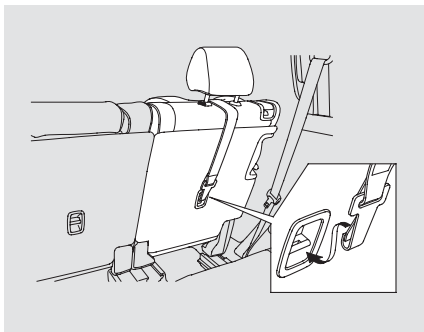

2. Attach the tether strap hook to the anchor, making sure the tether strap is not twisted.
3. Tighten the strap according to the seat maker's instructions.

Third Row Installation



Each third row seat has a tether anchorage point behind the seat-back.

1. After properly securing the child seat (see page 53), lower the head restraint.

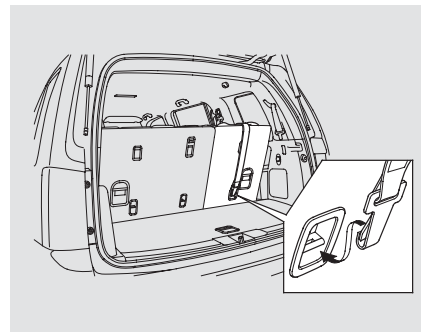

2. Route the tether strap over the head restraint, then attach the tether strap hook to the anchor, making sure the strap is not twisted.
3. Tighten the strap according to the seat maker's instructions.

Protecting Larger Children

When a child reaches the recommended weight or height limit for a forward-facing child seat, the child should sit in a back seat on a booster seat and wear the lap/shoulder belt.

The following pages give instructions on how to check proper seat belt fit, what kind of booster seat to use if one is needed, and important precautions for a child who must sit in front.

⚠ WARNING

Allowing a child age 12 or under to sit in front can result in injury or death if the passenger's front airbag inflates.

If a child must ride in front, move the vehicle seat as far back as possible, use a booster seat if needed, have the child sit up properly and wear the seat belt properly.

Checking Seat Belt Fit

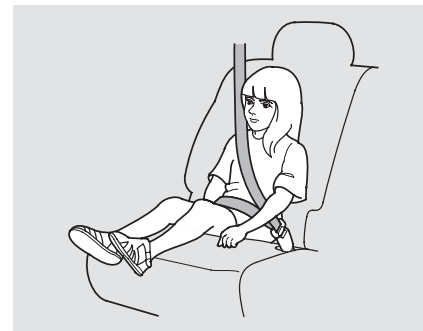

To determine if a lap/shoulder belt properly fits a child, have the child put on the seat belt, then ask yourself:

1. Does the child sit all the way back against the seat?
2. Do the child's knees bend comfortably over the edge of the seat?

CONTINUED

Protecting Larger Children

3. Does the shoulder belt cross between the child's neck and arm?
4. Is the lap part of the belt as low as possible, touching the child's thighs?
5. Will the child be able to stay seated like this for the whole trip?

If you answer yes to all these questions, the child is ready to wear the lap/shoulder belt correctly. If you answer no to any question, the child needs to ride on a booster seat.

Using a Booster Seat



A child who has outgrown a forward-facing child seat should ride in a back seat and use a booster seat until the lap/shoulder belt fits them properly without the booster.

Some states, Canadian provinces and territories also require children to use a booster seat until they reach a given age or weight (e.g., 6 years or 60 lbs). Be sure to check current laws in the states, provinces or territories where you intend to drive.

Booster seats can be high-back or low-back. Whichever style you select, make sure the booster seat meets federal safety standards (see page [47](#)) and that you follow the booster seat maker's instructions.

If a child who uses a booster seat must ride in front, move the vehicle seat as far back as possible and be sure the child is wearing the seat belt properly.

A child may continue using a booster seat until the tops of their ears are even with the top of the vehicle's or booster's seat-back. A child of this height should be tall enough to use the lap/shoulder belt without a booster seat.

When Can a Larger Child Sit in Front

The National Highway Traffic Safety Administration and Transport Canada recommend that all children age 12 and under be properly restrained in a back seat.

If the passenger's front airbag inflates in a moderate to severe frontal collision, the airbag can cause serious injuries to a child who is unrestrained, improperly restrained, sitting too close to the airbag, or out of position.

A side airbag also poses risks. If any part of a larger child's body is in the path of a deploying side airbag, the child could receive possibly serious injuries.

Of course, children vary widely. And while age may be one indicator of when a child can safely ride in front, there are other important factors you should consider.

Physical Size

Physically, a child must be large enough for the lap/shoulder belt to properly fit (see pages 17 and 57). If the seat belt does not fit properly, with or without the child sitting on a booster seat, the child should not sit in front.

Maturity

To safely ride in front, a child must be able to follow the rules, including sitting properly, and wearing the seat belt properly throughout a ride.

CONTINUED

Protecting Larger Children

If you decide that a child can safely ride up front, be sure to:

- Carefully read the owner's manual, and make sure you understand all seat belt instructions and all safety information.
- Move the vehicle seat to the rear-most position.
- Have the child sit up straight, back against the seat, and feet on or near the floor.
- Check that the child's seat belt is properly and securely positioned.
- Supervise the child. Even mature children sometimes need to be reminded to fasten the seat belts or sit properly.

Additional Safety Precautions

- ***Do not let a child wear a seat belt across the neck.*** This could result in serious neck injuries during a crash.
- ***Do not let a child put the shoulder part of a seat belt behind the back or under the arm.*** This could cause very serious injuries during a crash. It also increases the chance that the child will slide under the belt in a crash and be injured.
- ***Two children should never use the same seat belt.*** If they do, they could be very seriously injured in a crash.

- ***Do not put any accessories on a seat belt.*** Devices intended to improve a child's comfort or reposition the shoulder part of a seat belt can make the belt less effective and increase the chance of serious injury in a crash.

Your vehicle's exhaust contains carbon monoxide gas. Carbon monoxide should not enter the vehicle in normal driving if you maintain your vehicle properly and follow the information on this page.

Have the exhaust system inspected for leaks whenever:

- The vehicle is raised for an oil change.
- You notice a change in the sound of the exhaust.
- The vehicle was in a crash that may have damaged the underside.

WARNING

Carbon monoxide gas is toxic. Breathing it can cause unconsciousness and even kill you.

Avoid any enclosed areas or activities that expose you to carbon monoxide.

High levels of carbon monoxide can collect rapidly in enclosed areas, such as a garage. Do not run the engine with the garage door closed. Even with the door open, run the engine only long enough to move the vehicle out of the garage.

With the tailgate/glass hatch open, airflow can pull exhaust gas into your vehicle's interior and create a hazardous condition. If you must drive with the tailgate/glass hatch open, open all the windows and set the heating and cooling system/climate control system as shown below.

If you must sit in your parked vehicle with the engine running, even in an unconfined area, adjust the heating and cooling system/climate control system as follows:

1. Select the fresh air mode.
2. Select the  mode.
3. Turn the fan on high speed.
4. Set the temperature control to a comfortable setting.

Safety Labels

These labels are in the locations shown. They warn you of potential hazards that could cause serious injury or death. Read these labels carefully.

If a label comes off or becomes hard to read (except for the U.S. dashboard label which may be removed by the owner), contact your dealer for a replacement.

DASHBOARD

U.S. models only

This Vehicle is Equipped with
Advanced Air Bags

Even with Advanced Air Bags

Children can be killed or seriously injured by the air bag.
The back seat is the safest place for children.
Never put a rear-facing child seat in the front.
Always use seat belts and child restraints.
See owner's manual for more information about air bags.

To be removed by owner only.

RADIATOR CAP

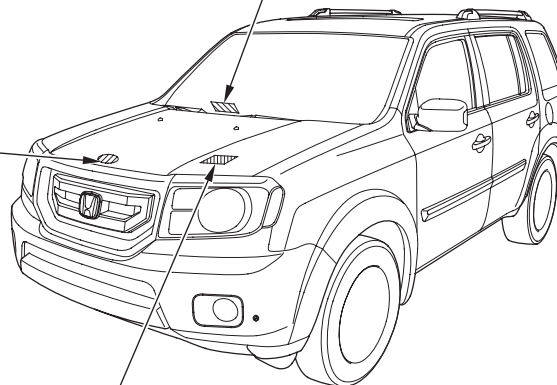

BATTERY LABEL

SUN VISOR

U.S. models

▲ WARNING

EVEN WITH ADVANCED AIR BAGS



- Children can be killed or seriously injured by the air bag.
- The back seat is the safest place for children.
- Never put a rear-facing child seat in the front.
- Always use seat belts and child restraints.
- See owner's manual for more information about air bags.

AIR BAG WARNING

FLIP VISOR OVER



Canadian models

<p>CAUTION</p> <p>TO AVOID SERIOUS INJURY, FOR MAXIMUM SAFETY PROTECTION IN ALL TYPES OF CRASHES, YOU MUST ALWAYS WEAR YOUR SAFETY BELT.</p> <ul style="list-style-type: none"> DO NOT INSTALL REARWARD FACING CHILD SEAT IN ANY POSITION. PRESELECTION REAR PROTECT SEAT BELT IS UNNECESSARILY. DO NOT PLACE ANY OBJECTS OVER THE AIR BAG OR BETWEEN THE AIR BAG AND YOURSELF. SEE THE OWNER'S MANUAL FOR FURTHER INFORMATION AND EXPLANATIONS. 	<p>PRECAUTIONS:</p> <p>POUR ÉVITER DES BLESSURES GRAVES:</p> <ul style="list-style-type: none"> POUR PROTÉGER D'UNE PROTECTION MAXIMALE, OBLIGÉ D'UNE COUROU-BONDE TOUJOURS VOTRE CEINTURE DE SÉCURITÉ. N'INSTALLEZ JAMAIS UN SIÈGE POUR ENFANT À L'ARRIÈRE FACÉ À L'ARRIÈRE SUR LE SIÈGE DE PASSAGER AVANT. NE VOUS APPUYEZ PAS SUR UN OBJET ASSÉYÉ PAR PRES DU COUSSIN D'ARRIÈRE. NE DÉPOSEZ AUCUN OBJET SUR LE COUSSIN D'ARRIÈRE DONT LE COUSSIN GONFLABLE ET VOUS. CONSULTEZ LE MANUEL DU PROPRIÉTAIRE POUR PLUS D'ÉCLAIRÉS RENSEIGNEMENTS.
--	--

U.S. models

▲ WARNING: HIGHER ROLLOVER RISK



Avoid Abrupt Maneuvers and Excessive Speed.

Always Buckle Up.

See Owner's Manual For Further Information.



DOORJAMBS

U.S. models

SIDE AIRBAG

- This car is equipped with side airbags in the front seats and side curtain airbags.
- Do not lean against the door.
- Do not lean against the door.
- See owner's manual for more information.

Canadian models

SIDE AIRBAG

- This car is equipped with side airbags in the front seats and side curtain airbags.
- Do not lean against the door.
- See owner's manual for more information.

COUSSIN GONFLABLE LATÉRAL

- Cette automobile est équipée de coussins gonflables latéraux dans les sièges avant ainsi que de coussins gonflables latéraux de type rideau.
- Ne vous appuyez pas sur la porte.
- Consultez le Manuel du propriétaire pour en savoir plus.

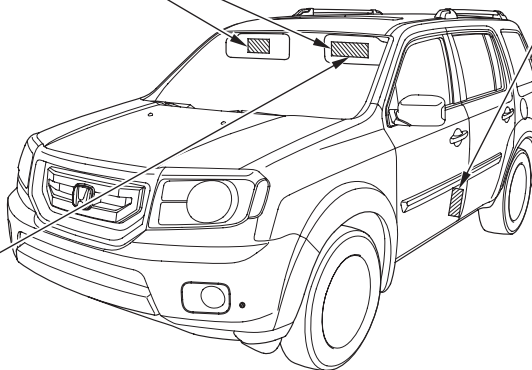

This section gives information about the controls and displays that contribute to the daily operation of your vehicle. All the essential controls are within easy reach.

Control Locations 66

Instrument Panel	67	Power Windows	165
Instrument Panel Indicators.....	69	Moonroof	168
Gauges	82	Parking Brake	169
Multi-Information Display	87	Mirrors	170
Controls Near the Steering		Driving Position Memory	
Wheel	123	System.....	173
Windshield Wipers and		Interior Lights.....	176
Washers.....	124	Interior Convenience Items.....	179
Rear Window Wiper and		Center Console	180
Washer.....	125	Console Compartments	180
Turn Signals and Headlights.....	126	Beverage Holders.....	181
Hazard Warning Button.....	130	Storage Compartment.....	182
Rear Window Defogger	130	Glove Box	183
Instrument Panel Brightness.....	131	Integrated Sunshades	183
Steering Wheel Adjustment	133	Sunglasses Holder	183
Keys and Locks.....	134	Conversation Mirror	184
Immobilizer System.....	135	Sun Visor	184
Ignition Switch	137	Vanity Mirror	185
Door Locks.....	138	Coat Hooks.....	185
Childproof Door Locks	144	Seat Under Tray	185
Tailgate and Glass Hatch.....	144	Accessory Power Sockets.....	186
Power Tailgate	145	AC Power Outlet.....	187
Remote Transmitter	150	Cargo Hooks	188
Seats	154	Cargo Floor Storage	
Detachable Anchor.....	162	Compartment	188
Seat Heaters	164	Cargo Net	189

Control Locations

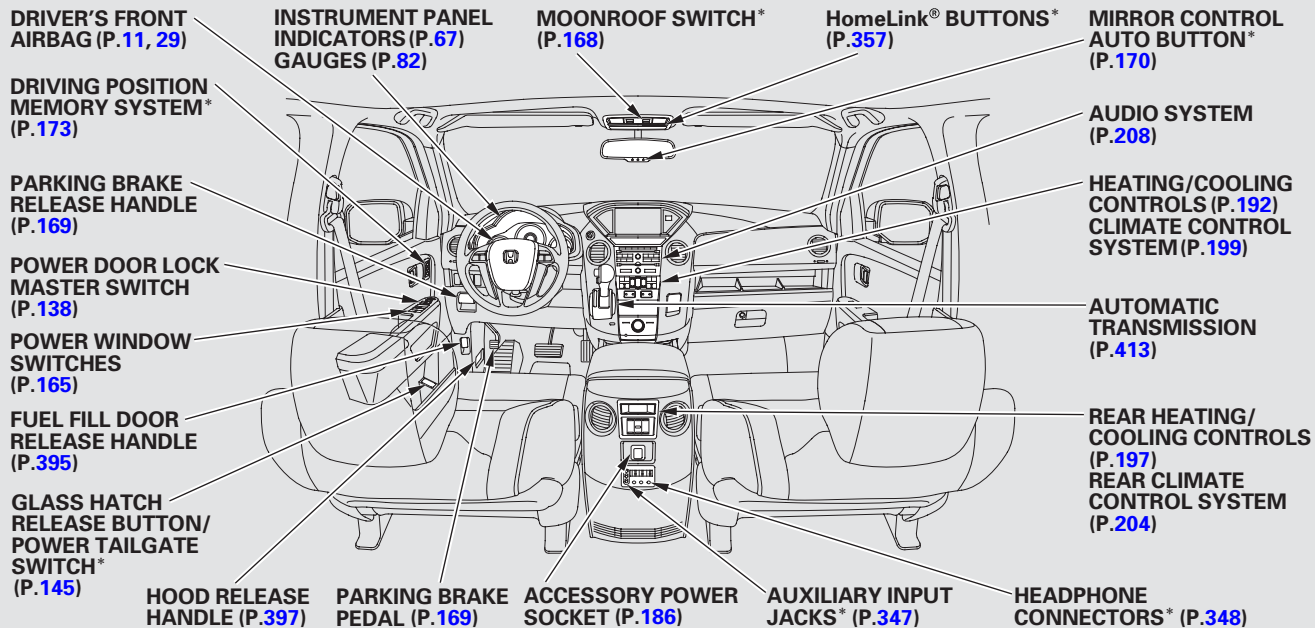

Vehicle with navigation system is shown.

*: If equipped

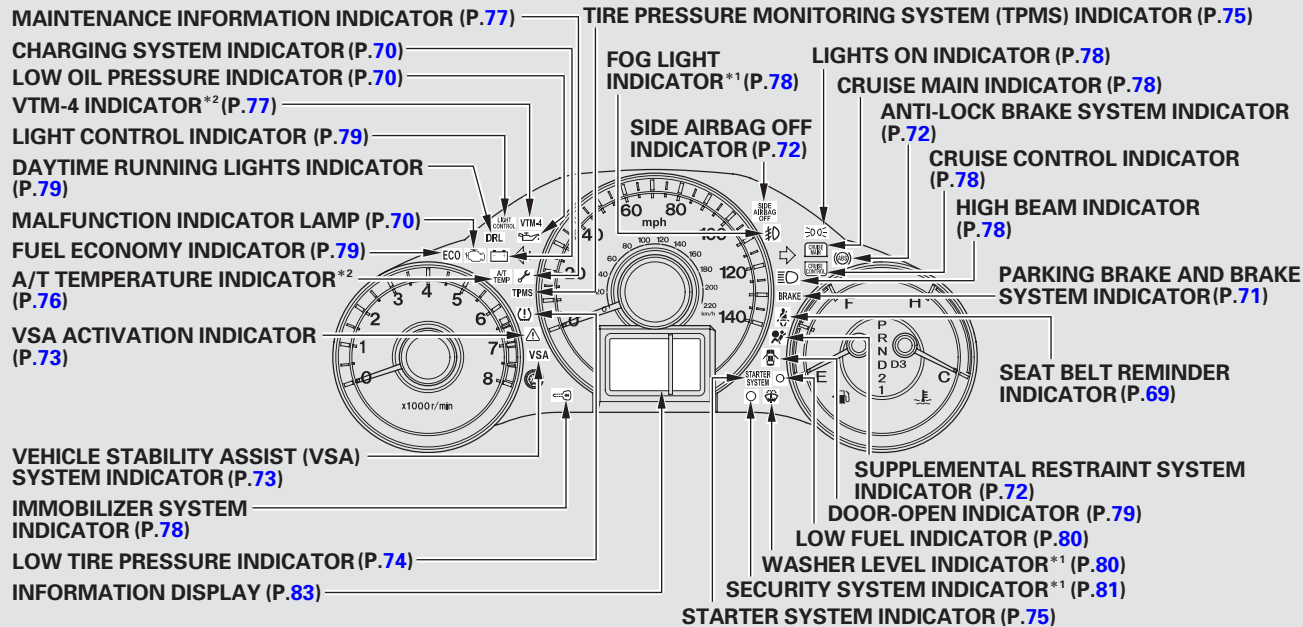
On vehicles without navigation system

*1 : If equipped

*2 : 4WD models only

The U.S. instrument panel is shown. Differences for the Canadian models are noted in the text.

Instrument Panel

On vehicles with navigation system

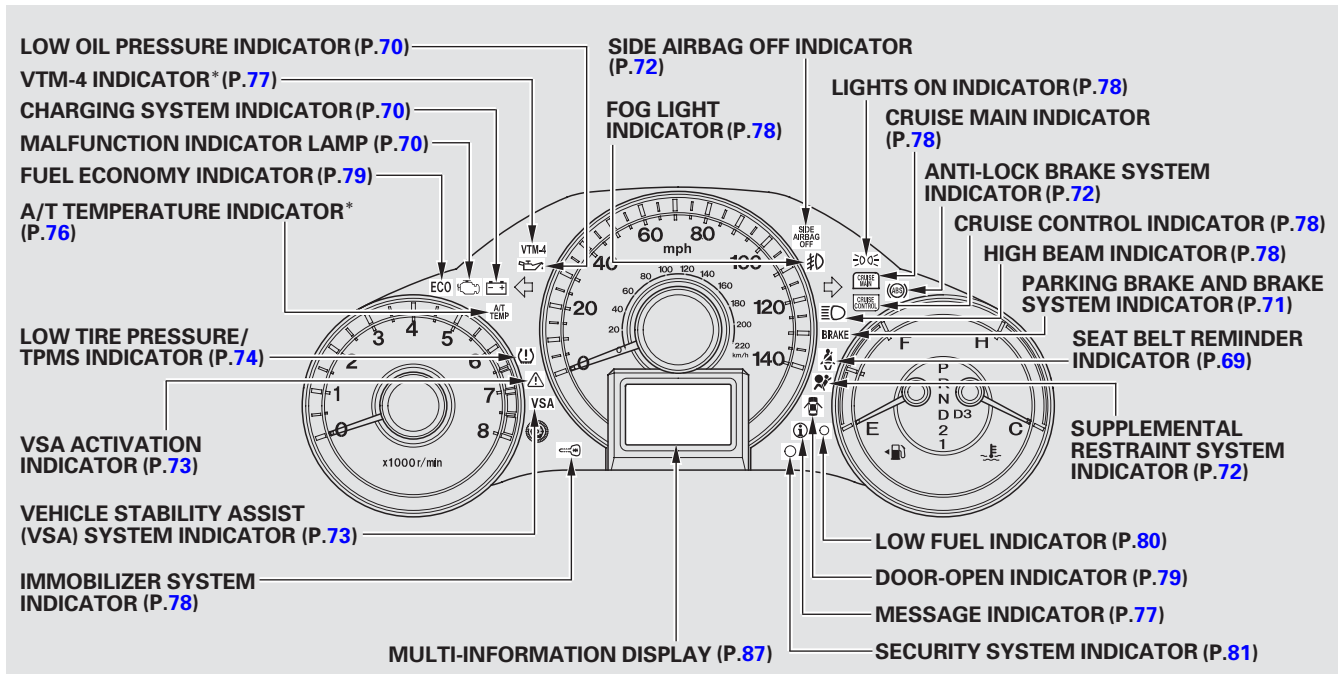

* : 4WD models only

The U.S. instrument panel is shown. Differences for the Canadian models are noted in the text.

The instrument panel has many indicators to give you important information about your vehicle.



Seat Belt Reminder Indicator

This indicator comes on when you turn the ignition switch to the ON (II) position. It reminds you and your passengers to fasten your seat belts. A beeper also sounds if you have not fastened your seat belt.

If you turn the ignition switch to the ON (II) position before fastening your seat belt, the beeper sounds, and the indicator flashes. If you do not fasten your seat belt before the beeper stops, the indicator stops flashing but remains on.

If your front passenger does not fasten their seat belt, the indicator comes on about 6 seconds after the ignition switch is turned to the ON (II) position.

If either of you do not fasten your seat belt while driving, the beeper will sound and the indicator will flash again at regular intervals. For more information, see page [22](#) .

On vehicles with navigation system
You will also see a “FASTEN SEAT BELT” or “FASTEN PASSENGER SEAT BELT” message on the multi-information display (see page [95](#)).

For more information, see page [22](#) .

Instrument Panel Indicators



Low Oil Pressure Indicator

The engine can be severely damaged if this indicator flashes or stays on when the engine is running. For more information, see page [521](#).

On vehicles with navigation system
You will also see a “CHECK ENGINE OIL LEVEL” message on the multi-information display (see page [95](#)).



Charging System Indicator

If this indicator comes on when the engine is running, the battery is not being charged. For more information, see page [521](#).

On vehicles with navigation system
You will also see a “CHECK CHARGING SYSTEM” message on the multi-information display (see page [95](#)).



Malfunction Indicator Lamp

For more information, see page [522](#).

On vehicles with navigation system
You will also see a “CHECK EMISSION SYSTEM” message on the multi-information display (see page [95](#)). For more information, see page [522](#).

U.S.

BRAKE

Canada



Parking Brake and Brake System Indicator (Red)

This indicator has two functions:

1. It comes on when you turn the ignition switch to the ON (II) position. It is a reminder to check the parking brake. A beeper sounds if you drive with the parking brake not fully released. Driving with the parking brake not fully released can damage the brakes and tires.

On vehicles with navigation system

You will also see a “RELEASE PARKING BRAKE” message on the multi-information display (see page [95](#)).

2. If it remains on after you have fully released the parking brake while the engine is running, or if it comes on while driving, there could be a problem with the brake system. For more information, see page [523](#) .

On vehicles with navigation system

You will also see a “LOW BRAKE FLUID” or “CHECK BRAKE SYSTEM” message on the multi-information display (see page [95](#)).

Instrument Panel Indicators



Supplemental Restraint System Indicator

This indicator comes on for several seconds when you turn the ignition switch to the ON (II) position. If it comes on at any other time, it indicates a potential problem with your front airbags. This indicator will also alert you to a potential problem with your side airbags, passenger's side airbag automatic cutoff system, side curtain airbags, automatic seat belt tensioners, driver's seat position sensor, or the front passenger's weight sensors. For more information, see page [35](#).

On vehicles with navigation system

You will also see a "CHECK AIRBAG SYSTEM" message on the multi-information display (see page [95](#)).

U.S.



Canada



Side Airbag Off Indicator

This indicator comes on for several seconds when you turn the ignition switch to the ON (II) position. If it comes on at any other time, it indicates that the passenger's side airbag has automatically shut off. For more information, see page [35](#).

On vehicles with navigation system

You will also see a "PASSENGER SIDE AIRBAG OFF" message on the multi-information display (see page [95](#)).



Anti-lock Brake System (ABS) Indicator

This indicator normally comes on for a few seconds when you turn the ignition switch to the ON (II) position, and when the ignition switch is turned to the START (III) position. If it comes on at any other time, there is a problem with the ABS. If this happens, have your vehicle checked at a dealer. With this indicator on, your vehicle still has normal braking ability but no anti-lock function. For more information, see page [429](#).

On vehicles with navigation system

You will also see a "CHECK ABS SYSTEM" message on the multi-information display (see page [95](#)).

VSA

Vehicle Stability Assist (VSA) System Indicator

This indicator normally comes on for a few seconds when you turn the ignition switch to the ON (II) position.

If it comes on and stays on at any other time, or if it does not come on when you turn the ignition switch to the ON (II) position, there is a problem with the VSA or Hill Start Assist systems. Take your vehicle to a dealer to have it checked. Without VSA, your vehicle still has normal driving ability, but will not have VSA traction and stability enhancement. See page 431 for more information on the VSA system.

On vehicles with navigation system

You will also see a “CHECK VSA SYSTEM” message on the multi-information display (see page 95).

**VSA Activation Indicator**

This indicator normally comes on for a few seconds when you turn the ignition switch to the ON (II) position. For more information, see page 431.

This indicator has three functions:

1. It comes on as a reminder that you have turned off the vehicle stability assist (VSA) system.
2. It flashes when VSA is active (see page 431).
3. It comes on along with the VSA system indicator if there is a problem with the VSA or Hill Start Assist systems.

On vehicles with navigation system

You will also see a “CHECK VSA SYSTEM” message on the multi-information display (see page 95).

**Turn Signal and Hazard Warning Indicators**

The left or right turn signal indicator blinks when you signal a lane change or turn. If an indicator does not blink or blinks rapidly, it usually means one of the turn signal bulbs is burned out (see page 484). Replace the bulb as soon as possible, since other drivers cannot see that you are signaling.

When you press the hazard warning button, both turn signal indicators and all turn signals on the outside of the vehicle flash.

Instrument Panel Indicators



Low Tire Pressure Indicator

On vehicles without navigation system

This indicator normally comes on for a few seconds when you turn the ignition switch to the ON (II) position. If it comes on while driving, it indicates that one or more of your vehicle's tires are significantly low on pressure.

If this happens, pull to the side of the road when it is safe, check which tire has lost the pressure, and determine the cause. If it is because of a flat tire, replace the flat tire with the compact spare (see page [508](#)), and have the flat tire repaired as soon as possible. If two or more tires are underinflated, call a professional towing service (see page [531](#)). For more information, see page [420](#).



Low Tire Pressure/TPMS Indicator

On vehicles with navigation system

This indicator normally comes on for a few seconds when you turn the ignition switch to the ON (II) position.

This indicator has two functions:

1. If it comes on while driving, it indicates that one or more of your vehicle's tires are significantly low on pressure.

You will also see a “CHECK TIRE PRESSURE” message on the multi-information display (see page [96](#)).

Check the tire pressure monitor on the multi-information display and determine the cause (see page [424](#)).

If this happens, pull to the side of the road when it is safe, check which tire has lost pressure on the multi-information display, and determine the cause. If it is because of a flat tire, have the flat tire repaired as soon as possible. If two or more tires are underinflated, call a professional towing service. For more information, see page [531](#).

2. If this indicator begins to flash, there is a problem with the tire pressure monitoring system (TPMS). You will also see a “CHECK TPMS SYSTEM” message on the multi-information display. The indicator continues to flash for a while (approximately 1 minute), then stays on. If this happens, have your dealer check the system as soon as possible. For more information, see page [426](#).

U.S. **Canada**

STARTER
SYSTEM



Starter System Indicator

On vehicles without navigation system
This indicator comes on when there is a problem with the starter system. For more information, see page [411](#).

On vehicles with navigation system
If you see a “CHECK STARTER SYSTEM” message on the multi-information display, there is a problem with the starter system (see page [96](#)).

TPMS

Tire Pressure Monitoring System (TPMS) Indicator

On vehicles without navigation system
This indicator normally comes on for a few seconds when you turn the ignition switch to the ON (II) position.

If this indicator comes on and stays on at any other time, or if it does not come on when you turn the ignition switch to the ON (II) position, there is a problem with the TPMS. With this indicator on, the low tire pressure indicator and the tire pressure monitor will not come on when a tire loses pressure. Take the vehicle to your dealer to have the system checked.

Instrument Panel Indicators

A/T
TEMP

A/T Temperature Indicator

4WD models only

This indicator monitors the temperature of the automatic transmission fluid. It should come on for a few seconds when you turn the ignition switch to the ON (II) position. If it comes on while driving, it means the transmission fluid temperature is too high. Pull to the side of the road when it is safe, shift to Park, and let the engine idle until the indicator goes out.

On 4WD models with navigation system
You will also see an “A/T TEMP HIGH” message on the multi-information display (see page [96](#)).

NOTICE

Continuing to drive with the A/T temperature indicator on may cause serious damage to the transmission.

**Maintenance Information Indicator**

On vehicles without navigation system

This indicator comes on for a few seconds when you turn the ignition switch to the ON (II) position. It reminds you that it is time to take your vehicle in for scheduled maintenance. The maintenance main items and sub items will be displayed in the information display. See page [455](#) for more information on the maintenance information.

This indicator goes off when your dealer resets it after completing the required maintenance service.

**Message Indicator**

On vehicles with navigation system

This indicator comes on when there is a system message on the multi-information display. Press the INFO button on the steering wheel (see page [87](#)) to see the message (see page [94](#)).

Most of the time, this indicator comes on along with other indicators in the instrument panel such as the seat belt reminder indicator, SRS indicator, VSA system indicator, etc.

VTM-4

VTM-4 Indicator

4WD models only

This indicator normally comes on for a few seconds when you turn the ignition switch to the ON (II) position. If it comes on at any other time, there is a problem in the 4WD system. Take the vehicle to your dealer to have it checked.

If the indicator blinks while driving, the VTM-4 fluid temperature is too high. Pull to the side of the road when it is safe, shift to Park, and let the engine idle until the indicator goes out.

NOTICE

Continuing to drive with the VTM-4 indicator blinking may cause serious damage to the system.

Instrument Panel Indicators





Immobilizer System Indicator

This indicator comes on briefly when you turn the ignition switch to the ON (II) position. It will then go off if you have inserted a properly coded ignition key. If it is not a properly coded key, the indicator will blink, and the engine's fuel system will be disabled (see page [135](#)).



Lights On Indicator

This indicator reminds you that the exterior lights are on. It comes on when the light switch is in either the  or  position. This indicator will also come on when the light switch is in AUTO and the lights turn on automatically. If you turn the ignition switch to the ACCESSORY (I) or the LOCK (0) position without turning off the light switch, this indicator will remain on. A reminder chime will also sound when you open the driver's door.



Fog Light Indicator

Except LX models

This indicator comes on when you turn on the fog lights. For more information, see page [128](#).



High Beam Indicator

This indicator comes on with the high beam headlights. For more information, see page [126](#).



Cruise Main Indicator

This indicator comes on when you turn on the cruise control system by pressing the CRUISE button (see page [350](#)).



Cruise Control Indicator

This indicator comes on when you set the cruise control. See page [350](#) for information on operating the cruise control.

LIGHT
CONTROL**Light Control Indicator**

On vehicles without navigation system
This indicator normally comes on for a few seconds when you turn the ignition switch to the ON (II) position. If it comes on at any other time, there is a problem with the automatic lighting control system. Have your vehicle checked by your dealer as soon as possible.

On vehicles with navigation system
If you see a “CHECK LIGHT CONTROL SYSTEM” message on the multi-information display, there is a problem with the automatic headlight control system. Take your vehicle to a dealer to have it checked.

DRL

Daytime Running Lights Indicator

On vehicles without navigation system
If this indicator comes on when the ignition switch is turned to the ON (II) position and the parking brake is released, it means there is a problem in the high beam headlight’s circuit. Have your vehicle checked by your dealer.

On vehicles with navigation system
If you see a “CHECK DRL SYSTEM” message on the multi-information display, there is a problem with the daytime running light system. Take your vehicle to a dealer to have it checked.

ECO

Fuel Economy Indicator

While the engine is operating in its most economical range, this indicator may come on and stay on. It goes off when your vehicle uses extra fuel.

**Door-open Indicator**

This indicator comes on if any door is not closed tightly.

Instrument Panel Indicators



Washer Level Indicator

If equipped

This indicator comes on when the washer fluid level is low. Add washer fluid when you see this indicator come on (see page [477](#)).

On 4WD models with navigation system

You will see a “LOW WASHER FLUID” message on the multi-information display (see page [96](#)).

Low Fuel Indicator

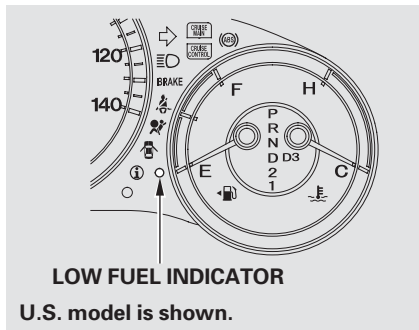

This indicator comes on as a reminder that you must refuel soon.

When the indicator comes on, there are about 2.9 U.S. gal (10.8 ℓ) of fuel remaining in the tank.

When the needle reaches E, there is a very small amount of fuel in the tank.

On vehicles with navigation system
You will also see a “LOW FUEL” message on the multi-information display.

Security System Indicator

Except LX models

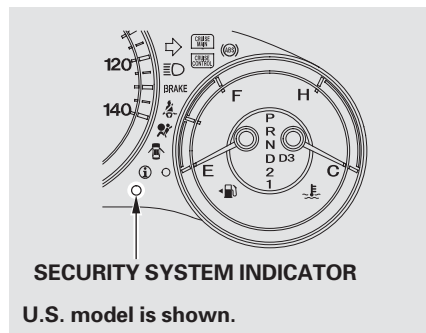

This indicator comes on when the security system is set. See page [349](#) for more information on the security system.

Door, Glass Hatch, and Tailgate Open Indicator

On vehicles without navigation system



Your vehicle has a door, glass hatch, and tailgate open indicator on the information display. If any door(s), the glass hatch, or the tailgate is not closed tightly, the appropriate light/lights will come on to remind you to close the tailgate, the glass hatch or the door(s).

On vehicles with navigation system

The door, glass hatch, and tailgate open indicator appears on the multi-information display (see page [13](#)).



Tire Pressure Monitor

On vehicles without navigation system

The appropriate tire indicator will come on along with the low tire pressure indicator if a tire is significantly underinflated or has suddenly lost pressure. See **Low Tire Pressure Indicator** for what to do if this indicator comes on.

On vehicles with navigation system

This indicator is displayed as the system message on the multi-information display (see page [424](#)).

Gauges

On vehicles without navigation system

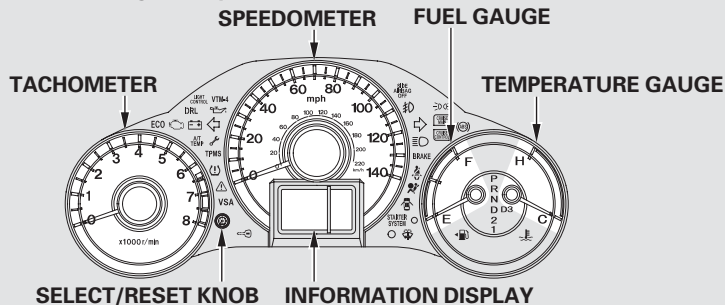

On vehicles with navigation system

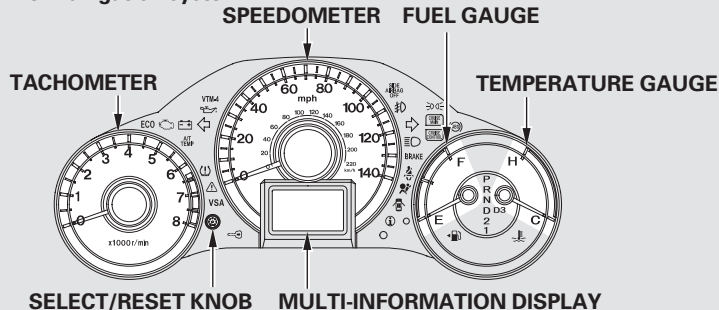

U.S. models are shown.

Temperature Gauge

This shows the temperature of the engine's coolant. During normal operation, the pointer should rise to about the middle of the gauge. In severe driving conditions, the pointer may rise to the upper zone. If it reaches the red (hot) mark, pull safely to the side of the road. For instructions and precautions on checking the engine's cooling system, see page [519](#).

Fuel Gauge

This shows how much fuel you have. It may show slightly more or less than the actual amount.

NOTICE

Avoid driving with an extremely low fuel level. Running out of fuel could cause the engine to misfire, damaging the catalytic converter.

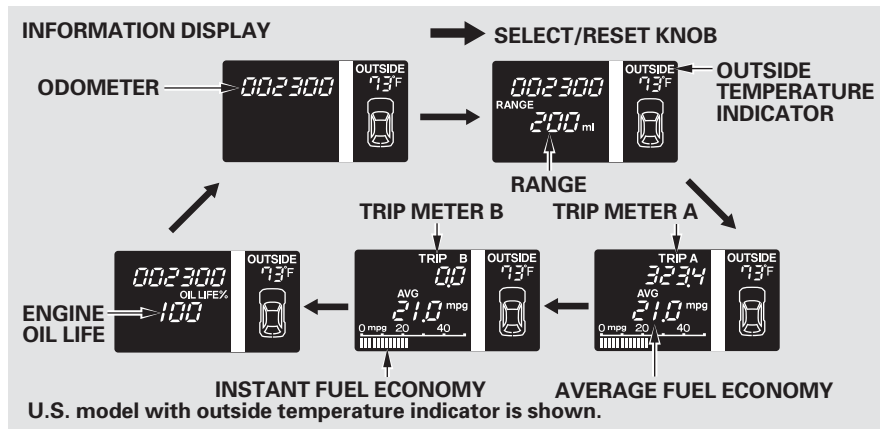

Information Display

On vehicles without navigation system
The information display shows the odometer, trip meter, engine oil life, outside temperature (if equipped), instant fuel economy, average fuel economy, range (estimated distance), and maintenance item code(s).

To switch the display, press and release the select/reset knob repeatedly. When you turn the ignition switch to the ON (II) position, your last selection is displayed.

On vehicles with navigation system
For information about the multi-information display, see page 87.

Odometer

The odometer shows the total distance your vehicle has been driven. It measures miles in U.S. models and kilometers in Canadian models. It is illegal under U.S. federal law and Canadian provincial/territorial regulations to disconnect, reset, or alter the odometer with the intent to change the number of miles or kilometers indicated.

Trip Meter

This meter shows the number of miles (U.S.) or kilometers (Canada) driven since you last reset it. There are two trip meters: Trip A and Trip B. Switch between these displays by pressing the select/reset knob repeatedly. Each trip meter works independently, so you can keep track of two different distances. To reset a trip meter, display it, and then press and hold the select/reset knob until the number resets to "0.0".

Gauges

Instant Fuel Economy

This display shows the instant fuel economy you are getting.

It shows the number of mpg (U.S.) or l/100 km (Canada).

Average Fuel Economy

When either of the trip meters (trip A or B) is displayed, your vehicle's average fuel economy since you last reset that trip meter can be shown on the information display (mpg on U.S. models and l/100 km on Canadian models). This number is updated once per 10 seconds. To see the average fuel economy, press and release the select/reset knob repeatedly.

When you reset a trip meter, the average fuel economy for that trip meter also resets.

Range (Estimated Distance)

This display shows the estimated distance you can travel on the fuel remaining in the tank.

This distance is estimated from the fuel economy you have achieved over the last few miles (kilometers), so it will vary with changes in speed, traffic condition, etc.

Outside Temperature Indicator

Except LX models

This indicator displays the outside temperature in Fahrenheit (U.S. models) or Celsius (Canadian models).

The temperature sensor is in the front bumper. The temperature reading can be affected by heat reflection from the road surface, engine heat, and the exhaust from surrounding traffic. This can cause an incorrect temperature reading when your vehicle speed is under 19 mph (30 km/h). When you start your trip, the sensor is not fully acclimatized, therefore it may take several minutes until the proper temperature is displayed.

In certain weather conditions, temperature readings near freezing (32°F, 0°C) could mean that ice is forming on the road surface.

If the outside temperature is incorrectly displayed, you can adjust it up to $\pm 5^{\circ}\text{F}$ in U.S. models ($\pm 3^{\circ}\text{C}$ in Canadian models) warmer or cooler.

NOTE: The temperature must be stabilized before doing this procedure.

To adjust the outside temperature indicator, press and hold the select/reset knob for 10 seconds. The following sequence will appear for 1 second each: 0, 1, 2, 3, 4, 5, -5, -4, -3, -2, -1, 0 (U.S.) or 0, 1, 2, 3, -3, -2, -1, 0 (Canada).

When the temperature reaches the desired value, release the select/reset knob. You should see the new outside temperature displayed.

Gauges

Maintenance Information

The information display in the instrument panel shows you the engine oil life and maintenance service items when the ignition switch is in the ON (II) position. This information helps to keep you aware of the periodic maintenance your vehicle needs for continued trouble-free driving. Refer to page [455](#) for more information.

Check Fuel Cap Message

Your vehicle's onboard diagnostic system will detect a loose or missing fuel fill cap as an evaporative system leak. The first time a leak is detected a "CHECK FUEL CAP" message appears on the information display.

Turn the engine off, and confirm the fuel fill cap is installed. If it is, loosen it, then retighten it until it clicks at least once. The message should go off after several days of normal driving once you tighten or replace the fuel fill cap. To scroll to another display, press the select/reset knob.

The "CHECK FUEL CAP" message will appear each time you restart the engine until the system turns the message off.

If the system still detects a leak in your vehicle's evaporative emissions system, the malfunction indicator lamp (MIL) comes on. If the fuel fill cap was not already tightened, turn the engine off, and check or retighten the fuel fill cap until it clicks at least once. The MIL should go off after several days of normal driving once the cap is tightened or replaced. If the MIL does not go off, have your vehicle inspected by a dealer. For more information, see page [522](#).

Multi-Information Display

On vehicles with navigation system

The multi-information display in the instrument panel displays various information and messages when the ignition switch is in the ON (II) position. Some of the messages help you operate your vehicle more comfortably. Others help to keep you aware of the periodic maintenance your vehicle needs for continued trouble-free driving.

When you open the driver's door, a "Welcome" message is shown on the multi-information display.

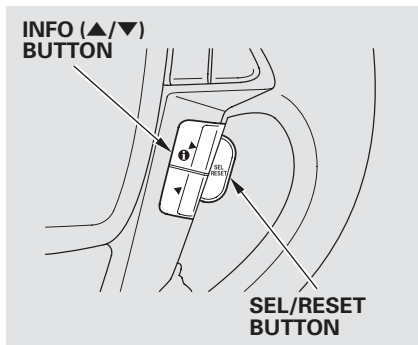

To change the display, press the INFO (▲/▼) button on the steering wheel repeatedly until the main menu appears (see page 88).

You can also change the display by pressing the select/reset knob in the instrument panel.

With the ignition switch in the ON (II) position, the multi-information display changes as shown on the next page each time you press the INFO (▲/▼) button or the SEL/RESET button.

When you turn the ignition switch to the ON (II) position, your last selection is displayed.

In the multi-information display, the system message is also displayed (see page 94) and you can customize your vehicle control settings (see page 97).

CONTINUED

Multi-Information Display

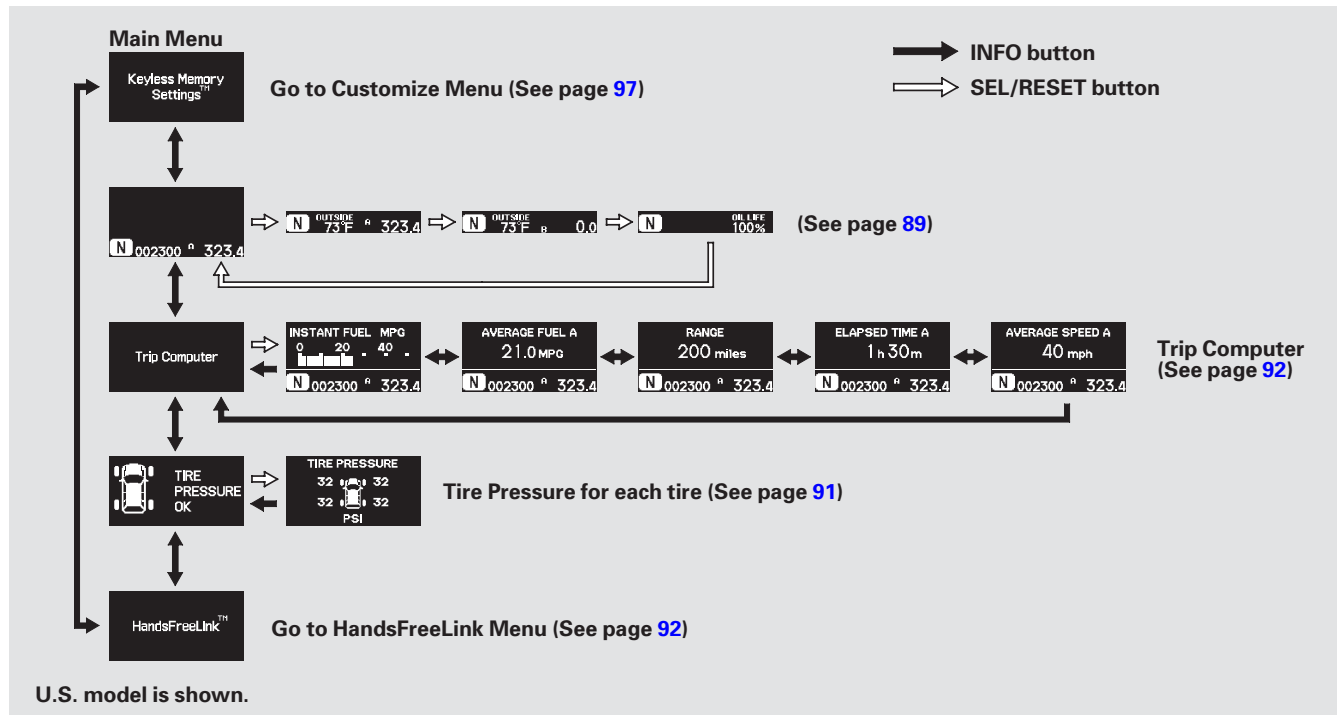

Multi-Information Display

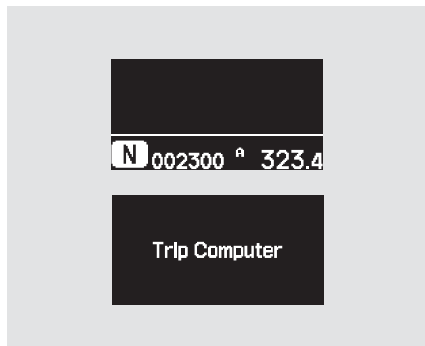

When the main menu is blank or Trip Computer is displayed, pressing the SEL/RESET button changes the display to “odometer/trip meter” “outside temperature/trip meter” and “engine oil life.”

Odometer

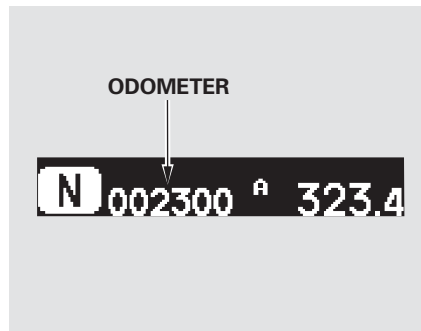

The odometer shows the total distance your vehicle has been driven. It measures miles in U.S. models and kilometers in Canadian models. It is illegal under U.S. federal law and Canadian provincial/territorial regulations to disconnect, reset, or alter the odometer with the intent to change the number of miles or kilometers indicated.

Trip Meter

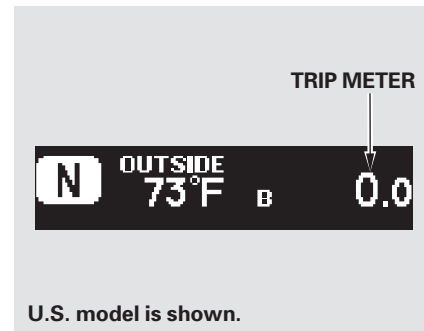

This meter shows the number of miles (U.S.) or kilometers (Canada) driven since you last reset it. There are two trip meters: Trip A and Trip B. Each trip meter works independently, so you can keep track of two different distances.

To reset a trip meter, display it, and then press and hold the SEL/RESET button until the number resets to “0.0.”

CONTINUED

Multi-Information Display

When you reset Trip A, AVERAGE FUEL A, AVERAGE SPEED A, and ELAPSED TIME A are reset at the same time. When you reset Trip B, AVERAGE FUEL B, AVERAGE SPEED B, and ELAPSED TIME B are reset.

You can customize the Trip A, AVERAGE FUEL A, AVERAGE SPEED A, and ELAPSED TIME A reset condition on the multi-information display (see page [106](#)).

Compass

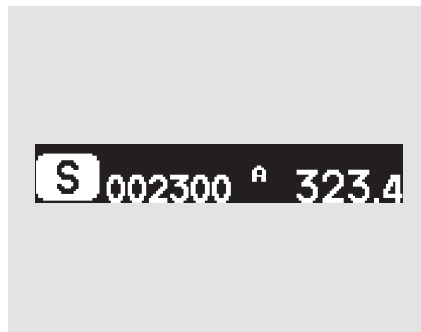

In the left corner of the lower segment, a compass indicates which direction your vehicle is pointed.

Outside Temperature

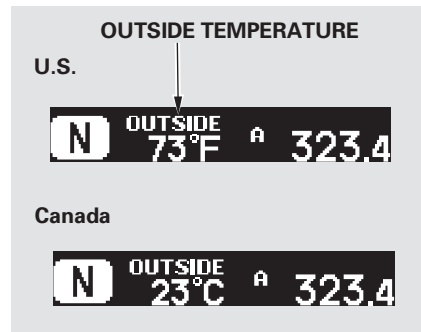

This shows the outside Fahrenheit temperature in U.S. models, and Celsius temperature in Canadian models.

The temperature sensor is in the front bumper. The temperature reading can be affected by heat reflection from the road surface, engine heat, and the exhaust from surrounding traffic. This can cause an incorrect temperature reading when your vehicle speed is under 19 mph (30 km/h). When you start your trip, the sensor is not fully acclimatized, therefore it may take several minutes until the proper temperature is displayed.

In certain weather conditions, temperature readings near freezing (32°F, 0°C) could mean that ice is forming on the road surface. You can adjust the outside temperature display (see page 105).

Engine Oil Life

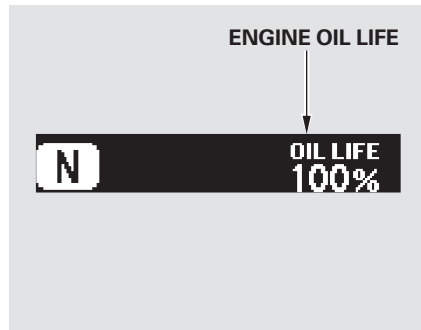

This shows the remaining life of the engine oil. It shows 100% after the engine oil is replaced and the display is reset. The engine oil life is calculated based on engine operating conditions and accumulated engine revolutions. For more information, see page 455.

Tire Pressure Monitor

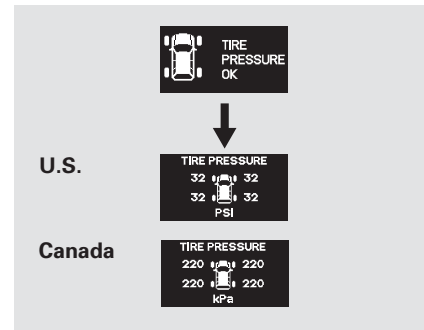

When the tire pressure monitor is shown on the multi-information display, press the SEL/RESET button. The display changes as shown.

You can see the pressure of each tire in this monitor. If one or more tires are low, inflate them to the correct pressure. For more information, see page 424.

Multi-Information Display

Bluetooth[®] HandsFreeLink[®]



You can receive or make phone calls from your cell phone through your vehicle's *Bluetooth*[®] HandsFreeLink[®] (HFL) system without touching your cell phone.

To use the system, your cell phone and the HFL system must be linked. Not all cell phones are compatible with this system. Refer to page [361](#) for instructions on how to link your cell phone to HFL and how to receive or make phone calls, or visit the handsfreelink.com website. In Canada, visit www.honda.ca, or call 1-(888) 9-HONDA-9.

Trip Computer

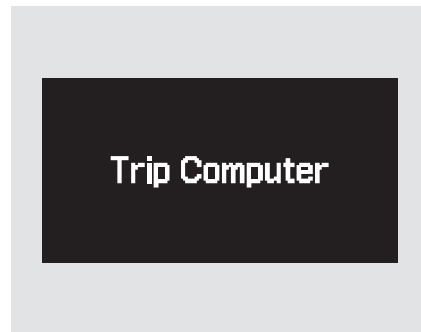

Along with the trip meter, the trip computer calculates these values:

- Instant Fuel Economy
- Average Fuel Economy
- Range
- Average Vehicle Speed
- Elapsed Time

INSTANT FUEL MPG (U.S. models)/INSTANT FUEL L/100 km (Canadian models)

This shows your instant fuel economy.

AVERAGE FUEL A/B

This shows your vehicle's average fuel economy in mpg (U.S. models) or liter/100 km (Canadian models) since you last reset Trip A or Trip B.

RANGE

This shows the estimated distance you can travel on the fuel remaining in the fuel tank. This distance is estimated from the fuel economy you received over the last several miles (U.S.) or kilometers (Canada), so it will vary with changes in speed, traffic, etc.

AVERAGE SPEED A/B

This shows the average speed you are traveling in miles per hour (mph) for U.S. models or kilometers per hour (km/h) for Canadian models.

ELAPSED TIME A/B

This shows the accumulated traveling time since you last reset it. When you turn the ignition switch to the ON (II) position, ELAPSED TIME is reset.

You can customize the TRIP A INFO (Trip A, AVERAGE FUEL A, ELAPSED TIME A, and AVERAGE SPEED A) reset condition in the multi-information display (see page [106](#)).

Multi-Information Display

System Messages

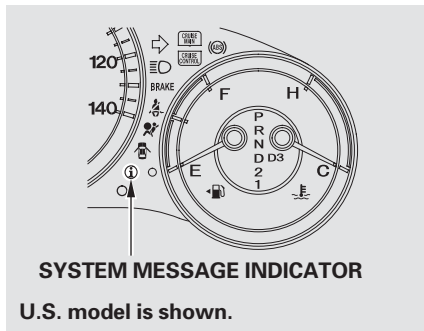

If there is a problem with your vehicle, for example the engine oil level is low or a door is not fully closed, the multi-information display will show you the problem. It does this by interrupting the current display with one or more messages.



















The system message(s) triggers the appropriate indicator(s) on the instrument panel, including the system message indicator, to come on. The system message indicator does not go off until the problem(s) is corrected.

You will also hear a beep when the system message comes on for the first time.

When there are several messages to be shown, the system switches the messages every 5 seconds. The message is shown until you push the INFO (▲ or ▼) button. To see the message again, press the INFO (▲ or ▼) button, 5 seconds after the display disappears.

















Here is a list of messages shown on the multi-information display:

Multi-Information Display

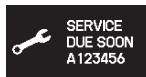
 DOOR, HATCH & TAILGATE OPEN	See page 13	U.S.  RELEASE PARKING BRAKE	See page 169	 CHECK CHARGING SYSTEM	See page 521
 FASTEN SEAT BELT	See page 22	Canada  RELEASE PARKING BRAKE		 CHECK EMISSION SYSTEM	See page 522
 FASTEN PASSENGER SEAT BELT	See page 22	U.S.  LOW BRAKE FLUID	See page 523	 CHECK ENGINE OIL LEVEL	See page 521
 CHECK AIRBAG SYSTEM	See page 35	Canada  LOW BRAKE FLUID		 CHECK ABS SYSTEM	See page 430
U.S.  PASSENGER SIDE AIRBAG OFF	See page 35	U.S.  CHECK BRAKE SYSTEM	See page 523	 CHECK VSA SYSTEM	See page 431
Canada  PASSENGER SIDE AIRBAG OFF		Canada  CHECK BRAKE SYSTEM		 CHECK LIGHT CONTROL SYSTEM	See page 79

CONTINUED

Multi-Information Display

 CHECK TIRE PRESSURE	See page 425	U.S.  CHECK STARTER SYSTEM	See page 412	 WARNING: APPROACHING OBJECT	See page 387
 TPMS CHECK TPMS SYSTEM	See page 426	Canada  CHECK STARTER SYSTEM		On Touring models  DRL CHECK DRL SYSTEM	See page 128
 SYSTEM FUNCTION ERROR	See page 426	 CHECK TRANS- MISSION	See page 413	 DRL DRL OFF	
 A/T TEMP A/T TEMP HIGH	See page 76	 CHECK PARKING SENSOR SYSTEM	See page 389	 SERVICE DUE SOON A 123456	See page 460
U.S.  TAIL GATE CHECK POWER TAILGATE	See page 147	On Touring models  LOW WASHER FLUID	See page 477	 TIGHTEN FUEL CAP	See page 396
Canada  CHECK POWER TAILGATE		 LOW FUEL	See page 80	 REMOVE KEY	See page 137
On Touring models					

Customize Settings



When the main menu displays “Keyless Memory Settings™,” you can customize some vehicle control settings.

To enter the customizing mode, press the SEL/RESET button.

To change the settings, the ignition switch must be in the ON (II) position, and the vehicle must be stopped with the transmission in Park.

If you turn the ignition switch to the ACCESSORY (I) or the LOCK (0) position, or move the shift lever out of Park, the display will change to the normal screen.

On Touring models

You can customize some vehicle control settings for “DRIVER 1” and “DRIVER 2” separately. If “DRIVER 1” or “DRIVER 2” is not displayed, customizing is not possible.

To have the driver’s ID detected, make sure your remote transmitter is linked to the system (see Keyless Memory Settings™ on page 153).

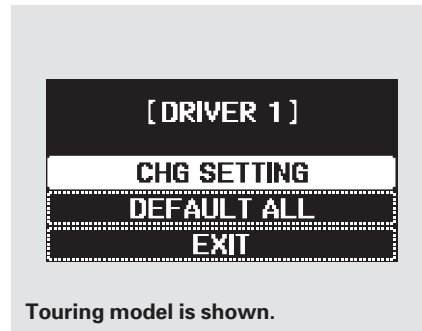

If you want the settings as they were when the vehicle left the factory, select DEFAULT ALL, as described on page 100 .

If you want to change any vehicle control settings, select CHG SETTING, then press the SEL/RESET button.

Refer to the table on the following pages about the settings you want to customize. *CONTINUED*

Multi-Information Display

Group Setup	Menu Item	Description	Setting Option	Page
METER SETUP (P.103)	LANGUAGE SELECTION	Changes the language used in the display.	ENGLISH* ¹	104
			FRENCH	
			SPANISH	
	ADJUST OUTSIDE TEMP. DISPLAY	Changes the outside temperature reading above or below its current reading.	-5°F ~ ±0°F* ¹ ~ 5°F (U.S.)	105
			-3°C ~ ±0°C* ¹ ~ 3°C (Canada)	
	TRIP A INFO RESET	Changes the setting of how to reset trip meter A, average fuel A, elapsed time A, and average speed A.	with REFUEL	106
MANUAL ONLY* ¹				
IGN OFF				
POSITION SETUP* ² (P.108)	MEMORY POSITION LINK	Changes the driver's seat and the outside mirror positions to a stored setting.	ON* ¹	109
			OFF	

*1 : Default setting

*2 : On Touring models

Multi-Information Display

Group Setup	Menu Item	Description	Setting Option		Page
LIGHTING SETUP (P.110)	INTERIOR LIGHT DIMMING TIME	Changes how long (in seconds) the interior lights stay on after you close the doors and the tailgate.	60 SEC	15 SEC	111
			30 SEC*		
	HEADLIGHT AUTO OFF TIMER	Changes how long (in seconds) the exterior lights stay on after you close the driver's door.	60 SEC		112
			30 SEC	0 SEC	
			15 SEC*		
	AUTO LIGHT SENSITIVITY	Changes the timing of when the headlights come on. The headlight switch needs to be in the AUTO position.	MAX	LOW	113
HIGH			MIN		
MID*					
DOOR/WINDOW SETUP (P.115)	AUTO DOOR LOCK	Changes the setting of when to automatically lock the doors.	SHIFT FROM P		116
			WITH VEH SPEED*		
			OFF		
	AUTO DOOR UNLOCK	Changes the setting of when to automatically unlock the driver's/all the doors.	SHIFT TO P*	DRIVER DOOR*/	117
			IGN OFF	ALL DOORS	
			OFF		
	KEY AND REMOTE UNLOCK MODE	Changes which doors unlock with the remote transmitter on a first push.	DRIVER DOOR*		119
			ALL DOORS		
	KEYLESS LOCK ACKNOWLEDGMENT	The exterior lights flash each time you press the LOCK or UNLOCK button. A beeper will also sound when you press the LOCK button twice.	ON*		120
			OFF		
SECURITY RELOCK TIMER	Changes how long it takes (in seconds) for the doors to relock and the security system to set after you unlock but do not open the door.	90 SEC		121	
		60 SEC			
		30 SEC*			
DEFAULT ALL (P.100)		Set/Cancel all the customized settings as default.		100	
		SET	CANCEL*		

* : Default setting

Multi-Information Display

DEFAULT ALL

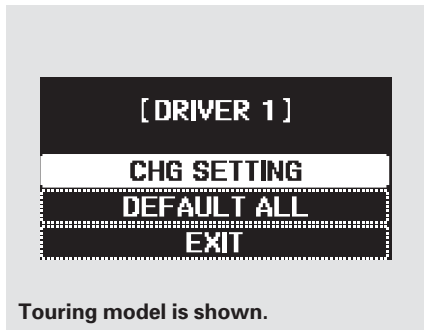

If you want to set the default settings, press the INFO (▲/▼) button to select DEFAULT ALL, then press the SEL/RESET button.

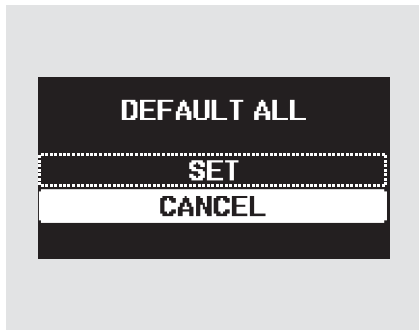

To set the default settings, press the INFO (▲/▼) button to select SET then press the SEL/RESET button.

If you want to cancel DEFAULT ALL, select CANCEL, then press the SEL/RESET button. The screen goes back to the previous display.



When DEFAULT ALL is set, you will see the above display for several seconds, then the screen returns to CUSTOMIZE ENTRY.

If the setting is not successfully completed, "FAILED" is shown for several seconds, and then the screen goes back to the normal message mode. Repeat the same procedure to select DEFAULT ALL.

Customize Settings

You can customize some of the vehicle control settings to your preference. Here are the settings you can customize:

- METER SETUP
- POSITION SETUP
- LIGHTING SETUP
- DOOR/WINDOW SETUP

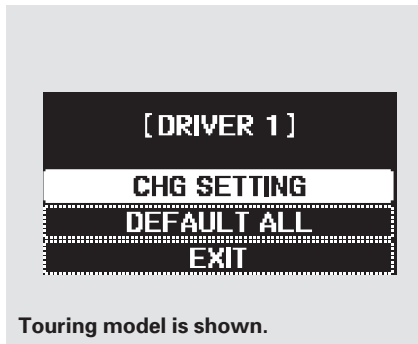

Touring model is shown.

When you want to change the vehicle control settings, press the INFO (▲/▼) button to select CHG SETTING, then press the SEL/RESET button.

Each time you press the INFO (▲/▼) button, the screen changes as shown on the [next](#) page. Press the INFO (▲/▼) button until you see the setup you want to customize, then press the SEL/RESET button to enter your selection.

CONTINUED

Multi-Information Display

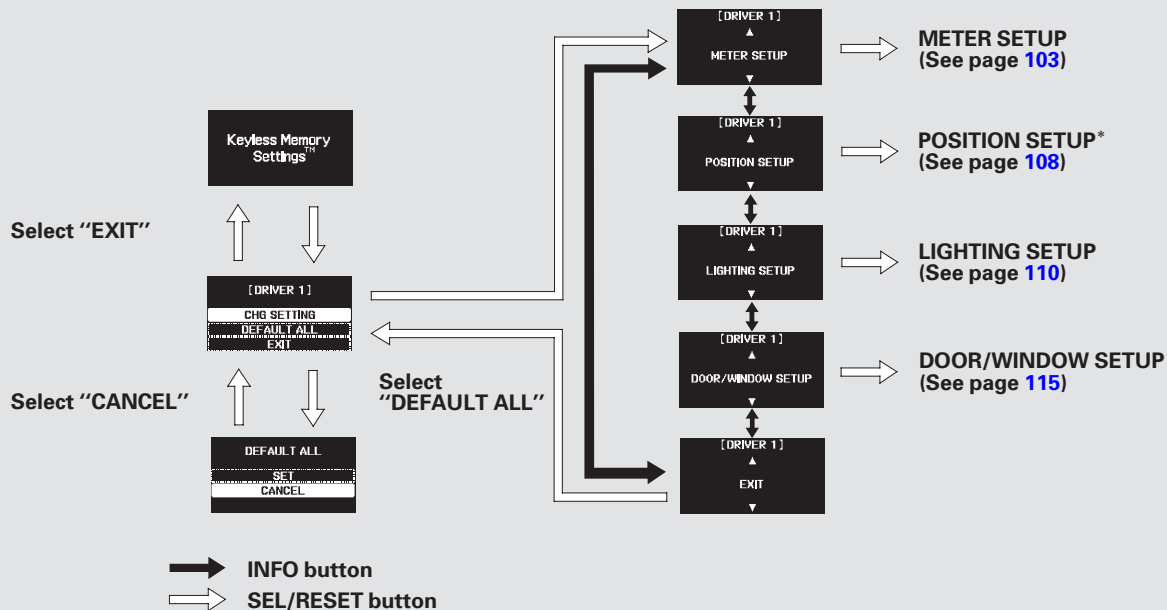

Touring model is shown.

* : On Touring models

Meter Setup

Here are the three custom settings for the meter setup:

- LANGUAGE SELECTION
- ADJUST OUTSIDE TEMP. DISPLAY
- TRIP A INFO RESET

While “METER SETUP” is shown, press the SEL/RESET button to enter the customize mode.

Each time you press the INFO (▲/▼) button, the screen changes as shown in the illustration. Press the INFO (▲/▼) button until you see the setting you want to customize, then press the SEL/RESET button to enter your selection.

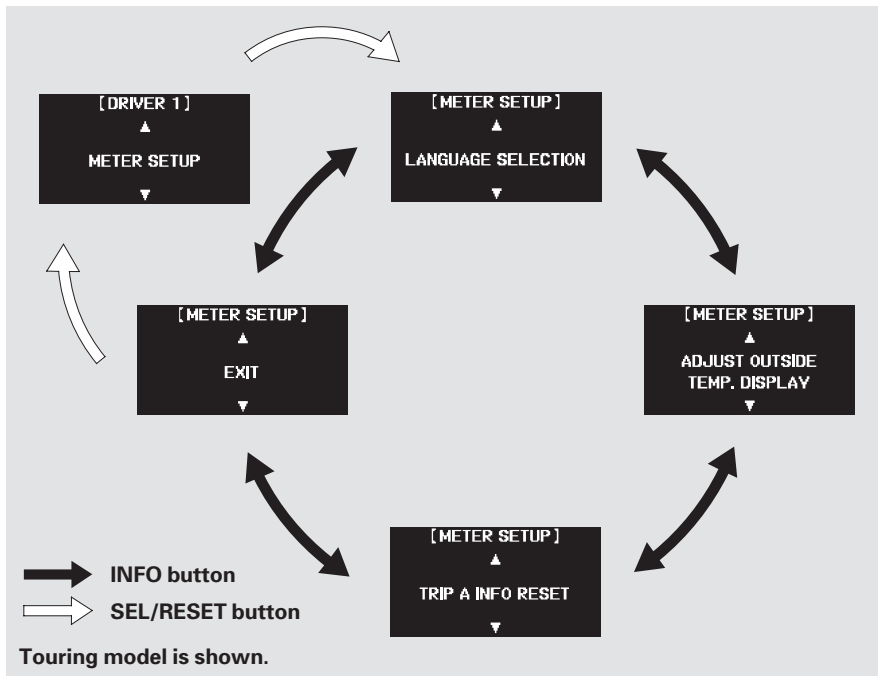

CONTINUED

Multi-Information Display

Language Selection

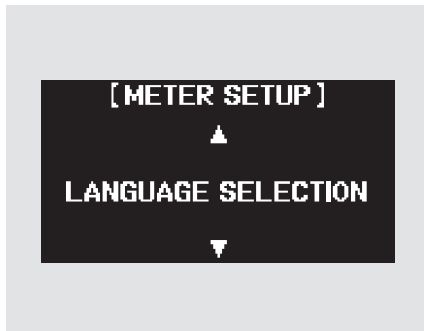

There are three language selections you can make: English, French, and Spanish. To choose the language you want, follow these instructions:

You can choose this item to customize from "METER SETUP" by pressing the INFO (▲/▼) button repeatedly.

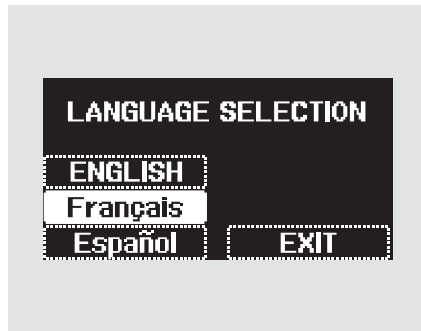

Press the SEL/RESET button to see the selections.

Select the desired language by pressing the INFO (▲/▼) button, then enter your selection by pressing the SEL/RESET button.



When your selection is successfully completed, the display changes as shown above, and then goes back to the customize item screen.

If the "SETTING INCOMPLETE" message appears, go back to "LANGUAGE SELECTION" and repeat the procedure again.

Multi-Information Display

Adjust Outside Temp. Display

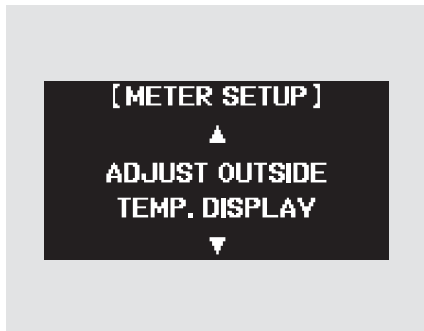

If you sometimes find that the temperature reading is a few degrees above or below the actual temperature, you can adjust it by following these instructions:

You can choose this item to customize from “METER SETUP” by pressing the INFO (▲/▼) button repeatedly.

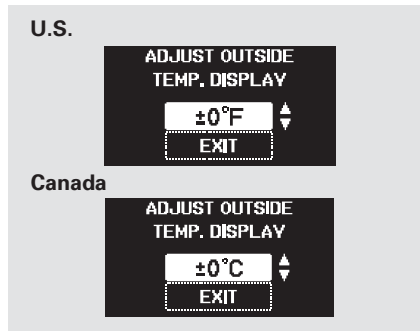

Adjust the outside temperature value by pressing the INFO (▲/▼) button repeatedly. Press the SEL/RESET button to set the desired value.

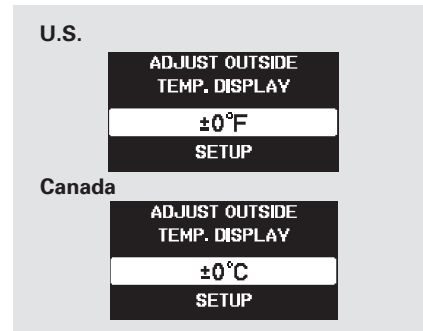

When your selection is successfully completed, the display changes as shown above, and then goes back to the customize item screen.

If the “SETTING INCOMPLETE” message appears, go back to “ADJUST OUTSIDE TEMP. DISPLAY” and repeat the procedure again.

CONTINUED

Multi-Information Display

Trip A Info Reset

There are three settings you can choose from:

with REFUEL – Trip A Info is reset every time you refuel your vehicle.

MANUAL ONLY – You can reset Trip A Info when you press and hold the SEL/RESET button until the number resets.

IGN OFF – Trip A Info is reset when you turn the ignition switch to the LOCK (0) position.

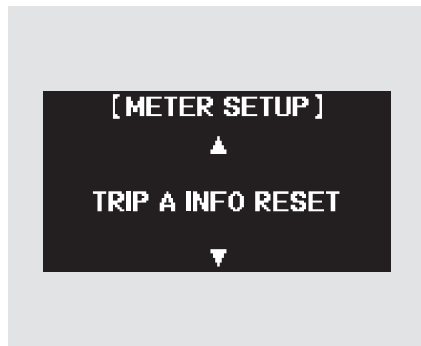

You can choose this item to customize from “METER SETUP” by pressing the INFO (▲/▼) button repeatedly.

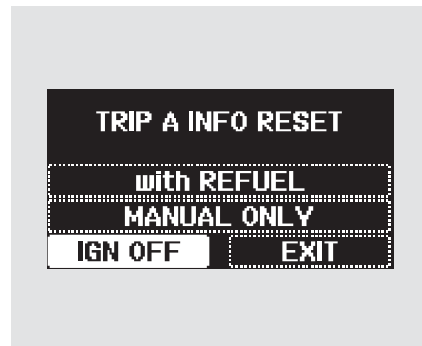

Press the SEL/RESET button to see the selections.

Select ON or OFF by pressing the INFO (▲/▼) button, then enter your selection by pressing the SEL/RESET button.

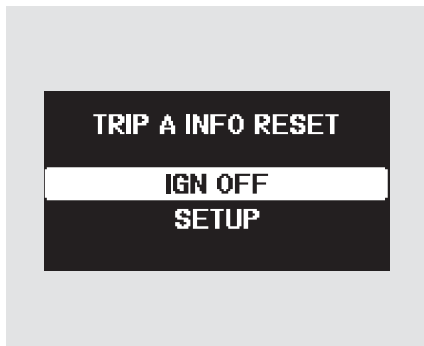

When your selection is successfully completed, the display changes as shown above, and then goes back to the customize item screen.

If the “SETTING INCOMPLETE” message appears, go back to “TRIP A INFO RESET” and repeat the procedure again.

Multi-Information Display

Position Setup

On Touring models

You can customize the MEMORY POSITION LINK setting in position setup.

While "POSITION SETUP" is shown, press the SEL/RESET button to enter the customize mode.

Each time you press the INFO (▲/▼) button, the screen changes as shown in the illustration. Press the INFO (▲/▼) button until you see the setting you want to customize, then press the SEL/RESET button to enter your selection.

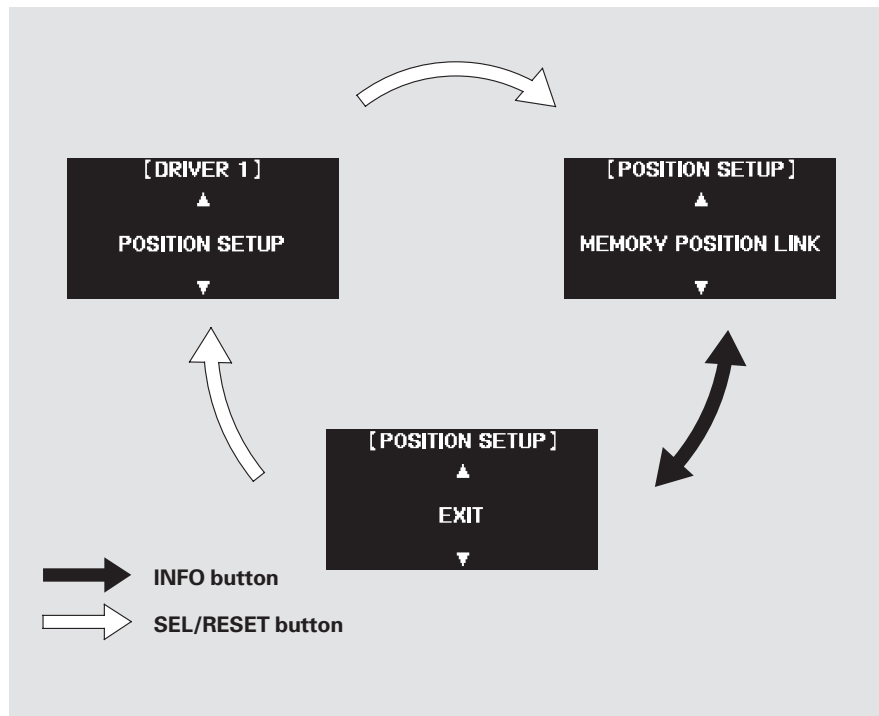

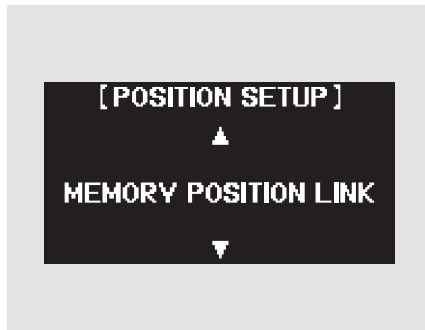
Memory Position Link

If “MEMORY POSITION LINK” is “ON,” the driver’s seat and outside mirrors move to the positions stored in the memory when you open the driver’s door, using the remote transmitter.

You can choose this item to customize from “POSITION SETUP” by pressing the INFO (▲/▼) button repeatedly.

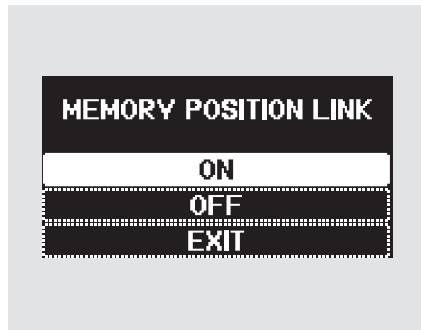

Press the SEL/RESET button to see the selections.

Select ON or OFF by pressing the INFO (▲/▼) button, then enter your selection by pressing the SEL/RESET button.

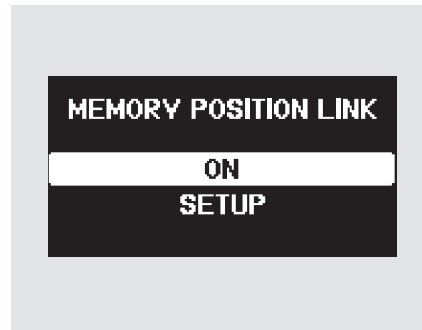

When your selection is successfully completed, the display changes as shown above, and then goes back to the customize item screen.

If the “SETTING INCOMPLETE” message appears, go back to “MEMORY POSITION LINK” and repeat the procedure again.

Multi-Information Display

Lighting Setup

Here are the three custom settings for the lighting setup:

- INTERIOR LIGHT DIMMING TIME
- HEADLIGHT AUTO OFF TIMER
- AUTO LIGHT SENSITIVITY

While “LIGHTING SETUP” is shown, press the SEL/RESET button to enter the customize mode.

Each time you press the INFO (▲/▼) button, the screen changes as shown in the illustration. Press the INFO (▲/▼) button until you see the setting you want to customize, then press the SEL/RESET button to enter your selection.

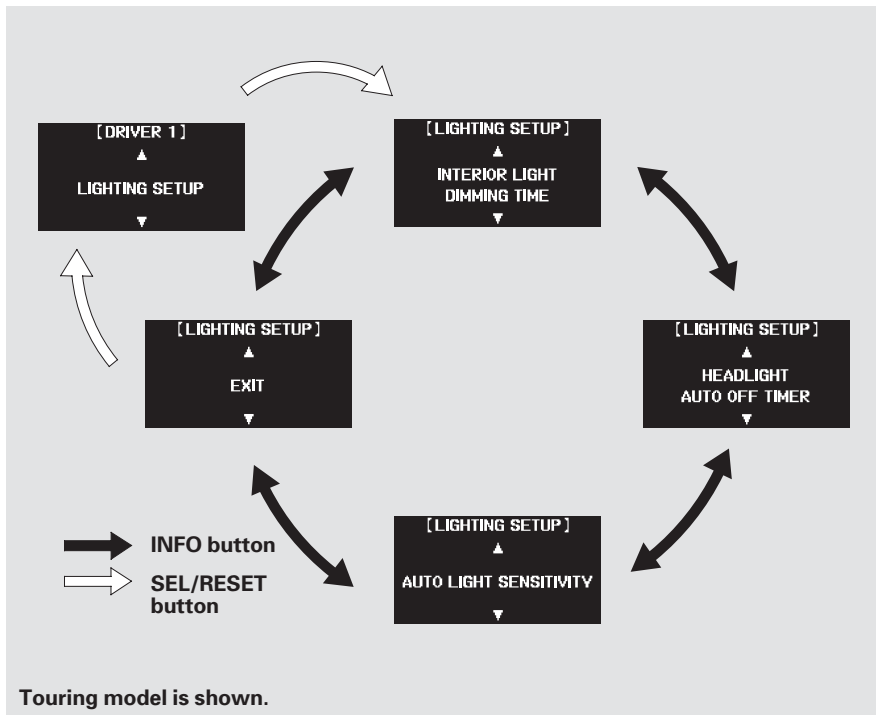

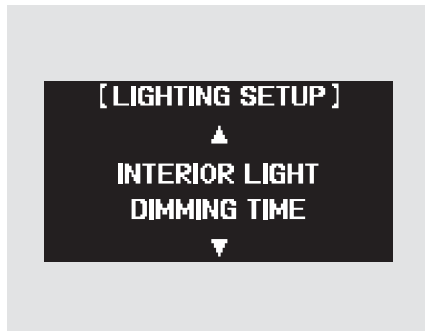
Interior Light Dimming Time

The interior lights fade out when you close all doors and tailgate. To change how long the lights stay on before they fade out, follow these instructions:

You can choose this item to customize from "LIGHTING SETUP" by pressing the INFO (▲/▼) button repeatedly.

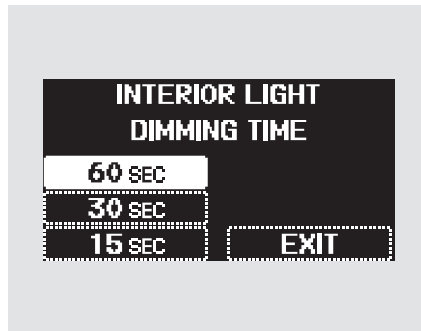

Press the SEL/RESET button to see the selections.

Select the desired setting by pressing the INFO (▲/▼) button, then enter your selection by pressing the SEL/RESET button.

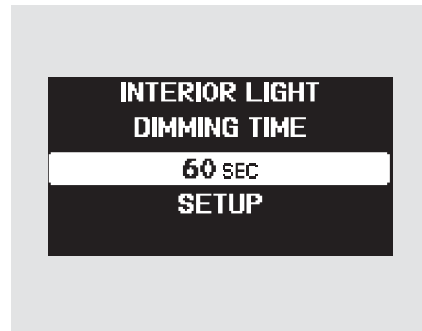

When your selection is successfully completed, the display changes as shown above, and then goes back to the customize item screen.

If the "SETTING INCOMPLETE" message appears, go back to "INTERIOR LIGHT DIMMING TIME" and repeat the procedure again.

CONTINUED

Multi-Information Display

Headlight Auto Off Timer

The headlights, parking lights, side marker lights, taillights, and license plate lights go off after the selected time when you remove the key from the ignition switch and close the driver's door. To change how long the lights stay on before they go off, follow these instructions:



You can choose this item to customize from “LIGHTING SETUP” by pressing the INFO (▲/▼) button repeatedly.

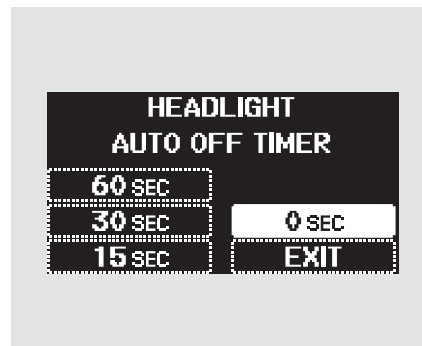

Press the SEL/RESET button to see the selections.

Select the desired setting by pressing the INFO (▲/▼) button, then enter your selection by pressing the SEL/RESET button.



HEADLIGHT
AUTO OFF TIMER

0 SEC

SETUP

When your selection is successfully completed, the display changes as shown above, and then goes back to the customize item screen.

If the “SETTING INCOMPLETE” message appears, go back to “HEADLIGHT AUTO OFF TIMER” and repeat the procedure again.

Auto Light Sensitivity

The headlights automatically come on when the headlight switch is in the AUTO position and the ambient light reaches a changeable level. You can select the auto light sensitivity from the following five levels:

MAX –

The headlights come on when it is bright.

HIGH –

The headlights come on when it is somewhat bright.

MID –

The headlights come on when it is as bright as sunset or sunrise.

LOW –

The headlights come on when it is somewhat dark.

MIN –

The headlights come on when it is dark.



[LIGHTING SETUP]

AUTO LIGHT SENSITIVITY

You can choose this item to customize from “LIGHTING SETUP” by pressing the INFO (▲/▼) button repeatedly.

CONTINUED

Multi-Information Display

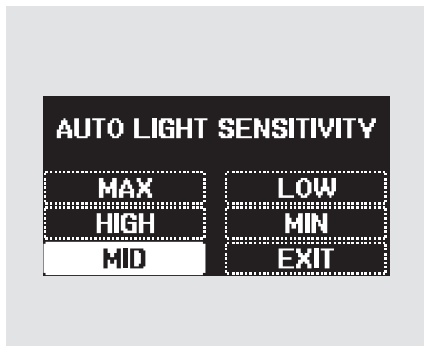

Press the SEL/RESET button to see the selections.

Select the desired setting by pressing the INFO (▲/▼) button, then enter your selection by pressing the SEL/RESET button.

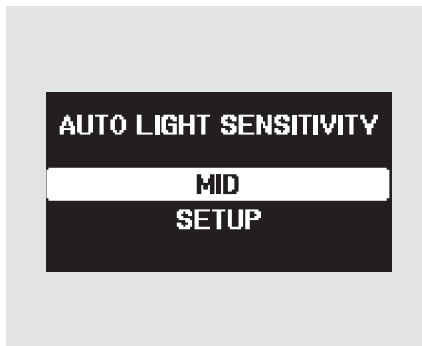

When your selection is successfully completed, the display changes as shown above, and then goes back to the customize item screen.

If the “SETTING INCOMPLETE” message appears, go back to “AUTO LIGHT SENSITIVITY” and repeat the procedure again.

Door/Window Setup

Here are the five custom settings for the door/window setup:

- AUTO DOOR LOCK
- AUTO DOOR UNLOCK
- KEY AND REMOTE UNLOCK MODE
- KEYLESS LOCK ACKNOWLEDGMENT
- SECURITY RELOCK TIMER

While “DOOR/WINDOW SETUP” is shown, press the SEL/RESET button to enter the customize mode.

Each time you press the INFO (▲/▼) button, the screen changes as shown in the illustration. Press the INFO (▲/▼) button until you see the setting you want to customize, then press the SEL/RESET button to enter your selection.

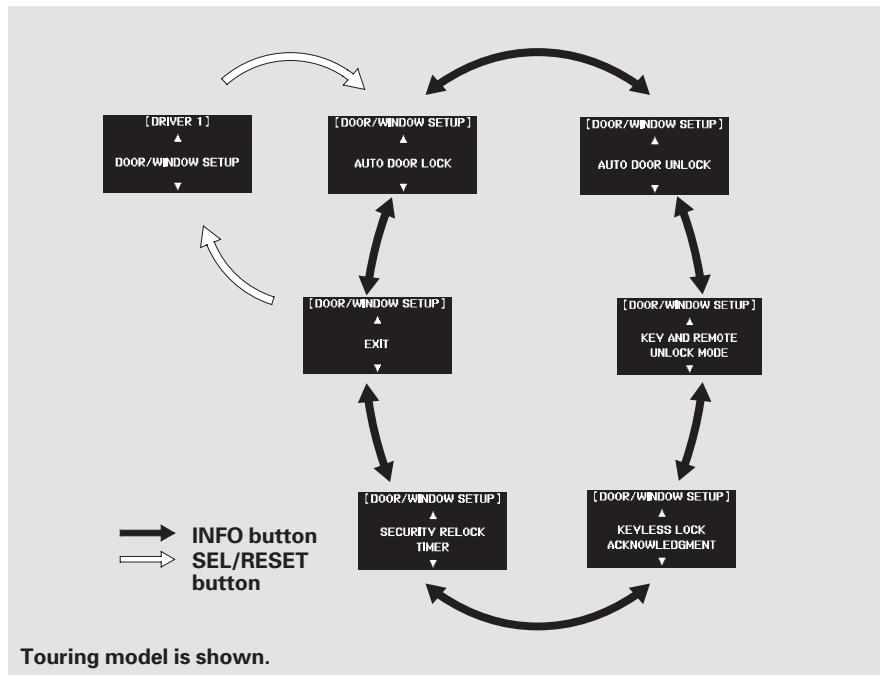

CONTINUED

Multi-Information Display

Auto Door Lock

There are three settings you can choose from:

SHIFT FROM P –

The doors lock whenever you move the shift lever out of Park.

WITH VEH SPEED –

The doors lock when the vehicle speed reaches about 10 mph (U.S.) and 15 km/h (Canada).

OFF –

The auto door lock mode is deactivated all the time.

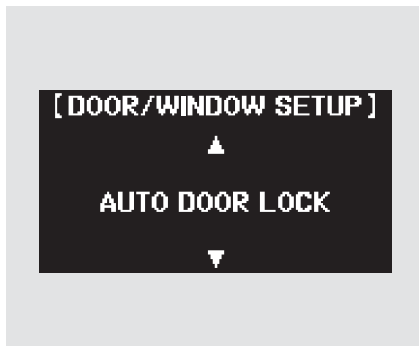

You can choose this item to customize from “DOOR/WINDOW SETUP” by pressing the INFO (▲/▼) button repeatedly.

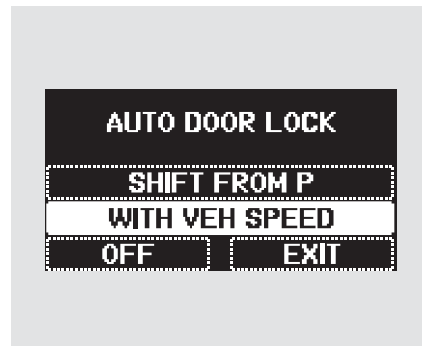

Press the SEL/RESET button to see the selections.

Select the desired setting by pressing the INFO (▲/▼) button, then enter your selection by pressing the SEL/RESET button.

Multi-Information Display



AUTO DOOR LOCK

WITH VEH SPEED
SETUP

When your selection is successfully completed, the display changes as shown above, and then goes back to the customize item screen.

If the “SETTING INCOMPLETE” message appears, go back to “AUTO DOOR LOCK” and repeat the procedure again.

Auto Door Unlock

There are three settings you can choose from:

SHIFT TO P – The driver’s door or all the doors, depending on your selection in the next step, unlock when you move the shift lever to Park.

IGN OFF – The driver’s door or all the doors, depending on your selection in the next step, unlock when you turn the ignition switch to the LOCK (0) position.

OFF – The auto door unlock mode is deactivated all the time.



[DOOR/WINDOW SETUP]

AUTO DOOR UNLOCK

You can choose this item to customize from “DOOR/WINDOW SETUP” by pressing the INFO (▲/▼) button repeatedly.

CONTINUED

Multi-Information Display



Press the SEL/RESET button to see the selections.

Select the desired setting by pressing the INFO (▲/▼) button, then enter your selection by pressing the SEL/RESET button.



If you choose “SHIFT TO P” or “IGN OFF”, you will see the above display.

Press the INFO (▲/▼) button to switch the door lock mode setting between the driver’s door and all doors. Then, press the SEL/RESET button to enter your selection.



When your selection is successfully completed, the display changes as shown above, and then goes back to the customize item screen.

If the “SETTING INCOMPLETE” message appears, go back to “AUTO DOOR UNLOCK” and repeat the procedure again.

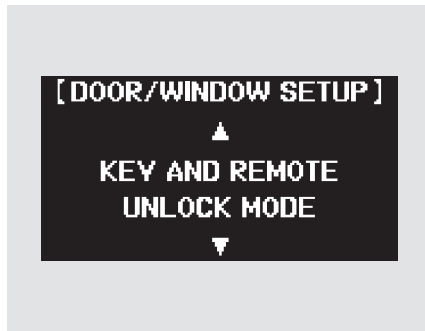
Key and Remote Unlock Mode

To select whether the driver's door unlocks or all the doors unlock when you unlock the doors with the remote transmitter, follow these instructions.

You can choose this item to customize from "DOOR/WINDOW SETUP" by pressing the INFO (▲/▼) button repeatedly.

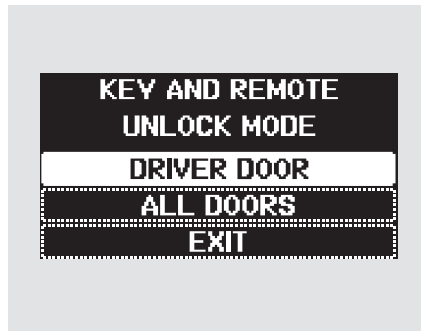

Press the SEL/RESET button to see the selections.

Select the desired setting by pressing the INFO (▲/▼) button, then enter your selection by pressing the SEL/RESET button.



When your selection is successfully completed, the display changes as shown above, and then goes back to the customize item screen.

If the "SETTING INCOMPLETE" message appears, go back to "KEY AND REMOTE UNLOCK MODE" and repeat the procedure again.

CONTINUED

Multi-Information Display

Keyless Lock Acknowledgment

When you push the LOCK button on the remote transmitter, some exterior lights flash, and a beeper sounds when you push the LOCK button again within 5 seconds to verify that the doors and the tailgate are locked and the security system has set (see page 349). You can customize the exterior lights not to flash and the beeper not to sound.

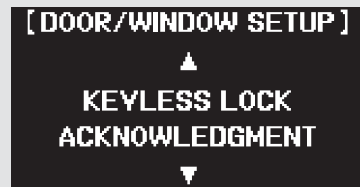

You can choose this item to customize from “DOOR/WINDOW SETUP” by pressing the INFO (▲/▼) button repeatedly.

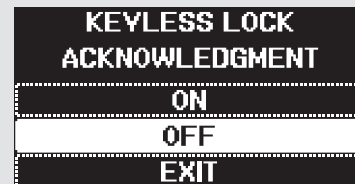

Press the SEL/RESET button to see the selections.

Select ON or OFF by pressing the INFO (▲/▼) button, then enter your selection by pressing the SEL/RESET button.



KEYLESS LOCK
ACKNOWLEDGMENT

OFF
SETUP

When your selection is successfully completed, the display changes as shown above, and then goes back to the customize item screen.

If the “SETTING INCOMPLETE” message appears, go back to “KEYLESS LOCK ACKNOWLEDGMENT” and repeat the procedure again.

Security Relock Timer

If you unlock the doors and the tailgate with the remote transmitter, but do not open any of the doors or the tailgate within 30 seconds, the doors and the tailgate automatically relock and the security system sets.

You can change this relock time from 30 seconds to 60 or 90 seconds.



[DOOR/WINDOW SETUP]

▲
SECURITY RELOCK
TIMER
▼

You can choose this item to customize from “DOOR/WINDOW SETUP” by pressing the INFO (▲/▼) button repeatedly.

CONTINUED

Multi-Information Display

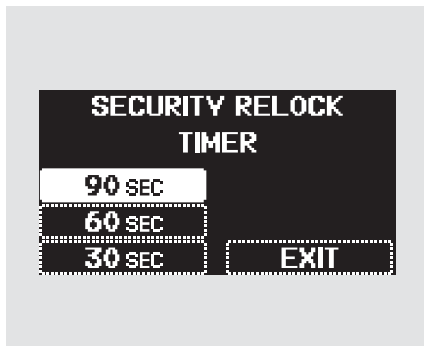

Press the SEL/RESET button to see the selections.

Select the desired setting by pressing the INFO (▲/▼) button, then enter your selection by pressing the SEL/RESET button.

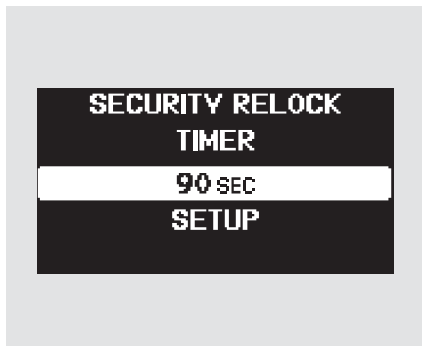

When your selection is successfully completed, the display changes as shown above, and then goes back to the customize item screen.

If the “SETTING INCOMPLETE” message appears, go back to “SECURITY RELOCK TIMER” and repeat the procedure again.

Controls Near the Steering Wheel

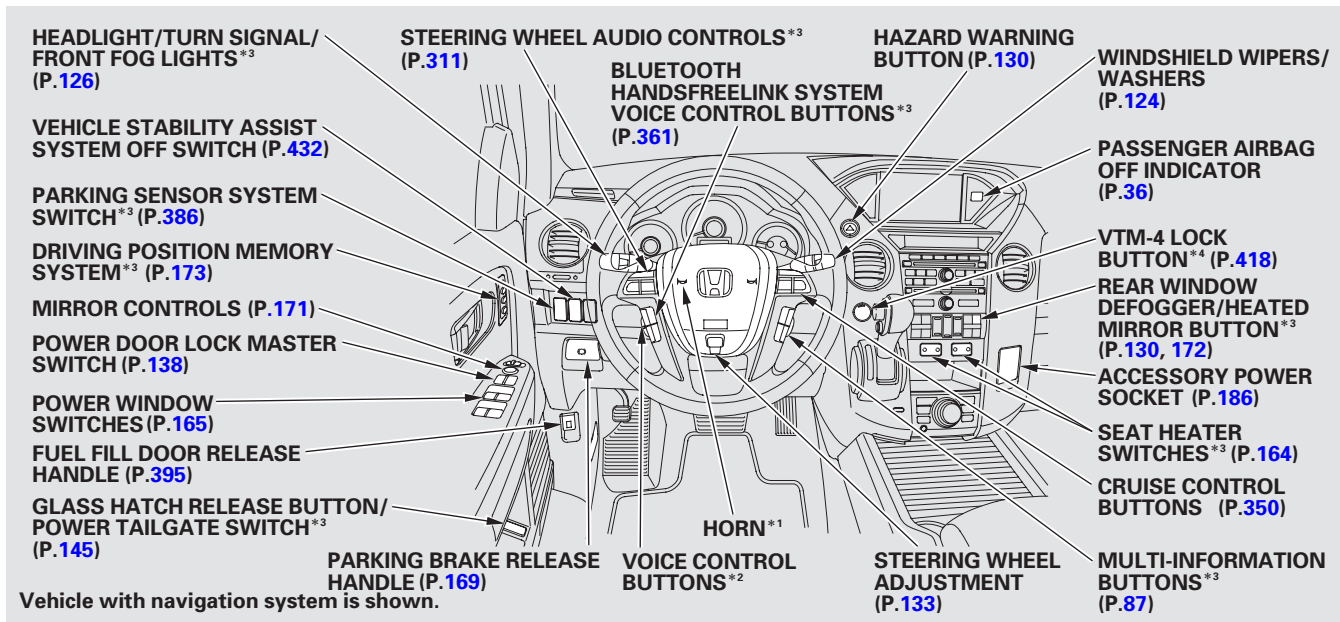

* 1 : To use the horn, press the center pad of the steering wheel.

* 2 : Only on vehicles equipped with navigation system. Refer to the navigation system manual.

* 3 : If equipped

* 4 : 4WD models only

Windshield Wipers and Washers

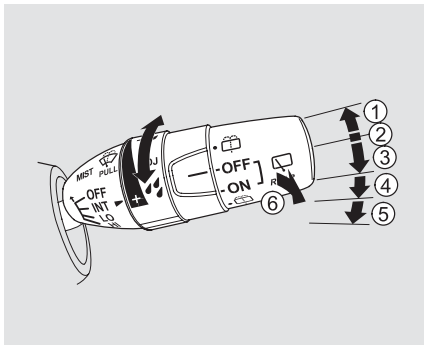

1. MIST
2. OFF
3. INT – Intermittent
4. LO – Low speed
5. HI – High speed
6. Windshield washers

Push the right lever up or down to select a position.

MIST – The wipers run at high speed until you release the lever.

OFF – The wipers are not activated.

INT – The length of the wipe interval is varied automatically according to vehicle speed.

If you turn it to the shortest delay, the wipers change to low speed operation when the vehicle speed exceeds 12 mph (20 km/h).

LO – The wipers run at low speed.

HI – The wipers run at high speed.

Windshield Washer – Pull the wiper control lever toward you, and hold it. The washers spray until you release the lever. The wipers run at low speed, then complete one more sweep after you release the lever.

Rear Window Wiper and Washer

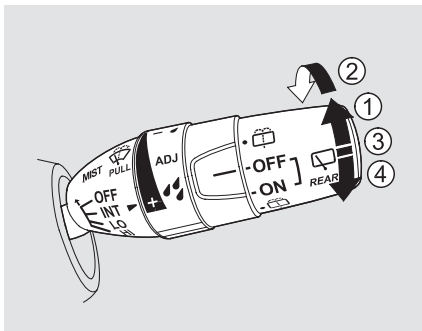

1. To turn on the rear window wiper, rotate the switch clockwise to ON. It operates intermittently.
2. Hold past ON to turn the rear window wiper on and to spray the rear window washer.

3. When you turn the wiper switch to the “OFF” position, the wiper will return to its parked position.
4. Rotate the switch counterclockwise to spray the window washer.

The rear wiper will not work if the glass hatch is not fully closed.

If you attempt to open the glass hatch while the rear wiper is operating, the wiper will return to the parked position, and then the glass hatch can be opened. After the glass hatch is closed, the rear wiper starts to operate again after a few seconds delay.

When you shift the transmission to the reverse position with the front windshield wipers activated, the rear window wiper operates automatically.

The rear window washer uses the same fluid reservoir as the windshield washer.

Turn Signals and Headlights

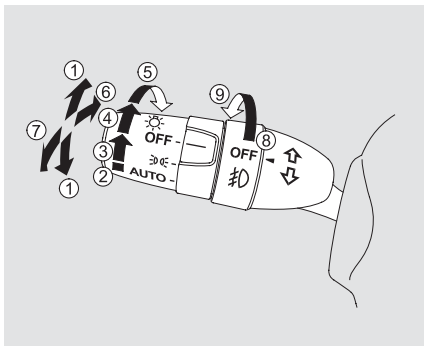

1. Turn signal
2. Off
3. Parking and indicator lights
4. AUTO
5. Headlights on
6. High beams
7. Flash high beams
8. Fog lights off*
9. Fog lights on*

*: If equipped

Turn Signal – Push down on the left lever to signal a left turn and up to signal a right turn. To signal a lane change, push lightly on the lever and hold it. The lever will return to the center when you release it or complete a turn.

Headlights On – Turning the switch to the “ ” position turns on the parking lights, taillights, instrument panel lights, side-marker lights, and rear license plate lights.

Turning the switch to the “ ” position turns on the headlights. If you leave the lights on with the key removed from the ignition switch, you will hear a reminder chime when you open the driver’s door.

When the light switch is in either of these positions, the lights on indicator comes on as a reminder.

This indicator stays on if you leave the lights on and turn the ignition switch to the ACCESSORY (I) or LOCK (0) position.

High Beams – To switch from low beams to high beams, push the left lever forward until you hear a click. The blue high beam indicator will come on (see page 78). Pull it back to return to low beams. To flash the high beams, pull the lever back lightly, then release it. The high beams stay on as long as you hold the lever back.

AUTO – The automatic lighting feature turns on the headlights and all other exterior lights, when it senses low ambient light.

To turn on automatic lighting, turn the light switch to AUTO. The lights will come on automatically when the outside light level becomes low (at dusk, for example). The lights on indicator comes on as a reminder. The lights and indicator will turn off automatically when the system senses high ambient light.

The lights will remain on when you turn off the ignition switch. They will turn off automatically when you remove the key and open the driver's door. To turn them on again, either turn the ignition switch to the ON (II) position or turn the light switch to the  position.

Even with the automatic lighting feature turned on, we recommend that you turn on the lights manually when driving at night or in a dense fog, or when you enter dark areas such as long tunnels or parking facilities.

On vehicles with navigation system
To change the “AUTO LIGHT SENSITIVITY” setting, see page [113](#).

Do not leave the light switch in AUTO if you will not be driving the vehicle for an extended period (a week or more). You should also turn off the lights if you plan to leave the engine idling or off for a long time.

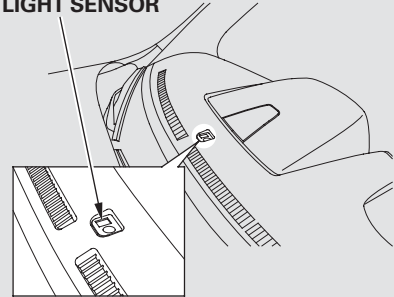
LIGHT SENSOR

The automatic lighting feature is controlled by a sensor located on top of the dashboard. Do not cover this sensor or spill liquids on it.

Headlights

Fog Lights

Except LX models

Turn the fog lights on and off by turning the switch next to the headlight switch.

You can use the fog lights only when the headlights are on low beam. With the light switch in the AUTO position, you can also use the fog lights when the headlights turn on automatically. They will go off when the headlights turn off.

Daytime Running Lights

With the headlight switch off, the daytime running lights come on when you turn the ignition switch to the ON (II) position and release the parking brake. They remain on until you turn the ignition switch off, even if you set the parking brake.

When the headlights are on, the daytime running lights are off.

On vehicles with navigation system

If you see a “CHECK DRL SYSTEM” message on the multi-information display, there is a problem with the daytime running light system. Take your vehicle to a dealer to have it checked.



When the multi-information display shows a “DRL OFF” message, the daytime running lights are off. Follow the procedure in the left column to turn them on.

Automatic Lighting Off Feature

This feature turns off the headlights, all other exterior lights, and the instrument panel lights within 15 seconds after you remove the key and close the driver's door.

On vehicles with navigation system

To change the "HEADLIGHT AUTO OFF TIMER" setting, see page [112](#).

The automatic lighting off feature activates if you leave the headlight switch in the "  " or "  " position or if the lights are turned on by setting the switch in the "AUTO" position, and you remove the key, then open and close the driver's door.

If you turn the ignition switch to the LOCK (0) position with the headlight switch on, but do not open the door, the lights turn off after 10 minutes (3 minutes, if the switch is in the "AUTO" position).

The lights turn on again when you unlock or open the driver's door. If you unlock the door, but do not open it within 15 seconds, the lights go off. With the driver's door open, you will hear a lights-on reminder chime.

Hazard Warning Button, Rear Window Defogger

Hazard Warning Button

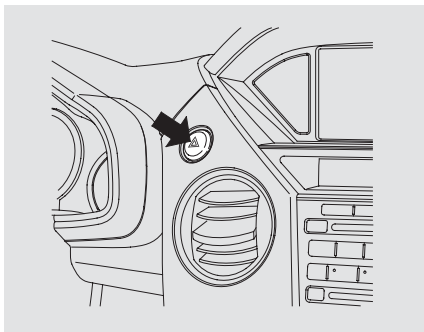

Push the button to turn on the hazard warning lights (four-way flashers). This causes all four outside turn signals and both turn indicators in the instrument panel to flash. Use the hazard warning lights if you need to park in a dangerous area near heavy traffic, or if your vehicle is disabled.

Rear Window Defogger

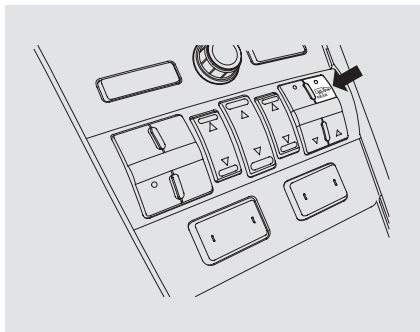

The rear window defogger will clear fog, frost, and thin ice from the window. Push the defogger button to turn it on and off. The indicator in the button lights to show the defogger is on. If you do not turn it off, the defogger will shut itself off after about 15 minutes. It also shuts off when you turn off the ignition. You have to turn it on again when you restart the vehicle.

Make sure the rear window is clear and you have good visibility before starting to drive.

The defogger wires on the inside of the rear window can be accidentally damaged. When cleaning the glass, always wipe side-to-side.

If equipped

Pushing this button also turns the mirror heaters on or off. For more information, see page [172](#).

Instrument Panel Brightness

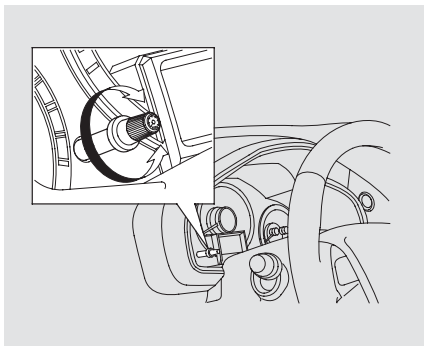

The select/reset knob on the instrument panel controls the brightness of the instrument panel lights. Turn the knob to adjust the brightness.

Separate adjustments can be made when the headlights are on and off.

You will hear a beep when maximum or minimum brightness is reached. You will also hear a beep when the maximum level is canceled by turning the knob a click to the left.

To reduce glare at night, the instrument panel illumination dims when you turn the light switch to ⦿ or ⦿ . Turning the select/reset knob to the right until you hear a beep will cancel the reduced brightness.

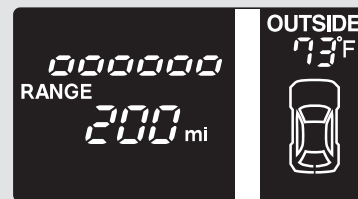

U.S. model is shown.

On vehicles without navigation system
The level of brightness is shown on the information display while you adjust it. It goes out about 5 seconds after you finish adjusting.

CONTINUED

Instrument Panel Brightness

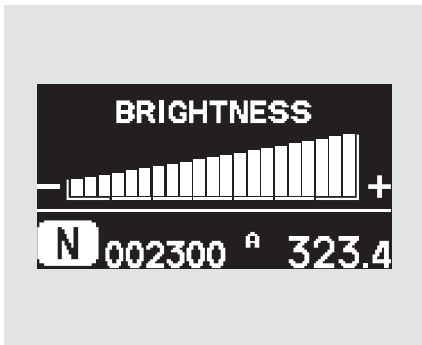

On vehicles with navigation system

The level of brightness is shown on the multi-information display while you adjust it. It goes out 5 seconds after you finish adjusting.

When the brightness reaches the maximum level, "BRIGHTNESS MAXIMUM LEVEL" appears on the display.

Steering Wheel Adjustment

Make any steering wheel adjustment before you start driving.

⚠ WARNING

Adjusting the steering wheel position while driving may cause you to lose control of the vehicle and be seriously injured in a crash.

Adjust the steering wheel only when the vehicle is stopped.

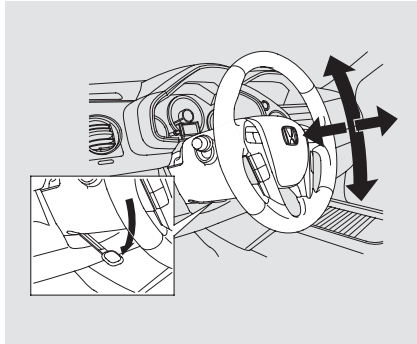

1. Push the lever under the steering column all the way down.
2. Move the steering wheel up or down, and in or out, so it points toward your chest, not toward your face. Make sure you can see the instrument panel gauges and indicators.

3. Push the lever up to lock the steering wheel in position.
4. Make sure you have securely locked the steering wheel in place by trying to move it up, down, in, and out.

Keys and Locks

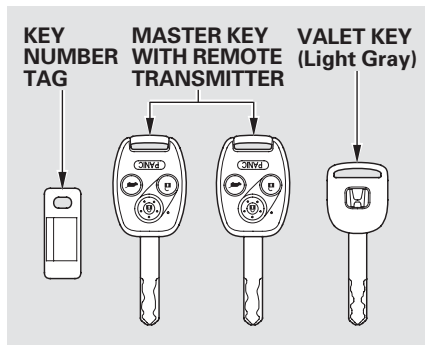

The master key fits all the locks on your vehicle. The valet key works only in the ignition and the driver's door lock. You can keep the glove box locked when you leave your vehicle and the valet key at a parking facility.

You should have received a key number tag with your keys. You will need this key number if you ever have to get a lost key replaced. Use only Honda-approved key blanks.

These keys contain electronic circuits that are activated by the immobilizer system. They will not work to start the engine if the circuits are damaged.

- Protect the keys from direct sunlight, high temperature, and high humidity.
- Do not drop the keys or set heavy objects on them.
- Keep the keys away from liquids. If they get wet, dry them immediately with a soft cloth.

The valet key does not contain a battery. Do not try to take it apart.

The immobilizer system protects your vehicle from theft. If an improperly coded key (or other device) is used, the engine's fuel system is disabled.

When you turn the ignition switch to the ON (II) position, the immobilizer system indicator should come on briefly, then go off. If the indicator starts to blink, it means the system does not recognize the coding of the key. Turn the ignition switch to the LOCK (0) position, remove the key, reinsert it, and turn the ignition switch to the ON (II) position again.

The system may not recognize your key's coding if another immobilizer key or other metal object (i.e. key chain) is near the ignition switch when you insert the key.

If the system repeatedly does not recognize the coding of your key, contact your dealer.

Do not attempt to alter this system or add other devices to it. Electrical problems could result that may make your vehicle inoperable.

If you have lost your key and you cannot start the engine, contact your dealer.

CONTINUED

Immobilizer System

NOTICE

Always take the ignition key with you whenever you leave the vehicle alone.

*As required by the FCC:
This device complies with Part 15 of the FCC rules. Operation is subject to the following two conditions: (1) This device may not cause harmful interference, and (2) this device must accept any interference received, including interference that may cause undesired operation.*

Changes or modifications not expressly approved by the party responsible for compliance could void the user's authority to operate the equipment.

*This device complies with Industry Canada Standard RSS-210.
Operation is subject to the following two conditions: (1) this device may not cause interference, and (2) this device must accept any interference that may cause undesired operation of the device.*

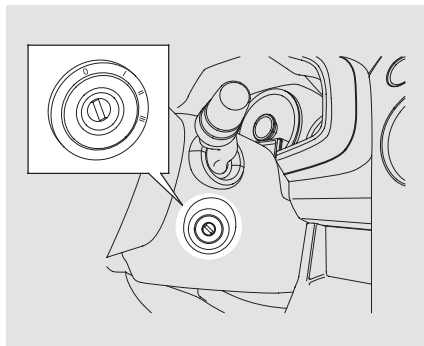

The ignition switch has four positions: LOCK (0), ACCESSORY (I), ON (II), and START (III).

LOCK (0) – You can insert or remove the key only in this position. To turn the key to the LOCK (0) position, the shift lever must be in Park, and you must push the key in slightly.

If the front wheels are turned, the anti-theft lock may make it difficult to turn the key. Firmly turn the steering wheel to the left or right as you turn the key.

ACCESSORY (I) – You can operate the audio system and the accessory power sockets in this position.

ON (II) – This is the normal key position when driving. Several of the indicators on the instrument panel come on as a test when you turn the ignition switch from the ACCESSORY (I) to the ON (II) position.

START (III) – Use this position only to start the engine. The switch returns to the ON (II) position when you let go of the key.

You will hear a reminder beeper if you leave the key in the ignition switch in the LOCK (0) or the ACCESSORY (I) position and open the driver's door. Remove the key to turn off the beeper.

On vehicles with navigation system
You will also see a “REMOVE KEY” message on the multi-information display (see page 96).

The shift lever must be in Park before you can remove the key from the ignition switch.

Door Locks

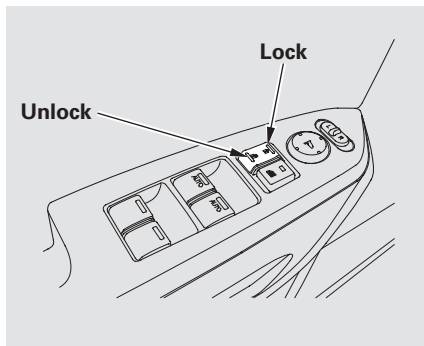

To lock all doors and the tailgate, push the top of the master door lock switch on either front door, pull the lock tab rearward on the driver's door, or use the key on the outside lock on the driver's door.

Pushing the rear of either master door lock switch will unlock all doors and the tailgate. Pushing forward the lock tab on the driver's door unlocks only that door.

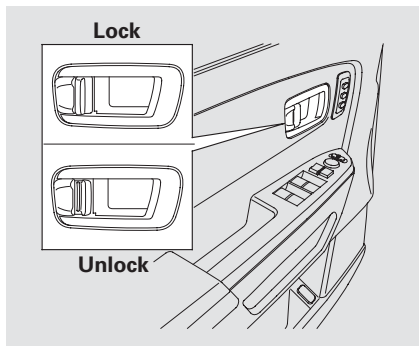

The lock tab on any passenger's door locks and unlocks that door.

All doors and the tailgate can be locked from the outside by using the key in the driver's door lock. To unlock only the driver's door, insert the key, turn the key, and release it. The remaining doors and the tailgate unlock when you turn the key a second time within a few seconds.

On vehicles with navigation system
To change the "KEY AND REMOTE UNLOCK MODE" setting, see page [119](#).

When the vehicle speed reaches about 10 mph (U.S.) and 15 km/h (Canada) or more, all the doors lock automatically.

To change the "AUTO DOOR LOCK" setting, see page [116](#).

When you shift to P after driving, the driver's door unlocks.

To change the "AUTO DOOR UNLOCK" setting, see page [117](#).

Auto Door Locking/Unlocking

On vehicles without navigation system
Your vehicle has customizable settings for the doors and tailgate to automatically lock and unlock. There are default settings for each of these features. You can turn off or change the settings for these features as described on the following pages.

When you customize the setting, make sure your vehicle is parked safely, the engine is off, and the parking brake is applied. Make all settings before you start driving.

On vehicles with navigation system
To change the “AUTO DOOR LOCK” setting, see page [116](#).

To change the “AUTO DOOR UNLOCK” setting, see page [117](#).

Auto Door Locking

On vehicles without navigation system
The auto door locking feature has three possible settings:

- The auto door locking is deactivated all the time.
- The doors and tailgate lock whenever you move the shift lever out of the Park (P) position.
- The doors and tailgate lock when the vehicle speed reaches 9 mph (15 km/h).
This is the default setting.

To turn off the Auto Door Lock modes:

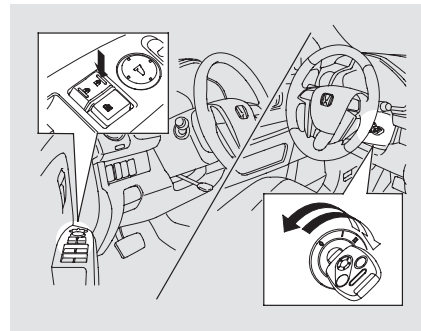

1. Make sure the shift lever is in the Park (P) position.
2. Turn the ignition switch to the ON (II) position, and open the driver's door.

CONTINUED

Door Locks

3. Push and hold the front of the master door lock switch on the driver's door until you hear a click (after about 5 seconds).
4. Release the switch, and within 5 seconds, turn the ignition switch to the LOCK (0) position.

To program the Park Lock mode:
Locks all doors and tailgate when the shift lever is moved out of the Park (P) position.

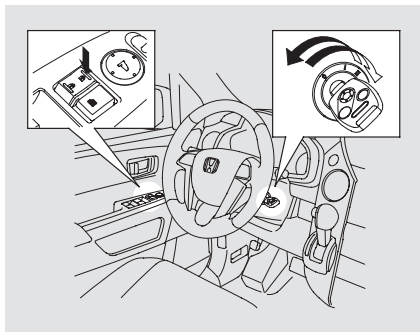

1. Make sure the shift lever is in the Park (P) position.
2. Turn the ignition switch to the ON (II) position, and make sure to close the driver's door.

3. Push and hold the front of the master door lock switch on the driver's door. You will hear a click. Keep holding the switch until you hear another click (after about 5 seconds).
4. Release the switch, and within 5 seconds, turn the ignition switch to the LOCK (0) position.

To program the Drive Lock mode:

Locks all doors and tailgate when the vehicle's speed reaches about 9 mph (15 km/h).

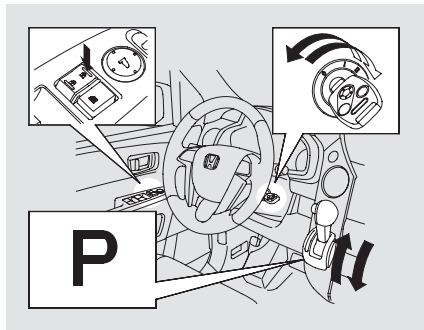

1. Make sure the shift lever is in the Park (P) position.
2. Turn the ignition switch to the ON (II) position, and make sure to close the driver's door.
3. Push and hold the brake pedal, and move the shift lever out of the Park (P) position.
4. Push and hold the front of the master door lock switch on the driver's door. You will hear a click. Keep holding the switch until you hear another click (after about 5 seconds).
5. Release the switch and, within 5 seconds, turn the ignition switch to the ACCESSORY (I) position. Move the shift lever to the Park (P) position.
6. Turn the ignition switch to the LOCK (0) position.

Auto Door Unlocking

On vehicles without navigation system
The auto door unlocking feature has five possible settings:

- The auto door unlocking is deactivated all the time.
- The driver's door unlocks when you move the shift lever to the Park (P) position with the brake pedal depressed.
This is the default setting.
- All doors and tailgate unlock when you move the shift lever to the Park (P) position with the brake pedal depressed.
- The driver's door unlocks whenever you turn the ignition switch to the ACCESSORY (I) position.
- All doors and tailgate unlock whenever you turn the ignition switch to the ACCESSORY (I) position.

CONTINUED

Door Locks

To turn off the Auto Door Unlock modes:

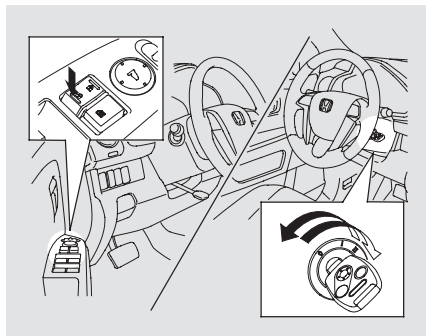

1. Make sure the shift lever is in the Park (P) position.
2. Turn the ignition switch to the ON (II) position, and open the driver's door.

3. Push and hold the rear of the master door lock switch on the driver's door. You will hear a click, and after about 5 seconds, you will hear another click.
4. Release the switch, and within 5 seconds, turn the ignition switch to the LOCK (0) position.

To program the Park Unlock mode:

Unlocks the driver's door or all doors and tailgate when the shift lever is moved into the Park (P) position with the brake pedal depressed.

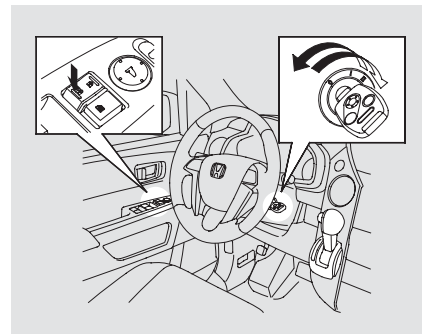

1. Make sure the shift lever is in the Park (P) position.
2. Turn the ignition switch to the ON (II) position, and make sure to close the driver's door.

3. Push and hold the rear of the master door lock switch on the driver's door. You will hear a click. Continue to hold down the switch:

- Until you hear another click (after about 5 seconds) to activate *driver's door unlock feature*.
- Or, until you hear two more clicks (after about 10 seconds) to activate *all doors and tailgate unlock feature*.

4. Release the switch, and within 5 seconds, turn the ignition switch to the LOCK (0) position.

To program the Ignition Switch

Unlock mode:

Unlocks the driver's door or all doors and tailgate when the ignition switch is moved out of the ON (II) position.

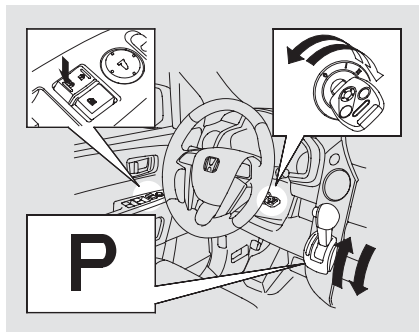

1. Make sure the shift lever is in the Park (P) position.
2. Turn the ignition switch to the ON (II) position, and make sure to close the driver's door.

3. Push and hold the brake pedal, and move the shift lever out of P.

4. Push and hold the rear of the master door lock switch on the driver's door. You will hear a click. Continue to hold the switch:

- Until you hear another click (after about 5 seconds) to activate the driver's door unlock feature.
- Or, until you hear two more clicks (after about 10 seconds) to activate all doors and tailgate unlock feature.

5. Release the switch and, within 5 seconds, turn the ignition switch to the ACCESSORY (I) position. Move the shift lever to the Park (P) position.

6. Turn the ignition switch to the LOCK (0) position. *CONTINUED*

Door Locks, Tailgate and Glass Hatch

Lockout Prevention

With any door and the tailgate open and the key in the ignition, both master door lock switches are disabled. They are not disabled if all the doors and the tailgate are closed. If you try to lock an open driver's door by pulling the lock tab rearward the lock tab on the driver's door pops out.

Childproof Door Locks

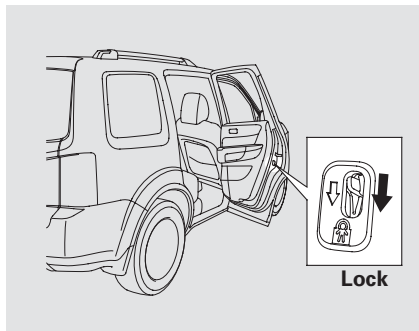

The childproof door locks are designed to prevent children seated in the rear from accidentally opening the rear doors. Each rear door has a lock lever near the edge. With the lever in the LOCK position (lever is down), the door cannot be opened from the inside regardless of the position of the lock tab. To open the door, push the lock tab forward and use the outside door handle.

Tailgate

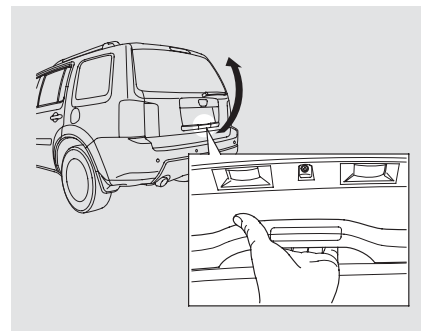

Make sure the shift lever is in the Park (P) position.

To open the tailgate, press and hold the switch, then lift up. To close the tailgate, use the inner handle to pull it down, then press down on the back edge.

Tailgate and Glass Hatch

Keep the tailgate closed at all times while driving to avoid damaging the tailgate and to prevent exhaust gas from getting into the interior. See **Carbon Monoxide Hazard** on page 61 .

Power Tailgate *On Touring models*

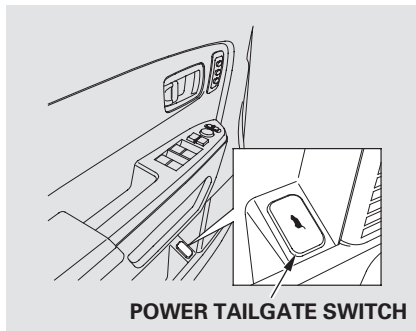

The tailgate can be opened and closed with the remote transmitter (see page 151) or the switch in the driver's door pocket when both front doors are unlocked.

If the glass hatch is opened, remote transmitter operation is canceled until it is closed.

Press and hold the tailgate button on the remote transmitter or the switch for about 1 second to open or close the tailgate. Each time you press the button on the remote transmitter or the switch, you will hear a beep, and some front and rear lights will flash.

If you push the same button or switch again while the tailgate is opening or closing, you will hear three beeps, and the tailgate will stop moving, reverse direction, and stop at the fully opened or closed position.

CONTINUED

Tailgate and Glass Hatch

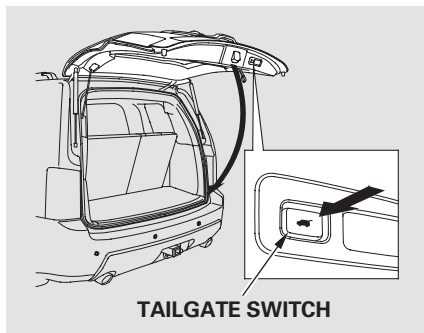

TAILGATE SWITCH

The tailgate can also be closed by pressing the button on the tailgate. If you press the button again while the tailgate is closing, you will hear three beeps, and the tailgate will stop moving, reverse direction, and stop at the fully opened position.

Auto-Reverse

The power tailgate has an auto-reverse feature. If it meets resistance while opening or closing, it will beep three times and reverse direction. However, the tailgate may not reverse immediately. Always make sure passengers and objects are clear of the tailgate before opening or closing it.

⚠ WARNING

Closing a power tailgate while anyone is in the path of the tailgate can cause serious injury.

Make sure everyone is clear before closing the power tailgate.

Also check that passengers, especially children, do not have their hands on the edge of the tailgate or on the tailgate sill. The auto reverse feature stops working when the tailgate is about to latch so the motor can pull the tailgate shut.

If your vehicle's battery is disconnected, goes dead, or the fuse is removed while the tailgate is fully open, the power tailgate needs to be reset. After connecting the battery or installing the fuse, close the tailgate fully by hand.

The power tailgate may not open or close under the these conditions:

- The vehicle is parked on a steep hill.
- When the vehicle is swayed in a strong wind.

- When the tailgate or the roof is covered with snow or ice.

Do not install any accessories on the tailgate. It may cause the tailgate to malfunction. If there is snow or ice on the tailgate, make sure to remove it before you operate the tailgate.

If you push the tailgate release button inside the handle while the tailgate is opening or closing, it will stop moving. You need to open or close it the rest of the way manually.

The tailgate has sensors on both sides. Be careful not to damage them. If the sensors are damaged, the power tailgate does not function properly.

If you try to drive off with the tailgate open, a beeper sounds and a “TAILGATE OPEN” message is shown on the multi-information display.

Keep the tailgate closed at all times while driving to avoid damaging the tailgate and to prevent exhaust gas from getting into the interior. See **Carbon Monoxide Hazard** on page 61 .

If there is a problem in the power tailgate system, you will see a “CHECK POWER TAILGATE” message on the multi-information display. Have the system checked by your dealer.

With this message shown on the multi-information display, you can still open or close the tailgate manually.

Unlocking the Tailgate

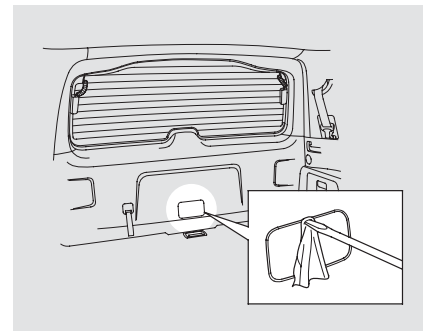

If the power door lock system cannot unlock the tailgate, unlock it manually.

Place a cloth on the top side of the cover to prevent scratches, then use a small flat-tip screwdriver to remove the cover on the back of the tailgate.

CONTINUED

Tailgate and Glass Hatch

On Touring models

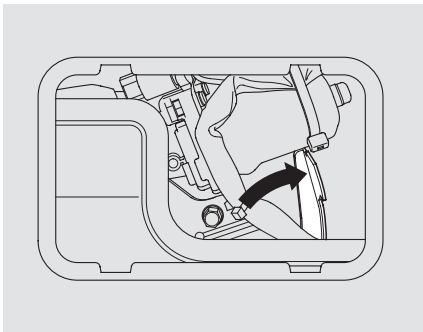

Make sure the shift lever is in the Park (P) position.

Push the release lever to the right as shown.

If you need to unlock the tailgate manually, it means there is a problem with the tailgate. Have the vehicle checked by your dealer.

Except Touring models

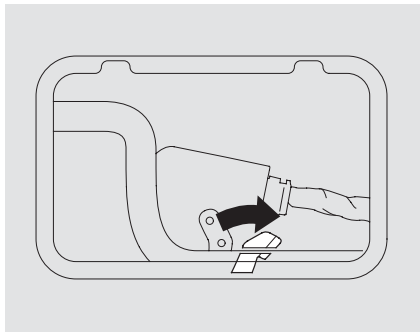

If you cannot open the tailgate, remove the cover on the back of the tailgate (see page 147). Make sure the shift lever is in the Park (P) position. Push the release lever to the right as shown, then pull the outer handle to open the tailgate.

Glass Hatch

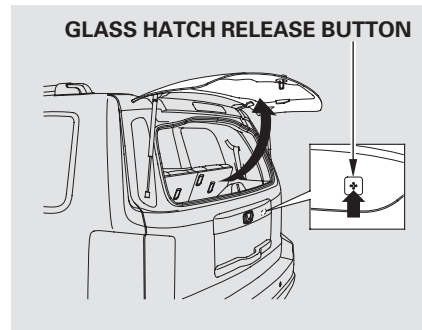

To open the glass hatch, press the glass hatch release button on the tailgate.

To close the glass hatch, lower it and press on the handle until it latches.

Tailgate and Glass Hatch

The rear wiper will not operate with the glass hatch open. If you open the glass hatch while the rear wiper is operating, the wiper will return to its parked position (see page 125). The wiper will resume operation after the glass hatch is closed.

Except Touring models

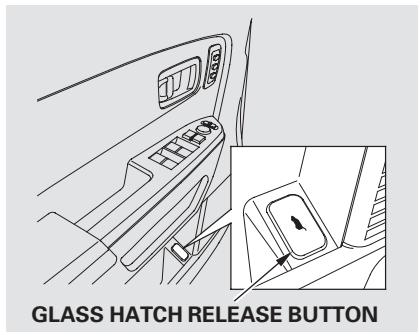

You can also open the glass hatch by pressing the glass hatch release button on the driver's door or on the remote transmitter.

Keep the tailgate and the glass hatch closed at all times while driving to avoid damaging the tailgate and the glass hatch, and to prevent exhaust gas from getting into the interior. See **Carbon Monoxide Hazard** on page 61.

Remote Transmitter

Except Touring models

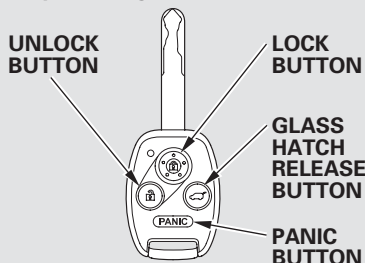

LOCK – Press this button once to lock all doors and the tailgate. Some exterior lights will flash. When you push LOCK twice within 5 seconds, you will hear a beep to verify that the doors and tailgate are locked and the security system has set. This button does not work if any door or tailgate is not fully closed.

On Touring models

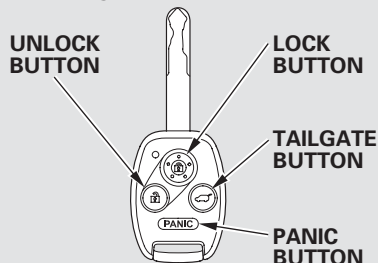

On vehicles with navigation system
To change the “KEYLESS LOCK ACKNOWLEDGEMENT” setting, see page [120](#) .

UNLOCK – Press this button once to unlock the driver’s door. Push it twice to unlock the other doors. Some exterior lights will flash twice when you push the button. If you do not open any door or the tailgate within 30 seconds, they will automatically relock.

On vehicles with navigation system
To change the “KEY AND REMOTE UNLOCK MODE” setting, see page [119](#) .

To change the “SECURITY RELOCK TIMER” setting, see page [121](#) .

When you press the UNLOCK button, the front and rear individual map lights and the cargo area light, depending on their switch positions, will come on (see page 176). If you do not open any door or the tailgate, the lights stay on for about 30 seconds, then go out. If you relock the doors and the tailgate with the remote transmitter before 30 seconds have elapsed, the lights will go off immediately.

Except Touring models

GLASS HATCH RELEASE – Press this button for about 1 second to open the glass hatch. Even if the glass hatch is open, the tailgate can be locked with the remote transmitter.

On Touring models

TAILGATE – Press and hold the TAILGATE button to open or close the power tailgate. When the tailgate begins to move, you will hear a beep, and some front and rear lights will flash.

If you push the same button again while the tailgate is opening or closing, three beeps sound, the tailgate stops moving, reverses direction and stops in the fully opened or fully closed position.

PANIC – Press and hold this button for about 1 second to attract attention; the horn will sound, and the exterior lights will flash for about 30 seconds. To cancel panic mode, press any other button on the remote transmitter, or turn the ignition switch to the ON (II) position. Panic mode does not work when the key is in the ignition switch.

Remote Transmitter Care

- Avoid dropping or throwing the transmitter.
- Protect the transmitter from extreme temperature.
- Do not immerse the transmitter in any liquid.
- If you lose a transmitter, the replacement needs to be reprogrammed by your dealer.

Remote Transmitter

Replacing the Transmitter Battery

If it takes several pushes on the button to lock or unlock the doors and the tailgate, replace the battery as soon as possible.

Battery type: CR1616

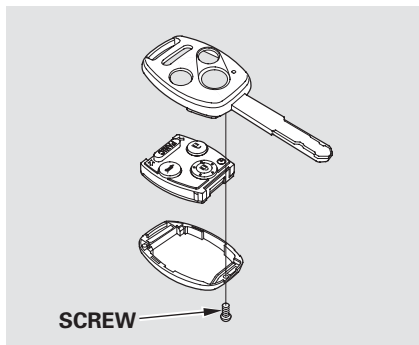

To replace the battery:

1. Remove the screw at the base of the transmitter with a small Phillips-head screwdriver.
2. Separate the transmitter by prying its middle seam with your fingernail.

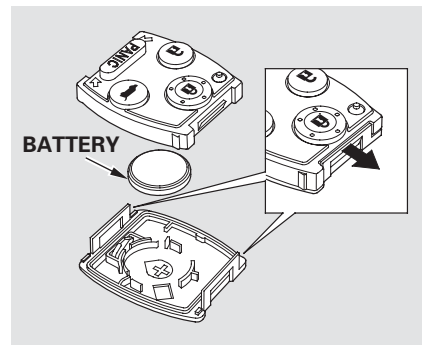

3. Inside the transmitter, separate the inner cover from the keypad by releasing the two tabs on the cover.

4. Remove the old battery, and insert a new battery into the back of the cover with the + side facing down.

An improperly disposed of battery can hurt the environment. Always confirm local regulations for battery disposal.

5. Install the parts in reverse order.

As required by the FCC:

This device complies with Part 15 of the FCC rules. Operation is subject to the following two conditions: (1) This device may not cause harmful interference, and (2) this device must accept any interference received, including interference that may cause undesired operation.

Changes or modifications not expressly approved by the party responsible for compliance could void the user's authority to operate the equipment.

This device complies with Industry Canada Standard RSS-210.

Operation is subject to the following two conditions: (1) this device may not cause interference, and (2) this device must accept any interference that may cause undesired operation of the device.

Keyless Memory Settings™

On Touring models

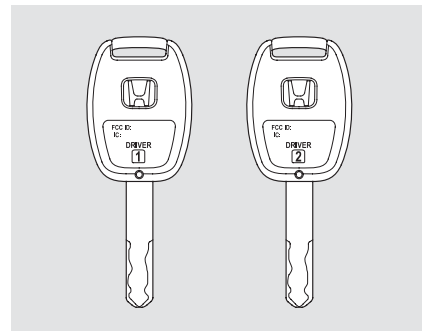

When you unlock the door with your remote, each remote activates the keyless memory settings related to that remote. The driver's ID (Driver 1 or Driver 2) is shown on the back of each remote.

CONTINUED

Remote Transmitter, Seats

Here are the settings activated with the remote:

- Customized settings (see page [97](#)).
- Driving position memory (see page [173](#)).

When you unlock and open the driver's door with the remote transmitter, the driver's seat (except the power lumbar feature) and outside mirrors start to move to the positions stored in memory. The indicator in the related memory button to the remote comes on.

Front Seat Power Adjustments

Except LX models

See pages [15](#) – [16](#) for important safety information and warnings about how to properly position the seats and seat-backs.

The controls for the power adjustable front seats are on the outside edge of each seat bottom. You can adjust the seats with the ignition switch in any position. Make all seat adjustments before you start driving.

On EX-L and Touring models

The passenger seat has the same adjustments as the driver's seat but without any height and lumbar adjustments.

Except EX-L and Touring models

The front passenger's seat adjusts manually.

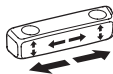
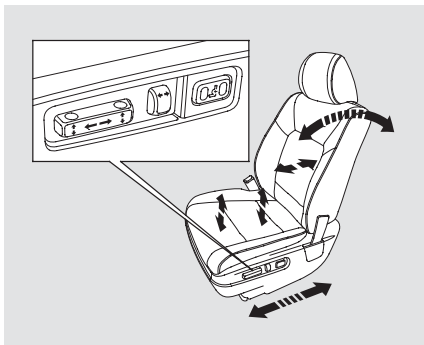

Moves the seat forward and backward.

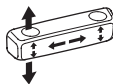

Moves the front of the seat up or down.

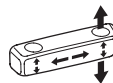

Raises or lowers the seat.

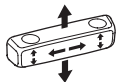

Moves the whole seat up and forward, or down and backward. The front of the seat also tilts up or down at the same time.



Adjusts the seat-back angle forward or backward.



Increases or decreases the lumbar support. (Driver's seat only)

Front Seat Manual Adjustments

Except EX-L and Touring models
See pages 15 – 16 for important safety information and warnings about how to properly position the seats and seat-backs.

Make all seat adjustments before you start driving.

CONTINUED

Seats

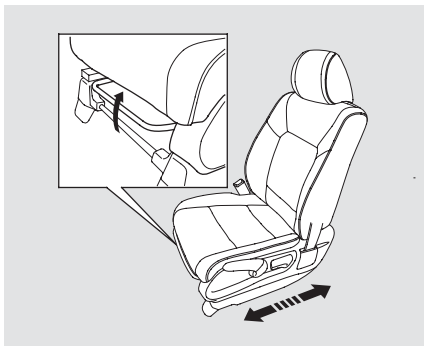

To adjust the seat forward or backward, pull up on the bar under the seat cushion's front edge. Move the seat to the desired position, and release the bar. Try to move the seat to make sure it is locked in position.

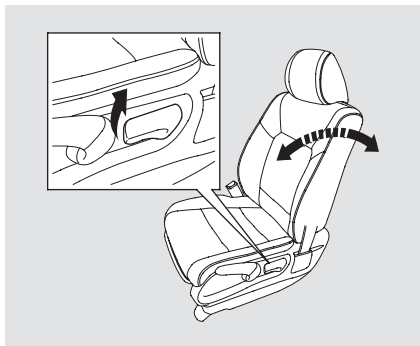

To change the seat-back angle, pull up on the lever on the outside of the seat bottom.

Once a seat is adjusted correctly, rock it back and forth to make sure it is locked in position.

Driver's Seat Manual Height Adjustment

On LX models

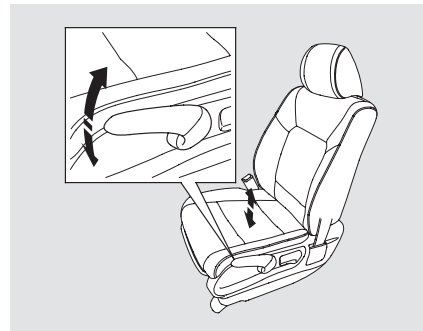

The height of your driver's seat is adjustable. To raise the seat, repeatedly pull up the lever on the outside of the seat cushion. To lower the seat, push the lever down repeatedly.

Head Restraints

See page 16 for important safety information and a warning about improperly positioning head restraints.

Your vehicle is equipped with head restraints in all seating positions to help protect you and your passengers from the likelihood of whiplash and other injuries.

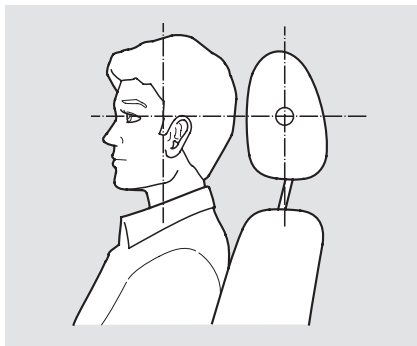

They are most effective when you adjust them so the center of the back of the occupant's head rests against the center of the restraint.

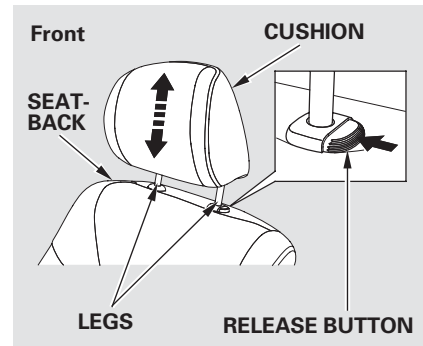

Adjusting the Head Restraint

The head restraints adjust for height. You need both hands to adjust the restraint. Do not attempt to adjust it while driving. To raise it, pull upward. To lower the restraint, push the release button sideways, and push the restraint down.

CONTINUED

Seats

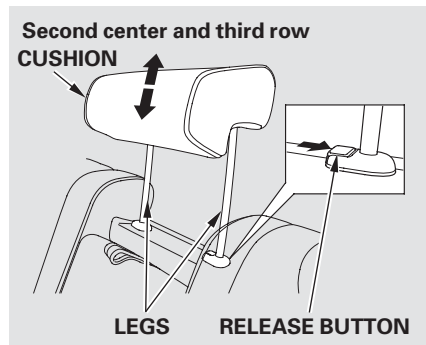

Removing the Head Restraint

To remove a head restraint for cleaning or repair, pull it up as far as it will go. Push the release button, then pull the restraint out of the seat-back.

⚠ WARNING

Failure to reinstall the head restraints can result in severe injury during a crash.

Always replace the head restraints before driving.

When reinstalling a head restraint, put the legs back in place. Then adjust it to the appropriate height while pressing the release button.

Make sure the head restraint locks in position when you reinstall it.

Active Head Restraints

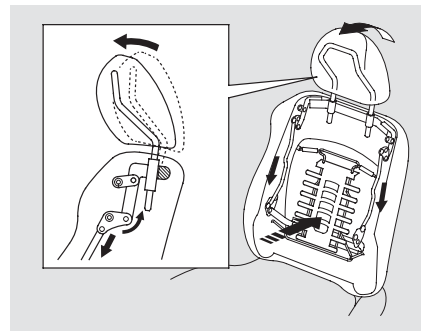

The driver's and front passenger's seats have active head restraints. If the vehicle is struck severely from the rear, the occupant properly secured with the seat belt will be pushed against the seat-back and the head restraint will automatically move forward.

This reduces the distance between the restraint and the occupant's head. It also helps protect the occupants against the likelihood of whiplash and injuries to the neck and upper spine.

After a collision, the activated restraint should return to its normal position.

If the restraints do not return to their normal position, or in the event of a severe collision, have the vehicle inspected by a Honda dealer.

For a head restraint system to work properly:

- Do not hang any items on the head restraints, or from the restraint legs.
- Do not place any object between an occupant and the seat-back.
- Install each restraint in its proper location.
- Only use genuine Honda replacement head restraints.

Adjusting the Second Row Seats

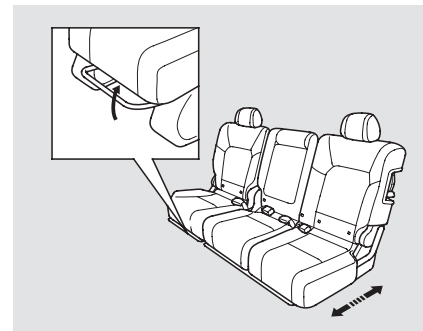

To adjust the second row seats forward and backward, pull up on the bar under the front edge of the seat cushion. Move the seat to the desired position and release the bar. Try to move the seat to make sure it is locked in position.

CONTINUED

Seats

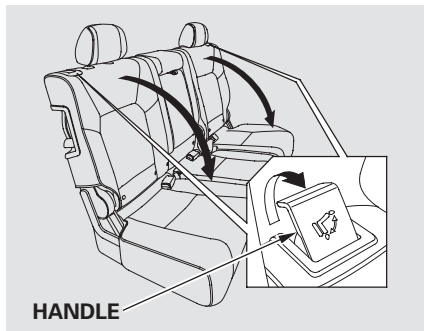

To change the seat-back angle of the seats in the second row, pull up on the handle on the outside of the seat-back, and push the seat-back.

Folding the Second Row Seats

The left and right halves can be folded separately.

1. To unlatch the detachable anchor before folding the seat-back, insert the latch plate into the slot on the side of the anchor buckle (see page 162) and allow the seat belt to retract. Store the detachable anchor and seat belt latch plates in the retractor housing.
2. Lower the head restraints to their lowest positions.
3. Pull up the handle on the outside of the seat-back.
4. Fold the seat-back forward.

Reverse this procedure to return the seat to the upright position. Make sure the seat is locked securely before driving.

Make sure that the folded seat-back does not press against the front passenger's seat, as this could cause the weight sensors to work improperly.

Third Row Access

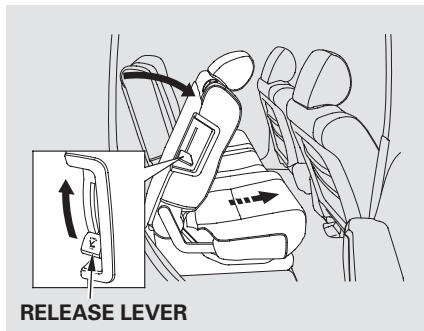

To get into the third row seats, pull up the lever on the side of the passenger's side second row seat-back. The seat-back will tilt forward, and then can be slid forward.

After you return the seat-back to the upright position, push the whole seat backwards until it latches. Make sure the seat is fully latched before sitting in it.

Folding the Third Row Seat

1. Use the latch plate to release the seat belt from the detachable anchor (see page 162).
2. Lower the head restraints to their lowest positions.

NOTE: To fold the third row seat, the second row seat-back must be folded down or in the full up right position.

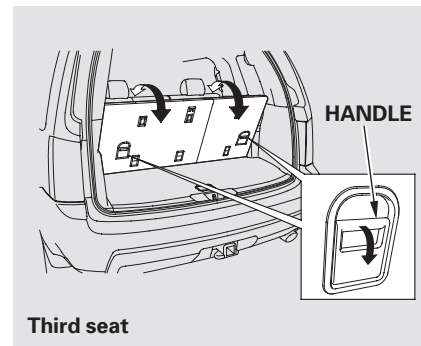

3. Unlock the seat-back by pulling the handle. Push the seat-back forward.

Make sure the outer shoulder belts are positioned in each holding slot on the side panel whenever the third seat is folded.

CONTINUED

Seats

Reverse this procedure to return the seat to the upright position. Make sure the seat is locked securely before driving. Reconnect the seat belts to the detachable anchors.

Make sure all items in the cargo area are secured. Loose items can fly forward and cause injury if you have to brake hard (See **Carrying Cargo** on page 404).

Detachable Anchor

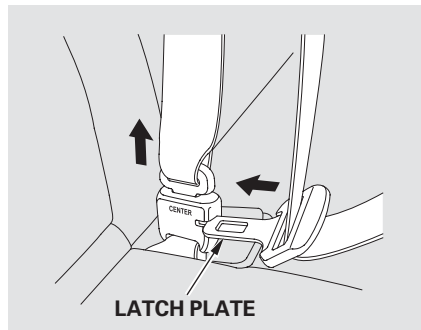

The seat belts in the second row center seat and the third row seats are equipped with detachable anchors.

To unlatch the detachable anchor, insert the latch plate into the slot on the side of the anchor buckle. Store the detachable anchor and seat belt latch plates in the retractor housing.

When the seats are returned to the upright position, these detachable anchors should be latched back properly.

⚠ WARNING

Using the seat belt with the detachable anchor unlatched increases the chance of serious injury or death in a crash.

Before using the seat belt, make sure the detachable anchor is correctly latched.

Second row and third row center seats

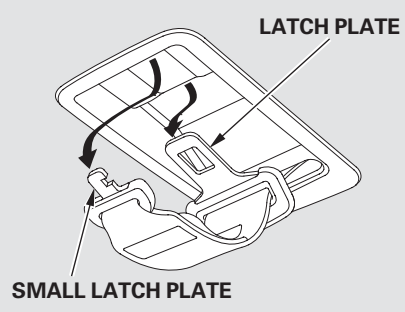

Pull out the small latch plate and the latch plate from each holding slot in the ceiling, and pull out the seat belt to extend it.

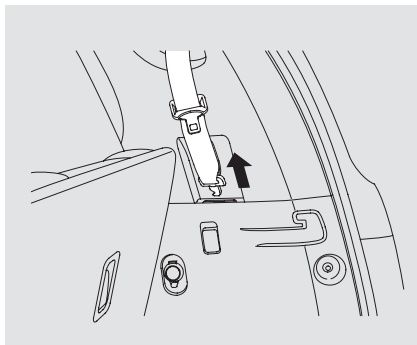

Pull out the outer shoulder belts from the holding slots. Both of the third-row holding slots should only be used when the seat belt is detached.

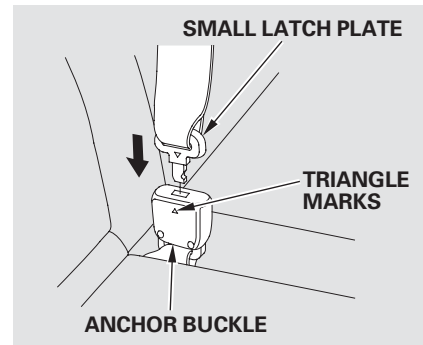

Line up the triangle marks on the small latch plate and anchor buckle when reattaching the belt and buckle.

Tug on the seat belt to verify that the detachable anchor is securely latched. Make sure the seat belt is not twisted.

Seat Heaters

Passenger's seat

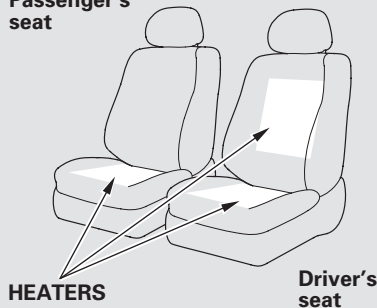

If equipped
Both front seats are equipped with seat heaters. Because of the sensors for the side airbag cutoff system, there is no heater in the passenger's seat-back. The ignition switch must be in the ON (II) position to use the heaters.

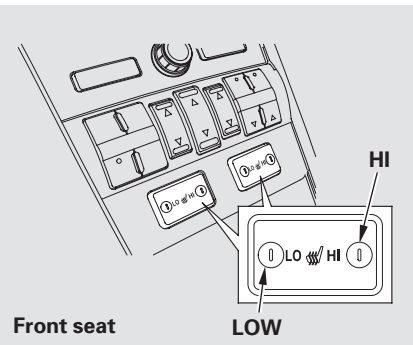

Push the right side of the switch, HI, to rapidly heat up the seat. After the seat reaches a comfortable temperature, select LO by pushing the left side of the switch. This will keep the seat warm.

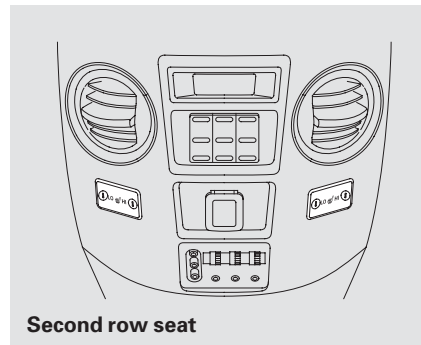

On Canadian Touring models
The outer second row seat cushions and seat-backs are equipped with seat heaters. Turning the switch on the driver side warms the outer seat behind the driver's seat only. The passenger side switch warms the outer seat behind the front passenger seat.

Seat Heaters, Power Windows

In the HI setting, the heater turns off when the seat gets warm, and turns back on after the seat's temperature drops.

In the LO setting, the heater runs continuously. It does not cycle with temperature changes.

Follow these precautions when using the seat heaters:

- Use the HI setting only to heat the seats quickly, because it draws large amounts of current from the battery.
- If the engine is left idling for an extended period, do not use the seat heaters even on the LO setting. It can weaken the battery, causing hard starting.

Power Windows

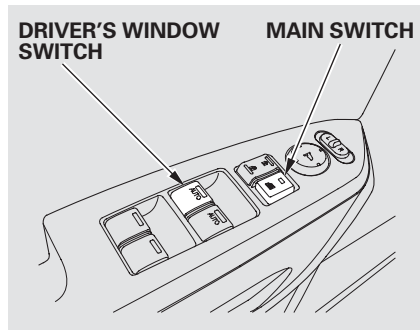

Turn the ignition switch to the ON (II) position to raise or lower any window. To open a window, push the switch down and hold it. Release the switch when you want the window to stop. Pull back on the switch and hold it to close the window.

The windows will operate for up to 10 minutes after you turn off the ignition switch. Opening either front door cancels this function.

⚠ WARNING

Closing a power window on someone's hands or fingers can cause serious injury.

Make sure your passengers are away from the windows before closing them.

AUTO – To open either front window fully, push the window switch firmly down to the second detent, then release it. The window automatically goes down all the way. To stop the window from going all the way down, pull back on the window switch briefly.

CONTINUED

Power Windows

To close either front window fully, pull back the window switch firmly to the second detent, then release it. The window automatically goes all the way up. To stop the window from going all the way up, push down on the window switch briefly.

When you push the MAIN switch in, the switch is off, and the passengers' windows cannot be raised or lowered. To cancel this feature, push on the switch again to get it to pop out. Keep the MAIN switch pushed in when you have children in the vehicle so they do not injure themselves by operating the windows unintentionally.

AUTO REVERSE — If either front window senses any obstacle while it is closing automatically, it will reverse direction and then stop. To close the window, remove the obstacle, then use the window switch again.

Auto reverse stops sensing when the window is almost closed. You should always check that all passengers and objects are away from the window before closing it.

If your vehicle's battery is disconnected or goes dead, or the driver's window fuse is removed, the AUTO function may be disabled. If the AUTO function is disabled, the power window system will need to be reset after reconnecting the battery or installing the fuse.

1. Start the engine. Push down and hold the driver's window switch until the window is fully open.
2. Pull and hold the driver's window switch to close the window completely, then hold the switch for about 2 seconds.

If the power windows do not operate properly after resetting, have your vehicle checked by your dealer.

Opening the Windows and Moonroof with the Remote Transmitter

You can open all of the windows and the moonroof (if equipped) from the outside with the remote transmitter.

1. Press the UNLOCK button once to unlock the driver's door.
2. Press the UNLOCK button a second time, and hold it. All the doors unlock, and all four windows and moonroof start to open. To stop the windows and moonroof, release the button.
3. To open the windows and moonroof further, press the button again (within 10 seconds of step 1) and hold it. If the windows and the moonroof stop before the desired position, repeat steps 1 and 2.

You cannot close the windows or the moonroof with the remote transmitter.

Opening/Closing the Windows and Moonroof with the Key

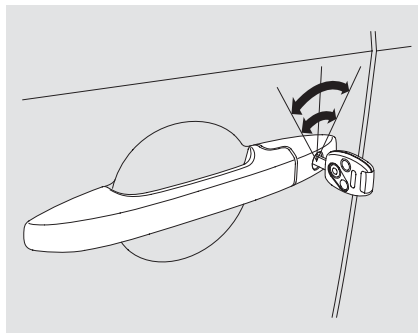

You can open and close the windows and the moonroof (if equipped) with the key in the driver's door lock.

To open:

1. Insert the key in the driver's door lock.
2. Turn the key clockwise, then release it.

3. Turn the key clockwise again, and hold it. All four windows and the moonroof start to open. To stop the windows and the moonroof, release the key.
4. To open the windows and the moonroof further, turn and hold the key again (within 10 seconds of step 2).

To close:

1. Insert the key in the driver's door lock.
2. Turn the key counterclockwise, then release it.
3. Turn the key counterclockwise again, and hold it. All four windows and the moonroof start to close. To stop the windows and the moonroof, release the key.

CONTINUED

Power Windows, Moonroof

4. To close the windows and the moonroof further, turn and hold the key again (within 10 seconds of step 2).

Auto reverse does not work when closing the windows and moonroof with the key.

NOTE: If the windows and the moonroof stop before the desired position, repeat steps 2 and 3.

Moonroof

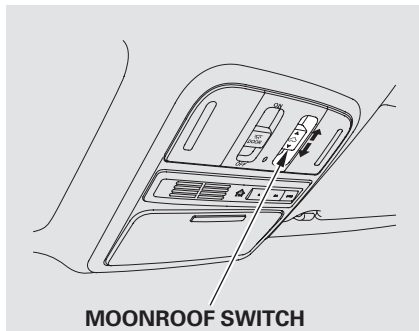

On EX-L and Touring models
Turn the ignition switch to the ON (II) position before operating the moonroof switch on the ceiling console.

To open the moonroof fully, pull back the moonroof switch firmly. The moonroof opens all the way. To stop the moonroof from opening fully, push the switch briefly.

To tilt up the moonroof, push on the center of the moonroof switch. To stop the moonroof from tilting up fully, push the switch briefly.

To close the moonroof fully, firmly push the moonroof switch forward, then release it. The moonroof automatically closes all the way. To stop the moonroof from closing, push the switch briefly.

To open or close the moonroof partially, pull back or push forward the moonroof switch lightly and hold it. The moonroof will stop when you release the switch.

AUTO REVERSE – If the moonroof runs into any obstacle while it is closing automatically, it will reverse direction and then stop. To close the moonroof, remove the obstacle, then use the moonroof switch again.

Auto reverse stops sensing when the moonroof is almost closed. You should always check that all passengers and objects are away from the moonroof before closing it.

⚠ WARNING

Opening or closing the moonroof on someone's hands or fingers can cause serious injury.

Make sure all hands and fingers are clear of the moonroof before opening or closing it.

You can open and close the moonroof for up to 10 minutes after you turn off the ignition switch. Opening either front door cancels this function.

NOTICE

If you try to open the moonroof in below-freezing temperatures, or when it is covered with snow or ice, you can damage the moonroof panel or its motor.

Operating the Moonroof with the Remote Transmitter or the Key

You can use the remote transmitter or the key to operate the moonroof from the outside. Refer to page [167](#) for details.

Parking Brake



To apply the parking brake, push the pedal down with your foot. To release it, pull the release handle fully. The parking brake indicator on the instrument panel should go out when the parking brake is fully released (see page [71](#)).

CONTINUED

Parking Brake, Mirrors

NOTICE

Driving the vehicle with the parking brake applied can damage the rear brakes and hubs. A beeper will sound if the vehicle is driven with the parking brake on.

On vehicles with navigation system
You will also see a “RELEASE PARKING BRAKE” message on the multi-information display (see page 95).

Mirrors

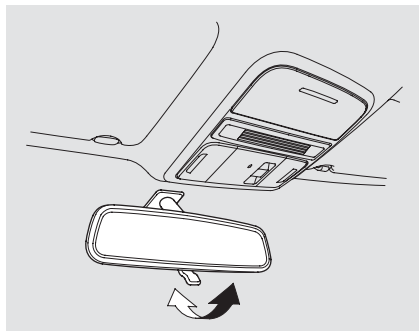

Keep the inside and outside mirrors clean and adjusted for best visibility. Be sure to adjust the mirrors before you start driving.

On LX and EX models

The inside mirror has day and night positions. The night position reduces glare from headlights behind you. Flip the tab on the bottom edge of the mirror to select the day or night position.

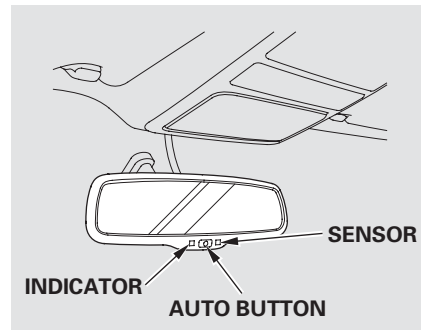

On EX-L and Touring models

The inside mirror can automatically darken to reduce glare. To turn on this feature, press the button on the bottom of the mirror. The AUTO indicator comes on as a reminder. When it is on, the mirror darkens when it senses the headlights of a vehicle behind you, then returns to normal visibility when the lights are gone. Press the button again to turn off this feature.

On EX-L models without navigation system

When you shift to reverse with the ignition switch in the ON (II) position, the rear view is shown on the left side of the inside mirror. For more information, see page [391](#).

NOTICE

There is also a sensor on the back of the mirror. Items hung on the mirror may block this sensor and affect its performance.

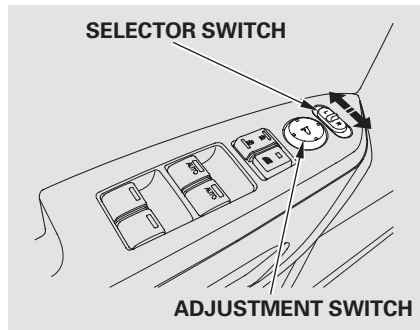
Adjusting the Power Mirrors

1. Turn the ignition switch to the ON (II) position.
2. Move the selector switch to L (driver's side) or R (passenger's side).

3. Push the appropriate edge of the adjustment switch to move the mirror right, left, up, or down.
4. When you finish, move the selector switch to the center (off) position. This turns the adjustment switch off to keep your settings.

Mirrors

Reverse Tilt Door Mirror

On Touring models

Both outside door mirrors have a reverse tilt feature. When in reverse, the selected mirror will tilt down slightly to improve your view as you parallel park. Shifting out of reverse will return the mirror to its original position.

- To tilt the driver's mirror, place the selector switch in the left position.
- To tilt the passenger's mirror, place the switch in the right position.
- To turn the feature off, place the switch in the center position.

Outside mirror positions can be stored in the driving position memory system (see page [173](#)).

Heated Mirrors

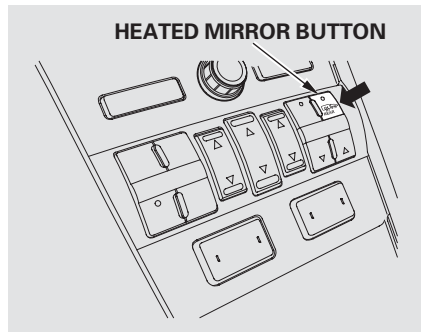

If equipped

The outside mirrors are heated to remove fog and frost. With the ignition switch in the ON (II) position, turn on the heaters by pressing the button. The indicator in the button comes on as a reminder. Press the button again to turn the heaters off. Pressing this button also turns the rear window defogger on and off.

Driving Position Memory System

On Touring models

Your vehicle has a memory feature for the driver's seat and outside mirror positions.

Two seat and outside mirror positions can be stored in separate memories. You select a memorized position by pushing the appropriate button or using the appropriate remote transmitter (Driver 1 or Driver 2).

You can change the "MEMORY POSITION LINK" setting on the multi-information display (see page [109](#)).

Storing a Driving Position in Memory

Store a driving position only when the vehicle is parked.

1. Turn the ignition switch to the ON (II) position. You cannot add a new driving position to the memory unless the ignition switch is in the ON (II) position. You can recall a memorized position with the ignition switch in any position.
2. Adjust the seat to a comfortable position (see page [154](#)).
3. Adjust the outside mirrors for best visibility (see page [171](#)).

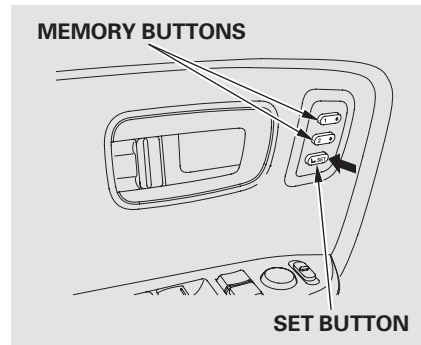

4. Press and release the SET button on the control panel. You will hear a beep. Immediately press and hold one of the memory buttons (1 or 2) until you hear two beeps. The indicator in the memory button will come on. The current positions of the driver's seat and outside mirrors are now stored.

CONTINUED

Driving Position Memory System

To cancel the storing procedure after pressing the SET button, do any of the following:

- Fail to press a memory button within 5 seconds.
- Pressing the SET button again within 5 seconds.
- Readjust the seat position.
- Readjusting the outside mirror position.

Each memory button stores only one driving position. Storing a new position erases the previous setting stored in that button's memory. If you want to add a new position while retaining the current one, use the other memory button.

All stored driving positions will be lost if your vehicle's battery goes dead or is disconnected.

Selecting a Memorized Position

To select a memorized position, do this:

1. Make sure the shift lever is in the Park (P) position.
2. Press the desired memory button (1 or 2) until you hear a beep, then release the button.

The system will move the seat and outside mirrors to the memorized positions. The indicator in the selected memory button will flash during movement. When the adjustments are complete, you will hear two beeps, and the indicator will remain on.

To stop the system's automatic adjustment, do any of these actions:

- Press any button on the control panel: SET, 1, or 2.
- Push any of the adjustment switches for the seat.
- Shift out of Park.
- Adjust the outside mirrors.

If desired, you can use the adjustment switches to change the positions of the seat or outside mirrors after they are in their memorized positions. If you change the memorized position, the indicator in the memory button will go out. To keep this driving position for later use, you must store it in the driving position memory.

Interior Lights

Light Control Switch

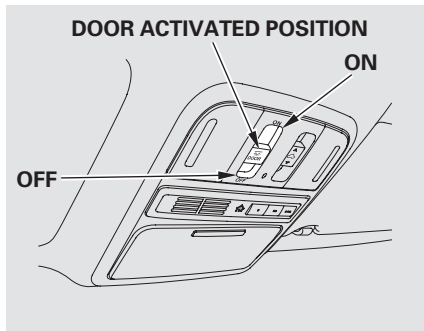

The light control switch has three positions: OFF, Door Activated, and ON.

When the switch is in the OFF position:

- The individual door lights will operate when a door is opened.
- The individual map lights in the front can be turned on and off by pressing the lenses.
- The individual map lights in the second and third rows cannot be turned on.

When the switch is in the door activated position:

- The individual map lights come on when any door or the tailgate is opened, or when the remote transmitter is used to unlock the doors. When the doors and the tailgate are closed, each light can be turned on and off by pushing the lens.
- The cargo area light comes on when the tailgate is opened if the light control switch is in the door activated (center) position. When the tailgate is closed, the cargo area light can be turned on with the switch in the light.

After all doors are closed tightly, the lights dim slightly, then fade out in about 30 seconds.

On vehicles with navigation system

To change the “INTERIOR LIGHT DIMMING TIME” setting, see page [111](#).

With any door or the tailgate left open, the lights stay on about 15 minutes, then go out.

The lights also come on when the key is removed from the ignition switch.

When the light control switch is in the ON position:

All the individual map lights come on and stay on as long as the switch remains in the ON position.

Individual Map Lights

Front

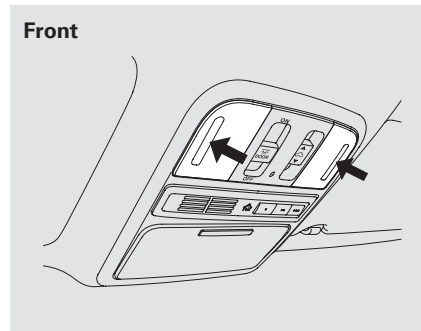

Turn on the front row individual map lights by pushing the lens. Push the lens again to turn it off. With the light control switch in the door activated position, the second row and third row map lights can be turned on by pushing the lens. Push the lens again to turn it off.

CONTINUED

Interior Lights

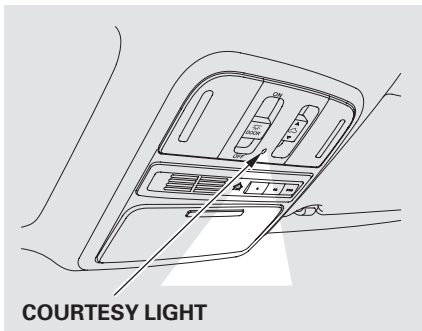

The courtesy light between the front map lights comes on when you turn the parking lights on. To adjust its brightness, turn the instrument panel brightness control dial on the dashboard (see page [131](#)).

Cargo Area Light

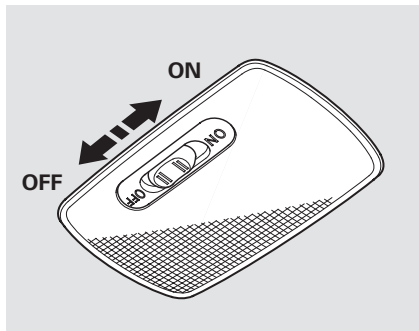

The cargo area light has a three-position switch. In the OFF position, the light does not come on. In the center position, the light comes on when you open the tailgate or the glass hatch. In the ON position, the light stays on continuously.

Individual Interior Lights

The courtesy lights in all four doors come on when you open any door. The light around the ignition switch only comes on when you open the driver's door. After you close the door, the ignition switch light stays on for several seconds.

On vehicles with navigation system
To change the "INTERIOR LIGHT DIMMING TIME" setting, see page [111](#).

Interior Convenience Items

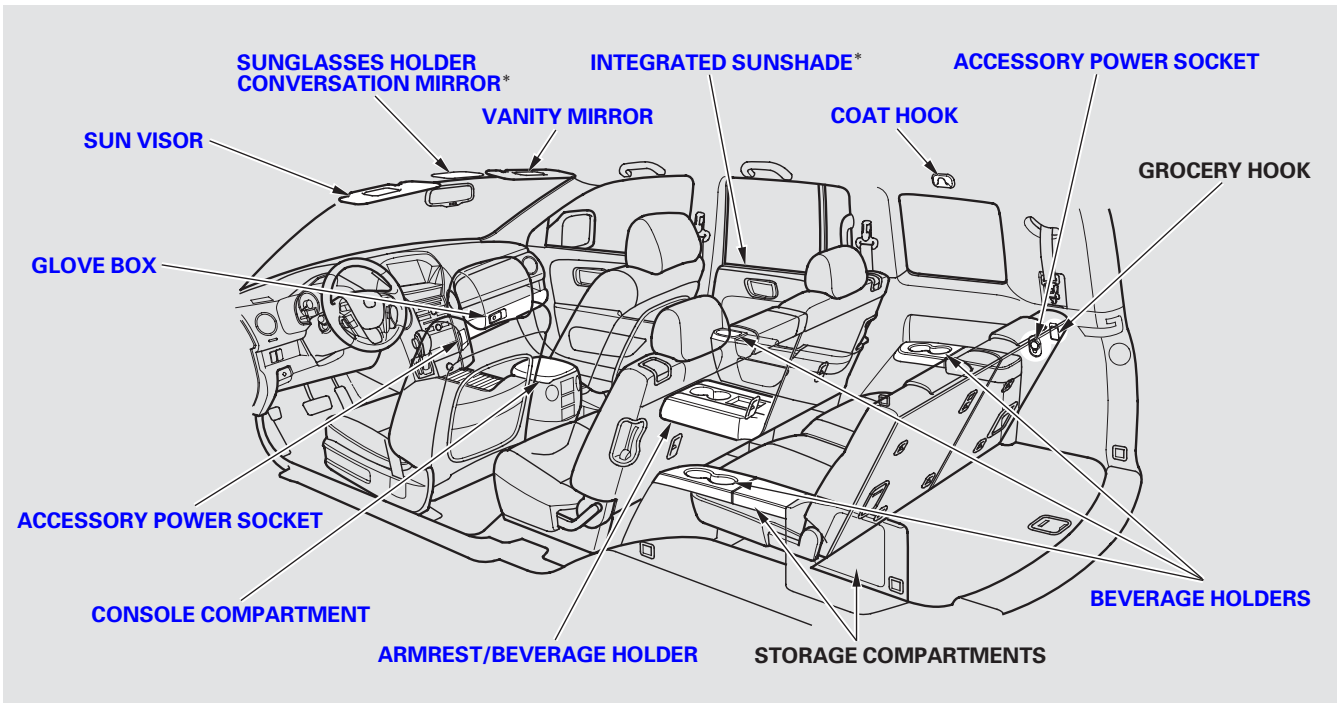

* : If equipped

Interior Convenience Items

Center Console

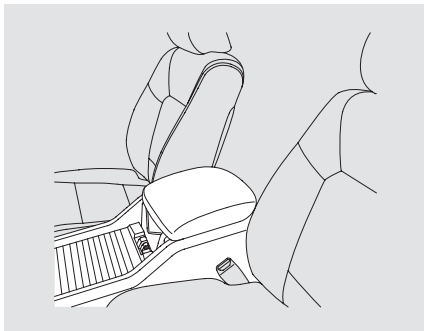

Your vehicle has a multi-function center console. It includes beverage holders, storage compartments, an armrest, and a storage tray.

Console Compartments

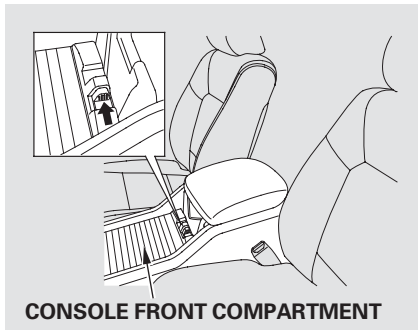

To open the front of the console compartment, squeeze the knob, and push it forward. To close, squeeze the knob and slide the cover backward.

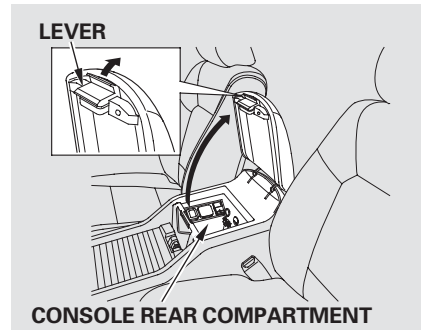

To open the rear of the console compartment, pull up on the lever and lift the armrest.

To close, lower the armrest, and push it down until it latches.

There is a removable partition in the main compartment area. The partition can be used to divide the forward compartment from the beverage holder area, or can be stored to the rear of the beverage area to create a deeper storage tray.

Beverage Holders

Be careful when you are using the beverage holders. A spilled liquid that is very hot can scald you or your passengers. Liquid can also spill from the door pocket beverage holders when you open or close the doors. Use only resealable containers in the door pockets.

Spilled liquids can damage the upholstery, carpeting, and electrical components in the interior.

CONTINUED

Interior Convenience Items

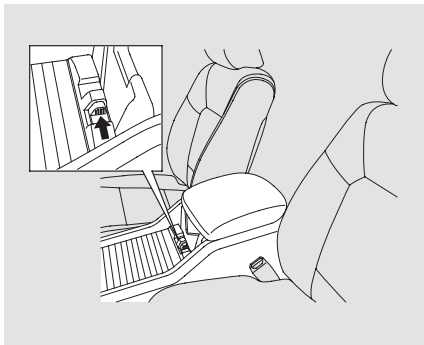

To open the beverage holder, squeeze the knob, and slide the cover forward.

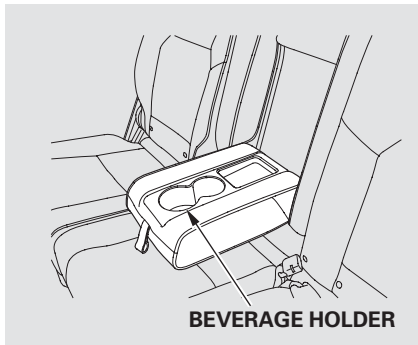

The center seat-back in the second row is equipped with an armrest that provides the beverage holder. Pivot down the seat-back to use them.

Storage Compartment

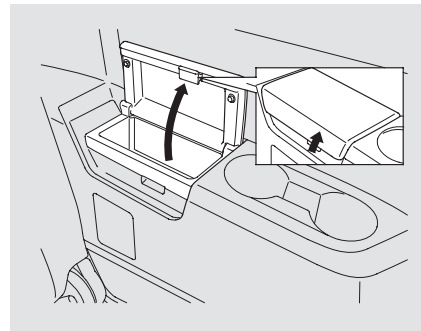

To open the compartment, pull the lever and lift the lid. To close, lower the lid and push it down until it latches.

Glove Box

Open the glove box by pulling up on the handle. Close it with a firm push. Lock or unlock the glove box with the master key.

The glove box light comes on when the parking lights are on.

⚠ WARNING

An open glove box can cause serious injury to your passenger in a crash, even if the passenger is wearing the seat belt.

Always keep the glove box closed while driving.

Integrated Sunshades

On Touring models

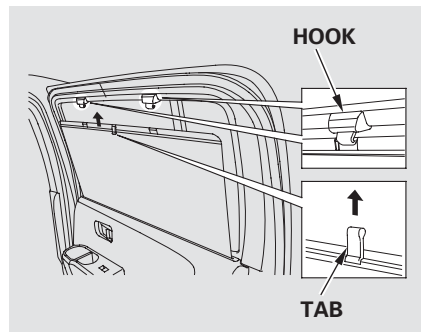

Each rear door has an integrated sunshade. To use a sunshade, hold the tab on the top, and pull the sunshade all the way up. Insert the holes on the sunshade into the hooks on the window frame.

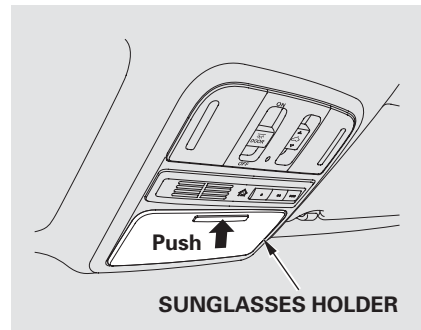
Sunglasses Holder

To open the sunglasses holder, push on the front edge. Make sure the holder is closed while you are driving.

Some larger styles of sunglasses may not fit in the holder.

CONTINUED

Interior Convenience Items

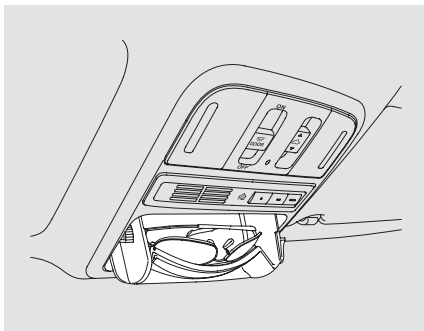

You may also store small items in this holder. Make sure they are small enough to let the holder close and latch, and that they are not heavy enough to cause the holder to pop open while driving.

Conversation Mirror

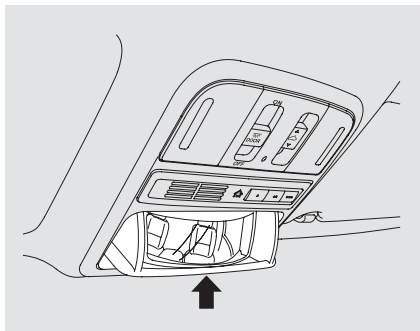

On EX-L and Touring models
The sunglasses holder uses a convex mirror for its bottom panel. You can see all the vehicle passengers in this mirror. To use the mirror, open the sunglasses holder fully, push it to the first detent, and release it.

Sun Visor

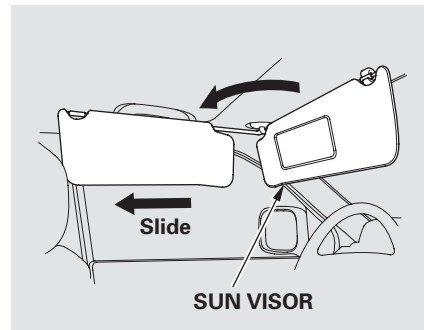

To use the sun visor, pull it down. When using the sun visor for the side window, remove the support rod from the clip, and swing it out.

In this position, the sun visor can be adjusted by moving it on its slider. Do not use the extended sun visor over the inside mirror. Make sure you put the sun visor back in place when you are getting into or out of the vehicle.

Vanity Mirror

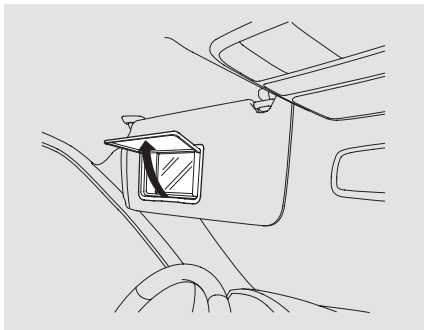

To use the vanity mirror on the back of the sun visor, pull up the cover.

Coat Hooks

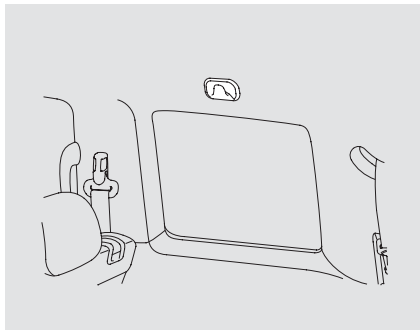

These hooks are not designed for large or heavy items.

Seat Under Tray

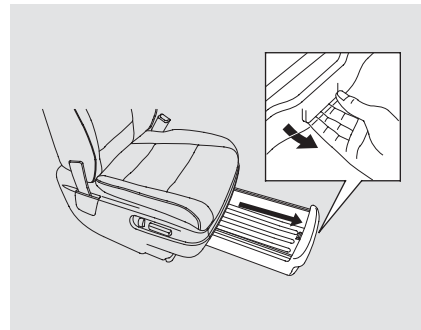

On Touring models
Your vehicle has a seat under tray located under the front passenger seat. Use the tray by pulling on the front center edge of the tray.

Interior Convenience Items

Accessory Power Sockets

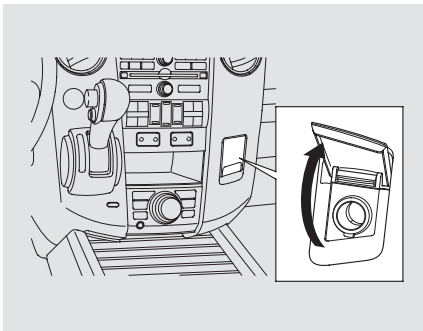

Your vehicle has four accessory power sockets. These are located on the instrument panel, in the console compartment, back of the center console box, or behind the third row seat on the passenger's side.

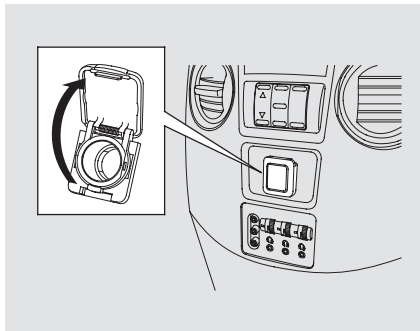

To use an accessory power socket, the ignition switch must be in the ACCESSORY (I) or ON (II) position.

Each socket is intended to supply power for 12 volt DC accessories that are rated 120 watts or less (10 amps).

Rear

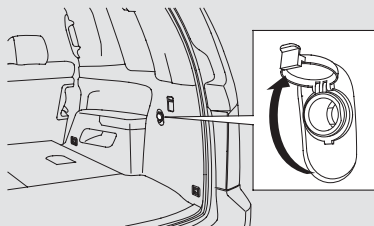

None of the sockets will power an automotive type cigarette lighter element.

Make sure to put the socket cover back in place to prevent any small foreign objects from getting into the socket.

AC Power Outlet

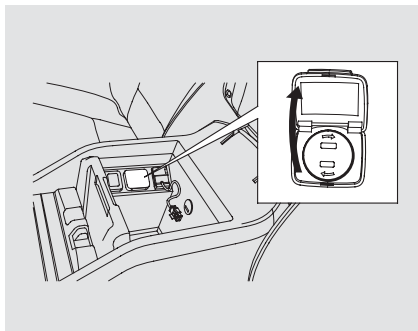

On vehicles with rear entertainment system

There is a 115 volt AC power outlet inside the front console compartment. To use the AC power outlet, open the lids and open the outlet cover. Insert the plug into the receptacle slightly, turn it 90° clockwise, then push in the plug all the way.

Always run the engine when you use the AC power outlet.

The maximum capacity for this power outlet is 115 volt AC at 100 watts or less. If you use an appliance which requires more than 100 watts, it automatically stops supplying the power. If this happens, turn the ignition switch off and turn it on again.

CONTINUED

Interior Convenience Items

NOTE: The AC power outlet is not designed for electric appliances which require high initial peak wattage such as cathode-ray tube type televisions, refrigerators, electric pumps, etc. It is also not suitable for devices that process precise data such as medical equipment or measuring instruments. Any appliances that require an extremely stable power supply such as microcomputer-controlled electric blankets, touch sensor lamps, etc., should not be connected to this outlet.

Cargo Hooks

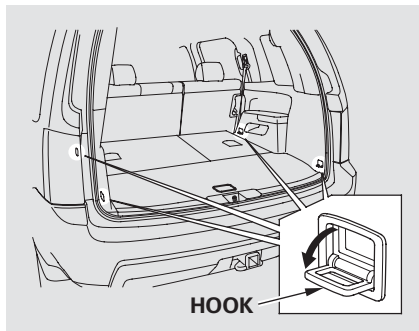

The hooks on the floor of the cargo area enable you to tie down items stored in the back. Make sure all stored items are secured before driving.

Cargo Floor Storage Compartment

Additional storage space for large items can be accessed by strapping the cargo floor to the seat back.

Cargo Net

On Touring models

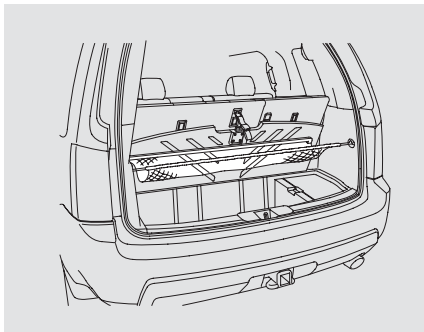

The cargo net will separate the storage area into two storage areas. On the upper area, you can store small and light items. You should place heavy items in the lower storage area. You can store the cargo net under the cargo floor to make a larger cargo area.

Make sure to use the cargo net securely hooked.

⚠ WARNING

Do not use this cargo net if the third row seats are folded down.

Objects placed on the cargo net could be thrown forward during a crash or sudden stop and hurt someone.

When any of the third row seats are folded down, do not place any objects on the cargo net. Make sure to store the cargo net under the cargo area floor. It could be unlatched during a crash.

The maximum load on the cargo net is 22 lbs on U.S. models, and 10 kg on Canadian models. This is shown on a label back of the cargo area floor (see page 190). To prevent damage to the cargo net, do not exceed the maximum load.

Make sure all items in the cargo area are secured. Loose items can fly forward and cause injury if you have to brake hard (See **Carrying Cargo** on page 404).

CONTINUED

Interior Convenience Items

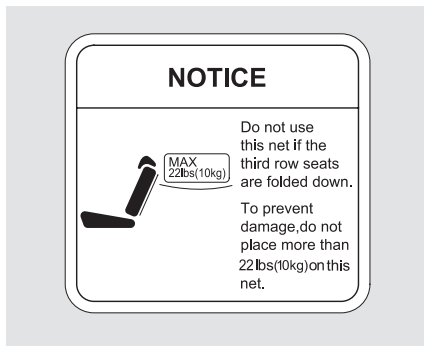

To prevent damage, do not place more than 22 lbs (10 kg) on this cargo net.

The heating and air conditioning system in your vehicle provides a comfortable driving environment in all weather conditions.

The standard audio system has many features. This section describes those features and how to use them.

Your vehicle has an anti-theft audio system that requires a code number to enable it.

Except LX models

The security system helps to discourage vandalism and theft of your vehicle.

On vehicles with navigation system

The climate control system and the audio system have a voice control feature. Refer to the navigation system manual for more information.

Vents, Heating and A/C	192	Playing a USB Flash Memory Device	298
Using the Rear A/C Unit.....	197	USB Flash Memory Device Error Messages.....	307
Climate Control System.....	199	FM/AM Radio Reception.....	308
Rear Climate Controls.....	204	Auxiliary Input Jack.....	310
Audio System	208	Remote Audio Controls.....	311
<i>LX models</i>		Radio Theft Protection.....	313
Playing the FM/AM Radio.....	210	Setting the Clock	314
Playing a Disc.....	218	Rear Entertainment System.....	317
Disc Player Error Messages	225	Security System	349
<i>EX and EX-L models without navigation system</i>		Cruise Control.....	350
Audio System	226	Compass.....	353
Playing the FM/AM Radio.....	227	HomeLink® Universal Transceiver.....	357
Playing the XM® Radio	236	<i>Bluetooth</i> ® HandsFreeLink®	361
Playing Discs.....	242	Parking Sensor System.....	386
Disc Changer Error Messages	251	Rearview Camera and Monitor	390
<i>Models with navigation system</i>			
Audio System	252		
Playing the FM/AM Radio.....	253		
Playing the XM® Radio	266		
Playing Discs.....	274		
Disc Changer Error Messages	284		
Protecting Your Discs.....	285		
Playing an iPod®.....	288		
iPod® Error Messages	297		

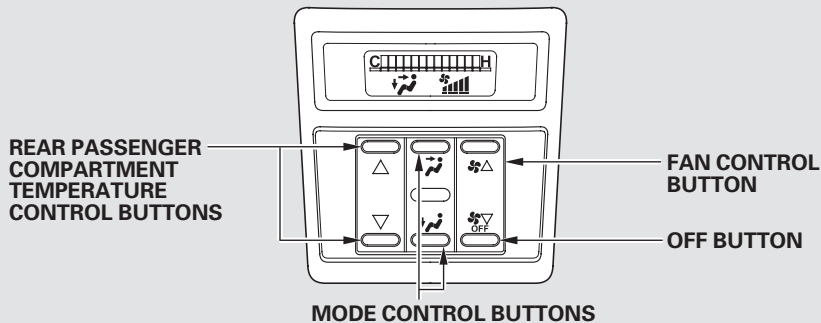
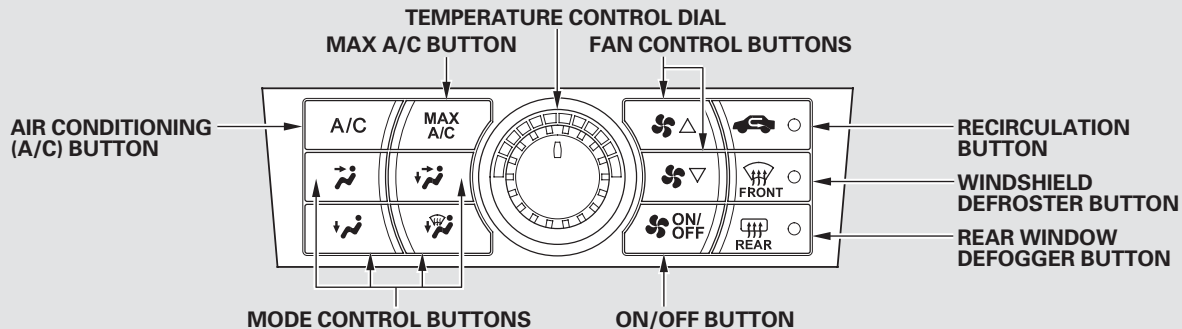

Vents, Heating, and A/C

LX models



U.S. model is shown.

Fan Control

Press the  ▲ button to increase the fan speed and airflow. Press the  ▼ button to decrease it.

Temperature Control

Turning this dial clockwise increases the temperature of the airflow.

Air Conditioning (A/C) Button

This button turns the air conditioning on and off. You will see A/C ON or A/C OFF in the display.

Recirculation Button

When the indicator in the button is on, air from the vehicle's interior is sent throughout the system again. When the indicator is off, air is brought in from the outside of the vehicle (fresh air mode).

The outside air intakes for the heating and cooling system are at the base of the windshield. Keep this area clear of leaves and other debris.

The system should be left in fresh air mode under almost all conditions. Keeping the system in recirculation mode, particularly with the A/C off, can cause the windows to fog up.

Switch to recirculation mode when driving through dusty or smoky conditions, then return to fresh air mode.

Vents, Heating, and A/C

Rear Window Defogger

Button

This button turns the rear window defogger on and off (see page [130](#)).

If equipped



Pushing this button also turns the power mirror heaters on and off.

Mode Control

Use the mode control buttons to select the vents air flows from. Some air will flow from the dashboard corner vents in all modes.

 Air flows from the center and corner vents in the dashboard.

 Airflow is divided between the vents in the dashboard and the floor vents.



 Air flows from the floor vents. When you select , the system automatically switches to fresh air mode.

 Airflow is divided between the floor vents and defroster vents at the base of the windshield.

 Air flows from the defroster vents at the base of the windshield.

When you select , the system automatically switches to fresh air mode and turns on the A/C.

 The system automatically turns on the A/C and switches to Recirculation mode. Air flows from the center and side vents in the dashboard.

When you switch to  from , the A/C stays on, and you can turn it on and off manually.

Ventilation

The ventilation system draws in outside air, circulates it through the interior, then exhausts it through vents near the rear side panels.

1. Set the temperature to the lower limit.
2. Make sure the A/C is off.
3. Select  and fresh air mode.
4. Set the fan to the desired speed.

Using the Heater

The heater uses engine coolant to warm the air. If the engine is cold, it will be several minutes before you feel warm air coming from the system.

1. Select  and fresh air mode.
2. Set the fan to the desired speed.
3. Adjust the warmth of the air with the temperature control dial.

Using the A/C

Air conditioning places an extra load on the engine. Watch the engine coolant temperature gauge (see page 82). If it moves near the red mark, turn off the A/C until the gauge reads normally.

1. Turn on the A/C by pressing the button. You will see A/C ON in the display.
2. Make sure the temperature is set to the lower limit.
3. Select .
4. If the outside air is humid, select recirculation mode. If the outside air is dry, select fresh air mode.
5. Set the fan to the desired speed.

CONTINUED

Vents, Heating, and A/C

If the interior is very warm, you can cool it down more rapidly by partially opening the windows, turning on the air conditioning, and setting the fan to maximum speed in fresh air mode.

Dehumidify the Interior



Air conditioning, as it cools, removes moisture from the air. When used in combination with the heater, it makes the interior warm and dry.

1. Switch the fan on.
2. Turn on the air conditioning.
3. Select  and fresh air mode.
4. Adjust the temperature to your preference.

This setting is suitable for all driving conditions whenever the outside temperature is above 32°F (0°C).



To Defog and Defrost

To remove fog from the inside of the windows:

1. Set the fan to the desired speed, or high for faster defrosting.
2. Select . The system automatically switches to fresh air mode and turns on the A/C. The A/C indicator will not come on if it was off to start with.
3. Adjust the temperature so the airflow feels warm.
4. Select  /  to help clear the rear window.
5. To increase airflow to the windshield, close the corner vents.

When you switch to another mode from , the A/C turns off. But if it was on to start with, it stays on.

To Remove Exterior Frost or Ice From the Windows

1. Select . The system automatically switches to fresh air mode and turns on the A/C. The A/C indicator does not come on if it was off to start with.
2. Select .
3. Set the fan and temperature controls to maximum level.

To clear the windows faster, you can close the dashboard corner vents by rotating the wheel next to each vent. This sends more warm air to the windshield defroster vents. Once the windshield is clear, select fresh air mode to avoid fogging the windows.

For your safety, make sure you have a clear view through all the windows before driving.

To Turn Everything Off

To turn the system completely off, press the ON/OFF button.

- Keep the system completely off for short periods only.
- To keep stale air and mustiness from collecting, you should have the fan running at all times.

Using the Rear A/C Unit

The rear passengers can adjust the fan speed, temperature, and airflow of the rear A/C unit with the rear control panel.

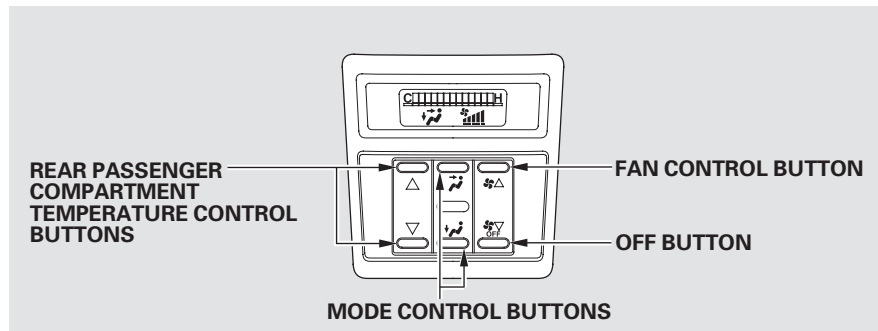

Rear Control Panel**Temperature Control**

Press the ▲ temperature control button to increase the temperature of airflow, and the ▼ button to decrease it. The temperature you adjust is shown in the system display.

CONTINUED

Vents, Heating, and A/C

Fan Control

Press the  ▲ fan control button to increase the fan speed and airflow. Press the  ▼ button to decrease it. The level of the fan speed is shown in the display.

Mode Control

When  is selected, air flows from the upper vents on the back of the center console.

When  is selected, air flows from the lower vents.

To shut off the rear A/C unit, press the OFF button until the system shuts off.

To turn on the rear A/C unit, increase the fan speed and airflow.

Except LX models

FRONT CONTROL PANEL

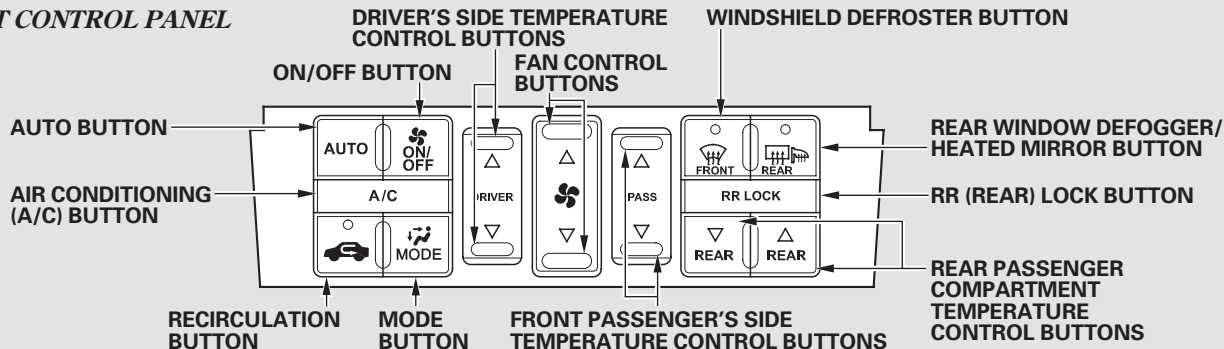

REAR CONTROL PANEL

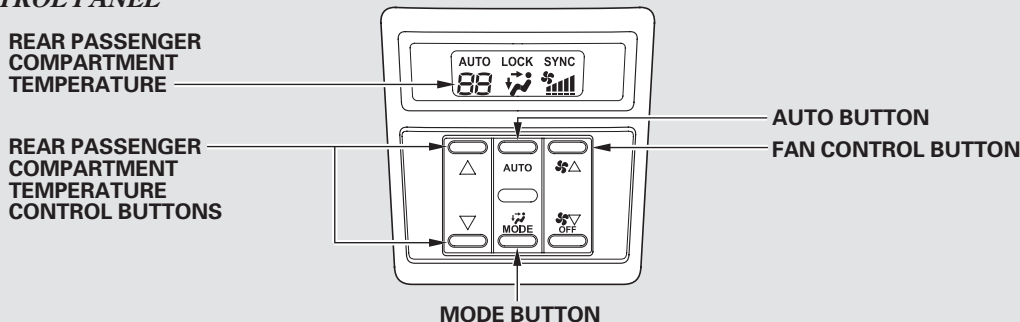

Climate Control System

Voice Control System

On vehicles with navigation system

The climate control system for your vehicle can also be operated using the voice control system. See the navigation system manual for complete details.

Using Automatic Climate Control

The automatic climate control system in your vehicle maintains the interior temperature you select. The system also adjusts the fan speed and airflow levels.

1. Press the Auto button on the front control panel.
2. Set the desired temperature with the temperature control buttons. You will see AUTO in the system's display.
3. You can set the driver's side temperature, the passenger's side temperature, and the temperature of the rear passenger compartment separately.

The system automatically selects the proper mix of conditioned and/or heated air that will, as quickly as possible, raise or lower the interior temperature to your preference.

Temperature Control

The driver's side temperature, the passenger's side temperature and the rear passenger compartment temperature can be set separately. Press the ▲ button of the appropriate temperature control to increase the temperature of airflow. Press the ▼ button to decrease it. Each set temperature is shown in the display. The rear temperature is shown in the display on the back of the center console.

When you set the temperature to its lower limit (**L**) or its upper limit (**H**), the system runs at full cooling or heating only. It does not regulate the interior temperature.

When you press a fan control button, the fan is taken out of AUTO mode.

On vehicles with navigation system

In the Auto mode, the vehicle's interior temperature is independently regulated for the driver, front passenger, and rear passengers according to each adjusted temperature. The system also regulates each temperature based on the information of the sunlight sensor and the sun's position which is updated automatically by the navigation's global positioning system (GPS). For example, if the driver's side of the vehicle is getting too much sun, the system will adjust to a lower temperature.

RR (Rear) Lock Button

When you turn the ignition switch to the ON (II) position, the temperature of the rear passenger compartment is synchronized to the driver's side set temperature. You will see SYNC on the system display of the rear control panel. Changing the temperature of the rear passenger compartment takes the system out of synchronized mode. This causes the word SYNC in the display to go out and displays the rear temperature in the front display. When you turn the ignition switch to the ON (II) position and see LOCK on the system display of the front and rear control panels, the temperature of the rear passenger compartment is not synchronized to the driver's side set temperature.

Climate Control System

To Turn Everything Off



To turn the system completely off, press the ON/OFF button.

- Keep the system completely off for short periods only.
- To keep stale air and mustiness from collecting, you should have the fan running at all times.

Semi-automatic Operation

You can manually select various functions of the climate control system when it is in fully automatic mode. All other features remain automatically controlled. Making any manual selection causes the word AUTO in the display to go out.

Fan Control

Press the  ▲ button to increase the fan speed and airflow. Press the  ▼ button to decrease it.

Air Conditioning (A/C) Button

This button turns the air conditioning on and off. You will see A/C ON or A/C OFF in the display.

When you turn the A/C off, the system cannot regulate the inside temperature if you set the temperature control below the outside temperature.

Recirculation Button

When the indicator in the button is on, air from the vehicle's interior is sent through the system again. When the indicator is off, air is brought in from the outside of the vehicle (fresh air mode).

The outside air intakes for the climate control system are at the base of the windshield. Keep this area clear of leaves and other debris.

The system should be left in fresh air mode under almost all conditions. Keeping the system in recirculation mode, particularly with the A/C off, can cause the windows to fog up.

Switch to recirculation mode when driving through dusty or smoky conditions, then return to fresh air mode.

Rear Window Defogger Button 

This button turns the rear window defogger off and on (see page 130).

Pushing this button also turns the power mirror heaters on and off.

Mode Control

Use the mode control button to select the vents the air flows from. Some air will flow from the dashboard vents in all modes.

 Air flows from the center and corner vents in the dashboard.

 Airflow is divided between the vents in the dashboard and the floor vents.

 Air flows from the floor vents.

 Airflow is divided between the floor and corner vents and the defroster vents at the base of the windshield.

Windshield Defroster Button 
This button directs the main airflow to the windshield for faster defrosting. It also overrides any mode selection you may have made.

When you select , the system automatically switches to fresh air mode and turns on the A/C. For faster defrosting, manually set the fan speed to high. You can also increase airflow to the windshield by closing the corner vents on the dashboard. To close the vents, rotate the wheel under each corner vent.

When you turn off  by pressing the button again, the system returns to its former settings.

For your safety, make sure you have a clear view through all the windows before driving.

When the indicator in the button is on, the front passenger's temperature cannot be set separately from the driver's.

Climate Control System

Rear Climate Controls

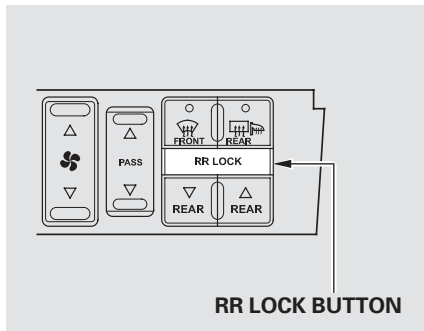

RR (Rear) Lock Button

When this button is on, you will see LOCK on the system display. The rear climate controls can only be controlled by the front control panel.

REAR CONTROL PANEL

REAR PASSENGER
COMPARTMENT
TEMPERATURE

REAR PASSENGER
COMPARTMENT
TEMPERATURE
CONTROL BUTTONS

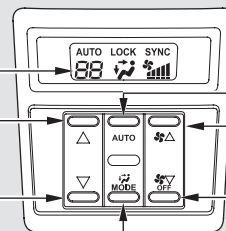

AUTO BUTTON

FAN CONTROL
BUTTON



OFF BUTTON

MODE BUTTON



Temperature Control

Press the ▲ temperature control button to increase the temperature of airflow, and the ▼ button to decrease it. The temperature you adjust is shown in the system display.

Fan Control

Press the  fan control button to increase the fan speed and airflow. Press the  button to decrease it. The level of the fan speed is shown in the display.

Mode Control

Each time you press the mode button, the mode display changes from  to .

When  is selected, air flows from the upper vents on the back of the center console.

When  is selected, air flows from the lower vents.

Automatic Operation



Pressing the AUTO button puts the system in automatic operation mode. The rear system automatically adjusts the fan speed and airflow levels to maintain the selected temperature of the rear passenger compartment. You will see AUTO in the display.

To shut off the rear climate control system, press the OFF button until the system shuts off.

Triple Zone Temperature Control

The temperatures of the driver's side and the front passenger's side are controlled independently.

When the RR (REAR) LOCK button is off, the temperature of the rear passenger compartment can be controlled independently.

To adjust each temperature, press either of the temperature control buttons ( or ) on the climate control panel.

CONTINUED

Climate Control System

When you set each temperature to its lower limit or its upper limit, it will be displayed as “Lo” or “Hi”.

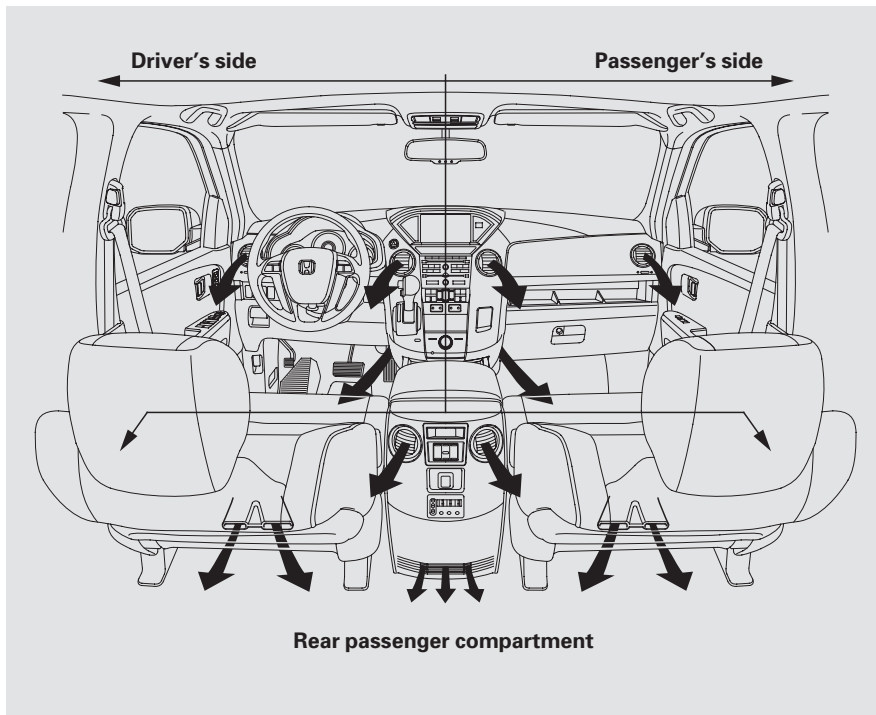

Sunlight and Temperature Sensors

SUNLIGHT SENSOR

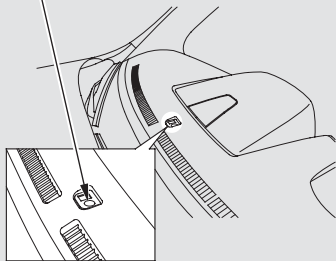

The climate control system has two sensors: a sunlight sensor on top of the dashboard, and a temperature and humidity sensor next to the steering column. Do not cover the sensors or spill any liquid on them.

TEMPERATURE/HUMIDITY SENSOR

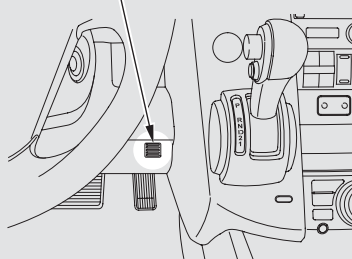

Audio System

An audio system is standard on all models. Read the appropriate pages (as shown below) to use your vehicle's audio system.

For LX models, see pages [210](#) through [225](#).

For vehicles without navigation system, see pages [226](#) through [251](#).

For vehicles with navigation system, see pages [252](#) through [307](#).

For vehicles with rear entertainment system, see pages [317](#) through [348](#).

LX models

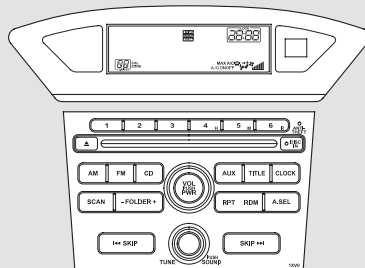

EX and EX-L models without rear entertainment system

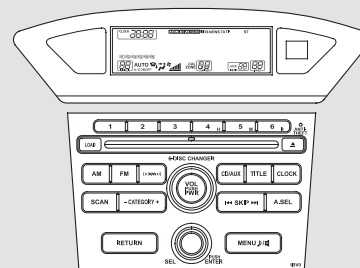

U.S. models are shown.

EX-L models with rear entertainment system

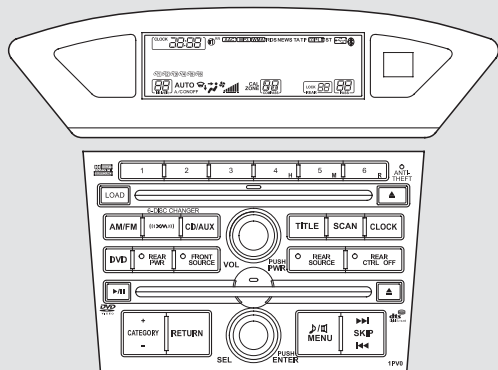

Touring models

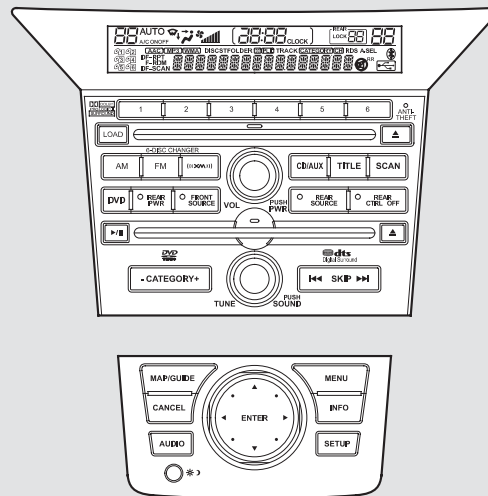

Playing the FM/AM Radio (LX model)

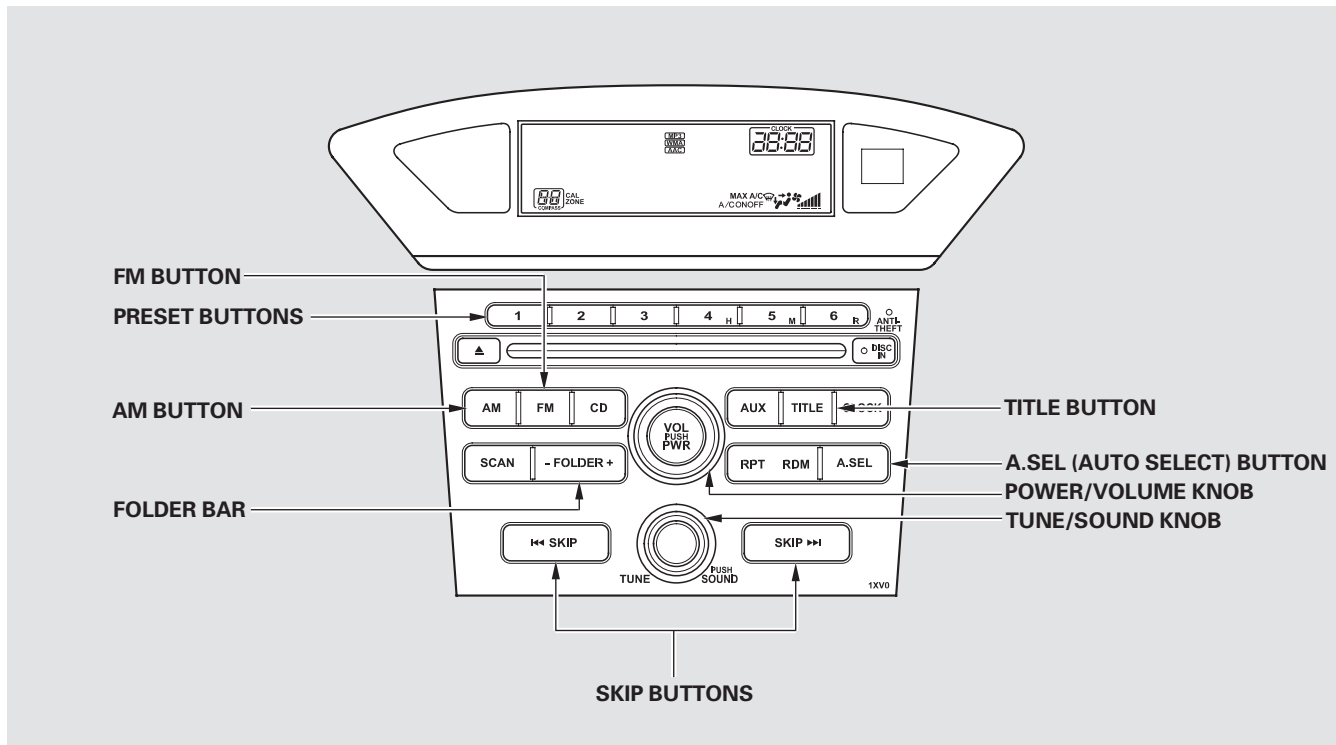

Playing the FM/AM Radio (LX model)

To Play the FM/AM Radio

The ignition switch must be in the ACCESSORY (I) or ON (II) position. Turn the system on by pushing the power/volume knob or the AM or FM button. Adjust the volume by turning the power/volume knob.

The band and frequency that the radio was last tuned to is displayed. To change bands, press the AM or FM button. On the FM band, ST will be displayed if the station is broadcasting in stereo. Stereo reproduction on AM is not available.

On the AM band, AM noise reduction turns on automatically.

To Select a Station

You can use any of five methods to find radio stations on the selected band: tune, skip, scan, the preset buttons, and auto select.

On the FM band, you can also use the features provided by the radio data system (RDS). For more information on the RDS, see page [213](#).

TUNE — Use the TUNE knob to tune the radio to a desired frequency. Turn the knob to the right to tune to a higher frequency, and turn it to the left to tune to a lower frequency.

SKIP — The skip function searches up and down from the current frequency to find a station with a strong signal. To activate it, press either of the SKIP buttons (**◀◀** or **▶▶**), then release it.

SCAN — The scan function samples all stations with strong signals on the selected band. To activate it, press the SCAN button, then release it. You will see SCAN in the display. When the system finds a strong signal, it will stop and play that station for about 10 seconds.

If you do nothing, the system will then scan for the next strong station and play it for 10 seconds. When it plays a station you want to listen to, press the SCAN button again.

CONTINUED

Playing the FM/AM Radio (LX model)

Preset – Each preset button can store one frequency on AM and two frequencies on FM.

1. Select the desired band, AM or FM. You can store one frequency on FM1, and one frequency on FM2 with each preset button.
2. Use the tune, skip, scan, or RDS function to tune the radio to a desired station.
3. Pick a preset button (1–6), and hold it until you hear a beep.
4. Repeat steps 1 through 3 to store a total of six stations on AM and twelve stations on FM.

AUTO SELECT – If you are traveling and can no longer receive your preset stations, you can use the auto select feature to find stations in the local area.

Press the A. SEL button. You will see A. SEL flashing in the display, and the system goes into scan mode for several seconds. It stores the frequencies of six AM, and twelve FM stations in the preset buttons.

You will see a “0” displayed after pressing a preset button if auto select cannot find a strong station for every preset button.

If you do not like the stations auto select has stored, you can store other frequencies on the preset buttons as previously described.

To turn off auto select, press the A. SEL (auto select) button. This restores the presets you originally set.

For information on FM/AM radio frequencies and reception, see page [308](#).

Playing the FM/AM Radio (LX model)

Radio Data System (RDS)

On the FM band, you can select a favorite station and display the program service name provided by the radio data system (RDS).

Program Service (PS) Name Display

The program service name display function shows the name of the station you are listening to. You can turn this function on or off.

To switch the function between on and off, press and release the TITLE button. With the system on, you will see the “PS NAME ON” message on the display. If the station you are listening to is an RDS station, the displayed frequency switches to the station name.

If the station you are listening to is not an RDS station, the display continues to show the frequency with the PS name display function on.

When you turn off this function by pressing the TITLE button, the display shows “PS NAME OFF.”

CONTINUED

Playing the FM/AM Radio (LX model)

Radio Data System (RDS) Category

With the FM band selected, you can select the program category provided by the RDS. Press either side of the FOLDER bar (– or +) to display and select an RDS category. The principal RDS categories are shown as follows;

ALL: All RDS category stations
ROCK: Rock, classic rock and soft rock music
COUNTRY: Country music

SOFT: Adult hits and soft music
TOP 40: Top 40 hits
OLDIES: Nostalgia music and oldies
R & B: Rhythm and blues, and soft rhythm and blues
RELIGION: Programs concerned with religion
CLASSIC: Classical music
JAZZ: Jazz
INFO: News, information, sports, talk shows, foreign language, personality, public, college, and weather
TRAFFIC: Traffic information

Press either side of the FOLDER bar to select an RDS category. The display shows the selected RDS category name for about 10 seconds. You can use the search or scan function to find radio stations on the selected RDS category. If you do nothing while the RDS category name is displayed, the selected category is canceled.

RDS Program Search

This function searches up and down a frequency for the strongest signal from the frequencies that carry the selected RDS category information. This can help you to find a station in your favorite category. To activate it, press and release either of the SKIP buttons (◀◀ or ▶▶). You will see the selected RDS category name blinking while searching it. When the system finds a station, the selected RDS category name will be displayed again for about 10 seconds.

If the system does not find a station, “NOTHING” will be blinking for about 5 seconds, then the system goes back to the last selected station.

RDS Program SCAN

The scan function samples all stations with strong signals on the selected RDS category. To activate it, press and release the SCAN button. You will see SCAN in the display. The system will scan for a station with a strong signal in the selected RDS category. You will also see the selected RDS category name blinking while searching it. When it finds a strong signal, it will stop and play that station for about 10 seconds.

If you do nothing, the system will scan for the next strong station and play it for 10 seconds. When it plays a station that you want to listen to, press the SCAN button again.

If the system does not find a station, “NOTHING” will be blinking for about 5 seconds, then the system goes back to the last selected station.

You can use the RDS program search or scan function even if the RDS information display function is off. In this case, the display shows a frequency in place of a RDS station name.

Playing the FM/AM Radio (LX model)

Adjusting the Sound

Press the TUNE (SOUND) knob repeatedly to display the BASS, TREBLE, FADER, BALANCE, SUBWOOFER, and SVC (speed-sensitive volume compensation) settings.

BASS – Adjusts the bass.

TREBLE – Adjusts the treble.

FADER – Adjusts the front-to-back strength of the sound.

BALANCE – Adjusts the side-to-side strength of the sound.

SUBWOOFER – Adjusts the strength of sound from the subwoofer speaker.

SVC – Adjusts the volume level based on the vehicle speed.

Each mode is shown in the display as it changes. Turn the TUNE knob to adjust the setting to your liking.

Except SVC adjustment

When the level reaches the center, you will see “C” in the display.

The system will return to the audio display about 10 seconds after you stop adjusting a mode.

Speed-sensitive Volume Compensation (SVC)

The SVC mode controls the volume based on vehicle speed. The faster you go, the louder the audio volume becomes. As you slow down, the audio volume decreases.

The SVC has four modes: SVC OFF, SVC LOW, SVC MID, and SVC HIGH. Turn the TUNE knob to adjust the setting to your liking. If you feel the sound is too loud, choose low. If you feel the sound is too quiet, choose high.

Playing the FM/AM Radio (LX model)

This function is set to MID as the default setting when the vehicle leaves the factory.

Audio System Lighting

You can use the instrument panel brightness control knob to adjust the illumination of the audio system (see page [131](#)). The audio system illuminates when the parking lights are on, even if the radio is turned off.

Playing a Disc (LX model)

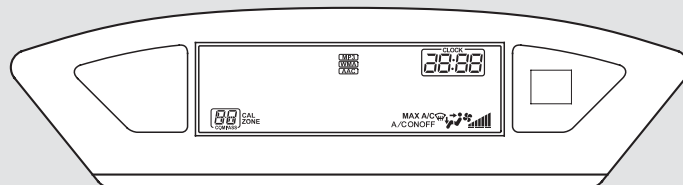

EJECT BUTTON

CD BUTTON

POWER/VOLUME KNOB

SCAN BUTTON

FOLDER BAR

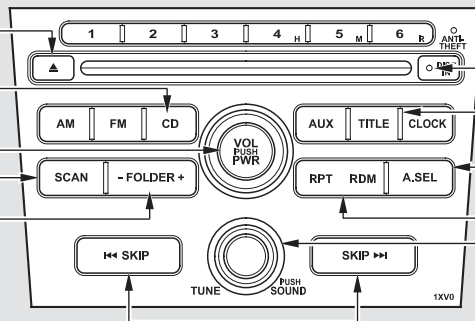

LOAD INDICATOR

TITLE BUTTON

A.SEL (AUTO SELECT) BUTTON

RPT/RDM (REPEAT/RANDOM)
BAR

TUNE/SOUND KNOB

SKIP BUTTONS

To Play a Disc

To load or play a disc, the ignition switch must be in the ACCESSORY (I) or ON (II) position.

You operate the disc player with the same controls used for the radio. To select the disc player, press the CD button. You will see “CD” in the display.

NOTICE

Do not use discs with adhesive labels. The label can curl up and cause the disc to jam in the unit.

This audio system can also play CD-Rs and CD-RWs compressed in MP3 or WMA formats. When playing a disc in MP3, you will see “MP3” in the display. In WMA format, “WMA” will appear in the display. You can select up to 99 folders, or up to 255 tracks/files.

If you have a disc that is a combination of CD-DA tracks and MP3/WMA files, you can choose the format to listen by pressing and holding CD button until you hear a beep.

NOTE:

If a file on an MP3 or WMA disc is protected by digital rights management (DRM), the audio unit displays UNSUPPORTED, and then skips to the next file.

Video CDs and DVDs do not work in this unit.

The specifications for compatible MP3 files are:

- Sampling frequency:
32/44.1/48 kHz (MPEG1)
16/22.05/24 kHz (MPEG2)
- Bitrate:
32/40/48/56/64/80/96/112/128/
160/192/224/256/320 kbps
(MPEG1)
8/16/24/32/40/48/56/64/80/96/
112/128/160 kbps (MPEG2)
- Compatible with variable bitrate and multi-session
- Maximum layers
(including ROOT): 8 layers

CONTINUED

Playing a Disc (LX model)

The specifications for compatible WMA files are:

- Sampling frequency:
32/44.1/48 kHz
- Bitrate:
48/64/80/96/128/160/192 kbps
- Compatible with variable bitrate and multi-session.
- Maximum layers
(including ROOT): 8 layers

To Load a Disc

Insert a disc about halfway into the disc slot. The drive will pull the disc in the rest of the way to play it. You operate the disc player with the same controls used for the radio.

The number of the current track is shown in the display. When playing a disc in MP3 or WMA, the numbers of the current folder and file are shown. The system will continuously play a disc until you change modes.

You cannot load and play 3-inch (8-cm) discs in this system.

For information on how to handle and protect compact discs, see page [285](#).

Text Data Display Function

Each time you press the TITLE button, the display shows you the text, if the disc was recorded with text data.

You can see the album, artist, and track name in the display. If a disc is recorded in MP3 or WMA, you can see the folder and file name, and the artist, album, and track tag.

When you press and release the TITLE button while a disc without text data is playing, you will see “NO INFO” on the display.

The display shows up to about 14 characters of selected text data (the folder name, file name, etc.). If the text data has more than 14 characters, you will see the first 14 characters and the ► indicator in the display. Press and hold the TITLE button until the next 14 characters are shown.

If any letter is not available, it is replaced with “.” (dot) in the display. When the disc has no text data, you will see “NO INFO” on the display.

You will also see some text data under these conditions:

- When a new folder, file, or track is selected.
- When you change the audio mode to play a disc with text data or in MP3 or WMA.
- When you insert a disc, and the system begins to play.

When playing a CD-DA with text data, the album and track name are shown in the display. With a disc in MP3 or WMA, the display shows the folder and file name.

To Change or Select Tracks/Files

You can use the SKIP buttons while a disc is playing to select passages and change tracks (files in MP3/WMA mode).

SKIP — Each time you press and release the ►► SKIP button, the player skips forward to the beginning of the next track (file in MP3 or WMA mode). Press and release the ◀◀ to skip backward to the beginning of the current track. Press it again to skip to the beginning of the previous track.

To move rapidly within a track, press and hold the ►► or ◀◀ SKIP button.

CONTINUED

Playing a Disc (LX model)

In MP3 or WMA mode

FOLDER SELECTION – To select a different folder, press either side of the FOLDER bar. Press the + side of the bar to skip to the next folder, and the – side of the bar to skip to the beginning of the previous folder.

REPEAT (TRACK/FILE

REPEAT) – To continuously replay a track (files in MP3 or WMA mode), press and release the RPT side of the RPT/RDM bar. You will see RPT in the display. Press and hold the RPT side for 2 seconds to turn it off.

In MP3 or WMA mode

FOLDER-REPEAT – This feature, when activated, replays all files in the selected folder in the order they are compressed. To activate folder repeat, press the RPT side of the RPT/RDM bar twice. You will see F-RPT in the display. The system continuously replays the current folder. Press the RPT side of the bar again to turn it off. Pressing the RDM side of the bar, or selecting a different folder with the FOLDER bar also turns off the repeat feature.

Each time you press and release the RPT side of the bar, the mode changes from file repeat to folder repeat, then to normal play.

RANDOM (Random within a disc)

– This feature plays the tracks within a disc (the files in MP3 or WMA mode) in random order. To activate random play, press and release the RDM side of the RPT/RDM bar. In MP3 or WMA mode, press the RDM side of the bar repeatedly to select RDM (within a disc random play). You will see RDM in the display. Press the RDM side of the bar for 2 seconds to return to normal play.

In MP3 or WMA mode

FOLDER-RANDOM — This feature, when activated, plays all files in the selected folder in random order. To activate folder random, press the RDM side of the RPT/RDM bar. You will see F-RDM in the display. The system will then select and play files randomly. This continues until you deactivate folder random by pressing and holding the RDM side of the bar again, or by selecting a different folder with the FOLDER bar.

Each time you press and release the RDM side of the bar, the mode changes from folder random play to random play (within a disc random play), then to normal play.

SCAN (TRACK/FILE SCAN) —

The scan function samples all tracks (files in MP3 or WMA) on the disc in the order they are recorded on the disc. To activate scan, press and release the SCAN button. You will see SCAN in the display. You will get a 10 second sampling of each track/file on the disc. Press and hold the SCAN button until you hear a beep to get out of scan mode and play the last track/file sampled.

Pressing either of the SKIP buttons also turns off the scan feature.

In MP3 or WMA mode

F-SCAN (FOLDER SCAN) — This feature, when activated, samples the first file in each folder on the disc. To activate folder scan, press the SCAN button twice. You will see F-SCAN in the display.

The system plays the first file in the first folder for about 10 seconds. If you do nothing, the system will then play the first files in the next folders for 10 seconds. After playing the first file in the last folder, the system plays normally.

Pressing either of the SKIP buttons, selecting a different folder with the FOLDER bar, or pressing the SCAN button, also turns off the folder scan.

Each time you press and release the SCAN button, the mode changes from file scan to folder scan, then to normal play.

Playing a Disc (LX model)

To Stop Playing a Disc

Press the eject button (▲) to remove the disc. If you eject the disc, but do not remove it from the slot, the system will automatically reload the disc after 10 seconds and begin playing.

You can also eject the disc when the ignition switch is off.

To play the radio when a disc is playing, press the AM or FM button. Press the CD button again to switch back to the disc player.

If you turn the system off while a disc is playing, either with the power/volume knob or by turning off the ignition switch, the disc will stay in the drive. When you turn the system back on, the disc will begin playing where it left off.

Protecting Discs

For information on how to handle and protect compact discs, see page [285](#).

Disc Player Error Messages (LX model)

The chart on the right explains the error messages you may see in the display while playing a disc.

If you see an error message in the display while playing a disc, press the eject button. After ejecting the disc, check it for damage or deformation. If there is no damage, insert the disc again. For additional information on damaged discs, see page [286](#).

The audio system will try to play the disc. If there is still a problem, the error message will reappear. Press the eject button, and pull out the disc. Insert a different disc. If the new disc plays, there is a problem with the first disc. If the error message cycle repeats and you cannot clear it, take your vehicle to a dealer.

Error Message	Cause	Solution
UNSUPPORTED	Track/File format not supported	Current track will be skipped. The next supported track or file plays automatically.
BAD DISC PLEASE CHECK OWNER'S MANUAL PUSH EJECT	Mechanical Error	Press the eject button and pull out the disc. Check the disc for serious damage, signs of deformation, excessive scratches, and/or dirt (see page 286). Insert the disc again. If the code does not disappear, or the disc cannot be removed, consult your dealer. Do not try to force the disc out of the player.
BAD DISC PLEASE CHECK OWNER'S MANUAL	Servo Error	

The ejected disc will not be reloaded automatically.

Audio System (EX and EX-L models)

Selector Knob

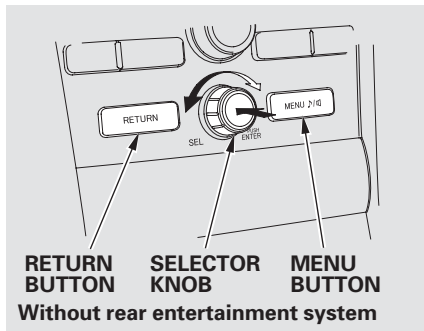

Most audio system functions can be controlled by standard buttons, bars, and knobs. In addition, you can access some functions by using the selector knob on the audio system.

The knob turns left and right. Use it to scroll through lists, or to make selections or adjustments to a list or menu item on the display. When you make a selection, push the center of the selector (ENTER) to go to that selection.

When the audio system is in XM[®] Radio mode or playing discs, pushing the selector (ENTER) knob switches the display between the normal display and the extended display. The extended display has three segments to display the detailed information.

Menu Display

To select any setting such as the clock, sound adjusting, or the compass, press the MENU button. To use any audio system function, the ignition switch must be in the ACCESSORY (I) or ON (II) position. You can select the item by turning the selector knob. To go back to the previous display, press the RETURN button.

Pressing the MENU button again will also cancel the menu display mode.

Playing the FM/AM Radio (EX and EX-L models)

EX models

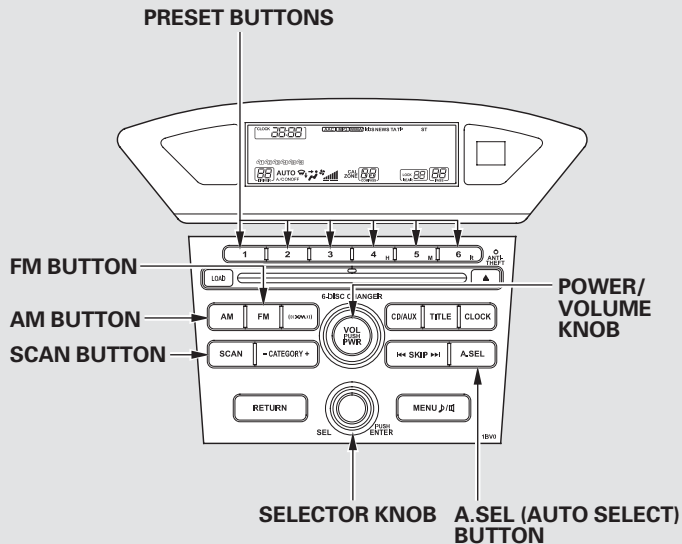

EX-L models with rear entertainment system

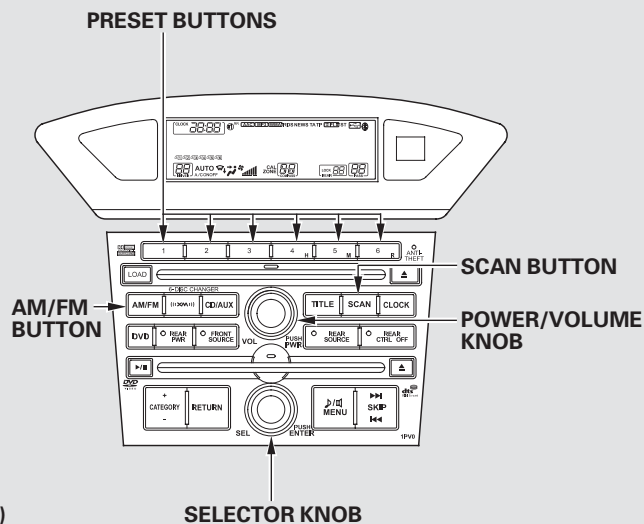

U.S. models are shown.

Playing the FM/AM Radio (EX and EX-L models)

To Play the Radio

The ignition switch must be in the ACCESSORY (I) or ON (II) position. Turn the system on by pushing the PWR/VOL knob. Adjust the volume by turning the same knob.

The band and frequency that the radio was last tuned to are displayed. To change bands, press the AM or FM button, or AM/FM button. On the FM band, ST will be displayed if the station is broadcasting in stereo. Stereo reproduction in AM is not available.

On the AM band, AM noise reduction turns on automatically.

To Select a Station

You can use any of five methods to find radio stations on the selected band: tune, seek, scan, the preset buttons, and auto select.

On the FM band, you can also use the features provided by the radio data system (RDS). For more information on the RDS, see page [230](#).

TUNE — Use the selector knob to tune the radio to a desired frequency. Turn the knob right to tune to a higher frequency, or left to tune to a lower frequency.

SKIP — The skip function searches up and down from the current frequency to find a station with a strong signal. To activate it, press and hold the ►► or ◄◄ side of the SKIP bar until you hear a beep, then release it.

Playing the FM/AM Radio (EX and EX-L models)

SCAN — The scan function samples all stations with strong signals on the selected band. To activate it, press the SCAN button, then release it. You will see SCAN in the display. When the system finds a strong signal, it will stop and play that station for about 10 seconds.

If you do nothing, the system will scan for the next strong station and play it for 10 seconds. When it plays a station that you want to listen to, press the SCAN button again.

Preset — Each preset button can store one frequency on AM and two frequencies on FM.

1. Select the desired band, AM or FM. You can store one frequency on FM1, and one frequency on FM2 with each preset button.
2. Use the tune, skip, scan, or RDS function to tune the radio to a desired station.
3. Pick a preset button, and hold it until you hear a beep.
4. Repeat steps 1 through 3 to store a total of six stations on AM and twelve stations on FM.

On vehicles without rear entertainment system

AUTO SELECT — If you are traveling and can no longer receive your preset stations, you can use the auto select feature to find stations in the local area.

Press the A. SEL button. “A. SEL” flashes in the display, and the system goes into scan mode for several seconds. It stores the frequencies of six AM and twelve FM stations in the preset buttons.

You will see a “0” displayed after pressing a preset button if auto select cannot find a strong station for that preset button.

If you do not like the stations auto select has stored, you can store other frequencies on the preset buttons as previously described.

CONTINUED

Playing the FM/AM Radio (EX and EX-L models)

To turn off auto select, press the A. SEL (auto select) button. This restores the presets you originally set.

For information on FM/AM radio frequencies and reception, see page [308](#).

Radio Data System (RDS)

On the FM band, you can select a favorite station and display the program service name provided by the radio data system (RDS).

Program Service (PS) Name Display

The program service name display function shows the name of the station you are listening to. You can turn this function on or off.

To switch the function between on and off, press and release the TITLE button. With the system on, you will see the "PS NAME ON" message on the display. If the station you are listening to is an RDS station, the displayed frequency switches to the station name.

Playing the FM/AM Radio (EX and EX-L models)

If the station you are listening to is not an RDS station, the display continues to show the frequency with the PS name display function on.

When you turn off this function by pressing the TITLE button, the display shows "PS NAME OFF."

Radio Data System (RDS) Category

On the FM band selected, you can select the program category provided by the RDS. Press either side (– or +) of the CATEGORY bar to display and select an RDS category. The principal RDS categories are shown as follows:

ALL: All RDS category stations

ROCK: Rock, classic rock and soft rock music

COUNTRY: Country music

SOFT: Adult hits and soft music

TOP 40: Top 40 hits

OLDIES: Nostalgia music and oldies

R & B: Rhythm and blues, and soft rhythm and blues

RELIGION: Programs concerned with religion

CLASSIC: Classical music

JAZZ: Jazz

INFO: News, information, sports, talk shows, foreign language, personality, public, college, and weather

TRAFFIC: Traffic information

Press either side of the CATEGORY bar to select an RDS category. The display shows the selected RDS category name for about 10 seconds. You can use the search or scan function to find radio stations on the selected RDS category. If you do nothing while the RDS category name is displayed, the selected category is canceled.

CONTINUED

Playing the FM/AM Radio (EX and EX-L models)

RDS Program Search

This function searches up and down a frequency for the strongest signal from the frequencies that carry the selected RDS category information. This can help you to find a station in your favorite category. To activate it, press and release either side (◀◀ or ▶▶) of the SKIP bar. You will see the selected RDS category name blinking while searching it. When the system finds a station, the selected RDS category name will be displayed again for about 10 seconds.

If the system does not find a station, “NOTHING” will be blinking for about 5 seconds, then the system goes back to the last selected station.

RDS Program SCAN

The scan function samples all stations with strong signals on the selected RDS category. To activate it, press and release the SCAN button. You will see SCAN in the display. The system will scan for a station with a strong signal in the selected RDS category. You will also see the selected RDS category name blinking while searching it. When it finds a strong signal, it will stop and play that station for about 10 seconds.

If you do nothing, the system will scan for the next strong station and play it for 10 seconds. When it plays a station that you want to listen to, press the SCAN button again.

If the system does not find a station, “NOTHING” will be blinking for about 5 seconds, then the system goes back to the last selected station.

You can use the RDS program search or scan function even if the RDS information display function is off. In this case, the display shows a frequency in place of a RDS station name.

Playing the FM/AM Radio (EX and EX-L models)

Adjusting the Sound

Press the MENU button to display the sound settings. Turn the selector knob to select an appropriate setting: BASS, TREBLE, FADER, BALANCE, SUBW (subwoofer), CENTER*, Dolby PL (Prologic) II*, and SVC (speed-sensitive volume compensation). Press the selector (ENTER) knob to enter the setting, then turn the selector knob to adjust the setting.

*: If equipped

BASS — Adjusts the bass.

TREBLE — Adjusts the treble.

FADER — Adjusts the front-to-back strength of the sound.

BALANCE — Adjusts the side-to-side strength of the sound.

SUBWOOFER — Adjusts the strength of sound from the subwoofer speaker.

If equipped

CENTER — Adjusts the strength of sound from the center speaker.

SVC — Adjusts the volume level based on the vehicle speed.

Each mode is shown in the display as it changes. Turn the selector knob to adjust the setting to your liking.

Except SVC adjustment

When the level reaches the center, you will see “C” in the display.

To return to the normal play, push the RETURN or MENU button after you stop adjusting a mode.

CONTINUED

Playing the FM/AM Radio (EX and EX-L models)

If equipped

Dolby PL (ProLogic) II – Dolby PL (ProLogic) II signal processing creates multi-channel surround sound from 2 channel stereo audio sources. Dolby ProLogic II can only be activated when listening to DISC (CD-DA, MP3/WMA), XM Radio, and AUX. When ProLogic II is active, “PL II” is shown in the audio display.

Manufactured under license from Dolby Laboratories. Dolby, Pro Logic, MLP Lossless and the double-D symbol are trademarks of Dolby Laboratories.

Speed-sensitive Volume Compensation (SVC)

The SVC mode controls the volume based on vehicle speed. The faster you go, the louder the audio volume becomes. As you slow down, the audio volume decreases.

The SVC has four modes: SVC OFF, SVC LOW, SVC MID, and SVC HIGH. Turn the selector knob to adjust the setting to your liking. If you feel the sound is too loud, choose low. If you feel the sound is too quiet, choose high.

This function is set to MID as the default setting when the vehicle leaves the factory.

Playing the FM/AM Radio (EX and EX-L models)

Audio System Lighting

You can use the instrument panel brightness control knob to adjust the illumination of the audio system (see page [131](#)). The audio system illuminates when the parking lights are on, even if the radio is turned off.

Playing the XM® Radio (EX-L and U.S. EX models)

EX and EX-L models without rear entertainment system

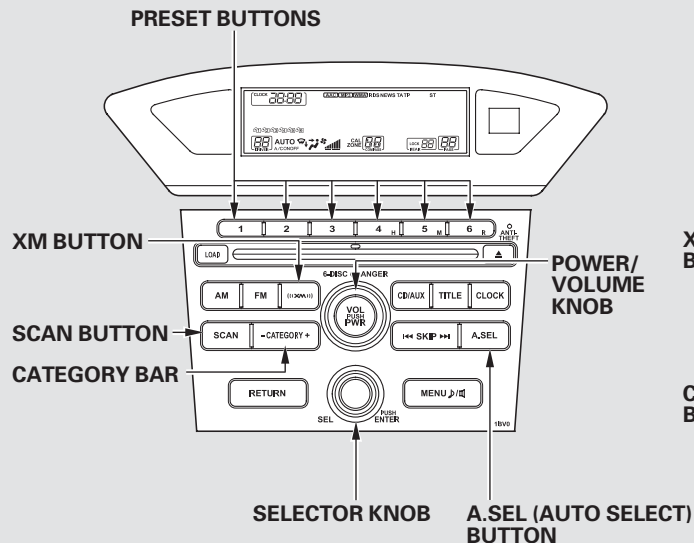

EX-L models with rear entertainment system

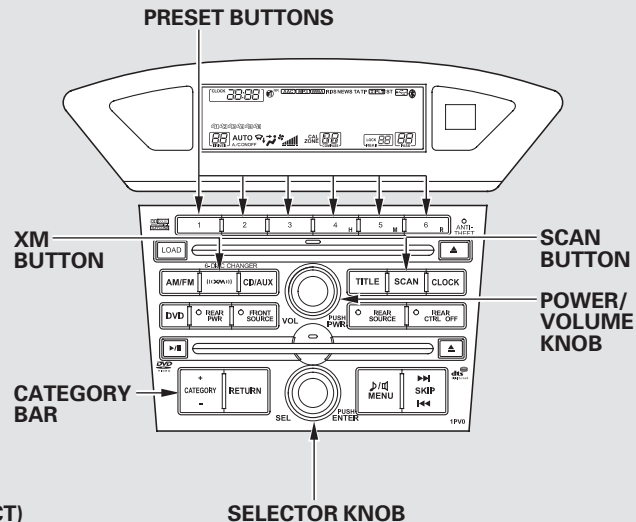

Playing the XM® Radio (EX-L and U.S. EX models)

Your vehicle is capable of receiving XM® Radio anywhere in the United States, and Canada, except Hawaii and Alaska. XM is a registered trademark of Sirius XM Radio®, Inc. and, XM CANADA® is a registered business name of Canadian Satellite Radio Inc.

XM Radio receives signals from two satellites to produce clear, high-quality digital reception. It offers many channels in several categories. Along with a large selection of different types of music, XM Radio allows you to view channel and category selections in the display.

Operating the XM Radio

To listen to XM Radio, turn the ignition switch to the ACCESSORY (I) or ON (II) position, and press the «» button. The last channel you listened to will show in the display. Adjust the volume by turning the power/volume knob.

MODE — To switch between channel mode and category mode, either press and hold the TITLE button until the mode changes, or press and release the selector knob.

In the channel mode, you can select all of the available channels. In the category mode, such as Jazz, Rock, Classical, etc., you can select all of the channels within that category.

Each time you press and release the TITLE button, the display changes in the following sequence: name, title, and category.

You may experience periods when XM Radio does not transmit the artist's name and song title information. If this happens, there is nothing wrong with your system.

CONTINUED

Playing the XM[®] Radio (EX-L and U.S. EX models)

TUNE – Turn the selector knob to change channel selections. Turn the knob right for higher numbered channels and left for lower numbered channels. In the category mode, you can only select channels within that category.

You can also select a channel or category from the list by using the selector knob. Push the selector knob (ENTER) to switch the display to the list displayed with three segments, then turn the knob to select a channel or category. Press the selector knob (ENTER) to set your selection.

CATEGORY (- or +) – Press either side of the CATEGORY bar to select another category.

SCAN – The SCAN function gives you a sampling of all channels while in the channel mode. In the category mode, only the stations within that category are scanned. To activate scan, press the SCAN button. The system plays each channel in numerical order for a few seconds, then selects the next channel. When you hear a channel you want to continue listening to, press the button again.

Playing the XM® Radio (EX-L and U.S. EX models)

Preset – You can store up to 12 preset channels using the six preset buttons. Each button stores one channel from the XM1 band and one channel from the XM2 band.

To store a channel:

1. Press the XM button. Either XM1 or XM2 will show in the display.
2. Use the selector knob, CATEGORY bar, or SCAN button to tune to a desired channel.

In category mode, only channels within that category can be selected. In channel mode, all channels can be selected.

3. Pick the preset button you want for that channel. Press and hold the button until you hear a beep.

4. Repeat steps 2 and 3 to store the first six channels.
5. Press the XM button again. The other XM band will show. Store the next six channels using steps 2 and 3.

Once a channel is stored, simply press and release the proper preset button to tune to it.

The presets may be lost if your vehicle's battery goes dead, is disconnected, or the radio fuse is removed.

XM Radio Display Messages

“LOADING” – XM is loading the audio or program information.

“OFF AIR” – The channel currently selected is no longer broadcasting.

“UPDATING” – The encryption code is being updated. Wait until the encryption code is fully updated. Channels 0 and 1 should still work normally.

CONTINUED

Playing the XM® Radio (EX-L and U.S. EX models)

“NO SIGNAL” – The signal is currently too weak. Move the vehicle to an area away from tall buildings, and with an unobstructed view of the southern horizon.

“ - - - - ” – The selected channel number does not exist, or is not part of your subscription, or this channel has no artist or title information at this time.

“ANTENNA” – There is a problem with the XM antenna. Please consult your dealer.

The XM satellites are in orbit over the equator; therefore, objects south of the vehicle may cause satellite reception interruptions. To help compensate for this, ground-based repeaters are placed in major metropolitan areas.

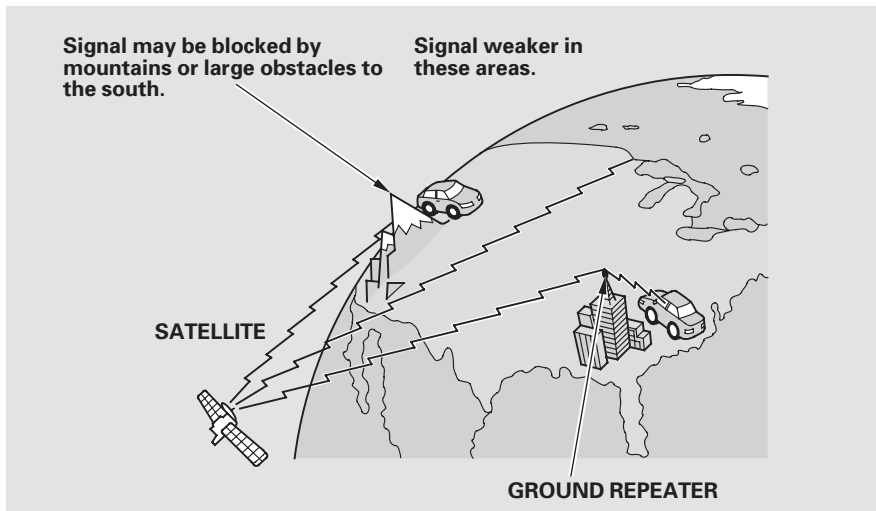

Satellite signals are more likely to be blocked by tall buildings and mountains the farther north you travel from the equator. Carrying large items on a roof rack can also block the signal.

Depending on where you drive, you may experience reception problems. Interference can be caused by any of these conditions:

Playing the XM® Radio (EX-L and U.S. EX models)

- Driving on the north side of an east/west mountain road.
- Driving on the north side of a large commercial truck on an east/west road.
- Driving in tunnels.
- Driving on a road beside a vertical wall, steep cliff, or hill to the south of you.
- Driving on the lower level of a multi-tiered road.
- Driving on a single lane road alongside dense trees taller than 50 ft. (15 m) to the south of you.
- Large items carried on a roof rack.

There may be other geographic situations that could affect XM Radio reception.

As required by the FCC:

Changes or modifications not expressly approved by the party responsible for compliance could void the user's authority to operate the equipment.

Receiving XM Radio Service

If your XM Radio service has expired or you purchased your vehicle from a previous owner, you can listen to a sampling of the broadcasts available on XM Radio. With the ignition switch in the ACCESSORY (I) or the ON (II) position, push the power/volume knob to turn on the audio system, and press the «XM» button. A variety of music types and styles will play.

If you decide to purchase XM radio service, contact XM Radio at www.xmradio.com, or at 1-800-852-9696. In Canada, contact XM CANADA® at www.xmradio.ca, or at 1-877-209-0079. You will need to give them your radio I.D. number and your credit card number. To get your radio I.D. number, press the «XM» button, then turn the selector knob until “CH 000” appears in the display. Your I.D. will appear in the display.

After you've registered with XM Radio, keep your audio system in the XM Radio mode while you wait for activation. This should take about 30 minutes.

While waiting for activation, make sure your vehicle remains in an open area with good reception. Once your audio system is activated, “CATEGORY” or “CH” will appear in the display, and you'll be able to listen to XM Radio broadcasts. XM Radio will continue to send an activation signal to your vehicle for at least 12 hours from the activation request. If the service has not been activated after 36 hours, contact XM Radio. In Canada, contact XM CANADA®.

Playing Discs (EX and EX-L models)

EX and EX-L models without rear entertainment system

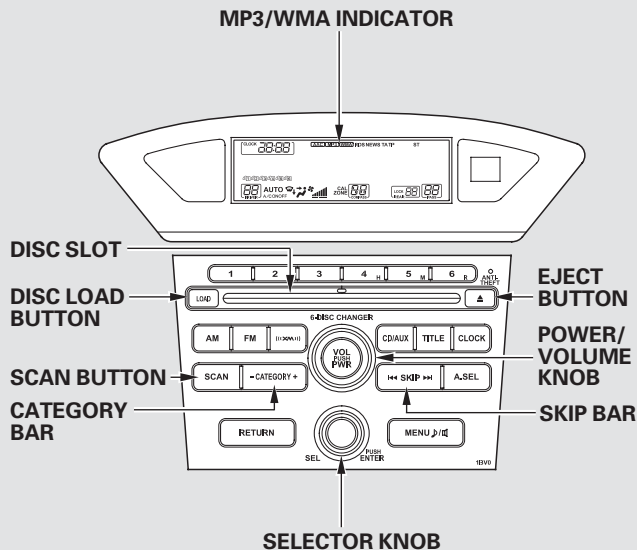

U.S. models are shown.

EX-L models with rear entertainment system

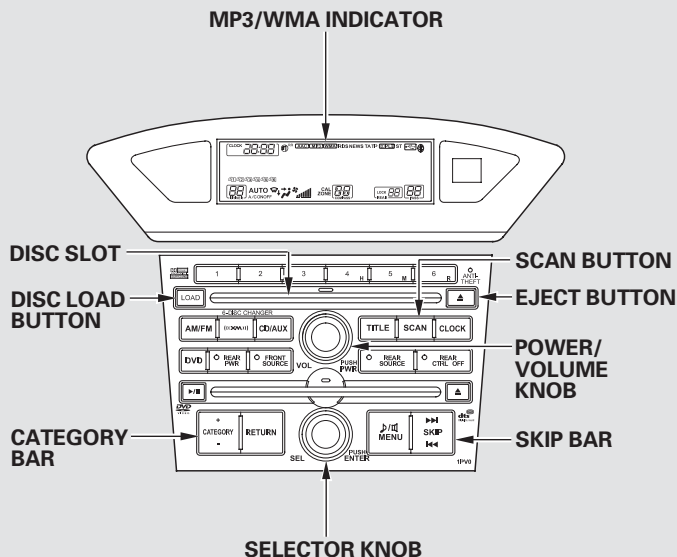

To Play a Disc

To load or play discs, the ignition switch must be in the ACCESSORY (I) or ON (II) position.

You operate the disc changer with the same controls used for the radio. To select the disc changer, press the CD/AUX or CD button. You will see “CD” in the display. The disc and track numbers, and the elapsed time are shown in the display. You can also select the displayed information with the TITLE button (see page 245). The system will continuously play a disc until you change modes.

NOTICE

Do not use discs with adhesive labels. The label can curl up and cause the disc to jam in the unit.

This audio system can also play CD-Rs and CD-RWs compressed in MP3 or WMA format. When playing a disc in MP3, you will see “MP3” in the display. In WMA format, “WMA” will appear in the display. The disc, folder and track numbers are displayed. You can select up to 255 folders or tracks.

If you have a disc that is a combination of CD-DA tracks and MP3/WMA files, you can choose the format to listen by pressing and holding CD/AUX or CD button until you hear a beep.

Video CDs and DVDs do not work in this unit.

The specifications for compatible MP3 files are:

- Sampling frequency:
32/44.1/48 kHz (MPEG1), 16/
22.05/24 kHz (MPEG2)
- Bitrate:
32/40/48/56/64/80/96/112/128/
160/192/224/256/320 kbps
(MPEG1), 8/16/24/32/40/48/56/
64/80/96/112/128/160 kbps
(MPEG2)
- Compatible with variable bitrate and multi-session.
- Maximum layers
(including ROOT): 8 layers

CONTINUED

Playing Discs (EX and EX-L models)

The specifications for compatible WMA files are:

- Sampling frequency:
22.05/32/44.1/48 kHz
- Bitrate:
48/64/80/96/128/160/192 kbps
- Compatible with variable bitrate and multi-session
- Maximum layers
(including ROOT): 8 layers

NOTE:

If a file on an MP3 or WMA disc is protected by digital rights management (DRM), the audio unit displays UNSUPPORTED, and then skips to the next file.

Loading Discs

Your vehicle's in-dash disc changer holds up to six discs.

1. To load more than one disc, press the LOAD button until you hear a beep and see "LOAD" in the display. To load only one disc, press and release the LOAD button.
2. The disc number for an empty position begins blinking.
3. Insert the disc into the disc slot when the green disc load indicator comes on. Insert it only about halfway; the drive will pull it in the rest of the way. You will see "BUSY" in the display while the disc load indicator turns red and blinks as the disc is loaded.

You cannot load and play 3-inch (8-cm) discs in this unit.

4. When the disc load indicator turns green and "LOAD" appears in the display again, insert the next disc in the slot. Do not try to insert a disc until "LOAD" appears. You could damage the audio unit.
5. Repeat this until all six positions are loaded. If you are not loading all six positions, the system begins playing the last disc loaded.

You can also load a disc into an empty position while a disc is playing by pressing the appropriate preset button. The system stops playing the current disc and starts the loading sequence. It then plays the disc just loaded.

Text Data Display Function

Each time you press the TITLE button, the display shows you the text, if the disc was recorded with text data.

You can see the album, artist, and track name in the display. If a disc is recorded in MP3 or WMA, you can see the folder and file name, and the album, artist, and track tag.

With the folder name, you will see the FOLDER indicator in the display. The TRACK indicator is shown with the file or track name.

When you press and release the TITLE button while a disc without text data is playing, you will see “NO INFO” on the display.

The display shows up to 16 characters of selected text data (the folder name, file name, etc.).

If the text data has more than 16 characters, you will see the first 16 characters and the ► indicator in the display. Press and hold the TITLE button until the next 16 characters are shown. You can see up to 32 characters of the text data.

If you press and hold the TITLE button again, the display shows the first 16 characters again.

If any letter is not available, it is replaced with “.” (dot) in the display. When the disc has no text data, you will see “NO INFO” on the display.

You will also see some text data under these conditions:

- When a new folder, file, or track is selected.

- When you change the audio mode to play a disc with text data or in MP3 or WMA.
- When you insert a disc, and the system begins to play.

When playing a CD-DA with text data, the album and track name are shown in the display. With a disc in MP3 or WMA, the display shows the folder and file name.

When you turn on the audio system next time, the system keeps your selection with the TITLE button.

CONTINUED

Playing Discs (EX and EX-L models)

To Change or Select Tracks/Files

Use the SKIP bar while a disc is playing to select passages and change tracks (files in MP3 or WMA mode).

In MP3 or WMA mode, use the CATEGORY bar to select folders on the disc and use either side of the SKIP bar to change files.

To select a different disc, use the appropriate preset buttons (1 through 6). If you select an empty position, the system will go into the loading sequence (see page [244](#)).

In MP3 or WMA mode, you can also select a folder or track/file from the list by using the selector knob. Push the selector knob (ENTER) to switch the display to the list displayed with three segments, then turn the knob to select a folder. Press the selector knob (ENTER) to change the display to the track/file list, then turn the same knob to select a track/file. Press the selector knob (ENTER) to set your selection.

SKIP — Each time you press and release the ►| side of the SKIP bar, the player skips forward to the beginning of the next track (file in MP3 or WMA mode). Press and release the |◀ side of the bar to skip backward to the beginning of the current track. Press it again to skip to the beginning of the previous track.

To move rapidly within a track or file, press and hold either side (|◀◀ or ►►) of the SKIP bar.

In MP3 or WMA mode

FOLDER SELECTION – To select a different folder, press either side (– or +) of the CATEGORY bar. Press the + side to skip to the next folder, and press the – side to skip to the beginning of the previous folder.

REPEAT (Track Repeat) – To continuously replay a track (file in MP3 or WMA mode), select the track repeat mode from the menu items. You will see REPEAT in the display. Select the normal play mode to turn it off.

Pressing either side of the SKIP bar also turns off the repeat feature.

In MP3 or WMA mode

FOLDER REPEAT – This feature, when activated, replays all the files in the selected folder in the order they are compressed in MP3 or WMA. To activate folder repeat mode, select the folder repeat mode from the menu items. You will see F-REPEAT in the display. The system continuously replays the current folder. Select the normal play mode to turn it off. Selecting a different folder with the CATEGORY bar also turns off the repeat feature.

DISC REPEAT – This feature continuously replays the current disc. To activate disc repeat, select the disc repeat mode from the menu items. You will see D-REPEAT in the display. Select normal play to turn it off.

RANDOM (Random within a disc) – This feature plays the tracks within a disc (the files in MP3 or WMA mode) in random order. To activate random play, select the disc random play from the menu items. You will see RANDOM in the display. Select the normal play mode to return to normal play.

CONTINUED

Playing Discs (EX and EX-L models)

In MP3 or WMA mode

FOLDER RANDOM – This feature, when activated, plays the files within the current folder in random order, rather than in the order they are compressed in MP3 or WMA. To activate folder random play, select the folder random mode from the menu items. You will see F-RANDOM in the display. The system will then select and play files randomly. This continues until you deactivate folder random play by selecting the normal play mode, or you select a different folder with the CATEGORY bar.

SCAN – The SCAN function samples all the tracks on the disc in the order they are recorded on the disc (all files in the selected folder in MP3 or WMA mode). To activate the scan feature, press and release the SCAN button. You will see SCAN in the display. You will get a 10 second sampling of each track/file in the disc/folder. Press and hold the SCAN button until you hear a beep to get out of scan mode and play the last track sampled.

In MP3 or WMA mode

F-SCAN – This feature, when activated, samples the first file in each folder on the disc in the order they are recorded. To activate the folder scan feature, press and release the SCAN button repeatedly. You will see “F-SCAN” in the display. The system will then play the first file in the main folders for about 10 seconds. If you do nothing, the system will then play the first file in each folder for 10 seconds. When it plays a file that you want to continue listening to, press and hold the SCAN button.

Pressing either side of the SKIP bar, or selecting a different disc (using the preset buttons) or folder (using the CATEGORY bar) turns off the SCAN or F-SCAN feature.

Playing Discs (EX and EX-L models)

D-SCAN – This feature, when activated, samples the first track on each disc in order (the first file in the main folder on each disc in MP3 or WMA mode). To activate the disc scan feature, press and release the SCAN button repeatedly until D-SCAN shows in the display. The system will then play the first track/file in the first main folder on the first disc for about 10 seconds. If you do nothing, the system will then play the following first track/file for 10 seconds each. When it plays a track/file that you want to continue listening to, press and hold the SCAN button again.

When the first track on the last disc, or the first file in the last main folder on the last disc begins to play, the disc scan mode will be canceled. Pressing either side of the SKIP bar or selecting a different folder with the CATEGORY bar also turns off the scan feature.

Each time you press and release the SCAN button, the mode changes from scan, disc scan, then to normal play.

In MP3 or WMA mode

Each time you press and release the SCAN button, the mode changes from file scan, folder scan, disc scan, then to normal play.

To Stop Playing a Disc

Press the eject button (▲) to remove the disc. If you eject the disc, but do not remove it from the slot, the system will automatically reload the disc after 10 seconds and begin playing.

You can also eject the disc when the ignition switch is off.

To play the radio when a disc is playing, press the AM, FM, AM/FM, or XM (if equipped) button. Press the CD (CD/AUX on models with XM Radio) button again to switch back to the disc changer.

CONTINUED

Playing Discs (EX and EX-L models)

If you turn the system off while a disc is playing, either with the power/volume knob or by turning off the ignition switch, the disc will stay in the drive. When you turn the system back on, the disc will begin playing where it left off.

Removing Discs from the In-dash Disc Changer

To remove the disc currently in play, press the eject button. When a disc is removed from a slot, the system automatically begins the load sequence so you can load another disc in that position. If you do not remove the disc from the changer within 10 seconds, the disc will reload into the slot. Then the system returns to the previous mode (AM, FM, or XM Radio).

To remove a different disc from the changer, first select it with the appropriate preset button. When that disc begins playing, press the eject button. Continue pressing the eject button to remove all the discs from the changer.

You can also eject discs when the ignition switch is off. The disc that was last selected is ejected first.

Protecting Discs

For information on how to handle and protect compact discs, see page [285](#).

Disc Changer Error Messages (EX and EX-L models)

The chart on the right explains the error messages you may see in the display while playing a disc.

If you see an error message in the display while playing a disc, press the eject button. After ejecting the disc, check it for damage or deformation. If there is no damage, insert the disc again.

For additional information on damaged discs, see page [286](#).

The audio system will try to play the disc. If there is still a problem, the error message will reappear. Press the eject button, and pull out the disc. Insert a different disc. If the new disc plays, there is a problem with the first disc. If the error message cycle repeats and you cannot clear it, take your vehicle to a dealer.

Error Message	Cause	Solution
HEAT ERROR	High temperature	Will disappear when the temperature returns to normal.
UNSUPPORTED	Track/File format not supported	Current track will be skipped. The next supported track or file plays automatically.
BAD DISC PLEASE CHECK OWNER'S MANUAL PUSH EJECT	Mechanical Error	Press the EJECT button and pull out the disc(s). Check the disc for serious damage, signs of deformation, excessive scratches, and/or dirt (see page 286). Insert the disc again. If the code does not disappear, or the disc(s) cannot be removed, consult your dealer. Do not try to force the disc out of the player.
BAD DISC PLEASE CHECK OWNER'S MANUAL	Servo Error	

Audio System (Models with navigation system)

Interface Dial

On models with navigation system

Most audio system functions can still be controlled by standard buttons, dials, and knobs, but some functions can only be accessed using the interface dial. The interface dial has two parts, a knob and a selector.

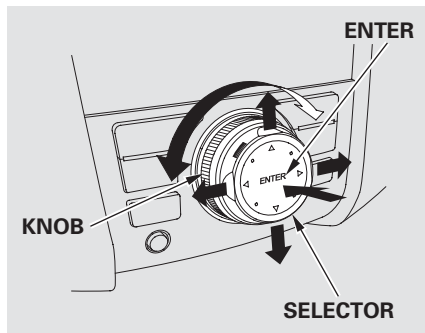

The knob turns left and right. Use it to make selections or adjustments to a list or menu on the screen.

The selector can be pushed left, right, up, down, and in. Use the selector to scroll through lists, to select menus, and to highlight menu items. When you make a selection, push the center of the selector (ENTER) to go to that selection.

Voice Control System

The audio system can also be operated by voice control. See the navigation system manual for complete details.

Playing the FM/AM Radio (Models with navigation system)

Without rear entertainment system

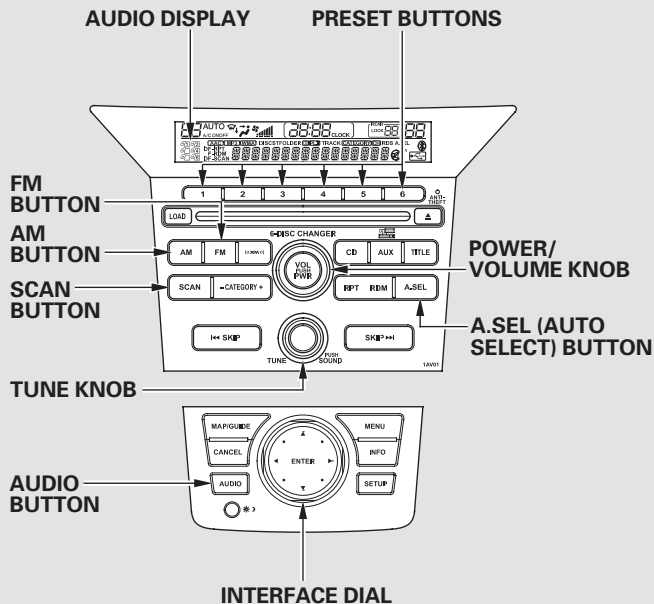

With rear entertainment system

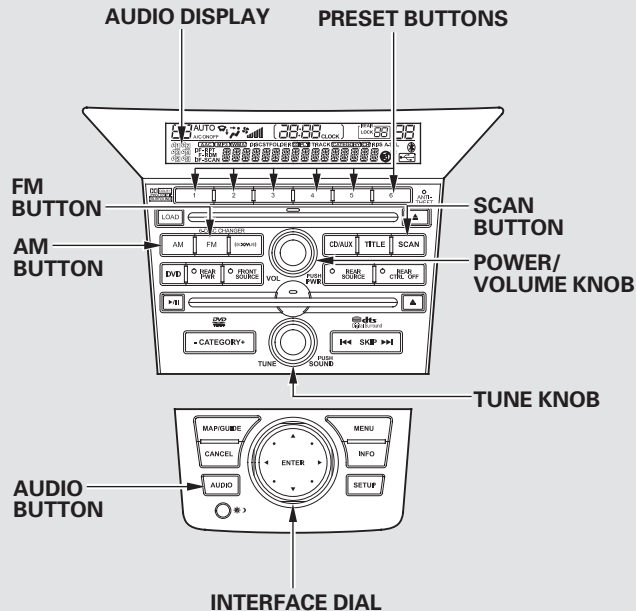

Features

Playing the FM/AM Radio (Models with navigation system)

To Play the FM/AM Radio

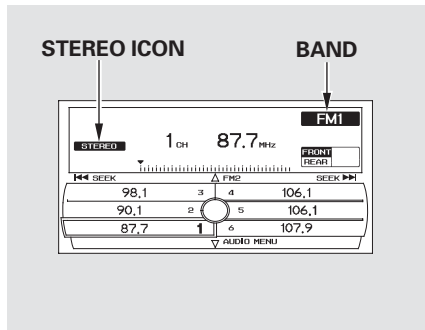

The ignition switch must be in the ACCESSORY (I) or the ON (II) position. Press the AUDIO button to view the audio control display. Turn the system on by pressing the power/volume knob, the AM, or FM button. Adjust the volume by turning the power/volume knob.

The band and frequency that the radio was last tuned to are shown on the display. To change bands, press the AM or FM button. You can also change bands by pushing the interface selector up. Each time you push it up, the band will change to FM1, FM2, or AM. On the FM bands, STEREO will be shown on the navigation screen and ST on the audio display, if the station is broadcasting in stereo. Stereo reproduction on AM is not available.

On the AM band, AM noise reduction turns on automatically.

To Select a Station

You can use any of five methods to find radio stations on the selected band: tune, skip (seek), scan, the preset buttons, and auto select.

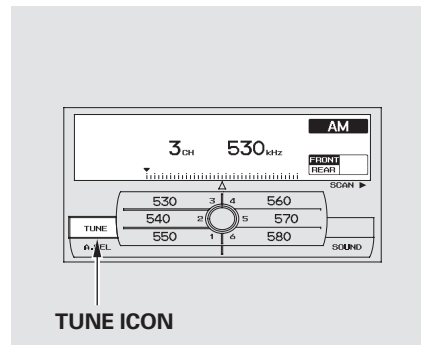

TUNE — Use the TUNE knob to tune the radio to a desired frequency. Turn the knob right to tune to a higher frequency, or left to tune to a lower frequency. To tune with the interface dial, push the selector down, and turn the knob to TUNE. Then press ENTER on the selector, and turn the knob to the desired frequency. To exit the TUNE mode, press ENTER on the selector.

Playing the FM/AM Radio (Models with navigation system)

SKIP (SEEK) – The SKIP (SEEK) function searches up and down from the current frequency to find a station with a strong signal. To activate it, press either side (◀◀ or ▶▶) of the SKIP bar or button, then release it. You can also activate the SKIP function (SEEK is displayed on the screen) by pushing the interface selector to the right or left.

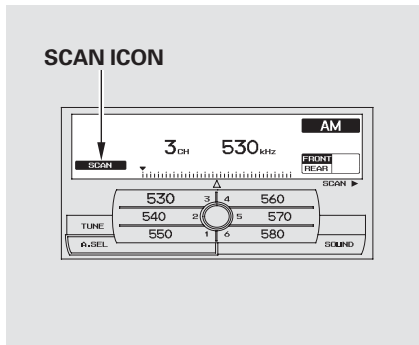

SCAN – The SCAN function samples all stations with strong signals on the selected band. To activate it, press the SCAN button, then release it.

To scan with the interface dial, push the selector down, and then push it to the right. You will see SCAN flashing on the screen.

The system will scan for a station with a strong signal. When it finds a strong signal, it will stop and play that station for about 10 seconds. If you do nothing, the system will then scan for the next strong station and play it for 10 seconds. When it plays a station that you want to listen to, press the scan button again, or push the interface selector to the right again.

CONTINUED

Playing the FM/AM Radio (Models with navigation system)

Preset – Each preset button or preset icon can store one frequency on AM and two frequencies on FM.

To store a preset memory location:

1. Select the desired band, AM or FM. FM1 and FM2 let you store two sets of FM frequencies with the preset buttons (on-screen icons).
2. Use the tune, seek, or scan function to tune the radio to a desired station.
3. Press the preset button, and hold it until you hear a beep. You can also store frequencies with the interface dial. Select the preset icon you want to store the frequency on, then press ENTER on the interface selector, and hold it for more than 2 seconds.
4. Repeat steps 1 through 3 to store a total of six stations on AM and twelve stations on FM.

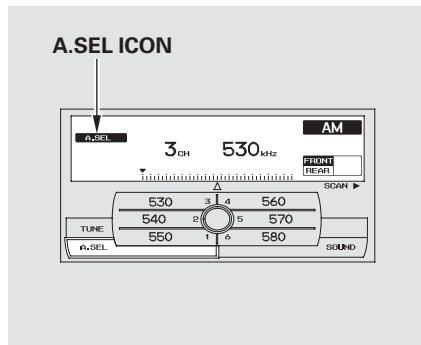

AUTO SELECT – If you are traveling and can no longer receive your preset stations, you can use the auto select feature to find stations in the local area.

Push the interface selector down to scroll down the screen, highlight A.SEL, then press ENTER on the interface selector. You will see A.SEL on the screen, and the system goes into scan mode for several seconds.

On vehicles without rear entertainment system

You can also press the A.SEL button. You will see A.SEL on the screen, and the system goes into scan mode for several seconds. The system stores the frequencies of six AM and twelve FM stations in the preset buttons.

You will see “0” displayed if auto select cannot find a strong station for every preset button.

If you do not like the stations auto select has stored, you can store other frequencies on the preset buttons (icons) as previously described.

To turn off auto select, press ENTER on the interface selector or press the A.SEL button again. This restores the presets you originally set.

Playing the FM/AM Radio (Models with navigation system)

For information on FM/AM radio frequencies and reception, see page [308](#).

Radio Data System (RDS)

On the FM band, you can select a favorite station and display the program service name provided by the radio data system (RDS).

Program Service (PS) Name Display

The program service name display function shows the name of the station you are listening to. You can turn this function on or off.

To switch the function between on and off, press and release the TITLE button. With the system on, you will see the “PS NAME ON” message on the center display. If the station you are listening to is an RDS station, the displayed frequency switches to the station name.

CONTINUED

Playing the FM/AM Radio (Models with navigation system)

If the station you are listening to is not an RDS station, the audio screen and the center display continue to show the frequency.

When you turn off this function by pressing the TITLE button, the center display shows “PS NAME OFF.”

Radio Data System (RDS) Category

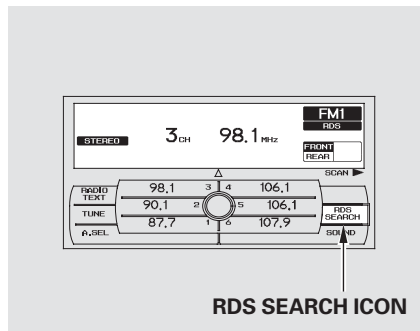

With the FM band selected, you can select the program type provided by the RDS. Press the AUDIO button to display the radio information on the screen. Push down the selector on the interface dial, then turn the knob to select RDS SEARCH icon. Press ENTER to set your selection. The principal RDS categories are shown as follows:

ALL: All RDS category stations
 ROCK: Rock, classic rock and soft rock music
 COUNTRY: Country music
 SOFT: Adult hits and soft music
 TOP 40: Top 40 hits
 OLDIES: Nostalgia music and oldies
 R & B: Rhythm and blues, and soft rhythm and blues
 RELIGION: Programs concerned with religion
 CLASSIC: Classical music
 JAZZ: Jazz
 INFO: News, information, sports, talk shows, foreign language, personality, public, college, and weather
 TRAFFIC: Traffic information

Playing the FM/AM Radio (Models with navigation system)

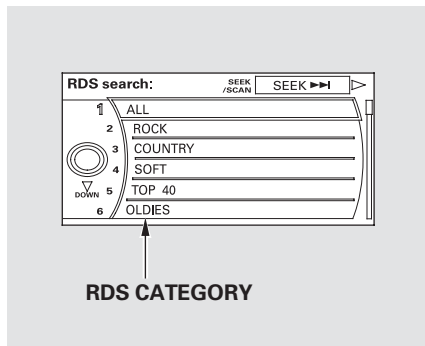

Turn the selector to select an RDS category. You can use the search or scan function to find radio stations on the selected RDS category by pressing the selector to the right repeatedly. Press ENTER to set your selection. If you do nothing while the RDS category is selected, the selected category is canceled.

You can also select an RDS category with the CATEGORY bar. Press either side (– or +) of the CATEGORY bar to display an RDS category in the center display. Select a category by pressing either side of the bar.

RDS Program Search

This function searches up and down a frequency for the strongest signal from the frequencies that carry the selected RDS category information. This can help you to find a station in your favorite category. To activate it, press and release either side (◀◀ or ▶▶) of the SKIP bar or button. You will also see the selected RDS category name blinking in the center display while searching it. When the system finds a station, the selected RDS category name will be displayed again for about 10 seconds in the center display.

If the system does not find a station, “NOTHING” will be blinking for about 5 seconds, then the system goes back to the last selected station.

CONTINUED

Playing the FM/AM Radio (Models with navigation system)

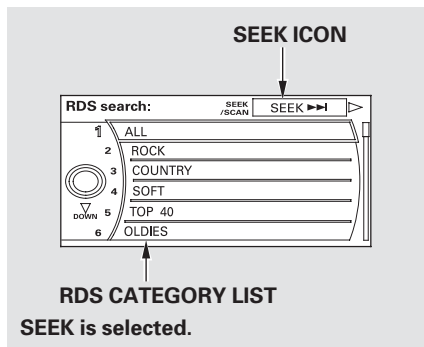

To activate RDS program search with the interface dial, push the AUDIO button to display the FM radio information on the screen. Push the selector down, and turn the knob to select the RDS SEARCH icon. Press ENTER on the selector. The screen shows you the RDS program category list.

Turn the knob to the desired RDS category.

While the RDS category is selected, move the selector knob to the right to select SEEK in the upper right corner of the screen. Then press ENTER to activate the seek function.

RDS Program SCAN

The scan function samples all stations with strong signals on the selected RDS category. To activate it, press and release the SCAN button. You will see SCAN in the display. The system will scan for a station with a strong signal in the selected RDS category. You will also see the selected RDS category name blinking while searching it. When it finds a strong signal, it will stop and play that station for about 10 seconds.

Playing the FM/AM Radio (Models with navigation system)

If you do nothing, the system will scan for the next strong station and play it for 10 seconds. When it plays a station that you want to listen to, press the SCAN button again.

If the system does not find a station, “NOTHING” will be blinking for about 5 seconds, then the system goes back to the last selected station.

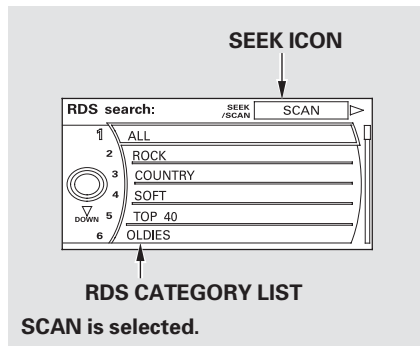

To activate RDS program scan with the interface dial, push the AUDIO button to display the FM radio information on the screen. Push the selector down, and turn the knob to select the RDS SEARCH icon. Press ENTER on the selector. The screen shows you the RDS category list.

Turn the knob to the desired RDS category.

While the RDS category is selected, move the selector knob to the right to select SCAN in the upper right corner of the screen. Then press ENTER to activate the scan function.

You can use the RDS program search or scan function even if the RDS information display function is off. In this case, the display shows a frequency in place of a RDS station name.

CONTINUED

Playing the FM/AM Radio (Models with navigation system)

Radio Text Display

This function displays the radio text information of the selected RDS station.

If the selected RDS station has the radio text information, you will see the text indicator on the screen.

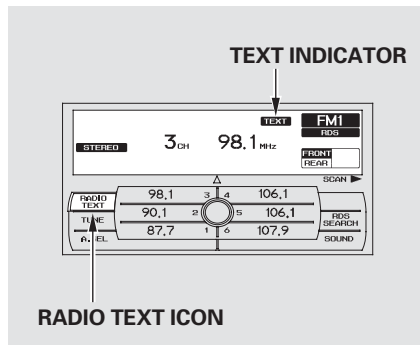

To activate radio text display, use the interface dial. Push the selector down, and turn the knob to select the RADIO TEXT icon. Press ENTER on the selector to enter the setting.



The display shows up to 64 characters on the selected RDS station.

Playing the FM/AM Radio (Models with navigation system)

Adjusting the Sound

BASS, TREBLE, BALANCE, and FADER are each adjustable. You can also adjust the strength of the sound coming from the center and subwoofer speakers. In addition, you can set the Dolby PL (ProLogic) II and Speed-sensitive volume compensation (SVC).

These adjustments can be made by the SOUND button or the interface dial.

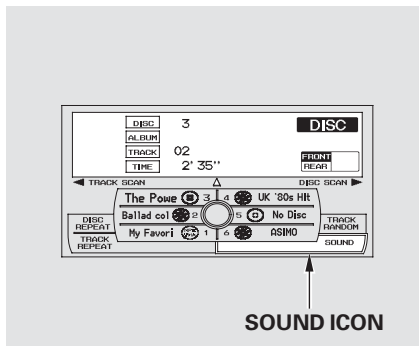

SOUND ICON

To adjust them, press the AUDIO button, push the interface selector down, and turn the interface knob to SOUND. Then press ENTER on the selector.

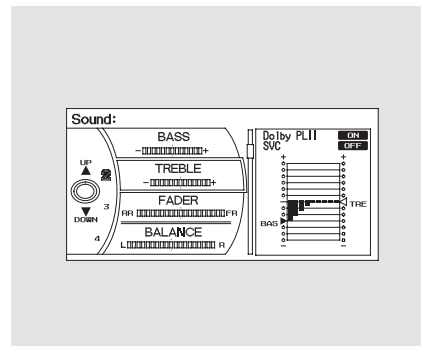

Select the mode you want to adjust by turning the interface dial.

You can also adjust the sound by pushing the SOUND button repeatedly. Each mode is shown in the audio display as it changes. Turn the TUNE knob to adjust the setting to your liking.

CONTINUED

Playing the FM/AM Radio (Models with navigation system)

BASS/TREBLE – To adjust bass and treble, select BASS or TREBLE, and press ENTER on the interface selector. The current setting is shown on the display. Turn the interface knob to the desired level, and enter your selection by pressing ENTER on the interface selector.

FADER/BALANCE – These modes adjust the strength of the sound coming from each speaker. Fader adjusts the front-to-back strength, while balance adjusts the side-to-side strength. To adjust fader and balance, select FADER or BALANCE, then press ENTER on the interface selector. The current setting is shown on the screen. Turn the interface knob to the desired level, and enter your selection by pressing ENTER on the interface selector. To equalize the fader or balance, turn the interface knob until the marks on the sound grid come to the center of the adjustment bar.

CENTER/SUBWOOFER – To adjust the strength of the sound from the center or subwoofer speaker, select it and press ENTER on the interface selector. Turn the interface knob to the desired level, and enter your selection by pressing ENTER on the interface selector.

Playing the FM/AM Radio (Models with navigation system)

Dolby PL (ProLogic) II — Dolby PL (ProLogic) II signal processing creates multi-channel surround sound from 2 channel stereo audio sources. Dolby ProLogic II can only be activated when listening to DISC (CD-DA, MP3/WMA), XM Radio, and AUX. When ProLogic II is active, “PL II” is shown in the audio display.

To set this feature on or off, select Dolby PL II, and press ENTER on the interface selector. Rotate the interface dial to ON or OFF, and press ENTER.

Manufactured under license from Dolby Laboratories. Dolby, Pro Logic, MLP Lossless and the double-D symbol are trademarks of Dolby Laboratories.

Speed-sensitive Volume Compensation (SVC)

The SVC mode controls the volume based on vehicle speed. The faster you go, the louder the audio volume becomes. As you slow down, the audio volume decreases.

The SVC has four modes: SVC OFF, SVC LOW, SVC MID, and SVC HIGH. The default setting is MID. To change the SVC mode, select SVC, then press ENTER on the interface selector. The current setting is shown on the screen. Turn the interface knob to the desired level, and enter your selection by pressing ENTER on the interface selector. If you feel the sound is too loud, choose low. If you feel the sound is too quiet, choose high.

Playing the XM® Radio (Models with navigation system)

Without rear entertainment system

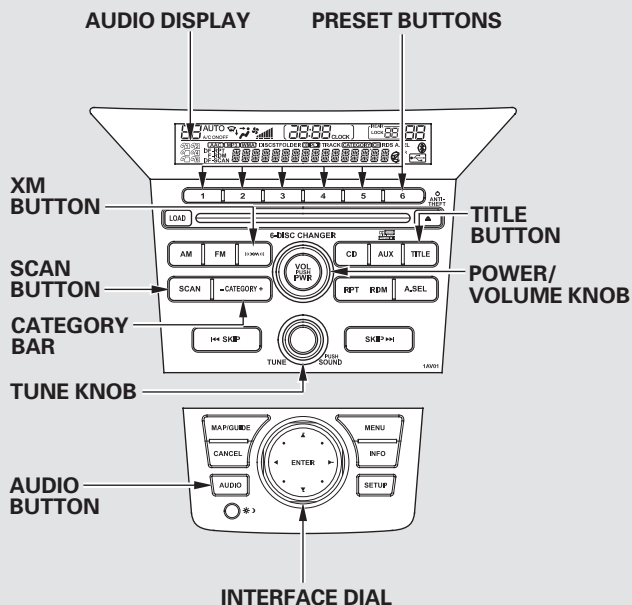

With rear entertainment system

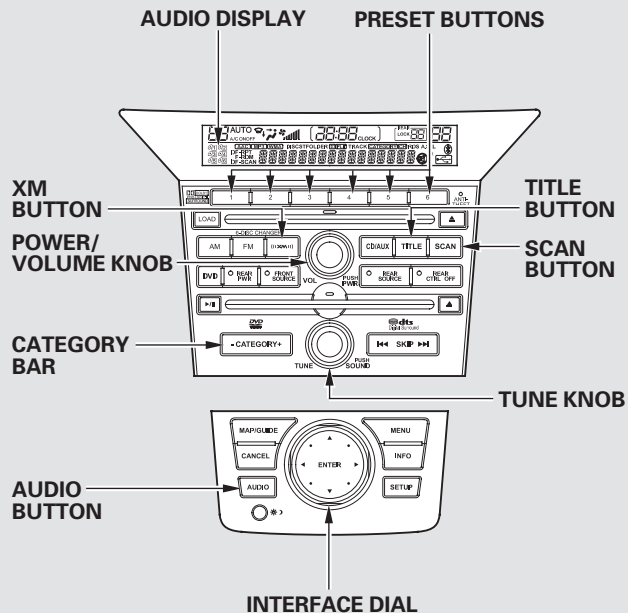

Playing the XM® Radio (Models with navigation system)

Your vehicle is capable of receiving XM® Radio anywhere in the United States, and Canada, except Hawaii and Alaska. XM is a registered trademark of Sirius XM Radio®, Inc. and, XM CANADA® is a registered business name of Canadian Satellite Radio Inc.

XM Radio receives signals from two satellites to produce clear, high-quality digital reception. It offers many channels in several categories. Along with a large selection of different types of music, XM Radio also allows you to view channel and category selections in the audio display.

Operating the XM Radio

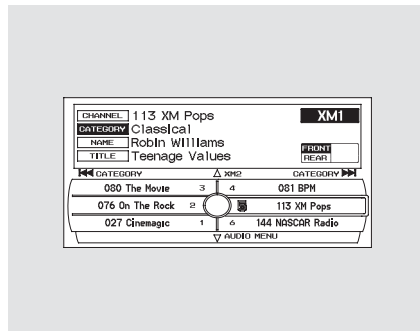

To listen to XM Radio, turn the ignition switch to the ACCESSORY (I) or ON (II) position. Push the power/volume knob to turn on the audio system, and press the (« XM ») button. The last channel you listened to will show in the display. Adjust the volume by turning the power/volume knob.

Push the AUDIO button to display XM information on the screen. You can operate the XM Radio system with the interface dial.

CONTINUED

Playing the XM[®] Radio (Models with navigation system)

MODE — To switch between the category mode and channel mode, press and hold the TITLE button until the mode changes. The CATEGORY or CHANNEL mode is displayed on the screen. To switch the mode with the interface dial, push down the interface selector to select AUDIO MENU, then turn the knob to select MODE, and press ENTER on the selector repeatedly.

In the category mode, such as Jazz, Rock, Classical, etc., you can navigate through all of the channels within that category. In the channel mode, you can select all of the available channels.

Each time you press and release the TITLE button, the center display changes in the following sequence: NAME (artist name), TITLE (music title), and CHANNEL NAME (channel name).

On the screen, you will see the selected CHANNEL (number), CATEGORY, NAME (artist name), and TITLE (music title).

TUNE — Turn the TUNE knob to change channel selections. Turn the knob right for higher numbered channels and left for lower numbered channels. You can also change channels with the interface selector, push down the interface selector to choose TUNE and press ENTER on the selector. Turn the interface knob to the same directions. In the category mode, you can only select channels within that category.

Playing the XM[®] Radio (Models with navigation system)

CATEGORY – Press either side of the bar (– or +) to select another category.

SCAN – The scan function gives you a sampling of all channels while in the channel mode. In the category mode, only the channels within that category are scanned. To activate SCAN, press the SCAN button. To scan with the interface dial, scroll down, and push the interface selector to the right. You will see SCAN on the screen and audio display.

The system plays each channel in numerical order for a few seconds, then selects the next channel. When you hear a channel you want to continue listening to, push the interface selector to the right again or press the SCAN button to cancel.

CONTINUED

Playing the XM® Radio (Models with navigation system)

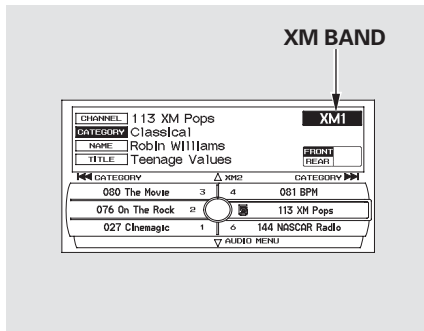

Preset – You can store up to 12 preset channels using the six preset buttons. Each button stores one channel from the XM1 band and one channel from the XM2 band.

To store a channel:

1. Press the «XM» button or scroll up by pushing the interface selector up. Either XM1 or XM2 will be shown on the display.

2. Use the tune or scan function to tune to a desired channel.

In category mode, only channels within that category can be selected. In channel mode, all channels can be selected.

3. Pick the preset button you want for that channel. Press and hold the preset button until you hear a beep. You can also pick the number with the interface dial. Select your desired number and press and hold ENTER on the interface selector.
4. Repeat steps 2 and 3 to store the first six channels.

5. Press the «XM» button or scroll up again. The other XM band will be shown. Store the next six channels using steps 2 and 3.

Once a channel is stored, press and release the proper preset button to tune to it.

Playing the XM® Radio (Models with navigation system)

XM Radio Display Messages

“LOADING” – XM is loading the audio or program information.

“OFF AIR” – The channel currently selected is no longer broadcasting.

“UPDATING” – The encryption code is being updated. Wait until the encryption code is fully updated. Channels 0 and 1 should still work normally.

“NO SIGNAL” – The signal is currently too weak. Move the vehicle to an area away from tall buildings, and with an unobstructed view of the southern horizon.

“ - - - - ” – The selected channel number does not exist, or is not part of your subscription, or this channel has no artist or title information at this time.

“ANTENNA” – There is a problem with the XM antenna. Please consult your dealer.

CONTINUED

Playing the XM[®] Radio (Models with navigation system)

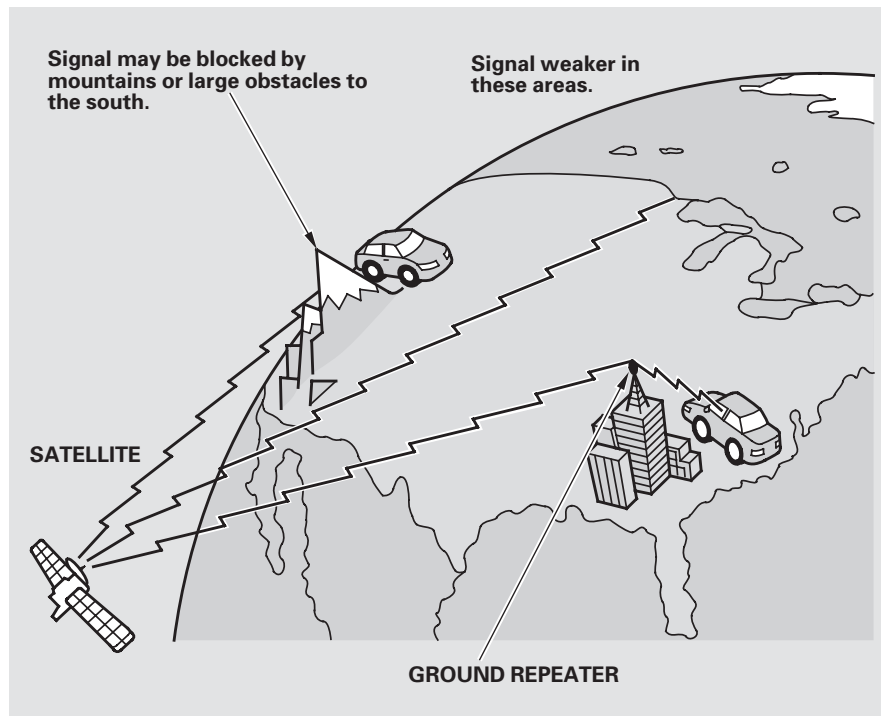

The XM satellites are in orbit over the equator; therefore, objects south of the vehicle may cause satellite reception interruptions. To help compensate for this, ground-based repeaters are placed in major metropolitan areas. Satellite signals are more likely to be blocked by tall buildings and mountains the farther north you travel from the equator.

Playing the XM® Radio (Models with navigation system)

Depending on where you drive, you may experience reception problems. Interference can be caused by any of these conditions:

- Driving on the north side of an east/west mountain road.
- Driving on the north side of a large commercial truck on an east/west road.
- Driving in tunnels.
- Driving on a road beside a vertical wall, steep cliff, or hill to the south of you.
- Driving on the lower level of a multi-tiered road.
- Driving on a single lane road alongside dense trees taller than 50 ft. (15 m) to the south of you.

There may be other geographic situations that could affect XM Radio reception.

*As required by the FCC:
Changes or modifications not expressly approved by the party responsible for compliance could void the user's authority to operate the equipment.*

Receiving XM Radio Service

If your XM Radio service has expired or you purchased your vehicle from a previous owner, you can listen to a sampling of the broadcasts available on XM Radio. With the ignition switch in the ACCESSORY (I) or the ON (II) position, push the power/volume knob to turn on the audio system, and press the «XM» button. A variety of music types and styles will play.

If you decide to purchase XM Radio service, contact XM Radio at www.xmradio.com, or at 1-800-852-9696. In Canada, contact XM Canada at www.xmradio.ca, or at 1-877-209-0079. You will need to give them your radio I.D. number and

your credit card number. To get your radio I.D. number, turn the TUNE knob until “0” appears in the display. Your I.D. will appear in the display.

After you've registered with XM Radio, keep your audio system in the XM Radio mode while you wait for activation. This should take about 30 minutes.

While waiting for activation, make sure your vehicle remains in an open area with good reception. Once your audio system is activated, “CATEGORY” or “CH” will appear in the display, and you'll be able to listen to XM Radio broadcasts. XM Radio will continue to send an activation signal to your vehicle for at least 12 hours from the activation request. If the service has not been activated after 36 hours, contact XM Radio. In Canada, contact XM CANADA®.

Playing Discs (Models with navigation system)

Without rear entertainment system

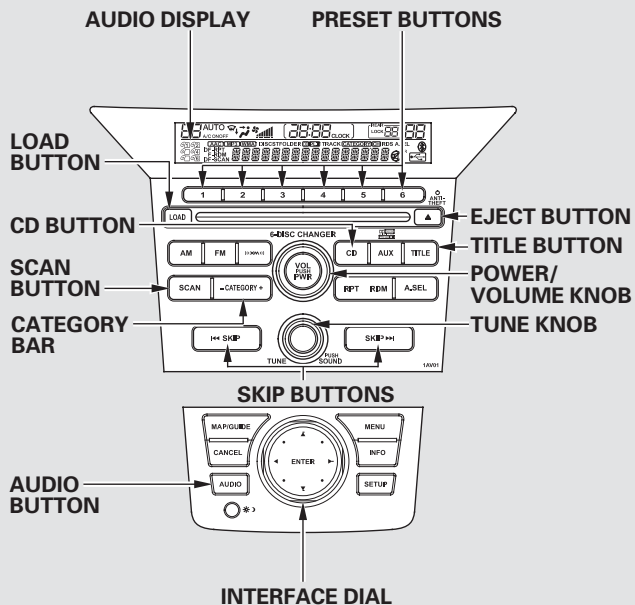

With rear entertainment system

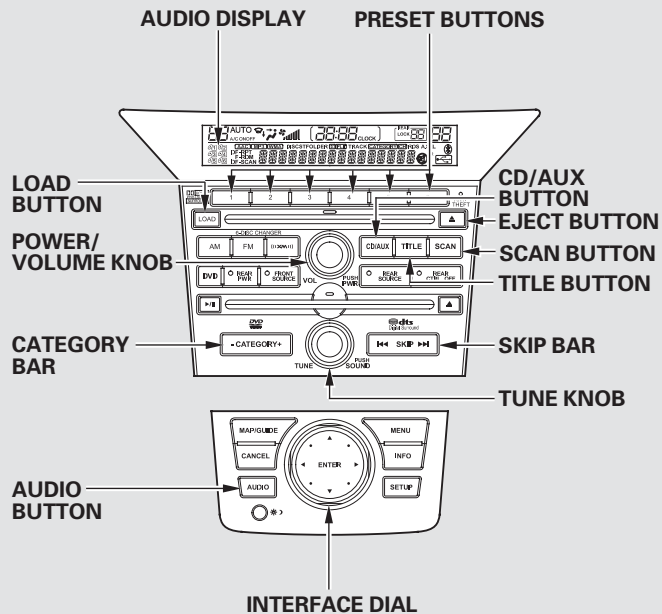

Playing Discs (Models with navigation system)

Your vehicle's audio system has an in-dash disc changer with the same controls used for the radio. To operate the disc changer, the ignition switch must be in the ACCESSORY (I) or the ON (II) position.

The disc changer can play these disc formats:

- CD (CD-DA)
- CD-R/RW
- MP3/WMA

If you have a disc that is a combination of CD-DA tracks and MP3/WMA files, you can choose the format to listen to by pressing and holding the CD/AUX button until you hear a beep.

The disc packages or jackets should have one of these marks.



The changer can also play MP3 or WMA format (see page [280](#)).

When playing a disc in MP3, you will see “MP3” in the display. In WMA format, “WMA” will appear in the display.

NOTE:

If a file on an MP3 or WMA disc is protected by digital rights management (DRM), the audio system displays UNSUPPORTED in the center display, and then skips to the next file.

Video CDs and DVD discs will not work in this unit.

Some CD-DA and CD-ROM mixed discs are not playable.

You cannot load and play 3-inch (8-cm) discs in this system.

NOTICE

Do not use discs with adhesive labels. The label can curl up and cause the disc to jam in the unit.

Playing Discs (Models with navigation system)

Loading Discs in the Changer

To load multiple discs in one operation:

1. With the ignition in the ACCESSORY (I) or the ON (II) position, press and hold the LOAD button until you hear a beep and see “LOAD” in the upper display, then release the button.
2. Insert a disc into the slot. Insert it only about halfway; the drive will pull it in the rest of the way. You will see “BUSY” in the audio display.
3. When “LOAD” appears in the audio display again, insert the next disc into the slot.
Do not try to insert a disc until “LOAD” appears. You could damage the audio unit.

4. Repeat this until all six positions are loaded. If you are not loading all six positions, the system will then begin playing the last disc loaded.

If you stop loading discs before all six positions are filled, the system will wait for 10 seconds, stop the load operation, and begin playing the last disc loaded.

To load a single disc:

1. Press and release the LOAD button.
2. “NO DISC” is shown on the screen for an empty position in the changer. When the green load indicator comes on and you see “LOAD” in the audio display, insert the disc into the slot. Insert it only about halfway; the drive will pull it in the rest of the way.

Do not try to insert a disc until “LOAD” appears. You could damage the audio unit.

You can select the position to load a disc. Turn the interface knob or press a preset button to select the position, then press ENTER on the selector. This starts the loading sequence. If you do not select the position, the system loads the disc to the first empty position in numerical order.

If you press the LOAD button while a disc is playing, the system will stop playing that disc and start the loading sequence. It will then play the disc just loaded.

Playing Discs (Models with navigation system)

To Play a Disc

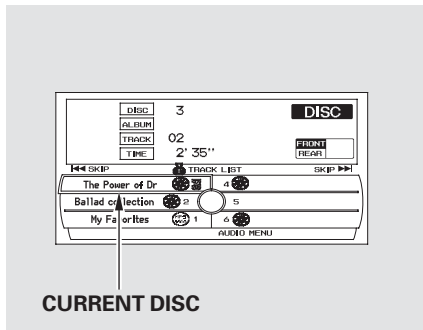

CURRENT DISC

Select the changer by pressing the CD or CD/AUX button. The system will begin playing the last selected disc in the disc changer. You will see the current disc position highlighted.

To select a different disc, press the corresponding number on the preset buttons, or turn the interface knob to highlight the desired disc, then press ENTER on the interface selector.

The player can play CD-TEXT, MP3, and WMA formats.

When you play CD-TEXT, you will see the track name, artist name, and album name on the screen. When you play MP3/WMA discs, you will see the track name and folder name on the screen. If the disc was not recorded with this information, it will not be displayed.

Each time you press the TITLE button, the center display changes from album name, to track name, to artist name, and then to normal display that shows the track number and the elapsed time. When playing a disc in MP3/WMA, the display mode changes from folder name, to file name, to artist tag, to album tag, to track tag, and then to normal display.

If the disc does not carry album, track, or artist name, pressing the TITLE button shows “NO INFO.”

To Change Tracks

Each time you press and release the ►► side of the SKIP bar, button, or push the interface selector to the right, the player skips forward to the beginning of the next track. Press and release the ◀◀ side of the SKIP bar, button, or push the interface selector to the left to skip backward to the beginning of the current track. Press the ◀◀ side or push the interface selector to the left again to skip to the previous track. To move rapidly within a track, press and hold either side of the SKIP bar or button.

Playing Discs (Models with navigation system)

To Choose a Track

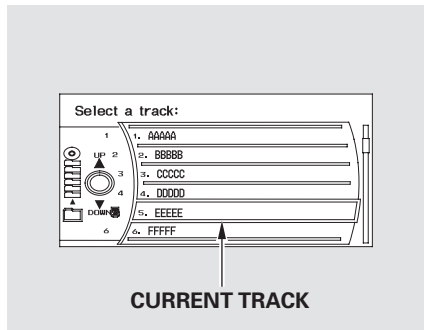

You can also choose a track directly from a track list. Press ENTER on the interface selector, and the track list screen will be shown. If there are no track names, track numbers are displayed. You will see the current track is highlighted. Turn the interface knob to select the desired track, then press ENTER on the interface selector.

To exit the track list display, press the AUDIO button, or push the interface selector to the left.

Track Scan

When you press the SCAN button or scroll down and push the interface selector to the left, the next track of the current track plays for about 10 seconds. You will see SCAN next to TRACK on the screen and audio display. To listen to the rest of the track, press and hold the SCAN button until you hear a beep or push the interface selector to the left again within 10 seconds.

If you don't, the system advances to the next track, plays about 10 seconds of it, and continues through the rest of the tracks the same way.

Disc Scan

When you press the SCAN button repeatedly until you see D-SCAN in the audio display, or push down the interface selector to the right, the first track of the current disc plays for about 10 seconds. You will see SCAN next to DISC on the screen and D-SCAN in the audio display. To listen to the rest of the disc, press and hold the SCAN button until you hear a beep, or push down the interface selector to the right again within 10 seconds.

If you don't, the system advances to the next disc, plays about 10 seconds of its first track, and continues through the rest of the discs the same way. When the system reaches the last disc, DISC SCAN is canceled, and that disc continues to play.

Playing Discs (Models with navigation system)

Track Repeat

To replay the current track continuously, press and release the RPT button, or use the interface selector to scroll down, select TRACK REPEAT, and press ENTER on the interface selector. As a reminder, you will see REPEAT next to TRACK on the screen and RPT in the audio display. To turn this feature off, press and hold the RPT button until you hear a beep, or highlight TRACK REPEAT (if not already highlighted), and press ENTER on the interface selector again.

Disc Repeat

To replay the current disc continuously, press the RPT button repeatedly until you see D-RPT in the audio display, or use the interface selector to scroll down, select DISC REPEAT, and press ENTER on the interface selector. As a reminder, you will see REPEAT next to DISC on the screen and D-RPT in the audio display. To turn this feature off, press and hold the RPT button until you hear a beep, or highlight DISC REPEAT (if not already highlighted), and press ENTER on the interface selector again.

Random Play

To play the tracks of the current disc in random order, press and release the RDM button, or use the interface selector to scroll down, select TRACK RANDOM, and press ENTER on the interface selector. As a reminder, you will see RANDOM next to TRACK on the screen and RDM in the audio display. To turn this feature off, press and hold the RDM button until you hear a beep, or highlight TRACK RANDOM (if not already highlighted), and press ENTER on the interface selector again.

Playing Discs (Models with navigation system)

To Stop Playing a Disc

To take the system out of disc mode, press the AM or FM button, the «» button, AUX button, or CD/AUX button. To return to disc mode, press the CD button or CD/AUX button.

If you turn the system off while a disc is playing, either with the power/volume knob or the ignition switch, play will continue at the same point when you turn it back on.

Playing an MP3/WMA Disc

The CD changer can play CD-Rs and CD-RWs compressed in MP3 and WMA format. When playing a disc in MP3 or WMA, you will see “MP3” or “WMA” on the center display. A disc can support more than 99 folders, and each folder can hold up to 255 playable files.

When there are more than 99 folders on a disc, the center display only shows two digits.

The specifications for compatible MP3 files are:

- Sampling frequency:
32/44.1/48 kHz (MPEG1), 16/
22.05/24 kHz (MPEG2)
- Bitrate:
32/40/48/56/64/80/96/112/128/
160/192/224/256/320 kbps
(MPEG1), 8/16/24/32/40/48/56/
64/80/96/112/128/160 kbps
(MPEG2)
- Compatible with variable bitrate

and multi-session.

- Maximum layers
(including ROOT): 8 layers

The specifications for compatible WMA files are:

- Sampling frequency:
22.05/32/44.1/48 kHz
- Bitrate:
48/64/80/96/128/160/192 kbps
- Compatible with variable bitrate
and multi-session
- Maximum layers
(including ROOT): 8 layers

To play an MP3/WMA disc, use the disc controls previously described, along with the following information.

Playing Discs (Models with navigation system)

Changing the Folders

While playing an MP3/WMA disc, you can select a folder within the disc by pressing either side of the category bar. Each time you press either side of the bar, the folder title and its first file's information appear in the center display in recorded order.

Changing and Selecting the Folders/ Files

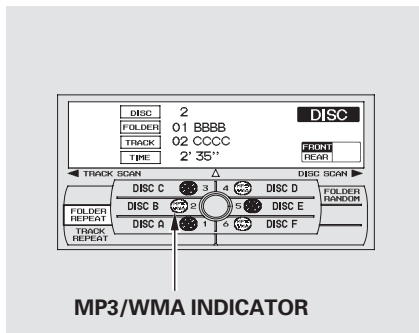

Using the interface selector, you can see the list of all the files and folders within a disc. While playing a MP3/WMA disc, press the AUDIO button. The currently playing folder and file information comes on the screen.

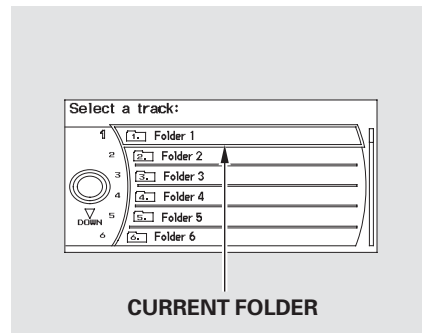

Push the selector to show the folder list. Turn the selector knob, highlight the folder you want to see the information within, and press ENTER.

CONTINUED

Playing Discs (Models with navigation system)

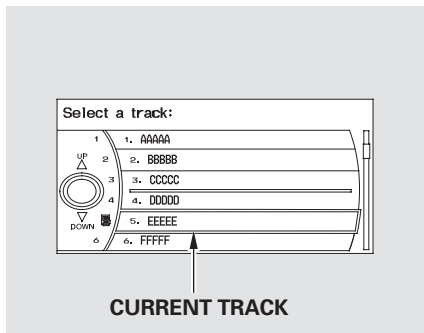

You can see the list of all the files in the selected folder. Turn the selector knob, then press ENTER to set your selection.

If the root folder has some additional folders in the lower layer, they will be listed on the screen.

Folder Scan

This feature, when activated, samples the first file of each folder for 10 seconds. To scan a folder, press the SCAN button repeatedly until you see F-SCAN in the audio display. You will see SCAN next to FOLDER and F-SCAN in the audio display.

To listen to the rest of the folder, press and hold the SCAN button until you hear a beep. If you do not, the system advances to the next folder, plays 10 seconds of it, and continues throughout the rest of the folder the same way. When the system samples the first file of all folders, folder scan is canceled, and the last file played comes back.

Folder Repeat

This feature, when activated, replays all files in the selected folder. To activate folder repeat mode, press the RPT button repeatedly until you see F-RPT in the audio display, or use the interface selector to scroll down, select FOLDER REPEAT by turning the interface knob, and press ENTER on the interface selector.

You will see REPEAT next to FOLDER on the screen and F-RPT in the audio display. To turn this feature off, press and hold the RPT button until you hear a beep, or highlight FOLDER REPEAT (if not already highlighted), and press ENTER on the interface selector again.

Playing Discs (Models with navigation system)

Folder Random

This feature, when activated, plays tracks in the current folder in random order. To activate folder random play, press the RDM button; or use the interface selector to scroll down, select FOLDER RANDOM by interface knob, and press ENTER on the interface selector. You will see RANDOM next to FOLDER on the screen and F-RDM in the audio display. To turn this feature off, press and hold the RDM button until you hear a beep, or highlight FOLDER RANDOM (if not already highlighted), and press ENTER on the interface selector again.

Removing Discs from the Changer

To remove the disc that is currently playing, press the eject button. You will see “EJECT” in the audio display. When you remove the disc from the slot, the system begins the load sequence so you can load another disc. If you do not load another disc, the load sequence is canceled, and the system continues playing in the previous mode.

If you do not remove the disc from the slot, the system will reload the disc after 10 seconds.

To remove a different disc from the changer, first select it by pressing the corresponding number on the preset button or turning the interface knob, and pressing ENTER on the interface selector. When that disc begins playing, press the eject button.

When you press the eject button while listening to the radio, or with the audio system turned off, the disc that was last selected is ejected. After that disc is ejected, pressing the eject button again will eject the next disc in numerical order. By doing this six times, you can remove all the discs from the changer.

You can also eject discs when the ignition switch is off:
To eject one disc, press and release the eject button.
To eject all discs, press and hold the eject button.

Disc Changer Error Messages

The chart on the right explains the error messages you may see in the display while playing a disc.

If you see an error message in the display while playing a disc, press the eject button. After ejecting the disc, check it for damage or deformation. If there is no damage, insert the disc again.

For additional information on damaged discs, see page [286](#).

The audio system will try to play the disc. If there is still a problem, the error message will reappear. Press the eject button, and pull out the disc. Insert a different disc. If the new disc plays, there is a problem with the first disc. If the error message cycle repeats and you cannot clear it, take your vehicle to a dealer.

Error Message	Cause	Solution
HEAT ERROR	High Temperature	Will disappear when the temperature returns to normal.
UNSUPPORTED	Track/File format not supported	Current track will be skipped. The next supported track or file plays automatically.
BAD DISC PLEASE CHECK OWNER'S MANUAL PUSH EJECT	Mechanical Error	Press the EJECT button and pull out the disc(s). Check the disc for serious damage, signs of deformation, excessive scratches, and/or dirt (see page 286). Insert the disc again. If the code does not disappear, or the disc(s) cannot be removed, consult your dealer. Do not try to force the disc out of the player.
BAD DISC PLEASE CHECK OWNER'S MANUAL	Servo Error	

General Information

- When using CD-R or CD-RW discs, use only high quality discs labeled for audio use.
- When recording a CD-R or CD-RW, the recording must be closed for it to be used by the disc changer.
- Play only standard, round, 5-inch (12 cm) discs. Smaller or odd-shaped discs may jam in the drive or cause other problems.
- Handle your discs properly to prevent damage and skipping.

NOTICE

Do not use discs with adhesive labels. The label can curl up and cause the disc to jam in the unit.

Protecting Discs

When a disc is not being played, store it in its case to protect it from dust and other contamination. To prevent warpage, keep discs out of direct sunlight and extreme heat.

To clean a disc, use a clean soft cloth. Wipe across the disc from the center to the outside edge.

A new disc may be rough on the inner and outer edges. The small plastic pieces causing this roughness can flake off and fall on the recording surface of the disc, causing skipping or other problems. Remove these pieces by rubbing the inner and outer edges with the side of a pencil or pen.

Never try to insert foreign objects in the disc changer.

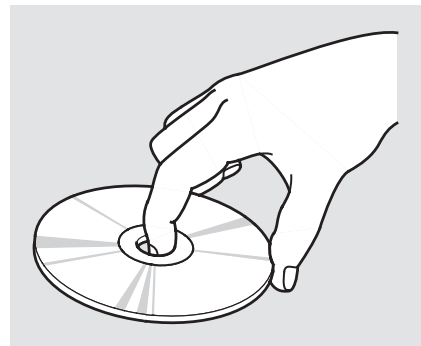

Handle a disc by its edges; never touch either surface. Do not place stabilizer rings or labels on the disc. These, along with contamination from finger prints, liquids, and felt-tip pens, can cause the disc to not play properly, or possibly jam in the drive.

Protecting Your Discs

Additional Information on Recommended Discs

The in-dash disc player/changer has a sophisticated and delicate mechanism. If you insert a damaged disc as indicated in this section, it may become stuck inside and damage the audio unit.

Examples of these discs are shown to the right:

1. Bubbled, wrinkled, labeled, and excessively thick discs

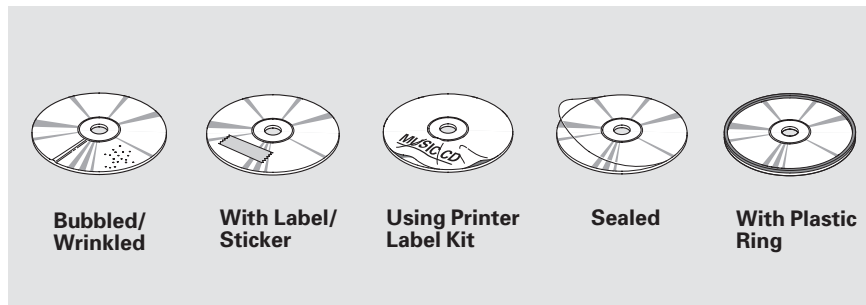

2. Damaged discs

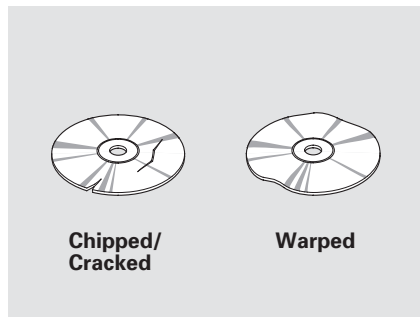

3. Poor quality discs

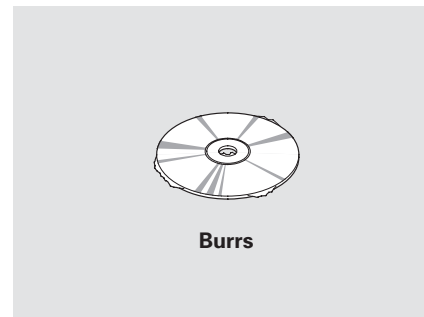

4. Small, irregular shaped discs

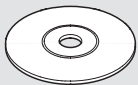

3-inch (8-cm) CD

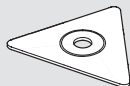

Triangle Shape

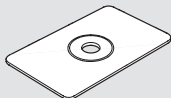

Can Shape

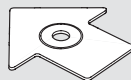

Arrow Shape

5. Discs with scratches, dirty discs

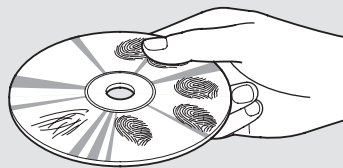

Fingerprints, scratches, etc.

- CD-R or CD-RW may not play due to the recording conditions.
- Scratches and fingerprints on the discs may cause the sound to skip.

- Recommended discs are printed with the following logo. For the rear entertainment system, see page [344](#).



- Audio unit may not play the following formats.



- This audio unit cannot play a Dual-disc®.

Playing an iPod® (Models with navigation system)

With rear entertainment system

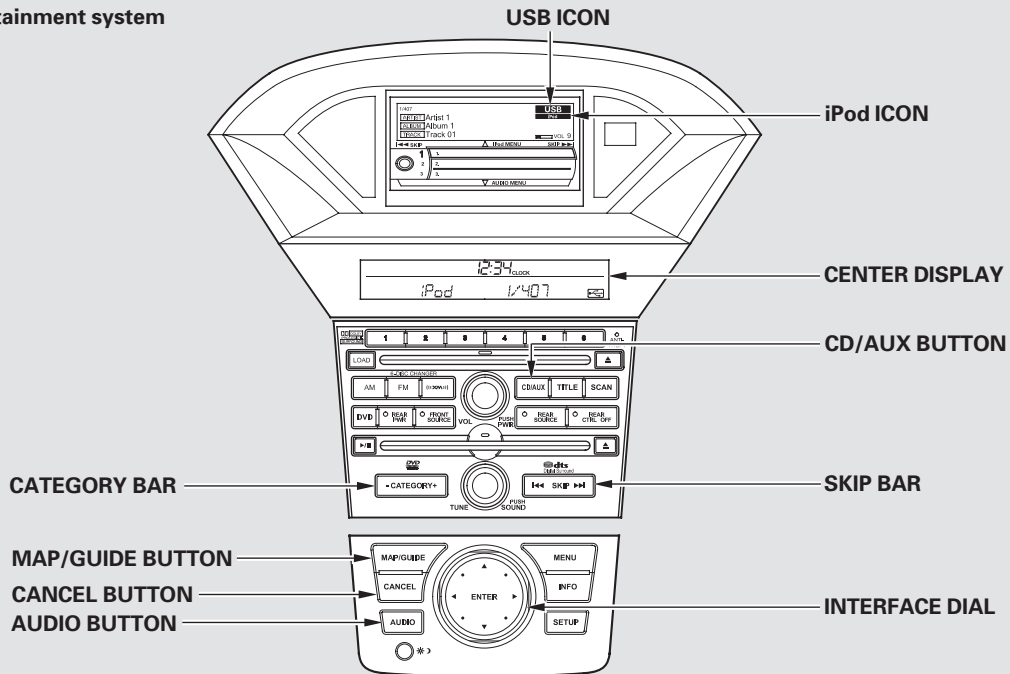

Playing an iPod® (Models with navigation system)

To Play an iPod®

This audio system can operate the audio files on the iPod® with the same controls used for the in-dash disc changer. To play an iPod, connect it to the USB adapter cable in the console compartment by using your dock connector, then press the AUX button. The ignition switch must be in the ACCESSORY (I) or ON (II) position. The iPod will also be recharged with the ignition switch in these positions.

The system will only play songs stored on the iPod with iTunes.

iPod and iTunes are registered trademarks owned by Apple Inc.

Voice Control System

You can select the AUX mode by using the navigation system voice control buttons, but cannot operate the play mode functions.

iPods compatible with your audio system using the USB adapter cable are:

Model	Software
iPod Classic 5 th Gen. (2005 or later)	Ver. 1.2 or more
iPod Classic (2007 or later)	Ver. 1.0 or more
iPod nano	Ver. 1.2 or more
iPod nano 2 nd generation	Ver. 1.1.2 or more
iPod nano 3 rd generation	Ver. 1.0 or more
iPod touch	Ver. 1.1.1 or more
iPhone	Ver. 1.1.1 or more

Use only compatible iPods with the latest software. iPods that are not compatible will not work in this audio unit.

CONTINUED

Playing an iPod® (Models with navigation system)

NOTE:

- Do not connect your iPod using a hub.
- Do not keep the iPod in the vehicle. Direct sunlight and high heat will damage it.
- Do not use an extension cable between the USB adapter cable equipped with your vehicle and your dock connector.
- We recommend backing up your data before playing it.

In AAC format, DRM (digital rights management) files cannot be played. If the system finds a DRM file, the audio unit displays UNPLAYABLE, and then skips to the next file.

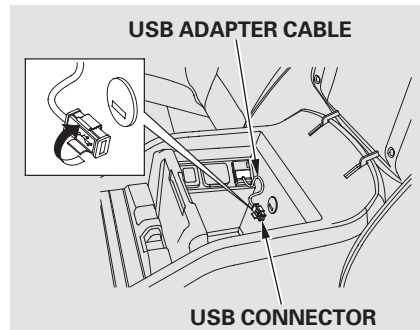
Connecting an iPod

1. Unclip the USB connector by pivoting it, and pull out the USB adapter cable in the console compartment.

Playing an iPod® (Models with navigation system)

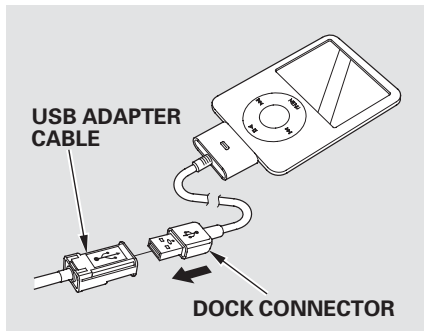

2. Connect your dock connector to the iPod correctly and securely.
3. Install the dock connector to the USB adapter cable securely.

If the iPod indicator does not appear in the audio display, check the connections, and try to reconnect the iPod a few times.

If the audio system still does not recognize the iPod, the iPod may need to be reset. Follow the instructions that came with your iPod, or you can find reset instructions online at www.apple.com/itunes/

The current file number and total of the selected playable files are displayed in the center display. Pressing the AUDIO button displays the artist, album and track (file) names on the navigation screen.

CONTINUED

Playing an iPod® (Models with navigation system)

To Change or Select Files

Use the SKIP bar or button while an iPod is playing to select passages and change files.

SKIP — Each time you press and release the ►►| side of the SKIP bar or button, the system skips forward to the beginning of the next file. Press and release the |◄◄ side of the bar or button, to skip backward to the beginning of the current file. Press it again to skip to the beginning of the previous file.

To move rapidly within a file, press and hold either side (►►| or |◄◄) of the SKIP bar or button.

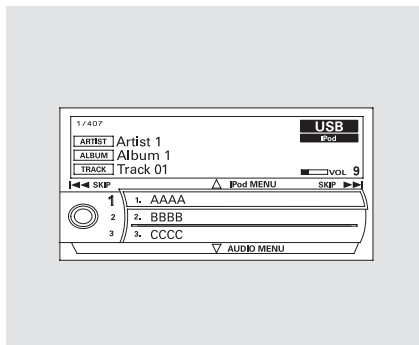

You can also change files with the interface dial. Press the AUDIO button to show the audio control display on the navigation screen. Push the selector to the right side to skip forward and to the left side to skip backward.

To Select a File from iPod Menu

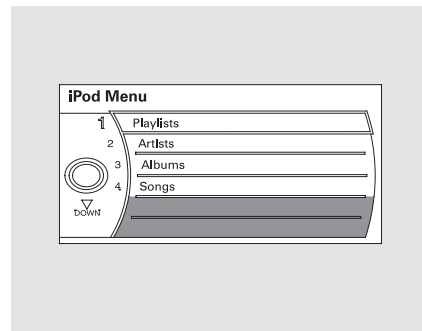

You can also select a file from any of the iPod menus: playlists, artists, albums and songs, by using the interface dial. Press the AUDIO button to display the audio control display on the navigation screen. Push up the interface selector to display the iPod menu. Turn the knob on the interface dial to select a desired list.

Playing an iPod® (Models with navigation system)

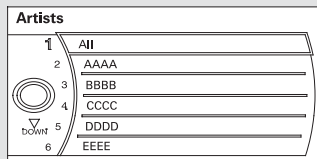

Push ENTER on the selector to display the items on that list, then turn the knob on the interface dial to select a desired list. Pushing the selector up or down moves a selection to the top or bottom of the screen items. Press ENTER to set your selection.

If you select “ALL” on either the artists or albums list, all available files on the selected list are played.

Press the AUDIO button to go back to the normal audio playing display. Pressing the CANCEL button goes back to the previous screen, and pressing the MAP/GUIDE button cancels the audio control display on the screen.

To Select Repeat or Random Mode:

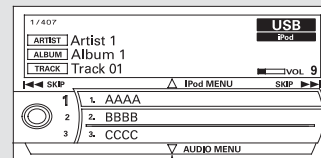

Push down the selector.

You can select any type of repeat and random mode on the audio menu. Press the AUDIO button to display the audio control screen, then push down the selector to display the audio menu. Turn the knob on the interface dial to select an audio mode: repeat, album random, and track random. Press ENTER to set your selection.

CONTINUED

Playing an iPod® (Models with navigation system)

To cancel the selected mode, press ENTER again while the highlighted mode is selected on the audio control display.

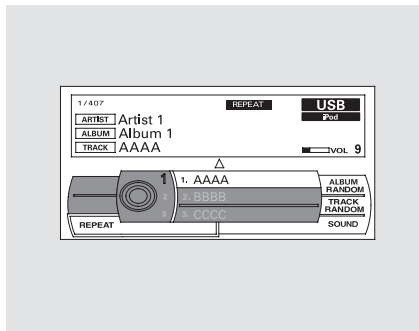

REPEAT – This feature continuously plays a file. To turn it off, press ENTER again.

Pressing either side of the SKIP bar or button changes the file while keeping the repeat feature.

TRACK RANDOM – This feature plays all available files from the selected items in the iPod menu list (playlists, artists, albums or songs) in random order. You will see TRACK RANDOM on the screen.

To turn it off, have this mode highlighted and press ENTER again.

Playing an iPod® (Models with navigation system)

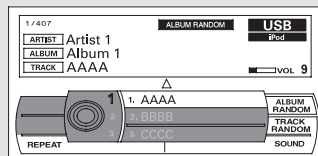

ALBUM RANDOM — This feature plays all available albums from the selected items in the iPod menu list (playlists, artists, albums or songs) in random order. The files in each album are played in the recorded order. You will see ALBUM RANDOM on the screen.

To turn it off, have this mode highlighted and press ENTER again.

You can also select another list from the iPod menu while keeping the random function.

NOTE:

Available operating functions vary on models or versions. Some functions may not be available on the vehicle's audio system.

To Stop Playing Your iPod

To play the radio, press the AM, FM, or XM button. Press the CD or CD/AUX button to switch to the disc mode (if a disc is loaded).

CONTINUED

Playing an iPod® (Models with navigation system)

Disconnecting an iPod

You can disconnect the iPod at any time when you see “OK to disconnect” message* in the iPod display. Always make sure you see “OK to disconnect” message in the iPod display before you disconnect it. Make sure to follow the iPod’s instructions on how to disconnect the dock connector from the USB adapter cable.

* : The displayed message may vary on models or versions. On some models, there is no message to disconnect.

When you disconnect the iPod while it is playing, the center display and the audio screen (if selected) show NO DATA.

If you reconnect the same iPod, the system may begin playing where it left off, depending on what mode the iPod is in when it is reconnected.

iPod® Error Messages

If you see an error message in the center display, see page [297](#).

iPod® Error Messages (Models with navigation system)

If you see an error message in the center display while playing an iPod, find the solution in the chart to the right. If you cannot clear the error message, take your vehicle to your dealer.

Error Message	Solution
FILE ERROR	The system cannot read the file(s). Check the files in the iPod. There is a possibility that the files have been damaged.
MEDIA ERROR	Appears when an unsupported iPod is connected.

Playing a USB Flash Memory Device (Models with navigation system)

With rear entertainment system

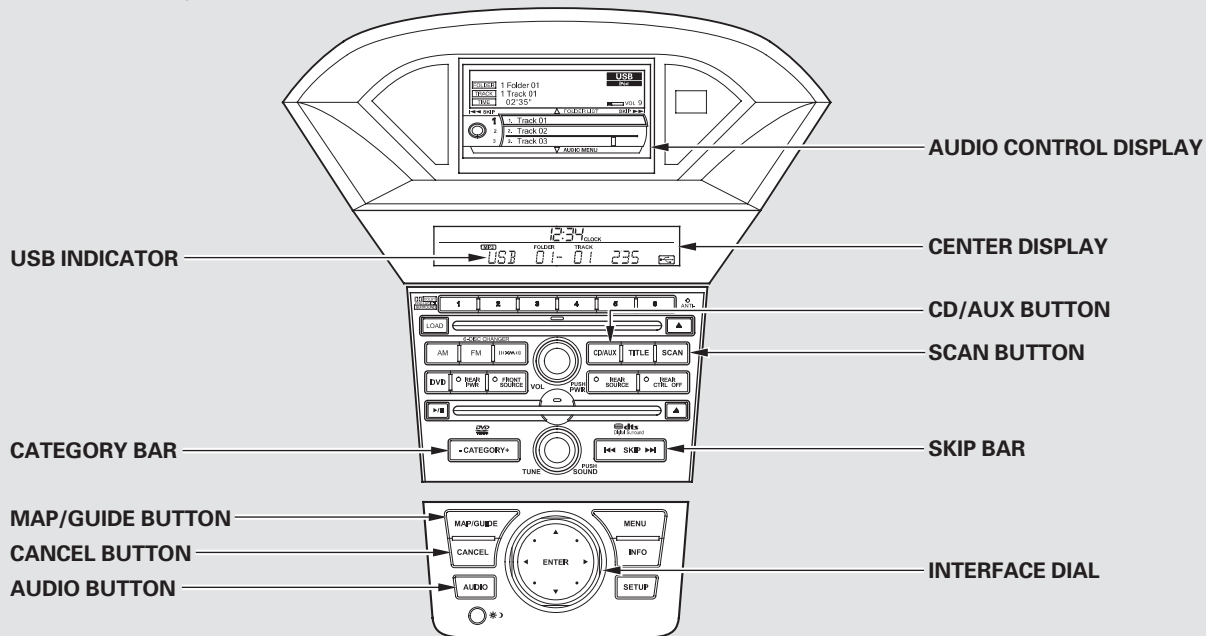

Playing a USB Flash Memory Device (Models with navigation system)

To Play a USB Flash Memory Device

This audio system can operate the audio files on a USB flash memory device with the same controls used for the in-dash disc changer. To play a USB flash memory device, connect it to the USB adapter cable in the console compartment, then press the AUX button. The ignition switch must be in the ACCESSORY (I) or ON (II) position.

The audio system reads and plays the audio files on the USB flash memory device in MP3, WMA or AAC* formats. Depending on the format, the display shows MP3, WMA or AAC when a USB flash memory device is playing. The USB flash memory device limit is up to 700 folders or up to 65535 files.

* : Only AAC format files recorded with iTunes are playable on this audio unit.

The recommended USB flash memory devices are 256 MB or higher, and formatted with the FAT file system. Some digital audio players may be compatible as well. Some USB flash memory devices (such as devices with security lock-out features, etc.) will not work in this audio unit.

NOTE:

- Do not use a device such as a card reader or hard drive as the device or your files may be damaged.
- Do not connect your USB flash memory device using a hub.
- Do not use an extension cable to the USB adapter cable equipped with your vehicle.

- Do not keep a USB flash memory device in the vehicle. Direct sunlight and high heat will damage it.
- We recommend backing up your data before playing a USB flash memory device.
- Depending on the type and number of files, it may take some time before they begin to play.
- Depending on the software the files were made with, it may not be possible to play some files, or display some text data.

Voice Control System

You can select the AUX mode by using the navigation system voice control buttons, but cannot operate the play mode functions.

CONTINUED

Playing a USB Flash Memory Device (Models with navigation system)

The specifications for compatible MP3 files are:

- Sampling frequency:
32/44.1/48 kHz (MPEG1)
16/22.05/24 kHz (MPEG2)
- Bitrate:
32/40/48/56/64/80/96/112/128/
160/192/224/256/320/VBR kbps
(MPEG1)
- Supported standards:
MPEG1 Audio Layer3
MPEG2 Audio Layer3
- Partition:
Top partition only
- Maximum layers: 8

The specifications for compatible WMA files are:

- Sampling frequency:
32/44.1/48 kHz
- Bitrate:
48 – 320/VBR kbps (Max 384)
- Supported standards:
WMA version 7/8/9

- Partition:
Top partition only
- Maximum layers: 8

The specifications for compatible AAC files are:

- Sampling frequency:
8/11.025/12/16/22.05/24/32/
44.1/48 kHz
- Bitrate:
48 – 320 kbps
- Supported standards:
MPEG4/AAC LC
MPEG2/AAC LC
- Partition:
Top partition only
- Maximum layers: 8

Some versions of MP3, WMA, or AAC format may not be supported. If an unsupported file is found, the audio unit displays UNSUPPORTED, then skips to the next file.

In WMA or AAC format, DRM (digital rights management) files cannot be played. If the system finds a DRM file, the audio unit displays UNPLAYABLE FILE, and then skips to the next file.

Playing a USB Flash Memory Device (Models with navigation system)

Connecting a USB Flash Memory Device

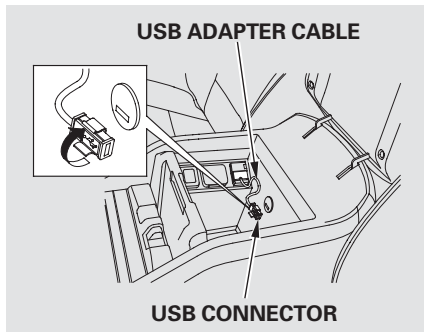

1. Unclip the USB connector by pivoting it, and pull out the USB adapter cable in the console compartment.

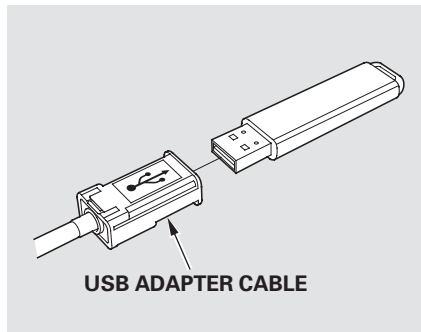

2. Connect the USB flash memory device to the USB adapter cable correctly and securely.

When the USB device is connected and the USB mode is selected on the audio system, the USB indicator is shown in the center display. It also shows the folder and file numbers. Pressing the AUDIO button displays the folder and file names, and the elapsed time in the navigation screen.

CONTINUED

Playing a USB Flash Memory Device (Models with navigation system)

To Change or Select Files

Use the SKIP bar or button while a USB flash memory device is playing to select passages and change files.

SKIP – Each time you press and release the ►►| side of the SKIP bar or button, the system skips forward to the beginning of the next file. Press and release the |◄◄ side of the bar or button, to skip backward to the beginning of the current file. Press it again to skip to the beginning of the previous file.

To move rapidly within a file, press and hold either side (►►| or |◄◄) of the SKIP bar or button.

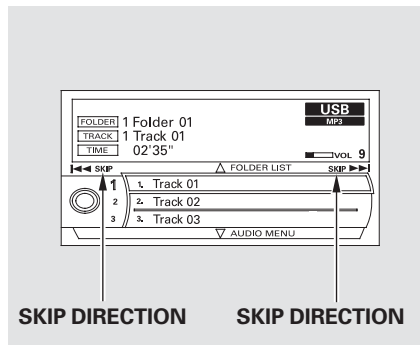

You can also change files with the interface dial. Press the AUDIO button to show the audio control display on the navigation screen. Push the selector knob to the right side to skip to the beginning of the next file, and to the left side to skip to the beginning of the current file. Pushing it to the left again skips to the beginning of the previous file.

Folder Selection – To select a different folder, press and release either side of the CATEGORY bar. Press the + side to skip to the next folder, and press the – side to skip to the beginning of the previous folder.

Playing a USB Flash Memory Device (Models with navigation system)

To Select a File from Folder and File Lists

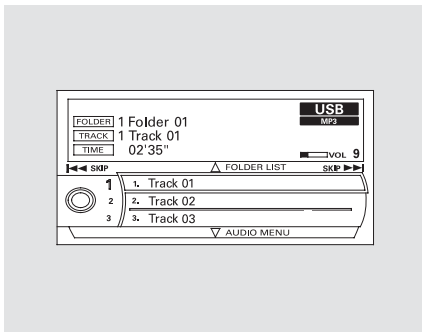

You can also select a folder or file from the list by using the interface dial. Press the AUDIO button to show the audio control display on the navigation screen.

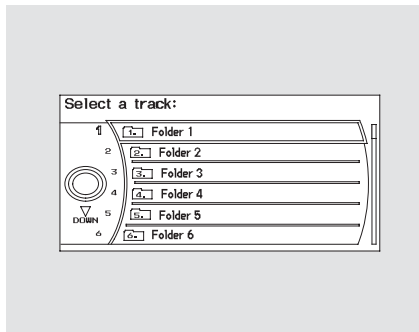

Push up the selector on the interface to switch the display to the folder list, then turn the knob on the interface dial to select a folder.

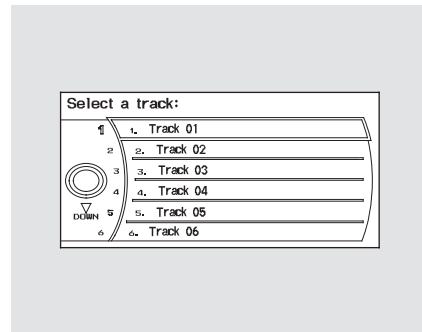

Press ENTER to change the display to the file list, then turn the knob on the interface dial to select a file. Press ENTER to set your selection. To go back to the normal play display, press the AUDIO button. Pressing the CANCEL button goes back to the previous screen and pressing the MAP/GUIDE button cancels the audio mode display.

CONTINUED

Playing a USB Flash Memory Device (Models with navigation system)

To Select Repeat, Random or Scan Mode:

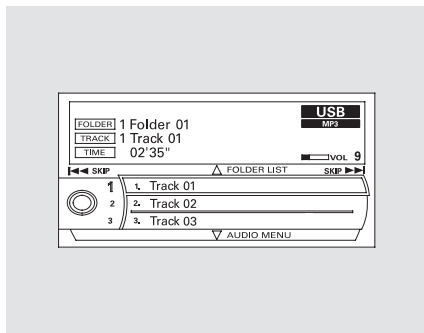

You can select any type of repeat, random and scan modes on the audio menu screen. Press the AUDIO button to show the audio control display on the navigation screen. Push down the selector on the interface dial to display the audio menu items.

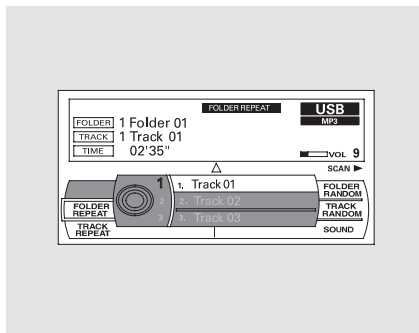

Turn the knob on the interface dial to select a play mode: folder random, track random, folder repeat, track repeat. Press ENTER to set your selection.

To cancel the selected mode, push down the selector to display the audio menu on the audio control display. Turn the knob on the interface dial to select the

highlighted play mode, then press ENTER to turn off that selected mode.

FOLDER REPEAT – This feature replays all the files in the selected folder in the order they are stored. Pressing either side of the CATEGORY bar also turns off this feature.

TRACK REPEAT – This feature continuously plays a file. Pressing either side of the SKIP bar or button also turns off this feature.

FOLDER RANDOM – This feature plays the files in the selected folder in random order.

TRACK RANDOM – This feature plays all the files in random order.

Playing a USB Flash Memory Device (Models with navigation system)

TRACK SCAN – This function samples all files in the selected folder in the order they are stored. To activate the scan feature, push the selector to the right. You will see TRACK SCAN on the screen. You will also see SCAN on the center display and the file number blinking. You will get a 10 second sampling of each file in the folder. Push the selector to the right repeatedly to get out of the scan mode. The system plays the last file sampled.

You can also select the scan feature with the SCAN button on the control panel. Press and release the SCAN button. Press and hold the SCAN button to get out of the scan mode and play the last file sampled.

FOLDER SCAN – This function samples the first file in each folder in the order they are stored. To activate the folder scan feature, push the selector to the right repeatedly. You will see FOLDER SCAN on the screen. You will also see SCAN on the center display and the folder number blinking. You will get a 10 second sampling of the first file in each folder. Push the selector to the right to get out of the scan mode. The system plays the last file sampled.

You can also select the folder scan feature with the SCAN button on the control panel. Press and release the SCAN button repeatedly. Press and hold the SCAN button to get out of the folder scan mode and play the last file sampled.

Pressing either side of the CATEGORY or SKIP bar or button also turns off the feature.

Playing a USB Flash Memory Device (Models with navigation system)

To Stop Playing a USB Flash Memory Device

To play the radio, press the AM, FM, or XM button. Press the CD or CD/AUX button to switch to the disc mode (if a disc is loaded).

If you reconnect the same USB flash memory device, the system will begin playing where it left off.

Disconnecting a USB Flash Memory Device

You can disconnect the USB flash memory device at any time even if the USB mode is selected on the audio system. Make sure to follow the USB flash memory device's instructions when you remove it.

When you disconnect the USB flash memory device while it is playing, the center display and the audio screen (if selected) show NO DATA.

USB Flash Memory Device Error Messages

If you see an error message in the center display, see page [307](#) .

USB Flash Memory Device Error Messages (Models with navigation system)

If you see an error message in the center display while playing a USB flash memory device, find the solution in the chart to the right. If you cannot clear the error message, take your vehicle to your dealer.

Error Message	Solution
FILE ERROR	The system cannot read the file(s). Check the files in the USB flash memory device. There is a possibility that the files have been damaged.
MEDIA ERROR	Appears when an unsupported USB flash memory device is connected.

FM/AM Radio Reception

Radio Frequencies

The radio can receive the complete AM and FM bands.

Those bands cover these frequencies:

AM band: 530 to 1,710 kHz

FM band: 87.7 to 107.9 MHz

Radio stations on the AM band are assigned frequencies at least 10 kHz apart (530, 540, 550). Stations on the FM band are assigned frequencies at least 0.2 MHz apart (87.9, 88.1, 88.3).

Stations must use these exact frequencies. It is fairly common for stations to round-off the frequency in their advertising, so your radio could display a frequency of 100.9 even though the announcer may identify the station as “FM101.”

Radio Reception

How well the radio receives stations is dependent on many factors, such as the distance from the station’s transmitter, nearby large objects, and atmospheric conditions.

A radio station’s signal gets weaker as you get farther away from its transmitter. If you are listening to an AM station, you will notice the sound volume becoming weaker, and the station drifting in and out. If you are listening to an FM station, you will see the stereo indicator flickering off and on as the signal weakens. Eventually, the stereo indicator will go off and the sound will fade completely as you get out of range of the station’s signal.

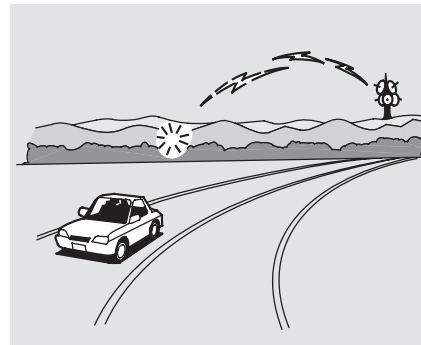

Driving very near the transmitter of a station that is broadcasting on a frequency close to the frequency of the station you are listening to can also affect your radio’s reception. You may temporarily hear both stations, or hear only the station you are close to.

FM/AM Radio Reception

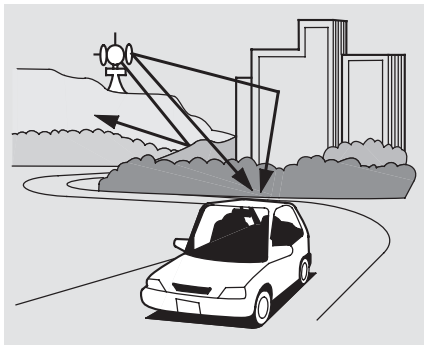

Radio signals, especially on the FM band, are deflected by large objects such as buildings and hills. Your radio then receives both the direct signal from the station's transmitter, and the deflected signal. This causes the sound to distort or flutter. This is a main cause of poor radio reception in city driving.



Radio reception can be affected by atmospheric conditions such as thunderstorms, high humidity, and even sunspots. You may be able to receive a distant radio station one day and not receive it the next day because of a change in conditions.

Electrical interference from passing vehicles and stationary sources can cause temporary reception problems.

*As required by the FCC:
Changes or modifications not expressly
approved by the party responsible for
compliance could void the user's
authority to operate the equipment.*

Auxiliary Input Jack

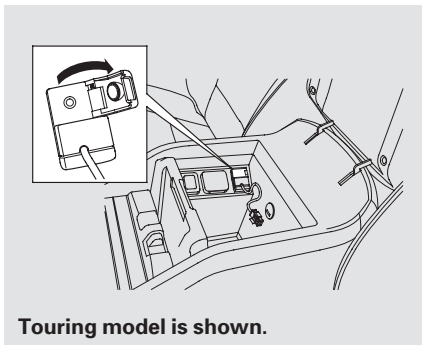

The auxiliary input jack is inside the front console compartment. The system will accept auxiliary input from standard audio accessories.

When a compatible audio unit is connected to the jack, press the AUX or CD/AUX button to select it.

On vehicles with rear entertainment system

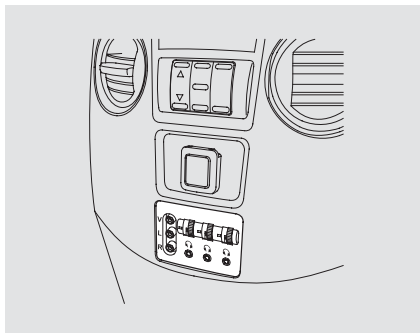

Auxiliary input jacks and headphone connectors for the rear entertainment system are on the back of the center console compartment.

For more information, see page [347](#).

Except LX models

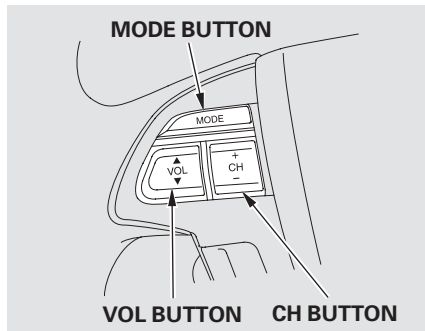

Three controls for the audio system are mounted in the steering wheel hub. These let you control basic functions without removing your hand from the wheel.

The VOL button adjusts the volume up (▲) or down (▼). Press the top or bottom of the button, hold it until the desired volume is reached, then release it.

The MODE button changes the mode.

On vehicles with navigation system
Pressing the MODE button repeatedly cycles through all possible media sources whether they are present or not.

On vehicles without navigation system
Pressing the MODE button repeatedly cycles through all present, connected media sources. Media sources that are not present or connected will not appear when cycling with the MODE button.

If you are listening to the radio, use the CH button to change stations. Each time you press the top (+) of the button, the system goes to the next preset station on the band you are listening to. Press the bottom (–) to go back to the previous station.

To search up and down from the current frequency and find a station with a strong signal, press the top (+) or bottom (–) of the button for 1 second.

If you are playing a disc, the system skips to the beginning of the next track each time you press the top (+) of the CH button. Press the bottom (–) to return to the beginning of the current track. Press it again to return to the previous track. You will see the disc and track numbers in the upper display.

CONTINUED

Remote Audio Controls

To go to the next disc, press the top (+) of the button for 1 second. Press the bottom (–) for 1 second to go back to the previous disc. When you play an MP3/WMA disc, press the top (+) of the button for 1 second to go to the next folder. Press the bottom (–) for 1 second to go back to the previous folder.

If you are listening to XM Radio, use the CH button to change channels. Each time you press the top (+) of the button, the system goes to the next preset channel. Press the bottom (–) to go back to the previous preset channel.

To go to the next channel of the category you are listening to, press the top (+) of the button for 1 second. Press the bottom (–) for 1 second to go back to the previous channel.

On vehicles with rear entertainment system

If you are playing a DVD video, use the channel button to change chapters. Each time you press the top (+) of the button, the system goes to the next chapter. Press the bottom (–) to return to the beginning of the current chapter. Press it again to return to the previous chapter.

On vehicles with navigation system

If you are playing a USB flash memory device or iPod with the USB adapter cable, press and release the top (+) of the CH button to skip forward to the beginning of the next file. Press the bottom (–) to skip backward to the beginning to the current file. Press it twice to return to the previous file.

Your vehicle's audio system may disable itself if it is disconnected from electrical power for any reason. To make it work again, you must enter a specific five-digit code with the preset buttons. Because there are hundreds of number combinations possible from the five digits, making the system work without knowing the exact code is nearly impossible.

You should have received a card that lists your audio system code number and serial number. It is best to store this card in a safe place at home. In addition, you should write the audio system's serial number in this owner's manual.

If you lose the card, you must obtain the code number from your dealer. To do this, you will need the audio system's serial number.

If your vehicle's battery is disconnected or goes dead, or the radio fuse is removed, the audio system will disable itself. If this happens, you will see "ENTER CODE" in the audio display the next time you turn on the system. Use the preset buttons to enter the five-digit code. The code is located on the radio code card included in your owner's manual kit. When it is entered correctly, the radio will start playing.

If you make a mistake entering the code, do not start over; complete the five-digit sequence, then enter the correct code. You have ten tries to enter the correct code. If you are unsuccessful in ten attempts, you must then leave the system on for 1 hour before trying again.

The system will retain your AM and FM presets even if power is disconnected.

Setting the Clock

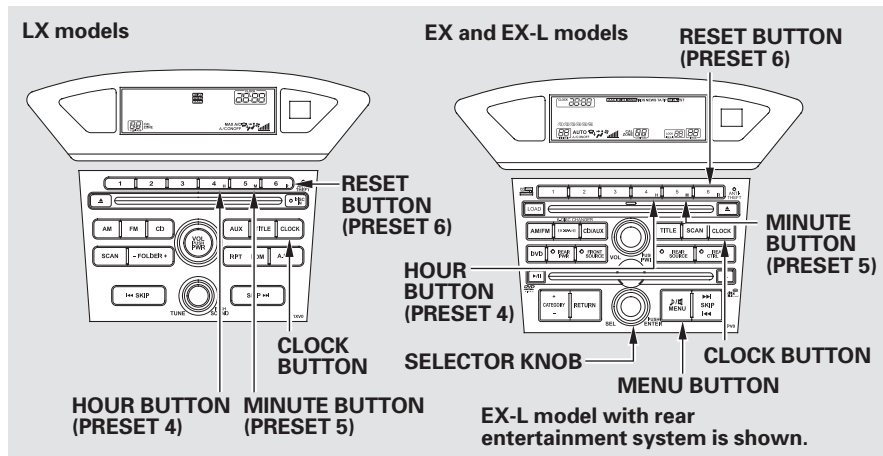

On vehicles without navigation system
If your vehicle's battery is disconnected or goes dead, you may need to set the clock.

To set the time, press the **CLOCK** button until you hear a beep. The displayed time begins to blink.

Change the hours by pressing the **H** (hour) button until the numbers advance to the desired time. Change the minutes by pressing the **M** (minute) button until the numbers advance to the desired time.

Press the **CLOCK** button again to enter the set time.

You can quickly set the time to the nearest hour. If the displayed time is before the half hour, press and hold the **CLOCK** button, then press the **R** (reset) button to set the time back to the previous hour. If the displayed time is after the half hour, the same procedure sets the time forward to the beginning of the next hour.

For example: 1:06 will reset to 1:00
1:52 will reset to 2:00

On vehicles with navigation system
The navigation system receives signals from the global positioning system (GPS), and the displayed time is updated automatically by the GPS. Refer to the navigation system manual for how to adjust the time.

On EX and EX-L models

Adjusting the Clock with MENU Button

You can also adjust the clock and switch the clock display between 24-hours and 12-hours in the menu mode.

To adjust the clock setting:

1. Press and release the MENU button. The display shows you the menu items.

You can adjust the clock setting with the ignition switch in the ACCESSORY (I) or ON (II) position.

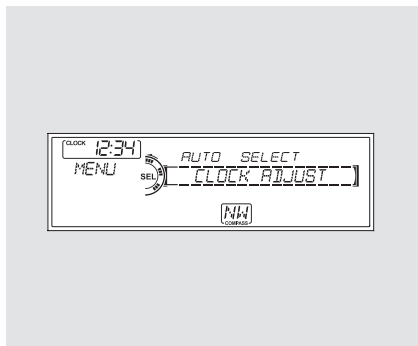

2. Turn the selector knob to select "CLOCK ADJUST."
3. Press the selector knob (ENTER) to enter your selection. The display changes to the clock adjusting display.

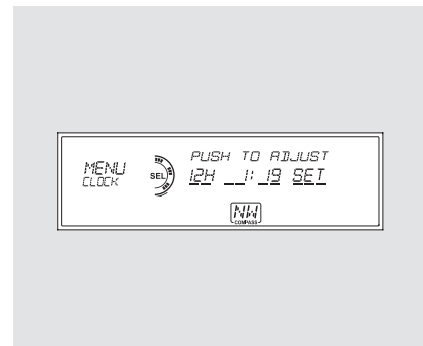

4. Turn the selector knob to select the item which you want to adjust. Turning the selector knob will change the selected item between the clock display setting, hours, minutes, and SET. The selected item is indicated with Δ in the display.

CONTINUED

Setting the Clock

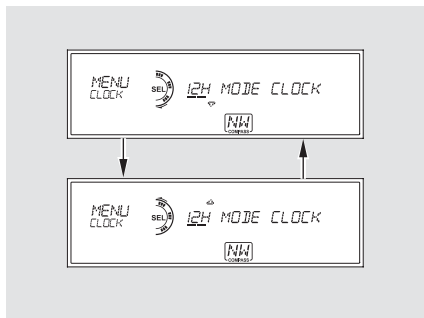

5. Turn the selector knob to change the setting between 12H and 24H.
6. Press the selector knob (ENTER) to enter your selection. The display will return to the clock adjusting display.

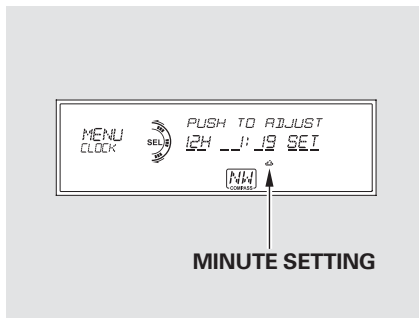

7. To set the time, turn the selector knob and select the hours or the minutes, then press the knob to enter your selection. The display changes to the setting display.
8. Turn the selector knob to count the numbers up or down.
9. Press the selector knob (ENTER) to enter your selection. The display will return to the clock adjusting display.

While setting the clock, pressing the RETURN button will go back to the previous display. Pressing the MENU button again will cancel this setting mode.

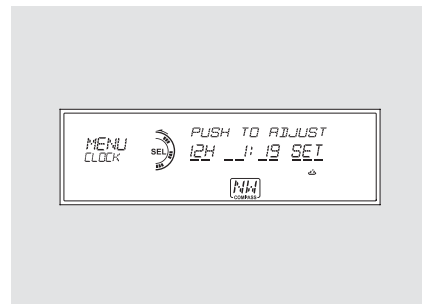

10. To enter the clock setting, turn the selector knob to select "SET," then press the knob. The display will return to the menu item display.
11. Press either the RETURN or MENU button to go back to the normal display.

On vehicles with rear entertainment system

Your vehicle is equipped with a rear entertainment system that includes a DVD player for the enjoyment of the rear passengers.

With this system, the rear passengers can enjoy a different entertainment source (radio, disc changer, DVD player, XM Radio, or optional CD changer/tape player) than the front seat occupants. The audio is broadcast through the supplied wireless headphones.

The ignition switch must be in the ACCESSORY (I) or the ON (II) position to operate the rear entertainment system.

To Turn On the System

Press the REAR PWR button. The indicator on the REAR PWR button will come on. The rear seat passengers can then operate the rear system from the control panel in the ceiling. The rear control panel can also be detached and used as a remote control, by pushing the RELEASE button, and pulling the remote toward you.

Pressing the REAR CTRL OFF button disables rear control. The indicator in the button comes on and your passengers can no longer operate the system with the rear control panel. When the button is pressed, the “CTRL OFF” message appears in the overhead screen to let your passengers know that the control panel is disabled. The rear system selects the source it was last set to. If that source has been removed (the DVD has been ejected from the player, for example),

you will see “DVD EJECT” in the display. You should select another source or insert a DVD.

Rear Speakers

When you turn on the system, the rear speakers are automatically turned off if the rear system selects a different entertainment source than the front system. You will see the Rear Speakers Off icon in the audio display. The sound for the rear system is sent to the wireless headphones.

If you want to turn the rear speakers on again, press and hold the REAR PWR button until the Rear Speakers Off icon goes off.

NOTE: The rear speakers are connected to the front system, so they will always play the source that the front system is set to.

CONTINUED

Rear Entertainment System

On vehicles with navigation system

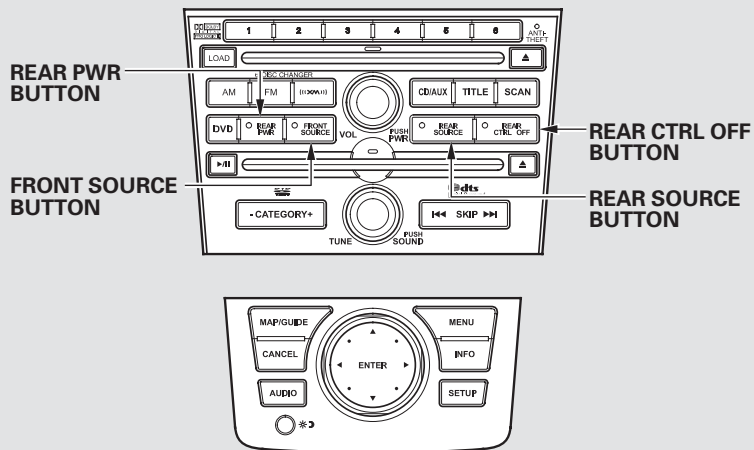

Overhead Screen Unit

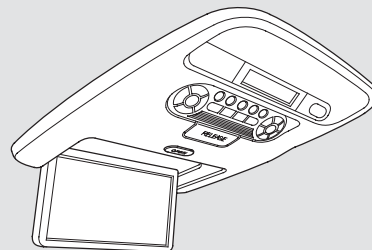

To Select Rear Entertainment from the Front Control Panel

To operate the rear entertainment system from the front panel, press the REAR SOURCE button. You will hear two beeps and the indicator in the button comes on to show that the control panel is enabled.

When REAR SOURCE is selected, the front entertainment system audio controls can also be used to operate the rear entertainment system in all modes.

The media that the rear passengers are listening to will then be heard from the front speakers.

If you do not operate the rear entertainment system from the front panel within 10 seconds, the indicator goes off and the FRONT SOURCE indicator comes on automatically.

To play the radio, the buttons for the front entertainment system have the same functions.

If an audio CD is loaded into the upper slot, select the CD/AUX button. If a DVD or CD is loaded into the lower slot, select the DVD button.

Operating the DVD Player from the Front Control Panel

The DVD player in your rear entertainment system can play DVD video discs, audio CDs, video CDs, MP3/WMA discs and DTS CDs.

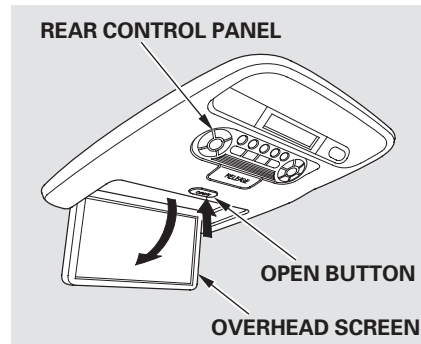

Open the overhead screen by pushing the OPEN button. The screen will swing down part-way. Pivot the screen the rest of the way. If you pivot the screen too far forward, past the second detent, the display will turn off. Pivot the screen back to the second or first detent to turn the display back on. To close the screen, pivot it up until it latches.

CONTINUED

Rear Entertainment System

On vehicles with navigation system

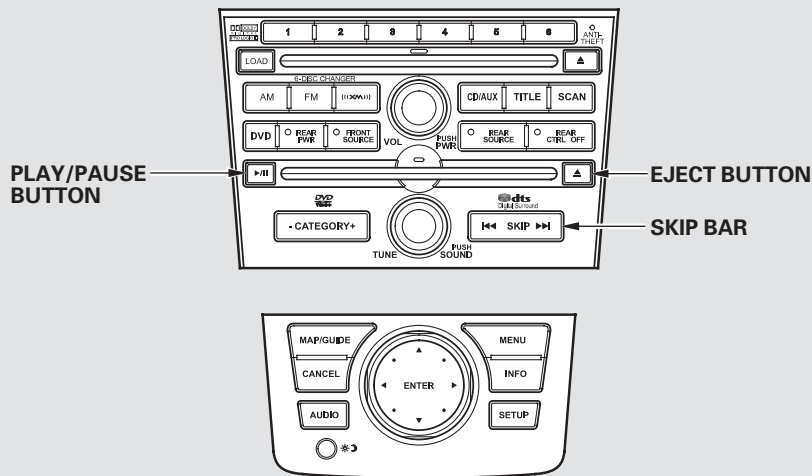

Insert a DVD into the lower DVD/CD slot in the audio unit.

Push the DVD in halfway, the drive will pull it in the rest of the way.

PLAY – Press the ►/|| button if the DVD does not start playing automatically.

PAUSE – Press the ►/|| button to pause the DVD. Press the button again or press PLAY to resume. Pause works only with the DVD player.

When the DVD menu is displayed, “DVD MENU” and “Push ►/|| to start” appears. Press ►/|| button to play the DVD.

SEEK/SKIP — Press and hold the ►► side of the SKIP bar to move forward; you will see the time elapsed shown in the overhead screen advances rapidly. Press and hold the ◀◀ side of the SKIP bar to move backward; you will see the time elapsed shown in the overhead screen decreases. Release the bar when the system reaches the point you want.

Each time you press the ►► side of the SKIP bar and release it, the system skips forward to the beginning of the next track or chapter. Press and release the ◀◀ side of the SKIP bar to skip backward to the beginning of the current track. Press and release it again to skip to the beginning of the previous track or chapter.

EJECT — Press the eject button to remove the DVD from the drive.

To Return to Front Audio Controls

To return front panel control to the front audio system, press the FRONT SOURCE button. You will hear a beep and the indicator in the button comes on. The indicator also comes on automatically when you do not operate the rear entertainment system for 10 seconds.

Using the Rear Control Panel

To turn on the rear entertainment system from the rear control panel, press the PWR button. Use the AM/FM button, XM button, CD button, or DVD/AUX button to select the entertainment source. The selected source will be shown in the display. Make sure the rear control operation has not been disabled with the REAR CTRL button on the front panel. When the audio system is off or the front side rear power is off, the rear control panel cannot be turned on.

Rear Entertainment System

To Play the Radio from the Rear Control Panel

Use the ▲, ▼, ◀, or ▶ button to highlight SEEK, TUNE, AUTO SELECT, SCAN, or one of the preset radio stations on the overhead screen. You can enter the highlighted function by pressing the ENT button. These functions have the same features as those of the front audio system. You can also use the ◀◀ or ▶▶ buttons to seek up/down and ▶▶ or ◀◀ to tune up/down.

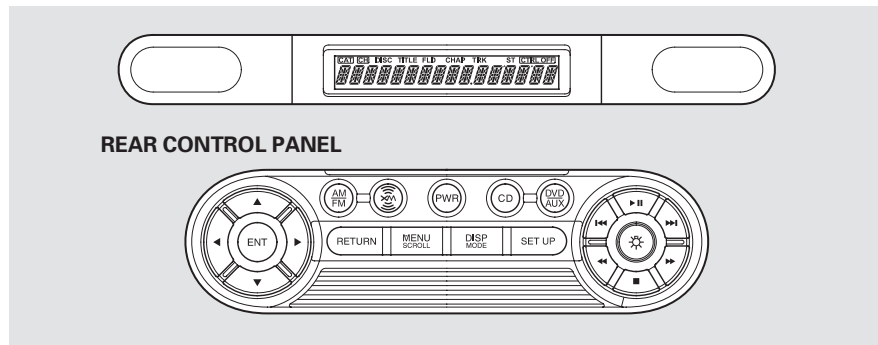

To Play the XM Radio from the Rear Control Panel

You can also use the ◀◀ or ▶▶ buttons to change categories up/down and ▶▶ or ◀◀ to change channels up/down within a category (in CATEGORY mode) or up/down for all channels (in CH mode).

Use the ▲, ▼, ◀, or ▶ button to highlight CATE (to change categories), CHAN (to change channels), MODE (to

change category or channel mode), SCAN, or one of the preset channels on the overhead screen. You can enter the highlighted function by pressing the ENT button. These functions have the same features as those of the front audio system.

While the overhead screen is closed, you can see the XM Radio information in the subsidiary display in the ceiling. Pressing the DISP MODE button repeatedly changes the subsidiary display from the channel number, to the category name, to the music title, to the artist name, and to the channel name, and then back to the channel number.

To change mode, press and hold the DISP MODE button for 5 seconds.

To Play a Disc in the 6-Disc Changer from the Rear Control Panel

If discs are loaded in the disc changer, select them by pressing the CD button.

Use the ▲, ▼, ◀, or ▶ button to highlight REPEAT, RANDOM, SCAN, ⏮, ⏭ (skip), ⏪, or ⏩ (cue) on the overhead screen. You can enter the highlighted function by pressing the ENT button. These functions have the same features as those of the front audio system.

To change the disc currently playing, use the ▲, ▼, ◀, or ▶ button to highlight your selected disc icon, and press ENT.

If CDs are loaded in the CD changer and the overhead screen is not open, pressing the ▲ or ▼ button changes the discs.

To Play an iPod® or USB Flash Memory Device from the Rear Control Panel

If an iPod® or USB flash memory device is connected to the USB adapter cable in the console compartment, you can select files to play.

For an iPod®, use the ▲, ▼, ◀, or ▶ button to highlight REPEAT, RANDOM, ⏮, ⏭ (skip), ⏪, or ⏩ (cue) on the overhead screen.

For a USB flash memory device, use the ▲, ▼, ◀, or ▶ button to highlight REPEAT, RANDOM, SCAN, ⏮, ⏭ (skip), ⏪, or ⏩ (cue) on the overhead screen.

Rear Entertainment System

To Play a DVD from the Rear Control Panel

The video screen is for use by rear seat passengers only. The driver and front seat passenger should not try to view the screen while driving.

Open the overhead screen by pushing the OPEN button. The screen will swing down part-way. Pivot the screen the rest of the way. If you pivot the screen too far forward, past the second detent, the display will turn off. Pivot the screen back to the second or first detent to turn the display back on. To close the screen, pivot it up until it latches.

Press the ►|| button when you want to pause the DVD. Press this button again to go back to PLAY.

Press the ►► button to skip to the beginning of the next chapter. Press the ◀◀ button to return to the beginning of the current chapter.

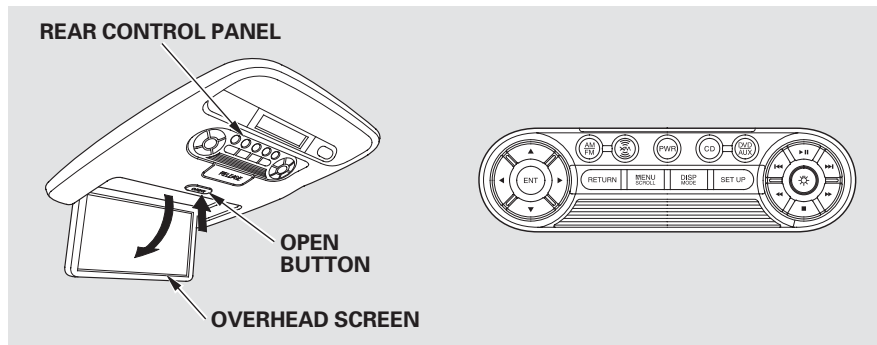

Press the ◀◀ button again quickly to go to the previous chapter.

To move rapidly within a chapter, press and hold the ►► or ◀◀ button. The system will continue to move through the chapter. Press the ►► button to move forward, or the ◀◀ button to move backward. Release the button when the system reaches the point you want.

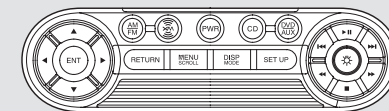

To select the menu on the DVD, press the MENU/SCROLL button. Use the ▲, ▼, ►, and ◀ buttons to move to the desired menu selection, then press the ENT button to enter your selection.

DISP MODE Button

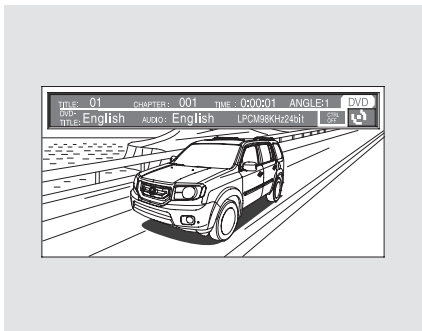

When you press the DISP MODE button while a DVD is playing, the current status of title, chapter, elapsed time, angle, subtitle, audio, and sound characteristics, with the personal surround logo are displayed. To return to the DVD video screen, press the DISP MODE button again.

MENU SCROLL Button

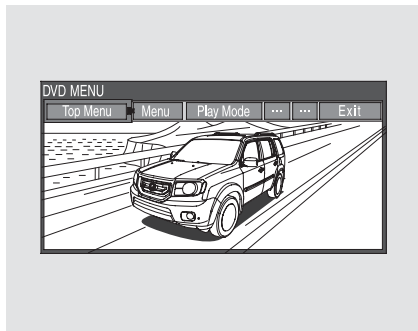

When you press the MENU SCROLL button while a DVD is playing, the DVD Menu appears. The menu options are TOP MENU, MENU, PLAY MODE, SEARCH, and NumInput.

To go to your selected menu, use the **▶** or **◀** button to highlight the icon and press the ENT button. To return to the DVD video screen, select EXIT.

Top Menu

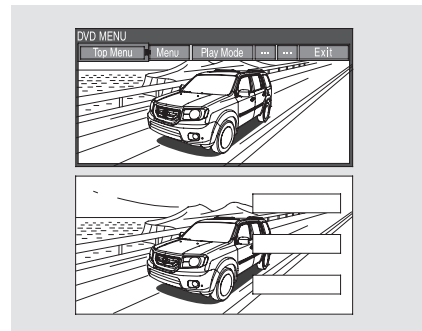

When you select "TOP MENU", the screen changes to the DVD's title menu. This menu also appears when you press the MENU SCROLL button while a DVD is not playing. To go back to play, press the RETURN button.

CONTINUED

Rear Entertainment System

Menu

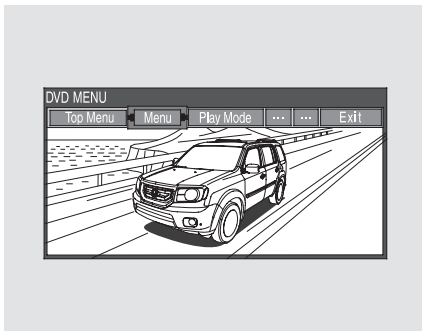

When you select “MENU” with the **▶** or **◀** button, the screen changes to the DVD’s title menu.

Play Mode

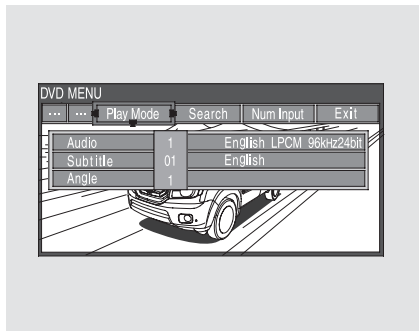

When you select “PLAY MODE” with the **▶** or **◀** button, you can change the DVD’s Audio, Subtitle or Angle setting.

“Audio”

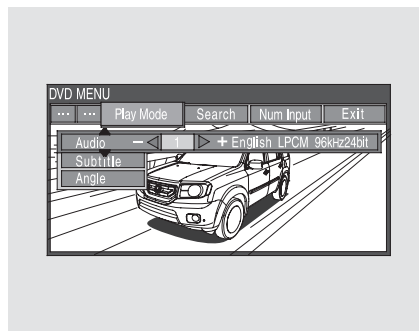

To change the Audio setting, highlight “Audio” from the play mode menu with the **▼** or **▲** button. A submenu of dubbed languages appears. You can select another language by pressing the **▶** or **◀** button. The sound characteristics (Dolby Digital, LPCM, MPEG Audio, dts) recorded with the selected language is also displayed next to the language.

The selectable languages vary from DVD to DVD, and this feature may not be available on some DVDs.

Press the RETURN button or cursor back with the ▼ or ▲ button to go back to the top of the Play Mode menu. Press the RETURN button again to exit completely.

“Subtitle”

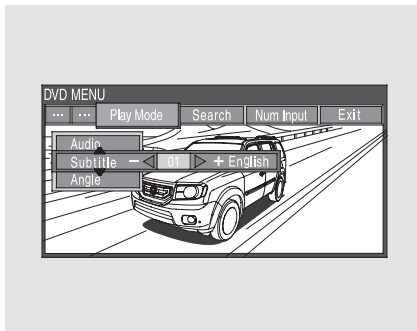

To change the DVD's subtitle, highlight "Subtitle" from the play mode menu with the ▼ or ▲ button. You can see the available subtitles with the ► or ◀ button.

After selecting your desired subtitle, press the RETURN button or cursor back with the ▼ or ▲ button to go back to the top of the Play Mode menu. Press the RETURN button again to exit completely.

CONTINUED

Rear Entertainment System

“Angle”

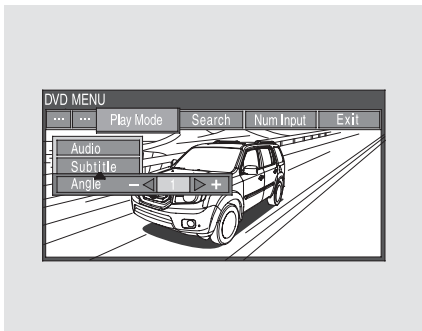

To change the view angle, highlight “Angle” from the play mode menu with the ▼ or ▲ button. You can see the available angle options with the ► or ◀ button.

If there are no multiple angles available on the DVD, you cannot change from “Angle 1”.

Press the RETURN button or cursor back with the ▼ or ▲ button to go back to the top of the Play Mode menu.

Press the RETURN button again to exit completely.

Search

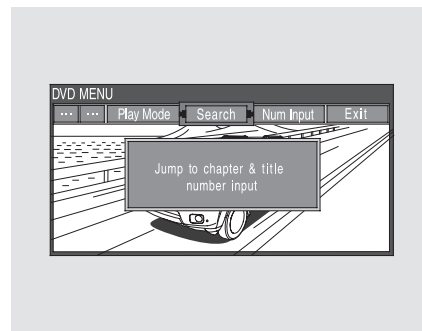

When you highlight “Search” with the ► or ◀ button, the “Jump to chapter and title number input” message appears. To select “Chapter” or “Title” search, press the ENT button.

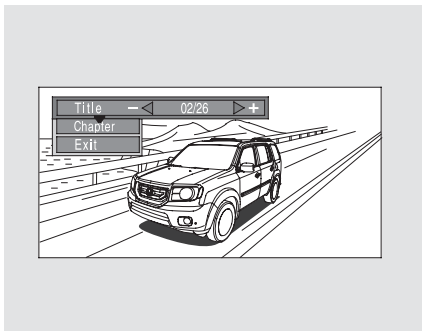
“Title/Chapter Search”

With “Title” highlighted, use the **▶** or **◀** button to jump to your desired title and press the ENT button. When “Chapter” is highlighted, follow the same procedure for the chapter search.

Num Input

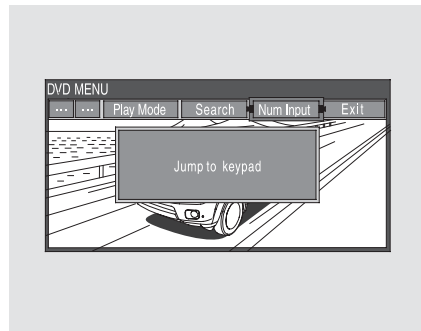

A numerical command can be issued to a DVD by inputting a two digit number, and a button number can be selected on the screen.

When you highlight, “NumInput” with the **▶** or **◀** button, the “Jump to keypad” message appears. Press the ENT button to go to the NumInput selection screen.

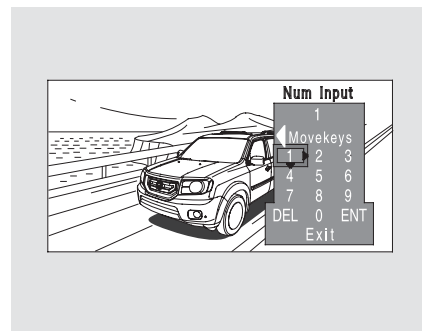

Select the first digit number using the **▼**, **▲**, **▶**, or **◀** button, and enter it by pressing the ENT button. If you want to change the number, select “DEL,” and press the ENT button, then select and enter the new number.

CONTINUED

Rear Entertainment System

Select and enter the second digit number the same way. The cursor will automatically move to the “ENT” icon when you press the ENT button. Press the ENT button to enter the number command. To go back to the DVD screen, press the RETURN button or select EXIT and press the ENT button.

SETUP Button

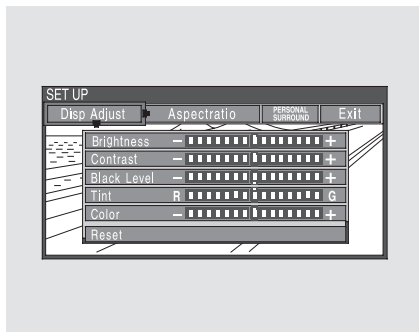

When you press the SETUP button while a DVD is playing, the setup menu appears. The menu options are DISP ADJUSTMENT, ASPECT RATIO, and PERSONAL SURROUND.

To change a setup, use the ► or ◀ button to highlight your selection and press the ENT button. To return to the DVD video screen, select EXIT.

Disp Adjust

To adjust the display, highlight “Disp Adjust” from the setup menu with the ▼ or ▲ button and press the ENT button. You can adjust these display settings:

- Brightness
- Contrast
- Black Level
- Tint
- Color



Select the quality you want to adjust by pressing the ▼ or ▲ button. Adjust the setting by pressing the ◀ or ▶ button. When you are finished with your adjustment, cursor back to the top of the setup menu, or press the RETURN button to exit.

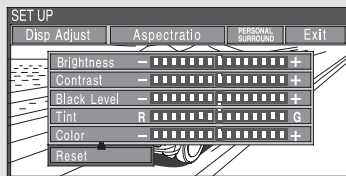

If you want to set the display to the default setting, select “Reset” by pressing the ▼ or ▲ button, then press the ENT button.

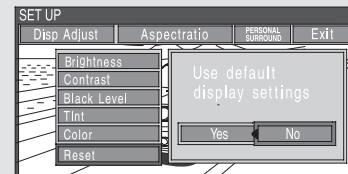

The display changes as shown above.

Select “Yes,” and press the ENT button. You will see the message “Default display settings applied” on the display for 5 seconds.

CONTINUED

Rear Entertainment System

Aspect Ratio

You can set the screen mode to these settings:

- Normal
- Wide
- Zoom
- Full

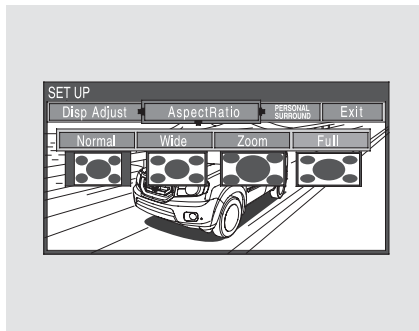

Select the “Aspect Ratio” by pressing the ► or ◀ button, then press the ENT button.

The selectable setting menu is displayed, and the current setting is highlighted in blue.

Select the desired setting by pressing the ► or ◀ button, then press the ENT button.

Personal Surround

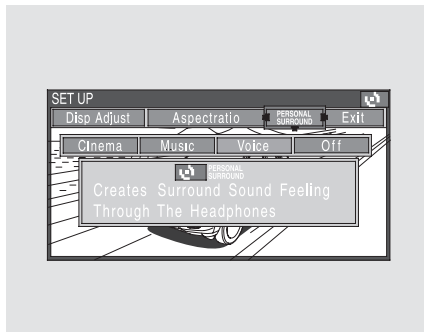

To change the Personal Surround setting, highlight "PERSONAL SURROUND" from the setup menu with the ▼ or ▲ button and press the ENT button. The effect selection appears.

Select "Cinema," "Music," or "Voice" by pressing the ► or ◀ button, and enter your selection by pressing the ENT button. The "PERSONAL SURROUND" logo is displayed in the upper right corner of the screen.

If you select "Off," the logo disappears, and there will be no special sound effect.

CONTINUED

Rear Entertainment System

INITIAL SETTINGS Menu

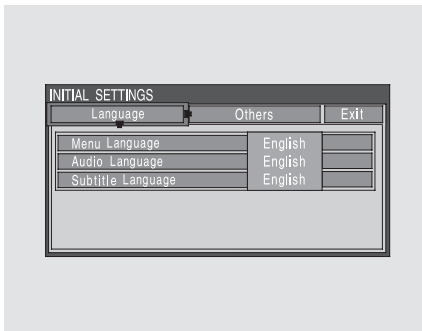

When you press the SETUP button on the rear control panel when a DVD is not playing, the “INITIAL SETTINGS” menu is displayed.

There are two selectable menus: “Language” and “Others.”

INITIAL SETTINGS (Language)



When you select “Language” with the ► or ◀ button, the menu shown above appears.

To return to the stop or prestop screen, select “Exit” using the ► or ◀ button, and then press the ENT, or the SETUP button.

Menu Language

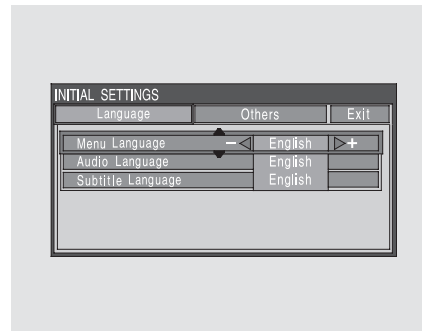

To select the language used in the DISC menus, select “Menu Language” by pressing the ▼ or ▲ button.

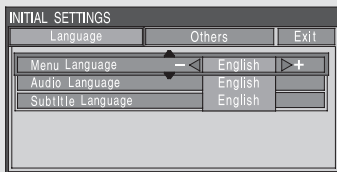

Select the desired language by pressing the ► or ◀ button.

The selectable languages are, English, French, Spanish, German, Italian, Dutch, Chinese, Korean, Thai, Japanese or others.

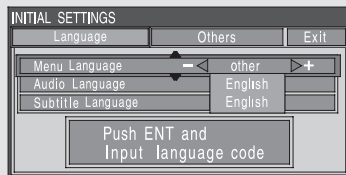

If you want another language than those listed, you need to enter the code number of the desired language. Select “other,” and press the ENT button. The display changes as shown in the next column.



If you select “No,” and press the ENT button, the display returns to the initial screen of the “Language” menu.

CONTINUED

Rear Entertainment System

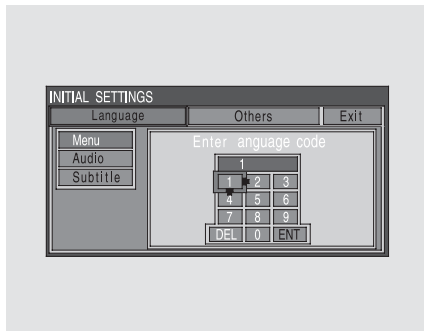

If you select “Yes,” the display changes to the language code input mode. Select the first number digit using the \blacktriangledown , \blacktriangle , \blacktriangleright , or \blacktriangleleft button, and press the ENT button to enter it. Repeat this until all four digits are filled. When the fourth digit is entered, the cursor automatically moves to “ENT” on the display. Press the ENT button on the control panel to enter the new language code.

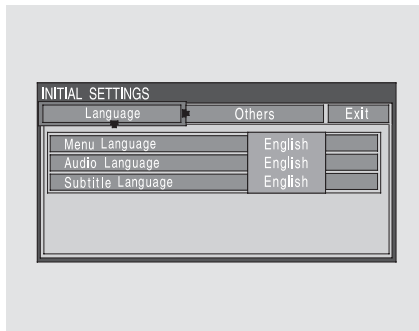

If you made a mistake entering a number digit, select “DEL” on the display with the \blacktriangledown , \blacktriangle , \blacktriangleright , or \blacktriangleleft button, and press the ENT button on the control panel. Then select and enter the correct number digit as described. The display returns to the initial “Language” menu screen.

Audio Language

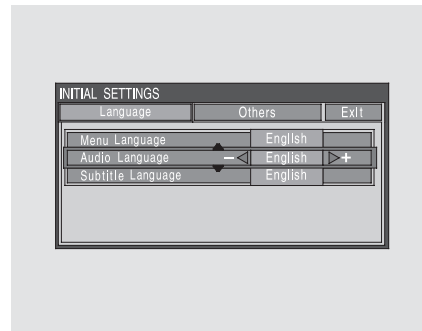

You can select the dubbed language before playing DVDs. Select “Audio Language” by pressing the \blacktriangledown or \blacktriangle button. You will see the submenu next to “Audio Language.”

Follow the same instructions you used to set the menu language.

Subtitle Language



You can select the subtitle language before playing DVDs. Select "Subtitle Language" by pressing the ▼ or ▲ button. You will see the submenu next to the "Subtitle Language."

Follow the same instructions you used to set the menu language.

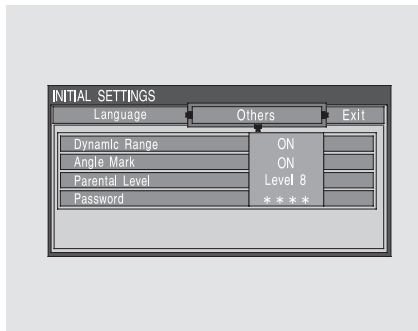
INITIAL SETTINGS (Others)

When you select "Others" at the top of the "INITIAL SETTINGS" screen, the above menu appears on the screen.

Dynamic Range
 "Dynamic Range" reduces the differences between the loud and quiet sound levels throughout the disc. When this is on, the louder sounds are lowered, and quieter sounds are increased.

CONTINUED

Rear Entertainment System

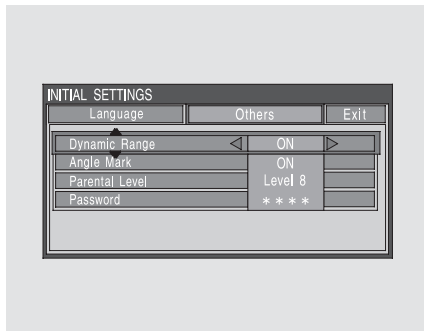

When you select the “Dynamic Range” by pressing the ▼ or ▲ button, you will see the submenu next to the “Dynamic Range” as shown above.

To turn “Dynamic Range” on or off, select “ON” or “OFF” by pressing the ► or ◀ button.

Angle Mark

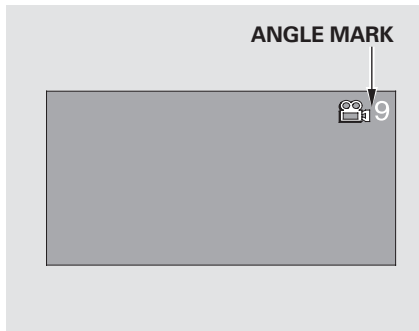

When you switch to another angle while playing a DVD, the angle mark is displayed in the upper right corner of the screen.

You can set the system to display or not display this angle mark.

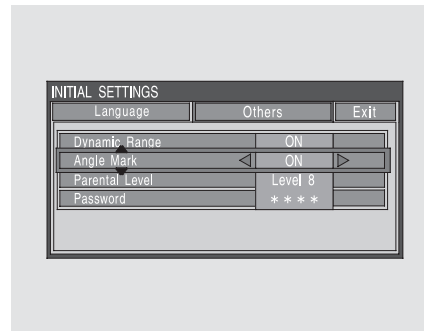

Select “Angle Mark” by pressing the ▼ or ▲ button. The above submenu appears. If you want the angle mark to be displayed, select “ON” with the ► or ◀ button.

Parental Level

You can place an auditory restriction by changing the parental control level. The higher the level number, the lower the restriction.

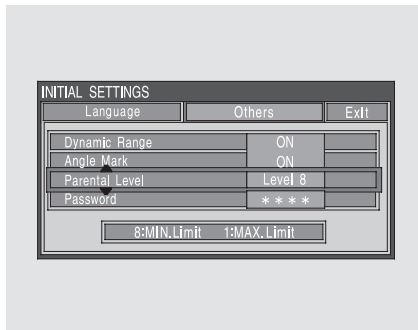

Highlight “Parental Level” and press ENT button. You will see the submenu. If you select “No” and press the ENT button, the screen goes back to the “Others” menu.

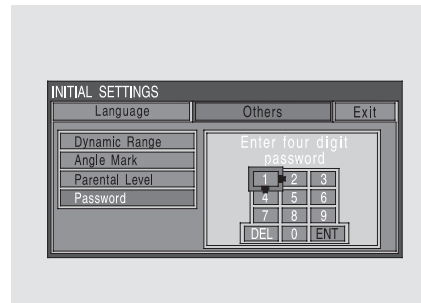

When you select and enter “Yes,” the display changes as shown above. To change the level, you need to enter your four digit password.

Select the number for the first digit by pressing the ▼, ▲, ►, or ◀ button, and enter it by pressing the ENT button. Repeat this until all four digits are filled. When you enter the fourth number, the cursor automatically moves to “ENT” on the display. Press the ENT button on the control panel.

CONTINUED

Rear Entertainment System



If the system does not recognize the password you entered, you will see the above display. Repeat the parental control level steps until you enter the correct password.

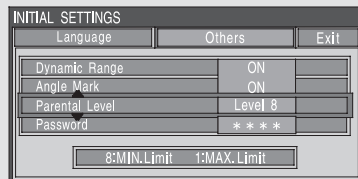

If you enter the password correctly, you can then change the parental control level.

Changing the Password

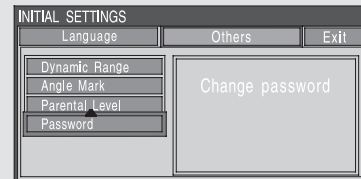

The password was set to “1111” when the vehicle left the factory.

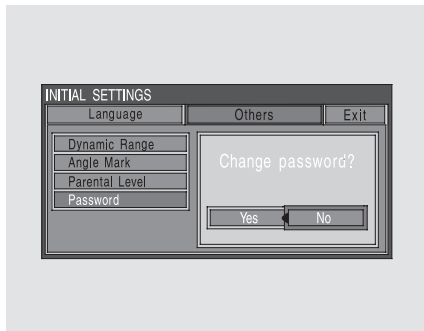

To change the password, select "Password." You will see the above menu displayed. Select "Yes" by pressing the **▶** or **◀** button, then press the ENT button.

If you select "No," and press the ENT button, the display returns to the "Others" menu.

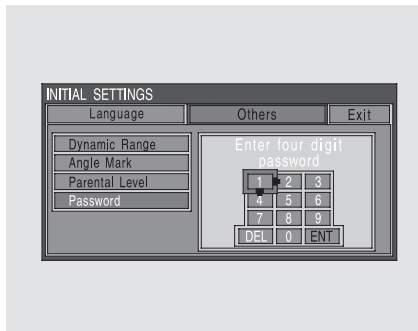

Select the first digit by pressing the **▼**, **▲**, **▶**, or **◀** button, and enter it by pressing the ENT button. Repeat this until all four digits are entered. When you enter the fourth number, the cursor automatically moves to "ENT" on the display. Press the ENT button on the control panel.

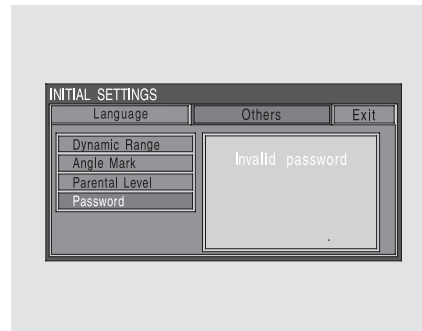

If the system does not recognize the password you entered, you will see the above display. Repeat the password setting steps until you enter the correct password.

CONTINUED

Rear Entertainment System

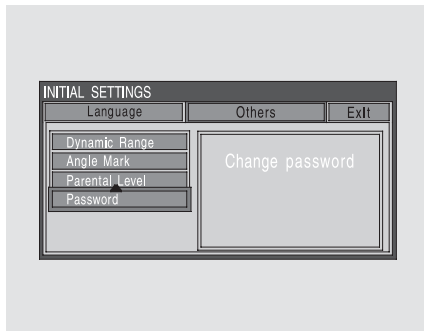

If you forget the password, select "Password," and press the ▲ button 10 times.

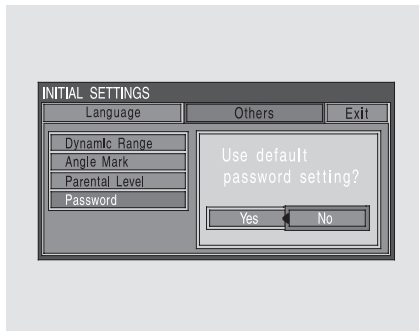

The display changes as shown above. If you want to use the default password (1111), select "Yes," and press the ENT button.

The message "Default password setting applied" is displayed for 5 seconds.

Remote Control



The rear control panel can be detached from the ceiling unit and used as a remote control. To remove it from the ceiling unit, press the release button. The control panel will swing down partway. Pivot it down further past the detent until it detaches from the hinge. To reinstall it, reverse the procedure.

Replacing the Remote Control Batteries

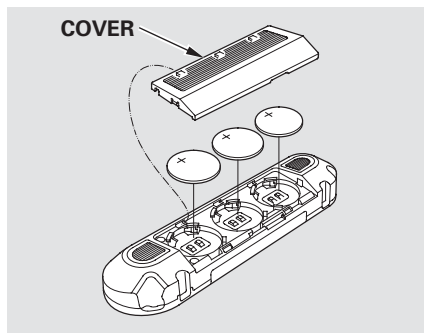

If it takes several pushes on the button to operate the rear entertainment system, have your dealer replace the batteries as soon as possible.

Battery type: BR3032

An improperly disposed of battery can hurt the environment. Always confirm local regulations for battery disposal.

*As required by the FCC:
This device complies with Part 15 of the FCC rules. Operation is subject to the following two conditions: (1) This device may not cause harmful interference, and (2) this device must accept any interference received, including interference that may cause undesired operation.*

Changes or modifications not expressly approved by the party responsible for compliance could void the user's authority to operate the equipment.

*This device complies with Industry Canada Standard RSS-210.
Operation is subject to the following two conditions: (1) this device may not cause interference, and (2) this device must accept any interference that may cause undesired operation of the device.*

Rear Entertainment System

Playable DVDs

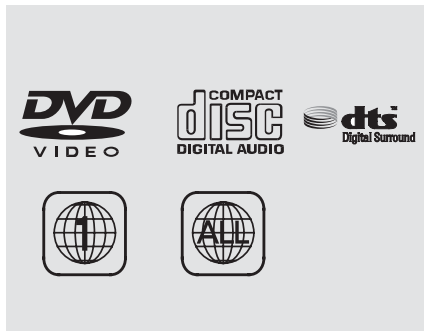

There are various types of DVDs available. Some of them are not compatible with your system.

The DVD player in your rear entertainment system can play DVDs and CDs bearing the above marks on their packages or jackets.

The DVD player can also play discs recorded in MP3/WMA formats and DTS CDs.

Those packages or jackets should also bear the designation of “1” or “ALL” region. DVD-ROMs cannot be played in this system.

This product incorporates copyright protection technology that is protected by U.S. patents and other intellectual property rights.

Use of this copyright protection technology must be authorized by Macrovision, and is intended for home and other limited viewing uses only unless otherwise authorized by Macrovision.

Manufactured under license under U.S. Patent # 's: 5,451,942; 5,956,674; 5,974,380; 5,978,762; 6,487,535 & other U.S. and worldwide patents issued & pending. DTS and DTS Digital Surround are registered trademarks and the DTS logos and Symbol are trademarks of DTS, Inc. © 1996-2008 DTS, Inc. All Rights Reserved.

Reverse engineering or disassembly is prohibited.

Protecting DVDs

The tips on how to handle and protect DVDs are basically the same as those for compact discs. Refer to “Protecting Your CDs” on page [285](#).

DVD Player Error Messages

The chart on the right explains the error messages you may see in the display while playing a disc.

If you see an error message in the display while playing a disc, press the eject button. After ejecting the disc, check it for damage or deformation. If there is no damage, insert the disc again.

The audio system will try to play the disc. If there is still a problem, the error message will reappear. Press the eject button, and pull out the disc.

Insert a different disc. If the new disc plays, there is a problem with the first disc. If the error message cycle repeats and you cannot clear it, take your vehicle to a dealer.

Error Message	Cause	Solution
CHECK DISC	FOCUS Error	Press the disc eject button, and remove the disc. Check for an error indication. Insert the disc again. If the code does not disappear or the disc cannot be removed, consult your dealer.
MECH ERROR	Mechanical Error	Press the disc eject button, and remove the disc. Check for an error indication. Insert the disc again. If the code does not disappear or the disc cannot be removed, consult your dealer.
HEAT ERROR	High Temperature	Will disappear when the temperature returns to normal.
REGION ERR	Invalid region code	The disc is not playable in this unit. Eject the disc, and insert a disc compatible with this system.
PARENTAL CHECK	Invalid parental control level	Reinsert the disc, and increase the parental control level (see page 339).

Rear Entertainment System

Wireless Headphones



Some state and local government agencies prohibit the use of headphones by the driver of a motor vehicle. Always obey applicable laws and regulations.

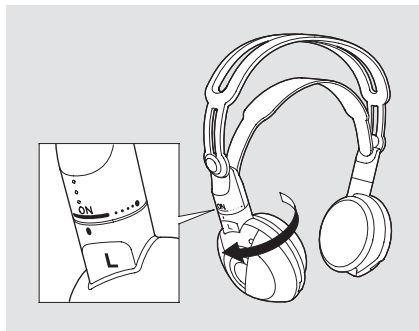

The audio for the rear entertainment system is sent to the wireless headphones that come with the system. When using the headphones, make sure you wear them correctly: L (left) and R (right) are marked on the sides of the frame. Wearing the headphones backwards may affect audio reception, limiting the sound quality and range.

To use the headphones, pivot the earpieces outward. This turns them on. To adjust the volume, turn the dial on the bottom of the right earpiece. When you remove the headphones, the earpieces automatically pivot inward, and the headphones turn off. When not in use, store the headphones in the pocket of either front seat, or the rear door lining pockets.

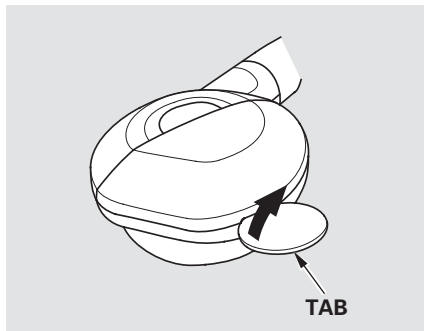
Replacing Batteries

Each headphone uses one AAA battery. The battery is under the cover on the left earpiece. To remove the cover, insert a coin in the slot and twist it slightly to pry the cover away from the earpiece. Pull the cover outward, and pivot it out of the way.

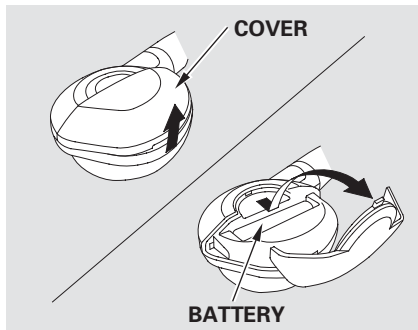

Remove the battery. Install the new battery in the earpiece as shown in the diagram next to the battery slot. Slide the cover back into place on the earpiece, then press down on the back edge to lock it in place.

An improperly disposed of battery can hurt the environment. Always confirm local regulations for battery disposal.

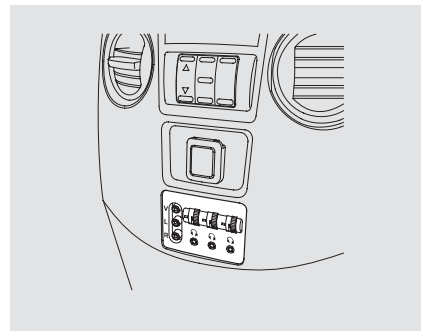
Auxiliary Input Jacks

Auxiliary input jacks and headphone connectors for the rear entertainment system are on the back of the center console compartment.

CONTINUED

Rear Entertainment System

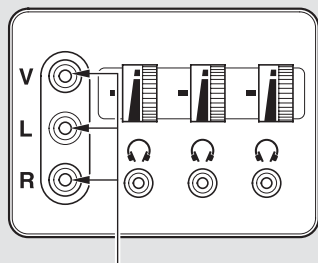

AUXILIARY INPUT JACKS

The system will accept auxiliary inputs from standard video games and video equipment.
Some video game power supplies may cause poor picture quality.

V = Video jack
L = Left audio jack
R = Right audio jack

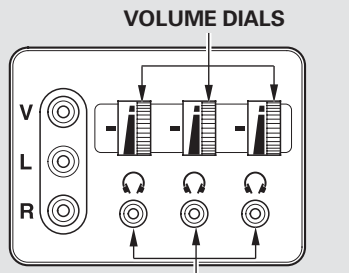

HEADPHONE CONNECTORS

There are three headphone connectors for the third seat passengers. Each connector has its own volume control.

Except LX models

The security system helps to protect your vehicle and valuables from theft. The horn sounds and a combination of headlights, parking lights, side marker lights and taillights flashes if someone attempts to break into your vehicle or remove the audio unit.

This alarm continues for two minutes, then the system resets. To reset an activated system before the two minutes have elapsed, unlock the driver's door with the key or the remote transmitter.

The security system automatically sets 15 seconds after you lock the doors, the hood, the tailgate, and the glass hatch. For the system to activate, you must lock the doors, the tailgate and the glass hatch from the outside with the key, driver's lock tab, door lock master switch, or remote transmitter. The security system indicator on the instrument panel starts blinking immediately to show you the system is setting itself.

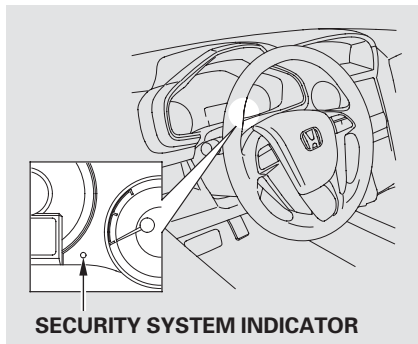

Once the security system is set, opening any door, the tailgate, the glass hatch, or the hood without using the key or the remote transmitter will cause the alarm to activate. It will also activate if the radio is removed from the dashboard or the wiring is cut.

The security system will not set if the hood, the tailgate, the glass hatch, or any door is not fully closed. If the system will not set, check that the doors, the tailgate and the hood are fully closed.

Do not attempt to alter this system or add other devices to it.

Cruise Control

Cruise control allows you to maintain a set speed above 25 mph (40 km/h) without keeping your foot on the accelerator pedal. It should be used for cruising on straight, open highways. It is not recommended for city driving, winding roads, slippery roads, heavy rain, or bad weather.

WARNING

Improper use of the cruise control can lead to a crash.

Use the cruise control only when traveling on open highways in good weather.

Using Cruise Control

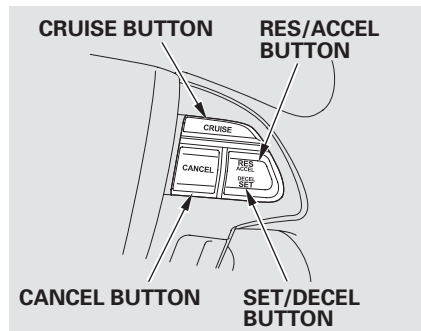

1. Push in the CRUISE button on the steering wheel. The CRUISE MAIN indicator on the instrument panel comes on.

The cruise control system can be left on, even when it is not in use.

2. Accelerate to the desired cruising speed above 25 mph (40 km/h).

3. Press and release the SET/DECEL button on the steering wheel. The CRUISE CONTROL indicator on the instrument panel comes on to show the system is now activated.

Cruise control may not hold the set speed when you are going up and down hills. If your vehicle speed increases going down a hill, use the brakes to slow down. This will cancel the cruise control. To resume the set speed, press the RES/ACCEL button. The CRUISE CONTROL indicator on the instrument panel will come back on.

Changing the Set Speed

You can increase the set cruising speed in any of these ways:

- Press and hold the RES/ACCEL button. When you reach the desired cruising speed, release the button.
- Push on the accelerator pedal. Accelerate to the desired cruising speed, then press the SET/DECEL button.
- To increase the speed in very small amounts, tap the RES/ACCEL button. Each time you do this, your vehicle will speed up about 1 mph (1.6 km/h).

You can decrease the set cruising speed in any of these ways:

NOTE: If you need to decrease your speed quickly, use the brakes as you normally would.

- Press and hold the SET/DECEL button. Release the button when you reach the desired speed.
- To slow down in very small amounts, tap the SET/DECEL button. Each time you do this, your vehicle will slow down about 1 mph (1.6 km/h).
- Tap the brake pedal lightly with your foot. The CRUISE CONTROL indicator on the instrument panel will go out. When the vehicle slows to the desired speed, press the SET/DECEL button.

CONTINUED

Cruise Control

Even with cruise control turned on, you can still use the accelerator pedal to speed up for passing. After completing the pass, take your foot off the accelerator pedal. The vehicle will return to the set cruising speed.

Resting your foot on the brake pedal causes cruise control to cancel.

Canceling Cruise Control

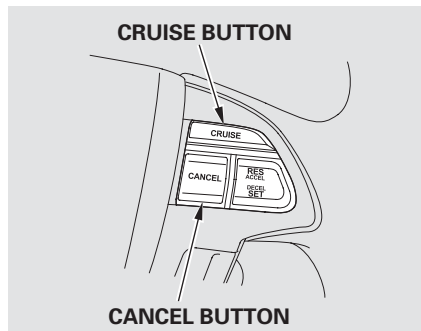

You can cancel cruise control in any of these ways:

- Tap the brake pedal.
- Push the CANCEL button on the steering wheel.
- Push the CRUISE button on the steering wheel.

Resuming the Set Speed

When you push the CANCEL button or tap the brake pedal, the system remembers the previously set speed. To return to that speed, accelerate to above 25 mph (40 km/h), then press and release the RES/ACCEL button. The CRUISE CONTROL indicator comes on. The vehicle accelerates to the same speed as before.

Pressing the CRUISE button turns the system completely off and erases the previous cruising speed.

On vehicles without navigation system

Compass Operation

Compass operation can be affected by driving near power lines or stations, across bridges, through tunnels, over railroad crossings, past large vehicles, or driving near large objects that can cause a magnetic disturbance. It can also be affected by accessories such as antennas and roof racks that are mounted by magnets.

If the compass display is blinking and the CAL indicator is shown, the compass is self-calibrating.

Compass Calibration

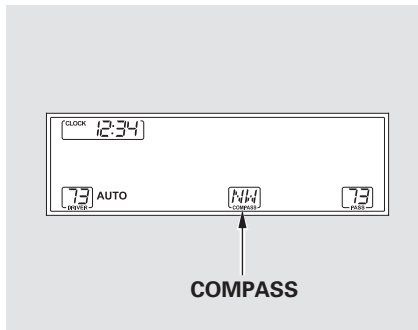

The compass may need to be manually calibrated after exposure to a strong magnetic field. If the compass seems to be continually showing the wrong direction and is not self-calibrating, or the compass display is blinking with the CAL indicator on, do the following.

1. Turn the ignition switch to the ON (II) position.

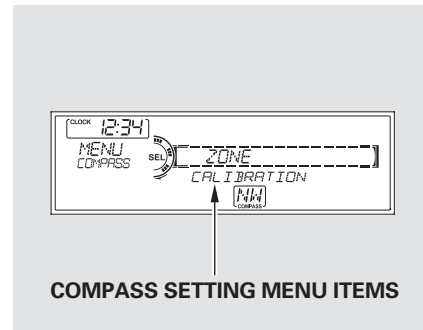

2. *On EX and EX-L models*
Press and hold the MENU button for about 5 seconds until you hear a beep. The display shows you the compass setting menu items.
On LX models
Press and hold the RPT button and TUNE/SOUND knob for about 2 seconds until you hear a beep. The display shows you the compass setting menu items.

CONTINUED

Compass

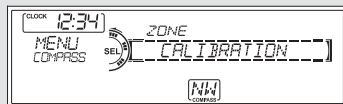

3. Turn the selector or TUNE/SOUND knob to select "CALIBRATION."

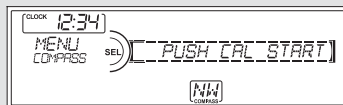

4. Press the selector or TUNE/SOUND knob to enter your selection. The display shows you "PUSH CAL START."

While setting the compass, pressing the RETURN button (on EX and EX-L models) will go back to the previous display. Pressing the MENU button will cancel the compass setting mode.

5. Press the selector or TUNE/SOUND knob. The compass display is blinking and the CAL indicator is shown.

6. Drive the vehicle slowly in two complete circles.

When the calibration is successfully completed, the CAL indicator goes off and the compass display will stop blinking and show an actual heading.

The audio system is not related to the compass system. Even if the compass system is calibrating, the display returns to the normal display which you last selected.

NOTE: Do this procedure in an open area, away from buildings, power lines, and other vehicles.

Compass Zone Selection

In most areas, there is a variation between magnetic north and true north. Zone selection is required so the compass can compensate for this variation. To check and select the zone, do this:

1. Turn the ignition switch to the ON (II) position.
2. *On EX and EX-L models*
Press and hold the MENU button for about 5 seconds until you hear a beep. The display shows you the compass setting menu items.

On LX models

Press and hold the RPT button and TUNE/SOUND knob for about 2 seconds until you hear a beep. The display shows you the compass setting menu items.

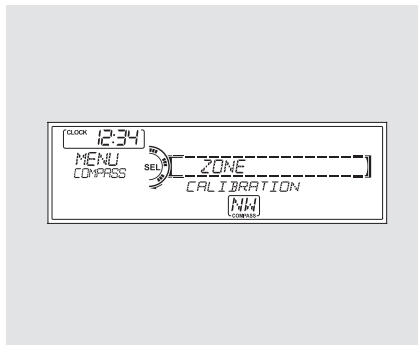

3. Turn the selector or TUNE/SOUND knob to select "ZONE." Press the selector knob to enter your selection. The display shows you the currently selected zone number.
4. Find the zone for your area on the map (see page 356). If the correct zone is not shown, turn the selector or TUNE/SOUND knob to cycle the zone lists up or down.

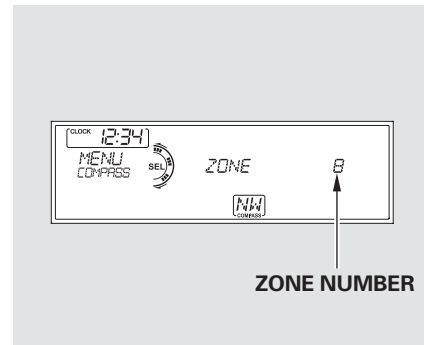

If necessary, press the RETURN button (on EX and EX-L models) to return to the previous display. Pressing the MENU button will cancel the compass setting mode.

5. Once the correct zone is displayed, press the selector or TUNE/SOUND knob. The display then returns to normal.

CONTINUED

Compass

The audio system is not related to the compass system. Even if the compass system is in the zone setting mode, the display returns to the normal display which you last selected.

Zone Map

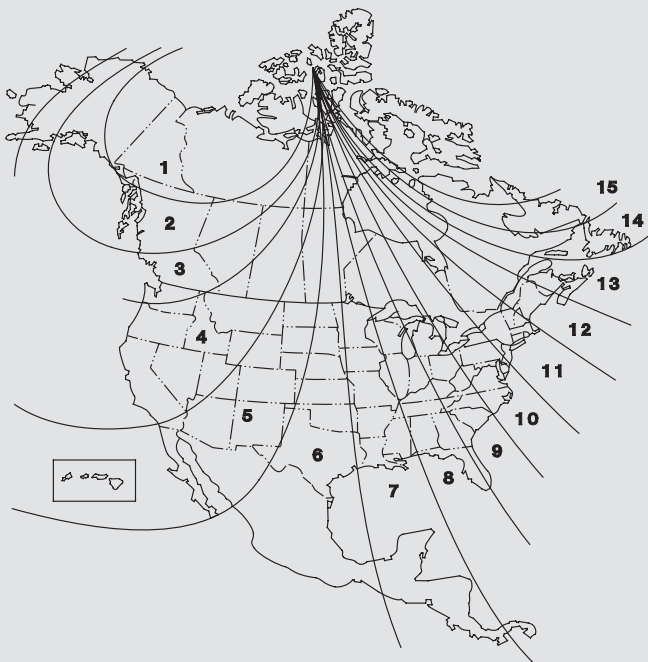

Except LX models

The HomeLink® Universal Transceiver built into your vehicle can be programmed to operate up to three remote controlled devices around your home, such as garage doors, lighting, or home security systems.

General Safety Information

Before programming your HomeLink to operate a garage door opener, confirm that the opener has an external entrapment protection system, such as an “electronic eye,” or other safety and reverse stop features.

If your garage door was manufactured before April 1, 1982, you may not be able to program HomeLink to operate it. These units do not have safety features that cause the motor to stop and reverse it if an obstacle is detected during closing, increasing the risk of injury.

Do not use HomeLink with any garage door opener that lacks safety stop and reverse features.

CONTINUED

HomeLink® Universal Transceiver

Units manufactured between April 1, 1982 and January 1, 1993 may be equipped with safety stop and reverse features. If your unit does not have an external entrapment protection system, an easy test to confirm the function and performance of the safety stop and reverse feature is to lay a 2×4 under the closing door. The door should stop and reverse upon contacting the piece of wood. As an additional safety feature, garage door openers manufactured after January 1, 1993 are required to have external entrapment protection systems, such as an electronic eye, which detect an object obstructing the door.

Important Safety Precautions

Refer to the safety information that came with your garage door opener to test that the safety features are functioning properly. If you do not have this information, contact the manufacturer of the equipment. Before programming HomeLink to a garage door or gate opener, make sure that people and objects are out of the way of the device to prevent potential injury or damage. When programming a garage door opener, park just outside the garage.

Training HomeLink

Before you begin — If you just received your vehicle and have not trained any of the buttons in HomeLink before, you should erase any previously learned codes before training the first button. To do this, press and hold the two outside buttons on the HomeLink transceiver for about 20 seconds, until the red indicator flashes. Release the buttons, then proceed to step 1.

If you are training the second or third buttons, go directly to step 1.

Training a Button

1 Position the remote transmitter you wish to link 1-3 inches (3-8cm) from the HomeLink button you want to program.

2 Press and hold the desired HomeLink button and the button on the remote transmitter you wish to link.
Does the HomeLink indicator (LED) blink at a faster rate after about 10 seconds?

NO

YES

a Press and hold the button on the remote and the HomeLink button at the same time. Then, while continuing to hold the HomeLink button, press and release the button on the remote every 2 seconds.
Does the LED blink at a faster rate within 20 seconds?

NO

YES

3 Press and hold the programmed HomeLink button for about a second.
Does the device (garage door opener) work?

NO

YES

4 Press and hold the HomeLink button again.

Training complete

HomeLink indicator flashes for 2 seconds, LED is on, then remains on.

a The remote has a rolling code. Press the "learn" button on the remotely controlled device (e.g., garage door opener).

b Within 30 seconds, press and hold the programmed HomeLink button for 2 seconds.

5 Press the programmed HomeLink button again; the remotely controlled device should operate.

Retraining a Button

1 Press and hold the desired HomeLink button until the HomeLink indicator begins to flash slowly.

Indicator remains on for about 25 seconds (standard transmitter)

Indicator flashes rapidly for 2 seconds, then remains on for about 23 seconds (rolling code transmitter)

2 When the indicator begins to flash slowly, continue to hold the HomeLink button and follow steps 1-3 under Training a Button.

Erasing Codes

To erase codes stored in all buttons, press and hold the two outer buttons until the HomeLink indicator begins to flash (about 10 to 20 seconds), then release the buttons. You should erase all three codes before selling the vehicle.

If you have any problems programming HomeLink, see the owner's manual included with the device you are trying to program, or call HomeLink at 1-800-355-3515 or go online to www.homelink.com.

CONTINUED

HomeLink® Universal Transceiver

HomeLink® is a registered trademark of Johnson Controls, Inc.

As required by the FCC:

This device complies with Part 15 of the FCC rules. Operation is subject to the following two conditions: (1) This device may not cause harmful interference, and (2) this device must accept any interference received, including interference that may cause undesired operation.

Changes or modifications not expressly approved by the party responsible for compliance could void the user's authority to operate the equipment.

This device complies with Industry Canada Standard RSS-210. Operation is subject to the following two conditions: (1) this device may not cause interference, and (2) this device must accept any interference that may cause undesired operation of the device.

On models with navigation system
Bluetooth® HandsFreeLink® (HFL) allows you to place and receive phone calls using voice commands, without handling your cell phone.

To use HFL, you need a Bluetooth-compatible cell phone. For a list of compatible phones, pairing procedures, and special feature capabilities:

In the U.S., visit handsfreelink.honda.com or call (888) 528-7876.

In Canada, visit www.honda.ca, or call (888) 9-HONDA-9.

Using HFL HFL Buttons

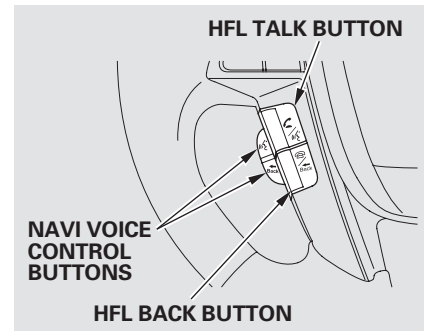

HFL Talk button — Press and release to give a command or answer a call.

HFL Back button — Press and release to end a call, go back to the previous command, or cancel the command.

CONTINUED

Bluetooth® HandsFreeLink®

Voice Control Tips

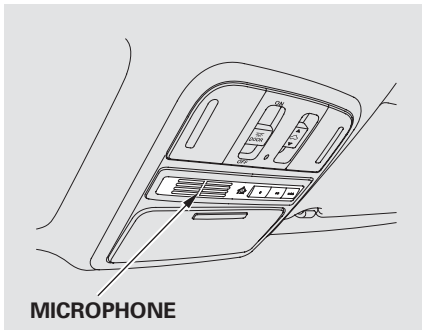

- Air or wind noise from the dashboard and side vents and all windows may interfere with the microphone. Adjust or close them as necessary.

- Press and release the HFL Talk button each time you want to make a command. After the beep, speak in a clear, natural tone.
- Try to reduce all background noise. If the microphone picks up voices other than yours, commands may be misinterpreted.
- Many commands can be spoken together. For example, you can say “Call 123-456-# # # #” or “Dial Peter.”
- When HFL is in use, navigation voice commands cannot be recognized.
- To change the volume level of HFL, use the audio system volume knob or the steering wheel volume controls.

Help Features

- To hear general HFL information, including help on pairing a phone or setting up the system, say “Tutorial.”
- For help at any time, including a list of available commands, say “Hands free help.”

Information Display

As an incoming call notification, you will see the following display:

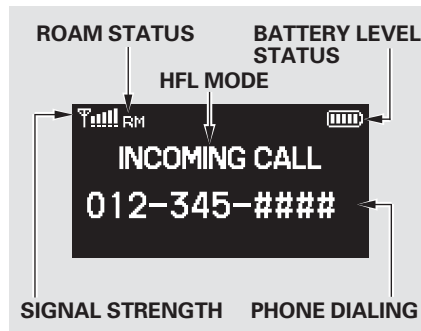

The Bluetooth icon  will also appear on the center display when a phone is linked.

Some phones may send battery, signal strength, and roaming status information to HFL.

CONTINUED

Bluetooth® HandsFreeLink®

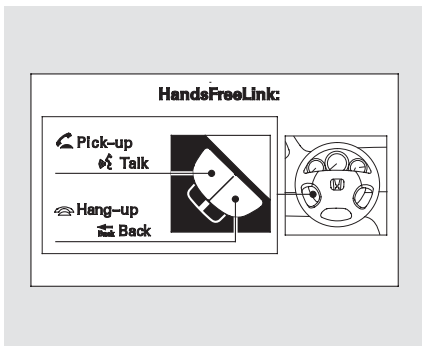

A notification that there is an incoming call, or HFL is in use, will appear on the navigation screen when the audio system is on.

When there is an incoming call, or HFL is in use, "HANDS FREE LINK" will appear on the center display.

How to Use HFL

The ignition switch must be in the ACCESSORY (I) or ON (II) position.

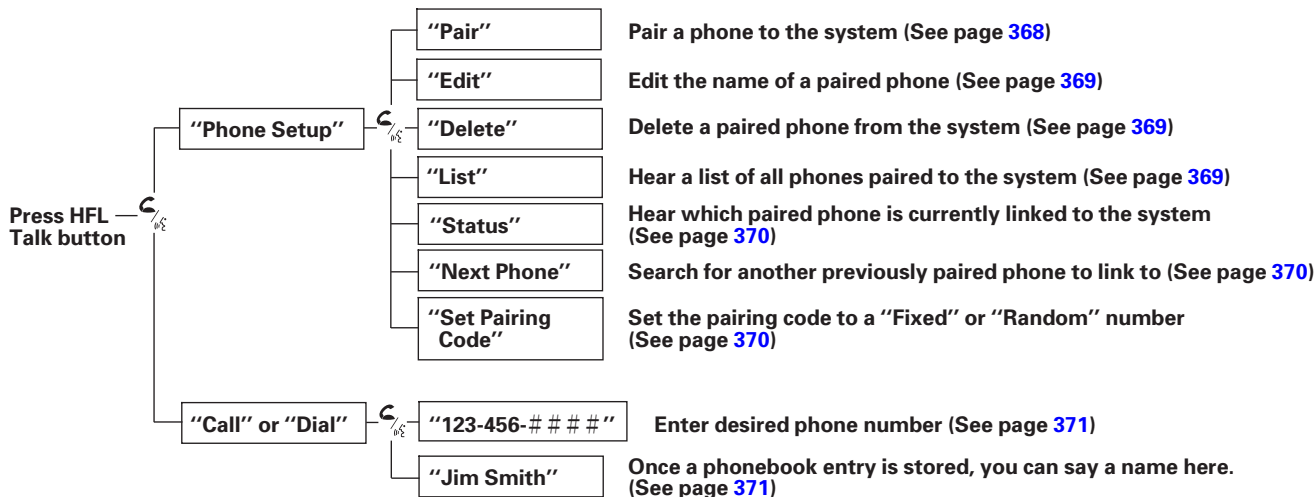

 Press and release the HFL Talk button each time you give a command.

CONTINUED

Bluetooth® HandsFreeLink®

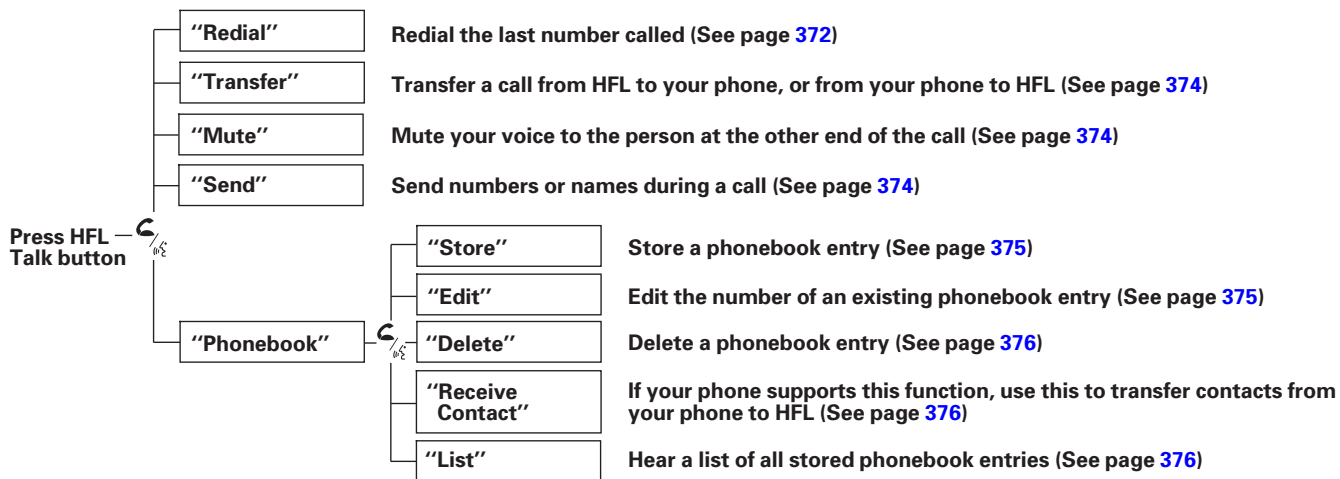

 Press and release the HFL Talk button each time you give a command.

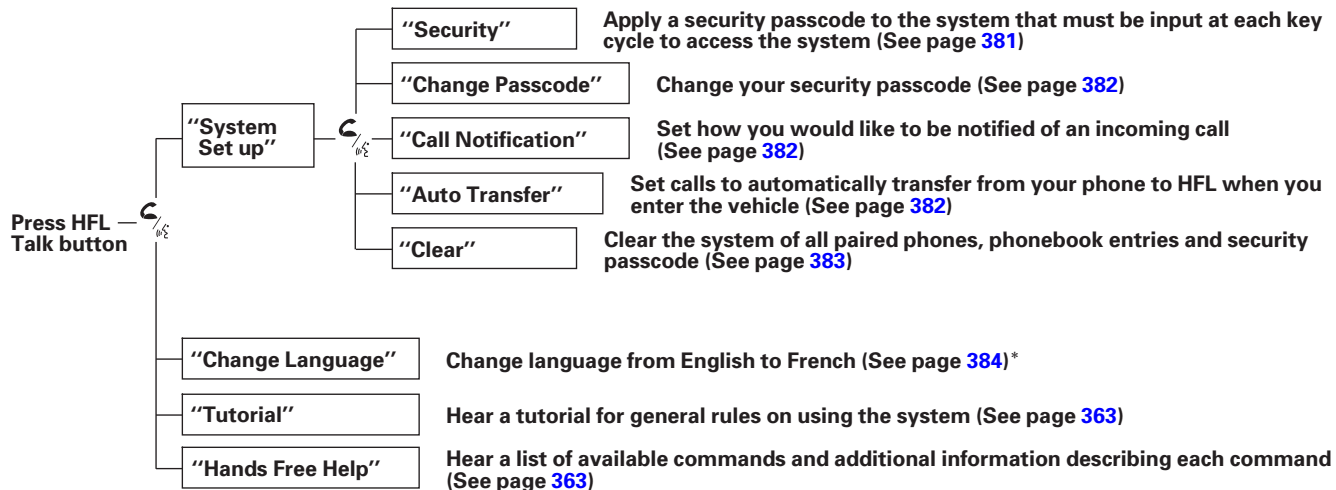

 Press and release the HFL Talk button each time you give a command.

* : Canadian models

CONTINUED

Bluetooth® HandsFreeLink®

To use HFL, you need to pair your Bluetooth-compatible cell phone to the system.

Phone Setup

This command group is available for paired cell phones.

Phone pairing tips

- You cannot pair your phone while the vehicle is moving.
- Your phone must be in discovery or search mode to pair. Refer to your phone's manual.
- Up to six phones can be paired.
- Your phone's battery may drain faster when it is paired to HFL.
- If after three minutes your phone is not ready to pair or a phone is not found, the system will time out and return to idle.

To pair a cell phone:

1. Press and release the HFL Talk button. If you are pairing a phone for the first time, HFL will give you information about the pairing process. If it is not the first phone you are pairing, say "**Phone setup**" and say "**Pair.**"
2. Follow the HFL prompts and put your phone in discovery or search mode. HFL will give you a 4-digit pairing code and begin searching for your phone.
3. When your phone finds a Bluetooth device, select HFL from the options and enter the 4-digit code from the previous step.
4. Follow the HFL prompts and name the newly paired phone.

To rename a paired phone:

Press and release the HFL Talk button before a command.

1. Say “**Phone setup.**”
2. Say “**Edit**” after the prompts.
3. If there is more than one phone paired to the system, HFL will ask you which phone’s name you want to change. Follow the HFL prompts and rename the phone.

To delete a paired phone:

Press and release the HFL Talk button before a command.

1. Say “**Phone setup.**”
2. Say “**Delete**” after the prompts.
3. HFL will ask you which phone you want to delete. Follow the HFL prompts to continue with the deletion.

To hear the names of all paired phones:

Press and release the HFL Talk button before a command.

1. Say “**Phone setup.**”
2. Say “**List**” after the prompts.
3. HFL will read out all the paired phone’s names.

CONTINUED

Bluetooth® HandsFreeLink®

To hear which paired phone is currently linked:

Press and release the HFL Talk button before a command.

1. Say “**Phone setup.**”
2. Say “**Status**” after the prompts.
3. HFL will tell you which phone is linked to the system.

To change from the currently linked phone to another paired phone:

Press and release the HFL Talk button before a command.

1. Say “**Phone setup.**”
2. Say “**Next phone**” after the prompts.
3. HFL disconnects the linked phone and searches for another paired phone.
4. Once another phone is found, it is linked to the system. HFL will inform you which phone is now linked.

If no other phones are found or paired, HFL will inform you that the original phone is linked again.

To change the pairing code setting:

Press and release the HFL Talk button before a command.

1. Say “**Phone setup.**”
2. Say “**Set pairing code**” after the prompts.
3. If you want HFL to create a random code each time you pair a phone, say “**Random.**” If you want to choose your own 4-digit code to be used each time, say “**Fixed**” and follow the HFL prompts.

Making a Call

You can make calls using any phone number or a name in the HFL phonebook. You can also redial the last number called.

HFL uses a Class 2 Bluetooth, which means, the maximum range between your phone and vehicle is 30 feet (10 meters).

During a call, HFL allows you to talk up to 30 minutes after you remove the key from the ignition switch. However, this may weaken the vehicle's battery.

To make a call using a phone number:

Press and release the HFL Talk button before a command.

1. Say “**Call**” or “**Dial**.”
2. Follow the HFL prompts and say the phone number you want to dial.
3. Follow the HFL prompts to confirm the number and say “**Call**” or “**Dial**.”

Once connected, you will hear the person you called through the audio speakers.

To make a call using a name in the HFL phonebook:

Press and release the HFL Talk button before a command.

1. Say “**Call**” or “**Dial**.”
2. Follow the HFL prompts and say the name stored in the HFL phonebook that you want to call.
3. Follow the HFL prompts to confirm the name and make the call.

CONTINUED

Bluetooth® HandsFreeLink®

To redial the last number called by HFL:

Press and release the HFL Talk button and say **“Redial.”**

To make a call from an imported phonebook:

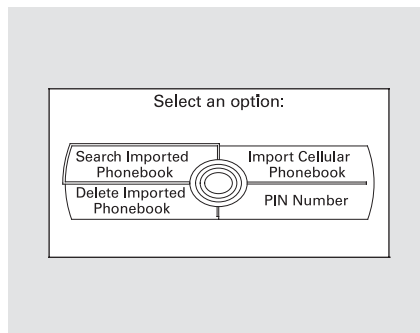

1. Press the INFO button, then select **“Cellular Phonebook.”**
2. Select **“Search Imported Phonebook.”**

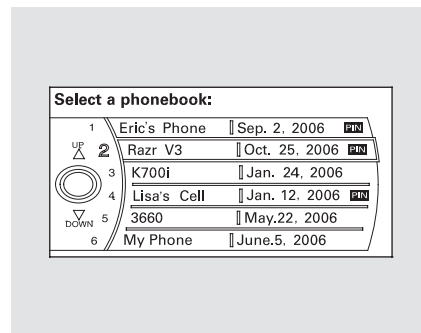

3. Select a phonebook you want to choose a phone number from.

If the phonebook you select is PIN-protected, you will need to enter the PIN to access it. See page [379](#) for more information.

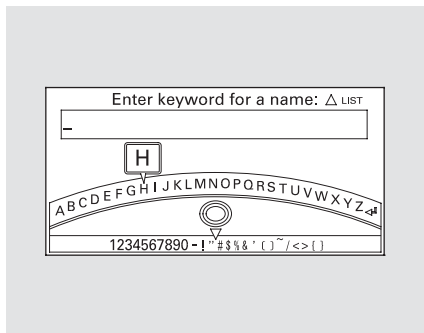

To search for a specific name in the phonebook, enter the keyword for either the first or last name.

To display all names in the phonebook, select the “**List**” option.

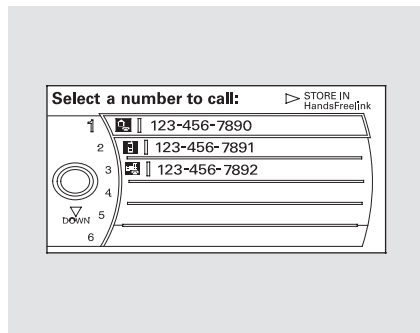

4. Select the name. All the phone numbers stored for that name will be listed.
5. Select the phone number, and HFL begins dialing.

If you choose “**Store in HandsFreeLink**,” the phone number will be stored in HFL, so that you can call it using HFL’s name tag by voice.

Receiving a Call

When you receive a call, an incoming call notification (if activated) will play and interrupt the audio system if it is on.

Press the HFL Talk button to answer the call, or the HFL Back button to hang up.

Call Waiting

If your phone has Call Waiting, press and release the HFL Talk button to put the original call on hold and answer the incoming call.

To return to the original call, press the HFL Talk button again. If you don’t want to answer the incoming call, disregard it and continue with your original call. If you want to hang up the original call and answer the new call, press the HFL Back button.

Bluetooth® HandsFreeLink®

Transferring a Call

You can transfer a call from HFL to your phone, or from your phone to HFL.

Press and release the HFL Talk button and say “**Transfer.**”

Muting a Call

You can mute your voice to the person you are talking to during a call.

To mute your voice during a call, press and release the HFL Talk button and say “**Mute.**”

To unmute your voice, press and release the HFL Talk button and say “**Mute**” again.

Send Numbers or Names During a Call

HFL allows you to send numbers or names during a call. This is useful when you call a menu-driven phone system.

To send a name or number during a call:

Press and release the HFL Talk button before a command.

1. Say “**Send.**”
2. Follow the HFL prompts and say the name or number you want to send.
3. Follow the HFL prompts to send the tones and continue the call.

NOTE: To send a pound (#), say “pound.” To send a star (*), say “star.”

Phonebook

You can store up to 50 names with their associated numbers in HFL. The numbers you store can be not only phone numbers but other types, such as account numbers or passwords, which can be sent during a menu-driven call.

To store a phonebook entry:

Press and release the HFL Talk button before a command.

1. Say “**Phonebook.**”
2. Say “**Store**” after the prompts.
3. Say a name you want to list as your phonebook entry.
4. Say the number you want to store for the name entry.
5. Follow the HFL prompts and say “**Enter**” to store the entry.

NOTE:

- Avoid using duplicate name entries.
- Avoid using “home” as a name entry.
- It is easier for HFL to recognize a multisyllabic or longer name. For example, use “Peter” instead of “Pete,” or “John Smith” instead of “John.”

To edit the number stored in a name:

Press and release the HFL Talk button before a command.

1. Say “**Phonebook.**”
2. Say “**Edit**” after the prompts.
3. Follow the HFL prompts and say the name entry you want to edit.
4. When asked, say the new number for that name.
5. Follow the HFL prompts to complete the edit.

CONTINUED

Bluetooth® HandsFreeLink®

To delete a name:

Press and release the HFL Talk button before a command.

1. Say “**Phonebook.**”
2. Say “**Delete**” after the prompts.
3. Say the name you want to delete and follow the HFL prompts to complete the deletion.

To list all names in the phonebook:

Press and release the HFL Talk button before a command.

1. Say “**Phonebook.**”
2. Say “**List**” after the prompts.
3. HFL begins reading the names in the order they were stored.
4. If you hear a name you want to call, immediately press the HFL Talk button and say “**Call.**”

To store a specific phone number from your cell phone directly to the HFL phonebook (available on some phones):

Press and release the HFL Talk button before a command.

1. Say “**Phonebook.**”
2. Say “**Receive contact**” after the prompts.
3. Follow the HFL prompts, select a number from your cell phone, and send it to HFL.
4. Follow the HFL prompts and name the number, or say “**Discard**” if it is not the number you want to store.
5. Follow the HFL prompts if you want to store another number.

Cellular Phonebook*(available on some phones)*

If you select **Cellular Phonebook** from the Information screen menu, you will see four HFL options.

For a list of cell phones that are compatible with this feature:

In the U.S., visit handsfreelink.honda.com or call (888) 528-7876.

In Canada, visit www.honda.ca, or call (888) 9-HONDA-9.

Import Cellular Phonebook:

The entire phonebook data of the cell phone that is linked to HFL can be imported to the navigation system.

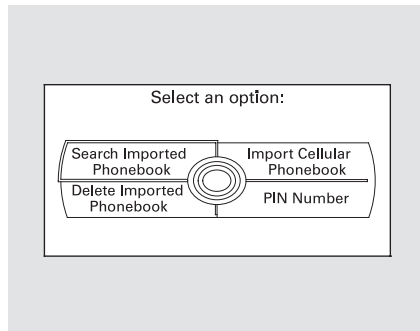

Select **“Import Cellular Phonebook,”** and HFL will begin importing the phonebook. Select **“OK”** after the import is completed.

Search Imported Phonebook:

Once a phonebook has been imported, you can search the phone numbers by the person’s name.

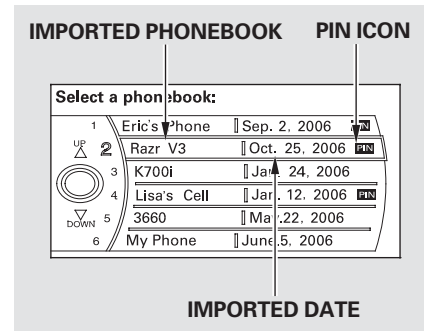

Select **“Search Imported Phonebook,”** and a list of imported phonebooks will be displayed.

Select a phonebook from the list.

CONTINUED

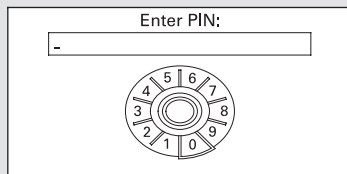
Bluetooth® HandsFreeLink®

If the phonebook is PIN-protected, you will need to enter the 4-digit PIN.

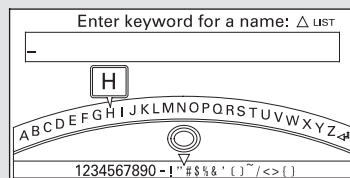

To search for a specific name in the phonebook, enter the keyword for either the first or last name.

To display all names in the phonebook, select the “**List**” option.

Select a person from the list. Up to three category icons are displayed in the left side of the list:

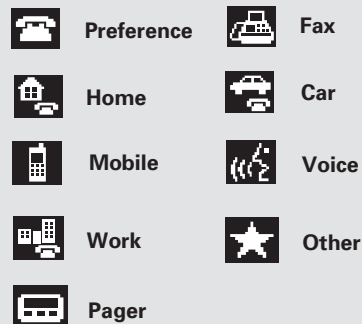

These indicate how many numbers are stored for the name. If a name has more than three category icons, “...” is displayed.

Select the person’s number you want to call, and press the HFL Talk button.

Delete Imported Phonebook:

You can delete any imported phonebook.

Select “**Delete Imported Phonebook,**” and a list of imported phonebooks will be displayed.

Select a phonebook you want to delete. If the phonebook is PIN-protected, you will need to enter the 4-digit PIN number.

After making a selection, the following screen will appear.

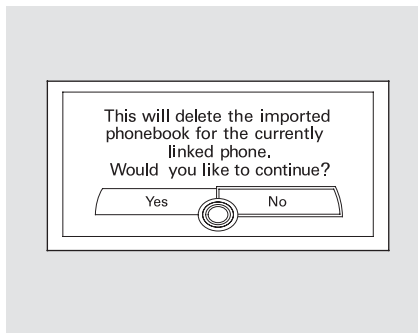

Select “**Yes,**” then “**OK**” to complete the deletion.

PIN Number

You can add, change, or remove a PIN number from any phonebook.

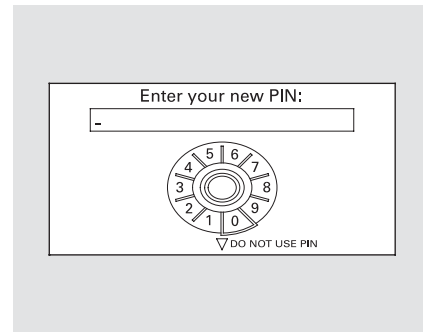
**To add a PIN:**

If you have selected a phonebook without a PIN, you will see the above display.

Enter the new 4-digit PIN. You will have to re-enter the PIN for confirmation.

CONTINUED

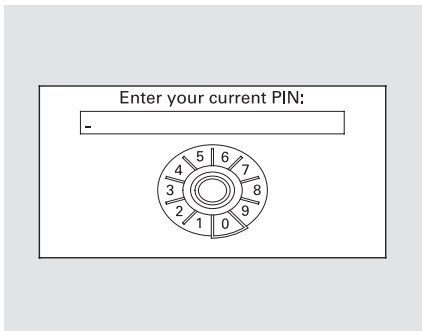
Bluetooth® HandsFreeLink®***To change the PIN to a new number:***

Select the phonebook you want. The display will change as shown above.

Enter the current PIN for this phonebook.

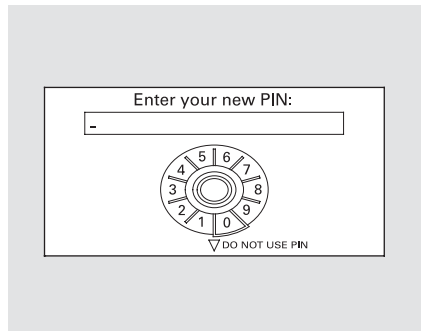

The display will change as shown above.

Enter the new 4-digit PIN number. You will be asked to re-enter the PIN for verification.

To remove a PIN:

Select **“PIN number,”** then select **“Do not use PIN”** after you enter the current PIN.

System Setup

This command group allows you to change or customize HFL basic settings.

To set a 4-digit passcode to lock the HFL system for security purposes:

Press and release the HFL Talk button before a command.

1. Say “**System setup.**”
2. Say “**Security**” after the prompts.
3. Follow the HFL prompts and say the 4-digit passcode you want to set.
4. Follow the HFL prompts to confirm the number.

NOTE: Once a passcode is set, you will need to enter it to use HFL each time you start the vehicle. If you forget the code, your dealer will have to reset it for you, or you will have to clear the entire system (see page [383](#)).

CONTINUED

Bluetooth® HandsFreeLink®

To change your security passcode:

Press and release the HFL Talk button before a command.

1. Say “**System setup.**”
2. Say “**Change passcode**” after the prompts.
3. Follow the HFL prompts and say the new 4-digit passcode.
4. Follow the HFL prompts to confirm the number.

To select either a ring tone or a prompt as the incoming call notification:*

Press and release the HFL Talk button before a command.

1. Say “**System setup.**”
2. Say “**Call notification**” after the prompts.
3. Follow the HFL prompts and say “**Ring tone**” or “**Prompt.**” You can also say “**Off**” for no audible incoming call notification.

* : The default setting is a ring tone.

To activate or deactivate the auto transfer function:

If you get into the vehicle while you are on the phone, the call can be automatically transferred to HFL with the ignition switch in the ACCESSORY (I) or ON (II) position.

Press and release the HFL Talk button before a command.

1. Say “**System setup.**”
2. Say “**Auto transfer**” after the prompts.
3. HFL will let you know if auto transfer is on or off, depending on the previous setting. Follow the HFL prompts to change the setting.

To clear the system:

This operation clears the passcodes, paired phones, all names in the HFL phonebook, and all imported phonebook data.

Press and release the HFL Talk button before a command.

1. Say “**System setup.**”
2. Say “**Clear**” after the prompts.
3. Follow the HFL prompts to continue to complete the clearing procedure.

You can also clear the system when you have forgotten the passcode and cannot access HFL. When HFL asks you for the passcode, say “**System clear.**” Paired phones, all names in the HFL phonebook and all imported phonebook data will be lost.

Quick Language Selection

Canadian models only

To quickly change the language:

Press and release the HFL Talk button before a command.

1. Say the language you want to change to in that language.
2. Follow the HFL prompts.

Bluetooth® HandsFreeLink®

Change Language

Canadian models only

To change the system language between English and French:

Press and release the HFL Talk button before a command.

1. Say “**Change language.**”
2. Follow the HFL prompts to change the language to English or French.

If you have not named your paired phone in the language you just selected, HFL will ask you to name it in the current language.

When French is your currently selected language, you can give voice commands in French.

Bluetooth® Wireless Technology

The *Bluetooth®* name and logos are registered trademarks owned by Bluetooth SIG, Inc. and any use of such marks by Honda Motor Co., Ltd. is under license. Other trademarks and trade names are those of their respective owners.

As required by the FCC:

This device complies with Part 15 of the FCC rules. Operation is subject to the following two conditions: (1) This device may not cause harmful interference, and (2) this device must accept any interference received, including interference that may cause undesired operation.

Changes or modifications not expressly approved by the party responsible for compliance could void the user's authority to operate the equipment.

This device complies with Industry Canada Standard RSS-210.

Operation is subject to the following two conditions: (1) this device may not cause interference, and (2) this device must accept any interference that may cause undesired operation of the device.

Parking Sensor System

On Touring models

Your vehicle has a parking sensor system. The system lets you know the approximate distance between your vehicle and most obstacles while you are parking. When the system is on and your vehicle is nearing an obstacle, you will hear a beeper and see system messages on the multi-information display.

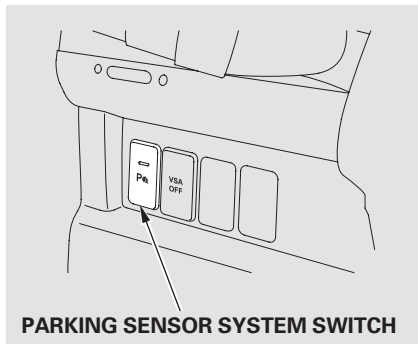

To activate the system, push the switch on the dashboard with the ignition in the ON (II) position. The indicator in the switch comes on when the system is on. To turn the system off, push the switch again.

All obstacles may not always be sensed. Even when the system is on, you should look for obstacles near your vehicle to make sure it is safe to park.

The system has two front corner sensors, two rear corner sensors, and two rear center sensors. The rear center sensors work when the shift lever is in reverse (R).

The corner sensors do not work when the shift lever is in drive (D), and the vehicle speed is more than 5 mph (8 km/h).

Multi-Information Display Messages and Beeper Operation







When you turn the system on, all indicators will appear on the multi-information display, and a beeper sounds once.

When the system senses an obstacle, the appropriate indicator comes on, and a beeper sounds as shown in the following tables.

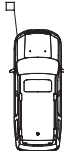
Corner Sensor Operation









Example shown: Obstacle is at the left front of the vehicle

Distance	About 18-24 in (45-60 cm) 	About 14-18 in (35-45 cm) 	About 14 in (35 cm) or less 
Indicator	Upper left indicator stays on 	Upper left indicator stays on 	Upper left indicator stays on 
Beeper	Short beeps	Very short beeps	Continuous beep

CONTINUED

Parking Sensor System

Rear Center Sensor Operation

Distance	About 24-40 in (60-100 cm) 	About 18-24 in (45-60 cm) 	About 14-18 in (35-45 cm) 	About 14 in (35 cm) or less 
Indicator	Bottom indicator stays on 	Bottom indicator stays on 	Bottom indicator stays on 	Bottom indicator stays on 
Beeper	Long beeps	Short beeps	Very short beeps	Continuous beeps

Parking Sensor System



If the system develops a problem, you will see a “CHECK PARKING SENSOR SYSTEM” message on the multi-information display, and a beeper sounds continuously. Very often, a sensor covered with mud, ice, snow, etc. is the cause of this message. Check the sensors first. If the message stays on or the beeper does not stop, have the system checked by your dealer.

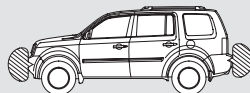
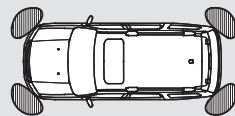

Within about 24 in (60 cm)

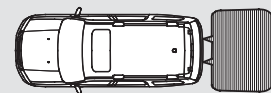

Within about 40 in (100 cm)

The range of the corner sensors and the rear center sensors are limited. Each corner sensor is capable of sensing an obstacle only when your vehicle is 24 in (60 cm) or closer. The rear center sensor senses an obstacle that is behind your vehicle 40 in (100 cm) or closer.

Do not put any accessories on or around the sensors.

The system may not function properly under these conditions:

- The sensors are covered with snow, ice, mud, etc.
- When the vehicle is on a rough road, on grass, or on a hill.
- After the vehicle has been sitting out in hot or cold weather.

CONTINUED

Parking Sensor System, Rearview Camera and Monitor

- When the system is affected by some electrical equipment or devices generating an ultrasonic wave.
- When operating the vehicle in bad weather.

The system may not sense thin or low objects, or sonic-absorptive materials such as snow, cotton, or sponge.

The system cannot sense objects directly under the bumper.

Canadian Owners:

This device complies with Industry Canada Standard RSS-210. Operation is subject to the following two conditions: (1) this device may not cause interference, and (2) this device must accept any interference that may cause undesired operation of the device.

This ISM device complies with Canadian ICES-001.

Rearview Camera and Monitor

On EX-L and Touring models

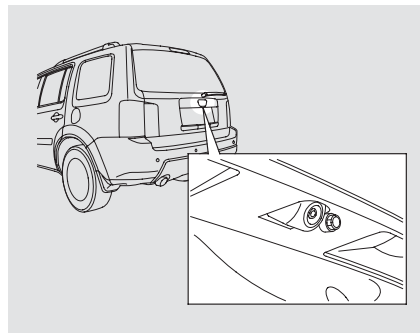

Whenever you shift to reverse (R) with the ignition switch in the ON (II) position, the rear view is shown on the navigation system screen. On vehicles without a navigation system, the rear view is shown on the left side of the inside mirror.

For the best picture, always keep the rearview camera clean, and do not cover the camera lens. To avoid scratching the lens when you clean it, use a moist, soft cloth.

Since the rearview camera display area is limited, you should always back up slowly and carefully, and look behind you for obstacles.

Rearview Camera and Monitor

On vehicles with navigation system

When in reverse, the navigation buttons are locked out, except the interface dial on the dashboard. Turn the knob clockwise to make the camera image brighter, and counter-clockwise to darken the image.

On EX-L models without navigation system

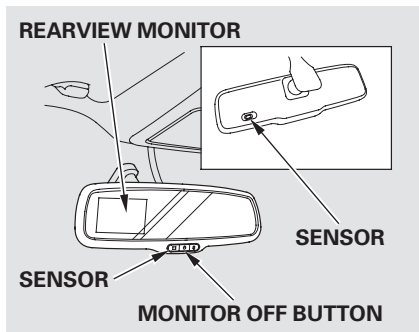

You can turn the monitor on and off by pressing the monitor off button when the shift lever is in reverse. The monitor turns on everytime you shift to reverse, even if you turned it off the last time.

Monitor brightness is adjusted automatically by sensors. If you use the monitor continuously at high temperature, the monitor will gradually dim.

The inside mirror will be hot when you use the monitor for an extended period of time.

If a bright light (such as sunlight) is shining on the inside mirror, the image may be difficult to see.

Before you begin driving your vehicle, you should know what gasoline to use and how to check the levels of important fluids. You also need to know how to properly store luggage or packages. The information in this section will help you. If you plan to add any accessories to your vehicle, please read the information in this section first.

- Break-in Period 394
- Fuel Recommendation 394
- Service Station Procedures 395
 - Refueling..... 395
 - Tighten Fuel Cap Message 396
- Opening and Closing the Hood..... 397
- Oil Check..... 398
- Engine Coolant Check 398
- Fuel Economy 399
- Accessories and Modifications 402
- Carrying Cargo 404

Break-in Period, Fuel Recommendation

Break-in Period

Help assure your vehicle's future reliability and performance by paying extra attention to how you drive during the first 600 miles (1,000 km). During this period:

- Avoid full-throttle starts and rapid acceleration.
- Avoid hard braking for the first 200 miles (300 km).
- Do not change the oil until the scheduled maintenance time.
- Do not tow a trailer.

You should also follow these recommendations with an overhauled or exchanged engine, or when the brakes are replaced.

Fuel Recommendation

Your vehicle is designed to operate on unleaded gasoline with a pump octane number of 87 or higher. Use of a lower octane gasoline can cause a persistent, heavy metallic rapping noise that can lead to engine damage.

We recommend quality gasolines containing detergent additives that help prevent fuel system and engine deposits. In addition, in order to maintain good performance, fuel economy, and emissions control, we strongly recommend, in areas where it is available, the use of gasoline that does NOT contain manganese-based fuel additives such as MMT.

Use of gasoline with these additives may adversely affect performance, and cause the malfunction indicator lamp on your instrument panel to come on. If this happens, contact your dealer for service.

Some gasoline today is blended with oxygenates such as ethanol or MTBE. Your vehicle is designed to operate on oxygenated gasoline containing up to 10% ethanol by volume and up to 15% MTBE by volume. Do not use gasoline containing methanol.

If you notice any undesirable operating symptoms, try another service station or switch to another brand of gasoline.

Premium fuel is recommended when towing in certain conditions (see page 446).

For further important fuel-related information for your vehicle, or information on gasoline that does not contain MMT, visit Owner Link at owners.honda.com. In Canada, visit www.honda.ca for additional information on gasoline.

Refueling

FUEL FILL DOOR RELEASE HANDLE

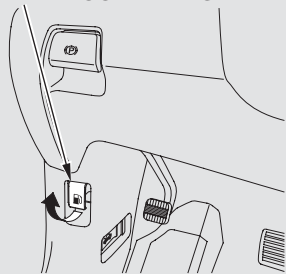

1. Park with the driver's side closest to the service station pump.
2. Open the fuel fill door by pulling on the handle located under the lower left corner of the dashboard.

FUEL FILL CAP

TETHER

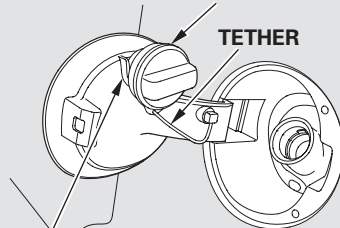

HOLDER

3. Remove the fuel fill cap slowly. You may hear a hissing sound as pressure inside the tank equalizes. Place the cap in the holder on the fuel fill door.
4. Stop filling the tank after the fuel nozzle automatically clicks off. Do not try to "top off" the tank. This leaves some room in the fuel tank for the fuel to expand with temperature changes.

If the fuel nozzle keeps clicking off even though the tank is not full, there may be a problem with your vehicle's fuel vapor recovery system. The system helps keep fuel vapor from going into the atmosphere. Try filling at another pump. If this does not fix the problem, consult your dealer.

⚠ WARNING

Gasoline is highly flammable and explosive. You can be burned or seriously injured when handling fuel.

- Stop the engine, and keep heat, sparks, and flame away.
- Handle fuel only outdoors.
- Wipe up spills immediately.

CONTINUED

Service Station Procedures

5. Screw the fuel fill cap back on until it clicks at least once.

On vehicles without navigation system

If you do not properly tighten the cap, you will see a “CHECK FUEL CAP” message on the information display (see page [86](#)).

On vehicles with navigation system

If you do not properly tighten the cap, you will see a “TIGHTEN FUEL CAP” message on the multi-information display.

6. Push the fuel fill door closed until it latches.

Tighten Fuel Cap Message

On vehicles with navigation system



Your vehicle’s on board diagnostic system will detect a loose or missing fuel fill cap as an evaporative system leak. The first time a leak is detected a “TIGHTEN FUEL CAP” message appears on the multi-information display. Turn the engine off, and confirm the fuel fill cap is installed. If it is, loosen it, then retighten it until it clicks at least once. The message should go off after several days of

normal driving once you tighten or replace the fuel fill cap. To scroll to another message, press the INFO button. The “TIGHTEN FUEL CAP” message will appear each time you restart the engine until the system turns the message off.

If the system still detects a leak in the vehicle’s evaporative emissions system, the malfunction indicator lamp (MIL) comes on. If the fuel fill cap was not already tightened, turn the engine off, and check or retighten the fuel fill cap until it clicks at least once. The MIL should go off after several days of normal driving once the cap is tightened or replaced. If the MIL does not go off, have your vehicle inspected by a dealer. For more information, see page [522](#).

Opening and Closing the Hood

HOOD RELEASE HANDLE

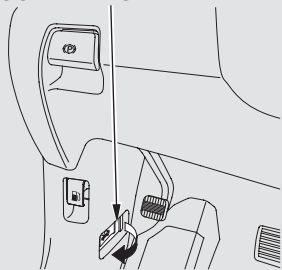

1. Park the vehicle, and set the parking brake. Pull the hood release handle located under the lower left corner of the dashboard. The hood will pop up slightly.

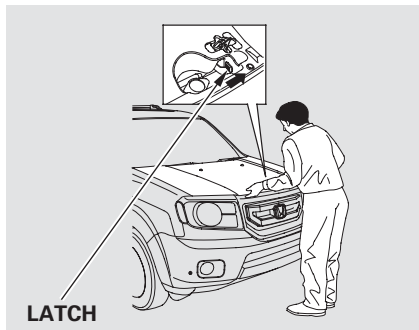

2. Put your fingers under the front edge of the hood near the center. Slide your hand to your left until you feel the hood latch handle. Push this handle up until it releases the hood. Lift up the hood.

If the hood latch handle moves stiffly, or if you can open the hood without lifting the handle, the mechanism should be cleaned and lubricated.

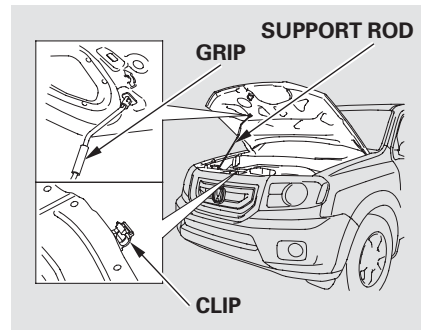

3. Holding the grip, pull the support rod out of its clip. Insert the end into the designated hole in the hood.

To close the hood, lift it up slightly to remove the support rod from the hole. Put the support rod back into its holding clip. Lower the hood to about a foot (30 cm) above the fender, then let it drop. Make sure it is securely latched.

Service Station Procedures

Oil Check

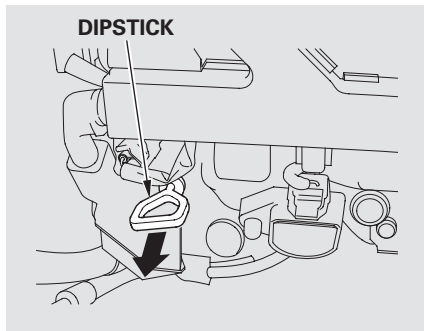

Wait a few minutes after turning the engine off before you check the oil.

1. Remove the dipstick (orange loop).
2. Wipe off the dipstick with a clean cloth or paper towel.
3. Insert the dipstick all the way back into its hole.

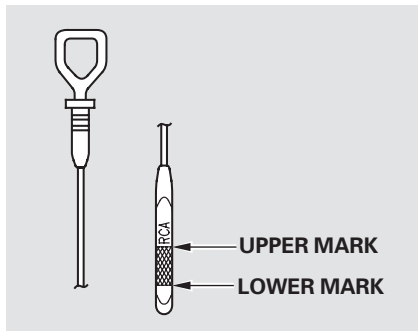

4. Remove the dipstick again, and check the level. It should be between the upper and lower marks.

If it is near or below the lower mark, see **Adding Engine Oil** on page 472.

Engine Coolant Check

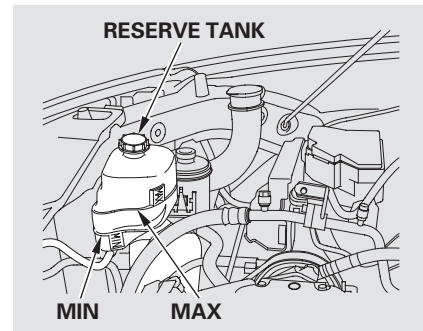

Look at the coolant level in the radiator reserve tank. Make sure it is between the MAX and MIN lines. If it is below the MIN line, see **Adding Engine Coolant** on page 475 for information on adding the proper coolant.

Refer to **Owner's Maintenance Checks** on page 467 for information about checking other items on your vehicle.

Actual Mileage and EPA Fuel Economy Estimates Comparison.

Fuel economy is not a fixed number. It varies based on driving conditions, driving habits, and vehicle condition. Therefore, it is not possible for one set of estimates to predict fuel economy precisely for all drivers in all environments.

The EPA fuel economy estimates shown in the example to the right are a useful tool for comparison when buying a vehicle. EPA estimates include:

City MPG – Represents urban driving in light traffic. A range of miles per gallon achieved is also provided.

Highway MPG – Represents a mixture of rural and interstate driving, in a warmed-up vehicle, typical of longer trips in free-flowing traffic. A range of miles per gallon

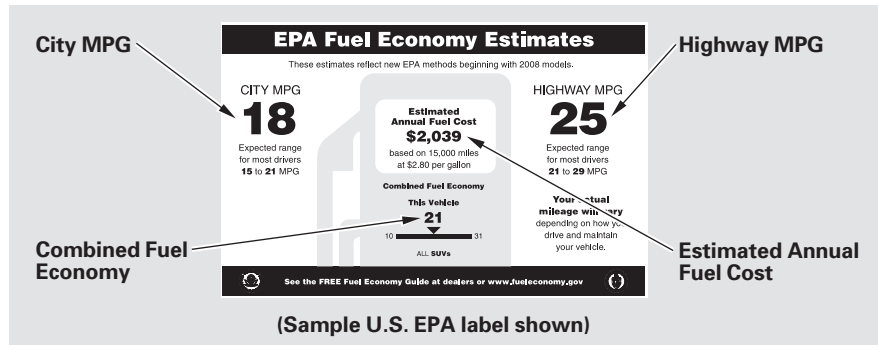

achieved is also provided.

Combined Fuel Economy – Represents a combination of city and highway driving. The scale represents the range of combined fuel economy for other vehicles in the class.

Estimated Annual Fuel Cost – Provides an estimated annual fuel cost, based on 15,000 miles (20,000 km) per year multiplied by the cost

per gallon (based on EPA fuel cost data) divided by the combined fuel economy.

For more information on fuel economy ratings and factors that affect fuel economy, visit www.fueleconomy.gov (Canada: Visit www.vehicles.gc.ca)

Fuel Economy

Fuel Economy Factors

The following factors can lower your vehicle's fuel economy:

- Aggressive driving (hard acceleration and braking)
- Excessive idling, accelerating and braking in stop-and-go traffic
- Cold engine operation (engines are more efficient when warmed up)
- Driving with a heavy load or the air conditioner running
- Improperly inflated tires

Improving Fuel Economy

Vehicle Maintenance

A properly maintained vehicle maximizes fuel economy. Poor maintenance can significantly reduce fuel economy. Always maintain your vehicle according to the maintenance messages displayed on the information display (see **Owner's Maintenance Checks** on page [467](#)). For example:

- **Use the recommended viscosity motor oil, displaying the API Certification Seal (see page [472](#)).**
 - **Maintain proper tire inflation** — An underinflated tire increases “rolling resistance,” which reduces fuel economy.
 - **Avoid carrying excess weight in your vehicle** — It puts a heavier load on the engine, increasing fuel consumption.
 - **Keep your vehicle clean** — In particular, a build-up of snow or mud on your vehicle's underside adds weight and rolling resistance. Frequent cleaning helps your fuel economy.
- Drive Efficiently*
- **Drive moderately** — Rapid acceleration, abrupt cornering, and hard braking increase fuel consumption.
 - **Observe the speed limit** — Aerodynamic drag has a big effect on fuel economy at speeds above 45 mph (75 km/h). Reduce your speed and you reduce the drag. Trailers, car top carriers, roof racks and bike racks are also big contributors to increased drag.
 - **Avoid excessive idling** — Idling results in 0 miles per gallon (0 kms per liter).

- **Minimize the use of the air conditioning system** – The A/C puts an extra load on the engine which makes it use more fuel. Use the fresh-air ventilation when possible.
- **Plan and combine trips** – Combine several short trips into one. A warmed-up engine is more fuel efficient than a cold one.

Calculating Fuel Economy

Measuring Techniques

Direct calculation is the recommended source of information about your actual fuel economy. Using frequency of fill-ups or taking fuel gauge readings are NOT accurate measures of fuel economy. Fuel economy may improve over the first several thousand miles (kilometers).

Checking Your Fuel Economy

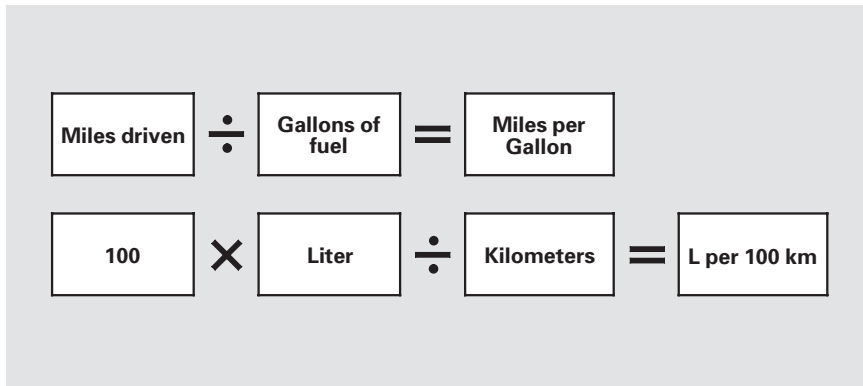

- 1) Fill the fuel tank until the nozzle automatically clicks off.
- 2) Reset trip counter to zero.
- 3) Record the total gallons (liters) needed to refill.
- 4) Follow one of the simple calculations above.

Accessories and Modifications

Modifying your vehicle, or installing some non-Honda accessories, can make it unsafe. Before you make any modifications or add any accessories, be sure to read the following information.

Accessories

Your dealer has Honda accessories that allow you to personalize your vehicle. These accessories have been designed and approved for your vehicle, and are covered by warranty.

Although non-Honda accessories may fit on your vehicle, they may not meet factory specifications, and could adversely affect your vehicle's handling, stability, and reliability.

WARNING

Improper accessories or modifications can affect your vehicle's handling, stability, and performance, and cause a crash in which you can be hurt or killed.

Follow all instructions in this owner's manual regarding accessories and modifications.

When properly installed, cellular phones, alarms, two-way radios, and low-powered audio systems should not interfere with your vehicle's computer controlled systems, such as your airbags, anti-lock brakes, and tire pressure monitoring system.

Before installing any accessory:

- Make sure the accessory does not obscure any lights, or interfere with proper vehicle operation or performance.
- Be sure electronic accessories do not overload electrical circuits (see page [524](#)) or interfere with proper operation of your vehicle.
- Do not install accessories on the side pillars or across the rear windows. Accessories installed in these areas may interfere with proper operation of the side curtain airbags.
- Before installing any electronic accessory, have the installer contact your dealer for assistance. **If possible, have your dealer inspect the final installation.**

Modifying Your Vehicle

Removing parts from your vehicle, or replacing components with non-Honda components could seriously affect your vehicle's handling, stability, and reliability.

Some examples are:

- Lowering your vehicle with a non-Honda suspension kit that significantly reduces ground clearance can allow the undercarriage to hit speed bumps or other raised objects, which could cause the airbags to deploy.
- Raising your vehicle with a non-Honda suspension kit can affect the handling, stability, and reliability.

- Non-Honda wheels, because they are a universal design, can cause excessive stress on suspension components and will not be compatible with the tire pressure monitoring system (TPMS).
- Larger or smaller wheels and tires can interfere with the operation of your vehicle's anti-lock brakes and other systems.

Modifying your steering wheel or any other part of your vehicle's safety features can make the systems ineffective.

If you plan to modify your vehicle, consult your dealer.

Carrying Cargo

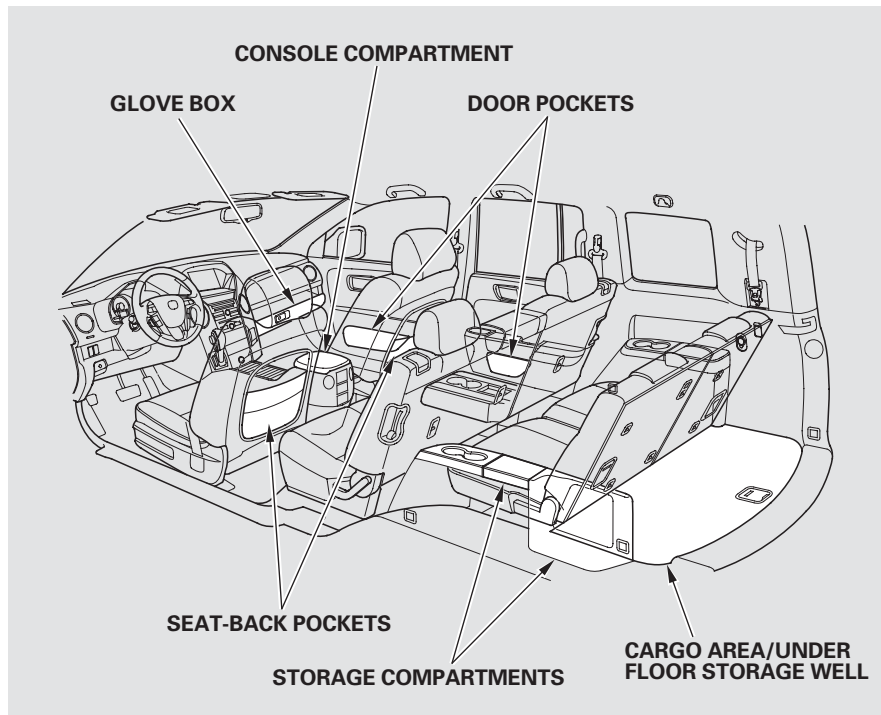

Your vehicle has several convenient storage areas:

- Glove box
- Door and seat-back pockets
- Rear cargo area, including the second and third row seats when folded flat
- Console compartment
- Storage compartment
- Roof-rack (if equipped)

However, carrying too much cargo, or improperly storing it, can affect your vehicle's handling, stability, stopping distance, and tires, and make it unsafe. Before carrying any type of cargo, be sure to read the following pages.

Load Limits

The maximum load for your vehicle is 1,320 lbs (600 kg).

See Tire And Loading Information label attached to the driver's doorjamb.

Label Example

TIRE AND LOADING INFORMATION			
SEATING CAPACITY		TOTAL 5 FRONT 2 REAR 3	
The combined weight of occupants and cargo should never exceed 385kg or 850lbs.			
TIRE	SIZE	COLD TIRE PRESSURE	SEE OWNER'S MANUAL FOR ADDITIONAL INFORMATION
FRONT	XXXX/XXXXX XXX	XXXKPA.XXPSI	
REAR	XXXX/XXXXX XXX	XXXKPA.XXPSI	
SPARE	XXXX/XXXXX XXXX	XXXKPA.XXPSI	

This figure includes the total weight of all occupants, cargo, and accessories, and the tongue load if you are towing a trailer.

⚠ WARNING

Overloading or improper loading can affect handling and stability and cause a crash in which you can be hurt or killed.

Follow all load limits and other loading guidelines in this manual.

Steps for Determining Correct Load Limit –



- (1) Locate the statement “The combined weight of occupants and cargo should never exceed XXX kg or XXX lbs.” on your vehicle’s placard.
- (2) Determine the combined weight of the driver and passengers that will be riding in your vehicle.
- (3) Subtract the combined weight of the driver and passengers from XXX kg or XXX lbs.

- (4) The resulting figure equals the available amount of cargo and luggage load capacity. For example, if the “XXX” amount equals 1,400 lbs. and there will be five 150 lb. passengers in your vehicle, the amount of available cargo and luggage load capacity is 650 lbs.
(1,400 – 750 (5 × 150) = 650 lbs.)

- (5) Determine the combined weight of luggage and cargo being loaded on the vehicle. That weight may not safely exceed the available cargo and luggage load capacity calculated in Step 4.
- (6) If your vehicle will be towing a trailer, load from your trailer will be transferred to your vehicle. Consult this manual to determine how this reduces the available cargo and luggage load capacity of your vehicle.

CONTINUED

Carrying Cargo

<p>Example 1</p>	 <p>Max Load (1,320 lbs) (600 kg)</p> <p>Passenger Weight (150 lbs x 2 = 300 lbs) (68 kg x 2 = 136 kg)</p> <p>Cargo Weight (1,020 lbs) (464 kg)</p>
<p>Example 2</p>	 <p>Max Load (1,320 lbs) (600 kg)</p> <p>Passenger Weight (150 lbs x 4 = 600 lbs) (68 kg x 4 = 272 kg)</p> <p>Cargo Weight (720 lbs) (328 kg)</p>
<p>Example 3</p>	 <p>Max Load (1,320 lbs) (600 kg)</p> <p>Passenger Weight (150 lbs x 5 = 750 lbs) (68 kg x 5 = 340 kg)</p> <p>Cargo Weight (570 lbs) (260 kg)</p>

In addition, the total weight of the vehicle, all occupants, accessories, cargo, and trailer tongue load must not exceed the Gross Vehicle Weight Rating (GVWR) or the Gross Axle Weight Rating (GAWR). Both are on a label on the driver's doorjamb.

Carrying Cargo in the Passenger Compartment

- Store or secure all items that could be thrown around and hurt someone during a crash.
- Be sure items placed on the floor behind the front seats cannot roll underneath and interfere with the proper operation of the seats, the sensors under the seats, or the driver's ability to operate the pedals.

Keep all cargo below the bottom of the windows. If it is higher, it could interfere with the proper operation of the side curtain airbags.

- Keep the glove box closed while driving. If it is open, a passenger could injure their knees during a crash or sudden stop.

Carrying Cargo in the Cargo Area or on a Roof Rack

- Distribute cargo evenly on the floor of the cargo area, placing the heaviest items on the bottom and as far forward as possible. Tie down items that could be thrown about the vehicle during a crash or sudden stop.
- If you fold down the second or third row seats, tie down items that could be thrown about the vehicle during a crash or sudden stop.

- If you carry large items that prevent you from closing the tailgate or the glass hatch, exhaust gas can enter the passenger area. To avoid the possibility of **carbon monoxide poisoning**, follow the instructions on page [61](#).
- If you carry any items on a roof rack, be sure the total weight of the rack and the items does not exceed 165 lbs (75 kg).

If you use an accessory roof rack, the roof rack weight limit may be lower. Refer to the information that came with your roof rack.

Carrying Cargo

Optional Separation Net

The separation net can be used to hold back soft, lightweight items stored in the cargo area. Heavy items should be tied down, as the net may not prevent them from being thrown about the vehicle in a crash or a sudden stop.

Optional Cargo Cover

The cargo cover can be used to cover the cargo area behind the third row seats. When the third row seats are folded down, the cargo cover can be extended over the larger area. Do not install the cover over the larger area if the third row seats are not folded down.

Cargo Hooks

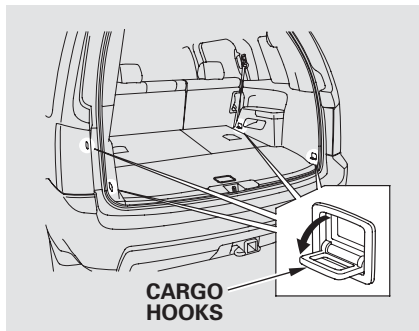

The four hooks on the side panels can be used to install a net for securing items. Each hook is designed to hold up to 56.2 lbs (25.5 kg) of weight.

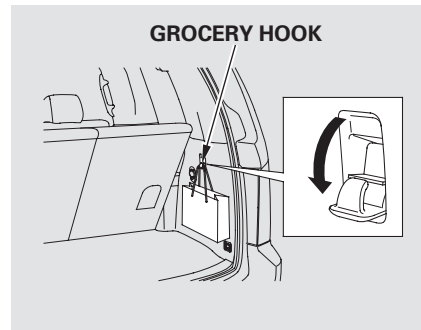

Your vehicle also has grocery hook(s) on the side panels and on the back of the third row seats in the cargo area. They are designed to hold light items. Heavy objects may damage the hook.

This section gives you tips on starting the engine under various conditions, and how to operate the automatic transmission. It also includes important information on parking your vehicle, the braking system, the Variable Torque Management[®] 4-wheel drive (VTM-4[®]) system, the vehicle stability assist (VSA[®]), aka Electronic Stability Control (ESC), system, the tire pressure monitoring system (TPMS), and facts you need if you are planning to tow a trailer or drive off-highway.

Driving Guidelines.....	410
Preparing to Drive	410
Starting the Engine.....	411
Check Starter System	
Message.....	412
Automatic Transmission.....	413
VTM-4 [®] System	418
Parking.....	419
Tire Pressure Monitoring System	
(TPMS)	420
Braking System.....	428
Anti-lock Brakes (ABS)	429
Vehicle Stability Assist (VSA [®]),	
aka Electronic Stability	
Control (ESC), System	431
Towing a Trailer	434
Off-Highway Driving	
Guidelines.....	449

Driving Guidelines, Preparing to Drive

Driving Guidelines

Your vehicle has higher ground clearance that allows you to travel over bumps, obstacles, and rough terrain. It also provides good visibility so you can anticipate problems earlier.

Because your vehicle rides higher off the ground, it has a high center of gravity that can cause it to roll over if you make abrupt turns. Utility vehicles have a significantly higher roll over rate than other types of vehicles.

To prevent rollovers or loss of control:

- Take corners at slower speeds than you would with a passenger vehicle.
- Avoid sharp turns and abrupt maneuvers whenever possible.

- Do not modify your vehicle in any way that would raise the center of gravity.
- Do not carry heavy cargo on the roof.

4WD models only

Your vehicle is equipped with a four-wheel drive (4WD) system. When the system senses a loss of front-wheel traction, it automatically transfers some power to the rear wheels. This gives you better traction and mobility.

You still need to exercise the same care when accelerating, steering, and braking that you would in a two-wheel drive vehicle.

See page [449](#) for off-highway driving guidelines.

Preparing to Drive

You should do the following checks and adjustments before you drive your vehicle.

1. Make sure all windows, mirrors, and outside lights are clean and unobstructed. Remove frost, snow, or ice.
2. Check that the hood is fully closed.
3. Visually check the tires. If a tire looks low, use a gauge to check its pressure.
4. Check that any items you may be carrying are stored properly or fastened down securely.
5. Check the seat adjustment (see page [154](#)).

Preparing to Drive, Starting the Engine

6. Check the adjustment of the inside and outside mirrors (see page [170](#)).
7. Check the steering wheel adjustment (see page [133](#)).
8. Make sure the doors, the tailgate, and the glass hatch are securely closed and locked.
9. Fasten your seat belt. Check that your passengers have fastened their seat belts (see page [17](#)).
10. When you start the engine, check the gauges and indicators in the instrument panel, and the messages on the information display or multi-information display (depending on models) (see pages [67](#), [68](#), [82](#), and [94](#)).

Starting the Engine

Your vehicle's starter system has an auto control mode. When you turn the ignition switch to the START (III) position, this feature keeps the engine's starter motor running until the engine starts. Follow these instructions to start the engine:

1. Apply the parking brake.
2. In cold weather, turn off all electrical accessories to reduce the drain on the battery.
3. Make sure the shift lever is in Park. Press on the brake pedal.
4. Without touching the accelerator pedal, turn the ignition switch to the START (III) position, then release the ignition switch. You do not need to hold the ignition switch in the START (III) position to start the engine. Depending on the outside temperature, the

starter motor runs for about 6 to 9 seconds until the engine starts.

If you hold the ignition switch in the START (III) position for more than 7 seconds, the starter motor, depending on the outside temperature, runs for about 10 to 25 seconds until the engine starts.

If the engine does not start, wait at least 10 seconds before trying again.

NOTICE

The immobilizer system protects your vehicle from theft. If an improperly coded key (or other device) is used, the engine's fuel system is disabled. For more information, see page [135](#).

CONTINUED

Starting the Engine

NOTICE

The engine is harder to start in cold weather. Also, the thinner air found at altitudes above 8,000 feet (2,400 meters) adds to this problem.

Check Starter System Message

On vehicles with navigation system

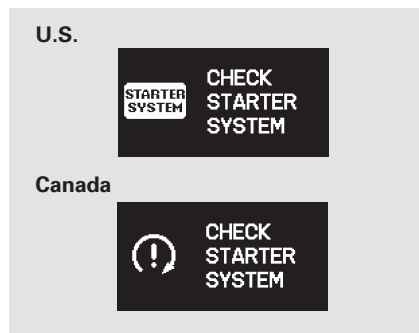

If there is a problem with the starter system, you will see a “CHECK STARTER SYSTEM” message on the multi-information display when the ignition switch is turned to the ON (II) position. You will also see this message when the auto control mode of the starter system has a problem.

If this message is on, the ignition switch has to be held in the START (III) position manually until the engine starts. The ignition switch can be held in that position up to 15 seconds.

Even though you may be able to start the engine manually without the auto control mode of the starter system, have your dealer inspect your vehicle.

Shift Lever Position Indicators

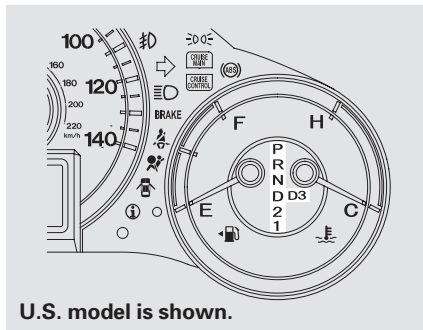

These indicators on the instrument panel show which position the shift lever is in.

The “D” indicator comes on for a few seconds when you turn the ignition switch to the ON (II) position. If it flashes while driving (in any shift position), it indicates a possible problem in the transmission.

If the malfunction indicator lamp comes on along with the “D” indicator, there is a problem with the automatic transmission control system. Avoid rapid acceleration, and have the transmission checked by your dealer as soon as possible.

On vehicles with navigation system
When the “D” indicator warns of a possible problem with the transmission, you will see a “CHECK TRANSMISSION” message on the multi-information display (see page 96).

Shifting

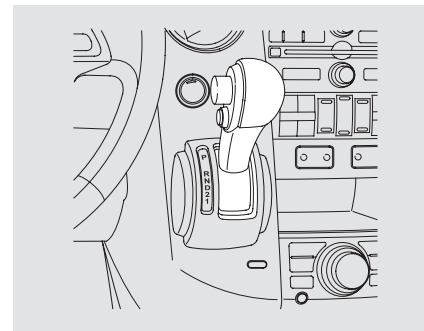

To shift from any position, press firmly on the brake pedal and the release button on the side of the shift lever. You cannot shift out of Park when the ignition switch is in the LOCK (0) or ACCESSORY (I) position.

CONTINUED

Automatic Transmission

To shift from:	Do this:
P to R	Press the brake pedal and the shift lever release button.
R to P N to R D to 2 2 to 1	Press the shift lever release button.
1 to 2 2 to D D to N N to D R to N	Move the shift lever.
D ₃ to D D to D ₃	Press the D ₃ button.

Park (P) — This position mechanically locks the transmission. Use Park whenever you are turning off or starting the engine. To shift out of Park, you must press on the brake pedal and the release button on the shift lever. Make sure your foot is off the accelerator pedal.

If you have done all of the above and still cannot move the lever out of Park, see **Shift Lock Release** on page 416.

To avoid transmission damage, come to a complete stop before shifting into Park. The shift lever must be in Park before you can remove the key from the ignition switch.

Reverse (R) — Press the brake pedal and the release button on the front of the shift lever to shift from Park to reverse. To shift from reverse to neutral, come to a complete stop, and then shift. Press the release button before shifting into reverse from neutral.

Neutral (N) — Use neutral if you need to restart a stalled engine, or if it is necessary to stop briefly with the engine idling. Shift to the Park position if you need to leave your vehicle for any reason. Press on the brake pedal when you are moving the shift lever from neutral to another gear.

Drive (D) – Use this position for your normal driving. The transmission automatically selects a suitable gear (1 through 5) for your speed and acceleration. You may notice the transmission shifting up at higher engine speeds when the engine is cold. This helps the engine warm up faster.

Drive (D₃) – To use D₃, press the D₃ button when the shift lever is in the “D” position. This position is similar to D, except only the first three gears are selected instead of all five. Use D₃ when towing a trailer in hilly terrain, or to provide engine braking when going down a steep hill. D₃ can also keep the transmission from cycling between third and fourth gears in stop-and-go driving.

Second (2) – This position locks the transmission in second gear. It does not downshift to first gear when you come to a stop.

Use second gear:

- For more power when climbing.
- To increase engine braking when going down steep hills.
- For starting out on a slippery surface or in deep snow.
- When driving downhill with a trailer.

CONTINUED

Automatic Transmission

First (1) – To shift from second to first, press the release button on the side of the shift lever. This position locks the transmission in first gear. By upshifting and downshifting through 1, 2, D3, and D, you can operate the transmission much like a manual transmission without a clutch pedal.

Engine Speed Limiter

If you exceed the maximum speed for the gear you are in, the engine speed will enter into the tachometer's red zone. If this occurs, you may feel the engine cut in and out. This is caused by a limiter in the engine's computer controls. The engine will run normally when you reduce the rpm below the red zone.

Before downshifting, make sure the engine will not go into the tachometer's red zone.

Shift Lock Release

This allows you to move the shift lever out of Park if the normal method of pushing on the brake pedal and pressing the release button does not work.

1. Set the parking brake.
2. Remove the key from the ignition switch.

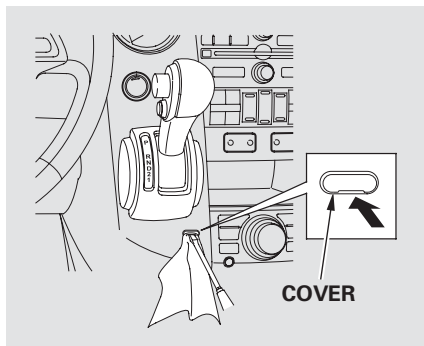

3. Put a cloth on the edge of the shift lock release slot cover to prevent scratches. Use a small flat-tip screwdriver or metal fingernail file to carefully pry up the edge of the cover and remove it from the slot.

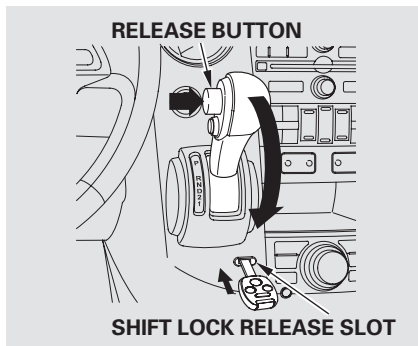

4. Insert the built-in key into the shift lock release slot.
5. Push down on the key while you press the release button on the shift lever and move the shift lever out of Park to neutral.

6. Remove the key from the shift lock release slot, then install the cover. Make sure the notch on the cover is on the underside. Insert the key back into the ignition switch, press the brake pedal, and restart the engine.

If you need to use the shift lock release, it means your vehicle is developing a problem. Have the vehicle checked by a dealer.

VTM-4® System

4WD models only

The variable torque management 4WD (VTM-4) system automatically transfers varying amounts of engine torque to the rear wheels under lower traction conditions.

If more traction is needed when your vehicle is stuck, or is likely to become stuck, you can use the VTM-4 LOCK button to increase torque to the rear wheels.

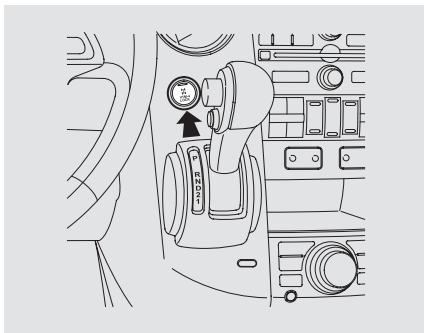

To Engage the VTM-4 Lock

1. The vehicle must be stopped with the engine running.
2. Move the shift lever to first (1), second (2), or reverse (R) gear.
3. Press the VTM-4 LOCK button. The indicator in the button comes on.

To get unstuck, apply light pressure to the accelerator pedal. Do not spin the front tires for more than a few seconds. Because of the amount of torque applied to the rear tires, they should not spin. This is normal. If you are not able to move the vehicle, stop and reverse direction.

NOTICE

Do not use the VTM-4 LOCK button on dry, paved roads. Driving on dry, paved roads with VTM-4 Lock ON may damage the rear differential when making a turn. Strange noise and vibration can also result.

To Disengage the VTM-4 Lock, do any of the following:

- Press the VTM-4 LOCK button.
- Move the shift lever to D or D3.
- Turn the ignition switch to the LOCK (0) position.

The VTM-4 Lock will temporarily disengage when the vehicle speed exceeds 18 mph (30 km/h). The indicator in the button will remain on.

NOTICE

Do not continuously spin the front tires of your vehicle. Continuously spinning the front tires can cause transmission or rear differential damage.

Always use the parking brake when you park your vehicle. Make sure the parking brake is set firmly, or your vehicle may roll if it is parked on an incline.

Set the parking brake before you put the transmission in Park. This keeps the vehicle from moving and putting pressure on the parking mechanism in the transmission.

Parking Tips

- Make sure the moonroof (if equipped) and the windows are closed.
 - Turn off the lights.
 - Place any packages, valuables, etc. in the cargo area or take them with you.
 - Lock the doors and the tailgate. Make sure the glass hatch is closed securely.
 - Never park over dry leaves, tall grass, or other flammable materials. The hot three way catalytic converter could cause these materials to catch on fire.
 - If the vehicle is facing uphill, turn the front wheels away from the curb.
 - If the vehicle is facing downhill, turn the front wheels toward the curb.
 - Make sure the parking brake is fully released before driving away. Driving with the parking brake partially set can overheat or damage the rear brakes.
- Except LX models*
- Check the indicator on the instrument panel to verify that the security system is set.

Tire Pressure Monitoring System (TPMS)

On vehicles without navigation system

Your vehicle is equipped with a tire pressure monitoring system (TPMS) that turns on every time you start the engine and monitors the pressure in your tires while driving.

Each tire has its own pressure sensor (not including the spare tire). If the air pressure of a tire becomes significantly low while driving, the sensor in that tire immediately sends a signal that causes the low tire pressure indicator to come on.



Low Tire Pressure Indicator

When the low tire pressure indicator is on, one or more of your tires is significantly underinflated. You should stop and check your tires as soon as possible, and inflate them to the proper pressure as indicated on the vehicle's tire information placard.

If you think you can safely drive a short distance to a service station, proceed slowly, and inflate the tire to the recommended pressure shown on the driver's doorjamb.

If the tire is flat, or if the tire pressure is too low to continue driving, replace the tire with the compact spare tire (see page [508](#)).

If you cannot make the low tire pressure indicator go out after inflating the tires to the specified values, have your dealer check the system as soon as possible.

Driving on a significantly under inflated tire causes the tire to overheat and can lead to tire failure. Underinflation also reduces fuel efficiency and tire tread life, and may affect the vehicle's handling and stopping ability.

Because tire pressure varies by temperature and other conditions, the low tire pressure indicator may come on unexpectedly.

Tire Pressure Monitoring System (TPMS)

For example, if you check and fill your tires in a warm area, then drive in extremely cold weather, the tire pressure will be lower than measured and could be underinflated and cause the low tire pressure indicator to come on. Or, if you check and adjust your tire pressure in cooler conditions, and drive into extremely hot conditions, the tire may become overinflated. However, the low tire pressure indicator will not come on if the tires are overinflated.

Refer to page [496](#) for tire inflation guidelines.

Although your tire pressure is monitored, you must manually check the tire pressures monthly.

Each tire, including the spare, should be checked monthly when cold, and set to the recommended inflation pressure as specified on the tire information label and in the owner's manual (see page [497](#)).



Tire Pressure Monitor

The appropriate tire indicator and low tire pressure indicator comes on if a tire becomes significantly underinflated. See **Low Tire Pressure Indicator** on page [74](#).

TPMS

Tire Pressure Monitoring System (TPMS) Indicator

This indicator comes on and stays on if there is a problem with the tire pressure monitoring system.

If this happens, the system will shut off and no longer monitor tire pressures. Have the system checked by your dealer as soon as possible.

If the low tire pressure indicator or TPMS indicator comes on, the VSA system automatically turns on even if the VSA system is turned off by pressing the VSA OFF switch (see page [432](#)). If this happens, you cannot turn the VSA system off by pressing the VSA OFF switch again.

When you restart the vehicle with the compact spare tire, the TPMS indicator may also come on and stay on after driving several miles (kilometers).

Tire Pressure Monitoring System (TPMS)

Changing a Tire with TPMS

If you have a flat tire, the low tire pressure indicator will come on. Replace the flat tire with the compact spare tire (see page 508).

Each wheel (except the compact spare tire wheel) is equipped with a tire pressure sensor. You must use TPMS specific wheels. It is recommended that you always have your tires serviced by your dealer or qualified technician.

After you replace the flat tire with the compact spare tire, the low tire pressure indicator stays on. This is normal; the system is not monitoring the spare tire pressure. Manually check the spare tire pressure to be sure it is correct. After several miles (kilometers) driving with the compact spare tire, the TPMS indicator comes on and the low tire pressure indicator goes off.

The low tire pressure indicator or the TPMS indicator will go off, after several miles (kilometers) driving, when you replace the spare tire with the specified regular tire equipped with the tire pressure monitor sensor.

Never use a puncture-repairing agent in a flat tire. If used, you will have to replace the tire pressure sensor. Have the flat tire repaired by your dealer as soon as possible.

As required by the FCC:

This device complies with Part 15 of the FCC rules. Operation is subject to the following two conditions: (1) This device may not cause harmful interference, and (2) this device must accept any interference received, including interference that may cause undesired operation.

Changes or modifications not expressly approved by the party responsible for compliance could void the user's authority to operate the equipment.

This device complies with Industry Canada Standard RSS-210.

Operation is subject to the following two conditions: (1) this device may not cause interference, and (2) this device must accept any interference that may cause undesired operation of the device.

Tire Pressure Monitoring System (TPMS)

On vehicles with navigation system

Your vehicle is equipped with a tire pressure monitoring system (TPMS) that turns on every time you start the engine and monitors the pressure in your tires while driving.

Each tire has its own pressure sensor. If the air pressure of a tire becomes significantly low, the sensor in that tire immediately sends a signal that causes the low tire pressure/TPMS indicator in the instrument panel to come on. If this happens, you will see which tire is losing pressure on the multi-information display along with a "CHECK TIRE PRESSURE" message.



Low Tire Pressure/ TPMS Indicator

When the low tire pressure/TPMS indicator is on, one or more of your tires is significantly underinflated. You should stop and check your tires as soon as possible, and inflate them to the proper pressure as indicated on the vehicle's tire information placard.

It is possible that the pressures shown on the multi-information display and the pressures you manually measure are slightly different.

If the difference is significant or you cannot make the low tire pressure/TPMS indicator and message on the multi-information display go out after inflating the tires to the specified values, have your dealer check the system as soon as possible.

If you think you can safely drive a short distance to a service station, proceed slowly to the station, then inflate the tire to the recommended pressure.

If the tire is flat, or if the tire pressure is too low to continue driving, replace the tire with the compact spare tire (see page 509).

Driving on a significantly underinflated tire causes the tire to overheat and can lead to tire failure. Under-inflation also reduces fuel efficiency and tire tread life, and may affect the vehicle's handling and stopping ability.

Because tire pressure varies by temperature and other conditions, the low tire pressure/TPMS indicator may come on unexpectedly.

CONTINUED

Tire Pressure Monitoring System (TPMS)

For example, if you check and fill your tires in a warm area, then drive in extremely cold weather, the tire pressure will be lower than measured and could be underinflated and cause the low tire pressure/TPMS indicator to come on. Or, if you check and adjust your tire pressure in cooler conditions, and drive into extremely hot conditions, the tire may become overinflated. However, the low tire pressure/TPMS indicator will not come on if the tires are overinflated.

Refer to page [496](#) for tire inflation guidelines.

If there is a problem with the TPMS, this indicator begins to flash. It stops flashing after approximately 1 minute, then stays on. You will also see a “CHECK TPMS SYSTEM” message on the multi-information display (see page [96](#)).

Although your tire pressure is monitored, you must manually check the tire pressures monthly.

Each tire, including the spare, should be checked monthly when the vehicle is cold, and set to the recommended inflation pressure as specified on the vehicle placard and in the owner’s manual (see page [497](#)).

Tire Pressure Monitor



To select the tire pressure monitor, press the INFO button several times with the ignition switch in the ON (II) position.

You will see the above display on the multi-information display when all tire pressures are normal.

Tire Pressure Monitoring System (TPMS)

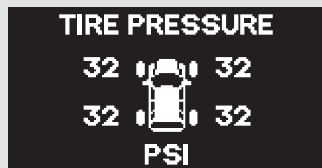

U.S. models

To see the inflation pressures of all four tires, press the SEL/RESET button. The display changes as shown above.

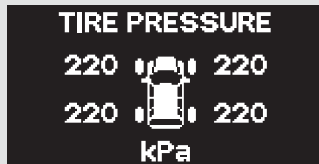

Canadian models

Each tire pressure is shown in PSI (U.S. models) or in kPa (Canadian models).



Each tire has its own pressure sensor. If the air pressure of a tire becomes significantly low, the sensor in that tire immediately sends a signal that causes the low tire pressure/TPMS indicator in the instrument panel to come on. If this happens, you will see which tire is losing pressure on the multi-information display along with a "CHECK TIRE PRESSURE" message.

CONTINUED

Tire Pressure Monitoring System (TPMS)



If any of the tires has low pressure, the tire pressure monitor also shows the above message to warn you about the low tire pressure when you select the display by pressing the INFO button several times. Following this display, press the SEL/RESET button to see each tire pressure. When you continue driving after installing the spare tire, you will also see this message on the multi-information display.

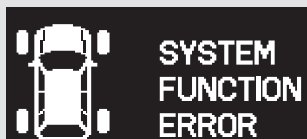

If there is a problem with the TPMS, the tire pressure monitor shows a "SYSTEM FUNCTION ERROR" message and the tire pressure readings are not displayed. If this happens, you will first see a system warning message "CHECK TPMS SYSTEM" on the multi-information display.

TPMS System Failure

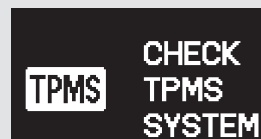

If there is a problem with the TPMS, you will see the above message on the multi-information display.

If you see this message, the system is off and is not monitoring the tire pressures. Have the system checked by your dealer as soon as possible.

Also, the low tire pressure/TPMS indicator begins to flash, then stays on (see page [423](#)).

Tire Pressure Monitoring System (TPMS)

If the low tire pressure/TPMS indicator comes on, or the multi-information display shows a “CHECK TPMS SYSTEM” message, the VSA system automatically turns on even when the VSA system is turned off by pressing the VSA OFF switch (see page 432). If this happens, you cannot turn the VSA system off by pressing the VSA OFF switch again.

When you restart the vehicle with the compact spare tire, the TPMS system message will also be displayed on the multi-information display after several miles (kilometers) driving.

Changing a Tire with TPMS

If you have a flat tire, the low tire pressure/TPMS and tire monitor indicators will come on. Replace the indicated flat tire with the compact spare tire (see page 508).

After the flat tire is replaced with the spare tire, the low tire pressure/TPMS indicator stays on while driving. After several miles (kilometers) driving, this indicator begins to flash, then stays on again. You will also see a “CHECK TPMS SYSTEM” message on the multi-information display. This is normal; the system cannot monitor the spare tire pressure. Manually check the spare tire pressure to be sure it is correct.

This indicator and the warning message on the multi-information display will go off, after several miles (kilometers) driving, when the spare tire is replaced with the specified regular tire equipped with the tire pressure monitor sensor. Each wheel is equipped with a tire pressure sensor mounted inside the tire behind the valve stem. You must use TPMS specific wheels. It is recommended that you always have

your tires serviced by your dealer or a qualified technician. Never use a puncture-repairing agent in a flat tire. If used, you will have to replace the tire pressure sensor. Have the flat tire repaired by your dealer as soon as possible.

CONTINUED

Tire Pressure Monitoring System (TPMS), Braking System

As required by the FCC:

This device complies with Part 15 of the FCC rules. Operation is subject to the following two conditions: (1) This device may not cause harmful interference, and (2) this device must accept any interference received, including interference that may cause undesired operation.

Changes or modifications not expressly approved by the party responsible for compliance could void the user's authority to operate the equipment.

This device complies with Industry Canada Standard RSS-210.

Operation is subject to the following two conditions: (1) this device may not cause interference, and (2) this device must accept any interference that may cause undesired operation of the device.

Braking System

Your vehicle is equipped with disc brakes at all four wheels. A power assist helps reduce the effort needed on the brake pedal. The emergency brake assist system increases the stopping force when you depress the brake pedal hard in an emergency situation. The anti-lock brake system (ABS) helps you retain steering control when braking very hard.

Resting your foot on the pedal keeps the brakes applied lightly, builds up heat, reduces their effectiveness and reduces brake pad life. In addition, fuel economy can be reduced. It also keeps your brake lights on all the time, confusing drivers behind you.

Constant application of the brakes when going down a long hill builds up heat and reduces their effectiveness. Use the engine to assist the brakes by taking your foot off the accelerator and downshifting to a lower gear.

Check the brakes after driving through deep water. Apply the brakes moderately to see if they feel normal. If not, apply them gently and frequently until they do. Be extra cautious in your driving.

Braking System, Anti-lock Brakes (ABS)

Braking System Design

The hydraulic system that operates the brakes has two separate circuits. Each circuit works diagonally across the vehicle (the left-front brake is connected with the right-rear brake, etc.). If one circuit should develop a problem, you will still have braking at two wheels.

Brake Wear Indicators

All four brakes have audible brake wear indicators.

If the brake pads need replacing, you will hear a distinctive, metallic screeching sound when you apply the brake pedal. If you do not have the brake pads replaced, they will screech all the time. It is normal for the brakes to occasionally squeal or squeak when you apply them.

Anti-lock Brakes (ABS)

The anti-lock brake system (ABS) helps prevent the wheels from locking up, and helps you retain steering control by pumping the brakes rapidly, much faster than a person can do it.

The electronic brake distribution (EBD) system, which is part of the ABS, also balances the front-to-rear braking distribution according to vehicle loading.

You should never pump the brake pedal. Let the ABS work for you by always keeping firm, steady pressure on the brake pedal. This is sometimes referred to as “stomp and steer.”

You will feel a pulsation in the brake pedal when the ABS activates, and may hear some noise. This is normal: it is the ABS rapidly pumping the brakes. On dry pavement, you will need to press on the brake pedal very hard before the ABS activates. However, you may feel the ABS activate immediately if you are trying to stop on snow or ice.

Anti-lock Brakes (ABS)



ABS Indicator

If this indicator comes on, the anti-lock function of the braking system has shut down. The brakes still work like a conventional system, but without anti-lock. You should have your dealer inspect your vehicle as soon as possible.

On vehicles with navigation system
You will also see a “CHECK ABS SYSTEM” message on the multi-information display (see page [95](#)).

If the indicator comes on while driving, test the brakes as instructed on page [523](#) .

If the ABS indicator and the brake system indicator come on together, and the parking brake is fully released, the EBD system may also be shut down.

On vehicles with navigation system
If this happens, you will also see “CHECK ABS SYSTEM” and “CHECK BRAKE SYSTEM” messages on the multi-information display.

Test your brakes as instructed on page [523](#) . If the brakes feel normal, drive slowly and have your vehicle repaired by your dealer as soon as possible. Avoid sudden hard braking which could cause the rear wheels to lock up and possibly lead to a loss of control.

The VSA indicator will come on along with the ABS indicator.

Important Safety Reminders
ABS does not reduce the time or distance it takes to stop the vehicle. It only helps with steering control during braking.

ABS will not prevent a skid that results from changing direction abruptly, such as trying to take a corner too fast or making a sudden lane change. Always drive at a safe speed for the road and weather conditions.

ABS cannot prevent a loss of stability. Always steer moderately when you are braking hard. Severe or sharp steering wheel movement can still cause your vehicle to veer into oncoming traffic or off the road.

A vehicle with ABS may require a longer distance to stop on loose or uneven surfaces, such as gravel or snow, than a vehicle without anti-lock.

Vehicle Stability Assist (VSA®), aka Electronic Stability Control (ESC), System

The vehicle stability assist (VSA) system helps to stabilize the vehicle during cornering if the vehicle turns more or less than desired. It also assists you in maintaining traction while accelerating on loose or slippery road surfaces. It does this by regulating the engine's output and by selectively applying the brakes.

When VSA activates, you may notice that the engine does not respond to the accelerator in the same way it does at other times. There may also be some noise from the VSA hydraulic system. You will also see the VSA activation indicator blink.

The VSA system cannot enhance the vehicle's driving stability in all situations and does not control your vehicle's entire braking system. It is still your responsibility to drive and corner at reasonable speeds and to leave a sufficient margin of safety.



VSA Activation Indicator

When VSA activates, you will see the VSA activation indicator blink.



Vehicle Stability Assist (VSA) System Indicator

If this indicator comes on while driving, pull to the side of the road when it is safe, and turn off the engine. Reset the system by restarting the engine. If the VSA system indicator stays on or comes back on while driving, have the VSA system inspected by your dealer.

NOTE: The main function of the VSA system is generally known as Electronic Stability Control (ESC). The system also includes a traction control function.

If the indicator does not come on when the ignition switch is turned to the ON (II) position, there may be a problem with the VSA system. Have your dealer inspect your vehicle as soon as possible.

On vehicles with navigation system You will also see a "CHECK VSA SYSTEM" message on the multi-information display if there is a problem with the VSA system.

CONTINUED

Vehicle Stability Assist (VSA®), aka Electronic Stability Control (ESC), System

On vehicles without navigation system

- If the low tire pressure indicator or TPMS indicator comes on, see page [420](#).

On vehicles with navigation system

- If the low tire pressure/TPMS indicator comes on, see page [423](#). Or, if the multi-information display shows a “CHECK TPMS SYSTEM” message with the indicator flashing, see page [96](#).

In this case, you cannot turn off the VSA using the OFF switch again.

Without VSA, your vehicle will have normal braking and cornering ability, but it will not have VSA traction and stability enhancement.

VSA OFF Switch

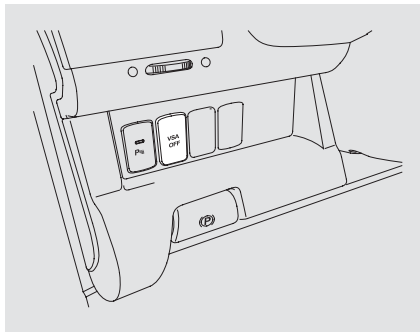

This switch is under the driver's side vent. To turn the VSA system on and off, press and hold it until you hear a beep.

When VSA is off, the VSA activation indicator comes on as a reminder.

VSA is turned on every time you start the engine, even if you turned it off the last time you drove the vehicle.

In certain unusual conditions when your vehicle gets stuck in shallow mud or fresh snow, it may be easier to free it with the VSA temporarily switched off. When the VSA system is off, the traction control system is also off. You should only attempt to free your vehicle with the VSA off if you are not able to free it when the VSA is on.

Immediately after freeing your vehicle, be sure to switch the VSA on again. We do not recommend driving your vehicle with the VSA and traction control systems switched off.

Vehicle Stability Assist (VSA®), aka Electronic Stability Control (ESC), System

VSA and Tire Sizes

Driving with varying tire or wheel sizes may cause the VSA to malfunction. When replacing tires, make sure they are of the same size and type as your original tires (see page [502](#)).

If you install winter tires, make sure they are the same size as those that were originally supplied with your vehicle. Exercise the same caution during winter driving as you would if your vehicle was not equipped with VSA.

Hill Start Assist

Your vehicle is equipped with a hill start assist feature to help prevent the vehicle from rolling on inclines as you move your foot from the brake pedal to the accelerator.

This feature starts operating a few seconds after you are in any drive gear position (when faced uphill) or in reverse (when faced downhill).

This feature requires that the vehicle has come to a complete stop before it can work.

Hill start assist may not hold a heavily loaded vehicle, such as when your vehicle is connected to a trailer, or prevent your vehicle from rolling downhill on a very steep or slippery slope.

Towing a Trailer

Your vehicle has been designed primarily to carry passengers and their cargo. You can also use it to tow a trailer if you carefully observe the load limits, use the proper equipment, and follow the guidelines in this section.

Break-In Period

Avoid towing a trailer during your vehicle's first 600 miles (1,000 km) (see page [394](#)).

Be sure to read the **Off-Highway Driving Guidelines** section on page [449](#) if you plan to tow off paved surfaces.

⚠ WARNING

Exceeding any load limit or improperly loading your vehicle and trailer can cause a crash in which you can be seriously hurt or killed.

Check the loading of your vehicle and trailer carefully before starting to drive.

Load Limit



Total Trailer Weight

The maximum allowable weight of the trailer and everything in or on it depends on the number of occupants in your vehicle and the type of trailer being towed (see page [438](#)).

Towing a trailer that is too heavy can seriously affect your vehicle's handling and performance. It can also damage the engine and drivetrain.

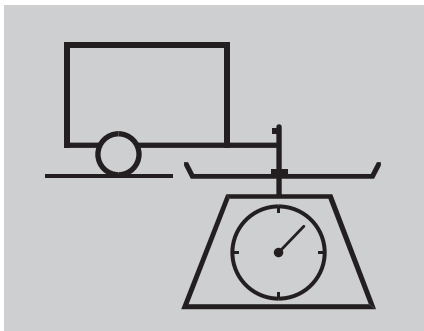

Tongue Load

The weight that the tongue of a fully loaded trailer puts on the hitch should be 5 to 10 percent of the total trailer weight for boat trailers, and 8 to 15 percent of total trailer weight for all other trailers. (See page [438](#) for limits for your towing situation). Too much tongue load reduces front-tire traction and steering control. Too little tongue load can make the trailer unstable

and cause it to sway.

Gross Vehicle Weight Rating (GVWR):

The maximum allowable weight of the vehicle, all occupants, all accessories, all cargo, and the tongue load is:

4WD models:

6,096 lbs (2,765 kg)

2WD models:

5,952 lbs (2,700 kg)

Gross Axle Weight Rating (GAWR):

The maximum allowable weight of the vehicle, all occupants, all accessories, all cargo, and the tongue load must not exceed:

4WD models:

2,921 lbs (1,325 kg)

on the front axle

3,362 lbs (1,525 kg) ^{*1}

3,251 lbs (1,475 kg) ^{*2}

on the rear axle

*1 : Except LX models

*2 : LX models

2WD models:

2,921 lbs (1,325 kg)

on the front axle

3,196 lbs (1,450 kg)

on the rear axle

Towing a Trailer

Gross Combined Weight Rating (GCWR):

The maximum allowable weight of the fully loaded vehicle and trailer with the proper hitch is:

4WD models:

9,579 lbs (4,345 kg)

2WD models:

8,466 lbs (3,840 kg)

The GCWR must be reduced 2 percent for every 1,000 feet (305 meters) of elevation.

Estimating Loads

The best way to confirm that all loads are within limits is to check them at a public scale. For public scales in your area, check your local phone book, or contact your trailer dealer or rental agency for assistance.

To help ensure a safe drive to a scale, or if you cannot get to a public scale, we recommend that you estimate your total trailer weight and tongue load as described next.

To Estimate the Total Trailer Weight

Add the weight of your trailer (as quoted by the manufacturer) with everything in or on the trailer. Then check the tables on page [438](#) to make sure you do not exceed the limit for your conditions.

To Estimate the Tongue Load

1. Park the vehicle on level ground.
2. Measure and record the distance from the ground to the bottom of the trailer hitch.
3. Connect the fully loaded trailer to the hitch.
4. Measure again from the ground to the same spot on the bottom of the hitch.
5. Subtract the second measurement from the first measurement, then refer to the following table.

2WD models

If the difference is:	Estimated tongue load is:
5/8"	150 lbs (68 kg)
1 1/4"	250 lbs (114 kg)
1 3/4"	350 lbs (159 kg)

If the difference is more than 1 ¾ inch, you have too much load on the tongue. Redistribute the load or remove cargo as needed.

4WD models

If the difference is:	Estimated tongue load is:
5/8"	150 lbs (68 kg)
1 1/4"	250 lbs (114 kg)
1 3/4"	350 lbs (159 kg)
2 1/4"	450 lbs (205 kg)

If the difference is more than 2 ¼ inch, you have too much load on the tongue. Redistribute the load or remove cargo as needed.

Towing a Trailer

Total Trailer Weight and Tongue Load Limits:

2WD models

Number of Occupants*	Maximum Total Trailer Weight	Maximum Tongue Load**
2	3,500 lbs (1,588 kg)	350 lbs (159 kg)
3	3,300 lbs (1,497 kg)	300 lbs (136 kg)
4	3,100 lbs (1,406 kg)	230 lbs (104 kg)
5	3,000 lbs (1,361 kg)	200 lbs (91 kg)
6	2,800 lbs (1,270 kg)	150 lbs (68 kg)
7	2,000 lbs (907 kg)	100 lbs (45 kg)
8	Towing is Not Recommended	

4WD models

Number of Occupants*	Maximum Total Trailer Weight	Maximum Tongue Load**
2	4,500 lbs (2,041 kg)	450 lbs (204 kg)
3	4,300 lbs (1,950 kg)	400 lbs (181 kg)
4	4,100 lbs (1,860 kg)	330 lbs (150 kg)
5	4,000 lbs (1,814 kg)	270 lbs (122 kg)
6	3,800 lbs (1,724 kg)	190 lbs (86 kg)
7	2,000 lbs (907 kg)	100 lbs (45 kg)
8	Towing is Not Recommended	

* The corresponding weight limits assume occupants fill seats from the front of the vehicle to the back, each occupant weighs 150 lbs (68 kg), and each has 15 lbs (7 kg) of cargo in the cargo area. Any additional weight, including cargo or accessories, reduces the maximum trailer weight and maximum tongue load. Never exceed the gross axle weight ratings (see page 435).

** Recommended tongue load should be 5–10% of the total trailer weight for boat trailers, and 8–15% of the total trailer weight for all other trailers.

Checking Loads

To accurately check your loads at the public scale, the vehicle and trailer should be fully loaded, and all occupants should stay in the vehicle while the attendant watches the scale.

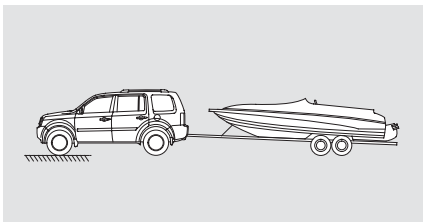

1. Check the front gross axle weight.
Limit: 2,921 lbs (1,325 kg)

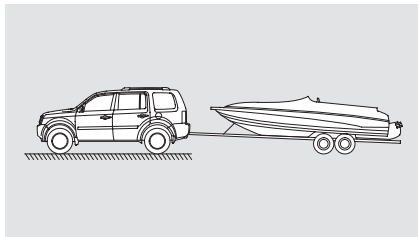

2. Check the gross vehicle weight.
Limit (4WD models): 6,096 lbs
(2,765 kg)
Limit (2WD models): 5,952 lbs
(2,700 kg)
3. Check the rear gross axle weight.
Limit (4WD models): 3,362 lbs
(1,525 kg)
Limit (2WD models): 3,196 lbs
(1,450 kg)

4. If you cannot weigh the rear axle directly, you can calculate the rear gross axle weight by subtracting the weight in step 1 from the weight in step 2.
Limit (4WD models): 3,175 lbs
(1,440 kg)
Limit (2WD models): 3,031 lbs
(1,375 kg)

CONTINUED

Towing a Trailer

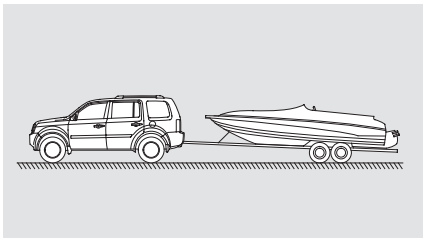

5. Check the gross combined weight.
Limit (4WD models): 9,579 lbs
(4,345 kg)
Limit (2WD models): 8,466 lbs
(3,840 kg)
Remember, maximum gross combined weight should be decreased 2% for every 1,000 feet (305 meters) of elevation.

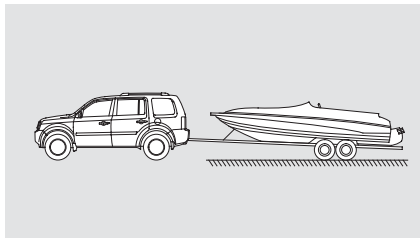

6. Check the weight of the hitched trailer. Write this number down.

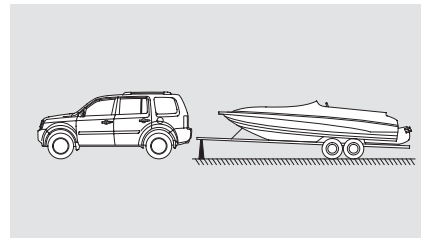

7. Check the weight of the unhitched trailer. Limit: See page [438](#).
8. Calculate the tongue load.
Subtract the weight in step 6 from the weight in step 7.
Limit: See page [438](#).
Recommended: see page [435](#).
Range: 5-10% for boat trailers
8-15% for other trailers

Towing Equipment and Accessories

Towing generally requires a variety of supplemental equipment. To ensure the best quality, we recommend that you purchase Honda equipment whenever possible.

Your dealer offers trailer packages that include a ball mount, hitch plug, and hitch pin. A wiring harness kit is also available from your dealer.

Discuss your needs with your trailer sales or rental agency, and follow the guidelines in this section. Also make sure that all equipment is properly installed and maintained, and that it meets federal, state, province, territory, and local regulations.

Hitch

Read the trailer manufacturer's instructions, and select the appropriate draw bar for the height of the trailer you will be towing.

Weight Distributing Hitch

A weight distributing hitch is not recommended for use with your vehicle, as an improperly adjusted weight distributing hitch may reduce handling, stability, and braking performance.

Trailer Brakes

Honda recommends that any trailer with a total trailer weight of 1,000 lbs (450 kg) or more has its own brakes.

There are two common types of trailer brakes: surge and electric. Surge brakes are common for boat trailers, since the brakes will get wet.

If you choose electric brakes, be sure they are electronically actuated. Do not attempt to tap into your vehicle's hydraulic system. No matter how successful it may seem, any attempt to attach trailer brakes to your vehicle's hydraulic system will lower braking effectiveness and create a potential hazard.

See your trailer dealer or rental agency for more information on installing electric brakes.

CONTINUED

Towing a Trailer

A factory installed, 4-pin gray connector is located under the instrument panel near the top of the parking brake pedal. This connector has all of the circuits required to install most electric trailer brake controllers. A jumper harness to adapt your electric trailer brake controller to the vehicle is included with the optional Genuine Honda trailer hitch kit. To obtain a trailer hitch kit, see your dealer.

Have a qualified mechanic install your trailer brake controller following the trailer brake controller manufacturer's instructions. Failure to properly install the trailer brake controller may increase the distance it takes for you to stop your vehicle when towing a trailer.

Use this illustration to identify each terminal in the trailer brake controller connector.

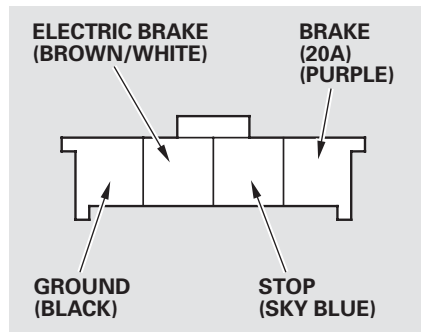

Safety Chains

Always use safety chains when you tow a trailer. Make sure the chains are secured to the trailer and hitch, and that they cross under the tongue and can catch the trailer if it becomes unhitched. Leave enough slack to allow the trailer to turn corners easily, but do not let the chains drag on the ground.

Sway Control

This device is recommended if your trailer tends to sway. Your trailer dealer or rental agency can tell you what kind of sway control you need and how to install it.

Trailer Mirrors

Many states and provinces require special exterior mirrors when towing a trailer. Even if they don't, you should install special mirrors if you cannot clearly see behind you, or if the trailer creates a blind spot.

Spare Tires

When towing a trailer, we recommend that you carry a full-size spare wheel and tire for your vehicle and trailer. When replacing the compact spare with a full size spare, remove the plastic spacer (see page 501). Store the plastic spacer and compact spare together. Reinstall the spacer before once again stowing the compact spare.

See page 502 for proper tire size, page 515 for how to store a full size wheel and tire, and page 509 for information on changing a flat tire.

Remember to unhitch the trailer before changing a flat. Ask your trailer sales or rental agency where and how to store the trailer's spare tire.

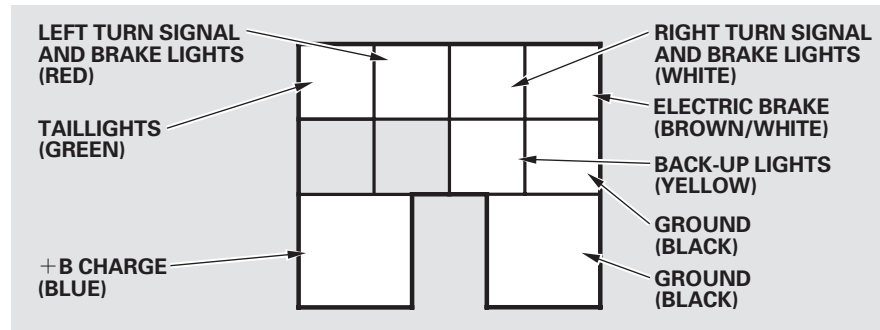
Trailer Lights

Trailer lights and equipment must comply with federal, state, province/territory, and local regulations. Check trailer light requirements for the areas where you plan to tow, and use only equipment designed for your vehicle.

Your vehicle is equipped with a connector to install an optional trailer lighting connector that mates with your vehicle. You can get this optional connector from your dealer.

Refer to the above illustration for wiring information.

CONTINUED

Towing a Trailer

We recommend that you have your dealer install a Honda wiring harness and converter. This harness has been designed for your vehicle.

If you use a non-Honda trailer lighting harness and converter, you can get the connector and pins that mate with the connector in your vehicle from your dealer.

Since lighting and wiring vary with trailer type and brand, you should also have a qualified mechanic install a suitable connector between the vehicle and the trailer.

Towing Equipment

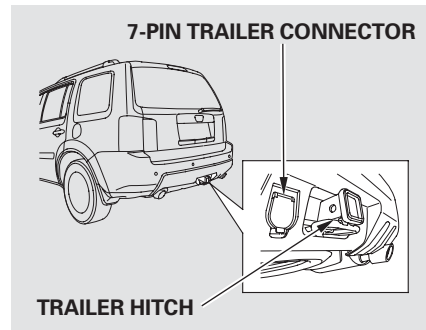

Your vehicle has a class 3 trailer hitch as standard equipment.

The jumper harness and trailer brake fuse are stored in the glove box.

Also see page [441](#) for trailer-related information.

Connecting the Trailer Connectors On Touring models

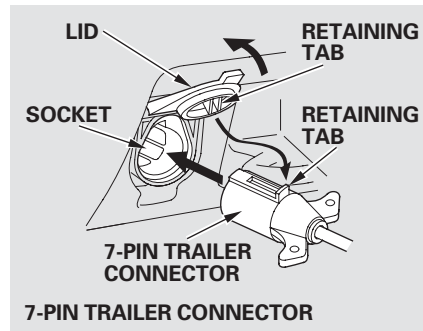

The 7-pin trailer connector is needed for the trailer lights. To connect the connector:

1. Make sure the connector and the socket are free of dirt, moisture, or other foreign material.
2. Open the socket lid by pulling it up.

3. Insert the connector securely into the socket.

Hook the retaining tab on the inner side of the lid against the retaining tab of the connector to prevent disconnection during operation.

Trailer Connector Sockets *On Touring models*

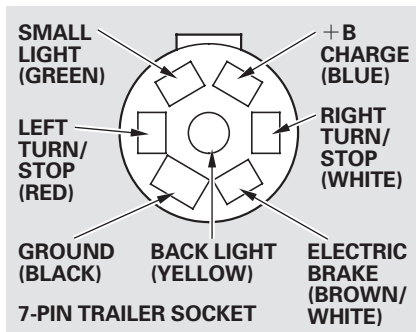

Refer to the above illustrations for wiring information.

Trailer Jumper Harness *On Touring models*

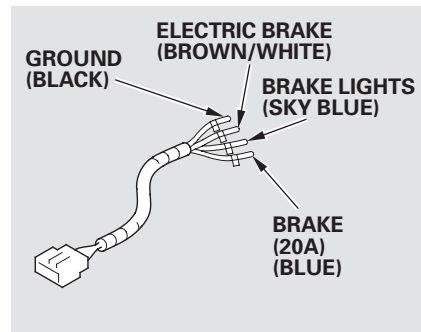

The trailer jumper harness is used to install the controller for the electric trailer brakes. For more information, see **Trailer Brakes** on page [441](#).

Trailer Brake Fuse

Insert the trailer brake fuse into the secondary under-hood fuse box (see page [529](#)).

Towing a Trailer

Pre-Tow Checklist

When preparing to tow, and before driving away, be sure to check the following:

- The vehicle has been properly serviced, and the suspension and the cooling system are in good operating condition.
- The trailer has been properly serviced and is in good condition.
- All weights and loads are within limits.
- The hitch, safety chains, and any other attachments are secure.
- All items on and in the trailer are properly secured and cannot shift while you drive.

- The lights and brakes on your vehicle and the trailer are working properly.
- Your vehicle tires and spare are in good condition and properly inflated.
- Towing performance can be affected by high altitude, high temperature, or when climbing steep grades. Therefore, premium fuel (premium unleaded gasoline with pump octane number of 91 or higher) is recommended when towing more than 3,500 lbs (1,590 kg).
- The trailer tires and spare are in good condition and inflated as recommended by the trailer maker.

Driving Safely With a Trailer

The added weight, length, and height of a trailer will affect your vehicle's handling and performance, so driving with a trailer requires some special driving skills and techniques.

For your safety and the safety of others, take time to practice driving maneuvers before heading for the open road, and follow the guidelines in this section.

Towing Speeds and Gears

Drive slower than normal in all driving situations, and obey posted speed limits for vehicles with trailers. Use D position when towing a trailer on level roads. D3 is the proper shift lever position to use when towing a trailer in hilly terrain. (See “***Driving on Hills***” on the [next](#) page for additional gear information.)

When towing a fixed-sided trailer (e.g., camper), do not exceed 55 mph (88 km/h). At higher speeds, the trailer may sway or affect vehicle handling.

Making Turns and Braking

Make turns more slowly and wider than normal. The trailer tracks a smaller arc than your vehicle, and it can hit or run over something the vehicle misses.

Allow more time and distance for braking. Do not brake or turn suddenly as this could cause the trailer to jackknife or turn over.

CONTINUED

Towing a Trailer

Driving on Hills

When climbing hills, closely watch your temperature gauge. If it nears the red (Hot) mark, turn the air conditioning off, reduce speed and, if necessary, pull to the side of the road to let the engine cool.

If the automatic transmission shifts frequently while going up a hill, shift to D3.

If you must stop when facing uphill, use the foot brake or parking brake. Do not try to hold the vehicle in place by pressing on the accelerator, as this can cause the automatic transmission to overheat.

When driving down hills, reduce your speed and shift down to D3. Do not “ride” the brakes. **Remember, it takes longer to slow down and stop when towing a trailer.**

Handling Crosswinds and Buffeting

Crosswinds and air turbulence caused by passing trucks can disrupt your steering and cause the trailer to sway. When being passed by a large vehicle, keep a constant speed, and steer straight ahead. Do not try to make quick steering or braking corrections.

Backing Up

Always drive slowly and have someone guide you when backing up. Grip the *bottom* of the steering wheel, then turn the wheel to the left to get the trailer to move to the left. Turn the wheel to the right to move the trailer to the right.

Parking

Follow all normal precautions when parking, including putting the transmission in Park and firmly setting the parking brake. Also, place wheel chocks at each of the trailer’s tires.

Retrieving a Boat

If the vehicle’s tires slip when retrieving a boat from the water, shift to first gear, and turn on VTM-4 lock (see page [418](#)). Disengage VTM-4 lock as soon as the boat is out of the water to prevent damage to the VTM-4 system.

Towing Your Vehicle

Your vehicle is not designed to be towed behind a motor home. If your vehicle needs to be towed in an emergency, see page [531](#).

General Information

Your vehicle has been designed primarily for use on pavement. But its higher ground clearance allows you to occasionally travel on unpaved roads, such as campgrounds, picnic sites, and similar locations. It is not designed for trail-blazing, mountain climbing, or other challenging off-road activities.

If you decide to drive on unpaved roads, you will find that it requires somewhat different driving skills. Your vehicle will also handle somewhat differently than it does on pavement. Be sure to pay extra attention to the precautions and tips in this section, and get acquainted with your vehicle before leaving the pavement.

WARNING

Improperly operating this vehicle on or off-pavement can cause a crash or rollover in which you and your passengers could be seriously injured or killed.

- Follow all instructions and guidelines in this owner's manual.
- Keep your speed low, and don't drive faster than conditions permit.

Important Safety Precautions

To avoid loss of control or rollover, be sure to follow all precautions and recommendations.

- Be sure to store cargo properly and do not exceed your cargo load limits (see page [405](#) and [434](#)).
- Whenever you drive, make sure you and your passengers always wear seat belts.
- Keep your speed low, and never go faster than the conditions allow.
- It's up to you to continually assess the situation and drive within the limits.

Off-Highway Driving Guidelines

Check Out Your Vehicle

Before you leave the pavement, be sure to do all scheduled maintenance and service, and inspect your vehicle for any problems. Pay special attention to the condition of the tires, and check the tire pressures.

After you return to the pavement, carefully inspect your vehicle to make sure there is no damage that could make driving it unsafe. Recheck the condition of the tires and the tire pressures.

Remember

The route presents limits (too steep or bumpy roads). You have limits (driving skill and comfort). And your vehicle has limits (traction, stability, and power).

Driving off-highway can be hazardous if you fail to recognize limits and take the proper precautions.

Accelerating and Braking

For better traction on all surfaces, accelerate slowly and gradually build up speed. If you try to start too fast on wet soil, mud, snow, or ice, you might not have enough traction to get underway, and you may dig yourself a hole. Starting with the shift lever in D position will help you have a smoother start on snow or ice.

Keep in mind that you will usually need more time and distance to brake to a stop on unpaved surfaces. Avoid hard braking. Do not “pump” the brakes; let the anti-lock braking system pump them for you.

Avoiding Obstacles

Debris in the road can damage your suspension or other components. Because your vehicle has a high center of gravity, driving over a large obstacle, or allowing a wheel to drop into a deep hole can cause your vehicle to tip or roll over.

Driving on Slopes

If you can't clearly see all conditions or obstacles on a slope, walk the slope before you drive on it. If you have any doubt whether or not you can safely drive on the slope, don't do it. Find another route.

If you are driving up a hill and find that you cannot continue, *do not try to turn around*. Your vehicle could roll over. Slowly back down the hill, following the same route you took up the hill.

Crossing a Stream

Before driving through water, stop, get out if necessary, and make sure that:

- The water is not deep enough to cover your wheel hubs, axles, or exhaust pipe. You could stall and not be able to restart your engine. The water can also damage important vehicle components.
- The banks are sloped so you can drive out.
- The water is not flowing too fast. Deep rushing water can sweep you downstream. Even very shallow rushing water can wash the ground from under your tires and cause you to lose traction and possibly roll over.

- The banks and surface under the water provide good traction. The water may hide hazards such as rocks, holes, or mud.

If you decide it is safe to drive through water, choose a suitable speed and engage the VTM-4 Lock. Proceed without shifting or changing speeds, and do not stop the vehicle or shut off the engine.

After driving through water, test your brakes. If they got wet, gently “pump” them while driving slowly until they operate normally.

If the water is deeper than the wheel hubs, some additional service may be required. This service is not covered by your warranties.

If You Get Stuck

If you get stuck, engage the VTM-4 Lock (see page 418). Carefully try to go in the direction (forward or reverse) that you think will get you unstuck. Do not spin the tires at high speeds. It will not help you get out and may cause damage to the transmission or VTM-4 system.

If you are still unable to free yourself, your vehicle is equipped with front and rear tow hooks designed for this purpose.

CONTINUED

Off-Highway Driving Guidelines

Use a nylon strap to attach your vehicle to the recovery vehicle, and carefully take out the slack in the strap. Once the strap is tight, the recovery vehicle should apply force. Remember that the recovery vehicle needs good traction to avoid becoming stuck, too.

You should never use a jack to try to get unstuck. Your vehicle could easily slip off the jack and hurt you or someone else.

Towing a Trailer Off-Road

You may be able to safely tow a lightweight trailer (such as a motorcycle or small tent trailer) off-road if you follow these guidelines.

- Do not exceed 1,000 lbs (450 kg) or a tongue weight of 100 lbs (45 kg).
- Stay on smooth, level dirt roads, and avoid driving in hilly terrain.
- Allow extra room for starting, stopping, and turning.
- Slow down if you encounter bumps or other obstacles.

This section explains why it is important to keep your vehicle well maintained and how to follow basic maintenance safety precautions.

This section also includes instructions on how to read the maintenance information messages on the information display or multi-information display (depending on models), and instructions for simple maintenance tasks you may want to take care of yourself.

If you have the skills and tools to perform more complex maintenance tasks on your vehicle, you may want to purchase the service manual. See page 557 for information on how to obtain a copy, or see your dealer.

Maintenance Safety	454
Maintenance Information	455
Fluid Locations.....	470
Engine Compartment Covers.....	471
Adding Engine Oil	472
Changing the Engine Oil and Filter	473
Engine Coolant.....	475
Windshield Washers	477
Automatic Transmission Fluid....	478
Rear Differential Fluid	480
Transfer Assembly Fluid	480
Brake Fluid.....	481
Power Steering Fluid.....	482
Timing Belt.....	482
Lights	483
Dust and Pollen Filter	490
Cleaning the Seat Belts.....	490
Floor Mats	491
Wiper Blades	492
Tires	496
Checking the Battery.....	504
Vehicle Storage.....	505
Interior Care.....	506

Maintenance Safety

All service items not detailed in this section should be performed by a certified technician or other qualified mechanic.

Important Safety Precautions

To eliminate potential hazards, read the instructions before you begin, and make sure you have the tools and skills required.

- Make sure your vehicle is parked on level ground, the parking brake is set, and the engine is off.
- To clean parts, use a commercially available degreaser or parts cleaner, not gasoline.
- To reduce the possibility of fire or explosion, keep cigarettes, sparks, and flames away from the battery and all fuel-related parts.

- Wear eye protection and protective clothing when working with the battery or compressed air.

WARNING

Improperly maintaining this vehicle, or failing to correct a problem before driving can cause a crash in which you can be seriously hurt or killed.

Always follow the inspection and maintenance recommendations and schedules in this owner's manual.

Potential Vehicle Hazards

- **Carbon Monoxide poison from engine exhaust.** Be sure there is adequate ventilation whenever you operate the engine.
- **Burns from hot parts.** Let the

engine and exhaust system cool down before touching any parts.

- **Injury from moving parts.** Do not run the engine unless instructed to do so.

WARNING

Failure to properly follow maintenance instructions and precautions can cause you to be seriously hurt or killed.

Always follow the procedures and precautions in this owner's manual.

Some of the most important safety precautions are given here. However, we cannot warn you of every conceivable hazard that can arise in performing maintenance. Only you can decide whether or not you should perform a given task.

Maintenance Information

Your vehicle displays engine oil life and maintenance service items on the information display or multi-information display (depending on models) to show you when you should have your dealer perform engine oil replacement and indicated maintenance services.

Based on the engine operating conditions and accumulated engine revolutions, the onboard computer in your vehicle calculates the remaining engine oil life and displays it as a percentage.

The remaining engine oil life is shown on the display according to this table:

Calculated Engine Oil Life (%)	Displayed Engine Oil Life (%)
100 % – 91 %	100 %
90 % – 81 %	90 %
80 % – 71 %	80 %
70 % – 61 %	70 %
60 % – 51 %	60 %
50 % – 41 %	50 %
40 % – 31 %	40 %
30 % – 21 %	30 %
20 % – 16 %	20 %
15 % – 11 %	15 %
10 % – 6 %	10 %
5 % – 1 %	5 %
0 %	0 %

Engine Oil Life Display

On vehicles without navigation system

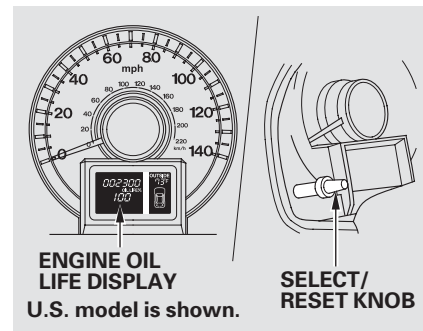

To see the current engine oil life, turn the ignition switch to the ON (II) position, and press the select/reset knob repeatedly until the engine oil life display appears (see page 83).

CONTINUED

Maintenance Information

MAINTENANCE INFORMATION INDICATOR

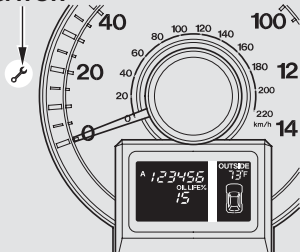

U.S. model is shown.

If the remaining engine oil life is 15 to 6 percent, you will see the engine oil life indicator every time you turn the ignition switch to the ON (II) position. The maintenance information indicator will also come on, and the maintenance item code(s) for other scheduled maintenance items needing service will be displayed near the “OIL LIFE” message.

MAINTENANCE ITEM CODE(S)

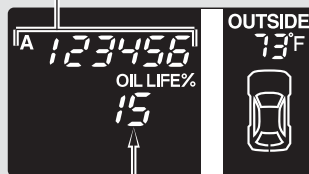

ENGINE OIL LIFE INDICATOR

U.S. model is shown.

The 15 and 10 percent oil life indicators remind you that your vehicle will soon be due for scheduled maintenance.

“SERVICE” MESSAGE



U.S. model is shown.

When the remaining engine oil life is 5 to 1 percent, you will see a “SERVICE” message along with the same maintenance item code(s), every time you turn the ignition switch to the ON (II) position.

Maintenance Information

The maintenance item code or codes indicate the main and sub items required at the time of the oil change (see page 458).

You can switch the information display from the engine oil life display to the odometer or the trip meter. Press and release the select/reset knob on the instrument panel.

When the engine oil life is 15 to 1 percent, the maintenance information indicator () comes on every time you turn the ignition switch to the ON (II) position, then it goes out if you switch the information display.

When you see this message, have the indicated maintenance performed by your dealer as soon as possible.

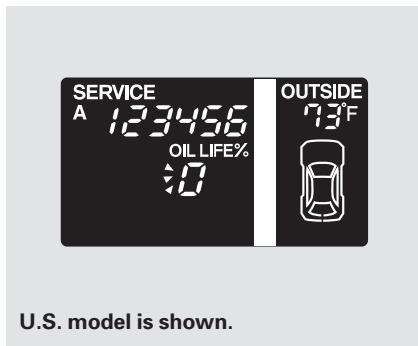

When the remaining engine oil life is 0 percent, the engine oil life indicator will blink. The display comes on every time you turn the ignition switch to the ON (II) position. The maintenance information indicator () also comes on and remains on in the instrument panel. When you see this message, immediately have the indicated maintenance done by your dealer.

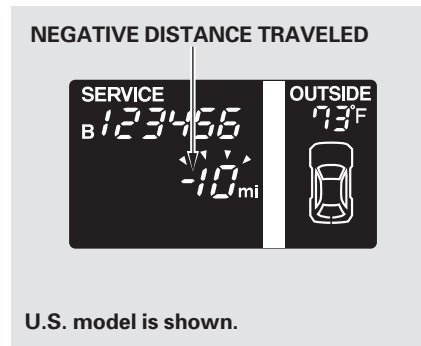

If you do not perform the indicated maintenance, negative distance traveled is displayed and begins to blink after the vehicle has been driven 10 miles (10 km) or more.

Negative distance traveled means your vehicle has passed the maintenance required point.

Immediately have the indicated maintenance done by your dealer.

CONTINUED

Maintenance Information

To change the information display from the engine oil life display to the odometer or the trip meter, press and release the select/reset knob.

When the engine oil life is 0 percent or negative distance traveled, the maintenance information indicator () remains on even if you change the information display.

Immediately have the service performed, and make sure to reset the display as described as follows.

Maintenance Main Items and Sub Items

On vehicles without navigation system

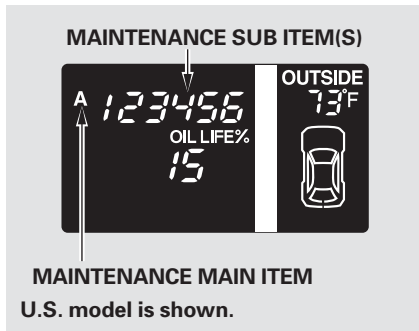

All maintenance items displayed on the information display are in code. For an explanation of these maintenance codes, see page [469](#).

Resetting the Engine Oil Life Display

On vehicles without navigation system

Your dealer will reset the display after completing the required maintenance service. You will see “OIL LIFE 100%” on the information display the next time you turn the ignition switch to the ON (II) position.

If maintenance service is done by someone other than your dealer, reset the maintenance information as follows:

1. Turn the ignition switch to the ON (II) position.
2. Press the select/reset knob repeatedly until the engine oil life is displayed.

Maintenance Information

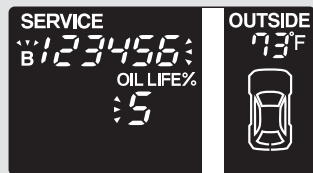

U.S. model is shown.

- Press the select/reset knob for about 10 seconds. The engine oil life and the maintenance item code(s) will blink.

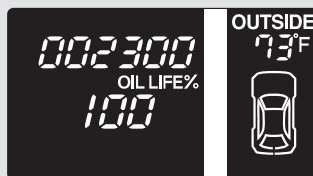

U.S. model is shown.

- Press the select/reset knob for another 5 seconds. The maintenance item code(s) will disappear, and the engine oil life will reset to "100."

On vehicles with navigation system

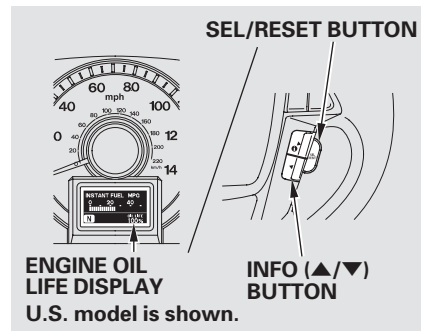

To see the current engine oil life, turn the ignition switch to the ON (II) position, and push and release the INFO (▲/▼) button on the steering wheel repeatedly, until the engine oil life is displayed (see page [88](#)).

CONTINUED

Maintenance Information

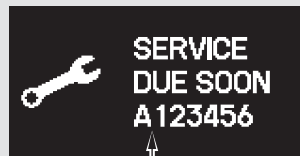

MAINTENANCE ITEM CODE(S)

When the remaining engine oil life is 15 percent or less, the display shows a “SERVICE DUE SOON” message along with the maintenance item code(s) for other scheduled maintenance items needing service.

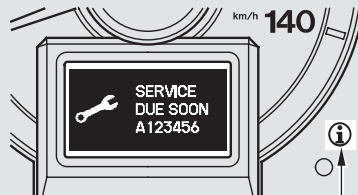

SYSTEM MESSAGE INDICATOR

The system message indicator on the instrument panel will also come on, and a beeper will sound.

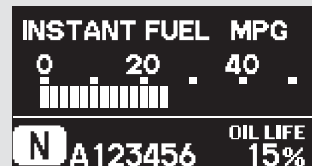

U.S. model is shown.

To cancel the system message, press and release the INFO (▲/▼) button on the steering wheel. At this time, the system message indicator will also be turned off. Then the display will change to the engine oil life display. You will see the maintenance item code(s) along with the engine oil life on the multi-information display.

You will also see the system message every time you turn the ignition switch to the ON (II) position until you have the indicated maintenance performed by your dealer.

The maintenance item code(s) indicate the main and sub items required at the time of the oil change (see page [465](#)).

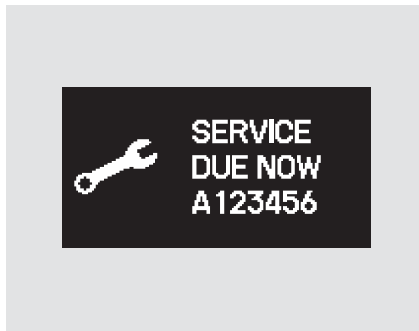

When the remaining engine oil life is less than 5 percent, you will see the above display. The display then changes to “SERVICE DUE NOW.” Have the indicated maintenance done as soon as possible.

The system message indicator on the instrument panel will also come on, and a beeper will sound.

CONTINUED

Maintenance Information

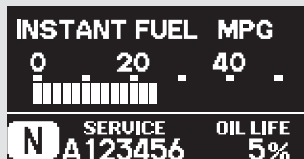

U.S. model is shown.

To cancel the system message, press and release the INFO (▲/▼) button on the steering wheel. At this time, the system message indicator will also be turned off. Then the display will change to the engine oil life display. You will see a “SERVICE” message and along with the maintenance item code(s) on the multi-information display.

You will also see the system message every time you turn the ignition switch to the ON (II) position until you have the indicated maintenance performed by your dealer.



U.S. model is shown.

If the indicated maintenance service is not done and the engine oil life reaches 0 percent, you will see a “SERVICE PAST DUE” message along with the maintenance item code(s) on the multi-information display.

Maintenance Information

The system message indicator on the instrument panel will also come on, and a beeper will sound.

When you see this message, have the indicated maintenance done by your dealer immediately.

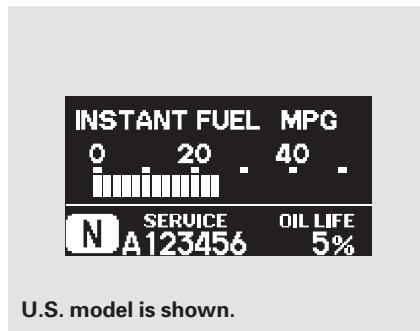

To cancel the system message, press and release the INFO (▲/▼) button on the steering wheel. At this time, the system message indicator will *not* be turned off. Then the display will change to the engine oil life display. You will see the engine oil life blinking and a “SERVICE” message along with the maintenance item code(s) on the multi-information display.

The system message will appear again by pressing the INFO (▲/▼) button after canceling it.

You will also see the system message every time you turn the ignition switch to the ON (II) position until you have the indicated maintenance performed by your dealer.

CONTINUED

Maintenance Information



If the indicated required service is not done and the remaining engine oil life becomes 0%, the multi-information display will show a “SERVICE PAST DUE” message, the total distance traveled after the remaining oil life became 0%, and the maintenance item code(s).

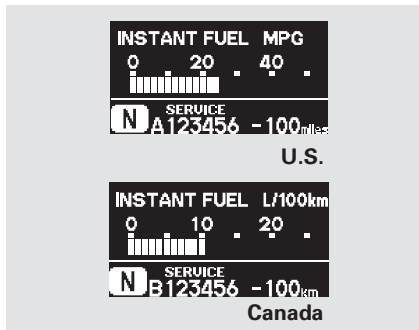

To cancel the system message, press and release the INFO (▲/▼) button on the steering wheel. At this time, the system message indicator will **not** be turned off. Then the display will change to the engine oil life display. You will see the negative distance traveled blinking and a “SERVICE” message along with the maintenance item code(s) on the multi-information display.

The system message will appear again by pressing the INFO (▲/▼) button after canceling it.

You will also see the system message every time you turn the ignition switch to the ON (II) position until you have the indicated maintenance performed by your dealer.

Negative distance traveled means your vehicle has passed the maintenance required point.

Immediately have the service performed, and make sure to reset the display as described on page [465](#).

Maintenance Main Items and Sub Items

On vehicles with navigation system

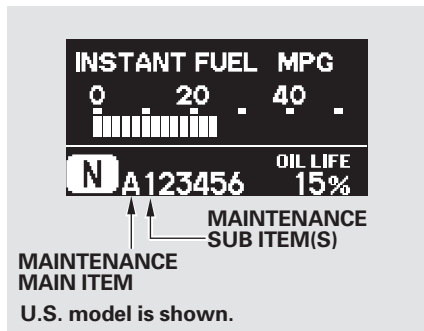

All maintenance items displayed on the information display are in code. For an explanation of these maintenance codes, see page [469](#).

Resetting the Engine Oil Life Display

On vehicles with navigation system

Your dealer will reset the display after completing the required maintenance service. You will see “OIL LIFE 100%” on the display the next time you turn the ignition switch to the ON (II) position.

If maintenance service is done by someone other than your dealer, reset the maintenance information as follows:

1. Turn the ignition switch to the ON (II) position.
2. Press the SEL/RESET button on the steering wheel until you see the engine oil life display.

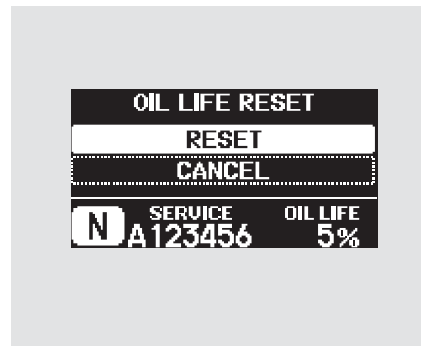

3. Press and hold the SEL/RESET button on the steering wheel for more than 10 seconds. The remaining engine oil life reset mode will be shown on the multi-information display.

CONTINUED

Maintenance Information



U.S. model is shown.

4. Select “RESET” by pressing the INFO (▲/▼) button, then press the SEL/RESET button to reset the engine oil life display. The maintenance item code(s) will disappear, and the engine oil life will reset to “100.” If you want to cancel the oil life reset mode, select “CANCEL.”

Important Maintenance Precautions

If you have the required service done but do not reset the display, or reset the display without doing the service, the system will not show the correct maintenance intervals. This can lead to serious mechanical problems because you will no longer have an accurate record of when maintenance is needed.

Your authorized Honda dealer knows your vehicle best and can provide competent, efficient service.

However, service at a dealer is not mandatory to keep your warranties in effect. Maintenance may be done by any qualified service facility or person who is skilled in this type of automotive service. Make sure to have the service facility or person reset the display as previously described. Keep all receipts as proof of completion, and have the person who does the work fill out your Honda Service History or Canadian Maintenance Log. Check your warranty booklet for more information.

We recommend the use of Honda parts and fluids whenever you have maintenance done. These are manufactured to the same high-quality standards as the original components, so you can be confident of their performance and durability.

U.S. Vehicles:
Maintenance, replacement, or repair of emissions control devices and systems may be done by any automotive repair establishment or individual using parts that are “certified” to EPA standards.

According to state and federal regulations, failure to perform maintenance on the items marked with # will not void your emissions warranties. However, all maintenance services should be performed in accordance with the intervals indicated by the odometer/trip meter display or the multi-information display.

Owner’s Maintenance Checks

You should check the following items at the specified intervals. If you are unsure of how to perform any check, turn to the appropriate page listed.

- Engine oil level – Check every time you fill the fuel tank. See page [398](#) .
- Engine coolant level – Check the radiator reserve tank every time you fill the fuel tank. See page [398](#) .
- Automatic transmission – Check the fluid level monthly. See page [478](#) .

CONTINUED

Maintenance Information

- Brakes — Check the fluid level monthly. See page [481](#) .
- Tires — Check the tire pressure monthly. Examine the tread for wear and foreign objects. See page [497](#) .
- Lights — Check the operation of the headlights, parking lights, taillights, high-mount brake light, and license plate lights monthly. See page [483](#) .

Symbol	Maintenance Main Items
A	<ul style="list-style-type: none"> ● Replace engine oil^{*1}
B	<ul style="list-style-type: none"> ● Replace engine oil^{*1} and oil filter ● Inspect front and rear brakes ● Check parking brake adjustment ● Inspect these items: <ul style="list-style-type: none"> ● Tie rod ends, steering gear box, and boots ● Suspension components ● Driveshaft boots ● Brake hoses and lines (including ABS/VSA) ● All fluid levels and condition of fluids ● Exhaust system[#] ● Fuel lines and connections[#]

* 1 : If the message, "SERVICE" does not appear more than 12 months after the display is reset, change the engine oil every year.

: See information on maintenance and emissions warranty on page 467.

NOTE : ● Independent of the maintenance messages in the information display, replace the brake fluid every 3 years.
● Inspect idle speed every 160,000 miles (256,000 km).
● Adjust the valves during services A, B, 1, 2, or 3 if they are noisy.

Symbol	Maintenance Sub Items
1	<ul style="list-style-type: none"> ● Rotate tires
2	<ul style="list-style-type: none"> ● Replace air cleaner element If you drive in dusty conditions, replace every 15,000 miles (24,000 km). ● Replace dust and pollen filter If you drive primarily in urban areas that have high concentrations of soot in the air from industry and from diesel-powered vehicles, replace every 15,000 miles (24,000 km). ● Inspect drive belt
3	<ul style="list-style-type: none"> ● Replace transmission and transfer^{**2} fluid
4	<ul style="list-style-type: none"> ● Replace spark plugs ● Replace timing belt and inspect water pump If you drive regularly in very high temperatures (over 110°F, 43°C), in very low temperatures (under -20°F, -29°C), or towing a trailer, replace every 60,000 miles (U.S.)/100,000 km (Canada). ● Inspect valve clearance
5	<ul style="list-style-type: none"> ● Replace engine coolant
6	<ul style="list-style-type: none"> ● Replace VTIM-4 rear differential fluid^{**2} Driving in mountainous areas at very low vehicle speeds or trailer towing results in higher level of mechanical (shear) stress to fluid. This requires differential fluid changes more frequently than recommended by the maintenance information. If you regularly drive your vehicle under these conditions, have the differential fluid changed at 7,500 miles (12,000 km), then every 15,000 miles (24,000 km).

*2 : 4WD models only

Fluid Locations

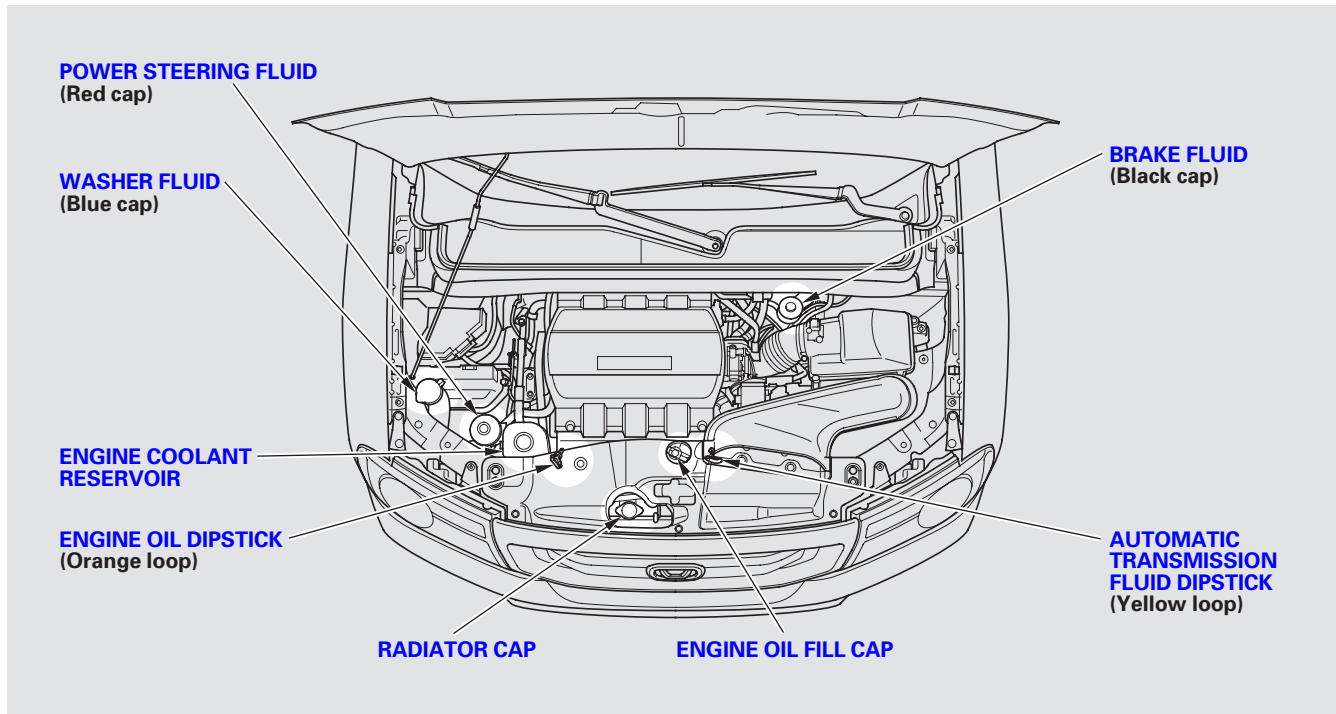

Engine Compartment Covers

The component parts in the engine compartment are protected by the cover. You may need to remove the cover and the air intake cover when you perform some simple maintenance work.

Covers are secured by holding clips.

To remove the front bulkhead cover and the air intake cover, remove the holding clips with a flat-tip screwdriver.

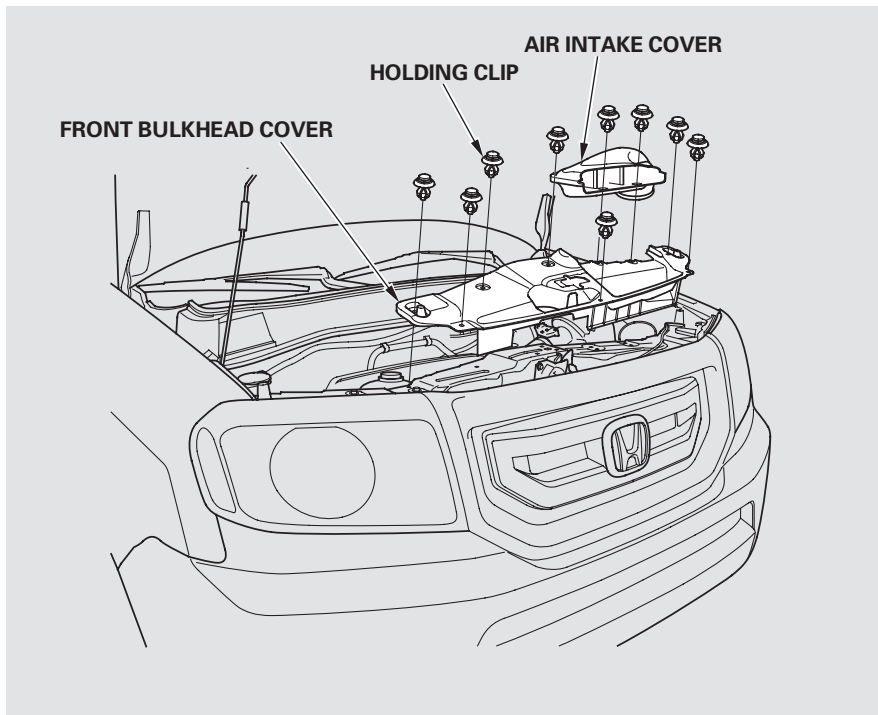

Adding Engine Oil

ENGINE OIL FILL CAP

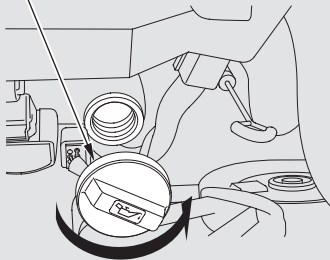

Unscrew and remove the engine oil fill cap on top of the valve cover. Pour in the oil slowly and carefully so you do not spill any. Clean up any spills immediately. Spilled oil could damage components in the engine compartment.

Reinstall the engine oil fill cap, and tighten it securely. Wait a few minutes, and recheck the oil level on the engine oil dipstick. Do not fill above the upper mark; you could damage the engine.

Recommended Engine Oil

Oil is a major contributor to your engine's performance and longevity. Always use a premium-grade 5W-20 detergent oil displaying the API Certification Seal. This seal indicates the oil is energy conserving, and that it meets the American Petroleum Institute's latest requirements. It is highly recommended that you use Honda motor oil in your vehicle. Make sure the API Certification Seal says "For Gasoline Engines."



API CERTIFICATION SEAL

The oil viscosity or weight is provided on the container's label. 5W-20 oil is formulated for year-round protection of your vehicle to improve cold weather starting and fuel economy.

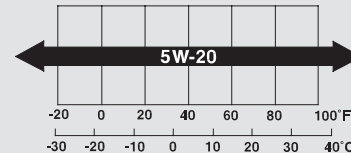

Ambient Temperature

Adding Engine Oil, Changing the Engine Oil and Filter

Synthetic Oil

You may use a synthetic motor oil if it meets the same requirements given for a conventional motor oil: it displays the API Certification Seal, and it is the proper weight. You must follow the oil and filter change intervals shown on the odometer/trip meter display or on the multi-information display.

Engine Oil Additives

Your vehicle does not require any oil additives. Additives may adversely affect the engine or transmission performance and durability.

Changing the Engine Oil and Filter

Always change the oil and filter according to the maintenance messages shown on the information display or multi-information display (depending on models). The oil and filter collect contaminants that can damage your engine if they are not removed regularly.

Changing the oil and filter requires special tools and access from underneath the vehicle. The vehicle should be raised on a service station-type hydraulic lift for this service. Unless you have the knowledge and proper equipment, you should have this maintenance done by a skilled mechanic.

1. Run the engine until it reaches normal operating temperature, then shut it off.

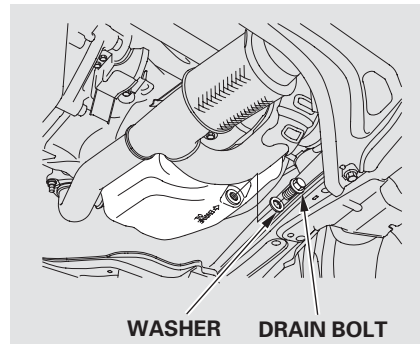

2. Open the hood, and remove the engine oil fill cap. Remove the oil drain bolt and washer from the bottom of the engine. Drain the oil into an appropriate container.

CONTINUED

Changing the Engine Oil and Filter

OIL FILTER

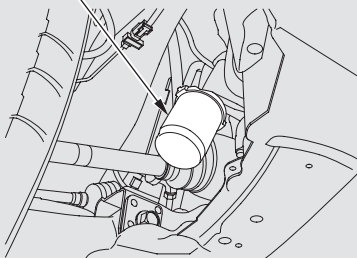

3. Remove the oil filter, and let the remaining oil drain. A special wrench (available from your dealer) is required.

Make sure the oil filter gasket is not stuck to the contacting surface of the engine. If it is, remove it before installing a new oil filter.

4. Install a new oil filter according to the instructions that come with it.

Make sure to clean off any dirt and dust on the contacting surface of a new oil filter.

5. Put a new washer on the drain bolt, then reinstall the drain bolt. Tighten the drain bolt to:
29 lbf·ft (39 N·m , 4.0 kgf·m)

6. Refill the engine with the recommended oil.

Engine oil change capacity
(including filter):
4.5 US qt (4.3 ℓ)

7. Reinstall the engine oil fill cap. Start the engine. The oil pressure indicator should go out within 5 seconds. If it does not, turn off the engine, and check your work.

8. Let the engine run for several minutes, then check the drain bolt and oil filter for leaks.

9. Turn off the engine and let it sit for several minutes, then check the oil level on the dipstick. If necessary, add more oil.

NOTICE

Improper disposal of engine oil can be harmful to the environment. If you change your own oil, please dispose of the used oil properly. Put it in a sealed container, and take it to a recycling center. Do not discard it in a trash bin or dump it on the ground.

Adding Engine Coolant

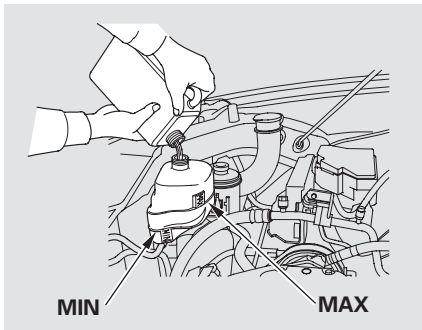

If the coolant level in the reserve tank is at or below the MIN line, add coolant to bring it up to the MAX line. Inspect the cooling system for leaks.

Always use Honda Long-life Antifreeze/Coolant Type 2. This coolant is pre-mixed with 50 percent antifreeze and 50 percent distilled water. Never add straight antifreeze or plain water.

If Honda antifreeze/coolant is not available, you may use another major-brand non-silicate coolant as a temporary replacement. Make sure it is a high-quality coolant recommended for aluminum engines. Continued use of any non-Honda coolant can result in corrosion, causing the cooling system to malfunction or fail. Have the cooling system flushed and refilled with Honda antifreeze/coolant as soon as possible.

If the reserve tank is completely empty, you should also check the coolant level in the radiator.

⚠ WARNING

Removing the radiator cap while the engine is hot can cause the coolant to spray out, seriously scalding you.

Always let the engine and radiator cool down before removing the radiator cap.

CONTINUED

Engine Coolant

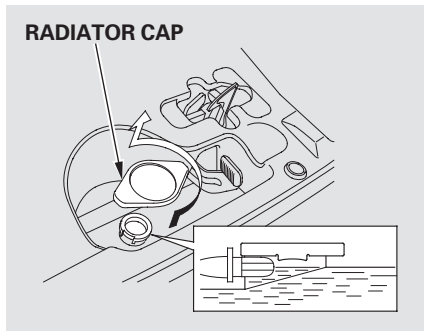

1. Make sure the engine and radiator are cool.
2. Relieve any pressure in the cooling system by turning the radiator cap counterclockwise, without pressing down.

3. Remove the radiator cap by pushing down and turning counterclockwise.
4. The coolant level should be up to the base of the filler neck. Add coolant if it is low.

Pour the coolant slowly and carefully so you do not spill any. Clean up any spill immediately; it could damage components in the engine compartment.

5. Put the radiator cap back on, and tighten it fully.

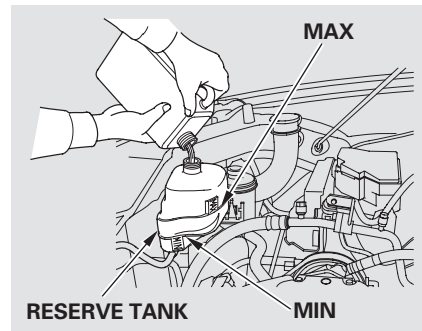

6. Pour coolant into the reserve tank. Fill it to halfway between the MAX and MIN marks. Put the cap back on the reserve tank.

Do not add any rust inhibitors or other additives to your vehicle's cooling system. They may not be compatible with the coolant or engine components.

Check the fluid level in the windshield washer reservoir at least monthly during normal use.

U.S. 2WD models

Check the fluid level by removing the cap and looking at the level gauge.

If equipped

The washer level indicator will come on when the level is low (see page 80).

On 4WD models with navigation system

If the washer fluid is low, a “LOW WASHER FLUID” message appears on the multi-information display.

Fill the reservoir with a good-quality windshield washer fluid. This increases the cleaning capability and prevents freezing in cold weather.

When you refill the reservoir, clean the edges of the windshield wiper blades with windshield washer fluid on a clean cloth. This will help to condition the blade edges.

NOTICE

Do not use engine antifreeze or a vinegar/water solution in the windshield washer reservoir. Antifreeze can damage your vehicle's paint, while a vinegar/water solution can damage the windshield washer pump. Use only commercially-available windshield washer fluid.

Automatic Transmission Fluid

The transmission should be drained and refilled with new fluid when this service is shown on the information display or multi-information display (depending on models).

Check the fluid level with the engine at normal operating temperature.

1. Park the vehicle on level ground. Start the engine, let it run until the radiator fan comes on, then shut off the engine. For accurate results, wait about 60 seconds (but no longer than 90 seconds) before doing step 2.

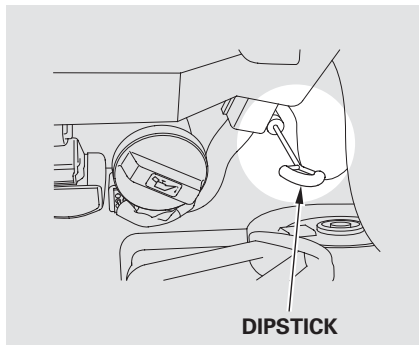

2. Remove the dipstick (yellow loop) from the transmission, and wipe it with a clean cloth.

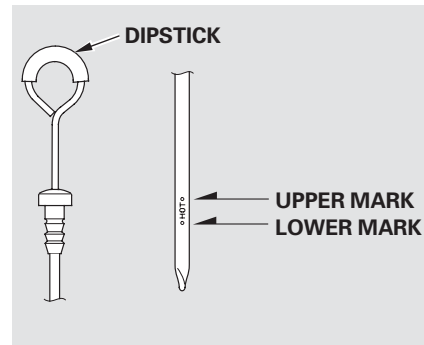

3. Insert the dipstick all the way into the transmission securely as shown in the illustration.
4. Remove the dipstick and check the fluid level. It should be between the upper and lower marks.

5. If the level is below the lower mark, add fluid into the dipstick hole to bring it to the level between the upper and lower marks.

Pour the fluid slowly and carefully so you do not spill any. Clean up any spill immediately; it could damage components in the engine compartment.

Always use Honda Genuine ATF-Z1 (automatic transmission fluid).

6. Insert the dipstick all the way back into the transmission securely as shown in the illustration.

Make sure the rubber cap on the dipstick fits in the dipstick guide and that you push the dipstick in all the way.

The transmission should be drained and refilled with new fluid when this service is indicated by a maintenance message on the multi-information display.

If you are not sure how to add fluid, contact your dealer.

NOTICE

Use only Honda Genuine ATF-Z1 (automatic transmission fluid). Do not mix with other transmission fluids. Using transmission fluid other than Honda Genuine ATF-Z1 may cause deterioration in transmission operation and durability, and could result in damage to the transmission. Damage resulting from the use of transmission fluid other than Honda Genuine ATF-Z1 is not covered by the Honda new vehicle warranty.

Rear Differential Fluid, Transfer Assembly Fluid

Rear Differential Fluid

4WD models only

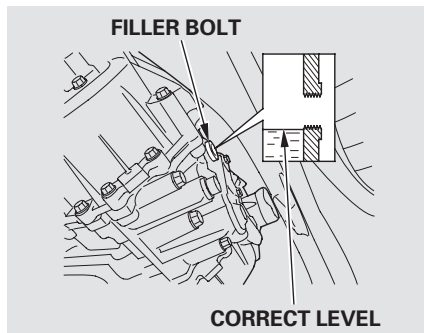

The rear differential should be drained and refilled with new fluid when this service is indicated by a maintenance message on the information display or multi-information display. This service may be needed more often under certain driving conditions (see page [469](#)).

Always use Honda VTM-4 Differential Fluid, and have your dealer replace the rear differential fluid.

Transfer Assembly Fluid

4WD models only

The transfer assembly should be drained and refilled with new fluid when this service is indicated by a maintenance message on the information display or multi-information display.

Always use hypoid gear oil GL4 or GL5 with a viscosity of SAE 90 or 80W-90. Have the fluid replaced by your dealer.

Replace the brake fluid when this service is indicated on a maintenance message on the information display or multi-information display (depending on models).

Check the fluid level in the brake fluid reservoir monthly.

Always use Honda Heavy Duty Brake Fluid DOT 3. If it is not available, you should use only DOT 3 or DOT 4 fluid, from a sealed container, as a temporary replacement.

Using any non-Honda brake fluid can cause corrosion and decrease the life of the system. Have the brake system flushed and refilled with Honda Heavy Duty Brake Fluid DOT 3 as soon as possible.

Brake fluid marked DOT 5 is not compatible with your vehicle's braking system and can cause extensive damage.

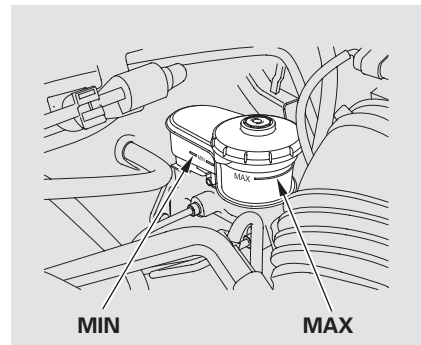

The fluid level should be between the MIN and MAX marks on the side of the reservoir. If the level is at or below the MIN mark, your brake system needs attention. Have the brake system inspected for leaks or worn brake pads.

Power Steering Fluid, Timing Belt

Power Steering Fluid

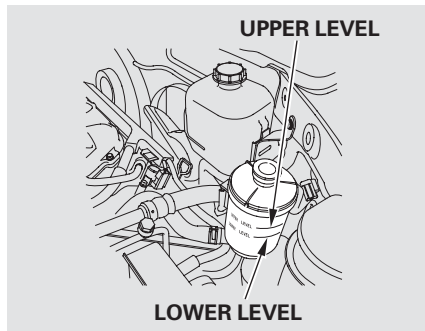

Check the level on the side of the reservoir when the engine is cold. The fluid should be between the UPPER LEVEL and LOWER LEVEL. If not add power steering fluid to the UPPER LEVEL mark.

Pour the fluid slowly and carefully so you do not spill any. Clean up any spills immediately; it could damage components in the engine compartment.

Always use Honda Power Steering Fluid. You may use another power steering fluid as an emergency replacement, but have the power steering system flushed and refilled with Honda PSF as soon as possible.

A low power steering fluid level can indicate a leak in the system. Check the fluid level frequently, and have the system inspected as soon as possible.

If you are not sure how to add fluid, contact your dealer.

NOTICE

Turning the steering wheel to full left or right lock and holding it there can damage the power steering pump.

Timing Belt

The timing belt should be replaced at the intervals shown in the maintenance information schedule.

Replace the timing belt every 60,000 miles (U.S.) or every 100,000 km (Canada) if you regularly drive your vehicle in any of the following conditions:

- In very high temperatures (over 110°F, 43°C).
- In very low temperatures (under -20°F, -29°C).
- Frequently towing a trailer.

Headlight Aiming

The headlights were properly aimed when your vehicle was new. If you regularly carry heavy items in the cargo area or pull a trailer, readjustment may be required. Adjustments should be done by your dealer or another qualified technician.

Replacing a Headlight/Daytime Running Light Bulb

Your vehicle has halogen headlight bulbs. When replacing a bulb, handle it by its base, and protect the glass from contact with your skin or hard objects. If you touch the glass, clean it with denatured alcohol and a clean cloth.

NOTICE

Halogen headlight bulbs get very hot when lit. Oil, perspiration, or a scratch on the glass can cause the bulb to overheat and shatter.

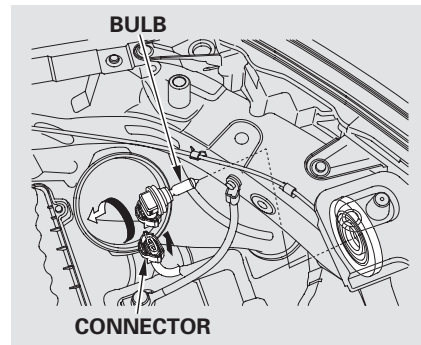

The high beam headlight bulb, the low beam headlight bulb, and daytime running light bulb are replaced the same way.

1. Open the hood.

If you need to change the headlight bulb on the driver's side, remove the front end of the air intake duct by pulling it out.

CONTINUED

Lights

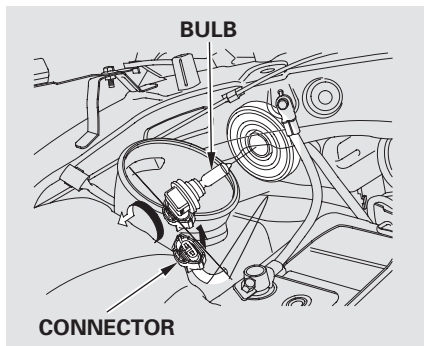

2. Remove the electrical connector from the bulb by pushing on the tab and pulling the connector down.
3. Remove the bulb by turning it about one-quarter turn counterclockwise.

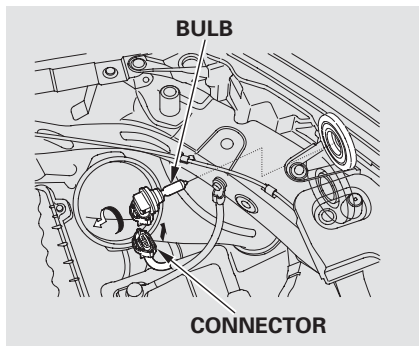

4. Insert the new bulb into the hole, and turn it one-quarter turn clockwise to lock it in place.
5. Push the electrical connector onto the new bulb.
6. Turn on the headlights to test the new bulb.

Replacing Front Turn Signal/ Parking and Side Marker Light Bulbs

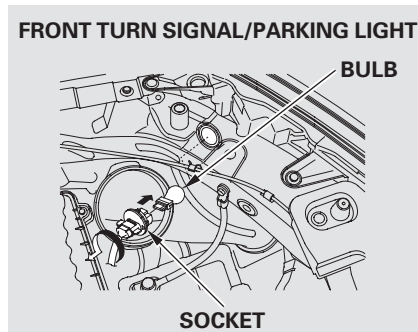

1. Open the hood.
2. Remove the socket by turning it one-quarter turn counterclockwise.
3. Pull the bulb straight out of its socket.

Replacing a Front Fog Light Bulb

Except LX models

Your vehicle uses halogen light bulbs. When replacing a bulb, handle it by its plastic case, and protect the glass from contact with your skin or hard objects. If you touch the glass, clean it with denatured alcohol and a clean cloth.

NOTICE

Halogen bulbs get very hot when lit. Oil, perspiration, or a scratch on the glass can cause the bulb to overheat and shatter.

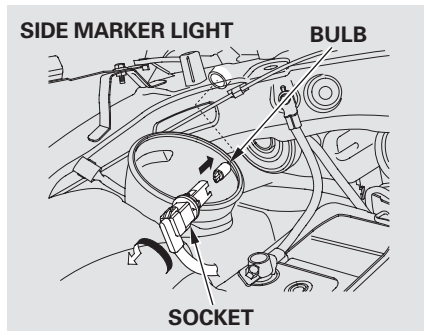

4. Push the new bulb straight into the socket until it bottoms.
5. Insert the socket back into the headlight assembly. Turn it clockwise to lock it in place.
6. Turn on the lights to make sure the new bulb is working.

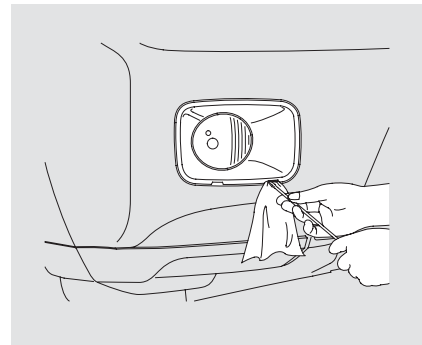

1. Place a cloth on the edge of the cover to prevent scratches. Remove the covers by carefully prying on the edge with a small flat-tip screwdriver.

CONTINUED

Lights

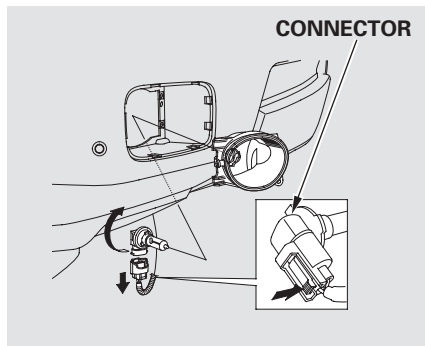

2. Remove the front fog light assembly from the bumper.
3. Remove the electrical connector from the bulb by pushing on the tab and pulling the connector down.
4. Remove the bulb from the fog light assembly by turning it one-quarter turn counterclockwise.

Replacing Rear Bulbs (in Rear Pillar)

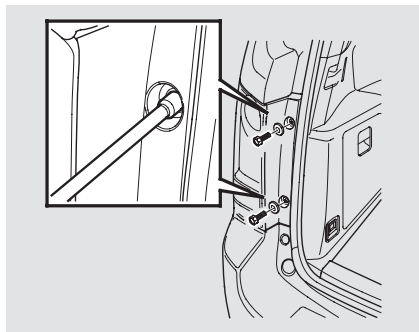

1. Open the tailgate.
2. Remove the two mounting bolts with an 8 mm wrench.

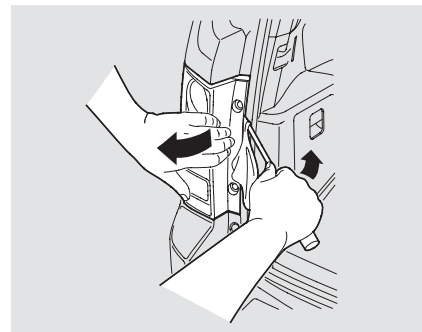

3. Place a cloth on the inner edge of the assembly to prevent scratches. Loosen the assembly by carefully prying on the top and side edges with a small flat-tip screwdriver. Use your fingers to further pull it loose.
4. Remove the assembly from the mounting holes by pulling it out.

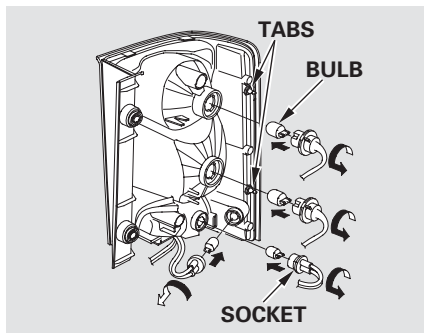

5. Determine which of the four bulbs is burned out: stop/taillight, back-up light, side marker light, or turn signal light.
6. Remove the socket by turning it one-quarter turn counterclockwise.
7. Pull the bulb straight out of its socket.

8. Push the new bulb straight into the socket until it bottoms.
9. Turn on the lights to make sure the new bulb is working.
10. Put the socket back into the light assembly, and turn it clockwise to lock it in place.
11. Align the two tabs on the light assembly with the mounting holes and install the rear light assembly in the rear pillar. Tighten the two bolts securely.

Side Turn Signal Lights

On Touring models

Each outside mirror has side turn signal lights. The lights should be replaced by your dealer.

Lights

Replacing a High-mount Brake Light Bulb

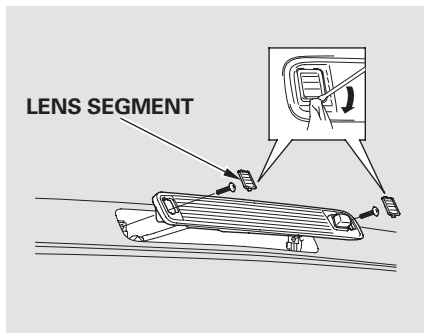

1. Place a cloth on the edge of the lens segment to prevent scratches. Remove each lens segment by carefully prying on its edge with a small flat-tip screwdriver.
2. Remove the screw under each lens.
3. Pull the high-mount brake light assembly out of the vehicle.

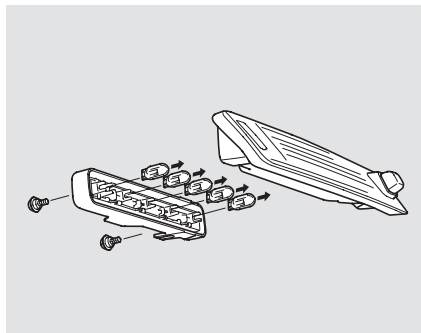

4. Remove the two mounting screws from the light assembly.
5. Remove the lens from the light assembly.
6. Pull the bulb straight out of its socket. Push the new bulb straight into the socket until it bottoms.

7. Put the lens back on the light assembly, and tighten the mounting bolts securely.
8. Turn on the lights to make sure the new bulb is working.
9. Put the light assembly back into the vehicle. Install the screws and tighten them securely. Reinstall the lens segments.

Replacing a Rear License Plate Bulb

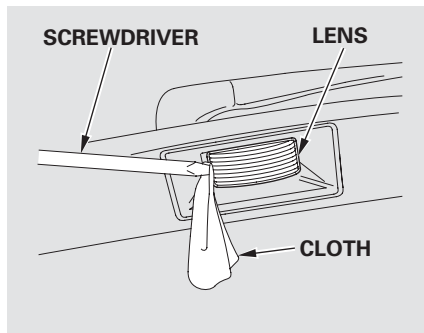

1. Place a cloth on the edge of the lens segment to prevent scratching. Insert a small flat-tip screwdriver between the left edge of the lens and the housing. The lens will come down.
2. Pull the bulb straight out of its socket. Push the new bulb in until it bottoms in the socket.

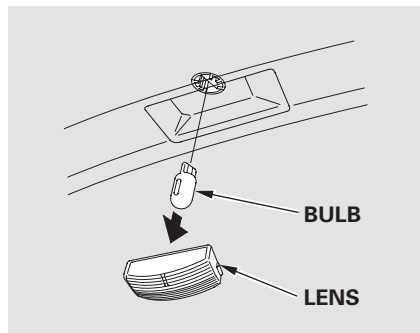

3. Turn on the parking lights and check that the new bulb is working.
4. Put the lens back into the light assembly, right side first. Push on the left edge until it snaps into place.

Dust and Pollen Filter, Cleaning the Seat Belts

Dust and Pollen Filter

This filter removes the dust and pollen that is brought in from the outside through the heating and cooling system/climate control system.

Have your dealer replace the filter when this service is indicated by a maintenance message on the information display or multi-information display (depending on the models). It should be replaced every 15,000 miles (24,000 km) if you drive primarily in urban areas that have high concentrations of soot in the air, or if the flow from the heating and cooling system/climate control system becomes less than usual.

Cleaning the Seat Belts

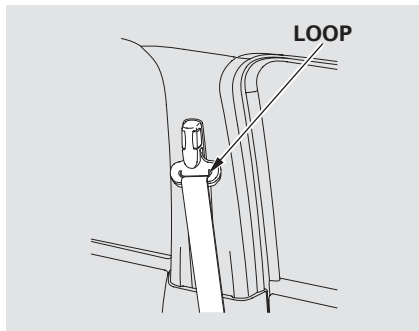

If your seat belts get dirty, use a soft brush with a mixture of mild soap and warm water to clean them. Do not use bleach, dye, or cleaning solvents. Let the belts air-dry before you use the vehicle.

Dirt build-up in the loops of the seat belt anchors can cause the belts to retract slowly. Wipe the insides of the loops with a clean cloth dampened in mild soap and warm water or isopropyl alcohol.

Front

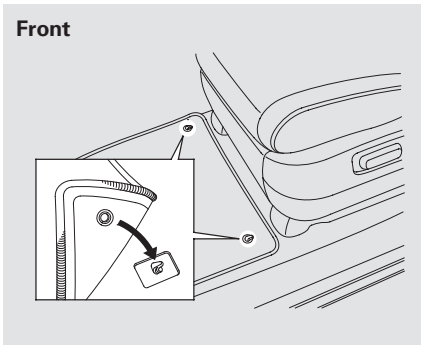

The floor mats that came with your vehicle hook over the floor mat anchors. This keeps the floor mats from sliding forward, possibly interfering with the pedals, or backwards, making the front passenger's weight sensors ineffective.

If you remove a floor mat, make sure to re-anchor it when you put it back in your vehicle.

Rear

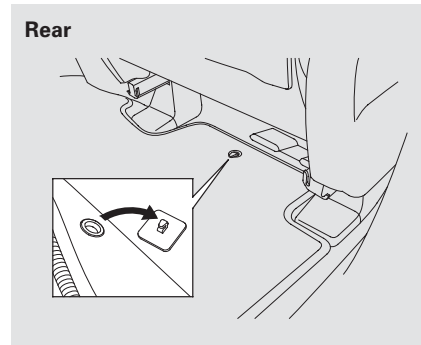

If you use a non-Honda floor mat, make sure it fits properly and that it can be used with the floor mat anchors. Do not put additional floor mats on top of the anchored mats.

Wiper Blades

Check the condition of the wiper blades at least every 6 months. Replace them if you find signs of cracking in the rubber, and areas that are getting hard or if they leave streaks and unwiped areas when used.

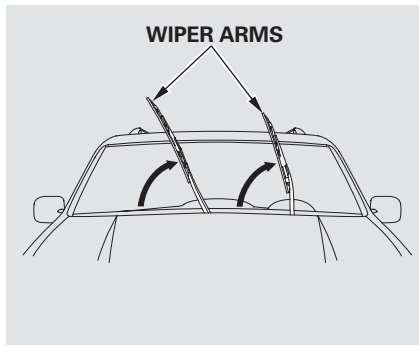

To replace the front wiper blades:

1. Raise each wiper arm off the windshield, lifting the driver's side first, then the passenger's side.

NOTICE

Do not open the hood when the wiper arms are raised, or you will damage the hood and the wiper arms.

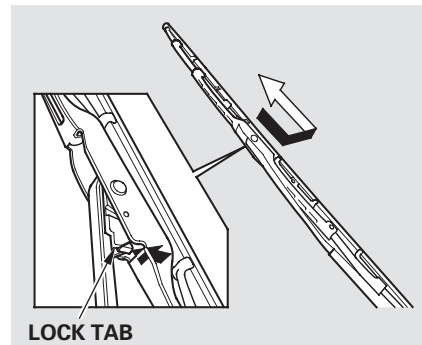

2. Disconnect the blade assembly from the wiper arm:
 - Press and hold the lock tab.
 - Slide the blade assembly toward the lock tab until it releases from the wiper arm.

When replacing a wiper blade, make sure not to drop the wiper blade or wiper arm down on the windshield.

Wiper Blades

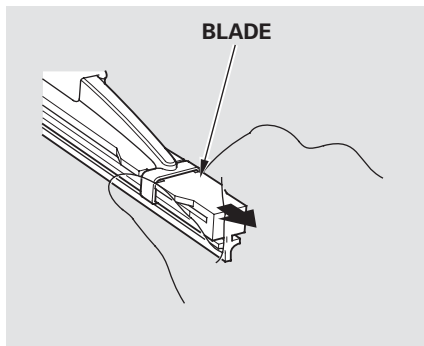

3. Remove the blade from its holder by grabbing the tabbed end of the blade. Pull firmly until the tabs come out of the holder.

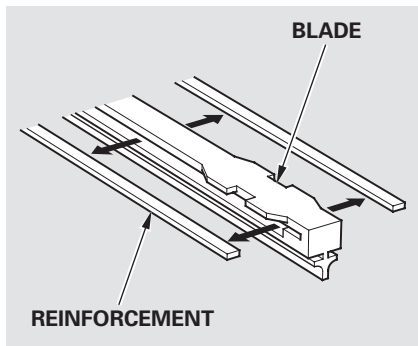

4. Examine the new wiper blades. If they have no plastic or metal reinforcement along the back edge, remove the metal reinforcement strips from the old wiper blade, and install them in the slots along the edge of the new blade.

5. Slide the new wiper blade into the holder until the tabs lock.
6. Slide the wiper blade assembly onto the wiper arm. Make sure it locks in place.
7. Lower the wiper arm against the window.
Windshield: Lower the passenger's side first, then the driver's side.

CONTINUED

Wiper Blades

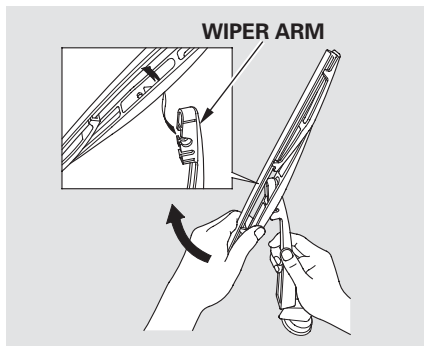

To replace the rear wiper blade:

1. Raise the wiper arm off the glass hatch and hold it.

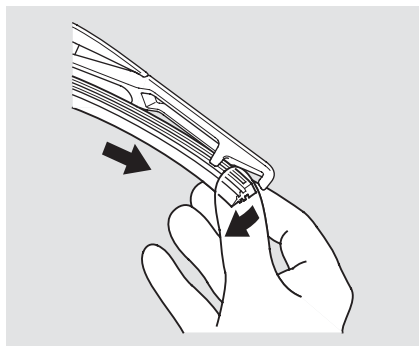

2. Slide the blade out of the wiper arm.

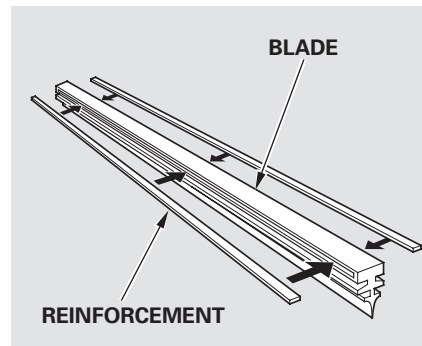

3. Examine the new wiper blades. If they have no plastic or metal reinforcement along the back edge, remove the metal reinforcement strips from the old wiper blade, and install them in the slots along the edge of the new blade.

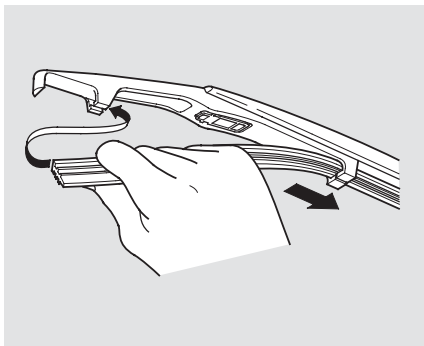

4. Slide the new blade into the wiper arm. Make sure it is engaged in the slot along its full length.
5. Lower the wiper arm down against the windshield or the hatch glass.

Tires

To safely operate your vehicle, your tires must be the proper type and size, in good condition with adequate tread, and correctly inflated.

The following pages give more detailed information on how to take care of your tires and what to do when they need to be replaced.

⚠ WARNING

Using tires that are excessively worn or improperly inflated can cause a crash in which you can be seriously hurt or killed.

Follow all instructions in this owner's manual regarding tire inflation and maintenance.

Inflation Guidelines

Keeping the tires properly inflated provides the best combination of handling, tread life, and riding comfort.

- Underinflated tires wear unevenly, adversely affect handling and fuel economy, and are more likely to fail from being overheated.
- Overinflated tires can make your vehicle ride more harshly, are more prone to damage from road hazards, and wear unevenly.

The tire pressure monitoring system (TPMS) warns you when a tire pressure is low. See page [420](#) or [423](#) for more information.

Even though your vehicle is equipped with TPMS, we recommend that you visually check your tires every day. If you think a tire might be low, check it immediately with a tire gauge.

Use a gauge to measure the air pressure in each tire at least once a month. Even tires that are in good condition may lose 1 to 2 psi (10 to 20 kPa, 0.1 to 0.2 kgf/cm²) per month. Remember to check the spare tire at the same time.

Check the air pressures when the tires are cold. This means the vehicle has been parked for at least 3 hours, or driven less than 1 mile (1.6 km). Add or release air, if needed, to match the recommended cold tire pressures.

If you check air pressures when the tires are hot (driven for several miles/kilometers), you will see readings 4 to 6 psi (30 to 40 kPa, 0.3 to 0.4 kgf/cm²) higher than the cold readings. This is normal. Do not let air out to match the recommended cold air pressure. The tire will be underinflated.

While tubeless tires have some ability to self-seal if they are punctured, you should look closely for punctures if a tire starts losing pressure.

You should get your own tire pressure gauge and use it whenever you check your tire pressures. This will make it easier for you to tell if a pressure loss is due to a tire problem and not due to a variation between gauges.

Recommended Tire Pressures

The following chart shows the recommended cold tire pressures for most normal and high-speed driving conditions.

Tire Size	Cold Tire Pressure for Normal Driving
P245/65R17 105T	Front/Rear: 32 psi (220 kPa , 2.2 kgf/cm ²)

The compact spare tire pressure is: **60 psi (420 kPa , 4.2 kgf/cm²)**

For convenience, the recommended tire sizes and cold tire pressures are on a label on the driver's doorjamb.

For additional information about your tires, see page [540](#).

Tires

Tire Inspection

Every time you check inflation, you should also examine the tires for damage, foreign objects, and wear.

You should look for:

- Bumps or bulges in the tread or side of the tire. Replace the tire if you find either of these conditions.
- Cuts, splits, or cracks in the side of the tire. Replace the tire if you can see fabric or cord.
- Excessive tread wear.

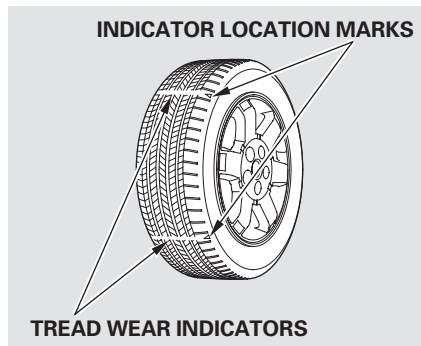

Your tires have wear indicators molded into the tread. When the tread wears down, you will see a 1/2 inch (12.7 mm) wide band across the tread. This shows there is less than 1/16 inch (1.6 mm) of tread left on the tire.

A tire this worn gives very little traction on wet roads. You should replace the tire if you can see three or more tread wear indicators.

Tire Service Life

The service life of your tires is dependent on many factors, including, but not limited to, driving habits, road conditions, vehicle loading, inflation pressure, maintenance history, speed, and environmental conditions (even when the tires are not in use). In addition to your regular inspections and inflation pressure maintenance, it is recommended that you have annual inspections performed once the tires reach five years old. It is also recommended that all tires, including the spare, be removed from service after 10 years from the date of manufacture, regardless of their condition or state of wear.

The last four digits of the TIN (tire identification number) are found on the sidewall of the tire and indicate the date of manufacture (See **Tire Labeling** on page [542](#)).

Tire Maintenance

In addition to proper inflation, correct wheel alignment helps to decrease tire wear. If you find a tire is worn unevenly, have your dealer check the wheel alignment.

Have your dealer check the tires if you feel a consistent vibration while driving. A tire should always be rebalanced if it is removed from the wheel. When you have new tires installed, make sure they are balanced. This increases riding comfort and tire life. For best results, have the installer perform a dynamic balance.

NOTICE

On vehicles with aluminum wheels, improper wheel weights can damage your vehicle's aluminum wheels. Use only Honda wheel weights for balancing.

Tire Rotation

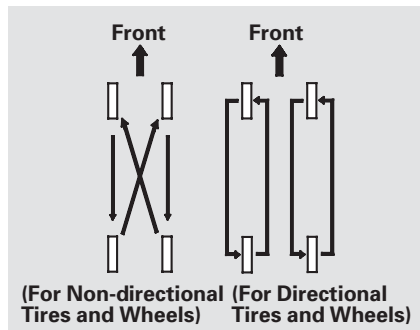

To help increase tire life and distribute wear more evenly, rotate the tires according to the maintenance messages displayed on the information display or multi-information display (depending on models). Move the tires to the positions shown in the diagram each time they are rotated. If you purchase directional tires, rotate only front-to-back.

Replacing Tires and Wheels

Replace your tires with radial tires of the same size, load range, speed rating, and maximum cold tire pressure rating (as shown on the tire's sidewall).

Mixing radial and bias-ply tires on your vehicle can reduce braking ability, traction, and steering accuracy. Using tires of a different size or construction can cause the ABS and vehicle stability assist system (VSA) to work inconsistently.

CONTINUED

Tires

The ABS works by comparing the speed of the wheels. When replacing tires, use the same size originally supplied with the vehicle. Tire size and construction can affect wheel speed and may cause the system to activate.

When the tires are rotated, make sure the air pressures are checked.

It is best to replace all four tires at the same time. If that is not possible or necessary, replace the two front tires or two rear tires as a pair. Replacing just one tire can seriously affect your vehicle's handling.

If you ever replace a wheel, make sure that the wheel's specifications match those of the original wheels.

Also be sure you use only TPMS specific wheels. If you do not, the tire pressure monitoring system will not work.

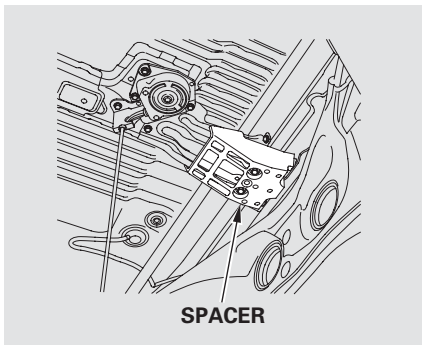

If you store a full size tire on the hoist, remove the spacer. Otherwise the hoist will not fully return to its original position.

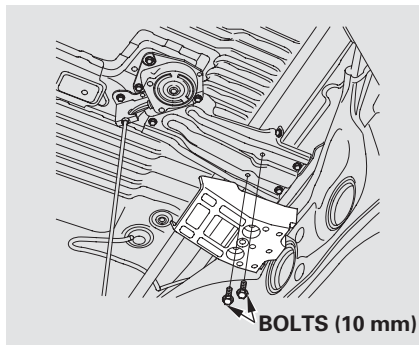

To remove the spacer, loosen the two bolts.

Replacement wheels are available at your dealer.

⚠ WARNING

Installing improper tires on your vehicle can affect handling and stability. This can cause a crash in which you can be seriously hurt or killed.

Always use the size and type of tires recommended in this owner's manual.

Tires

Wheel and Tire Specifications

Wheels:

17 x 7 1/2J

Tires:

P245/65R17 105T

See page [540](#) for information about DOT Tire Quality Grading, and page [542](#) for tire size and labeling information.

Winter Driving

Tires marked “M + S” or “All Season” on the sidewall have an all-weather tread design suitable for most winter driving conditions.

For the best performance in snowy or icy conditions, you should install snow tires or tire chains. They may be required by local laws under certain conditions.

Snow Tires

If you mount snow tires on your vehicle, make sure they are radial tires of the same size and load range as the original tires. Mount snow tires on all four wheels. The traction provided by snow tires on dry roads may be lower than your original tires. Check with the tire dealer for maximum speed recommendations.

Tire Chains

Mount tire chains on your tires when required by driving conditions or local laws. Install them only on the front tires.

Because your vehicle has limited tire clearance, Honda strongly recommends using the chains listed below.

SCC Super Z-6# SZ-435

When installing chains, follow the manufacturer's instructions and mount them as tightly as you can. Drive slowly with chains installed. If you hear them contacting the body or chassis, stop and investigate. Make sure the chains are installed tightly, and that they are not contacting the brake lines or suspension. Remove the chains as soon as you start driving on cleared roads.

▲ WARNING

Using the wrong chains, or not properly installing chains, can damage the brake lines and cause a crash in which you can be seriously injured or killed.

Follow all instructions in this owner's manual regarding the selection and use of tire chains.

NOTICE

Traction devices that are the wrong size or improperly installed can damage your vehicle's brake lines, suspension, body, and wheels. Stop driving if they are hitting any part of the vehicle.

Wheels

Clean the wheels as you would the rest of the exterior. Wash them with the same solution, and rinse them thoroughly.

Aluminum alloy wheels have a protective clear-coat that keeps the aluminum from corroding and tarnishing. Cleaning the wheels with harsh chemicals (including some commercial wheel cleaners) or a stiff brush can damage the clear-coat. To clean the wheels, use a mild detergent and a soft brush or sponge.

Checking the Battery

TEST INDICATOR WINDOW

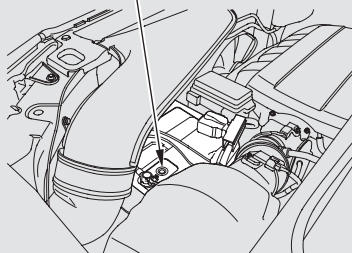

Check the condition of the battery monthly by looking at the test indicator window. The label on the battery explains the test indicator's colors.

Check the terminals for corrosion (a white or yellowish powder). To remove it, cover the terminals with a solution of baking soda and water. It will bubble up and turn brown. When this stops, wash it off with plain water. Dry off the battery with a cloth or paper towel. Coat the terminals with grease to help prevent further corrosion.

If additional battery maintenance is needed, see your dealer or a qualified technician.

WARNING: Battery posts, terminals, and related accessories contain lead and lead compounds. **Wash your hands after handling.**

If you need to connect the battery to a charger, disconnect both cables to prevent damaging your vehicle's electrical system. Always disconnect the negative (–) cable first, and reconnect it last.

⚠ WARNING

The battery gives off explosive hydrogen gas during normal operation.

A spark or flame can cause the battery to explode with enough force to kill or seriously hurt you.

Wear protective clothing and a face shield, or have a skilled technician do the battery maintenance.

If the radio fuse is removed, the audio system will disable itself. The next time you turn on the radio you will see "ENTER CODE" in the frequency display. Use the preset buttons to enter the digit code (see page [313](#)).

Checking the Battery, Vehicle Storage

On vehicles without navigation system

If your vehicle's battery is disconnected, or goes dead, the time setting will be reset to 1:00. To set the time again, follow the setting procedure (see page [314](#)).

On vehicles with navigation system

The navigation system will also disable itself. The next time you turn on the ignition switch, the system will require you to enter a PIN before it can be used. Refer to the navigation system manual.

Vehicle Storage

If you need to park your vehicle for an extended period (more than 1 month), there are several things you should do to prepare it for storage. Proper preparation helps prevent deterioration and makes it easier to get your vehicle back on the road. If possible, store your vehicle indoors.

- Fill the fuel tank.
- Wash and dry the exterior completely.
- Clean the interior. Make sure the carpeting, floor mats, etc., are completely dry.
- Leave the parking brake off. Put the transmission in Park.

CONTINUED

Vehicle Storage, Interior Care

- Block the rear wheels.
 - If the vehicle is to be stored for a longer period, it should be supported on jackstands so the tires are off the ground.
 - Leave one window open slightly (if the vehicle is being stored indoors).
 - Disconnect the battery.
 - Support the front and rear wiper blade arms with a folded towel or rag so they do not touch the windshield.
 - To minimize sticking, apply a silicone spray lubricant to all door and tailgate seals. Also, apply a vehicle body wax to the painted surfaces that mate with the door and tailgate seals.
- Cover the vehicle with a “breathable” cover, one made from a porous material such as cotton. Non-porous materials, such as plastic sheeting, trap moisture, which can damage the paint.
 - If possible, periodically run the engine until it reaches full operating temperature (the cooling fans cycle on and off twice). Preferably, do this once a month.

Leather

On EX-L and Touring models

Vacuum dirt and dust from the leather frequently. Pay close attention to the pleats and seams. Clean the leather with a soft cloth dampened with a 90% water and 10% neutral wool detergent solution. Then buff it with a clean, dry cloth. Remove any dust or dirt on leather surfaces immediately.

This section covers the more common problems that motorists experience with their vehicles. It gives you information about how to safely evaluate the problem and what to do to correct it. If the problem has stranded you on the side of the road, you may be able to get going again. If not, you will also find instructions on getting your vehicle towed.

Compact Spare Tire.....	508
Changing a Flat Tire	509
If the Engine Won't Start.....	516
Jump Starting	517
If the Engine Overheats	519
Low Oil Pressure Indicator	521
Charging System Indicator.....	521
Malfunction Indicator Lamp	522
Brake System Indicator	523
Fuses	524
Fuse Locations	528
Emergency Towing	531
If Your Vehicle Gets Stuck.....	532

Compact Spare Tire

Use the compact spare tire as a temporary replacement only. Get your regular tire repaired or replaced, and put it back on your vehicle as soon as you can.

Check the air pressure of the compact spare tire every time you check the other tires. It should be inflated to:

60 psi (420 kPa , 4.2 kgf/cm²)

Follow these precautions:

- Never exceed 50 mph (80 km/h).
- This tire gives a harsher ride and less traction on some road surfaces. Use greater caution while driving.
- Do not mount snow chains on a compact spare.
- Do not use your compact spare tire on another vehicle unless it is the same make and model.

- If you store a full size tire on the hoist, remove the spacer. Otherwise the hoist will not fully return to its original position.

On vehicles without navigation system

The low tire pressure indicator comes on and stays on after you replace the flat tire with the compact spare tire. After several miles (kilometers) driving with the compact spare tire, the TPMS indicator comes on and the low tire pressure indicator goes off.

On vehicles with navigation system

After the flat tire is replaced with the spare tire, the low tire pressure/TPMS indicator stays on. After several miles (kilometers) driving with the spare, this indicator begins to flash, then stays on again. You will also see a “CHECK TPMS SYSTEM” message on the multi-information display (see page [426](#)).

INDICATOR LOCATION MARK

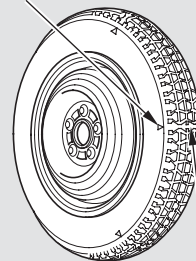

TREAD WEAR INDICATOR BAR

Replace the tire when you can see the tread wear indicator bars. The replacement should be the same size and design tire, mounted on the same wheel. The spare tire is not designed to be mounted on a regular wheel, and the spare wheel is not designed for mounting a regular tire.

Changing a Flat Tire

If you have a flat tire while driving, stop in a safe place to change it. Drive slowly along the shoulder until you get to an exit or an area to stop that is far away from the traffic lanes.

⚠ WARNING

The vehicle can easily roll off the jack, seriously injuring anyone underneath.

Follow the directions for changing a tire exactly, and never get under the vehicle when it is supported only by the jack.

1. Park the vehicle on firm, level, and non-slippery ground. Put the transmission in Park. Apply the parking brake.

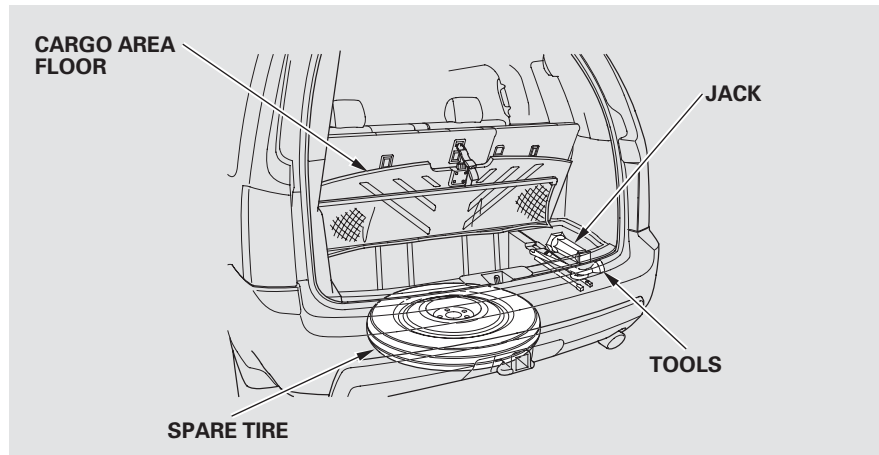

2. Turn on the hazard warning lights, and turn the ignition switch to the LOCK (0) position. Have all passengers get out of the vehicle while you change the tire.

3. Open the tailgate.

4. Push the rear edge of the handle to raise the handle loop and pull up the loop to raise the cargo area floor. Remove the cargo area floor.

CONTINUED

Changing a Flat Tire

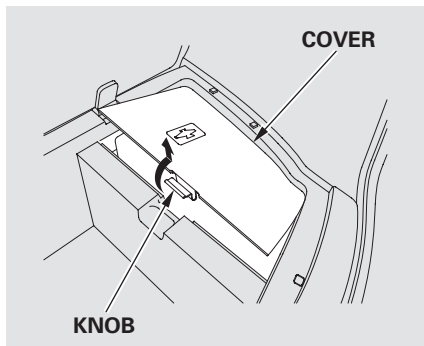

5. The tools and jack are under the cargo area behind a cover on the passenger's side. Remove the cover and take the jack out of the tool kit case.

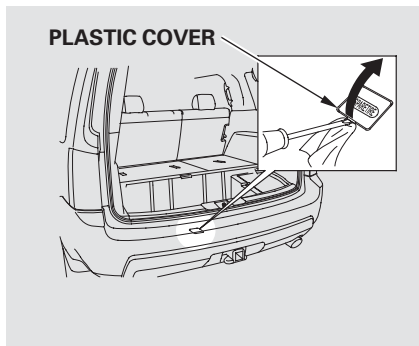

6. The spare tire is stored underneath the rear cargo area. Remove the plastic cover and the rubber cap on the cargo area lining to access the shaft for the spare tire hoist.
7. Fold down the third row seat (see page [161](#)).

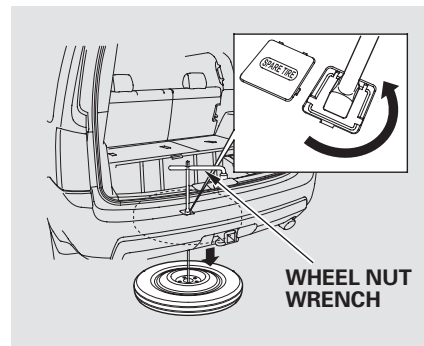

NOTICE

The wheel nut wrench supplied with your vehicle is specially adapted to fit the hoist shaft. Do not use any other tool.

8. Put the extension with the wheel nut wrench on the hoist shaft. Turn the wrench counterclockwise to lower the spare tire to the ground.

Changing a Flat Tire

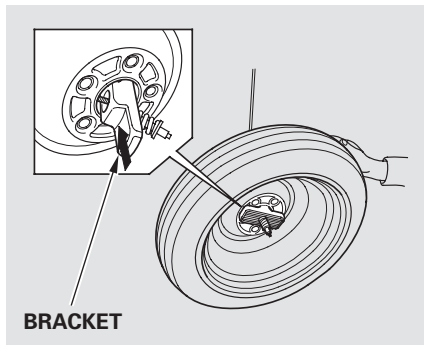

9. Keep turning the wheel nut wrench to create slack in the cable.
10. Remove the bracket from the spare tire.



11. Loosen each wheel nut 1/2 turn with the wheel nut wrench.

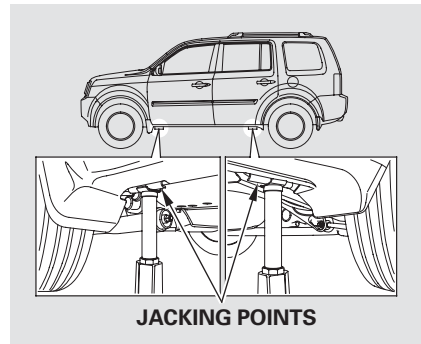

12. Place the jack under the jacking point nearest the tire you need to change.

CONTINUED

Changing a Flat Tire

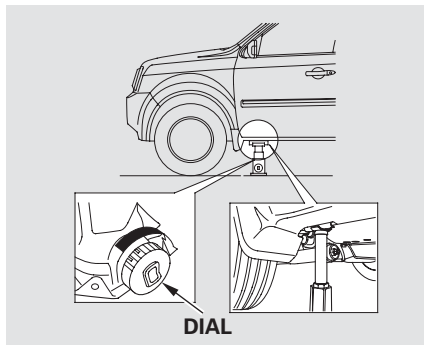

13. Turn the dial at the bottom of the jack clockwise until the top of the jack contacts the jacking point. Make sure the jacking point tab is resting in the jack notch.

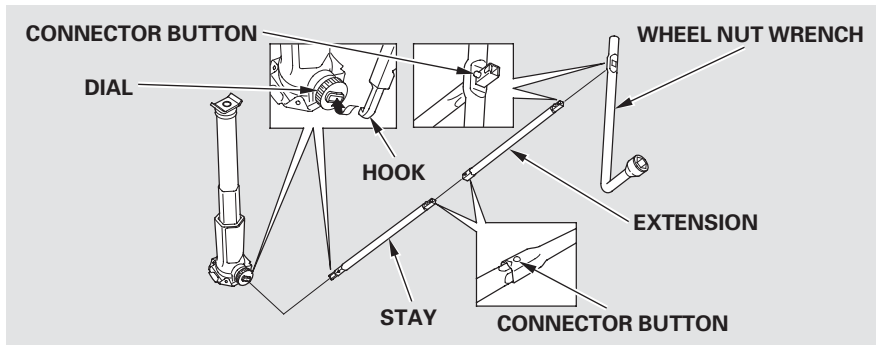

14. Attach the stay to the extension, then attach the wheel nut wrench to the end of the extension. Make sure the stay, the extension, and the wheel nut wrench are securely attached.

15. Insert the hook at the end of the stay into the opening on the dial at the bottom of the jack.

Changing a Flat Tire



16. Turn the jack dial (wheel nut wrench) clockwise as shown to raise the vehicle until the flat tire is off the ground.

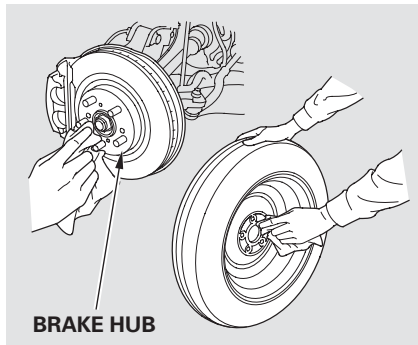

17. Before mounting the spare tire, wipe any dirt off the mounting surface of the wheel and hub with a clean cloth. Wipe the hub carefully; it may be hot from driving.

18. Put on the spare tire. Put the wheel nuts back on finger-tight, then tighten them in a crisscross pattern with the wheel nut wrench until the wheel is firmly against the hub. Do not try to tighten the wheel nuts fully.
19. Lower the vehicle to the ground, and remove the jack.

CONTINUED

Changing a Flat Tire

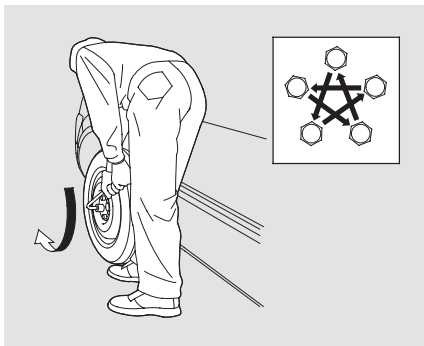

20. Tighten the wheel nuts securely in the same crisscross pattern. Have the wheel nut torque checked at the nearest automotive service facility.

Tighten the wheel nuts to:
94 lbf·ft (127 N·m , 13 kgf·m)

21. Remove the center cap from the flat tire, and place the flat tire under the hoist, with the valve stem facing up.

22. Insert the hoist bracket into the center hole of the flat tire.

WHEEL NUT WRENCH

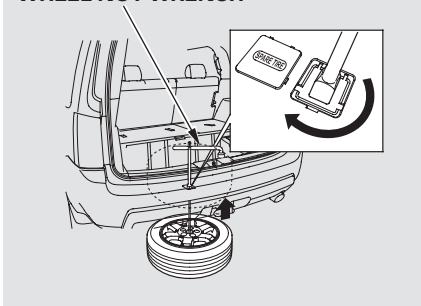

23. Slowly turn the extension with the wheel nut wrench clockwise to take up the slack of the hoist cable. Make sure the bracket is seated in the center hole of the flat tire.
24. Turn the extension with the wheel nut wrench clockwise until the flat tire rests against the underbody of the vehicle and you hear the hoist click.

NOTICE

Always raise the spare tire hoist, even if you are not stowing a tire. If the hoist is left down, it will be damaged during driving and need to be replaced.

25. Store the jack and the tools in the tool box.
26. Refer to **Changing a Tire with TPMS** (see page [422](#) or [427](#)).

⚠ WARNING

Loose items can fly around the interior in a crash and could seriously injure the occupants.

Store the wheel, jack, and tools securely before driving.

If the Engine Won't Start

Diagnosing why the engine won't start falls into two areas, depending on what you hear when you turn the ignition switch to the START (III) position:

- You hear nothing, or almost nothing. The engine's starter motor does not operate at all, or operates very slowly.
- You can hear the starter motor operating normally, or the starter motor sounds like it is spinning faster than normal, but the engine does not start up and run.

Nothing Happens or the Starter Motor Operates Very Slowly

When you turn the ignition switch to the START (III) position, you do not hear the normal noise of the engine trying to start. You may hear a clicking sound, a series of clicks, or nothing at all.

Check these things:

- Check the transmission interlock. The transmission must be in Park or neutral or the starter will not operate.
- Turn the ignition switch to the ON (II) position. Turn on the headlights, and check their brightness. If the headlights are very dim or do not come on at all, the battery is discharged. See **Jump Starting** on page [517](#).
- Turn the ignition switch to the START (III) position. If the headlights do not dim, check the condition of the fuses. If the fuses are OK, there is probably something wrong with the electrical circuit for the ignition switch or starter motor. You will need a qualified technician to determine the problem. See **Emergency Towing** on page [531](#).

If the headlights dim noticeably or go out when you try to start the engine, either the battery is discharged or the connections are corroded. Check the condition of the battery and terminal connections (see page [504](#)). You can then try jump starting the vehicle from a booster battery (see page [517](#)).

The Starter Operates Normally

In this case, the starter motor's speed sounds normal, or even faster than normal, when you turn the ignition switch to the START (III) position, but the engine does not run.

- Are you using a properly coded key? An improperly coded key will cause the immobilizer system indicator in the instrument panel to blink rapidly (see page [78](#)).

If the Engine Won't Start, Jump Starting

- Are you using the proper starting procedure? Refer to **Starting the Engine** on page [411](#) .
- Do you have fuel? Check the fuel gauge; the warning indicator may not be working.
- There may be an electrical problem, such as no power to the fuel pump. Check all the fuses (see page [525](#)).

If you find nothing wrong, you will need a qualified technician to find the problem. See **Emergency Towing** on page [531](#) .

Jump Starting

Although this seems like a simple procedure, you should take several precautions.

WARNING

A battery can explode if you do not follow the correct procedure, seriously injuring anyone nearby.

Keep all sparks, open flames, and smoking materials away from the battery.

You cannot start your vehicle by pushing or pulling it.

To Jump Start Your Vehicle:

1. Open the hood, and check the physical condition of the battery. In very cold weather, check the condition of the electrolyte. If it seems slushy or frozen, do not try jump starting until it thaws.

NOTICE

If a battery sits in extreme cold, the electrolyte inside can freeze. Attempting to jump start with a frozen battery can cause it to rupture.

2. Turn off all the electrical accessories: heater, A/C, climate control, audio system, lights, etc. Put the transmission in neutral or Park, and set the parking brake.

CONTINUED

Jump Starting

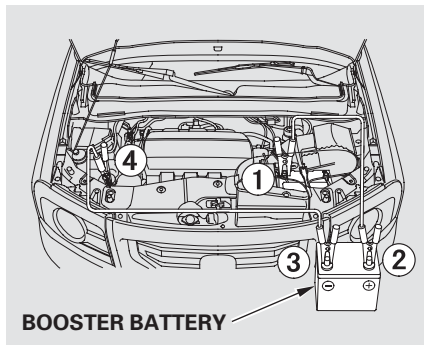

The numbers in the illustration show you the order to connect the jumper cables.

3. Connect one jumper cable to the positive (+) terminal on your vehicle's battery. Connect the other end to the positive (+) terminal on the booster battery.

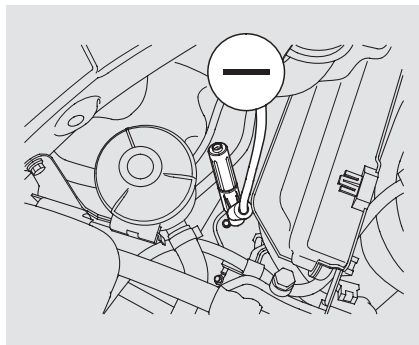

4. Connect the second jumper cable to the negative (-) terminal on the booster battery. Connect the other end to the grounding strap as shown. Do not connect this jumper cable to any other part of the engine.

5. If the booster battery is in another vehicle, have an assistant start that vehicle and run it at a fast idle.
6. Start your vehicle. If the starter motor still operates slowly, check that the jumper cables have good metal-to-metal contact.
7. Once the vehicle is running, disconnect the negative cable from your vehicle, then from the booster battery. Disconnect the positive cable from your vehicle, and then from the booster battery.

Keep the ends of the jumper cables away from each other and any metal on the vehicle until everything is disconnected. Otherwise, you may cause an electrical short.

If the Engine Overheats

The pointer of your vehicle's temperature gauge should stay in the midrange under most conditions. If it climbs to the red mark, you should determine the reason (hot day, driving up a steep hill, etc.).

If the vehicle overheats, you should take immediate action. The only indication may be the temperature gauge climbing to or above the red mark. Or you may see steam or spray coming from under the hood.

NOTICE

Driving with the temperature gauge pointer at the red mark can cause serious damage to the engine.

WARNING

Steam and spray from an overheated engine can seriously scald you.

Do not open the hood if steam is coming out.

1. Safely pull to the side of the road. Put the transmission in Park, and set the parking brake. Turn off all the accessories, and turn on the hazard warning lights.
2. If you see steam and/or spray coming from under the hood, turn off the engine. Wait until you see no more signs of steam or spray, then open the hood.
3. If you do not see steam or spray, leave the engine running and watch the temperature gauge. If the high heat is due to overloading, the engine should start to cool down almost immediately. If it does, wait until the temperature gauge comes down to the midpoint, then continue driving.

CONTINUED

If the Engine Overheats

4. If the temperature gauge stays at the red mark, turn off the engine.
 5. Look for any obvious coolant leaks, such as a split radiator hose. Everything is still extremely hot, so use caution. If you find a leak, it must be repaired before you continue driving (see **Emergency Towing** on page 531).
 6. If you do not find an obvious leak, check the coolant level in the radiator reserve tank. Add coolant if the level is below the MIN mark.
 7. If there was no coolant in the reserve tank, you may need to add coolant to the radiator. Let the engine cool down until the pointer reaches the middle of the temperature gauge, or lower, before checking the radiator.
- ⚠ WARNING**

Removing the radiator cap while the engine is hot can cause the coolant to spray out, seriously scalding you.

Always let the engine and radiator cool down before removing the radiator cap.
8. Using gloves or a large heavy cloth, turn the radiator cap counterclockwise, without pushing down, to the first stop. After the pressure releases, push down on the cap, and turn it until it comes off.
 9. Start the engine, and set the temperature to maximum heat (climate control to AUTO at “H”). Add coolant to the radiator up to the base of the filler neck. If you do not have the proper coolant mixture available, you can add plain water. Remember to have the cooling system drained and refilled with the proper mixture as soon as you can.
 10. Put the radiator cap back on tightly. Run the engine, and check the temperature gauge. If it goes back to the red mark, the engine needs repair (see **Emergency Towing** on page 531).
 11. If the temperature stays normal, check the coolant level in the radiator reserve tank. If it has gone down, add coolant to the MAX mark. Put the cap back on tightly.

Low Oil Pressure Indicator, Charging System Indicator



Low Oil Pressure Indicator

This indicator should never come on when the engine is running. If it starts flashing or stays on, the oil pressure has dropped very low or lost pressure. Serious engine damage is possible, and you should take immediate action.

On vehicles with navigation system

You will also see a “CHECK ENGINE OIL LEVEL” message on the multi-information display when this indicator comes on.

NOTICE

Running the engine with low oil pressure can cause serious mechanical damage almost immediately. Turn off the engine as soon as you can safely get the vehicle stopped.

1. Safely pull off the road, and shut off the engine. Turn on the hazard warning indicators.
2. Let the vehicle sit for a minute. Open the hood, and check the oil level (see page [398](#)). An engine very low on oil can lose pressure during cornering and other driving maneuvers.
3. If necessary, add oil to bring the level back to the full mark on the dipstick (see page [472](#)).
4. Start the engine, and watch the oil pressure indicator. If it does not go out within 10 seconds, turn off the engine. There is a mechanical problem that needs to be repaired before you can continue driving (see **Emergency Towing** on page [531](#)).



Charging System Indicator

If the charging system indicator comes on brightly when the engine is running, the battery is not being charged.

On vehicles with navigation system

You will also see a “CHECK CHARGING SYSTEM” message on the multi-information display (see page [95](#)).

Immediately turn off all electrical accessories. Try not to use other electrically operated controls such as the power windows. Keep the engine running; starting the engine will discharge the battery rapidly.

Go to a service station or garage where you can get technical assistance.

Malfunction Indicator Lamp



If this indicator comes on while driving, it means one of the engine's emissions control systems may have a problem. Even though you may feel no difference in your vehicle's performance, it can reduce your fuel economy and cause increased emissions. Continued operation may cause serious damage.

If you have recently refueled your vehicle, the indicator coming on could be due to a loose or missing fuel fill cap. Tighten the cap until it clicks at least once. Tightening the cap will not turn the indicator off immediately; it can take several days of normal driving.

If the indicator comes on repeatedly, even though it may turn off as you continue driving, have your vehicle checked by the dealer as soon as possible.

NOTICE

If you keep driving with the malfunction indicator lamp on, you can damage your vehicle's emissions controls and engine. Those repairs may not be covered by your vehicle's warranties.

On vehicles with navigation system

You will also see a "CHECK EMISSION SYSTEM" message on the multi-information display (see page 95).

Readiness Code

Your vehicle has certain "readiness codes" that are part of the on-board diagnostics for the emissions systems. In some states, part of the emissions testing is to make sure these codes are set. If they are not set, the test cannot be completed.

If the battery in your vehicle has been disconnected or gone dead, these codes may be erased. It takes several days of driving under various conditions to set the codes again.

To check if they are set, turn the ignition switch to the ON (II) position, without starting the engine. The malfunction indicator lamp will come on for 20 seconds. If it then goes off, the readiness codes are set. If it blinks five times, the readiness codes are not set. If possible, do not take your vehicle for an emissions test until the readiness codes are set. Refer to **Emissions Testing** for more information (see page 550).

Brake System Indicator

U.S.



Canada



The brake system indicator normally comes on when you turn the ignition switch to the ON (II) position, and as a reminder to check the parking brake. It will stay on if you do not fully release the parking brake.

If the brake system indicator comes on while driving, the brake fluid level is probably low. Press lightly on the brake pedal to see if it feels normal. If it does, check the brake fluid level the next time you stop at a service station (see page [481](#)).

On vehicles with navigation system
You will also see a “LOW BRAKE FLUID” message on the multi-information display (see page [95](#)).

If the fluid level is low, take your vehicle to a dealer, and have the brake system inspected for leaks or worn brake pads.

However, if the brake pedal does not feel normal, you should take immediate action. A problem in one part of the system’s dual circuit design will still give you braking at two wheels. You will feel the brake pedal go down much farther before the vehicle begins to slow down, and you will have to press harder on the pedal.

On vehicles with navigation system
You will also see a “CHECK BRAKE SYSTEM” message on the multi-information display (see page [95](#)).

Slow down by shifting to a lower gear, and pull to the side of the road when it is safe. Because of the long distance needed to stop, it is hazardous to drive the vehicle. You should have it towed, and repaired as soon as possible (see **Emergency Towing** on page [531](#)).

If you must drive the vehicle a short distance in this condition, drive slowly and carefully.

If the ABS indicator and the VSA system indicator come on with the brake system indicator, have your vehicle inspected by your dealer immediately.

Fuses

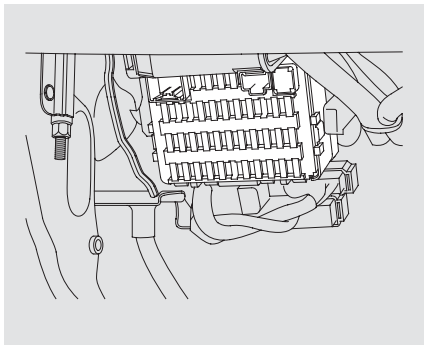

The vehicle's fuses are located in four fuse boxes.

The interior fuse box is underneath the dashboard on the driver's side.

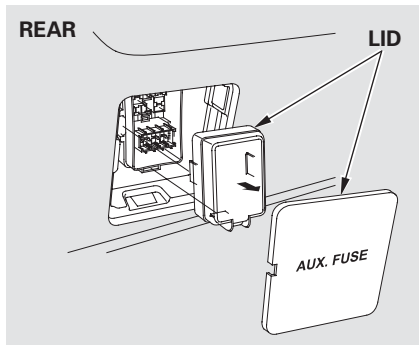

The rear fuse box is located at the left side of cargo area.

The primary under-hood fuse box is located on the passenger's side. The secondary fuse box is located next to the battery.

To open it, push the tabs as shown.

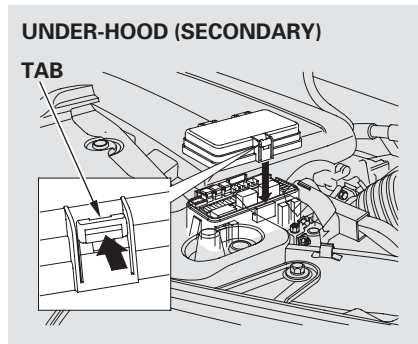
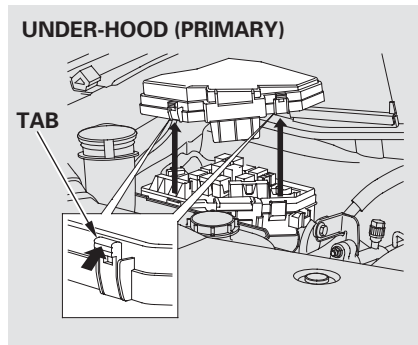

Checking and Replacing Fuses

If something electrical in your vehicle stops working, the first thing you should check for is a blown fuse. Determine from the chart on pages [528](#), [529](#), and [530](#), or the diagram on the fuse box lid, which fuse or fuses control that device. Check those fuses first, but check all the fuses before deciding that a blown fuse is the cause. Replace any blown fuses, and check if the device works.

1. Turn the ignition switch to the LOCK (0) position. Make sure the headlights and all other accessories are off.
2. Remove the cover from the fuse box.

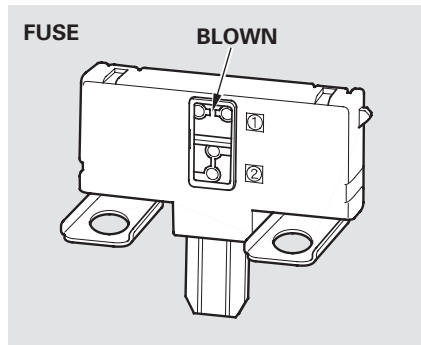

3. Check each of the large fuses in the under-hood fuse boxes by looking through the top at the wire inside. Removing these fuses requires a Phillips-head screwdriver.

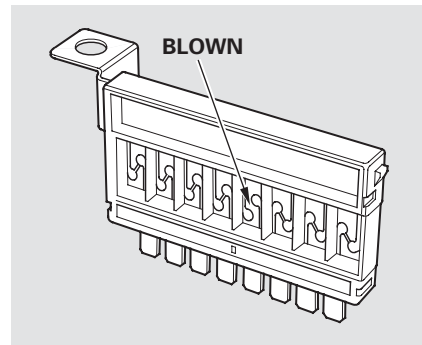

CONTINUED

Fuses

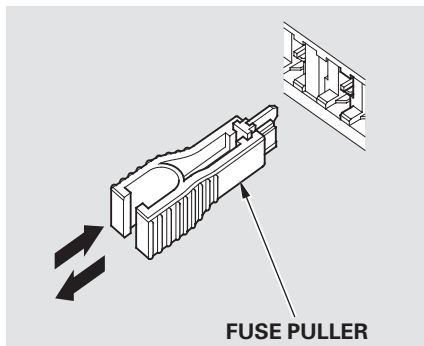

4. Check the smaller fuses in the under-hood fuse boxes and rear fuse box, and all the fuses in the interior and rear fuse boxes by pulling out each one with the fuse puller provided in the primary under-hood fuse box.

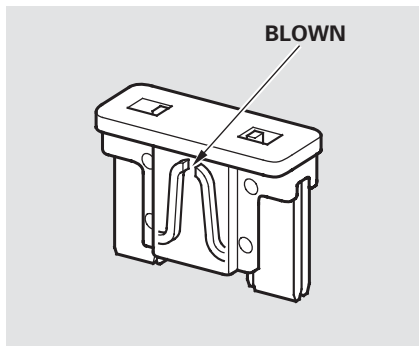

5. Look for a burned wire inside the fuse. If it is burned out, replace it with one of the spare fuses of the same rating or lower.

If you cannot drive the vehicle without fixing the problem, and you do not have a spare fuse, take a fuse of the same rating or a lower rating from one of the other circuits. Make sure you can do without that circuit temporarily (such as the accessory power socket or radio).

If you replace the blown fuse with a spare fuse that has a lower rating, it might blow out again. This does not indicate that anything is wrong. Replace the fuse with one of the correct rating as soon as you can.

NOTICE

Replacing a fuse with one that has a higher rating greatly increases the chances of damaging the electrical system. If you do not have a replacement fuse with the proper rating for the circuit, install one with a lower rating.

6. If the replacement fuse of the same rating blows in a short time, there is probably a serious electrical problem with your vehicle. Leave the blown fuse in that circuit, and have your vehicle checked by a qualified technician.

If the radio fuse is removed, the audio system will disable itself. The next time you turn on the radio you will see “ENTER CODE” in the frequency display. Use the preset buttons to enter the digit code (see page [313](#)).

Fuse Locations

PRIMARY UNDER-HOOD FUSE BOX

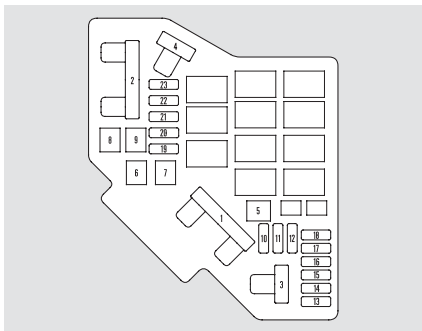

No.	Amps.	Circuits Protected
1	120 A	Main Fuse
	—	Not Used
2	80 A	OP Main
	50 A	IG Main
3	—	Not Used
	—	Not Used
4	50 A	Head Light Main
	40 A	Power Window Main
5	—	Not Used
6	30 A	Condenser Fan
7	30 A	Cooling Fan
8	30 A	Rear Defroster
9	40 A	Blower
10	20 A	Front Fog Light
11	15 A	Sub
12	10 A	ACM

No.	Amps.	Circuits Protected
13	20 A	Front Passenger's Power Seat Reclining
14	20 A	Front Passenger's Power Seat Slide
15	7.5 A	Oil Level
16	20 A	Head Light Hi Main
17	20 A	Radio
18	15 A	IG Coil
19	15 A	Main
20	7.5 A	MG Clutch
21	15 A	DBW
22	10 A	Interior Light
23	10 A	Back Up

SECONDARY UNDER-HOOD FUSE BOX

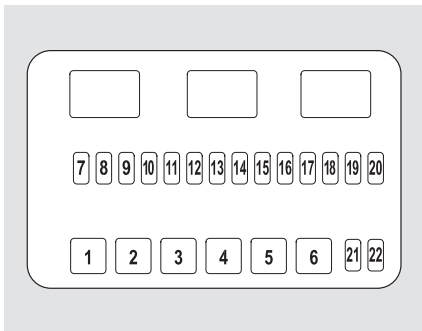

No.	Amps.	Circuits Protected
1	40 A	Power Tailgate Motor
2	20 A	VTM-4
3	30 A	Trailer Main
4	40 A	VSA FSR

No.	Amps.	Circuits Protected
5	30 A	Rear Blower
6	30 A	VSA Motor
7	15 A	Hazard
8	20 A	Power Tailgate Closer
9	20 A	Driver's Power Seat Reclining
10	20 A	Driver's Power Seat Slide
11	20 A	Stop & Horn
12	15 A	Rear Console Accessory Socket
13	10 A	Rear Wiper
14	20 A	Trailer E-Brake
15	20 A	A/C Inverter
16	15 A	Center Console Accessory Socket
17	20 A	Trailer Charge
18	15 A	Front Accessory Socket
19	15 A	Rear Accessory Socket
20	20 A	Glass Hatch Motor
21	15 A	Rear Heated Seat
22	30 A	Head Light Washer Motor

REAR FUSE BOX

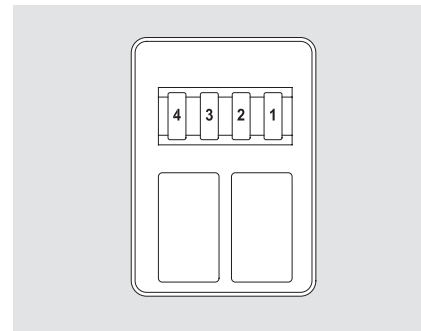

No.	Amps.	Circuits Protected
1	20 A	Small Light
2	7.5 A	Stop Lamp
3	7.5 A	Back Lamp
4	7.5 A	Turn Lamp, Hazard

Fuse Locations

INTERIOR FUSE BOX

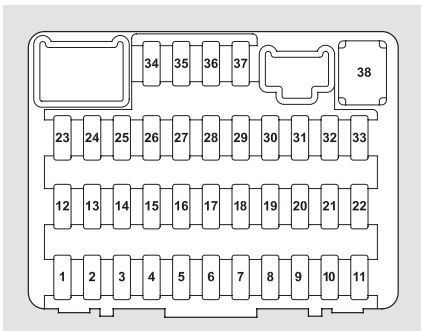

No.	Amps.	Circuits Protected
1	7.5 A	VTM-4
2	15 A	Fuel Pump
3	10 A	ACG
4	7.5 A	VSA
5	15 A	Heated Seat

No.	Amps.	Circuits Protected
6	—	Not Used
7	10 A	Auto Light
8	7.5 A	Auto Light
9	7.5 A	ODS
10	7.5 A	Meter
11	10 A	SRS
12	10 A	Right Daytime Running Light
13	10 A	Left Daytime Running Light
14	7.5 A	Small Lights (Interior)
15	10 A	Small Lights (Exterior)
16	15 A	Right Head Light Low
17	15 A	Left Head Light Low
18	20 A	Daytime Running Light Main
19	15 A	Small Lights Main
20	—	Not Used
	7.5 A	TPMS
21	20 A	Head Light Low Main

No.	Amps.	Circuits Protected
22	7.5 A	VBSOL2
23	7.5 A	STRLD
24	—	Not Used
25	—	Not Used
26	20 A	Driver's Power Window
27	20 A	HAC OP
28	20 A	Moonroof
29	20 A	Door Lock
30	20 A	Front Passenger's Power Window
31	30 A	Audio Amp*
32	20 A	Passenger's Side Rear Power Window
33	20 A	Driver's Side Rear Power Window
34	—	Not Used
35	10 A	ACC
36	10 A	HAC
37	7.5 A	Day Light
38	30 A	Wiper

* : On vehicles with rear entertainment system

If your vehicle needs to be towed, call a professional towing service or organization. Never tow your vehicle with just a rope or chain. It is very dangerous.

The only way you can safely tow your vehicle is with flat-bed equipment. The operator will load your vehicle on the back of a truck. Any other method of towing will damage the drive system. When you contact the towing agency, inform them a flat-bed is required.

4WD models only

NOTICE

Towing with only two tires on the ground will damage parts of the 4WD system. It should be transported on a flat-bed truck or trailer.

If Your Vehicle Gets Stuck

If your vehicle gets stuck in sand, mud, or snow, call a towing service to pull it out (see the [previous](#) page).

For very short distances, such as freeing the vehicle, you can use the detachable towing hook that mounts on the anchors in the front and rear bumpers.

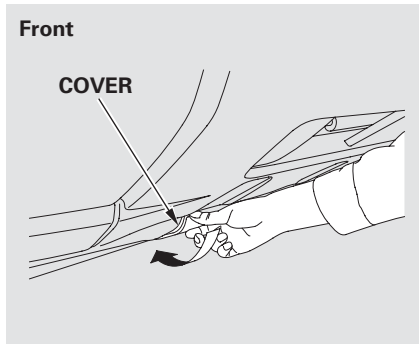

1. Remove the cover, put cloth on the edge of the cover to prevent scratches and carefully pry with a small flat-tip screwdriver or a metal fingernail file.

The cover is attached to the bumper with a tether.

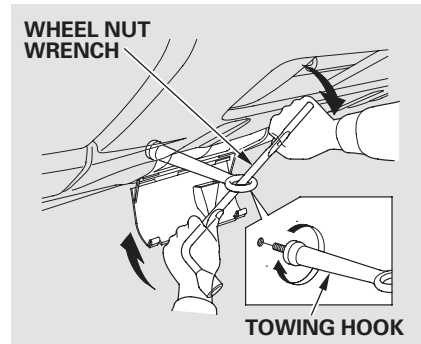

2. Remove the towing hook and wheel nut wrench placed behind a cover under the cargo area.
3. Screw the towing hook into the hole, and tighten it with the wheel nut wrench.

NOTICE

To avoid damage to your vehicle, use the towing hook for straight, flat ground towing only. Do not tow at an angle. The tow hook should not be used to tow the vehicle onto a flat bed. Do not use it as a tie down.

Rear

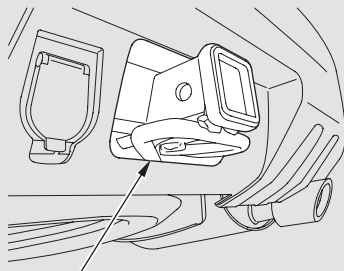

TRAILER HITCH

The diagrams in this section give you the dimensions and capacities of your vehicle and the locations of the identification numbers. It also includes information you should know about your vehicle's tires and emissions control systems.

Identification Numbers.....	536
Specifications	538
DOT Tire Quality Grading (U.S. Vehicles)	540
Tire Labeling	542
Tire Pressure Monitoring System (TPMS) – Required Federal Explanation.....	544
Emissions Controls.....	547
Three Way Catalytic Converter...	549
Emissions Testing	550

Identification Numbers

Your vehicle has several identifying numbers located in various places.

The vehicle identification number (VIN) is the 17-digit number your dealer uses to register your vehicle for warranty purposes. It is also necessary for licensing and insuring your vehicle. The easiest place to find the VIN is on a plate fastened to the top of the dashboard. You can see it by looking through the windshield on the driver's side. It is also on the certification label attached to the driver's doorjamb, and is stamped on the engine compartment bulkhead. The VIN is also provided in bar code on the certification label.

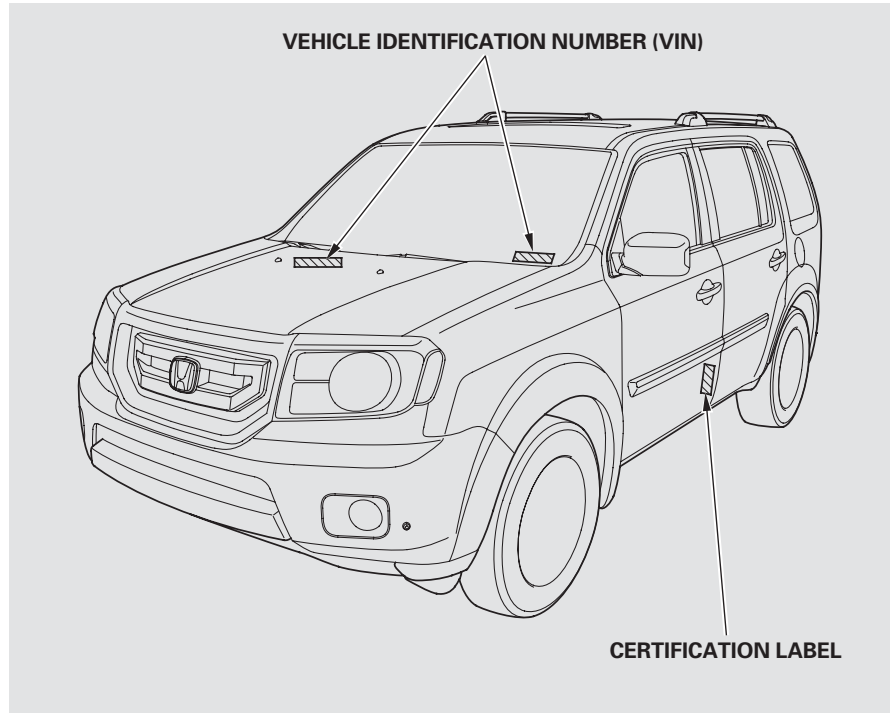

Identification Numbers

The engine number is stamped into the engine block. It is on the front.

The transmission number is on a label on top of the transmission.

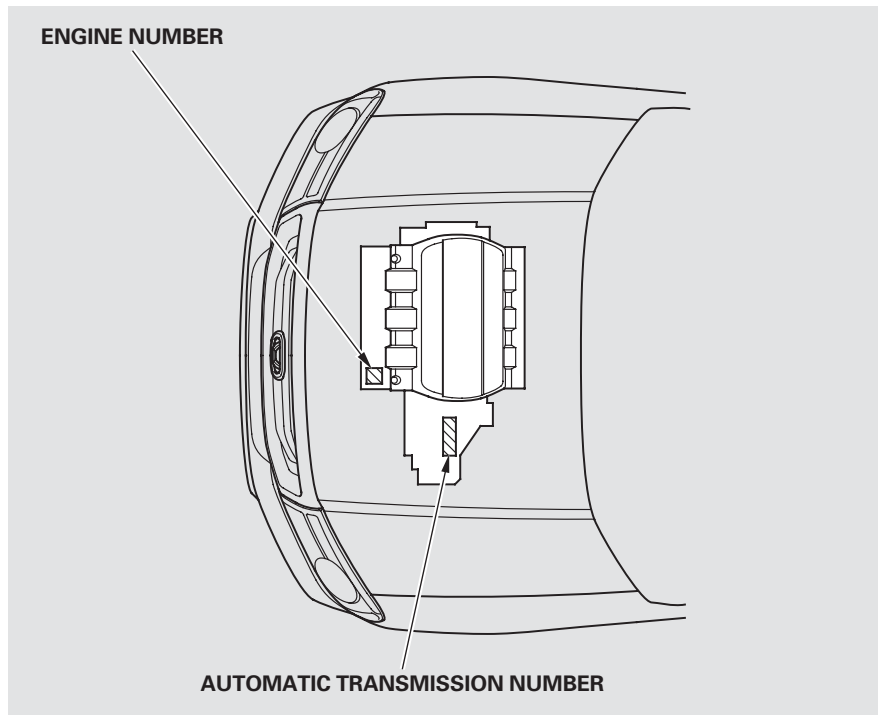

Specifications

Dimensions

Length	190.9 in (4,850 mm)
Width	78.5 in (1,995 mm)
Height	70.9 in (1,802 mm)* ¹ 72.7 in (1,846 mm)* ²
Wheelbase	109.3 in (2,775 mm)
Track	Front 67.7 in (1,720 mm) Rear 67.5 in (1,715 mm)

* 1 : U.S. LX models

* 2 : Except U.S. LX models

Weights

Gross vehicle weight rating	See the tire information label attached to the driver's doorjamb.
Gross combined weight rating (GCWR)* ¹	8,466 lbs (3,840 kg)* ² 9,579 lbs (4,345 kg)* ³

* 1 : The GCWR must be reduced 2 percent for every 1,000 feet (305 meters) of elevation.

* 2 : 2WD models

* 3 : 4WD models

Air Conditioning

Refrigerant type	HFC-134a (R-134a)
Charge quantity	21.2 – 22.9 oz (600 – 650 g)
Lubricant type	ND-OIL8

Seating Capacities

Total	8
Front	2
Second	3
Third	3

Capacities

Fuel tank		Approx. 21.00 US gal (79.5 ℓ)
Engine coolant	Change* ¹	1.98 US gal (7.5 ℓ)
	Total	2.48 US gal (9.4 ℓ)
Engine oil	Change* ²	
	Including filter	4.5 US qt (4.3 ℓ)
	Without filter	4.2 US qt (4.0 ℓ)
	Total	5.3 US qt (5.0 ℓ)
Automatic transmission fluid	2WD Change	3.6 US qt (3.4 ℓ)
	Total	8.6 US qt (8.1 ℓ)
	4WD Change	3.6 US qt (3.4 ℓ)
	Total	8.6 US qt (8.1 ℓ)
Rear differential fluid (4WD)	Change	2.79 US qt (2.64 ℓ)
	Total	3.01 US qt (2.85 ℓ)
Transfer assembly fluid (4WD)	Change	0.45 US qt (0.43 ℓ)
	Total	0.48 US qt (0.45 ℓ)
Windshield washer reservoir	U.S. vehicles	4.2 US qt (4.0 ℓ)
	Canadian vehicles	6.9 US qt (6.5 ℓ)

* 1 : Including the coolant in the reserve tank and that remaining in the engine

Reserve tank capacity:
0.196 US gal (0.74 ℓ)

* 2 : Excluding the oil remaining in the engine

Lights

Headlights	High	12 V – 60 W (HB3)
	Low	12 V – 55 W (H11)
Daytime running lights		12 V – 60 W (HB3)
Front side marker lights		12 V – 3 CP
Front turn signal/ parking lights		12 V – 28/8 W
Front fog lights*		12 V – 55 W (H11)
Rear turn signal/taillights		12 V – 21/5 W
Stop/taillights		12 V – 21/5 W
Rear side marker lights		12 V – 5 W
Back-up lights		12 V – 18 W
License plate lights		12 V – 5 W
Individual map lights	Front	12 V – 8 W
	Rear	12 V – 4 CP
Cargo area lights		12 V – 8 W
High-mount brake lights		12 V – 5 W
Vanity mirror lights		12 V – 1.4 W
Door courtesy lights		12 V – 2 CP

* : Except LX models

Battery

Capacity	12 V – 60 AH/5 HR
	12 V – 72 AH/20 HR

Fuses

Interior	See page 530 or the fuse label attached on the side panel.
Rear	See page 529 or the fuse label attached to the inside of the fuse box lid.
Under-hood	See page 528 and 529 or the fuse box cover.

Engine

Type	Water cooled 4-stroke SOHC i-VTEC VCM 6-cylinder (V6) gasoline engine
Bore x Stroke	3.50 x 3.66 in (89.0 x 93.0 mm)
Displacement	212 cu-in (3,471 cm ³)
Compression ratio	10.5 : 1
Spark plugs	DENSO: SXU22HCR11 NGK: ILZKR7B11

Alignment

Toe-in	Front	0.00 in (0.0 mm)
	Rear	0.08 in (2.0 mm)
Camber	Front	– 0°30'
	Rear	– 0°30'
Caster	Front	4°12'

Tires

Size	Front/Rear	P245/65R17 105T
	Spare	T165/80D17 104M
Pressure	Front/Rear	32 psi (220 kPa, 2.2 kgf/cm ²)
	Spare	60 psi (420 kPa, 4.2 kgf/cm ²)

DOT Tire Quality Grading (U.S. Vehicles)

The tires on your vehicle meet all U.S. Federal Safety Requirements. All tires are also graded for treadwear, traction, and temperature performance according to Department of Transportation (DOT) standards. The following explains these gradings.

Uniform Tire Quality Grading

Quality grades can be found where applicable on the tire sidewall between tread shoulder and maximum section width. For example:

Treadwear 200

Traction AA

Temperature A

All passenger car tires must conform to Federal Safety Requirements in addition to these grades.

Treadwear

The treadwear grade is a comparative rating based on the wear rate of the tire when tested under controlled conditions on a specified government test course. For example, a tire graded 150 would wear one and one-half (1 1/2) times as well on the government course as a tire graded 100. The relative performance of tires depends upon the actual conditions of their use, however, and may depart significantly from the norm due to variations in driving habits, service practices and differences in road characteristics and climate.

Traction

The traction grades, from highest to lowest, are AA, A, B, and C. Those grades represent the tire's ability to stop on wet pavement as measured under controlled conditions on specified government test surfaces of asphalt and concrete. A tire marked C may have poor traction performance.

Warning: The traction grade assigned to this tire is based on straight-ahead braking traction tests, and does not include acceleration, cornering, hydroplaning, or peak traction characteristics.

DOT Tire Quality Grading (U.S. Vehicles)

Temperature

The temperature grades are A (the highest), B, and C, representing the tire's resistance to the generation of heat and its ability to dissipate heat when tested under controlled conditions on a specified indoor laboratory test wheel. Sustained high temperature can cause the material of the tire to degenerate and reduce tire life, and excessive temperature can lead to sudden tire failure. The grade C corresponds to a level of performance which all passenger car tires must meet under the Federal Motor Vehicle Safety Standard No. 109. Grades B and A represent higher levels of performance on the laboratory test wheel than the minimum required by law.

Warning: The temperature grade for this tire is established for a tire that is properly inflated and not overloaded. Excessive speed, underinflation, or excessive loading, either separately or in combination, can cause heat buildup and possible tire failure.

Tire Labeling

The tires that came on your vehicle have a number of markings. Those you should be aware of are described below.

TIRE LABELING EXAMPLE

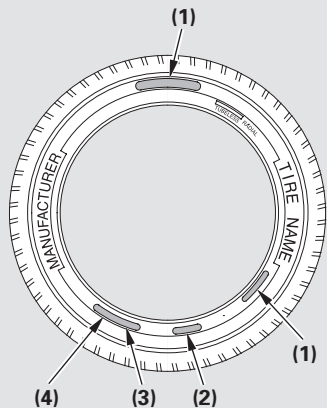

- (1) Tire Size
- (2) Tire Identification Number (TIN)
- (3) Maximum Tire Pressure
- (4) Maximum Tire Load

Tire Size

Whenever tires are replaced, they should be replaced with tires of the same size. The following is an example of tire size with an explanation of what each component means.

P245/65R17 105T

- P – Vehicle type (P indicates passenger vehicle).
- 245 – Tire width in millimeters.
- 65 – Aspect ratio (the tire's section height as a percentage of its width).
- R – Tire construction code (R indicates radial).
- 17 – Rim diameter in inches.

105 – Load index (a numerical code associated with the maximum load the tire can carry).

T – Speed symbol (an alphabetical code indicating the maximum speed rating).

Tire Identification Number (TIN)

The tire identification number (TIN) is a group of numbers and letters that look like the following example. TIN is located on the sidewall of the tire.

DOT B97R FW6X 2202

DOT – This indicates that the tire meets all requirements of the U.S. Department of Transportation.

B97R – Manufacturer's identification mark.

FW6X — Tire type code.

2202 — Date of manufacture.

Year

Week

Glossary of Tire Terminology

Cold Tire Pressure — The tire air pressure when the vehicle has been parked for at least three hours or driven less than 1 mile (1.6 km).

Load Rating — Means the maximum load that a tire is rated to carry for a given inflation pressure.

Maximum Inflation Pressure — The maximum tire air pressure that the tire can hold.

Maximum Load Rating — Means the load rating for a tire at the maximum permissible inflation pressure for that tire.

Recommended Inflation Pressure — The cold tire inflation pressure recommended by the manufacturer.

Treadwear Indicators (TWI) — Means the projections within the principal grooves designed to give a visual indication of the degrees of wear of the tread.

Tire Pressure Monitoring System (TPMS) – Required Federal Explanation

Each tire, including the spare (if provided), should be checked monthly when cold and inflated to the inflation pressure recommended by the vehicle manufacturer on the vehicle placard or tire inflation pressure label.

(If your vehicle has tires of a different size than the size indicated on the vehicle placard or tire inflation pressure label, you should determine the proper tire inflation pressure for those tires.)

As an added safety feature, your vehicle has been equipped with a tire pressure monitoring system (TPMS) that illuminates a low tire pressure telltale



when one or more of your tires is significantly under-inflated.

Accordingly, when the low tire pressure telltale illuminates, you should stop and check your tires as soon as possible, and inflate them to the proper pressure.

Driving on a significantly under inflated tire causes the tire to overheat and can lead to tire failure. Underinflation also reduces fuel efficiency and tire tread life, and may affect the vehicle's handling and stopping ability.

Please note that the TPMS is not a substitute for proper tire maintenance, and it is the driver's responsibility to maintain correct tire pressure, even if under-inflation has not reached the level to trigger illumination of the TPMS low tire pressure telltale.

Tire Pressure Monitoring System (TPMS) – Required Federal Explanation

On vehicles without navigation system

Your vehicle has also been equipped with a TPMS malfunction indicator to indicate when the system is not operating properly. The TPMS malfunction indicator is provided by a separate telltale, which displays the symbol “TPMS” when illuminated.

When the malfunction indicator is illuminated,



the system may not be able to detect or signal low tire pressure as intended.

TPMS malfunctions may occur for a variety of reasons, including the installation of replacement or alternate tires or wheels on the vehicle that prevent the TPMS from functioning properly.

Always check the TPMS malfunction telltale after replacing one or more tires or wheels on your vehicle to ensure that the replacement or alternate tires and wheels allow the TPMS to continue to function properly.

Tire Pressure Monitoring System (TPMS) – Required Federal Explanation

On vehicles with navigation system

Your vehicle has also been equipped with a TPMS malfunction indicator to indicate when the system is not operating properly. The TPMS malfunction indicator is combined with the low tire pressure telltale.

When the system detects a malfunction, the telltale will flash for approximately one minute and then remain continuously illuminated.

This sequence will continue upon subsequent vehicle start-ups as long as the malfunction exists.

When the malfunction indicator is illuminated, the system may not be able to detect or signal low tire pressure as intended.

TPMS malfunctions may occur for a variety of reasons, including the installation of replacement or alternate tires or wheels on the vehicle that prevent the TPMS from functioning properly.

Always check the TPMS malfunction telltale after replacing one or more tires or wheels on your vehicle to ensure that the replacement or alternate tires and wheels allow the TPMS to continue to function properly.

The burning of gasoline in your vehicle's engine produces several by-products. Some of these are carbon monoxide (CO), oxides of nitrogen (NO_x), and hydrocarbons (HC). Gasoline evaporating from the tank also produces hydrocarbons. Controlling the production of NO_x, CO, and HC is important to the environment. Under certain conditions of sunlight and climate, NO_x and HC react to form photochemical "smog." Carbon monoxide does not contribute to smog creation, but it is a poisonous gas.

The Clean Air Act

The United States Clean Air Act* sets standards for automobile emissions. It also requires that automobile manufacturers explain to owners how their emissions controls work and what to do to maintain them. This section summarizes how the emissions controls work. Scheduled maintenance is on page 469.

* In Canada, Honda vehicles comply with the Canadian emission requirements, as specified in an agreement with Environment Canada, at the time they are manufactured.

Crankcase Emissions Control System

Your vehicle has a positive crankcase ventilation system. This keeps gasses that build up in the engine's crankcase from going into the atmosphere. The positive

crankcase ventilation valve routes them from the crankcase back to the intake manifold. They are then drawn into the engine and burned.

Evaporative Emissions Control System

As gasoline evaporates in the fuel tank, an evaporative emissions control canister filled with charcoal adsorbs the vapor. It is stored in this canister while the engine is off. After the engine is started and warmed up, the vapor is drawn into the engine and burned during driving.

Onboard Refueling Vapor Recovery

The onboard refueling vapor recovery (ORVR) system captures the fuel vapors during refueling. The vapors are adsorbed in a canister filled with activated carbon. While driving, the fuel vapors are drawn into the engine and burned off.

Emissions Controls

Exhaust Emissions Controls

The exhaust emissions controls include four systems: PGM-FI, ignition timing control, exhaust gas recirculation, and three way catalytic converter. These four systems work together to control the engine's combustion and minimize the amount of HC, CO, and NOx that come out the tailpipe. The exhaust emissions control systems are separate from the crankcase and evaporative emissions control systems.

PGM-FI System

The PGM-FI system uses sequential multiport fuel injection. It has three subsystems: air intake, engine control, and fuel control. The powertrain control module (PCM) uses various sensors to determine how much air is going into the engine. It then controls how much fuel to inject under all operating conditions.

Ignition Timing Control System

This system constantly adjusts the ignition timing, reducing the amount of HC, CO, and NOx produced.

Exhaust Gas Recirculation (EGR) System

The exhaust gas recirculation (EGR) system takes some of the exhaust gas and routes it back into the intake manifold. Adding exhaust gas to the air/fuel mixture reduces the amount of NOx produced when the fuel is burned.

Three Way Catalytic Converter

The three way catalytic converter is in the exhaust system. Through chemical reactions, it converts HC, CO, and NOx in the engine's exhaust to carbon dioxide (CO₂), nitrogen (N₂), and water vapor.

Replacement Parts

The emissions control systems are designed and certified to work together in reducing emissions to levels that comply with the Clean Air Act. To make sure the emissions remain low, you should use only new Honda replacement parts or their equivalent for repairs. Using lower quality parts may increase the emissions from your vehicle.

The emissions control systems are covered by warranties separate from the rest of your vehicle. Read your warranty manual for more information.

Three Way Catalytic Converter

The three way catalytic converter contains precious metals that serve as catalysts, promoting chemical reactions to convert the exhaust gasses without affecting the metals. The catalytic converter is referred to as a three-way catalyst, since it acts on HC, CO, and NOx. A replacement unit must be an original Honda part or its equivalent.

The three way catalytic converter must operate at a high temperature for the chemical reactions to take place. It can set on fire any combustible materials that come near it. Park your vehicle away from high grass, dry leaves, or other flammables.

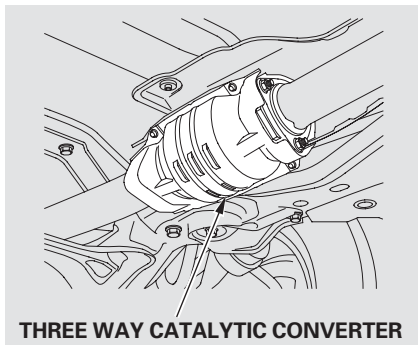

A defective three way catalytic converter contributes to air pollution, and can impair your engine's performance. Follow these guidelines to protect your vehicle's three way catalytic converter.

- Always use unleaded gasoline. Even a small amount of leaded gasoline can contaminate the catalyst metals, making the three way catalytic converter ineffective.

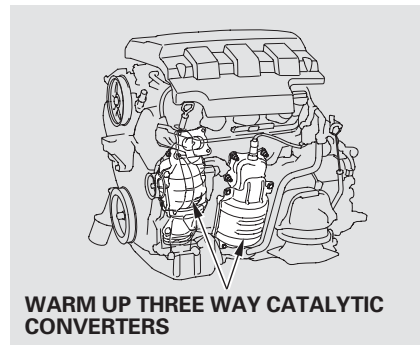

- Keep the engine well maintained.
- Have your vehicle diagnosed and repaired if it is misfiring, back-firing, stalling, or otherwise not running properly.

Emissions Testing

Testing of Readiness Codes

If you take your vehicle for an emissions test shortly after the battery has been disconnected or gone dead, it may not pass the test. This is because of certain “readiness codes” that must be set in the on-board diagnostics for the emissions systems. These codes are erased when the battery is disconnected, and set again only after several days of driving under a variety of conditions.

If the testing facility determines that the readiness codes are not set, you will be requested to return at a later date to complete the test. If you must get the vehicle retested within the next two or three days, you can condition the vehicle for retesting by doing the following.

1. Make sure the gas tank is nearly, but not completely, full (around 3/4).
2. Make sure the vehicle has been parked with the engine off for 6 hours or more.
3. Make sure the ambient temperature is between 40° and 95° F (4° and 35° C).
4. Without touching the accelerator pedal, start the engine, and let it idle for 20 seconds.
5. Keep the vehicle in Park. Increase the engine speed to 2,000 rpm, and hold it there until the temperature gauge rises to at least 1/4 of the scale (about 3 minutes).
6. Without touching the accelerator pedal, let the engine idle for 20 seconds.

7. Select a nearby lightly traveled major highway where you can maintain a speed of 50 to 60 mph (80 to 97 km/h) for at least 20 minutes. Drive on the highway in D. Do not use the cruise control. When traffic allows, drive for 90 seconds without moving the accelerator pedal. (Vehicle speed may vary slightly; this is okay.) If you cannot do this for a continuous 90 seconds because of traffic conditions, drive for at least 30 seconds, then repeat it two more times (for a total of 90 seconds).
8. Then drive in city/suburban traffic for at least 10 minutes. When traffic conditions allow, let the vehicle coast for several seconds without using the accelerator pedal or the brake pedal.
9. Make sure the vehicle has been parked with the engine off for 30 minutes.

If the testing facility determines the readiness codes are still not set, see your dealer.

Warranty and Customer Relations

- Customer Service Information..... 554
- Warranty Coverages 555
- Reporting Safety Defects
(U.S. Vehicles) 556
- Authorized Manuals 557



Customer Service Information

Honda dealership personnel are trained professionals. They should be able to answer all your questions. If you encounter a problem that your dealership does not solve to your satisfaction, please discuss it with the dealership's management. The service manager or general manager can help. Almost all problems are solved in this way.

If you are dissatisfied with the decision made by the dealership's management, contact Honda Customer Service.

U.S. Owners:

American Honda Motor Co., Inc.
Automobile Customer Service
Mail Stop 500-2N-7A
1919 Torrance Boulevard
Torrance, California 90501-2746

Tel: (800) 999-1009

Canadian Owners:

Customer Relations
Honda Canada Inc.

Visit www.honda.ca for contact information

Tel: 1-888-9-HONDA-9

Fax: 1-877-939-0909

In Puerto Rico and the U.S. Virgin Islands:

Vortex Motor Corp.
Bella International
P.O. Box 190816
San Juan, PR 00919-0816

Tel: (787) 620-7546

When you call or write, please give us this information:

- Vehicle Identification Number (see page [536](#))
- Name and address of the dealer who services your vehicle
- Date of purchase
- Odometer reading of your vehicle
- Your name, address, and telephone number
- A detailed description of the problem
- Name of the dealer who sold the vehicle to you

U.S. Owners

Your new vehicle is covered by these warranties:

New Vehicle Limited Warranty – covers your new vehicle, except for the emissions control systems and accessories, against defects in materials and workmanship.

Emissions Control Systems Defects Warranty and Emissions Performance Warranty

– these two warranties cover your vehicle's emissions control systems. Time, mileage, and coverage are conditional. Please read your warranty booklet for exact information.

Seat Belt Limited Warranty – a seat belt that fails to function properly is covered by a limited warranty. Please read your warranty booklet for details.

Rust Perforation Limited Warranty – all exterior body panels are covered for rust-through from the inside for the specified time period with no mileage limit.

Accessory Limited Warranty – Honda accessories are covered under this warranty. Time and mileage limits depend on the type of accessory and other factors. Please read your warranty booklet for details.

Replacement Parts Limited Warranty – covers all Honda replacement parts against defects in materials and workmanship.

Replacement Battery Limited Warranty – provides prorated coverage for a replacement battery purchased from your dealer.

Replacement Muffler Lifetime Limited Warranty – provides coverage for as long as the purchaser of the muffler owns the vehicle.

Restrictions and exclusions apply to all these warranties. Please read the 2011 Honda warranty information booklet that came with your vehicle for precise information on warranty coverages. Your vehicle's original tires are covered by their manufacturer. Tire warranty information is in a separate booklet.

Canadian Owners

Please refer to the 2011 warranty manual that came with your vehicle.

Reporting Safety Defects (U.S. Vehicles)

If you believe that your vehicle has a defect which could cause a crash or could cause injury or death, you should immediately inform the National Highway Traffic Safety Administration (NHTSA), in addition to notifying American Honda Motor Co., Inc.

If NHTSA receives similar complaints, it may open an investigation, and if it finds that a safety defect exists in a group of vehicles, it may order a recall and remedy campaign. However, NHTSA cannot become involved in individual problems between you, your dealer, or American Honda Motor Co., Inc.

To contact NHTSA, you may call the Vehicle Safety Hotline toll-free at 1-888-327-4236 (TTY: 1-800-424-9153); go to <http://www.safercar.gov>; or write to: Administrator, NHTSA, 1200 New Jersey Avenue, SE., Washington, DC 20590. You can also obtain other information about motor vehicle safety from <http://www.safercar.gov>.

Purchasing Factory Authorized Manuals (U.S. only)

The publications shown below can be purchased from Helm Incorporated. You can order by phone or online:

- Call Helm Inc. at 1-800-782-4356 (credit card orders only)
- Go online at www.helminc.com

If you are interested in other years or models, contact Helm Inc. at 1-800-782-4356.

Publication Form Number	Form Description
61SZA02	2011 Honda Pilot Service Manual
61SZA02EL	2011 Honda Pilot Electrical Troubleshooting Manual
61SZA30	2011 Honda Pilot Body Repair Manual
31SZA620	2011 Honda Pilot Owner's Manual
31SZA820	2011 Honda Pilot Navigation System Owner's Manual
31SZAM20	2011 Honda Pilot Honda Service History
31SZAQ20	2011 Honda Pilot Technology Reference Guide
HON	Order Form for Previous Years Indicate Year and Model Desired

Service Manual:

Covers maintenance and recommended procedures for repair to engine and chassis components. It is written for the journeyman mechanic, but it is simple enough for most mechanically inclined owners to understand.

Electrical Troubleshooting Manual:

Complements the Service Manual by providing in-depth troubleshooting information for each electrical circuit in your vehicle.

Body Repair Manual:

Describes the procedures involved in the replacement of damaged body parts.

A

AAC	300
Accessories and Modifications	402
ACCESSORY (Ignition Key Position)	137
Accessory Power Sockets.....	186
AC Power Outlet.....	187
Active Head Restraints	158
Additives, Engine Oil.....	473
Advanced Airbags.....	31
Airbag (SRS)	11, 26
Airbag System Components.....	26
Air Conditioning System.....	192, 199
Rear A/C Control.....	197, 204
Air Outlets (Vents).....	206
Air Pressure, Tires	496
Antifreeze	475
Anti-lock Brakes (ABS) Indicator Light	72, 430
Operation.....	429
Anti-theft, Audio System.....	313
Anti-theft Steering Column Lock.....	137
Audio System.....	208, 210, 226, 252

Auto Control Mode, Starting Engine	411
Auto Door Lock	116
Auto Door Locking/Unlocking....	139
Auto Door Unlock.....	117
Automatic Climate Control.....	199
Automatic Lighting.....	127
Automatic Seat Belt Tensioners	24
Automatic Speed Control.....	350
Automatic Transmission.....	413
Capacity, Fluid	538
Checking Fluid Level.....	478
Shifting.....	413
Shift Lever Position Indicators.....	413
Shift Lever Positions	414
Shift Lock Release.....	416
Auxiliary Input Jack.....	310

B

Battery Charging System Indicator.....	70, 521
Jump Starting	517
Maintenance.....	504

Specifications	539
Before Driving	393
Belts, Seat	9, 22
Beverage Holders.....	181
Bluetooth® HandsFreeLink®	361
Booster Seats	58
Brakes Anti-lock System (ABS)	429
Break-in, New Linings	394
Bulb Replacement	486, 488
Fluid	481
Parking.....	169
System Indicator.....	71, 523
Wear Indicators	429
Braking System.....	428
Break-in, New Vehicle	394
Brightness Control, Instruments.....	131

Index

Bulb Replacement			
Back-up Lights	486		
Brake Lights.....	486		
Fog Lights	485		
Front Parking Lights.....	484		
Front Side Marker Lights.....	484		
Headlights	483		
Rear Bulbs	486		
Specifications	539		
Turn Signal Lights.....	484		
Bulbs, Halogen.....	483		
C			
Cancel Button.....	352		
Capacities Chart.....	538		
Carbon Monoxide Hazard	61		
Cargo Area Light	178		
Cargo Hook	408		
Cargo, How to Carry	404		
CAUTION, Explanation of	iii		
Certification Label.....	536		
Chains, Tires	503		
Changing a Flat Tire	509		
Changing Oil			
How to.....	473		
When to.....	455		
Charging System Indicator ...	70, 521		
Checklist, Before Driving.....	410		
Childproof Door Locks	144		
Child Safety	39		
Booster Seats	58		
Child Seats.....	44, 47		
Important Safety Reminders.....	39		
Infants	44		
Larger Children	57		
LATCH.....	49		
Risks with Airbags.....	40		
Small Children.....	45		
Tether	54		
Warning Labels.....	62		
Where Should a Child Sit?.....	40		
Child Seats.....	47		
LATCH Anchorage Points	49		
Tether Anchorage Points.....	55, 56		
Cleaning Seat Belts.....	490		
Climate Control System.....	199		
Clock	314		
Coat Hooks.....	185		
Code, Audio System	313		
CO in the Exhaust	547		
Compact Spare Tire.....	508		
Compass.....	353		
Console Compartment	180		
Consumer Information.....	554		
Controls, Instruments and.....	65		
Conversation Mirror	184		
Coolant			
Adding.....	475		
Checking	398		
Proper Solution	475		
Temperature Gauge.....	82		
Crankcase Emissions Control			
System.....	547		
Cruise Control Indicator	78		
Cruise Control Operation	350		
Cup Holders.....	181		
Customer Service Office	554		
Customize Settings.....	97		
Door/Window Setup.....	115		
Lighting Setup.....	110		
Meter Setup.....	103		
Position Setup	108		
Setting to Default.....	100		
D			
DANGER, Explanation of	iii		

- Dashboard 3, 66
 Daytime Running Lights 128
 Dead Battery 517
 Defects, Reporting Safety 556
 Defogger, Rear Window 130
 Defrosting the Windows 194, 203
 Differential Fluid 538
 Dimensions 538
 Dimming the Headlights 126
 Dipstick
 Automatic Transmission 478
 Engine Oil 398
 Directional Signals 73
 Disc Brake Wear Indicators 429
 Disc Care 285
 Disc Changer 242, 274
 Disc Changer Error
 Messages 251, 284
 Disc Player 218, 242, 274
 Disposal of Used Oil 474
 Doors
 Indicator 13, 95
 Locking and Unlocking 138
 Lockout Prevention 144
 Power Door Locks 138
 DOT Tire Quality Grading 540
 Driver and Passenger Safety 5
 Driving 409
 Economy 399
 Driving Position Memory
 System 173
 Dust and Pollen Filter 490
 DVD Player Error Messages 345
 DVD Player 320
- E**
- Economy, Fuel 399
 Electronic Stability Control (ESC)
 System 431
 Emergencies 507
 Battery, Jump Starting 517
 Brake System Indicator 523
 Changing a Flat Tire 509
 Charging System Indicator 521
 Checking the Fuses 525
 Driving with a Flat Tire 508
 Hazard Warning Flashers 130
 Jump Starting 517
 Low Oil Pressure Indicator 521
 Malfunction Indicator Lamp 522
 Overheated Engine 519
 Towing 531
 Emergency Brake 169
 Emergency Flashers 130
 Emergency Towing 531
 Emissions Controls 547
 Emissions Testing 550
 Engine
 Check Starter System 412
 Coolant Temperature Gauge 82
 If it Won't Start 516
 Malfunction Indicator
 Lamp 70, 522
 Oil Life 455
 Oil Pressure Indicator 70, 521
 Oil, What Kind to Use 472
 Overheating 519
 Specifications 539
 Speed Limiter 416
 Starting 411
 Evaporative Emissions Controls .. 547
 Exhaust Fumes 61
 Exhaust Gas Recirculation
 System 548

CONTINUED

Index

Expectant Mothers, Use of Seat Belts by 20

F

Fan, Interior 193, 202

Features, Comfort and Convenience 191

Filling the Fuel Tank 395

Filters

Dust and Pollen 490

Oil 473

Flashers, Hazard Warning 130

Flat Tire, Changing a 509

Floor Mats 491

Fluids

Automatic Transmission 478

Brake 481

Power Steering 482

Rear Differential 480

Transfer Assembly 480

Windshield Washer 477

FM Stereo Radio

Reception 308

Fog Lights 128

Folding the Second Seat 160

Folding the Third Seat 161

Four-way Flashers 130

Front Airbags 11, 29

Front Seat 154

Adjusting 154

Airbags 11, 29

Heaters 164

Fuel 394

Fill Door and Cap 395

Gauge 82

Octane Requirement 394

Oxygenated 394

Reserve Indicator 80

Tank, Filling the 395

Tighten Fuel Cap 396

Fuel Economy 399

Fuses, Checking the 525

G

Gas Mileage, Improving 400

Gasoline 394

Gauge 82

Low Fuel Indicator 80

Octane Requirement 394

Tank, Refueling 395

Gas Station Procedures 395

Gauges

Engine Coolant Temperature 82

Fuel 82

Speedometer 82

Tachometer 82

GAWR (Gross Axle Weight

Rating) 435

GCWR (Gross Combined Weight

Rating) 436

Gearshift Lever Positions 413

Glass Hatch 148

Glove Box 183

GVWR (Gross Vehicle Weight

Rating) 435

H

Halogen Headlight Bulbs 483

HandsFreeLink[®] 361

HFL Buttons 361

Hazard Warning Flashers 130

Index

J

Jacking up the Vehicle	511
Jack, Tire	509
Jump Starting	517

K

Keys.....	134
Keyless Memory Settings	153

L

Label, Certification.....	536
Lane Change, Signaling	126
Lap/Shoulder Belts	17, 23
Light Control Switch	176
Lights	
Bulb Replacement	483
Indicator.....	67, 68
Interior	176
Parking.....	126
Turn Signal.....	126
Load Limit	405, 434
LOCK (Ignition Key Position)	137

Locks

Anti-theft Steering Column	137
Fuel Fill Door	395
Glove Box	183
Lockout Prevention	144
Power Door	138
Tailgate	144, 145
Low Coolant Level.....	398
Low Fuel Indicator	80
Low Oil Pressure Indicator ...	70, 521
Lubricant Specifications Chart ...	538
Luggage, Storing (cargo)	404

M

Maintenance.....	453
Information.....	455
Owner's Maintenance	
Checks	467
Safety.....	454
Schedule	469
Malfunction Indicator Lamp	522
Memory, Driving Position	173
Message Display.....	95
Message Indicator	77
Meters, Gauges.....	82

Mirrors, Adjusting.....	171
Modifications.....	403
Modifying Your Vehicle.....	403
Moonroof	168
MP3.....	219, 243, 280, 300
Multi-Information Display	87

N

Neutral Gear Position.....	414
New Vehicle Break-in	394
NOTICE, Explanation of.....	i
Numbers, Identification.....	536

O

Octane Requirement, Gasoline ...	394
Odometer.....	83, 89
Odometer, Trip.....	83, 89
Off-Highway Driving.....	449
Off-Road Precautions.....	449

- Oil
 Change, How to 473
 Change, When to 455
 Checking Engine 398
 Life, Engine 455
 Pressure Indicator 70, 521
 Selecting Proper Viscosity
 Chart 472
- ON (Ignition Key Position) 137
- Outside Mirrors 171
- Outside Temperature 85, 90
- Overheating, Engine 519
- Owner's Maintenance Checks 467
- Oxygenated Fuels 394
- P**
- Panel Brightness Control 131
- Park Gear Position 414
- Parking 419
- Parking Brake 169
- Parking Brake and Brake
 System Indicator 71, 523
- Parking Lights 126
- Parking Over Things that Burn... 419
- Passenger Airbag Off Indicator 36
- PGM-FI System 548
- Pollen Filter 490
- Power Door Locks 138
- Power Seat Adjustments 154
- Power Socket Locations 179
- Power Windows 165
- Pregnancy, Using Seat Belts 20
- Protecting Adults and Teens 13
 Additional Safety Precautions 21
 Advice for Pregnant Women 20
- Protecting Children 39
 General Guidelines 39
- Protecting Infants 44
- Protecting Larger Children 57
- Protecting Small Children 45
- Using Child Seats with
 Tethers 54
- Using LATCH 49
- R**
- Radiator Overheating 519
- Radio/Disc Sound
 System 210, 227, 253
- Radio Theft Protection 313
- RDS 213, 230, 257
- Readiness Codes 550
- Rear A/C Unit 197, 204
- Rear Audio Control Panel 321
- Rear Entertainment System 317
- Rear Lights, Bulb Replacement... 486
- Rearview Camera and Monitor ... 390
- Rearview Mirror 170
- Rear Window Defogger 194, 203
- Rear Window Wiper and
 Washer 125
- Reclining the Seat Backs 154, 155
- Reclining the Second Seats 159
- Reminder Indicators 69
- Remote Audio Controls 311
- Remote Control (RES) 322
- Remote Transmitter 150
- Replacement Information
 Engine Oil and Filter 473
 Fuses 525
 Light Bulbs 483
 Schedule 469
 Timing Belt 482
 Tires 499
 Wiper Blades 492

CONTINUED

Index

- Tires 496
 Air Pressure 496
 Checking Wear 498
 Compact Spare 508
 DOT Tire Quality Grading 540
 Inflation 496
 Inspection 498
 Maintenance 499
 Replacing 499
 Rotating 499
 Snow 502
 Specifications 539
 Tire Chains 503
 Tools, Tire Changing 509
- Towing
 A Trailer 434
 Emergency Wrecker 531
 Equipment and Accessories 441
 Weight Limit 434
 Trailer Loading 434
 Trailer Towing Tips 446
- Transmission
 Checking Fluid Level 478
 Fluid Selection 479
 Identification Number 536
 Shifting the Automatic 413
- Treadwear 498
 Trip Computer 92
 Trip Meter 83, 89
 Turn Signals 73
- U**
- Unexpected, Taking Care
 of the 507
 Uniform Tire Quality Grading 540
 Unleaded Gasoline 394
 USB Adapter Cable 290, 301
 USB Flash Memory Device 298
 Used Oil, How to Dispose of 474
- V**
- Vanity Mirror 185
 Vehicle Capacity Load 405
 Vehicle Dimensions 538
 Vehicle Identification Number 536
 Vehicle Stability Assist (VSA®)
 System 431
 VSA Activation
 Indicator 73, 95, 431
 VSA Off Switch 432
 VSA System Indicator 73, 431
 Vehicle Storage 505
 Ventilation 195
 VIN 536
 Viscosity, Oil 472
 Voice Control System 200, 252
 VTM-4 Lock 418
- W**
- WARNING, Explanation of iii
 Warning Labels, Location of 62
 Warranty Coverages* 555
 Washer, Windshield
 Checking the Fluid Level 477
 Level Indicator 80
 Operation 124
 Wheels
 Adjusting the Steering 133
 Alignment and Balance 499
 Aluminum Alloy Wheels 503
 Cleaning 503
 Compact Spare 508
 Wrench, Nut 510

Windows	
Auto Reverse.....	166
Operating the Power.....	165
Rear, Defogger	130
Windshield	
Cleaning.....	124
Defroster	194, 203
Washers.....	124
Wipers, Windshield	
Changing Blades.....	492
Operation.....	124
Rear Windshield Wiper and Washer.....	125
WMA.....	219, 243, 280, 300
Worn Tires	498
Wrecker, Emergency Towing.....	531

X

XM® Radio.....	236, 266
----------------	----------

*: U.S. only

Service Information Summary

Gasoline:

Unleaded gasoline, pump octane number of 87 or higher.

Premium fuel is recommended when towing in certain conditions (see page [446](#)).

Fuel Tank Capacity:

21.00 US gal (79.5 ℓ)

Recommended Engine Oil:

API Premium grade 5W-20 detergent oil (see page [472](#)).

Oil change capacity (including filter):

4.5 US qt (4.3 ℓ)

Automatic Transmission Fluid:

Honda Genuine ATF-Z1 (automatic transmission fluid) (see page [479](#)).

4WD models only

Rear Differential Fluid:

Honda VTM-4 Differential Fluid (see page [480](#)).

4WD models only

Transfer Assembly Fluid:

SAE 90 or SAE 80W-90 viscosity hypoid gear oil, API service classified GL4 or GL5 only.

Power Steering Fluid:

Honda Power Steering Fluid preferred, or another brand of power steering fluid as a temporary replacement. Do not use ATF (see page [482](#)).

Brake Fluid:

Honda Heavy Duty Brake Fluid DOT 3 preferred, or a DOT 3 or DOT 4 brake fluid as a temporary replacement (see page [481](#)).

Tire Pressure (measured cold):

Front/Rear:

32 psi (220 kPa , 2.2 kgf/cm²)

Compact Spare Tire:

60 psi (420 kPa , 4.2 kgf/cm²)

Owner's Identification

OWNER _____

ADDRESS _____
STREET

CITY

STATE/PROVINCE/TERRITORY

ZIP CODE/
POSTAL CODE

V. I. N. _____

DELIVERY DATE _____
(Date sold to original retail purchaser)

DEALER NAME _____ DEALER NO. _____

ADDRESS _____
STREET

CITY

STATE/PROVINCE/TERRITORY

ZIP CODE/
POSTAL CODE

OWNER'S SIGNATURE _____

DEALER'S SIGNATURE _____

This owner's manual should be considered a permanent part of the vehicle and should remain with the vehicle when it is sold.

This owner's manual covers all models of the Pilot. You may find descriptions of equipment and features that are not on your particular model.

The information and specifications included in this publication were in effect at the time of approval for printing. Honda Motor Co., Ltd. reserves the right, however, to discontinue or change specifications or design at any time without notice and without incurring any obligation whatsoever.

POUR CLIENTS CANADIEN
AVIS IMPORTANT: Si vous avez
besoin d'un Manuel du Conducteur
en français, veuillez demander à
votre concessionnaire de
commander le numéro de pièce
33SZAC20