



Mercedes-Benz



# E-Class Operator's Manual

E 320

E 430

E 55 AMG

Our company and staff congratulate you on the purchase of your new Mercedes-Benz.

Your selection of our product is a demonstration of your trust in our company name. Further, it exemplifies your desire to own an automobile that will be as easy as possible to operate and provide years of service.

Your Mercedes-Benz represents the efforts of many skilled engineers and craftsmen. To ensure your pleasure of ownership, and for your safety and that of your passengers, we ask you to make a small investment of your time:

- Please read this manual carefully before putting it aside. Then return it to your vehicle where it will be handy for your reference.
- Please abide by the recommendations contained in this manual. They are designed to acquaint you with the operation of your Mercedes-Benz.
- Please abide by the warnings and cautions contained in this manual. They are designed to help improve the safety of the vehicle operator and occupants.

We extend our best wishes for many miles of safe, pleasurable driving.

DaimlerChrysler AG

## Introduction

Product information .....	7
Operator's manual .....	8
Where to find it .....	13
Reporting Safety Defects .....	15

## Instruments and controls

Instruments and controls .....	18
Center console .....	20
Overhead control panel .....	21

## Operation

Vehicle keys .....	24
Start lock-out .....	26
General notes on the central locking system .....	26
Central locking system .....	27
Radio frequency and infrared remote control .....	27
Opening the trunk .....	30
Opening and closing windows and sliding/pop-up roof from outside .....	31

Panic button .....	32
Mechanical keys .....	32
Doors .....	33
Central locking switch .....	35
Automatic central locking .....	36
Emergency unlocking in case of accident .....	36
Trunk .....	37
Trunk lamp .....	39
Trunk lid release switch .....	40
Trunk lid emergency release .....	41
Trunk lid emergency release .....	42
Antitheft alarm system .....	43
Tow-away alarm .....	44
Power seats front .....	45
Front seat head restraints .....	51
Rear seat head restraints .....	52
Multicontour seat .....	53
Seat heater .....	54
Seat ventilation .....	57
Seat belts and integrated restraint system .....	59
Seat belts .....	59

Seat belt nonusage warning system .....	60
BabySmart™ airbag deactivation system .....	66
Self-test BabySmart™ without special child seat installed .....	66
Supplemental restraint system (SRS) .....	67
Emergency tensioning retractor (ETR) .....	68
Airbags .....	69
Safety guidelines for the seat belt, emergency tensioning retractor and airbag .....	75
Infant and child restraint systems .....	77
Steering wheel adjustment .....	81
Rear view mirrors .....	82
Instrument cluster .....	86
Multifunction steering wheel, multifunction display .....	92
Trip and main odometer, FSS and engine oil level display .....	96

Audio systems .....	97	Special settings .....	129	Rear window sunshade .....	160
Radio .....	97	Defogging windows .....	129	Sun visors .....	161
CD player .....	98	Defrosting .....	129	Illuminated vanity mirrors .....	161
Cassette player .....	99	Rear window defroster .....	130	Interior .....	162
Telephone .....	100	Air distribution .....	130	Armrest, rear bench .....	162
Telephone book .....	100	Air volume .....	130	Cup holder	
Redialing .....	102	Air recirculation .....	131	in rear bench armrest .....	162
Incoming call .....	104	Dust filter .....	131	Glove box .....	163
Navigation system .....	105	Activated charcoal filter .....	132	Cup holder and coin holder	
Trip computer .....	106	Residual engine		in glove box lid .....	163
Malfunction message memory ....	108	heat utilization .....	132	Storage compartment above	
Individual settings .....	110	Front center console		ashtray in center console .....	164
Setting the audio volume .....	113	compartment ventilation .....	133	Storage compartments	
Flexible service system (FSS) .....	114	Rear passenger compartment		in center console .....	164
Engine oil level indicator .....	117	adjustable air outlet .....	134	Cup holder in center console .....	165
Engine oil consumption .....	118	Audio and telephone,		Ashtrays .....	166
Exterior lamp switch .....	119	operation .....	135	Lighter .....	168
Night security illumination .....	120	Power windows .....	154	Cargo tie-down hooks .....	169
Headlamp cleaning system .....	121	Sliding / pop-up roof .....	157	Parcel net	
Combination switch .....	122	Interior lighting .....	159	in front passenger footwell ....	169
Hazard warning flasher switch ...	125	Entrance lamps,		Cellular telephone .....	170
Automatic climate control .....	126	exit lamps in doors .....	159	Shelf below rear window .....	170
Display and controls .....	128	Reading lamps		Garage door opener .....	171
Basic setting .....	129	rear compartment .....	160		

## Driving

Control and operation of radio transmitters .....	176
The first 1 000 miles (1 500 km) .....	177
Maintenance .....	177
Tele Aid .....	178
Catalytic converter .....	188
Emission control .....	189
Steering lock .....	190
Starting and turning off the engine .....	192
Automatic transmission .....	193
Parking brake .....	202
Driving instructions .....	203
Drive sensibly - Save Fuel .....	203
Drinking and driving .....	203
Pedals .....	203
Power assistance .....	204
Brakes .....	204

Driving off .....	205
Parking .....	206
Tires .....	206
Snow chains .....	209
Winter driving instructions .....	209
Block heater .....	211
Deep water .....	211
Passenger compartment .....	211
Traveling abroad .....	211
Cruise control .....	212
Brake assist system (BAS) .....	215
Antilock brake system (ABS) .....	217
Four Wheel Electronic Traction System (4MATIC) .....	219
Electronic stability program (ESP) .....	220
Parking assist (Parktronic) .....	224
What you should know at the gas station .....	229
Check regularly and before a long trip .....	231

## Instrument cluster display

Malfunction and indicator lamps in the instrument cluster .....	234
On-board diagnostic system .....	234
Check engine malfunction indicator lamp .....	234
Brake warning lamp .....	235
Supplemental restraint system (SRS) indicator lamp .....	236
Fuel reserve and fuel cap placement warning .....	236
Electronic stability program (ESP) – warning lamp .....	237
BAS / ESP malfunction indicator lamp .....	237
ABS malfunction indicator lamp .....	238
Seat belt warning lamp .....	238
Malfunction and indicator lamp in the center console .....	239

AIRBAG OFF indicator lamp .....	239
Malfunction and warning messages in the multifunction display .....	240
DISPLAY DEFECTIVE .....	241
BATTERY / ALTERNATOR .....	242
ABS-SYSTEM .....	243
BRAKE ASSIST .....	243
BRAKE LINING WEAR .....	244
BRAKE FLUID .....	244
PARKING BRAKE .....	245
ENGINE FAN .....	245
COOLANT (coolant level) .....	246
COOLANT TEMP. ....	247
LIGHTING SYSTEM .....	248
LIGHT SENSOR .....	249
REMOVE KEY .....	249
STEERING GEAR OIL .....	250
ENGINE OIL LEVEL .....	251
WASHER FLUID .....	252
ELEC. STABIL. PROG. (Electronic stability program) ..	253
TELE AID .....	253

## Practical hints

First aid kit .....	256
Stowing things in the vehicle .....	256
Fuses .....	257
Hood .....	259
Checking engine oil level .....	262
Automatic transmission fluid level .....	263
Coolant level .....	263
Adding coolant .....	264
Windshield and headlamp washer system .....	265
Windshield and headlamp washer fluid mixing ratio .....	265
Spare wheel, vehicle tools, storage compartment .....	266
Vehicle jack .....	267
Wheels .....	268
Tire replacement .....	268
Rotating wheels .....	269
Spare wheel .....	270
Spare wheel bolts .....	270
Spare wheel .....	271
Changing wheels .....	273
Tire inflation pressure .....	278
Battery .....	280
Jump starting .....	282
Towing the vehicle .....	285
Transmission selector lever, manually unlocking .....	287
Exterior lamps .....	288
Headlamp assembly .....	289
Taillamp assemblies .....	292
Changing batteries in the electronic main key .....	294
Synchronizing remote control .....	296
Emergency engine shut-down .....	296
Rear seat cushion .....	297
Emergency operation of sliding / pop-up roof .....	298
Manual release for fuel filler flap .....	299
Replacing wiper blade insert .....	300
Roof rack .....	302

## Vehicle care

Cleaning and care	
of the vehicle .....	304
Power washer .....	305
Tar stains .....	305
Paintwork, painted body components .....	305
Engine cleaning .....	306
Vehicle washing .....	306
Ornamental moldings .....	306
Headlamps, taillamps, turn signal lenses .....	306
Cleaning the parktronic system sensors .....	307
Window cleaning / glass sunroof .....	307
Wiper blades .....	307
Light alloy wheels .....	308
Instrument cluster .....	308
Steering wheel and gear selector lever .....	308
Cup holder .....	308
Seat belts .....	308

Headliner and shelf below rear window .....	308
Upholstery .....	309
Hard plastic trim items .....	309
Plastic and rubber parts .....	309

## Technical data

Spare parts service .....	312
Warranty coverage .....	312
Identification labels .....	313
Layout of poly-V-belt drive .....	315
Technical data .....	316
Fuels, coolants, lubricants etc. - capacities .....	322
Engine oils .....	324
Engine oil additives .....	324
Air conditioner refrigerant .....	324
Brake fluid .....	324
Premium unleaded gasoline .....	325
Fuel requirements .....	325
Gasoline additives .....	326
Coolants .....	326
Consumer information .....	328

## Index

Index .....	330
-------------	-----





## Product information

Kindly observe the following in your own best interest:

We recommend using Mercedes-Benz original parts as well as conversion parts and accessories explicitly approved by us for your vehicle model.

We have tested these parts to determine their reliability, safety and their special suitability for Mercedes-Benz vehicles.

We are unable to make an assessment for other products and therefore cannot be held responsible for them, even if in individual cases an official approval or authorization by governmental or other agencies should exist. Use of such parts and accessories could adversely affect the safety, performance or reliability of your vehicle. Please do not use them.

Mercedes-Benz original parts as well as conversion parts and accessories approved by us are available at your authorized Mercedes-Benz Center where you will receive comprehensive information, also on permissible technical modifications, and where proper installation will be performed.

## **Operator's manual**

This Operator's Manual contains a great deal of useful information. We urge you to read it carefully and familiarize yourself with the vehicle before driving.

For your own safety and longer service life of the vehicle, we urge you to follow the instructions and warnings contained in this manual. Ignoring them could result in damage to the vehicle or personal injury to you or others. Vehicle damage caused by failure to follow instructions is not covered by the Mercedes-Benz Limited Warranty.

Your vehicle may have some or all of the equipment described in this manual. Therefore, you may find explanations for optional equipment not installed in your vehicle. If you have any questions about the operation of any equipment, your authorized Mercedes-Benz Center will be glad to demonstrate the proper procedures.

## **Service and warranty information**

The Service and Warranty Information Booklet contains detailed information about the warranties covering your Mercedes-Benz, including:

- New Car Limited Warranty,
- Emission System Warranty,
- Emission Performance Warranty,
- California, Massachusetts, and Vermont Emission Control System Warranty (California, Massachusetts, and Vermont only),
- State Warranty Enforcement Laws (Lemon Laws).

### **Important notice for California retail buyers of Mercedes-Benz automobiles**

Under California law you may be entitled to a replacement of your vehicle or a refund of the purchase price or lease price, if Mercedes-Benz USA, LLC and/or its authorized repair or service facilities fail to fix one or more substantial defects or malfunctions in the vehicle that are covered by its express warranty after a reasonable number of repair attempts. During the period of 18 months from original delivery of the vehicle or the accumulation of 18 000 miles on the odometer of the vehicle, whichever occurs first, a reasonable number of repair attempts is presumed for a retail buyer or lessee if one or more of the following occurs: (1) the same substantial defect or malfunction results in a condition that is likely to cause death or serious bodily injury if the vehicle is driven, that defect or malfunction has been subject to repair two or more times, and you have directly notified Mercedes-Benz USA, LLC in writing of the need for its repair and have given us a direct opportunity to perform a repair ourselves, (2) the same substantial defect or malfunction of a less serious nature than category (1) has been subject to repair four or more times and you have directly notified us of the need for its repair and given us the opportunity to repair ourselves, or (3) the vehicle is out of service by reason of repair of the same or different substantial defects or malfunctions for a cumulative total of more than 30 calendar days. Written notification should be sent to us, not a dealer, at Mercedes-Benz USA, LLC, Customer Assistance Center, One Mercedes Drive, Montvale, NJ 07645-0350.

### **Maintenance**

The Service Booklet describes all the necessary maintenance work which should be performed at regular intervals.

Always have the Service Booklet with you when you take the vehicle to your authorized Mercedes-Benz Center for service. The service advisor will record each service in the booklet for you.

**Roadside assistance**

The Mercedes-Benz Roadside Assistance Program provides factory trained technical help in the event of a breakdown. Calls to the toll-free Roadside Assistance number:

**1-800-FOR-MERCEdes (in the USA)**

**1-800-387-0100 (in Canada)**

will be answered by Mercedes-Benz Customer Assistance Representatives 24 hours a day, 365 days a year.

For additional information refer to the Mercedes-Benz Roadside Assistance Program brochure in your glove box.

**Change of address or ownership**

If you change your address, be sure to send in the “Change of Address Notice” found in the Service and Warranty Information Booklet, or simply call the Mercedes-Benz Customer Assistance Center (in the USA) at 1-800-FOR-MERCEdes, or Customer Service (in Canada) at 1-800-387-0100. It is in your own interest that we can contact you should the need arise.

If you sell your Mercedes, please leave all literature with the vehicle to make it available to the next operator.

If you bought this vehicle used, be sure to send in the “Notice of Purchase of Used Car” found in the Service and Warranty Information Booklet, or call the Mercedes-Benz Customer Assistance Center (in the USA) at 1-800-FOR-MERCEdes, or Customer Service (in Canada) at 1-800-387-0100.

## **Operating your vehicle outside the USA or Canada**

If you plan to operate your vehicle in foreign countries, please be aware that:

- Service facilities or replacement parts may not be readily available,
- unleaded gasoline for vehicles with catalytic converters may not be available; the use of leaded fuels will damage the catalyts,
- gasoline may have a considerably lower octane rating, and improper fuel can cause engine damage.

Certain Mercedes-Benz models are available for delivery in Europe under our European Delivery Program. For details, consult your authorized Mercedes-Benz Center or write to:

In the USA:

Mercedes-Benz USA, LLC  
European Delivery Department  
One Mercedes Drive  
Montvale, NJ 07645-0350

In Canada:

Mercedes-Benz Canada, Inc.  
European Delivery Department  
849 Eglinton Avenue East  
Toronto, Ontario M4G 2L5

We continuously strive to improve our product, and ask for your understanding that we reserve the right to make changes in design and equipment. Therefore, information, illustrations and descriptions in this Operator's Manual might differ from your vehicle.

Optional equipment is also described in this manual, including operating instructions wherever necessary. Since they are special-order items, the descriptions and illustrations herein may vary slightly from the actual equipment of your vehicle.

If there are any equipment details that are not shown or described in this Operator's Manual, your authorized Mercedes-Benz Center will be glad to inform you of correct care and operating procedures.

The Operator's Manual and Service Booklet are important documents and should be kept with the vehicle.

## Where to find it

The Operator's Manual is divided into eight sections:

- **Instruments and controls:** An overview of all the controls that can be operated from the driver's seat.
- **Operation:** Information on the vehicle's equipment and its operation.
- **Driving:** Important information on driving.
- **Instrument cluster display:** Displays and indicator lamps on the instrument cluster with brief instructions.
- **Practical hints:** Assistance and instructions in the event of an emergency.
- **Car care:** Instructions on caring for your vehicle.
- **Technical data:** All the important technical data for your vehicle as well as consumer information such as fuels, coolants, lubricants etc. is contained here.
- **Index:** Key terms to help you find a topic quickly.

Other documents may also be supplied, depending on your vehicle's equipment.

Explanation of color used:

Warning notices for the protection of yourself and others appear on red background.



### **Problems with your vehicle**

If you should experience a problem with your vehicle, particularly one that you believe may affect its safe operation, we urge you to immediately contact your authorized Mercedes-Benz Center to have the problem diagnosed and corrected if required. If the matter is not handled to your satisfaction, please discuss the problem with the Mercedes-Benz Center management, or if necessary contact us at the following addresses:

In the USA: Customer Assistance Center  
Mercedes-Benz USA, LLC  
One Mercedes Drive  
Montvale, NJ 07645-0350

In Canada: Customer Relations Department  
Mercedes-Benz Canada, Inc.  
849 Eglinton Avenue East  
Toronto, Ontario, M4G 2L5

For the USA only:

The following text is published as required of manufacturers under Title 49, Code of U.S. Federal Regulations, Part 575 pursuant to the “National Traffic and Motor Vehicle Safety Act of 1966”.

## **Reporting Safety Defects**

If you believe that your vehicle has a defect which could cause a crash or could cause injury or death, you should immediately inform the National Highway Traffic Safety Administration (NHTSA) in addition to notifying Mercedes-Benz USA, LLC.

If NHTSA receives similar complaints, it may open an investigation, and if it finds that a safety defect exists in a group of vehicles, it may order a recall and remedy campaign. However, NHTSA cannot become involved in individual problems between you, your dealer, or Mercedes-Benz USA, LLC.

To contact NHTSA, you may either call the Auto Safety Hotline toll-free at 1-888-327-4236 or write to: NHTSA, U.S. Department of Transportation, Washington, D.C. 20590. You can also obtain other information about motor vehicle safety from the Hotline.



## **Instruments and controls**

Instruments and controls .....	18
Center console .....	20
Overhead control panel .....	21

Instruments and controls



- 1 Parking assist warning indicators, see page 226
- 2 Side defroster outlet
- 3 Side air outlet, adjustable
- 4 Air volume control for side air outlet
- 5 Exterior lamp switch, see page 119
- 6 Parking brake release, see page 202
- 7 Hood lock release, see page 259
- 8 Combination switch, see page 122
- 9 Cruise control switch, see page 212
- 10 Instrument cluster, see page 86
- 11 Multifunction steering wheel, see page 92  
Horn (with electronic key in steering lock position 1 or 2),  
Airbag, see page 69
- 12 Steering lock with ignition/starter switch, see page 190
- 13 Voice recognition system switch, see separate operating instructions
- 14 Center air outlets, adjustable
- 15 Air volume control for center air outlets
- 16 Left front seat heater switch, see page 54  
Left front seat ventilation switch, see page 57
- 17 Headlamp washer switch, see page 121
- 18 Rear seat head restraints switch, see page 52
- 19 Hazard warning flasher switch, see page 125
- 20 Central locking switch, see page 35
- 21 Tow-away alarm switch, see page 44  
Indicator lamp for antitheft alarm system, see page 43
- 22 Right front seat heater switch, see page 54  
Right front seat ventilation switch, see page 57
- 23 Glove box (illuminated with electronic key in steering lock position 1 or 2)
- 24 Automatic climate control, see page 126  
Rear window defroster switch  
Activated charcoal filter switch
- 25 Audio system, see page 135
- 26 Storage/eyeglasses compartment, see page 164

## Instruments and controls

20

## Center console



P68.20-2279-27

- 1 Ashtray with lighter, see page 166
- 2 ESP control switch, see page 220
- 3 Power window switches, front doors, see page 154
- 4 Power window safety switch, rear doors, see page 154
- 5 Airbag Off indicator lamp, see page 239
- 6 Power window switches, rear doors, see page 154
- 7 Parktronic system deactivation switch, see page 228
- 8 Trunk lid release switch, see page 40
- 9 Mirror adjustment switch, see page 82
- 10 Rear window sunshade switch, see page 160

## Overhead control panel

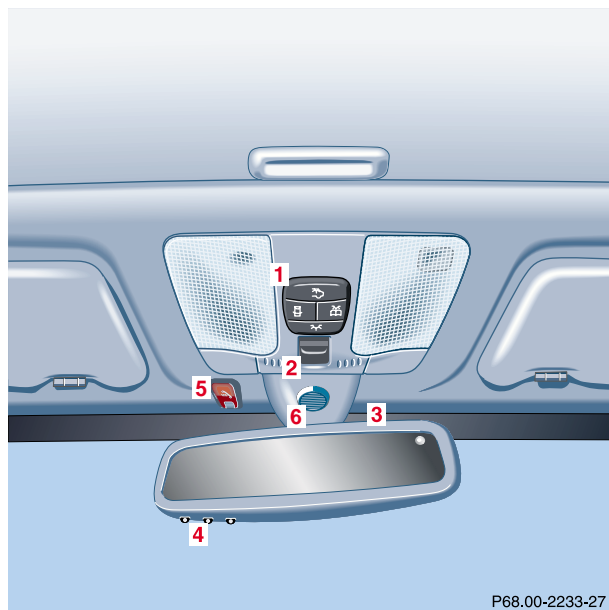

- 1 Interior lighting, see page 159
- 2 Sliding/pop-up roof, see page 157
- 3 Rear view mirror, see page 82
- 4 Garage door opener, see page 171
- 5 Tele Aid (emergency call system), see page 178
- 6 Hands free microphone for Tele Aid, telephone and voice recognition system



## Contents – Operation

## 22

**Operation**

Vehicle keys .....	24	Trunk lid emergency release .....	42	Safety guidelines for the seat belt, emergency tensioning retractor and airbag .....	75
Start lock-out .....	26	Antitheft alarm system .....	43	Infant and child restraint systems .....	77
General notes on the central locking system .....	26	Tow-away alarm .....	44	Steering wheel adjustment .....	81
Central locking system .....	27	Power seats front .....	45	Rear view mirrors .....	82
Radio frequency and infrared remote control .....	27	Front seat head restraints .....	51	Instrument cluster .....	86
Opening the trunk .....	30	Rear seat head restraints .....	52	Multifunction steering wheel, multifunction display .....	92
Opening and closing windows and sliding/pop-up roof from outside .....	31	Multicontour seat .....	53	Trip and main odometer, FSS and engine oil level display .....	96
Panic button .....	32	Seat heater .....	54	Audio systems .....	97
Mechanical keys .....	32	Seat ventilation .....	57	Radio .....	97
Doors .....	33	Seat belts and integrated restraint system .....	59	CD player .....	98
Central locking switch .....	35	Seat belts .....	59	Cassette player .....	99
Automatic central locking .....	36	Seat belt nonusage warning system .....	60	Telephone .....	100
Emergency unlocking in case of accident .....	36	BabySmart™ airbag deactivation system .....	66	Telephone book .....	100
Trunk .....	37	Self-test BabySmart™ without special child seat installed .....	66	Redialing .....	102
Trunk lamp .....	39	Supplemental restraint system (SRS) .....	67	Incoming call .....	104
Trunk lid release switch .....	40	Emergency tensioning retractor (ETR) .....	68	Navigation system .....	105
Trunk lid emergency release .....	41	Airbags .....	69	Trip computer .....	106
				Malfunction message memory ....	108
				Individual settings .....	110

Setting the audio volume .....	113	Air recirculation .....	131	Illuminated vanity mirrors .....	161
Flexible service system (FSS) .....	114	Dust filter .....	131	Interior .....	162
Engine oil level indicator .....	117	Activated charcoal filter .....	132	Armrest, rear bench .....	162
Engine oil consumption .....	118	Residual engine heat utilization .....	132	Cup holder in rear bench armrest .....	162
Exterior lamp switch .....	119	Front center console compartment ventilation .....	133	Glove box .....	163
Night security illumination .....	120	Rear passenger compartment adjustable air outlet .....	134	Cup holder and coin holder in glove box lid .....	163
Headlamp cleaning system .....	121	Audio and telephone, operation .....	135	Storage compartment above ashtray in center console .....	164
Combination switch .....	122	Power windows .....	154	Storage compartments in center console .....	164
Hazard warning flasher switch .....	125	Sliding / pop-up roof .....	157	Cup holder in center console .....	165
Automatic climate control .....	126	Interior lighting .....	159	Ashtrays .....	166
Display and controls .....	128	Entrance lamps, exit lamps in doors .....	159	Lighter .....	168
Basic setting .....	129	Reading lamps rear compartment .....	160	Cargo tie-down hooks .....	169
Special settings .....	129	Rear window sunshade .....	160	Parcel net in front passenger footwell .....	169
Defogging windows .....	129	Sun visors .....	161	Cellular telephone .....	170
Defrosting .....	129			Shelf below rear window .....	170
Rear window defroster .....	130			Garage door opener .....	171
Air distribution .....	130				
Air volume .....	130				

## Central locking system

24

**Vehicle keys**

Included with your vehicle are 2 electronic keys with integrated radio frequency and infrared remote controls plus removable mechanical key.

The locking tabs for the mechanical key portion of the two electronic keys are a different color to help distinguish it.

**Warning!**

**When leaving the vehicle always remove the electronic key from the steering lock, and lock your vehicle. Do not leave children unattended in the vehicle, or with access to an unlocked vehicle. Unsupervised use of vehicle equipment may cause serious personal injury.**

## Electronic key

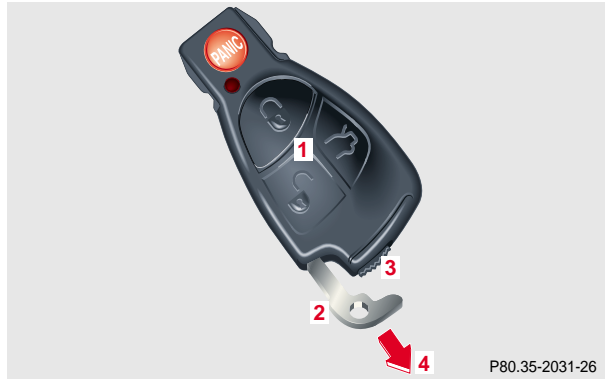

The electronic key has an integrated radio frequency and infrared remote control, plus removable mechanical key.

The remote control (1) operates all locks on the vehicle.

The mechanical key (2) works only in the driver's door, trunk, and storage compartment locks.

When using the mechanical key (2) for lock operations, it can be removed by sliding it out of the remote control. To do so, move locking tab (3) to the right and slide the mechanical key (2) in direction of arrow (4).

The remote control transmitter is located in the electronic key.

The infrared receivers are located in the front door handles.

Note:

Remove the mechanical key from the electronic key when using valet parking service. To prevent access to trunk or storage compartments lock them separately and retain the mechanical key.

See page 37 for separate locking of trunk and page 163 for locking of glove box.

### Obtaining replacement keys

Your vehicle is equipped with a theft deterrent locking system requiring a special key manufacturing process. For security reasons, replacement keys can only be obtained from your authorized Mercedes-Benz Center.

## Central locking system

26

**Start lock-out****Important!**

Removing the electronic key from the steering lock activates the start lock-out. The engine cannot be started.

Inserting the electronic key in the steering lock deactivates the start lock-out.

**Note:**

In case the engine cannot be started (vehicle's battery is in order), the system is not operational. Contact an authorized Mercedes-Benz Center or call 1-800-FOR-MERCEdes (in the USA), or 1-800-387-0100 (in Canada).

**General notes on the central locking system**

If the electronic key is inserted in the steering lock, the vehicle cannot be locked or unlocked with the remote control.

If the vehicle cannot be locked or unlocked:

- Aim transmitter eye at a receiver of either front door handle. Check the batteries of the electronic key, see page 294 or to synchronize the remote control, see page 296.
- Use the mechanical key to unlock the vehicle. To start engine, insert the electronic key in the steering lock. There could be a slight delay until the electronic key can be turned in the steering lock.

**Important!**

When unlocking the driver's door with the mechanical key, the exterior lamps will flash and the alarm will sound.

To cancel the alarm, insert the electronic key in the steering lock or press button  or < on the electronic key.



## Central locking system

### Radio frequency and infrared remote control

The electronic key has an integrated radio frequency and infrared remote control.

Due to the extended operational range of the remote control, it could be possible to unintentionally lock or unlock the vehicle by pressing the transmit button. If one of the transmit buttons is pressed, the battery check lamp lights up briefly – indicating that the batteries are in order. See page 294 for checking batteries.

The vehicle doors, trunk and fuel filler flap can be centrally locked and unlocked via remote control.

Opening and closing the windows and sliding/pop-up roof remotely can only be done with the infrared portion of the remote control. Aim transmitter eye at a receiver (6 or 7), press and hold transmit button  or .

With vehicle centrally locked, the trunk can also be opened by using the remote control.

If the electronic key is inserted in steering lock, the vehicle cannot be locked or unlocked, and the trunk lid cannot be opened with the remote control.



#### 1 Transmit button

 Locking

 Unlocking

 Opening trunk (if not separately locked)

#### 2 Lamp for battery check (see page 294 for changing batteries if it does not light up briefly)

#### 3 PANIC button

#### 4 Transmitter eye

#### 5 Locking tab for mechanical key

## Central locking system

28

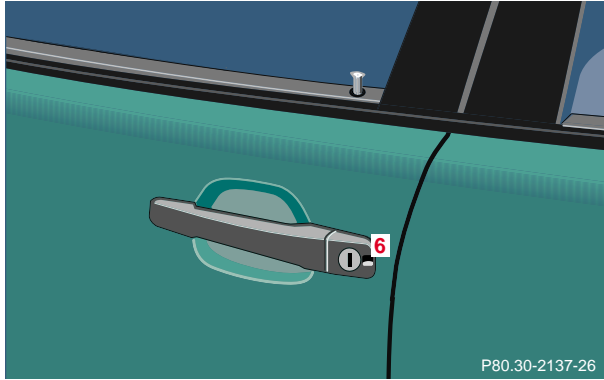

6 Infrared receiver in driver's door handle

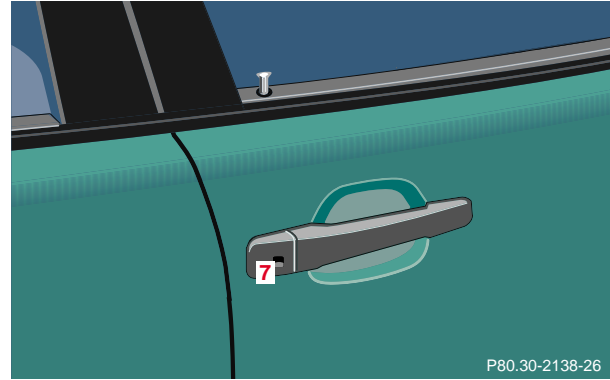

7 Infrared receiver in front passenger door handle

## Locking and unlocking with remote control

Unlocking:

Press transmit button  . All turn signal lamps blink once to indicate that the vehicle is unlocked.

The remote control can be programmed for two kinds of unlocking modes (see below):

Selective unlocking mode –

Press transmit button  once to unlock driver's door and fuel filler flap.

Press transmit button  twice to unlock all doors, fuel filler flap, and trunk.

Global unlocking mode –

Press transmit button  once to unlock all doors, fuel filler flap, and trunk.

Notes:

If the trunk was previously locked separately, it will remain locked, see page 37.

The presently active unlocking mode (selective or global) can only be determined by unlocking the vehicle with the remote control (see below for changing mode).

If within 40 seconds of unlocking with the remote control, neither door nor trunk is opened, the electronic key is not inserted in the steering lock, or the central locking switch is not activated, the vehicle will automatically lock.

Locking:

Press transmit button  once. All turn signal lamps blink three times to indicate that the vehicle is locked.

If the turn signal lamps do not blink, a door or trunk is not closed properly.

Note:

If the vehicle cannot be locked or unlocked by pressing the transmit button, then it may be necessary to change the batteries in the electronic key (if ok, battery check lamp in electronic key will light briefly when pressing transmit button) or to synchronize the remote control, see pages 294 and 296.



## Central locking system

30

**Choosing global or selective mode on remote control**

Press and hold transmit buttons < and  simultaneously for five seconds to reprogram the remote control. Battery check lamp will blink two times indicating the completed mode change.

**Opening the trunk**

The trunk lid will swing open automatically. You should always make sure there is sufficient clearance.

A minimum height clearance of 5.9 ft. (1.8 m) is required to open the trunk lid.

Press transmit button  until trunk lid is open.

**Important!**

Do not place remote control in trunk since trunk is locked when the lid is closed if the vehicle is centrally locked.

Note:

If the trunk was previously locked separately, it will remain locked, see page 37.

### Opening and closing windows and sliding/pop-up roof from outside (summer opening/convenience feature)

Aim transmitter eye of remote control at a door receiver.

#### Summer opening:

Continue to press transmit button  $\text{CE}$  after unlocking the vehicle.

The windows and sliding/pop-up roof begin to open after approximately 1 second.

To interrupt opening procedure, release transmit button.

#### Convenience feature:

Continue to press transmit button  $\text{<}$  after locking the vehicle.

The windows and sliding/pop-up roof begin to close after approximately 1 second.

To interrupt closing procedure, release transmit button.

Ensure that all side windows and the sliding/pop-up roof are properly closed before leaving the vehicle.

#### Warning!

**Never operate the windows or sliding/pop-up roof if there is the possibility of anyone being harmed by the opening or closing procedure.**

**In case the procedure causes potential danger, the procedure can be immediately halted by releasing the remote control button. To reverse direction of movement press  $\text{CE}$  for opening or  $\text{<}$  for closing.**

#### Note:

If the windows and sliding/pop-up roof cannot be operated automatically by pressing the transmit button of the remote control then it may be necessary to change the batteries in the electronic key (if ok, battery check lamp in electronic key will light briefly when transmitting), or to synchronize the remote control, see page 294 and 296.

## Central locking system

## Panic button



To activate press and hold button (1) for at least one second. An audible alarm and blinking exterior lamps will operate for approximately 3 minutes.

To deactivate press button (1) again, or insert electronic key in steering lock.

## 32

Note:

For operation in the USA only: This device complies with Part 15 of the FCC Rules. Operation is subject to the following two conditions:

- (1) This device may not cause harmful interference, and
- (2) this device must accept any interference received, including interference that may cause undesired operation.

Any unauthorized modification to this device could void to the user's authority to operate the equipment.

**Mechanical keys**

The mechanical keys work only in the driver's door, trunk, and storage compartment locks.

Notes:

The mechanical key does not operate the central locking system or antitheft alarm system.

The fuel filler flap cannot be locked or unlocked with the mechanical key.

## Doors

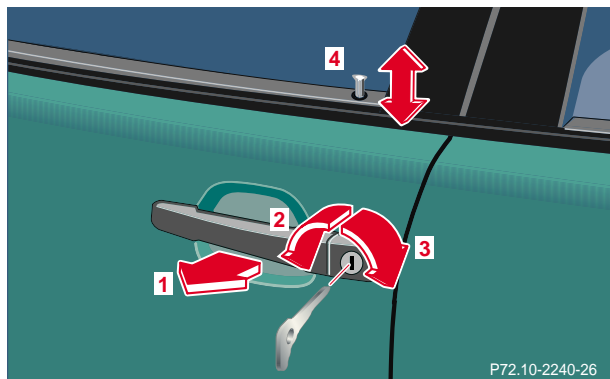

- 1 Opening – pull handle
- 2 Unlocking driver's door
- 3 Locking driver's door
- 4 Individual door from inside:  
Push lock button down to lock.

### Important!

The mechanical key does not operate the central locking system or antitheft alarm system.

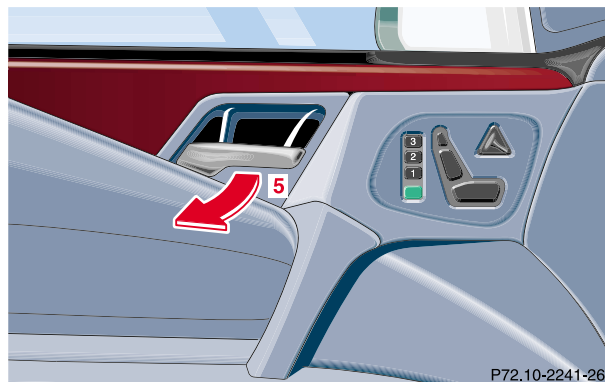

- 5 Front door from inside:  
Pull handle to unlock.

When you lock the driver's door with the mechanical key, the door lock button should move down.

Each individual door must be locked with the respective door lock button – the driver's door can only be locked when it is closed.

## Central locking system

34

If the vehicle has previously been locked from the outside, opening a door from the inside will trigger the alarm. When opening a door while the central locking system is in the:

- selective unlocking mode, only that individual door is unlocked. The remaining doors, the trunk and fuel filler flap remain locked.
- global unlocking mode, all doors, the trunk and fuel filler flap are unlocked.

Notes:



In case of a malfunction in the central locking system the doors can be locked and unlocked individually.

To lock, push down lock buttons and turn mechanical key in driver's door lock to position 3, see page 33. In addition lock the trunk.

To unlock, pull inside door handles or turn mechanical key in driver's door lock to position 2, see page 33.

Rear doors can only be opened from inside by first pulling up the door lock button.

When unlocking the driver's door with the mechanical key, the exterior lamps will flash and the alarm will sound.

To cancel the alarm, insert the electronic key in the steering lock or press button  or  on the electronic key.

## Central locking switch



1 Locking

2 Unlocking

The central locking switch is located in the center console.

The doors and trunk can only be locked with the central locking switch if both front doors are closed.

If the vehicle was previously locked with the central locking switch, while in the selective remote control mode, only the door opened from the inside is unlocked.

If the vehicle was previously locked with the central locking switch, while in the global remote control mode, the complete vehicle is unlocked when a front door is opened from the inside.

Notes:

If the vehicle was previously locked with the remote control, the doors and trunk cannot be unlocked with the central locking switch.

The fuel filler flap cannot be locked or unlocked with the central locking switch.

If the vehicle has previously been locked from the outside, opening a door from the inside will trigger the alarm. To cancel the alarm, insert the electronic key in the steering lock or press button  $\square$  or  $<$  on the electronic key.

### Warning!

**When leaving the vehicle always remove the electronic key from the steering lock, and lock your vehicle. Do not leave children unattended in the vehicle, or with access to an unlocked vehicle. Unsupervised use of vehicle equipment may cause serious personal injury.**

## Central locking system

36

**Automatic central locking**

The central locking switch also operates the automatic central locking.

With the automatic central locking system activated, the doors and trunk are locked at vehicle speeds of approximately 9 mph (15 km/h) or more. The fuel filler flap remains unlocked.

To activate:

With electronic key in steering lock position 2 hold upper portion of switch (1) for a minimum of 5 seconds.

To deactivate:

With electronic key in steering lock position 2 hold lower portion of switch (2) for a minimum of 5 seconds.

Notes:

If doors are unlocked with the central locking switch after activating the automatic central locking, and neither door is opened, then the doors remain unlocked even at vehicle speeds of approximately 9 mph (15 km/h) or more.

If a door is opened from the inside at speeds of approximately 9 mph (15 km/h) or less with the automatic central locking activated, the door will again be automatically locked at speeds of approximately 9 mph (15 km/h) or more.

**Important!**

When towing the vehicle, or with the vehicle on a dynamometer test stand, please, note the following:

With the automatic central locking activated and the electronic key in steering lock position 2, the vehicle doors will lock if the left front wheel as well as the right rear wheel spin at vehicle speeds of approximately 9 mph (15 km/h) or more.

To prevent the vehicle door locks from locking, deactivate the automatic central locking.

**Emergency unlocking in case of accident**

The doors unlock automatically a short time after a strong deceleration is detected, such as in a collision (this is intended to aid rescue and exit).

Driving on rough roads may cause the vehicle to unlock. If necessary, the vehicle can be locked again with the central locking switch, see page 35.

## Trunk

When the trunk is separately locked, it remains locked when centrally unlocking the vehicle.

To deny any unauthorized person access to the trunk, lock it separately with the mechanical key. Leave only the electronic key less its mechanical key with the vehicle.



Notes:

In case of a malfunction in the central locking system the trunk can be unlocked individually.

To unlock and open the trunk lid, turn mechanical key to position 1, hold and push to open.

The mechanical key does not operate the central locking system or antitheft alarm system.

When unlocking the trunk with the mechanical key, the exterior lamps will flash and the alarm will sound.

To cancel the alarm, insert the electronic key in the steering lock or press button  or  on the electronic key.

If the fuel filler flap cannot be opened, see page 299.

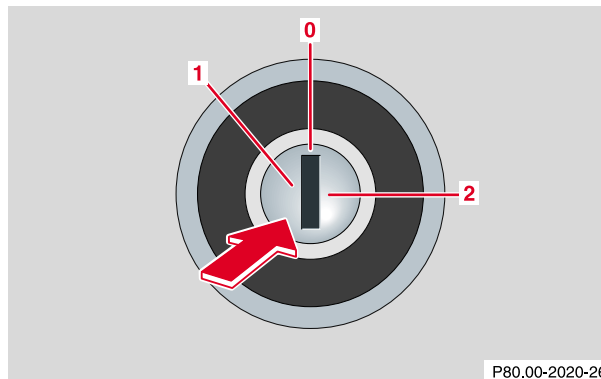

P80.00-2020-26

- 0** Neutral position – push to open (arrow)
- 1** Unlocking
- 2** Separate locking of trunk – remove mechanical key in this position (only vehicles built prior 09/01). The vehicle production date (e.g. 09/01) can be found on the certification label, which is located on the driver's door pillar, see page 313.

The trunk lid cannot be opened by the trunk lid release switch or the electronic key when previously locked separately with the mechanical key.



## Central locking system

38

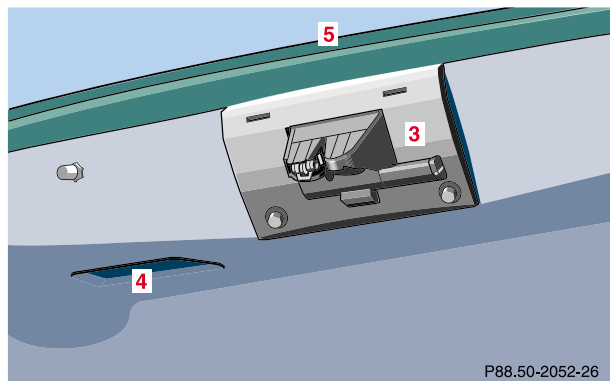

Lower trunk lid using handle (3) or recessed grip (4) and close it with grip molding (5). Please remember to keep your fingers out of the space between the lid and the vehicle.

**Important!**

Do not place mechanical key inside trunk, since trunk is locked again when the lid is closed if the vehicle has been previously centrally locked.

**Warning!**

To prevent possible personal injury, always keep hands and fingers away from the trunk opening when closing the trunk lid. Be especially careful when small children are around.

## Trunk lamp

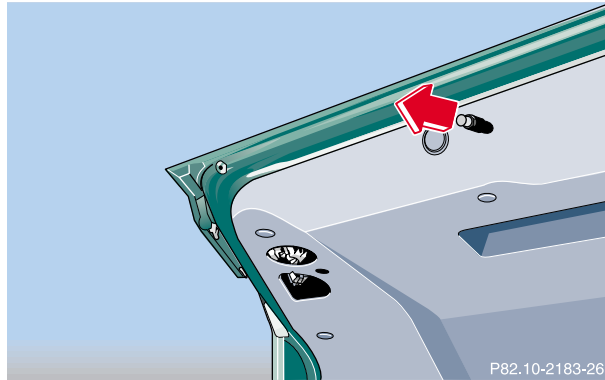

If the trunk is to remain open for a long period of time, the trunk lamp can be switched off by pulling out the plunger in the switch (arrow). This prevents the vehicle battery from being discharged.

When the trunk lid is closed, the switch will reset and turn on the lamp next time the lid is opened.

## Central locking system

40

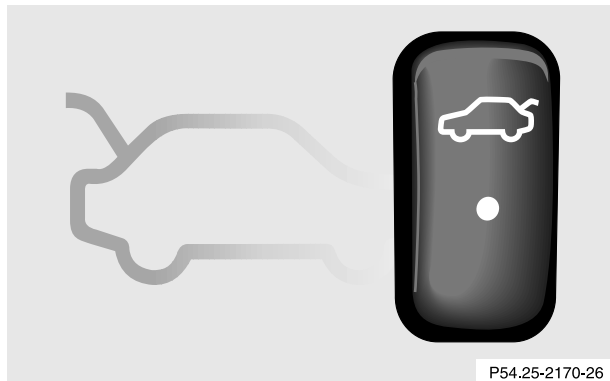
**Trunk lid release switch**

The switch is located on the center console.

The trunk lid will swing open automatically. You should always make sure there is sufficient clearance.

A minimum height clearance of 5.9 ft. (1.8 m) is required to open the trunk lid.

To open the trunk, the vehicle must be at standstill. Pull up on switch until trunk lid is open.

The indicator lamp in the switch remains on with trunk lid open.

Notes:

The trunk can also be opened by using the remote control. Press  button.

The trunk lid cannot be opened by the switch or the remote control when previously locked separately with the mechanical key. To open, see page 37.

The trunk lid cannot be opened with the trunk lid release switch when the vehicle was previously locked with the remote control. To unlock vehicle with the remote control, see page 27.

## Trunk lid emergency release (vehicles built prior to September 2001)

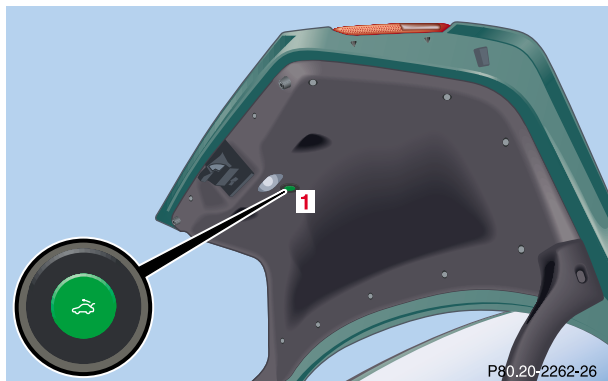

The emergency release button (1) is located in the trunk lid.

Briefly press emergency release button (1).  
The doors, the fuel filler flap, and the trunk unlocks;  
and the trunk lid opens.

The vehicle production date (e.g. 09/01) can be found  
on the certification label, which is located on the  
driver's door pillar, see page 313.

Note:

The emergency release button (1) only unlocks and  
opens the trunk while the vehicle is not in motion.

### Important!

The emergency trunk lid release button (1), does not  
open the trunk lid, if the trunk has been locked using  
the mechanical key or if the vehicle battery is  
discharged or disconnected.

Illumination of the emergency release button (1):

The button will blink for 30 minutes after opening the  
trunk.

The button will blink for 60 minutes after closing the  
trunk.

## Central locking system

42

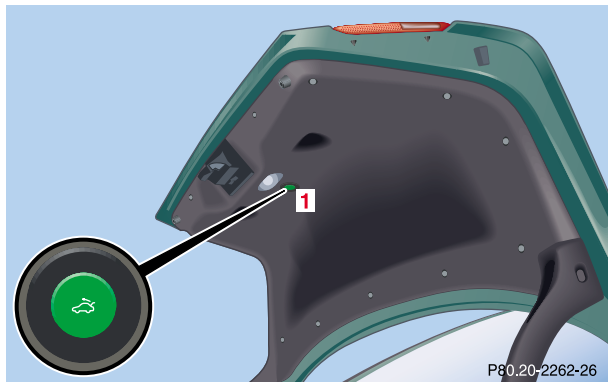
**Trunk lid emergency release**  
(vehicles built September 2001 and later)

The emergency release button (1) is located in the trunk lid.

Briefly press emergency release button (1).  
The trunk unlocks and the trunk lid opens.

The vehicle production date (e.g. 09/01) can be found on the certification label, which is located on the driver's door pillar, see page 313.

**Important!**

The emergency trunk lid release button (1), does not open the trunk lid, if the vehicle battery is discharged or disconnected.

Illumination of the emergency release button (1):

The button will blink for 30 minutes after opening the trunk.

The button will blink for 60 minutes after closing the trunk.

## Antitheft alarm system



### 1 Indicator lamp in switch located in center console

The antitheft alarm is automatically armed or disarmed with the remote control by locking or unlocking the vehicle.

The antitheft alarm is armed within approximately 15 seconds after locking the vehicle.

A blinking lamp (1) indicates that the alarm is armed.

### Operation:



Once the alarm system has been armed, the exterior vehicle lamps will flash and an alarm will sound when someone:

- opens a door,
- opens the trunk,
- opens the hood,
- attempts to raise the vehicle.

The alarm will last approximately 3 minutes in form of flashing exterior lamps. At the same time an alarm will sound for 30 seconds. The alarm will stay on even if the activating element (a door, for example) is immediately closed. If the alarm stays on for more than 20 seconds, an emergency call is initiated automatically. See Tele Aid on page 178.

### Notes:

When you unlock the driver's door with the mechanical key, the exterior lamps will flash and the alarm will sound.

To cancel the alarm, insert the electronic key in the steering lock or press button  or <  on the electronic key.

## Tow-away alarm

44

**Tow-away alarm**

The switch is located in the center console.

- 1 Press to switch off
- 2 Indicator lamp

Once the alarm system has been armed, the exterior vehicle lamps will flash and an alarm will sound when someone attempts to raise the vehicle.

The alarm will last approximately 3 minutes in form of flashing exterior lamps. At the same time an alarm will sound for 30 seconds. The alarm will stay on even if the vehicle is immediately lowered. To cancel the alarm, insert the electronic key in the steering lock or press button  $\text{CE}$  or  $<$  on the electronic key

If the alarm stays on for more than 20 seconds, an emergency call is initiated automatically. See Tele Aid on page 178.

To prevent triggering the tow-away alarm feature, switch off the tow-away alarm before towing the vehicle, or when parking on a surface subject to movement, such as a ferry or auto train.

To do so, turn electronic key in steering lock to position 0 or 1, or remove electronic key from steering lock. Press tow-away alarm switch (1). The indicator lamp (2) illuminates briefly.

Exit vehicle, and lock vehicle with the remote control.

The tow-away alarm remains switched off until the vehicle is locked again with the electronic key, at which time it is automatically reactivated.

## Power seats front

### Warning!

**Do not adjust the driver's seat while driving. Adjusting the seat while driving could cause the driver to lose control of the vehicle.**

**Never ride in a moving vehicle with the backrest reclined. Sitting in an excessively reclined position can be dangerous. You could slide under the seat belt in a collision. If you slide under it, the belt would apply force at the abdomen or neck. That could cause serious or even fatal injuries. The backrest and seat belt provide the best restraint when the wearer is in an upright position and the belt properly positioned on the body.**

**Never place hands under seat or near any moving parts while a seat is being adjusted.**

**When leaving the vehicle always remove the electronic key from the steering lock, and lock your vehicle.**

**The power seats can also be operated with the driver's or front passenger door open. Do not leave children unattended in the vehicle or with access to an unlocked vehicle. Unsupervised use of vehicle equipment may cause serious personal injury.**

To operate the front power seat adjustment switches, turn electronic key in steering lock to position 1 or 2 (with the driver's or front passenger's door open, the power seats can also be operated with the electronic key removed or in steering lock position 0).



## Seats

46

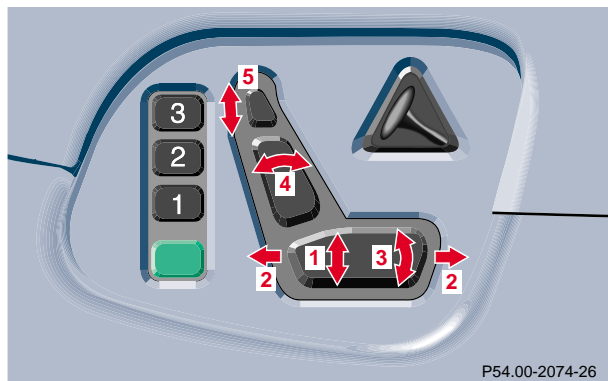

The slide switches are located in each front door.

We recommend to adjust the power seat in the following order:

**1 Seat, up/down**

Press the switch (up/down direction) until comfortable seating position with still sufficient headroom is reached.

**2 Seat adjustment, fore/aft**

Press the switch (fore/aft direction) until a comfortable seating position is reached that still

allows you to reach the accelerator/brake pedal safely. The position should be as far rearward as possible, consistent with ability to properly operate controls.

**3 Seat cushion tilt**

Press the switch in the direction of the arrow until your legs are lightly supported.

**4 Backrest tilt**

Press the switch in the direction of the arrow until your arms are slightly angled when holding the steering wheel.

**5 Head restraint**

The height of the head restraint is adjusted automatically with the seat so that the back of the head is supported approximately at ear level. Adjust the head restraint using the switch if the preset position does not support the back of your head approximately at ear level.

Adjust the head restraint angle by hand.

Note:

Your vehicle is equipped with power head restraints, do not try to raise or lower them manually.

## Synchronizing Head Restraints

If the power supply was interrupted (battery disconnected or empty), the head restraints are no longer adjusted automatically.

To resynchronize the adjustment feature, turn electronic key in steering lock to position 2, move the seat completely forward and the head restraint fully down, and hold respective buttons for approximately two seconds.

## Caution!

Do not remove head restraints except when mounting seat covers. For removal refer to Front seat head restraints, see page 51. Whenever restraints have been removed be sure to reinstall them before driving.

## Memory function

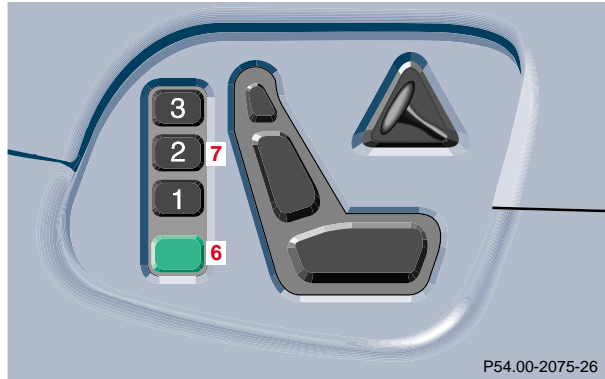

**6** Memory button

**7** Position buttons

### Warning!

**Do not activate the memory function while driving. Activating the memory function while driving could cause the driver to lose the control of the vehicle.**

## Storing positions into memory

Three sets of seat/head restraint/steering wheel and exterior rear view mirror positions may be programmed into memory. After the seat/head restraint/steering wheel and exterior rear view mirrors are positioned, push memory button (6), release, and within 3 seconds push position button “1”. A second and third set of positions for the same seat/head restraint/steering wheel and exterior rear view mirrors can be programmed into memory by pushing first memory button (6) and then “2”, respectively “3”.

Note:

For instructions on adjustment of steering wheel and mirrors, see page 81 and 82.

### Recalling positions from memory

To recall a seat/head restraint/steering wheel and exterior rear view mirror position, push and hold position button “1”, “2” or “3” until seat/head restraint/steering wheel and exterior rear view mirror movement has stopped. The seat/head restraint/steering wheel and exterior rear view mirror movement stops when the position button is released.

### Caution!

Do not operate the power seats using the memory button if the seat backrest is in an excessively reclined position. Doing so could cause damage to front or rear seats.

First move the backrest to an upright position.

### Important!

Prior to operating the vehicle, the driver should adjust the seat height for proper vision as well as fore/aft placement and backrest angle to ensure adequate control, reach, operation, and comfort. The head restraint should also be adjusted for proper height. See also airbag section for proper seat positioning.

In addition, also adjust the steering wheel to ensure adequate control, reach, operation, and comfort.

Both the inside and outside rear view mirrors should be adjusted for adequate rearward vision.

Fasten seat belts. Infants and small children should be seated in a properly secured restraint system that complies with U.S. Federal Motor Vehicle Safety Standard 213 and Canadian Motor Vehicle Safety Standard 213.1.

All seat, head restraint, steering wheel, and rear view mirror adjustments as well as fastening of seat belts should be done before the vehicle is put into motion.

**Warning!**

Children 12 years old and under must never ride in the front seat, except in a Mercedes-Benz authorized BabySmart™ compatible child seat, which operates with the BabySmart™ system installed in the vehicle to deactivate the passenger-side front airbag when it is properly installed. Otherwise they will be struck by the airbag when it inflates in a crash. If this happens, serious or fatal injury can result.

According to accident statistics, children are safer when properly restrained in the rear seating positions than in the front seating positions. Infants and small children must ride in the back seats and be seated in an appropriate infant or child restraint system, which is properly secured with the vehicle's seat belt, fully in accordance with the child seat manufacturer's instructions.

A child's risk of serious or fatal injuries is significantly increased if the child restraints are not properly secured in the vehicle and the child is not properly secured in the child restraint.

## Front seat head restraints

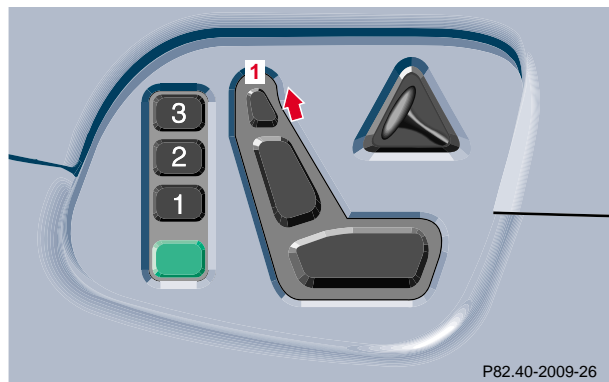

### Removal:

Push button (1) up to bring the power adjustable head restraint to its highest position.

Pull out head restraint completely with both hands.

### Installation:

Push button (1) of the power adjustable head restraint up for approximately 5 seconds.

Insert the head restraint and push it down to the stop.

Adjust head restraint to the desired position.

For positioning of head restraints, see page 45 and 52.

### Warning!

**For your protection, drive only with properly positioned head restraints.**

**Adjust head restraint to support the back of the head approximately at ear level.**

**Do not drive the vehicle without the seat head restraints. Head restraints are intended to help reduce injuries during an accident.**

## Rear seat head restraints



Folding head restraints backward (with engine running):

Press symbol-side of rocker switch to release the head restraints. The head restraints will then fold backward for increased visibility.

Placing head restraints upright:

Pull head restraint forward until it locks in position.

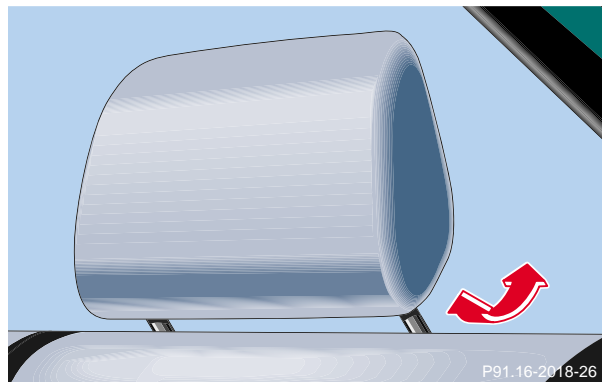

Angle of head restraints:

The head restraint angle can be adjusted manually.

### Important!

For safety reasons, always drive with the rear head restraints in the upright position when the rear seats are occupied. Keep area around head restraints clear of articles (e.g. clothing) to not obstruct the folding operation of the head restraints.

## Multicontour seat (optional)

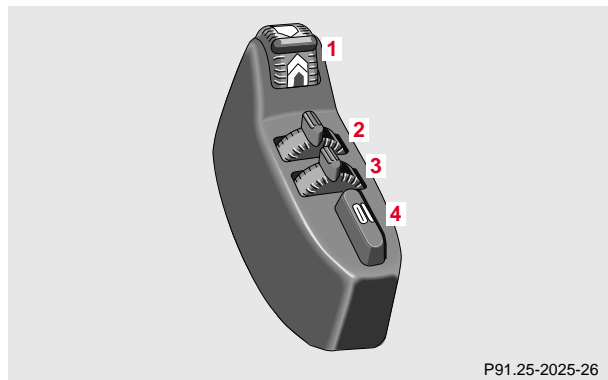

We recommend to adjust the multicontour seat in the following order:

- 1 Seat cushion depth
- 2 Backrest bottom
- 3 Backrest center
- 4 Side bolster adjustment

Some models may be equipped with multicontour seats. These seats have movable seat cushions, and inflatable air cushions built into the backrest to provide additional lumbar and side support.

The seat cushion movement and amount of backrest cushion height and curvature can be continuously varied with regulators (1, 2 and 3) after turning the electronic key in steering lock to position 2.

The side bolsters of the backrest can be adjusted with rocker switch (4):

- press to the right – increase side support,
- press to the left – decrease side support.

If the engine is turned off, the last cushion setting is retained in memory, and automatically adjusts the cushion to this setting when the engine is restarted.



**Seat heater**

The seat heaters can be switched on with the electronic key in steering lock positions 1 or 2.

## Notes:

When in operation, the seat heater consumes a large amount of electrical power. It is not advisable to use the seat heater longer than necessary.

The seat heaters may automatically switch off if too many power consumers are switched on at the same time, or if the battery charge is low. When this occurs, the indicator lamp in the switch will blink (both indicator lamps blink during rapid seat heating mode). The seat heaters will switch on again automatically as soon as sufficient voltage is available.

If the blinking of the indicator lamps is distracting to you, the seat heaters can be switched off.

## Vehicles without seat ventilation



The front seat heater switches are located in the center console.

Press switch to turn on seat heater:

- 1** Normal seat heating mode. One indicator lamp in the switch lights up.
- 2** Rapid seat heating mode. Both indicator lamps in the switch light up.  
After approximately 5 minutes in the rapid seat heating mode, the seat heater automatically switches to normal operation and only one indicator lamp will stay on.

Turning off seat heater:

If one indicator lamp is on, press upper half of switch.

If both indicator lamps are on, press lower half of switch.

If left on, the seat heater automatically turns off after approximately 30 minutes of operation.

**Vehicles with seat ventilation (optional)**

The front seat heater switches are located in the center console.

Rapid heating mode:

Press button (3) once.

Both red indicator lamps above the button light up.

The system switches over to normal heating mode automatically after approximately 5 minutes.

Normal heating mode:

Press button (3) twice.

One red indicator lamp above the button lights up.

The seat heater will be automatically switched off after approximately 30 minutes.

Turning off the heater:

Press the button (3) again.

The indicator lamps go out. The seat heater is switched off.

## Seat ventilation (optional)



The front seat ventilation switches are located in the center console.

Turn the electronic key in steering lock to position 1 or 2.

Level 3 ventilation setting (maximum):

Press button (1).

Three blue indicator lamps beside the button light up.

Level 2 ventilation setting (middle):

Press button (1) again.

Two blue indicator lamps beside the button light up.

Level 1 ventilation setting (minimum):

Press button (1) again.

One blue indicator lamp beside the button lights up.

Turning off seat ventilation:

If one blue indicator lamp is on, press button (1) once.

If two blue indicator lamps are on, press button (1) twice.

If three blue indicator lamps are on, press button (1) three times.

## Notes:

When in operation, the seat ventilation consumes a large amount of electrical power. It is not advisable to use the seat ventilation longer than necessary.

The seat ventilation may automatically switch off if too many power consumers are switched on at the same time or if the battery charge is low. When this occurs, one or more indicator lamps in the switch will blink.

The seat ventilation will switch on again automatically as soon as sufficient voltage is available.

If the blinking indicator lamps pose a distraction, the seat ventilation can be switched off.

## Seat belts and integrated restraint system

Your vehicle is equipped with seat belts for all seats, emergency tensioning retractors for all outboard seat belts, dual front airbags, door mounted side impact airbags and head protective window curtain airbags. Their protective functions are designed to complement one another.

### Seat belts

#### Important

Laws in most states and all Canadian provinces require seat belt use.

All states and provinces require use of child restraints that comply with U.S. Federal Motor Vehicle Safety Standard 213 and Canadian Motor Vehicle Safety Standard 213.

All child restraint systems are designed to be secured in vehicle seats by lap belts or the lap belt portion of a lap-shoulder belt.

For your safety and that of your passengers we strongly recommend their use.

#### Warning!

**Children 12 years old and under must never ride in the front seat, except in a Mercedes-Benz authorized BabySmart™ compatible child seat, which operates with the BabySmart™ system installed in the vehicle to deactivate the passenger front airbag when it is properly installed. Otherwise they will be struck by the airbag when it inflates in a crash. If this happens, serious or fatal injury will result.**

According to accident statistics, children are safer when properly restrained in the rear seating positions than in the front seating positions. Infants and small children must ride in back seats and be seated in an appropriate infant or child restraint system, which is properly secured with the vehicle's seat belt, fully in accordance with the child seat manufacturer's instructions.

**A child's risk of serious or fatal injuries is significantly increased if the child restraints are not properly secured in the vehicle and the child is not properly secured in the child restraint.**

**Warning!**

Never ride in a moving vehicle with the backrest reclined. Sitting in an excessively reclined position can be dangerous. You could slide under the seat belt in a collision. If you slide under it, the belt would apply force at the abdomen or neck. That could cause serious or even fatal injuries. The backrest and seat belt provide the best restraint when the wearer is in an upright position and the belt is properly positioned on the body.

Note:

For cleaning and care of the seat belts, see page 308.

**Seat belt nonusage warning system**

With the electronic key in steering lock position 2, a warning sounds for a short time if the driver's seat belt is not fastened.

**Warning!**

Failure to wear and properly fasten and position your seat belt greatly increases your risk of injuries and their likely severity in an accident. You and your passengers should always wear seat belts.

If you are ever in an accident, your injuries can be considerably more severe without your seat belt properly buckled. Without your seat belt buckled, you are much more likely to hit the interior of the vehicle or be ejected from it. You can be seriously injured or killed.

In the same crash, the possibility of injury or death is lessened if you are wearing your seat belt.

**Warning!**

Never let more people ride in the vehicle than there are seat belts available. Be sure everyone riding in the vehicle is correctly restrained with a separate seat belt.

## Fastening of seat belts

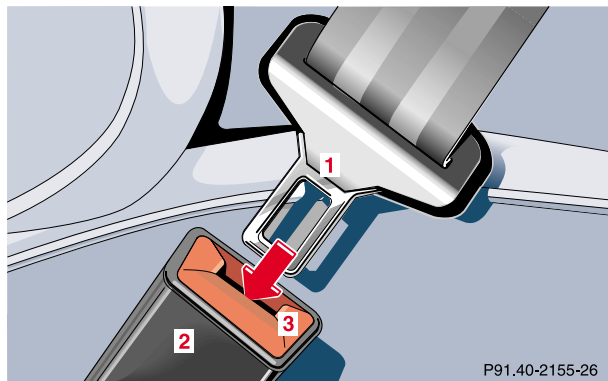

- 1 Latch plate
- 2 Buckle
- 3 Release button

Push latch plate (1) into buckle (2) until it clicks. Do not twist the belt. A twisted seat belt may cause injury.

To help avoid severe or fatal injuries, the lap belt should be positioned as low as possible on your hips and not across the abdomen.

### Warning!

**Always fasten your seat belt before driving off. Always make sure your passengers are properly restrained – even those sitting in the rear.**



## Restraint systems

62

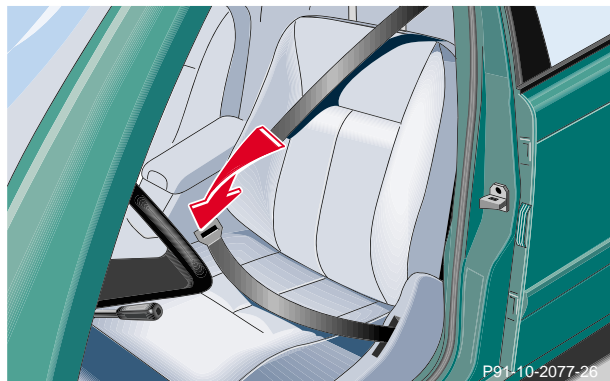

Tighten the lap portion to a snug fit by pulling shoulder portion up.

The shoulder portion of the seat belt must be pulled snug and checked for snugness immediately after engaging it.

Adjust seat belt so that shoulder portion is located as close as possible to the middle of your shoulder (it should not touch the neck). For this purpose, you can adjust the height of the belt outlet. Three positions are available.

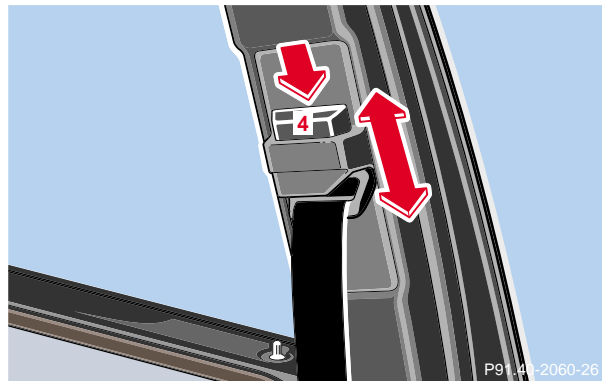

**4** Button for belt outlet

Raising: Slide belt outlet upward.

Lowering:  
Press button (4) and slide belt outlet downward.

**Caution!**

For safety reasons, avoid adjusting the seat or seat back into positions which could affect the correct seat belt positioning.

## Unfastening of seat belts

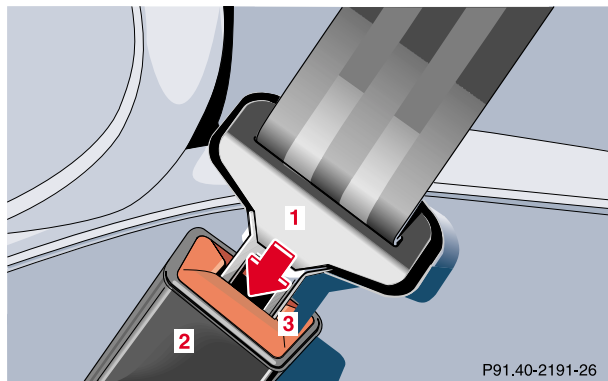

Push the release button (3) in the belt buckle (2).

Allow the retractor to completely rewind the seat belt by guiding the latch plate (1).

### Operation

The inertia reel stops the belt from unwinding during sudden vehicle stops or when quickly pulling on the belt. The locking function of the reel may be checked by quickly pulling out the belt.

### Warning!

#### USE SEAT BELTS PROPERLY.

- Seat belts can only work when used properly. Never wear seat belts in any other way than as described in this section, as that could result in serious injuries in case of an accident.
- Each occupant should wear their seat belt at all times, because seat belts help reduce the likelihood of and potential severity of injuries in accidents, including rollovers. The integrated restraint system includes “SRS” (driver airbag, front passenger airbag, front and rear door mounted side impact airbags, head protection window curtain airbags for side windows), “ETR” (seat belt emergency tensioning retractors), and front seat knee bolsters. The system is designed to enhance the protection offered to properly belted occupants in certain frontal (front airbags) and side (side impact and window curtain airbags) impacts which exceed preset deployment thresholds.

## Restraint systems

64

- Never wear belts over rigid or breakable objects in or on your clothing, such as eyeglasses, pens, keys etc., as these might cause injuries.
- Position the lap belt as low as possible on your hips and not across the abdomen. If the belt is positioned across your abdomen, it could cause serious injuries in a crash.
- Never wear the shoulder belt under your arm, against your neck or off your shoulder. In a crash, your body would move too far forward. That would increase the chance of head and neck injuries. The belt would also apply too much force to the ribs or abdomen, which could severely injure internal organs such as your liver or spleen.
- Each seat belt should never be used for more than one person at a time. Do not fasten a seat belt around a person and another person or other objects.
- Belts should not be worn twisted. In a crash, you wouldn't have the full width of the belt to manage impact forces, The twisted belt against your body could cause injuries.
- Pregnant women should also use a lap-shoulder belt. The lap belt portion should be positioned as low as possible on the hips to avoid any possible pressure on the abdomen.
- Never place your feet on the instrument panel or on the seat. Always keep both feet on the floor in front of the seat.

## **Warning!**

### **USE CHILD RESTRAINTS PROPERLY.**

**Children 12 years old and under must never ride in the front seat, except in a Mercedes-Benz authorized BabySmart™ compatible child seat, which operates with the BabySmart™ system installed in the vehicle to deactivate the passenger front airbag when it is properly installed. Otherwise they will be struck by the airbag when it inflates in a crash. If this happens, serious or fatal injury will result.**

**According to accident statistics, children are safer when properly restrained in the rear seating positions than in the front seating positions. Infants and small children must ride in back seats and be seated in an appropriate infant or child restraint system, which is properly secured with the vehicle's seat belt, fully in accordance with the child seat manufacturer's instructions.**

**A child's risk of serious or fatal injuries is significantly increased if the child restraints are not properly secured in the vehicle and the child is not properly secured in the child restraint.**

**Children too big for child restraint systems must ride in back seats using regular seat belts. Position shoulder belt across chest and shoulder, not face or neck. A booster seat may be necessary to achieve proper belt positioning.**

### BabySmart™ airbag deactivation system

Special BabySmart™ compatible child seats, designed for use with the Mercedes-Benz system and available at any authorized Mercedes-Benz Center are required for use with the BabySmart™ airbag deactivation system.

With the special child seat properly installed, the passenger front airbag will not deploy. The 7 indicator lamp located on the center console will be illuminated, except with electronic key removed or in steering lock position 0. The system does not deactivate the door mounted side impact airbag and the window airbag.

### Self-test BabySmart™ without special child seat installed

After turning electronic key in steering lock to position 1 or 2, the 7 indicator lamp located on the center console comes on for approximately 6 seconds and then extinguishes.

If the indicator lamp should not come on or is continuously lit, the system is not functioning. You must see an authorized Mercedes-Benz Center before seating any child on the front passenger seat.

BabySmart™ is a trademark of Siemens Automotive Corp.

### Warning!

The BabySmart™ airbag deactivation system will ONLY work with a special child seat designed to operate with it. It will not work with child seats which are not BabySmart™ compatible.

Never place anything between seat cushion and child seat (e.g. pillow), since it reduces the effectiveness of the deactivation system. The bottom of the child seat must make full contact with the passenger seat cushion. An incorrectly mounted child seat could cause injuries to the child in case of an accident instead of protecting the child.

Follow the manufacturer's instructions for installation of special child seats.

The passenger front airbag will not deploy only if the 7 indicator lamp remains illuminated.

Please be sure to check the indicator every time you use the special system child seat.

Should the light go out while the restraint is installed, please check installation. If the light remains out, do not use the BabySmart™ restraint to transport children on the front passenger seat until the system has been repaired.

## Supplemental restraint system (SRS)

Airbags are intended as a supplement to seat belts. Airbags alone cannot protect as well as airbags plus seat belts in impacts for which the airbags were designed to operate, and do not afford any protection whatsoever in crashes for which the airbags are not designed to deploy.

The SRS uses two crash severity levels (thresholds) to activate either the Emergency Tensioning Retractor (ETR) or front airbag or both. Activation depends on the direction and severity of the impact exceeding the preset thresholds and whether the seat belt is fastened.

Seat belt fastened

- first threshold exceeded: ETR activates
- second threshold exceeded: airbag also activates

Seat belt not fastened

Front seats:

- first threshold exceeded: airbag activates, but not ETR

Rear outer seats:

- first threshold exceeded: ETR activates

Driver, front passenger and rear outer seat systems operate independently of each other.

## Restraint systems

68

**Emergency tensioning retractor (ETR)**

The seat belts for the front and outer rear seats are equipped with emergency tensioning retractors. These tensioning retractors are located in each belt's inertia reel and become operationally ready with the electronic key in steering lock position 1 or 2.

The emergency tensioning retractors are designed to activate only when the seat belts are fastened during frontal impacts exceeding the first threshold of the SRS and in rear impacts exceeding a preset severity level. They remove slack from the belts in such a way that the seat belts fit more snugly against the body restricting its forward movement as much as possible.

In cases of other frontal impacts, angled impacts, roll-overs, certain side impacts, or other accidents without sufficient frontal or rear forces, the emergency tensioning retractors will not be activated. The driver and passengers will then be protected by the fastened seat belts and inertia reel in the usual manner.

For seat belt and emergency tensioning retractor safety guidelines, see page 75.

Note:

The front passenger ETR activates only if the front passenger seat is occupied.

Heavy objects on the front passenger seat can appear to the "SRS" to indicate the presence of an occupant in that seat which causes the passenger front airbag to deploy and the ETR to activate in a crash exceeding the appropriate threshold.

## Airbags



1 Driver airbag

2 Front passenger airbag

The most effective occupant restraint system yet developed for use in production vehicles is the seat belt. In some cases, however, the protective effect of a seat belt can be further enhanced by an airbag.

In conjunction with wearing the seat belts, the driver and front passenger airbags can provide increased protection for the driver and front passenger in certain frontal impacts exceeding preset thresholds.

Door mounted side impact and head protection window curtain airbags can provide increased protection to belted outboard occupants on the impacted side of the vehicle in side impacts exceeding its preset threshold.

The operational readiness of the airbag system is verified by the indicator lamp “SRS” in the instrument cluster when turning the electronic key in steering lock to position 1 or 2. If no fault is detected, the lamp will go out after approximately 4 seconds; after the lamp goes out, the system continues to monitor the components and circuitry of the airbag system and will indicate a malfunction by coming on again. If the lamp does not come on at all or if it fails to extinguish after approximately 4 seconds or if it comes on thereafter, a malfunction in the system has been detected.



## Restraint systems

70

The following system components are monitored or undergo a selfcheck: crash-sensor(s), airbag ignition circuits, front seat belt buckles, emergency tensioning retractors, seat sensor.

Initially, when the electronic key is turned from steering lock position 0 to position 1 or 2, malfunctions in the crash-sensors are detected and indicated (the “SRS” indicator lamp stays on longer than 4 seconds or does not come on).

Have the system checked at your authorized Mercedes-Benz Center immediately.

In the operational mode, after the indicator lamp has gone out following the initial check, interruptions or short circuits in the airbag ignition circuit and in the driver and front passenger seat belt buckle harnesses, and low voltage in the entire system are detected and indicated.

**Warning!**

**In the event a malfunction of the “SRS” is indicated as outlined above, the “SRS” may not be operational. For your safety, we strongly recommend that you visit an authorized Mercedes-Benz Center immediately to have the system checked; otherwise the “SRS” may not be activated when needed in an accident, which could result in serious or fatal injury, or it might deploy unexpectedly and unnecessarily which could also result in injury.**

## Note:

See page 236 for information on the Supplemental Restraint System (SRS) indicator lamp.

## Front airbags

The driver and passenger front airbags are designed to activate only in certain frontal impacts exceeding a preset threshold.

The front passenger airbag deploys only if the front passenger seat is occupied and the 7 indicator lamp on the center console is not illuminated.

Note:

Heavy objects on the front passenger seat can appear to the “SRS” to indicate the presence of an occupant in that seat which causes the passenger front airbag to deploy in a crash exceeding the appropriate threshold.

## Side impact airbags, window curtain airbags

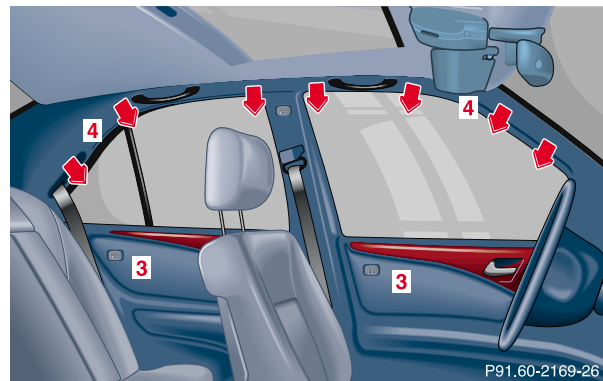

3 Side impact airbags

4 Window curtain airbag

## Restraint systems

72

**Side impact airbags**

The side impact airbags are designed to activate only in certain side impacts exceeding a preset threshold. Only the side impact airbags on the impacted side of the vehicle deploy.

The side impact airbag for the front passenger deploys only if the front passenger seat is occupied.

Side impact airbags operate best in conjunction with a properly positioned and fastened seat belt.

Note:

Heavy objects on front passenger seat can cause the front passenger-side impact airbag to deploy in a crash.

**Window curtain airbags**

The head protection window curtain airbags afford greater protection against injuries to the head and upper body. They fill up in the area between the A and C pillars (see arrows) between the side windows and an occupant's head.

The window curtain airbags are designed to activate only in certain side impacts exceeding a preset threshold. Only the head protection window curtain airbag on the impacted side of the vehicle deploys.

**Important!**

**Airbags are designed to activate only in certain frontal (front airbags) impacts, or side (side impact and head protection window curtain airbags) impacts which exceed preset thresholds.**

**Only during these types of impacts, if of sufficient severity to meet the deployment thresholds, will they provide their supplemental protection.**

**The driver and passenger should always wear their seat belts, otherwise it is not possible for the airbags to provide their supplemental protection.**

**In cases of other frontal impacts, angled impacts, roll-overs, other side impacts, rear collisions, or other accidents, the airbags will not be activated. The driver and passengers will then be protected by the fastened seat belts.**

**We caution you not to rely on the presence of the airbags in order to avoid wearing your seat belt.**

### Warning!

Airbags are designed to reduce the potential of injury in certain frontal (front airbags) impacts, or side (side impact and head protection window curtain airbags) impacts which may cause significant injuries, however, no system available today can totally eliminate injuries and fatalities.

The activation of the “SRS” temporarily releases a small amount of dust from the airbags. This dust, however, is neither injurious to your health, nor does it indicate a fire in the vehicle. The dust might cause some temporary breathing difficulty for people with asthma or other breathing trouble. To avoid this, you may wish to get out of the vehicle as soon as it is safe to do so. If you have any breathing difficulty but cannot get out of the vehicle after the airbag inflates, then get fresh air by opening a window or door.

Your vehicle was originally equipped with airbags which are designed to activate in certain impacts exceeding a preset threshold to reduce the potential and severity of injury. It is important to your safety and that of your passenger that you replace deployed airbags and repair any malfunctioning airbags to ensure the vehicle will continue to provide crash protection for occupants.

### Warning!

To reduce the risk of injury when the front airbags inflate, it is very important for the driver and front passenger to always be in a properly seated position and to wear their seat belts.

For maximum protection in the event of a collision always be in normal seated position with your back against the backrest. Fasten your seat belt and ensure that it is properly positioned on your body.

Since the airbag inflates with considerable speed and force, a proper seating and hands on steering wheel position will help to keep you at a safe distance from the airbag. Occupants who are unbelted, out of position or too close to the airbag can be seriously injured by an airbag as it inflates with great force in the blink of an eye:

## Restraint systems

74

- Sit properly belted in an upright position with your back against the backrest.
- Adjust the driver's seat as far as possible rearward, still permitting proper operation of vehicle controls. The distance from the center of the driver's breastbone to the center of the airbag cover on the steering wheel must be at least ten inches (25 cm) or more. You should be able to accomplish this by a combination of adjustments to the seat and steering wheel. If you have any problems, please see your authorized Mercedes-Benz Center.
- Do not lean with your head or chest close to the steering wheel or dashboard.
- Keep hands on the outside of steering wheel rim. Placing hands and arms inside the rim can increase the risk and potential severity of hand/arm injury when driver front airbag inflates.
- Adjust the front passenger seat as far as possible rearward from the dashboard when the seat is occupied.

- Occupants, especially children, should never lean their heads in the area of the door where the side airbag inflates. This could result in serious injuries or death should the airbag be triggered. Always sit upright, properly use the seatbelts and appropriate size infant or child restraint system
- Children 12 years old and under must never ride in the front seat, except in a Mercedes-Benz authorized Baby Smart™ compatible child seat, which operates with the BabySmart™ system installed in the vehicle to deactivate the passenger front airbag when it is properly installed. Otherwise they will be struck by the airbag when it inflates in a crash. If this happens, serious or fatal injury can result.

Failure to follow these instructions can result in severe injuries to you or other occupants.

### Warning!

Accident research shows that the safest place for children in an automobile is in the rear seat. Should you choose to place a child 12 years old or under in the front passenger seat of your vehicle, you must properly use a BabySmart™ child restraint which will turn off the passenger side front airbag. BabySmart™ will not, however, turn off the vehicle's side impact airbag.

It should be noted that with respect to both front and rear side impact airbags there is a possibility for a side airbag related injury if occupants, especially children, are not properly seated or restrained when next to a side airbag which needs to deploy rapidly in a side impact in order to do its job.

To help avoid the possibility of injury, please follow these guidelines: (1) occupants, especially children, should never place their bodies or lean their heads in the area of the door where the side airbag inflates. This could result in serious injuries or death should the side airbag be activated; (2) always sit upright, properly use the seat belts and use an appropriately sized infant or child restraint system for all children 12 years old or under; and (3) always wear seat belts properly.

If you believe that, even with the use of these guidelines, it would be safer for your rear seat occupants to have both rear door mounted side airbags deactivated, then deactivation can be accomplished upon your written election to do so at your authorized Mercedes-Benz Center at an additional cost. Please contact your local authorized Mercedes-Benz Center or call our Customer Assistance Center at 1-800-FOR-MERCEdes (1-800-367-6372) for details.

Safety guidelines for the seat belt, emergency tensioning retractor and airbag

### Warning!

- Damaged seat belts or belts that were highly stressed in an accident must be replaced and their anchoring points must also be checked. Use only belts installed or supplied by an authorized Mercedes-Benz Center.
- Do not pass belts over sharp edges.
- Do not make any modification that could change the effectiveness of the belts.

## Restraint systems

76

- Airbags and “ETR’s” are designed to function on a one-time-only basis. An airbag or emergency tensioning retractor (ETR) that was activated must be replaced.
- No modifications of any kind may be made to any components or wiring of the “SRS”. This includes changing or removing any component or part of the “SRS”, the installation of additional trim material, badges etc. over the steering wheel hub, front passenger airbag cover, door trim panels, or door frame trims, and installation of additional electrical/electronic equipment on or near “SRS” components and wiring. Keep area between airbags and occupants free of objects (e.g. packages, purses, umbrellas, etc.).
- Do not use handles above doors for placing such items as coat hangers etc.
- An airbag system component within the steering wheel gets hot after the airbag has inflated. Do not touch.

- Improper work on the system, including incorrect installation and removal, can lead to possible injury through an unintended activation of the “SRS”.
- In addition, through improper work there is the risk of rendering the “SRS” inoperative or causing unintended deployment. Work on the “SRS” must therefore only be performed by an authorized Mercedes-Benz Center.
- For your protection and the protection of others, when scrapping the airbag unit or emergency tensioning retractor, our safety instructions must be followed. These instructions are available at your authorized Mercedes-Benz Center.
- Given the considerable deployment speed and the textile structure of the airbags, there is the possibility of abrasions or other injuries resulting from airbag deployment.

When you sell the vehicle we strongly urge you to give notice to the subsequent owner that it is equipped with an “SRS” by alerting him to the applicable section in the Operator’s Manual.

## Infant and child restraint systems

We recommend all infants and children be properly restrained at all times while the vehicle is in motion. All lap-shoulder belts except the driver's seat belt have special seat belt retractors for secure fastening of child restraints.

To activate, pull shoulder belt out completely and let it retract. During the seat belt retraction a ratcheting sound can be heard to indicate that the special seat belt retractor is activated. The belt is now locked.

To deactivate, release seat belt buckle and let seat belt retract completely. The seat belt can again be used in the usual manner.

Note:

For child seats with mounting fittings for tether anchorages refer to page 80 (installation of infant and child restraint systems).

### Warning!

**Never release the seat belt buckle while vehicle is in motion, since the special seat belt retractor will be deactivated.**



## Restraint systems

78

**Important!**

The use of infant or child restraints is required by law in all 50 states and all Canadian provinces.

Infants and small children should be seated in an appropriate infant or child restraint system properly secured by a lap-shoulder belt, and that complies with U.S. Federal Motor Vehicle Safety Standard 213 and Canadian Motor Vehicle Safety Standard 213.

A statement by the child restraint manufacturer of compliance with this standard can be found on the instruction label on the restraint and in the instruction manual provided with the restraint.

When using any infant or child restraint system, be sure to carefully read and follow all manufacturer's instructions for installation and use.

Please read and observe warning labels affixed to inside of vehicle and to infant or child restraints.

### **Warning!**

Children 12 years old and under must never ride in the front seat, except in a Mercedes-Benz authorized BabySmart™ compatible child seat, which operates with the BabySmart™ system installed in the vehicle to deactivate the passenger front airbag when it is properly installed. Otherwise they will be struck by the airbag when it inflates in a crash. If this happens, serious or fatal injury can result.

According to accident statistics, children are safer when properly restrained in the rear seating positions than in the front seating positions. Infants and small children must ride in back seats and be seated in an appropriate infant or child restraint system, which is properly secured with the vehicle's seat belt, fully in accordance with the child seat manufacturer's instructions.

Infants and small children should never share a seat belt with another occupant. During an accident, they could be crushed between the occupant and seat belt.

Children too big for child restraint systems must ride in back seats using regular seat belts. Position shoulder belt across chest and shoulder, not face or neck. A booster seat may be necessary to achieve proper belt positioning for children from 41 lbs. to the point where a lap/shoulder belt fits properly without one.

When the child restraint is not in use, remove it from the vehicle or secure it with the seat belt to prevent the child restraint from becoming a projectile in the event of an accident.

Do not leave children unattended in the vehicle; even if the children are secured in a child restraint system may use vehicle equipment can cause serious personal injury.

## Restraint systems

80

## Installation of infant and child restraint systems

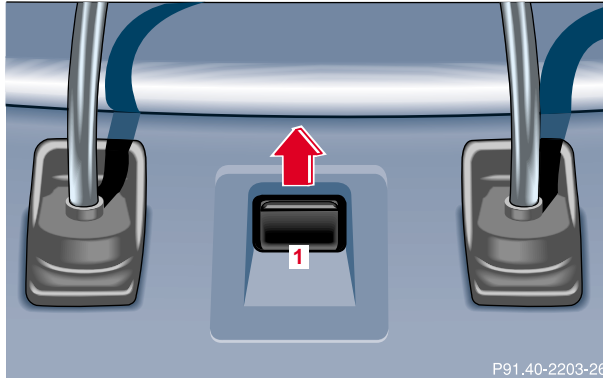

This vehicle is provided with tether anchorages for a top tether strap at each of the rear seating positions.

Prior to installing a tether strap, note the following steps:

- 1 Remove cover (1) from anchorage ring and store in a convenient place (e.g. glove box).
- 2 Guide tether strap through head restraints. Be careful that the tether strap is not twisted.

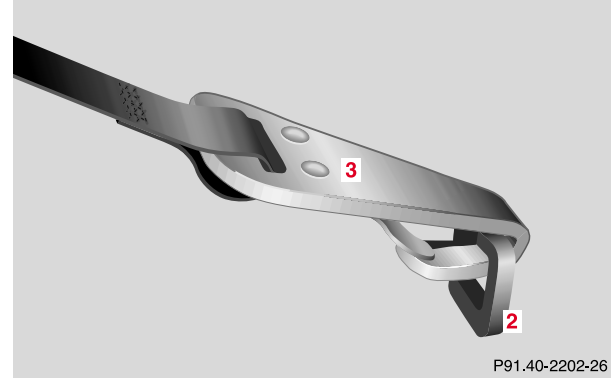

- 3 Fold up anchorage rings (2).

To secure a tether strap to the anchorage, securely fasten the hook (3), which is part of the tether strap, to the anchorage ring (2). For safety, please make sure that the hook has attached to the ring beyond the safety catch, as illustrated.

After removing the tether strap, reinstall the cover (1).

## Steering wheel adjustment

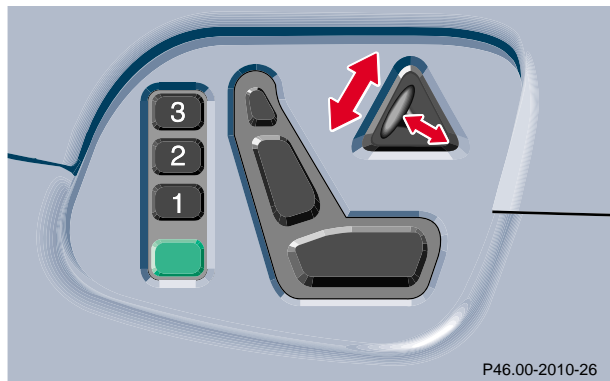

Turn electronic key in steering lock to position 1 or 2 (with the driver's or front passenger's door open, the steering wheel can also be operated with the electronic key removed or in steering lock position 0).

To lengthen or shorten the steering column, push switch forward or backward.

To raise or lower steering wheel, push switch up or down.

Note:

The steering wheel position can be stored in memory together with the seat/head restraint/exterior rear view mirror positions, see page 48.

### Warning!

**Do not adjust the steering wheel while driving. Adjusting the steering wheel while driving could cause the driver to lose control of the vehicle.**

## Rear view mirrors

82

**Rear view mirrors****Inside rear view mirror**

Manually adjust the inside rear view mirror.

Use your inside rear view mirror to determine the size and distance of objects seen in the passenger-side convex mirror.

**Rear view mirror, automatic antiglare**

Antiglare mode:

With the electronic key in steering lock position 2, the mirror reflection brightness responds to changes in light sensitivity.

With gear selector lever in position “R”, or with the interior lamp switched on, the mirror reflection brightness does not respond to changes in light sensitivity.

Note:

The automatic antiglare function does not react, if incoming light is not aimed directly at sensors in the inside rear view mirror.

The automatic antiglare function will not react for example, if the rear window sun shade is in raised position.

**Warning!**

**In the case of an accident liquid electrolyte may escape the mirror housing when the mirror glass breaks.**

**Electrolyte has an irritating effect. Do not allow the liquid to come into contact with eyes, skin, clothing, or respiratory system. In cases it does, immediately flush affected area with water, and seek medical help if necessary.**

## Exterior rear view mirrors

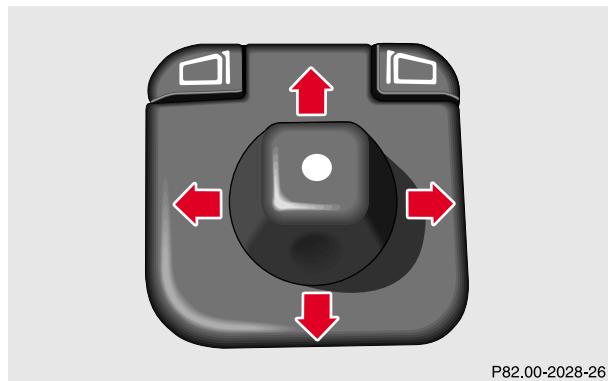

The switch is located on the center console.

Turn electronic key in steering lock to position 1 or 2.

First select the mirror to be adjusted – press button:

% Left mirror

& Right mirror

To adjust, toggle the switch forward, backward or to either side.

With the electronic key in steering lock position 2, the driver's side mirror reflection brightness responds to changes in light sensitivity.

With gear selector lever in position "R", or with the interior lamp switched on, the driver's side mirror brightness does not respond to changes in light sensitivity.

### Warning!

**Exercise care when using the passenger-side mirror. The passenger-side exterior mirror is convex (outwardly curved surface for a wider field of view). Objects in mirror are closer than they appear. Check your inside rear view mirror or glance over your shoulder before changing lanes.**

## Rear view mirrors

84

**Warning!**

**In the case of an accident liquid electrolyte may escape the mirror housing when the mirror glass breaks.**

**Electrolyte has an irritating effect. Do not allow the liquid come into contact with eyes, skin, clothing, or respiratory system. In cases it does, immediately flush affected area with water, and seek medical help if necessary.**

## Note:

The exterior mirrors have electrically heated glass. The heater switches on automatically, depending on outside temperature.

If an exterior mirror housing is forcibly pivoted from its normal position, it must be repositioned by applying firm pressure until it snaps into place.

The automatic antiglare function will not react for example, if the rear window sun shade is in raised position.

**Important!**

Electrolyte drops coming into contact with the vehicle paint finish can only be completely removed while in their liquid state, by applying plenty of water.

**Storing mirror positions in memory**

The exterior rear view mirror positions are stored in memory with the seat/head restraint/steering column positions and can be recalled when necessary, see page 49.

## Parking position

The passenger-side exterior mirror can be adjusted and programmed to assist the driver during parking maneuvers (e.g. to observe the curb or other objects close to the vehicle).

With the electronic key in steering lock position 2, and the exterior rear view mirror switch in the passenger side position, the passenger side mirror will be turned downward when placing the gear selector lever in “R” reverse.

The passenger side mirror will return to its previous position:

- immediately at speeds above approximately 6 mph (10 km/h) - independent of the engaged gear,
- after 20 seconds when shifting gear selector lever from “R” Reverse,
- by pressing the driver’s side mirror button % .

One passenger-side mirror position can be stored in memory. To do so:

1. Turn electronic key to steering lock position 2.  
The vehicle must be stationary.
2. Select passenger-side mirror and adjust the mirror to view the curb.
3. Press green memory button located in switch cluster for driver seat, see page 48.
4. Within 2 seconds pull the mirror toggle switch rearward. The mirror should not move.

Repeat the memory procedure if the mirror moves.



Instrument cluster

Instrument cluster

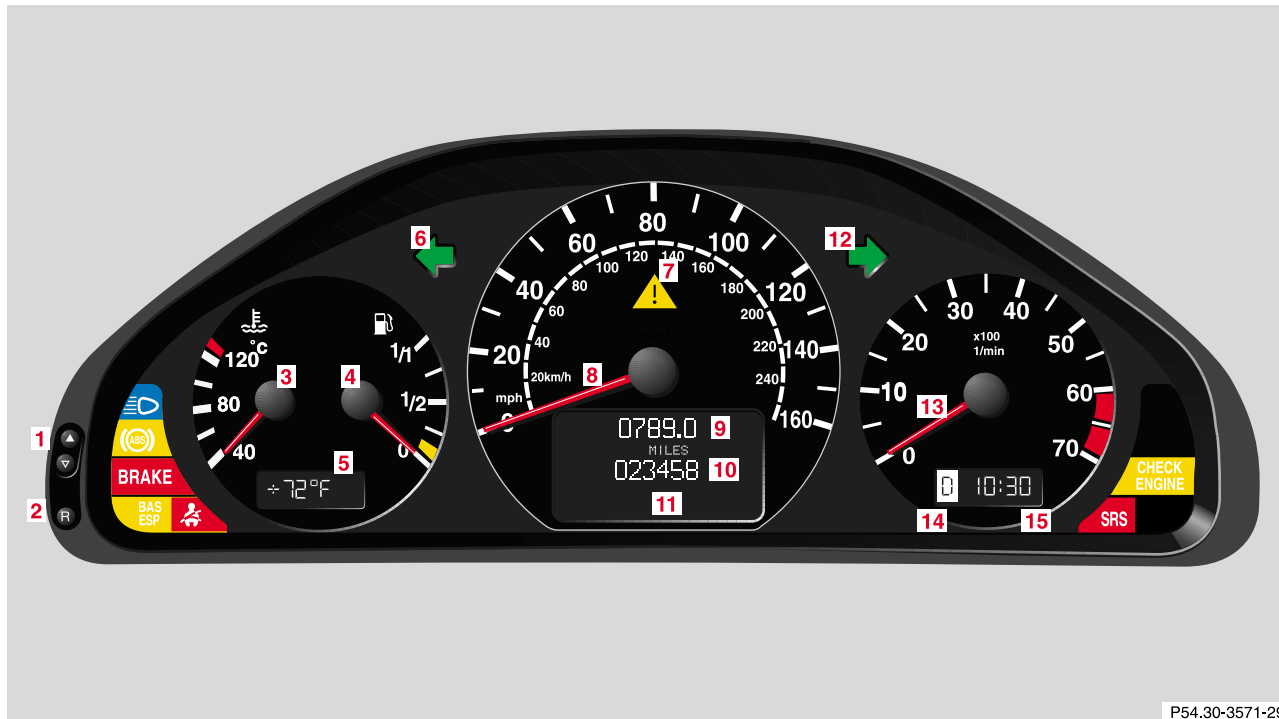

- 1** Push buttons for intensity of instrument lamps, see page 89
- 2** Push button for resetting trip odometer, see page 91, or to acknowledge a malfunction warning message, see page 108
- 3** Coolant temperature gauge, see page 90
- 4** Fuel gauge with reserve and fuel cap placement warning lamp, see page 236
- 5** Outside temperature indicator, see page 90
- 6** Left turn signal indicator lamp, see combination switch on page 122
- 7** Electronic stability program (ESP) warning lamp, see page 237
- 8** Speedometer
- 9** Trip odometer, see page 91 and 96
- 10** Main odometer, see page 96
- 11** Multifunction indicator, see page 92, or FSS indicator, see page 114, or engine oil level indicator, see page 117
- 12** Right turn signal indicator lamp, see combination switch on page 122
- 13** Tachometer, see page 91
- 14** Gear range indicator display, see page 196
- 15** Clock  
To set the time, see page 110

## Instrument cluster

88

**Indicator lamps in the instrument cluster**

High beam



ABS malfunction, see page 238

Brake fluid low (except Canada).  
Parking brake engaged, see page 202Brake fluid low (Canada only).  
Parking brake engaged, see page 202BAS malfunction, see page 237  
ESP malfunction, see page 237

Fasten seat belts, see page 59

ESP. Adjust driving to road condition,  
see page 237

Engine malfunction indicator lamp. If the “CHECK ENGINE” malfunction indicator lamp comes on when the engine is running, it indicates a malfunction of the fuel management system, emission control system, systems which impact emissions, or the fuel cap is not closed tight. In all cases, we recommend that you have the malfunction checked as soon as possible, see page 234



SRS malfunction, see page 236

**Function indicator lamp on the center console**

Front passenger airbag automatically switched off, see page 239

## Activating instrument cluster display

The instrument cluster is activated by:

- Opening the door.
- Pressing button **R**, **▲** or **▼** on the instrument cluster.
- Turning the electronic key in steering lock to position 1 or 2.
- Switching on the exterior lamps.

## Instrument cluster illumination

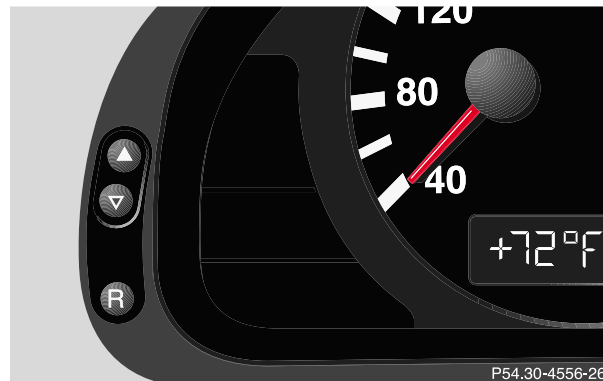

Activating the instrument cluster.

Press **▲** or **▼** button to vary intensity of instrument lamps.

### Coolant temperature gauge (3)

During severe operating conditions and stop-and-go city traffic, the coolant temperature may rise close to the red marking.

The engine should not be operated with the coolant temperature in the red zone. Doing so may cause serious engine damage which is not covered by the Mercedes-Benz Limited Warranty.

#### Warning!

- **Driving when your engine is badly overheated can cause some fluids which may have leaked into the engine compartment to catch fire. You could be seriously burned.**
- **Steam from an overheated engine can cause serious burns and can occur just by opening the engine hood. Stay away from the engine if you see or hear steam coming from it.**

**Turn off the engine, get out of the vehicle and do not stand near the vehicle until it cools down.**

### Outside temperature indicator (5)

The temperature sensor is located in the front bumper area. Due to its location, the sensor can be affected by road or engine heat during idling or slow driving. This means that the accuracy of the displayed temperature can only be verified by comparison to a thermometer placed next to the sensor, not by comparison to external displays (e.g. bank signs etc.).

Adaption to ambient temperature takes place in steps and depends on the prevailing driving conditions (stop-and-go or moderate, constant driving) and amount of temperature change.



#### Warning!

**The outside temperature indicator is not designed to serve as an Ice-Warning Device and is therefore unsuitable for that purpose. Indicated temperatures just above the freezing point do not guarantee that the road surface is free of ice.**

### **Trip odometer (9)**

To reset to “0” miles/km:

Activate the instrument cluster if it is not already activated, see page 89.

Press button  or  on the multifunction steering wheel repeatedly until the trip odometer appears if it is not displayed, see page 96.

Press button  (2) on the instrument cluster.

### **Tachometer (13)**

The red marking on tachometer denotes excessive engine speed.

Avoid this engine speed, as it may result in serious engine damage that is not covered by the Mercedes-Benz Limited Warranty.

To help protect the engine, the fuel supply is interrupted if the engine is operated within the red marking.

## Multifunction steering wheel, multifunction display

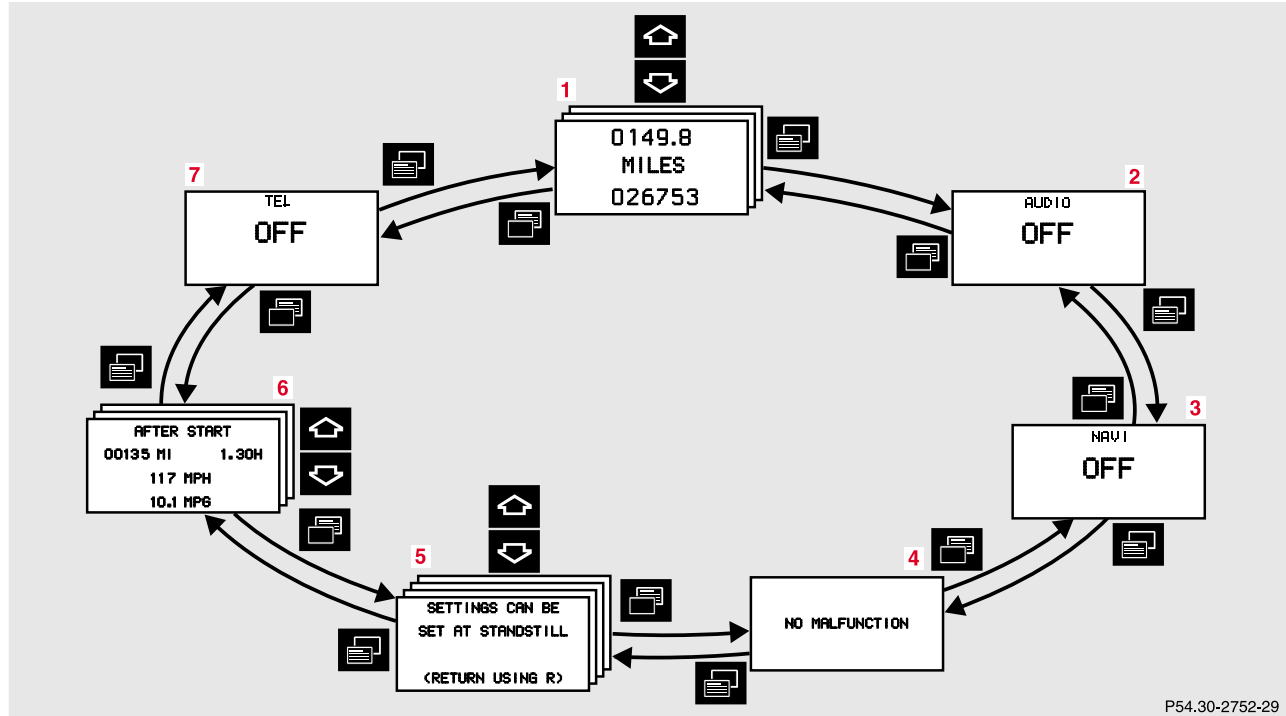

92

## Multifunction steering wheel, multifunction display





Depending on your vehicle's equipment, you may use the buttons on the multifunction steering wheel to call up, control and set the following systems in the multifunction display:

- 1 Trip odometer and main odometer, see page 96
  - Vehicle speed, see page 96
  - Flexible service system (FSS), see page 114
  - Engine oil level indicator, see page 117
- 2 Audio systems, see page 97
  - Radio, see page 97
  - CD player (optional), see page 98
  - Cassette player, see page 99
- 3 Navigation system (if so equipped), see page 105
- 4 Malfunction message memory, see page 108
- 5 Individual settings, see page 110
- 6 Trip computer, see page 106
  - After start
  - After reset
  - Fuel tank content
- 7 Telephone (if so equipped), see page 100

Press the  or  button repeatedly until the required system is displayed.

Pressing the  button advances the display to the next system.

Pressing the  button returns the display to the previous system.

You may call up additional displays within some of these categories by pressing the  or  button.

### Warning!

**A driver's attention to the road must always be his/her primary focus when driving.**

**For your safety and the safety of others, selecting features through the multifunction steering wheel should only be done by the driver when traffic and road conditions permit it to be done safely. Programming individual settings in the system can only be made while the vehicle is at standstill.**



## Multifunction steering wheel, multifunction display

94



- 1** Multifunction display
- 2** Multifunction steering wheel

Turn the electronic key in steering lock to position 1 or 2.

Press button:

- 3** è for next system
- 4** ÿ for previous system
- 5** j for next display in system
- 6** k for previous display in system
- 7** æ to increase the volume, see page 113
- 8** Ç to decrease the volume, see page 113
- 9** í to dial a telephone number, see page 100

See page 104 for instructions on answering an incoming call.

- 10** ì to end a call
- 11** Horn pad

Press the  $\ominus$  or  $\odot$  button repeatedly until the required system is displayed.

Pressing the  $\ominus$  button advances the display to the next system.

Pressing the  $\odot$  button returns the display to the previous system.

You may call up additional displays in some systems by pressing the  $\text{j}$  or  $\text{k}$  button.

Note:

The displays in the multifunction display can be set to German, English, French, Italian or Spanish language. See the “TEXT” individual setting on page 110 for instructions on changing the language setting.

The displays for the audio systems (radio, CD player, cassette player) will appear in English, regardless of the language selected.

## Multifunction steering wheel, multifunction display

96

### Trip and main odometer, vehicle speed, FSS and engine oil level display

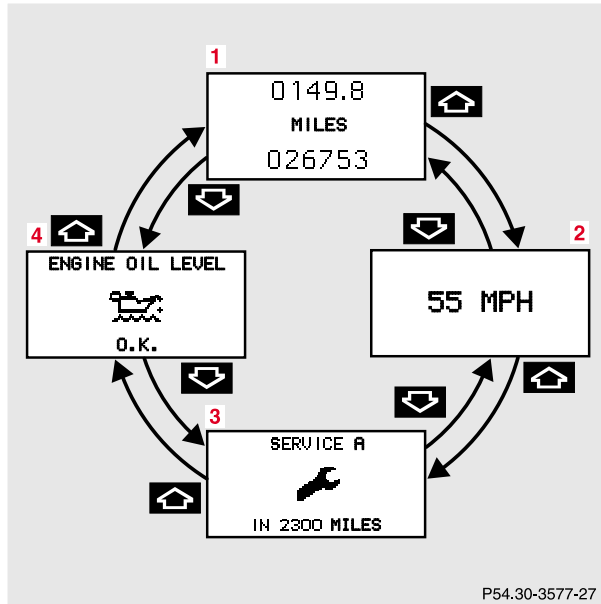

- 1** Trip odometer and main odometer  
See page 91 for instructions on resetting the trip odometer.
- 2** Vehicle speed
- 3** FSS (Flexible service system), see page 114
- 4** Engine oil level indicator, see page 117

Press  $\leftarrow$  or  $\downarrow$  button repeatedly until the trip odometer and main odometer display (1) appears.

Press the  $\rightarrow$  or  $\leftarrow$  button repeatedly until the required display (2, 3, 4, 1) appears.

Pressing the  $\leftarrow$  or  $\downarrow$  button displays the next or previous system.

## Audio systems

### Radio

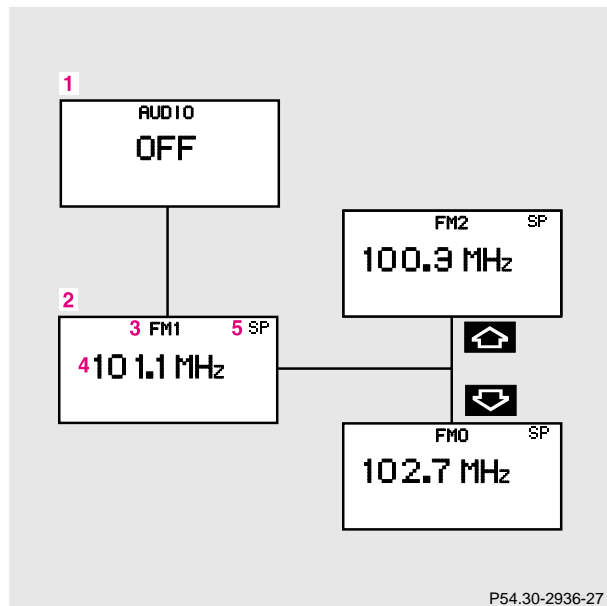

- 1 Audio system is switched off.
- 2 The radio is switched on.
- 3 Wave band setting and memory location number, where appropriate.
- 4 Station frequency.
- 5 This only appears when “MEMORY” rather than “FREQUENCY” has been selected in the Individual settings. See page 110.

The radio must be switched on.

Press the  $\grave{\text{e}}$  or  $\grave{\text{y}}$  button repeatedly until display (2) appears.

Press button  $\text{j}$  or  $\text{k}$  repeatedly until the required station or frequency is displayed.

Use the  $\text{j}$  or  $\text{k}$  button to select a stored station or station frequency. This depends on the selection made in the “STATION SEARCH USING” setting menu. See individual settings, page 110.

Pressing the  $\grave{\text{e}}$  or  $\grave{\text{y}}$  button displays the next or previous system.

## Multifunction steering wheel, multifunction display

98

## CD player (optional)

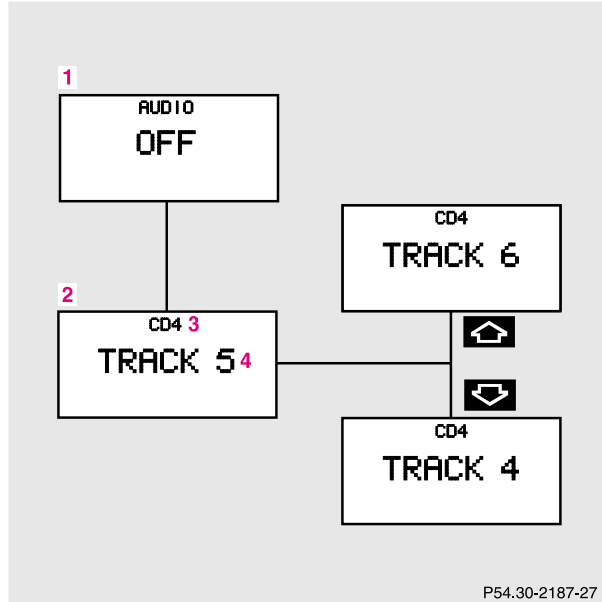

- 1** Audio system is switched off.
- 2** The CD player is switched on.
- 3** The number of the CD currently playing is displayed if you are using a CD changer.
- 4** Track number.

The radio must be switched on.

The CD player must be switched on.

Press the  $\leftarrow$  or  $\rightarrow$  button repeatedly until display (2) appears.

Press the j or k button repeatedly until the required track number (4) is displayed.

Pressing the  $\leftarrow$  or  $\rightarrow$  button displays the next or previous system.

Note:

To select a CD from the magazine, press a number on the audio or the (optional) COMAND system located in the center dashboard.

## Cassette player

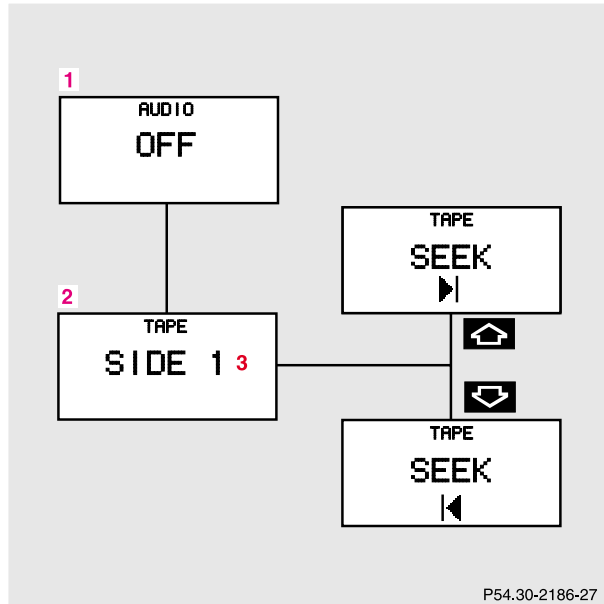

- 1 Audio system is switched off.
- 2 The cassette player is switched on.
- 3 Side being played.

The radio must be switched on.

The cassette player must be switched on.

Press the  $\grave{\text{e}}$  or  $\grave{\text{y}}$  button repeatedly until display (2) appears.

Pressing the  $\text{j}$  button fast forwards on to the next track.

Pressing the  $\text{k}$  button rewinds the cassette to the beginning of the current track.

Pressing the  $\grave{\text{e}}$  or  $\grave{\text{y}}$  button displays the next or previous system.

Note:

To select the reverse side of the tape, press button below track number on the audio system display, or enter request on the (optional) COMAND system located in center dashboard.

## Multifunction steering wheel, multifunction display

100

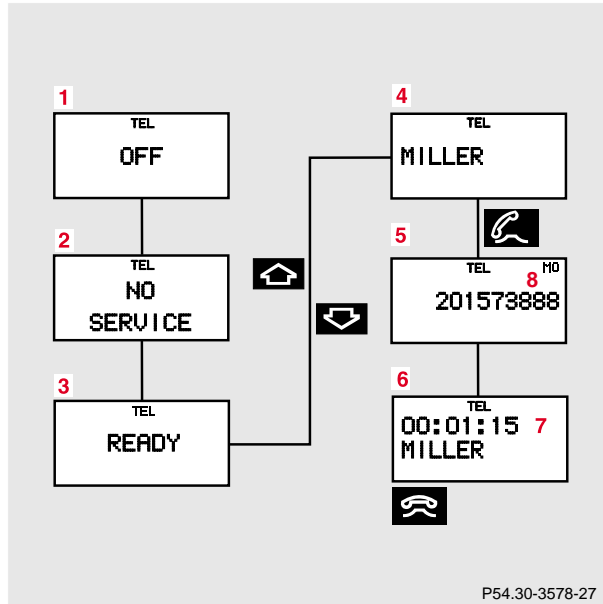
**Telephone (optional)****Telephone book**

- 1** The telephone is switched off.
- 2** The vehicle is currently outside the transmitter or receiver range.
- 3** The telephone is ready for use.
- 4** Name selected from the telephone book.
- 5** Number for the name selected. Dialing commences.
- 6** Dialing is completed. The name is displayed. The display remains for the duration of the call.
- 7** Duration of call.
- 8** Memory location number.

The telephone must be switched on.

Press the  $\ominus$  or  $\ddot{y}$  button repeatedly until display (3) appears. Refer to the separate telephone instruction manual.

Pressing j or  $\llcorner$  “browses” alphabetically forwards or backwards through the telephone book, providing it was previously downloaded. See telephone operator’s manual for details concerning downloading. Pressing button j or  $\llcorner$  for longer than a second “browses” rapidly through the telephone book. The name selected appears in the display.

Note:

Press the  $\grave{\imath}$  button if you do not wish to make a call.

The procedure is cancelled and display (3) appears.

Press the  $\acute{\imath}$  button when the name you require appears in the display (4). The telephone number (5) is dialed.

The name will be displayed when dialing is completed. Display (6) remains for the duration of the call.

Pressing the  $\grave{\imath}$  button hangs up and display (3) appears.

Pressing the  $\ominus$  or  $\ddot{y}$  button displays the next or previous system.



## Multifunction steering wheel, multifunction display

102

## Redialing

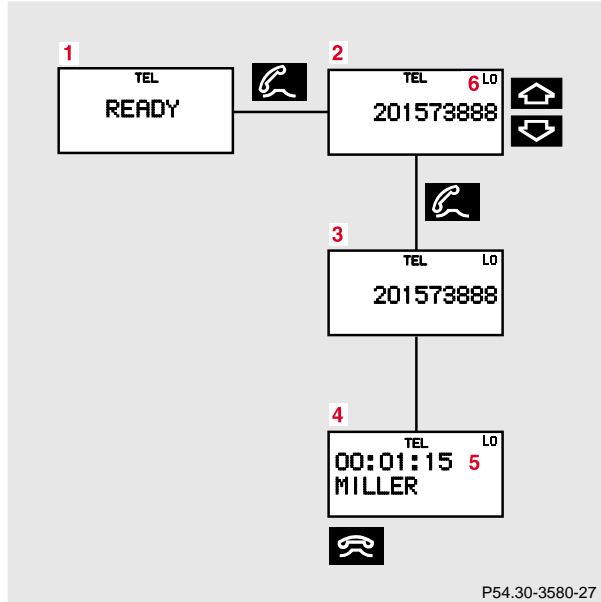

- 1** The telephone is ready for use.
- 2** Number or name stored in the redial memory.
- 3** Number in the redial memory – redialing has commenced.
- 4** Dialing is completed and the name stored in the telephone book is displayed or the number dialed will remain displayed if no name has been stored. The display remains for the duration of the call.
- 5** Duration of call.
- 6** Memory location numbers – the 10 most recently dialed numbers are stored.  
L0, most recently dialed number,  
L1 to L9, previously dialed numbers.

The telephone is switched on.

Press the  $\ominus$  or  $\ddot{y}$  button repeatedly until the display (1) appears.

Pressing the  $\acute{ı}$  button activates the redial memory and the most recently dialed number is displayed.

Pressing the  $j$  or  $k$  button “browses” forwards or backwards through the redial memory. The number selected appears in the display.

Note:

Press the  $\grave{\imath}$  button if you do not wish to make a call.

The procedure is cancelled and display (1) appears.

Press the  $\acute{ı}$  button when the required number or name appears in the display (2).  
The telephone number (3) is dialed.

Once dialing is completed the name (4) is displayed if the name is stored in the telephone book; failing that the number dialed will remain displayed. The display remains for the duration of the call.

Pressing the  $\grave{\imath}$  button hangs up and display (1) appears.

Pressing the  $\ominus$  or  $\ddot{y}$  button displays the next or previous system.

## Multifunction steering wheel, multifunction display

104

## Incoming call



The telephone must be switched on.

**1** “CALL” – you are being called

Press the **í** button to answer the call.

Press the **ì** button to hang up or if you do not wish to answer the incoming call.

## Navigation system (optional)

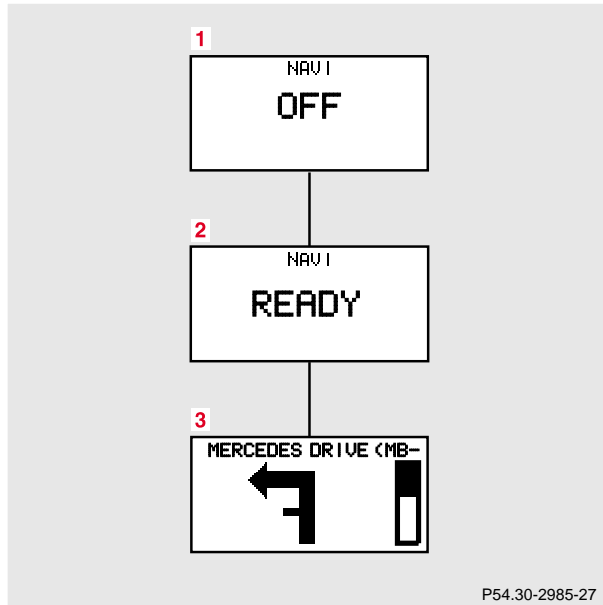

- 1 The navigation system is switched off.
- 2 The navigation system is switched on but no destination has been specified.
- 3 The navigation system is switched on and destination guidance is active.

Press the  $\hat{e}$  or  $\check{y}$  button repeatedly until the required system is displayed.

See the separate COMAND (Cockpit Management and Data System) operator's manual for notes on the navigation system.

Pressing the  $\hat{e}$  or  $\check{y}$  button displays the next or previous system.

## Multifunction steering wheel, multifunction display

106

## Trip computer

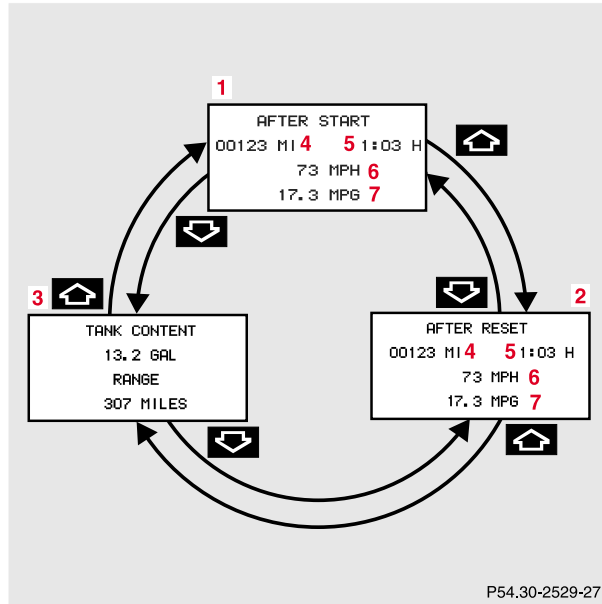

- 1 “AFTER START” – trip odometer records distance from first engine start after more than five hours of electronic key not being in steering lock position 2
- 2 “AFTER RESET” – trip odometer records distance from first engine start until it is reset
- 3 Estimated driving range remaining and fuel tank contents
- 4 Distance covered “AFTER START” respectively “AFTER RESET”
- 5 Elapsed time “AFTER START” respectively “AFTER RESET”
- 6 Average speed “AFTER START” respectively “AFTER RESET”
- 7 Average fuel consumption “AFTER START” respectively “AFTER RESET”

Press the button  $\ominus$  or  $\ddot{y}$  repeatedly until the display (1) appears.

Press the  $j$  or  $k$  button until the display for trip odometer memory “AFTER START” (1) and “AFTER RESET” (2), or the display (3) for estimated driving range remaining and fuel tank contents appears.

### **Important!**

The reading in the display “TANK CONTENT” might be off by approximately +/- 2.2 US qt (2 l). Please refuel in time.

Pressing the  $\ominus$  or  $\ddot{y}$  button displays the next or previous system.

Note:

The “AFTER START” display (1) always appears when the trip computer is called up.

To reset the “AFTER START” (1) or “AFTER RESET” (2) odometer memory at any time:

Call up the relevant display (1 or 2) using the  $j$  or  $k$  button and press the  $\text{R}$  button in the instrument cluster until the values are reset.

The “AFTER START” trip odometer reading is automatically reset after four hours of electronic key not being in steering lock position 2.

## Multifunction steering wheel, multifunction display

108

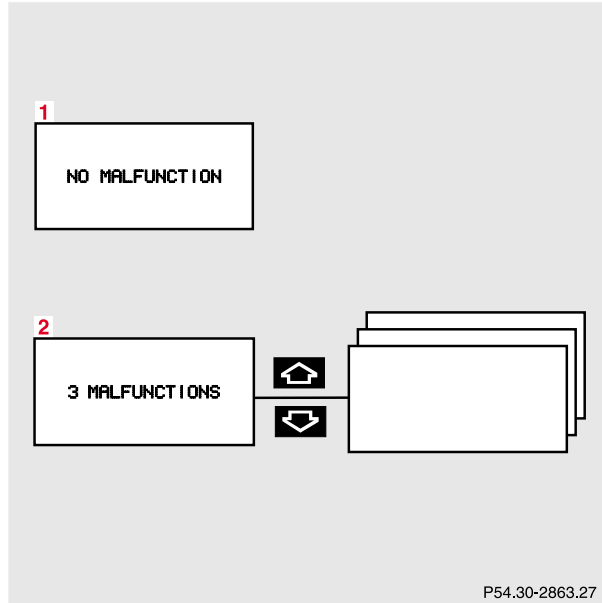
**Malfunction message memory**

- 1** There are no messages stored in the system
- 2** Number of messages stored in the system

Press the  $\hat{e}$  or  $\ddot{y}$  button repeatedly until the malfunction message memory (1 or 2) is displayed.

Press the  $j$  or  $k$  button if display (2) appears. The stored malfunction messages will now be displayed in order. See page 240 for malfunction and warning messages.

Display (2) will reappear after you have scanned all the malfunction messages.

Should any malfunctions be stored while driving, they will reappear in the display (2) when the electronic key is in steering lock position 0 or removed from the steering lock.

Specific malfunctions can be recalled by pressing button **R**. Each malfunction or warning message must be acknowledged by pressing button **R**. Once all messages are cancelled the odometer display should reappear.

Pressing the **R** button in the instrument cluster immediately switches to the next malfunction message.

The malfunction message memory will be cleared when the electronic key is turned in the steering lock to position 1 or 2. Should subsequent malfunctions occur, they will be displayed in the malfunction message memory.

Pressing the **←** or **→** button displays the next or previous system.

### **Important!**

Malfunctions and warning messages are only indicated for certain systems and displayed to a low level of detail.

The malfunction and warning messages are simply a reminder with respect to the operation of certain systems and do not replace the driver's responsibility to maintain the vehicle's operating safety by having all required maintenance and safety checks performed on the vehicle and by bringing the vehicle to an authorized Mercedes-Benz Center to address the malfunction and warning messages. See page 240.



## Multifunction steering wheel, multifunction display

110

## Individual settings

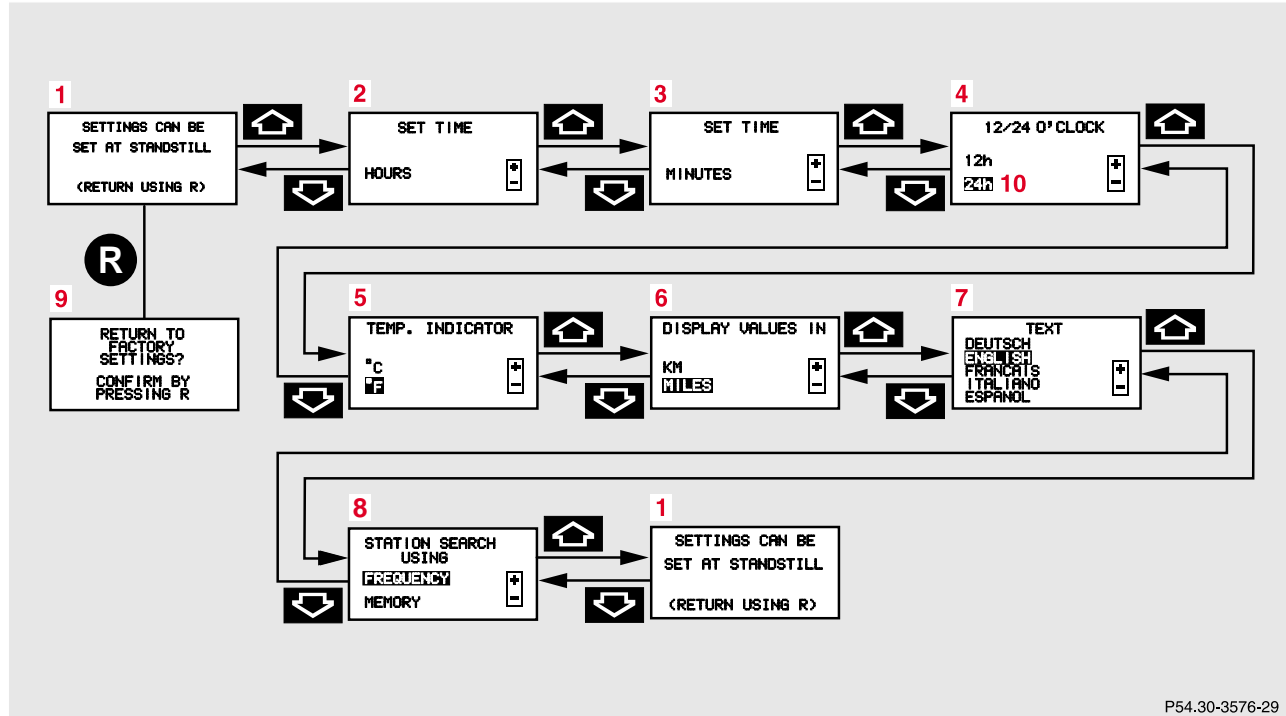

- 1 Preliminary display of the individual settings
- 2 “SET TIME – HOURS”  
(Only vehicles without COMAND)
- 3 “SET TIME – MINUTES”  
(Only vehicles without COMAND)
- 4 “12/24 O’CLOCK”, the unit set is displayed in the instrument cluster  
(Only vehicles without COMAND)
- 5 “TEMP. INDICATOR” – the unit set is displayed in the outside temperature display in the instrument cluster and in the automatic air conditioner display
- 6 “DISPLAY VALUES IN” – the unit set is displayed in the trip and main odometer.
- 7 “TEXT” – sets the language used in the multifunction display
- 8 “STATION SEARCH USING” – radio adjustment  
“FREQUENCY” – use the j or k button to select a frequency  
“MEMORY” – use the j or k button to select a stored station (preset memory)
- 9 See page 113 for instructions on returning the setting menus to the factory settings
- 10 Selection marker – indicates the setting selected

Notes:

These settings may only be performed with the vehicle at standstill and with the key in steering lock position 1 or 2.

The figure depicts the factory setting for the Federal Republic of Germany.

**Multifunction steering wheel, multifunction display****112**

Press the  $\grave{e}$  or  $\grave{y}$  button repeatedly until the individual setting preliminary display (1) appear.

Press the j or k button until the required setting menu (2 to 8) is displayed.

Pressing the  $\ae$  or  $\c$  button sets the time in setting menus (2, 3) and controls the selection marker in setting menus (4 to 8).

The settings made are stored and applied immediately.

The individual setting preliminary display (1) will appear again after you have run through all the setting menus.

Pressing the  $\grave{e}$  or  $\grave{y}$  button displays the next or previous system.

Notes:

Settings can only be selected with the vehicle stationary or moving slowly.

The individual setting preliminary display (1) will appear if you speed up.

The setting menu previously called up will reappear when the vehicle stops or slows down, providing no other system has been called up in the meantime.

To return setting menus (4 to 8) to their factory settings:

- Call up the individual setting preliminary display (1).
- Press the **R** button in the instrument cluster for approximately 3 seconds. Display (9) will appear.
- Press the **R** button once more, the message “RESET TO FACTORY SETTINGS” appears in the display.

The individual setting preliminary display (1) will appear if you do not press the **R** button within about 5 seconds. The setting menus will not be reset.

### Setting the audio volume

You can only adjust the volume of the system currently in use. The volume setting for each system (audio, telephone, navigation and voice recognition system) is stored separately.

Setting button:

⌘ increases the volume.

⌘ reduces the volume.

## Flexible service system

114

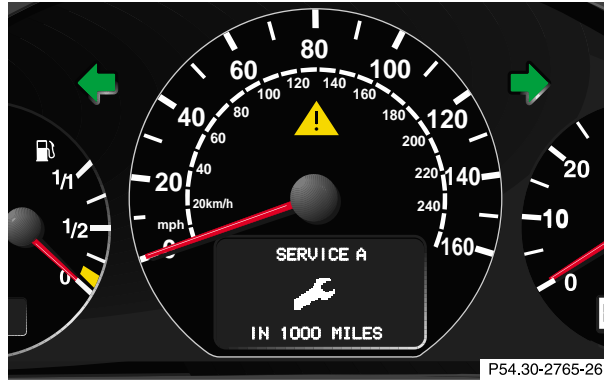
**Flexible service system (FSS)  
(service indicator)**

The FSS permits a flexible service schedule that is directly related to the operating conditions of the vehicle.

The symbol  $\text{9}$  or  $\frac{1}{2}$  appears together with a message in the multifunction indicator prior to the next suggested service.

Depending on operating conditions throughout the year, the next service is calculated and displayed in days or distance remaining.

The message is displayed for approximately 10 seconds when turning the electronic key in steering lock to position 2, or while driving when reaching the service warning threshold.

The symbols and messages indicate the type of service to be performed:

$\text{9}$  Service A

$\frac{1}{2}$  Service B

One of the following messages will appear in the display (e.g. Service A):

“SERVICE A – IN xx DAYS”

“SERVICE A – IN xx MILES” (Canada: KM)

“SERVICE A – EXCEEDED BY xx DAYS”

“SERVICE A – EXCEEDED BY xx MILES” (Canada: KM)

“SERVICE A – DUE NOW”

The next service due date is displayed either in days or in miles, depending on your driving style.

Once the suggested service term has passed, the symbol and message appear for approximately 30 seconds and a signal sounds every time when turning the electronic key in steering lock to position 2.

The service indicator disappears automatically after 30 seconds or if button **R** on the instrument cluster is pressed.

Calling up service indicator manually:

Turn the electronic key in steering lock to position 1 or 2.

Call up the trip odometer and main odometer by pressing button **e** or **y** on the multifunction steering wheel until the display appears. See page 96.

Press button **j** or **k** until the FSS indicator appears.

Pressing the **e** or **y** button displays the next or previous system.

### **Important!**

The FSS indicator is not an engine oil level indicator. See page 117 for engine oil level indicator.

Note:

When disconnecting vehicle battery for one or more days at a time, such days will not be counted. Any such days not counted by the FSS can be added by your Mercedes-Benz Center.

The interval between services is determined by the type of driving for which the vehicle is used. For example, driving at extreme speeds, and cold starts combined with short distance driving in which the engine does not reach operating normal temperature, reduce the interval between services.



## Flexible service system



## 116

Following a completed A or B service the Mercedes-Benz Center sets the counter mileage to 10 000 miles (Canada: 15 000 km).

The counter can also be set by any individual. To do so:

Turn the electronic key in steering lock to position 2.

To call up the trip odometer and main odometer, press button  or  on the multifunction steering wheel until the display appears. See page 96.

Press button  or  until the FSS indicator appears.

Press button  on the instrument cluster for approximately 4 seconds.

The multifunction display will show the question: “DO YOU WANT TO RESET SERVICE INTERVAL? CONFIRM BY PRESSING R”

Press button  on the instrument cluster again for approximately 4 seconds, and hold until a signal sounds. The message “SERVICE INTERVAL HAS BEEN RESET” appears in the multifunction display.

The new service indicator is displayed with the reset distance of 10 000 miles (Canada 15 000 km).

If the FSS counter was inadvertently reset, have a Mercedes-Benz Center correct it.

However you choose to set your reference numbers, the scheduled services as posted in the Service Booklet must be followed to properly care for your vehicle.

## Engine oil level indicator

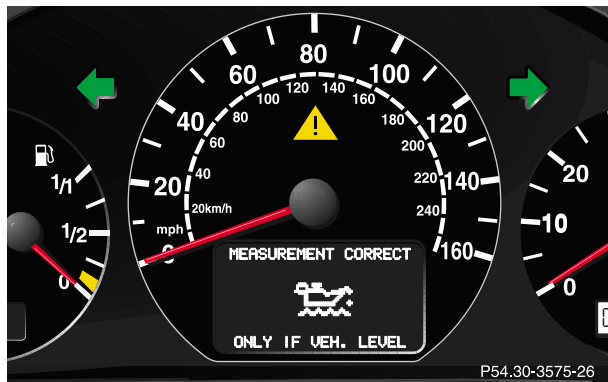

To check the engine oil level, park vehicle on level ground, with engine at normal operational temperature.

Check oil level approximately 5 minutes after stopping the engine, allowing for the oil to return to the oil pan.

Turn the electronic key in steering lock to position 2.

To call up the trip odometer and main odometer, press button  $\ominus$  or  $\dot{y}$  on the multifunction steering wheel until the display appears. See page 96.

Press button  $j$  or  $\llcorner$  on the multifunction steering wheel repeatedly until the “MEASUREMENT CORRECT – ONLY IF VEH. LEVEL” engine oil level indicator appears. This indicator is only a reminder. Measurement can be cancelled by pressing button  $j$  or  $\llcorner$  if the vehicle is not parked on level ground. An incorrect reading will be displayed if you do not cancel the measurement. Move the vehicle to level ground and measure again.

The electronic key in steering lock is not in position 2 if the “ENGINE OIL LEVEL – SWITCH ON IGNITION” message appears.

The “ENGINE OIL LEVEL – MEASURING NOW” message is displayed after approximately 3 seconds.



## Engine oil level indicator

118

One of the following messages will subsequently appear on the indicator:

**“ENGINE OIL LEVEL – O.K.”**

No oil needs to be added.

**“ENGINE OIL LEVEL – ADD 1.0 QUART”**

(Canada: 1.0 L)

**“ENGINE OIL LEVEL – ADD 1.5 QUART”**

(Canada: 1.5 L)

**“ENGINE OIL LEVEL – ADD 2.0 QUART”**

(Canada: 2.0 L)

See page 262 for instructions on adding engine oil.

**“ENGINE OIL LEVEL – REDUCE OIL LEVEL”**

Do not overfill the engine.

Excessive oil must be siphoned or drained off. It could cause damage to the engine and catalytic converter not covered by the Mercedes-Benz Limited Warranty.

The message “MEASURING NOT POSSIBLE” will be displayed if a proper oil level check cannot be performed. The engine oil level check can be repeated after a short time.

Perform the engine oil level check with the dipstick, if it cannot be completed via the multifunction display. See page 262.

In this case we recommend that you have the system checked at a Mercedes-Benz Center.

Note:

See “Malfunction and warning messages” on page 240 and page 251 if an engine oil level indicator appears on the multifunction display when the engine is running.

The engine oil level cannot be checked while the engine is running. The “ENGINE OIL LEVEL – NOT WHEN ENGINE ON” message will appear.

### Engine oil consumption

Engine oil consumption checks should only be made after the break-in period. During the break-in period, higher oil consumption may be noticed and is normal. Frequent driving at high engine speeds results in increased consumption.

## Exterior lamp switch

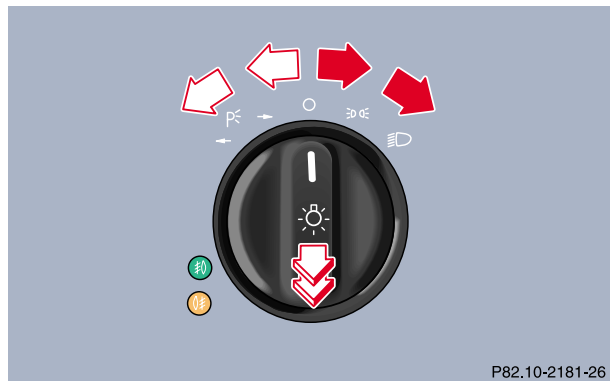

- D Off
- C Parking lamps (also side marker lamps, taillamps, licence plate lamps, instrument panel lamps)  
Canada only: When the engine is running, the low beam is additionally switched on.

- B Parking lamps plus low beam or high beam headlamps (combination switch pushed forward).
- ^ Standing lamps, right (turn left one stop)
- , Standing lamps, left (turn left two stops)
- ‡ Front fog lamps (pull out one stop) with parking lamps and/or low beam headlamps on. Green indicator in lamp switch comes on.
- † Rear fog lamp (pull out to second detent) in addition to the front fog lamps. Yellow indicator in lamp switch comes on.

### Standing lamps

When the vehicle is parked on the street the standing lamps (right or left side parking lamps) can be turned on, making the vehicle more visible to passing vehicles.

The standing lamps cannot be operated with the electronic key in steering lock position 2.

## Exterior lamp switch

120

Note:

With the electronic key removed and the driver's door open, a warning sounds and the message "SWITCH OFF LIGHTS!" in the multifunction indicator appears if the vehicle's exterior lamps (except standing lamps) are not switched off.

Fog lamps will operate with the parking lamps and/or the low beam headlamps on. Fog lamps should only be used in conjunction with low beam headlamps. Consult your State or Province Motor Vehicle Regulations regarding allowable lamp operation.

Fog lamps are automatically switched off when the exterior lamp switch is turned to position D .

**Daytime running lamps**

(Canada only)

When the engine is running and the selector lever is in a driving position, the low beam headlamps (includes parking lamps, side marker lamps, taillamps and license plate lamps) are automatically switched on.

When shifting from a driving position to position "N" or "P", the low beam switches off (2 seconds delay).

For nighttime driving the exterior lamp switch should be turned to position B to permit activation of the high beam headlamps.

**Night security illumination**

When exiting the vehicle after driving with the exterior lamps on, they switch on again for added illumination for approximately 30 seconds after closing the last door. The lamp-on time period can be changed at your Mercedes-Benz Center.

## Headlamp cleaning system (optional)



The switch is located in the center console.

The headlamp washer can be activated with the electronic key in steering lock position 2.

Briefly press symbol side of switch.

## Combination switch

122

## Combination switch

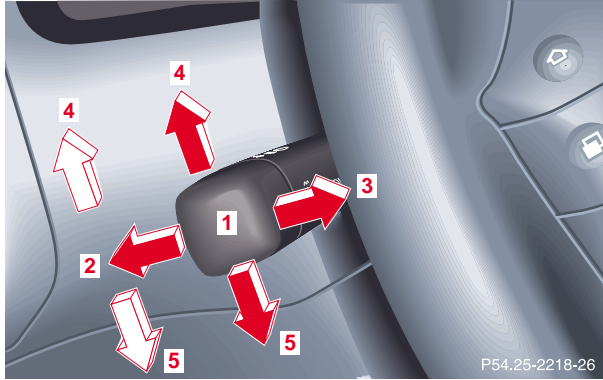

- 1 Low beam (exterior lamp switch position B )
- 2 High beam (exterior lamp switch position B )

- 3 High beam flasher (high beam available independent of exterior lamp switch position)
- 4 Turn signals, right
- 5 Turn signals, left

To signal minor directional changes, such as changing lanes on a highway, move combination switch to the point of resistance only and hold it there.

To operate the turn signals continuously, move the combination switch past the point of resistance (up or down). The switch is automatically canceled when the steering wheel is turned to a large enough degree.

**Turn signal failure**

If one of the turn signals fails, the turn signal indicator system flashes and sounds at a faster than normal rate.

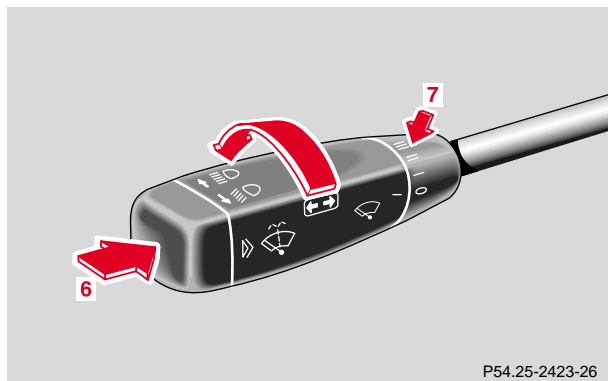

- 6 Control for windshield wiper/washer system:
  - Push briefly for single wipe without adding washer fluid (use only when windshield is wet).
  - Push past detent and hold to activate wiper and washer.
- 7 Windshield wiper
  - 0 Wiper off

## I Intermittent wiping

Vehicles with optional rain sensor:

One initial wipe, pauses between wipes are automatically controlled by a rain sensor monitoring the wetness of the windshield.

Notes:

With switch in this position, one wipe occurs when turning the electronic key in steering lock from position 0. However, this might cause scratches on a dry windshield. Turn combination switch to Off position before turning the electronic key in steering lock from position 0.

Optional rain sensor:

Do not leave in intermittent setting when vehicle is taken to an automatic car wash or during windshield cleaning. Wiper will operate in presence of water spray at windshield, and wiper may be damaged as a result.

## II Normal wiper speed

## III Fast wiper speed

Vehicles without optional rain sensor:

If the vehicle is standing still, the wiper will switch back one setting.

## Combination switch

124

Note:

The windshield washer reservoir, hoses and nozzles are automatically heated.

For windshield and headlamp washer fluid mixing ratio see page 265.

**Windshield wiper smears**

If the windshield wiper smears the windshield, even during rain, activate the washer system as often as necessary. The fluid in the washer reservoir should be mixed in the correct ratio.

**Blocked windshield wiper**

If the windshield wiper becomes blocked (for example, due to snow), switch off the wiper.

For safety reasons before removing ice or snow, remove electronic key from steering lock. Remove blockage.

Activate combination switch again (electronic key in steering lock position 1).

## Hazard warning flasher switch

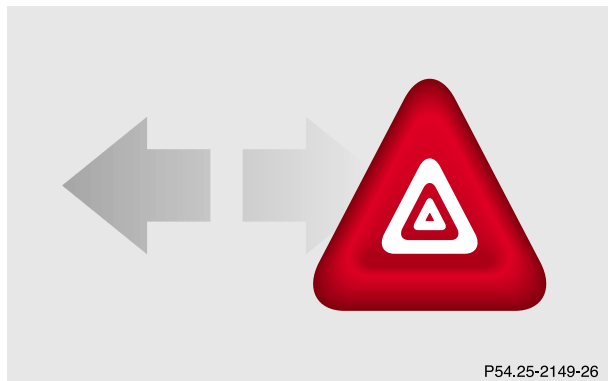

The hazard warning flasher can be activated either manually via the switch located in the dashboard, or it is activated automatically at the time an airbag is deployed.

To activate hazard warning flasher, press switch once.  
To deactivate, press switch again.

If hazard warning flasher was activated automatically, press switch twice to deactivate.

Note:

With the hazard warning flasher activated, the combination switch in position for either left or right turn, and the electronic key in steering lock position 2, only the respective left or right side turn signals will operate. After turn signal cancellation, the hazard warning flasher is activated.



Automatic climate control

Automatic climate control

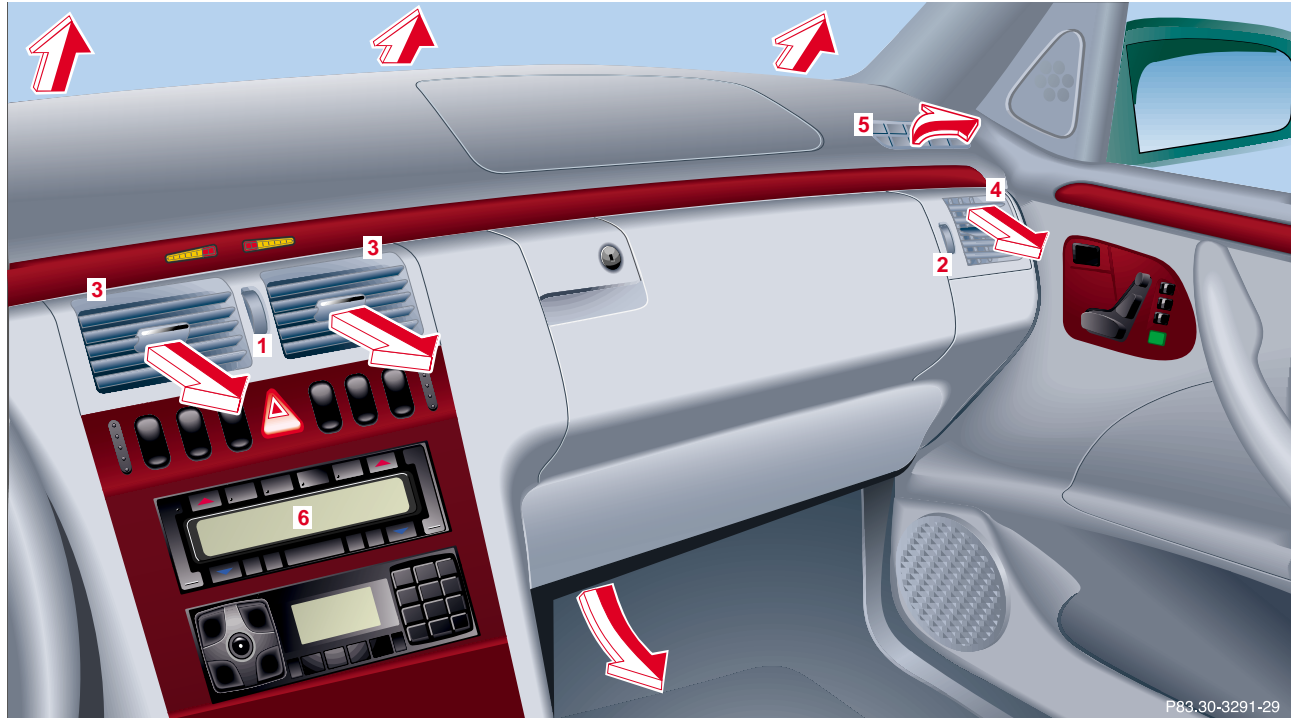

- 1 Air volume control for center air outlets, turn wheel up to open.
- 2 Air volume control for side air outlet and side window defroster outlet.  
  
To open side air outlets:  
Turn wheel to position I .  
  
To open defroster outlets:  
Turn wheel to position I .
- 3 Center air outlets, adjustable
- 4 Side air outlet, adjustable
- 5 Side defroster outlet
- 6 Display and controls

The system is always at operational readiness, except when manually switched off.

The automatic climate control only operates with the engine running.

The temperature selector should be left at the desired temperature setting. The temperature selected is reached as quickly as possible.

The system will not heat or cool any quicker by setting a higher or lower temperature.

The automatic climate control removes considerable moisture from the air during operation in the cooling mode. It is normal for water to drip on the ground through ducts in the underbody.

The desired interior temperature can be selected separately for the left and right side of the passenger compartment.

## Automatic climate control

## Display and controls



## 128

Press the desired button to activate, indicator lamp is on while activated.

- U Automatic mode
- f Raise temperature
- g Lower temperature
- P Defrost
- O Air recirculation
- e Activated charcoal filter
- F Rear window defroster
- b Air distribution, manual
- S Economy mode
- i Air volume, manual
- T Residual engine heat utilization

### Basic setting - automatic mode

Press left and right **U** button for automatic mode.

Simultaneously press both **f** and **g** buttons for temperature setting of 72°F.



Air volume and distribution are controlled automatically.

This setting can be used all year around.

### Economy

The function of this setting corresponds to the automatic mode. However, because the air conditioning compressor will not engage (fuel savings), it is not possible to air condition in this setting.

Press **S** button to activate.

Press **S** button once again to return to previous setting.

### Special settings (use only for short duration)

#### Defogging windows

Switch off **O** button.

Press left and right **U** buttons.

Press **b** button repeatedly until air is directed upward.



Turn wheels (2) to position to open left and right defroster outlets (5).

#### Defrosting

Turn wheels (2) to position **l** to open left and right defroster outlets (5).

Press **P** button. Maximum heated and automatically controlled amount of air is directed to the windshield and side windows.



Press **P** button once again to return to previous setting.

## Automatic climate control

130

**Rear window defroster**

Turn electronic key in steering lock to position 2.

To select, press F button.

To cancel, press F button again.

Notes:

Heavy accumulation of snow and ice should be removed before activating the defroster.

The rear window defroster uses a large amount of power. To keep the battery drain to a minimum, turn off the defroster as soon as the window is clear.

The defroster is automatically turned off after a maximum of 12 minutes of operation.

If several power consumers are turned on simultaneously, or the battery is only partially charged, it is possible that the defroster will automatically turn itself off. When this happens, the indicator lamp inside the switch starts blinking.

As soon as the battery has sufficient voltage, the defroster automatically turns itself back on.

**Air distribution**

Press b button for each side repeatedly until the requested symbol is displayed.

**Air volume**

Press - or + side of rocker switch i until the requested blower speed is attained. A choice of 7 blower speeds is available.

To switch the automatic climate control off, press - side of rocker switch i until symbol OFF is displayed.

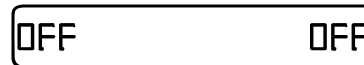

The fresh air supply to the car interior is shut off.

While driving, use this setting only temporarily, otherwise the windshield could fog up.

To switch the automatic climate control on again, press U, P, or + side of i.

## Air recirculation

This mode can be selected to temporarily reduce the entry of annoying odors or dust into the vehicle's interior.

Outside air is not supplied to the car's interior.

To select, press  button.

To cancel, press  button again.

The system will automatically switch from recirculated air to fresh air

- after approximately 5 minutes at outside temperatures below approximately 40°F (5°C),
- after approximately 30 minutes, at outside temperatures above approximately 40°F (5°C),
- after approximately 5 minutes, if button  is pressed.

If the windows should fog up from the inside, switch from recirculated air back to fresh air.

At high outside temperatures, the system automatically engages the recirculated air mode thereby increasing the cooling capacity performance, switching to partially fresh air within 20 minutes.

## Dust filter

Nearly all dust particles and pollen are filtered out before outside air enters the passenger compartment through the air distribution system.

Notes:

Do not obstruct the air flow by placing objects on the air flow through exhaust slots below the rear window.

Also keep the air intake grille in front of windshield free of snow and debris.

## Automatic climate control

132

**Activated charcoal filter**

An activated charcoal filter markedly reduces bad odors and removes pollutants from the air entering the passenger compartment.

To select, press  $\ominus$  button.

To cancel, press  $\ominus$  button again.

The blower speed is slightly increased to supply a constant volume of air.

The system switches automatically to the air recirculation mode, if the carbon monoxide (CO) or nitric oxide (NO<sub>x</sub>) of the outside air increases beyond a predetermined level.

When pressing button P or S, the filter is also switched off.

**Notes:**

The automatic air recirculation does not function when selecting the Economy mode S, or the outside temperature is below 45°F (7°C).

The activated charcoal filter should be switched off when windows fog up on the inside, or if the passenger compartment needs to be quickly heated or cooled down.

**Residual engine heat utilization**

With the engine switched off, it is possible to continue heating the interior for a short while.

Air volume and distribution are controlled automatically.

To select:

Turn electronic key in steering lock to position 1 or 0 or remove electronic key. Close air outlet in rear passenger compartment.

Press T button.

This function selection will not activate if the battery charge level is insufficient.

To cancel:

Press T button.

The system will automatically shut off

- If you turn electronic key in steering lock to position 2,
- after approximately 30 minutes,
- if the battery voltage drops.

### **Front center console compartment ventilation**

The front center console compartment has its own air outlet.

To open:  
Push lever down.

To close:  
Push lever up.

The air volume is dependent on the setting of the

- air volume control
- air distribution control
- air outlets in the dashboard and rear passenger compartment.

The air temperature is about the same as that of the dashboard air outlets. It cannot be regulated separately.

Note:

The compartment can get very warm due to its confined space. When storing heat sensitive objects in the compartment, close the air outlet while heating the passenger compartment.

Also, do not obstruct the air outlet.



## Automatic climate control

134

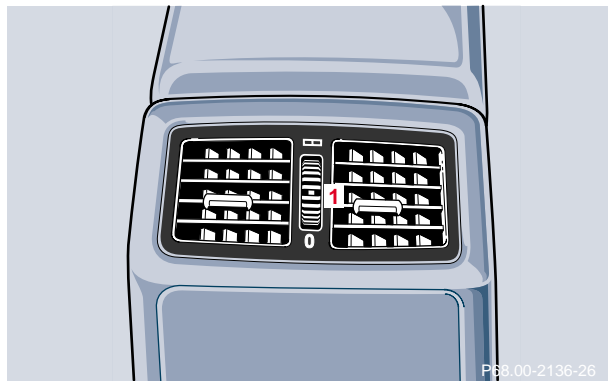
**Rear passenger compartment adjustable air outlet**

To open air outlet, rotate wheel (1) upward.

The air outlet is adjustable.

**Important**

This vehicle is equipped with an air conditioner system that uses R-134a (HFC: hydrofluorocarbon) as a refrigerant. Repairs should always be performed by a qualified technician, and refrigerant should be collected in a recovery system for recycling.

## Operation – audio and telephone

These instructions are intended to help you become acquainted with your Mercedes-Benz car radio. They contain useful tips and a detailed description of the user functions.

### Warning!

**In order to avoid distraction which could lead to an accident, system settings should be entered with the vehicle at standstill and systems should be operated by the driver only when traffic conditions permit. Always pay full attention to traffic conditions first before operating system controls while driving.**

**Bear in mind that at a speed of just 30 mph (approximately 50 km/h), your vehicle is covering a distance of approximately 50 feet (approximately 14 m) every second.**

The right to correct errors and make technical amendments is reserved.

## Operating safety

### Warning!

**Any alternations made to electronic components can cause malfunctions**

**The radio, cassette deck, CD changer<sup>1</sup> and telephone<sup>1</sup> are interconnected. Therefore, when one of the components is defective or has not been removed/replaced properly this may impair the function of other components.**

**These malfunctions might seriously impair the operating safety of your vehicle.**

**We recommend that you have any service work or alternations on electronic components done in an authorized Mercedes-Benz Center.**

### 1 Optional equipment

Dolby and the double-D symbol  are trademarks of Dolby laboratories Licensing Corporation. The Dolby noise reduction system is manufactured under licence from Dolby Laboratories Licensing Corporation.

**Operating and display elements**

**1** On/off, volume, see page 139

**2** Telephone mode selector, see page 151

**3** Seek, see page 141, 145 and 149

**4** Radio mode selector, see page 141

**5** Tune, see page 141 and 142

Fast forward/reverse, see page 145 and 149

**6** CD mode selector, see page 148

**7** Display panel, see page 143

**8** Alpha-numeric keypad for station storage and frequency entry, see page 142  
CD/Track access, see page 145 and 150  
optional telephone, see page 151

**9** Function button, see page 142 and 150

- 10 Soft keys for
  - radio band selection, see page 141
  - tone controls, see page 139
  - scan, see page 142
  - Tape eject, see page 144
  - Tape track select, see page 144
  - Dolby, see page 146
  - CD random/repeat, see page 150
- 11 Tape mode selector, see page 143

### Anti-theft system

**CODE**

If the power supply to the radio has been interrupted, "CODE" will appear on the display when it is next switched on. The radio will only work after the five-digit code has been entered using the buttons on the right-hand control panel.



The code number is shown on the Radio code card, supplied with the radio.

### Important!

Never leave the Radio code card in the vehicle. Keep it in a safe place.

## Audio system

138

**Entering the code number**

Switch on the radio. "CODE" will appear on the display. Using the buttons on the alpha-numeric keypad, enter the five digit code. Confirm by pressing the "OK" key.

If an incorrect code has been entered and confirmed, "CODE" will reappear on the display. The correct code must be entered once again.

**WAIT**

If an incorrect code is entered three times, "WAIT" will appear on the display and the radio will be locked out for about 10 minutes.

Note:

The lock out time will only count down if the radio is left switched on.

**Button and soft key operation**

In these instructions, the alpha-numeric keypad (right side of radio face) and the function buttons (left side of the radio face) are referred to as "buttons" and the four keys under the display are referred to as "soft keys".

Note:

Do not press directly on the radio display face.

## Operation

### Switching on and off

Press the control knob .

The radio is switched off when the ignition key is turned to position 0 or removed from the ignition. The radio is switched on again when the ignition key is turned to position 1 or 2.

Note:

The radio can also be switched on even if the ignition key is not inserted, but will switch itself off automatically after one hour to conserve vehicle battery power.

### Adjusting the volume

Turn the control knob - turning the knob clockwise will increase the volume, counterclockwise will decrease the volume.

## Audio functions

The AUD key is used to select the BASS, TREBLE, FADER and BALANCE functions. Settings for bass and treble are stored separately for the cassette and CD modes. Tone level settings are identified by the vertical bars. The center (flat) setting is shown by one longer bar in the center of the display.

### Bass



Press the AUD key repeatedly until "BASS" appears in the display.

### Treble



Press the AUD key repeatedly until "TREBLE" appears in the display.

Press the "+" key to increase or the "-" key to decrease the level.

## Audio system

140

Fader <sup>1</sup>

Press the AUD key repeatedly until “FADER” appears on the display. Press the “R” key to move the sound to the rear speakers or the “F” key to

move the sound to the front speakers.

## Balance



Press the AUD key repeatedly until “BALANCE” appears in the display.

Press the “L” key to move the sound to the left speaker or the “R” key to move the sound to the right speaker.

<sup>1</sup> not available on all models

## Centering all audio functions

Push and hold down the “AUD” key. All audio functions (bass, treble, balance and fader) are set to center or flat positions, and the volume is adjusted to a pre-set level.

## Radio mode

### Selecting radio mode

Press **RADIO** button.

### Selecting the band

```
FMS ST
 95.5 MHz
AM WB AUD SC
```

Press the key located below the desired band. The band selected is shown in the top line of the display.

```
AM4
 880 kHz
FM WB AUD SC
```

Frequency ranges:	FM	87.9 - 107.9 MHz
	AM	530 - 1710 kHz
	WB	approx. 162 MHz

## Manual tuning

```
WB1
CH 1
FM AM AUD SC
```

Press either the **▲** or **▼** button. Step-by-step tuning in ascending or descending order of frequency will take place.

The first three tuning steps will take place without muting. The radio will then be muted and high-speed tuning will take place until the button is released. The following tuning intervals will be shown on the display:

FM	200 kHz
AM	10 kHz
WB	Channels 1-7

### Seek tuning

Press either the **▶** or **◀** button. The radio will tune to the next receivable station.







## Audio system

142

## Scan tuning

```
FM
 95.5 MHz
AM WB AUD SC
```

Press the SC key. Each strong receivable station on the band selected will be tuned in for 8 seconds. The first scan will tune only the stations with a

high signal strength. The second scan will tune every receivable station. By pressing either the , ,  or  buttons, or the “SC” key the scan mode can be cancelled.

## Station memory

```
FM ST
 95.5 MHz
AM WB AUD
```

Ten stations can be stored in the AM and FM bands via the alpha-numeric keypad. The “0” button corresponds to location 10. Weatherband (WB) channels 1 to 7 can be retrieved via the alpha-numeric keypad and are preset at the factory.

## Storing stations

Hold the number button down for approximately 2 seconds. The currently displayed frequency is stored on the selected station button. The storage procedure is confirmed by a short signal tone.

## Retrieving a station from memory

Press the desired station button.

## Direct frequency input (AM and FM only)

```
FM ST
--.- MHz
AM WB AUD SC
```

Select the band. Press the “ ” button and enter the desired frequency using the alpha-numeric keypad.

Frequencies outside of the frequency ranges (frequencies specified on page 141) will not be accepted. The frequency input mode is cancelled if no button is pressed within 4 seconds.

## Cassette mode

Note:

Vehicles equipped with the COMAND system do not come with a factory installed cassette mechanism. A standard 1/8" stereo phono plug for auxiliary audio input (located in glove box) is provided for connection of a portable battery operated cassette player or any other portable device which uses a headphone output. Please refer to the COMAND operating manual for information concerning the activation of the audio input.

## Playing cassettes

Press the "TAPE" button. When the eject (EJ) key is pressed, the display folds down and the cassette slot becomes visible. Push the cassette into the slot until it engages. The cassette will be pulled in automatically.

Notes:

Do not press directly on the radio display face.

Return the display panel to its normal position by folding it back up and pressing gently on the display frame to lock in place.

When playing mono recorded tapes (e.g. books) through a stereo system the sound from one track might bleed to the other track, despite setting the balance to the full left or full right speakers.

## Audio system

144

**Important!**

If the display is in the down position for more than 20 seconds, 2 successive beeps will be heard. This will continue at 5 second intervals until the display is returned to its normal position.

```
TAPE NR  
SIDE 1  
TRK EJ AUD SC
```

The radio will switch to cassette mode. Track 1 will be played and “SIDE 1” displayed. Track 1 is the side of the cassette which is facing

upwards. The cassette deck will automatically detect the type of tape and switch the equalization automatically. A cassette symbol in the display indicates that a tape is in the mechanism. This symbol appears in all modes but not in cassette mode.

The cassette will not be ejected when the radio is switched off or another mode is selected.

```
NR  
NO TAPE  
EJ
```

If a cassette is in the mechanism, cassette mode can be selected by using the “TAPE” button. If no cassette has been inserted, the display will show “NO TAPE”.

**Cassette eject**

Press the eject (EJ) key. The display will fold down and the cassette will be ejected. Remove the cassette, then fold the display back up manually. The radio will switch back to radio mode automatically.

Note:

The cassette will not be ejected when the radio is switched off.

**Important!**

If the display is in the down position for more than 20 seconds, 2 successive beeps will be heard. This will continue at 5 second intervals until the display is returned to its normal position.

**Track selection**

```
TAPE NR  
SIDE 1  
TRK EJ AUD SC
```

Press the track selection (TRK) key. The current track will be displayed as “SIDE 1” or “SIDE 2”. The track will be changed automatically at the end of the tape.

## Track search forwards/backwards

TAPE NR  
SEEK FWD  
TRK EJ AUD SC

Press the  button.  
“SEEK FWD” will be shown on the display and the track search will run the tape forwards to the start of the next track.

TAPE NR  
SEEK RWD  
TRK EJ AUD SC

Press the  button.  
“SEEK RWD” will be shown on the display and the track search will run the tape backwards to the start of the

track currently playing. Track search can be interrupted by pressing the same button again.

Note:

The beginning of a track can only be located if there is a break of at least 4 seconds between tracks.

## Fast forward/reverse

TAPE NR  
FORWARD  
TRK EJ AUD SC

Press the  button.  
“FORWARD” will appear on the display and fast forward will start.

TAPE NR  
REWIND  
TRK EJ AUD SC

Press the  button.  
“REWIND” will appear on the display and fast reverse will start.

Fast forward/reverse is stopped by pressing the same button again, or it will stop automatically at the beginning or the end of the tape. The track will automatically change at the end or beginning of the tape and play will begin.

## Audio system

146





## Scanning

```
TAPE NR  
SCAN FWD  
TRK EJ AUD SC
```

Press the “SC” key. Each track on the cassette will be played for 8 seconds in ascending order.

Note:

The beginning of a track can only be located if there is a break of at least 4 seconds between tracks.

Scan will be interrupted if the , , ,  buttons or the “SC” key is pressed.

Dolby NR <sup>1</sup> (noise reduction system)

```
TAPE BASS  
.....|.....  
<- NR AUD +>
```

To enable optimum reproduction of cassettes recorded using the Dolby B system, press the “AUD” key followed by the NR key so the “NR” in the display is not highlighted. To turn off Dolby B noise reduction, press the “NR” key so the “NR” in the display is highlighted.

<sup>1</sup> Dolby and the double-D symbol  are trademarks of Dolby Laboratories Licensing Corporation. The Dolby noise reduction system is manufactured under licence from Dolby Laboratories Licensing Corporation.

## CD mode

### General notes on CD mode

Should excessive temperatures occur while in CD mode, “TEMP HIGH” will appear in the display and muting will take place. The unit will then switch back to radio mode until the temperature has decreased to a safe operating level.

Should temperatures occur while in CD mode which are too low, “TEMP LOW” will be displayed, but the CD will play. It will be sensitive to skipping if you are driving over rough roads.

Handle CDs carefully to prevent interference during playback.

Avoid fingerprints and dust on CDs. Do not write on the CDs or apply any label to the CDs.

Clean CDs from time to time with a commercially available cleaning cloth. No solvents, anti-static sprays, etc. should be used.

Replace the CD in its container after use. Protect CDs from heat and direct sunlight.



Only use CDs, which bear the label shown and that conform to the compact disc digital audio standard (IEC 60908).

Use of CDs which do not meet this standard may cause damage to the CD changer. Do not play single-CDs (80 mm) with an adapter.

### Warning!

**The CD changer <sup>1</sup> is a Class 1 laser product. There is a danger of invisible laser radiation if the cover is opened or damaged.**

**Do not remove the cover. The CD changer <sup>1</sup> does not contain any parts which can be serviced by the user. For safety reasons, have any service work which may be necessary performed only by qualified personnel.**

1 Optional equipment

## Audio system

148

## CD changer installed (optional)

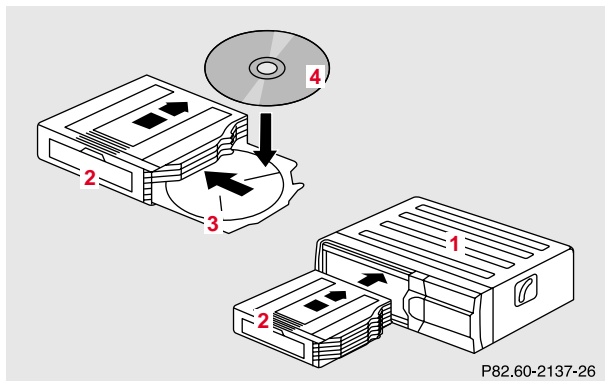

- 1 CD changer <sup>1</sup>
- 2 CD magazine
- 3 CD tray
- 4 CD

If a CD changer <sup>1</sup> is installed, it can be operated from the front control panel of the radio. A loaded magazine must be installed for CD playing.

1 Optional equipment

## Loading/emptying the CD magazine

Slide the changer door to the right and press the eject button . The magazine will be ejected. Remove the magazine. Pull out the CD tray until its stop is reached and place the CDs in the recess of the tray, label side up. Push the tray into the magazine in the direction shown by the arrow. Insert the loaded magazine into the changer.

## Important!

Close the door after the magazine has been inserted.

## Playing CDs

Press the CD button. The CD most recently played will start at the point where it was last switched off. CDs stored in the magazine can be selected by using the station preset buttons 1-6.

CD1  
TRACK 1  
RDM RPT AUD SC

The magazine slot number of the selected CD will then be displayed after “CD”. The number of the track being played will be displayed after “TRACK”.

CD1  
NO CD3  
RDM RPT AUD SC

If there is no CD in the selected magazine slot, “NO CD” and the corresponding slot number will be displayed

(e.g. “NO CD3”). After the last track on a CD has been played, the next CD will automatically be selected and played.

### Skipping tracks forwards/backwards

Press the  button. The next track on the CD will be played.

Press the  button. If the track has been playing for more than 10 seconds, it will revert to the start of that track. If it has been playing for less than ten seconds it will revert to the preceding track. To skip several tracks, the respective button must be pressed until the desired track is reached. If the beginning or end of the CD is reached during the search, the first or last track will be played.

### Fast forward/reverse





Press the  button and hold it down for audible fast forward.

Press the  button and hold it down for audible reverse.

CD1  
02:46  
RDM RPT AUD SC

The search will stop when the button is released. The relative time of the track will be displayed during the search. The search mode will cancel if the beginning or end of the CD is reached.

### Scanning

Press the SC key. Each track will be played for 8 seconds in ascending order. The search will stop at the track in question if the , , ,  buttons or the “SC” key is pressed.



## Audio system

150

**Random play/repeat function**

The tracks of the current CD are played in random order when the random feature (RDM) is selected. Press the RDM key to switch on, and press RDM again to switch off.

```
CD1  
TRACK 10  
RDM RPT AUD SC
```

When the repeat function (RPT) has been selected, a particular track can be played for as many times as desired.

Press the RPT key to switch on, and press RPT again to switch off.

Note:

Both functions cannot be used simultaneously.

**Direct track selection**

Tracks can be selected directly using the buttons on the alpha-numeric keypad. Press the " " function button, followed by the track number.

## Telephone operation

Various functions of the Mercedes-Benz integrated cellular telephone <sup>1</sup> can be performed and displayed via the car radio. Further instructions for operating the car telephone can be found in the operation guide for the cellular telephone <sup>1</sup>.

### Switching the telephone on and off

```
FM5 ST TEL  
95.5 MHz  
FM WB AUD SC
```

Switching on: Press the **TEL** button, “TEL” appears in the corner of the display.

Switching off: Press and hold the **TEL** button until the telephone symbol “TEL” no longer appears in the display, or press the “PWR” button on the phone’s keypad.

<sup>1</sup> Optional equipment

### Entering telephone number and starting dialing process

```
S.. ROAM  
READY  
SND END
```

Enter the desired telephone number using the alphanumeric keypad. The number can have up to 32 digits, but only 13 of these can be

displayed. The dialing process is started by pressing the SND button. The entered number can be corrected using the “CLR” key.

```
S.. ROAM  
5551212  
SND CLR END
```

Press the CLR key briefly - and the last digit will be deleted.

Press the CLR key longer - and the complete number will be deleted.

### Calling up the phone book

The numbers stored in the telephone memory can be called up via either name or number entries. The memory contents from the portable phone must be downloaded and the telephone menu must be selected in order to call up the phone book. Refer to the “Memory download” section of the cellular telephone operation guide for more information.

## Audio system





152

**Switching between name search and number search**





Press ABC key - Name search

Press NUM key - Number search

**Searching and selecting phone book entries by name**

Press the ABC key. The current name is shown on the display. The stored entries in alphabetical order can be selected using the  or  button. By pressing the  or  buttons, the stored entries can be selected according to alphabetical initial letters (e.g. A-Adam, B-Brown, M-Miller).

**Searching and selecting phone book entries by number**





Press the NUM key. The current number is shown on the display. The stored entries can be selected in numerical order using the  or  button. By pressing the  or  buttons, the stored entries can be selected in increments of 5 (e.g. Entry no. 2, Entry no. 7, etc.).

**Placing a call**

```
S.. ROAM  
5551212  
SND CLR END
```

When a number or a name has been selected using the method described above, press the SND key.

**Manual repeat dialing (redial)**

The last number entered can be re-selected by pressing the SND key once and the call can be placed by pressing the SND key a second time. The last dialed telephone number is shown on the display. Using the , ,  or  button, the numbers stored in the re-dial memory of the telephone can be selected.

```
S.. ROAM L2  
5551212  
SND CLR END
```

The abbreviation L and the number in the memory are shown in the top line of the display.

### Accepting incoming call in telephone mode

With an incoming call, the ringing tone will be heard and the message “CALL” appears in the display. Press the SND key to answer the call.

### Accepting incoming call in tape, CD or radio mode

If the telephone is activated in the background (telephone symbol in the display), then a switch is made automatically to telephone when an incoming call is received. The audio source is muted, the ringing tone is heard and the message “CALL” appears. After the call has been terminated, the previously selected audio source is resumed.

### Terminating call

A current call can be terminated by pressing the END key.

### Component malfunctions

The radio, CD changer <sup>1</sup>, and Mercedes-Benz integrated cellular telephone <sup>1</sup> are part of a fiberoptic networked system. Failure of one of the components can lead to malfunctions of the other components. Please contact your authorized Mercedes-Benz Center or call 1-800-FOR-MERCEdes for more information in the event of a malfunction.

1 Optional equipment

## Interior equipment

154

## Power windows

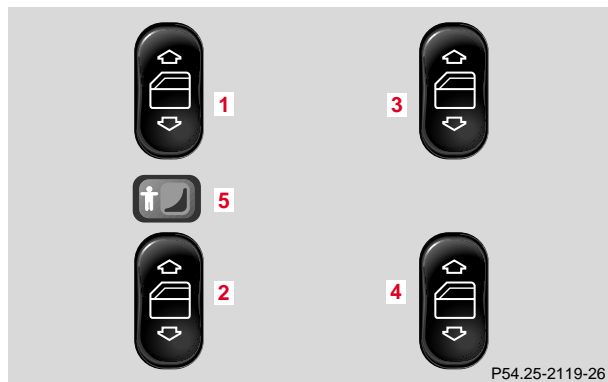

Power window switches located on center console

Switches for:

- 1** left, front
- 2** left, rear
- 3** right, front
- 4** right, rear
- 5** Switch for rear door window override

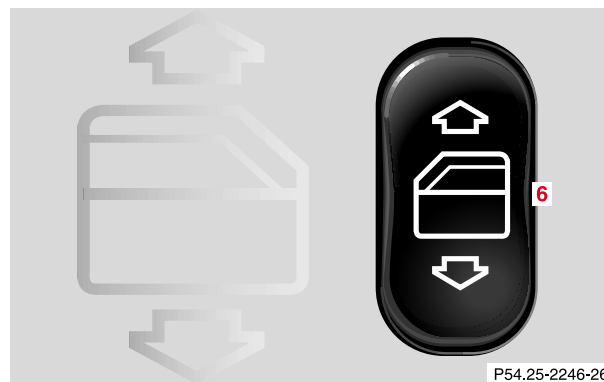

Power window switches located in rear doors

- 6** Individual switches (rear doors)

Turn electronic key in steering lock to position 1 or 2.

Press switch in to resistance point:

↳ to open

┘ to close

Release switch when window is in desired position.

## Express opening and closing

Press switch **K** or **j** past resistance point and release – window opens or closes completely.

To interrupt procedure, briefly press **K** or **j**.

If the upward movement of the window is blocked during the closing procedure, the window will stop during the last few inches before closure and open slightly.

When pressing and holding the switch **j** to close the window, and upward movement of the window is blocked during the last few inches before closure, it will stop but not open slightly.

### Warning!

**When leaving the vehicle, always remove the electronic key from the steering lock, and lock the vehicle. Do not leave children unattended in the vehicle, or with access to an unlocked vehicle. Unsupervised use of vehicle equipment can cause serious personal injury.**

## Blocking of rear door window operation

If no operation of the rear windows by switch (6), (for instance by children) is desired, slide override switch (5) to right, symbol **N** becomes visible, see page 154.

### Warning!

**When closing the windows, be sure that there is no danger of anyone being harmed by the closing procedure.**

**In case of obstruction, the automatic reversal will not operate if a window is being closed by pressing the switch to its resistance point and holding it there, or when using the remote control.**

**The closing procedure can be immediately reversed by either pressing the switch **K**, or pressing button **CE** on the remote control, and holding it.**

Note:

The power windows can also be opened and closed using the summer opening/convenience feature, see page 31.

## Interior equipment

156

**Synchronizing power windows**

If the power supply was interrupted (battery disconnected or low), the windows cannot be opened or closed by the Express feature.

To resynchronize the express feature, press j side of power window switch to resistance point until the window is completely closed and hold for additional 2 seconds. Repeat procedure for each window.

The automatic full opening and closing procedure of the windows should now be restored.

## Sliding/pop-up roof (optional for USA)

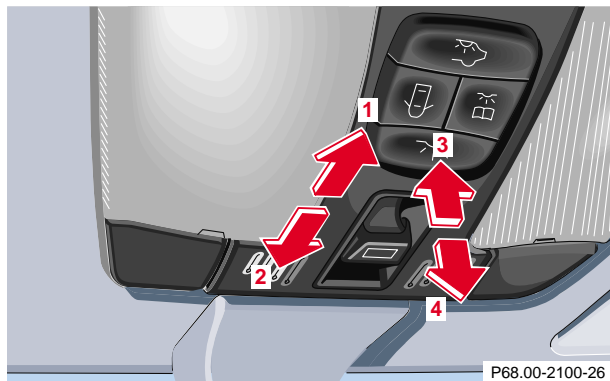

- 1 to slide roof open
- 2 to slide roof closed
- 3 to raise roof at rear
- 4 to lower roof at rear

Turn electronic key in steering lock to position 1 or 2, see page 190.

To open, close, raise or lower the sliding/pop-up roof: Move switch to resistance point in the required direction.

Release the switch when the roof has reached the required position.

The switch is illuminated when the exterior lamps are switched on (except standing lamps).

### Warning!

When closing the sliding/pop-up roof, be sure that there is no danger of anyone being harmed by the closing procedure.

The closing procedure can be immediately reversed by either moving the switch in direction (1) or (3), or pressing button  $\square$  on the remote control, and holding it.

When leaving the vehicle, always remove the electronic key from steering lock, and lock your vehicle. Do not leave children unattended in the vehicle, or with access to an unlocked vehicle. Unsupervised use of vehicle equipment can cause serious personal injury.



## Interior equipment

158

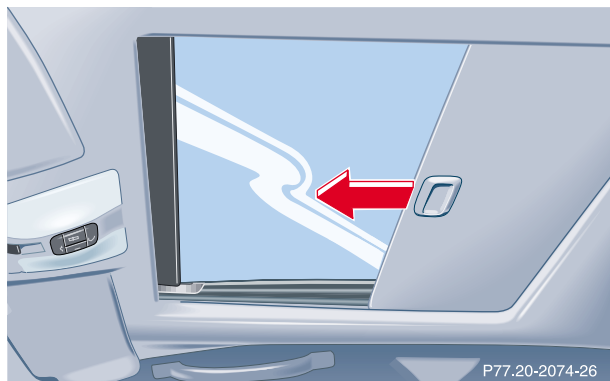

With the roof closed or tilted open, a screen can be slid into the roof opening to guard against sun rays. When sliding the roof open, the screen will also retract.

**Express opening of sliding/pop-up roof**

Move switch past resistance point and release – the sliding/pop-up roof slides open automatically.

To interrupt procedure, briefly move switch in any direction.

**Synchronizing sliding/pop-up roof**

If the power supply was interrupted (battery disconnected or low), or if the sliding/pop-up roof is blocked during closing/opening procedure, the system has to be synchronized.

To do so, turn electronic key in steering lock to position 2, move and hold switch in direction (3), until the sliding/pop-up roof is completely raised at rear, and hold for additional 1 second.

**Notes:**

The sliding/pop-up roof can be opened or closed manually should an electrical malfunction occur, see page 298.

The sliding/pop-up roof can also be opened and closed using the summer opening/convenience future, see page 31.

## Interior lighting



### 1 Automatic interior lighting

Press once and the automatic interior lighting is activated.

Interior lamps are switched on, and off (soft fade) delayed, when unlocking or locking the vehicle, or when opening or closing a door. However, there will be no (soft fade) delay when the electronic key is in steering lock position 2.

Press again and interior lamps remain switched off, even when centrally unlocking or opening a door.

- 2 Press to switch interior and reading lamps on or off.
- 3 Press to switch rear passenger compartment lamp (including reading lamps) on or off.
- 4 Press to switch reading lamp on or off.

Notes:

To prevent the vehicle battery from being discharged, with reading lamps switched on manually and electronic key in steering lock position 0 or removed, the reading lamps go out after approximately 30 minutes.

### Entrance lamps, exit lamps in doors

The lamps are switched on and off by the door contact switches.

Notes:

To prevent the vehicle battery from being discharged, with doors open all interior lamps go out after approximately 5 minutes.

## Interior equipment

160

## Reading lamps rear compartment (optional)

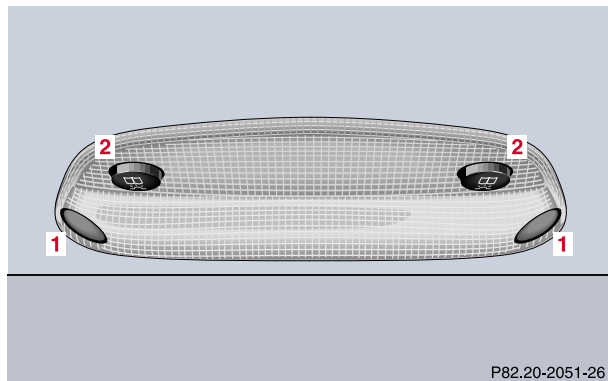

**1** Reading lamp

**2** Press to switch reading lamp on or off.

The lamp is located above the rear center seat.

## Notes:

If you turn the electronic key in steering lock position 0, the reading lamps go out after approximately 30 minutes.

## Rear window sunshade (optional)



**1** Hold to raise

**2** Hold to lower

The switch is located on center console.

Turn electronic key in steering lock to position 1 or 2.

The sunshade should always be either fully raised or fully lowered.

## Sun visors

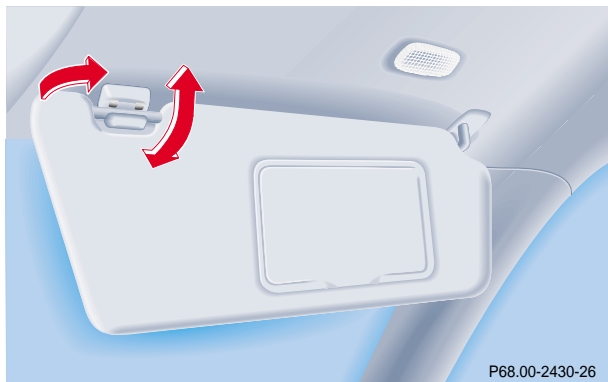

Swing sun visors down to protect against sun glare.

If sunlight enters through a side window, disengage visor from inner mounting, pivot to the side and slide it to the desired position.

## Illuminated vanity mirrors

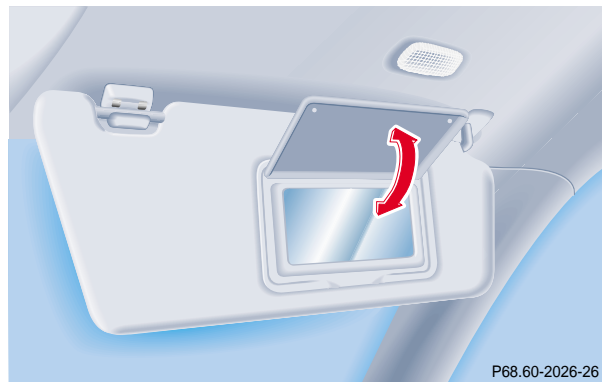

With the visor engaged in its inner mounting, the lamp is switched on by opening the cover.

### **Warning!**

**Do not use the vanity mirror while driving.**

The lamp goes out automatically after approximately 5 minutes.

## Interior equipment

162

**Interior****Warning**

To help avoid personal injury during a collision or sudden maneuver, exercise care when stowing things. Put luggage or cargo in the trunk if possible. Do not pile luggage or cargo higher than the seat backs. Do not place anything on the shelf below the rear window.

Luggage nets cannot secure hard or heavy objects.

**Armrest, rear bench**

Pull down the armrest by its strap.

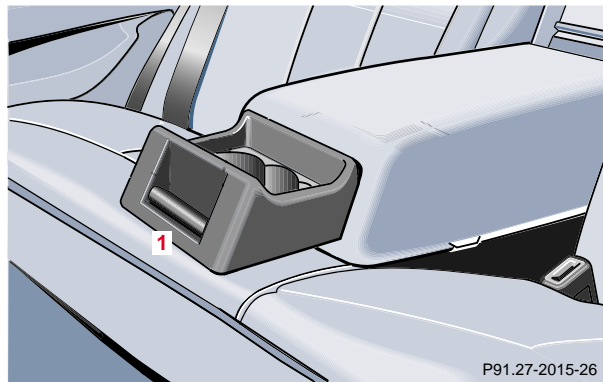
**Cup holder in rear bench armrest**

Press button (1) and pull out drawer to its detent.

**Caution!**

Keep cup holder closed while traveling. Place only containers that fit into the cup holder to prevent spills.

Do not fill containers to a height where the contents could spill during vehicle maneuvers, especially hot liquids.

## Glove box

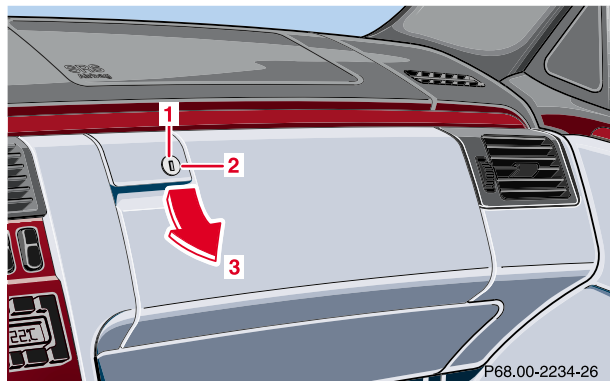

- 1** Unlocking: Turn mechanical key to vertical position and remove.
- 2** Locking: Turn mechanical key to the right and remove.
- 3** Opening: Pull on handle.

The glove box can be locked and unlocked with the mechanical key. See page 25 for instructions on how to remove the mechanical key from the electronic key (e.g. for valet parking service).

## Cup holder and coin holder in glove box lid

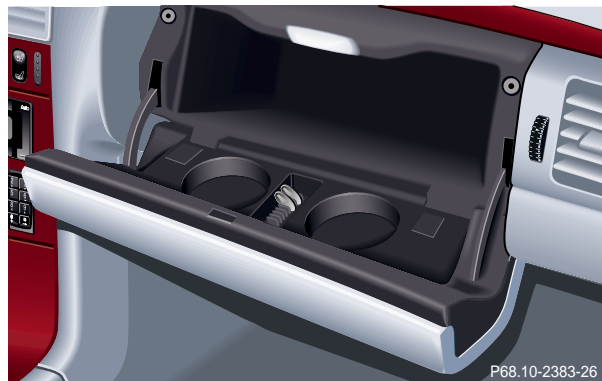

### Caution!

Keep glove box lid closed while traveling. Place only containers that fit into the cup holder to prevent spills.

## Interior equipment

164

**Storage compartment above ashtray  
in center console**

To open:  
Touch bottom of cover slightly. The cover opens automatically.

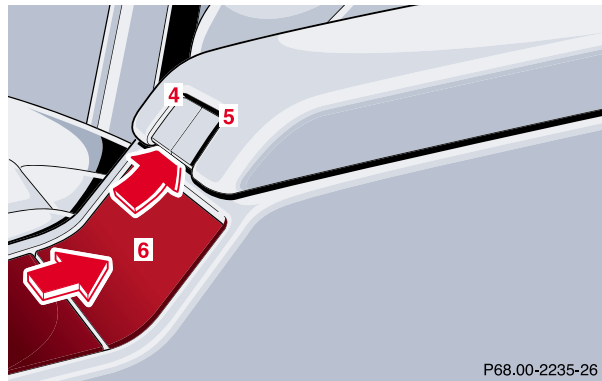
**Storage compartments in center console**

To open compartment in armrest:  
Lift lid with handle (4).

To open compartment under armrest:  
Lift lid with handle (5).

To close:  
Lower lid until it engages in lock.

## Cup holder in center console

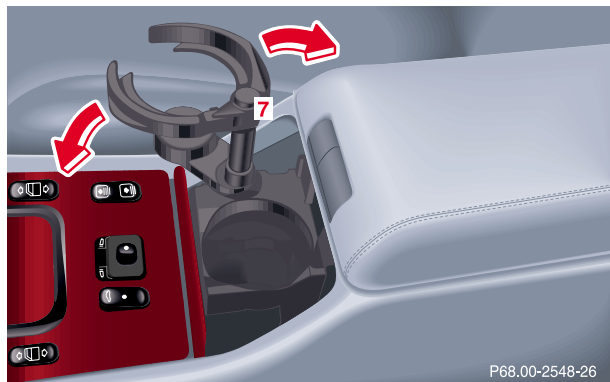

To open cover:  
Touch top of cover (6) slightly. The cover opens automatically.

To open cup holder:  
Briefly press button (7). The cup holder opens automatically.

To store cup holder:  
Push button (7) down until cup holder engages. Close cover (6).

Note:

The right claw is adjustable to accommodate most container sizes.

An additional second (smaller size) container can be placed in the cup holder.

Spilling liquids (e.g. soda or coffee) could restrict the movement of the claw. Refer to page 308 for cleaning the cup holder.

### Caution!

Keep cup holder closed while traveling. Place only containers that fit into the cup holder to prevent spills.

Do not fill containers to a height where the contents could spill during vehicle maneuvers, especially hot liquids.

### Warning!

**Keep compartment lids closed. This will help to prevent stored objects from being thrown about and injuring vehicle occupants during an accident and sudden maneuver**



## Interior equipment

166

## Ashtrays

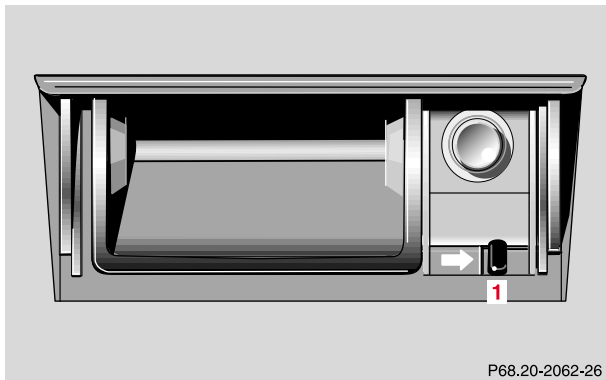

## Center console, front

By touching the bottom of the cover lightly, the ashtray opens automatically.

Prior to removing the ashtray insert, move the gear selector lever to position “N”.

**Warning!**

**Remove front ashtray only with vehicle standing still. With the gear selector lever in position “N”, turn off the engine and set the parking brake. Otherwise the vehicle might move as a result of unintended contact with the gear selector lever.**

To remove ashtray:

Push sliding knob (1) toward the right to eject the insert.

To install ashtray:

Install insert into ashtray frame and push down to engage.

## Rear doors

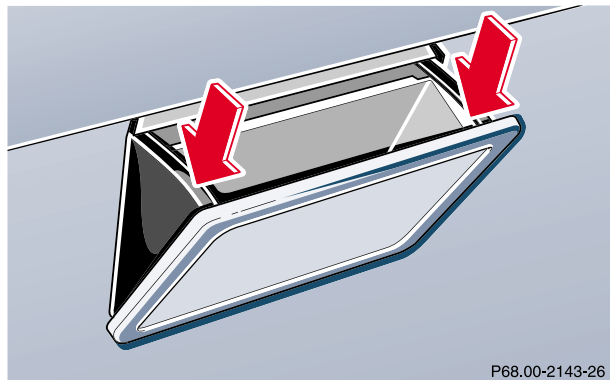

To remove ashtray:  
Push left and right sides down and pull out the ashtray.

To install ashtray:  
Install top of ashtray, push bottom part in to engage.

## Interior equipment

168

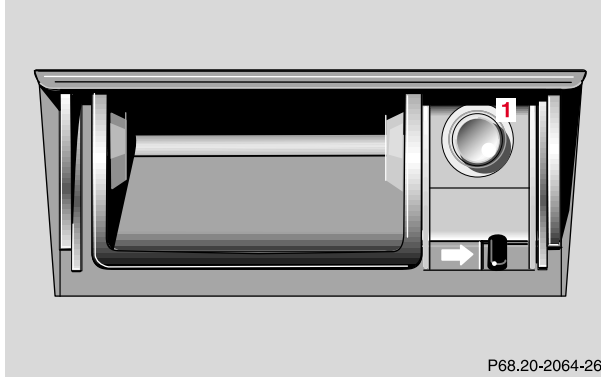
**Lighter**

Turn electronic key in steering lock to position 1 or 2.  
Push in lighter (1); it will pop out automatically when hot.

**Warning!**

**Never touch the heating element or sides of the lighter, they are extremely hot, hold at knob only.**

**When leaving the vehicle always remove the electronic key from the steering lock. Do not leave children unattended in the vehicle, or with access to an unlocked vehicle. Unsupervised use of vehicle equipment may cause serious personal injury.**

The lighter socket can be used to accommodate electrical accessories up to maximum 85 W.

## Cargo tie-down hooks

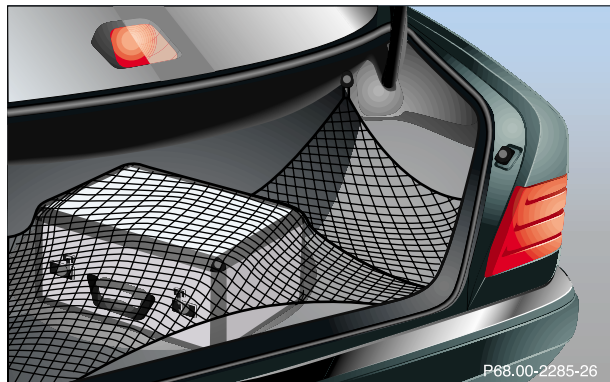

Inside the trunk are six cargo tie-down hooks. Secure cargo by applying even load on the hooks using the cargo net.

## Parcel net in front passenger footwell

A small convenience parcel net is located in the front passenger footwell. It is for small and light items, such as road maps, mail, etc.

### Warning!

**Do not place heavy or fragile objects, or objects having sharp edges, in the parcel net.**

**In an accident, during hard braking or sudden maneuvers, they could be thrown around inside the vehicle, and cause injury to vehicle occupants.**

## Interior equipment

170

**Cellular telephone**

The vehicle is prepared for the installation of a cellular telephone. For further information and installation contact your authorized Mercedes-Benz Center.

**Warning!**

**Some jurisdictions prohibit the driver from using a cellular telephone while driving a vehicle. Whether or not prohibited by law, for safety reasons, the driver should not use the cellular telephone while the vehicle is in motion. Stop the vehicle in a safe location before answering or placing a call.**

**Shelf below rear window****Warning!**

**The shelf below the rear window should not be used to carry objects. This will avoid such objects from being thrown about and injuring vehicle occupants during an accident or sudden maneuver.**

**The trunk is the preferred place to carry objects.**

## Garage door opener

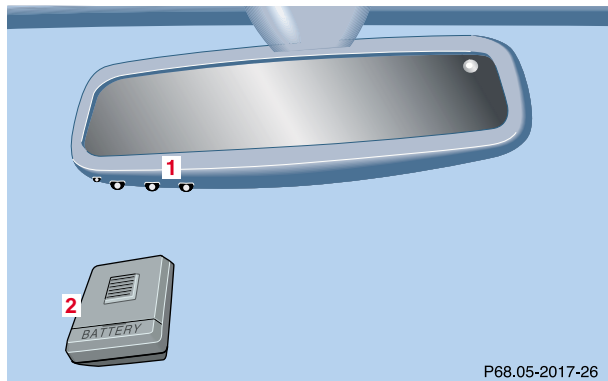

- 1 Integrated remote control transmitter
- 2 Portable remote control transmitter

### Warning!

When programming a garage door opener, the door moves up or down.

When programming or operating the remote control make sure there is no possibility of anyone being harmed by the moving door.

The built-in remote control is capable of operating up to three separately controlled objects.

### Note:

Certain types of garage door openers are incompatible with the integrated opener. If you should experience difficulties with programming the transmitter, contact your authorized Mercedes-Benz Center, or call Mercedes-Benz Customer Assistance Center (in the USA only) at 1-800-FOR-MERCEdes, or Customer Service (in Canada) at 1-800-387-0100.

For operation in the USA only: This device complies with Part 15 of the FCC Rules. Operation is subject to the following two conditions:

- (1) This device may not cause harmful interference, and
- (2) this device must accept any interference received, including interference that may cause undesired operation.

Any unauthorized modification to this device could void to the user's authority to operate the equipment.

## Garage door opener

172

**Programming or reprogramming the integrated remote control:**

1. Turn electronic key in steering lock to position 1 or 2.
2. Hold the end of the hand-held transmitter of the device you wish to train approximately 2 to 5 inches (5 cm to 12 cm) away from the surface of the integrated remote control located on the inside rear view mirror, keeping the indicator lamp in view.
3. Using both hands, simultaneously push the hand-held transmitter button and the desired integrated remote control button. Do not release the buttons until completing step 4.
4. The indicator lamp on the integrated remote control will flash, first slowly and then rapidly. When the indicator lamp flashes rapidly, both buttons may be released (the rapid flashing lamp indicates successful programming of the new frequency signal). To program the remaining two buttons, follow steps 1 through 4.

## Note:

If, after repeated attempts, you do not successfully program the integrated remote control device to learn the signal of the hand-held transmitter, the garage door opener could be equipped with the “rolling code feature”.

### Rolling code programming:

To train a garage door opener (or other rolling code devices) with the rolling code feature, follow these instructions after completing the “Programming” portion of this text. (A second person may make the following training procedures quicker and easier.)

1. Locate training button on the garage door opener motor head unit. Exact location and color of the button may vary by garage door opener brand. If there is difficulty locating the transmitting button, reference to garage door opener operator’s manual.
2. Press “training” button on the garage door opener motor head unit (which activated the “training light”).

Note:

Following step 2, there are 30 seconds to initiate step 3.

3. Firmly press and release the programmed integrated remote control transmit button. Press and release same button a second time to complete the training process. (Some garage door openers may require you to do this procedure a third time to complete the training.)
4. Confirm the garage door operation by pressing the programmed button on the integrated remote control transmitter.

### Canadian programming:

During programming, your hand-held transmitter may automatically stop transmitting. Continue to press and hold the integrated remote control transmitter button (note steps 2 through 4 in the “Programming” portion) while you press and re-press (“cycle”) your hand-held transmitter every two seconds until the frequency signal has been learned. The indicator lamp will flash slowly and then rapidly after several seconds upon successful training.



## Garage door opener

174

**Operation of remote control:**

1. Turn electronic key in steering lock to position 1 or 2.
2. Select and press the appropriate button to activate the remote controlled device. The integrated remote control transmitter continues to send the signal as long as the button is pressed – up to 20 seconds.

**Erasing the remote control memory:**

1. Turn electronic key in steering lock to position 1 or 2.
2. Simultaneously holding down the left and right side buttons for approximately 20 seconds, or until the control lamp blinks rapidly, will erase the codes of all three channels.

## Driving

Control and operation of radio transmitters .....	176
The first 1 000 miles (1 500 km) .....	177
Maintenance .....	177
Tele Aid .....	178
Catalytic converter .....	188
Emission control .....	189
Steering lock .....	190
Starting and turning off the engine .....	192
Automatic transmission .....	193
Parking brake .....	202

Driving instructions .....	203	Cruise control .....	212
Drive sensibly - Save Fuel .....	203	Brake assist system (BAS) .....	215
Drinking and driving .....	203	Antilock brake system (ABS) .....	217
Pedals .....	203	Four Wheel Electronic Traction System (4MATIC) .....	219
Power assistance .....	204	Electronic stability program (ESP) .....	220
Brakes .....	204	Parking assist (Parktronic) .....	224
Driving off .....	205	What you should know at the gas station .....	229
Parking .....	206	Check regularly and before a long trip .....	231
Tires .....	206		
Snow chains .....	209		
Winter driving instructions .....	209		
Block heater .....	211		
Deep water .....	211		
Passenger compartment .....	211		
Traveling abroad .....	211		

**Control and operation of radio transmitters**

## COMAND, radio and telephone

**Warning!**

Please do not forget that your primary responsibility is to drive the vehicle. Only operate the COMAND (Cockpit Management and Data System), radio or telephone<sup>1</sup> if road and traffic conditions permit.

Bear in mind that at a speed of just 30 mph (approximately 50 km/h), your vehicle is covering a distance of approximately 50 feet (approximately 14 m) every second.

<sup>1</sup> Observe all legal requirements.

## Telephones and two-way radio

**Warning!**

Never operate radio transmitters equipped with a built-in or attached antenna (i.e. without being connected to an external antenna) from inside the vehicle while the engine is running. Doing so could lead to a malfunction of the vehicle's electronic system, possibly resulting in an accident and personal injury.

Radio transmitters, such as a portable telephone or a citizens band unit should only be used inside the vehicle if they are connected to an antenna that is installed on the outside of the vehicle.

Refer to the radio transmitter operation instructions regarding use of an external antenna.

### **The first 1 000 miles (1 500 km)**

The more cautiously you treat your vehicle during the break-in period, the more satisfied you will be with its performance later on. Therefore, drive your vehicle during the first 1 000 miles (1 500 km) at moderate vehicle and engine speeds.

During this period, avoid heavy loads (full throttle driving) and excessive engine speeds.

Avoid accelerating by kickdown. It is not recommended to brake the vehicle by manually shifting to a lower gear. We recommend that you select positions “3”, “2” or “1” only at moderate speeds (for hill driving).

After 1 000 miles (1 500 km) speeds may be gradually increased to the permissible maximum.

### **Maintenance**

We strongly recommend that you have your vehicle serviced by your authorized Mercedes-Benz Center, in accordance with the Service Booklet at the times called for by the FSS.

Failure to have the vehicle maintained in accordance with the Service Booklet at the designated times/mileage may result in vehicle damage not covered by the Mercedes-Benz Limited Warranty.

For information on the Flexible service system (FSS), see page 114.

**Tele Aid (optional for Canada)****Important!**



The initial activation of the Tele Aid system may only be performed by completing the subscriber agreement and placing an acquaintance call using the “SOS” button. Failure to complete either of these steps will result in a system that is not activated. If the system is not activated the indicator lamp in the “SOS” button stays on after turning electronic key in steering lock to position 2 and the message “TELE AID – NOT ACTIVATED” will be shown in the multifunction display for approx. 10 seconds.



If you have any questions regarding activation, please call the Response Center at 1-800-756-9018 (in the USA) or 1-888-923-8367 (in Canada).

**(Telematic Alarm Identification on Demand)**

The Tele Aid system consists of three types of response; automatic and manual emergency, roadside assistance and information.

The Tele Aid system is operational providing that the vehicle’s battery is charged, properly connected, not damaged and cellular and GPS coverage is available.



The speaker volume of a Tele Aid call can be adjusted when using the volume control on the multifunction steering wheel, for raising press button  and for lowering press button .

To activate, press the “SOS” button, the Roadside Assistance button  or the Information button , depending on the type of response required.

Shortly after the completion of your Acquaintance Call, you will receive a user ID and password via first call mail. By visiting [www.mbusa.com](http://www.mbusa.com) and selecting “Tele Aid” (USA only), you will have access to account information, remote door unlock, Info Services’ profile and more.

\* Optional – available only with COMAND

**System self-check**

Initially, after turning the electronic key in steering lock to position 2, malfunctions are detected and indicated (the indicator lamps in the “SOS” button, the Roadside Assistance button  and the Information button  stay on longer than 10 seconds or do not come on). The message “TELE AID – VISIT WORKSHOP” appears for approx. 10 seconds in the multifunction display.

## Important!

Always make sure that the indicator lamps in the “SOS” button, in the “Roadside Assistance” button and in the “Information” button do not remain illuminated constantly in red and the message “TELE AID – VISIT WORKSHOP” is not displayed in the multifunction display after the system self check.

If a malfunction is indicated as outlined above, have the system checked at the nearest Mercedes-Benz Center as soon as possible.

## Emergency calls

An emergency call is initiated automatically:

- following an accident in which the Emergency Tensioning Retractors (ETR’s) or airbags deploy,
- if the antitheft alarm or the tow away alarm stays on for more than 20 seconds, see pages 43 and 44.

An emergency call can also be initiated manually by opening the cover next to the inside rear view mirror labeled “SOS”, then briefly pressing the button located under the cover. See below for instructions on initiating an emergency call manually.

Once the emergency call is in progress, the indicator lamp in the “SOS” button will begin to flash. The message “EMERGENCY CALL – CONNECTING CALL” appears in the multifunction display. When the connection is established, the message “EMERGENCY CALL – CALL CONNECTED” appears in the multifunction display. All information relevant to the emergency, such as the location of the vehicle (determined by the GPS satellite location system), vehicle model, identification number and color are generated.

A voice connection between the Response Center and the occupants of the vehicle will be established automatically soon after the emergency call has been initiated. When a voice connection is established the audio system mutes and the message “TELE AID – EMERGENCY CALL ACTIVE” appears in the multifunction display. The Response Center will attempt to determine more precisely the nature of the accident provided they can speak to an occupant of the vehicle.

## Tele Aid

180

The Tele Aid system is available if:

- it has been activated and is operational. Activation requires a subscription for monitoring services and cellular air time
- the relevant cellular phone network and GPS signals are available and pass the information on to the response center.

Note:

Location of the vehicle on a map is possible if the vehicle is able to receive signals from the GPS satellite network and pass the information on to the response center.

**Warning!**

**If the indicator lamp in the “SOS” button is illuminated continuously and there was no voice connection to the Response Center established, then the Tele Aid system could not initiate an emergency call (e.g. the relevant cellular phone network is not available). The message “EMERGENCY CALL – CALL FAILED” appears in the multifunction display for approx. 10 seconds.**

**Should this occur, assistance must be summoned by other means.**

## Initiating an emergency call manually

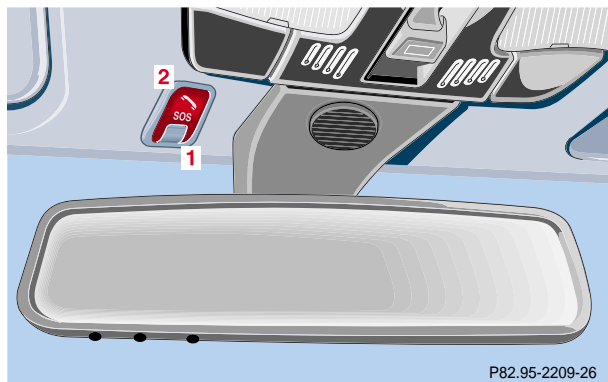

Briefly press on cover (1) – the cover will open.

Press the SOS button (2) briefly. The indicator lamp in the SOS button (2) will flash until the emergency call is concluded. Wait for a voice connection to the Response Center.

Close the cover (1) after the emergency call is concluded.

### Warning!

If you feel at any way in jeopardy when in the vehicle (e.g. smoke or fire in the vehicle, vehicle in a dangerous road location), please do not wait for voice contact after you have pressed the emergency button. Carefully leave the vehicle and move to a safe location. The Response Center will automatically contact local emergency officials with the vehicle's approximate location if they receive an automatic "SOS" signal and cannot make voice contact with the vehicle occupants.



**Roadside Assistance button •**

Located below the center armrest cover is the Roadside Assistance button • . Pressing and holding the button (for longer than 2 seconds) will initiate a call to a Mercedes-Benz Roadside Assistance dispatcher. The button will flash while the call is in progress. The message “ROADSIDE ASSISTANCE – CONNECTING CALL” will appear in the multifunction display. When the connection is established, the message “ROADSIDE ASSISTANCE – CALL CONNECTED” appears in the multifunction display. The Tele Aid system will transmit data generating the vehicle identification number, model, color and location (subject to availability of cellular and GPS signals).

A voice connection between the Roadside Assistance dispatcher and the occupants of the vehicle will be established. When a voice connection is established the audio system mutes and the message “TELE AID – ROADSIDE ASSISTANCE CALL ACTIVE” appears in the multifunction display. The nature of the need for assistance can then be described. The Mercedes-Benz Roadside assistance dispatcher will either dispatch a qualified Mercedes-Benz technician or arrange to tow your vehicle to the nearest Mercedes-Benz Center.

For services such as labor and/or towing charges may apply. Refer to the Roadside Assistance manual for more information.

These programs are only available in the USA:

- Sign and Drive services: Services such as jump start, a few gallons of fuel or the replacement of a flat tire with the vehicle spare tire are obtainable,
- Remote Vehicle Diagnostics: This function permits the Mercedes-Benz Roadside Assistance dispatcher to download malfunction codes and actual vehicle data.

Notes:

The indicator lamp in the Roadside Assistance button • remains illuminated in red for approx. 10 seconds during the system self-check after turning electronic key in steering lock to position 2 (together with the “SOS” button and the Information button j ).

See system self-check on page 178 when the indicator lamp does not light up in red or stays on longer than approximately 10 seconds.

If the indicator lamp in the Roadside Assistance button **•** is illuminated continuously and there was no voice connection to the Response Center established, then the Tele Aid system could not initiate an Roadside Assistance call (e.g. the relevant cellular phone network is not available). The message “ROADSIDE ASSISTANCE – CALL FAILED” appears in the multifunction display.

Roadside Assistance calls can be terminated using the **ì** button on the multifunction steering wheel.

### Information button **j**

Located below the center armrest cover is the Information button **j**. Pressing and holding the button (for longer than 2 seconds) will initiate a call to the Customer Assistance Center. The button will flash while the call is in progress. The message “INFO – CONNECTING CALL” will appear in the multifunction display. When the connection is established, the message “INFO – CALL CONNECTED” appears in the multifunction display. The Tele Aid system will transmit data generating the vehicle identification number, model, color and location (subject to availability of cellular and GPS signals).

A voice connection between the Customer Assistance Center representative and the occupants of the vehicle will be established. When a voice connection is established the audio system mutes and the message “TELE AID – INFO CALL ACTIVE” appears in the multifunction display. Information regarding the operation of your vehicle, the nearest Mercedes-Benz Center or Mercedes-Benz USA products and services is available to you.

For more details concerning Tele Aid, please visit [www.mbusa.com](http://www.mbusa.com) and use your ID and password, sent to you separately, to learn more (USA only).

### Notes:

The indicator lamp in the Information button **j** remains illuminated in red for approximately 10 seconds during the system self-check after turning electronic key in steering lock to position 2 (together with the “SOS” button and the Roadside Assistance button **•**).

See system self-check on page 178 when the indicator lamp does not light up in red or stays on longer than approximately 10 seconds.

## Tele Aid

## 184

If the indicator lamp in the Information button  is illuminated continuously and there was no voice connection to the Response Center established, then the Tele Aid system could not initiate an Information call (e.g. the relevant cellular phone network is not available). The message “INFO – CALL FAILED” appears in the multifunction display.

Information calls can be terminated using the  button on the multifunction steering wheel.

**Important!**

If the indicator lamps do not start flashing after pressing one of the buttons or remain illuminated (in red) at any time, the Tele Aid system has detected a fault or the service is not currently active, and may not initiate a call. Visit your Mercedes-Benz Center and have the system checked or contact the Response Center at 1-800-756-9018 (in the USA) or 1-888-923-8367 (in Canada) as soon as possible.

## Upgrade Signals

Tele Aid system processes calls using the following priority.

- Automatic emergency – First priority
- Manual emergency – Second priority
- Roadside assistance – Third priority
- Information – Fourth priority

Should a higher priority call be initiated while you are connected, an upgrade (alternating) tone will be heard, and the appropriate indicator lamp will flash. If certain information such as vehicle identification number or customer information is not available, the operator may need to retransmit. During this time you will hear a chirp and voice contact will be interrupted. Voice contact will resume once the retransmission is completed. Once a call is concluded, a chirp will be heard and the appropriate indicator lamp will stop flashing. The COMAND system operation will resume (only vehicles with COMAND).

### **Important!**

If the indicator lamp continues to flash or the system does not reset, contact the Response Center at 1-800-756-9018 (in the USA) or 1-888-923-8367 (in Canada), or Mercedes-Benz Customer Assistance at 1-800-FOR-MERCEdes (1-800-367-6372) in the USA or Customer Service at 1-800-387-0100 in Canada.

#### Notes:

The indicator lamp in the respective button flashes until the call is concluded. Calls can only be terminated by a Response Center or Customer Assistance Center representative except Roadside Assistance and Information calls, which can also be terminated by pressing the  button on the multifunction steering wheel.

When a Tele Aid call has been initiated, the audio system or the COMAND system audio (only vehicles with COMAND) is muted and the selected mode (radio, tape or CD) pauses. The optional cellular phone (if installed) switches off. If you must use this phone, the vehicle must be parked. Disconnect the coiled cord and place the call. The navigation system (if engaged) will continue to run. The display in the instrument cluster is available for use and spoken commands are only available by pressing the RPT button on the COMAND unit. A pop-up window will appear in the COMAND display to indicate that a Tele Aid call is in progress.

**Remote door unlock**

In the case you have your vehicle locked unintentionally (e.g. key inside vehicle), and no other key is available, contact the Mercedes-Benz Response Center at 1-800-756-9018 (in the USA) or 1-888-923-8367 (in Canada). You will be asked to provide your password which you provided when you completed the subscriber agreement.

Then return to your vehicle and press trunk lock for minimum of 20 seconds until the “SOS” button is flashing. The message “EMERGENCY CALL –CALL CONNECTED” appears in the multifunction display.

As an alternative, you may unlock the vehicle via Internet using the ID and password sent to you shortly after the completion of your Acquaintance Call.

The Response Center will then unlock your vehicle with the remote door unlocking feature.

## Notes:

The remote door unlock feature is available if the relevant cellular phone network is available.

The SOS button will flash and the message “EMERGENCY CALL – CALL CONNECTED” will appear in the multifunction display to indicate receipt of the door unlock command.

Once the vehicle is unlocked, a Response Center specialist will attempt to establish voice contact with the vehicle occupants.

If the trunk lock was pressed for more than 20 seconds before door unlock authorization was received by the Response Center, you must wait 15 minutes before pressing trunk lock again.

## Stolen vehicle tracking services

In the event your vehicle was stolen, report the incident to the police who will issue a numbered incident report. Pass this number on to the Mercedes-Benz Response Center.

The Response Center will then attempt to covertly contact the vehicle's Tele Aid system. Once the vehicle is located, the Response Center will contact the local Law Enforcement and you. The vehicle's location will only be provided to Law Enforcement.

**Info Services** (optional, except Canada)  
(only vehicles with COMAND)

Info Services categories include news, sports, stocks, weather and calendar reminders. Choices can be selected via [www.mbusa.com](http://www.mbusa.com) or by calling 1-800-FOR-MERcedes.

To request Info Services, press the SVC button on the COMAND system, then select "SEND NEW REQUEST FOR INFO SERVICE". "NEW INFO SERVICE REQUEST TRANSMITTED" will appear in the COMAND display and call status messages will appear in the multifunction display.

Once information is available, the message "NEW INFO RECEIVED - READ LATER WHEN STOPPED?" will appear. Select "Yes". With the vehicle stopped in a safe location press SVC, then select "View Info Service of mm.dd.yyyy hh.mm". Messages will be retained for 30 minutes once the ignition is switched off.

## Important!

Tele Aid utilizes the cellular network for communication and the GPS (Global Positioning System) satellites for vehicle location. If either of these signals are unavailable, the Tele Aid system may not function and if this occurs, assistance must be summoned by other means.

## Warning!

**If the indicator lamp in the "SOS" button does not illuminate during or remains illuminated after the system self-check or if the message "TELE AID - VISIT WORKSHOP" appears in the multifunction display, have the system checked at the nearest Mercedes-Benz Center as soon as possible.**

## Catalytic converter

188

**Catalytic converter**

Your Mercedes-Benz is equipped with monolithic type catalytic converters, an important element in conjunction with the oxygen sensors to achieve substantial control of the pollutants in the exhaust emissions. Keep your vehicle in proper operating condition by following our recommended maintenance instructions as outlined in your Service Booklet.

**Caution!**

To prevent damage to the catalytic converters, use only premium unleaded gasoline in this vehicle.

Any noticeable irregularities in engine operation should be repaired promptly. Otherwise, excessive unburned fuel may reach the catalytic converter causing it to overheat, which could start a fire.

**Warning!**

**As with any vehicle, do not idle, park or operate this vehicle in areas where combustible materials such as grass, hay or leaves can come into contact with the hot exhaust system, as these materials could be ignited and cause a vehicle fire.**

## Emission control

Certain systems of the engine serve to keep the toxic components of the exhaust gases within permissible limits required by law.

These systems, of course, will function properly only when maintained strictly according to factory specifications. Any adjustments on the engine should, therefore, be carried out only by qualified Mercedes-Benz authorized Center technicians. Engine adjustments should not be altered in any way. Moreover, the specified service jobs must be carried out regularly according to Mercedes-Benz servicing requirements. For details refer to the Service Booklet.

### Warning!

**Inhalation of exhaust gas is hazardous to your health. All exhaust gas contains carbon monoxide, and inhaling it can cause unconsciousness and lead to death.**

**Do not run the engine in confined areas (such as a garage) which are not properly ventilated. If you think that exhaust gas fumes are entering the vehicle while driving, have the cause determined and corrected immediately. If you must drive under these conditions, drive only with at least one window fully open.**



## Steering lock

190

## Steering lock

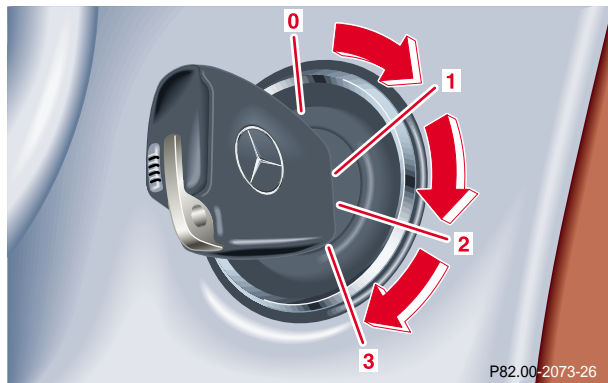

- 0** The electronic key can be withdrawn in this position only. The steering is locked when the electronic key is removed from the steering lock. If necessary, move steering wheel slightly to allow the locking mechanism to engage. The electronic key can only be removed with the selector lever in position “P”. After removing the electronic key or with the electronic key in steering lock position 0, the selector lever is locked in position “P”.

- 1** Steering is unlocked. (If necessary, move steering wheel slightly to allow the electronic key to be turned clockwise to position 1.)

Most electrical consumers can be operated. For detailed information see respective subjects.

- 2** Driving position.

Gear selector lever is unlocked.

To move the selector lever out of position “P”, firmly depress the service brake pedal.

- 3** Starting position.

See page 192 for instructions on starting and stopping the engine.

**Warning!**

**When leaving the vehicle always remove the electronic key from the steering lock, and lock the vehicle. Do not leave children unattended in the vehicle, or with access to an unlocked vehicle. Unsupervised use of vehicle equipment may cause serious personal injury.**

### Important!

If the electronic key is left in the steering lock position 0 for an extended period of time, it can no longer be turned in the lock. In this case, remove electronic key from steering lock and reinsert.

### Caution!

To prevent accelerated battery discharge and a possible dead battery, always remove the electronic key from the steering lock. **Do not** leave the electronic key in steering lock position 0.

### Notes:

A warning sounds when the driver's door is opened while the electronic key is in steering lock position 1 or 0.

The steering lock can only be unlocked with the vehicle battery properly charged and connected. See battery on page 280 or jump starting on page 282.

With the engine at idle speed, the charging rate of the alternator (output) is limited.

It is therefore recommended that you turn off unnecessary electrical consumers while driving in stop-and-go traffic. This precaution helps to avoid draining of the battery.

Unnecessary strain on the battery and charging system may be minimized by turning off the following power consumers, for example:

Heated seats, rear window defroster. In addition, the automatic climate air volume control should be set to the lowest position.

## Starting and turning off the engine

192

### Starting and turning off the engine

#### Before starting

Ensure that parking brake is engaged and that selector lever is in position “P” or “N”. Turn electronic key in steering lock to position 2.

#### Starting

Do not depress accelerator.

Briefly turn electronic key in steering lock clockwise to the stop and release. The starter will engage until the engine is running.

If engine will not run, and the starting procedure stops, turn electronic key completely to the left and repeat starting the engine.

After several unsuccessful attempts, have the system checked at the nearest authorized Mercedes-Benz Center.

#### Important!

Due to the installed starter non-repeat feature, the electronic key must be turned completely to the left before attempting to start the engine again.

In areas where temperatures frequently drop below -4°F (-20°C) we recommend that an engine block heater be installed. Your authorized Mercedes-Benz Center will advise you on this subject, see page 211.

#### Turning off

Turn the electronic key in the steering lock to position 0 to stop the engine.

The electronic key can only be removed with the selector lever in position “P”.

## Automatic transmission

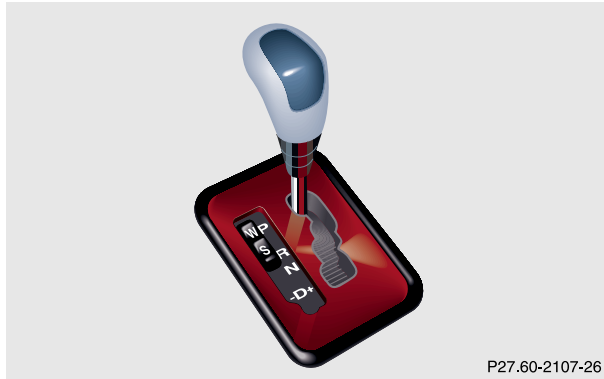

The automatic transmission selects individual gears automatically, dependent upon

- Selector lever position
- Program mode selector
- Accelerator position
- Vehicle speed

The gear shifting process is continuously adapted, dependent on the driving style, the driving situation and the road characteristics.

### Important!

When parking the vehicle or before working on the vehicle with the engine running, firmly depress the parking brake pedal and shift the selector lever into “P”.

## Automatic transmission

194

**Driving**

The selector lever is automatically locked while in position “P”. To move the selector lever out of position “P”, the service brake pedal must be firmly depressed before the shift lock will release.

Shift selector lever to the desired position only when the engine is idling normally and the service brake is applied. Do not release the brake until ready to drive. The vehicle may otherwise start creeping when the selector lever is in drive or reverse position.

**Warning!**

**It is dangerous to shift the selector lever out of “P” or “N” if the engine speed is higher than idle speed. If your foot is not firmly on the brake pedal, the vehicle could accelerate quickly forward or in reverse. You could lose control of the vehicle and hit someone or something. Only shift into gear when the engine is idling normally and when your right foot is firmly on the brake pedal.**

**Important!**

After selecting any driving position from “N” or “P”, wait a moment to allow the gear to fully engage before accelerating, especially when the engine is cold.

**Accelerator position**

Partial throttle = early upshifting = normal acceleration

Full throttle = later upshifting = rapid acceleration

Kickdown (depressing the accelerator beyond full throttle) = downshifting to a lower gear = maximum acceleration. Once the desired speed is attained, ease up on the accelerator – the transmission shifts up again.

## Stopping

For brief stops, e.g. at traffic lights, leave the transmission in gear and hold vehicle with the service brake.

For longer stops with the engine idling, shift into “N” or “P” and hold the vehicle with the service brake.

When stopping the vehicle on an uphill gradient, do not hold it with the accelerator, use the brake. This avoids unnecessary transmission heat build up.

## Maneuvering

To maneuver in tight areas, e.g. when pulling into a parking space, control the vehicle speed by gradually releasing the brakes. Accelerate gently and never abruptly step on the accelerator.

To rock a vehicle out of soft ground (mud or snow), alternately shift from forward to reverse, while applying slight partial throttle.

Rocking a vehicle free in this manner may cause the ABS or traction system malfunction indicator lamp to come on. Turn off and restart the engine to clear the malfunction indication.

## Warning!

**Getting out of your vehicle with the selector lever not fully engaged in position “P” is dangerous. Also, when parked on an incline, position “P” alone may not prevent your vehicle from moving, possibly hitting people or objects.**

**Always set the parking brake in addition to shifting to position “P”, see page 202 for parking brake.**

**When parked on an incline, also turn front wheel against curb.**

## Warning!

**When leaving the vehicle always remove the key from the steering lock, and lock the vehicle. Do not leave children unattended in the vehicle, or with access to an unlocked vehicle. Children could move the gear selector lever from position “P”, which could result in an accident or serious injury.**

## Automatic transmission

196

## Selector lever position

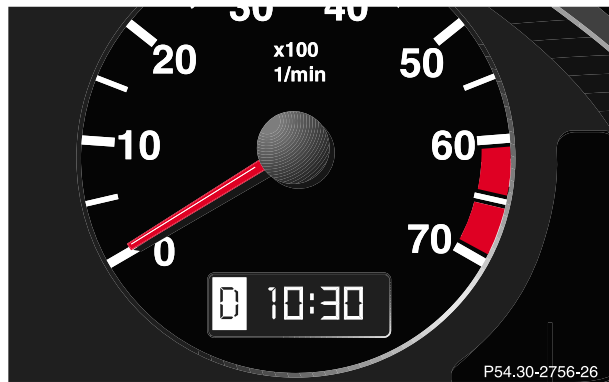

The current selector lever position is indicated in the gear range indicator display. The automatic gear shifting process can be adapted to specific operating conditions using the selector lever.

**P** Park position

The park position is to be used when parking the vehicle. Engage only with the vehicle stopped. The park position is not intended to serve as a brake when the vehicle is parked. Rather, the driver should always use the parking brake in addition to placing the selector lever in park to secure the vehicle.

Note:

The electronic key can only be removed from the steering lock with the selector lever in position "P". With the electronic key removed, the selector lever is locked in position "P".

With a malfunction in the vehicle's electrical system the selector lever could remain locked in position "P". To unlock the selector lever manually, see page 287.

**R** Reverse gear

Shift to reverse gear only with the vehicle stopped.

Dependent on the program mode selector switch position “S” or “W” the maximum speed in the reverse gear is different. However, it is not possible to change the program mode while in reverse.

#### **N** Neutral

No power is transmitted from the engine to the drive axle. When the brakes are released, the vehicle can be moved freely (pushed or towed). Do not engage “N” while driving except to coast when the vehicle is in danger of skidding (e.g. on icy roads, see page 209 for winter driving instructions).

#### **Important!**

Coasting the vehicle, or driving for any other reason with selector lever in “N” can result in transmission damage that is not covered by the Mercedes-Benz Limited Warranty.

#### **D** Drive

The transmission automatically upshifts through 5th gear. Position “D” provides optimum driving characteristics under all normal operating conditions.

#### **Gear selection for special circumstances**

The transmission gear ranges for special circumstances can be selected by pressing the selector lever to the right or the left with the selector lever in position “D”.

The gear range currently selected is indicated in the instrument cluster display.

Briefly press selector lever in the  $\curvearrowright$  direction:  
The transmission downshifts, one gear at a time, in the order “4”, “3”, “2”, “1”.

Press and hold selector lever in the  $\curvearrowright$  direction:  
The selector lever position display will switch to the gear range currently selected by the automatic transmission.

The transmission will only shift down one gear if the gear range currently selected has already shifted to its highest possible gear.

Briefly press selector lever in the  $\curvearrowleft$  direction:  
The transmission will shift from the current gear range to the next higher gear range. If the transmission is already in gear range “D”, an additional upshift of one gear is possible.



## Automatic transmission

198

Press and hold selector lever in the  $\infty$  direction: The transmission will shift from the current gear directly to gear range “D”.

### Warning!

**On slippery road surfaces, never downshift in order to obtain braking action. This could result in drive wheel slip and reduced vehicle control. Your vehicle's ABS will not prevent this type of loss of control.**

### Important!

With transmission in gear range “D”, “4” or “3”, upshifting from 1st to 2nd to 3rd gear is delayed depending on vehicle speed and engine temperature. This allows the catalytic converter to heat up more quickly to operating temperatures. During the brief warm-up period this delayed upshift and increased engine noise might be perceived as a malfunction. However, neither the engine nor transmission are negatively affected by this mode of operation.

The delayed upshift is effective with vehicle speeds below 31 mph (50km/h) at partial throttle and engine temperatures below 95°F (35°C).

To avoid overrevving the engine when the selector lever is moved to a lower gear range, the transmission will not shift to a lower gear, if the engine's revolutions per minute limit would be exceeded. In this case there will be no downshift, even when the vehicle speed reaches the engine's RPM limit of that gear, e.g. by applying the service brakes.

To prevent the engine from laboring at low RPM when driving uphill gradients or with your vehicle heavily loaded, the automatic transmission will downshift when necessary to maintain engine RPM within the best torque range.

Gear ranges:

- 4** Upshift through 4th gear only. Suitable for performance driving.
- 3** Upshift through 3rd gear only. Suitable for moderately steep hills. Since the transmission does not shift higher than 3rd gear, this gear selection will allow use of the engine's braking power downhill.
- 2** Upshift through 2nd gear only. For driving in mountainous regions or under extreme operating conditions. This gear selection will allow use of the engine's braking power when descending steep grades.
- 1** Use this position, which makes maximum use of the engine's braking effect, while descending very steep or lengthy downgrades and only at speeds below 40 mph (60 km/h).

## Automatic transmission

200

## Program mode selector switch

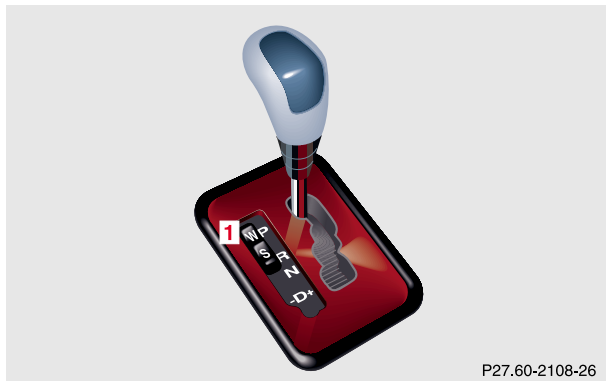

The transmission is provided with a selector switch (1) for Standard “S” and Winter/Wet (snow and ice) “W” program modes.

**S** Standard mode

Press switch on symbol “S”. Use this mode for all regular driving.

The vehicle starts out in 1st gear.

## Accelerator Operation:

Fast on = depressing the accelerator pedal quickly (not into kickdown position) while driving continuously, rather than depressing the accelerator pedal in the usual manner, will cause the automatic transmission to shift down into a lower gear. This gear shifting process is dependent on the current vehicle speed.

Fast off = there will be no upshift when releasing the accelerator pedal quickly, e.g. using the engine’s braking power during performance driving.

**W** Winter/Wet (snow and ice) mode

Press switch on symbol “W”. The vehicle starts out in 2nd gear, except with selector lever in 1st gear, or with accelerator pedal in kick-down position.

The “W” mode helps to improve traction and driving stability of the vehicle.

The gear shifting process occurs at lower vehicle and engine speeds than in the “S” program mode.

### **Caution!**

Never change the program mode when the selector lever is out of position “P”. It could result in a change of driving characteristics for which you may not be prepared.

### **Important!**

Always be certain of the program mode selected since the vehicle driving characteristics change with the selection of the program mode.

Dependent on the program mode selector switch position “S” or “W” and the gear selector lever in position “R”, the ratio of power transmission changes.

### **Emergency operation (Limp home mode)**

If vehicle acceleration worsens or the transmission no longer shifts, the transmission is most likely operating in Limp Home Mode which engages when there is a malfunction of the transmission. This condition may be accompanied by the “CHECK ENGINE” malfunction indicator lamp in the instrument cluster coming on.

In this mode only the 2nd gear or reverse gear can be activated.

To engage 2nd gear or reverse:

1. Stop the vehicle.
2. Move selector lever to position “P”.
3. Turn off the engine.
4. Wait approximately 10 seconds.
5. Restart the engine.
6. Move selector lever to position “D” (for 2nd gear), or move selector lever to position “R” (for reverse gear).

Have the transmission checked at your authorized Mercedes-Benz Center as soon as possible.

With a malfunction in the vehicles electrical system the selector lever may be locked in position “P”. To unlock the selector lever manually, see page 287.

## Parking brake

202

## Parking brake

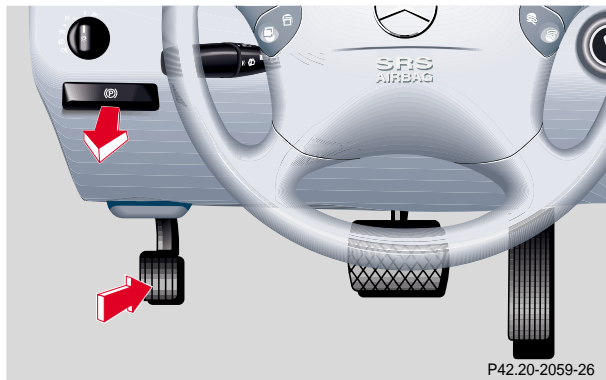

To engage, firmly depress parking brake pedal. When the electronic key is in steering lock position 2, the brake warning lamp in the instrument cluster should come on brightly.

To release the parking brake, pull handle on instrument panel. The brake warning lamp in the instrument cluster should go out.

A warning sounds, if you start to drive without having released the parking brake.

Also see brake warning lamp on page 235.

**Warning!**

**When leaving the vehicle always remove the electronic key from the steering lock, and lock the vehicle. Do not leave children unattended in the vehicle, or with access to an unlocked vehicle. Children could release the parking brake, which could result in an accident or serious injury.**

## Driving instructions

### Drive sensibly - Save Fuel

Fuel consumption, to a great extent, depends on driving habits and operating conditions.

To save fuel you should:

- keep tires at the recommended inflation pressures,
- remove unnecessary loads,
- remove roof rack when not in use,
- allow engine to warm up under low load use,
- avoid frequent acceleration and deceleration,
- have all maintenance work performed at regular intervals by an authorized Mercedes-Benz Center.

Fuel consumption is also increased by driving in cold weather, in stop-and-go traffic, on short trips and in hilly country.

## Drinking and driving

### Warning!

**Drinking or taking drugs and driving can be a very dangerous combination. Even a small amount of alcohol or drugs can affect your reflexes, perceptions and judgement.**

**The possibility of a serious or even fatal accident is sharply increased when you drink or take drugs and drive.**

**Please don't drink or take drugs and drive or allow anyone to drive after drinking or taking drugs.**

## Pedals

### Warning!

**Keep driver's foot area clear at all times. Objects stored in this area may impair pedal movement.**

## Power assistance

### Warning!

**When the engine is not running, the brake and steering systems are without power assistance. Under these circumstances, a much greater effort is necessary to stop or steer the vehicle.**

## Brakes

### Warning!

**After driving in heavy rain for some time without applying the brakes or through water deep enough to wet brake components or salty road conditions, the first braking action may be somewhat reduced and increased pedal pressure may be necessary to obtain expected braking effect. Be sure to maintain a safe distance from vehicles in front.**

**Resting your foot on the brake pedal will cause excessive and premature wear of the brake pads.**

**It can also result in the brakes overheating thereby significantly reducing their effectiveness. It may not be possible to stop the vehicle in sufficient time to avoid an accident.**

Excessive use of salt and other snow melting chemicals spread on roads during the winter months may cause a build up of moisture or residue to form on the braking components. This build up or residue could cause light corrosion of the braking components if the vehicle is parked with the brakes cold. Apply steady and even braking pressure when stopping the vehicle to warm up and dry the brake components.

### Important

Please pay attention to the function of the brake assist system (BAS), see page 215.

The condition of the parking brake system is checked each time the vehicle is in the shop for the required maintenance service.

If the parking brake is released and the brake warning lamp in the instrument cluster stays on the brake fluid level in the reservoir is too low.

Brake pad wear or a leak in the system may be the reason for low brake fluid in the reservoir.

Have the brake system inspected at an authorized Mercedes-Benz Center immediately.

All checks and service work on the brake system should be carried out by an authorized Mercedes-Benz Center.

Install only brake pads and brake fluid recommended by Mercedes-Benz.

### **Warning!**

**If other than recommended brake pads are installed, or other than recommended brake fluid is used, the braking properties of the vehicle can be degraded to an extent that safe braking is substantially impaired. This could result in an accident.**

### **Caution!**

When driving down long and steep grades, relieve the load on the brakes by shifting into a lower gear to use the engine's braking power. This helps prevent overheating of the brakes and reduces brake pad wear.

After hard braking, it is advisable to drive on for some time, rather than immediately parking, so the air stream will cool down the brakes faster.

### **Driving off**

Apply the service brakes to test them briefly after driving off. Perform this procedure only when the road is clear of other traffic.

Warm up the engine smoothly. Do not place full load on the engine until the operating temperature has been reached.

When starting off on a slippery surface, do not allow one drive wheel to spin for an extended period with the ESP switched off. Doing so may cause serious damage to the drive train which is not covered by the Mercedes-Benz Limited Warranty.



**Parking****Warning!**

To reduce the risk of personal injury as a result of vehicle movement, before turning off the engine and leaving the vehicle, always:

1. Keep right foot on the service brake pedal.
2. Firmly depress parking brake pedal.
3. Move the selector lever to position “P”.
4. Slowly release the service brake pedal.
5. Turn front wheels towards the road curb.
6. Turn the electronic key to steering lock position 0 and remove.
7. Take the electronic key and lock vehicle when leaving.

**Important!**

It is advisable to set the parking brake whenever parking or leaving the vehicle. In addition, move selector lever to position “P”.

When parking on hills, always set the parking brake.

**Tires****Warning!**

If you feel a sudden significant vibration or ride disturbance, or you suspect that possible damage to your vehicle has occurred, you should turn on the hazard warning flashers, carefully slow down, and drive with caution to an area which is a safe distance from the roadway.

Inspect the tires and under the vehicle for possible damage. If the vehicle or tires appear unsafe, have it towed to the nearest Mercedes-Benz Center or tire dealer for repairs.

Tread wear indicators (TWI) are required by law. These indicators are located in six places on the tread circumference and become visible at a tread depth of approximately  $\frac{1}{16}$  in (1.5 mm), at which point the tire is considered worn and should be replaced.

The tread wear indicator appears as a solid band across the tread.

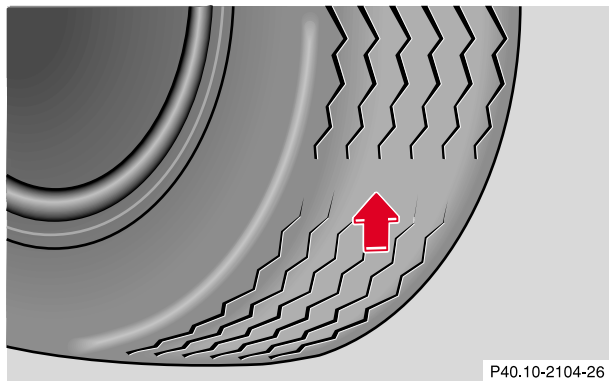

P40.10-2104-26

#### **Warning!**

**Do not allow your tires to wear down too far. As tread depth approaches  $\frac{1}{16}$  in (1.5 mm), the adhesion properties on a wet road are sharply reduced.**

**Depending upon the weather and/or road surface (conditions), the tire traction varies widely.**

Specified tire pressures must be maintained. This applies particularly if the tires are subjected to high loads (e.g. high speeds, heavy loads, high ambient temperatures).

#### **Warning!**

**Do not drive with a flat tire. A flat tire affects the ability to steer or brake the vehicle. You may lose control of the vehicle. Continued driving with a flat tire or driving at high speed with a flat tire will cause excessive heat build-up and possibly a fire.**

#### **Aquaplaning**

Depending on the depth of the water layer on the road, aquaplaning may occur, even at low speeds and with new tires. Reduce vehicle speed, avoid track grooves in the road and apply brakes cautiously in the rain.

## Driving instructions

208

**Tire traction**

The safe speed on a wet, snow covered or icy road is always lower than on a dry road.

You should pay particular attention to the condition of the road whenever the outside temperatures are close to the freezing point.

**Warning!**

**If ice has formed on the road, tire traction will be substantially reduced. Under such weather conditions, drive, steer and brake with extreme caution.**

We recommend M+S rated radial-ply tires for the winter season for all four wheels to insure normal balanced handling characteristics. On packed snow, they can reduce your stopping distance as compared with summer tires. Stopping distance, however, is still considerably greater than when the road is not snow or ice covered.

**Tire speed rating**

E 320:

Your vehicle is factory equipped with “H”-rated tires, which have a speed rating of 130 mph (210 km/h).

E 430:

Your vehicle is factory equipped with “W”-rated tires, which have a speed rating of 168 mph (268 km/h). An electronic speed limiter for models E 320 and E 430 prevents your vehicle from exceeding the speed rating.

Model E 55 AMG:

Your vehicle is factory equipped with “Z”-rated tires. An electronic speed limiter prevents your vehicle from exceeding a speed of 155 mph (250 km/h).

Despite the tire rating, local speed limits should be obeyed. Use prudent driving speeds appropriate to prevailing conditions.

**Warning!**

**Even when permitted by law, never operate a vehicle at speeds greater than the maximum speed rating of the tires.**

**Exceeding the maximum speed for which tires are rated can lead to sudden tire failure causing loss of vehicle control and resulting in personal injury and possible death.**

### **Snow chains**

Use only snow chains that are tested and recommended by Mercedes-Benz. Your authorized Mercedes-Benz Center will be glad to advise you on this subject.

Chains should only be used on the rear wheels. Follow the manufacturer's mounting instructions.

Snow chains should only be driven on snow covered roads at speeds not to exceed 30 mph (50 km/h). Remove chains as soon as possible when driving on roads without snow.

When driving with snow chains, press the ESP control switch to OFF, see page 220.

Model E 55 AMG:

Use of snow chains is not permissible with tire size 275/35 ZR 18.

### **Winter driving instructions**

The most important rule for slippery or icy roads is to drive sensibly and to avoid abrupt acceleration, braking and steering maneuvers. Do not use the cruise control system under such conditions.

When the vehicle is in danger of skidding, move selector lever to position "N". Try to keep the vehicle under control by corrective steering action.

Road salts and chemicals can adversely affect braking efficiency. Increased pedal force may become necessary to produce the normal brake effect. We therefore recommend depressing the brake pedal periodically when traveling at length on salt-strewn roads. This can bring road salt impaired braking efficiency back to normal. A prerequisite is, however, that this be done without endangering other drivers on the road.

If the vehicle is parked after being driven on salt treated roads, the braking efficiency should be tested as soon as possible after driving is resumed while observing the safety rules in the previous paragraph.

**Warning!**

**If the vehicle becomes stuck in snow, make sure that snow is kept clear of the exhaust pipe and from around the vehicle with engine running. Otherwise, deadly carbon monoxide (CO) gases may enter vehicle interior resulting in unconsciousness and death.**

**To assure sufficient fresh air ventilation, open a window slightly on the side of the vehicle not facing the wind.**

**Winter driving**

Have your vehicle winterized at your authorized Mercedes-Benz Center before the onset of winter.

- Change the engine oil if the engine contains an oil which is not approved for winter operation. For viscosity (SAE/CCMC class) and filling quantity, see page 322.
- Check engine coolant anticorrosion/antifreeze concentration.

- Additive for the windshield washer and headlamp cleaning system: Add MB Concentrate “S” to a premixed windshield washer solvent/antifreeze which is formulated for below freezing temperatures, see page 265.
- Test battery: Battery capacity drops with decreasing ambient temperature. A well charged battery helps to ensure that the engine can be started, even at low ambient temperatures.
- Tires: We recommend M+S rated radial-ply tires on all four wheels for the winter season. Observe permissible maximum speed for M+S rated radial-ply tires and the legal speed limit.

## Note:

In winter operation, the maximum effectiveness of the antilock brake system (ABS) or electronic stability program (ESP) can only be achieved with M+S rated radial-ply tires and/or snow chains recommended by Mercedes-Benz. Snow chains maximize performance.

### **Block heater** (for Canada only)

The engine is equipped with a block heater.

The electrical cable may be installed at your authorized Mercedes-Benz Center.

### **Deep water**

#### **Caution!**

Do not drive through flooded areas or water of unknown depth.

If you must drive through deep water, drive slowly to prevent water from entering the engine compartment or passenger compartment, being ingested by the air intake, possibly causing damage to electrical components or wiring, to engine or transmission that is not covered by the Mercedes-Benz Limited Warranty.

### **Passenger compartment**

#### **Warning!**

**Always fasten items being carried as securely as possible.**

**In an accident, during hard braking or sudden maneuvers, loose items will be thrown around inside the vehicle, and cause injury to vehicle occupants unless the items are securely fastened in the vehicle.**

**The trunk is the preferred place to carry objects.**

### **Traveling abroad**

Abroad, there is a widely-spread Mercedes-Benz service network at your disposal. If you plan to travel into areas which are not listed in the index of your Mercedes-Benz Center directory, you should request pertinent information from your authorized Mercedes-Benz Center.

## Driving systems

212

## Cruise control

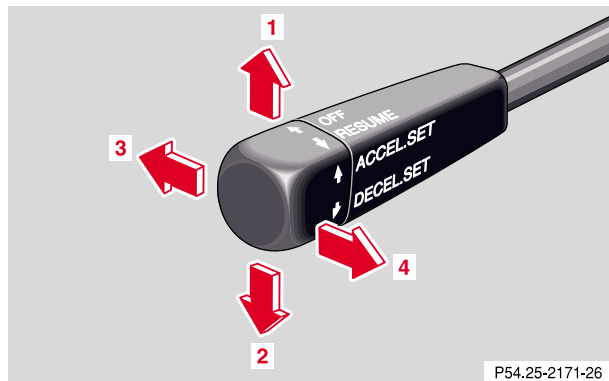

The cruise control allows you to drive in a more relaxed manner, for example over long distances, as it automatically maintains the set speed by actively regulating the throttle setting.

Any given speed above approximately 25 mph (40 km/h) can be maintained with the cruise control by operating the lever.

- 1** Accelerate and set:  
Lift lever briefly to set speed. Hold lever up to accelerate.
- 2** Decelerate and set:  
Depress lever briefly to set speed.  
Hold lever down to decelerate.

Normally the vehicle is accelerated to the desired speed with the accelerator.

Speed is set by briefly pushing the lever to position 1 or 2. The accelerator can then be released.

The speed can be increased (e.g. for passing) by using the accelerator. After the accelerator is released, the previously set speed will be resumed automatically.

If a set speed is to be increased or decreased slightly, e. g. to adapt to the traffic flow, hold lever in position 1 or 2 until the desired speed is reached, or briefly tip the lever in the appropriate direction for increases or decreases in 0.6 mph (1 km/h) increments. When the lever is released, the newly set speed remains.

### 3 Canceling

To cancel the cruise control, briefly push lever to position 3.

When you step on the brake pedal or the vehicle speed drops below approximately 25 mph (40 km/h), for example when driving upgrade, the cruise control will be canceled.

If the cruise control cancels by itself and remains inoperative until the engine is restarted, have the system checked at your authorized Mercedes-Benz Center as soon as possible.

### 4 Resume

If the lever is briefly pushed to position 4 when driving at a speed exceeding approximately 25 mph (40 km/h), the vehicle resumes the speed which was set prior to the cancellation of the cruise control. The last memorized speed is canceled when the electronic key in the steering lock is turned to position 1 or 0.

### Important!

Moving gear selector lever to position “N” switches the cruise control off.

### Warning!

**Only use the cruise control if the traffic and weather conditions make it advisable to travel at a steady speed.**

- **The use of cruise control can be dangerous on winding roads or in heavy traffic because conditions do not allow safe driving at a steady speed.**
- **The use of cruise control can be dangerous on slippery roads. Rapid changes in tire adhesion can result in wheel spin and loss of control.**

**The “Resume” function should only be operated if the driver is fully aware of the previously set speed and wishes to resume this particular preset speed.**



## Driving systems

214

## Notes:

If the engine does not brake the vehicle sufficiently while driving on a downgrade, the speed you set on the cruise control may be exceeded. In this case the automatic transmission shifts down (max. to 3rd gear) to maintain the set cruise control speed by using the engine's braking power.

As soon as the grade eases, the automatic transmission shifts up again dependent on the selector lever position.

Nevertheless, in some cases you may have to step on the brake pedal to slow down. In this case the cruise control is switched off.

Use the lever to resume the previously set speed.

## Brake assist system (BAS)

### Warning!

**BAS cannot prevent the natural laws of physics from acting on the vehicle, nor can it increase braking efficiency beyond that afforded by the condition of the vehicle brakes and tires or the traction afforded. The BAS cannot prevent accidents, including those resulting from excessive speed in turns, following another vehicle too closely, or aquaplaning. Only a safe, attentive, and skillful driver can prevent accidents. The capabilities of a BAS equipped car must never be exploited in a reckless or dangerous manner which could jeopardize the user's safety or the safety of others.**

The BAS is designed to maximize the vehicle's braking capability during emergency braking maneuvers by having maximum power boost applied to the brakes more quickly in emergency braking conditions than might otherwise be afforded solely by the driver's braking style. This can help reduce braking distances over what ordinary driving and braking style might do. The BAS complements the antilock brake system (ABS).

Applying the brakes very quickly results in maximum BAS assistance.

To receive the benefit of the system you must apply continuous full braking power during the stopping sequence. Do not reduce brake pedal pressure.

Once the brake pedal is released, the BAS is deactivated.

## Driving systems

## 216

The malfunction indicator lamps for the ESP are combined with the BAS malfunction indicator lamp.

The BAS/ESP malfunction indicator lamp in the instrument cluster comes on with the electronic key in steering lock position 2 and should go out with the engine running.

If the BAS/ESP malfunction indicator lamp comes on permanently while the engine is running, a malfunction has been detected in either system. As a result, it is possible that now only partial engine output will be available, and pressing the accelerator pedal will require more effort. If the BAS malfunctions, the brake system functions in the usual manner, but without BAS.

If the charging voltage falls below 10 volts, the malfunction indicator lamp comes on and the BAS is switched off. When the voltage is above this value again, the malfunction indicator lamp should go out and the BAS is operational.

With the ABS malfunctioning, the BAS and ESP is also switched off. Both malfunction indicator lamps come on with the engine running.

If a BAS warning message is displayed, have the BAS and ESP checked at your authorized Mercedes-Benz Center as soon as possible.

## Antilock brake system (ABS)

### Warning!

**Do not pump the brake pedal, rather use firm, steady brake pedal pressure. Pumping the brake pedal defeats the purpose for ABS and significantly reduces braking effectiveness.**

### Important!

The ABS improves steering control of the vehicle during hard braking maneuvers.

The ABS prevents the wheels from locking up above a vehicle speed of approximately 5 mph (8 km/h) independent of road surface conditions.

At the instant one of the wheels is about to lock up, a slight pulsation can be felt in the brake pedal, indicating that the ABS is in the regulating mode. Keep firm and steady pressure on the brake pedal while experiencing the pulsation.

Continuous steady brake pedal pressure results in applying the advantages of the ABS, namely braking power and ability to steer the vehicle.

In the case of an emergency brake maneuver keep continuous full pressure on the brake pedal. In this manner only can the ABS be most effective.

On slippery road surfaces, the ABS will respond even with light brake pedal pressure because of the increased likelihood of locking wheels. The pulsating brake pedal can be an indication of hazardous road conditions and functions as a reminder to take extra care while driving.

## Driving systems

218

**ABS control**

The ABS malfunction indicator lamp - in the instrument cluster comes on with the electronic key in steering lock position 2 and should go out with the engine running.

When the ABS malfunction indicator lamp in the instrument cluster comes on while the engine is running, it indicates that the ABS has detected a malfunction and has switched off. In this case, the brake system functions in the usual manner, but without antilock assistance.

For ABS malfunction indicator lamp, see page 238.

With the ABS malfunctioning, the BAS and ESP are also switched off. Both malfunction indicator lamps come on with the engine running.

If the charging voltage falls below 10 volts, the malfunction indicator lamp comes on and the ABS is switched off. When the voltage is above this value again, the malfunction indicator lamp should go out and the ABS is operational.

If the ABS malfunction indicator lamp stays illuminated, have the system checked at your authorized Mercedes-Benz Center as soon as possible.

**Warning!**

**ABS cannot prevent the natural laws of physics from acting on the vehicle, nor can it increase braking or steering efficiency beyond that afforded by the condition of the vehicle brakes and tires or the traction afforded. The ABS cannot prevent accidents, including those resulting from excessive speed in turns, following another vehicle too closely, or aquaplaning. Only a safe, attentive, and skillful driver can prevent accidents. The capabilities of an ABS equipped vehicle must never be exploited in a reckless or dangerous manner which could jeopardize the user's safety or the safety of others.**

## Note:

To alert following vehicles to slippery road conditions you discover, operate your hazard warning flashers as appropriate.

### **Four Wheel Electronic Traction System (4MATIC) with Electronic Stability Program (ESP) (Model with All Wheel Drive [AWD])**

The 4MATIC improves vehicle's ability to use available traction, e.g. during winter operation in mountains under snowy conditions, by applying power to all four wheels.

#### **Important!**

If the ESP warning lamp flashes:

- during take-off, apply as little throttle as possible,
- while driving, ease up on the accelerator.

Adapt your speed and driving to the prevailing road conditions.

#### **Caution!**

Operational tests with the engine running can only be conducted on a 2-axle dynamometer. Otherwise the ESP will immediately be engaged and will apply the brakes to the spinning wheels.

If the vehicle is towed with one axle raised (see page 285), or when testing the parking brake on a brake test dynamometer, the engine must be shut off (electronic key in steering lock position 0 or 1).

If one or more wheels tend to spin, ESP will apply the brakes to them. The traction control for the front axle wheels deactivate at approximately 50 mph (80 km/h), and for the rear axle wheels at approximately 80 mph (130 km/h).

The warning lamp in the speedometer blinks at any speed as soon as one tire loses traction.

Note:

In winter operation, the maximum effectiveness of the 4MATIC is only achieved with Mercedes-Benz recommended M+S rated radial-ply tires and/or snow chains.

### Electronic stability program (ESP)

#### Warning!

**ESP cannot prevent the natural laws of physics from acting on the vehicle, nor can it increase the traction afforded. The ESP cannot prevent accidents, including those resulting from excessive speed in turns, or aquaplaning. Only a safe, attentive, and skillful driver can prevent accidents. The capabilities of an ESP equipped vehicle must never be exploited in a reckless or dangerous manner which could jeopardize the user's safety or the safety of others.**

The ESP enhances directional control and reduces driving wheel spin of the vehicle under various driving conditions.

Over/understeering of the vehicle is counteracted by applying brakes to the appropriate wheel to create a countervailing vehicle movement. Engine torque is also limited. The ESP warning lamp, located in the speedometer dial, starts to flash when ESP is in operation.

#### Important!

If the ESP warning lamp  $\vee$  flashes:

- During take-off apply as little throttle as possible.
- While driving ease up on the accelerator.
- Adapt your speed and driving to the prevailing road conditions.
- Do not switch off the ESP.

#### Caution!

If the vehicle is towed with the front axle raised (see page 285), the engine must be shut off (electronic key in steering lock position 0 or 1). Otherwise, the ESP will immediately be engaged and will apply the rear wheel brakes.

Notes:

The malfunction indicator lamp for the ESP is combined with that of the BAS.

The yellow BAS/ESP malfunction indicator lamp in the instrument cluster and the yellow ESP warning lamp  $\vee$  in the speedometer dial come on with the electronic key in steering lock position 2. They should go out with the engine running.

If the BAS/ESP malfunction indicator lamp comes on continuously with the engine running, a malfunction has been detected in either system. Only partial engine output will be available.

If the BAS malfunctions, the brake system functions in the usual manner, but without BAS.

If the ESP warning message is displayed, have the BAS or ESP checked at your authorized Mercedes-Benz Center as soon as possible.

With the ABS malfunctioning, the ESP is also switched off.

Driving the vehicle with varied size tires will cause the wheels to rotate at different speeds, therefore the ESP may activate (yellow ESP warning lamp in speedometer dial comes on). For this reason, all wheels, including the spare wheel, must have the same tire outside diameter.

When testing the parking brake on a brake test dynamometer, the engine must be shut off. Otherwise, the ESP will immediately be engaged and will apply the rear wheel brakes.

In winter operation, the maximum effectiveness of the ESP is only achieved with Mercedes-Benz recommended M+S rated radial-ply tires and/or snow chains.

### **Synchronizing ESP**

If the power supply was interrupted (battery disconnected or empty), the BAS/ESP malfunction indicator lamp may be illuminated with the engine running.

Turn steering wheel completely to the left and then to the right. The BAS/ESP malfunction indicator lamp should go out.



## Driving systems

222

## ESP control switch





ESP control switch located on center console.

**1** Press to switch ESP off

ESP warning lamp  , located in speedometer dial, comes on.

**2** Press to switch ESP on

ESP warning lamp  , located in speedometer dial, goes out.

To improve the vehicle's traction when driving with snow chains, or starting off in deep snow, sand or gravel, switch off ESP by pressing the upper half (1) of the ESP switch. The ESP warning lamp  , located in the speedometer dial, is continuously illuminated.

**Warning!**

**When the ESP warning lamp is illuminated continuously, the ESP is switched off.**

**Adapt your speed and driving to the prevailing road conditions.**

With the ESP system switched off, the engine torque reduction feature is cancelled. Therefore, the enhanced vehicle stability offered by ESP is unavailable.

Adapt your speed and driving to the prevailing road conditions.

A portion of the ESP system remains active, even with the switch in the OFF position.

If one drive wheel loses traction and begins to spin, the brake is applied until the wheel regains sufficient traction. The traction control engages at vehicle speeds up to approximately 24 mph (40 km/h), and switches off at 50 mph (80 km/h).

Note:

Avoid spinning of one drive wheel. This may cause serious damage to the drive train which is not covered by the Mercedes-Benz Limited Warranty.

The ESP warning lamp, located in the speedometer dial, starts to flash at any vehicle speed as soon as the tires lose traction and the wheels begin to spin.

To return to the enhanced vehicle stability offered by ESP: press lower half (2) of the switch (the ESP warning lamp in the speedometer dial goes out).

### **Warning!**

**ESP should not be switched off during normal driving other than in circumstances described above. Disabling of the system will reduce vehicle stability in standard driving maneuvers.**

### **Important!**

If the ESP warning lamp flashes:

- during take-off, apply as little throttle as possible,
- while driving, ease up on the accelerator.

## Parking system

224

**Parking assist (Parktronic)**  
(optional)

The Parktronic system assists the driver during parking maneuvers. It visually and audibly indicates the distance between the vehicle and an obstacle.

The front area of the vehicle is monitored when driving forward. When reversing, the front as well as the rear areas are monitored.

With the electronic key in steering lock position 2, Parktronic engages automatically at speeds up to approximately 10 mph (15 km/h) and deactivates during higher speeds.

Parktronic can be switched off by a control switch located in the center console. It engages automatically again when starting the engine.

See page 228 for parktronic switch.

**Warning!**

**Parktronic is a supplemental system. It is not intended to nor does it replace the need for extreme care. The responsibility during parking and other critical maneuvers rests always with the driver.**

**Special attention must be paid to objects having smooth surfaces or low silhouettes (e.g. trailer couplings, painted posts, or street curbs). Such objects may not be detected by the system and can damage the vehicle.**

**The operational function of the Parktronic can be affected by dirty sensors, especially at times of snow and ice. See page 307 for notes on cleaning the parktronic system sensors.**

**Interference caused by other ultrasonic signals (e.g. working jackhammers or the air brakes of trucks) can cause the system to send erratic indications, and should be taken into consideration.**

## Sensors

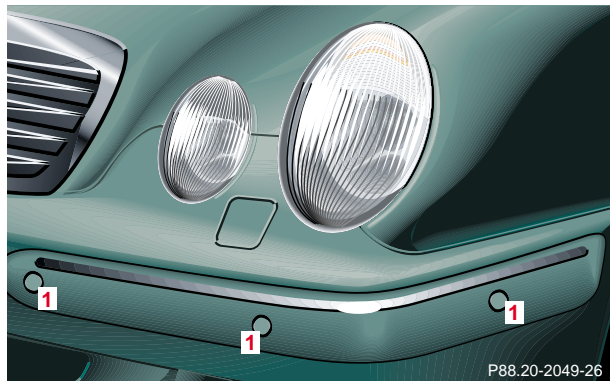

- 1** Sensors located in bumper  
(front bumper shown)

A total of 10 sensors (1) monitor the vehicle's front and rear areas. Six sensors are located in the front bumper, four sensors in the rear bumper.

For proper operation of the Parktronic always keep the sensors clean, especially at times of snow and ice.

See page 307 for instructions on cleaning the sensors in the bumpers.

## Parking system

226

## Warning indicators

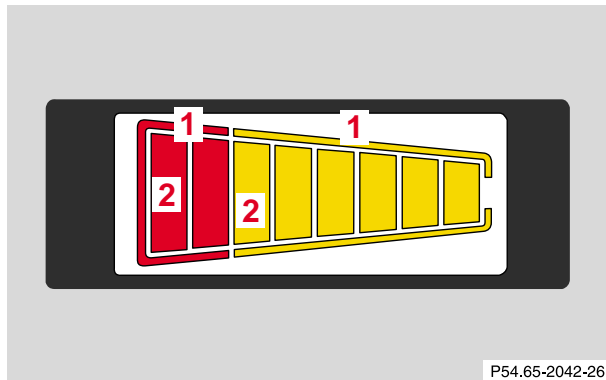

1 Frame

2 Segments

Visual and audible signals indicate to the driver the relative distance between the vehicle and an obstacle.

Warning indicators for the front area are located above the center air outlets in the dashboard.

Warning indicators for the rear area are located in the rear passenger compartment lamp.

The frames are illuminated when the Parktronic is engaged.

Each warning indicator has 6 yellow and 2 red segments.

As soon as the sensors detect an obstacle, one or more segments light up, depending on the distance. An intermittent acoustic warning will also sound as the seventh segment lights up and a constant acoustic warning lasting a maximum of 3 seconds will sound for the eighth segment.

## Monitoring reach of sensors

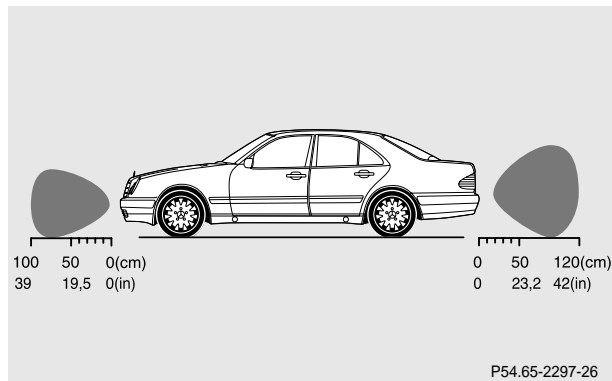

Front bumper:

Center approx. 40 in (100 cm)

Corner approx. 24 in (60 cm)

Rear bumper:

Center approx. 48 in (120 cm)

Corner approx. 32 in (80 cm)

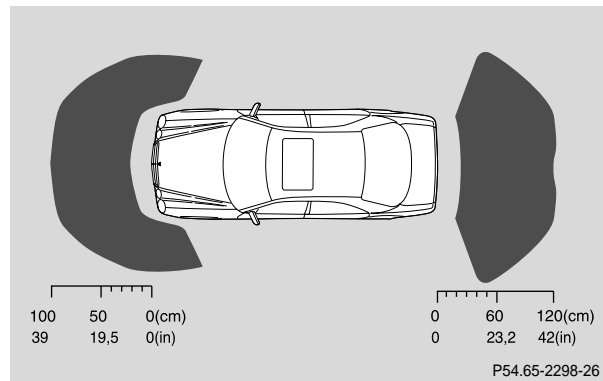

The first yellow segment lights up at these distances. Additional segments light up as the vehicle comes closer to the obstacle.

Minimum distance between vehicle and obstacle at which the system stops indicating:

Front corners approx. 6 in (15 cm)

Front center and rear approx. 8 in (20 cm)

## Parking system

228

The obstacle may not be recognized if outside the shaded sensor field, and no longer be indicated when approaching it any closer (warning indicators go out).

**Parktronic malfunction**

All red segments of the warning indicators light up, and a warning sounds for 3 seconds, if Parktronic does not function properly.

A dirty sensor could be the reason. See page 307 for instructions on cleaning the sensors in the bumpers.

After cleaning the sensors, turn electronic key in steering lock to position 2. If the defect continues to be displayed, have the system checked at your authorized Mercedes-Benz Center.

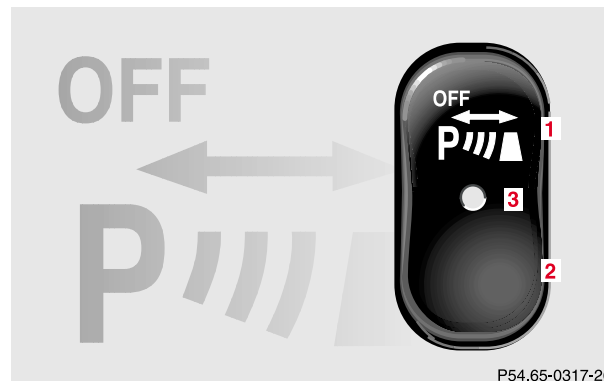
**Parktronic switch**

The switch is located on the center console.

- 1 Parktronic switched off
- 2 Parktronic switched on
- 3 Indicator lamp – comes on when Parktronic is switched off

The parktronic system is switched on again when turning the electronic key in steering lock position 2.

## What you should know at the gas station

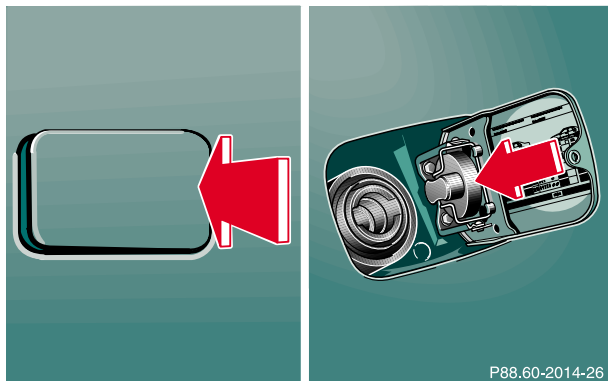

### Fuel supply

#### Warning!

Gasoline is highly flammable and poisonous. It burns violently and can cause serious injury. Whenever you are around gasoline, avoid inhaling fumes and skin contact, extinguish all smoking materials. Never allow sparks, flame or smoking materials near gasoline!

Open flap by pushing near front (arrow). Turn fuel cap to the left and hold on to it until possible pressure in tank has been released, then remove cap. Failure to remove slowly could result in personal injury.

See page 299 for notes on fuel filler flap, manual release.

### Fuel

To prevent fuel vapors from escaping into open air, fully insert filler nozzle unit. Only fill fuel tank until the filler nozzle unit cuts out – do not top up or overfill.

#### Warning!

**Overfilling of fuel tank may result in creating pressure in the system which could cause a gas discharge such as the gas spraying back out upon removing the filler nozzle which could cause personal injury.**

Leaving the engine running and the fuel cap open can cause the “CHECK ENGINE” lamp to illuminate, see page 234 for notes on the “CHECK ENGINE” lamp.



**What you should know at the gas station**

Fuel tank capacity approximately 21.1 US gal (80.0 l).  
This includes approximately 2.6 US gal (10.0 l) reserve.

Use premium unleaded gasoline:  
Posted Octane Index 91 (Average of 96 RON/86 MON).

**Engine oil**

Engine oil level check, see page 262.

Fill quantity between upper and lower dipstick marking  
level: 2.1 US qt (2.0 l).

Recommended engine oils, see Approved Service  
Products sheet.

**Coolant**

For normal replenishing, use water (potable water  
quality).

For further information (e.g. anticorrosion/antifreeze),  
see page 326.

**Spark plugs**

Approved spark plugs, see page 320.

**230****Tire pressure**

For tire pressure, refer to tire pressure label inside the  
fuel filler flap.

**Air conditioner**

R-134a refrigerant and special PAG lubricant, see  
page 322.

**Bulbs**

High and low beams: H7 (55 W),  
low beam: Xenon (optional)  
fog lamps: H1 (55 W),  
turn signal lamps,  
front 1156 NA (26.9/5 W/32/4 cp),  
parking and standing lamps, front: H 6W (6 W)  
side marker lamps, front: 5 W/4 cp,  
turn signal lamps, rear: 21 W/24 cp,  
stop, tail and parking lamp: 21 W/4 cp,  
tail, parking and side marker lamp: 5 W/4 cp,  
rear fog lamp, driver's side: 21 W/32 cp,  
backup lamps: 21 W/32 cp,  
license plate lamps: 5 W/4 cp

## Check regularly and before a long trip

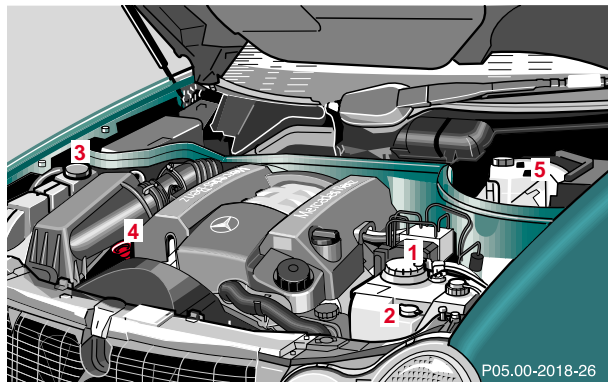

E 320 shown

### 1 Windshield washer system

For refilling reservoir see page 265.

### 2 Headlamp cleaning system

Auxiliary tank connected to windshield washer reservoir. Open filler caps on both reservoirs during refilling.

### 3 Coolant level

See “Adding coolant”, page 264.

### 4 Engine oil level

See “Checking engine oil level”, page 262.

### 5 Brake fluid

See “Brake fluid”, page 324.

Opening hood, see page 259.

**Vehicle lighting:** Check function and cleanliness. For replacement of light bulbs, see “Lamps, exterior” on page 288.

Exterior lamp switch, see page 119.



## Instrument cluster display

Malfunction and indicator lamps	
in the instrument cluster .....	234
On-board diagnostic system .....	234
Check engine malfunction	
indicator lamp .....	234
Brake warning lamp .....	235
Supplemental restraint system	
(SRS) indicator lamp .....	236
Fuel reserve and fuel cap	
placement warning .....	236
Electronic stability program	
(ESP) – warning lamp .....	237
BAS / ESP malfunction	
indicator lamp .....	237

ABS malfunction	
indicator lamp .....	238
Seat belt warning lamp .....	238
Malfunction and indicator lamp	
in the center console .....	239
AIRBAG OFF	
indicator lamp .....	239
Malfunction and warning	
messages in the	
multifunction display .....	240
DISPLAY DEFECTIVE .....	241
BATTERY / ALTERNATOR .....	242
ABS-SYSTEM .....	243
BRAKE ASSIST .....	243
BRAKE LINING WEAR .....	244

BRAKE FLUID .....	244
PARKING BRAKE .....	245
ENGINE FAN .....	245
COOLANT (coolant level) .....	246
COOLANT TEMP. ....	247
LIGHTING SYSTEM .....	248
LIGHT SENSOR .....	249
REMOVE KEY .....	249
STEERING GEAR OIL .....	250
ENGINE OIL LEVEL .....	251
WASHER FLUID .....	252
ELEC. STABIL. PROG.	
(Electronic stability program) ..	253
TELE AID .....	253

## Malfunction and indicator lamps

234

### Malfunction and indicator lamps in the instrument cluster

General information:

If a bulb in the instrument cluster fails to light up during the bulb self-check when turning the electronic key in steering lock to position 2, have it checked and replaced if necessary.

#### On-board diagnostic system

##### Check engine malfunction indicator lamp



Engine malfunction indicator lamp. If the “CHECK ENGINE” malfunction indicator lamp comes on when the engine is running, it indicates a malfunction of the fuel management system, emission control system, systems which impact emissions, or the fuel cap is not closed tight (check the fuel cap). If the “CHECK ENGINE” lamp is illuminated continuously and the vehicle is driving normally, you may still drive the vehicle, however, in all cases, we recommend that you have the system checked at your authorized Mercedes-Benz Center as soon as possible.

If the “CHECK ENGINE” lamp comes on continuously and/or the vehicle is not driving normally, serious damage can occur to the emission system. Please contact your authorized Mercedes-Benz Center immediately.

The Sequential Multiport Fuel Injection (SFI) control module monitors emission control components that either provide input signals to or receive output signals from the control module. Malfunctions resulting from interruptions or failure of any of these components are indicated by the “CHECK ENGINE” malfunction indicator lamp in the instrument cluster and are simultaneously stored in the SFI control module.

If the “CHECK ENGINE” malfunction indicator lamp comes on, have the system checked at your authorized Mercedes-Benz Center as soon as possible.

With some exceptions, the control module switches off the “CHECK ENGINE” malfunction indicator lamp if the condition, causing the lamp to come on, no longer exists during three consecutive cycles. See also page 236 for fuel cap placement warning.

An on-board diagnostic connector is located in the passenger compartment near to the parking brake pedal, allowing the accurate identification of system malfunctions through the readout of diagnostic trouble codes.

### Brake warning lamp



Except Canada



Canada only

When the brake warning lamp and message appear while the engine is running, this means:

- there is insufficient brake fluid in the reservoir (engine running and parking brake released), or
- the parking brake is set (engine running).

### Warning!

**Driving with the brake warning lamp illuminated can result in an accident. Have your brake system checked immediately if the brake warning lamp stays on. Don't add brake fluid before checking the brake system. Overfilling the brake fluid reservoir can result in spilling brake fluid on hot engine parts and the brake fluid catching fire. You can be seriously burned.**

Note:

If you find that the minimum mark on the brake fluid reservoir is reached, have the brake system checked for brake pad thickness and leaks.

## Malfunction and indicator lamps

236

**Supplemental restraint system (SRS) indicator lamp****SRS**

The operational readiness of the airbag system is verified by the indicator lamp “SRS” in the instrument cluster when turning the electronic key in steering lock to position 1 or 2. If no malfunction is detected, the lamp will go out after approximately 4 seconds; after the lamp goes out, the system continues to monitor the components and circuitry of the airbag system and will indicate a malfunction by coming on again.

**Warning!**

**In the event a malfunction of the “SRS” is indicated as outlined above, the “SRS” may not be operational. For your safety, we strongly recommend that you visit an authorized Mercedes-Benz Center immediately to have the system checked; otherwise the “SRS” may not be activated when needed in an accident, which could result in serious or fatal injury, or it might deploy unexpectedly and unnecessarily which could also result in injury.**

See page 69 for notes on airbags, see page 68 for belt tensioners and page 59 for infant and child seat restraint.

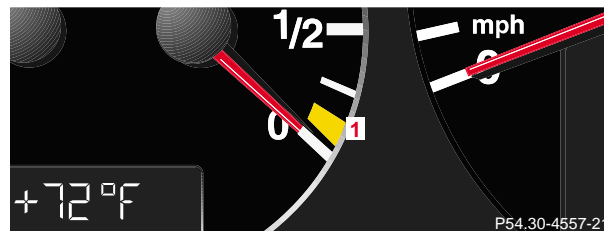
**Fuel reserve and fuel cap placement warning**

When the warning lamp (1) comes on after starting the engine, or if it comes on while driving, it indicates that the fuel level is down to the reserve quantity of approximately 2.6 gal (10 liters).

The warning lamp blinks when the fuel cap is not closed, or a fuel system leak has been detected. Retighten cap and see if lamp goes out after restart and next OBD selfcheck.

If the warning lamp continues to blink after closing the fuel cap correctly, have the fuel system checked at your authorized Mercedes-Benz Center as soon as possible.

Leaving the engine running and the fuel cap open can also cause the “CHECK ENGINE” lamp to illuminate, see page 234.

### Electronic stability program (ESP) – warning lamp



The yellow ESP warning lamp in the speedometer dial comes on with the electronic key in steering lock position 2. It should go out with engine running.

It should go out with engine running.

See page 219 and 220 if the warning lamp lights up or flashes when the vehicle is moving.

### BAS/ESP malfunction indicator lamp



The malfunction indicator lamp for the ESP is combined with that of the BAS.

The yellow BAS/ESP malfunction indicator lamp in the instrument cluster comes on with the electronic key in steering lock position 2. It should go out with the engine running.

If the BAS/ESP malfunction indicator lamp remains illuminated with the engine running, see page 215 for notes on brake assist system (BAS) and page 220 for notes on electronic stability program (ESP).



## Malfunction and indicator lamps

238

### ABS malfunction indicator lamp



The ABS malfunction indicator lamp in the instrument cluster comes on with the electronic key in steering lock position 2 and should go out with the engine running.

When the ABS malfunction indicator lamp symbol and warning in the instrument cluster remains illuminated while the engine is running, it indicates that the ABS has detected a malfunction and has switched off. In this case, the brake system functions in the usual manner, but without antilock assistance.

With the ABS malfunctioning, the BAS and ESP are also switched off. Both malfunction indicator lamps come on with the engine running.

If the charging voltage falls below 10 volts, the malfunction indicator lamp comes on and the ABS is switched off. When the voltage is above this value again, the malfunction indicator lamp should go out and the ABS is operational.

Have the system checked at your authorized Mercedes-Benz Center as soon as possible.

See page 217 for notes on antilock brake system (ABS).

### Seat belt warning lamp



With the electronic key in steering lock position 2, the seat belt warning lamp comes on and a warning sounds for approximately 6 seconds if the driver's seat belt is not fastened.

## Malfunction and indicator lamp in the center console

### AIRBAG OFF indicator lamp

The 7 indicator lamp will light up for approximately 6 seconds when you turn the electronic key in steering lock to position 1 or 2.

The 7 indicator lamp stays lit as long as a BabySmart™ compatible child seat is properly installed on the front passenger seat. It indicates that the front passenger airbag is switched off.

See page 66 for BabySmart™ deactivation system.

#### Warning!

**The BabySmart™ airbag deactivation system will ONLY work with a special child seat designed to operate with it. It will not work with child seats which are not BabySmart™ compatible.**

Never place anything between seat cushion and child seat (e.g. pillow), since it reduces the effectiveness of the deactivation systems.

Follow the manufacturer's instructions for installation of special child seats.

**The passenger front airbag will not deploy only if the 7 indicator lamp remains illuminated.**

**Please be sure to check the indicator every time you use the special system child seat. Should the light go out while the restraint is installed, please check installation. If the light remains out, do not use the BabySmart™ restraint to transport children on the front passenger seat until the systems has been repaired.**

BabySmart™ is a trademark of Siemens Automotive Corp.

## Malfunction and warning messages

240

**Malfunction and warning messages in the multifunction display**

Malfunction and warning messages for the following systems will be displayed immediately in the multifunction display.

These messages can be cleared from the instrument cluster by:

- using the **R** button on the instrument cluster, or
- pressing button **j**, **k**, **è** or **ÿ** on the multifunction steering wheel.

They are then stored in the malfunction message memory. See page 108.

Notes:

Certain malfunction and warning messages are accompanied by an audible signal.

Malfunction and warning messages in red are always accompanied by an audible signal.

Temporary messages such as “SWITCH OFF LIGHTS” will not be stored in the malfunction message memory.

**Warning!**

**All messages contain important information which should be taken note of and, where malfunction indicated, addressed as soon as possible at an authorized Mercedes-Benz Center.**

**Failure to repair condition noted may cause damage not covered by the Mercedes-Benz Limited Warranty, or result in property damage or personal injury.**

### DISPLAY DEFECTIVE (engine control unit)



Line 1	Line 2
DISPLAY DEFECTIVE	VISIT WORKSHOP!

This message is displayed to indicate that the information being relayed by the engine control unit is no longer complete. The coolant temperature gauge, tachometer, or the cruise control may have failed.

### DISPLAY DEFECTIVE (several systems)



Line 1	Line 2
DISPLAY DEFECTIVE	VISIT WORKSHOP!

The displays for several systems have failed. Some systems themselves may also have failed.

## Malfunction and warning messages

242

## BATTERY/ALTERNATOR



Line 1	Line 2
BATTERY/ALTERNATOR	VISIT WORKSHOP!
OVERVOLTAGE	VISIT WORKSHOP!
UNDERVOLTAGE	CONSUMER DEFECTIVE!

This message indicates a malfunction which must be repaired immediately.

It may indicate that the poly-V-belt has broken. Should this condition occur, the poly-V-belt must be replaced before continuing to operate the vehicle. Otherwise, the engine will overheat due to an inoperative water pump which may result in damage to the engine.

Do not continue to drive the vehicle with this message displayed.

Doing so could result in serious engine damage that is not covered by the Mercedes-Benz Limited Warranty.

## ABS-SYSTEM



Line 1	Line 2
ABS-SYSTEM	VISIT WORKSHOP!

A malfunction has been detected in the system. The brake system functions in the usual manner, but without antilock assistance.

With the ABS malfunctioning, the BAS and ESP are also switched off.

Have the system checked at your authorized Mercedes-Benz Center as soon as possible.

## BRAKE ASSIST



Line 1	Line 2
BRAKE ASSIST	VISIT WORKSHOP!
DISPLAY DEFECTIVE	VISIT WORKSHOP!

A malfunction has been detected in the system. The brake system functions in the usual manner, but without BAS.

## Malfunction and warning messages

244

## BRAKE LINING WEAR



Line 1

BRAKE LINING WEAR

Line 2

VISIT WORKSHOP!

When this message appears during braking, it indicates that the brake pads are worn down.

Have the brake system checked at your authorized Mercedes-Benz Center as soon as possible.

## BRAKE FLUID



Line 1

BRAKE FLUID

Line 2

VISIT WORKSHOP!

**Warning!**

**Driving with this message displayed can result in an accident. Have your brake system checked immediately. Don't add brake fluid before checking the brake system. Overfilling the brake fluid reservoir can result in spilling brake fluid on hot engine parts and the brake fluid catching fire. You can be seriously burned.**

## PARKING BRAKE



Line 1	Line 2
PARKING BRAKE	RELEASE BRAKE!

Parking brake, see page 202.

## ENGINE FAN

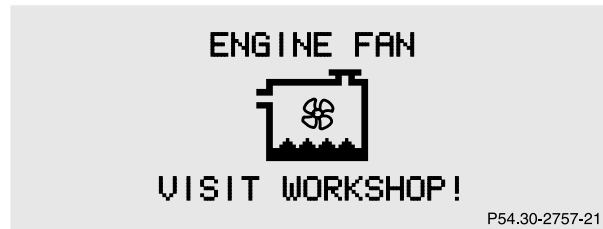

Line 1	Line 2
ENGINE FAN	VISIT WORKSHOP! <sup>1</sup>

- <sup>1</sup> The cooling fan for the coolant is faulty.  
Observe the coolant temperature gauge while driving, see page 90.



## Malfunction and warning messages

246

## COOLANT (coolant level)

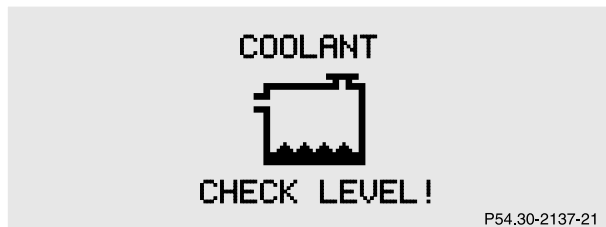

Line 1	Line 2
COOLANT	CHECK LEVEL!

When this message appears while driving, the coolant level has dropped below the required level. If no leaks are noticeable and the engine temperature does not increase, continue to drive to the nearest service station and have coolant added to the coolant system.

The low engine coolant level warning should not be ignored. Extended driving with the symbol displayed may cause serious engine damage not covered by the Mercedes-Benz Limited Warranty.

In cases of major or frequent minor coolant loss, have the cooling system checked at your authorized Mercedes-Benz Center as soon as possible.

Notes:

Do not drive without coolant in the cooling system. The engine will overheat causing major engine damage.

Monitor the coolant temperature gauge while driving, see page 90.

See page 263 for instructions on topping up the coolant.

**Warning!**

**Do not spill antifreeze on hot engine parts. Antifreeze contains ethylene glycol which may burn if it comes into contact with hot engine parts. You can be seriously burned.**

## COOLANT TEMP.

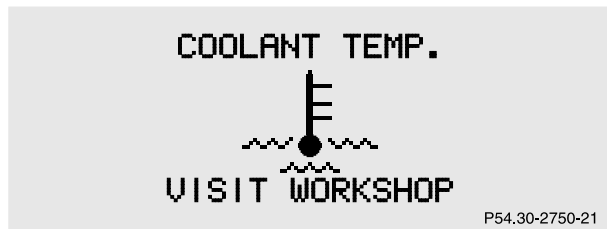

Line 1	Line 2
COOLANT TEMP.	VISIT WORKSHOP! <sup>1</sup>

- 1 Observe the coolant temperature gauge. See page 90. Check coolant level, see page 263.

This may indicate that the poly-V-belt has broken. Should this condition occur, the poly-V-belt must be replaced before continuing to operate the vehicle. Otherwise, the engine will overheat due to an inoperative water pump which may result in damage to the engine. Do not continue to drive the vehicle with this message displayed. Doing so could result in serious engine damage that is not covered by the Mercedes-Benz Limited Warranty.

During severe operating conditions and stop-and-go city traffic, the coolant temperature may rise close to the red marking.

The engine should not be operated with the coolant temperature in the red zone. Doing so may cause serious engine damage which is not covered by the Mercedes-Benz Limited Warranty.

### Warning!

**Driving when your engine is badly overheated can cause some fluids which may have leaked into the engine compartment to catch fire. You could be seriously burned.**

**Steam from an overheated engine can cause serious burns and can occur just by opening the engine hood. Stay away from the engine if you see or hear steam coming from it.**

**Turn off the engine, get out of the vehicle and do not stand near the vehicle until it cools down.**

## Malfunction and warning messages

248

## LIGHTING SYSTEM

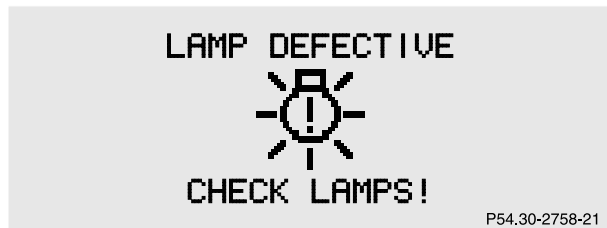

Line 1	Line 2
LAMP DEFECTIVE	CHECK LAMPS!
DISPLAY DEFECTIVE	VISIT WORKSHOP!

When the message appears after starting the engine, or if it come on while driving, this indicates a failure in the parking lamp, taillamp, stop lamp, or low beam headlamp. See page 288 for instructions on replacing bulbs.

If an exterior lamp fails, the message will appear only when that lamp is switched on.

If a brake lamp fails, the message will appear when applying the brake and stays on until the engine is turned off.

## Note:

If additional lighting is installed (e.g. auxiliary headlamps etc.) be certain to connect into the fuse before the failure indicator monitoring unit order to avoid damaging the system.

## LIGHT SENSOR

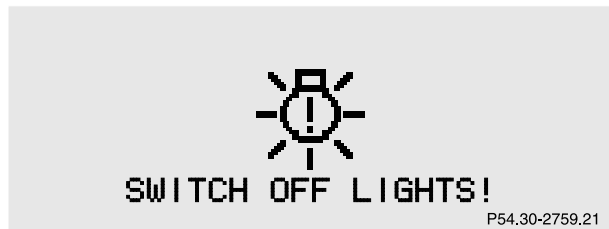

Line 1	Line 2
	SWITCH OFF LIGHTS!

With the electronic key removed and the driver's door open, a warning sounds and the message "SWITCH OFF LIGHTS!" appears in the multifunction indicator if the vehicle's exterior lamps (except standing lamps) are not switched off.

## REMOVE KEY



Line 1	Line 2
	REMOVE KEY!

This message plus an audible alarm indicate that the electronic key is in steering lock position 0 or 1, and the driver's door is open.

## Malfunction and warning messages

250

## STEERING GEAR OIL



Line 1	Line 2
STEERING GEAR OIL	VISIT WORKSHOP!

System without or with insufficient steering gear oil level. Danger of damage to steering gear exists.

When this message appears, the steering gear oil level has dropped below the required level. Have the system checked at the nearest Mercedes-Benz Center as soon as possible.

**Warning!**

If the level of steering gear oil in reservoir is too low, the steering power assistance could fail. Much greater effort will then be needed to turn the steering wheel.

Do not add steering oil without checking the steering system.

Do not drive the vehicle. Have the system checked at your authorized Mercedes-Benz Center as soon as possible.

## ENGINE OIL LEVEL

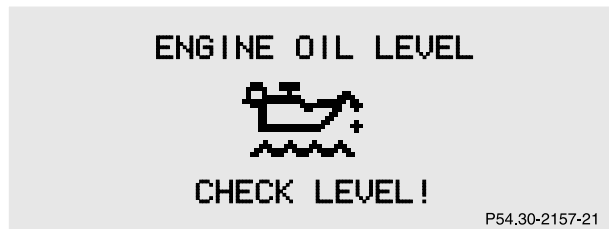

Line 1	Line 2
ENGINE OIL LEVEL	CHECK LEVEL! <sup>1</sup>
ENGINE OIL LEVEL	STOP, ENGINE OFF! <sup>2</sup>
ENGINE OIL LEVEL	REDUCE OIL LEVEL! <sup>3</sup>
ENGINE OIL LEVEL	VISIT WORKSHOP! <sup>4</sup>
ENGINE OIL SENSOR	VISIT WORKSHOP! <sup>5</sup>
ENGINE OIL	VISIT WORKSHOP! <sup>6</sup>

- 1 The engine oil level must be checked immediately. See Engine oil level indicator on page 117.
- 2 There is no oil in the engine. There is a danger of engine damage.

- 3 There is a risk of damaging the engine or catalytic converter. The engine oil level must be checked immediately. See Engine oil level indicator on page 117.
- 4 The engine oil level has dropped to a critical level. Check the engine oil level immediately. See Engine oil level indicator on page 117 and check the engine for visible leakage (loss of oil).
- 5 The measuring system is malfunctioning.
- 6 It may be that there is water in the engine oil. Have the engine oil checked.

When the “ENGINE OIL LEVEL – CHECK LEVEL” message appears while the engine is running and at operating temperature, the engine oil level has dropped to approximately the minimum mark on the dipstick. When this occurs, the warning will first come on intermittently and then stay on if the oil level drops further.

If no oil leaks are noted, continue to drive to the nearest service station where the engine oil should be topped to the “full” mark on the dipstick with an approved oil.

The engine oil level warnings should not be ignored. Extended driving with the symbol displayed could result in serious engine damage that is not covered by the Mercedes-Benz Limited Warranty.

## Malfunction and warning messages

252

## WASHER FLUID

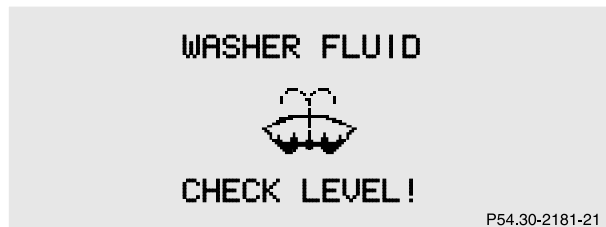

Line 1	Line 2
WASHER FLUID	CHECK LEVEL!

When this message appears while the engine is running, the level of the reservoir has dropped to approximately  $\frac{1}{3}$  of the total volume. The reservoir should be refilled with the prescribed mixture of MB Windshield Washer Concentrate “S” and water or the Concentrate and commercially available premixed windshield washer solvent/antifreeze, depending on ambient temperature, at the next opportunity. The reservoir for the windshield and headlamp washer systems is located in the engine compartment.

See windshield washer system on page 265 for instructions on topping up the washer fluid.

**ELEC. STABIL. PROG.**  
**(Electronic stability program)**



Line 1	Line 2
DISPLAY DEFECTIVE	VISIT WORKSHOP!
ELEC. STABIL. PROG.	VISIT WORKSHOP! <sup>1, 2, 3</sup>

- 1 A malfunction has been detected in the system. Pressing the accelerator pedal will require greater effort. Only partial engine output will be available.
- 2 This message may be displayed if the power supply was interrupted (battery disconnected or empty).
- 3 Synchronize ESP. See page 221.

**TELE AID**



Line 1	Line 2
TELE AID	VISIT WORKSHOP!

- 1 The Tele Aid system consists of three types of response; automatic and manual emergency, roadside assistance and information. With this message displayed, one or more functions may not be available.

See page 178 for notes on the Tele Aid.

If a malfunction is indicated as outlined above, have the system checked at the nearest Mercedes-Benz Center as soon as possible.





## Practical hints

First aid kit .....	256	Vehicle jack .....	267	Exterior lamps .....	288
Stowing things in the vehicle .....	256	Wheels .....	268	Headlamp assembly .....	289
Fuses .....	257	Tire replacement .....	268	Taillamp assemblies .....	292
Hood .....	259	Rotating wheels .....	269	Changing batteries	
Checking engine oil level .....	262	Spare wheel .....	270	in the electronic main key .....	294
Automatic transmission		Spare wheel bolts .....	270	Synchronizing	
fluid level .....	263	Spare wheel .....	271	remote control .....	296
Coolant level .....	263	Changing wheels .....	273	Emergency engine shut-down .....	296
Adding coolant .....	264	Tire inflation pressure .....	278	Rear seat cushion .....	297
Windshield and headlamp		Battery .....	280	Emergency operation of	
washer system .....	265	Jump starting .....	282	sliding / pop-up roof .....	298
Windshield and headlamp		Towing the vehicle .....	285	Manual release for	
washer fluid mixing ratio .....	265	Transmission selector lever,		fuel filler flap .....	299
Spare wheel, vehicle tools,		manually unlocking .....	287	Replacing wiper blade insert .....	300
storage compartment .....	266			Roof rack .....	302

## First aid kit

256

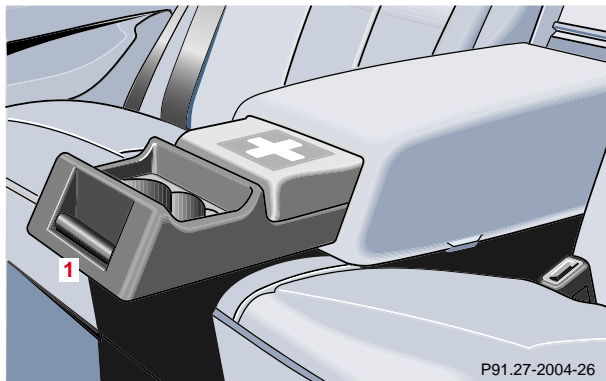
**First aid kit**

The first aid kit is located in the rear bench armrest.

To open:

Press button (1) and pull drawer out to its final stop.  
Remove the first aid kit.

**Stowing things in the vehicle****Warning!**

To help avoid personal injury during a collision or sudden maneuver, exercise care when stowing things. Put luggage or cargo in the trunk if possible. Do not pile luggage or cargo higher than the seat backs. Do not place anything on the shelf below the rear window.

## Fuses

Before replacing a blown fuse, determine the cause of the short circuit.

Spare fuses are supplied inside the main fuse box. Observe amperage and color of fuse.

A special fuse puller is supplied with the vehicle tools.

Always use a new fuse for replacement. Never attempt to repair or bridge a blown fuse.

A fuse chart can be found inside the corresponding fuse box cover.

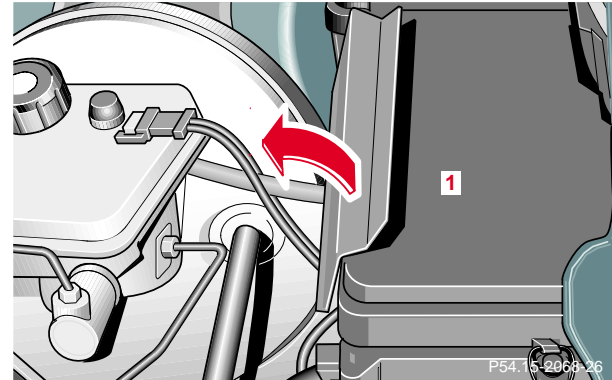

### 1 Main fuses box in engine compartment

To gain access to the main fuse box (1), release clamp (arrow), lift the fuse box cover up and remove it.

To close the main fuse box, engage right end of cover and secure with clamp.

## Fuses

258

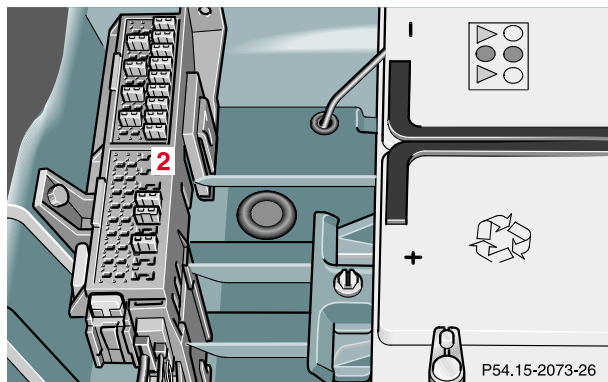

- 2** Auxiliary fuse box below rear seat bench  
To gain access, remove rear seat bench.  
See page 297.

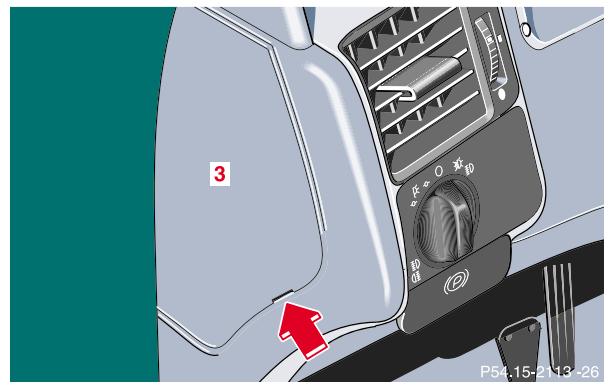

- 3** Auxiliary fuse box to left of exterior lamp switch  
To gain access, open door, pry off cover and  
remove.

## Hood

### Warning!

To help prevent personal injury, stay clear of moving parts when the hood is open and the engine is running. Be sure the hood is properly closed before driving. When closing hood, use extreme caution not to catch hands or fingers.

The radiator fan may continue to run for approximately 30 seconds or even restart after the engine has been turned off. Stay clear from fan blades.

If you see flames or smoke coming from the engine compartment, or if the coolant temperature gauge indicates that the engine is overheated, do not open the hood. Move away from vehicle and do not open the hood until the engine has cooled. If necessary, call a fire department.

The engine is equipped with a transistorized ignition system. Because of the high voltage it is dangerous to touch any components (ignition coils, spark plug sockets, diagnostic socket) of the ignition system

- with the engine running,
- while starting the engine,
- if ignition is “on” and the engine is turned manually.

## Engine compartment

260

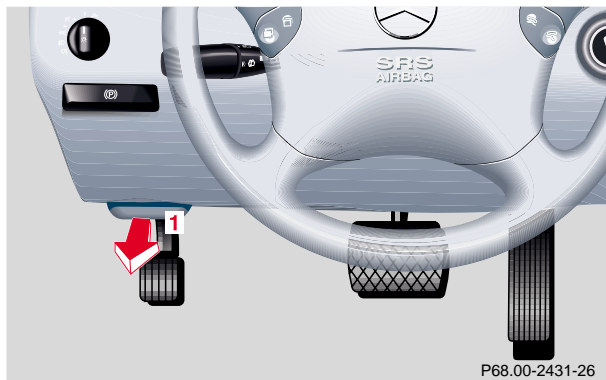

To open:

To unlock the hood, pull release lever (1) under the driver's side of the instrument panel. At the same time a handle will extend out of the radiator grill (it may be necessary to lift the hood up slightly).

**Caution!**

To avoid damage to the windshield wiper or hood, open the hood only with wiper in the parked position.

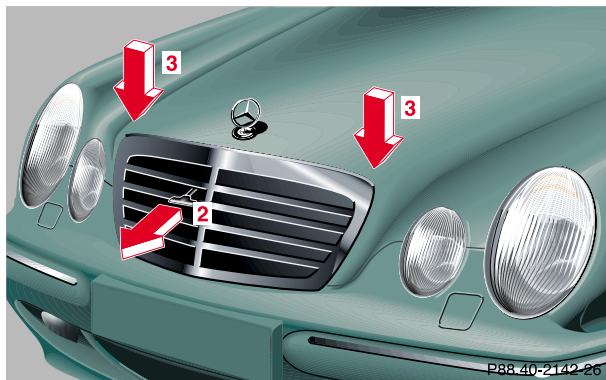

Pull handle (2) to its stop out of radiator grill and open hood (do not pull up on handle).

To close:

Lower hood and let it drop into lock from a height of approximately 1 ft. (30 cm), assisting with hands placed flat on edges of hood (3).

To avoid hood damage, please make sure that hood is fully closed. If not, repeat closing procedure. Do not push down on hood to attempt to fully close it.



## Engine compartment

262

## Checking engine oil level

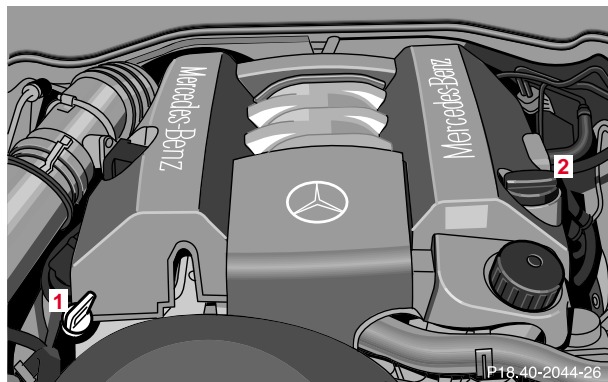

E 320 shown

- 1 Oil dipstick
- 2 Oil filler cap

To check the engine oil level, park vehicle on level ground, with engine at normal operational temperature.

Check engine oil level approximately 5 minutes after stopping the engine, allowing for the oil to return to the oil pan.

The engine oil level can be checked by either the oil dipstick or via the multifunction display in the instrument cluster.

Wipe oil dipstick clean prior to checking the engine oil level. Fully insert dipstick in tube, and remove after three seconds to obtain accurate reading.



The oil level must be between the lower mark (min) and the upper mark (max) on the oil dipstick.

Fill quantity between upper and lower dipstick marking level is approximately 2.1 US qt (2.0 l).

Do not overfill the engine.

Excessive oil must be drained or siphoned. It could cause damage to engine and catalytic converter not covered by the Mercedes-Benz Limited Warranty.

See malfunction and warning messages on page 251 if an engine oil level display appears on the multifunction display when the engine is running.

Note:

See page 117 for engine oil level indicator.

### Automatic transmission fluid level

The transmission has a permanent fill of automatic transmission fluid.

Regular automatic transmission fluid level checks and changes are not required. For this reason the dipstick is omitted.

If you notice fluid leaks or gear shifting malfunctions, have your authorized Mercedes-Benz Center check the transmission fluid level.

### Coolant level

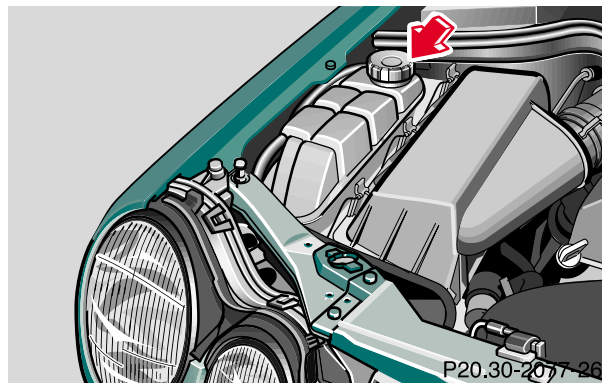

To check the coolant level, the vehicle must be parked on level ground and the engine stopped.

Check coolant level only when coolant is cold.

The coolant level should reach the black top part of the reservoir.

**Adding coolant**

If coolant has to be added, a 50/50 mixture of water and MB anticorrosion/antifreeze should be added.

The drain plugs for the cooling system are located on the right side of the engine block and at the bottom of the radiator.

Anticorrosion/antifreeze, see page 326.

**Warning!**

**In order to avoid possibly serious burns:**

- Use extreme caution when opening the hood if there are any signs of steam or coolant leaking from the cooling system, or if the coolant temperature gauge indicates that the coolant is overheated.

- Do not remove pressure cap on coolant reservoir if engine temperature is above 194°F (90°C). Allow engine to cool down before removing cap. The coolant reservoir contains hot fluid and is under pressure.
- Using a rag, slowly open cap approximately 1/2 turn to relieve excess pressure. If opened immediately, scalding hot fluid and steam will be blown out under pressure.
- Do not spill antifreeze on hot engine parts. Antifreeze contains ethylene glycol which may burn if it comes into contact with hot engine parts.

## Windshield and headlamp washer system

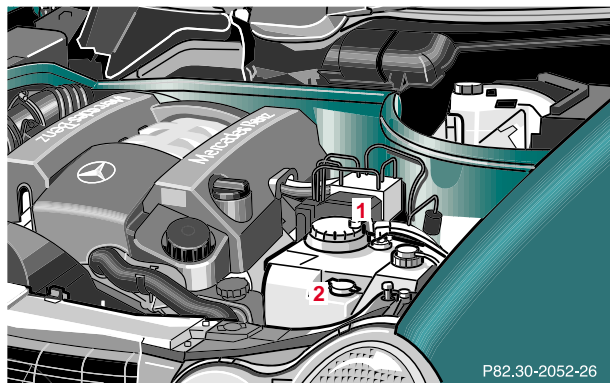

E 320 shown

### 1 Windshield washer fluid reservoir

Capacity approximately 5.8 US qt (5.5 l)

### 2 Headlamp washer fluid reservoir

Auxiliary tank connected to windshield washer reservoir. Open filler caps on both reservoirs during refilling.

Capacity approximately 1.9 US qt (1.8 l)

## Windshield and headlamp washer fluid mixing ratio

For temperatures above freezing:

MB Windshield Washer Concentrate “S” and water.

1 part “S” to 100 parts water

(40 ml “S” to 1 gallon water).

For temperature below freezing:

MB Windshield Washer Concentrate “S” and commercially available premixed windshield washer solvent/antifreeze.

1 part “S” to 100 parts solvent

(40 ml “S” to 1 gallon solvent).

## Spare wheel

266

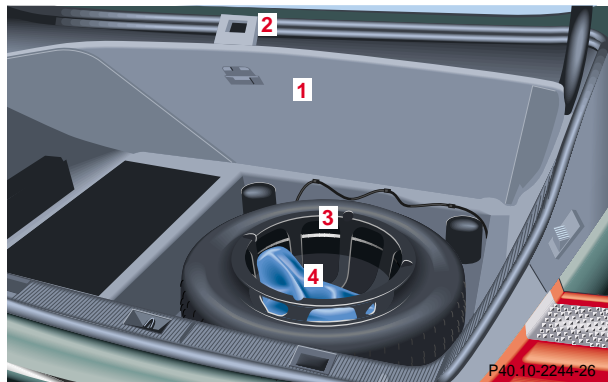
**Spare wheel, vehicle tools, storage compartment**

- 1 Trunk floor
- 2 Handle
- 3 Luggage bowl
- 4 Vehicle tools

Lift trunk floor and engage handle in upper edge of the trunk.

To remove spare tire:  
Turn luggage bowl counterclockwise and remove.

To store spare tire:  
Place spare tire in wheel well and secure it with luggage bowl. Turn luggage bowl clockwise to its stop.

Note:

Always lower trunk floor before closing trunk lid.

## Vehicle jack

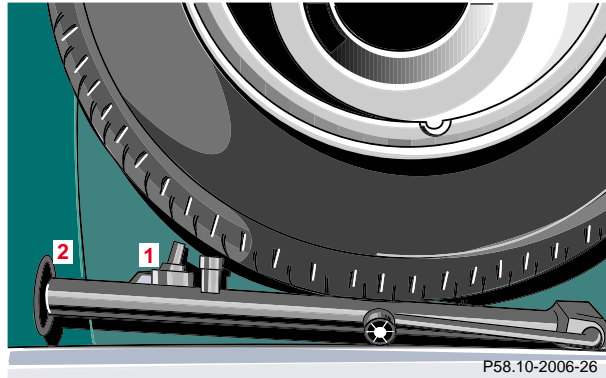

- 1 Jack arm
- 2 Jack base

See illustration for proper storage of jack.

Before storing the jack on the felt in the spare wheel well, the jack arm must be lowered almost to the base of the jack.

## Warning!

The jack is designed exclusively for jacking up the vehicle at the jack tubes built into either side of the vehicle. To help avoid personal injury, use the jack only to lift the vehicle during a wheel change. Never get beneath the vehicle while it is supported by the jack. Keep hands and feet away from the area under the lifted vehicle. Always firmly set parking brake and block wheels before raising vehicle with jack.

Do not disengage parking brake while the vehicle is raised. Be certain that the jack is always vertical when in use, especially on hills. Always try to use the jack on level surface. Be sure that the jack arm is fully inserted in the jack tube. Always lower the vehicle onto sufficient capacity jackstands before working under the vehicle.

## Tires, Wheels

268

**Wheels**

Replace rims or tires with the same designation, manufacturer and type as shown on the original part. See your authorized Mercedes-Benz Center for further information.

See your authorized Mercedes-Benz Center for information on tested and recommended rims and tires for summer and winter operation. They can also offer advice concerning tire service and purchase.

**Tire replacement**

Front tires should be replaced in sets. Rims and tires must be of the correct size and type. For dimensions, see page 317.

We recommend that you break in new tires for approximately 60 miles (100 km) at moderate speed.

It is imperative that the wheel mounting bolts be fastened to a tightening torque of 80 ft.lb. (110 Nm) whenever wheels are mounted.

For rim and tire specifications, see 317.

**Warning!**

**Worn, old tires can cause accidents. If the tire tread is badly worn, or if the tires have sustained damage, replace them.**

**When replacing rims, use only genuine Mercedes-Benz wheel bolts specified for the particular rim type. Failure to do so can result in the bolts loosening and possibly an accident.**

## Rotating wheels

Rotation of wheels does not apply to model E 55 AMG with summer tires.

The wheels can be rotated according to the degree of tire wear while retaining the same direction of travel.

Rotating, however, should be carried out as recommended by the tire manufacturer, before the characteristic tire wear pattern (shoulder wear on front wheels and tread center wear on rear wheels) becomes visible, as otherwise the driving properties deteriorate.

### Important!

Unidirectional tires must always be mounted with arrow on tire sidewall pointing in direction of vehicle forward movement.

### Notes:

Thoroughly clean the inner side of the wheels any time you rotate the wheels or wash the vehicle underside.

The use of retread tires is not recommended. Retread tires may adversely affect the handling characteristics and safety of the vehicle.

Dented or bent rims can cause tire pressure loss and damage to the tire beads. For this reason, check rims for damage at regular intervals. The rim flanges must be checked for wear before a tire is mounted. Remove burrs, if any.

Check and ensure proper tire inflation pressure after rotating the wheels. For tire inflation pressure see page 278.



## Tires, Wheels

270

**Spare wheel****Steel spare wheel rim**

(E 320 without sport package)

**Important!**

Unidirectional tires must always be mounted with arrow on tire sidewall pointing in direction of vehicle forward movement.

If the arrow on tire side wall does not point in direction of vehicle forward movement when using the spare wheel, observe the following restrictions:

- Drive to the nearest tire repair facility as soon as possible.

For rim and tire specifications, see page 317.

**Spare wheel bolts****Warning!**

Be sure to use the original length wheel bolts when remounting the original light alloy wheel after it has been repaired.

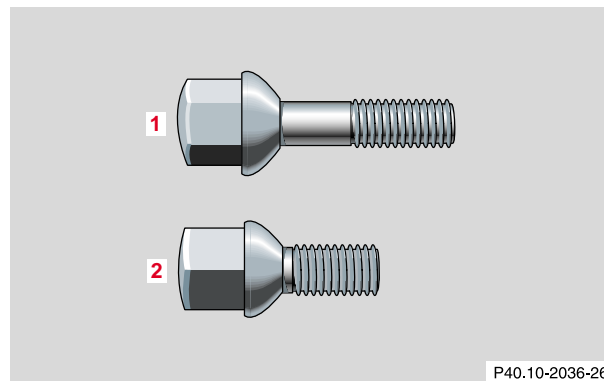

P40.10-2036-26

**1** Wheel bolt for light alloy wheel rim

**2** Wheel bolt for steel spare wheel rim

Note:

Wheel bolts (2) must be used when mounting steel spare wheel rim.

## Spare wheel

(E 320 with sport package, E 430)

### Important!

The spare wheel rim is mounted with a full size tire of the same type as on the vehicle, and is fully functional. However, that spare wheel rim is weight optimized and has a limited service life of 12 000 miles (20 000 km) use before a standard wheel rim must replace it.

In the case of a flat tire, you may temporarily use the spare wheel.

Do not operate vehicle with more than one spare wheel mounted.

Unidirectional tires must always be mounted with arrow on tire sidewall pointing in direction of vehicle forward movement.

If the arrow on tire side wall does not point in direction of vehicle forward movement when using the spare wheel, observe the following restrictions:

- Drive to the nearest tire repair facility as soon as possible.

### Warning!

**The spare wheel rim is for temporary use only. Use for over a total of 12 000 miles (20 000 km) (aggregate off all uses) may cause wheel rim failure leading to an accident and possible injuries.**

For rim and tire specifications, see page 317.

## Tires, Wheels

272

**Spare wheel**

(E 55 AMG)

The spare wheel rim size is 7 1/2 J x 17 H 2 with tire size 235/45 R 17 93 W.

**Important!**

In the case of a flat tire or breakdown, you may temporarily use the wheel when observing the following restrictions:

- Do not exceed vehicle speed of 50 mph (80 km/h).
- Drive to the nearest repair facility to have the flat tire repaired or replaced as appropriate.
- Do not operate vehicle with more than one spare wheel mounted.

**Warning!**

**The spare wheel rim is for temporary use only. Use for over a total of 12 000 miles (20 000 km) (aggregate off all uses) may cause wheel rim failure leading to an accident and possible injuries.**

**The dimensions of the spare wheel are different from those of road wheels. As a result, the vehicle handling characteristics change when driving with a mounted spare wheel.**

**The spare wheel should only be used temporarily, and replaced with a regular road wheel as quickly as possible.**

For rim and tire specifications, see page 317.

## Changing wheels

### Warning!

The jack is designed exclusively for jacking up the vehicle at the jack tubes built into either side of the vehicle. To help avoid personal injury, use the jack only to lift the vehicle during a wheel change.

Never get beneath the vehicle while it is supported by the jack. Keep hands and feet away from the area under the lifted vehicle. Always firmly set parking brake and block wheels before raising vehicle with jack.

Do not disengage parking brake while the vehicle is raised. Be certain that the jack is always vertical when in use, especially on hills. Always try to use the jack on level surface. Be sure that the jack arm is fully inserted in the jack tube. Always lower the vehicle onto sufficient capacity jackstands before working under the vehicle.

Move vehicle to a level area which is a safe distance from the roadway.

1. Set parking brake and turn on hazard warning flasher.
2. Move selector lever to position “P” and turn off engine.
3. Prevent vehicle from rolling away by blocking wheels with wheel chocks (not supplied with vehicle) or sizable wood block or stone. When changing a wheel on a hill, place chocks on the downhill side blocking both wheels of the other axle. On a level road, place one chock in front of and one behind the wheel that is diagonally opposite to the wheel being changed.

## Tires, Wheels

274



4. Using the wrench, loosen but do not yet remove the wheel bolts.

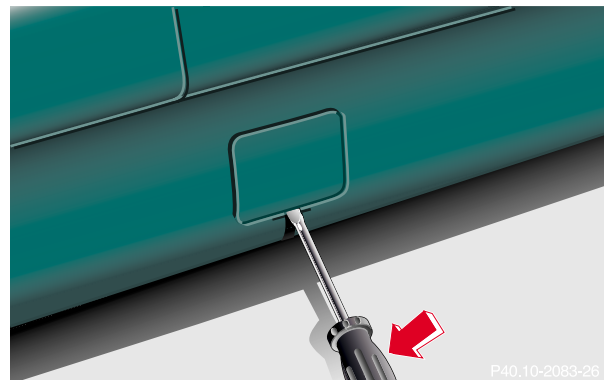

5. Remove the protective cover from the jack support tube opening by inserting the screwdriver (supplied in the tool kit) in the opening and prying it out.

The tube openings are located directly behind the front wheel housings and in front of the rear wheel housings.

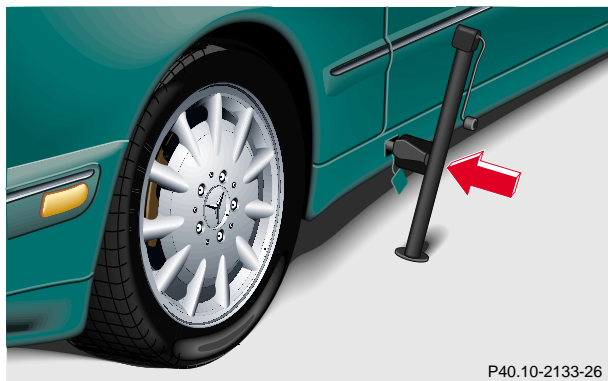

6. Insert jack arm fully into the tube hole up to the stop. Place jack on firm ground. Position the jack so that it is always vertical (plumb-line) as seen from the side (see arrow), even if the vehicle is parked on an incline.
7. Jack up the vehicle until the wheel is clear of the ground. Never start engine while vehicle is raised.



8. Unscrew upper-most wheel bolt and install alignment bolt (1) supplied in the tool kit. Remove the remaining bolts. Keep bolt threads protected from dirt and sand.
9. Remove wheel. Grip wheel from the sides. Keep hands from beneath the wheels.

## Tires, Wheels

276

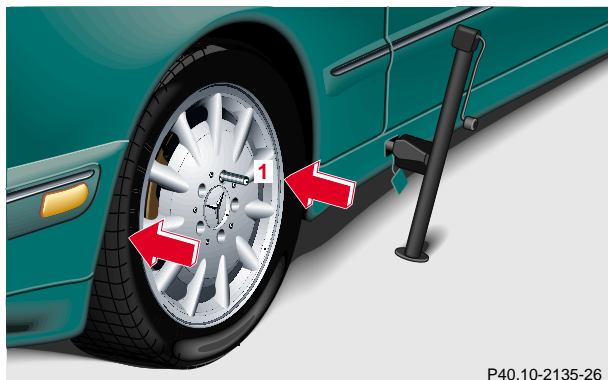

10. Clean contact surfaces of wheel and wheel hub. Install wheel on wheel hub. Insert wheel bolts and tighten them slightly.

To avoid paint damage, place wheel flat against hub and hold it there while installing first wheel bolt.

Unscrew the alignment bolt (1) to install the last wheel bolt.

**Important!**

E 320 (except sport package) only:

When installing steel spare wheel rim, make certain to use the correct wheel bolts, supplied in the vehicle tool kit, see page 270 and page 266.

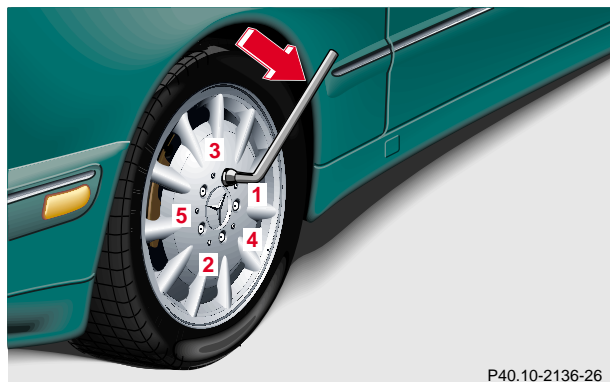

11. Lower vehicle. Remove jack and insert jack tube cover.  
Before storing the jack, the jack arm must be lowered almost to the base of the jack.
12. Using the wrench, tighten the five bolts evenly, following the sequence illustrated, until all bolts are tight.  
Observe a tightening torque of 80 ft.lb. (110 Nm).
13. Ensure proper tire pressure.

### Warning!

Always replace wheel bolts that are damaged or rusted.

Never apply oil or grease to wheel bolts.

Damaged wheel hub threads should be repaired immediately.

Incorrect mounting bolts or improperly tightened mounting bolts can cause the wheel to come off. This could cause an accident. Be sure to use the correct mounting bolts.

### Warning!

The spare wheel rim is for temporary use only. Use for over a total of 12 000 miles (20 000 km) (aggregate of all uses) may cause wheel rim failure leading to an accident and possible injuries.



## Tires, Wheels

278

**Tire inflation pressure**

A table (see fuel filler flap) lists the tire inflation pressures specified for Mercedes-Benz recommended tires as well as for the varying operating conditions.

**Important!**

Tire pressure changes by approximately 1.5 psi (0.1 bar) per 18°F (10°C) of air temperature change. Keep this in mind when checking tire pressure inside a garage - especially in the winter.

Example:

If garage temperature = approximately +68°F (+20°C)  
and ambient temperature = approximately +32°F (0°C)  
then the adjusted air pressure = specified air pressure +3 psi (+0.2 bar).

Tire pressures listed for light loads are minimum values offering high driving comfort. Increased inflation pressures for heavy loads produce favorable handling characteristics with lighter loads and are perfectly permissible. The ride of the vehicle, however, will become somewhat harder.

Tire temperature and pressure increase with the vehicle speed. Tire pressure should therefore only be checked and corrected on cold tires. Correct tire pressure in warm tires only if pressure has dropped below the pressure listed in the table and the respective operating conditions are taken into consideration.

An underinflated tire due to a slow leak (e.g. due to a nail in the tire) may cause damage such as tread separation, bulging etc.. Regular tire pressure checks (including the spare tire) at intervals of no more than 14 days are therefore essential.

If a tire constantly loses air, it should be inspected for damage.

The spare tire should be checked periodically for condition and inflation. Spare tire will age and become worn over time even if never used, and thus should be inspected and replaced when necessary.

### Warning!

**Do not overinflate tires. Overinflating tires can result in sudden deflation (blowout) because they are more likely to become punctured or damaged by road debris, potholes etc.. Follow recommended inflation pressures.**

**Do not overload the tires by exceeding the specified vehicle capacity weight (as indicated by the label on the driver's door latch post). Overloading the tires can overheat them, possibly causing a blowout.**

**Battery****Warning!**

**Failure to follow these instructions can result in severe injury or death.**

**Never lean over batteries while connecting, you might get injured.**

**Battery fluid contains sulfuric acid. Do not allow this fluid to come in contact with eyes, skin or clothing. In case it does, immediately flush affected area with water and seek medical help if necessary.**

**A battery will also produce hydrogen gas, which is flammable and explosive. Keep flames or sparks away from battery, avoid improper connection of jumper cables, smoking etc..**

**Important!**

Battery replacement information:

The maintenance-free battery is located under the rear seat cushion. To minimize the chance for acid leakage which could cause severe burns during a crash or rollover, a special acid leakage resistant battery was factory installed. A replacement battery for the vehicle

must not leak acid when upside down for at least 15 minutes. Your authorized Mercedes-Benz Center can provide such a special battery.

The service life of the battery is dependent on its condition of charge. The battery should always be kept sufficiently charged, in order to last an optimum length of time.

**Therefore, we strongly recommend that you have the battery charge checked frequently, and corrected if necessary, especially if you use the vehicle less than approximately 200 miles (300 km) per month, mostly for short distance trips, or if it is not used for long periods of time.**

Only charge a battery with a battery charger after the battery has been disconnected from the vehicle's electrical circuit.

Always disconnect the battery negative lead first and connect last.

When removing and connecting the battery, always make sure that all electrical consumers are off and the electronic key is in steering lock position 0. The battery, its filler caps, the vent tube and the opposite plug must always be securely installed when the vehicle in

operation. During removal and installation always protect the disconnected battery positive (+) terminal with the cover attached to the battery.

While the engine is running the battery terminal clamps must not be loosened or detached, otherwise the generator and other electronic components would be damaged.

Note:

The selector lever will remain locked in position “P” and the electronic key cannot be turned in the steering lock, if the vehicle battery is disconnected or discharged.

After reconnecting the battery also resynchronize the front seat head restraints, the express feature of the power windows, and the electronic stability program (ESP), see pages 47, 156 and 221.

## **Battery recycling**

Batteries contain material that can harm the environment with improper disposal.

Large 12 Volt storage batteries contain lead.

Recycling of batteries is the preferred method of disposal.

Many states require sellers of batteries to accept old batteries for recycling.

## Jump starting

282

**Jump starting****Warning!**

**Failure to follow these directions will cause damage to the electronic components, and can lead to a battery explosion and severe injury or death.**

**Never lean over batteries while connecting or jump starting, you might get injured.**

**Battery fluid contains sulfuric acid. Do not allow this fluid to come in contact with eyes, skin or clothing. In case it does, immediately flush affected area with water, and seek medical help if necessary.**

**A battery will also produce hydrogen gas, which is flammable and very explosive. Keep flames or sparks away from battery, avoid improper connection of jumper cables, smoking etc..**

**Read all instructions before proceeding.**

**Important!**

A discharged battery can freeze at approximately +14°F (-10°C). In that case, it must be thawed out before jumper cables are used. Attempting to jump start a frozen battery can result in it exploding, causing personal injury.

Jumper cable specifications:

- Minimum cable cross-section of 25 mm<sup>2</sup> or approximately 2 AWG
- Maximum length of 11.5 ft. (3.5 m).

If the battery is discharged, the engine should be started with jumper cables and the (12 V) battery of another vehicle.

Only use 12 V battery to jump start your vehicle. Jump starting with more powerful battery could damage the vehicle's electrical systems, which will not be covered by the Mercedes-Benz Limited Warranty.

Jump start the vehicle by using the battery terminals located under hood.

Proceed as follows:

1. Position the vehicle with the charged battery so that the jumper cables will reach, but never let the vehicles touch. Make sure the jumper cables do not have loose or missing insulation.
2. On both vehicles:
  - Turn off engine and all lights and accessories, except hazard warning flashers or work lights.
  - Apply parking brake and shift selector lever to position "P".

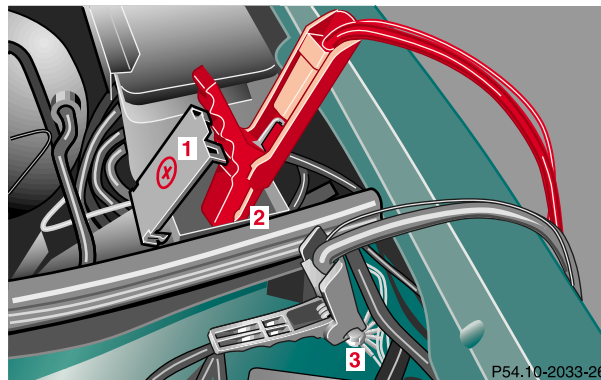

### Important!

3. Lift cover (1) and clamp one end of the first jumper cable to the positive (+) under hood terminal (2) of the discharged battery and the other end to the positive (+) terminal of the charged battery. Make sure the cable clamps do not touch any other metal parts.
4. Clamp one end of the second jumper cable to the grounded negative (-) terminal of the charged battery and the final connection to the negative (-) under hood terminal (3) of the disabled vehicle.

## Jump starting

284

**Important!**

5. Start engine of the vehicle with the charged battery and run at high idle. Make sure the cables are not on or near pulleys, fans, or other parts that move when the engine is started. Allow the discharged battery to charge for a few minutes. Start engine of the disabled vehicle in the usual manner.
6. After the engine has started, remove jumper cables by exactly reversing the above installation sequence, starting with the last connection made first. When removing each clamp, make sure that it does not touch any other metal while the other end is still attached.

## Note:

If engine does not run after several unsuccessful starting attempts, have it checked at the nearest authorized Mercedes-Benz Center.

Excessive unburned fuel may damage the catalytic converter.

## Towing the vehicle

### Warning

**Prior to towing the vehicle with all wheels on the ground, make certain that the electronic key is in steering lock position 2. The maximum towing speed and distance with the vehicle on the ground is 30 mph and 30 miles.**

**If the electronic key is left in the steering lock position 0 for an extended period of time, it can no longer be turned in the lock. In this case, the steering is locked. To unlock, remove electronic key from steering lock and reinsert.**

### Important!

When towing the vehicle, please, note the following:

With the automatic central locking activated and the electronic key in steering lock position 2, the vehicle doors lock if the left front wheel as well as the right rear wheel are turning at vehicle speeds of approximately 9 mph (15 km/h) or more.

To prevent the vehicle door locks from locking, deactivate the automatic central locking.

The rear towing eye is located at the right, below the bumper.



## Towing the vehicle

286

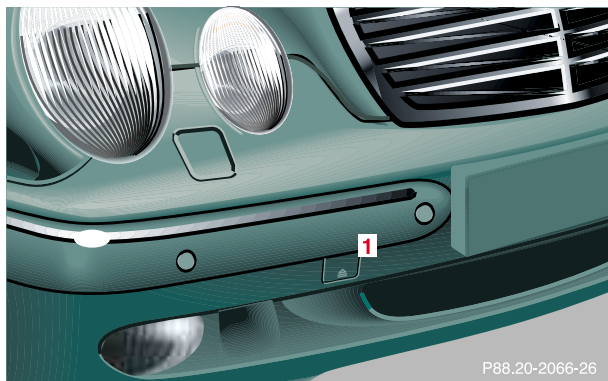
**1** Cover on right side of front bumper

To remove cover:

Press mark on cover in direction of arrow and lift cover off to reveal threaded hole for towing eye bolt. The towing eye bolt is supplied with the vehicle tools. Screw towing eye bolt in to its stop and tighten with lug wrench.

To reinstall cover:

Engage cover (1) at bottom and press in top securely.

We recommend that the vehicle be transported using flat bed equipment. This method is preferable to other types of towing.

The vehicle may be towed with all wheels on the ground and the selector lever in position “N” for distances up to 30 miles (50 km) and at a speed not to exceed 30 mph (50 km/h). The electronic key must be in steering lock position 2.

To be certain to avoid a possibility of damage to the transmission, however, we recommend the drive shaft be disconnected at the rear axle drive flange for any towing beyond a short tow to a nearby garage.

Do not tow with sling-type equipment. Towing with sling-type equipment over bumpy roads will damage radiator and supports.

Use wheel lift, dolly, or flat bed equipment, with electronic key in steering lock turned to position 0.

**Warning!**

**With the engine not running, there is no power assistance for the braking and steering systems. In this case, it is important to keep in mind that a considerably higher degree of effort is necessary to brake and steer the vehicle.**

Note:

To signal turns while being towed with hazard warning flasher in use, turn electronic key in steering lock to position 2 and activate combination switch for left or right turn signal in usual manner – only the selected turn signal will operate.

Upon canceling the turn signal, the hazard warning flasher will operate again.

### Caution!

If the vehicle is towed with the front axle raised, the engine must be shut off (electronic key in steering lock position 0 or 1). Otherwise, the ESP will immediately be engaged and will apply the rear wheel brakes.

Switch off the tow-away alarm, see page 44, and the automatic center locking on page 35.

### Transmission selector lever, manually unlocking



P27.60-2048-26

In the case of power failure the transmission selector lever can be manually unlocked, e.g. to tow the vehicle.

To do so, insert a pin (1), e.g. ball point pen, into the covered opening below the position “D” of the shift pattern. While pushing the pin down, move selector lever from position “P”.

After removal of the pin from the opening, the cover will not close fully. Only after moving the selector lever to positions “D+” and “D-” does the cover return to its closed position.

## Exterior lamps

288

**Exterior lamps****Replacing bulbs****Warning!**

**Bulbs and bulb holder can be very hot. Allow the lamp to cool down before changing a bulb.**

**Halogen lamps contain pressurized gas. A bulb can explode if you:**

- touch or move it when hot,
- drop the bulb,
- scratch the bulb.

**Wear eye and hand protection.**

Notes:

To prevent a possible electrical short circuit, switch off lamp prior to replacing a bulb.

When replacing bulbs, install only 12 volt bulbs with the specified watt rating.

When replacing halogen bulbs do not touch glass portion of bulb with bare hands. Use plain paper or a clean cloth.

**Warning!**

**Because of high voltage in Xenon lamps, it is dangerous to replace the bulb or repair the lamp and its components. We recommend that you have such work done by a qualified technician.**

## Headlamp assembly

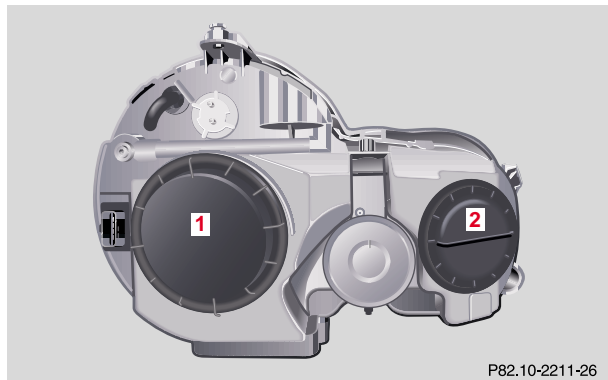

- 1 Headlamp cover for low beam headlamp
- 2 Headlamp cover for high beam headlamp, parking and standing lamp

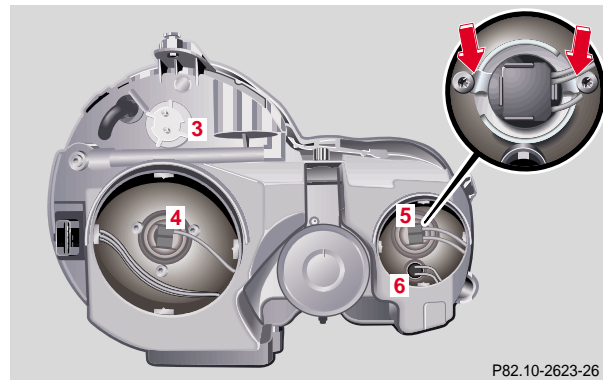

- 3 Bulb socket for turn signal lamp
- 4 Electrical connector for low beam headlamp bulb
- 5 Electrical connector for high beam headlamp bulb
- 6 Bulb socket for parking and standing lamp

## Exterior lamps

290

**Bulbs for high and low beam**

H7 (55 W)

Open hood.

Twist cover (1 or 2) counterclockwise and remove.

Pull off electrical connector (4) or (5).

Twist bulb holder counterclockwise and remove bulb from it.

Insert the new bulb so that its base fits in recess of the holder.

Install bulb holder and twist clockwise to its stop, and reinstall electrical connector.

Reinstall cover (1 or 2), twist it clockwise until seated securely.

**Xenon** (optional)**Bulb for low beam****Warning!**

**Because of high voltage in Xenon lamps, it is dangerous to replace the bulb or repair the lamp and its components. We recommend that you have such work done by a qualified technician.**

**Bulbs for high beam**

H7 (55 W)

Open hood.

Twist cover (2) counterclockwise and remove.

Pull off electrical connector.

Twist bulb holder counterclockwise and remove bulb from it.

Insert the new bulb so that its base fits in recess of the holder.

Install bulb holder and twist clockwise to its stop, and reinstall electrical connector. Ensure that base is secured on both sides (arrows)

Reinstall cover (2), twist it clockwise until seated securely.

### **Turn signal lamp**

1156 NA (26.9/5 W/32/4 cp bulb)

Open hood.

Twist bulb socket (3) counterclockwise and pull out. Push bulb into socket, turn counterclockwise and remove.

Insert new bulb in socket, push in and twist clockwise. Reinstall bulb socket. Reinstall lamp assembly until properly seated.

### **Parking and standing lamp**

H 6W (6 W bulb)

Open hood.

Twist cover (2) counterclockwise and remove.

Pull off electrical connector (6).

Twist bulb socket (6) counterclockwise and pull out. Push bulb into socket, turn counterclockwise and remove.

Insert new bulb in socket, push in and twist clockwise. Reinstall bulb socket. Reinstall lamp assembly until properly seated.

## Exterior lamps

292

## Taillamp assemblies

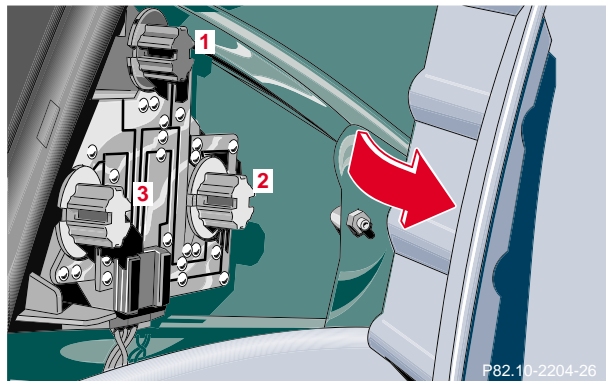

Open trunk lid.

Swing cover aside.

- 1 Turn signal lamp (21 W/24 cp bulb)
- 2 Stop, tail and parking lamp (21/4 W bulb)
- 3 Tail, parking and side marker lamp (5 W/4 cp bulb)

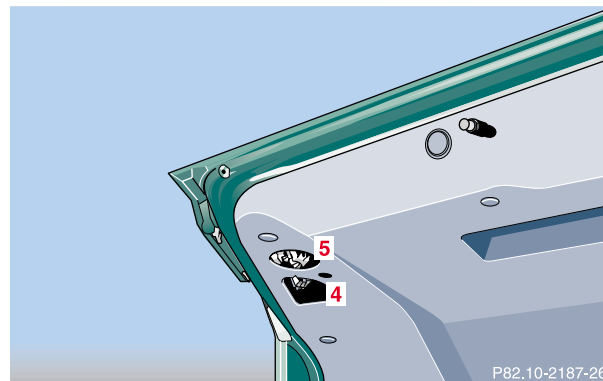

- 4 Driver's side:  
Rear fog lamp (21 W/32 cp bulb)
- 5 Backup lamp (21 W/32 cp bulb)

Twist bulb socket counterclockwise and pull out. Push bulb into socket, turn counterclockwise and remove.

Insert new bulb in socket, push in and twist clockwise. Reinstall bulb socket.

### Side marker lamp, front

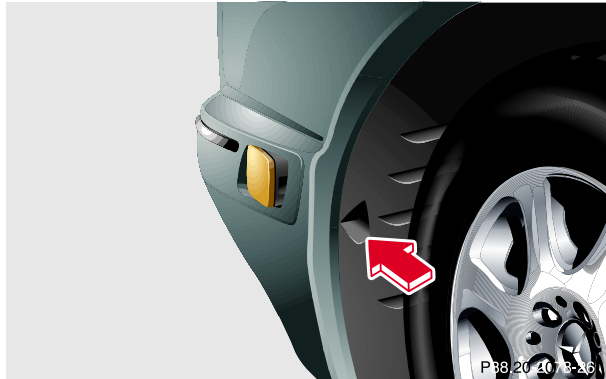

### Side marker lamp, front (5 W/4 cp bulb)

From inside wheel house (arrow) reach behind side marker lamp and press tab. Remove lamp from bumper and take out bulb.

### High mounted stop lamp, Additional turn signals on the exterior mirror

The high mounted stop lamp (3rd brake lamp), and the additional turn signals on the exterior mirrors are equipped with LED's.

Have the system checked at an authorized Mercedes-Benz Center if a malfunction occurs.



## Electronic main key

294

**Changing batteries in the electronic main key****1** Transmit buttons**2** Lamp for battery check and function control**Checking batteries**

If one of the transmit buttons (1) is pressed, the battery check lamp (2) lights up briefly – indicating that the batteries are in order.

Change batteries if the battery check lamp (2) does not light up briefly.

**Changing batteries**

Move locking tab (3) in direction of right arrow and remove mechanical key (4, left arrow).



Insert mechanical key (4) in side opening (5) to open latch. Press briefly (do not use mechanical key as lever) to release battery compartment.

Remove mechanical key from side opening.

Carefully remove battery compartment in direction of arrow (6).



Change batteries (7), inserting new ones under contact spring (8) with plus (+) side facing up.

Return battery compartment into housing until locked in place and slide mechanical key back into electronic main key.

## Electronic main key

296

**Important!**

Batteries contain materials that can harm the environment if disposed of improperly. Recycling of batteries is the preferred method of disposal. For disposal, please follow manufacturer's recommendation on battery package.

Replacement Battery:  
Lithium, type CR 2025 or equivalent.

**Synchronizing remote control**

The remote control may have to be resynchronized, if the vehicle cannot be locked or unlocked.

To synchronize insert electronic key in steering lock.

The remote control should once again be operational.

**Emergency engine shut-down**

If the engine can no longer be stopped using the electronic key, the engine can be turned off by removing two fuses.

For easy removal of fuses use the fuse extractor (supplied with vehicle tool kit) to pull out the fuses marked on the fuse chart as "ENGINE EMERGENCY OFF".

The fuse chart is also located in the vehicle tool kit, see page 266.

For fuses see page 257.

## Rear seat cushion

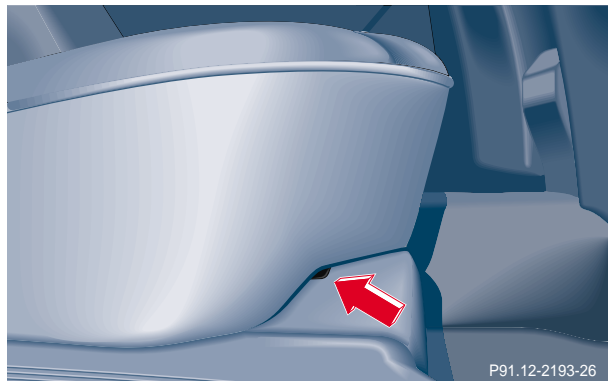

### Removal:

Pull locking tabs up (on left and right side of seat) and lift seat at the front.

### Installation:

Guide seat belt buckles through openings in seat cushion. Slide rear edge of cushion under the backrest as far as it will go, and push front of cushion down until it locks in place.

### Caution!

Watch out for sharp edges when removing or installing the rear seat cushion, and make sure that it is securely locked in place again, to prevent personal injury.

## Emergency operation of sliding / pop-up roof

298

## Emergency operation of sliding/pop-up roof

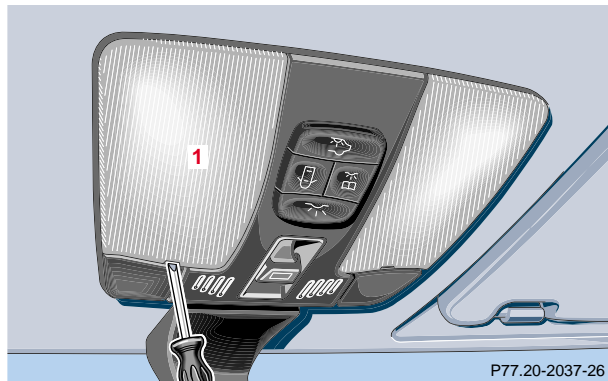

The sliding/pop-up roof can be opened or closed manually should an electrical malfunction occur.

The sliding/pop-up roof drive is located behind the lens of the left interior lamp between the sun visors.

1. Pry off lens (1) by using a screw driver.
2. Remove cover (2).
3. Obtain crank (3) (supplied with vehicle) and insert it through hole.

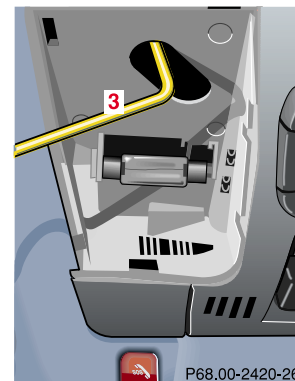
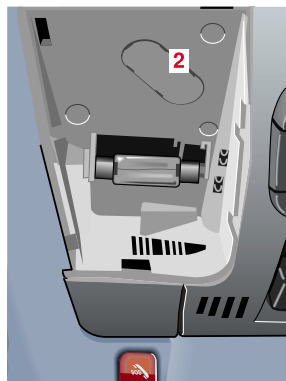

To slide the roof closed or to raise the roof at the rear: turn crank clockwise.

To slide the roof open or to lower the roof at the rear: turn crank counterclockwise.

Note:

Push crank upward while turning it, to disengage the electric motor.

## Manual release for fuel filler flap

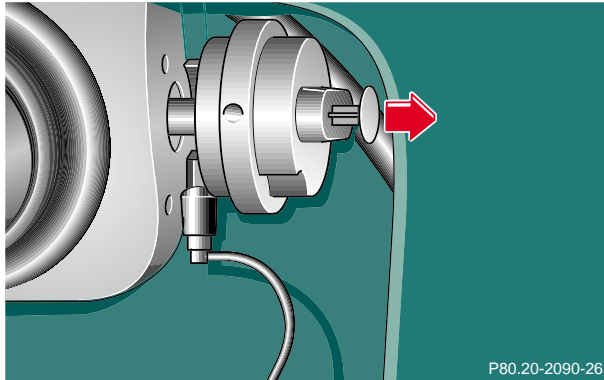

The manual release knob is located behind the right side trunk panel.

In case the central locking system does not release the fuel filler flap, pull the manual release knob while simultaneously opening the fuel filler flap.

## Replacing wiper blade insert

300

**Replacing wiper blade insert**

For safety reasons, remove electronic key from steering lock before replacing the wiper blade, otherwise the motor can suddenly turn on and cause injury.

## Notes:

Do not open engine hood with wiper arm folded forward.

Do not allow the wiper arm to contact the windshield glass without a wiper blade inserted. The glass may be scratched or broken.

Make certain that the wiper blade is properly installed. An improperly installed wiper blade may cause windshield damage.

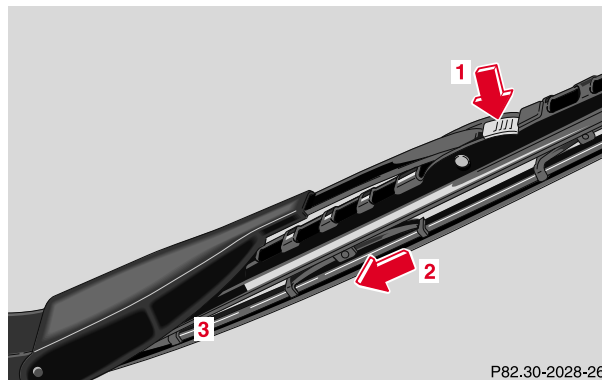

## Removal:

Fold wiper arm forward. Press safety tab down (1), push wiper blade downward (2) and remove.

Place wiper blade on firm support. Press down both tabs and slide (direction of arrow) the wiper blade insert out of the retainers.

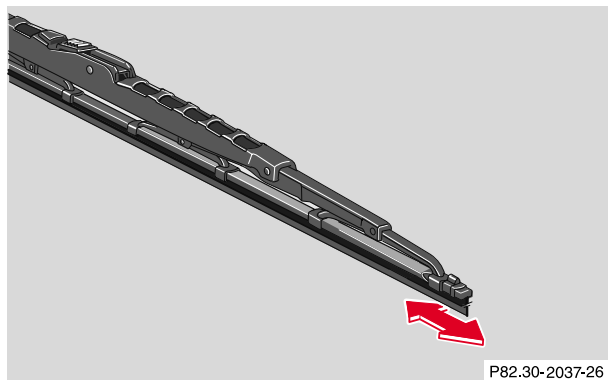

#### Installation:

Slide (direction of arrow) wiper blade insert into retainer claws until tabs are engaged.

Insert wiper blade between tabs (3) on the wiper arm, and slide into end of wiper arm. Press safety tab upward until it locks in place.



## Roof rack

302

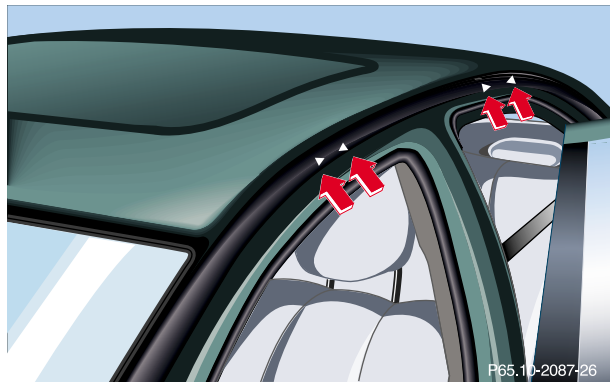
**Roof rack**

Use only those roof racks approved by Mercedes-Benz to avoid damage to the vehicle. Follow manufacturer's installation instructions.

Mount supports only between markings on border of roof which are visible when doors are opened.

## Vehicle care

### Cleaning and care

of the vehicle .....	304
Power washer .....	305
Tar stains .....	305
Paintwork, painted body components .....	305
Engine cleaning .....	306
Vehicle washing .....	306
Ornamental moldings .....	306
Headlamps, taillamps, turn signal lenses .....	306
Cleaning the parktronic system sensors .....	307

Window cleaning / glass sunroof .....	307
Wiper blades .....	307
Light alloy wheels .....	308
Instrument cluster .....	308
Steering wheel and gear selector lever .....	308
Cup holder .....	308
Seat belts .....	308
Headliner and shelf below rear window .....	308
Upholstery .....	309
Hard plastic trim items .....	309
Plastic and rubber parts .....	309

### Cleaning and care of the vehicle

#### Warning!

**Many cleaning products can be hazardous. Some are poisonous, others are flammable. Always follow the instructions on the particular container. Always open your vehicle's doors or windows when cleaning the inside.**

**Never use fluids or solvents that are not designed for cleaning your vehicle.**

In operation, your vehicle is subjected to varying external influences which, if gone unchecked, can attack the paintwork as well as the underbody and cause lasting damage.

Such damage is caused not only by extreme and varying climatic conditions, but also by air pollution, road salt, tar, gravel and stone chipping. Grease and oil, fuel, coolant, brake fluid, bird droppings, insects, tree resins etc. should be removed immediately to avoid paint damage. Frequent washing reduces and/or eliminates the aggressiveness and potency of the above adverse influences.

More frequent washings are necessary to deal with unfavorable conditions; for example, near the ocean, in industrial areas (smoke, exhaust emissions), or during winter operation.

You should check your vehicle from time to time for stone chipping or other damage. Any damage should be repaired as soon as possible to prevent the start of corrosion.

In doing so, do not neglect the underside of the vehicle. A prerequisite for a thorough check is a washing of the underbody followed by a thorough inspection. Damaged areas need to be reundercoated.

Your vehicle has been treated at the factory with a wax-base rustproofing in the body cavities which will last for the lifetime of the vehicle. Post-production treatment is neither necessary nor recommended by Mercedes-Benz because of the possibility of incompatibility between materials used in the production process and others applied later.

We have selected car-care products and compiled recommendations which are specially matched to our vehicles and which always reflect the latest technology. You can obtain Mercedes-Benz approved car-care products at your authorized Mercedes-Benz Center.

Scratches, corrosive deposits, corrosion or damage due to negligent or incorrect care cannot always be removed or repaired with the car-care products recommended here. In such cases it is best to seek aid at your authorized Mercedes-Benz Center.

The following topics deal with the cleaning and care of your vehicle and give important “how-to” information as well as references to Mercedes-Benz approved car-care products.

Additional information can be found in the booklet titled “Vehicle Car Guide”.

### **Power washer**

When using a power washer for cleaning the vehicle always observe manufacturers’ operating instructions.

### **Caution!**

Never use a round nozzle to power wash tires. The intense jet of water can result in damage to the tire.

Always replace a damaged tire.

Always keep the jet of water moving across the surface. Do not aim directly at electrical parts, electrical connectors, seals, or other rubber parts.

### **Tar stains**

Quickly remove tar stains before they dry and become more difficult to remove. A tar remover is recommended.

### **Paintwork, painted body components**

Mercedes-Benz approved Paint Care should be applied when water drops on the paint surface do not “bead up”, normally in 3 to 5 months, depending on climate and washing detergent used.

Mercedes-Benz approved Paint Cleaner should be applied if paint surface shows signs of dirt embedding (i.e. loss of gloss).

Do not apply any of these products or wax if your vehicle is parked in the sun or if the hood is still hot.

Use the appropriate MB-Touch-Up Stick for quick and provisional repairs of minor paint damage (i.e. chips from stones, vehicle doors etc.).

**Cleaning and care of the vehicle**

306

**Engine cleaning**

Prior to cleaning the engine compartment make sure to protect electrical components and connectors from the intrusion of water and cleaning agents.

Corrosion protection, such as MB Anticorrosion Wax should be applied to the engine compartment after every engine cleaning. Before applying, all control linkage bushings and joints should be lubricated. The poly-V-belt and all pulleys should be protected from any wax.

**Vehicle washing**

Do not use hot water or wash your vehicle in direct sunlight. Use only a mild car wash detergent, such as Mercedes-Benz approved Car Shampoo.

Thoroughly spray the vehicle with a diffused jet of water. Direct only a very weak spray towards the ventilation intake. Use plenty of water and rinse the sponge and chamois frequently.

Rinse with clear water and thoroughly wipe dry with a chamois. Do not allow cleaning agents to dry on the finish.

Due to the width of the vehicle, prior to running the vehicle through an automatic car wash, fold back the outside mirrors to prevent them from getting damaged.

In the winter, thoroughly remove all traces of road salt as soon as possible.

When washing the underbody, do not forget to clean the inner sides of the wheels.

**Ornamental moldings**

For regular cleaning and care of very dirty chrome-plated parts, use a chrome cleaner.

**Headlamps, taillamps, turn signal lenses**

Use a mild car wash detergent, such as Mercedes-Benz approved Car Shampoo, with plenty of water.

To prevent scratches, never apply strong force and use only a soft, non-scratchy cloth when cleaning the lenses. Do not attempt to wipe dirty lenses with a dry cloth or sponge.

## Cleaning the parktronic system sensors

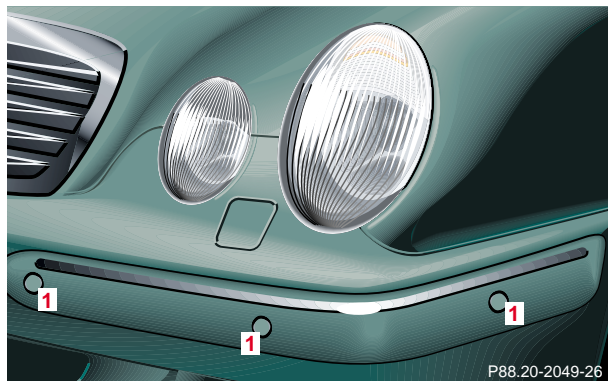

Use a mild car wash detergent, such as Mercedes-Benz approved Car Shampoo, with plenty of water.

When using a steam cleaner or power washer, aim nozzle only briefly from a minimum distance of 4 in. (10 cm) at sensors (1).

To prevent scratches, never apply strong force and use only a soft, non-scratchy cloth when cleaning the sensors. Do not attempt to wipe dirty sensors with a dry cloth or sponge.

## Window cleaning

Use a window cleaning solution on all glass surfaces. An automotive glass cleaner is recommended.

Note:

For safety reasons, remove electronic key from steering lock before cleaning the windshield, otherwise the wiper motor can suddenly turn on and cause injury.

## Wiper blade

Clean the wiper blade rubber with a clean cloth and detergent solution.

Note:

For safety reasons, remove electronic key from steering lock before cleaning the wiper blade, otherwise the wiper motor can suddenly turn on and cause injury.

## Cleaning and care of the vehicle

308

### Light alloy wheels

Mercedes-Benz approved Wheel Care should be used for regular cleaning of the light alloy wheels.

If possible, clean wheels once a week with Mercedes-Benz approved Wheel Care, using a soft bristle brush and a strong spray of water.

Follow instructions on container.

Note:

Use only acid-free cleaning materials. The acid could lead to corrosion.

### Instrument cluster

Use a gentle dishwashing detergent or mild detergent for delicate fabrics as a washing solution. Wipe with a cloth moistened in lukewarm solution. Do not use scouring agents.

### Steering wheel and gear selector lever

Wipe with a damp cloth and dry thoroughly or clean with Mercedes-Benz approved Leather Care.

### Cup holder

Use a gentle dishwashing detergent or mild detergent for delicate fabrics as a washing solution. Wipe with a cloth moistened in lukewarm solution. Do not use scouring agents.

### Seat belts

The webbing must not be treated with chemical cleaning agents. Use only clear, lukewarm water and soap. Do not dry the webbing at temperatures above 176°F (80°C) or in direct sunlight.

### Warning!

**Do not bleach or dye seat belts as this may severely weaken them. In a crash they may not be able to provide adequate protection.**

### Headliner and shelf below rear window

Clean with soft bristle brush, or use a dry-shampoo cleaner in case of excessive dirt.

## **Upholstery**

Using aftermarket seat covers or wearing clothing that have the tendency to give off coloring (e.g. when wet etc.) may cause the upholstery to become permanently discolored. By lining the seats with a proper intermediate cover, contact-discoloration will be prevented.

### **Leather Upholstery**

Wipe leather upholstery with a damp cloth and dry thoroughly or clean with Mercedes-Benz approved Leather Care. Exercise particular care when cleaning perforated leather as its underside should not become wet.

### **Cloth Upholstery**

Clean with soft bristle brush, or use a dry-shampoo cleaner in case of excessive dirt.

### **MB Tex Upholstery**

Pour Mercedes-Benz approved Interior Care onto soft lint-free cloth and apply with light pressure.

## **Hard plastic trim items**

Pour Mercedes-Benz approved Interior Care onto soft lint-free cloth and apply with light pressure.

## **Plastic and rubber parts**

Do not use oil or wax on these parts.





## Technical data

Spare parts service .....	312	Engine oils .....	324
Warranty coverage .....	312	Engine oil additives .....	324
Identification labels .....	313	Air conditioner refrigerant .....	324
Layout of poly-V-belt drive .....	315	Brake fluid .....	324
Technical data .....	316	Premium unleaded gasoline .....	325
Fuels, coolants, lubricants		Fuel requirements .....	325
etc. - capacities .....	322	Gasoline additives .....	326
		Coolants .....	326
		Consumer information .....	328

### Spare parts service

All authorized Mercedes-Benz Centers maintain a stock of original spare parts required for maintenance and repair work. In addition, strategically located parts distribution centers provide quick and reliable parts service.

More than 300 000 different spare parts, for Mercedes-Benz models, are available.

Mercedes-Benz original spare parts are subjected to stringent quality inspections. Each part has been specifically developed, manufactured or selected for and adapted to Mercedes-Benz vehicles.

Therefore, Mercedes-Benz original spare parts should be installed.

### Important!

The use of non-genuine parts and accessories not authorized by Mercedes-Benz could damage the vehicle which damage is not covered by the Mercedes-Benz Limited Warranty or compromise its durability or safety.

### Warranty coverage

Your vehicle is covered under the terms of the “warranties” printed in the Service and Warranty Information booklet and your authorized Mercedes-Benz Center will exchange or repair any defective parts originally installed on the vehicle in accordance with the terms of the following warranties:

1. New vehicle limited warranty
2. Emission system warranty
3. Emission performance warranty
4. California, Massachusetts, and Vermont emission control systems warranty

Replacement parts and accessories are covered by the Mercedes-Benz Spare Parts and Accessories warranties, copies of which are available at any Mercedes-Benz Center.

### Loss of Service and Warranty Information Booklet

Should you lose your Service and Warranty Information booklet, have your authorized Mercedes-Benz Center arrange for a replacement. It will be mailed to you.

## Identification labels



**1** Certification label

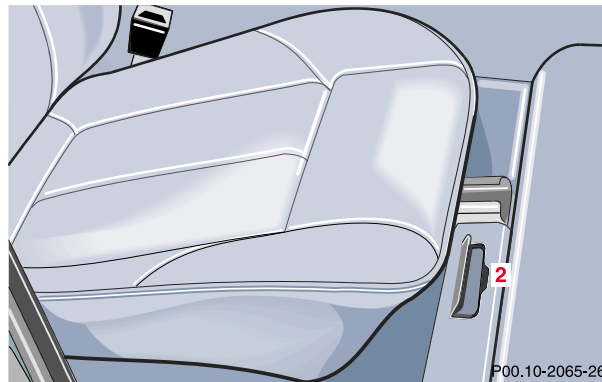

**2** Vehicle Identification Number (VIN)

When ordering spare parts, please specify vehicle identification and engine number.

## Technical data

314

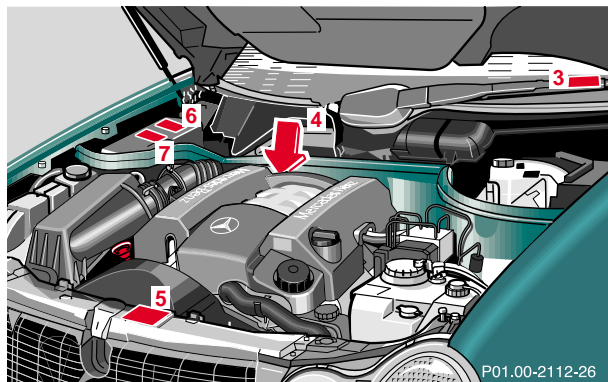

- 3 VIN, visible (lower edge of windshield)
- 4 Engine number
- 5 Body number and paintwork number
- 6 Emission control label
- 7 Information label, California version  
Vacuum line routing for emission control system

E 320 shown

## Layout of poly-V-belt drive

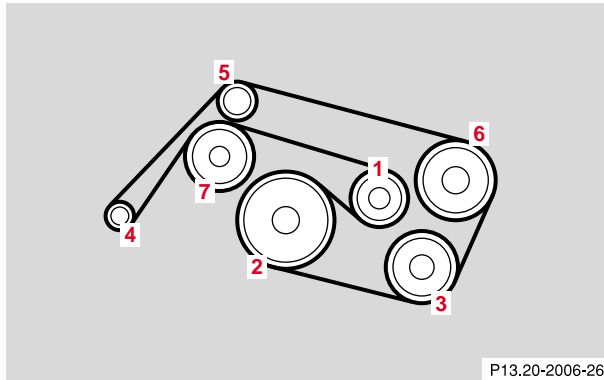

- 1 Automatic belt tensioner
- 2 Crankshaft
- 3 Air conditioner compressor
- 4 Generator (alternator)
- 5 Idler pulley
- 6 Power steering pump
- 7 Coolant pump

Technical data

316

**Technical data**

<b>Model</b>	<b>E 320</b> (210.065) <sup>1</sup> <b>E 320 AWD</b> (210.082) <sup>1</sup>	<b>E 430</b> (210.070) <sup>1</sup> <b>E 430 AWD</b> (210.270) <sup>1</sup>	<b>E 55 AMG</b> (210.074) <sup>1</sup>
<b>Engine</b>	112	113	113
Mode of operation	4-stroke engine, gasoline injection	4-stroke engine, gasoline injection	4-stroke engine, gasoline injection
No. of cylinders	6	8	8
Bore	3.54 in (89.90 mm)	3.54 in (89.90 mm)	3.82 in (97.00 mm)
Stroke	3.30 in (84.00 mm)	3.31 in (84.00 mm)	3.60 in (92.00 mm)
Total piston displacement	195.2 cu.in. (3199 cm <sup>3</sup> )	260.6 cu.in. (4265 cm <sup>3</sup> )	332.0 cu.in (5439 cm <sup>3</sup> )
Compression ratio	10:1	10:1	10.5:1
Output acc. to SAE J 1349	221 hp/5600 rpm (165 kW/5600 rpm)	275 hp/5750 rpm (205 kW/5750 rpm)	355 hp/5500 rpm (265 kW/5500 rpm)
Maximum torque acc. to SAE J 1349	232 ft.lb/3000 rpm (315 Nm/3000 rpm)	295 ft.lb/3200 rpm (400 Nm/3200 rpm)	390 ft.lb/3150 rpm (530 Nm/3150 rpm)
Maximum engine speed	6000 rpm	6000 rpm	6000 rpm
Firing order	1-4-3-6-2-5	1-5-4-2-6-3-7-8	1-5-4-2-6-3-7-8
Poly-V-belt	2390 mm	2390 mm	2390 mm

<sup>1</sup> The quoted data apply only to the standard vehicle. See an authorized Mercedes-Benz Center for the corresponding data of all special bodies and special equipment.

## Rims – Tires

### Model

**E 320  
(without Sport Package)**

Rims (light alloy)

7<sup>1</sup>/<sub>2</sub> J x 16 H 2

Wheel offset

1.6 in (41 mm)

All season tires:

Radial-ply tires

215/55 R 16 93 H

Winter tires:

Radial-ply tires

215/55 R 16 93 H M+S

### Spare wheel

Rim (steel)

7<sup>1</sup>/<sub>2</sub> J x 16 H 2

Wheel offset

1.6 in (41 mm)

All season tire:

Radial-ply tire

215/55 R 16 93 H



Technical data

Model	E 320 (Sport Package)	E 430 (without Sport Package)	E 430 (Sport Package)
Rims (light alloy)	8 J x 17 H2	7½ J x 17 H2	8 J x 17 H2
Wheel offset	1.46 in (37 mm)	1.46 in (37 mm)	1.46 in (37 mm)
Summer tires:			
Radial-ply tires	235/45 R 17 93 W <sup>2,3</sup>	235/45 R 17 93 W <sup>2,3</sup>	235/45 R 17 93 W <sup>2,3</sup>
Winter tires:			
Radial-ply tires	235/45 R 17 93 W M+S <sup>2</sup>	235/45 R 17 93 H M+S <sup>2</sup>	235/45 R 17 93 H M+S <sup>2</sup>
<b>Spare wheel</b>			
Rim (light alloy)	7½ J x 17 H 2	7½ J x 17 H 2	7½ J x 17 H 2
Wheel offset	1.46 in (37 mm)	1.46 in (37 mm)	1.46 in (37 mm)
Summer tire:			
Radial-ply tire	235/45 R 17 93 W <sup>2,3</sup>	235/45 R 17 93 W <sup>2,3</sup>	235/45 R 17 93 W <sup>2,3</sup>

2 Must only be used with special MB authorized snow chains.

3 Also permissible 235/45 ZR 17.

**Model****E 55 AMG****Rims and summer tires**

Rims front axle (AMG light alloy)	8 J x 18 H 2
Wheel offset	1.2 in (31 mm)
Rims rear axle (AMG light alloy)	9 J x 18 H 2
Wheel offset	1.4 in (35 mm)
Radial-ply tires, front axle	245/40 ZR 18 <sup>4</sup>
Radial-ply tires, rear axle	275/35 ZR 18 <sup>4</sup>

**Rims and winter tires**

Rims (AMG light alloy)	7½ J x 17 H 2
Wheel offset	1.4 in (35 mm)
Radial-ply tires	235/45 R 17 93 H M+S

**Spare wheel**

Rim (AMG light alloy)	7½ J x 17 H 2
Wheel offset	1.46 in (37 mm)
Summer tire: Radial-ply tire	235/45 R 17 93 W <sup>3</sup>

3 Also permissible 235/45 ZR 17.

4 Must not be used with snow chains.

## Technical data

## 320

**Electrical system****Model****E 320****E 430****E 55 AMG**

Generator (alternator)

14 V/115 A

14 V/150 A

14 V/150 A

Starter motor

12V/1.7 kW

12V/1.7 kW

12V/1.7 kW

Battery

12V/100 Ah

12V/100 Ah

12V/100 Ah

Spark plugs

Bosch F 8 DPER  
Beru 14 FGH 8 DPUR X 2  
NGK PFR 5 R-11Bosch F 8 DPER  
Beru 14 FGH 8 DPUR X 2  
NGK PFR 5 R-11

NGK PFR 5 -11

Electrode gap

0.039 in (1.0 mm)

0.039 in (1.0 mm)

0.039 in (1.0 mm)

Tightening torque

15 – 22 ft.lb (20 – 30 Nm)

15 – 22 ft.lb (20 – 30 Nm)

15 – 22 ft.lb (20 – 30 Nm)

**Weights**

(see certification tag)

Roof load max.

220 lb (100 kg)

Trunk load max.

220 lb (100 kg)

## Main Dimensions

<b>Model</b>	<b>E 320</b>	<b>E 430</b>	<b>E 55 AMG</b>
Overall vehicle length	189.5 in (4812 mm)	189.5 in (4812 mm)	190 in (4818 mm)
Overall vehicle width	70.8 in (1799 mm)	70.8 in (1799 mm)	70.8 in (1799 mm)
Overall height	56.7 in (1441 mm)	56.8 in (1443 mm)	56.9 in (1445 mm)
Wheel base	111.5 in (2833 mm)	111.5 in (2833 mm)	111.5 in (2833 mm)
Track, front	60.4 in (1534 mm)	60.7 in (1542 mm)	61.4 in (1560 mm)
Track, rear	60.2 in (1528 mm)	60.5 in (1536 mm)	60.7 in (1543 mm)

<b>Model</b>	<b>E 320 AWD</b>	<b>E 430 AWD</b>
Overall vehicle length	189.5 in (4812 mm)	189.5 in (4812 mm)
Overall vehicle width	70.8 in (1799 mm)	70.8 in (1799 mm)
Overall height	57.1 in (1451 mm)	57.3 in (1455 mm)
Wheel base	111.5 in (2833 mm)	111.5 in (2833 mm)
Track, front	60.2 in (1528 mm)	60.1 in (1526 mm)
Track, rear	60.1 in (1526 mm)	60.4 in (1534 mm)

## Fuels, coolants, lubricants etc. - capacities

322

**Fuels, coolants, lubricants etc. - capacities**

Vehicle components and their respective lubricants must match. Therefore use only brands tested and recommended by us. Please refer to the Factory Approved Service Products pamphlet, or inquire at your authorized Mercedes-Benz Center.

	<b>Model</b>	<b>Capacity</b>	<b>Fuels, coolants, lubricants etc.</b>
Engine with oil filter	E 320, E 430 E 55 AMG	8.5 US qt (8.0 l) 8.0 US qt (7.5 l)	Recommended engine oils
Automatic transmission	E 320, E 430 with AWD, E 430, E 55 AMG	8.0 US qt (7.5 l) 9.1 US qt (8.6 l) 9.6 US qt (9.1 l)	Automatic transmission fluid
Rear axle		1.4 US qt (1.3 l)	Hypoid gear oil SAE 90, 85 W 90
Front axle	E 320 with AWD E 430 with AWD	0.5 US qt (0.46 l)	Hypoid gear oil SAE 90, 85 W 90
Transfer case	E 320 with AWD E 430 with AWD	approx. 1.1 US qt (1.0 l)	Automatic transmission fluid
Power steering		approx. 1.3 US qt (1.1 l)	MB Power steering fluid
Front wheel hubs		approx. 2.1 oz (60 g) each	High temperature roller bearing grease
Brake system	E 320 E 430	approx. 0.5 US qt (0.5 l) approx. 0.7 US qt (0.7 l)	MB Brake fluid (DOT 4)

	<b>Model</b>	<b>Capacity</b>	<b>Fuels, coolants, lubricants etc.</b>
Windshield washer system		approx. 5.8 US qt (5.5 l)	MB Windshield washer concentrate "S" <sup>1</sup>
Headlamp washer system		approx. 1.9 US qt (1.8 l)	MB Windshield washer concentrate "S" <sup>1</sup>
Cooling system	E 320 E 430, E 55 AMG	approx. 10.6 US qt (10.1 l) approx. 11.8 US qt (11.2 l)	MB Anticorrosion/antifreeze
Fuel tank including a reserve of		approx. 21.1 US gal (80.0 l) approx. 2.6 US gal (10.0 l)	Premium unleaded gasoline: Posted Octane 91 (Avg. of 96 RON/86 MON)
Air conditioner system			R-134a refrigerant and special PAC lubricant ( <i>Never R-12</i> )

- <sup>1</sup> Use MB Windshield Washer Concentrate "S" and water for temperatures above freezing or MB Windshield Washer Concentrate "S" and commercially available premixed windshield washer solvent/antifreeze for temperatures below freezing. Follow suggested mixing ratios, see page 265.

**Engine oils**

Engine oils are specifically tested for their suitability in our engines. Therefore, use only engine oils recommended by Mercedes-Benz. Information on recommended brands is available at your authorized Mercedes-Benz Center.

Please follow Service Booklet recommendations for scheduled oil changes. Failure to do so could result in engine damage not covered by the Mercedes-Benz Limited Warranty.

**Engine oil additives**

Do not blend oil additives with engine oil. They may be harmful to the engine operation.

Damage or malfunctions resulting from blending oil additives are not covered by the Mercedes-Benz Limited Warranty.

**Air conditioner refrigerant**

R-134a (HFC) refrigerant and special PAG lubricating oil is used in the air conditioner system.

Never use R-12 (CFC) or mineral-based lubricating oil, otherwise damage to the system will occur.

**Brake fluid**

During vehicle operation, the boiling point of the brake fluid is continuously reduced through the absorption of moisture from the atmosphere. Under extremely hard operating conditions, this moisture content can lead to the formation of bubbles in the system thus reducing the system's efficiency.

The brake fluid must therefore be replaced every two years, preferably in the spring.

It is recommended to use only brake fluid approved by Mercedes-Benz. Your authorized Mercedes-Benz Center will provide you with additional information.

## Premium unleaded gasoline

### Caution!

To maintain the engine's durability and performance, premium unleaded gasoline must be used. If premium unleaded is not available and low octane fuel is used, follow these precautions:

- have the fuel tank filled only partially with unleaded regular and fill up with premium unleaded as soon as possible,
- avoid full throttle driving and abrupt acceleration,
- do not exceed an engine speed of 3000 rpm, if the vehicle is loaded with a light load such as two persons and no luggage,
- do not exceed  $\frac{2}{3}$  of maximum accelerator pedal position, if the vehicle is fully loaded or operating in mountainous terrain.

## Fuel requirements

Use only Premium unleaded meeting ASTM standard D 439:

The octane number (posted at the pump) must be 91 min. It is an average of both the Research (R) octane number and the Motor (M) octane number:  $[(R+M)/2]$ . This is also known as ANTI-KNOCK INDEX.

Unleaded gasoline containing oxygenates such as Ethanol, IPA, IBA and TBA can be used provided the ratio of any one of these oxygenates to gasoline does not exceed 10%, MTBE not to exceed 15%.

The ratio of Methanol to gasoline must not exceed 3% plus additional cosolvents.

Using mixtures of Ethanol and Methanol is not allowed. Gasohol, which contains 10% Ethanol and 90% unleaded gasoline, can be used.

These blends must also meet all other fuel requirements such as resistance to spark knock, boiling range, vapor pressure etc.



### Gasoline additives

A major concern among engine manufacturers is carbon build up caused by gasoline. Mercedes-Benz recommends the use of only quality gasoline containing additives that prevent the build up of carbon deposits.

After an extended period of using fuels without such additives, carbon deposits can build up especially on the intake valves and in the combustion area, leading to engine performance problems such as:

- warm-up hesitation,
- unstable idle,
- knocking/pinging,
- misfire,
- power loss.

Do not blend other specific fuel additives with fuel. They only result in unnecessary cost, and may be harmful to the engine operation.

Damage or malfunctions resulting from poor fuel quality or from blending specific fuel additives are not covered by the Mercedes-Benz Limited Warranty.

### Coolants

The engine coolant is a mixture of water and anticorrosion/antifreeze, which provides:

- corrosion protection,
- freeze protection,
- boiling protection (by increasing the boiling point).

The cooling system was filled at the factory with a coolant providing freeze protection to approximately -22°F (-30°C) and corrosion protection.

If the antifreeze mixture is effective to -22°F (-30°C), the boiling point of the coolant in the pressurized cooling system is reached at approximately 266°F (130°C).

The coolant solution must be used year round to provide the necessary corrosion protection and increase in the boil-over protection. You should have it replaced every 3 years.

To provide the important corrosion protection, the solution must be at least 45% anticorrosion/antifreeze (equals a freeze protection to approx. -22 °F [-30 °C]). If you use a solution that is more than 55% anticorrosion/antifreeze (freeze protection to approx. -49 °F [-45°C]),

the engine temperature will increase due to the lower heat transfer capability of the solution. Therefore, do not use more than this amount of anticorrosion/antifreeze.

If the coolant level is low, water and MB anticorrosion/antifreeze should be used to bring it up to the proper level (have cooling system checked for signs of leakage).

The water in the cooling system must meet minimum requirements, which are usually satisfied by normal drinking water. If you are not sure about the water quality, consult your authorized Mercedes-Benz Center.

#### Anticorrosion/antifreeze

Your vehicle contains a number of aluminum parts. The use of aluminum components in motor vehicle engines necessitates that anticorrosion/antifreeze coolant used in such engines be specifically formulated to protect the aluminum parts. (Failure to use such anticorrosion/antifreeze coolant will result in a significantly shortened service life.)

Therefore the following product is strongly recommended for use in your vehicle: Mercedes-Benz Anticorrosion/Antifreeze Agent.

Before the start of the winter season (or once a year in the hot southern regions), you should have the anticorrosion/antifreeze concentration checked. The coolant is also regularly checked each time you bring your vehicle to your authorized Mercedes-Benz Center for service.

#### Anticorrosion/antifreeze quantity

Model	Approx. freeze protection	
	- 35°F (- 37°C)	- 49°F (- 45°C)
E 320	5.6 US qt (5.3 l)	5.8 US qt (5.5 l)
E 430, E 55 AMG	6.1 US qt (5.8 l)	6.5 US qt (6.1 l)

### Consumer information

This has been prepared as required of all manufactures of passenger cars under Title 49, Code of U.S. Federal Regulations, Part 575 pursuant to the “National Traffic and Motor Vehicle Safety Act of 1966”.

#### Uniform tire quality grading

Quality grades can be found where applicable on the tire sidewall between tread shoulder and maximum section width. For example:

Tread wear 200    Traction AA    Temperature A

All passenger car tires must conform to federal safety requirements in addition to these grades.

#### Treadwear

The treadwear grade is a comparative rating based on the wear rate of the tire when tested under controlled conditions on a specified government test course. For example, a tire graded 150 would wear one and one-half ( $1\frac{1}{2}$ ) times as well on the government course as a tire graded 100. The relative performance of tires depends upon the actual conditions of their use, however, and may depart significantly from the norm due to variations in driving habits, service practices and differences in road characteristics and climate.

#### Traction

The traction grades, from highest to lowest are “AA”, “A”, “B”, and “C”. Those grades represent the tire’s ability to stop on wet pavement as measured under controlled conditions on specified government test surfaces of asphalt and concrete. A tire marked “C” may have poor traction performance.

#### Warning!

**The traction grade assigned to this tire is based on straightahead braking traction tests, and does not include acceleration, cornering, hydroplaning, or peak traction characteristics.**

## Temperature

The temperature grades are “A” (the highest), “B”, and “C”, representing the tire’s resistance to the generation of heat and its ability to dissipate heat when tested under controlled conditions on a specified indoor laboratory test wheel. Sustained high temperature can cause the material of the tire to degenerate and reduce tire life, and excessive temperature can lead to sudden tire failure. The grade “C” corresponds to a level of performance which all passenger car tires must meet under the Federal Motor Vehicle Safety Standard No. 109. Grades B and A represent higher levels of performance on the laboratory test wheel than the minimum required by law.

### Warning!

**The temperature grade for this tire is established for a tire that is properly inflated and not overloaded. Excessive speed, underinflation, or excessive loading, either separately or in combination, can cause excessive heat build up and possible tire failure.**

**Index****A**

ABS (Antilock brake system) .....	217
Malfunction indicator lamp .....	238
ABS-SYSTEM - malfunction and warning messages .....	243
Adjusting steering wheel .....	81
Air conditioner refrigerant .....	324
Air distribution .....	130
Air volume .....	130
Airbag deactivation system .....	66
AIRBAG OFF indicator lamp .....	239
Airbags .....	69
Alarm system .....	43, 44
Anticorrosion/antifreeze .....	210, 264, 323, 326
Antilock brake system (ABS) .....	217
Malfunction indicator lamp .....	238
Antitheft alarm system .....	43
Aquaplaning .....	207
Armrest, rear bench .....	162
Ashtrays .....	166
Center console .....	166
Rear doors .....	167

Audio system	
Anti-theft system .....	137
Button and soft key operation .....	138
Cassette mode .....	143
CD changer .....	148
CD mode .....	147
Operating and display elements .....	136
Operating safety .....	135
Operation - audio and telephone .....	135
Radio mode .....	141
Telephone operation .....	151
Audio systems .....	97
Cassette player .....	99
CD player .....	98
Radio .....	97
Automatic central locking .....	36
Automatic climate control .....	126
Activated charcoal filter .....	132
Air distribution .....	130
Air recirculation .....	131
Air volume .....	130
Basic setting .....	129
Defogging windows .....	129
Defrosting .....	129
Display and controls .....	128
Dust filter .....	131

Economy .....	129	Block heater .....	211
Front center console		BRAKE ASSIST -	
compartment ventilation .....	133	malfunction and warning messages .....	243
Rear passenger compartment		Brake assist system (BAS) .....	215
adjustable air outlet .....	134	Malfunction indicator lamp .....	237
Rear window defroster .....	130	Brake fluid .....	324
Residual engine heat utilization (REST) .....	132	BRAKE FLUID -	
Special settings .....	129	malfunction and warning messages .....	244
Automatic transmission .....	193	BRAKE LINING WEAR -	
Emergency operation .....	201	malfunction and warning messages .....	244
Fluid level .....	263	Brake pad wear .....	244
Program mode selector switch .....	200	Brake warning lamp .....	235
Selector lever position .....	196	Brake fluid low .....	235
Transmission selector lever,		Brakes .....	204, 215, 217, 220
manually unlocking .....	287	Bulbs	
		Replacing bulbs .....	288

## B

BabySmart™ airbag deactivation system .....	66
Self-test .....	66
BAS (Brake assist system) .....	215
Malfunction indicator lamp .....	237
Battery .....	280
Battery recycling .....	281
BATTERY / ALTERNATOR -	
malfunction and warning messages .....	242

## C

Capacities	
Fuels, coolants, lubricants etc. ....	322
Cargo tie-down hooks .....	169
Catalytic converter .....	188
CD changer .....	148
Audio systems .....	97
Cellular telephone .....	170

## Index

## 332

Center console .....	20
Central locking switch .....	35
Central locking system .....	27
Automatic central locking .....	36
Choosing global or selective mode .....	30
Electronic main key .....	25
Locking and unlocking .....	29
Mechanical keys .....	32
Remote control .....	25
Summer opening/convenience feature .....	31
CHECK ENGINE	
malfunction indicator lamp .....	234
Check regularly and before a long trip .....	231
Checking engine oil level	
Via engine oil level indicator .....	117
Via oil dipstick .....	262
Child restraint .....	59, 66, 77
Child seat	
Infant and child restraint systems .....	77
Cleaning and care of the vehicle .....	304
Clock, setting .....	111
Coin holder in glove box lid .....	163
COMAND, radio and telephone .....	176
Combination switch .....	122
Consumer information .....	328
Control and operation of radio transmitters .....	176

COOLANT (coolant level) -	
malfunction and warning messages .....	246
Coolant level .....	263
Adding coolant .....	264
Checking .....	263
COOLANT TEMP. -	
malfunction and warning messages .....	247
Coolant temperature gauge .....	90
Coolants .....	326
Anticorrosion/antifreeze quantity .....	327
Cruise control .....	212
Cup holder	
In center console .....	165
In glove box lid .....	163
In rear bench armrest .....	162

## D

Daytime running lamps .....	120
Deep water	
Driving instructions .....	211
DISPLAY DEFECTIVE (engine control unit) -	
malfunction and warning messages .....	241
DISPLAY DEFECTIVE (several systems) -	
malfunction and warning messages .....	241
Display illumination .....	89

Doors .....	33	Emission control .....	189
Drinking and driving .....	203	Emission control label .....	314
Drive sensibly - Save Fuel .....	203	Engine compartment .....	259
Driving instructions .....	203	ENGINE FAN -	
Driving off .....	205	malfunction and warning messages .....	245
<b>E</b>		Engine malfunction	
ELEC. STABIL. PROG. -		CHECK ENGINE	
malfunction and warning messages .....	253	malfunction indicator lamp .....	234
Electronic main key .....	25	Engine Oil Additives .....	324
Changing batteries .....	294	Engine oil consumption .....	118
Synchronizing remote control .....	296	Engine oil level	
Electronic stability program (ESP) .....	220	Checking .....	117, 262
Control switch .....	222	Warning .....	251
Malfunction indicator lamp .....	237	ENGINE OIL LEVEL -	
Synchronizing .....	221	malfunction and warning messages .....	251
Warning lamp .....	237	Engine oil level indicator .....	117
Emergency call		Engine oils .....	324
See Tele Aid .....	178	ESP (Electronic Stability Program) .....	220
Emergency engine shut-down .....	296	Control switch .....	222
Emergency tensioning retractor (ETR) .....	68	Malfunction indicator lamp .....	237
SRS Indicator lamp .....	236	Synchronizing .....	221
Emergency trunk lid release button .....	41, 42	Warning lamp .....	237
Emergency unlocking in case of accident .....	36	ETR (Emergency tensioning retractor) .....	68
		SRS Indicator lamp .....	236
		Express opening and closing	
		Power windows .....	154



## Index

334

Exterior lamp switch .....	119
Exterior lamps .....	288
Additional turn signals	
on the exterior mirror .....	293
Headlamp assembly .....	289
High mounted stop lamp .....	293
Low and high beams .....	290
Parking lamps .....	291, 292
Replacing bulbs .....	288
Side marker lamp, front .....	293
Standing lamps .....	291, 292
Taillamp assemblies .....	292
Turn signal lamps .....	291, 292

**F**

First aid kit .....	256
Flat tire	
Changing wheels .....	273
Flexible service system (FSS) .....	114
Four wheel	
electronic traction system (4MATIC)	
with Electronic Stability Program (ESP) .....	219

Fuel .....	229
Gasoline Additives .....	326
Premium unleaded gasoline .....	229, 323, 325
Fuel cap placement warning .....	236
Fuel Requirements .....	325
Fuel reserve warning .....	236
Fuels, coolants, lubricants etc. - capacities .....	322
Fuse box	
Fuses .....	257
Fuses, electrical .....	257

**G**

Garage door opener .....	171
Gasoline	
Additives .....	326
Fuel Requirements .....	325
Premium unleaded .....	229
General notes on the	
central locking system .....	26
Global locking	
Central locking system .....	27
Glove box .....	163

## H

Hazard warning flasher switch .....	125
Head restraints	
Front seat .....	51
Rear seat .....	52
Synchronizing .....	47
Headlamp cleaning system .....	121
Headlights .....	122
Heated seats .....	54
High beams	
Combination switch .....	122
Hood .....	259

## I

Identification labels .....	313
Illuminated vanity mirrors .....	161
Indicator lamps	
in the instrument cluster .....	88, 234
Individual settings .....	110
Infant and child restraint systems .....	77
Information call	
See Tele Aid .....	178
Instrument cluster .....	86
Activating .....	89

Illumination .....	89
Indicator lamps .....	88
Instruments and controls .....	18
Interior	
General notes .....	162
Interior lighting .....	159

## J

Jump starting .....	282
---------------------	-----

## K

Keys, changing batteries .....	294
Keys, vehicle .....	24

## L

Lamps	
Replacing bulbs .....	288
Lamps, exterior	
Fog lamps .....	119, 292
Headlamps .....	119, 248, 289, 306
Parking lamps .....	119, 291, 292

## Index

336

Side marker lamp, front .....	119, 293
Standing lamps .....	119, 291, 292
Taillamps .....	119, 248, 292, 306
Layout of poly-V-belt drive .....	315
LIGHT SENSOR - malfunction and warning messages .....	249
Lighter .....	168
LIGHTING SYSTEM - malfunction and warning messages .....	248
Limp home mode .....	201
Locking and unlocking .....	29
Low beams Exterior lamps .....	288

**M**

Maintenance .....	177
Malfunction and indicator lamp in the center console .....	239
Malfunction and indicator lamps in the instrument cluster .....	234
Malfunction and warning messages .....	240
ABS-SYSTEM .....	243
BATTERY / ALTERNATOR .....	242
BRAKE ASSIST .....	243
BRAKE FLUID .....	244

BRAKE LINING WEAR .....	244
COOLANT (coolant level) .....	246
COOLANT TEMP. ....	247
DISPLAY DEFECTIVE (engine control unit) .....	241
DISPLAY DEFECTIVE (several systems) .....	241
ELEC. STABIL. PROG. ....	253
ENGINE FAN .....	245
ENGINE OIL LEVEL .....	251
LIGHT SENSOR .....	249
LIGHTING SYSTEM .....	248
PARKING BRAKE .....	245
REMOVE KEY .....	249
STEERING GEAR OIL .....	250
TELE AID .....	253
WASHER FLUID .....	252
Malfunction message memory .....	108
Manual release for fuel filler flap .....	299
Mechanical key, Electronic key .....	25
Mechanical keys .....	32
Memory .....	48, 81, 84
Recalling .....	49
Storing .....	48
Mirror, exterior, adjusting .....	83
Mirror, exterior, rear view .....	83
Mirror, inside, rear view .....	82
Multicontour seat .....	53

Multifunction display .....	92
Audio systems .....	97
Engine oil level indicator .....	96
FSS (Flexible service system) .....	96
Individual settings .....	110
Malfunction message memory .....	108
Navigation system .....	105
Telephone .....	100
Trip and main odometer .....	96
Trip computer .....	106
Vehicle speed .....	96
Multifunction steering wheel .....	92
Setting the audio volume .....	113

## N

Navigation system	
Multifunction display .....	105
Night security illumination .....	120

## O

On-board diagnostic system .....	234
Operator's manual .....	8

Outside temperature indicator .....	90
Overhead control panel .....	21

## P

Panic button .....	32
Parcel net in front passenger footwell .....	169
Parking .....	206
Parking assist (Parktronic) .....	224
Malfunction .....	228
Parktronic switch .....	228
Sensors .....	225
Warning indicators .....	226
Parking brake .....	202, 204, 206, 221, 235
PARKING BRAKE - malfunction and warning messages .....	245
Power assistance .....	204
Power seats front .....	45
Power windows .....	154
Blocking of rear door window operation .....	155
Opening and closing .....	31
Synchronizing power windows .....	156
Problems with your vehicle .....	14
Product information .....	7

**R**

Radio transmitters .....	176
Radio, Audio system .....	97
Rain sensor .....	123
Reading lamps rear compartment .....	160
Rear seat cushion .....	297
Rear view mirrors .....	82
Antiglare night position .....	82
Exterior .....	83
Inside .....	82
Parking position .....	85
Storing mirror positions in memory .....	84
Rear window defroster .....	130
Rear window sunshade .....	160
Remote control .....	27
Battery replacement .....	294
REMOVE KEY - malfunction and warning messages .....	249
Replacement keys Obtaining .....	25
Replacing bulbs .....	288
Replacing wiper blade insert .....	300
Reporting Safety Defects .....	15
Residual engine heat utilization (REST) .....	132
Roadside assistance .....	10

Roadside assistance call See Tele Aid .....	178
Roof rack .....	302

**S**

Safety guidelines for the seat belt, emergency tensioning retractor and airbag .....	75
Seat belts .....	59
Fastening .....	61
Seat belt nonusage warning system .....	60
Unfastening .....	63
Warning lamp .....	238
Seat belts and integrated restraint system .....	59
Seat heater .....	54
Vehicles with seat ventilation .....	56
Vehicles without seat ventilation .....	55
Seat ventilation .....	57
Seats .....	45
Memory function .....	48
Multicontour seat .....	53
Power seats front .....	45
Selective locking Central locking system .....	27
Service indicator	

See Flexible service system (FSS) .....	114
Setting the audio volume .....	113
Shelf below rear window .....	170
Side marker lamp .....	293
Sliding/pop-up roof .....	157
Emergency operation .....	298
Express opening .....	158
Opening and closing .....	31
Synchronizing .....	158
Snow chains .....	209
SOS-call	
See Tele Aid .....	178
Spare parts service .....	312
Spare wheel .....	266
Special settings (Automatic climate control) .....	129
SRS (Supplemental restraint system) .....	67
Indicator lamp .....	236
SRS malfunction .....	69
Start lock-out .....	26
Starting and turning off the engine .....	192
STEERING GEAR OIL -	
malfunction and warning messages .....	250
Steering lock .....	190
Steering wheel adjustment .....	81
Storage compartment .....	266

Storage compartments	
Above ashtray in center console .....	164
Glove box .....	163
In center console .....	164
Stowing things in the vehicle .....	256
Sun visors .....	161
Supplemental restraint system (SRS) .....	67
Indicator lamp .....	236
SRS malfunction .....	69

## T

Tachometer .....	91
Technical data .....	316
Electrical system .....	320
Main Dimensions .....	321
Rims and Tires .....	317
Weights .....	320
Tele Aid .....	178
Information .....	183
Initiating an emergency call manually .....	181
Roadside Assistance .....	182
TELE AID -	
malfunction and warning messages .....	253

## Index

## 340

Telephone .....	100
General notes .....	176
Incoming call .....	104
Redialing .....	102
Telephone book .....	100
Telephones and two-way radios .....	176
The first 1 000 miles (1 500 km) .....	177
Tires .....	206
Driving instructions .....	206
Rims and tires .....	317
Rotating wheels .....	269
Tire inflation pressure .....	278
Tire replacement .....	268
Tire speed rating .....	208
Tire traction .....	208
Winter driving instructions .....	209
Tool kit	
Vehicle tools .....	266
Tow-away alarm .....	44
Towing the vehicle .....	285

Transmission selector lever, manually unlocking .....	287
Traveling abroad .....	211
Trip computer .....	106
Trip odometer .....	91
Trunk .....	37
Remote opening .....	27
Separately locked .....	37
Trunk lamp .....	39
Trunk lid	
Emergency release .....	41, 42
Release switch .....	40
Turn signal failure .....	122
Turn signals .....	122

## V

Vanity mirrors .....	161
Vehicle jack .....	267
Vehicle tools .....	266
Ventilated seats .....	56

## W

### Warning lamps

Indicator lamps in the instrument cluster ..... 88

Warranty coverage ..... 312

### WASHER FLUID -

malfunction and warning messages ..... 252

What you should know at the gas station ..... 229

Wheels ..... 268

Changing wheels ..... 273

Light alloy wheels ..... 308

Rims and tires ..... 317

Rotating ..... 269

Spare wheel ..... 270, 271, 272

Where to find it ..... 13

### Windows

Power windows ..... 154

### Windshield and headlamp washer

fluid mixing ratio ..... 265

### Windshield and headlamp washer system

Refilling ..... 265

Winter driving ..... 210

Winter driving instructions ..... 209

### Wiper

Replacing wiper blade insert ..... 300

### Wiper operation

Combination switch ..... 122









## Service and Literature

Your authorized Mercedes-Benz Center has trained technicians and original Mercedes-Benz parts to service your vehicle properly. For expert advice and quality service, see your authorized Mercedes-Benz Center.

If you are interested in obtaining service literature for your vehicle, please contact your authorized Mercedes-Benz Center. We consider this the best way for you to obtain accurate information for your vehicle.

For further information you can find us on the Mercedes-Benz web-site *www.mbusa.com*.

### **Warning!**

**To help avoid personal injury, be extremely careful when performing any service work or repairs. Improper or incomplete service or the use of incorrect or inappropriate parts or materials may damage the vehicle or its equipment, which may in turn result in personal injury.**

**If you have any question about carrying out some service, turn to the advice of an authorized Mercedes-Benz Center.**

We reserve the right to modify the technical details of the vehicle as given in the data and illustrations of this Operator's Manual. Reprinting, translation and copying, even of excerpts, is not permitted without our prior authorization in writing.

Title illustration no. P00.00-2611-26

Press time 05/18/01

GSI/SIP

Printed in Germany



# Please observe the following: BOOKSPINE for Operator's Manual

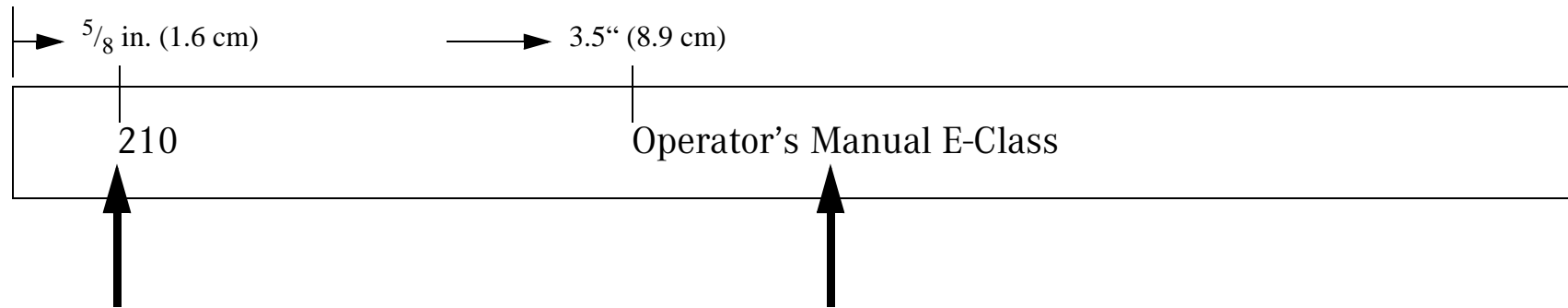

Please ensure the correct position of model code and model name