



Operator's Manual  
C-Class Wagon



Mercedes-Benz



2035846182

Order No. 6515 0136 13 Part No. 203 584 61 82 USA Edition A 2005

C 240

C 240 4MATIC

Our company and staff congratulate you on the purchase of your new Mercedes-Benz.

Your selection of our product is a demonstration of your trust in our company name. Furthermore, it exemplifies your desire to own an automobile that will be as easy as possible to operate and provide years of service.

Your Mercedes-Benz represents the efforts of many skilled engineers and craftsmen. To help assure your driving pleasure, and also the safety of you and your passengers, we ask you to make a small investment of time:

- Please read this manual carefully, then return it to your vehicle where it will be handy for your reference.
- Please follow the recommendations contained in this manual. They are designed to acquaint you with the operation of your Mercedes-Benz.
- Please pay attention to the warnings and cautions contained in this manual. They are designed to help improve the safety of the vehicle operator and occupants.

We extend our best wishes for many miles of safe, pleasurable driving.

Mercedes-Benz USA, LLC  
A DaimlerChrysler Company

## Contents

<b>Introduction</b> .....	9	<b>At a glance</b> .....	21	<b>Getting started</b> .....	31
Product information .....	9	Cockpit .....	22	Unlocking .....	32
Operator's Manual .....	10	Instrument cluster .....	24	Unlocking with the SmartKey .....	32
Service and warranty information ..	10	Multifunction steering wheel .....	26	Starter switch positions .....	33
Important notice for California		Center console .....	27	Adjusting .....	35
retail buyers and lessees of		Upper part .....	27	Seats .....	35
Mercedes-Benz automobiles .....	11	Lower Part .....	28	Steering wheel .....	39
Maintenance .....	12	Overhead control panel .....	29	Mirrors .....	41
Roadside Assistance .....	12	Door control panel .....	30	Driving .....	43
Change of address or ownership .....	12			Fastening the seat belt .....	43
Operating your vehicle outside				Starting the engine .....	46
the USA or Canada .....	13			Switching on headlamps .....	49
Where to find it .....	14			Turn signals .....	50
Symbols .....	15			Windshield wipers .....	50
Operating safety .....	16			Rear window wiper .....	53
Proper use of the vehicle .....	16			Problems while driving .....	54
Problems with your vehicle .....	17			Parking and locking .....	55
Reporting safety defects .....	18			Parking brake .....	55
Reporting Safety Defects .....	18			Switching off headlamps .....	56
Vehicle data recording .....	19			Turning off engine .....	57
Information regarding electronic					
recording devices .....	19				

## Contents

<b>Safety and Security</b> .....	59	<b>Controls in detail</b> .....	89	Lighting .....	108
Occupant safety .....	60	Locking and unlocking .....	90	Exterior lamp switch .....	108
Air bags .....	61	SmartKey .....	90	Combination switch .....	112
Seat belts .....	66	Opening the doors from		Hazard warning flasher .....	113
Children in the vehicle .....	69	the inside .....	93	Interior lighting .....	114
Blocking of rear door window		Opening the tailgate .....	94	Door entry lamps .....	115
operation .....	77	Closing the tailgate .....	94	Instrument cluster .....	116
Panic alarm* .....	78	Automatic central locking .....	95	Instrument cluster illumination ....	116
Activating .....	78	Locking and unlocking from		Coolant temperature gauge .....	117
Deactivating .....	78	the inside .....	96	Trip odometer .....	117
Driving safety systems .....	79	Seats .....	97	Tachometer .....	118
ABS .....	79	Easy-entry/exit feature* .....	97	Outside temperature indicator .....	118
BAS .....	80	Removing and installing front		Control system .....	119
ESP .....	81	seat head restraints .....	99	Multifunction display .....	119
Four wheel electronic traction		Rear seat head restraints .....	100	Multifunction steering wheel .....	120
system (4MATIC) with the ESP .....	84	Multicontour seats* .....	103	Menus .....	122
Anti-theft systems .....	85	Seat heating* .....	104	Standard display menu .....	124
Immobilizer .....	85	Memory function* .....	105	AUDIO menu .....	125
Anti-theft alarm system* .....	85	Storing positions into memory .....	106	NAV* menu .....	128
Tow-away alarm* .....	87	Recalling positions from memory .....	106	Vehicle status message memory	
		Storing exterior rear view mirror		menu .....	128
		parking position .....	107	Settings menu .....	130
				Trip computer menu .....	146
				TEL menu* .....	148

## Contents

Automatic transmission.....	152	Audio system.....	175	Loading .....	226
One-touch gearshifting.....	154	Audio and telephone, operation....	175	Roof rack* .....	226
Gear ranges .....	155	Operating safety .....	175	Parcel net in cargo	
Gear selector lever position .....	156	Operating and display elements....	176	compartment.....	226
Automatic shift program .....	158	Button and soft key operation.....	178	Storage compartment under	
Driving tips.....	159	Operation.....	178	cargo compartment floor.....	227
Emergency operation		Radio operation .....	183	Retractable luggage cover and	
(Limp Home Mode) .....	160	Introduction to satellite radio*		partition net.....	228
Good visibility .....	161	(USA only).....	188	Split rear bench seat .....	230
Headlamp cleaning system* .....	161	CD mode.....	193	Loading instructions .....	232
Rear view mirrors.....	161	GSM network phones .....	200	Cargo tie-down rings.....	233
Sun visors .....	164	TDMA or CDMA network phones ..	206	Useful features.....	234
Rear window defroster.....	165	Emergency calls “911” .....	213	Storage compartments.....	234
Climate control.....	166	Power windows .....	215	Ashtrays.....	238
Deactivating the climate control		Opening and closing the		Cigarette lighter.....	239
system .....	169	windows.....	215	Electrical outlet.....	240
Setting the temperature.....	169	Synchronizing power windows.....	218	Telephone* .....	241
Adjusting air distribution and		Power tilt/sliding sunroof* .....	219	Tele Aid* .....	242
volume .....	170	Opening and closing the power		Garage door opener* .....	249
Defrosting.....	171	tilt/sliding sunroof.....	219		
Air recirculation mode.....	171	Synchronizing the power			
Air conditioning.....	173	tilt/sliding sunroof.....	222		
Rear passenger compartment		Driving systems .....	223		
adjustable air vents.....	174	Cruise control .....	223		

## Contents

<b>Operation</b> .....	255	At the gas station .....	267	Winter driving .....	282
The first 1000 miles (1500 km).....	256	Refueling .....	267	Winter tires .....	282
Driving instructions.....	257	Check regularly and before		Block heater (Canada only).....	283
Drive sensibly – save fuel.....	257	a long trip.....	269	Snow chains.....	283
Drinking and driving .....	257	Engine compartment .....	270	Maintenance.....	284
Pedals .....	257	Hood .....	270	Clearing the maintenance	
Power assistance .....	257	Engine oil .....	272	service indicator .....	285
Brakes .....	258	Transmission fluid level.....	274	Maintenance service term	
Driving off.....	259	Coolant level .....	275	exceeded .....	285
Parking.....	259	Battery .....	276	Calling up the maintenance	
Tires .....	260	Windshield washer system and		service indicator .....	285
Hydroplaning.....	260	headlamp cleaning system* .....	277	Resetting the maintenance	
Tire traction.....	261	Tires and wheels.....	278	service indicator .....	286
Tire speed rating .....	261	Important guidelines .....	278	Vehicle care.....	287
Winter driving instructions .....	262	Life of tire.....	279	Cleaning and care of the	
Standing water .....	263	Direction of rotation.....	279	vehicle .....	287
Passenger compartment .....	263	Checking tire inflation pressure ...	279		
Driving abroad.....	263	Rotating tires .....	281		
Control and operation of radio					
transmitter .....	264				
Catalytic converter .....	264				
Emission control.....	265				
Coolant temperature .....	266				



## Contents

<b>Practical hints</b> .....	293	Replacing SmartKey batteries .....	330	Jump starting.....	350
What to do if ... ..	294	SmartKey .....	331	Towing the vehicle.....	352
Lamps in instrument cluster .....	294	Replacing bulbs .....	332	Installing towing eye bolt.....	355
Lamp in center console.....	300	Bulbs.....	332	Fuses.....	356
Vehicle status messages in the		Replacing bulbs for front lamps ....	335	Aids for changing fuses .....	357
multifunction display.....	301	Replacing bulbs for rear lamps .....	339	Main fuse box in passenger	
Where will I find ...? .....	321	Replacing wiper blades.....	341	compartment.....	357
First aid kit.....	321	Removing wiper blades.....	341	Fuse box in engine	
Vehicle tool kit.....	321	Installing wiper blades .....	341	compartment.....	358
Minispare wheel.....	324	Flat tire.....	342	Fuse box in cargo	
Unlocking/locking in an emergency..	326	Preparing the vehicle .....	342	compartment.....	359
Unlocking the vehicle.....	326	Mounting the Minispare wheel.....	342		
Locking the vehicle .....	327	Battery.....	347		
Fuel filler flap .....	328	Disconnecting the battery.....	348		
Manually unlocking the		Removing the battery.....	348		
transmission gear selector lever..	328	Charging and reinstalling			
Opening/closing in an emergency.....	329	the battery .....	348		
Power tilt/sliding sunroof* .....	329	Reconnecting the battery.....	349		

## Contents

<b>Technical data</b> .....	361	Fuels, coolants, lubricants, etc. ....	373	<b>Technical terms</b> .....	385
Parts service .....	362	Capacities .....	373		
Warranty coverage .....	363	Engine oils.....	375		
Loss of Service and Warranty		Engine oil additives .....	375	<b>Index</b> .....	391
Information Booklet.....	363	Air conditioning refrigerant .....	375		
Identification labels.....	364	Brake fluid.....	375		
Layout of poly-V-belt drive .....	365	Premium unleaded gasoline .....	376		
C 240 (all models).....	365	Fuel requirements .....	376		
Engine .....	366	Gasoline additives .....	377		
Rims and Tires .....	367	Flexible Fuel Vehicles.....	377		
Same size tires .....	368	Coolants.....	379		
Minispare wheel .....	369	Windshield washer and			
Electrical system.....	370	headlamp cleaning system* .....	381		
Main Dimensions .....	371	Consumer information .....	382		
Weights.....	372	Uniform tire quality grading .....	382		

▼ **Product information**

Please observe the following in your own best interest:

We recommend using genuine Mercedes-Benz parts as well as conversion parts and accessories explicitly approved by us for your vehicle model.

We have tested these parts to determine their reliability, safety and special suitability for Mercedes-Benz vehicles.

We are unable to make an assessment for other products and therefore cannot be held responsible for them, even if in individual cases an official approval or authorization by governmental or other agencies should exist. Use of such parts and accessories could adversely affect the safety, performance or reliability of your vehicle. Please do not use them.

Genuine Mercedes-Benz parts as well as conversion parts and accessories approved by us are available at your authorized Mercedes-Benz Center where you will receive comprehensive information, also on permissible technical modifications, and where proper installation will be performed.

## Introduction

### Operator's Manual

This Operator's Manual contains a great deal of useful information. We urge you to read it carefully and familiarize yourself with the vehicle before driving.

For your own safety and longer service life of the vehicle, we urge you to follow the instructions and warnings contained in this manual. Ignoring them could result in damage to the vehicle or personal injury to you or others. Vehicle damage caused by failure to follow instructions is not covered by the Mercedes-Benz Limited Warranty.

Your vehicle may have some or all of the equipment described in this manual. Therefore, you may find explanations for optional equipment not installed in your vehicle. If you have any questions about the operation of any equipment, your authorized Mercedes-Benz Center will be glad to demonstrate the proper procedures.

We continuously strive to improve our product, and ask for your understanding that we reserve the right to make changes in design and equipment. Therefore, information, illustrations and descriptions in this Operator's Manual might differ from your vehicle.

Optional equipment is also described in this manual, including operating instructions wherever necessary. Since they are special-order items, the descriptions and illustrations herein may vary slightly from the actual equipment of your vehicle.

If there are any equipment details that are not shown or described in this Operator's Manual, your authorized Mercedes-Benz Center will be glad to inform you of correct care and operating procedures.

The Operator's Manual and Maintenance Booklet are important documents and should be kept with the vehicle.

### Service and warranty information

The Service and Warranty Information Booklet contains detailed information about the warranties covering your Mercedes-Benz, including:

- New Car Limited Warranty,
- Emission System Warranty,
- Emission Performance Warranty,
- California, Maine, Massachusetts, and Vermont Emission Control System Warranty (California, Maine, Massachusetts, and Vermont only),
- State Warranty Enforcement Laws (Lemon Laws).

**Important notice for California retail buyers and lessees of Mercedes-Benz automobiles**

Under California law you may be entitled to a replacement of your vehicle or a refund of the purchase price or lease price, if Mercedes-Benz USA, LLC and/or its authorized repair or service facilities fail to fix one or more substantial defects or malfunctions in the vehicle that are covered by its express warranty after a reasonable number of repair attempts. During the period of 18 months from original delivery of the vehicle or the accumulation of 18000 miles (approx. 29000 km) on the odometer of the vehicle, whichever occurs first, a reasonable number of repair attempts is presumed for a retail buyer or lessee if one or more of the following occurs:

- (1) the same substantial defect or malfunction results in a condition that is likely to cause death or serious bodily injury if the vehicle is driven, that defect or malfunction has been subject to repair two or more times, and you have directly notified Mercedes-Benz USA, LLC in writing of the need for its repair,
- (2) the same substantial defect or malfunction of a less serious nature than category (1) has been subject to repair four or more times and you have directly notified us in writing of the need for its repair, or
- (3) the vehicle is out of service by reason of repair of the same or different substantial defects or malfunctions for a cumulative total of more than 30 calendar days.

Written notification should be sent to us, not a dealer, at Mercedes-Benz USA, LLC, Customer Assistance Center, One Mercedes Drive, Montvale, NJ 07645-0350.

## Introduction

### Operator's Manual

#### Maintenance

---

The Maintenance Booklet describes all the necessary maintenance work which should be performed at regular intervals.

Always have the Maintenance Booklet with you when you take the vehicle to your authorized Mercedes-Benz Center for service. The service advisor will record each service in the booklet for you.

#### Roadside Assistance

---

The Mercedes-Benz Roadside Assistance Program provides factory-trained technical help in the event of a breakdown. Calls to the toll-free Roadside Assistance number

**1-800-FOR-MERCEdes (in the USA)**  
**1-800-387-0100 (in Canada)**

will be answered by Mercedes-Benz Customer Assistance Representatives 24 hours a day, 365 days a year.

For additional information refer to the Mercedes-Benz Roadside Assistance Program Brochure in your glove box.

#### Change of address or ownership

---

If you change your address, be sure to send in the "Change of Address Notice" found in the Service and Warranty Information Booklet, or simply call the Mercedes-Benz Customer Assistance Center (in the USA) at 1-800-FOR-MERCEdes, or Customer Service (in Canada) at 1-800-387-0100. It is in your own interest that we can contact you should the need arise.

If you sell your Mercedes, please leave all literature with the vehicle to make it available to the next operator.

If you bought this vehicle used, be sure to send in the "Notice of Purchase of Used Car" found in the Service and Warranty Information Booklet, or call the Mercedes-Benz Customer Assistance Center (in the USA) at 1-800-FOR-MERCEdes, or Customer Service (in Canada) at 1-800-387-0100.

**Operating your vehicle outside the USA or Canada**

---

If you plan to operate your vehicle in foreign countries, please be aware that:

- service facilities or replacement parts may not be readily available,
- unleaded gasoline for vehicles with catalytic converters may not be available; the use of leaded fuels will damage the catalyts,
- gasoline may have a considerably lower octane rating, and improper fuel can cause engine damage.

Certain Mercedes-Benz models are available for delivery in Europe under our European Delivery Program. For details, consult an authorized Mercedes-Benz Center or write to:

In the USA:

Mercedes-Benz USA, LLC  
European Delivery Department  
One Mercedes Drive  
Montvale, NJ 07645-0350

In Canada:

Mercedes-Benz Canada Inc.  
European Delivery Department  
98 Vanderhoof Avenue  
Toronto, Ontario M4G 4C9

## Introduction

### Where to find it

This Operator's Manual is designed to provide comprehensive support information for you, the vehicle operator. Each section has its own reference color so you can find information quickly.

#### At a glance

Here you will find an overview of all the controls that can be operated from the driver's seat.

#### Getting started

Here you will find all the information you need for your first drive. You should read this section first if this is your first Mercedes-Benz vehicle or if you are renting or borrowing this vehicle.

#### Safety and Security

Here you will find descriptions of the safety features of your vehicle.

#### Controls in detail

Here you will find detailed information about the equipment installed in your vehicle. This section expands on the "Getting started" section and also describes technical innovations. If you are already familiar with the basic functions of your vehicle, this section will be of particular interest to you.

#### Operation

Here you will find all the information you need for the proper operation of your vehicle.

#### Practical hints

This section provides fast assistance for dealing with problems you may encounter.

#### Technical data

All important technical data for your vehicle can be found in this section.

#### Indexes

The glossary provides explanations of the most important technical terms.

The table of contents and the index are designed to help you find information quickly and easily.

The following publications are part of your vehicle documentation:

- this Operator's Manual
- the Maintenance Booklet

Separate operating instructions will be provided as required depending on the equipment options installed in your vehicle.



## ▼ Symbols

The following symbols are found in this Operator's Manual:

- \* Optional equipment is identified with an asterisk. Since standard equipment varies between models, the descriptions and illustrations in this manual may differ slightly from the actual equipment of your vehicle.

### Warning!



Warning notices draw your attention to hazards that may endanger your health or life, or the health or life of others.



Highlights hazards that may result in damage to your vehicle.



Helpful hints or further information you may find useful.

- ▶ This symbol points to instructions for you to follow.
- ▶ A number of these symbols appearing in succession indicates a multiple-step procedure.
  - ▷ Page This symbol tells you where to look for further information on a topic.
  - ▷▷ This continuation symbol marks an interrupted procedure which will be continued on the next page.
  - > In the glossary of technical terms, this symbol is used to indicate cross-references to term definitions.
  - Display Words appearing in the multi-function display are printed in the type shown here.

## Introduction

### Operating safety

#### Warning!



Work improperly carried out on electronic components and associated software could cause them to cease functioning. Because the vehicle's electronic components are interconnected, any modifications made may produce an undesired effect on other systems. Electronic malfunctions could seriously impair the operating safety of your vehicle.

See an authorized Mercedes-Benz Center for repairs or modifications to electronic components.

Other improper work or modifications on the vehicle could also have a negative impact on the operating safety of the vehicle.

Some safety systems only function while the engine is running. You should therefore never turn off the engine while driving.

#### Warning!



Heavy blows against the vehicle underbody or tires/wheels, for example when running over an obstacle, road debris or a pothole, may cause serious damage and impair the operating safety of your vehicle. If you feel a sudden significant vibration or ride disturbance, or you suspect that damage to your vehicle has occurred, you should turn on your hazard warning flashers, carefully slow down, and drive with caution to an area which is a safe distance from the road.

Inspect the vehicle underbody and tires/wheels for possible damage. If the vehicle appears unsafe, have it towed to the nearest authorized Mercedes-Benz Center or other qualified maintenance or repair facility for further inspection or repairs.

#### Proper use of the vehicle

Proper use of the vehicle requires that you are familiar with the following information and rules:

- the safety precautions in this manual
- the “Technical data” section in this manual
- traffic rules and regulations
- motor vehicle laws and safety standards

#### Warning!



Various warning labels are attached to your vehicle. These warning labels are intended to make you and others aware of various risks. You should not remove any of these warning labels unless explicitly instructed to do so by information on the label itself. Removal of any of these labels may cause you and others to be unaware of certain risks which may result in an accident and/or personal injury.

▼ **Problems with your vehicle**

If you should experience a problem with your vehicle, particularly one that you believe may affect its safe operation, we urge you to immediately contact an authorized Mercedes-Benz Center to have the problem diagnosed and corrected if required. If the matter is not handled to your satisfaction, please discuss the problem with the Mercedes-Benz Center management, or if necessary contact us at one of the following addresses:

In the USA:

Customer Assistance Center  
Mercedes-Benz USA, LLC  
One Mercedes Drive  
Montvale, NJ 07645-0350

In Canada:

Customer Relations Department  
Mercedes-Benz Canada Inc.  
98 Vanderhoof Avenue  
Toronto, Ontario, M4G 4C9

## Introduction

### Reporting safety defects

For the USA only:

The following text is published as required of manufacturers under Title 49, Code of U.S. Federal Regulations, Part 575 pursuant to the “National Traffic and Motor Vehicle Safety Act of 1966”.

#### **Reporting Safety Defects**

---

If you believe that your vehicle has a defect which could cause a crash or could cause injury or death, you should immediately inform the National Highway Traffic Safety Administration (NHTSA) in addition to notifying Mercedes-Benz USA, LLC.

If NHTSA receives similar complaints, it may open an investigation, and if it finds that a safety defect exists in a group of vehicles, it may order a recall and remedy campaign. However, NHTSA cannot become involved in individual problems between you, your dealer, or Mercedes-Benz USA, LLC.

To contact NHTSA, you may either call the Auto Safety Hotline toll-free at 1-888-327-4236 (or 366-0123 in Washington, D.C. area) or write to: NHTSA, U.S. Department of Transportation, Washington, D.C. 20590. You can also obtain other information about motor vehicle safety from the Hotline.

**▼ Vehicle data recording****Information regarding electronic recording devices**

---

(Including notice pursuant to California Code § 9951)

Please note that your vehicle is equipped with devices that can record vehicle systems data and, if equipped with the Tele Aid system, may transmit some data in certain accidents.

This information helps, for example, to diagnose vehicle systems after a collision and to continuously improve vehicle safety. DaimlerChrysler may access the information and share it with others

- for safety research or vehicle diagnosis purposes
- with the consent of the vehicle owner or lessee
- in response to an official request by law enforcement or other government agency
- for use in dispute resolution involving DaimlerChrysler, its affiliates or sales/service organization and/or
- as otherwise required or permitted by law.

Please check the Tele Aid subscription service agreement for details regarding the information that may be recorded or transmitted via that system.





**At a glance**

**Cockpit**

**Instrument cluster**

**Multifunction steering wheel**

**Center console**

**Overhead control panel**

**Door control panel**

## At a glance

### Cockpit

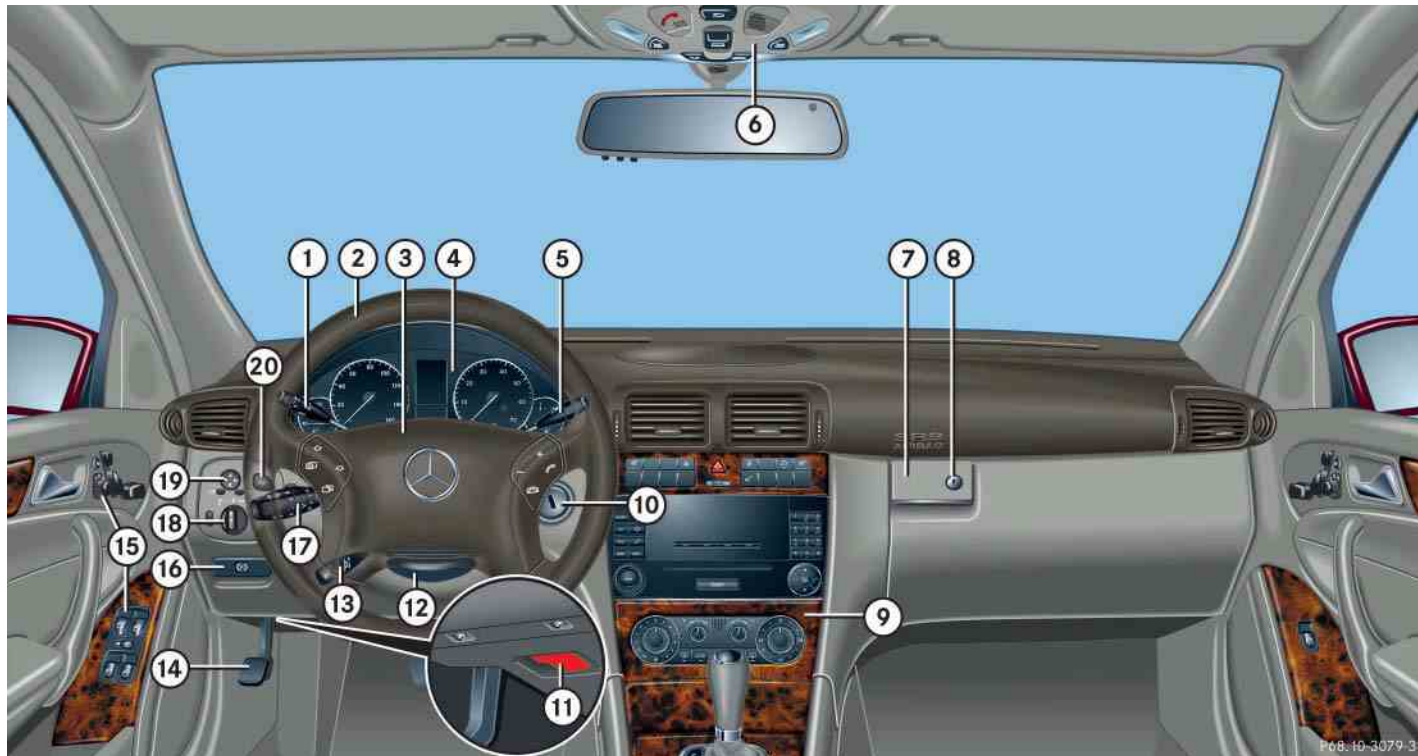



## At a glance

### Cockpit

Item	Page
① Cruise control lever	223
② Multifunction steering wheel	26, 120
③ Horn	
④ Instrument cluster	24, 116
⑤ Lever for voice control system* <sup>1</sup> , see separate operating instructions	
⑥ Overhead control panel	29
⑦ Glove box lid release	234
⑧ Glove box lock	234

Item	Page
⑨ Center console	27
⑩ Starter switch	33
⑪ Hood lock release	270
⑫ Steering wheel adjustment handle (manual)	40
⑬ Steering wheel adjustment stalk (electrical)*	40
⑭ Parking brake pedal	47, 55
⑮ Door control panel	30
⑯ Parking brake release	47

Item	Page
⑰ Combination switch	
• Turn signals	50
• Windshield wipers	50
• Rear window wiper	53
• High beam	49
⑱ Exterior lamp switch	49, 108
⑲ Exterior rear view mirror adjustment	41, 107
⑳ Headlamp washer switch*	161

<sup>1</sup> Feature description is based on preliminary information at time of printing. At time of printing, no date for availability of voice control had been set. Contact an authorized Mercedes-Benz Center for details and availability for your vehicle model.





## At a glance





### Instrument cluster





## At a glance

### Instrument cluster

Item	Page
① <b>Speedometer with:</b>	
 Electronic Stability Program (ESP) warning lamp	81, 298
 Brake warning lamp, USA only	47, 55, 295
 Brake warning lamp, Canada only	47, 55, 295
 Low beam headlamp indicator lamp	49, 108
②  Left turn signal indicator lamp	50
③ <b>Multifunction display with:</b>	119
Trip odometer	117
Main odometer	119
Gear selector lever position	46, 156

Item	Page
Program mode	158
Status indicator (outside temperature/digital speedometer)	118, 134
Digital clock	119, 135
④  Right turn signal indicator lamp	50
⑤ <b>Tachometer with:</b>	118
 Antilock Brake System (ABS) indicator lamp	79, 294
 Engine malfunction indicator lamp, USA only	296, 297
 Engine malfunction indicator lamp, Canada only	296, 297
 Supplemental restraint system indicator lamp	60, 299

Item	Page
 Seat belt telltale	66, 299
 High beam headlamp indicator lamp	49, 112
⑥ <b>Fuel gauge with:</b>	
Fuel reserve warning lamp	299
 Fuel filler cap location indicator: The fuel filler cap is on the rear right-hand side.	
⑦ Coolant temperature gauge	117
⑧ <b>Reset button for:</b>	
• Resetting trip odometer	117
• Resetting individual settings	130
• Instrument cluster illumination	116

## At a glance

### Multifunction steering wheel

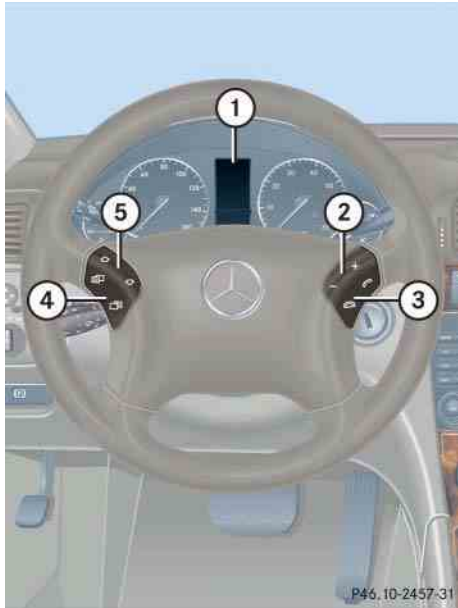

Item	Page
① Multifunction display	119
<b>Operating control system</b>	120
② Selecting the submenu or setting the volume: Press button	
up/to increase	
down/to decrease	
③ Telephone*: Press button	
to take a call	
to end a call	

Item	Page
④ Menu systems: Press button	
for next menu	
for previous menu	
⑤ Moving within a menu: Press button	
for next display	
for previous display	

## At a glance

### Center console

#### ▼ Center console

##### Upper part



Item	Page
① Seat heating*, driver's side	104
② ESP control switch	81
③ Hazard warning flasher switch – switching on/off	113
④ Central locking switch	96
Central unlocking switch	96
⑤ Tow-away alarm switch*	87
Anti-theft alarm system indicator lamp*	86
⑥ Seat heating*, passenger side	104

Item	Page
⑦ Front passenger front air bag off indicator lamp	72, 300
⑧ Audio system, or COMAND* (see separate operating instructions)	175
⑨ Climate control	166
Rear window defroster	165

## At a glance

### Center console

#### Lower Part



	Item	Page
①	Ashtray	238
	Cigarette lighter	239
②	Gear selector lever for automatic transmission	46, 156
③	Cup holders	236
④	Armrest	235
⑤	Program mode selector switch for automatic transmission	158

## At a glance

### Overhead control panel

#### ▼ Overhead control panel



Item	Page
① Rear interior lighting on/off	115
② Power tilt/sliding sunroof*	219
③ Right reading lamp on/off	115
④ Interior lighting control	114
⑤ Hands-free microphone for Tele Aid* (emergency call system), telephone* and voice control system* (see separate operating instructions)	148, 200, 242

Item	Page
⑥ Interior rear view mirror	41, 161
⑦ Garage door opener*	249
⑧ Left reading lamp on/off	115
⑨ Tele Aid* (emergency call system) button	242

## At a glance

### Door control panel



	Item	Page
①	Door handle	93
②	Memory function* (for storing seat, exterior mirror and steering wheel settings)	105
③	Switches for seat adjustment*	35, 97
④	Switches for opening/closing front door windows	215
⑤	Switch for rear door window override	77
⑥	Switches for opening/closing rear door windows	215





**Getting started**

**Unlocking**

**Adjusting**

**Driving**

**Parking and locking**

## Getting started

### Unlocking



The “Getting started” section provides an overview of the vehicle’s most basic functions. First-time Mercedes-Benz owners should pay special attention to the information given here.

If you are already familiar with the basic functions described here, the “Controls in detail” section will provide you with further information. The corresponding page references are located at the end of each segment.

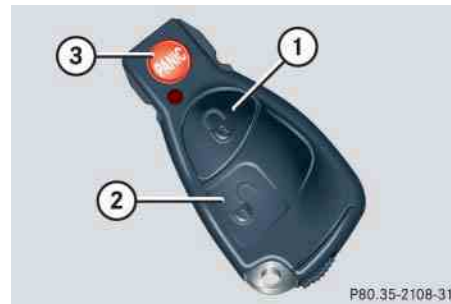
#### Unlocking with the SmartKey



#### SmartKey with remote control

- ①  Lock button
- ②  Unlock button
- ③  Panic button\* (▷ page 78)

#### i

Canada only:  
Only vehicles equipped with an anti-theft alarm system\* have SmartKeys with integrated panic button\* ③.

- ▶ Press unlock button  on the SmartKey.

All turn signal lamps flash once. The locking knobs in the doors move up.

- ▶ Get in the vehicle and insert the SmartKey in the starter switch.

For more information, see “Locking and unlocking” (▷ page 90).

#### Starter switch positions

##### Warning!



When leaving the vehicle, always remove the SmartKey from the starter switch and lock the vehicle. Do not leave children unattended in the vehicle, or with access to an unlocked vehicle. Unsupervised use of vehicle equipment may cause an accident and/or serious personal injury.

#### SmartKey

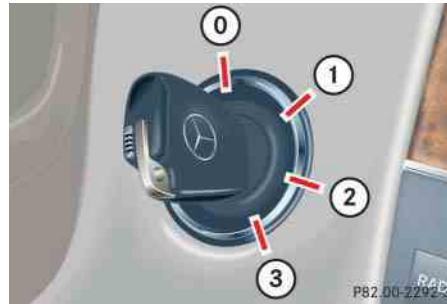

#### Starter switch

##### 0 For removing SmartKey

The steering is locked when the SmartKey is removed from the starter switch. If necessary, move steering wheel slightly to allow the locking mechanism to engage.

##### 1 Power supply to some electrical consumers, such as seat adjustment

##### 2 Ignition (power supply for all electrical consumers) and driving position.

All lamps in the instrument cluster come on. If a lamp in the instrument cluster fails to come on when the ignition is switched on, have it checked and replaced if necessary. If a lamp in the instrument cluster remains on after starting the engine or comes on while driving, refer to “Lamps in instrument cluster” (▷ page 294).

##### 3 Starting position

## Getting started

### Unlocking



When you switch on the ignition, the indicator and warning lamps in the instrument cluster come on. This indicates that the respective systems are operational. They should go out when the engine is running.



The SmartKey can only be removed from the starter switch with the gear selector lever in position **P**.



If the SmartKey cannot be turned in the starter switch, the battery may not be sufficiently charged.

- Check the battery and charge it if necessary (▷ page 347)
- Get a jump start (▷ page 350).

To prevent accelerated battery discharge and a possible dead battery, always remove the SmartKey from the starter switch when the engine is not in operation.

## ▼ Adjusting

### Warning!



All seat, head restraint, steering wheel, and rear view mirror adjustments, as well as fastening of seat belts, must be done before the vehicle is put into motion.

## Seats

The seats can be adjusted either manually or electrically, depending on the vehicle's equipment.

### Warning!



Do not adjust the driver's seat while driving. Adjusting the seat while driving could cause the driver to lose control of the vehicle.

Never ride in a moving vehicle with the seat back in an excessively reclined position as this can be dangerous. You could slide under the seat belt in a collision. If you slide under it, the belt would apply force at the abdomen or neck.

That could cause serious or fatal injuries. The seat back and seat belts provide the best restraint when the wearer is in a nearly upright position and belts are properly positioned on the body. Your seat must be adjusted so that you can correctly fasten your seat belt (▷ page 43).

Never place hands under the seat or near any moving parts while a seat is being adjusted.

### Warning!



When leaving the vehicle, always remove the SmartKey from the starter switch, and lock your vehicle.

Even with the SmartKey removed from the starter switch, the power seats\* can be operated when the respective door is open. Therefore, do not leave children unattended in the vehicle, or with access to an unlocked vehicle. Unsupervised use of vehicle equipment may cause an accident and/or serious personal injury.

## Getting started

### Adjusting

### Warning!



Children 12 years old and under must never ride in the front seat, except in a Mercedes-Benz authorized BabySmart<sup>TM1</sup> compatible child seat, which operates with the BabySmart<sup>TM</sup> system installed in the vehicle to deactivate the passenger front air bag when it is properly installed. Otherwise they will be struck by the air bag when it inflates in a crash. If this happens, serious or fatal injury will result.

According to accident statistics, children are safer when properly restrained in the rear seating positions than in the front seating positions. Infants and small children must ride in back seats and be seated in an appropriate infant or child restraint system, which is properly secured with the vehicle's seat belt and top tether strap, or secured via lower anchors and top tether strap, fully in accordance with the child seat manufacturer's instructions. ▷▷

<sup>1</sup> BabySmart<sup>TM</sup> is a trademark of Siemens Automotive Corp.

## Getting started

### Adjusting

- ▷▷ A child's risk of serious or fatal injuries is significantly increased if the child restraints are not properly secured in the vehicle and the child is not properly secured in the child restraint.

#### Manual seat adjustment

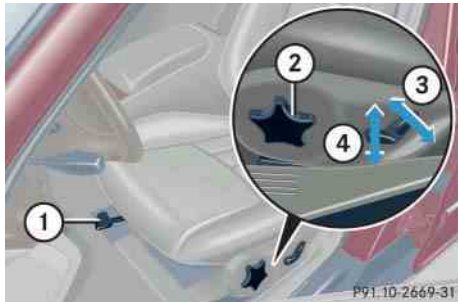

- ① Seat fore and aft adjustment
- ② Seat cushion tilt
- ③ Seat backrest tilt
- ④ Seat height

#### Seat fore and aft adjustment

- ▶ Lift handle ①.
- ▶ Slide seat to the desired position.
- ▶ Allow handle ① to reengage.
- ▶ Check for proper engagement before driving.

Adjust seat to a comfortable seating position that still allows you to reach the accelerator/brake pedal safely. The position should be as far rearward as possible, consistent with ability to properly operate controls.



When moving the seat, make sure that there are no items in the footwell or behind the seat. Otherwise you could damage the seat.

#### Seat cushion tilt

- ▶ Turn handwheel ② forward or backward until your upper legs are lightly supported

#### Seat backrest tilt

- ▶ Switch on ignition (▷ page 33).
- ▶ Press switch ③ in direction of arrow until your arms are slightly angled when holding the steering wheel.

#### Seat height

- ▶ Switch on ignition (▷ page 33).
- ▶ Press switch ④ in direction of arrow until your legs are lightly supported.

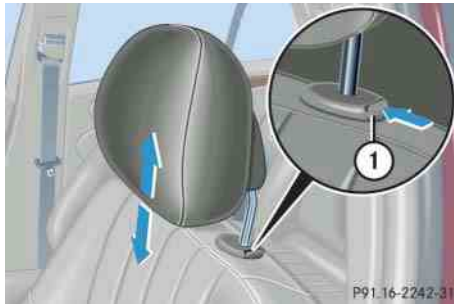
**Head restraint height**

① Release button

Raising:

- ▶ Manually adjust the height of the head restraint by pulling it upward.

Lowering:

- ▶ To lower head the restraint, push release button ① and push down on the head restraint.

**Warning!**

For your protection, drive only with properly positioned head restraints.

Adjust head restraint so that the center of the head restraint supports the back of the head at eye level. This will reduce the potential for injury to the head and neck in the event of an accident or similar situation.

Do not drive the vehicle without the seat head restraints. Head restraints are intended to help reduce injuries during an accident.

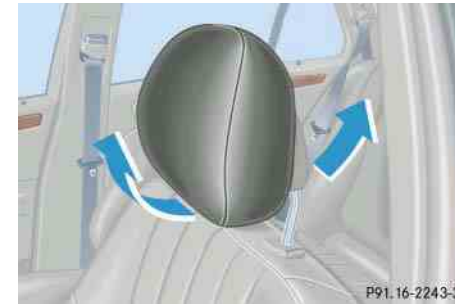

Adjust the head restraint in such a way that it is as close to the head as possible.

**Head restraint tilt**

Manually adjust the angle of the head restraint.

- ▶ Push or pull on the lower edge of the head restraint cushion.

For more information, see “Seats” (▷ page 97).

## Getting started

### Adjusting

#### Power seat\* adjustment

The seat adjustment switches are located in each front door.

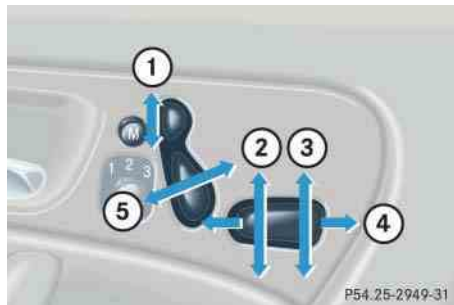

- ① Head restraint height
- ② Seat height
- ③ Seat cushion tilt
- ④ Seat fore and aft adjustment
- ⑤ Seat backrest tilt

▶ Switch on ignition (▷ page 33).

or

▶ Open the respective door.

#### Seat fore and aft adjustment

▶ Press switch forward or backward in direction of arrow ④.

Adjust seat to a comfortable seating position that still allows you to reach the accelerator/brake pedal safely. The position should be as far rearward as possible, consistent with ability to properly operate controls.



When moving the seat, make sure that there are no items in the footwell or behind the seat. Otherwise you could damage the seat.



The memory function\* (▷ page 105) lets you store the setting for the seat position together with the settings for the steering wheel and exterior rear view mirrors.

#### Seat cushion tilt

▶ Press switch up or down in direction of arrow ③ until your upper legs are lightly supported.

#### Seat backrest tilt

▶ Press switch forward or backward in direction of arrow ⑤ until your arms are slightly angled when holding the steering wheel.

#### Seat height

▶ Press switch up or down in direction of arrow ②.

#### Head restraint height

▶ Press switch up or down in direction of arrow ①.



Adjust the head restraint in such a way that it is as close to the head as possible.



#### Warning!



For your protection, drive only with properly positioned head restraints.

Adjust head restraint so that the center of the head restraint supports the back of the head at eye level. This will reduce the potential for injury to the head and neck in the event of an accident or similar situation.

Do not drive the vehicle without the seat head restraints. Head restraints are intended to help reduce injuries during an accident.

#### Head restraint tilt

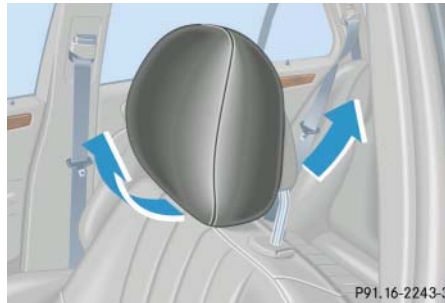

Manually adjust the angle of the head restraint.

- Push or pull on the lower edge of the head restraint cushion.

For more information, see “Seats” (▷ page 97).

#### Steering wheel

#### Warning!



Do not adjust the steering wheel while driving. Adjusting the steering wheel while driving, or driving without the adjustment locked could cause the driver to lose control of the vehicle.

When leaving the vehicle, always remove the SmartKey from the starter switch and lock your vehicle.

Even with the SmartKey removed from the starter switch, the electrical steering wheel adjustment feature\* can be operated when the driver's door is open. Therefore, do not leave children unattended in the vehicle, or with access to an unlocked vehicle. Unsupervised use of vehicle equipment may cause an accident and/or serious personal injury.

## Getting started

### Adjusting

#### Steering wheel adjustment, manual

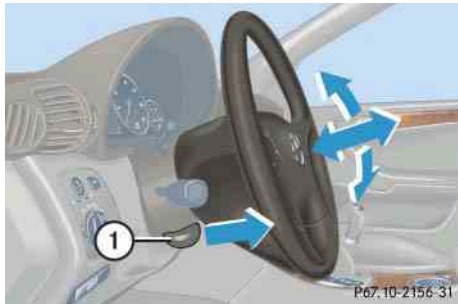

##### ① Handle

- ▶ To unlock the steering column, pull handle ① out to its stop limit.
- ▶ Move steering wheel to the desired position.
- ▶ To lock the steering column, push handle ① all the way in until it engages.

The steering wheel is once again locked into position.

- ▶ Make sure the steering wheel is securely locked by trying to move it up and down, and in and out before driving off.

#### Warning!



Only adjust the steering wheel with the vehicle at a standstill and make sure the steering wheel is securely locked in place before driving off.

Driving without the steering wheel adjustment locked may cause an unexpected steering wheel movement which could cause the driver to lose control of the vehicle. Make sure the steering wheel is securely locked by trying to move it up and down, and in and out before driving off.

#### Steering wheel adjustment, electrical\*

The stalk for steering wheel adjustment is located on the steering column (lower left).



- ① Adjusting steering column, in or out
- ② Adjusting steering column, up or down

- ▶ Switch on ignition (▷ page 33).

or

- ▶ Open the driver's door.

**Adjusting steering column in or out**

- ▶ Move stalk forward or back in the direction of arrow ① until a comfortable steering wheel position is reached with your arms slightly bent at the elbow.

**Adjusting steering column up or down**

- ▶ Move stalk up or down in the direction of arrow ②.

Make sure your legs can move freely and that all the displays (incl. malfunction and indicator lamps) on the instrument cluster are clearly visible.



The memory function\* (> page 105) lets you store the setting for the steering wheel together with the settings for the seat position and exterior rear view mirrors.

**Mirrors**

Adjust the interior and exterior rear view mirrors before driving so that you have a good view of the road and traffic conditions.

**Warning!**

In the case of an accident, liquid electrolyte may escape the mirror housing if the mirror glass breaks.

Electrolyte has an irritating effect. Do not allow the liquid to come into contact with eyes, skin, clothing, or respiratory system. In case it does, immediately flush affected area with water, and seek medical help if necessary.

**Interior rear view mirror**

- ▶ Manually adjust the interior rear view mirror.

For more information, see “Rear view mirrors” (> page 161).

**Exterior rear view mirrors****Warning!**

Exercise care when using the passenger-side exterior rear view mirror. The mirror surface is convex (outwardly curved surface for a wider field of view). Objects in mirror are closer than they appear. Check your interior rear view mirror or glance over your shoulder before changing lanes.



Electrolyte drops coming into contact with the vehicle paint finish can only be completely removed while in their liquid state and by applying plenty of water.

## Getting started

### Adjusting

The buttons are located above the exterior lamp switch.

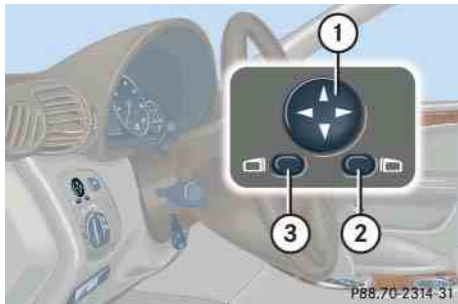

- ① Adjustment button
  - ② Passenger-side exterior rear view mirror button
  - ③ Driver's side exterior rear view mirror button
- ▶ Switch on ignition (▷ page 33).

- ▶ Press button ③ for the driver's side exterior rear view mirror or button ② for the passenger-side exterior rear view mirror.
- ▶ Push adjustment button ① up, down, left, or right according to the desired setting.



If an exterior rear view mirror was forcibly pushed forward (hit from the rear) or forcibly pushed rearward (hit from the front), reposition it by applying firm pressure until it snaps into place. The mirror housing is now properly positioned and you can adjust the mirror normally.



The memory function\* (▷ page 105) lets you store the setting for the exterior rear view mirrors together with the settings for the steering wheel and seat position.



At low ambient temperatures, the exterior rear view mirrors will be heated automatically.

For more information, see "Rear view mirrors" (▷ page 161).

## ▼ Driving

**Warning**

Do not lay any objects in the driver's footwell. Be careful that floor mats or carpets in the driver's footwell have sufficient clearance for the pedals.

During sudden driving or braking maneuvers the objects could get caught between the pedals. You could then no longer brake or accelerate.

**Fastening the seat belt****Warning!**

Always fasten your seat belt before driving off. Always make sure your passengers are properly restrained, even those sitting in the rear and pregnant women.

Failure to wear and properly fasten and position your seat belt greatly increases your risk of injuries and their likely severity in an accident. You and your passengers should always wear seat belts.

If you are ever in an accident, your injuries can be considerably more severe without your seat belt properly buckled. Without your seat belt buckled, you are much more likely to hit the interior of the vehicle or be ejected from it. You can be seriously injured or killed.

In the same crash, the possibility of injury or death is lessened if you are wearing your seat belt. The air bags can only provide the protection they were designed to afford if the occupants are using their seat belts (▷ page 66).

**Warning!**

Children 12 years old and under must never ride in the front seat, except in a Mercedes-Benz authorized BabySmart<sup>TM1</sup> compatible child seat, which operates with the BabySmart<sup>TM</sup> system installed in the vehicle to deactivate the passenger front air bag when it is properly installed. Otherwise they will be struck by the air bag when it inflates in a crash. If this happens, serious or fatal injury will result.

According to accident statistics, children are safer when properly restrained in the rear seating positions than in the front seating positions. Infants and small children must ride in back seats and be seated in an appropriate infant or child restraint system, which is properly secured with the vehicle's seat belt and top tether strap, or secured via lower anchors and top tether strap, fully in accordance with the child seat manufacturer's instructions. ▷▷

<sup>1</sup> BabySmart<sup>TM</sup> is a trademark of Siemens Automotive Corp.

## Getting started

### Driving

- ▷▷ A child's risk of serious or fatal injuries is significantly increased if the child restraints are not properly secured in the vehicle and the child is not properly secured in the child restraint.

#### Warning!



Never ride in a moving vehicle with the seat backrest in an excessively reclined position as this can be dangerous. You could slide under the seat belt in a collision. If you slide under it, the belt would apply force at the abdomen or neck. That could cause serious or even fatal injuries. The seat backrest and seat belt provide the best restraint when the wearer is in a nearly upright position and the belt is properly positioned on the body.

#### Warning!



Never let more people ride in the vehicle than there are seat belts available. Be sure everyone riding in the vehicle is correctly restrained with a separate seat belt. Never use a seat belt for more than one person at a time.

#### Warning!



Read and observe the additional warning notices printed in the "Safety and Security" section (▷ page 64) and (▷ page 66).

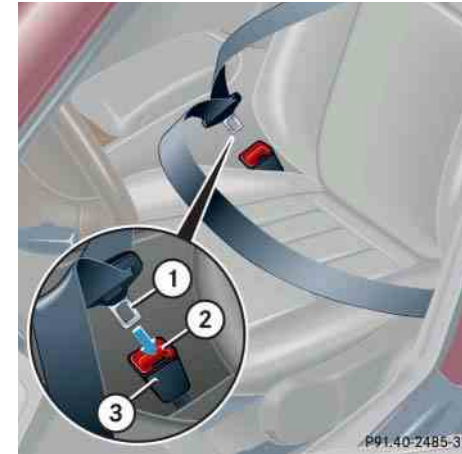

- ① Latch plate
- ② Release button
- ③ Buckle

- ▶ With a smooth motion, pull the belt from the belt outlet.
- ▶ Place the shoulder portion of the belt across the top of your shoulder and the lap portion across your hips.
- ▶ Push latch plate ① into buckle ③ until it clicks.

- ▶ If necessary, tighten the lap portion to a snug fit by pulling shoulder portion up.

### Seat belt height adjustment

Adjust seat belt so that shoulder portion is located as close as possible to the middle of your shoulder (it should not touch the neck or pass under the arm).

#### Front seats



- ④ Button for belt outlet height adjustment
- ▶ Press button ④ and slide belt outlet upward or downward.

#### Rear outer seats



- ⑤ Button for belt outlet height adjustment
- ▶ Press button ⑤ and slide belt outlet upward or downward.

### Proper use of seat belts

- Do not twist the belt when fastening.
- Adjust seat belt so that the shoulder portion is located as close as possible to the middle of the shoulder (it should not touch the neck). Never pass the shoulder portion of the belt under your arm. For this purpose, you can adjust the height of the belt outlet.
- Position the lap belt as low as possible on your hips (over hip joint) and not across the abdomen.
- Place the seat backrest in a nearly upright position.
- Never use a seat belt for more than one person at time.
- Do not fasten a seat belt around a person and another object at the same time. When using a seat belt to secure infant or toddler restraints or children in booster seats, always follow the child seat manufacturer's instructions.

## Getting started

### Driving

- Check your seat belt during travel to make sure that it is properly positioned.
- Make sure that the seat belt is always fitted snugly. Take special care of this when wearing loose clothing.

#### Warning!



Do not pass belts over sharp edges. They could tear.

Do not allow the belt to get caught in the door or in the seat adjustment mechanism. This could damage the belt.

Never attempt to make modifications to seat belts. This could impair the effectiveness of the belts.

Do not bleach or dye seat belts as this may severely weaken them. In a crash, they may not be able to provide adequate protection.

Damaged seat belts or belts that were highly stressed in an accident must be replaced. Contact an authorized Mercedes-Benz Center.

### Starting the engine

#### Warning!



Inhalation of exhaust gas is hazardous to your health. All exhaust gas contains carbon monoxide, and inhaling it can cause unconsciousness and lead to death.

Do not run the engine in confined areas (such as garage) which are not properly ventilated. If you think that exhaust gas fumes are entering the vehicle while driving, have the cause determined and corrected immediately. If you must drive under these conditions, drive only with at least one window fully open.

### Automatic transmission



#### Gearshift pattern for automatic transmission

- P** Park position with gear selector lever lock
- R** Reverse gear
- N** Neutral
- D** Drive position

For more information, see “Automatic transmission” (▷ page 152).



**Starting**

- ▶ Make sure the gear selector lever is set to **P**.
- ▶ Do not depress accelerator.
- ▶ Turn the SmartKey in the starter switch to position **3** and hold until the engine starts (▷ page 33).



You can also use the “touch-start” function. Turn the SmartKey in the starter switch to position **3** and release it again immediately. The engine then starts automatically.

- ▶ Depress the brake pedal.

The gear selector lever lock is released.

For information on turning off the engine, see “Turning off engine” (▷ page 57).

**Starting difficulties**

If the engine does not start as described, carry out the following steps:

- ▶ Turn the SmartKey in the starter to position **0** and repeat starting procedure (▷ page 46).
- ▶ Remember that extended starting attempts can drain the battery.
- ▶ Get a jump start (▷ page 350).

If the engine does not start after several starting attempts, there could be a malfunction in the engine electronics or in the fuel supply system.

- ▶ Notify an authorized Mercedes-Benz Center.

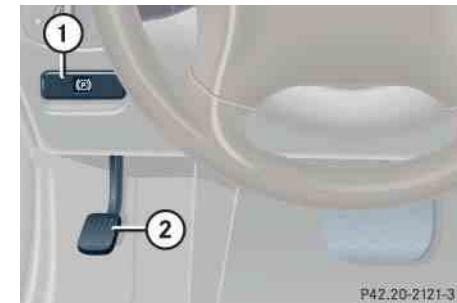
**Parking brake**

- ① Release handle
- ② Parking brake

**Warning!**

When leaving the vehicle, always remove the SmartKey from the starter switch, and lock the vehicle. Do not leave children unattended in the vehicle, or with access to an unlocked vehicle. Children could release the parking brake, which could result in an accident and/or serious injury.

## Getting started

### Driving

- ▶ Release parking brake by pulling on handle ①.  
The warning lamp **BRAKE** (USA only) or  (Canada only) in the instrument cluster goes out.

### Driving

- ▶ Depress the brake pedal.
- ▶ Move gear selector lever to position **D** or **R**.



Wait for the gear selection process to complete before setting the vehicle in motion.

- ▶ Release the brake pedal.
- ▶ Carefully depress the accelerator.  
Once the vehicle is in motion, the automatic central locking system engages and the locking knobs drop down.



You can open a locked door from the inside. Open door only when conditions are safe to do so.

You can deactivate the automatic locking using the control system (> page 143).



Simultaneously depressing the accelerator pedal and applying the brake reduces engine performance and causes premature brake and drivetrain wear.



If you hear a warning signal when driving off, you have forgotten to release the parking brake.

Release the parking brake.

After a cold start, the automatic transmission shifts at a higher engine revolution. This allows the catalytic converter to reach its operating temperature earlier.

### Warning!



On slippery road surfaces, never downshift in order to obtain braking action. This could result in drive wheel slip and reduced vehicle control. Your vehicle's ABS will not prevent this type of loss of control.



Place the gear selector lever in position **R** only when the vehicle is stopped in order to avoid damaging the transmission.



Do not run cold engine at high engine speeds. Running a cold engine at high engine speeds may shorten the service life of the engine.

### Warning!



It is dangerous to shift the gear selector lever out of **P** or **N** if the engine speed is higher than idle speed. If your foot is not firmly on the brake pedal, the vehicle could accelerate quickly forward or in reverse. You could lose control of the vehicle and hit someone or something. Only shift into gear when the engine is idling normally and when your right foot is firmly on the brake pedal.

For more information on driving, see “Driving instructions” (▷ page 257).

### Switching on headlamps

For more information on headlamps, see “Lighting” (▷ page 108).

### Low beam headlamps

The exterior lamp switch is located on the dashboard to the left of the steering wheel.



### Exterior lamp switch

- ① Off
- ② Low beam headlamps on

## Getting started

### Driving

- ▶ Turn exterior lamp switch to position .

The low beam headlamp indicator lamp  in the instrument cluster comes on (▷ page 24).

### High beam

The combination switch is located on the left of the steering column.



### Combination switch

- ① High beam
- ② High beam flasher

## Getting started

### Driving

- ▶ Push combination switch in direction of arrow ①.

The high beam headlamp indicator lamp  in the instrument cluster comes on (▷ page 24).

### Turn signals



The combination switch is located on the left of the steering column.



#### Combination switch

- ① Turn signals, right
- ② Turn signals, left

- ▶ Press combination switch in direction of arrow ① or ②.

The corresponding turn signal indicator lamp  or  in the instrument cluster flashes (▷ page 24).

The combination switch resets automatically after major steering wheel movements.



To signal minor directional changes such as changing lanes, press combination switch only to point of resistance and release. The corresponding turn signals will flash three times.

### Windshield wipers

The combination switch is located on the left of the steering column.



#### Combination switch

- ① Single wipe
  - ② Switching on windshield wipers
- ▶ Switch on ignition (▷ page 33).

### Switching on windshield wipers

- ▶ Turn the combination switch to the desired position depending on the intensity of the rain.
  - 0 Windshield wipers off
  - I Intermittent wiping
  - II Normal wiper speed
  - III Fast wiper speed



Vehicles without rain sensor:  
When the vehicle is standing still, the wiper speed returns to next lower setting.

Vehicles with rain sensor\*:  
Intermittent wiping interval is dependent on wetness of windshield. After the initial wipe, pauses between wipes are automatically controlled by the rain sensor.



Vehicles with rain sensor\*:  
Do not leave windshield wipers in intermittent setting when the vehicle is taken to an automatic car wash or during windshield cleaning. Wipers will operate in the presence of water sprayed on the windshield, and wipers may be damaged as a result.

The switch should not be left in intermittent setting as the wipers will wipe the windshield once every time the engine is started. Dust that accumulates on the windshield might scratch the glass and/or damage the wiper blades when wiping occurs on a dry windshield.

## Getting started

### Driving

#### Intermittent wiping

- ▶ Set the wiper switch to position I.



Intermittent wiping is interrupted when the vehicle is at a standstill and a front door is opened.

#### Single wipe

- ▶ Press combination switch briefly in direction of arrow ①.

The windshield wipers wipe one time without washer fluid.

#### Wiping with windshield washer fluid

- ▶ Push combination switch in direction of arrow ① past the resistance point.

The windshield wipers operate with washer fluid.

For information on filling up the washer reservoir, see “Windshield washer system and headlamp cleaning system\*” (▷ page 277).



If anything blocks the windshield wipers (leaves, snow, etc.), switch them off immediately.

- For safety reasons, withdraw SmartKey from starter switch before attempting to remove any blockage.
- Remove blockage.
- Turn the windshield wipers on again.

If windshield wipers fail to function at all in switch position I,

- set the combination switch to the next highest wiper speed
- have the windshield wipers checked at the nearest authorized Mercedes-Benz Center

### Rear window wiper

The combination switch is located on the left of the steering column.



#### Combination switch

- ① Rear window wiper switch
- ② Wiping rear window with washer fluid
- ③ Intermittent wiping
- ④ Rear window wiper off
- ⑤ Wiping rear window with washer fluid

- ▶ Switch on ignition (▷ page 33).



The rear window wiper engages automatically if the gear selector lever is moved to position **R** with the windshield wipers switched on.

#### Activating intermittent wipe

- ▶ Turn switch ① to position ③.

#### Deactivating intermittent wipe

- ▶ Turn switch ① to position ④.

### Wiping with washer fluid

- ▶ Turn switch ① to position ② or ⑤.

The rear window wiper operates with washer fluid.

Hold switch ① in position ② or ⑤ until the rear window is clean.

For information on filling up the washer reservoir, see “Windshield washer system and headlamp cleaning system\*” (▷ page 277).

## Getting started

### Driving

#### Problems while driving

##### The engine runs erratically and misfires

- An ignition cable may be damaged.
- The engine electronics may not be operating properly.
- Unburned gasoline may have entered the catalytic converter and damaged it.
- ▶ Give very little gas.
- ▶ Have the problem repaired by an authorized Mercedes-Benz Center as soon as possible.

##### The coolant temperature is above 248°F (120°C)

The coolant is too hot and is no longer cooling the engine.

- ▶ Stop the vehicle as soon as possible and turn off the engine. Allow engine and coolant to cool.
- ▶ Check the coolant level and add coolant if necessary (▷ page 275).

##### In case of accident

If the vehicle is leaking gasoline:

- ▶ Do not start the engine under any circumstances.
- ▶ Notify local fire and/or police authorities.

If the extent of the damage cannot be determined:

- ▶ Notify an authorized Mercedes-Benz Center.

If no damage can be determined on the

- major assemblies
- fuel system
- engine mount:
- ▶ Start the engine in the usual manner.



## ▼ Parking and locking

You have now completed your first drive. You have properly stopped and parked your vehicle. End your drive as follows.

### Warning!



Wait until the vehicle is stationary before removing the SmartKey from the starter switch. The vehicle cannot be steered when the SmartKey is removed.

### Warning!



With the engine not running, there is no power assistance for the brake and steering system. In this case, it is important to keep in mind that a considerably higher degree of effort is necessary to brake and steer the vehicle.

### Warning!



Do not park this vehicle in areas where combustible materials such as grass, hay or leaves can come into contact with the hot exhaust system, as these materials could be ignited and cause a vehicle fire.

To reduce the risk of personal injury as a result of vehicle movement, before turning off the engine and leaving the vehicle always:

- Keep right foot on brake pedal.
- Firmly depress parking brake pedal.
- Move the gear selector lever to position **P**.
- Slowly release brake pedal.
- When parked on an incline, turn front wheels towards the road curb.
- Turn the SmartKey in the starter switch to position **0** and remove the SmartKey from the starter switch.
- Take the SmartKey and lock vehicle when leaving.

## Getting started

### Parking and locking

#### Parking brake

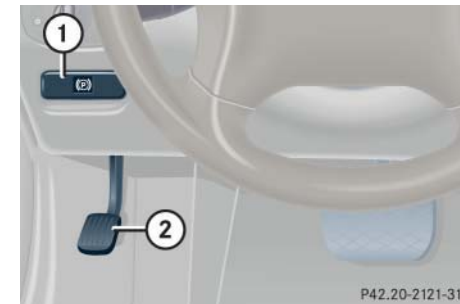

- ① Release handle
- ② Parking brake

- ▶ Step firmly on parking brake pedal ②.

When the engine is running, the warning lamp **BRAKE** (USA only) or  (Canada only) in the instrument cluster will be illuminated.

## Getting started

### Parking and locking

#### Warning!



When leaving the vehicle, always remove the SmartKey from the starter switch, and lock the vehicle. Do not leave children unattended in the vehicle, or with access to an unlocked vehicle. Children could release the parking brake and/or move the gear selector lever from position **P**, either of which could result in an accident and/or serious injury.

#### Warning!



Getting out of your vehicle with the gear selector lever not fully engaged in position **P** is dangerous. Also, when parked on an incline, position **P** alone may not prevent your vehicle from moving, possibly hitting people or objects.

Always set the parking brake in addition to shifting to position **P**.

When parked on an incline, turn front wheels towards the road curb.

#### Switching off headlamps

- ▶ Turn the exterior lamp switch to **0** (▷ page 49).

For more information on headlamps, see “Lighting” (▷ page 108).

## Turning off engine

- ▶ Place the gear selector lever in position **P**.



Always set the parking brake in addition to shifting to position **P**.

On steep slopes, turn the front wheels towards the road curb.

- ▶ Turn the SmartKey in the starter switch to position **0** and remove the SmartKey from the starter switch.  
The immobilizer is activated.



The SmartKey can only be removed from the starter switch with the gear selector lever in position **P**.

- ▶ Press the seat belt release button (▷ page 44).

Allow the retractor to completely rewind the seat belt by guiding the latch plate.



With the SmartKey removed and the driver's door open, a warning sounds if the vehicle's exterior lamps are not switched off.

### Warning!



To prevent possible personal injury, always keep hands and fingers away from the door openings when closing the doors. Be especially careful when small children are around.

Before closing doors, make sure there is no possibility of someone getting caught in a door during closing.

## Getting started

### Parking and locking

- ▶ After exiting the vehicle, press the lock button  on the SmartKey (▷ page 32).

All turn signal lamps flash three times. The locking knobs in the doors move down.

### Warning!



When leaving the vehicle, always remove the SmartKey from the starter switch, and lock your vehicle. Do not leave children unattended in the vehicle, or with access to an unlocked vehicle. Unsupervised use of vehicle equipment may cause an accident and/or serious personal injury.

For more information, see “Locking and unlocking” (▷ page 90).



## **Safety and Security**

**Occupant safety**

**Panic alarm\***

**Driving safety systems**

**Anti-theft systems**

## Safety and Security

### Occupant safety

In this section you will learn the most important facts about the restraint systems of the vehicle.

The restraint systems are

- Seat belts
- Emergency tensioning device
- Air bags
- Child seats
- Child seat recognition
- Lower anchors and tethers for children (LATCH)

As independent systems, their protective effects work in conjunction with each other.



For information on infants and children traveling with you in the vehicle and restraint systems for infants and children, see “Children in the vehicle” (▷ page 69).

The **SRS** indicator lamp in the instrument cluster (▷ page 24) comes on:

- for about four seconds when you turn the SmartKey in the starter switch to position **1**. It then goes out briefly, comes on again and remains lit until you start the engine.
- for about four seconds when you start the engine by turning the SmartKey.



The **SRS** indicator lamp remains lit if the SmartKey in the starter switch is turned to position **2** and left there. The indicator lamp will go out when you start the engine.

The **SRS** indicator lamp goes out shortly after you start the engine. This shows that the restraint systems are operational.

A malfunction in the system has been detected if the **SRS** indicator lamp:

- fails to extinguish after approximately four seconds.
- does not come on at all.
- comes on after the engine was started or while driving.

For safety reasons, we strongly recommend that you visit an authorized Mercedes-Benz Center immediately to have the system checked.

For more information, see “Practical hints” (▷ page 299).

#### Warning!



In the event that the **SRS** indicator lamp comes on during driving or does not come on at all, the SRS self-check has detected a malfunction. For your safety, we strongly recommend that you visit an authorized Mercedes-Benz Center immediately to have the system checked; otherwise the SRS may not be activated when needed in an accident, which could result in serious or fatal injury, or it might deploy unexpectedly and unnecessarily which could also result in injury.

In addition, improper work on the SRS creates a risk of rendering the SRS inoperative or causing unintended air bag deployment. Work on the SRS must therefore only be performed by qualified technicians. Contact an authorized Mercedes-Benz Center.

#### Air bags

#### Warning!



Air bags are designed to reduce the potential of injury and fatality in certain frontal impacts (front air bags), or side impacts (side impact air bags and head protection window curtain air bags). However, no system available today can totally eliminate injuries and fatalities.

The activation of the air bags temporarily releases a small amount of dust from the air bags. This dust, however, is neither injurious to your health, nor does it indicate a fire in the vehicle. The dust might cause some temporary breathing difficulty for people with asthma or other breathing trouble. To avoid this, you may wish to get out of the vehicle as soon as it is safe to do so. If you have any breathing difficulty but cannot get out of the vehicle after the air bag inflates, then get fresh air by opening a window or door.

#### Warning!



To reduce the risk of injury when the front air bags inflate, it is very important for the driver and front passenger to always be in a properly seated position and to wear your seat belts.

For maximum protection in the event of a collision always be in normal seated position with your back against the backrest. Fasten your seat belt and make sure that it is properly positioned on your body.

Since the air bag inflates with considerable speed and force, a proper seating and hands on steering wheel position will help to keep you at a safe distance from the air bag. Occupants who are unbelted, out of position or too close to the air bag can be seriously injured by an air bag as it inflates with great force in the blink of an eye:

- Sit properly belted in a nearly upright position with your back against the seat backrest.



## Safety and Security

### Occupant safety



- Adjust the driver seat as far as possible rearward, still permitting proper operation of vehicle controls. The distance from the center of the driver's breastbone to the center of the air bag cover on the steering wheel must be at least ten inches (25 cm) or more. You should be able to accomplish this by a combination of adjustments to the seat and steering wheel. If you have any problems, please see an authorized Mercedes-Benz Center.
- Do not lean with your head or chest close to the steering wheel or dashboard.
- Keep hands on the outside of steering wheel rim. Placing hands and arms inside the rim can increase the risk and potential severity of hand/arm injury when driver front air bag inflates.

- Adjust the front passenger seat as far as possible rearward from the dashboard when the seat is occupied.
- Occupants, especially children, should never lean their heads in the area of the door where the side air bag inflates. This could result in serious injuries or death should the air bag be triggered. Always sit nearly upright, properly use the seat belts and appropriate size infant or child restraint system.
- Children 12 years old and under must never ride in the front seat, except in a Mercedes-Benz authorized BabySmart<sup>TM1</sup> compatible child seat, which operates with the BabySmart<sup>TM</sup> system installed in the vehicle to deactivate the passenger front air bag when it is properly installed. Otherwise they will be struck by the air bag when it inflates in a crash. If this happens, serious or fatal injury will result.

<sup>1</sup> BabySmart<sup>TM</sup> is a trademark of Siemens Automotive Corp.

Failure to follow these instructions can result in severe injuries to you or other occupants.

If you sell your vehicle, it is important that you make the buyer aware of this safety information. Be sure to give the buyer this Operator's Manual.



## Safety and Security

### Occupant safety

#### Warning!



Accident research shows that the safest place for children in an automobile is in the rear seat. Should you choose to place a child 12 years old or under in the front passenger seat of your vehicle, you must properly use a BabySmart<sup>TM</sup><sup>1</sup> child restraint which will turn off the passenger front air bag. BabySmart<sup>TM</sup> will not, however, turn off any side impact air bag.

It should be noted that with respect to both front and rear side impact air bags there is a possibility for a side air bag related injury if occupants, especially children, are not properly seated or restrained when next to a side air bag which needs to deploy rapidly in a side impact in order to do its job.

<sup>1</sup> BabySmart<sup>TM</sup> is a trademark of Siemens Automotive Corp.

To help avoid the possibility of injury, please follow these guidelines:

- (1) Occupants, especially children, should never place their bodies or lean their heads in the area of the door where the side air bag inflates. This could result in serious injuries or death should the side air bag be activated.
- (2) Always sit nearly upright, properly use the seat belts and use an appropriately sized infant or child restraint system for all children 12 years old or under.
- (3) Always wear seat belts properly.

If you believe that, even with the use of these guidelines, it would be safer for your rear seat occupants to have both rear door mounted side air bags deactivated, then deactivation can be accomplished upon your written request to do so at an authorized Mercedes-Benz Center at an additional cost.

Please contact your local authorized Mercedes-Benz Center or call our Customer Assistance Center at 1-800-FOR-MERCEdes (1-800-367-6372) for details.



Air bags are designed to activate only in certain frontal impacts (front air bags) and in side impacts (side impact and head protection window curtain air bags) which exceed preset thresholds.

Only during these types of impacts, if of sufficient severity to meet the deployment thresholds, will they provide their supplemental protection.

The driver and passengers should always wear their seat belts. Otherwise it is not possible for air bags to provide their supplemental protection.

## Safety and Security

### Occupant safety

In cases of other frontal impacts, angled impacts, roll-overs, other side impacts, rear collisions, or other accidents, the air bags will not be activated. The driver and passengers will then be protected by the fastened seat belts.

We caution you not to rely on the presence of the air bags in order to avoid wearing your seat belt.

Your vehicle was originally equipped with air bags that are designed to activate in certain impacts exceeding a preset threshold to reduce the potential and severity of injury. It is important to your safety and that of your passengers that you replace deployed air bags and repair any malfunctioning air bags to make sure that the vehicle will continue to provide supplemental crash protection for occupants.

#### Safety guidelines for the seat belt, emergency tensioning device and air bag

##### Warning!



- Damaged seat belts or belts that were highly stressed in an accident must be replaced and their anchoring points must also be checked. Only use belts installed or supplied by an authorized Mercedes-Benz Center.
- Air bags and emergency tensioning devices (ETDs) are designed to function on a one-time only basis. An air bag or ETD that was activated must be replaced.

- No modifications of any kind may be made to any components or wiring of the SRS. This includes changing or removing any component or part of the SRS, the installation of additional trim material, badges, etc. over the steering wheel hub, passenger front air bag cover, door trim panels, or door frame trims, and installation of additional electrical/electronic equipment on or near SRS components and wiring. Keep area between air bags and occupants free from objects (e.g. packages, purses, umbrellas, etc.).
- Do not pass belts over sharp edges. They could tear.
- Do not make any modification that could change the effectiveness of the belts.
- Do not bleach or dye seat belts as this may severely weaken them. In a crash they may not be able to provide adequate protection.

## Safety and Security

### Occupant safety

- Do not hang items such as coat hangers from the coat hooks or handles over the door. These items may turn into projectiles and cause head and other injuries when curtain air bag is deployed.
- Never place your feet on the instrument panel, dashboard, or on the seat. Always keep both feet on the floor in front of the seat.
- Air bag system components will be hot after an air bag has inflated. Do not touch.
- In addition, improper repair work on the SRS creates a risk of rendering the SRS inoperative or causing unintended air bag deployment. Work on the SRS must therefore only be performed by qualified technicians. Contact an authorized Mercedes-Benz Center.
- For your protection and the protection of others, when scrapping the air bag unit or emergency tensioning device, our safety instructions must be followed. These instructions are available from your authorized Mercedes-Benz Center.

- Given the considerable deployment speed and the textile structure of the air bags, there is the possibility of abrasions or other injuries resulting from air bag deployment.

When you sell your vehicle we strongly urge you to give notice to the subsequent owner that it is equipped with an SRS by alerting them to the applicable section in the Operator's Manual.

#### Front air bags



- ① Driver's air bag
- ② Passenger front air bag

Driver and front passenger air bags are deployed:

- in the event of a frontal impact
- if impact exceeds a preset deployment threshold
- independently of the side impact air bags

The air bags will not deploy in impacts which do not exceed the system's deployment thresholds. You will then be protected by the fastened seat belts.

The passenger front air bag will only be deployed if:

- the front passenger seat is occupied
- the  indicator lamp in the center console is not lit (▷ page 72)
- the impact exceeds a preset deployment threshold

## Safety and Security

### Occupant safety



Do not place objects heavier than 20 lbs (9 kg) on the front passenger seat. This could cause the front or side impact air bag on the front passenger side to deploy in a crash which exceeds the system's deployment threshold.

#### Side impact air bags, window curtain air bags

The window curtain air bags ① fill up the area between the A and C pillars (see arrows)

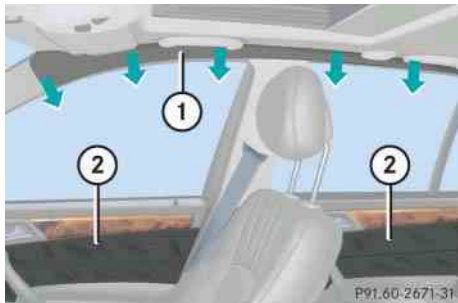

- ① Window curtain air bag
- ② Side impact air bags



The side impact air bags and window curtain air bags are deployed:

- on the impacted side of the vehicle
- in impacts exceeding a preset deployment threshold
- independently of the front air bags

The front passenger side impact air bag will only deploy if the system senses that the front passenger seat is occupied.

The side impact air bags and window curtain air bags are not deployed in impacts which do not exceed the system's deployment threshold.

#### Seat belts

When the engine is started, the seat belt telltale  illuminates to remind you and your passengers to fasten your seat belts. If the driver's seat belt is not fastened before the engine is started, the seat belt telltale  illuminates and a warning chime sounds for approximately six seconds when the engine is started.

The use of seat belts and infant and child restraint systems is required by law in all 50 states, the District of Columbia, the U.S. territories and all Canadian provinces.

Even where this is not the case, all vehicle occupants should have their seat belts fastened whenever the vehicle is in motion.

For more information on seat belts, see "Fastening the seat belt" (▷ page 43).



For information on infants and children traveling with you in the vehicle and restraint systems for infants and children, see "Children in the vehicle" (▷ page 69).

## Safety and Security

### Occupant safety

#### Warning!



Always fasten your seat belt before driving off. Always make sure your passengers are properly restrained, even those sitting in the rear and pregnant women.

Failure to wear and properly fasten and position your seat belt greatly increases your risk of injuries and their likely severity in an accident. You and your passengers should always wear seat belts.

If you are ever in an accident, your injuries can be considerably more severe without your seat belt properly buckled. Without your seat belt buckled, you are much more likely to hit the interior of the vehicle or be ejected from it. You can be seriously injured or killed.

In the same crash, the possibility of injury or death is lessened if you are properly wearing your seat belt. Air bags can only protect as they are designed if the occupants are properly wearing their seat belts.

#### Warning!



Never ride in a moving vehicle with the seat backrest in an excessively reclined position as this can be dangerous. You could slide under the seat belt in a collision. If you slide under it, the belt would apply force at the abdomen or neck. That could cause serious or even fatal injuries. The seat backrest and seat belt provide the best restraint when the wearer is in a nearly upright position and the belt is properly positioned on the body.

#### Warning!



Never let more people ride in the vehicle than there are seat belts available. Be sure everyone riding in the vehicle is correctly restrained with a separate seat belt. Never use a seat belt for more than one person at a time.

#### Warning!



Damaged seat belts or belts that were highly stressed in an accident must be replaced and their anchoring points must also be checked.

Only use seat belts which have been approved by Mercedes-Benz.

Do not make any modifications to the seat belts. This can lead to unintended activation or to failure.

Do not bleach or dye seat belts as this may severely weaken them. In a crash, they may not be able to provide adequate protection.

Have all work carried out only by qualified technicians. Contact an authorized Mercedes-Benz Center.

## Safety and Security

### Occupant safety

#### Warning!



#### USE SEAT BELTS PROPERLY

- Seat belts can only work when used properly. Never wear seat belts in any other way than as described in this section, as that could result in serious injuries in case of an accident.
- Each occupant should wear their seat belt at all times, because seat belts help reduce the likelihood of and potential severity of injuries in accidents, including rollovers. The integrated restraint system includes SRS (driver air bag, passenger front air bag, side impact air bags, head protection window curtain air bags for side windows), ETD (seat belt emergency tensioning device), and front seat knee bolsters. The system is designed to enhance the protection offered to properly belted occupants in certain frontal (front air bags and ETD) and side (side impact, window curtain air bags and ETD) impacts which exceed preset deployment thresholds.

- Never wear the shoulder belt under your arm, against your neck or off your shoulder. In a crash, your body would move too far forward. That would increase the chance of head and neck injuries. The belt would also apply too much force to the ribs or abdomen, which could severely injure internal organs such as your liver or spleen.
- Never wear belts over rigid or breakable objects in or on your clothing, such as eyeglasses, pens, keys, etc., as these might cause injuries.
- Position the lap belt as low as possible on your hips and not across the abdomen. If the belt is positioned across your abdomen, it could cause serious injuries in a crash.
- Never use a seat belt for more than one person at a time. Do not fasten a seat belt around a person and another person or other objects.
- Belts should not be worn twisted. In a crash, you wouldn't have the full width of the belt to manage impact forces. The twisted belt against your body could cause injuries.
- Pregnant women should also use a lap-shoulder belt. The lap belt portion should be positioned as low as possible on the hips to avoid any possible pressure on the abdomen.
- Never place your feet on the instrument panel, dashboard or on the seat. Always keep both feet on the floor in front of the seat.

#### Emergency tensioning device (ETD), seat belt force limiter

The seat belts for the front and rear outer seats are equipped with emergency tensioning devices and belt force limiters.

The ETD is designed to activate in the following cases:

- in frontal or rear-end impacts exceeding a preset severity level.
- if the restraint systems are operational and functioning correctly. See **SRS** indicator lamp (▷ page 60).



The ETDs for the front seats will only activate if the respective front seat belt is fastened (latch plate properly inserted into buckle).

The ETDs for the rear outer seats will activate with or without the respective seat belt fastened.

In an impact, emergency tensioning devices remove slack from the belts in such a way that the seat belts fit more snugly against the body. Belt force limiters reduce the force exerted by the seat belts on occupants during a crash.

#### Warning!



An emergency tensioning device (ETD) that was activated must be replaced.

When scrapping the emergency tensioning device, our safety instructions must be followed. These are available at your authorized Mercedes-Benz Center.



Do not place objects heavier than 20 lbs (9 kg) on the front passenger seat. This could cause the front or side impact air bag on the front passenger side to deploy in a crash which exceeds the system's deployment threshold.

#### Children in the vehicle

If an infant or child is traveling with you in the vehicle:

- Secure the child using an infant or child restraint appropriate to the age and size of the child.
- Make sure that the infant or child is properly secured at all times while the vehicle is in motion.

Infant and child restraint seats and information on choosing an appropriate restraint system can be obtained from any Mercedes-Benz Center.

#### Infant and child restraint systems

Only use a BabySmart<sup>TM1</sup> compatible child restraint for the front passenger seat in this vehicle.

<sup>1</sup> BabySmart<sup>TM</sup> is a trademark of Siemens Automotive Corp.

## Safety and Security

### Occupant safety

We recommend all infants and children be properly restrained at all times while the vehicle is in motion.

All lap-shoulder belts except the driver's seat belt have special seat belt retractors for secure fastening of child restraints.

To fasten a child restraint, follow child restraint instructions for mounting. Then pull the shoulder belt out completely and let it retract. During the seat belt retraction, a ratcheting sound can be heard to indicate that the special seat belt retractor is activated. The belt is now locked. Push down on child restraint to take up any slack.

To deactivate, release seat belt buckle and let seat belt retract completely. The seat belt can again be used in the usual manner.



For information on child seats with anchor fittings for tether anchorages, see "Installation of infant and child restraint systems" (> page 74).

For information on child seat anchors – LATCH-type (> page 75).

#### Warning!



Never release the seat belt buckle while the vehicle is in motion, since the special seat belt retractor will be deactivated.



The use of infant or child restraints is required by law in all 50 states, the District of Columbia, the U.S. territories and all Canadian provinces.

Infants and small children should be seated in an appropriate infant or child restraint system properly secured by a lap-shoulder belt or, if so equipped, a child restraint lower anchorage system that complies with U.S. Federal Motor Vehicle Safety Standards 213 and 225 and Canadian Motor Vehicle Safety Standards 213 and 210.2.



A statement by the child restraint manufacturer of compliance with this standard can be found on the instruction label on the restraint and in the instruction manual provided with the restraint.

When using any infant or child restraint system, be sure to carefully read and follow all manufacturer's instructions for installation and use.

Please read and observe warning labels affixed to inside of vehicle and to infant or child restraints.

### Warning!



Children 12 years old and under must never ride in the front seat, except in a Mercedes-Benz authorized BabySmart<sup>TM</sup><sup>1</sup> compatible child seat, which operates with the BabySmart<sup>TM</sup> system installed in the vehicle to deactivate the passenger front air bag when it is properly installed. Otherwise they will be struck by the air bag when it inflates in a crash. If this happens, serious or fatal injury will result.

According to accident statistics, children are safer when properly restrained in the rear seating positions than in the front seating positions. Infants and small children must ride in back seats and be seated in an appropriate infant or child restraint system, which is properly secured with the vehicle's seat belt and top tether strap, or secured via lower anchors and top tether strap, fully in accordance with the child seat manufacturer's instructions.

<sup>1</sup> BabySmart<sup>TM</sup> is a trademark of Siemens Automotive Corp.

## Safety and Security

### Occupant safety

Infants and small children should never share a seat belt with another occupant. During an accident, they could be crushed between the occupant and seat belt.

A child's risk of serious or fatal injuries is significantly increased if the child restraints are not properly secured in the vehicle and the child is not properly secured in the child restraint.

Children too big for child restraint systems must ride in back seats using regular seat belts. Position shoulder belt across chest and shoulder, not face or neck. A booster seat may be necessary to achieve proper belt positioning for children from 41 lbs until they reach a height where a lap/shoulder belt fits properly without a booster.

When the child restraint is not in use, remove it from the vehicle or secure it with the seat belt to prevent the child restraint from becoming a projectile in the event of an accident.



## Safety and Security

### Occupant safety

- ▷▷ Do not leave children unattended in the vehicle; even if the children are secured in a child restraint system. Unsupervised children in a child restraint system may use vehicle equipment and may cause an accident and/or serious personal injury.

#### BabySmart™<sup>1</sup> air bag deactivation system

The  indicator lamp is located in the center console.



- ① Front passenger front air bag off indicator lamp

<sup>1</sup> BabySmart™ is a trademark of Siemens Automotive Corp.

Special BabySmart™ compatible child seats, designed for use with the Mercedes-Benz system and available at any authorized Mercedes-Benz Center are required for use with the BabySmart™ air bag deactivation system. With the special child seat properly installed, the passenger front air bag will not deploy.

The  indicator lamp will be illuminated, except with the SmartKey removed or in starter switch position **0**.



The system does not deactivate the side impact air bag and the emergency tensioning device.

#### Self-test BabySmart™ without special child seat installed

After turning the SmartKey in the starter switch to position **1** or **2**, the  indicator lamp comes on for approximately six seconds and then goes out.

If the  indicator lamp should not come on or is continuously lit, the system is not functioning. You must see an authorized Mercedes-Benz Center before seating any child on the front passenger seat.

For more information, see “Practical hints” (▷ page 300).

## Safety and Security

### Occupant safety

#### Warning!



The BabySmart<sup>TM1</sup> air bag deactivation system will ONLY work with a special child seat designed to operate with it. It will not work with child seats which are not BabySmart<sup>TM</sup> compatible.

Never place anything between seat cushion and child seat (e.g. pillow), since it reduces the effectiveness of the deactivation system. The bottom of the child seat must make full contact with the passenger seat cushion. An incorrectly mounted child seat could cause injuries to the child in case of an accident, instead of protecting the child.

Follow the manufacturer's instructions for installation of special child seats.

<sup>1</sup> BabySmart<sup>TM</sup> is a trademark of Siemens Automotive Corp.



#### Warning!



When using a BabySmart<sup>TM</sup> compatible child seat on the front passenger seat, the passenger front air bag will not deploy only if the  indicator lamp (> page 72) remains illuminated.

Please be sure to check

the  indicator lamp every time you use the special system child seat.

Should the  indicator lamp go out while the restraint is installed, please check installation. If the  indicator lamp remains out, do not use the BabySmart<sup>TM</sup> restraint to transport children on the front passenger seat until the system has been repaired.

#### Warning!



Do not place powered-on laptops, cell phones and like electronic devices on the front passenger seat. Signals from such devices may interfere with the BabySmart<sup>TM</sup> system. Such signal interference may cause the  indicator lamp (> page 72) not to come on during self-test or be continuously lit, indicating that the system is not functioning.

## Safety and Security

### Occupant safety

#### Installation of infant and child restraint systems

Prior to installing a tether strap, note the following steps:

- ▶ Roll up retractable luggage cover and partition net.
- ▶ If you place a child seat in the left or center rear seat position, remove twin roller blind (▷ page 229) and return seat to its original position.



Do not reinstall twin roller blind with a child seat and top tether installed in the left and center rear seat position.

- ▶ If you place a child seat in the right rear seat position, the twin roller blind can remain installed if so desired.
- ▶ Fold the rear backrest slightly forward (▷ page 230).

- ▶ Guide top tether strap between head restraint and top of seat back.

Head restraints must be installed (if removable) and positioned such that the top tether strap can pass freely between the head restraint and top of the seat back.

Make sure the tether strap is not twisted.

- ▶ Fold the rear backrest back until it locks in place (▷ page 231).



With a child seat and top tether installed in the right rear seat position and twin roller blind installed, make sure the top tether strap is positioned between seat backrest and twin roller blind.

#### Warning!



Always lock backrest in its upright position when rear seat bench is occupied by passengers, or the extended cargo area is not in use. Check for secure locking by pushing and pulling on the backrest.

Anchorage rings ① are located on the back side of the outer rear backrests and on the floor behind the rear center seat.

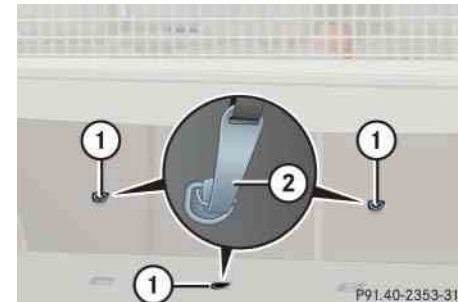

- ① Anchorage ring
- ② Hook

- ▶ Fold up anchorage ring ①.
- ▶ Securely fasten hook ②, which is part of the tether strap, to anchorage ring ①.



For safety, make sure the hook has attached to the ring beyond the safety catch, as illustrated.

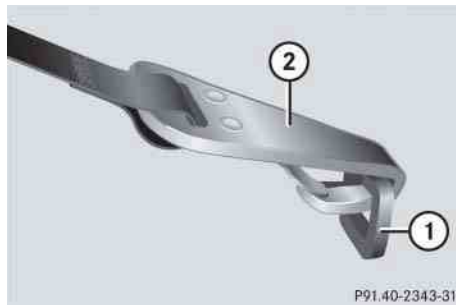

- ① Anchorage ring
- ② Hook

Once the top tether anchorage hook is attached, the child restraint itself can be secured. Tighten the top tether strap according to the child restraint manufacturer's instructions

#### Child seat anchors – LATCH-type

This vehicle is equipped with two LATCH- (Lower Anchors and Tethers for Children) type anchors (at each of the outer rear seats) for the installation of a LATCH-type child seat with the matching mounting fittings.

## Safety and Security

### Occupant safety

The foldable LATCH-type anchors are located between the seat cushion and the backrest.

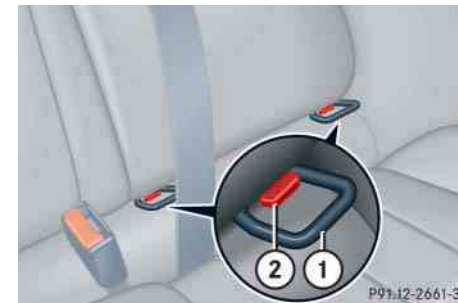

- ① Anchors
- ② Button

- ▶ Grip inner side of anchors ① and fold forward until they audibly lock in place.
- ▶ Install child seat according to the manufacturer's instructions.



If a child seat is not installed, the LATCH-type anchors can be folded back between the seat cushion and the backrest (▷ page 76).

## Safety and Security

### Occupant safety



The child seat must be firmly attached in the right and left side anchors ①.

With a child seat installed in the left rear seat, the seat belt for the center seat occupied by a passenger must operate freely. Guide seat belt between its seat cushion mount and backrest mount along outside of right side child seat anchor.

#### **To fold anchors back**

- ▶ Press down button ② on each anchor and return anchor ① to its catch.



Non-LATCH-type child seats may also be used and can be installed using the vehicle's seat belt system. Install child seat according to the manufacturer's instructions.

#### **Warning!**



Children too big for child restraint systems must ride in back seats using regular seat belts. Position shoulder belt across chest and shoulder, not face or neck. A booster seat may be necessary to achieve proper belt positioning for children from 41 lbs until they reach a height where a lap/shoulder belt fits properly without a booster.

Before installing the child seat, make sure anchors ① are folded out and locked in place.

Install child seat according to manufacturer's instructions.

The child seat must be firmly attached in the right and left side anchors ①.

An incorrectly mounted child seat may come loose during an accident which could result in serious injury or death to your child.

Damaged or impact damaged child seats or child seat anchors ① must be replaced.

Do not leave children unattended in the vehicle, even if the children are secured in a child restraint system.

#### Blocking of rear door window operation

You can block the rear door window operation (for instance when you have children riding in the rear passenger compartment).

The override switch is located on the door control panel of the driver's door.

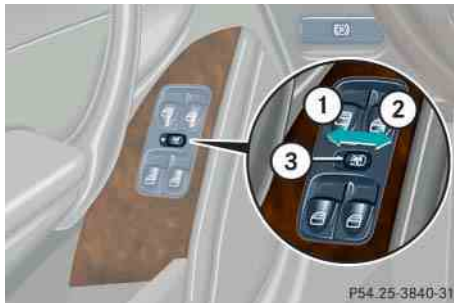

- ① Enable
- ② Disable
- ③ Override switch

#### Activating override switch

- ▶ Slide override switch ③ to the right.

The rear door windows can no longer be operated using the respective switch located in the rear doors.



Operation of the rear door windows with the switches located on the door control panel of the driver's door is still possible.

#### Deactivating override switch

- ▶ Slide override switch ③ to the left.

The rear door windows can be operated again using the respective switch located in the rear doors .

#### Warning!



Activate the override switch when children are riding in the back seats of the vehicle. The children may otherwise injure themselves, e.g. by becoming trapped in the window opening.

When leaving the vehicle, always remove the SmartKey from the starter switch, and lock the vehicle. Do not leave children unattended in the vehicle, or with access to an unlocked vehicle. Unsupervised use of vehicle equipment may cause an accident and/or serious personal injury.

For more information, see "Power windows" (▷ page 215).

## Safety and Security

### Panic alarm\*

An audible alarm and flashing exterior lamps will operate for approximately 2<sup>1</sup>/<sub>2</sub> minutes.



① PANIC button



Canada only:  
Only vehicles equipped with an anti-theft alarm system\* have SmartKeys with integrated panic button ①.

#### Activating

- ▶ Press and hold button ① for at least one second.

#### Deactivating

- ▶ Press button ① again.
- or
- ▶ Insert SmartKey in starter switch.



For operation in the USA only:  
This device complies with Part 15 of the FCC Rules. Operation is subject to the following two conditions:

- (1) This device may not cause harmful interference, and
- (2) this device must accept any interference received, including interference that may cause undesired operation.

Any unauthorized modification to this device could void the user's authority to operate the equipment.



#### ▼ Driving safety systems

In this section you will find information on the following driving safety systems:

- ABS (Antilock Brake System)
- BAS (Brake Assist System)
- ESP (Electronic Stability Program)
- 4MATIC (Four Wheel Electronic Traction System)



In winter operation, the maximum effectiveness of the ABS, ESP, and 4MATIC (if so equipped) is only achieved with winter tires (M+S tires), or snow chains as required.

#### Warning!



The following factors increase the risk of accidents:

- Excessive speed, especially in turns
- Wet and slippery road surfaces
- Following another vehicle too closely

The ABS, BAS, ESP, and 4MATIC (if so equipped) cannot reduce this risk.

Always adjust your driving style to the prevailing road and weather conditions.

#### ABS

#### Warning!



Do not pump the brake pedal. Use firm, steady brake pedal pressure instead. Pumping the brake pedal defeats the purpose of the ABS and significantly reduces braking effectiveness.

The Antilock Brake System (ABS) regulates the brake pressure so that the wheels do not lock during braking. This allows you to maintain the ability to steer your vehicle.

The ABS is functional above a speed of approximately 5 mph (8 km/h) independent of road surface conditions.

On slippery road surfaces, the ABS will respond even to light brake pressure.

The  indicator lamp in the instrument cluster (▷ page 24) comes on when you switch on the ignition. It goes out when the engine is running.

## Safety and Security

### Driving safety systems

#### Braking

At the instant one of the wheels is about to lock up, a slight pulsation can be felt in the brake pedal, indicating that the ABS is in the regulating mode.

- ▶ Keep firm and steady pressure on the brake pedal while experiencing the pulsation.

Continuous steady brake pedal pressure yields the advantages provided by the ABS, namely braking power and ability to steer the vehicle.

The pulsating brake pedal can be an indication of hazardous road conditions and functions as a reminder to take extra care while driving.

#### Emergency brake maneuver

- ▶ Keep continuous full pressure on the brake pedal.

#### Warning!



The ABS cannot prevent the natural laws of physics from acting on the vehicle, nor can it increase braking or steering efficiency beyond that afforded by the condition of the vehicle brakes and tires or the traction afforded. The ABS cannot prevent accidents, including those resulting from excessive speed in turns, following another vehicle too closely, or hydroplaning. Only a safe, attentive, and skillful driver can prevent accidents. The capabilities of an ABS equipped vehicle must never be exploited in a reckless or dangerous manner which could jeopardize the user's safety or the safety of others.

For more information, see "Practical hints" (▷ page 294) and (▷ page 302).

#### BAS

The Brake Assist System (BAS) operates in emergency situations. If you apply the brakes very quickly, the BAS automatically provides full brake boost, thereby potentially reducing the braking distance. Apply continuous full braking pressure until the emergency braking situation is over. The ABS will prevent the wheels from locking.

When you release the brake pedal, the brakes function again as normal. The BAS is then deactivated.

#### Warning!



If the BAS is malfunctioning, the brake system is still functioning normally, but without the additional brake boost available that BAS would normally provide in an emergency braking maneuver. Therefore, the braking distance may increase.

## Safety and Security

### Driving safety systems

#### Warning!



The BAS cannot prevent the natural laws of physics from acting on the vehicle, nor can it increase braking efficiency beyond that afforded by the condition of the vehicle brakes and tires or the traction afforded. The BAS cannot prevent accidents, including those resulting from excessive speed in turns, following another vehicle too closely, or hydroplaning. Only a safe, attentive, and skillful driver can prevent accidents. The capabilities of a BAS equipped vehicle must never be exploited in a reckless or dangerous manner which could jeopardize the user's safety or the safety of others.

For more information, see "Practical hints" (▷ page 303).

#### ESP

The Electronic Stability Program (ESP) is operational as soon as the engine is running and monitors the vehicle's traction (force of adhesive friction between the tires and the road surface) and handling.

The ESP recognizes when a wheel is spinning or if the vehicle starts to skid. By applying brakes to the appropriate wheel and by limiting the engine output, the ESP works to stabilize the vehicle. The ESP is especially useful while driving off and on wet or slippery road surfaces. The ESP also stabilizes the vehicle during braking maneuvers.

The ESP warning lamp  in the speedometer flashes when the ESP is engaged.

The ESP warning lamp  in the speedometer comes on when you switch on the ignition. It goes out when the engine is running.

#### Warning!



Never switch off the ESP when you see the ESP warning lamp  flashing in the speedometer. In this case, proceed as follows:

- While driving off, apply as little throttle as possible.
- While driving, ease up on the accelerator.
- Adapt your speed and driving style to the prevailing road conditions.

Failure to observe these guidelines could cause the vehicle to skid.

The ESP cannot prevent accidents resulting from excessive speed.

## Safety and Security

### Driving safety systems

#### Warning!



The ESP cannot prevent the natural laws of physics from acting on the vehicle, nor can it increase the traction afforded. The ESP cannot prevent accidents, including those resulting from excessive speed in turns or hydroplaning. Only a safe, attentive, and skillful driver can prevent accidents. The capabilities of an ESP equipped vehicle must never be exploited in a reckless or dangerous manner which could jeopardize the user's safety or the safety of others.



The ESP will only function properly if you use wheels of the recommended tire size (▷ page 367).



Vehicles without 4MATIC:  
Because of the ESP's automatic operation, the engine must be shut off (SmartKey in starter switch position **0** or **1**) when

- the parking brake is being tested on a brake test dynamometer
- the vehicle is being towed with the front axle raised

Active braking action through the ESP may otherwise seriously damage the brake system.

For information on vehicles with 4MATIC, see "Four wheel electronic traction system (4MATIC) with the ESP" (▷ page 84).

For more information, see "Practical hints" (▷ page 298) and (▷ page 304).

#### Switching off the ESP

#### Warning!



The ESP should not be switched off during normal driving other than in the circumstances described below. Disabling of the system will reduce vehicle stability in standard driving maneuvers.

To improve the vehicle's traction, turn off the ESP in driving situations where it would be advantageous to have the drive wheels spin and thus cut into surfaces for better grip such as:

- starting out on slippery surfaces and in deep snow in conjunction with snow chains
- in sand or gravel



Turn on the ESP immediately if the aforementioned circumstances do not apply anymore.

## Safety and Security

### Driving safety systems

When you switch off the ESP

- the ESP does not stabilize the vehicle
- the engine output is not limited, which allows the drive wheels to spin and thus cut into surfaces for better grip
- the traction control will still brake a spinning wheel
- the ESP continues to operate when you are braking



When the ESP is switched off and one or more drive wheels are spinning, the ESP warning lamp  in the speedometer flashes. However, the ESP will then not stabilize the vehicle.

The switch is located on the center console.



① ESP switch (off/on)

- ▶ Press switch ①.

The ESP warning lamp  in the speedometer comes on.

The ESP is deactivated.

#### Warning!



When the ESP warning lamp  is illuminated continuously, the ESP is switched off.

Adapt your speed and driving to the prevailing road conditions and to the non-operating status of the ESP.



Avoid spinning of a drive wheel for an extended period with the ESP switched off. This may cause serious damage to the drivetrain which is not covered by the Mercedes-Benz Limited Warranty.

#### Switching on the ESP

- ▶ Press switch ① again.

The ESP warning lamp  in the speedometer goes out.

You are now again in normal driving mode with the ESP switched on.

## Safety and Security

### Driving safety systems

#### Four wheel electronic traction system (4MATIC) with the ESP

Models with all-wheel-drive only.

The 4MATIC improves vehicle's ability to use available traction, e.g. during winter operation in mountains under snowy conditions, by applying power to all four wheels.

#### Warning!



If you see the ESP warning lamp  flashing in the speedometer, proceed as follows:

- While driving off, apply as little throttle as possible
- While driving, ease up on the accelerator
- Adapt your speed and driving style to the prevailing road conditions

Failure to observe these guidelines could cause the vehicle to skid.

The ESP cannot prevent accidents resulting from excessive speed.



Do not tow with one axle raised.

Otherwise the transfer case can be damaged, which is not covered by the Mercedes-Benz Limited Warranty.



Performance testing must only be conducted on a two-axle dynamometer.

Otherwise the transfer case can be damaged, which is not covered by the Mercedes-Benz Limited Warranty.



Because of the ESP's automatic operation, the engine must be shut off (SmartKey in starter switch position **0** or **1**) when the parking brake is being tested on a brake test dynamometer

Active braking action through ESP may otherwise seriously damage the front or rear axle brake system.

Operational tests with the engine running can only be conducted on a two-axle dynamometer.



At highly demanding operating conditions, the electronic traction system may temporarily switch off to prevent overheating of the drive wheel brakes.

The message `unavailable`

See Operator's Manual will then appear in the multifunction display while the ESP warning lamp  is flashing. The ESP is still functioning normally.

#### ▼ Anti-theft systems

##### Immobilizer

The immobilizer prevents unauthorized persons from starting your vehicle.

##### Activating

- ▶ Remove the SmartKey from the starter switch.

##### Deactivating

- ▶ Switch on ignition (▷ page 33).



Starting the engine will also deactivate the immobilizer.

In case the engine cannot be started (yet the vehicle's battery is charged), the system is not operational. Contact an authorized Mercedes-Benz Center or call 1-800-FOR-MERCEdes (in the USA), or 1-800-387-0100 (in Canada).

##### Anti-theft alarm system\*

Once the alarm system has been armed, a visual and audible alarm is triggered when someone opens

- a door
- the tailgate
- the hood

The alarm system will also be triggered when

- someone attempts to raise the vehicle (▷ page 87)
- opening the vehicle with the mechanical key



The alarm will stay on, even if the activating element (a door, for example) is immediately closed.



If the alarm stays on for more than 30 seconds, a call to the Response Center is initiated automatically by the Tele Aid system\* (▷ page 242) provided Tele Aid service was subscribed to and properly activated, and that necessary cellular service and GPS coverage are available.

## Safety and Security

### Anti-theft systems

#### Arming the alarm system

The indicator lamp is in the switch for the tow-away alarm\* in the center console.



① Indicator lamp

- ▶ Lock the vehicle with the SmartKey.

The turn signal lamps flash three times to indicate that the alarm system is activated. Indicator lamp ① begins to flash after approximately 30 seconds after arming the alarm system.



If the turn signal lamps do not flash three times, one of the following elements may not be properly closed:

- a door
- the tailgate
- the hood

Close the respective element and lock the vehicle again.

#### Disarming the alarm system

- ▶ Unlock your vehicle with the SmartKey.



The turn signal lamps flash once to indicate that the alarm system is deactivated.



The alarm system will rearm automatically after approximately 40 seconds if no door or the tailgate lid was opened.

#### Canceling the alarm

To cancel the alarm:

- ▶ Press the  or  button on the SmartKey.

or

- ▶ Insert the SmartKey in the starter switch.



## Safety and Security

### Anti-theft systems

#### Tow-away alarm\*

Once the tow-away alarm is armed, a visual and audible alarm will be triggered when someone attempts to raise the vehicle.



The tow-away protection alarm is triggered, for example, if the vehicle is lifted on one side.

If the alarm stays on for more than 30 seconds, a call to the Response Center is initiated automatically by the Tele Aid system\* (▷ page 242) provided Tele Aid service was subscribed to and properly activated, and that necessary cellular service and GPS coverage are available.

#### Arming tow-away alarm

- ▶ Lock your vehicle with the SmartKey.

The tow-away alarm is automatically armed after about 30 seconds.



When you unlock your vehicle, the tow-away protection disarms automatically. The tow-away alarm remains disarmed until you lock the vehicle again.

#### Disarming tow-away alarm

To prevent triggering the tow-away alarm, switch off the tow-away alarm feature before towing the vehicle, or when parking on a surface subject to movement, such as a ferry or auto train.

The switch is located on the center console.



- ① Tow-away alarm off switch
- ② Indicator lamp

- ▶ Switch off ignition.



You cannot disarm the tow-away alarm while the ignition is switched on. ▷▷

## Safety and Security

### Anti-theft systems

- ▷▷▶ Press switch ①.



Indicator lamp ② in switch comes on briefly.

- ▶ Exit and lock your vehicle with the SmartKey.

The tow-away alarm remains disarmed until you lock your vehicle again.

#### Canceling the alarm

To cancel the alarm:

- ▶ Press the  or  button on the SmartKey.

or

- ▶ Insert the SmartKey in the starter switch.

## **Controls in detail**

**Locking and unlocking**

**Seats**

**Memory function\***

**Lighting**

**Instrument cluster**

**Control system**

**Automatic transmission**

**Good visibility**

**Climate control**

**Audio system**

**Power windows**

**Power tilt/sliding sunroof\***

**Driving systems**

**Loading**

**Useful features**

## Controls in detail

### Locking and unlocking

In the “Controls in detail” section you will find detailed information on how to operate the equipment installed on your vehicle. If you are already familiar with the basic functions of your vehicle, this section will be of particular interest to you.

To quickly familiarize yourself with the basic functions of the vehicle, refer to the “Getting started” section of this manual. The corresponding page numbers are given at the beginning of each segment.

For more information on locking and unlocking, see “Getting started” (▷ page 32) and (▷ page 55).

#### SmartKey

Your vehicle comes supplied with two SmartKeys, each with remote control and a removable mechanical key.

The locking tabs for the mechanical key portion of the two SmartKeys are a different color to help distinguish each SmartKey unit.

The SmartKey provides an extended operating range. To prevent theft, however, it is advisable to only unlock the vehicle when you are in close proximity to it.

The SmartKey centrally locks and unlocks:

- the doors
- the tailgate
- the fuel filler flap

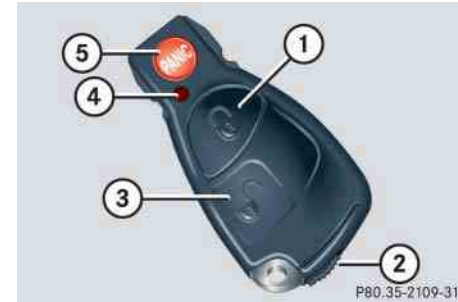

#### SmartKey with remote control

- ① Lock button
- ② Mechanical key locking tab
- ③ Unlock button
- ④ Battery check lamp
- ⑤ PANIC Panic button\* (▷ page 78)

#### i

Canada only:

Only vehicles equipped with an anti-theft alarm system\* have SmartKeys with integrated panic button ⑤.

### Warning!



When leaving the vehicle, always remove the SmartKey from the starter switch and lock the vehicle. Do not leave children unattended in the vehicle, or with access to an unlocked vehicle. It is possible for children to open a locked door from the inside, which could result in an accident and/or serious injury.



To prevent possible malfunction, avoid exposing the SmartKey to high levels of electromagnetic radiation.



You can also open and close the power windows (▷ page 217) and power tilt/sliding sunroof\* (▷ page 221) from outside using the SmartKey.

### Factory setting

#### Global unlocking

- ▶ Press button

All turn signal lamps flash once. The locking knobs in the doors move up. The anti-theft alarm system\* is switched off.

The vehicle will lock again automatically and reactivate the anti-theft alarm system\* within approximately 40 seconds of unlocking if:

- neither door nor tailgate is opened
- the SmartKey is not inserted in the starter switch
- the central locking switch is not activated

## Controls in detail

### Locking and unlocking

#### Global locking

- ▶ Press button

All turn signal lamps flash three times. The locking knobs in the doors move down. The anti-theft alarm system\* is activated.

#### Selective setting

If you frequently travel alone, you may wish to reprogram the SmartKey so that pressing only unlocks the driver's door and the fuel filler flap.

- ▶ Press and hold buttons and simultaneously for about five seconds until battery check lamp ④ flashes twice. ▷▷

## Controls in detail

### Locking and unlocking

- ▷▷ The SmartKey will then function as follows:

#### **Unlocking driver's door and fuel filler flap**

- ▶ Press button  once.

All turn signal lamps flash once. The locking knob in the driver's door moves up. The anti-theft alarm system\* is switched off.

#### **Global unlocking**

- ▶ Press button  twice.



All turn signal lamps flash once. The locking knobs in the doors move up. The anti-theft alarm system\* is switched off.

#### **Global locking**

- ▶ Press button .

All turn signal lamps flash three times. The locking knobs in the doors move down. The anti-theft alarm system\* is activated.

#### **Restoring to factory setting**

- ▶ Press and hold buttons  and  simultaneously for about six seconds until battery check lamp  flashes twice.



If you can no longer lock or unlock the vehicle with the SmartKey, then either the batteries in the SmartKey are discharged, the SmartKey is malfunctioning, or the vehicle battery is drained.

- Check the batteries in the SmartKey (▷ page 93) and replace them if necessary (▷ page 331).
- Use the mechanical key to unlock the driver's door (▷ page 326).
- Use the mechanical key to lock the driver's door (▷ page 327).
- Have the vehicle battery and the battery connections checked (▷ page 347).

If the SmartKey is malfunctioning, contact an authorized Mercedes-Benz Center.

### Checking the batteries

- ▶ Press button  or .

Battery check lamp ④ comes on briefly to indicate that the SmartKey batteries are in order.





If battery check lamp ④ does not come on briefly during check, then the SmartKey batteries are discharged.

Replace the batteries (▷ page 331).

You can obtain the required batteries at any authorized Mercedes-Benz Center.



If the batteries are checked within signal range of the vehicle, pressing the  or  button will lock or unlock the vehicle accordingly.

### Loss of SmartKey or mechanical key

If you lose a SmartKey or mechanical key, you should do the following:

- ▶ Have the SmartKey deactivated by an authorized Mercedes-Benz Center.
- ▶ Report the loss of the SmartKey or the mechanical key immediately to your car insurance company.
- ▶ If necessary, have the mechanical lock replaced.

Your authorized Mercedes-Benz Center will be glad to supply you with a replacement.

## Controls in detail

### Locking and unlocking

#### Opening the doors from the inside

You can open a locked door from the inside. Open door only when conditions are safe to do so.

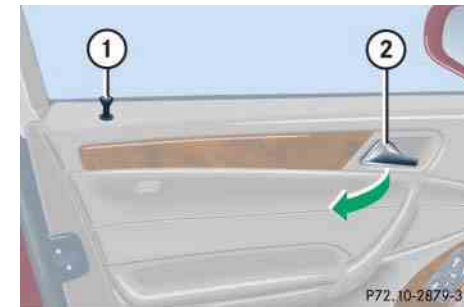

① Locking knob

② Inside door handle

#### Front doors

- ▶ Pull on door handle ② on the respective front door to open door.

If door was locked, locking knob ① will move up.

## Controls in detail

### Locking and unlocking

#### Rear doors

- ▶ Pull up locking knob ① on the respective rear door to unlock door.
- ▶ Pull on door handle ② on the respective rear door to open door.



If the vehicle has previously been locked from the outside with the SmartKey, opening a door from the inside will trigger the anti-theft alarm system\*.

To cancel the alarm, do one of the following:

- Press button or on the SmartKey.
- Insert the SmartKey in the starter switch.

#### Opening the tailgate

A minimum height clearance of 6.40 ft (1.95 m) is required to open the tailgate.

The handle is located above the rear license plate recess.

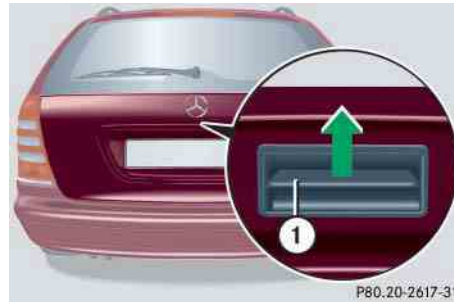

① Handle

The vehicle must be unlocked.

- ▶ Pull on handle ①.
- ▶ Lift the tailgate.



Always make sure there is sufficient overhead clearance.

#### Closing the tailgate



① Handle

- ▶ Lower tailgate by pulling firmly on handle ①.
- ▶ Close tailgate with hands placed flat on it.



## Controls in detail

### Locking and unlocking

#### Warning!



To prevent possible personal injury, always keep hands and fingers away from the tailgate opening when closing the tailgate. Be especially careful when small children are around.

When leaving the vehicle, always remove the SmartKey from the starter switch, take it with you and lock your vehicle. Do not leave children unattended in the vehicle, or with access to an unlocked vehicle. Unsupervised use of vehicle equipment may cause an accident and/or serious personal injury.

#### Warning!



Only drive with the tailgate closed as exhaust fumes may enter the vehicle interior.



Do not place the SmartKey in the open cargo compartment. You may lock yourself out.



If the vehicle was previously centrally locked, the tailgate lid will lock automatically when closed. The turn signals will flash three times to confirm locking.

#### Automatic central locking

The doors and the tailgate automatically lock when the ignition is switched on and the wheels are turning at vehicle speeds of approximately 9 mph (15 km/h) or more.

You can open a locked door from the inside. Open door only when conditions are safe to do so.



The doors unlock automatically after an accident if the force of the impact exceeds a preset threshold.

To prevent the vehicle door locks from locking, deactivate the automatic central locking when the vehicle

- is pushed or towed
- is on a test stand

You can deactivate the automatic locking using the control system, see “Setting automatic locking” (> page 143).

## Controls in detail

### Locking and unlocking

#### Locking and unlocking from the inside

You can lock or unlock the doors and the tailgate from inside using the central locking or unlocking switch. This can be useful, for example, if you want to lock the vehicle before starting to drive.

You cannot lock or unlock the fuel filler flap with the central locking or unlocking switch.

#### Warning!



When leaving the vehicle, always remove the SmartKey from the starter switch, take it with you and lock the vehicle. Do not leave children unattended in the vehicle, or with access to an unlocked vehicle. Unsupervised use of vehicle equipment may cause an accident and/or serious personal injury.

The switches are located in the center console.



- ① Central locking switch
- ② Central unlocking switch



You can open a locked door from the inside. Open door only when conditions are safe to do so.

If the vehicle was previously centrally locked using the SmartKey, it will not unlock using the central unlocking switch ②.

If the vehicle was previously locked with the central locking switch ①

- while in the selective remote control mode, only the door opened from the inside is unlocked.
- while in the global remote control mode, the vehicle is unlocked completely when a door is opened from the inside.

#### Locking

- ▶ Press central locking switch ①.  
If all doors are closed, the vehicle locks.

#### Unlocking

- ▶ Press central unlocking switch ②.  
The vehicle unlocks.

## ▼ Seats

For information on seat adjustment, see “Adjusting” (▷ page 35).

### Easy-entry/exit feature\*

This feature allows for easier entry into and exit from the vehicle.

The easy-entry/exit feature can be activated or deactivated in the Convenience submenu of the control system (▷ page 144).

### Warning!



You must make sure no one can become trapped or injured by the moving steering wheel and driver’s seat when the easy-entry/exit feature is activated.

To cancel seat/steering wheel movement, do one of the following:

- Press seat adjustment switch\* (▷ page 30).
- Move steering column stalk\* (▷ page 40).
- Press memory position switch\* (▷ page 106).

Do not leave children unattended in the vehicle, or with access to an unlocked vehicle. Children could open the driver’s door and unintentionally activate the easy-entry/exit feature, which could result in an accident and/or serious personal injury.

## Controls in detail

### Seats

When exiting the vehicle, with the easy-entry/exit feature activated and depending on your selection, the steering wheel tilts upwards and/or the driver’s seat moves a few inches to the rear when you:

- remove the SmartKey from the starter switch,  
or
- open the driver’s door with the SmartKey in starter switch position **0** or **1**.

## Controls in detail

### Seats



If the current position for the steering wheel is in the uppermost tilt position, the steering wheel will no longer be able to move upward when the easy-entry/exit feature is activated.

If the current seat position falls into a factory-set position range and the system recognizes the current seat position to be rearward enough for easy entry and exit, the driver's seat will not move to the rear when the easy-entry/ exit feature is activated.

When entering the vehicle, with the easy-entry/exit feature activated, the steering wheel or, depending on your selection, the steering wheel and driver's seat will return to their last set position or a factory-set maximum forward position when you:

- close the driver's door with the ignition switched on
- insert the SmartKey into the starter switch with the driver's door closed.



For safety reasons, the driver's seat will not return to its last set position with the easy-entry/exit feature activated if the system recognizes the last set position as an extreme forward position. Instead, the driver's seat will remain at or move to a factory-set maximum forward position. To again fully return the driver's seat to your last set position or to memory position, adjust the seat to the desired position or press and hold the respective memory position switch\* (▷ page 106).

## Removing and installing front seat head restraints

For information on head restraint adjustment, see “Seats” (▷ page 35).



Adjust the head restraint in such a way that it is as close to the head as possible.

### Warning!



For your protection, drive only with properly positioned head restraints.

Adjust head restraint so that the center of the head restraint supports the back of the head at eye level. This will reduce the potential for injury to the head and neck in the event of an accident or similar situation.

Do not drive the vehicle without the seat head restraints. Head restraints are intended to help reduce injuries during an accident.

Do not interchange head restraints from front and rear seat.



Tilt the backrest to the rear for easier removal and installation of the head restraints.

## Controls in detail

### Seats

#### Front seat head restraints, manual seat

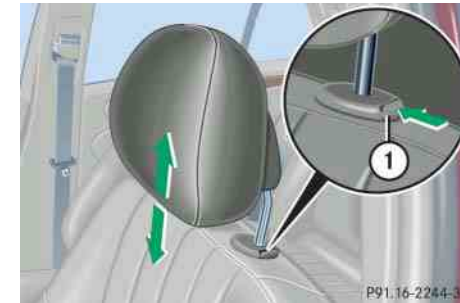

① Release button

#### Removing front seat head restraints

- ▶ Pull head restraint to its highest position.
- ▶ Push release button ① and pull out head restraint.

#### Installing front seat head restraints

- ▶ Insert head restraint and push it down until it engages.
- ▶ Push release button ① and adjust head restraint to desired position.

## Controls in detail

### Seats

#### Front seat head restraints, power seat\*

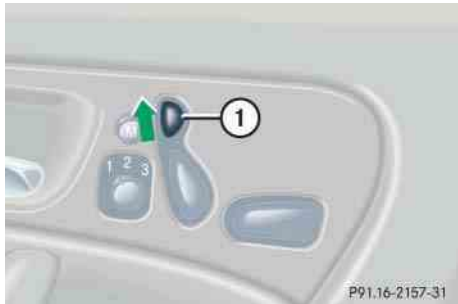

① Head restraint switch

- ▶ Switch on ignition (▷ page 33).

#### Removing front seat head restraints

- ▶ Press switch ① upwards and hold until head restraint is fully extended.
- ▶ Pull out head restraint.

#### Installing front seat head restraints

- ▶ Press switch ① upwards and hold for about five seconds.
- ▶ Push head restraint down until it engages.
- ▶ Adjust head restraint to desired position (▷ page 38).

#### Rear seat head restraints

#### Warning!



For safety reasons, always drive with the rear head restraints in the upright position when the rear seats are occupied.  
Keep the area around head restraints clear of articles (e.g. clothing) to not obstruct the folding operation of the head restraints.

#### Head restraint height (rear outer seats)

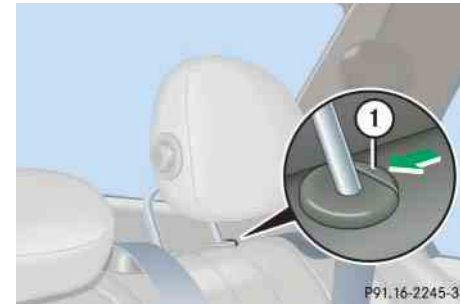

① Release button

#### Raising:

- ▶ Manually adjust the height of the head restraint by pulling it upward.

If the head restraint is fully retracted, push release button ① and pull the head restraint out.

#### Lowering:

- ▶ To lower the head restraint, push release button ① and push down on the head restraint.



Adjust the head restraint in such a way that it is as close to the head as possible.

### Warning!



For your protection, drive only with properly positioned head restraints.

Adjust head restraint so that the center of the head restraint supports the back of the head at eye level. This will reduce the potential for injury to the head and neck in the event of an accident or similar situation.

Do not drive the vehicle without the seat head restraints. Head restraints are intended to help reduce injuries during an accident.

### Folding head restraints back

The rear seat head restraints can be folded backward for increased visibility.

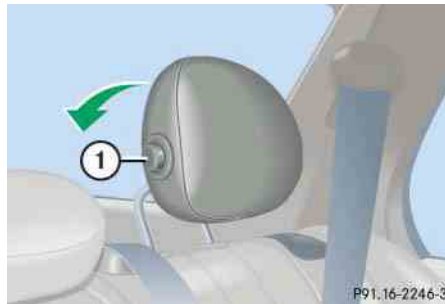

① Release button

- ▶ Push release button ①.

The head restraints will fold backward.

## Controls in detail

### Seats

### Placing head restraints upright



- ▶ Pull the head restraint forward until it locks into position.

### Warning!



Make sure the head restraints engage when placing them upright. Otherwise their protective function cannot be assured.

## Controls in detail

### Seats

#### Head restraint tilt (rear outer seats)

Two different head restraint angle positions are available.

- ▶ Press the release button (▷ page 101) and tilt the head restraint to the desired position.

#### Removing and installing rear seat head restraints (rear outer seats)



Adjust the head restraint in such a way that it is as close to the head as possible.



The rear center seat head restraint cannot be removed.

#### Warning!



For your protection, drive only with properly positioned head restraints.

Adjust head restraint so that the center of the head restraint supports the back of the head at eye level. This will reduce the potential for injury to the head and neck in the event of an accident or similar situation.

Do not drive the vehicle without the seat head restraints. Head restraints are intended to help reduce injuries during an accident.

Do not interchange head restraints from front and rear seat.

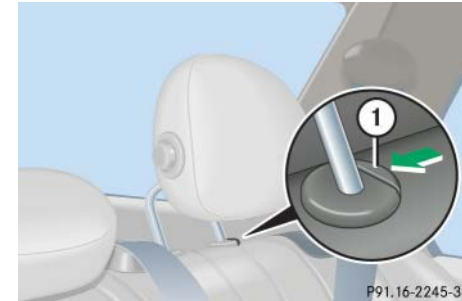

- ① Release button

#### Removing rear seat head restraints

- ▶ Fold back head restraint (▷ page 101).
- ▶ Pull head restraint to its highest position.
- ▶ Push release button ① and pull out head restraint.

#### Installing rear seat head restraints

- ▶ Insert head restraint and push it down until it engages.
- ▶ Push button ① and adjust head restraint to desired position.



### Multicontour seats\*

This multicontour seat has a movable seat cushion and inflatable air cushions built into the backrest to provide additional lumbar and side support.

The seat cushion movement, backrest cushion height and curvature can be continuously varied with switches on the side of the seat after switching on ignition.

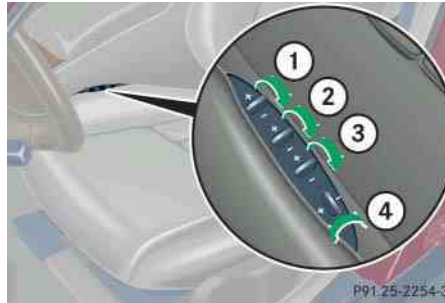

- ① Seat cushion depth
- ② Backrest bottom
- ③ Backrest center
- ④ Backrest side bolster adjustment

## Controls in detail

### Seats

- ▶ Switch on ignition (▷ page 33).

#### Seat cushion depth

- ▶ Adjust the seat cushion depth to the length of your upper leg using switch ①.

#### Backrest contour

- ▶ Adjust the contour of the backrest to the desired position using switches ② and ③.

#### Backrest side bolsters

- ▶ Adjust the backrest side bolsters so that they provide good lateral support using switch ④.

## Controls in detail

### Seats

#### Seat heating\*

The switches for the front seats are located in the center console.



- ① Seat heating switch
- ② Indicator lamps

The red indicator lamps ② in the switch show the heating level selected.

Level	
3	Three indicator lamps on. After approximately five minutes, seat heating is automatically switched to level 2.
2	Two indicator lamps on. After approximately ten minutes, seat heating is automatically switched to level 1.
1	One indicator lamp on. After approximately 20 minutes, seat heating is automatically switched off.
off	No indicator lamp on.

- ▶ Switch on ignition (▷ page 33).

#### Switching on seat heating

- ▶ Press switch ① twice.  
Three red indicator lamps ② in the switch come on.
- ▶ Continue pressing switch ① until desired seat heating level is reached.

#### Switching off seat heating

- ▶ Press switch ① repeatedly until all indicator lamps ② go out.



If one or all of the indicator lamps ② on the seat heating switch are flashing, there is insufficient voltage due to too many electrical consumers are turned on. The seat heating switches off automatically.

The seat heating will switch back on again automatically as soon as sufficient voltage is available.

## ▼ Memory function\*



Prior to operating the vehicle, the driver should check and adjust the seat height, seat position fore and aft, and seat backrest angle if necessary, to ensure adequate control, reach and comfort. The head restraint should also be adjusted for proper height. See also the section on air bags (▷ page 61) for proper seat positioning.

In addition, adjust the steering wheel to ensure adequate control, reach, operation and comfort. Both the interior and exterior rear view mirrors should be adjusted for adequate rear vision.

Fasten seat belts. Infants and small children should be seated in a properly secured restraint system that complies with U.S. Federal Motor Vehicle Safety Standards 213 and 225 and Canadian Motor Vehicle Safety Standards 213 and 210.2.

You can store up to three different settings per SmartKey.

The following settings are stored when using the buttons on the driver's door:

- Driver's seat, backrest and head restraint position
- Steering wheel position
- Exterior rear view mirror positions

These key-dependent memory settings can be deactivated if desired. For information on key-dependent memory settings, see "Setting key-dependency" (▷ page 145).

## Controls in detail

### Memory function\*

The following settings are not key-dependent. They are stored when using the buttons on the front passenger door:

- Front passenger seat, backrest and head restraint position

#### Warning!



Do not activate the memory function while driving. Activating the memory function while driving could cause the driver to lose control of the vehicle.

## Controls in detail

### Memory function\*

The memory button and memory position switch are located on the door.

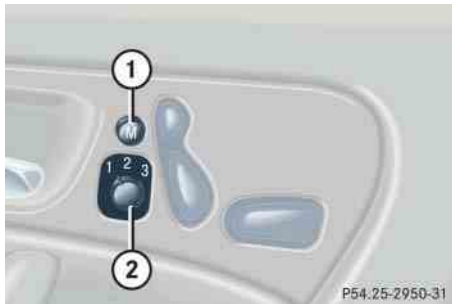

① Memory button

② Memory position switch

- ▶ Switch on ignition (▷ page 33).

or

- ▶ Open the respective door.

#### Storing positions into memory

- ▶ Adjust the seat, steering wheel and exterior rear view mirrors to the desired position (▷ page 35).
- ▶ Turn memory position switch ② to the selected memory position.
- ▶ Press memory button ①.
- ▶ Release memory button ① and press memory position switch ② within three seconds.

All settings are stored to the selected position.

#### Recalling positions from memory



Do not operate the power seats using the memory button if the seat backrest is in an excessively reclined position. Doing so could cause damage to front or rear seats.

- ▶ Turn memory position switch ② to the selected memory position.
- ▶ Press and hold memory position switch ② until the seat, steering wheel and exterior rear view mirrors have completely moved to the stored positions.



Releasing the memory position switch stops movement to the stored positions immediately.

### Storing exterior rear view mirror parking position

For easier parking, you can adjust the passenger-side exterior rear view mirror so that you can see the right rear wheel as soon as you engage reverse gear **R**.

For information on activating the parking position, see “Activating exterior rear view mirror parking position\*” (▷ page 163).



You can store a parking position for the passenger-side exterior rear view mirror for each SmartKey.



- ① Memory button
- ② Adjustment button
- ③ Passenger side exterior rear view mirror button

- ▶ Stop the vehicle.
- ▶ Switch on ignition (▷ page 33).

## Controls in detail

### Memory function\*

- ▶ Press button ③.  
The passenger-side exterior rear view mirror is selected.
- ▶ Adjust the exterior rear view mirror with button ② so that you see the rear wheel and the road curb.
- ▶ Press memory button ①.
- ▶ Within three seconds, press bottom of adjustment button ②.

The parking position is stored if the mirror does not move.



If the mirror does move, repeat the above steps. After the setting is stored you can move the mirror again.

## Controls in detail

### Lighting

For information on how to switch on the headlamps and use the turn signals, see “Switching on headlamps” (▷ page 49) and “Turn signals” (▷ page 50).



If you drive in countries where vehicles drive on the other side of the road than the country where the vehicle is registered, you must have the headlamps modified for symmetrical low beams. Relevant information can be obtained at your authorized Mercedes-Benz Center.

#### Exterior lamp switch

The exterior lamp switch is located on the dashboard to the left of the steering wheel.



Exterior lamp switch

- 0** Off  
Daytime running lamp mode (▷ page 110)
- AUTO** Automatic headlamp mode  
Daytime running lamp mode (▷ page 110)
- Parking lamps (also tail lamps, license plate lamps, side marker lamps, instrument panel lamps)
- Low beam headlamps (or high beam headlamps when the combination switch is pushed forward) and parking lamps
- P** Standing lamps, right (turn left one stop)
- ←P** Standing lamps, left (turn left two stops)
- Indicator lamp for front fog lamps
- Indicator lamp for rear fog lamp



With the SmartKey removed from the starter switch and the driver's door open, a warning sounds if the parking lamps or low beam headlamps are switched on.

The message *Switch off lights.* appears in the multifunction display

### Manual headlamp mode

The low beam headlamps and the parking lamps can be switched on and off with the exterior lamp switch.

### Automatic headlamp mode

The following lamps switch on and off automatically depending on the brightness of the ambient light:

- Low beam headlamps
- Tail and parking lamps
- License plate lamps
- Side marker lamps



### Warning!



If the exterior lamp switch is set to **AUTO**,

- the headlamps may switch off unexpectedly when the system senses bright ambient light, for example light from oncoming traffic.
- the headlamps will not be automatically switched on under foggy conditions.

To minimize risk to you and to others, activate headlamps by turning exterior lamp switch to  when driving or when traffic and / or ambient lighting conditions require you to do so.

In low ambient lighting conditions, only switch from position **AUTO** to  with the vehicle at a standstill. Switching from **AUTO** to  will briefly switch off the headlamps. Doing so while driving in low ambient lighting conditions may result in an accident.

## Controls in detail

### Lighting

The automatic headlamp feature is only an aid to the driver. The driver is responsible for the operation of the vehicle's lights at all times.

- ▶ Turn the exterior lamp switch to position **AUTO**.

With the SmartKey in starter switch position **1**, only the parking lamps will switch on and off automatically.

When the engine is running, the low beam headlamps, the tail and parking lamps, the license plate lamps, and the side marker lamps will switch on and off automatically.

## Controls in detail

### Lighting

#### Daytime running lamp mode

- ▶ Turn the exterior lamp switch to position **0** or **AUTO**.

When the engine is running, the low beam headlamps are switched on.

In low ambient light conditions, the following lamps will switch on additionally:

- Tail and parking lamps
- License plate lamps
- Side marker lamps

For nighttime driving you should turn the exterior lamp switch to position  to permit activation of the high beam headlamps.



With the daytime running lamp mode activated and the exterior lamp switch in position **0**, the high beam headlamps cannot be switched on.



The high beam flasher is available at all times.

#### Canada only

The daytime running lamp mode is mandatory and therefore in a constant mode.

When the engine is running, and you shift from a driving position to position **N** or **P**, the low beam headlamps will switch off with a three-minute delay.



When the engine is running, and you

- turn the exterior lamp switch to position , the parking lamps switch on additionally.
- turn the exterior lamp switch to position , the manual headlamp mode has priority over the daytime running lamp mode.

The corresponding exterior lamps switch on (▷ page 108).

#### USA only

By default, the daytime running lamp mode is deactivated. Activate the daytime running lamp mode using the control system, see “Setting daytime running lamp mode (USA only)” (▷ page 140).

When the engine is running, and you turn the exterior lamp switch to position  or , the manual headlamp mode has priority over the daytime running lamp mode.

The corresponding exterior lamps switch on (▷ page 108).





### Locator lighting and night security illumination

The locator lighting and the night security illumination are described in the “Control system” section, see “Setting locator lighting” (▷ page 141) and “Setting night security illumination” (▷ page 141).

### Fog lamps

#### Warning!



In low ambient lighting or foggy conditions, only switch from position **AUTO** to  with the vehicle at a standstill. Switching from **AUTO** to  will briefly switch off the headlamps. Doing so while driving in low ambient lighting conditions may result in an accident.



Fog lamps will operate with the parking lamps and/or the low beam headlamps on. Fog lamps should only be used in conjunction with low beam headlamps. Consult your State or Province Motor Vehicle Regulations regarding permissible lamp operation.



Fog lamps cannot be switched on with the exterior lamp switch in position **AUTO**. For switching on the fog lamps, turn the exterior lamp switch to position  first.

### Front fog lamps

- ▶ Switch on the low beam headlamps (▷ page 108).
- ▶ Pull out the exterior lamp switch to first stop.

The front fog lamps switch on.

The green indicator lamp  in the exterior lamp switch comes on (▷ page 108).

- ▶ Push down the exterior lamp switch.



The front fog lamps switch off.

The green indicator lamp  in the exterior lamp switch goes out.

## Controls in detail

### Lighting

#### Rear fog lamp (driver's side only)

- ▶ Switch on the front fog lamps (▷ page 111).
- ▶ Pull out the exterior lamp switch to second stop.  
The rear fog lamp switches on.  
The yellow indicator lamp  in the exterior lamp switch comes on (▷ page 108).
- ▶ Push down the exterior lamp switch to first stop.  
The rear fog lamp switches off.  
The yellow indicator lamp  in the exterior lamp switch goes out.  
The front fog lamps remain lit.

#### Combination switch



The combination switch is located on the left of the steering column.



#### Combination switch

- ① High beam
- ② High beam flasher

#### High beam

- ▶ Turn the exterior lamp switch to position  or **AUTO** (▷ page 108).
- ▶ Push the combination switch in direction of arrow ① to switch on the high beam.  
The high beam headlamp indicator lamp  in the instrument cluster comes on (▷ page 24).
- ▶ Pull the combination switch in direction of arrow ② to its original position to switch off the high beam.  
The high beam headlamp indicator lamp  in the instrument cluster goes out.

#### High beam flasher

- ▶ Pull the combination switch briefly in direction of arrow ②.

#### Hazard warning flasher

The hazard warning flasher can be switched on at all times, even with the SmartKey removed from the starter switch.

The hazard warning flasher switches on automatically when an air bag deploys.

The hazard warning flasher switch is located on the upper part of the center console.



① Hazard warning flasher switch

#### Switching on hazard warning flasher

- ▶ Press hazard warning flasher switch ①.

All turn signals are flashing.



With the hazard warning flasher activated and the combination switch set for either left or right turn, only the respective turn signals will operate when the ignition is switched on.

#### Switching off hazard warning flasher

- ▶ Press hazard warning flasher switch ① again.



If the hazard warning flasher has been activated automatically, press hazard warning flasher switch ① once to switch it off.

## Controls in detail

### Lighting

#### Interior lighting

The controls are located in the overhead control panel.



- ① Rear interior lights
- ② Right front reading lamp
- ③ Rocker switch for automatic control system
- ④ Left front reading lamp

#### Activating automatic control

- ▶ Press rocker switch ③ to center position.

Interior lamps are switched on in darkness, even when you:

- unlock the vehicle
- open a door
- remove the SmartKey from the starter switch
- open the tailgate

The interior lamps are switched off after a preset time, see “Setting interior lighting delayed shut-off” (▷ page 143).



If the door remains open, the interior lamps switch off automatically after approximately five minutes, when the SmartKey is removed or in starter switch position 0.

An interior lamp switched on manually does not go out automatically.

#### Deactivating automatic control

- ▶ Press the  symbol on rocker switch ③.

The interior lighting remains switched off, even when you:

- unlock the vehicle
- open a door
- remove the SmartKey from the starter switch
- open the tailgate

#### Manual control

##### **Switching all front interior lights on and off**

- ▶ Press the  symbol on rocker switch ③.

The front interior lights come on.

- ▶ Press rocker switch ③ to center position to activate the automatic control.



The setting selected for the interior lighting is used for the cargo compartment lighting as well.

If you leave the tailgate open for an extended period of time, the cargo compartment lighting will switch off automatically after approximately ten minutes

#### **Switching rear interior lights on and off**

- ▶ Press button

The lights in the rear passenger compartment come on.

- ▶ Press button again.

The lights in the rear passenger compartment go out.

#### **Switching right front reading lamp on and off**

- ▶ Press right button

The right reading lamp comes on.

- ▶ Press right button again.

The right reading lamp goes out.

#### **Switching left front reading lamp on and off**

- ▶ Press left button

The left reading lamp comes on.

- ▶ Press left button again.

The left reading lamp goes out.

## **Controls in detail**

### **Lighting**

#### **Door entry lamps**

The appropriate door entry lamp switches on if a door is opened in darkness and if the interior lighting is switched to automatic function.

The entry lamp switches off automatically when the door is closed.



If you turn the SmartKey in the starter switch to position **0** and switch off the exterior headlamps, the door entry lamps will remain lit for approximately five minutes.

## Controls in detail

### Instrument cluster

For a full view illustration of the instrument cluster, see “At a glance” (▷ page 24).



① Reset button

The instrument cluster is activated when you

- open a door
- switch on ignition
- press reset button ①
- switch on the exterior lamps

You can change the instrument cluster settings in the Instrument cluster submenu of the control system (▷ page 133).

### Instrument cluster illumination

Use reset button ① to adjust the illumination brightness for the instrument cluster.



The instrument cluster illumination is dimmed or brightened automatically to suit ambient light conditions.

The instrument cluster illumination will also be adjusted automatically when you switch on the vehicle's exterior lamps.

### To brighten illumination

- ▶ Turn reset button ① clockwise.  
The instrument cluster illumination will brighten.

### To dim illumination

- ▶ Turn reset button ① counterclockwise.  
The instrument cluster illumination will dim.

#### Coolant temperature gauge

The coolant temperature gauge is on the left side in the instrument cluster (▷ page 24).

#### Warning!





- Driving when your engine is badly overheated can cause some fluids which may have leaked into the engine compartment to catch fire. You could be seriously burned.
- Steam from an overheated engine can cause serious burns and can occur just by opening the hood. Stay away from the engine if you see or hear steam coming from it.

Turn off the engine, get out of the vehicle and do not stand near the vehicle until the engine has cooled down.

During severe operating conditions, e.g. stop-and-go traffic, the coolant temperature may rise close to 248°F (120°C).

The engine should not be operated with the coolant temperature above 248°F (120°C). Doing so may cause serious engine damage which is not covered by the Mercedes-Benz Limited Warranty.

#### Trip odometer

- ▶ Make sure you are viewing the trip odometer and main odometer in the multifunction display (▷ page 119).
- ▶ If it is not displayed, press button  or  on the multifunction steering wheel until the trip odometer appears (▷ page 120).
- ▶ Press and hold the reset button in the instrument cluster (▷ page 116) until the trip odometer is reset.

## Controls in detail

### Instrument cluster

#### Tachometer

The red marking on the tachometer (▷ page 24) denotes excessive engine speed.



Avoid driving at excessive engine speeds, as it may result in serious engine damage that is not covered by the Mercedes-Benz Limited Warranty.

To help protect the engine, the fuel supply is interrupted if the engine is operated within the red marking.

#### Outside temperature indicator

##### Warning!



The outside temperature indicator is not designed to serve as an ice-warning device and is therefore unsuitable for that purpose.

Indicated temperatures just above the freezing point do not guarantee that the road surface is free of ice. The road may still be icy, especially in wooded areas or on bridges.

The outside temperature is indicated in the multifunction display (▷ page 119). For information on how to select the unit of the indicated temperature, i.e. degrees Celsius (°C) or degrees Fahrenheit (°F), see “Selecting temperature display mode” (▷ page 133).

The temperature sensor is located in the front bumper area. Due to its location, the sensor can be affected by road or engine heat during idling or slow driving. This means that the accuracy of the displayed temperature can only be verified by comparison to a thermometer placed next to the sensor, not by comparison to external displays (e.g. bank signs, etc.).

When moving the vehicle into colder ambient temperatures (e.g. when leaving your garage), you will notice a delay before the lower temperature is displayed.

A delay also occurs when ambient temperatures rise. This prevents inaccurate temperature indications caused by heat radiated from the engine during idling or slow driving.



## ▼ Control system

The control system is activated as soon as the SmartKey in the starter switch is turned to position **1**. The control system enables you to

- call up information about your vehicle
- change vehicle settings

For example, you can use the control system to find out when your vehicle is next due for service, to set the language for messages in the instrument cluster display, and much more.



The displays for the audio systems (radio, CD player) will appear in English, regardless of the language selected.

### Warning!



A driver's attention to the road and traffic conditions must always be his/her primary focus when driving.

For your safety and the safety of others, selecting features through the multifunction steering wheel should only be done by the driver when traffic and road conditions permit it to be done safely.

Bear in mind that at a speed of just 30 mph (approximately 50 km/h), your vehicle is covering a distance of 44 feet (approximately 14 m) every second.

The control system relays information to the multifunction display.

## Controls in detail

### Control system

#### Multifunction display

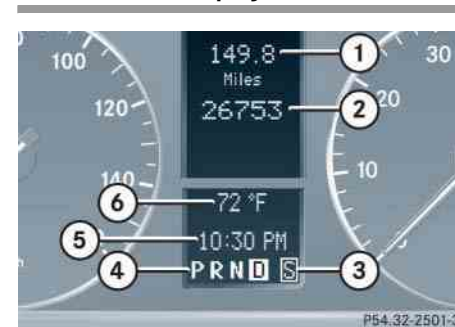

- ① Trip odometer
- ② Main odometer
- ③ Current program mode
- ④ Current gear selector lever position/gear range
- ⑤ Digital clock
- ⑥ Status indicator (outside temperature/digital speedometer)

## Controls in detail

### Control system

#### Multifunction steering wheel

The displays in the multifunction display and the settings in the control system are controlled by the buttons on the multifunction steering wheel.

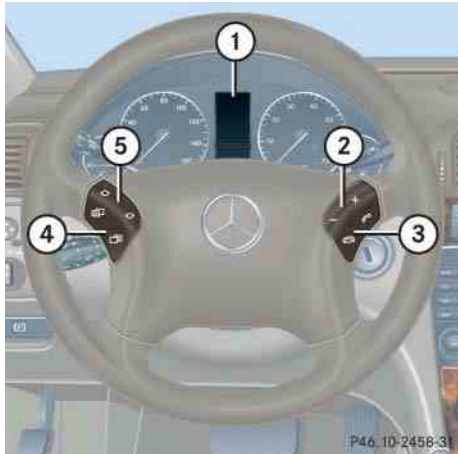

① Multifunction display

#### Operating the control system

② Selecting the submenu or setting the volume:

Press button

 up/to increase

 down/to decrease

③ Telephone\*:

Press button

 to take a call

 to end a call

④ Menu systems:

Press button

 for next menu

 for previous menu

⑤ Moving within a menu:

Press button

 for next display





 for previous display

Pressing any of the buttons on the multifunction steering wheel will alter what is shown in the multifunction display.

The information available in the multifunction display is arranged in menus, each containing a number of functions or sub-menus.

The individual functions are then found within the relevant menu (radio or CD operations under AUDIO, for example). These functions serve to call up relevant information or to customize the settings for your vehicle.

It is helpful to think of the menus, and the functions within each menu, as being arranged in a circular pattern.

- If you press button  or  repeatedly, you will pass through each menu one after the other.
- If you press button  or  repeatedly, you will pass through each function display, one after the other, in the current menu.

In the **Settings** menu, instead of functions you will find a number of submenus for calling up and changing settings. For instructions on using these submenus, see “Submenus in the Settings menu” (▷ page 131).

The number of menus available in the system depends on which optional equipment is installed in your vehicle.

The menus are described on the following pages.

## Controls in detail

### Control system

#### Menus

This is what you will see when you scroll through the menus.

The table on the next page provides an overview of the individual menus.

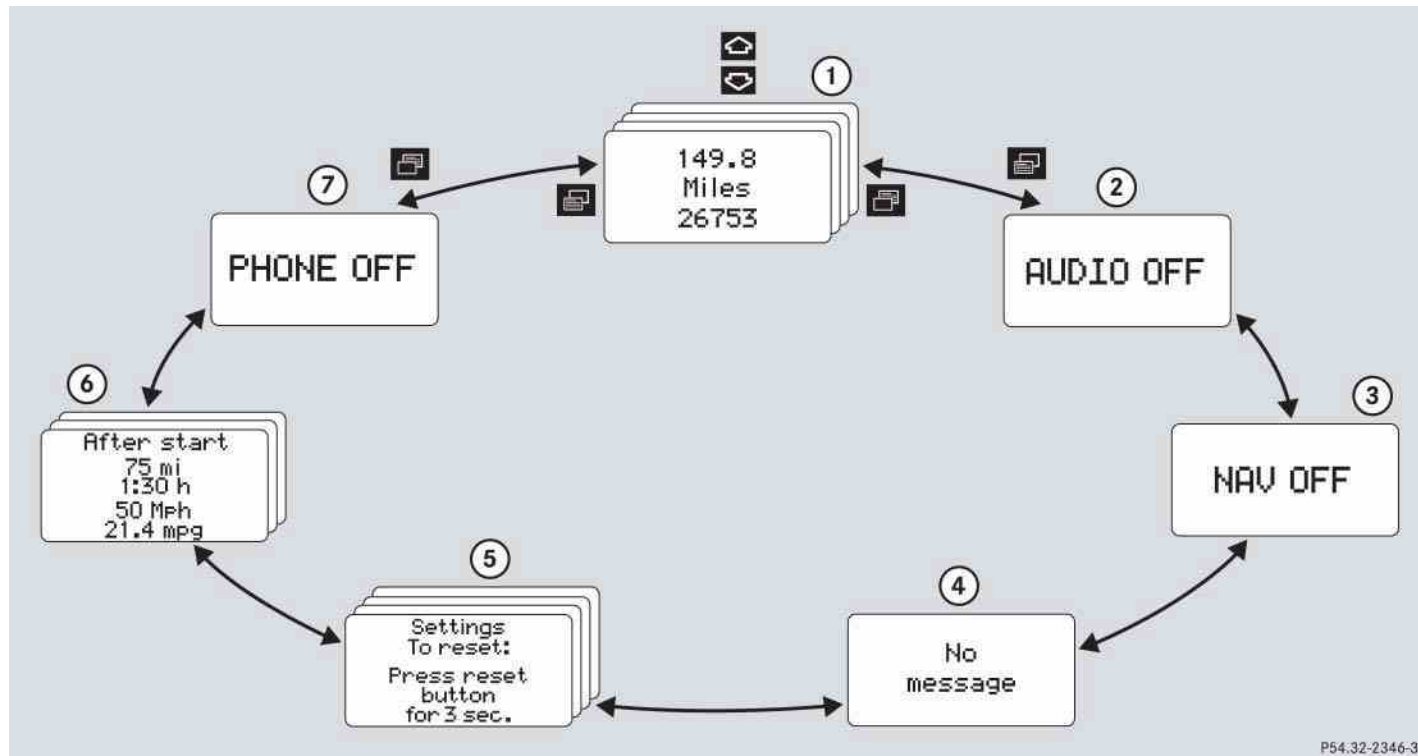

**Menus, submenus and functions**

	<b>Menu ①</b>	<b>Menu ②</b>	<b>Menu ③</b>	<b>Menu ④</b>	<b>Menu ⑤</b>	<b>Menu ⑥</b>	<b>Menu ⑦</b>
	<b>Standard display</b>	<b>AUDIO</b>	<b>NAV*</b>	<b>Vehicle status message memory</b>	<b>Settings</b>	<b>Trip computer</b>	<b>Telephone*</b>
	(▷ page 124)	(▷ page 125)	(▷ page 128)	(▷ page 128)	(▷ page 130)	(▷ page 146)	(▷ page 148)
<b>Commands/submenus</b>	Digital speedometer or outside temperature	Select radio station	Activate route guidance	Call up vehicle malfunction, warning and system status messages stored in memory	Reset to factory settings	Fuel consumption statistics after start	Load phone book
	Call up maintenance service display	Select satellite radio station* (USA only)			Instrument cluster submenu	Fuel consumption statistics since the last reset	Search for name in phone book
	Check engine oil level	Operate the CD player*			Time/Date submenu Lighting submenu Vehicle submenu Convenience submenu	Call up range	

## Controls in detail

### Control system



The headings used in the menus table are designed to facilitate navigation within the system and are not necessarily identical to those shown in the control system displays.



The first function displayed in each menu will automatically show you which part of the system you are in.



#### Standard display menu

In the standard display, the main odometer and the trip odometer are shown in the multifunction display.



- ① Trip odometer
- ② Main odometer



If you see another display, press button  or  repeatedly until the standard display appears.

You can select the functions in the standard display menu with button  or .

The following functions are available:

Function	Page
Display digital speedometer or outside temperature	125
Calling up maintenance service display	284
Checking engine oil level	272

#### Display digital speedometer or outside temperature

- ▶ Press button  or  repeatedly until the digital speedometer appears in the multifunction display.

The current vehicle speed is shown in the multifunction display.

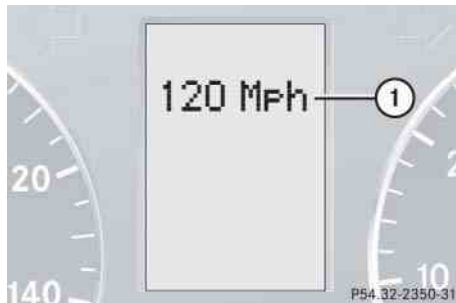

① Digital speedometer



You can have the outside temperature displayed instead of the digital speedometer. You can select the setting in the submenu *Instr.Cl.* via the function *Status line display* (▶ page 134).

#### AUDIO menu

The functions in the *AUDIO* menu operate the audio equipment which you currently have turned on.

If no audio equipment is currently turned on, the message *AUDIO OFF* appears in the multifunction display.



The following functions are available:

Function	Page
Select radio station	126
Select satellite radio station* (USA only)	126
Operate CD player*	127

## Controls in detail



### Control system

#### Select radio station

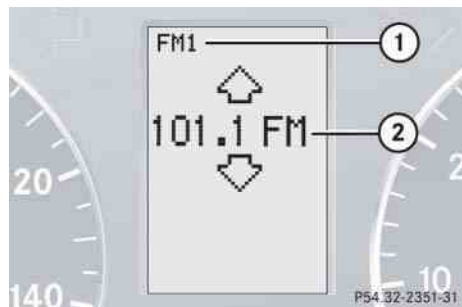
- ▶ Turn on the radio (▷ page 178).  
Vehicles with COMAND\*:  
Refer to separate operating instructions.
- ▶ Press button  or  repeatedly until the currently tuned station appears in the multifunction display.



- ① Waveband setting
- ② Station frequency

- ▶ Press button  or  repeatedly until the desired station is found.



You can only store new stations using the corresponding feature on the radio (▷ page 186).

Vehicles with COMAND\*:  
Refer to separate operating instructions.

You can also operate the radio in the usual manner.

#### Select satellite radio station\*

The Sirius-Satellite-Radio is treated as a radio application.

- ▶ Select satellite radio with the corresponding soft key (SAT) in the radio menu.

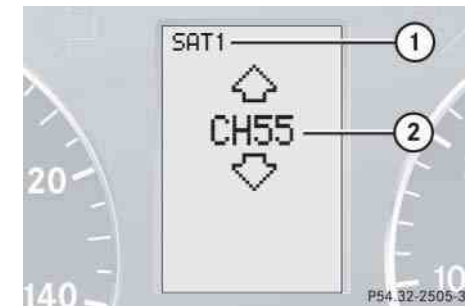

- ① SAT mode and preset number
- ② Channel name or number



- ▶ Press button  or  repeatedly until the desired channel is found.





Feature description is based on preliminary information available at time of printing.

For more information on satellite radio operation, see “Introduction to satellite radio\* (USA only)” (▷ page 188).

Vehicles with COMAND\*:  
Refer to separate operating instructions.

#### Operate the CD player\*

- ▶ Turn on the radio and select the CD player (▷ page 193).  
Vehicles with COMAND\*:  
Refer to separate operating instructions.
- ▶ Press button  or  repeatedly until the settings for the CD currently being played appear in the multifunction display.

## Controls in detail

### Control system

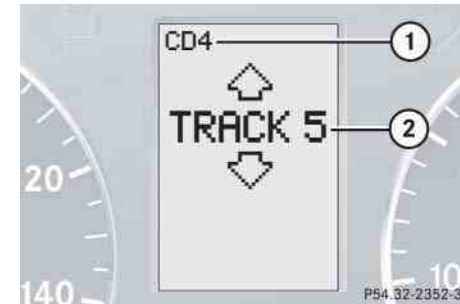

① Current CD (for CD changer\*)

② Current track

- ▶ Press button  or  repeatedly until the desired track is selected.





To select a CD from the magazine, press a number on the audio system or the COMAND\* system key pad located in the center dashboard.

## Controls in detail

### Control system

#### NAV\* menu

The NAV menu contains the functions needed to operate your navigation system.

- ▶ Press button  or  repeatedly until the message NAV appears in the multifunction display.
- If the navigation system is switched off, the message NAV OFF appears in the multifunction display.
- If the navigation system is on, different messages, depending on the current state of the navigation system, appear in the multifunction display.

Please refer to the COMAND\* manual for instructions on how to activate the route guidance system\*.



#### Vehicle status message memory menu

Use the vehicle status message memory menu to scan malfunction and warning messages that may be stored in the system. Such messages appear in the multifunction display and are based on conditions or system status the vehicle's system has recorded.

#### Warning!



Malfunction and warning messages are only indicated for certain systems and are intentionally not very detailed. The malfunction and warning messages are simply a reminder with respect to the operation of certain systems and do not replace the owner's and/or driver's responsibility to maintain the vehicle's operating safety by having all required maintenance and safety checks performed on the vehicle and by bringing the vehicle to an authorized Mercedes-Benz Center to address the malfunction and warning messages (> page 301).

- ▶ Press button  or  repeatedly until the vehicle status message memory appears in the multifunction display.

#### No vehicle status messages

If no conditions are recorded in memory, the message in the multifunction display is: No message

#### Vehicle status messages have been recorded

If conditions have occurred causing status messages to be recorded, the number of messages appears in the multifunction display:

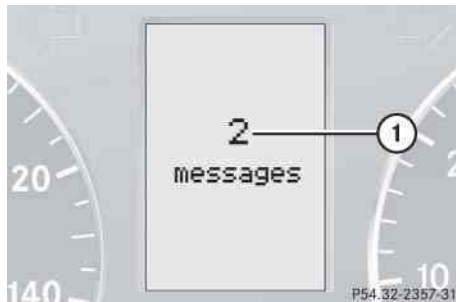

① Number of messages

► Press button  or .

The stored messages will now be displayed in order in which they have occurred. For malfunction and warning messages, see “Vehicle status messages in the multifunction display” (▷ page 301).

Should the vehicle’s system record any conditions while driving, the number of malfunctions will reappear in the multifunction display when the SmartKey in the starter switch is turned to position **0** or removed from the starter switch.





The vehicle status message memory will be cleared when you turn the SmartKey in the starter switch to position **1** or **2**. You will then only see high-priority messages in the multifunction display (▷ page 301).

## Controls in detail

### Control system

#### Settings menu

In the Settings menu there are two functions:

- The function **Reset to factory settings**, with which you can reset all the settings to the original factory settings.
  - A collection of submenus with which you can make individual settings for your vehicle.
- ▶ Press button  or  repeatedly until the Settings menu appears in the multifunction display.



#### Resetting all settings

You can reset all the functions of all submenus to the factory settings.

- ▶ Press the reset button in the instrument cluster (▷ page 116) for approximately three seconds.

The request to press the reset button once more to confirm appears in the multifunction display.

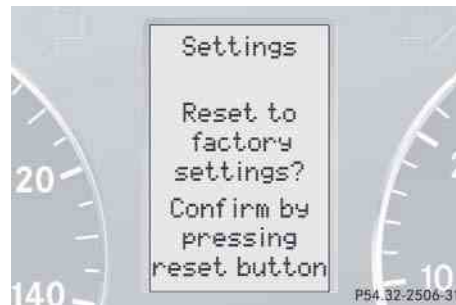

- ▶ Press the reset button once more.

The functions of all the submenus will reset to factory settings.



The settings you have changed will not be reset unless you confirm the action by pressing the reset button a second time. After approximately five seconds, the Settings menu reappears in the multifunction display.

For safety reasons, the following functions are not reset while driving:

- the **Hd lamp mode** function in the **Lighting submenu**
- the **Key dependency** function in the **Convenience submenu**

#### Submenus in the Settings menu



- ▶ Press button  or .

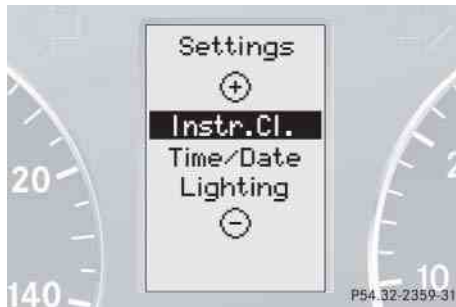

The collection of the submenus appears in the multifunction display.





- ▶ Press button .

The selection marker moves to the next submenu.

The submenus are arranged by hierarchy. Scroll down with button , scroll up with button .

Move within the submenus with button  or  to the individual functions.

The settings themselves are made with button  or .

#### Resetting the functions of a submenu

For each submenu you can reset all the functions to the factory settings.

- ▶ Move to a function in the submenu.
- ▶ Press the reset button (> page 116) in the instrument cluster for approximately three seconds.

The request to press the reset button once more to confirm appears in the multifunction display.

- ▶ Press the reset button once more.

All functions of the submenu will reset to factory settings.



The settings you have changed will not be reset unless you confirm the action by pressing the reset button a second time. After approximately five seconds, the Settings menu reappears in the multifunction display.

## Controls in detail

### Control system

The table below shows what settings can be changed within the various menus.

Detailed instructions on making individual settings can be found on the following pages.

Instrument cluster	Time/Date	Lighting	Vehicle	Convenience
Selecting temperature display mode	Time synchronization with head unit*	Setting daytime running lamp mode (USA only)	Setting automatic locking	Activating easy-entry/exit feature
Selecting speedometer display mode	Setting the time (hours)	Setting locator lighting		Setting key-dependency
Selecting language	Setting the time (minutes)	Setting night security illumination		Setting parking position for exterior rear view mirror
Selecting display (speed display or outside temperature) for status indicator	Selecting time display mode	Setting interior lighting delayed shut-off		
	Selecting automatic time change (Daylight Saving Time (DST) summer/Standard time winter)			
	Setting the date (month)			
	Setting the date (day)			
	Setting the date (year)			

#### Instrument cluster submenu

Access the Instr.Cl. submenu via the Settings menu. Use the Instr.Cl. submenu to change the instrument cluster display settings.

The following functions are available:

Function	Page
Selecting temperature display mode	133
Selecting speedometer display mode	133
Selecting language	134
Selecting display (speed display or outside temperature) for status indicator	134

#### Selecting temperature display mode

- ▶ Move the selection marker with button **+** or **-** to the Instr.Cl. submenu.
- ▶ Press button **↕** or **↔** repeatedly until the message Temperature indicator appears in the multifunction display.

The selection marker is on the current setting.

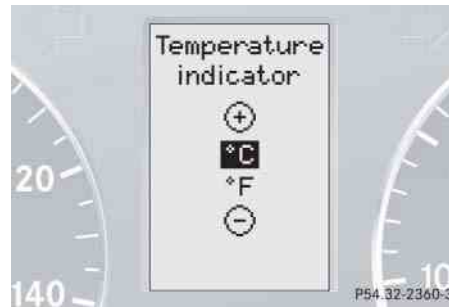

- ▶ Press button **+** or **-** to set temperature unit to °C (degrees Celsius) or °F (degrees Fahrenheit).

#### Selecting speedometer display mode

- ▶ Move the selection marker with button **+** or **-** to the Instr.Cl. submenu.
- ▶ Press button **↕** or **↔** repeatedly until the message Disp.Unit Speed/odo appears in the multifunction display.

The selection marker is on the current setting.



- ▶ Press button **+** or **-** to set speedometer unit to km or Miles.

## Controls in detail

### Control system

#### Selecting language

- ▶ Move the selection marker with button **+** or **-** to the Instr.Cl. submenu.
- ▶ Press button **▲** or **▼** repeatedly until the message Language appears in the multifunction display.

The selection marker is on the current setting.



- ▶ Press button **+** or **-** to select the language to be used for the multifunction display messages.

Available languages:

- German
- English
- French
- Italian
- Spanish

#### Selecting display (speed display or outside temperature) for status indicator

- ▶ Move the selection marker with button **+** or **-** to the Instr.Cl. submenu.
- ▶ Press button **▲** or **▼** repeatedly until the message Status line display appears in the multifunction display.

The selection marker is on the current setting.

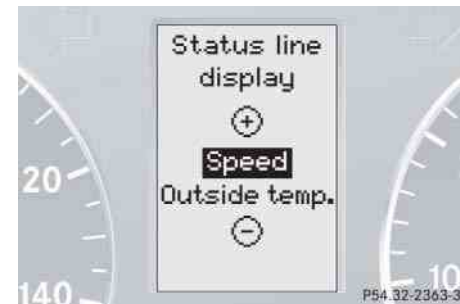

- ▶ Press button **+** or **-** to select the desired setting.

The selected display is then shown continuously in the lower display.

The other display now appears in the menu of the standard display:

- Digital speedometer  
or
- Outside temperature



#### Time/Date submenu

Access the Time/Date submenu via the Settings menu. Use the Time/Date submenu to change the instrument cluster display settings.

The following functions are available:

Function	Page
Time synchronization with head unit*	135
Setting the time (hours)	135
Setting the time (minutes)	136
Selecting time display mode	137
Selecting automatic time change (Daylight Saving Time (DST) summer/Standard time winter)	137
Setting the date (month)	137
Setting the date (day)	138
Setting the date (year)	139

#### Time synchronizing with head unit\*

This function can only be seen on vehicles with COMAND\* and navigation module\*.

- ▶ Move the selection marker with button **+** or **-** to the Time/Date submenu.
- ▶ Press button **▲** or **▼** repeatedly until the message Time synchro. w/Head Unit appears in the multifunction display.

The selection marker is on the current setting.



- ▶ Press button **+** or **-** to select the desired setting.

#### Setting the time (hours)

This function can only be seen with audio system.



Vehicles with COMAND\*:  
For information on setting the time, refer to the separate COMAND operating instructions.

- ▶ Move the selection marker with button **+** or **-** to the Time/Date submenu.
- ▶ Press button **▲** or **▼** repeatedly until the message Time Hours appears in the multifunction display. ▷▷

## Controls in detail

### Control system

- ▷▷ The selection marker is on the hour setting.



- ▶ Press button **+** or **-** to set the hour.
- ▶ Press the reset button in the instrument cluster (▷ page 116) to confirm. The hour is set and stored.

### Setting the time (minutes)

This function can only be seen with audio system.



Vehicles with COMAND\*:  
For information on setting the time, refer to the separate COMAND operating instructions.

- ▶ Move the selection marker with button **+** or **-** to the Time/Date submenu.
- ▶ Press button **↶** or **↷** repeatedly until the message *Time Minutes* appears in the multifunction display.

- The selection marker is on the minute setting.



- ▶ Press button **+** or **-** to set the minutes.
- ▶ Press the reset button in the instrument cluster (▷ page 116) to confirm. The minutes are set and stored.

### Selecting time display mode

- ▶ Move the selection marker with button **+** or **-** to the Time/Date submenu.
- ▶ Press button **↶** or **↷** repeatedly until the message **Clock display** appears in the multifunction display.  
The selection marker is on the current setting.



- ▶ Press button **+** or **-** to set the 12h or 24h time display mode.

### Selecting automatic time change (Daylight Saving Time (DST) summer/Standard time winter)

- ▶ Move the selection marker with button **+** or **-** to the Time/Date submenu.
- ▶ Press button **↶** or **↷** repeatedly until the message **Change-over Summer / Winter time** appears in the multifunction display.  
The selection marker is on the current setting.



## Controls in detail

### Control system

- ▶ Press button **+** or **-** to select if the changeover between summer and winter time should be automatic or manual.

### Setting the date (month)

This function can only be seen with audio system.



Vehicles with COMAND\*:  
For information on setting the date, refer to the separate COMAND operating instructions.

- ▶ Move the selection marker with button **+** or **-** to the Time/Date submenu.
- ▶ Press button **↶** or **↷** repeatedly until the message **Date Set MM** appears in the multifunction display. ▷▷

## Controls in detail

### Control system

- ▷▷ The selection marker is on the month setting.



- ▶ Press button **+** or **-** to set the month.

### Setting the date (day)

This function can only be seen with audio system.



Vehicles with COMAND\*:  
For information on setting the date,  
refer to the separate COMAND  
operating instructions.

- ▶ Move the selection marker with button **+** or **-** to the Time/Date submenu.
- ▶ Press button **↶** or **↷** repeatedly until the message Date Set day appears in the multifunction display.

- The selection marker is on the day setting.

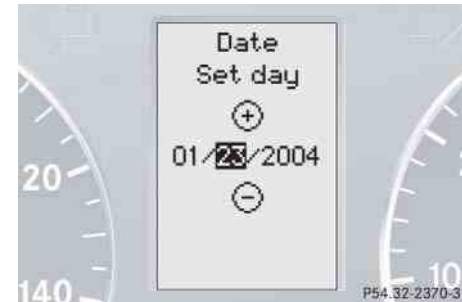

- ▶ Press button **+** or **-** to set the day.

#### Setting the date (year)

This function can only be seen with audio system.



Vehicles with COMAND\*:  
For information on setting the date, refer to the separate COMAND operating instructions.

- ▶ Move the selection marker with button **+** or **-** to the Time/Date submenu.
- ▶ Press button **↶** or **↷** repeatedly until the message Date Set YY appears in the multifunction display.

The selection marker is on the year setting.

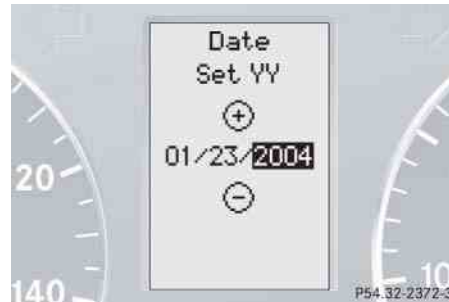

- ▶ Press button **+** or **-** to set the year.

#### Lighting submenu

Access the Lighting submenu via the Settings menu. Use the Lighting submenu to change the lamp and lighting settings on your vehicle.

The following functions are available:

Function	Page
Setting daytime running lamp mode (USA only)	140
Setting locator lighting	141
Setting night security illumination	141
Setting interior lighting delayed shut-off	143

## Controls in detail

### Control system

#### Setting daytime running lamp mode (USA only)



This function is not available in countries where the daytime running lamp mode is mandatory and therefore in a constant mode.

- ▶ Move the selection marker with button **+** or **-** to the Lighting submenu.
- ▶ Press button **↶** or **↷** repeatedly until the message Hd lamp mode appears in the multifunction display.

The selection marker is on the current setting.

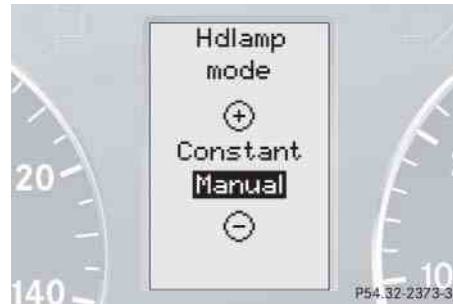

- ▶ Press button **+** or **-** to select manual operation (Manual) or daytime running lamp mode (Constant) activated.

With daytime running lamp mode activated and the exterior lamp switch in position **0** or **AUTO**, the low beam headlamps are switched on when the engine is running.

In low ambient light conditions the following lamps will switch on additionally:

- Parking lamps
- Tail lamps
- License plate lamps
- Side marker lamps

For more information on the daytime running lamp mode, see "Lighting" (▷ page 108).



For safety reasons, resetting the Lighting submenu to factory settings (▷ page 131) while driving will not deactivate the daytime running lamp mode.

The following message appears in the multifunction display:

Lighting - Cannot be completely reset to factory sets. while driving.

#### Setting locator lighting

With the locator lighting feature activated and the exterior lamp switch in position **AUTO**, the following lamps will switch on when the vehicle is unlocked with the SmartKey during darkness:

- Parking lamps
- Tail lamps
- License plate lamps
- Side marker lamps
- Front fog lamps

The locator lighting switches off when the driver's door is opened.

If you do not open a door after unlocking with the SmartKey the lamps will switch off automatically after approximately 40 seconds.

- ▶ Move the selection marker with button **+** or **-** to the **Lighting** submenu.

- ▶ Press button **↶** or **↷** repeatedly until the message **Surround lighting** appears in the multifunction display.

The selection marker is on the current setting.



- ▶ Press button **+** or **-** to switch the locator lighting function **On**.
- ▶ Turn the exterior lamp switch to position **AUTO** when exiting the vehicle (▷ page 108).

The locator lighting feature is activated.

#### Setting night security illumination (Headlamps delayed shut-off)

Use this function to set whether and how long you would like the exterior lamps to illuminate during darkness after exiting the vehicle and all doors closed.

With the delayed shut-off feature activated and the exterior lamp switch in position **AUTO** before the engine is turned off, the following lamps will switch on after you have removed the SmartKey from the starter switch:

- Parking lamps
- Tail lamps
- License plate lamps
- Side marker lamps
- Front fog lamps

If you do not open a door after removing the SmartKey from the starter switch, the lamps will switch off automatically after approximately 60 seconds.

## Controls in detail

### Control system



You can reactivate this function within ten minutes by opening a door.

- ▶ Move the selection marker with button **+** or **-** to the Lighting submenu.
- ▶ Press button **↶** or **↷** repeatedly until the message Hdlamp delay off appears in the multifunction display.

The selection marker is on the current setting.



- ▶ Press button **+** or **-** to select the desired lamp-on period.

You can select:

- 0 sec., the delayed shut-off feature is deactivated.
- 15 sec., 30 sec., 45 sec. or 60 sec., select the desired lamp-on period.
- ▶ Turn the exterior lamp switch to position **AUTO** before turning off the engine (▷ page 108).

The headlamps delayed shut-off feature is activated.

You can temporarily deactivate the delayed shut-off feature:

- ▶ Before exiting the vehicle, turn the SmartKey in the starter switch to position **0**.
- ▶ Then turn it to position **2** and back to position **0**.

The delayed shut-off feature is deactivated. It will reactivate as soon as you reinsert the SmartKey in the starter switch.



#### Setting interior lighting delayed shut-off

Use this function to set whether and how long you would like the interior lighting to remain lit during darkness after you have removed the SmartKey from the starter switch.

- ▶ Move the selection marker with button **+** or **-** to the Lighting submenu.
- ▶ Press button **↕** or **↘** repeatedly until the message Int. light delay off appears in the multifunction display.

The selection marker is on the current setting.

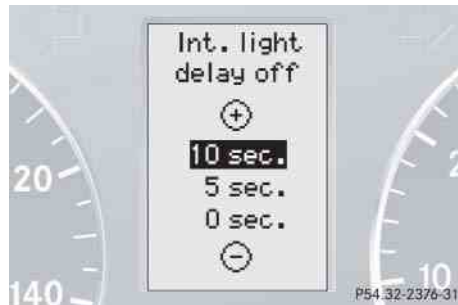

- ▶ Press button **+** or **-** to select the desired lamp-on time period.

You can select:

- 0 sec., the delayed shut-off feature is deactivated.
- 5 sec. 10 sec., 15 sec. or 20 sec., the interior lighting delayed shut-off feature is activated with the desired lamp-on period.

#### Vehicle submenu

Access the Vehicle submenu via the Settings menu. Use the Vehicle submenu to make general vehicle settings.

The following function is available:

Function	Page
Setting automatic locking	143

#### Setting automatic locking

Use this function to activate or deactivate the automatic central locking. With the automatic central locking system activated, the vehicle is centrally locked at vehicle speeds of approximately 9 mph (15 km/h).

- ▶ Move the selection marker with button **+** or **-** to the Vehicle submenu.
- ▶ Press button **↕** or **↘** repeatedly until the message Automatic door lk. appears in the multifunction display. ▶▶

## Controls in detail

### Control system

- ▷▷ The selection marker is on the current setting.



- ▶ Press button **+** or **-** to switch the automatic central locking On or Off.

#### Convenience submenu

Access the Convenience submenu via the Settings menu. Use the Convenience submenu to change the settings for a number of convenience features.

The following functions are available:

Function	Page
Activating easy-entry/exit feature*	144
Setting key-dependency	145
Setting parking position* for exterior rear view mirror	146

#### Activating easy-entry/exit feature\*

Use this function to activate and deactivate the easy-entry/exit feature (▷ page 97).

#### Warning!



You must make sure no one can become trapped or injured by the moving steering wheel and driver's seat when the easy-entry/exit feature is activated.

To cancel seat/steering wheel movement, do one of the following:

- Press seat adjustment switch\* (▷ page 30).
- Move steering column stalk\* (▷ page 40).
- Press memory position switch\* (▷ page 106).

Do not leave children unattended in the vehicle, or with access to an unlocked vehicle. Children could open the driver's door and unintentionally activate the easy-entry/exit feature, which could result in an accident and/or serious personal injury.

- ▶ Move the selection marker with button **+** or **-** to the Convenience submenu.
- ▶ Press button **↕** or **↘** repeatedly until the message Easy-entry feature appears in the multifunction display.  
The selection marker is on the current setting.



- ▶ Press button **+** or **-** to change the easy-entry/exit setting.

The following settings are available for the easy-entry/exit feature:

Off	The easy-entry/exit feature is deactivated
Steer. Column	Only the steering column is moved
St.col.+seat	Both the steering column and the seat are moved

### Setting key-dependency

Use this function to set whether the memory settings for the seats, the steering wheel and the mirrors should be stored separately for each SmartKey (▷ page 105).

- ▶ Move the selection marker with button **+** or **-** to the Convenience submenu.
- ▶ Press button **↕** or **↘** repeatedly until the message Key dependency appears in the multifunction display.  
The selection marker is on the current setting.



## Controls in detail

### Control system

## Controls in detail

### Control system

- ▶▶ Press button **+** or **-** to set key-dependency On or Off.

#### **Setting parking position\* for exterior rear view mirror**

Use the Mirror set. parking aid function to select whether the passenger-side exterior rear view mirror should be turned downward during parking maneuvers when reverse gear **R** is engaged. For additional information, see “Activating exterior rear view mirror parking position\*” (▷ page 163).

- ▶ Move the selection marker with button **+** or **-** to the Convenience submenu.

- ▶ Press button **↕** or **↔** repeatedly until the message Mirror set. parking aid appears in the multifunction display.

The selection marker is on the current setting.



- ▶ Press button **+** or **-** to switch function On or Off.





### Trip computer menu

Use the trip computer menu to call up statistical data on your vehicle.

The following information is available:

Function	Page
Fuel consumption statistics after start	147
Fuel consumption statistics since last reset	147
Calling up range (distance to empty)	148

### Fuel consumption statistics after start

- ▶ Press button  or  repeatedly until the first function of the Trip computer menu appears in the multifunction display.
- ▶ Press button  or  repeatedly until the message *After start* appears in the multifunction display.

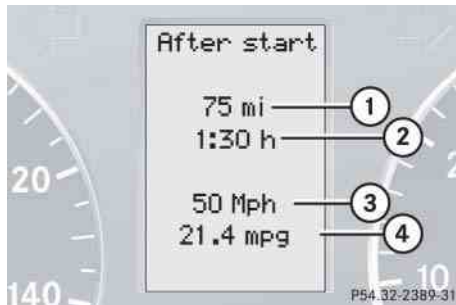

- ① Distance driven since start
- ② Time elapsed since start
- ③ Average speed since start
- ④ Average fuel consumption since start







All statistics stored since the last engine start will be reset approximately four hours after the SmartKey in the starter switch is turned to position **0** or removed from the starter switch.

Resetting will not occur if you turn the SmartKey back to position **1** or **2** within this time period.

## Controls in detail

### Control system

### Fuel consumption since last reset

- ▶ Press button  or  repeatedly until the first function of the Trip computer menu appears in the multifunction display.
- ▶ Press button  or  repeatedly until the message *After reset* appears in the multifunction display.

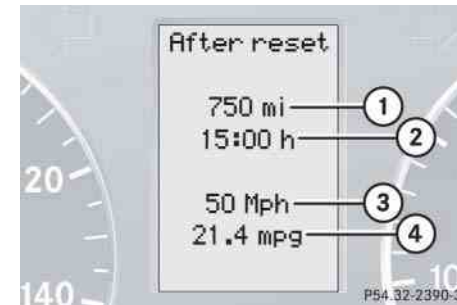





- ① Distance driven since last reset
- ② Time elapsed since last reset
- ③ Average speed since last reset
- ④ Average fuel consumption since last reset





## Controls in detail

### Control system

#### Resetting fuel consumption statistics

- ▶ Press button  or  repeatedly until the first function of the Trip computer menu appears in the multifunction display.
- ▶ Press button  or  repeatedly until the reading that you want to reset appears in the multifunction display.
- ▶ Press and hold the reset button in the instrument cluster (▷ page 116) until the value is reset to 0.

#### Call up range (distance to empty)

- ▶ Press button  or  repeatedly until the first function of the Trip computer menu appears in the multifunction display.
- ▶ Press button  or  repeatedly until the message *Distance* appears in the multifunction display.

The calculated range based on the current fuel tank level appears in the multifunction display.



#### TEL menu\*

##### Warning!





A driver's attention to the road must always be his/her primary focus when driving. For your safety and the safety of others, we recommend that you pull over to a safe location and stop before placing or taking a telephone call. If you choose to use the telephone while driving, please use the hands-free device and only use the telephone when weather, road and traffic conditions permit.

Some jurisdictions prohibit the driver from using a cellular telephone while driving a vehicle.

Bear in mind that at a speed of just 30 mph (approximately 50 km/h), your vehicle is covering a distance of 44 feet (approximately 14 m) every second.

Never operate radio transmitters equipped with a built-in or attached antenna (i.e. without being connected to an external antenna) from inside the vehicle while the engine is running. Doing so could lead to a malfunction of the vehicle's electronic system, possibly resulting in an accident and/or personal injury.

You can use the functions in the TEL menu to operate your telephone, provided it is connected to a hands-free system and switched on.

- ▶ Switch on the telephone and COMAND\*.
- ▶ Press button  or  on the steering wheel repeatedly until the message TEL appears in the multifunction display.

Which messages will appear in the multifunction display depends on whether your telephone is switched on or off:

- If the telephone is off, the message PHONE OFF appears in the multifunction display.

- If the telephone is on:

The telephone will then search for a network. During this time the multifunction display is empty.

As soon as the telephone has found a network, the message READY appears in the multifunction display.



This standby message indicates that your telephone is ready for use and you can operate it using the control system.

## Controls in detail

### Control system

#### Answering a call

When your telephone is ready to receive calls, you can answer a call at any time. In the multifunction display you will then see the message:



- ▶ Press button .

You have answered the call. The duration of the call appears in the multifunction display.

## Controls in detail

### Control system



#### Ending a call



- ▶ Press button .

You have ended the call. The standby message appears in the multifunction display.

#### Dialing a number from the phone book



If your telephone is ready to receive calls, you may select and dial a number from the phone book at any time.

- ▶ Press button  or  repeatedly until the message TEL appears in the multifunction display.

- ▶ Press button  or .

The control system reads the phone book which is stored in the telephone. This may take up to 30 seconds. The message *Please wait* appears in the multifunction display.

When the message *Please wait* disappears, the phone book has been loaded.

- ▶ Press button  or  repeatedly until the desired name appears in the multifunction display.

The stored names are displayed in ascending or descending alphabetical order.

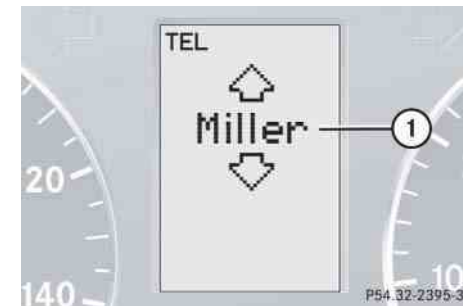

- ① Name from the phone book



## Controls in detail

### Control system



If you press and hold or for longer than one second, the system scrolls rapidly through the list of names until you release the button again.

Cancel the quick search mode by pressing button .

- ▶ Press button .

The system dials the selected phone number.

- If the connection is successful, the name of the party you called and the duration of the call will appear in the multifunction display.



- If no connection is made, the control system stores the dialed number in the redial memory.

### Redialing

The control system stores the most recently dialed phone numbers. This eliminates the need to search through your entire phone book.

- ▶ Press button or repeatedly until the message TEL appears in the multifunction display.

- ▶ Press button .

The first number in the redial memory appears in the multifunction display.

- ▶ Press button or repeatedly until the desired name appears in the multifunction display.

- ▶ Press button .

The control system dials the selected phone number.

## Controls in detail

### Automatic transmission

For more information on driving with an automatic transmission, see “Automatic transmission” (▷ page 46).

Your vehicle’s transmission adapts its gear shifting process to your individual driving style by continually adjusting the shift points up or down. These shift point adjustments are performed based on current operating and driving conditions.

If the operating conditions change, the automatic transmission reacts by adjusting its gear shift program.



During the brief warm-up, transmission upshifting is delayed. This allows the catalytic converter to heat up more quickly to operating temperature.



**Gearshift pattern for automatic transmission**

The automatic transmission selects individual gears automatically, depending on:

- the gear selector lever position **D** (▷ page 156) with gear ranges **4, 3, 2, 1** (▷ page 155)
- the selected program mode (**C/S**) (▷ page 158)
- the position of the accelerator pedal (▷ page 159)
- the vehicle speed



- ① Current gear range/gear selector lever position
- ② Current program mode

The current gear range/gear selector lever position and program mode (C/S) appear in the multifunction display.

An additional indication of the current gear selector lever position can be found on the cover of the shifting-gate.

The indicators come on when you activate a switch (e.g. unlocking the vehicle or opening a door) and go out after approximately 15 minutes.

## Controls in detail

### Automatic transmission

#### Warning!



It is dangerous to shift the gear selector lever out of **P** or **N** if the engine speed is higher than idle speed. If your foot is not firmly on the brake pedal, the vehicle could accelerate quickly forward or reverse. You could lose control of the vehicle and hit someone or something. Only shift into gear when the engine is idling normally and when your right foot is firmly on the brake pedal.

When the gear selector lever is in position **D**, you can influence transmission shifting by:

- limiting the gear range
- changing gears manually

## Controls in detail

### Automatic transmission

#### One-touch gearshifting

Even with an automatic transmission you can change the gears manually when the gear selector lever is in position **D**.

#### Downshifting

- ▶ Briefly press the gear selector lever to the left in the **D-** direction.

The transmission will shift from the current gear to the next lower gear. This action simultaneously limits the gear range of the transmission (▷ page 155).

#### Warning!



On slippery road surfaces, never downshift in order to obtain braking action. This could result in drive wheel slip and reduced vehicle control. Your vehicle's ABS will not prevent this type of loss of control.



To avoid overrevving the engine when the gear selector lever is moved to the **D-** direction, the transmission will not shift to a lower gear if the engine's max. speed would be exceeded.

#### Upshifting

- ▶ Briefly press the gear selector lever to the right in the **D+** direction.

The transmission will shift from the current gear to the next higher gear as permitted by the shift program. This action simultaneously extends the gear range of the transmission.

#### Canceling gear range limit

- ▶ Press and hold the gear selector lever in the **D+** direction until **D** reappears in the multifunction display.

The transmission will shift from the current gear range directly to gear range **D**.

#### Shifting into optimal gear range

- ▶ Press and hold the gear selector lever in the **D-** direction.

The transmission will automatically select the gear range suited for optimal acceleration and deceleration. This will involve shifting down one or more gears.

### Gear ranges

With the gear selector lever in position **D**, you can limit the transmission's gear range by pressing the gear selector lever to the left (**D-**), and reverse the gear range limit by pressing the gear selector lever to the right (**D+**).

The selected gear range appears in the multifunction display (▷ page 153). If you press on the accelerator when the engine has reached its rpm limit, the transmission will upshift beyond any gear range limit selected.

	Effect
<b>4</b>	The transmission shifts through fourth gear only.
<b>3</b>	The transmission shifts through third gear only.  With this selection you can use the braking effect of the engine.

## Controls in detail

### Automatic transmission

	Effect
<b>2</b>	The transmission shifts through second gear only.  Allows the use of engine's braking power when driving: <ul style="list-style-type: none"><li>• on steep downgrades</li><li>• in mountainous regions</li><li>• under extreme operating conditions</li></ul>
<b>1</b>	The transmission operates in first gear only.  For maximum use of engine's braking effect on very steep or lengthy downgrades.

## Controls in detail

### Automatic transmission

#### Gear selector lever position

	Effect
<b>P</b>	<b>Park position</b> Gear selector lever position when the vehicle is parked. Place gear selector lever in position <b>P</b> only when vehicle is stopped. The park position is not intended to serve as a brake when the vehicle is parked. Rather, the driver should always set the parking brake in addition to placing the gear selector lever in position <b>P</b> to secure the vehicle.

	Effect
	The SmartKey can only be removed from the starter switch with the gear selector lever in position <b>P</b> . With the SmartKey removed, the gear selector lever is locked in position <b>P</b> .  If the vehicle's electrical system is malfunctioning, the gear selector lever could remain locked in position <b>P</b> (▷ page 328).
<b>R</b>	<b>Reverse gear</b> Place gear selector lever in position <b>R</b> only when vehicle is stopped.

	Effect
<b>N</b>	<b>Neutral</b> No power is transmitted from the engine to the drive axle. When the brakes are released, the vehicle can be moved freely (pushed or towed).  To avoid damage to the transmission, never engage <b>N</b> while driving.  If the ESP is deactivated or malfunctioning: Move gear selector lever to <b>N</b> only if the vehicle is in danger of skidding, e.g. on icy roads.
<b>D</b>	<b>Drive</b> The transmission shifts automatically. All five forward gears are available.



Coasting the vehicle, or driving for any other reason with gear selector lever in **N** can result in transmission damage that is not covered by the Mercedes-Benz Limited Warranty.

### Warning!



Getting out of your vehicle with the gear selector lever not fully engaged in position **P** is dangerous. Also, position **P** alone is not intended to or capable of preventing your vehicle from moving, possibly hitting people or objects.

Always set the parking brake in addition to shifting to position **P** (> page 55).

When parked on an incline, turn the front wheels towards the road curb.

Do not park this vehicle in areas where combustible materials such as grass, hay or leaves can come into contact with the hot exhaust system, as these materials could be ignited and cause a vehicle fire.

## Controls in detail

### Automatic transmission

### Warning!



When leaving the vehicle, always remove the SmartKey from the starter switch, take it with you and lock the vehicle. Do not leave children unattended in the vehicle, or with access to an unlocked vehicle. Children could move the gear selector lever from position **P**, which could result in an accident and/or serious personal injury.

## Controls in detail

### Automatic transmission

#### Automatic shift program

The program mode selector switch is located on the lower part of the center console.

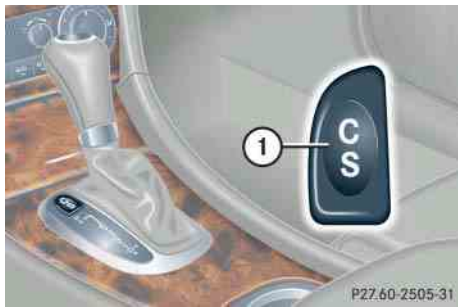

① Program mode selector switch

**C** Comfort      For comfort driving

**S** Sport        For standard driving



Never change the program mode when the gear selector lever is out of position **P**. This could result in a change of driving characteristics for which you may not be prepared.



The last selected program mode (**C** or **S**) is switched on when the engine is restarted in the automatic program mode.

► Press program mode selector switch ① repeatedly until the letter of the desired program mode appears in the multifunction display (► page 153).

Select **C** for comfort driving:

- The vehicle starts out in second gear (both forward and reverse) for gentler starts. This does not apply if full throttle is applied or gear range **1** is selected.
- Traction and driving stability are improved on icy roads.
- Upshifts occur earlier even when you give more gas. The engine then operates at lower rpms and the wheels are less likely to spin.



#### Driving tips

##### Accelerator position

Your driving style influences the transmission's shifting behavior:

Less throttle      Earlier upshifting  
More throttle      Later upshifting

##### Kickdown

Use kickdown when you want maximum acceleration.

- ▶ Press the accelerator past the point of resistance.  
The transmission shifts into a lower gear.
- ▶ Ease on the accelerator when you have reached the desired speed.  
The transmission shifts up again.

#### Stopping

When you stop briefly, e.g. at traffic lights:

- ▶ Leave the transmission in gear.
- ▶ Hold the vehicle with the brake.

When you stop longer with the engine idling or on an uphill gradient:

- ▶ Move the gear selector lever to position **P**.
- ▶ Set the parking brake.

#### Maneuvering

When you maneuver in tight areas, e.g. when pulling into a parking space:

- ▶ Control the vehicle speed by gradually releasing the brakes.
- ▶ Accelerate gently.
- ▶ Never abruptly step on the accelerator.

#### Working on the vehicle

##### Warning!



When working on the vehicle, set the parking brake and move gear selector lever to position **P**. Otherwise the vehicle could roll away.

## Controls in detail

### Automatic transmission

#### Emergency operation (Limp Home Mode)

---

If vehicle acceleration worsens or the transmission no longer shifts, the transmission is most likely operating in limp home (emergency operation) mode. In this mode only second gear and reverse gear can be activated.

- ▶ Stop the vehicle.
- ▶ Move gear selector lever to **P**.
- ▶ Turn off the engine.
- ▶ Wait at least ten seconds before restarting.
- ▶ Restart the engine.
- ▶ Move gear selector lever to position **D** (for second gear) or **R**.
- ▶ Have the transmission checked at an authorized Mercedes-Benz Center as soon as possible.

## ▼ Good visibility

For information on the windshield wipers, see “Windshield wipers” (▷ page 50).

### Headlamp cleaning system\*

The switch is located on the left side of the dashboard.



① Headlamp washer switch

- ▶ Switch on ignition (▷ page 33).

- ▶ Press switch ①.

The headlamps are cleaned with a high-pressure water jet.

For information on filling up the washer reservoir, see “Windshield washer system and headlamp cleaning system\*” (▷ page 277).

## Controls in detail

### Good visibility

### Rear view mirrors

For more information on setting the rear view mirrors, see “Mirrors” (▷ page 41).

### Interior rear view mirror, antiglare position



① Lever

- ▶ Tilt the mirror to the antiglare night position by moving lever ① towards the windshield.

The interior rear view mirror is dimmed.

## Controls in detail

### Good visibility

#### Automatic antiglare rear view mirrors\*

The reflection brightness of the exterior rear view mirror on the driver's side and the interior rear view mirror will respond automatically to glare when

- the ignition is switched on and
- incoming light from headlamps falls on the sensor in the interior rear view mirror.

The rear view mirror will not react if

- reverse gear **R** is engaged
- the interior lighting is turned on

#### Warning!



The automatic antiglare function does not react if incoming light is not aimed directly at sensors in the interior rear view mirror.

The interior rear view mirror and the exterior rear view mirror on the driver's side do not react, for example, when transporting cargo which covers the rear window.

Glare can endanger you and others.

#### Warning!



In the case of an accident liquid electrolyte may escape from the mirror housing if the mirror glass breaks.

Electrolyte has an irritating effect. Do not allow the liquid to come into contact with eyes, skin, clothing, or respiratory system. In case it does, immediately flush affected area with water, and seek medical help if necessary.

#### Warning!



Exercise care when using the passenger-side exterior rear view mirror. The mirror surface is convex (outwardly curved surface for a wider field of view). Objects in mirror are closer than they appear. Check your interior rear view mirror or glance over your shoulder before changing lanes.



Electrolyte drops coming into contact with the vehicle paint finish can be completely removed only while in the liquid state and by applying plenty of water.

#### Activating exterior rear view mirror parking position\*

Follow these steps to activate the mirror parking position so that the passenger-side exterior rear view mirror will be turned downward to the stored position.

The buttons are located above the exterior lamp switch.



- ① Driver's side exterior rear view mirror button
- ② Passenger-side exterior rear view mirror button

- ▶ Make sure you have stored a parking position for the passenger-side exterior rear view mirror (▷ page 107).
- ▶ Make sure the **Mirror set. parking aid function** in the **Convenience** submenu of the control system is switched to **On** (▷ page 146).
- ▶ Switch on ignition (▷ page 33).
- ▶ Press button ② for the passenger-side exterior rear view mirror.
- ▶ Place the gear selector lever in reverse gear **R**.

The passenger-side exterior rear view mirror will be turned downward to the stored position.

The exterior rear view mirror returns to its previously stored driving position:

- ten seconds after you put the gear selector lever out of position **R**
- immediately once your vehicle exceeds a speed of approx. 6 mph (10 km/h)
- immediately when you press button ① for the driver's side mirror

## Controls in detail

### Good visibility

#### Sun visors

The sun visors protect you from sun glare while driving.

#### Warning!



Do not use the vanity mirror while driving.  
Keep the mirrors in the sun visors closed while vehicle is in motion. Reflected glare can endanger you and others.

- Swing sun visors down when you experience glare.

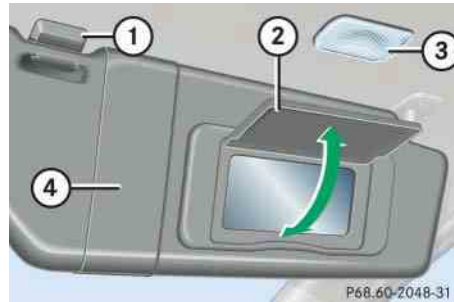

- ① Mounting
- ② Mirror cover
- ③ Mirror lamp
- ④ Sun visor

- To use illuminated mirror, lift up cover ②.

#### i

If sunlight enters through a side window, disengage sun visor from mounting ① and pivot to the side. The mirror lamp ③ will switch off.

## Rear window defroster

The rear window defroster uses a large amount of power. To keep the battery drain to a minimum, switch off the defroster as soon as the rear window is clear. The defroster is automatically deactivated after approximately 6 to 17 minutes of operation depending on the outside temperature.

### Activating

- ▶ Press button  in the climate control panel (▷ page 167).

The indicator lamp on the button comes on.

### Deactivating

- ▶ Press button  again.

The indicator lamp on the button goes out.

## Controls in detail

### Good visibility

#### Warning!



Any accumulation of snow and ice should be removed from the rear window before driving. Visibility could otherwise be impaired, endangering you and others.



If the rear window defroster switches off too soon and the indicator lamp starts flashing, this means that too many electrical consumers are operating simultaneously and there is insufficient voltage in the battery. The system responds automatically by deactivating the rear window defroster.

As soon as the battery has sufficient voltage, the rear window defroster automatically turns itself back on.

## Controls in detail

### Climate control

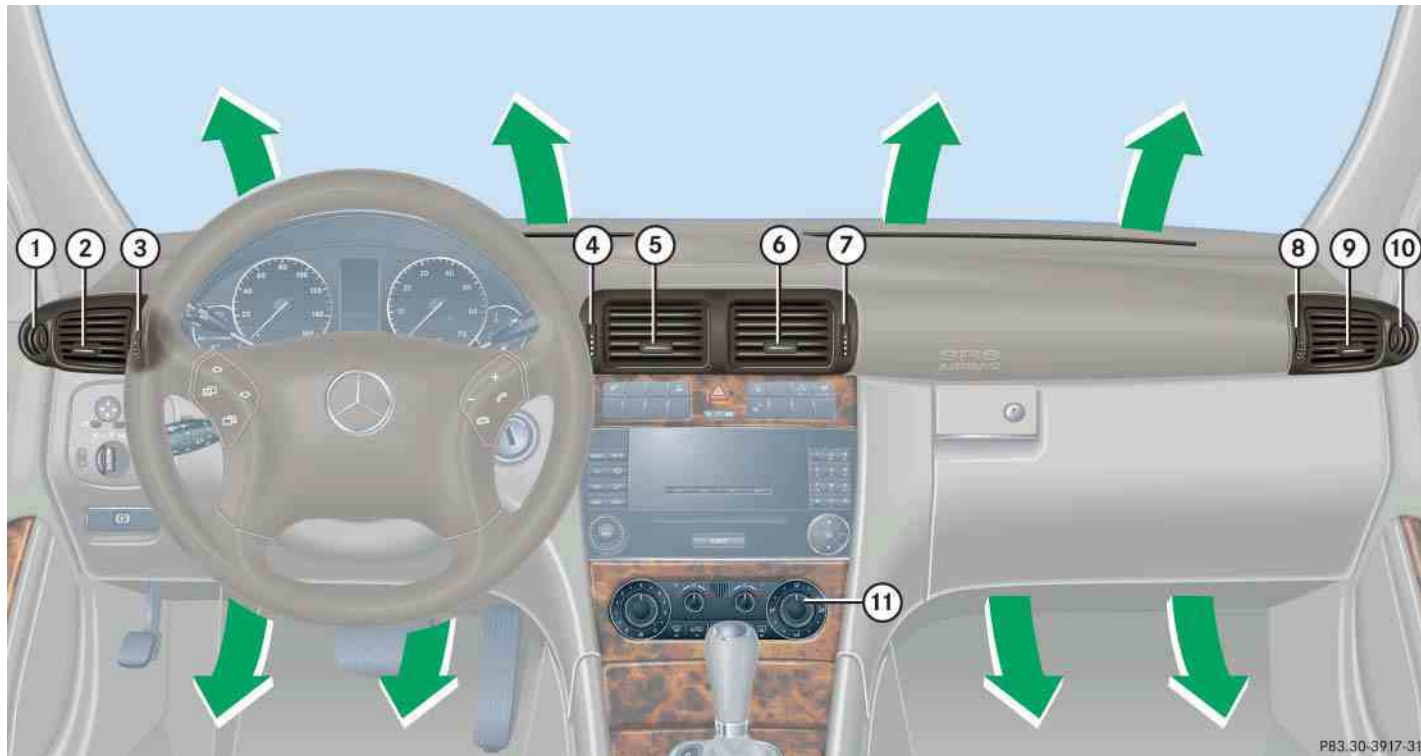



Item
① Left side defroster vent, fixed
② Left side air vent, adjustable
③ Thumbwheel for air volume control for left side air vent
④ Thumbwheel for air volume control for left center air vent
⑤ Left center air vent, adjustable
⑥ Right center air vent, adjustable
⑦ Thumbwheel for air volume control for right center air vent
⑧ Thumbwheel for air volume control for right side air vent
⑨ Right side air vent, adjustable
⑩ Right side defroster vent, fixed
⑪ Climate control panel



For draft-free ventilation, move the sliders for the side air vents ② and ⑨ and center air vents ⑤ and ⑥ to the middle position.



Climate control panel

## Controls in detail

### Climate control

Item
① Air volume control
② Left side temperature control
③ Right side temperature control
④ Air distribution control
⑤ Rear window defroster
⑥ AC cooling on/off ( <b>AC<sup>OFF</sup></b> )
⑦ Air distribution and air volume (automatic mode)
⑧ Air recirculation
⑨ Defrosting

## Controls in detail

### Climate control

The climate control is operational whenever the engine is running. You can operate the climate control system in either the automatic or manual mode. The system cools or heats the interior depending on the selected interior temperature and the current outside temperature.

#### Warning!



When operating the climate control, the air that enters the passenger compartment through the air vents in the footwell can be very hot or very cold (depending on the set temperature). This may cause burns or frostbite on unprotected skin in the immediate area of the air vents. Always keep sufficient distance between unprotected parts of the body and the footwell air vents. If necessary, change the air flow using the air distribution controls to direct the air away from the footwell air vents (▷ page 170).

Nearly all dust particles, pollutants and odors are filtered out before outside air enters the passenger compartment through the air distribution system.

The air conditioning will not engage (no cooling) if the mode **AC<sup>OFF</sup>** is selected (▷ page 173).

#### Warning!



Follow the recommended settings for heating and cooling given on the following pages. Otherwise the windows could fog up, impairing visibility and endangering you and others.



Severe conditions (e.g. strong air pollution) may require replacement of the filter before its scheduled interval. A clogged filter will reduce the air volume to the interior.

If the vehicle interior is hot, ventilate the interior before driving off, see “Opening (Summer opening feature)” (▷ page 221).

Keep the air intake grille in front of the windshield free of snow and debris.

#### Deactivating the climate control system

##### Deactivating

- ▶ Set air volume control ① (▷ page 167) to position **0**.



When the air conditioning is switched off, the outside air supply and circulation are also switched off. Only choose this setting for a short time. Otherwise the windows could fog up.

##### Reactivating

- ▶ Set air volume control ① (▷ page 167) to any speed.

#### Setting the temperature

Use temperature controls ② and ③ (▷ page 167) to separately adjust the air temperature on each side of the passenger compartment. You should raise or lower the temperature setting in small increments, preferably starting at 72°F (22°C).



When operating the climate control system in automatic mode, you will only rarely need to adjust the temperature, air volume and air distribution.

#### Increasing

- ▶ Turn the temperature control ② or ③ slightly to the right.

The climate control system will correspondingly adjust the interior air temperature.

#### Decreasing

- ▶ Turn the temperature control ② or ③ slightly to the left.





The climate control system will correspondingly adjust the interior air temperature.

## Controls in detail

### Climate control

#### Adjusting air distribution and volume

Use air distribution control ④ (▷ page 167) to adjust the air distribution. The following symbols are found on the controls:

Symbol	Function
	Directs air to the windshield and the side defroster vents
	Directs air into the entire vehicle interior
	Directs air to the footwells
	Directs air through the center, side and rear passenger compartment air vents

Use the air volume control ① (▷ page 167) to adjust the air volume. You can select between six air volume speeds.

#### Adjusting manually

- ▶ Press button **AUTO** (▷ page 167).

The indicator lamp on the button goes out.



- ▶ Select any of the six air volume speeds and the air distribution.

#### Adjusting automatically

- ▶ Press button **AUTO** (▷ page 167).

The indicator lamp on the button comes on. The temperature, air distribution and volume are adjusted automatically.

#### Windshield fogged on the outside

- ▶ Switch the windshield wipers on (▷ page 50).
- ▶ Switch to manual mode.
- ▶ Turn the air distribution control to  or .

## Controls in detail

### Climate control

#### Defrosting



These settings should only be selected for a short time.

#### Activating

- ▶ Press button  (▷ page 167).  
The indicator lamp on the button comes on.

The air conditioning switches automatically to the following functions:

- maximum blowing and heating power
- air flows onto the windshield and the front side windows
- the air recirculation mode is switched off

#### Deactivating

- ▶ Press button  (▷ page 167).

The indicator lamp on the button goes out. Defrosting is turned off.

#### Air recirculation mode

Switch to air recirculation mode to prevent unpleasant odors from entering the vehicle from the outside. This setting cuts off the intake of outside air and recirculates the air in the passenger compartment.

#### Warning!



When the outside temperature is below 41°F (5°C), only switch to air recirculation mode for short periods to prevent window fogging.

Window fogging may impair visibility and endanger you and others.

#### Activating

- ▶ Press button  (▷ page 167).

The indicator lamp on the button comes on.



If you keep button  pressed the side windows and tilt/sliding sunroof\* will close.

#### Warning!



Never operate the side windows and the tilt/sliding sunroof\* if there is the possibility of anyone being harmed by the closing procedure.

In the event that the closing procedure causes potential danger, the closing of the side windows can be immediately halted by pressing or pulling the respective window switch. The closing of the tilt/sliding sunroof\* can be immediately halted by moving the tilt/sliding sunroof\* switch in the overhead control panel in any direction. ▷▷

## Controls in detail

### Climate control

▷▷ The closing of the side windows and tilt/sliding sunroof\* can be reversed by again pressing and holding the  button.



The air recirculation mode is activated automatically at high outside temperatures.

The indicator lamp on the  button is not lit when the air recirculation mode is automatically switched on.

After approx. 30 minutes, outside air is added to the air inside the vehicle.

If you have turned off the air conditioning (▷ page 173) or the outside temperature is below 41°F (5°C), the air recirculation mode will not switch on automatically.

#### Deactivating

▶ Press button  (▷ page 167).

The indicator lamp on the button goes out.



If you keep button  pressed the side windows and tilt/sliding sunroof\* will return to their previous position.

The air recirculation mode is deactivated automatically:

- after five minutes if the outside temperature is below approximately 41°F (5°C)
- after five minutes if the air conditioning is turned off
- after 30 minutes if the outside temperature is above approximately 41°F (5°C)

At outside temperatures above 79°F (26°C) the system will not automatically switch back to outside air. A quantity of outside air is added after approximately 30 minutes.

#### Air conditioning

The air conditioning is operational while the engine is running and cools the interior air to the temperature set by the operator.



Condensation may drip out from underneath the vehicle. This is normal and not an indication of a malfunction.

#### Warning!



If you turn off the cooling function, the vehicle will not be cooled when weather conditions are warm. The windows can fog up more quickly. Window fogging may impair visibility and endanger you and others.

#### Deactivating

It is possible to deactivate the air conditioning (cooling) function of the climate control system. The air in the vehicle will then no longer be cooled or dehumidified.

- ▶ Press button **AC<sup>OFF</sup>** (▷ page 167).

The indicator lamp on the button comes on.

The cooling function switches off after a short delay.

#### Activating

Moist air can fog up the windows. You can dehumidify the air with the air conditioning.

- ▶ Press button **AC<sup>OFF</sup>** (▷ page 167).

The indicator lamp on the button goes out.

The air conditioning uses the refrigerant R134a. This refrigerant is free of CFCs which are harmful to the ozone layer.



If the air conditioning cannot be turned on again, this indicates that the air conditioning is losing refrigerant. The compressor has turned itself off.

Have the air conditioning checked at the nearest authorized Mercedes-Benz Center.

## Controls in detail

### Climate control

#### Rear passenger compartment adjustable air vents

The air conditioning for the rear passenger compartment is controlled via the climate control panel (▷ page 167).



The temperature at the center air vents for the rear passenger compartment ① and ③ is the same as at the dashboard center air vents.

The air vents for the rear passenger compartment are located in the rear center console.



- ① Left center air vent
- ② Thumbwheel for air volume control for center air vents
- ③ Right center air vent

#### Adjusting air distribution

- ▶ Push the slide for the left center vent ① or right center vent ③ to the left, right, up or down.

The air flow is directed in the corresponding direction.



For draft-free ventilation, push slides ① and ③ upward.

#### Adjusting air volume

- ▶ Turn thumbwheel ② up or down.

The air volume is increased or decreased.



#### ▼ Audio system

##### Audio and telephone, operation

These instructions are intended to help you become familiar with your Mercedes-Benz audio system. They contain useful tips and a detailed description of the user functions.

##### Warning!



In order to avoid distraction which could lead to an accident, the driver should enter system settings with the vehicle at a standstill and operate the system only when road and traffic conditions permit. Always pay full attention to traffic conditions first before operating system controls while driving.

Bear in mind that at a speed of just 30 mph (approximately 50 km/h), your car is covering a distance of 44 feet (approximately 14 m) every second.

##### Operating safety

##### Warning!



Any alterations made to electronic components can cause malfunctions.

The radio, amplifier, CD changer\*, satellite radio\*, telephone\* and voice control system\* are interconnected. When one of the components is not operational or has not been removed/replaced properly, the function of other components may be impaired.

This condition might seriously impair the operating safety of your vehicle.

We recommend that you have any service work on electronic components carried out by an authorized Mercedes-Benz Center.

## Controls in detail

### Audio system

#### Operating and display elements

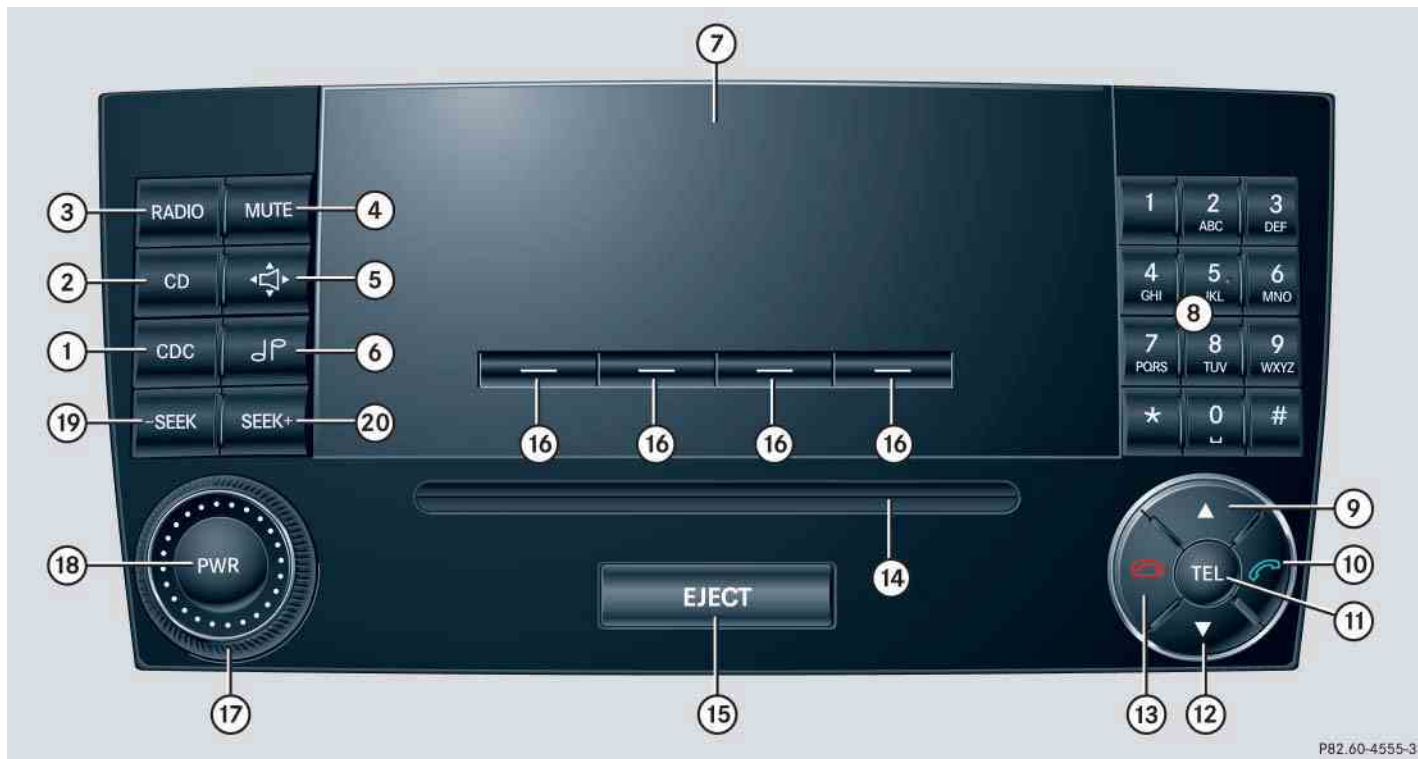

## Controls in detail

### Audio system

Item	Page
① CD changer mode selector	193
AUX mode selector	183
② Single CD mode selector	195
③ Radio mode selector	
④ Mute function (radio)	187
Pause (CD)	199
⑤ Volume distribution	181
⑥ Sound settings	179
⑦ Display	
⑧ Alphanumeric keypad	

Item	Page
⑨ Speed dialing memory (telephone) in descending order	
⑩ Accepting a call (telephone)	205
⑪ Telephone mode selector	200
⑫ Speed dialing memory (telephone) in ascending order	201
⑬ Terminating a call (telephone)	205
⑭ CD slot	
⑮ CD ejection	195

Item	Page
⑯ Soft keys	178
⑰ Volume	179
⑱ Switching on/off	178
⑲ Manual tuning / seek tuning (radio)	185
Track search, reverse (CD)	198
⑳ Manual tuning / seek tuning (radio)	185
Track search, fast forward (CD)	198

## Controls in detail

### Audio system

#### Button and soft key operation

In these instructions, the alphanumeric keypad (right side of radio panel) and the function buttons (left side of radio panel) are referred to as “buttons”. The four keys below the display panel are referred to as “soft keys”.



Do not press directly in the display face. Otherwise, the display will be damaged.

#### Operation

##### Switching the unit on/off

##### Switching on

- ▶ Turn the SmartKey in the starter switch to position **1** or **2**.
- ▶ If the audio system was on as you removed the SmartKey from the starter switch, the audio system will automatically come back on as you turn the SmartKey to position **1** or **2**.

or

- ▶ Press  button.



If the radio is switched on without the key in the starter switch, it will automatically switch off again after approx. 30 minutes.

If your vehicle is equipped with a telephone, the display may prompt you to enter your PIN (GSM network) or code (TDMA or CDMA network).

### Switching off

- ▶ Remove SmartKey from starter switch.  
or
- ▶ Press  button.



Should excessively high temperatures occur while the audio system is being operated, the display will dim. If temperatures continue to rise, HIGH TEMP will appear in the display, after which the audio system will be switched off for a cooling-down period.

### Adjusting the volume

- ▶ Turn rotary control of  button.  
The volume will increase or decrease depending on the direction turned.



If your vehicle equipment includes a Mercedes-Benz specified mobile telephone\*, you can adjust its volume separately from the volume of the audio system while the telephone is being used.

### Adjusting sound functions

The bass and treble functions are called up by pressing the  button. Settings for bass and treble are stored separately for the AM and FM wavebands, weather band, CD mode and telephone mode.

#### Bass

- ▶ Press  button repeatedly until BASS appears in the display.

## Controls in detail

### Audio system



- ▶ Press + or - soft key to increase or decrease tone level accordingly.  
or
- ▶ Press RES soft key briefly to reset bass tones to their center level.  
The radio switches back to the standard radio menu eight seconds after the last soft key is pressed.

## Controls in detail

### Audio system

#### Adjusting treble

- ▶ Press **⏮** button repeatedly until TREBLE appears in the display.



- ▶ Press + or - soft key to increase or decrease tone level accordingly.

or

- ▶ Press RES soft key briefly to reset treble tones to their center level.

The radio switches back to the standard radio menu eight seconds after the last soft key is pressed.

#### Sound system\*

You can either program the sound settings manually (▷ page 179) or choose settings via preset sound characteristics.

You can select from among the following settings:

- STANDARD: conventional stereo sound.
  - SURROUND: the sound is set for better three-dimensional acoustic characteristics.
  - SPEECH: the sound is optimized for the spoken word.
- ▶ Press **⏮** button repeatedly until STANDARD, SURROUND or SPEECH appears in the display.

- ▶ Press <<< or >>> soft key repeatedly until the desired sound setting has been reached.

The sound is set accordingly.

or

- ▶ Press RES soft key briefly.

The sound setting is reset depending on the sound source activated.

- Radio mode: STANDARD
- CD/AUX mode: SURROUND
- Telephone: SPEECH

The radio switches back to the standard radio menu eight seconds after the last soft key is pressed.

### Returning sound functions to factory settings

- ▶ Press  button to call up settings menu in the display.



- ▶ Press RES soft key briefly; the respective sound function is reset to its center level.

or

- ▶ Press and hold RES soft key until RESET appears in the display.

The sound settings for bass and treble are returned to their center level and the volume is set to a predefined level.

Vehicles with sound system\*:

The sound setting is reset depending on the sound source activated.

- Radio mode: STANDARD
- CD/AUX mode: SURROUND
- Telephone: SPEECH

The radio switches back to the standard radio menu four seconds after the last soft key is pressed.

### Adjusting volume distribution

Call up fader and balance functions by pressing the  button.



#### Fader

- ▶ Press  button repeatedly until FADER appears in the display.

## Controls in detail

### Audio system



- ▶ Press  or  soft key.

The volume is distributed accordingly between the front and rear of the vehicle.

or

- ▶ Press RES soft key briefly.

The fader is reset to its center level.

The radio switches back to the standard radio menu eight seconds after the last soft key is pressed.

## Controls in detail

### Audio system

#### Adjusting balance

- ▶ Press  button repeatedly until BALANCE appears in the display.



- ▶ Press <<< or >>> soft key.  
The volume is distributed between the left and right sides of the vehicle.

or

- ▶ Press RES soft key briefly.  
The balance is reset to its center level.  
The radio switches back to the standard radio menu eight seconds after the last button is pressed.

#### Returning volume distribution to factory settings

- ▶ Press  button to call up settings menu in the display.



- ▶ Press RES soft key briefly; the respective volume distribution is reset to its center (flat) level.

or

- ▶ Press and hold RES soft key until RESET appears in the display.

The volume distribution settings for fader and balance are set to their center level.

The radio switches back to the standard radio menu four seconds after the last soft key is pressed.

#### Telephone\* muting

If your vehicle equipment includes a Mercedes-Benz specified mobile telephone\*, you can adjust its volume separately from the volume of the audio system while the telephone is being used.



**Connecting an external audio source (AUX) to the radio\***

An optional dealer-installed cinch-connector\* for connecting an external audio source may become available for your vehicle model. Feature description is based on preliminary information at time of printing. Contact an authorized Mercedes-Benz Center for availability.

You can adjust the volume (▷ page 179), the sound settings (▷ page 179) and the volume distribution (▷ page 181) for the AUX input.

**Calling up AUX mode**

- ▶ Press and hold **CD** button until AUX appears in the display.

**Canceling AUX mode**

- ▶ Press any audio source button.

**Radio operation****Selecting radio mode**

- ▶ Press **RADIO** button.

**Calling up wavebands**

You can choose from among the FM, AM and WB wavebands.

Weather band (▷ page 187).



FM waveband: 87.7.....107.9 MHz  
AM waveband: 530.....1710 KHz

**Calling up wavebands for radios without SAT**

- ▶ Press FM or AM soft key to switch between FM and AM.

The FM and AM wavebands are called up one after another.

or

- ▶ Press WB soft key.

The weather band menu is called up.

The waveband currently selected appears in the upper left-hand corner of the display.

## Controls in detail

### Audio system

#### *Calling up wavebands for radios with SAT*

- ▶ Press FM, AM or WB soft key repeatedly until desired waveband has been selected.

The FM, AM and WB wavebands are called up one after another.

The waveband currently selected appears in the upper left-hand corner of the display.

#### **Selecting a station**

The following options are available for selecting a station:

- Direct frequency input (▷ page 184)
- Manual tuning (▷ page 185)
- Automatic seek tuning (▷ page 185)
- Scan search (▷ page 185)
- Station memory (▷ page 186)
- Automatic station memory (Autostore) (▷ page 186)

The station search proceeds in the following frequency increments:

- 200 kHz in FM range
- 10 kHz in AM range

#### *Direct frequency input*

- ▶ Select desired waveband.



- ▶ Press **\*** button.
- ▶ Enter desired frequency with buttons **1** to **0**.



You can only enter frequencies within the respective waveband.

If a button is not pressed within four seconds, the radio will return to the last station tuned.

### Manual tuning

- ▶ Select desired waveband.
- ▶ Press **SEEK+** or **SEEK-** button for approx. three seconds.
- ▶ Press button repeatedly until desired frequency has been reached.

Step-by-step station tuning takes place in ascending or descending order. Each time the button is pressed, the radio tunes further by 0.2 MHz. During manual tuning, the radio is muted.

### Automatic seek tuning

- ▶ Select desired waveband.
- ▶ Press **SEEK+** or **SEEK-** button briefly.

The radio will tune to the next highest or next lowest receivable frequency.



If no station is received after two consecutive scans of the complete frequency range, then the scan stops at the frequency from which it began.

## Controls in detail

### Audio system

### Scan search

- Starting scan search
  - ▶ Select desired waveband.



- ▶ Press **SC** soft key.

SC will appear in the display. The radio briefly tunes in all receivable stations on the waveband selected.

## Controls in detail

### Audio system

- Ending scan search
  - ▶ Press SC soft key or **SEEK+** or **-SEEK**.  
The station last played will be selected and SC disappears from the display.

#### Station memory

You can store ten AM and ten FM stations in the memory.

- Storing stations
  - ▶ Tune in desired station.

- ▶ Press and hold desired station button **1** to **0** until a brief signal tone is heard.

The frequency is stored on the selected station button.

- Calling up stations

- ▶ Press desired station button **1** to **0** briefly.

#### Autostore – automatic station memory

The Autostore memory function provides an additional memory level. The station memory for manually stored stations is not overwritten.

- Calling up Autostore memory level and storing stations



- ▶ Press AS soft key briefly.

The radio switches to the Autostore memory level. AS and SEARCH appear in the display and the radio finds the ten stations with the strongest signals. These stations are stored on the station buttons **1** to **0** in order of signal strength.

- Calling up stations
  - ▶ Press desired station button **1** to **0**.
- Leaving the Autostore memory level
  - ▶ Press FM or AM soft key briefly.

#### **Interrupting radio mode**

The radio mode is interrupted by an incoming call on the telephone\* (▷ page 205).

- Mute on
  - ▶ Press **MUTE** button.  
The radio mode is interrupted and MUTED appears in the display.
- Mute off
  - ▶ Press **MUTE** button.  
The radio mode is again active.

#### **Weather band**



- ▶ Press WB soft key.  
The weather band station last received is tuned in.

## **Controls in detail**

### **Audio system**

#### **Selecting a weather band station directly**

- ▶ Select desired weather band station with buttons **1** to **7**.

If a station cannot be tuned in, a search is automatically started.

#### **Search**

- ▶ Press **SEEK+** or **-SEEK** button to tune in the next receivable weather band station.



If no weather band station is received after three consecutive scans of the complete frequency range, then the scan stops at the channel with which it began and NO WB FOUND appears in the display.

If this happens, switch back to standard radio mode.

## Controls in detail

### Audio system

#### Scan search

- Starting scan search
  - ▶ Press **SC** soft key.  
SC will appear in the display. The radio briefly tunes in all receivable weather band stations.
- Ending scan search
  - ▶ Press **SC** soft key or **SEEK+** or **-SEEK**.  
The weather band station last played will be selected and **SC** disappears from the display.

#### Introduction to satellite radio\* (USA only)

SIRIUS satellite radio provides 100 channels of digital-quality radio, among others music, sports, news, and entertainment, free of commercials. SIRIUS satellite radio uses a fleet of high-power satellites to broadcast 24 hours per day, coast to coast.

This diverse, satellite-delivered programming is available for a monthly subscription fee.

For more information call the SIRIUS Service Center (> page 193), or contact [www.siriusradio.com](http://www.siriusradio.com)



Additional satellite radio equipment and a subscription to a satellite radio service provider are required for the satellite radio operation described here. Feature description is based on preliminary information available at time of printing.



At time of printing, no date for the availability of optional equipment required for satellite radio operation had been set.

Contact an authorized Mercedes-Benz Center for details and availability for your vehicle.

Note that categories and channels shown in illustrations are dependent on programming content delivered by the service provider. Programming content is subject to change. Therefore, channels and categories shown in illustrations and descriptions contained in this manual may differ from the channels and categories delivered by the service provider.



Satellite radio service may be unavailable or interrupted from time to time for a variety of reasons, such as environmental or topographic conditions and other things beyond the service provider's or our control. Service might also not be available in certain places (e.g., in tunnels, parking garages, or within or next to buildings) or near other technologies.

### Program categories

The channels are categorized. Categories allow you to tune to stations broadcasting a certain type of program (category mode) (▷ page 191).

### Calling up the SAT main menu

- ▶ Press SAT soft key.

SAT is displayed in the upper left-hand corner of the display.

Prior to activation of the satellite radio service (▷ page 189).

After activation of satellite radio service (▷ page 189).

### *Prior to activation of the satellite radio service*



The telephone number of the SIRIUS Service Center (888-539-7474) is displayed.

## Controls in detail

### Audio system

- ▶ Press ESN soft key.

The twelve-digit electronic serial number (ESN) of the SAT tuner\* installed in your vehicle is displayed.

This information is required to call the SIRIUS Service Center for an activation request.



Credit card information may also be required for your application.

The activation process takes approximately five to ten minutes after calling the SIRIUS Service Center.

### *After activation of the satellite radio service*

The satellite radio main menu appears. The radio station selected last is audible, provided it can be received.

## Controls in detail

### Audio system



The system will tune to a default station if no station had been selected previously.



The first channel 001 is called up and the PTY system changes to All categories.

If no station can be received, **ACQUIRING** appears in the display.

If the Satellite radio service is not activated, **ACQUIRING** will also appear in the radio display and **NO SAT** will appear in the multifunction display.

#### Selecting a station

The following options are available:

- Selecting a station using the selected category (▷ page 191),
- Tuning via station presets (▷ page 190),
- Tuning via scan search (▷ page 192).
- Tuning via manual channel input (▷ page 190).
- Tuning via the program category list (▷ page 191).

#### Tuning via station presets

Ten satellite radio station presets are available.

You can access the presets via number keys.

#### Accessing via number keys

- ▶ Enter number of preset you wish to select, e.g. **1**.

The radio plays the station stored under this number and the PTY function changes to the category corresponding to the station.

#### Tuning via manual channel input



**Example: tuning in channel 16**



- ▶ Press **\***.

Input line appears in the main radio menu.

- ▶ Use number keys to enter desired channel within eight seconds, e.g. **1** **6**.

The system tunes to channel 16.

The station you have selected begins to play.



You can only enter available channel numbers.

### ***Tuning via the program category list***

The category list contains all currently receivable categories of programs. It is arranged alphabetically.

- Selecting a category
  - ▶ Press PTY soft key.



The current PTY category of the station is displayed.

- ▶ Press **<<<** or **>>>** soft key. This switches between the individual categories.

When changing the category, the channel selected last in the new category becomes audible.

## Controls in detail

### Audio system

The system will automatically switch to a station of the selected category if the currently selected station is not of the selected category. Otherwise, the currently selected station remains tuned.

- Tuning a station within the selected category

The channels identified for the currently selected category are arranged numerically. Only one entry is visible at a time.

- ▶ Press **SEEK+** or **-SEEK** button briefly.

The next station within the category is started.

or

- ▶ Press and hold **SEEK+** or **-SEEK** button for approx. three seconds until desired station has been reached.

## Controls in detail

### Audio system

#### *Tuning via scan search*

Scan search is characterized as follows:

- Scan search plays a channel for approx. eight seconds and then skips to the next channel within the current category.
- Scan search can be terminated manually.
- ▶ Press **SC** soft key.  
The search starts. **SC** appears in the display.
- ▶ Press **SC** soft key again.  
The search stops.

#### **Obtaining additional text information**

Additional text information (artist, title) related to the current channel can be displayed.

- ▶ Press **INF** soft key.

The title being played is displayed.

- ▶ Press **INF** soft key again.

The name of the artist performing the title being played is displayed.



If a button is not pressed within four seconds, the radio will return to the standard display.

#### **Storing stations**

- ▶ Tune in desired station.
- ▶ Press and hold desired station button **1** to **0** until a brief signal tone is heard.

The frequency is stored on the selected station button.

The radio saves the current station at the memory preset selected. The memory preset selected appears in the status line, e.g. S3.



There are ten presets available.

An existing entry is overwritten in the memory list when a new entry is given.

#### Calling up the ESN information menu

- ▶ Press INF soft key.
- ▶ Press ESN soft key.

The twelve-digit electronic serial number (ESN) of the SAT tuner\* installed in your vehicle is displayed.

- ▶ Press RET soft key to exit the menu.

#### CD mode

##### Safety precautions

##### Warning!



The single CD player and the CD changer\* are Class 1 laser products. There is a danger of invisible laser radiation if the housing is opened or damaged.

Do not open the housing. The single CD player and the CD changer\* do not contain any parts that can be serviced by the user. For safety reasons, have any service work which may be necessary performed only by qualified personnel.

##### Warning!



In order to avoid distraction which could lead to an accident, the driver should insert CDs with the vehicle at a standstill and operate the audio system only if permitted by road, weather and traffic conditions. Bear in mind that at a speed of just 30 mph (approximately 50 km/h), your car covers a distance of 44 feet (approximately 14 m) every second.

##### General notes

The system may not be able to play audio CDs with copy protection.

Playing copied CDs may cause malfunctions during playback.

## Controls in detail

### Audio system



If you affix stickers to the CDs, they can become warped due to the heat that develops in the CD drive or CD changer.

In certain situations, the CDs can then no longer be ejected and cause damage to the drive. Such damage is not covered by the Mercedes-Benz Limited Warranty.



Your CD drive or CD changer has been designed to play CDs which correspond to the EN 60908 standard. You can therefore only use CDs with a maximum thickness of 1.3 mm.

If you insert thicker data carriers, e.g. ones that have data on both sides (one side with DVD data, the other side with audio data), they cannot be ejected and will damage the drive.

Do not use CDs with an eight cm diameter, not even with a CD adapter. Attempting to play CDs with an eight cm diameter or playing such CDs with an adapter may cause damage to the CD drive. Such damage is not covered by the Mercedes-Benz Limited Warranty.

Should excessively high or low temperatures occur while in CD changer mode\*, CD TEMP will appear in the display, and the CD will be muted until the temperature has reached an acceptable level for the system to continue operation.

The single CD player and the CD changer\* play audio CDs.

#### ***Tips on handling CDs***

- Handle CDs carefully to prevent interference during playback.
- Avoid scratches, fingerprints and dust on the CDs.
- Do not write on CDs or apply any labels or other material to them.
- Clean CDs from time to time with a commercially available cleaning cloth. Never wipe the CD in a circular motion; instead, wipe it in a straight line starting in the center and moving outward. Do not use solvents, anti-static sprays, etc. for cleaning.
- Replace the CD in its case after use.
- Protect CDs from heat and direct sunlight.

#### Operating the single CD player in the audio system unit

##### Loading a CD

The single CD player in the audio system unit has capacity for one CD. The CD slot for loading the drive is located underneath the soft keys.

- ▶ Make sure the system is switched on.
- ▶ Insert CD into CD slot. The label side of the CD must face upwards.

The system automatically pulls the CD into the CD slot. The audio CD begins to play.



If a CD is already loaded, it must be ejected before inserting a new CD. Inserting a second CD in the slot with another CD still loaded will cause damage to the CD drive not covered by the Mercedes-Benz Limited Warranty.



If a CD has been inserted incorrectly or cannot be read, **WRONG CDO** will appear in the display.

##### Ejecting a CD

- ▶ Make sure the system is switched on.
- ▶ Press **EJECT** button.  
The system ejects the CD. **NO CD** will appear in the display.
- ▶ Remove CD from slot.



If you do not take the CD out of the CD slot within approx. 15 seconds, the system automatically pulls the CD back in and plays it.

If a CD is pulled back in, press **EJECT** button for five seconds; the CD will then be ejected.

#### Operational readiness of CD changer\*

If a CD changer\* has been installed in the vehicle, it can be operated from the front control panel of the audio system.

A loaded magazine must be installed to play CDs.

The CD changer is located in the glove box.

#### Loading/unloading the CD magazine



The CD changer\* may not be able to play audio CDs with copy protection.

- ▶ Slide changer door to the right and press  button.
- ▶ Magazine will be ejected.

## Controls in detail

### Audio system

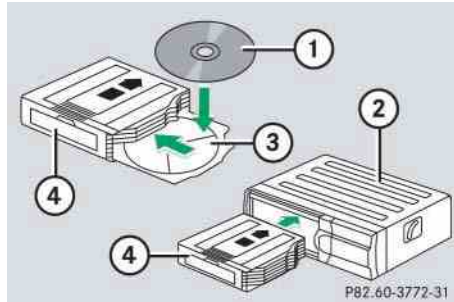

- ① CD
- ② CD changer
- ③ CD tray
- ④ CD magazine

- ▶ Remove magazine ④ and pull CD tray ③ fully out.
- ▶ Place CD ① in recess of tray, label side up.

- ▶ Push tray into magazine in direction of arrow.



CDs which have been inserted improperly or are unreadable will not be played.

- ▶ Push magazine into CD changer\* ② in direction of arrow and close sliding door.

#### Playing CDs

##### *Single CD player in the audio unit*

- ▶ Press **CD** button.

CD 0 will appear in the upper left-hand corner of the display.

The CD will resume playback at the point where it was switched off.

##### *CD changer\**

- ▶ Press **cdc** button.

CD and the selected magazine slot number appear in the upper left-hand corner of the display.

If you have not removed a CD since the last time the CD audio source was activated, the last CD listened to will begin to play at the point where it was switched off.

After the last track on a CD has finished, the next CD is automatically played.

### Playing tracks

You have the following options:

- Audio system with CD changer\*: selecting CDs
- Direct track entry
- Track skip forward/reverse
- Fast forward/reverse
- Scan
- Random tracks
- Repeat track

### Selecting CDs in the audio unit with CD changer\*



- ▶ You can select from among the inserted CDs with buttons

**0** to **6**.

**0** = CD player in the audio unit

**1** to **6** = CDs in the

CD changer\*

The magazine slot number of the selected CD appears next to CD in the display, and the number of the currently played track appears next to TRACK.

## Controls in detail

### Audio system



If there is no CD in the selected magazine slot, NO CD appears in the display with the corresponding slot number.

### Direct track entry



You can make a direct selection from among the tracks on a CD.

- ▶ Press **\*** button.
- ▶ Enter track number using buttons **1** to **0**.

## Controls in detail

### Audio system

- ▷▷ The number of the track being played appears next to **TRACK** in the display.

You can only enter available track numbers.

#### **Skipping tracks forward/backward**

- Skipping tracks forward
  - ▶ Press **SEEK+** button briefly.  
The next track will be played.
- Skipping tracks backward
  - ▶ Press **-SEEK** button briefly.  
If the track has been playing for more than ten seconds, the unit skips back to the beginning of the track currently playing. If less than ten seconds have been played, the unit skips back to the beginning of the previous track.

Pressing the **-SEEK** or **SEEK+** button repeatedly will result in multiple tracks being skipped.

#### **Fast forward/reverse**

- Fast forward
  - ▶ Press and hold **SEEK+** button until desired point has been reached.
- Reverse
  - ▶ Press and hold **-SEEK** button until desired point has been reached.



The track number and the relative time of the track is shown in the display during the search.

#### **Scan**

- Starting scan
  - ▶ Press **SC** soft key.  
**SC** will appear in the display.  
Each track on the current CD will be played for approx. eight seconds in ascending order.
- Ending scan
  - ▶ Press **SC** soft key or **-SEEK** or **SEEK+**.

#### **Random play**

The random function (RDM) plays the tracks of the current CD in random order.



When you start the RDM function, the RPT function is automatically switched off.



- Switching on random
  - ▶ Press RDM soft key.  
RDM appears in the display.  
A randomly selected track is played.
- Switching off random
  - ▶ Press RDM soft key again.

#### **Repeat**

The track being played is repeated until the repeat function is switched off.



When you start the RPT function, the RDM function is automatically switched off.

- Switching on repeat
  - ▶ Press RPT soft key.  
RPT appears in the display.
- Switching off repeat
  - ▶ Press RPT soft key again.

#### **Pause function**

The CD changer mode is interrupted by an incoming call on the telephone\* (▷ page 205).

## Controls in detail

### Audio system

- Switching on pause function



- ▶ Press **MUTE** button.  
The CD changer mode is interrupted and PAUSE appears in the display.
- Switching off pause function
  - ▶ Press **MUTE** button.  
The CD changer mode is active again.

## Controls in detail

### Audio system

#### Track and time display



- ▶ Press T soft key.  
The number of the track being played and the elapsed playing time appear in the display.
- ▶ Press T soft key again.  
The total number of tracks and the total playing time of the CD appear in the display.
- ▶ Press T soft key.  
The standard CD playback menu appears in the display.

#### GSM network phones

Using your Mercedes-Benz specified mobile telephone\*, a number of functions and operating steps can be performed and displayed in the audio system display.

Further operating instructions not covered here can be found in the operating instructions for the multifunction steering wheel and the cellular telephone\*.

If your audio system is set up for telephone operation, the  symbol will appear in the display.

When you insert your Mercedes-Benz specified mobile telephone\* into the telephone cradle, you will be prompted to enter your PIN for 30 seconds (▷ page 201). This display disappears when you press any button.

When your mobile telephone is inserted into the telephone cradle, you will see the reception strength in the upper right-hand corner of the display.

#### Switching on the telephone

##### **Switching on the telephone**

- ▶ Press **TEL** button.

If the telephone was previously switched off, PROCESSING appears in the display and you will then be prompted to enter your PIN.

##### **Switching off the telephone**

- ▶ Press **TEL** button for approx. three seconds.

PROCESSING appears in the display until the telephone is off. Afterward, PHONE OFF appears in the display.

#### *PIN entry*



- ▶ Enter PIN number using buttons **1** to **0**.
- ▶ If necessary, correct number entered with the CLR soft key. Press soft key briefly to delete the last digit entered; press soft key and hold to delete the complete number.
- ▶ Press OK soft key after entering correct PIN.
- ▶ READY or ROAMING will appear in the display.



If the PIN is entered incorrectly three times, NEED PUK will appear in the display. Enter PUK via your telephone. Please refer to the separate telephone operating instructions for more information.

#### *Adjusting the volume*

- ▶ Turn rotary control of  button during a telephone call.

The volume will increase or decrease depending on the direction turned.



The volume can be adjusted separately for telephone mode and audio mode.

#### *Adjusting sound*

- ▶ Adjust sound during a telephone call. Sound adjustment (▷ page 179).

#### *Placing a call*

##### *Entering a telephone number and starting the dialing process*



- ▶ Enter desired telephone number using buttons **1** to **0**.

The number can have up to 32 digits, but only twelve of these are visible in the display. ▷▷

## Controls in detail

### Audio system

- ▶▶ If necessary, correct number entered with the CLR soft key. Press soft key briefly to delete the last digit entered; press soft key and hold to delete the complete number.
- ▶ After correct telephone number has been entered, press  button.



If the telephone number has been saved together with a name in the telephone book, the name will appear in the display.

#### Phone book

The numbers stored in the phone book of the telephone can be called up either by name or number.

In addition, incoming calls are stored in the phone book.







This is only possible, however, when the call information transmitted includes the number of the person calling. If the telephone number is not transmitted, NO NUMBER will be stored in the phone book.





- Searching and calling up telephone book entries by name

You can access your mobile telephone's phone book using the audio system. You can access both the main entries and the sub-entries of your phone book.





- ▶ Press MEM soft key or press button  or .
  - ▶ Press desired numerical key  to .
- The stored entries are selected according to the alphabetical order of the initial letters (e.g. for S-Schneider, press button  four times).

or

- ▶ Press and hold button  or .
- The system jumps from one initial letter to the next in ascending or descending order.
- ▶ Press and hold button  or  until desired initial letter has been reached.

or

- ▶ Press button  or  repeatedly until desired entry has been reached.

The stored entries are selected in alphabetical order with the sub-entries.



Several sub-entries can be stored for each main entry (name). These entries are marked by a corresponding abbreviation that appears in the upper left-hand corner of the display. The following abbreviations for sub-entries are possible:

CEL = Mobile phone  
 HOM = Home  
 WOR = Work  
 FAX = Fax  
 PAG = Pager  
 TEL = Main

- ▶ When you have selected a number, press  button.

The call will be made.

- Viewing the telephone number of a telephone book entry

- ▶ Search for desired entry.

- ▶ Press NUM soft key.



The telephone number of the phone book entry appears in the display.

- Returning calls received





## Controls in detail

### Audio system

- ▶ Press MEM soft key or press button  or .

- ▶ Press RCV soft key (received calls).

The number of received calls and then the call last received appear briefly in the display.

- ▶ Select desired telephone number with button  or .

The letter R and the number of the memory position appear in the upper left-hand corner of the display. The numbers are stored in the order of the calls received.

- ▶ When you have selected a number, press  button.

The call will be made.

## Controls in detail

### Audio system

- Speed dial

If you have stored telephone numbers as speed dial numbers in your telephone, you can also enter these with buttons **1** to **0** on the radio head unit.

- ▶ Press desired button **1** to **0** briefly.
- ▶ Press  button.  
The call will be made.

- Turbo dial

If you have stored telephone numbers as turbo dial numbers in your telephone, you can also enter these with buttons **1** to **0** on the radio head unit.

- ▶ Press desired button **1** to **0** until the call is made.

### Redial

If the number you have dialed is busy, you can again place calls to the last ten telephone numbers dialed using the redial function.





If you have activated the automatic redial function on your telephone, the number of the person being called is automatically redialed after a short waiting period if there is a busy signal. Refer to the separate operating instructions for the mobile telephone.

- Manual redial



- ▶ Press  button.

The telephone number last dialed will appear in the display.

- ▶ Select desired telephone number with button  or .

The letter L and the number of the memory position appears in the left-hand corner of the display. The numbers are stored in the order of the calls received.

- ▶ When you have selected a number, press  button.

The call will be made.

#### ***Accepting an incoming call***

If the telephone is active in the background (reception symbol is visible in the display), the audio source is muted when an incoming call is received. A ringing tone can be heard and the caller's telephone number, or the name under which the telephone number has been saved in the phone book, appears in the display. If the caller's number is not transmitted with the call, CALL will appear in the display.

- ▶ Press  button.

The call is accepted.

#### ***Muting a call***

It is possible to mute a call; the caller is then no longer able to hear you.

- Mute on
  - ▶ Press MUT soft key.
  - ▶ MIC MUTE will appear in the display.
- Mute off
  - ▶ Press MUT soft key again.

#### ***Terminating a call***

- ▶ Press  button.

The current call is terminated and the muted audio source becomes active again.

#### ***Talking with two callers at the same time***

If you wish to receive or place another call during an already active call, you can accept or place the second call and switch between the callers or combine them into one call. Note that the features described here are depending on availability from your mobile phone service provider.

- Placing/accepting a second call
  - ▶ Place new call by entering telephone number manually.
  - ▶ Press  button.

You are connected to the second caller; the first caller is kept on hold.

or



## Controls in detail



### Audio system





- ▷▷ ▶ Press  button to accept a second call.



You will be notified of the second call acoustically, but you will not see this in the display.

You are connected with the second caller; the first caller is kept on hold.

- Switching between calls
  - ▶ Press  and  buttons.  
This switches between the calls.  
The non-active call is kept on hold.

- Terminating a call
  - ▶ Press  button.  
The current call is terminated. You are again connected with the caller previously placed on hold.
- Combining two calls
  - ▶ Press  and  buttons.  
The calls are combined into one call.
- Terminating a combined call
  - ▶ Press  button.  
The connection to both callers is terminated.

### TDMA or CDMA network phones

Using your Mercedes-Benz specified mobile telephone\*, a number of functions and operating steps can be performed and displayed in the audio system display.

Further operating instructions not covered here can be found in the operating instructions for the multifunction steering wheel and the mobile telephone\*.

If your audio system is set up for telephone operation, the  symbol will appear in the display.

When you insert your Mercedes-Benz specified mobile telephone\* into the telephone cradle, you will be prompted to enter your PIN for 30 seconds (▷ page 207). This display disappears when you press any button.

When your mobile telephone is inserted into the telephone cradle, you will see the reception strength in the upper right-hand corner of the display.



#### Switching on the telephone

##### Switching on the telephone

- ▶ Press **TEL** button.

If you have programmed an unlock code for the telephone, you must now enter the code.



- ▶ Enter code using buttons **1** to **0**.
- ▶ If necessary, correct number entered with the CLR soft key. Press soft key briefly to delete the last digit entered; press soft key and hold to delete the complete number.

- ▶ Press OK soft key after entering correct code.

The telephone is unlocked. If you have entered an incorrect code, you must enter the correct code.

##### Switching off the telephone

- ▶ Press **TEL** button for approx. three seconds.

PROCESSING appears in the display until the telephone is off. Afterward, PHONE OFF appears in the display.

##### Adjusting the volume

- ▶ Turn rotary control of  button during a telephone call.

The volume will increase or decrease depending on the direction turned.



The volume can be adjusted separately for telephone mode and audio mode.

##### Adjusting sound

- ▶ Adjust sound during a telephone call. Sound adjustment (▷ page 179).

##### Placing a call

##### Entering a telephone number and starting the dialing process

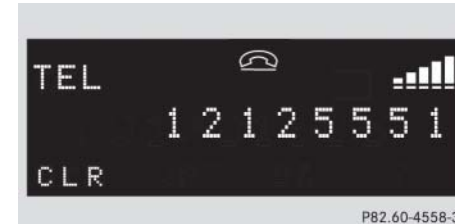

- ▶ Enter desired telephone number using buttons **1** to **0**.

The number can have up to 32 digits, but only twelve of these are visible in the display. ▷▷

## Controls in detail

### Audio system

- ▶▶ If necessary, correct number entered with the CLR soft key. Press soft key briefly to delete the last digit entered; press soft key and hold to delete the complete number.
- ▶ After correct telephone number has been entered, press  button.



If the telephone number has been saved together with a name in the phone book, the name will appear in the display.

#### Phone book

The numbers stored in the phone book of the mobile telephone can be called up either by name or number.

In addition, incoming calls are stored in the phone book.







This is only possible, however, when the call information transmitted includes the number of the person calling. If the telephone number is not transmitted, NO NUMBER will be stored in the phone book.

- Searching and calling up phone book entries by name



You can access your mobile telephone's phone book with the audio system. You can access both the main entries and the sub-entries of your phone book.





- ▶ Press MEM soft key or press button  or .
- ▶ Press desired numerical key  to .

The stored entries are selected according to the alphabetical order of the initial letters (e.g. for S-Schneider, press button  four times).

or

- ▶ Press and hold button  or .

The system jumps from one initial letter to the next in ascending or descending order.

- ▶ Press and hold button  or  until desired initial letter has been reached.

or

- ▶ Press button ▲ or ▼ repeatedly until desired entry has been reached.

The stored entries are selected in alphabetical order with the sub-entries.



Several sub-entries can be stored for each main entry (name). These entries are marked by a corresponding abbreviation that appears in the upper left-hand corner of the display. The following abbreviations for sub-entries are possible:

CEL = Mobile phone  
 HOM = Home  
 WOR = Work  
 FAX = Fax  
 PAG = Pager  
 TEL = Main

- ▶ When you have selected a number, press button.

The call will be made.

- Viewing the telephone number of a phone book entry

- ▶ Search for desired entry.

- ▶ Press NUM soft key.

The telephone number of the phone book entry appears in the display.

- Returning calls received

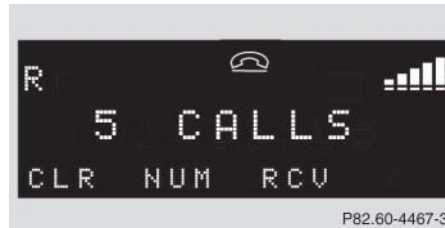

## Controls in detail

### Audio system

- ▶ Press MEM soft key or press button ▲ or ▼.

- ▶ Press RCV soft key (received calls).

The number of received calls and then the call last received appear briefly in the display.

- ▶ Select desired telephone number with button ▲ or ▼.

The letter R and the number of the memory position appear in the upper left-hand corner of the display. The numbers are stored in the order of the calls received.

- ▶ When you have selected a number, press button.

The call will be made.

## Controls in detail

### Audio system

- Speed dial

If you have stored telephone numbers as speed dial numbers in your telephone, you can also enter these with buttons **1** to **0** on the radio unit.

- ▶ Press desired button **1** to **0** briefly.
- ▶ Press  button.

The call will be made.

- Turbo dial

If you have stored telephone numbers as turbo dial numbers in your telephone, you can also enter these with buttons **1** to **0** on the radio unit.

- ▶ Press desired button **1** to **0** until the call is made.

### Redial

If the number you have dialed is busy, you can again place calls to the last ten telephone numbers dialed using the redial function.





If you have activated the automatic redial function on your mobile telephone, the number of the person being called is automatically redialed after a short waiting period if there is a busy signal. Refer to the separate operating instructions for the mobile telephone.

- Manual redial



- ▶ Press  button.

The telephone number last dialed will appear in the display.

- ▶ Select desired telephone number with button  or .

The letter L and the number of the memory position appears in the left-hand corner of the display. The numbers are stored in the order of the calls received.

- ▶ When you have selected a number, press  button.

The call will be made.

#### ***Accepting an incoming call***

If the telephone is active in the background (reception symbol is visible in the display), the audio source is muted when an incoming call is received. A ringing tone can be heard and the caller's telephone number, or the name under which the telephone number has been saved in the telephone book, appears in the display. If the caller's number is not relayed, CALL will appear in the display.

- ▶ Press  button.  
The call is accepted.

#### ***Muting a call***

It is possible to mute a call; the caller is then no longer able to hear you.

- Mute on
  - ▶ Press MUT soft key.
  - ▶ MIC MUTE will appear in the display.
- Mute off
  - ▶ Press MUT soft key again.

#### ***Terminating a call***

- ▶ Press  button.

The current call is terminated and the muted audio source becomes active again.

#### ***Accepting a second incoming call***

If you receive another call during an already active call, you can accept the second call and switch between the two.

- Accepting a second call
  - ▶ Place new call by entering telephone number manually.





You will be notified of the second call acoustically, but you will not see this in the display.

You are connected to the second caller; the first caller is kept on hold.

## Controls in detail



### Audio system

- Switching between calls
  - ▶ Press  button.  
This switches between the calls.  
The non-active call is kept on hold.
- Terminating a call
  - ▶ Press  button.  
The current call is terminated. The connection to the caller previously kept on hold is also interrupted; however, reconnection is indicated by an acoustic signal.

#### *Placing a second call*

If you wish to place another call during an already active call, you can place the second call and switch between the callers or combine them into one call. Note that this feature is depending on availability from your mobile phone service provider.

- Placing a second call
  - ▶ Place a new call by entering telephone number manually.
  - ▶ Press  button.  
You are connected to the second caller; the first caller is kept on hold.

- Terminating a call
  - ▶ Press  button.  
The current call is terminated. The connection to the caller previously kept on hold is also interrupted; however, reconnection is indicated by an acoustic signal.
- Combining two calls
  - ▶ Press  button.  
The calls are combined into one call.
- Terminating a combined call
  - ▶ Press  button.  
The connection to both callers is terminated.

#### Emergency calls “911”

The following describes how to dial a “911” emergency call using the audio system head unit when a Mercedes-Benz specified mobile phone\* is inserted in the phone cradle\*. Unless otherwise specified, the descriptions refer to the audio system head unit.

Consult the separate telephone operating instructions that came with your mobile phone\* for information on how to place a “911” emergency call on the mobile phone\*.

#### Warning!



The “911” emergency call system is a public service. Using it without due cause is a criminal offense.

The following conditions must be met for a “911” emergency call:

- Telephone must be switched on.
- The corresponding mobile communications network must be available.



Emergency calls may not be possible with all telephone networks or if certain network services and/or telephone functions are active. Check with your local service providers.

If you cannot make an emergency call, you will have to initiate rescue measures yourself.

#### GSM network phones

##### *Placing a “911” emergency call using audio head unit with the phone locked*

- ▶ Press **TEL** button to switch to telephone operation.

PIN? appears in the audio display.

- ▶ Enter 911 using the number keypad on the audio head unit.
- ▶ Press OK soft key or  button for dialing to begin.

DIALING appears in the audio display while the telephone establishes the connection.

- ▶ Wait until the emergency call center answers, then describe the emergency.

## Controls in detail

### Audio system

#### *Placing a “911” emergency call using audio head unit with the phone unlocked*

- ▶ Press **TEL** button to switch to telephone operation.
- ▶ Enter 911 using the number keypad on the audio head unit.
- ▶ Press  button for dialing to begin. **DIALING** appears in the audio display while the telephone establishes the connection.
- ▶ Wait until the emergency call center answers, then describe the emergency.



If no SIM card is in the mobile phone, **NO SERVICE** appears in the audio display. In that case, you only can make an emergency call on the mobile phone itself, without the use of the head unit.

#### TDMA/CDMA network phones

#### *Placing a “911” emergency call using audio head unit with the phone locked*

- ▶ Press **TEL** button to switch to telephone operation. **CODE?** appears in the audio display.
- ▶ Enter 911 using the number keypad on the audio head unit.
- ▶ Press **OK** soft key or  button for dialing to begin. **DIALING** appears in the audio display while the telephone establishes the connection.
- ▶ Wait until the emergency call center answers, then describe the emergency.

#### *Placing a “911” emergency call using audio head unit with the phone unlocked*

- ▶ Press **TEL** button to switch to telephone operation.
- ▶ Enter 911 using the number keypad on the audio head unit.
- ▶ Press  button for dialing to begin. **DIALING** appears in the audio display while the telephone establishes the connection.
- ▶ Wait until the emergency call center answers, then describe the emergency.



## ▼ Power windows

### Opening and closing the windows

The side windows can be opened and closed electrically. The switches for all the side windows are on the driver's door. The switches for the respective windows are on the front passenger door and the rear doors.



- ① Left front window
- ② Right front window
- ③ Right rear window
- ④ Left rear window
- ⑤ Rear window override switch  
(▷ page 77)

### Warning!



When closing the windows, make sure there is no danger of anyone being harmed by the closing procedure.

The closing of the door windows can be immediately halted by releasing the switch or, if switch was pulled past the resistance point and released, by either pressing or pulling the respective switch.

If the window encounters an obstruction that blocks its path in a circumstance where you pulled the switch past the resistance point and released it to close the window, the automatic reversal function will stop the window and open it slightly.

## Controls in detail

### Power windows

If the window encounters an obstruction that blocks its path in a circumstance where you are closing the window by pulling and holding the switch, or by pressing and holding button  on the SmartKey, the automatic reversal function will not operate.

When leaving the vehicle, always remove the SmartKey from starter switch, take it with you, and lock your vehicle. Do not leave children unattended in the vehicle, or with access to an unlocked vehicle. Unsupervised use of vehicle equipment can cause an accident and/or serious personal injury.

## Controls in detail

### Power windows



You can also open or close the windows using the SmartKey (summer opening/convenience closing feature) (▷ page 217).

You can close and reopen the windows using the air recirculation button  in the climate control panel (▷ page 167).

- ▶ Switch on ignition (▷ page 33).

#### Opening the windows

- ▶ Press switch ① to ④ to the resistance point.  
The corresponding window will move downwards until you release the switch.

#### Closing the windows

- ▶ Pull switch ① to ④ to the resistance point.  
The corresponding window will move upwards until you release the switch.

#### Warning!



If you pull and hold the switch up when closing the window, and upward movement of the window is blocked by some obstruction including but not limited to arms, hands, fingers, etc., the automatic reversal will not operate.

#### Fully opening the windows (Express-open)

- ▶ Press switch ① to ④ past the resistance point and release.  
The corresponding window opens completely.

#### Fully closing the windows (Express-close)

- ▶ Pull switch ① to ④ past the resistance point and release.  
The corresponding window closes completely.



If the upward movement of the window is blocked during the closing procedure, the window will stop and open slightly.

Remove the obstruction, pull the switch again past the resistance point and release.

If the window still does not close when there is no obstruction, then pull and hold the switch again. The side window will then close without the obstruction sensor function

### Warning!



Driver's door only:  
If within five seconds you again pull the switch past the resistance point and release, the automatic reversal will not function.

### Stopping windows

- ▶ Press or pull respective switch again.

## Controls in detail

### Power windows



#### Opening and closing the windows with the SmartKey

The tilt/sliding sunroof\* (▷ page 221) will also be opened or closed when the power windows are operated with the SmartKey .

### Warning!



Never operate the windows or tilt/sliding sunroof\* if there is the possibility of anyone being harmed by the opening or closing procedure.

In the event that the procedure causes potential danger, the procedure can be immediately halted by releasing the transmit button on the SmartKey. To reverse direction of movement, press button  for opening or  for closing.



## Controls in detail

### Power windows





- ▶ Aim transmitter eye at the driver's door handle.

#### **Opening (Summer opening feature)**

- ▶ Press and hold button  after unlocking the vehicle.  
The windows and tilt/sliding sunroof\* begin to open after approximately one second.
- ▶ Release the  button to stop procedure.

#### **Closing (Convenience feature)**

- ▶ Press and hold button  after locking the vehicle.  
The windows and tilt/sliding sunroof\* begin to close after approximately one second.
- ▶ Release the  button to stop procedure.

Make sure all side windows and the tilt/sliding sunroof\* are properly closed before leaving the vehicle.

#### **Synchronizing power windows**

The power windows must be resynchronized each time

- after the battery has been disconnected.
  - if the power windows cannot be fully opened (Express-open) or closed (Express-close).
- ▶ Switch on ignition (▷ page 33).
  - ▶ Pull the power window switches until the side windows are closed.  
Hold the switches for approximately one second.  
The power windows are synchronized.

## ▼ Power tilt/sliding sunroof\*

### Opening and closing the power tilt/sliding sunroof

The tilt/sliding sunroof can be opened and closed electrically. The switch for the tilt/sliding sunroof is on the overhead control panel.



#### Sunroof switch

- ① Push up to raise sunroof at rear
- ② Pull down to lower sunroof at rear
- ③ Push forward to slide sunroof closed
- ④ Push back to slide sunroof open

With the sunroof closed or tilted open, a screen can be slid into the roof opening to guard against sun rays. When sliding the sunroof open, the screen will also retract.



Screen

## Controls in detail

### Power tilt/sliding sunroof\*

#### Warning!



When closing the tilt/sliding sunroof, make sure there is no danger of anyone being harmed by the closing procedure.

The opening/closing procedure of the tilt/sliding sunroof can be immediately halted by releasing the switch or, if the switch was moved past the resistance point and released, by moving the switch in any direction.

The tilt/sliding sunroof is made out of glass. In the event of an accident, the glass may shatter. This may result in an opening in the roof.

In a vehicle rollover, occupants not wearing their seat belts or not wearing them properly may be thrown out of the opening. Such an opening also presents a potential for injury for occupants wearing their seat belts properly as entire body parts or portions of them may protrude from the passenger compartment.



## Controls in detail

### Power tilt/sliding sunroof\*



When leaving the vehicle, always remove the SmartKey from starter switch, and lock your vehicle. Do not leave children unattended in the vehicle, or with access to an unlocked vehicle. Unsupervised use of vehicle equipment can cause an accident and/or serious personal injury.



To avoid damaging the seals, do not transport any objects with sharp edges which can stick out of the tilt/sliding sunroof.

Do not open the tilt/sliding sunroof if there is snow or ice on the roof, as this could result in malfunctions.

The tilt/sliding sunroof can be opened or closed manually should an electrical malfunction occur (▷ page 329).



You can also open or close the tilt/sliding sunroof using the SmartKey (summer opening/convenience closing feature) (▷ page 221).

You can close and reopen the tilt/sliding sunroof using the air recirculation button  in the climate control panel (▷ page 167).

- ▶ Switch on ignition (▷ page 33).

#### Opening and closing the power tilt/sliding sunroof

- ▶ To open, close, raise, or lower the tilt/sliding sunroof, move the sunroof switch to resistance point in the required direction of arrows ① to ④. Release the sunroof switch when the tilt/sliding sunroof has reached the desired position.

#### Fully opening (Express-open) and closing (Express-close) the power tilt/sliding sunroof

- ▶ To open or close the tilt/sliding sunroof, move the sunroof switch past the resistance point in the required direction of arrow ④ or ③ and release. The tilt/sliding sunroof opens or closes completely.

### Stopping the power tilt/sliding sunroof during Express-operation

- ▶ Move the sunroof switch in any direction.



If the movement of the tilt/sliding sunroof is blocked during the closing procedure, the tilt/sliding sunroof will stop and reopen slightly.



### Opening and closing the tilt/sliding sunroof with the SmartKey

The power windows (▷ page 217) will also be opened or closed when you operate the tilt/sliding sunroof with the SmartKey .

#### Warning!



Never operate the windows or tilt/sliding sunroof if there is the possibility of anyone being harmed by the opening or closing procedure.

In the event that the procedure causes potential danger, the procedure can be immediately halted by releasing the transmit button on the SmartKey. To reverse direction of movement, press button  for opening or  for closing.

## Controls in detail

### Power tilt/sliding sunroof\*



- ▶ Aim transmitter eye at the driver's door handle.

#### Opening (Summer opening feature)

- ▶ Press and hold button  after unlocking the vehicle.

The windows and the tilt/sliding sunroof begin to open after approximately one second.

- ▶ Release the  button to stop procedure.

## Controls in detail

### Power tilt/sliding sunroof\*

#### *Closing (Convenience feature)*

- ▶ Press and hold button  after locking the vehicle.

The windows and the tilt/sliding sunroof begin to close after approximately one second.

- ▶ Release the  button to stop procedure.

Make sure all side windows and the tilt/sliding sunroof are properly closed before leaving the vehicle.

#### **Synchronizing the power tilt/sliding sunroof**

---

The tilt/sliding sunroof must be synchronized

- after the battery has been disconnected or discharged
- after the tilt/sliding sunroof has been closed manually (▷ page 329)
- after a malfunction
- if the tilt/sliding sunroof does not open smoothly

- ▶ Switch on ignition (▷ page 33).
- ▶ Move and hold the sunroof switch in the direction of arrow ① (▷ page 219) until the tilt/sliding sunroof is fully raised at the rear.

Hold the sunroof switch for approximately one second.

- ▶ Check the Express-open feature (▷ page 220).

If the tilt/sliding sunroof opens completely, the tilt/sliding sunroof is synchronized. Otherwise repeat the above steps.



## ▼ Driving systems

The driving system of your vehicle is described on the following pages:

- Cruise control, with which the vehicle can maintain a preset speed

For information on the BAS, ABS and ESP driving systems, see “Driving safety systems” (▷ page 79).

### Cruise control

Cruise control automatically maintains the speed you set for your vehicle.

Use of cruise control is recommended for driving at a constant speed for extended periods of time. You can set or resume cruise control at any speed over 20 mph (30 km/h).

The cruise control function is operated by means of the cruise control lever.

The cruise control lever is the uppermost lever on the left-hand side of the steering column (▷ page 22).

## Controls in detail

### Driving systems

#### Warning!



Cruise control is a convenience system designed to assist the driver during vehicle operation. The driver is and must remain at all times responsible for the vehicle speed and for safe brake operation.

Only use cruise control if the road, traffic and weather conditions make it advisable to travel at a steady speed.

- The use of cruise control can be dangerous on winding roads or in heavy traffic because conditions do not allow safe driving at a steady speed.
- The use of cruise control can be dangerous on slippery roads. Rapid changes in tire traction can result in wheel spin and loss of control.
- Deactivate cruise control when driving in fog.

The “Resume” function should only be operated if the driver is fully aware of the previously set speed and wishes to resume this particular preset speed.

## Controls in detail

### Driving systems

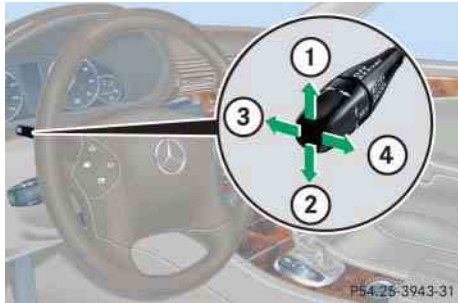

- ① Sets current or higher speed
- ② Sets current or lower speed
- ③ Cancels cruise control
- ④ Resumes at last set speed

#### Setting current speed

- ▶ Accelerate or decelerate to the desired speed.
- ▶ Briefly lift ① or depress ② the cruise control lever.

The current speed is set.

- ▶ Remove your foot from the accelerator pedal.

Cruise control is activated.



On uphill or downhill grades, cruise control may not be able to maintain the set speed. Once the grade eases, the set speed will be resumed.

#### Canceling cruise control

There are several ways to cancel cruise control:

- ▶ Step on the brake pedal.

Cruise control is canceled. The last speed set is stored for later use.

or

- ▶ Briefly push the cruise control lever to position ③.

Cruise control is canceled. The last speed set is stored for later use.



Moving the gear selector lever to position **N** while driving also cancels cruise control. However, the gear selector lever should not be moved to position **N** while driving, except to coast when the vehicle is in danger of skidding (e.g. on icy roads).



The last stored speed is canceled when you turn off the engine.

#### Setting a higher speed

- ▶ Lift cruise control lever to position ① and hold it up until the desired speed is reached.
- ▶ Release cruise control lever.  
The new speed is set.



Depressing the accelerator pedal does not deactivate cruise control. After brief acceleration (e.g. for passing), cruise control will resume the last speed set.

#### Setting a lower speed

- ▶ Depress cruise control lever to position ② and hold it down until the desired speed is reached.
- ▶ Release cruise control lever.  
The new speed is set.



When you use the cruise control lever to decelerate, the transmission will automatically downshift if the engine's braking power does not brake the vehicle sufficiently.

#### Fine adjustment in 1 mph (Canada: 1 km/h) increments

##### *Faster*

- ▶ Briefly tip cruise control lever in direction of arrow ①.

##### *Slower*

- ▶ Briefly tip cruise control lever in direction of arrow ②.

#### Setting to last stored speed ("Resume" function)

##### Warning!



The speed stored in memory should only be set again if prevailing road conditions permit. Possible acceleration or deceleration differences arising from returning to preset speed could cause an accident and/or serious injury to you and others.

- ▶ Briefly push cruise control lever to position ④.  
The cruise control resumes the last set speed.
- ▶ Remove your foot from the accelerator pedal.

## Controls in detail

### Loading

#### Roof rack\*

##### Warning!



Only use roof racks approved by Mercedes-Benz for your vehicle model to avoid damage to the vehicle. Follow manufacturer's installation instructions.

- ▶ Attach the roof rack only to the roof rails.
- ▶ Secure the roof rack according to manufacturer's instructions for installation.



Load the roof rack in such a way that the vehicle cannot be damaged while driving.

Make sure

- you can fully raise the tilt/sliding sunroof\*.
- you can fully open the tailgate.

#### Parcel net in cargo compartment

There is a parcel net located on left side of the cargo compartment. Dependent on the equipment of your vehicle, there is another parcel net located on right side of the cargo compartment.

##### Warning!



The parcel net is designed only to carry light loads.

Do not place heavy or fragile objects, or objects having sharp edges, in the parcel net.

In an accident, during hard braking or sudden maneuvers, they could be thrown around inside the vehicle, and cause injury to vehicle occupants.

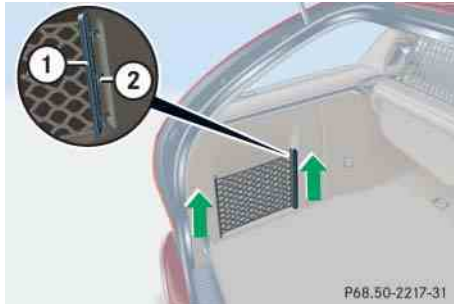

- ① Rail
- ② Mounting lug

#### Removal of parcel net

- ▶ Slide rails ① upward and remove.

#### Installation of parcel net

- ▶ Place mounting lugs ② in opening.
- ▶ Slide rails ① down as far as they can go.

#### Storage compartment under cargo compartment floor

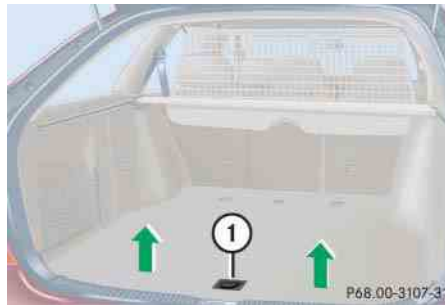

#### To open cargo compartment floor

- ▶ Press handle ① on the recess.
- ▶ Lift compartment cover.



The compartment can be used to store small, light or flat objects.

## Controls in detail

### Loading

#### To close cargo compartment floor

- ▶ Lower the cover and lock by applying light pressure to handle ①.

#### Warning!



If items are stored in the compartment, make sure compartment is securely closed.

In an accident, during hard braking or sudden maneuvers, they could be thrown around inside the vehicle, and cause injury to vehicle occupants.

## Controls in detail

### Loading

#### Retractable luggage cover and partition net

The twin-reel roller blind comprises a luggage cover and a partition net. It is mounted on the backrest of the rear seat and can also be used with backrest folded down.

#### Partition net

##### Warning!



To help avoid personal injury during a collision or sudden maneuver, always use partition net when transporting cargo.

*Partition net with rear seats folded up*

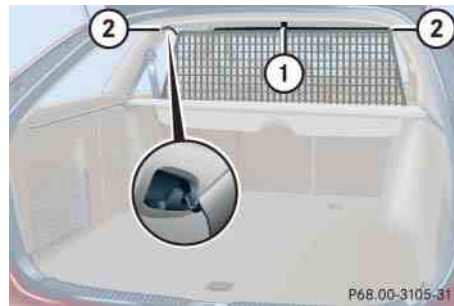

- ① Tab
- ② Eyelets on roof
- ▶ Pull out upper blind (partition net) by tab ①.
- ▶ Engage it into eyelets on the roof ②.

*Partition net with rear seats folded down*

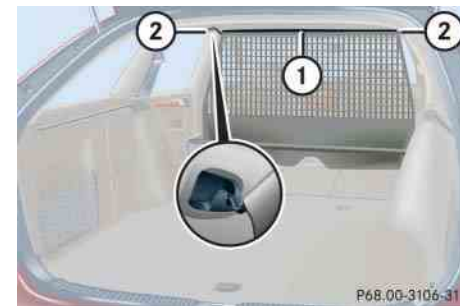

- ① Tab
- ② Eyelets on roof
- ▶ Pull out upper blind (partition net) by tab ① until it engages.
- ▶ Fold the backrest forward (> page 230).
- ▶ Pull out upper blind fully.
- ▶ Engage it into eyelets on the roof ②.

#### Luggage cover



#### Closing

- ▶ Pull luggage cover back by handle ① until it locks into position.

#### Opening

- ▶ Press handle ① down and release.  
The luggage cover retracts automatically.



With the luggage cover rolled up, fold the lip down.

#### Twin-reel roller blind

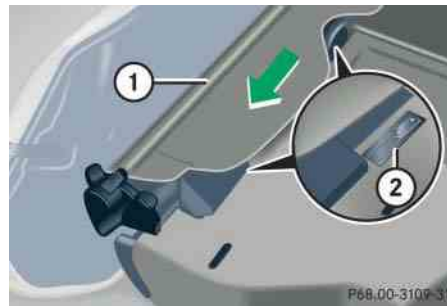

- ① Twin-reel roller blind
- ② Guide rail

- ▶ Retract the partition net and luggage cover.

#### Removing

- ▶ Fold the backrest forward (▷ page 230).
- ▶ Slide twin-reel roller blind ① to left and remove.

#### Installing

- ▶ Fold the backrest forward (▷ page 230).
- ▶ Place twin-reel roller blind ① into right and left guide rails ②.
- ▶ Slide towards right to the end stop.

## Controls in detail

### Loading

#### Split rear bench seat

To expand the cargo compartment, you can fold down the left and right rear seat backrests.

The two sections can be folded down separately.

#### Warning!



When expanding the luggage compartment, always fold the seat cushions fully forward and always use the partition net when transporting cargo.

Unless you are transporting cargo, the backrests must remain properly locked in the upright position.

In an accident, during hard braking or sudden maneuvers, loose items will be thrown around inside the vehicle, and cause injury to vehicle occupants unless the items are securely fastened in the vehicle.

Always use the cargo tie down rings (▷ page 233).

#### Folding the backrest forward

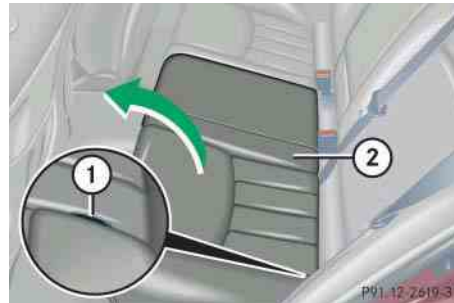

- ▶ Pull release handle ①.
- ▶ Fold seat cushion ② forward.

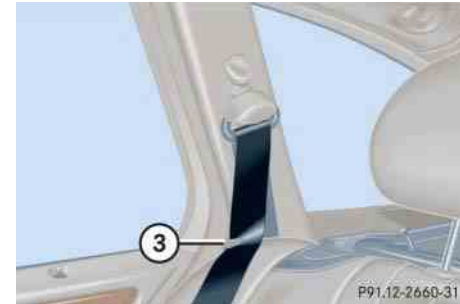

#### Right hand side of rear seat

- ▶ Slip seat belt webbing behind retainer ③.
- ▶ Fully retract and fold rearward head restraints (▷ page 101).



## Controls in detail

### Loading

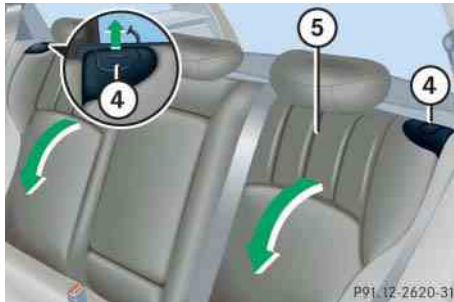

- ▶ Pull release lever ④.
- ▶ Fold backrest ⑤ forward.



With the twin-reel roller blind installed:

- When folding the backrest forward, fold the right section first and then the left section.
- If only the left section is to be folded, first remove the twin-reel roller blind (▷ page 229).

### Returning the backrest to original position

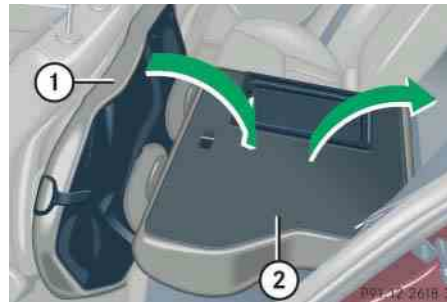

- ▶ Fold backrest ② rearward until it engages.
- ▶ Fold seat cushion ① rearward until it locks into position.



If the backrest is not locked into position, a red indicator ③ will be visible.

- ▶ Check for secure locking by pushing and pulling on the backrest.

## Controls in detail

### Loading

#### Warning!



If a red indicator is visible with the backrest up, then the backrest is not properly locked into position.

Always lock backrest in its upright position when rear seat bench is occupied, or the extended cargo compartment is not in use. Check for secure locking by pushing and pulling on the backrest.

In an accident, during hard braking or sudden maneuvers, loose items will be thrown around inside the vehicle, and cause injury to vehicle occupants unless the items are securely fastened in the vehicle.

To help avoid personal injury during a collision or sudden maneuver, exercise care when transporting cargo.

#### Loading instructions

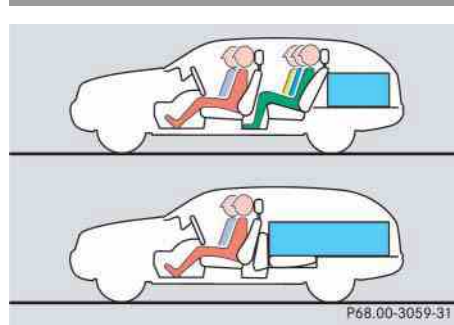

The total load weight including vehicle occupants and luggage/cargo should not exceed the vehicle capacity weight indicated on the corresponding label located on the driver's door pillar.

The handling characteristics of a fully loaded vehicle depend greatly on the load distribution. It is therefore recommended to load the vehicle according to the illustrations shown, with the heaviest items being placed towards the front of the vehicle.

Always place items being carried against front or rear seat backrests, and fasten them as securely as possible.

The heaviest portion of the cargo should always be kept as low as possible since it influences the handling characteristics of the vehicle.

**Warning!**

Always fasten items being carried as securely as possible.

In an accident, during hard braking or sudden maneuvers, loose items will be thrown around inside the vehicle and can cause injury to vehicle occupants unless the items are securely fastened in the vehicle.

To help avoid personal injury during a collision or sudden maneuver, exercise care when transporting cargo.

Never drive vehicle with tailgate open.

Deadly carbon monoxide (CO) gases may enter vehicle interior resulting in unconsciousness and death.

**Cargo tie-down rings**

The four cargo tie-down rings are located in the cargo compartment.

**Cargo tie-down rings**

- ▶ Carefully secure cargo by applying even load on all rings with rope of sufficient strength to hold down the cargo.

Always follow loading instructions (> page 232).

## Controls in detail

### Useful features

#### Storage compartments

##### Warning!



To help avoid personal injury during a collision or sudden maneuver, exercise care when stowing objects in the vehicle. Put luggage or cargo in the cargo compartment if possible. Do not pile luggage or cargo higher than the seat backs.

Always use partition net when transporting cargo. Partition net cannot secure hard or heavy objects.

Parcel nets cannot secure hard or heavy objects.

Keep compartment lids closed. This will help to prevent stored objects from being thrown about and injuring vehicle occupants during an accident.

#### Glove box

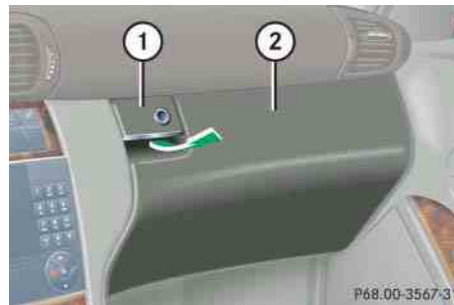

- ① Glove box lid release
- ② Glove box

##### Opening the glove box

- ▶ Pull lid release ①.  
The glove box lid opens downward.

##### Closing the glove box

- ▶ Push lid up to close.

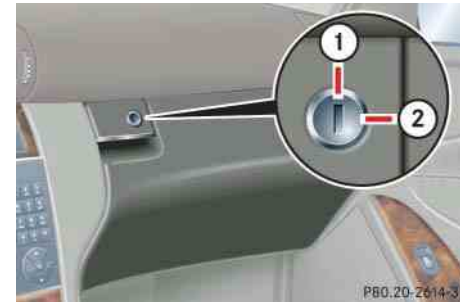

- ① Unlocking
- ② Locking

##### Locking the glove box

- ▶ Insert mechanical key (▷ page 326) into the glove box lock and turn it to position ②.

##### Unlocking the glove box

- ▶ Turn mechanical key in the glove box lock to position ①.

**Armrest storage compartments**

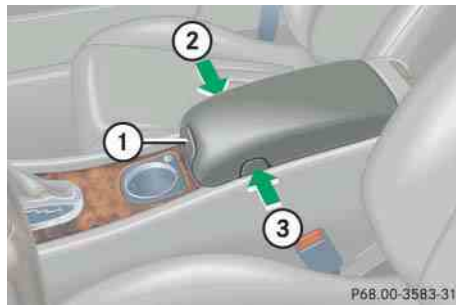

- ① Handle
- ② Button, passenger side
- ③ Button, driver's side



Do not store any items between the telephone holder and the cover for the blower. Otherwise these items could be damaged when the holder is closed. Use the space in the front door pocket for stowing.

**Opening storage compartment**

- ▶ Pull handle ① and lift armrest.

**Closing storage compartment**

- ▶ Press armrest down until it engages into place.

**Opening telephone compartment**

- ▶ Press button ③ on driver's side or button ② on passenger side and lift armrest.

**Closing telephone compartment**

- ▶ Press armrest down until it engages into place.

**Changing inclination of armrest**



- ① Handle
- ▶ Pull up on armrest.

**Lowering armrest**

- ▶ Pull handle ① to lower armrest.

## Controls in detail

### Useful features

#### Armrest in the rear passenger compartment



- ▶ Pull the top of the armrest out and fold it down.

#### Cup holders in front of seat armrest

##### Warning!



When not in use, keep the cup holder closed. Place only containers that fit into the cup holder to prevent spills. Use lids on open containers and do not fill containers to a height where the contents, especially hot liquids, could spill during vehicle maneuvers.

Underneath the swiveling cup holder is another stationary cup holder. You can only use this when the swiveling cup holder is pulled out and completely turned outward.

#### Sliding out the swiveling cup holder



- ▶ Push button ①.

The cup holder slides upward.



No objects should be in the swiveling cup holder when the swiveling cup holder is slid upward. Otherwise the swiveling cup holder or the objects could be damaged.

## Controls in detail

### Useful features

#### Turning the swiveling cup holder outward



- ▶ Turn the cup holder in the direction of arrow ② until it engages.  
You can now use both cup holders.

#### Turning the swiveling cup holder inward and sliding it in



- ▶ Turn the cup holder in the direction of arrow ③ until it engages.
- ▶ Turn the cup holder in the direction of arrow ④ until it engages.



No objects should be in the stationary cup holder when the swiveling cup holder is turned inward and pushed in. Otherwise the swiveling cup holder or the objects could be damaged.

#### Cup holder in rear seat armrest

##### Warning!



When not in use, keep the cup holder closed. Place only containers that fit into the cup holder to prevent spills. Use lids on open containers and do not fill containers to a height where the contents, especially hot liquids, could spill during vehicle maneuvers.

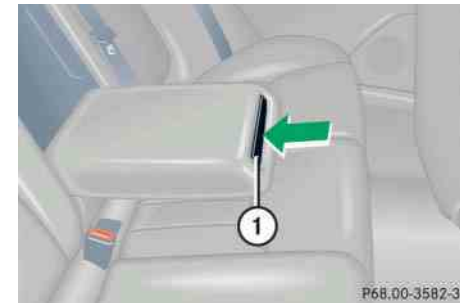

- ① Cup holder

## Controls in detail

### Useful features

#### Opening cup holder

- ▶ Briefly press the front of cup holder ①. The cup holder slides out slightly.
- ▶ Pull out the cup holder until it stops.

#### Closing cup holder

- ▶ Slide cup holder ① in until it engages.

#### Parcel net in front passenger footwell

A small convenience parcel net is located in the front passenger footwell. It is for small and light items, such as road maps, mail, etc.

#### Warning!



Do not place heavy or fragile objects, or objects having sharp edges, in the parcel net.

In an accident, during hard braking or sudden maneuvers, they could be thrown around inside the vehicle, and cause injury to vehicle occupants.

### Ashtrays

#### Center console ashtray



- ① Cover plate
- ② Sliding button
- ③ Ashtray insert

- ▶ Briefly press the bottom of cover plate ①. The cover plate opens automatically.

#### Removing ashtray insert

#### Warning!



Remove front ashtray only with vehicle standing still. Set the parking brake to secure vehicle from movement. Move gear selector lever to position **N**. With gear selector lever in position **N**, turn off the engine.

- ▶ Secure vehicle from movement by setting the parking brake.
- ▶ Move the gear selector lever to position **N**.  
Now you have more room to take out the insert.
- ▶ Push sliding button ② to the right. The ashtray insert ③ slides out slightly.
- ▶ Remove the ashtray insert.



#### Reinstalling the ashtray insert

- ▶ Push the ashtray insert ③ down into the retainer until it engages.
- ▶ Push down cover plate ① to close ashtray.  
The cover plate engages.

#### Rear seat ashtray



- ① Button
- ② Ashtray insert
- ③ Cover

- ▶ Pull at top of cover ③.

#### Removing ashtray insert

- ▶ Push button ① to disengage ashtray insert ② and remove it.

#### Reinstalling ashtray insert

- ▶ Push the ashtray insert ② down into the retainer until it engages.
- ▶ Push at top of cover ③ to close ashtray.

#### Cigarette lighter



- ① Cover plate
- ② Cigarette lighter

- ▶ Switch on ignition (▷ page 33).
- ▶ Briefly press the bottom of cover plate ①.  
The cover plate opens automatically.
- ▶ Push in cigarette lighter ②.  
The cigarette lighter will pop out automatically when hot.

## Controls in detail

### Useful features

#### Warning!



Never touch the heating element or sides of the lighter; they are extremely hot. Hold the knob only.

When leaving the vehicle, always remove the SmartKey from the starter switch, and lock your vehicle. Do not leave children unattended in the vehicle, or with access to an unlocked vehicle. Unsupervised use of vehicle equipment may cause an accident and/or serious personal injury.



The lighter socket can be used to accommodate electrical accessories up to a maximum 85 W.

- ▶ Push down cover plate ① to close ashtray.

The cover plate engages.

#### Electrical outlet



The electrical outlet can be used to accommodate electrical consumers (e.g. air pump, auxiliary lamps) up to a maximum of 180 W.

#### Electrical outlet in the rear passenger compartment



- ① Electrical outlet
- ② Cover

- ▶ Switch on ignition (▷ page 33).
- ▶ Pull at top of cover ②.
- ▶ Flip cover ① to the left and insert electrical plug (cigarette lighter type).

#### Electrical outlet in the cargo compartment



- ▶ Switch on ignition (▷ page 33).
- ▶ Flip up cover and insert electrical plug (cigarette lighter type).

## Telephone\*

### Warning!



Never operate radio transmitters equipped with a built-in or attached antenna (i.e. without being connected to an external antenna) from inside the vehicle while the engine is running. Doing so could lead to a malfunction of the vehicle's electronic system, possibly resulting in an accident and/or serious personal injury.

Radio transmitters, such as a portable telephone or a citizens band unit, should only be used inside the vehicle if they are connected to an antenna that is installed on the outside of the vehicle.

The external antenna must be approved by Mercedes-Benz. Please contact an authorized Mercedes-Benz Center for information on the installation of an approved external antenna. Refer to the radio transmitter operation instructions regarding use of an external antenna.

### Warning!



Please do not forget that your primary responsibility is to drive the vehicle. A driver's attention to the road must always be his/her primary focus when driving. For your safety and the safety of others, we recommend that you pull over to a safe location and stop before placing or taking a telephone call.

If you choose to use the telephone<sup>1</sup> while driving, please use the hands-free device and only use the telephone when road, weather and traffic conditions permit. Some jurisdictions prohibit the driver from using a cellular telephone while driving a vehicle.



Only operate the COMAND\* (Cockpit Management and Data System)<sup>1</sup> if road, weather and traffic conditions permit.

Bear in mind that at a speed of just 30 mph (approximately 50 km/h), your vehicle is covering a distance of 44 feet (approximately 14 m) every second.

<sup>1</sup> Observe all legal requirements.

## Controls in detail

### Useful features

You can take and place telephone calls using the  and  buttons on the steering wheel. To carry out other telephone functions, use the control system (▷ page 148).

See separate operating manual for instructions on how to use the telephone.

### Warning!



Some jurisdictions prohibit the driver from using a cellular telephone while driving a vehicle. Whether or not prohibited by law, for safety reasons, the driver should not use the cellular telephone while the vehicle is in motion.

Stop the vehicle in a safe location before answering or placing a call.

## Controls in detail

### Useful features

#### Tele Aid\*



The initial activation of the Tele Aid system may only be performed by completing the subscriber agreement and placing an acquaintance call using the  button. Failure to complete either of these steps will result in a system that is not activated.

If you have any questions regarding activation, please call the Response Center at 1-800-756-9018 (in the USA) or 1-888-923-8367 (in Canada).



#### The Tele Aid system



(Telematic Alarm Identification on Demand)

The Tele Aid system consists of three types of response:

- automatic and manual emergency
- roadside assistance and
- information



The Tele Aid system is operational providing that the vehicle's battery is charged, properly connected, not damaged and cellular and GPS coverage is available.

The speaker volume of a Tele Aid call can be adjusted when using the volume control on the multifunction steering wheel. To raise, press button  and to lower, press button . The volume can also be adjusted using the volume knob on your audio system or COMAND\* head unit.

- ▶ To activate, press the SOS button, the Roadside Assistance button  or the Information button , depending on the type of response required.



The SOS button is located above the interior rear view mirror.



The Roadside Assistance button  and the Information button  are located below the center armrest cover.

Shortly after the completion of your Tele Aid acquaintance call, you will receive a user ID and password. By visiting [www.mbusa.com](http://www.mbusa.com) and selecting "Tele Aid" (USA only), you will have access to account information, remote door unlock and more.



The Tele Aid system utilizes the cellular network for communication and the GPS (Global Positioning System) satellites for vehicle location. If either of these signals are unavailable, the Tele Aid system may not function and if this occurs, assistance must be summoned by other means.

#### System self-check

Initially, after switching on ignition, malfunctions are detected and indicated (the indicator lamps in the SOS button, the indicator lamps in the SOS button, the Roadside Assistance button  and the Information button  stay on longer than ten seconds or do not come on). The message *Tele Aid malfunction*. Drive to workshop appears in the multifunction display.

#### Warning!



If the indicator lamps in the SOS button, in the Roadside Assistance button and/or in the Information button remain illuminated constantly in red and/or the message *Tele Aid malfunction*. Drive to workshop is displayed in the multifunction display after the system self-check, a malfunction in the system has been detected.

If a malfunction is indicated as outlined above, the system may not operate as expected. Have the system checked at the nearest Mercedes-Benz Center as soon as possible.

#### Emergency calls

An emergency call is initiated automatically following an accident in which the emergency tensioning devices (ETDs) or air bags deploy.

An emergency call can also be initiated manually by opening the cover next to the interior rear view mirror labeled SOS, then briefly pressing the button located under the cover. See (▷ page 244) for instructions on initiating an emergency call manually.

Once the emergency call is in progress, the indicator lamp in the SOS button will begin to flash. The message *Connecting call* appears in the multifunction display and the audio system is muted. When the connection is established, the message *Call connected* appears in the multifunction display. All information relevant to the emergency, such as the location of the vehicle (determined by the GPS satellite location system), vehicle model, identification number and color are generated.

## Controls in detail

### Useful features

A voice connection between the Response Center and the occupants of the vehicle will be established automatically soon after the emergency call has been initiated. The Response Center will attempt to determine more precisely the nature of the emergency provided they can speak to an occupant of the vehicle.

The Tele Aid system is available if

- it has been activated and is operational. Activation requires a subscription for monitoring services, connection and cellular air time
- the relevant cellular phone network and GPS signals are available and pass the information on to the Response Center



Location of the vehicle on a map is only possible if the vehicle is able to receive signals from the GPS satellite network and pass the information on to the Response Center.

### Warning!



If the indicator lamp in the SOS button is flashing continuously and there was no voice connection to the Response Center established, then the Tele Aid system could not initiate an emergency call (e.g. the relevant cellular phone network is not available). The message `Call failed.` appears in the multifunction display for approximately ten seconds.

Should this occur, assistance must be summoned by other means.

### Initiating an emergency call manually



① Cover

② SOS button

- ▶ Briefly press on cover ①.  
The cover will open.
- ▶ Press SOS button ② briefly.  
The indicator lamp in SOS button ② will flash until the emergency call is concluded.
- ▶ Wait for a voice connection to the Response Center.
- ▶ Close cover ① after the emergency call is concluded.

### Warning!



If you feel at any way in jeopardy when in the vehicle (e.g. smoke or fire in the vehicle, vehicle in a dangerous road location), please do not wait for voice contact after you have pressed the emergency button. Carefully leave the vehicle and move to a safe location. The Response Center will automatically contact local emergency officials with the vehicle's approximate location if they receive an automatic SOS signal and cannot make voice contact with the vehicle occupants.

### Roadside Assistance button

Located below the center armrest cover is the Roadside Assistance button .

- ▶ Press and hold button (for longer than two seconds).

A call to a Mercedes-Benz Roadside Assistance dispatcher will be initiated. The button will flash while the call is in progress. The message *Connecting call* will appear in the multifunction display and the audio system is muted.

When the connection is established, the message *Call connected* appears in the multifunction display. The Tele Aid system will transmit data generating the vehicle identification number, model, color and location (subject to availability of cellular and GPS signals).

A voice connection between the Roadside Assistance dispatcher and the occupants of the vehicle will be established.

- ▶ Describe the nature of the need for assistance.

## Controls in detail

### Useful features

The Mercedes-Benz Roadside Assistance dispatcher will either dispatch a qualified Mercedes-Benz technician or arrange to tow your vehicle to the nearest authorized Mercedes-Benz Center. For services such as labor and/or towing, charges may apply. Refer to the Roadside Assistance manual for more information.



The following is only available in the USA:

- Sign and Drive services: Services such as jump start, a few gallons of fuel or the replacement of a flat tire with the vehicle spare tire are obtainable.

## Controls in detail

### Useful features



The indicator lamp on the Roadside Assistance button  remains illuminated in red for approximately ten seconds during the system self-check after switching on ignition (together with the SOS button and the Information button ).

See system self-check (▷ page 243) when the indicator lamp does not come on in red or stays on longer than approximately ten seconds.

If the indicator lamp on the Roadside Assistance button  is flashing continuously and there was no voice connection to the Response Center established, then the Tele Aid system could not initiate a Roadside Assistance call (e.g. the relevant cellular phone network is not available). The message `Call failed.` appears in the multifunction display.

Roadside Assistance calls can be terminated using the  button on the multifunction steering wheel or the respective button for ending a telephone call on the audio system or COMAND\* head unit.

#### Information button

Located below the center armrest cover is the Information button .

- ▶ Press and hold button (for longer than two seconds).

A call to the Customer Assistance Center will be initiated. The button will flash while the call is in progress. The message `Connecting call` will appear in the multifunction display and the audio system is muted.

When the connection is established, the message `Call connected` appears in the multifunction display. The Tele Aid system will transmit data generating the vehicle identification number, model, color and location (subject to availability of cellular and GPS signals).

A voice connection between the Customer Assistance Center representative and the occupants of the vehicle will be established. Information regarding the operation of your vehicle, the nearest Mercedes-Benz Center or Mercedes-Benz USA products and services is available to you.



For more details concerning the Tele Aid system, please visit [www.mbusa.com](http://www.mbusa.com) and use your ID and password (sent to you separately) to learn more (USA only).



## Controls in detail

### Useful features



The indicator lamp on the Information button  remains illuminated in red for approximately ten seconds during the system self-check after switching on ignition (together with the SOS button and the Roadside Assistance button ).

See system self-check (▷ page 243) when the indicator lamp does not come on in red or stays on longer than approximately ten seconds.

If the indicator lamp on the Information button  is flashing continuously and there was no voice connection to the Response Center established, then the Tele Aid system could not initiate an Information call (e.g. the relevant cellular phone network is not available). The message *Call failed.* appears in the multifunction display.

Information calls can be terminated using the  button on the multifunction steering wheel or the respective button for ending a telephone call on the audio system or COMAND\* head unit.



If the indicator lamps do not start flashing after pressing one of the buttons or remain illuminated (in red) at any time, the Tele Aid system has detected a malfunction or the service is not currently active, and may not initiate a call. Visit your Mercedes-Benz Center and have the system checked or contact the Response Center at 1-800-756-9018 (in the USA) or 1-888-923-8367 (in Canada) as soon as possible.

### Upgrade scenario

An emergency call is possible even if other services are active.



If the indicator lamp continues to flash or the system does not reset, contact the Response Center at 1-800-756-9018 (in the USA) or 1-888-923-8367 (in Canada), or Mercedes-Benz Customer Assistance at 1-800-FOR-MERCEdes (1-800-367-6372) in the USA or Customer Service at 1-800-387-0100 in Canada.

## Controls in detail

### Useful features



The indicator lamp in the respective button flashes until the call is concluded. Calls can only be terminated by a Response Center or Customer Assistance Center representative except Roadside Assistance and Information calls, which can also be terminated by pressing button  on the multifunction steering wheel or the respective button for ending a telephone call on the audio system or COMAND\* head unit.



When a Tele Aid call has been initiated, the audio system or the COMAND\* system audio is muted and the selected mode (radio or CD) pauses. The optional cellular phone (if installed) switches off. If you must use this phone, the vehicle must be parked. Disconnect the coiled cord and place the call. The COMAND\* navigation system (if engaged) will continue to run. The display in the instrument cluster is available for use, and spoken commands are only available by pressing the RPT button on the COMAND\* unit. A pop-up window will appear in the COMAND\* display to indicate that a Tele Aid call is in progress.

### Remote door unlock

In case you have locked your vehicle unintentionally (e.g. SmartKey inside vehicle), and the reserve SmartKey is not handy:

- ▶ Contact the Mercedes-Benz Response Center at 1-800-756-9018 (in the USA) or 1-888-923-8367 (in Canada).

You will be asked to provide your password which you provided when you completed the subscriber agreement.

- ▶ Then return to your vehicle and pull the tailgate recessed handle for a minimum of 20 seconds until the SOS button is flashing.

The message *Connecting call* appears in the multifunction display.

As an alternative, you may unlock the vehicle via Internet using the ID and password sent to you shortly after the completion of your acquaintance call.

The Response Center will then unlock your vehicle with the remote door unlocking feature.



The remote door unlock feature is available if the relevant cellular phone network is available.

The SOS button will flash and the message *Connecting call* will appear in the multifunction display to indicate receipt of the door unlock command.

Once the vehicle is unlocked, a Response Center specialist will attempt to establish voice contact with the vehicle occupants.

If the tailgate recessed handle was pulled for more than 20 seconds before door unlock authorization was received by the Response Center, you must wait 15 minutes before pulling the tailgate recessed handle again.

### Stolen Vehicle Recovery services

In the event your vehicle was stolen:

- ▶ Report the incident to the police.  
The police will issue a numbered incident report.
- ▶ Pass this number on to the Mercedes-Benz Response Center along with your password issued to you when you subscribed to the service.

The Response Center will then attempt to covertly contact the vehicle's Tele Aid system. Once the vehicle is located, the Response Center will contact the local law enforcement and you. The vehicle's location will only be provided to law enforcement.



When the anti-theft alarm or the tow-away alarm stays on for more than 30 seconds, a call is initiated automatically to the Response Center. See anti-theft alarm system\* (▷ page 85) and tow-away alarm\* (▷ page 87).

## Controls in detail

### Useful features

#### Garage door opener\*

The built-in remote control is capable of operating up to three separately controlled devices, for example garage door openers, gate openers, or other devices compatible with HomeLink® or some other systems.

You can program the signal transmitter buttons.

## Controls in detail

### Useful features

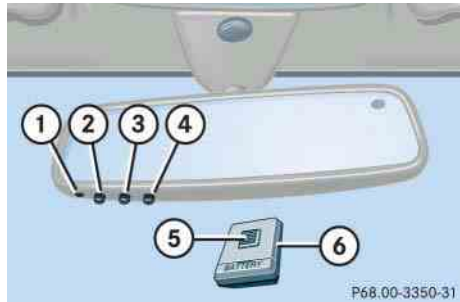

#### Remote control integrated into the interior rear view mirror

- ① Indicator lamp
- ② ③ ④ Signal transmitter button
- ⑤ Hand-held transmitter button
- ⑥ Hand-held remote control transmitter (not part of the vehicle equipment)

#### Warning!



Before programming the integrated remote control to a garage door opener or gate operator, make sure people and objects are out of the way of the device to prevent potential harm or damage. When programming a garage door opener, the door moves up or down. When programming a gate operator, the gate opens or closes.

Do not use the integrated remote control with any garage door opener that lacks safety stop and reverse features as required by U.S. federal safety standards (this includes any garage door opener model manufactured before April 1, 1982). A garage door that cannot detect an object - signaling the door to stop and reverse - does not meet current U.S. federal safety standards.

#### i

Certain types of garage door openers are incompatible with the integrated opener. If you should experience difficulties with programming the transmitter, contact an authorized Mercedes-Benz Center, or call Mercedes-Benz Customer Assistance Center (in the USA only) at 1-800-FOR-MERCEdes, or Customer Service (in Canada) at 1-800-387-0100.



For operation in the USA only:  
This device complies with Part 15 of the FCC Rules. Operation is subject to the following two conditions:

- (1) This device may not cause harmful interference, and
- (2) this device must accept any interference received, including interference that may cause undesired operation.

Any unauthorized modification to this device could void the user's authority to operate the equipment.

### Programming or reprogramming the integrated remote control

Step 1:

- ▶ Switch on ignition (▷ page 33).

Step 2:

- ▶ If you have previously programmed an integrated signal transmitter button and wish to retain its programming, proceed to step 3. Otherwise, press and hold the two outer signal transmitter buttons ② and ④ and release them only when the indicator lamp ① begins to flash after approximately 20 seconds (do not hold the button for longer than 30 seconds). This procedure erases any previous settings for all three channels and initializes the memory. If you later wish to program a second and/or third hand-held transmitter to the remaining two signal transmitter buttons, do not repeat this step and begin directly with step 3.

## Controls in detail

### Useful features

Step 3:

- ▶ Hold the end of the hand-held remote control transmitter ⑥ of the device you wish to train approximately 2 to 5 in (5 to 12 cm) away from the surface of the integrated remote control located on the interior rear view mirror, keeping the indicator lamp ① in view.

Step 4:

- ▶ Using both hands, simultaneously press the hand-held transmitter button ⑤ and the desired integrated signal transmitter button (②, ③ or ④). Do not release the buttons until completing step 5.

The indicator lamp ① on the integrated remote control will flash, first slowly and then rapidly.



## Controls in detail

### Useful features



The indicator lamp ① flashes the first time the signal transmitter button is programmed. If this button has already been programmed, the indicator lamp will only start flashing after 20 seconds.

Step 5:

- ▶ When the indicator lamp ① flashes rapidly, release both buttons.

Step 6:

- ▶ Press and hold the just-trained integrated signal transmitter button and observe the indicator lamp ①.

If the indicator lamp ① stays on constantly, programming is complete and your device should activate when the integrated signal transmitter button is pressed and released.



If the indicator lamp ① flashes rapidly for about two seconds and then turns to a constant light, continue with programming steps 8 through 12 as your garage door opener may be equipped with the “rolling code” feature.

Step 7:

- ▶ To program the remaining two buttons, repeat the steps above starting with step 3.

### ***Rolling code programming***

To train a garage door opener (or other rolling code devices) with the rolling code feature, follow these instructions after completing the “Programming” portion (steps 1 through 6) of this text. (A second person may make the following training procedures quicker and easier.)

Step 8:

- ▶ Locate “training” button on the garage door opener motor head unit.

Exact location and color of the button may vary by garage door opener brand. Depending on manufacturer, the “training” button may also be referred to as “learn” or “smart” button. If there is difficulty locating the transmitting button, refer to the garage door opener operator’s manual.

## Controls in detail

### Useful features

Step 9:

- ▶ Press “training” button on the garage door opener motor head unit.

The “training light” is activated.

You have 30 seconds to initiate the following step.

Step 10:

- ▶ Firmly press, hold for two seconds and release the programmed integrated signal transmitter button (②, ③ or ④).

Step 11:

- ▶ Press, hold for two seconds and release same button a second time to complete the training process.

Some garage door openers (or other rolling code equipped devices) may require you to perform this procedure a third time to complete the training.

Step 12:

- ▶ Confirm the garage door operation by pressing the programmed integrated signal transmitter button (②, ③ or ④).

Step 13:

- ▶ To program the remaining two buttons, repeat the steps above starting with step 3.

#### ***Gate operator/Canadian programming***

Canadian radio-frequency laws require transmitter signals to “time-out” (or quit) after several seconds of transmission which may not be long enough for the integrated signal transmitter to pick up the signal during programming. Similar to this Canadian law, some U.S. gate operators are designed to “time-out” in the same manner.

If you live in Canada or if you are having difficulties programming a gate operator (regardless of where you live) by using the programming procedures, replace step 4 with the following:

Step 4:

- ▶ Continue to press and hold the integrated signal transmitter button (②, ③ or ④) while you press and re-press (“cycle”) your hand-held remote control transmitter ⑥ every two seconds until the frequency signal has been learned. Upon successful training, the indicator lamp ① will flash slowly and then rapidly after several seconds.
- ▶ Proceed with programming step 5 and step 6 to complete.

## Controls in detail

### Useful features

#### Operation of integrated remote control

- ▶ Switch on ignition (▷ page 33).
- ▶ Select and press the appropriate integrated signal transmitter button (②, ③ or ④) to activate the remote controlled device.

The integrated remote control transmitter continues to send the signal as long as the button is pressed – up to 20 seconds.

#### Erasing the integrated remote control memory

- ▶ Switch on ignition (▷ page 33).
- ▶ Simultaneously hold down the signal transmitter buttons ② and ④, for approximately 20 seconds, until the indicator lamp ① flashes rapidly. Do not hold for longer than 30 seconds.

The codes of all three channels are erased.



If you sell your vehicle, erase the codes of all three channels.

#### Reprogramming a single integrated signal transmitter button

To program a device using a signal transmitter button previously trained, follow these steps:

- ▶ Press and hold the desired signal transmitter button (②, ③ or ④). Do not release the button.
- ▶ The indicator lamp will begin to flash after 20 seconds. Without releasing the integrated signal transmitter button, proceed with programming starting with step 3.



## **Operation**

**The first 1000 miles (1500 km)**

**Driving instructions**

**At the gas station**

**Engine compartment**

**Tires and wheels**

**Winter driving**

**Maintenance**

**Vehicle care**

## Operation

### The first 1 000 miles (1 500 km)

In the “Operation” section you will find detailed information on operating, maintaining and caring for your vehicle.

The more cautiously you treat your vehicle during the break-in period, the more satisfied you will be with its performance later on.

- Drive your vehicle during the first 1 000 miles (1 500 km) at varying but moderate vehicle and engine speeds.
- During this period, avoid heavy loads (full throttle driving) and excessive engine speeds (no more than  $\frac{2}{3}$  of maximum rpm in each gear).
- Shift gears in a timely manner.
- Avoid accelerating by kick-down.
- Do not attempt to slow the vehicle down by shifting to a lower gear using the gear selector lever.
- Select positions **3**, **2** or **1** only when driving at moderate speeds (for hill driving).

After 1 000 miles (1 500 km) you may gradually increase vehicle and engine speeds to the permissible maximum.

All of the above instructions, as may apply to your vehicle type, also apply when driving the first 1 000 miles (1 500 km) after the engine or the rear differential has been replaced.



Always obey applicable speed limits.

▼ **Driving instructions**

**Drive sensibly – save fuel**

Fuel consumption, to a great extent, depends on driving habits and operating conditions.

To save fuel you should:

- Keep tires at the recommended inflation pressures.
- Remove unnecessary loads.
- Remove roof rack when not in use.
- Allow engine to warm up under low load use.
- Avoid frequent acceleration and deceleration.
- Have all maintenance work performed at the intervals specified in the Maintenance Booklet and as required by the maintenance service display. Contact an authorized Mercedes-Benz Center.

Fuel consumption is also increased by driving in cold weather, in stop-and-go traffic, on short trips and in hilly country.

**Drinking and driving**

**Warning!**



Drinking and driving and/or taking drugs and driving are very dangerous combinations. Even a small amount of alcohol or drugs can affect your reflexes, perceptions and judgement.

The possibility of a serious or even fatal accident are greatly increased when you drink or take drugs and drive.

Do not drink or take drugs and drive or allow anyone to drive who has been drinking or taking drugs.

**Pedals**

**Warning!**



Keep driver's foot area clear at all times. Objects stored in this area may impair pedal movement.

**Power assistance**

**Warning!**



With the engine not running, there is no power assistance for the brake and steering systems. In this case, it is important to keep in mind that a considerably higher degree of effort is necessary to brake and steer the vehicle.

## Operation

### Driving instructions

#### Brakes

##### Warning!



After driving in heavy rain for some time without applying the brakes or through water deep enough to wet brake components, the first braking action may be somewhat reduced and increased pedal pressure may be necessary to obtain expected braking effect. Maintain a safe distance from vehicles in front.

Resting your foot on the brake pedal will cause excessive and premature wear of the brake pads.

It can also result in the brakes overheating, thereby significantly reducing their effectiveness. It may not be possible to stop the vehicle in sufficient time to avoid an accident.

To help prevent brake disk corrosion after driving on wet road surfaces (particularly salted roads), it is advisable to brake the vehicle with considerable force prior to parking. The heat generated serves to dry the brakes.

If your brake system is normally only subjected to moderate loads, you should occasionally test the effectiveness of the brakes by applying above-normal braking pressure at higher speeds. This will also enhance the grip of the brake pads.



Be very careful not to endanger other road users when you apply the brakes.

Refer to the description of the Brake Assist System (BAS) (> page 80).

If the parking brake is released and the brake warning lamp in the instrument cluster stays on, the brake fluid level in the reservoir is too low.

Brake pad wear or a leak in the system may be the reason for low brake fluid in the reservoir.

Have the brake system inspected immediately. Contact an authorized Mercedes-Benz Center.

All checks and service work on the brake system should be carried out by qualified technicians only. Contact an authorized Mercedes-Benz Center.

Only install brake pads and brake fluid recommended by Mercedes-Benz.

##### Warning!



If other than recommended brake pads are installed, or other than recommended brake fluid is used, the braking properties of the vehicle can be degraded to an extent that safe braking is substantially impaired. This could result in an accident.



When driving down long and steep grades, relieve the load on the brakes by shifting into a lower gear to use the engine's braking power. This helps prevent overheating of the brakes and reduces brake pad wear.

After hard braking, it is advisable to drive on for some time, rather than immediately parking, so that the air stream will cool down the brakes faster.

### Driving off

Apply the brakes to test them briefly after driving off. Perform this procedure only when the road is clear of other traffic.

Warm up the engine smoothly. Do not place full load on the engine until the operating temperature has been reached.

When starting off on a slippery surface, do not allow a drive wheel to spin for an extended period with the ESP switched off. Doing so may cause serious damage to the drivetrain which is not covered by the Mercedes-Benz Limited Warranty.



Simultaneously depressing the accelerator pedal and applying the brake reduces engine performance and causes premature brake and drivetrain wear.

### Parking



Set the parking brake whenever parking or leaving the vehicle. In addition, move gear selector lever to position **P**.

When parking on hills, always turn front wheels towards the road curb.

## Operation

### Driving instructions

#### Warning!



Do not park this vehicle in areas where combustible materials such as grass, hay or leaves can come into contact with the hot exhaust system, as these materials could be ignited and cause a vehicle fire.

To reduce the risk of personal injury as a result of vehicle movement, before turning off the engine and leaving the vehicle always:

- Keep right foot on brake pedal.
- Firmly depress parking brake pedal.
- Move the gear selector lever to position **P**.
- Slowly release brake pedal.
- When parked on an incline, turn front wheels towards the road curb.
- Turn the SmartKey in the starter switch to position **0** and remove the SmartKey from the starter switch.
- Take the SmartKey with you and lock vehicle when leaving.

## Operation

### Driving instructions

#### Tires

##### Warning!



If you feel a sudden significant vibration or ride disturbance, or you suspect that possible damage to your vehicle has occurred, you should turn on the hazard warning flashers, carefully slow down, and drive with caution to an area which is a safe distance from the road.

Inspect the tires and the vehicle underbody for possible damage. If the vehicle or tires appear unsafe, have it towed to the nearest Mercedes-Benz Center or tire dealer for repairs.

Treadwear indicators (TWI) are required by law. These indicators are located in six places on the tread circumference and become visible at a tread depth of approximately  $\frac{1}{16}$  in (1.6 mm), at which point the tire is considered worn and should be replaced.

The treadwear indicator appears as a solid band across the tread.

##### Warning!



Although the applicable federal motor vehicle safety laws consider a tire to be worn when the treadwear indicators (TWI) become visible at approximately  $\frac{1}{16}$  in (1.6 mm), we recommend that you do not allow your tires to wear down to that level. As tread depth approaches  $\frac{1}{8}$  in (3 mm), the adhesion properties on a wet road are sharply reduced.

Depending upon the weather and/or road surface (conditions), the tire traction varies widely.

Specified tire pressures must be maintained. This applies particularly if the tires are subjected to high loads (e.g. high speeds, heavy loads, high ambient temperatures).

##### Warning!



Do not drive with a flat tire. A flat tire affects the ability to steer or brake the vehicle. You may lose control of the vehicle. Continued driving with a flat tire or driving at high speed with a flat tire will cause excessive heat build-up and possibly a fire.

#### Hydroplaning

Depending on the depth of the water layer on the road, hydroplaning may occur, even at low speeds and with new tires. Reduce vehicle speed, avoid track grooves in the road and apply brakes cautiously in the rain.

### Tire traction

The safe speed on a wet, snow covered or icy road is always lower than on a dry road.

You should pay particular attention to the condition of the road whenever the outside temperatures are close to the freezing point.

#### Warning!



If ice has formed on the road, tire traction will be substantially reduced. Under such weather conditions, drive, steer and brake with extreme caution.

Mercedes-Benz recommends M+S rated radial-ply tires with a minimum tread depth of approximately  $\frac{1}{6}$  in (4 mm) on all four wheels for the winter season to ensure normal balanced handling characteristics. On packed snow, they can reduce your stopping distance compared to summer tires. Stopping distance, however, is still

considerably greater than when the road is not covered with snow or ice. Exercise appropriate caution.



Avoid spinning of one drive wheel. This may cause serious damage to the drivetrain which is not covered by the Mercedes-Benz Limited Warranty.

### Tire speed rating

Regardless of the tire speed rating, local speed limits should be obeyed. Use prudent driving speeds appropriate to prevailing conditions.

## Operation

### Driving instructions

#### Warning!



Even when permitted by law, never operate a vehicle at speeds greater than the maximum speed rating of the tires.

Exceeding the maximum speed for which tires are rated can lead to sudden tire failure, causing loss of vehicle control and possibly resulting in an accident and/or personal injury and possible death, for you and for others.

Your vehicle is factory equipped with “H”-rated tires, which have a speed rating of 130 mph (210 km/h).

An electronic speed limiter prevents your vehicle from exceeding the tire speed rating.



For information on tire speed rating for winter tires, see “Winter tires” (> page 282).

## Operation

### Driving instructions

#### Winter driving instructions

The most important rule for slippery or icy roads is to drive sensibly and to avoid abrupt acceleration, braking and steering maneuvers. Do not use the cruise control system under such conditions.

When the vehicle is in danger of skidding, move gear selector lever to position **N**. Try to keep the vehicle under control by corrective steering action.



For information on driving with snow chains, see “Snow chains” (▷ page 283).

#### Warning!



On slippery road surfaces, never downshift in order to obtain braking action. This could result in drive wheel slip and reduced vehicle control. Your vehicle’s ABS will not prevent this type of control loss.

Road salts and chemicals can adversely affect braking efficiency. Increased pedal force may become necessary to produce the normal braking effect.

Depressing the brake pedal periodically when traveling at length on salt-strewn roads can bring road-salt-impaired braking efficiency back to normal.

If the vehicle is parked after being driven on salt-treated roads, the braking efficiency should be tested as soon as possible after driving is resumed.

#### Warning!



Make sure not to endanger any other road users when carrying out these braking maneuvers.

#### Warning!



If the vehicle becomes stuck in snow, make sure snow is kept clear of the exhaust pipe and from around the vehicle with the engine running. Otherwise, deadly carbon monoxide (CO) gases may enter vehicle interior resulting in unconsciousness and death.

To assure sufficient fresh air ventilation, open a window slightly on the side of the vehicle not facing the wind

#### Warning!



The outside temperature indicator is not designed to serve as an ice-warning device and is therefore unsuitable for that purpose. Indicated temperatures just above the freezing point do not guarantee that the road surface is free of ice.

For more information, see “Winter driving” (▷ page 282).



### Standing water



Do not drive through flooded areas or water of unknown depth. Before driving through water, determine its depth. Never accelerate before driving into water. The bow wave could force water into the engine and auxiliary equipment, thus damaging them.

If you must drive through standing water, drive slowly to prevent water from entering the passenger compartment or the engine compartment. Water in these areas could cause damage to electrical components or wiring of the engine or transmission, or could result in water being ingested by the engine through the air intake causing severe internal engine damage. Any such damage is not covered by the Mercedes-Benz Limited Warranty.

### Passenger compartment

#### Warning!



Always fasten items being carried as securely as possible.

In an accident, during hard braking or sudden maneuvers, loose items will be thrown around inside the vehicle, and cause injury to vehicle occupants unless the items are securely fastened in the vehicle.

The cargo compartment is the preferred place to carry objects. Always use partition net when transporting cargo. Partition net cannot secure hard or heavy objects.

### Driving abroad

Abroad, there is an extensive Mercedes-Benz service network at your disposal. If you plan to drive into areas which are not listed in the index of your Mercedes-Benz Center directory, you should request pertinent information from an authorized Mercedes-Benz Center.

## Operation

### Driving instructions

#### Control and operation of radio transmitter

##### COMAND\*, radio and telephone\*

###### Warning!



Please do not forget that your primary responsibility is to drive the vehicle safely. Only operate the COMAND (Cockpit Management and Data System), radio or telephone<sup>1</sup> if road, weather and traffic conditions permit.

Bear in mind that at a speed of just 30 mph (approximately 50 km/h), your vehicle is covering a distance of 44 feet (approximately 14 m) every second.

<sup>1</sup> Observe all legal requirements.

#### Telephones\* and two-way radios

###### Warning!



Never operate radio transmitters equipped with a built-in or attached antenna (i.e. without being connected to an external antenna) from inside the vehicle while the engine is running. Doing so could lead to a malfunction of the vehicle's electronic system, possibly resulting in an accident and/or personal injury.

Radio transmitters, such as a portable telephone or a citizens band unit should only be used inside the vehicle if they are connected to an antenna that is installed on the outside of the vehicle.

Refer to the radio transmitter operation instructions regarding use of an external antenna.

#### Catalytic converter

Your Mercedes-Benz is equipped with monolithic-type catalytic converters, an important element in conjunction with the oxygen sensors to achieve substantial control of the pollutants in the exhaust emissions. Keep your vehicle in proper operating condition by following our recommended maintenance instructions as outlined in your Maintenance Booklet.



To prevent damage to the catalytic converters, only use premium unleaded gasoline in this vehicle.

Any noticeable irregularities in engine operation should be repaired promptly. Otherwise, excessive unburned fuel may reach the catalytic converter, causing it to overheat and start a fire.

#### Warning!



As with any vehicle, do not idle, park or operate this vehicle in areas where combustible materials such as grass, hay or leaves can come into contact with the hot exhaust system, as these materials could be ignited and cause a vehicle fire.

#### Emission control

Certain systems of the engine serve to keep the toxic components of the exhaust gases within permissible limits required by law.

These systems, of course, will function properly only when maintained strictly according to factory specifications. Any adjustments on the engine should, therefore, be carried out only by qualified Mercedes-Benz Center authorized technicians. Engine adjustments should not be altered in any way. Moreover, the specified service jobs must be carried out regularly according to Mercedes-Benz servicing requirements. For details refer to the Maintenance Booklet.

#### Warning!



Inhalation of exhaust gas is hazardous to your health. All exhaust gas contains carbon monoxide, and inhaling it can cause unconsciousness and lead to death.

Do not run the engine in confined areas (such as a garage) which are not properly ventilated. If you think that exhaust gas fumes are entering the vehicle while driving, have the cause determined and corrected immediately. If you must drive under these conditions, drive only with at least one window fully open at all times.

## Operation

### Driving instructions

#### Coolant temperature

During severe operating conditions and stop-and-go city traffic, the coolant temperature may rise close to approximately 248°F (120°C).

The engine should not be operated with the coolant temperature above 248°F (120°C). Doing so may cause serious engine damage which is not covered by the Mercedes-Benz Limited Warranty.

#### Warning!



- Driving when your engine is badly overheated can cause some fluids, which may have leaked into the engine compartment, to catch fire. You could be seriously burned
- Steam from an overheated engine can cause serious burns and can occur just by opening the hood. Stay away from the engine if you see or hear steam coming from it.

Turn off the engine, get out of the vehicle and do not stand near the vehicle until the engine has cooled down.

## ▼ At the gas station

### Refueling

#### Warning!



Gasoline is highly flammable and poisonous. It burns violently and can cause serious injury. Whenever you are around gasoline, avoid inhaling fumes and skin contact, extinguish all smoking materials. Never allow sparks, flame or smoking materials near gasoline!

#### Warning!



Flexible Fuel Vehicles only (identified by a label reading **Premium gasoline or E85 only!** on fuel filler flap):

Ethanol fuel (E85) and its vapors are highly flammable, poisonous and burn easily. Ethanol fuel can cause serious injuries if ignited or if you come into contact with it or inhale fumes of it. Avoid inhalation of Ethanol fumes and skin contact with Ethanol. Extinguish all open flames before refueling. Never smoke or create sparks close to Ethanol.

## Operation

### At the gas station

The fuel filler flap is located on the right-hand side of the vehicle towards the rear. Locking/unlocking the vehicle with the SmartKey automatically locks/unlocks the fuel filler flap.

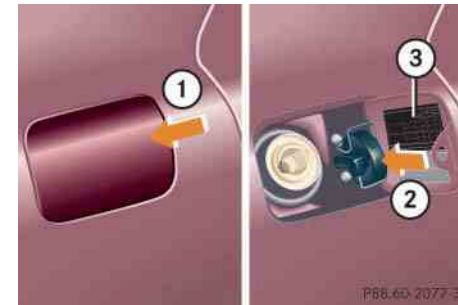

- ① To open the fuel filler flap
- ② To insert the fuel filler cap
- ③ Tire pressure table

- ▶ Turn the engine off by turning the SmartKey to position **0**.
- ▶ Remove the SmartKey from the starter switch.



## Operation

### At the gas station

- ▷▷▶ Open the fuel filler flap by pushing at the point indicated by arrow ①.  
The fuel filler flap springs open.
- ▶ Turn fuel cap counterclockwise and hold on to it until possible pressure is released.
- ▶ Take off cap and set it in direction of arrow ② in the recess on fuel filler flap.  
To prevent fuel vapors from escaping into open air, fully insert filler nozzle unit.
- ▶ Only fill your tank until the filler nozzle unit cuts out – **do not top up or overfill.**

#### Warning!



Overfilling of the fuel tank may create pressure in the system which could cause a gas discharge. This could cause the gas to spray back out when removing the fuel pump nozzle, which could cause personal injury.

- ▶ Replace fuel cap by turning it clockwise.  
You will hear when fuel cap is tightened.
- ▶ Close fuel filler flap.





Only use premium unleaded gasoline with a minimum Posted Octane Rating of 91 (average of 96 RON/86 MON). Information on gasoline quality can normally be found on the fuel pump.

More information on gasoline can be found in the Factory Approved Service Products pamphlet.

Flexible Fuel Vehicles are identified by a label reading **Premium gasoline or E85 only!** on fuel filler flap.

For more information, see “Flexible Fuel Vehicles” (▷ page 377).



Leaving the engine running and the fuel cap open can cause the  malfunction indicator lamp (USA only) or the  malfunction indicator lamp (Canada only) to illuminate.

For more information, see “Practical hints” (▷ page 296) and (▷ page 297).

#### Check regularly and before a long trip

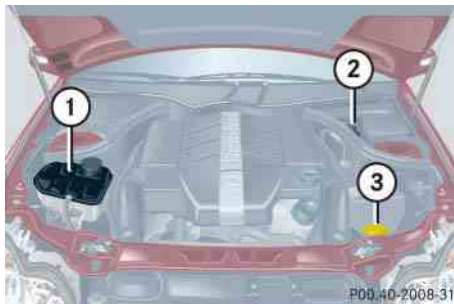

- ① Coolant
- ② Brake fluid (fuse box cover removed)
- ③ Windshield washer and headlamp cleaning system\*



Opening the hood, see (▷ page 270).

#### Coolant

For normal replenishing, use water (potable water quality). For more information, see “Coolant level” (▷ page 275) and see “Fuels, coolants, lubricants, etc.” (▷ page 373).

#### Brake fluid



If you find that the brake fluid in the brake fluid reservoir has fallen to the minimum mark or below, have the brake system checked for brake pad thickness and leaks immediately. Notify an authorized Mercedes-Benz Center immediately. Do not add brake fluid as this will not solve the problem. For more information, see “Practical hints” (▷ page 295).

Removing fuse box cover (▷ page 358).

#### Windshield washer and headlamp cleaning system\*

For more information on filling up the washer reservoir, see “Windshield washer system and headlamp cleaning system\*” (▷ page 277).

#### Engine oil level

For more information on engine oil level, see “Engine oil” (▷ page 272).

#### Vehicle lighting

Check function and cleanliness. For more information on replacing light bulbs, see “Replacing bulbs” (▷ page 332).

Exterior lamp switch (▷ page 108).

#### Tire inflation pressure

More information on tire inflation pressure (▷ page 279).

## Operation

### Engine compartment

#### Hood

##### Warning!



Do not pull the release lever while the vehicle is in motion. Otherwise the hood could be forced open by passing air flow.

#### Opening

The hood lock release lever is located to the left of the steering wheel under the dashboard.



① Hood lock release lever

- ▶ Pull lever ① downwards.

The hood is unlocked and handle ② will extend out of the radiator grille.



To avoid damage to the windshield wipers or hood, never open the hood if the wiper arms are folded forward away from the windshield.

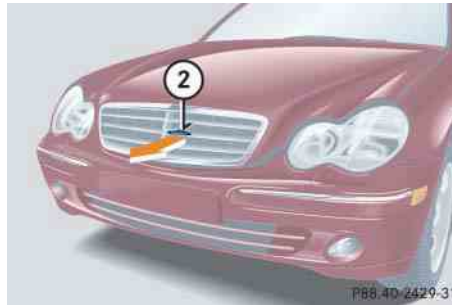

② Handle for opening the hood

- ▶ Pull handle ② to its stop out of the radiator grille.
- ▶ Pull up on the hood (do not pull up on the handle) and then release it.

The hood will be automatically held open at shoulder height by gas-filled struts.

##### Warning!



To help prevent personal injury, stay clear of moving parts when the hood is open and the engine is running. Make sure the hood is properly closed before driving. When closing the hood, use extreme caution not to catch hands or fingers.

The radiator fan may continue to run for approximately 30 seconds or even restart after the engine has been turned off. Stay clear of fan blades.



## Operation

### Engine compartment

#### Warning!



If you see flames or smoke coming from the engine compartment, or if the coolant temperature display indicates that the engine is overheated, do not open the hood. Move away from vehicle and do not open the hood until the engine has cooled. If necessary, call the fire department.

#### Warning!



The engine is equipped with a transistorized ignition system. Because of the high voltage it is dangerous to touch any components (ignition coils, spark plug sockets, diagnostic socket) of the ignition system

- with the engine running
- while starting the engine
- if ignition is “on” and the engine is turned manually

#### Closing

#### Warning!



Be careful that you do not close the hood on anyone.

- ▶ Let the hood drop from a height of approximately 1 ft (30 cm).  
The hood will lock audibly.
- ▶ Check to make sure the hood is fully closed.

If you can raise the hood at a point above the headlamps, then it is not properly closed. Open it again and let it drop with somewhat greater force.

## Operation

### Engine compartment

#### Engine oil

The amount of oil your engine needs will depend on a number of factors, including driving style. Higher oil consumption can occur when

- the vehicle is new
- the vehicle is driven frequently at higher engine speeds

Engine oil consumption checks should only be made after the vehicle break-in period.



Do not use any special lubricant additives, as these may damage the drive assemblies. Using special additives not approved by Mercedes-Benz will restrict your warranty entitlement. More information on this subject is available at any Mercedes-Benz Center.

#### Checking engine oil level with the control system



When checking the oil level

- the vehicle must be parked on level ground
- with the engine at operating temperature, the vehicle must have been stationary for at least five minutes with the engine turned off
- with the engine not at operating temperature yet, the vehicle must have been stationary for at least 30 minutes with the engine turned off

To check the engine oil level via the multifunction display, do the following:

- ▶ Switch on ignition (▷ page 33).

The standard display (▷ page 119) should appear in the multifunction display.

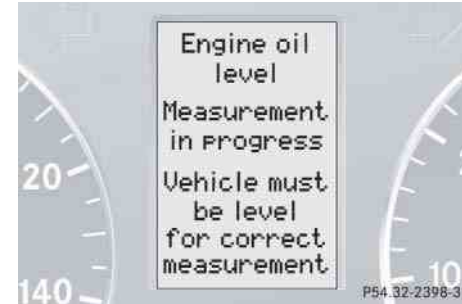

- ▶ Press button  or  on the steering wheel until the following message is seen in the multifunction display:



One of the following messages will subsequently appear in the indicator:

- Engine oil level OK
- Add 1.0 qt engine oil for max. oil level (Canada: 1.0 l)
- Add 1.5 qts engine oil for max. oil level (Canada: 1.5 l)
- Add 2.0 qts engine oil for max. oil level (Canada: 2.0 l)



If you want to interrupt the checking procedure, press the  or  button on the multifunction steering wheel.

- ▶ If necessary, add engine oil.

For adding engine oil see (▷ page 274).

More information on engine oil can be found in the “Technical data” section (▷ page 373) and (▷ page 375).

### **Other display messages**

If the SmartKey is not turned to position **2** in the starter switch, the following message will appear:

Switch ignition on to check engine oil level

- ▶ Switch on the ignition (▷ page 33).

If you see the message:

Observe waiting time

- ▶ If engine is at operating temperature, wait five minutes before repeating check procedure.
- ▶ If engine is not at operating temperature yet, wait 30 minutes before repeating check procedure.

If you see the message:

Engine oil level  
Not when engine on

- ▶ Turn off the engine.
- ▶ If the engine is at operating temperature, wait five minutes before checking oil.
- ▶ If the engine is not at operating temperature yet, you must wait 30 minutes before checking oil.

## Operation

### Engine compartment

If there is excess engine oil with the engine at normal operating temperature, the following message will appear:

Engine oil level  
Reduce oil level

- ▶ Have excess oil siphoned or drained off. Contact an authorized Mercedes-Benz Center.



Excess oil must be siphoned or drained off. It could cause damage to the engine and catalytic converter not covered by the Mercedes-Benz Limited Warranty.

More information on messages in the display concerning engine oil can be found in the “Practical hints” section (▷ page 312) and (▷ page 313).

## Operation

### Engine compartment

#### Adding engine oil



Only use approved engine oils and oil filters required for vehicles with Maintenance System (U.S. vehicles) or FSS (Canada vehicles). For a listing of approved engine oils and oil filters, refer to the Factory Approved Service Products pamphlet in your vehicle literature portfolio, or contact an authorized Mercedes-Benz Center.

Using engine oils and oil filters of specification other than those expressly required for the Maintenance System (U.S. vehicles) or FSS (Canada vehicles), or changing of oil and oil filter at change intervals longer than those called for by the Maintenance System (U.S. vehicles) or FSS (Canada Vehicles) will result in engine damage not covered by the Mercedes-Benz Limited Warranty.



① Filler cap

- ▶ Unscrew filler cap ① from filler neck.
- ▶ Add engine oil as required. Be careful not to overfill with oil.

Be careful not to spill any oil when adding. Avoid environmental damage caused by oil entering the ground or water.



Excess oil must be siphoned or drained off. It could cause damage to the engine and catalytic converter not covered by the Mercedes-Benz Limited Warranty.

- ▶ Screw filler cap ① back on filler neck.

More information on engine oil can be found in the “Technical data” section (▷ page 373) and (▷ page 375).

#### Transmission fluid level

The transmission fluid level does not need to be checked. If you notice transmission fluid loss or gear shifting malfunctions, have an authorized Mercedes-Benz Center check the transmission.

## Coolant level

The engine coolant is a mixture of water and anticorrosion/antifreeze. To check the coolant level, the vehicle must be parked on level ground and the engine must be cool.

The coolant expansion tank is located on the passenger side of the engine compartment.

### Warning!



In order to avoid any possibly serious burns:

- Use extreme caution when opening the hood if there are any signs of steam or coolant leaking from the cooling system, or if the coolant temperature gauge indicates that the coolant is overheated.
- Do not remove pressure cap on coolant reservoir if coolant temperature is above 158°F (70°C). Allow engine to cool down before removing cap. The coolant reservoir contains hot fluid and is under pressure.

- Using a rag, slowly open the cap approximately  $\frac{1}{2}$  turn to relieve excess pressure. If opened immediately, scalding hot fluid and steam will be blown out under pressure.
- Do not spill antifreeze on hot engine parts. Antifreeze contains ethylene glycol which may burn if it comes into contact with hot engine parts.



- ① Coolant expansion tank
- ② Cap

## Operation

### Engine compartment

- ▶ Using a rag, turn cap ② slowly approximately one half turn to the left to release any excess pressure.
- ▶ Continue turning the cap to the left and remove it.

The coolant level is correct if the level

- for cold coolant: reaches the black top part of the reservoir
- for warm coolant: is approx. 0.6 in (1.5 cm) higher

- ▶ Add coolant as required.
- ▶ Replace and tighten cap.

For more information on coolant, see “Coolants” (▷ page 379).

## Operation

### Engine compartment

#### Battery

Your vehicle's battery is located in the engine compartment on the right hand side (▷ page 347).

The battery should always be sufficiently charged in order to achieve its rated service life. Refer to Maintenance Booklet for battery maintenance intervals.

If you use your vehicle mostly for short-distance trips, you will need to have the battery charge checked more frequently.

When replacing the battery, always use batteries approved by Mercedes-Benz.

If you do not intend to operate your vehicle for an extended period of time, consult an authorized Mercedes-Benz Center about steps you need to observe.



Observe all safety instructions and precautions when handling automotive batteries.



Risk of explosion



Keep flames or sparks away from battery. Do not smoke.



Battery acid is caustic. Do not allow it to come into contact with skin, eyes or clothing.

In case it does, immediately flush affected area with clear water and seek medical help if necessary.



Wear eye protection.



Keep children away.



Follow the instructions in this Operator's Manual.

Batteries contain materials that can harm the environment if disposed of improperly. Recycling of batteries is the preferred method of disposal. Many states require sellers of batteries to accept old batteries for recycling.

### Windshield washer system and headlamp cleaning system\*

The windshield washer reservoir is located in the engine compartment.



#### ① Washer fluid reservoir cap

Fluid for the windshield washer system and the headlamp cleaning system\* is supplied from the windshield washer reservoir. It has a capacity of:

- 3.2 US qt (3.0 l) in vehicles without headlamp cleaning system\*
- 6.4 US qt (6.0 l) in vehicles with headlamp cleaning system\*

During all seasons, add MB Windshield Washer Concentrate “S” to water. Premix the windshield washer fluid in a suitable container.

- ▶ Refill the reservoir with MB Windshield Washer Concentrate and water (or commercially available premixed windshield washer solvent/antifreeze, depending on ambient temperatures).

Always use washer solvent/antifreeze where temperatures may fall below the freezing point. Failure to do so could result in damage to the washer system/reservoir.



Only use washer fluid which is suitable for plastic lenses. Improper washer fluid can damage the plastic lenses of the headlamps.

## Operation

### Engine compartment

#### Warning!



Washer solvent/antifreeze is highly flammable. Do not spill washer solvent/antifreeze on hot engine parts, because it may ignite and burn. You could be seriously burned.

For more information, see “Windshield washer and headlamp cleaning system\*” (▷ page 381).

## Operation

### Tires and wheels

See an authorized Mercedes-Benz Center for information on tested and recommended rims and tires for summer and winter operation. They can also offer advice concerning tire service and purchase.

#### Warning!



Replace rims or tires with the same designation, manufacturer and type as shown on the original part. See an authorized Mercedes-Benz Center for further information. If incorrectly sized rims and tires are mounted:

- The wheel brakes or suspension components can be damaged.
- The correct operating clearance of the wheels and the tires are no longer guaranteed.

#### Warning!



Worn, old tires can cause accidents. If the tire tread is badly worn, or if the tires have sustained damage, replace them.

When replacing rims, only use genuine Mercedes-Benz wheel bolts specified for the particular rim type. Failure to do so can result in the bolts loosening and possibly an accident.

Retreaded tires are not tested or recommended by Mercedes-Benz, since previous damage cannot always be recognized on retreads. Mercedes-Benz can therefore not assure the operating safety of the vehicle when such tires are used.

See an authorized Mercedes-Benz Center for information on tested and recommended rims and tires for summer and winter operation.

#### Important guidelines

- Only use sets of tires and rims of the same type and make.
- Tires must be of the correct size for the rim.
- Break in new tires for approximately 60 miles (100 km) at moderate speeds.
- Regularly check the tires and rims for damage. Dented or bent rims can cause tire pressure loss and damage to the tire beads.
- If vehicle is heavily loaded, check tire pressure and correct as required.
- Do not allow your tires to wear down too far. Adhesion properties on wet roads are sharply reduced at tread depths under  $\frac{1}{8}$  in (3 mm).
- When replacing individual tires, you should mount new tires on the front wheels first (on vehicles with same-sized wheels all around).



### Life of tire

The service life of a tire is dependent upon varying factors including but not limited to:

- Driving style
- Tire pressure
- Distance driven

#### Warning!



Tires and spare tire should be replaced after six years, regardless of the remaining tread.



Keep unmounted tires in a cool, dry place with as little exposure to light as possible. Protect tires from contact with oil, grease and gasoline.

### Direction of rotation

Unidirectional tires offer added advantages, such as better hydroplaning performance. To benefit, however, you must make sure the tires rotate in the direction specified.

An arrow on the sidewall indicates the intended direction of tire rotation.

### Checking tire inflation pressure

#### Warning!



If the tire pressure drops repeatedly:

- Check the tires for punctures from foreign objects.
- Check to see whether air is leaking from the valves or from around the rim.

Correct the tire pressure only when tires are cold.

Regularly check your tire pressure at intervals of no more than 14 days.

If the tires are warm you should only correct the tire pressure if it is too low for current operating conditions.

A table on the fuel filler flap lists the specified tire inflation pressures for warm and cold tires as well as for various operating conditions.

## Operation

### Tires and wheels



The pressures listed for light loads are minimum values offering high driving comfort.

Increased inflation pressures listed for heavier loads may also be used for light loads. These higher pressures produce favorable handling characteristics. The ride of the vehicle, however, will be somewhat harder. Never exceed the max. values or inflate tires below the min. values listed in the fuel filler flap.

Tire pressure changes by approx. 1.5 psi (0.1 bar) per 18°F (10°C) of air temperature change. Keep this in mind when checking tire pressure where the temperature is different from the outside temperature.

Tire temperature and tire pressure are also increased while driving, depending on the driving speed and the tire load.

Check the spare tire periodically for condition and inflation. Spare tires will age and become worn over time even if never used, and thus should be inspected and replaced when necessary.

#### Warning!



Follow recommended inflation pressures.

Do not overinflate tires. Overinflated tires can result in sudden deflation (blowout) because they are more likely to become punctured or damaged by road debris, potholes, etc.

Do not underinflate tires. Underinflated tires wear unevenly, adversely affect handling and fuel economy, and are more likely to fail from being overheated.

Do not overload the tires by exceeding the specified vehicle capacity weight (as indicated by the label on the pillar in the driver's door opening). Overloading the tires can overheat them, possibly causing a blowout.

## Rotating tires

### Warning!



Rotate front and rear wheels only if the tires are of the same dimension.

If your vehicle is equipped with mixed-size tires (different tire dimensions front vs. rear), tire rotation is not possible.

Tire rotation can be performed on vehicles with tires of the same dimension all around. If your vehicle is equipped with tires of the same dimension all around, tires can be rotated, observing a front-to-rear rotation pattern that will maintain the intended rotation (spinning) direction of the tire (▷ page 279).

In some cases, such as when your vehicle is equipped with mixed-size tires (different tire dimension front vs. rear), tire rotation is not possible.

If applicable to your vehicle's tire configuration, tires can be rotated according to the tire manufacturer's recommended intervals in the tire manufacturer's warranty pamphlet located in your vehicle literature portfolio. If none is available, tires should be rotated every 3000 to 6000 miles (5000 to 10000 km), or sooner if necessary, according to the degree of tire wear. The same rotation (spinning) direction must be maintained (▷ page 279).

Rotate tires before the characteristic tire wear pattern becomes visible (shoulder wear on front tires and tread center wear on rear tires).

Thoroughly clean the mounting face of wheels and brake disks, i.e. the inner side of the wheels/tires, during each rotation. Check for and ensure proper tire inflation pressure.

## Operation

### Tires and wheels

### Warning!



Have the tightening torque checked after changing a wheel. Wheels could become loose if not tightened with a torque of 80 lb-ft (110 Nm).

Only use genuine Mercedes-Benz wheel bolts specified for your vehicle's rims.

For information on wheel change, see the "Practical hints" section (▷ page 321) and (▷ page 342).

## Operation

### Winter driving

Before the onset of winter, have your vehicle winterized at an authorized Mercedes-Benz Center. This service includes:

- Check of anticorrosion and antifreeze concentration.
- Addition of cleaning concentrate to the water of the windshield and headlamp cleaning system. Add MB Concentrate "S" to a premixed windshield washer solvent/antifreeze which is formulated for below freezing temperatures (▷ page 381).
- Battery test. Battery capacity drops with decreasing ambient temperature. A well charged battery helps to make sure that the engine can be started, even at low ambient temperatures.
- Tire change. Mercedes-Benz recommends M+S rated radial-ply tires with a minimum tread depth of approximately  $\frac{1}{6}$  in (4 mm) on all four wheels for the winter season.

#### Winter tires

Always use winter tires at temperatures below 45°F (7°C) and whenever wintry road conditions prevail. Use of winter tires is the only way to achieve the maximum effectiveness of the ABS, ESP and 4MATIC in winter operation.

For safe handling, make sure that all mounted winter tires are of the same make and have the same tread design.

#### Warning!



Winter tires with a tread depth under  $\frac{1}{6}$  in (4 mm) must be replaced. They are no longer suitable for winter operation.

Always observe the speed rating of the winter tires installed on your vehicle. If the maximum speed for which your tires are rated is below the speed rating of your vehicle, you must place a notice to this effect where it will be seen by the driver. Such notices are available from your tire dealer or from any authorized Mercedes-Benz Center.

#### Warning!



If you use your spare tire when winter tires are fitted on the other wheels, be aware that the difference in tire characteristics may very well impair turning stability and that overall driving stability may be reduced. Adapt your driving style accordingly.

Have the spare tire replaced with a winter tire at the nearest authorized Mercedes-Benz Center.

#### Block heater (Canada only)

The engine is equipped with a block heater.

The electrical cable may be installed at an authorized Mercedes-Benz Center.

#### Snow chains

Snow chains should only be driven on snow-covered roads at speeds not to exceed 30 mph (50 km/h). Remove chains as soon as possible when driving on roads without snow.



When driving with snow chains, you may wish to deactivate the ESP (▷ page 81) before setting the vehicle in motion. This will improve the vehicle's traction.

Please observe the following guidelines when using snow chains:

- Use of snow chains is not permissible with all wheel/tire combinations.
- Snow chains should only be used on the rear wheels. Follow the manufacturer's mounting instructions.
- Only use snow chains that are approved by Mercedes-Benz. Your authorized Mercedes-Benz Center will be glad to advise you on this subject.
- Use of snow chains may be prohibited depending on location. Always check local and state laws before installing snow chains.



Even on vehicles with all-wheel-drive use snow chains on rear tires only.

Use of snow chains is not permissible with tire size:

- T 125/90 R16 98M

## Operation

### Maintenance

In the “Operation” section you will find detailed information on operating, maintaining and caring for your vehicle.

We strongly recommend that you have your vehicle serviced by an authorized Mercedes-Benz Center, in accordance with the Maintenance Booklet at the times called for by the maintenance service indicator display.

Failure to have the vehicle maintained in accordance with the Maintenance Booklet and maintenance service indicator at the designated times /mileage will result in vehicle damage not covered by the Mercedes-Benz Limited Warranty.



The maintenance service indicator will notify you when your next maintenance service is due.

Starting approximately one month before your next maintenance service is due, one of the following messages will appear in the multifunction display while you are driving or when you switch on the ignition (example service A):

Service A in XX Days  
Service A in XX Miles (Km)  
A Service due now



The type of maintenance service due is indicated in the multifunction display:

-  Minor service (A)
-  Major service (B)



Vehicles equipped with FSS (Flexible Service System) only (Canada vehicles): The interval between maintenance services depends on your driving habits. A gentle driving style, moderate engine speeds and the avoidance of short-distance trips will lengthen the interval between services.

### Clearing the maintenance service indicator

The maintenance service indicator is automatically cleared

- after ten seconds when you switch on the ignition or when reaching the maintenance service threshold while driving
- after 30 seconds, once the suggested maintenance service term has passed

You can also clear it yourself.



① Reset button

- ▶ Press reset button ① on the instrument cluster.

### Maintenance service term exceeded

If you have exceeded the suggested maintenance service term, you will see the following message in the multifunction display:

Service A exceeded by XX Days  
Service A exceeded by XX Miles (Km)





In addition, a signal sounds when the message appears.

Any authorized Mercedes-Benz Center will reset the maintenance service indicator following a completed maintenance service.

### Calling up the maintenance service indicator

- ▶ Switch on ignition (▷ page 33).

The standard display of the control system appears (▷ page 119).

- ▶ Press button  or  on the multifunction steering wheel until the maintenance service indicator with the service symbol  or  and the service deadline appears in the multifunction display.



If the battery is disconnected, the days of disconnection will not be included in the count shown by the maintenance service indicator. To arrive at the true maintenance service deadline, you will need to subtract these days from the days shown in the maintenance service indicator.

Do not confuse the maintenance service indicator with the engine oil level indicator .

### Resetting the maintenance service indicator

---

In the event that the maintenance service on your vehicle is not carried out by an authorized Mercedes-Benz Center, you can have the maintenance service indicator reset. The automotive maintenance facility carrying out the maintenance service will find the information for resetting the maintenance service indicator in the maintenance-relevant information for your vehicle. Such information is available from either your authorized Mercedes-Benz Center or directly from Mercedes-Benz.



If the maintenance service indicator was inadvertently reset, have an authorized Mercedes-Benz Center correct it.

Only reset if the proper maintenance service has been performed. Resetting the system without performing the proper service as called for by the maintenance service indicator will result in engine damage and/or other vehicle damage not covered by the Mercedes-Benz Limited Warranty.



## ▼ Vehicle care

### Cleaning and care of the vehicle

#### Warning!



Many cleaning products can be hazardous. Some are poisonous, others are flammable. Always follow the instructions on the particular container. Always open your vehicle's doors or windows when cleaning the inside.

Never use fluids or solvents that are not designed for cleaning your vehicle.

While in operation, even while parked, your vehicle is subjected to varying external influences which, if gone unchecked, can attack the paintwork as well as the underbody and cause lasting damage.

Such damage is caused not only by extreme and varying climatic conditions, but also by:

- Air pollution
- Road salt
- Tar
- Gravel and stone chipping

To avoid paint damage, you should immediately remove:

- Grease and oil
- Fuel
- Coolant
- Brake fluid
- Bird droppings
- Insects
- Tree resins, etc.

Frequent washing reduces and/or eliminates the aggressiveness and potency of the above adverse influences.

More frequent washings are necessary to deal with unfavorable conditions:

- near the ocean
- in industrial areas (smoke, exhaust emissions)
- during winter operation

You should check your vehicle from time to time for stone chipping or other damage. Any damage should be repaired as soon as possible to prevent corrosion.

In doing so, do not neglect the underbody of the vehicle. A prerequisite for a thorough check is a washing of the underbody followed by a thorough inspection. Damaged areas need to be re-undercoated.

Your vehicle has been treated at the factory with a wax-base rustproofing in the body cavities which will last for the lifetime of the vehicle. Post-production treatment is neither necessary nor recommended by Mercedes-Benz because of the possibility of incompatibility between materials used in the production process and others applied later.

## Operation

### Vehicle care

We have selected car-care products and compiled recommendations which are specially matched to our vehicles and which always reflect the latest technology. You can obtain Mercedes-Benz approved car-care products at an authorized Mercedes-Benz Center.

Scratches, corrosive deposits, corrosion or damage due to negligent or incorrect care cannot always be removed or repaired with the car-care products recommended here. In such cases it is best to seek aid at an authorized Mercedes-Benz Center.

The following topics deal with the cleaning and care of your vehicle and give important “how-to” information as well as references to Mercedes-Benz approved car-care products.

Additional information can be found in the booklet “Vehicle Care Guide”.

#### Power washer

When using a power washer for cleaning the vehicle, always observe the manufacturer’s operating instructions.



Never use a round nozzle to power-wash tires. The intense jet of water can result in damage to the tire.

Always replace a damaged tire.

Always keep the jet of water moving across the surface. Do not aim directly at electrical parts, electrical connectors, seals, or other rubber parts.

#### Tar stains

Quickly remove tar stains before they dry and become more difficult to remove. A tar remover is recommended.

#### Paintwork, painted body components

Mercedes-Benz approved Paint Care should be applied when water drops on the paint surface do not “bead up”, normally every three to five months, depending on climate and washing detergent used.

Mercedes-Benz approved Paint Cleaner should be applied if the paint surface shows signs of embedded dirt (i.e. loss of gloss).

Do not apply any of these products or wax if your vehicle is parked in the sun or if the hood is still hot.

Use the appropriate MB-Touch-Up Stick for quick and provisional repairs of minor paint damage (i.e. chips from stones, vehicle doors, etc.).

**Engine cleaning**

Prior to cleaning the engine compartment, make sure to protect electrical components and connectors from the intrusion of water and cleaning agents.

Corrosion protection, such as MB Anticorrosion Wax, should be applied to the engine compartment after every engine cleaning. Before applying, all control linkage bushings and joints should be lubricated. The poly-V-belt and all pulleys should be protected from any wax.

**Vehicle washing**

Do not use hot water or wash your vehicle in direct sunlight. Only use a mild car wash detergent, such as Mercedes-Benz approved Car Shampoo.

Thoroughly spray the vehicle with a diffused jet of water. Direct only a very weak spray towards the ventilation intake. Use plenty of water and rinse the sponge and chamois frequently.

Rinse with clear water and thoroughly dry with a chamois. Do not allow cleaning agents to dry on the finish.

Due to the width of the vehicle, fold in exterior rear view mirrors prior to running the vehicle through an automatic car wash to prevent damage to the mirrors.

In the winter, thoroughly remove all traces of road salt as soon as possible.

When washing the underbody, do not forget to clean the inner sides of the wheels.

**Ornamental moldings**

For regular cleaning and care of very dirty chrome-plated parts, use a chrome cleaner.

**Headlamps, tail lamps, side markers, turn signal lenses**

Use a mild car wash detergent, such as Mercedes-Benz approved Car Shampoo, with plenty of water.

To prevent scratches, never apply strong force and only use a soft, non-scratchy cloth when cleaning the lenses. Do not attempt to wipe dirty lenses with a dry cloth or sponge.

## Operation

### Vehicle care

#### Wiper blades

- ▶ Fold wiper arms forward.

#### Warning!



For safety reasons, switch off wipers and remove SmartKey from starter switch before cleaning the wiper blades, otherwise the wiper motor might suddenly turn on and cause injury.

- ▶ Clean the wiper blade inserts with a clean cloth and detergent solution.



Fold the windshield wiper arms back onto the windshield before turning the SmartKey in the starter switch.

Hold on to the wiper when folding the wiper arm back. If released, the force of the impact from the tensioning spring could crack the windshield.

#### Window cleaning

- ▶ Fold wiper arms forward.

#### Warning!



For safety reasons, switch off wipers and remove SmartKey from starter switch before cleaning the windshield, otherwise the wiper motor might suddenly turn on and cause injury.

- ▶ Use a window cleaning solution on all glass surfaces.

An automotive glass cleaner is recommended.



Fold the windshield wiper arms back onto the windshield before turning the SmartKey in the starter switch.

Hold on to the wiper when folding the wiper arm back. If released, the force of the impact from the tensioning spring could crack the windshield.

#### Light alloy wheels

Mercedes-Benz approved Wheel Care should be used for regular cleaning of the light alloy wheels.

If possible, clean wheels once a week with Mercedes-Benz approved Wheel Care, using a soft bristle brush and a strong spray of water.

Follow the instructions on container.



Only use acid-free cleaning materials. Acid may cause corrosion or damage the clear coat.

#### Instrument cluster

Use a gentle dishwashing detergent or mild detergent for delicate fabrics as a washing solution. Wipe with a cloth moistened in lukewarm solution. Do not use scouring agents.

**Steering wheel and gear selector lever**

Wipe with a damp cloth and dry thoroughly or clean with Mercedes-Benz approved Leather Care.

**Cup holders**

Use a gentle dishwashing detergent or mild detergent for delicate fabrics as a washing solution. Wipe with a cloth moistened in lukewarm solution. Do not use scouring agents.

**Hard plastic trim items**

Pour Mercedes-Benz approved Interior Care onto soft lint-free cloth and apply with light pressure.

**Headliner and rear window shelf**

Clean with soft bristle brush, or use a dry-shampoo cleaner in case of excessive dirt.

**Seat belts**

The webbing must not be treated with chemical cleaning agents. Only use clear, lukewarm water and soap. Do not dry the webbing at temperatures above 176°F (80°C) or in direct sunlight.

**Warning!**

Do not bleach or dye seat belts as this may severely weaken them. In a crash they may not be able to provide adequate protection.

**Upholstery**

Using aftermarket seat covers or wearing clothing that have the tendency to give off coloring (e.g. when wet, etc.) may cause the upholstery to become permanently discolored. By lining the seats with a proper intermediate cover, contact-discoloration will be prevented.

**Leather upholstery**

Wipe leather upholstery with a damp cloth and dry thoroughly or clean with Mercedes-Benz approved Leather Care. Exercise particular care when cleaning perforated leather as its underside should not become wet.

## Operation

### Vehicle care

#### *Cloth upholstery*

Clean with soft bristle brush, or use a dry-shampoo cleaner in case of excessive dirt.

#### *MB Tex upholstery*

Pour Mercedes-Benz approved Interior Care onto soft lint-free cloth and apply with light pressure.

#### **Plastic and rubber parts**

Do not use oil or wax on these parts.

#### **Wood trims**

Dampen cloth using water and use damp cloth to clean wood trims in your vehicle. Do not use solvents like tar remover or wheel cleaner nor polishes or waxes as these may be abrasive.

## **Practical hints**

**What to do if ...**

**Where will I find ...?**

**Unlocking/locking in an emergency**

**Opening/closing in an emergency**

**Replacing SmartKey batteries**

**Replacing bulbs**

**Replacing wiper blades**

**Flat tire**

**Battery**

**Jump starting**

**Towing the vehicle**

**Fuses**

## Practical hints

### What to do if ...

#### Lamps in instrument cluster

General information:

If a bulb in the instrument cluster fails to come on during the bulb self-check when

switching on ignition, have it checked and replaced if necessary.

Problem	Possible cause	Suggested solution
 The yellow ABS malfunction indicator lamp comes on while driving.	<p>The ABS has detected a malfunction and has switched off. The BAS and the ESP are also switched off (see messages in display).</p> <p>The brake system is still functioning normally but without the ABS available.</p> <p>If the ABS control unit is malfunctioning, other systems such as the navigation system* or the automatic transmission may also be malfunctioning.</p>	<ul style="list-style-type: none"> <li>▶ Continue driving with added caution. Wheels may lock during hard braking, reducing steering capability.</li> <li>▶ Read and observe messages in the display (▷ page 301).</li> <li>▶ Have the system checked at an authorized Mercedes-Benz Center as soon as possible.</li> </ul> <p>Failure to follow these instructions increases the risk of an accident.</p>
	<p>The charging voltage has fallen below ten volts. The ABS has switched off.</p> <p>The battery might not be charged sufficiently.</p>	<ul style="list-style-type: none"> <li>▶ Switch off electrical consumers that are currently not needed, e.g. seat heating*.</li> <li>▶ If necessary, have the generator (alternator) and battery checked.</li> </ul> <p>When the voltage is above this value again, the ABS is operational again.</p>



## Practical hints

### What to do if ...

Problem		Possible cause	Suggested solution
<b>BRAKE</b>	(USA only)	The red brake warning lamp comes on while driving and you hear a warning sound.	▶ Release the parking brake (▷ page 47).
	(Canada only)	The red brake warning lamp comes on while driving.	▶ Risk of accident! Carefully stop the vehicle and notify an authorized Mercedes-Benz Center. Do not add brake fluid! This will not solve the problem.

### Warning!





Driving with the brake warning lamp illuminated can result in an accident. Have your brake system checked immediately if the brake warning lamp stays on. Don't add brake fluid before checking the brake system. Overfilling the brake fluid reservoir can result in spilling brake fluid on hot engine parts and the brake fluid catching fire. You can be seriously burned.



If you find that the brake fluid in the brake fluid reservoir has fallen to the minimum mark or below, have the brake system checked for brake pad thickness and leaks.



## Practical hints

### What to do if ...

Problem		Possible cause	Suggested solution
 (USA only)	The yellow engine malfunction indicator lamp comes on while driving.	There is a malfunction in: <ul style="list-style-type: none"><li>• The fuel management system</li><li>• The ignition system</li><li>• The emission control system</li><li>• Systems which affect emissions</li></ul> Such malfunctions may result in excessive emissions values and may switch the engine to its limp-home (emergency operation) mode.	▶ Have the vehicle checked as soon as possible by an authorized Mercedes-Benz Center. An on-board diagnostic connector is used by the service station to link the vehicle to the shop diagnostics system. It allows the accurate identification of system malfunctions through the readout of diagnostic trouble codes. It is located in the front left area of the footwell next to the parking brake pedal.
 (Canada only)			

## Practical hints

### What to do if ...

Problem		Possible cause	Suggested solution
 (USA only)	The yellow engine malfunction indicator lamp comes on while driving.	A loss of pressure has been detected in the fuel system. The fuel cap may not be closed properly or the fuel system may be leaky.	<ul style="list-style-type: none"><li>▶ Check the fuel cap (▷ page 267).</li></ul> If it is not closed properly: <ul style="list-style-type: none"><li>▶ Close the fuel cap.</li></ul> If it is closed properly: <ul style="list-style-type: none"><li>▶ Have the fuel system checked by an authorized Mercedes-Benz Center.</li></ul>
 (Canada only)			

## Practical hints

### What to do if ...

Problem	Possible cause	Suggested solution
 The yellow ESP warning lamp comes on while driving.	The ESP is deactivated. Risk of accident! Adapt your speed and driving to the prevailing road, weather and traffic conditions.	▶ Switch the ESP back on (▷ page 81). If the ESP cannot be switched back on, have the system checked at an authorized Mercedes-Benz Center as soon as possible.
The yellow ESP warning lamp flashes while driving.	The ESP or traction control has come into operation because of detected traction loss in at least one tire.	▶ When driving off, apply as little throttle as possible. ▶ While driving, ease up on the accelerator. ▶ Adapt your speed and driving to the prevailing road and weather conditions. ▶ Do not deactivate the ESP. Exceptions: (▷ page 81). Failure to follow these instructions increases the risk of an accident.

## Practical hints

### What to do if ...

Problem	Possible cause	Suggested solution
The yellow fuel tank reserve warning lamp comes on while driving.	The fuel level has gone below the reserve mark.	▶ Refuel at the next gas station (▷ page 267).
 The red seat belt telltale illuminates for a brief period after starting the engine.	The telltale reminds you to fasten seat belts.	▶ Fasten your seat belt. The telltale goes out.
<b>SRS</b> The red SRS indicator lamp comes on while driving.	There is a malfunction in the restraint systems. The air bags or emergency tensioning device (ETDs) could deploy unexpectedly or fail to activate in an accident.	▶ Drive with added caution to the nearest authorized Mercedes-Benz Center.

### Warning!



In the event a malfunction of the SRS is indicated as outlined above, the SRS may not be operational. For your safety, we strongly recommend that you visit an authorized Mercedes-Benz Center immediately to have the system checked; otherwise the SRS may not be activated when needed in an accident, which could result in serious or fatal injury, or it might deploy unexpectedly and unnecessarily which could result in an accident and/or injury to you or to others.

## Practical hints

### What to do if ...

#### Lamp in center console

Problem	Possible cause	Suggested solution
 The front passenger front air bag off indicator lamp comes on.	A BabySmart <sup>TM1</sup> child seat is installed on the front passenger seat. Therefore the passenger front air bag is switched off.	
	The system is malfunctioning when there is no BabySmart <sup>TM</sup> child seat installed on the front passenger seat.	▶ Have the system checked as soon as possible by an authorized Mercedes-Benz Center.
The front passenger front air bag off indicator lamp does not come on with a BabySmart <sup>TM</sup> child seat properly installed on the front passenger seat.	The system is malfunctioning.	▶ Make sure there is nothing between seat cushion and child seat and check installation of the child seat. ▶ If the front passenger front air bag off indicator lamp remains out, have the system checked as soon as possible by an authorized Mercedes-Benz Center.  Do not use the BabySmart <sup>TM</sup> restraint to transport children on the front passenger seat until the system has been repaired.

<sup>1</sup> BabySmart<sup>TM</sup> is a trademark of Siemens Automotive Corp.

### Vehicle status messages in the multifunction display

Warning and malfunction messages appear in the multifunction display located in the instrument cluster.

Certain warning and malfunction messages are accompanied by an audible signal.

Address these messages accordingly and follow the additional instructions given in this Operator's Manual.

Selecting the vehicle status message memory menu in the control system (▷ page 128) displays both cleared and uncleared messages.

High-priority messages appear in the multifunction display in red color.

Certain messages of high priority cannot be cleared from the multifunction display using the reset button (▷ page 116).

Other messages of high priority and messages of less immediate priority can be cleared from the multifunction display using the reset button (▷ page 116). They are then stored in the vehicle status message memory (▷ page 128). Remember that clearing a message will only make the message disappear. Clearing a message will not correct the condition that caused the message to appear.

#### Warning!



All categories of messages contain important information which should be taken note of and, where a malfunction is indicated, addressed as soon as possible at an authorized Mercedes-Benz Center.

Failure to repair condition noted may cause damage not covered by the Mercedes-Benz Limited Warranty, or result in property damage or personal injury.

## Practical hints

### What to do if ...

#### Warning!



No messages will be displayed if either the instrument cluster or the multifunction display is inoperative.

Contact your nearest authorized Mercedes-Benz Center.



Switching on ignition, causes all lamps as well as the multifunction display to come on. Make sure that they are all in working order before starting your journey.

On the pages that follow, you will find a compilation of the most important warning and malfunction messages that may appear in the multifunction display. High priority messages appear in red color.

## Practical hints

### What to do if ...

#### Text messages

Display message	Possible cause	Possible solution
ABS malfunction. Visit workshop.	<p>The ABS has detected a malfunction and has switched off. The ESP and the BAS are also deactivated.</p> <p>The brake system is still functioning normally but without the ABS available.</p>	<ul style="list-style-type: none"><li>▶ Continue driving with added caution. Wheels may lock during hard braking, reducing steering capability.</li><li>▶ Have the system checked at an authorized Mercedes-Benz Center as soon as possible.</li></ul> <p>Failure to follow these instructions increases the risk of an accident.</p>
Display malfunction. Visit workshop.	The ABS or the ABS display is malfunctioning.	<ul style="list-style-type: none"><li>▶ Continue driving with added caution. Wheels may lock during hard braking, reducing steering capability.</li><li>▶ Have the system checked at an authorized Mercedes-Benz Center as soon as possible.</li></ul> <p>Failure to follow these instructions increases the risk of an accident.</p>



## Practical hints

### What to do if ...

Display message	Possible cause	Possible solution
BAS unavailable See Operator's Manual	The charging voltage has fallen below ten volts. The BAS has switched off.  The battery might not be charged sufficiently.  The brake system is still functioning normally but without the BAS available.	<ul style="list-style-type: none"> <li>▶ Continue driving with added caution.</li> <li>▶ If necessary, have the generator and battery checked.</li> </ul> <p>When the voltage is above this value again, the BAS is operational again.</p>
malfunction. Visit workshop.	The BAS has detected a malfunction and switched off.	<ul style="list-style-type: none"> <li>▶ Continue driving with added caution.</li> <li>▶ Have the system checked at an authorized Mercedes-Benz Center as soon as possible.</li> </ul> <p>Failure to follow these instructions increases the risk of an accident.</p>
Display malfunction. Visit workshop.	The BAS or the BAS display is malfunctioning.	<ul style="list-style-type: none"> <li>▶ Continue driving with added caution.</li> <li>▶ Have the system checked at an authorized Mercedes-Benz Center as soon as possible.</li> </ul> <p>Failure to follow these instructions increases the risk of an accident.</p>

## Practical hints

### What to do if ...

Display message	Possible cause	Possible solution
ESP unavailable See Operator's Manual	The ESP was deactivated because of a malfunction or interrupted power supply.  The ABS might not be operational.  The brake system is still functioning normally but without the ESP available.	<ul style="list-style-type: none"> <li>▶ Continue driving with added caution.</li> <li>▶ Visit an authorized Mercedes-Benz Center as soon as possible.</li> </ul> Failure to follow these instructions increases the risk of an accident.
	If the yellow ESP warning lamp  flashes while driving and this message appears, the electronic traction system has switched off to prevent overheating of the drive wheel brakes.	As soon as the brakes have cooled off, the electronic traction system switches on again.
	The self-diagnosis has not been completed yet.  The brake system is still functioning normally but without the ESP available.	The display will clear after driving a short distance at more than 12 mph (20 km/h).
	The charging voltage has fallen below ten volts. The ESP has switched off.  The battery might not be charged sufficiently.	<ul style="list-style-type: none"> <li>▶ Continue driving with added caution.</li> <li>▶ If necessary, have the generator and battery checked.</li> </ul> When the voltage is above this value again, the ESP is operational again.

## Practical hints

### What to do if ...

Display message	Possible cause	Possible solution
ESP malfunction. Visit workshop.	The ESP is deactivated because of a malfunction.  The brake system is still functioning normally but without the ESP available.	<ul style="list-style-type: none"> <li>▶ Continue driving with added caution.</li> <li>▶ Visit an authorized Mercedes-Benz Center as soon as possible.</li> </ul> <p>Failure to follow these instructions increases the risk of an accident.</p>
Display malfunction. Visit workshop.	The ESP or the ESP display is malfunctioning.	<ul style="list-style-type: none"> <li>▶ Continue driving with added caution.</li> <li>▶ Visit an authorized Mercedes-Benz Center as soon as possible.</li> </ul> <p>Failure to follow these instructions increases the risk of an accident.</p>
SRS Restraint system malfunction Drive to workshop	The system is malfunctioning.	<ul style="list-style-type: none"> <li>▶ Drive with added caution to the nearest authorized Mercedes-Benz Center.</li> </ul>

### Warning!



In the event a malfunction of the SRS is indicated as outlined above, the SRS may not be operational. For your safety, we strongly recommend that you visit an authorized

Mercedes-Benz Center immediately to have the system checked; otherwise the SRS may not be activated when needed in an accident, which could result in serious or fatal injury, or it might deploy unexpectedly and unnecessarily which could also result in injury.

## Practical hints





### What to do if ...

#### Symbol messages

Display symbol	Display message	Possible cause	Possible solution
	Battery Alternator Visit workshop.	The battery is no longer charging. Possible causes: <ul style="list-style-type: none"> <li>• broken poly-V-belt</li> <li>• alternator malfunctioning</li> </ul>	<ul style="list-style-type: none"> <li>▶ Stop immediately and check the poly-V-belt.</li> </ul> If it is broken: <ul style="list-style-type: none"> <li>▶ Do not continue to drive. Otherwise the engine will overheat due to an inoperative water pump which may result in damage to the engine. Notify an authorized Mercedes-Benz Center.</li> </ul> If it is intact: <ul style="list-style-type: none"> <li>▶ Drive immediately to the nearest authorized Mercedes-Benz Center.</li> </ul>
	Low voltage Charge battery	The battery has insufficient voltage.	▶ Start the engine (> page 46).
	Low voltage Switch off consumers	The battery has insufficient voltage.	▶ Turn off unnecessary electrical consumers.

## Practical hints

### What to do if ...

Display symbol	Display message	Possible cause	Possible solution
 (USA only)  (Canada only)	Parking brake Release brake.	You are driving with the parking brake set.	► Release the parking brake (> page 47).
	Brake wear Visit workshop.	The brake pads have reached their wear limit.	► Have the brake pads replaced as soon as possible.
	Brake fluid Visit workshop.	There is insufficient brake fluid in the reservoir.	► Risk of accident! Stop the vehicle and notify an authorized Mercedes-Benz Center. Do not add brake fluid! This will not solve the problem.

### Warning!



Driving with this message displayed can result in an accident. Have your brake system checked immediately. Do not add brake fluid before checking the brake system. Overfilling the brake fluid reservoir can result in spilling brake fluid on hot engine parts and the brake fluid catching fire. You can be seriously burned.



If you find that the brake fluid in the brake fluid reservoir has fallen to the minimum mark or below, have the brake system checked for brake pad thickness and leaks.



Brake pad thickness must be visually checked by a qualified technician at the intervals specified in the Maintenance booklet.

## Practical hints

### What to do if ...

Display symbol	Display message	Possible cause	Possible solution
	Coolant Check level	The coolant level is too low.	<ul style="list-style-type: none"><li>▶ Add coolant (▷ page 275).</li><li>▶ If you have to add coolant frequently, have the cooling system checked by an authorized Mercedes-Benz Center.</li></ul>

#### Warning!



Do not spill antifreeze on hot engine parts. Antifreeze contains ethylene glycol which may burn if it comes into contact with hot engine parts. You can be seriously burned.



Do not ignore the low engine coolant level warning. Extended driving with the message and symbol displayed may cause serious engine damage not covered by the Mercedes-Benz Limited Warranty.

Do not drive without sufficient amount of coolant in the cooling system. The engine will overheat causing major engine damage.

## Practical hints

### What to do if ...

Display symbol	Display message	Possible cause	Possible solution
	Coolant Stop, engine off!	The coolant is too hot.	<ul style="list-style-type: none"><li>▶ Stop the vehicle and turn off the engine.</li><li>▶ Only start the engine again after the message disappears. You could otherwise damage the engine.</li></ul>

#### Warning!



Driving when your engine is badly overheated can cause some fluids which may have leaked into the engine compartment to catch fire. You could be seriously burned.

Steam from an overheated engine can cause serious burns and can occur just by opening the hood. Stay away from the engine if you see or hear steam coming from it.

Turn off the engine, get out of the vehicle and do not stand near the vehicle until the engine has cooled down.

During severe operating conditions and stop-and-go city traffic, the coolant temperature may rise close to 248°F (120°C).



The engine should not be operated with the coolant temperature above 248°F (120°C). Doing so may cause serious engine damage which is not covered by the Mercedes-Benz Limited Warranty.

## Practical hints





### What to do if ...

Display symbol	Display message	Possible cause	Possible solution
	Coolant Stop, engine off!	The poly-V-belt could be broken.	<ul style="list-style-type: none"> <li>▶ Stop immediately and check the poly-V-belt.</li> </ul> If it is broken: <ul style="list-style-type: none"> <li>▶ Do not continue to drive. Otherwise the engine will overheat due to an inoperative water pump which may result in damage to the engine. Notify an authorized Mercedes-Benz Center.</li> </ul> If it is intact: <ul style="list-style-type: none"> <li>▶ Do not continue to drive the vehicle with this message displayed. Doing so could result in serious engine damage that is not covered by the Mercedes-Benz Limited Warranty.</li> <li>▶ Observe the coolant temperature gauge in the instrument cluster (▷ page 24).</li> <li>▶ Drive immediately to the nearest authorized Mercedes-Benz Center.</li> </ul>
	Coolant Visit workshop.	The cooling fan for the coolant is malfunctioning.	<ul style="list-style-type: none"> <li>▶ Observe the coolant temperature gauge in the instrument cluster (▷ page 24).</li> <li>▶ Have the fan replaced as soon as possible.</li> </ul>



## Practical hints

### What to do if ...

Display symbol	Display message	Possible cause	Possible solution
	Cruise contr. Drive to workshop	Cruise control is malfunctioning.	▶ Visit an authorized Mercedes-Benz Center.
	Display malfunction. Visit workshop.	The instrument cluster display is malfunctioning.	▶ Continue driving with added caution. ▶ Visit an authorized Mercedes-Benz Center as soon as possible.
		The displays for several systems have malfunctioned. Some systems themselves may also have malfunctioned.	▶ Have the electronic systems checked by an authorized Mercedes-Benz Center.
	Display malfunction. Visit workshop.	Certain electronic systems are unable to relay information to the control system. The following systems may have failed: <ul style="list-style-type: none"> <li>• Coolant temperature display</li> <li>• Tachometer</li> <li>• Cruise control display</li> </ul>	▶ Have the electronic systems checked by an authorized Mercedes-Benz Center.
	Doors open	You are attempting to drive with one or more doors open.	▶ Close the doors.

## Practical hints

### What to do if ...

Display symbol	Display messages	Possible cause	Suggested solution
	<p>USA only: At next gas station add 1.0 qt engine oil</p> <p>Canada only: At next gas station add 1.0 l engine oil</p>	The engine oil level is too low.	<ul style="list-style-type: none"> <li>▶ Add engine oil (▷ page 274) and check the engine oil level (▷ page 272).</li> </ul>
	<p>Engine oil level Stop, engine off!</p>	There is no oil in the engine. There is a danger of engine damage.	<ul style="list-style-type: none"> <li>▶ Carefully bring the vehicle to a halt as soon as possible.</li> <li>▶ Turn off the engine.</li> <li>▶ Add engine oil (▷ page 274) and check the engine oil level (▷ page 272).</li> </ul>
	<p>Engine oil level Reduce oil level</p>	You have added too much engine oil. There is a risk of damaging the engine or the catalytic converter.	<ul style="list-style-type: none"> <li>▶ Have oil siphoned or drained off. Observe all legal requirements with respect to its disposal.</li> </ul>
	<p>Change engine oil Visit workshop.</p>	It may be that there is water in the engine oil.	<ul style="list-style-type: none"> <li>▶ Have the engine oil checked.</li> </ul>

## Practical hints

### What to do if ...

Display symbol	Display messages	Possible cause	Suggested solution
	Engine oil level Visit workshop.	The engine oil has dropped to a critical level.	<ul style="list-style-type: none"> <li>▶ Check the engine oil level (▷ page 272) and add oil as required (▷ page 274).</li> <li>▶ If you must add engine oil frequently, have the engine checked for possible leaks.</li> </ul>
	Oil sensor malfunction Visit workshop.	The measuring system is malfunctioning.	▶ Have the measuring system checked by an authorized Mercedes-Benz Center.

When the message At next gas station add 1.0 qt engine oil (Canada: 1.0 l) appears while the engine is running and at operating temperature, the engine oil level has dropped to approximately the minimum level.

When this occurs, the warning will first come on intermittently and then stay on if the oil level drops further.



Visually check for oil leaks. If no obvious oil leaks are noted, drive to the nearest service station where the engine oil should be topped to the required level with an approved oil specified in the Factory Approved Service Products pamphlet.



The engine oil level warnings should not be ignored. Extended driving with the symbol displayed could result in serious engine damage that is not covered by the Mercedes-Benz Limited Warranty.

## Practical hints

### What to do if ...

Display symbol	Display message	Possible cause	Possible solution
	Check gas cap. See Operator's Manual	A loss of pressure has been detected in the fuel system. The fuel cap may not be closed properly or the fuel system may be leaky.	<ul style="list-style-type: none"> <li>▶ Check the fuel cap (▷ page 267).</li> </ul> If it is not closed properly: <ul style="list-style-type: none"> <li>▶ Close the fuel cap.</li> </ul> If it is closed properly: <ul style="list-style-type: none"> <li>▶ Have the fuel system checked by an authorized Mercedes-Benz Center.</li> </ul>
	Hood open	You are driving with the hood open.	<ul style="list-style-type: none"> <li>▶ Close the hood (▷ page 270).</li> </ul>
	Remove key.	You have forgotten to remove the SmartKey.	<ul style="list-style-type: none"> <li>▶ Remove the SmartKey from the starter switch.</li> </ul>
	Replace key Drive to workshop	No additional code available for SmartKey.	<ul style="list-style-type: none"> <li>▶ Change the SmartKey.</li> </ul>

## Practical hints

### What to do if ...

Display symbol	Display message	Possible cause	Possible solution
	3rd brake lamp	The high mounted brake lamp is malfunctioning. This message will only appear if all light emitting diodes have stopped working.	► Visit an authorized Mercedes-Benz Center as soon as possible.
	Backup lamp, left	The left backup lamp is malfunctioning.	► Replace the bulb as soon as possible.
	Backup lamp, right	The right backup lamp is malfunctioning.	► Replace the bulb as soon as possible.
	Brake lamp Drive to workshop	Brake lamp illumination is delayed or lamp is permanently on.	► Visit an authorized Mercedes-Benz Center as soon as possible.
	Brake lamp left	The left brake lamp is malfunctioning.	► Replace the bulb as soon as possible.
	Brake lamp right	The right brake lamp is malfunctioning.	► Replace the bulb as soon as possible.
	Display malfunction. Visit workshop.	The display for the lamps or the system is malfunctioning.	► Visit an authorized Mercedes-Benz Center as soon as possible.
	Front foglamp left	The left front fog lamp is malfunctioning.	► Visit an authorized Mercedes-Benz Center as soon as possible.
	Front foglamp right	The right front fog lamp is malfunctioning.	► Visit an authorized Mercedes-Benz Center as soon as possible.
	Front left side marker lamp	The left front side marker lamp is malfunctioning.	► Replace the bulb as soon as possible.
Front right side marker lamp	The right front side marker lamp is malfunctioning.	► Replace the bulb as soon as possible.	

## Practical hints

### What to do if ...

Display symbol	Display message	Possible cause	Possible solution
	High beam left	The left high beam lamp is malfunctioning.	▶ Replace the bulb as soon as possible.
	High beam right	The right high beam lamp is malfunctioning.	▶ Replace the bulb as soon as possible.
	License plate lamp, left	The left license plate lamp is malfunctioning.	▶ Replace the bulb as soon as possible.
	License plate lamp, right	The right license plate lamp is malfunctioning.	▶ Replace the bulb as soon as possible.
	Light sensor Drive to workshop	The lamp sensor is malfunctioning. The headlamps switch on automatically.	<ul style="list-style-type: none"> <li>▶ In the control system, set lamp operation to manual (▷ page 140).</li> <li>▶ Switch on the headlamps using the exterior lamp switch (▷ page 108).</li> <li>▶ Visit an authorized Mercedes-Benz Center as soon as possible.</li> </ul>
	Low beam left	The left low beam lamp is malfunctioning.	<p>Halogen headlamp:</p> <ul style="list-style-type: none"> <li>▶ Replace the bulb as soon as possible.</li> </ul> <p>Bi-Xenon* headlamp:</p> <ul style="list-style-type: none"> <li>▶ Visit an authorized Mercedes-Benz Center as soon as possible.</li> </ul>

## Practical hints

### What to do if ...

Display symbol	Display message	Possible cause	Possible solution
	Low beam right	The right low beam lamp is malfunctioning.	Halogen headlamp: ▶ Replace the bulb as soon as possible. Bi-Xenon* headlamp: ▶ Visit an authorized Mercedes-Benz Center as soon as possible.
	Parking lamp left front	The left front parking lamp is malfunctioning.	▶ Replace the bulb as soon as possible.
	Parking lamp right front	The right front parking lamp is malfunctioning.	▶ Replace the bulb as soon as possible.
	Rear fog lamp Substitute bulb on	The rear fog lamp is malfunctioning. A substitute bulb is being used.	▶ Replace the bulb as soon as possible.
	Switch off lights.	Headlamps have been turned on with the driver's door opened and the SmartKey removed from the starter switch.	▶ Switch off the headlamps.
	Taillamp left Substitute bulb on	The left tail lamp is malfunctioning. A substitute bulb is being used.	▶ Replace the bulb as soon as possible.
	Taillamp right Substitute bulb on	The right tail lamp is malfunctioning. A substitute bulb is being used.	▶ Replace the bulb as soon as possible.

## Practical hints



### What to do if ...

Display symbol	Display message	Possible cause	Possible solution
	Turn signal left front	The left front turn signal lamp is malfunctioning.	► Replace the bulb as soon as possible.
	Turn signal right front	The right front turn signal lamp is malfunctioning.	► Replace the bulb as soon as possible.
	Turn signal left mirror	The left turn signal in the side mirror is malfunctioning. This message will only appear if all light emitting diodes have stopped working.	► Visit an authorized Mercedes-Benz Center as soon as possible.
	Turn signal right mirror	The right turn signal in the side mirror is malfunctioning. This message will only appear if all light emitting diodes have stopped working.	► Visit an authorized Mercedes-Benz Center as soon as possible.
	Turn signal left rear Substitute bulb on	The left rear turn signal lamp is malfunctioning. A substitute bulb is being used.	► Replace the bulb as soon as possible.
	Turn signal right rear Substitute bulb on	The right rear turn signal lamp is malfunctioning. A substitute bulb is being used.	► Replace the bulb as soon as possible.



## Practical hints

### What to do if ...

Display symbol	Display message	Possible cause	Possible solution
	Belt system Drive to workshop	The seat belt system is malfunctioning.	▶ Visit an authorized Mercedes-Benz Center as soon as possible.
	Steering oil Visit workshop.	The steering gear oil level is too low. There is a danger of steering gear damage.	▶ Have the system checked by an authorized Mercedes-Benz Center.

### Warning!











If the level of steering gear oil in reservoir is too low, the steering power assistance could fail. Much greater effort will then be needed to turn the steering wheel.

Do not add steering oil without checking the steering system.

Do not drive the vehicle. Have the system checked at an authorized Mercedes-Benz Center as soon as possible.

## Practical hints

### What to do if ...

Display symbol	Display message	Possible cause	Possible solution
	Close slid./pop-up sunroof	You have opened the driver's door with the SmartKey removed from the starter switch and the tilt/sliding sunroof open.	▶ Close the tilt/sliding sunroof (▷ page 219).
	Close slid./pop-up sunroof	You have opened the driver's door with the SmartKey removed from the starter switch and the tilt/sliding sunroof open.	▶ Close the tilt/sliding sunroof (▷ page 219).
	Tele Aid malfunction. Drive to workshop	One or more main functions of the Tele Aid system* are malfunctioning.	▶ Have the Tele Aid system* checked by an authorized Mercedes-Benz Center.
	Function unavailable.	This display appears if button  or  on the multifunction steering wheel is pressed and the vehicle is not equipped with a telephone*.	
	Trunk open	This message will appear whenever the tailgate is open.	▶ Close the tailgate.
	Washer fluid please refill	The fluid level has dropped to about $\frac{1}{3}$ of total reservoir capacity.	▶ Add washer fluid (▷ page 277).

## Practical hints

### Where will I find ...?

#### ▼ Where will I find ...?

##### First aid kit

The first aid kit is located in the storage compartment behind the left trim panel.

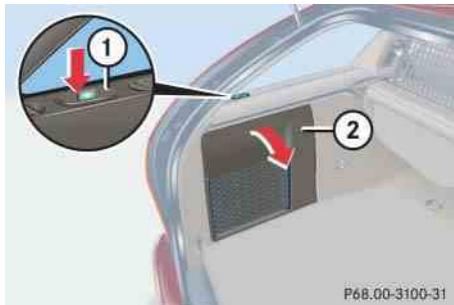

- ▶ Press button ①.
- ▶ Fold down panel ②.



- ▶ Remove first aid kit ③.



Check expiration dates and contents for completeness at least once a year and replace missing/expired items.

##### Vehicle tool kit

The vehicle tool kit is located in the storage compartment behind the left trim panel.

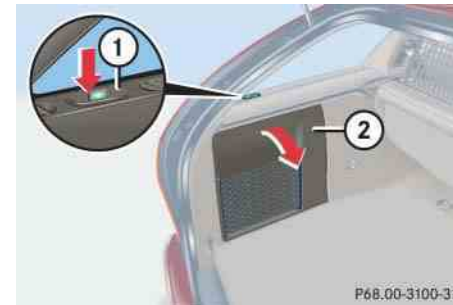

- ▶ Press button ①.
- ▶ Fold down panel ②.

## Practical hints

### Where will I find ...?

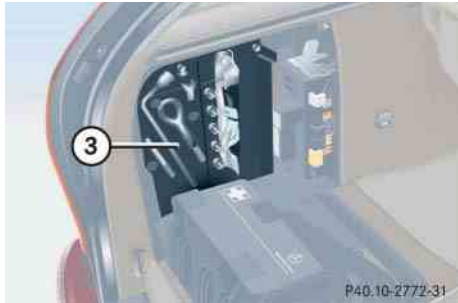

#### ③ Vehicle tool kit

The following is included:

- Towing eye bolt
- Wheel wrench
- Alignment bolt
- Vehicle jack
- Spare wheel bolts
- Fuse extractor
- Spare fuses
- Collapsible wheel chock
- A pair of gloves

#### Vehicle jack

##### Warning!



The jack is designed exclusively for jacking up the vehicle at the jack take-up brackets built into both sides of the vehicle. To help avoid personal injury, use the jack only to lift the vehicle during a wheel change. Never get beneath the vehicle while it is supported by the jack. Keep hands and feet away from the area under the lifted vehicle. Always firmly set parking brake and block wheels before raising vehicle with jack.

Do not disengage parking brake while the vehicle is raised. Be certain that the jack is always vertical (plumb line) when in use, especially on hills. Always try to use the jack on level surface. Make sure the jack arm is fully seated in the jack take-up bracket. Always lower the vehicle onto sufficient capacity jackstands before working under the vehicle.

The vehicle jack is located in the storage compartment behind the left trim panel.

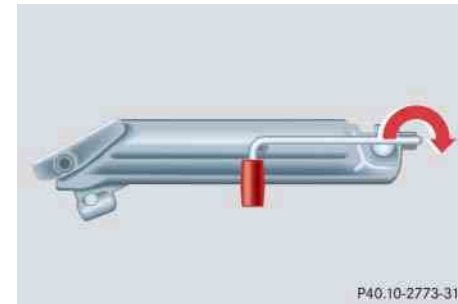

#### Storage position

- ▶ Remove vehicle jack from its compartment.
- ▶ Push crank handle up.

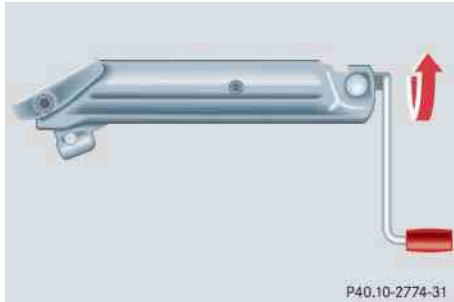

#### Operational position

- ▶ Turn crank handle clockwise until it engages (operational position).

Before storing the vehicle jack in its compartment:

- It should be fully collapsed.
- The handle must be folded in (storage position).

#### Setting up the collapsible wheel chock

The collapsible wheel chock serves to additionally secure the vehicle, e.g. while changing the wheel.

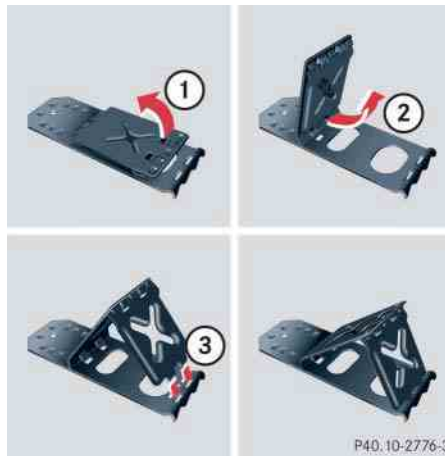

- ① Tilt the plates upward
- ② Fold the lower plate outward
- ③ Insert the plate

## Practical hints

### Where will I find ...?

- ▶ Tilt both plates upward ①.
- ▶ Fold the lower plate outward ②.
- ▶ Guide the tabs of the lower plate all the way into the openings of the base plate ③.

## Practical hints

### Where will I find ...?

#### Minispare wheel

The Minispare wheel is located in the storage compartment underneath the cargo compartment floor.

#### Removing the Minispare wheel

- ▶ Lift up cargo compartment floor cover.

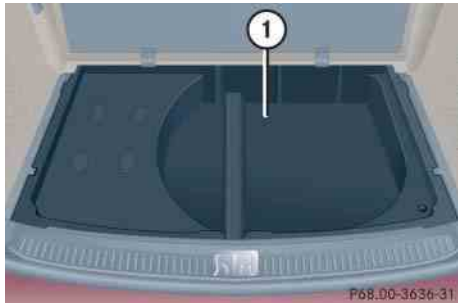

① Storage box

- ▶ Remove storage box ①.

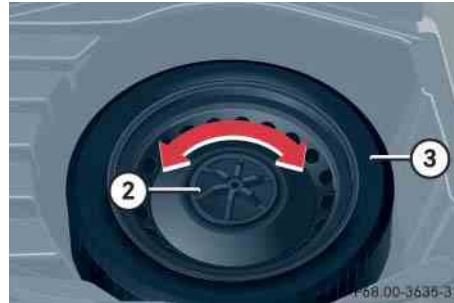

② Retaining screw

③ Minispare wheel

- ▶ Loosen retaining screw ② by turning it counterclockwise.
- ▶ Remove Minispare wheel ③.

#### Storing the Minispare wheel

- ▶ Store Minispare wheel ③ in the storage compartment underneath the cargo compartment floor.
- ▶ Fasten retaining screw ② by turning it clockwise.
- ▶ Reinstall storage box ①.

#### Warning!



The dimensions of the Minispare wheel are different from those of the road wheels. As a result, the vehicle handling characteristics change when driving with a Minispare wheel mounted.

The Minispare wheel should only be used temporarily, and should be replaced with a regular road wheel as quickly as possible.

In the case of a flat tire, you may temporarily use the Minispare wheel when observing the following restrictions:

- Do not exceed a vehicle speed of 50 mph (80 km/h).
- Drive to the nearest tire repair facility to have the flat tire repaired or replaced as appropriate.
- Do not operate vehicle with more than one Minispare wheel mounted.

For more information, see “Rims and Tires” (▷ page 367).

### Minispare wheel bolts

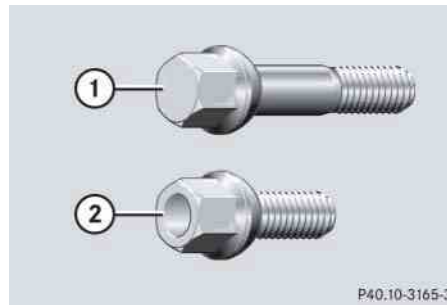

- ① Wheel bolt for light alloy rims
- ② Wheel bolt for Minispare wheel or other steel rims (located in vehicle tool kit)

## Practical hints

### Where will I find ...?



Wheel bolts ② must be used when mounting the Minispare wheel or other steel rims. The use of any wheel bolts other than wheel bolts ② for the Minispare wheel or other steel rims will physically damage the vehicle's brakes.

### Warning!



Make sure to use the original length wheel bolts when remounting the original wheel after it has been repaired.

## Practical hints

### Unlocking/locking in an emergency

#### Unlocking the vehicle

If you are unable to unlock the vehicle with the SmartKey, open the driver's door using the mechanical key and the tailgate using the emergency release.

#### Removing the mechanical key



① Mechanical key locking tab

② Mechanical key

- ▶ Move locking tab ① in direction of arrow.
- ▶ Slide mechanical key ② out of the housing.

#### Unlocking the driver's door

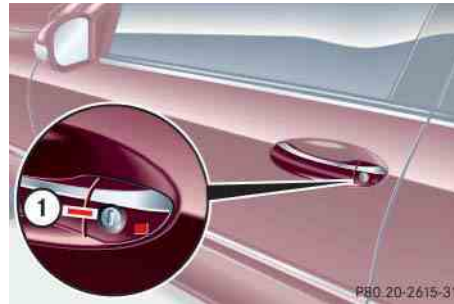

① Unlocking



- ▶ Insert the mechanical key into the driver's door lock until it stops.
- ▶ Turn the mechanical key counterclockwise to position ①.

The driver's door is unlocked.



Unlocking the driver's door with the mechanical key will trigger the anti-theft alarm system\*.

To cancel the alarm, do one of the following:

- Press button  or  on the SmartKey
- Insert the SmartKey in the starter switch

#### Unlocking and opening the tailgate

A minimum height clearance of 6.40 ft (1.95 m) is required to open the tailgate.

The emergency release is located on the inside of the tailgate.

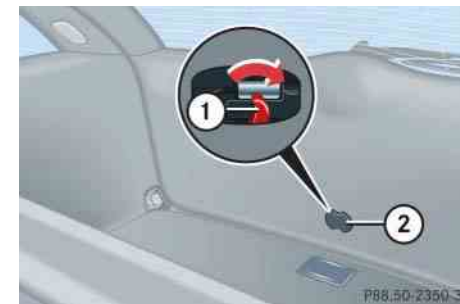

① Release lever

② Cover



- ▶ Remove cover ② from the trim on the tailgate.
- ▶ Push release lever ① all the way to the right.
- ▶ Lift the tailgate.





Always make sure there is sufficient overhead clearance.



If the vehicle has previously been locked from the outside using the SmartKey, opening the tailgate from the inside will trigger the anti-theft alarm system\*.

To cancel the alarm, do one of the following:

- Press button  or  on the SmartKey
- Insert the SmartKey in the starter switch

### Locking the vehicle

If you are unable to lock the vehicle with the SmartKey, do the following:

- ▶ Close the passenger doors and the tailgate.
  - ▶ Press the central locking switch in the center console (> page 96).
  - ▶ Check to see whether the locking knobs on the passenger doors have moved down.
  - ▶ If necessary push them down manually.
- Except for the driver's door, the vehicle should now be locked.

## Practical hints

### Unlocking/locking in an emergency

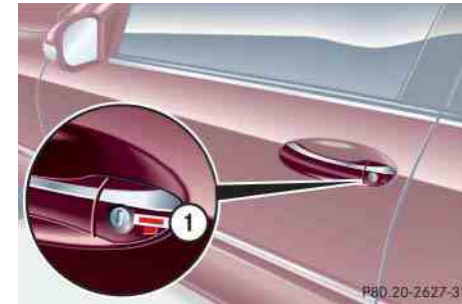

#### ① Locking

- ▶ Insert the mechanical key into the driver's door lock until it stops.
- ▶ Turn the mechanical key clockwise to position ①.

The driver's door is locked.

## Practical hints

### Unlocking/locking in an emergency

#### Fuel filler flap

In case the central locking system does not release the fuel filler flap, you can open it manually.

#### Warning!



If you operate the emergency release button, be careful of the sharp edges so that you do not injure yourself.

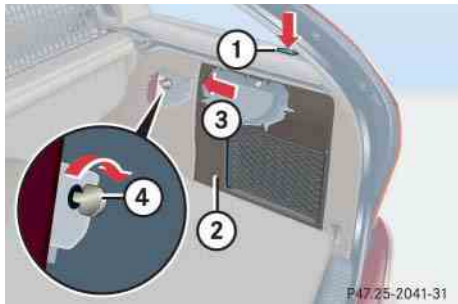

- ▶ Open the tailgate.
- ▶ Press button ①.
- ▶ Fold down trim panel ②.
- ▶ Reach inside through opening ③ in direction of arrow.
- ▶ Turn release knob ④ clockwise (arrow).

The fuel filler flap can now be opened.

#### Manually unlocking the transmission gear selector lever

In the case of power failure the transmission gear selector lever can be manually unlocked, e.g. to tow the vehicle.

- ▶ Slide out the swiveling cup holder (▷ page 236).

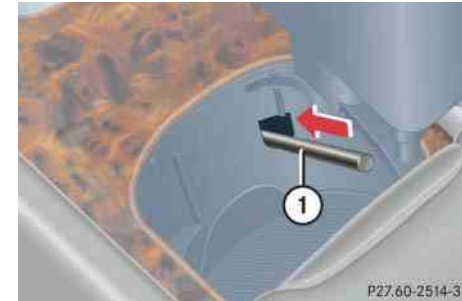

① Tool

- ▶ Insert a tool ① (e.g. flat blade screwdriver) into the opening.
- ▶ Perform the following two steps simultaneously:
  - ▶ Press tool ① forward in the direction of arrow.
  - ▶ Move gear selector lever from position **P**.
- ▶ Remove tool ① from the opening.

#### i

The gear selector lever is locked again when moving it to position **P**.

▼ **Opening/closing in an emergency**

**Power tilt/sliding sunroof\***

You can open or close the tilt/sliding sunroof manually should an electrical malfunction occur.

The tilt/sliding sunroof drive is located behind the lens ① of the interior overhead light.



- ▶ Remove SmartKey from the starter switch.
- ▶ Pry off lens ① using a flat blade screwdriver.



- ▶ Slide both locking tabs ② in direction of the arrows.
- ▶ Lower the rear of the cover and remove.
- ▶ Remove the cover.
- ▶ Take the crank ③ out of the Operator's Manual pouch.



Do not disconnect electrical connectors.

- ▶ Insert crank ③ through hole on the left side.

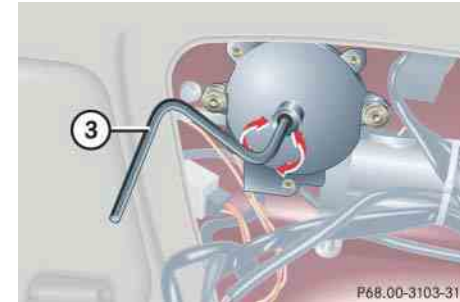

- ▶ Turn crank ③ clockwise to:
  - slide sunroof closed
  - raise sunroof at the rear
- ▶ Turn crank ③ counterclockwise to:
  - slide sunroof open
  - lower sunroof at the rear



Turn crank ③ slowly and smoothly.

The tilt/sliding sunroof must be synchronized after being operated manually (▷ page 222).

## Practical hints

### Replacing SmartKey batteries

If the batteries in the SmartKey are discharged, the vehicle can no longer be locked or unlocked. It is recommended to have the batteries replaced at an authorized Mercedes-Benz Center.

#### Warning!



Keep the batteries out of reach of children.

If a battery is swallowed, seek medical help immediately.

Batteries contain materials that can harm the environment if disposed of improperly. Recycling of batteries is the preferred method of disposal. Many states require sellers of batteries to accept old batteries for recycling.



When inserting the batteries, make sure they are clean and free of lint.



When replacing batteries, always replace both batteries.

The required replacement batteries are available at any Mercedes-Benz Center.

## SmartKey

Replacement batteries: Lithium, type CR 2025 or equivalent.

- ▶ Remove the mechanical key (▷ page 326).

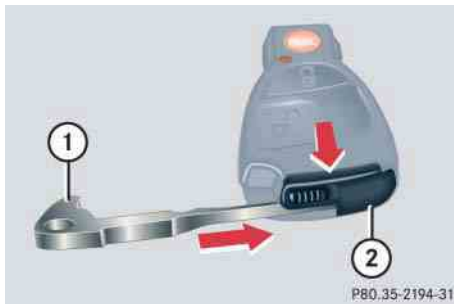

- ① Mechanical key
- ② Battery compartment

- ▶ Insert mechanical key ① in side opening and push grey slide. Battery compartment ② is unlatched.
- ▶ Pull battery compartment ② out of the housing in direction of arrow.
- ▶ Remove the batteries.

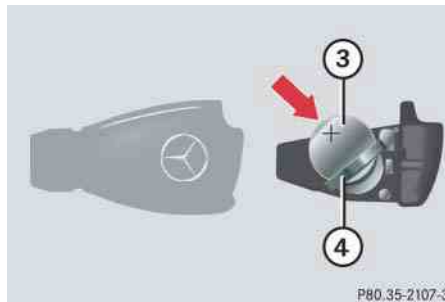

- ③ Battery
- ④ Contact spring

## Practical hints

### Replacing SmartKey batteries

- ▶ Using a lint-free cloth, insert new batteries ③ under contact spring ④ with the plus (+) side facing up.
- ▶ Return battery compartment ② into housing until it locks into place.
- ▶ Slide mechanical key ① back into the SmartKey.
- ▶ Check the operation of the SmartKey.

## Practical hints

### Replacing bulbs

Safe vehicle operation depends on proper exterior lighting and signaling. It is therefore essential that all bulbs and lamp assemblies are in good working order at all times.

Correct headlamp adjustment is extremely important. Have headlamps checked and readjusted at regular intervals and when a bulb has been replaced. See an authorized Mercedes-Benz Center for headlamp adjustment.



If the headlamps or front fog lamps are fogged up on the inside as a result of high humidity, driving the vehicle a distance with the lights on should clear up the fogging.



Substitute bulbs will be brought into use when lamps malfunction. Observe the messages in the multifunction display (> page 301)

### Bulbs



## Practical hints

### Replacing bulbs

#### Front lamps

	Lamp	Type
①	Additional turn signal lamp	LED
②	Halogen headlamp: Turn signal lamp	1156 A
	Bi-Xenon* headlamp: Turn signal lamp	2357 A
③	Halogen headlamp: Low beam	H7 (55 W)
	Bi-Xenon* headlamp: Low and high beam <sup>1</sup>	D2S-35 W

<sup>1</sup> Vehicles with Bi-Xenon\* headlamps: Low beam and high beam use the same D2S-35W lamp. Do not replace the Xenon bulbs yourself. See an authorized Mercedes-Benz Center.

	Lamp	Type
④	Halogen headlamp: High beam/high beam flasher	H7 (55 W)
	Bi-Xenon* headlamp: High beam flasher	H7 (55 W)
	Parking and standing lamp	W 5 W
⑤	Front fog lamp	HB4/9006 (55 W)
⑥	Side marker lamp	W 5 W

#### Rear lamps

	Lamp	Type
⑦	High mounted brake lamp	LED
⑧	Brake lamp	P 21 W
⑨	Turn signal lamp	PY 21 W
⑩	Backup lamp	P 21 W
⑪	License plate lamps	C 5 W
⑫	Rear fog lamp (driver's side only), tail, parking, standing and side marker lamp	P 21/4 W

## Practical hints

### Replacing bulbs

#### Warning!



Bulbs and bulb sockets can be very hot. Allow the lamp to cool down before changing a bulb.

Keep bulbs out of reach of children.

Halogen lamps contain pressurized gas. A bulb can explode if you

- touch or move it when hot
- drop the bulb
- scratch the bulb

Wear eye and hand protection.

Because of high voltage in Xenon lamps, it is dangerous to replace the bulb or repair the lamp and its components. We recommend that you have such work done by a qualified technician.

#### Notes on bulb replacement

- Only use 12 volt bulbs of the same type and with the specified watt rating.
- Switch lights off before changing a bulb to prevent short circuits.
- Always use a clean lint-free cloth when handling bulbs.
- Your hands should be dry and free of oil and grease.
- If the newly installed bulb does not come on, visit an authorized Mercedes-Benz Center.

Have the LEDs and bulbs for the following lamps replaced by an authorized Mercedes-Benz Center:

- Additional turn signals in the exterior rear view mirrors
- High mounted brake lamp
- Xenon\* lamps
- Front fog lamps



Have the headlamp adjustment checked regularly.



## Replacing bulbs for front lamps

Before you start to replace a bulb for a front lamp, do the following first:

- ▶ Turn the exterior lamp switch to position **0** (▷ page 108).
- ▶ Open the hood (▷ page 270) (except for side marker lamps).

### Halogen headlamp

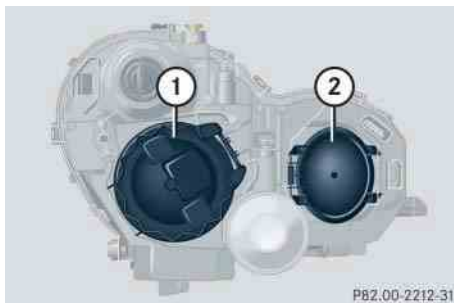

- ① Housing cover for low beam headlamp
- ② Housing cover for high beam headlamp, parking and standing lamp

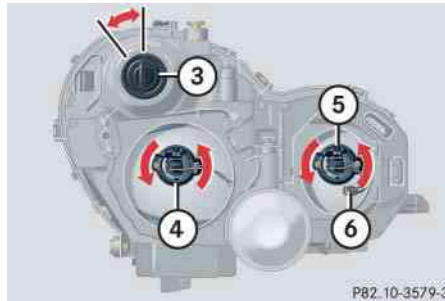

- ③ Bulb socket for turn signal lamp bulb
- ④ Bulb socket for low beam bulb
- ⑤ Bulb socket for high beam bulb
- ⑥ Bulb socket for parking and standing lamp bulb

## Practical hints

### Replacing bulbs

#### Low beam bulb

- ▶ Press the clamp on housing cover ① and remove it.
- ▶ Pull the electrical connector off.
- ▶ Turn bulb socket ④ counterclockwise and take out the bulb.
- ▶ Insert the new bulb so that its socket locates in the recess of the lamp housing.
- ▶ Turn bulb socket ④ clockwise until it engages.
- ▶ Plug the electrical connector onto the bulb.
- ▶ Align housing cover ① and press until it engages.

## Practical hints

### Replacing bulbs

#### *High beam bulb*

- ▶ Press the clamp on housing cover ② and remove it.
- ▶ Pull the electrical connector off.
- ▶ Turn bulb socket ⑤ counterclockwise and take out the bulb.
- ▶ Insert the new bulb so that its socket locates in the recess of the lamp housing.
- ▶ Turn bulb socket ⑤ clockwise until it engages.
- ▶ Plug the electrical connector onto the bulb.
- ▶ Align housing cover ② and press until it engages.

#### *Front turn signal lamp bulb*

- ▶ Turn bulb socket ③ with the bulb counterclockwise and remove it.
- ▶ Press gently onto the bulb and turn it counterclockwise out of bulb socket ③.
- ▶ Press new bulb gently into bulb socket ③ and turn clockwise until it engages.
- ▶ Place bulb socket ③ back into the lamp and turn it clockwise.

#### *Parking and standing lamp bulb*

- ▶ Press the clamp on housing cover ② and remove it.
- ▶ Pull out bulb socket ⑥ with the bulb.
- ▶ Pull the bulb out of bulb socket ⑥.
- ▶ Press the new bulb into bulb socket ⑥.
- ▶ Press bulb socket ⑥ back into the lamp.
- ▶ Align housing cover ② and press until it engages.

## Bi-Xenon\* headlamp

### Warning!



Do not remove the cover ① for the Bi-Xenon headlamp. Because of high voltage in Bi-Xenon lamps, it is dangerous to replace the bulb or repair the lamp and its components. We recommend that you have such work done by a qualified technician.

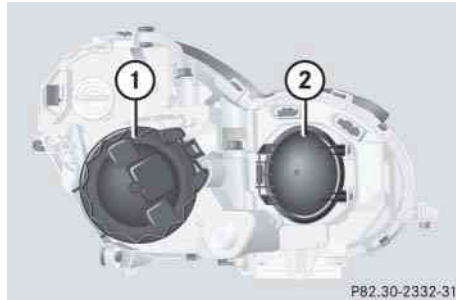

- ① Housing cover for Bi-Xenon headlamp
- ② Housing cover for high beam flasher, parking and standing lamp

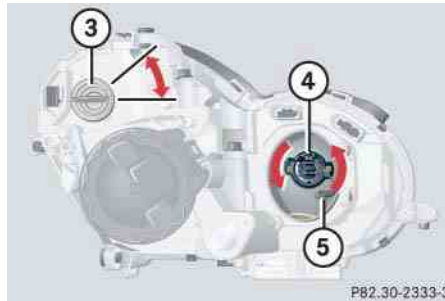

- ③ Bulb socket for turn signal lamp bulb
- ④ Bulb socket for high beam flasher bulb
- ⑤ Bulb socket for parking and standing lamp bulb

## Practical hints

### Replacing bulbs

#### High beam flasher bulb

- ▶ Press the clamp on housing cover ② and remove it.
- ▶ Pull the electrical connector off.
- ▶ Turn bulb socket ④ counterclockwise and take out the bulb.
- ▶ Insert the new bulb so that its socket locates in the recess of the lamp housing.
- ▶ Turn bulb socket ④ clockwise until it engages.
- ▶ Plug the electrical connector onto the bulb.
- ▶ Align housing cover ② and press until it engages.

## Practical hints

### Replacing bulbs

#### *Front turn signal lamp bulb*

- ▶ Turn bulb socket ③ with the bulb counterclockwise and remove it.
- ▶ Press gently onto the bulb and turn it counterclockwise out of bulb socket ③.
- ▶ Press new bulb gently into bulb socket ③ and turn clockwise until it engages.
- ▶ Place bulb socket ③ back into the lamp and turn it clockwise.

#### *Parking and standing lamp bulb*

- ▶ Press the clamp on housing cover ② and remove it.
- ▶ Pull out bulb socket ⑤ with the bulb.
- ▶ Pull the bulb out of bulb socket ⑤.
- ▶ Press the new bulb into bulb socket ⑤.
- ▶ Press bulb socket ⑤ back into the lamp.
- ▶ Align housing cover ② and press until it engages.

#### *Side marker lamp*

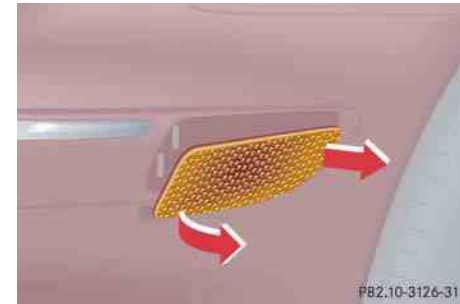

- ▶ Carefully slide the lamp towards the rear in direction of arrows.
- ▶ Remove the front end first.
- ▶ Turn the bulb socket with the bulb counterclockwise and remove it.
- ▶ Pull the bulb out of the bulb socket.
- ▶ Insert the new bulb into the bulb socket.
- ▶ Place the bulb socket back into the lamp and turn it clockwise.
- ▶ To reinstall the lamp, set the rear end in the bumper and let the front end engage.

## Replacing bulbs for rear lamps

Before you start to replace a bulb for a rear lamp, do the following first:

- ▶ Turn the exterior lamp switch to position **0** (▷ page 108).
- ▶ Open the tailgate (▷ page 94).

### Tail lamp unit

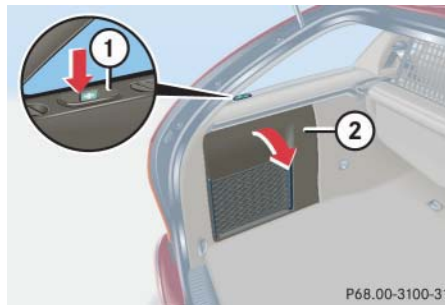

- ① Latch
- ② Trim panel

- ▶ Press latch ① on the corresponding side.
- ▶ Fold down trim panel ②.

## Practical hints

### Replacing bulbs

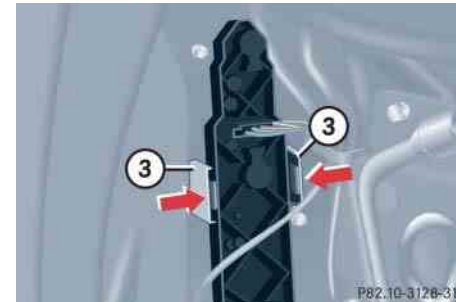

- ③ Tab

- ▶ Press tabs ③ together in direction of arrows and remove the bulb carrier.

## Practical hints

### Replacing bulbs

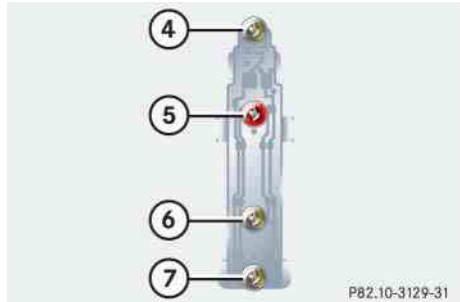

#### Bulb carrier

- ④ Brake lamp bulb
- ⑤ Turn signal lamp bulb
- ⑥ Backup lamp bulb
- ⑦ Rear fog lamp (driver's side only), tail, parking, standing and side marker lamp bulb

- ▶ Press gently onto the respective bulb and turn counterclockwise out of its bulb socket.
- ▶ Press the new bulb gently into its bulb socket and turn clockwise until it engages.
- ▶ Reinstall the bulb carrier.  
Let tabs ③ engage.
- ▶ Reinstall trim panel ②.  
Let latch ① engage.

#### License plate lamp

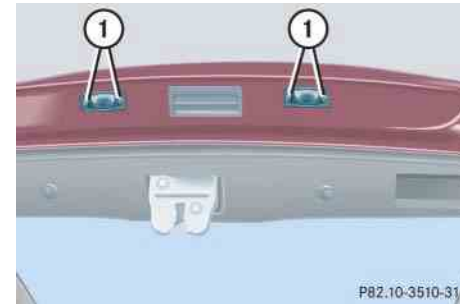

#### ① Screw

- ▶ Loosen both screws ①.
- ▶ Remove the license plate lamp.
- ▶ Replace the bulb.
- ▶ Reinstall the license plate lamp.
- ▶ Retighten screws ①.

## ▼ Replacing wiper blades

### Removing wiper blades

#### Warning!



For safety reasons, remove SmartKey from starter switch before replacing a wiper blade. Otherwise the motor could suddenly turn on and cause injury.

- ▶ Remove SmartKey from starter switch.
- ▶ Fold wiper arm forward.

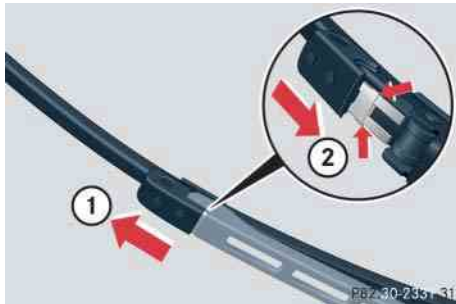

- ① Unlock
- ② Lock

- ▶ Pull the tab in direction of arrow ① and remove wiper blade.

### Installing wiper blades

- ▶ Slide the wiper blade into the cutout on the wiper arm (see arrows).
- ▶ Slide the tab back in direction of arrow ② until it audibly engages.
- ▶ Fold the wiper arm backward to rest on the windshield. Make sure you hold on to the wiper when folding the wiper arm back.

## Practical hints

### Replacing wiper blades



Never open the hood when the wiper arms are folded forward.

Hold on to the wiper when folding the wiper arm back. If released, the force of the impact from the tensioning spring could crack the windshield.

Do not allow the wiper arms to contact the windshield glass without a wiper blade inserted.

Make certain that the wiper blades are properly installed. Improperly installed wiper blades may cause windshield damage.

For your convenience, we recommend that you have this work carried out by an authorized Mercedes-Benz Center.

## Practical hints

### Flat tire

#### Warning!



The dimensions of the Minispare wheel are different from those of the road wheels. As a result, the vehicle handling characteristics change when driving with a Minispare wheel mounted. Adapt your driving style accordingly.

The Minispare wheel is for temporary use only. When driving with spare wheel mounted, ensure proper tire pressure and do not exceed a vehicle speed of 50 mph (80 km/h).

Drive to the nearest Mercedes-Benz Center as soon as possible to have the Minispare wheel replaced with a regular road wheel.

Never operate the vehicle with more than one Minispare wheel mounted.

#### Preparing the vehicle

- ▶ Park the vehicle as far as possible from moving traffic on a hard surface.
- ▶ Turn on the hazard warning flasher (▷ page 113).
- ▶ Turn the steering wheel so that the front wheels are in the straight ahead position.
- ▶ Set the parking brake (▷ page 55).
- ▶ Move the gear selector lever to **P**.
- ▶ Turn off the engine (▷ page 57).
- ▶ Remove the SmartKey from the starter switch.
- ▶ Have any passenger exit the vehicle at a safe distance from the roadway.



Open door only when conditions are safe to do so.

#### Mounting the Minispare wheel

##### Preparing the vehicle

Prepare the vehicle as described on (▷ page 342).

- ▶ Take the wheel wrench, the wheel bolts, and the jack out of the storage compartment behind the left trim panel (▷ page 321).
- ▶ Take the Minispare wheel out of the storage compartment underneath the cargo compartment floor (▷ page 324).



### Lifting the vehicle

- ▶ Prevent the vehicle from rolling away by blocking wheels with wheel chocks or other sizable objects.

One wheel chock is included with the vehicle tool kit (▷ page 322).

When changing wheel on a level surface:

- ▶ Place the wheel chock in front of and another sizable object behind the wheel that is diagonally opposite to the wheel being changed.

When changing wheel on a hill:

- ▶ Place the wheel chock and another sizable object on the downhill side blocking both wheels of the other axle.

### Warning!



The jack is designed exclusively for jacking up the vehicle at the jack take-up brackets built into both sides of the vehicle. To help avoid personal injury, use the jack only to lift the vehicle during a wheel change. Never get beneath the vehicle while it is supported by the jack. Keep hands and feet away from the area under the lifted vehicle. Always firmly set parking brake and block wheels before raising vehicle with jack.

Do not disengage parking brake while the vehicle is raised. Be certain that the jack is always vertical (plumb line) when in use, especially on hills. Always try to use the jack on level surface. Make sure the jack arm is fully seated in the jack take-up bracket. Always lower the vehicle onto sufficient capacity jackstands before working under the vehicle.

## Practical hints

### Flat tire



- ▶ On wheel to be changed, loosen but do not yet remove the wheel bolts (approximately one full turn with wrench).

## Practical hints

### Flat tire

The jack take-up brackets are located directly behind the front wheel housings and in front of the rear wheel housings.

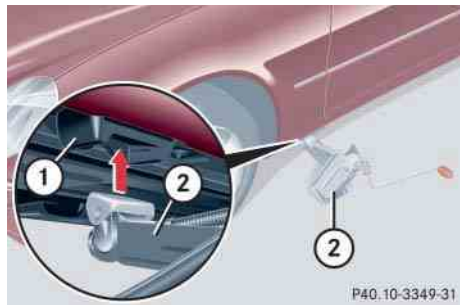

① Take-up bracket

② Jack

- ▶ Place jack ② on firm ground.
- ▶ Position jack ② under take-up bracket ① so that it is always vertical (plumb-line) as seen from the side, even if the vehicle is parked on an incline.

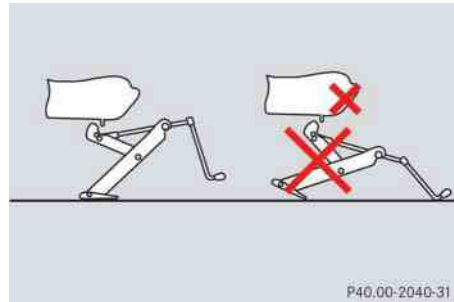

- ▶ Jack up the vehicle until the wheel is a maximum of 1.2 in (3 cm) from the ground. Never start engine while vehicle is raised.

### Warning!



The jack is intended only for lifting the vehicle briefly for wheel changes. It is not suited for performing maintenance work under the vehicle.

- Never start the engine when the vehicle is raised.
- Never lie down under the raised vehicle.

### Removing the wheel



① Alignment bolt

- ▶ Unscrew upper-most wheel bolt and remove.
- ▶ Replace this wheel bolt with alignment bolt ① supplied in the tool kit.
- ▶ Remove the remaining bolts.



Do not place wheel bolts in sand or dirt. This could result in damage to the bolts and wheel hub threads.

- ▶ Remove the wheel.

### Mounting the Minispare wheel

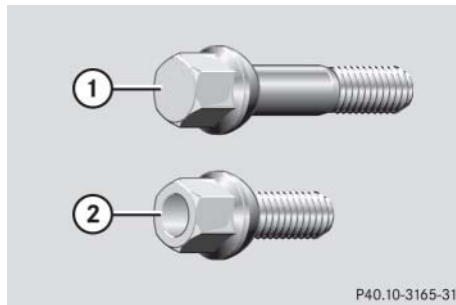

- ① Wheel bolt for light alloy rims
- ② Wheel bolt for Minispare wheel or other steel rims (located in vehicle tool kit)



Wheel bolts ② must be used when mounting the Minispare wheel or other steel rims. The use of any wheel bolts other than wheel bolts ② for the Minispare wheel or other steel rims will physically damage the vehicle's brakes.

- ▶ Clean contact surfaces of wheel and wheel hub.



To avoid paint damage, place wheel flat against hub and hold it there while installing first wheel bolt.

#### Warning!



Always replace wheel bolts that are damaged or rusted.

Never apply oil or grease to wheel bolts.

Damaged wheel hub threads should be repaired immediately. Do not continue to drive under these circumstances! Contact an authorized Mercedes-Benz Center or call Roadside Assistance.

Incorrect wheel bolts or improperly tightened wheel bolts can cause the wheel to come off. This could cause an accident. Make sure to use the correct wheel bolts.

## Practical hints

### Flat tire



- ▶ Guide Minispare wheel onto alignment bolt and push it on.
- ▶ Insert wheel bolts and tighten them slightly.

## Practical hints

### Flat tire



- ▶ Unscrew the alignment bolt, install last wheel bolt and tighten slightly.

#### Warning!



Only use genuine equipment Mercedes-Benz wheel bolts. Other wheel bolts may come loose.

Do not tighten the wheel bolts when the vehicle is raised. Otherwise the vehicle could fall of the jack.

#### Lowering the vehicle

- ▶ Lower vehicle by turning crank counterclockwise until vehicle is resting fully on its own weight.
- ▶ Remove the jack.

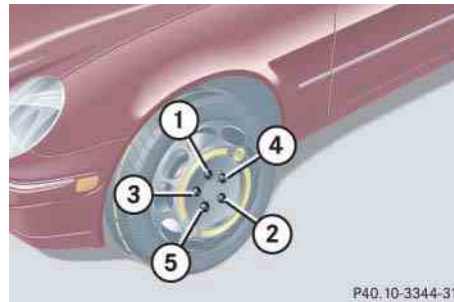

① - ⑤ Wheel bolts

- ▶ Tighten the five wheel bolts evenly, following the diagonal sequence illustrated (① to ⑤), until all bolts are tight. Observe a tightening torque of 80 lb-ft (110 Nm).

#### Warning!



Have the tightening torque checked after changing a wheel. The wheels could come loose if they are not tightened to a torque of 80 lb-ft (110 Nm).

Before storing the jack, it should be fully collapsed, with handle folded in (storage position) (▷ page 322).

- ▶ Store the jack and the other vehicle tools in the storage compartment behind the left trim panel (▷ page 322).

## ▼ Battery

The battery is located in the engine compartment on the right hand side.

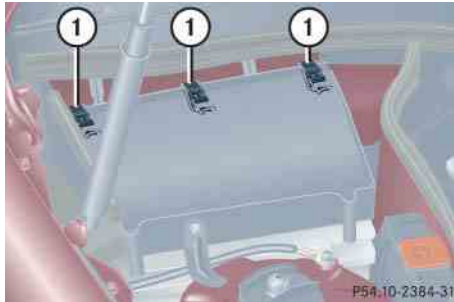

### ① Clamps

Removing filter box:

- ▶ Release clamps ①.
- ▶ Remove filter box.

Installing filter box:

- ▶ Insert filter box properly.
- ▶ Secure it with clamps ①.

### Warning!



Failure to follow these instructions can result in severe injury or death.

Observe all safety instructions and precautions when handling automotive batteries (▷ page 276).

Never lean over batteries while connecting, you might get injured.

Battery fluid contains sulfuric acid. Do not allow this fluid to come in contact with eyes, skin or clothing. In case it does, immediately flush affected area with water and seek medical help if necessary.

A battery will also produce hydrogen gas, which is flammable and explosive. Keep flames or sparks away from battery, avoid improper connection of jumper cables, smoking, etc.

## Practical hints

### Battery



Never loosen or detach battery terminal clamps while the engine is running or the SmartKey is in the starter switch. Otherwise the alternator and other electronic components could be severely damaged.

Have the battery checked regularly by an authorized Mercedes-Benz Center.

Refer to Maintenance Booklet for maintenance intervals or contact an authorized Mercedes-Benz Center for further information.

### Warning!



Do not place metal objects on the battery as this could result in a short circuit.

Use leak-proof battery only to avoid the risk of acid burns in the event of an accident.

## Practical hints

### Battery

#### Warning!



With a disconnected battery

- you will no longer be able to turn the SmartKey in the starter switch
- the gear selector lever will remain locked in position **P**

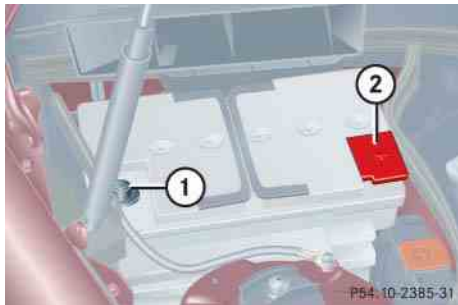

- ① Negative terminal
- ② Positive terminal cover

#### Disconnecting the battery

- ▶ Turn off the engine (▷ page 57).
- ▶ Turn off all electrical consumers.
- ▶ Remove SmartKey from starter switch.
- ▶ Open the hood (▷ page 270).
- ▶ Remove the filter box (▷ page 347).
- ▶ Disconnect the battery negative lead from negative terminal ①.
- ▶ Remove cover ② from the positive terminal.
- ▶ Disconnect the battery positive lead.

#### Removing the battery

- ▶ Remove the screw-nuts securing the battery.
- ▶ Remove the battery bracket.
- ▶ Take out the battery.

#### Charging and reinstalling the battery

- ▶ Charge battery in accordance with the instructions of the battery charger manufacturer.
- ▶ Reinstall the charged battery. Follow the previously described steps in reverse order.

#### Warning!



Never charge a battery while still installed in the vehicle. Gases may escape during charging and cause explosions that may result in paint damage, corrosion or personal injury.

#### Reconnecting the battery

- ▶ Turn off all electrical consumers.
- ▶ Remove SmartKey from starter switch.
- ▶ Connect the battery positive lead and fasten its cover ②.
- ▶ Connect the battery negative lead.



NEVER invert the terminal connections.

- ▶ Reinstall the filter box (▷ page 347).



The battery, its filler caps and the vent tube must always be securely installed when the vehicle is in operation.



The following procedures must be carried out following any interruption of battery power (e.g. due to reconnection):

- Set the clock (▷ page 135).  
Vehicles with COMAND\*:  
See COMAND operator's manual.
- Synchronize side windows (▷ page 218).
- Synchronize tilt/sliding sunroof\* (▷ page 222).

Batteries contain materials that can harm the environment if disposed of improperly. Large 12 volt storage batteries contain lead. Recycling of batteries is the preferred method of disposal. Many states require sellers of batteries to accept old batteries for recycling.

## Practical hints

### Jump starting

#### Warning!



Failure to follow these directions will cause damage to the electronic components, and can lead to a battery explosion and severe injury or death.

Never lean over batteries while connecting or jump starting, you might get injured.

Battery fluid contains sulfuric acid. Do not allow this fluid to come in contact with eyes, skin or clothing. In case it does, immediately flush affected area with water, and seek medical help if necessary.

A battery will also produce hydrogen gas, which is flammable and very explosive. Keep flames or sparks away from battery, avoid improper connection of jumper cables, smoking, etc.

Attempting to jump start a frozen battery can result in it exploding, causing personal injury.

Read all instructions before proceeding.

If the battery is discharged, the engine can be started with jumper cables and the battery of another vehicle. Observe the following:

- Jump starting should only be performed when the engine and catalytic converter are cold.
- Do not start the engine if the battery is frozen. Let the battery thaw out first.
- Only jump start from batteries with the same voltage rating (12 V). Jump starting with a more powerful battery could damage the vehicle's electrical system, which will not be covered by the Mercedes-Benz Limited Warranty.
- Only use jumper cables with sufficient cross-section and insulated terminal clamps.
- Always make sure the jumper cables are not on or near pulleys, fans, or other parts that move when an engine is started or running.



Jump starting may only be performed on the battery installed in the engine compartment.

Avoid repeated and lengthy starting attempts.

Do not attempt to start the engine using a battery quick charge unit.

If engine does not run after several unsuccessful starting attempts, have it checked at the nearest authorized Mercedes-Benz Center.

Excessive unburned fuel generated by repeated failed starting attempts may damage the catalytic converter and may present a fire risk.

Make sure the jumper cables do not have loose or missing insulation.

Make sure the cable clamps do not touch any other metal part while the other end is still attached to a battery.



### Warning!



Keep flames or sparks away from battery.  
Do not smoke.

Observe all safety instructions and precautions when handling automotive batteries (▷ page 276).

The battery is located in the engine compartment on the right hand side. The terminals for jump starting are located in front of the battery.

- ▶ Make sure the two vehicles do not touch.
- ▶ Turn off all electrical consumers.
- ▶ Apply parking brake.
- ▶ Shift gear selector lever to position **P**.

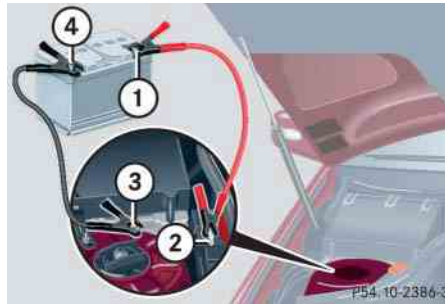

- ① Positive terminal of charged battery
  - ② Positive under hood terminal in front of discharged battery
  - ③ Negative under hood terminal in front of discharged battery
  - ④ Negative terminal of charged battery
- ▶ Connect positive terminal ① of the charged battery with positive under hood terminal ② in front of the discharged battery with the jumper cables. Clamp cable to charged battery ① first.
  - ▶ Start engine of the vehicle with the charged battery and run at idle speed.

## Practical hints

### Jump starting

- ▶ Connect negative terminal ④ of the charged battery with negative under hood terminal ③ in front of the discharged battery with the jumper cables. Clamp cable to charged battery ④ first.
- ▶ Start the engine of the disabled vehicle.

You can now again turn on the electrical consumers. Do not turn on the lights under any circumstances.

- ▶ Remove the jumper cables first from negative terminals ④ and ③ and then from positive terminals ① and ②.

You can now turn on the lights.

- ▶ Have the battery checked at the nearest authorized Mercedes-Benz Center.



Do not tow-start the vehicle.

## Practical hints

### Towing the vehicle

Mercedes-Benz recommends that the vehicle be transported with all wheels off the ground using flatbed or appropriate wheel lift/dolly equipment. This method is preferable to other types of towing.



Use flatbed or wheel lift/dolly equipment with the SmartKey in the starter switch turned to position **0**.

Do not tow with sling-type equipment. Towing with sling-type equipment over bumpy roads will damage radiator and supports.

To prevent damage during transport, do not tie down vehicle by its chassis or suspension parts.

Switch off the tow-away alarm (▷ page 87) and deactivate the automatic central locking (▷ page 143).

When circumstances do not permit the recommended towing methods, the vehicle may be towed with all wheels on the ground or front wheels raised (except vehicles with 4MATIC) only so far as necessary to have the vehicle moved to a safe location where the recommended towing methods can be employed.



Do not tow-start the vehicle.



Vehicles with 4MATIC:

Do not tow with one axle raised. Doing so could damage the transfer case, which is not covered by the Mercedes-Benz Limited Warranty.

All wheels must be on or off the ground. Observe instructions for towing the vehicle with all wheels on the ground.



If the vehicle is towed with the front axle raised (not permissible for vehicles with 4MATIC), the engine must be shut off (SmartKey in starter switch position **0** or **1**). Otherwise the ESP will immediately be engaged and will apply the rear wheel brakes.

When towing the vehicle with all wheels on the ground, the gear selector lever must be in position **N** and the SmartKey must be in starter switch position **2**.

When towing the vehicle with all wheels on the ground or the front axle raised, the vehicle may be towed only for distances up to 30 miles (50 km) and at a speed not to exceed 30 mph (50 km/h).



To be certain to avoid a possibility of damage to the drivetrain, however, we recommend the drive shaft be disconnected at the rear axle drive flange (vehicles with 4MATIC: disconnected at the front and rear axle drive flanges) for any towing beyond a short tow to a nearby garage.

### Warning!



If circumstances require towing the vehicle with all wheels on the ground, always tow with a tow bar if:

- the engine will not run
- there is a malfunction in the power supply or in the vehicle's electrical system

as that will be necessary to adequately control the towed vehicle.

Prior to towing the vehicle with all wheels on the ground, make sure the SmartKey is in starter switch position **2**.

If the SmartKey is left in starter switch position **0** for an extended period of time, it can no longer be turned in the switch. In this case, the steering is locked. To unlock, remove SmartKey from starter switch and reinsert.

## Practical hints

### Towing the vehicle



To signal turns while being towed with the hazard warning flasher in use, switch on ignition and activate the combination switch for the left or right turn signal in the usual manner – only the selected turn signal will operate.

Upon canceling the turn signal, the hazard warning flasher will operate again.

## Practical hints

### Towing the vehicle

#### Warning!



With the engine not running, there is no power assistance for the brake and steering systems. In this case, it is important to keep in mind that a considerably higher degree of effort is necessary to brake and steer the vehicle. Adapt your driving accordingly.



When towing the vehicle with all wheels on the ground, please note the following:

With the automatic central locking activated and the SmartKey in starter switch position **2**, the vehicle doors lock if the left front wheel as well as the right rear wheel are turning at vehicle speeds of approx. 9 mph (15 km/h) or more.

Switch off the tow-away alarm\* (▷ page 87).

To prevent the vehicle doors from locking, deactivate the automatic central locking (▷ page 143).

Towing of the vehicle should only be done using the properly installed towing eye bolt. Never attach tow cable, tow rope or tow rod to vehicle chassis, frame or suspension parts.



If the battery is disconnected or discharged

- the SmartKey will not turn in the starter switch. For more information, see “Battery” (▷ page 347) and “Jump starting” (▷ page 350).
- the gear selector lever will remain locked in position **P**. For information on manually unlocking the transmission gear selector lever, see (▷ page 328).

### Installing towing eye bolt

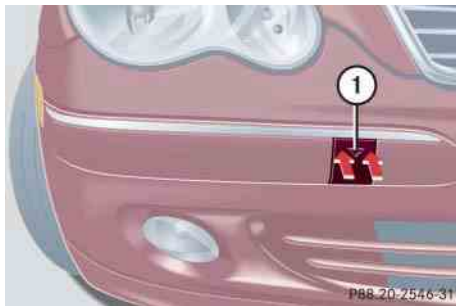

① Cover on right side of front bumper.

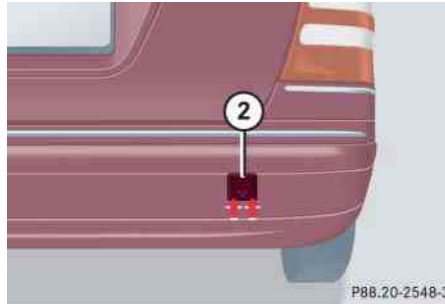

② Cover on right side of rear bumper.

## Practical hints

### Towing the vehicle

#### Removing cover

- ▶ Press mark on cover ① or ② in direction of arrows.
- ▶ Lift cover off to reveal threaded hole for towing eye bolt.

The towing eye bolt is supplied with the tool kit (located behind the left hand trim panel in cargo compartment).

- ▶ Screw towing eye bolt in to its stop and tighten with lug wrench.

#### Reinstalling cover

- ▶ Fit cover ① or ② and snap into place.

## Practical hints

### Fuses

The electrical fuses in your vehicle serve to stop the supply of electricity to a device that is malfunctioning. This helps to prevent damage to the other vehicle electronics.

The following aids are available to help you change fuses (▷ page 357):

- Fuse chart
- Spare fuses
- Fuse extractor

#### Warning!



Only use fuses approved for Mercedes-Benz with the specified amperage for the system in question. Otherwise, a short circuit could result and cause a fire.



Only install fuses that have been tested and approved by Mercedes-Benz and that have the specified amperage rating.

Otherwise, electrical parts or systems could be damaged.

Never attempt to repair or bridge a blown fuse. Have the cause determined and remedied by an authorized Mercedes-Benz Center.

The electrical fuses are located in different fuse boxes:

- Main fuse box in passenger compartment (▷ page 357)
- Fuse box in engine compartment (▷ page 358)
- Fuse box in cargo compartment (▷ page 359)

## Aids for changing fuses

### Fuse chart

The fuse chart is found in the main fuse box in the passenger compartment (▷ page 357). The amperages of the fuses are also given there.

### Spare fuses

Spare fuses are found in the vehicle tool kit in the cargo compartment (▷ page 359).

### Fuse extractor

The fuse extractor is found in the vehicle tool kit in the cargo compartment (▷ page 359).

## Main fuse box in passenger compartment

The main fuse box is located in the passenger compartment on the driver's side of the cockpit.



① Main fuse box cover

## Practical hints

### Fuses

#### Opening fuse box

- ▶ Open the driver's door.
- ▶ Pull fuse box cover ① open with a screw driver or similar tool (see arrow).
- ▶ Remove fuse box cover ① rearward.

#### Closing fuse box

- ▶ Attach fuse box cover ① in the front.
- ▶ Fold fuse box cover ① in until it engages.

## Practical hints

### Fuses

#### Fuse box in engine compartment

The fuse box is located in the engine compartment on the driver's side.

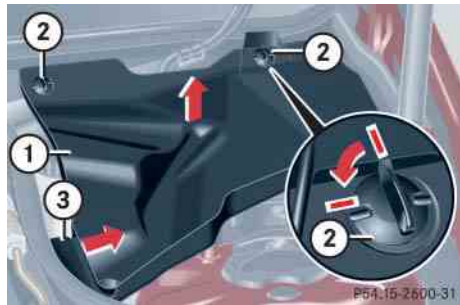

- ① Cover
- ② Screws
- ③ Retainer

#### Removing cover

- ▶ Twist screws ② 90° counterclockwise.
- ▶ Lift the rear of cover ①.
- ▶ Slide out retainer ③ and remove cover ① by pulling towards front.

#### Opening fuse box

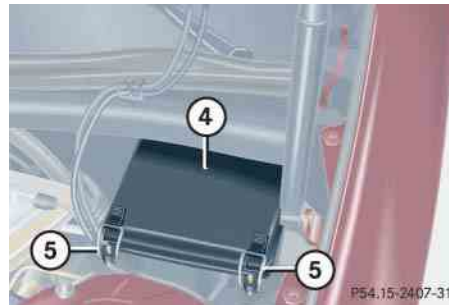

- ④ Fuse box cover
- ⑤ Clamps

- ▶ With a dry cloth, remove any moisture from the fuse box.
- ▶ Release clamps ⑤.
- ▶ Remove fuse box cover ④.

#### Closing fuse box

- ▶ Make sure that the sealing rubber is properly positioned.
- ▶ Press fuse box cover ④ down and secure with clamps ⑤.

#### Installing cover

- ▶ Insert cover ① sideways into retainer ③.
- ▶ Twist screws ② 90° clockwise.



### Fuse box in cargo compartment

The fuse box is located in the cargo compartment behind the left hand trim panel.

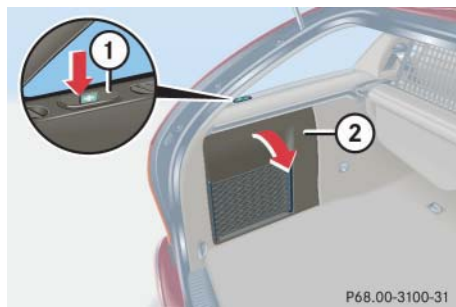

- ① Button for unlocking trim panel
- ② Trim panel

### Opening trim panel

- ▶ Press button ①.
- ▶ Fold down trim panel ②.

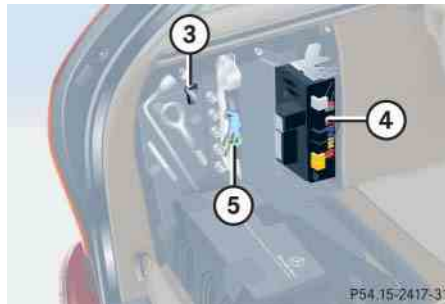

- ③ Fuse extractor
- ④ Fuse box
- ⑤ Spare fuses

### Closing trim panel

- ▶ Fold up trim panel ②.



## **Technical data**

**Parts service**

**Warranty coverage**

**Identification labels**

**Layout of poly-V-belt drive**

**Engine**

**Rims and Tires**

**Electrical system**

**Main Dimensions**

**Weights**

**Fuels, coolants, lubricants, etc.**

**Consumer information**

## Technical data

### Parts service

The “Technical data” section provides the necessary technical data for your vehicle.

All authorized Mercedes-Benz Centers maintain a stock of genuine Mercedes-Benz parts required for maintenance and repair work. In addition, strategically located parts distribution centers provide quick and reliable parts service.

More than 300 000 different parts for Mercedes-Benz models are available.

Genuine Mercedes-Benz parts are subjected to stringent quality inspections. Each part has been specifically developed, manufactured or selected for and adapted to Mercedes-Benz vehicles.

Therefore, genuine Mercedes-Benz parts should be installed.



The use of non-genuine Mercedes-Benz parts and accessories not authorized by Mercedes-Benz could damage the vehicle, which is not covered by the Mercedes-Benz Limited Warranty, or could compromise the vehicle's durability or safety.

▼ **Warranty coverage**

Your vehicle is covered under the terms of the “warranties” printed in the Service and Warranty Information booklet. Your authorized Mercedes-Benz Center will exchange or repair any defective parts originally installed in the vehicle in accordance with the terms of the following warranties:

- New Vehicle Limited Warranty
- Emission System Warranty
- Emission Performance Warranty
- California, Maine, Massachusetts, and Vermont Emission Control Systems Warranty

Replacement parts and accessories are covered by the Mercedes-Benz Parts and Accessories warranties, copies of which are available at any Mercedes-Benz Center.

**Loss of Service and Warranty Information Booklet**

---

Should you lose your Service and Warranty Information booklet, have an authorized Mercedes-Benz Center arrange for a replacement. It will be mailed to you.

## Technical data

### Identification labels



① Certification label



② Vehicle Identification Number (VIN)

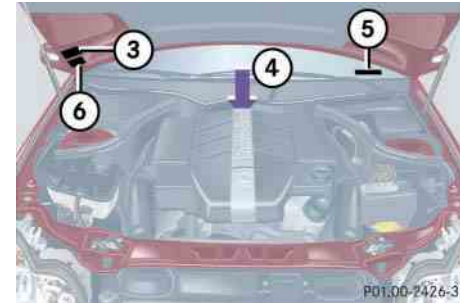

- ③ Emission control information label, includes both federal and California certification exhaust emission standards
- ④ Engine number (engraved on engine)
- ⑤ VIN, visible (lower edge of windshield)
- ⑥ Vacuum line routing diagram label

When ordering parts, please specify vehicle identification and engine numbers.

▼ **Layout of poly-V-belt drive**

C 240 (all models)

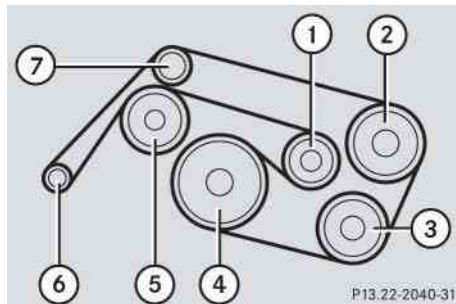

- ① Automatic belt tensioner
- ② Power steering pump
- ③ Air conditioning compressor
- ④ Crankshaft
- ⑤ Coolant pump
- ⑥ Generator (alternator)
- ⑦ Idler pulley

## Technical data

### Engine

<b>Model</b>	<b>C 240 (203.261)<sup>1</sup></b> <b>C 240 4MATIC (203.281)<sup>1</sup></b>
<b>Engine</b>	112
<b>Mode of operation</b>	4-stroke engine, gasoline injection
<b>No. of cylinders</b>	6
<b>Bore</b>	3.54 in (89.90 mm)
<b>Stroke</b>	2.68 in (68.20 mm)
<b>Total piston displacement</b>	158.5 cu in (2597 cm <sup>3</sup> )
<b>Compression ratio</b>	10.5:1
<b>Output acc. to SAE J 1349</b>	168 hp/5 500 rpm <sup>2</sup> (125 kW/5 500 rpm)
<b>Maximum torque acc. to SAE J 1349</b>	177 lb-ft/4 500 rpm (240 Nm/4 500 rpm)
<b>Maximum engine speed</b>	6 200 rpm
<b>Firing order</b>	1-4-3-6-2-5
<b>Poly-V-belt</b>	2380 mm

<sup>1</sup> The quoted data apply only to the standard vehicle. See an authorized Mercedes-Benz Center for the corresponding data of all special bodies and special equipment.

<sup>2</sup> Premium fuel required. Performance may vary with fuel octane rating.



### ▼ Rims and Tires

Only use tires and rims which have been specifically developed for your vehicle and tested and approved by Mercedes-Benz. Other tires and rims can have detrimental effects, such as

- poor handling characteristics
- increased noise
- increased fuel consumption



Moreover, tires and rims not approved by Mercedes-Benz may, under load, exhibit dimensional variations and different tire deformation characteristics that could cause them to come into contact with the vehicle body or axle parts. Damage to the tires or the vehicle may be the result.



Further information on tires and rims is available at any authorized Mercedes-Benz Center. A tire inflation pressure table is located on the fuel filler cap of the vehicle. The tire pressure should be checked regularly and should only be adjusted on cold tires. Follow tire manufacturer's maintenance recommendation included with vehicle.

## Technical data

### Rims and Tires

## Technical data

### Rims and Tires

#### Same size tires

<b>Model</b>	<b>C 240 (all models)</b>
<b>Rims (light alloy)</b>	7 J x16 H2
<b>Wheel offset</b>	1.22 in (31 mm)
<b>All-season tires (radial-ply tires)</b>	205/55 R16 91H
<b>Summer tires (radial-ply tires)</b>	-
<b>Winter tires (radial-ply tires)</b>	205/55 R16 91H M+S

**Minispare wheel**

---

<b>Model</b>	<b>C 240 (all models)</b>
<b>Rim (steel)</b>	3.5 B x16 H2
<b>Wheel offset</b>	0.67 in (17 mm)
<b>Tire</b>	T 125/90 R16 98M <sup>1</sup>

<sup>1</sup> Must not be used with snow chains.

## Technical data

### Electrical system

<b>Model</b>	<b>C 240 (all models)</b>
<b>Generator (alternator)</b>	14 V/120 A
<b>Starter motor</b>	12 V/1.7 kW
<b>Battery</b>	12 V/100 Ah
<b>Spark plugs</b>	Bosch F 8 DPP 332 NGK PFR 5 R-11
<b>Electrode gap</b>	0.039 in (1.0 mm)
<b>Tightening torque</b>	15 – 22 lb-ft (20 – 30 Nm)

## Technical data

### Main Dimensions

#### ▼ Main Dimensions

<b>Model</b>	<b>C 240 (all models)</b>
<b>Overall vehicle length</b>	179.0 in (4546 mm)
<b>Overall vehicle width</b>	68.0 in (1728 mm)
<b>Overall vehicle height</b>	57.8 in (1467 mm)
<b>Wheelbase</b>	106.9 in (2715 mm)
<b>Track, front</b>	59.3 in (1505 mm)
<b>Track, rear</b>	58.1 in (1476 mm)

## Technical data

### Weights

Roof load max.	220 lb (100 kg)
----------------	-----------------

▼ Fuels, coolants, lubricants, etc.

**Capacities**

Vehicle components and their respective

lubricants must match. Therefore only use brands tested and approved by Mercedes-Benz.

Please refer to the Factory Approved Service Products pamphlet, or inquire at your Mercedes-Benz Center.

	Model	Capacity	Fuels, coolants, lubricants, etc.
<b>Engine with oil filter</b>	C 240	7.9 US qt (7.5 l)	Approved engine oils
	C 240 4MATIC	7.4 US qt (7.0 l)	
<b>Automatic transmission</b>		8.5 US qt (8.0 l)	MB Automatic Transmission Fluid
<b>Rear axle</b>		1.2 US qt (1.1 l)	Hypoid gear oil SAE 85 W 90
<b>Front axle</b>	C 240 4MATIC	0.5 US qt (0.46 l)	Hypoid gear oil SAE 85 W 90
<b>Transfer case</b>	C 240 4MATIC	approx. 0.62 US qt (0.59 l)	MB Transfer case fluid
<b>Power steering</b>		approx. 1.1 US qt (1.0 l)	MB Power Steering Fluid (Pentosin CHF 11S)
<b>Front wheel hubs</b>		approx. 2.1 oz (60 g) each	High temperature roller bearing grease
<b>Brake system</b>		0.5 US qt (0.5 l)	MB Brake Fluid (DOT 4+)
<b>Cooling system</b>		approx. 6.8 US qt (6.4 l)	MB 325.0 Anticorrosion/Antifreeze Agent

## Technical data

### Fuels, coolants, lubricants, etc.

	Model	Capacity	Fuels, coolants, lubricants, etc.
Fuel tank including a reserve of		16.4 US gal (62.0 l)	Premium unleaded gasoline: Minimum Posted Octane 91 (Avg. of 96 RON/86 MON)
		2.1 US gal (8.0 l)	Flexible Fuel Vehicle (identified by a label reading <b>Premium gasoline or E85 only!</b> on fuel filler flap): Alternative fuel: Ethanol fuel (E85)
Air conditioning system			R-134a refrigerant and special PAG lubricant oil (never R-12)
Windshield washer		3.2 US qt (3.0 l)	MB Windshield Washer Concentrate <sup>1</sup>
Windshield washer and headlamp cleaning system*		6.4 US qt (6.0 l)	

<sup>1</sup> Use MB Windshield Washer Concentrate "S" and water for temperatures above freezing point or MB Windshield Washer Concentrate "S" and commercially available premixed windshield washer solvent/antifreeze for temperatures below freezing point. Follow suggested mixing ratios (> page 381).



#### Engine oils

Engine oils are specifically tested for their suitability in our engines and durability for our service intervals. Therefore, only use approved engine oils and oil filters required for vehicles with Maintenance System (U.S. vehicles) or FSS (Canada vehicles). For a listing of approved engine oils and oil filters, refer to the Factory Approved Service Products pamphlet, or contact an authorized Mercedes-Benz Center.

Using engine oils and oil filters of specification other than those expressly required for the Maintenance System (U.S. vehicles) or FSS (Canada vehicles), or changing of oil and oil filter at change intervals longer than those called for by the Maintenance System (U.S. vehicles) or FSS (Canada Vehicles) will result in engine damage not covered by the Mercedes-Benz Limited Warranty.

Please follow Maintenance System (U.S. vehicles) or FSS (Canada vehicles) recommendations for scheduled oil changes. Failure to do so will result in engine damage not covered by the Mercedes-Benz Limited Warranty.

#### Engine oil additives

Do not blend oil additives with engine oil. They may damage the engine.

Damage or malfunctions resulting from blending oil additives are not covered by the Mercedes-Benz Limited Warranty.

#### Air conditioning refrigerant

R-134a (HFC) refrigerant and special PAG lubricating oil is used in the air conditioning system.

Never use R-12 (CFC) or mineral-based lubricating oil. Otherwise damage to the system will occur.

#### Brake fluid

During vehicle operation, the boiling point of the brake fluid is continuously reduced through the absorption of moisture from the atmosphere. Under extremely strenuous operating conditions, this moisture content can lead to the formation of bubbles in the system, thus reducing the system's efficiency.

Therefore, the brake fluid must be replaced every two years, preferably in the spring.

Only brake fluid approved by Mercedes-Benz is recommended. Your authorized Mercedes-Benz Center will provide you with additional information.

## Technical data

### Fuels, coolants, lubricants, etc.

#### Premium unleaded gasoline



To maintain the engine's durability and performance, premium unleaded gasoline must be used. If premium unleaded is not available and low octane fuel is used, follow these precautions:

- Have the fuel tank only partially filled with unleaded regular and fill up with premium unleaded as soon as possible.
- Avoid full throttle driving and abrupt acceleration.
- Do not exceed an engine speed of 3000 rpm if the vehicle is loaded with a light load such as two persons and no luggage.
- Do not exceed  $\frac{2}{3}$  of maximum accelerator pedal position if the vehicle is fully loaded or operating in mountainous terrain.

#### Fuel requirements



Flexible Fuel Vehicles (identified by a label reading **Premium gasoline or E85 only!**) are designed to operate on premium unleaded gasoline or Ethanol fuel (E85) or any mixture of these two.

For more information, see "Flexible Fuel Vehicles" (> page 377).

Only use premium unleaded fuel:

- The octane number (posted at the pump) must be 91 min. It is an average of both the Research (R) octane number and the Motor (M) octane number:  $(R+M)/2$ . This is also known as the ANTI-KNOCK INDEX.

Unleaded gasoline containing oxygenates such as Ethanol, IPA, IBA and TBA can be used provided the ratio of any one of these oxygenates to gasoline does not exceed 10%; MTBE must not exceed 15%.

The ratio of Methanol to gasoline must not exceed 3% plus additional cosolvents.

Using mixtures of Ethanol and Methanol is not allowed. Gasohol, which contains 10% Ethanol and 90% unleaded gasoline, can be used.

These blends must also meet all other fuel requirements, such as resistance to spark knock, boiling range, vapor pressure, etc.

## Technical data

### Fuels, coolants, lubricants, etc.

#### Gasoline additives

A major concern among engine manufacturers is carbon build-up caused by gasoline. Mercedes-Benz recommends only the use of quality gasoline containing additives that prevent the build up of carbon deposits.

After an extended period of using fuels without such additives, carbon deposits can build up especially on the intake valves and in the combustion area, leading to engine performance problems such as:

- Warm-up hesitation
- Unstable idle
- Knocking/pinging
- Misfire
- Power loss

In areas where carbon deposits may be encountered due to lack of availability of gasolines which contain these additives, Mercedes-Benz recommends the use of additives approved by us for use on Mercedes-Benz vehicles. Refer to Factory Approved Service Products pamphlet for a listing of approved product(s). Follow directions on product label.

Do not blend any specific fuel additives with fuel. This only results in unnecessary cost and may be harmful to engine operation.

Damage or malfunction resulting from poor fuel quality or from blending additional fuel additives other than those tested and approved by us for use on Mercedes-Benz vehicles listed in the Factory Approved Service Products pamphlet are not covered by the Mercedes-Benz Limited Warranty.

#### Flexible Fuel Vehicles

Flexible Fuel Vehicles are identified by a label reading **Premium gasoline or E85 only!** on fuel filler flap.

These vehicles are designed to operate on premium unleaded gasoline or Ethanol fuel (E85), or on any mixture of these two.

Ethanol fuel (E85) is a mixture of approximately 85% ethanol and 15% unleaded gasoline.

#### Warning!



Ethanol fuel (E85) and its fumes are highly flammable, poisonous and burn easily. Ethanol fuel can cause serious injuries if ignited or if you come into contact with it or inhale fumes of it. Avoid inhalation of ethanol fumes and skin contact with ethanol. Extinguish all open flames before fueling. Never smoke or create sparks close to ethanol.

## Technical data

### Fuels, coolants, lubricants, etc.

#### Switching fuels

For best performance and driveability it is recommended to use either one or the other fuel. A refueling pattern that alternates between the two different fuels should be avoided if possible.

When switching fuels, make sure:

- Fuel level is below half full.
- Fuel level is above reserve (fuel reserve warning lamp is not lit).
- Amount of added fuel is more than 5 gallons (20 liters).
- Ignition is off during refill.
- Immediately after refueling engine is started and operated for at least five minutes.

These precautions and recommendations are supposed to prevent any difficulties when starting and operating the engine which otherwise may be experienced before the engine has fully adapted to the different fuel.

If in spite of these recommendations the engine does not perform properly, adding more gasoline [at least 3 gallons (12 liters)] to the fuel may improve the engine behavior.

#### Cold weather performance

It is possible that starting times will significantly increase at temperatures below 32°F (0°C). At low temperatures the use of a block heater (Canada only) is recommended (see an authorized Mercedes-Benz Center for further information). Rough idling may also be experienced at such temperatures before the engine is fully warmed up.



E85 fuel is unsuitable for use when ambient temperatures fall below 14°F (-10°C).

#### Hot weather performance

At ambient temperatures above 95°F (35°C) start times may increase and be accompanied by a rough idle following the start.

#### Cruising range

E85 fuel contains less energy per gallon than gasoline. To make sure that engine performance with ethanol fuel is similar to that when using gasoline, the engine must burn more ethanol fuel. As a result, it is to be expected that the fuel consumption will increase when using E85 compared to gasoline operation.



Use of E85 may reduce your driving range.

#### Maintenance

Please inform your Mercedes-Benz Center if you use or have used E85 fuel when your vehicle is delivered for maintenance or repairs.

### Coolants

The engine coolant is a mixture of water and anticorrosion/antifreeze, which provides:

- Corrosion protection
- Freeze protection
- Boiling protection (by increasing the boiling point)

The cooling system was filled at the factory with a coolant providing freeze protection to approximately -22°F (-30°C) and corrosion protection.

If the antifreeze mixture is effective to -22°F (-30°C), the boiling point of the coolant in the pressurized cooling system is reached at approx. 266°F (130°C).

The coolant solution must be used year-round to provide the necessary corrosion protection and increase boil-over protection. Refer to Maintenance Booklet for replacement interval.

Coolant system design and coolant used determine the replacement interval. The replacement interval published in the Maintenance Booklet is only applicable if MB 325.0 anticorrosion/antifreeze solution or other Mercedes-Benz approved products of equal specification (see Factory Approved Service Products pamphlet) are used to renew the coolant concentration or bring it back up to the proper level.

To provide important corrosion protection, the solution must be at least 45% anticorrosion/antifreeze [equivalent to freeze protection to approx. - 22°F (-30°C)].

If you use a solution that is more than 55% anticorrosion/antifreeze [freeze protection to approx. - 49°F (-45°C)], the engine temperature will increase due to the lower heat transfer capability of the solution. Therefore, do not use more than this amount of anticorrosion/antifreeze.

If the coolant level is low, water and MB 325.0 anticorrosion/antifreeze should be used to bring it up to the proper level (have cooling system checked for signs of leakage). Please make sure the mixture is in accordance with label instructions.

The water in the cooling system must meet minimum requirements, which are usually satisfied by normal drinking water. If you are not sure about the water quality, consult an authorized Mercedes-Benz Center.

## Technical data

### Fuels, coolants, lubricants, etc.

#### Anticorrosion/antifreeze

Your vehicle contains a number of aluminum parts. The use of aluminum components in motor vehicle engines necessitates that anticorrosion/antifreeze coolant used in such engines be specifically formulated to protect the aluminum parts.

Failure to use such anticorrosion/antifreeze coolant will result in a significantly shortened service life.

Therefore, the following product is strongly recommended for use in your vehicle:

Mercedes-Benz 325.0

Anticorrosion/Antifreeze Agent.

Before the start of the winter season (or once a year in hot southern regions), you should have the anticorrosion/antifreeze concentration checked. The coolant is also regularly checked each time you bring your vehicle to an authorized Mercedes-Benz Center for service.

#### Anticorrosion/antifreeze quantity

Model	Approx. freeze protection	
	-35°F (-37°C)	-49°F (-45°C)
C 240 (all models)	3.4 US qt (3.2 l)	3.8 US qt (3.6 l)

### Windshield washer and headlamp cleaning system\*

Both the windshield washer and headlamp cleaning system\* are supplied from the windshield washer fluid reservoir.

The washer fluid reservoir has a capacity of approx.:

- 3.2 US qt (3.0 l) in vehicles without headlamp cleaning system\*
- 6.4 US qt (6.0 l) in vehicles with headlamp cleaning system\*

- ▶ Refill the reservoir with MB Windshield Washer Concentrate and water (or concentrate and commercially available premixed windshield washer solvent/antifreeze, depending on ambient temperatures).

#### Warning!



Washer solvent/antifreeze is highly flammable. Do not spill washer solvent/antifreeze on hot engine parts, because it may ignite and burn. You could be seriously burned.

## Technical data

### Fuels, coolants, lubricants, etc.

#### Washer fluid mixing ratio

For temperatures above freezing point, use MB Windshield Washer Concentrate “S” and water:

- 1 part “S” to 100 parts water  
(1.34 fl oz [40 ml] “S” to 1 gallon [4.0 l] water)

For temperatures below freezing point, use MB Windshield Washer Concentrate “S” and commercially available premixed windshield washer solvent/antifreeze:

- 1 part “S” to 100 parts solvent  
(1.34 fl oz [40 ml] “S” to 1 gallon [4.0 l] solvent)

## Technical data

### Consumer information

The following text is published as required of all manufacturers of passenger cars under Title 49, Code of U.S. Federal Regulations, Part 575 pursuant to the “National Traffic and Motor Vehicle Safety Act of 1966”.

#### Uniform tire quality grading

Quality grades can be found, where applicable, on the tire sidewall between tread shoulder and maximum section width. For example:

Treadwear	Traction	Temperature
200	AA	A

All passenger car tires must conform to federal safety requirements in addition to these grades.

#### Treadwear

The treadwear grade is a comparative rating based on the wear rate of the tire when tested under controlled conditions on a specified government test course. For example, a tire graded 150 would wear one and one-half ( $1\frac{1}{2}$ ) times as well on the government course as a tire graded 100. The relative performance of tires depends upon the actual conditions of their use, however, and may depart significantly from the norm due to variations in driving habits, service practices and differences in road characteristics and climate.

#### Traction

The traction grades, from highest to lowest are AA, A, B, and C. Those grades represent the tire’s ability to stop on wet pavement as measured under controlled conditions on specified government test surfaces of asphalt and concrete. A tire marked C may have poor traction performance.

#### Warning!



The traction grade assigned to this tire is based on straight ahead braking traction tests, and does not include acceleration, cornering, hydroplaning, or peak traction characteristics.



## Temperature

The temperature grades are A (the highest), B, and C, representing the tire's resistance to the generation of heat and its ability to dissipate heat when tested under controlled conditions on a specified indoor laboratory test wheel. Sustained high temperature can cause the material of the tire to degenerate and reduce tire life, and excessive temperature can lead to sudden tire failure. The grade C corresponds to a level of performance which all passenger car tires must meet under the Federal Motor Vehicle Safety Standard No. 109. Grades B and A represent higher levels of performance on the laboratory test wheel than the minimum required by law.

### Warning!



The temperature grade for this tire is established for a tire that is properly inflated and not overloaded. Excessive speed, underinflation, or excessive loading, either separately or in combination, can cause excessive heat build-up and possible tire failure.

## Technical data

## Consumer information



### **ABS**

(Antilock Brake System)

Prevents the wheels from locking up during braking so that the vehicle can continue to be steered.

### **Alignment bolt**

Metal pin with thread. The centering pin is an aid used when changing a tire to align the wheel with the wheel hub.

### **BabySmart<sup>TM1</sup> air bag deactivation system**

This system detects if a special system compatible child restraint seat is installed on the front passenger seat. The system will automatically deactivate the passenger front air bag when such a seat is properly installed (the  indicator lamp located in the center console comes on). See an authorized Mercedes-Benz Center for availability.

### **BabySmart<sup>TM</sup> compatible child seats**

Special restraint system for children. The sensor system for the passenger seat prevents deployment of the passenger front air bag if a BabySmart<sup>TM</sup> compatible child seat is installed.

### **BAS**

(Brake Assist System)

System for potentially reducing braking distances in emergency braking situations. The system is activated when it senses an emergency based on how fast the brake is applied.

### **Bi-Xenon headlamps\***

Headlamps which use an electric arc as the light source and produce a more intense light than filament headlamps. Bi-Xenon headlamps produce low beam and high beam.

### **CAC**

(Customer Assistance Center)

Mercedes-Benz customer service center, which can help you with any questions about your vehicle and provide assistance in the event of a breakdown.

### **CAN system**

(Controller Area Network)

Data bus network serving to control vehicle functions such as door locking or windshield wiping depending on vehicle settings and/or ambient conditions.

### **Cockpit**

All instruments, switches, buttons and indicator/warning lamps in the passenger compartment needed for vehicle operation and monitoring.

<sup>1</sup> BabySmart<sup>TM</sup> is a trademark of Siemens Automotive Corp.

## Technical terms

### **COMAND\***

(Cockpit Management and Data System)

Information and operating center for vehicle sound and communications systems, including the radio and the navigation system, as well as other optional equipment (CD changer\*, telephone\*, etc.).

### **Control system**

The control system is used to call up vehicle information and to change component settings. Information and messages appear in the multifunction display. The driver uses the buttons on the multifunction steering wheel to navigate through the system and to adjust settings.

### **Cruise control**

Driving convenience system that automatically maintains the vehicle speed set by the driver.

### **Engine number**

The number set by the manufacturer and placed on the cylinder block to uniquely identify each engine produced.

### **Engine oil viscosity**

Measurement for the inner friction (viscosity) of the oil at different temperatures. The higher the temperature an oil can tolerate without becoming thin, or the lower the temperature it can tolerate without becoming viscous, the better the viscosity.

### **ESP**

(Electronic Stability Program)  
Improves vehicle handling and directional stability.

### **ETD**

(Emergency Tensioning Device)  
Device which deploys in certain frontal and rear collisions exceeding the system's threshold to tighten the seat belts.  
->SRS

### **FSS (Canada vehicles)**

(Flexible Service System)

Maintenance service indicator in the multifunction display that informs the driver when the next vehicle maintenance service is due. FSS evaluates engine temperature, oil level, vehicle speed, engine speed, distance driven and the time elapsed since your last maintenance service, and calls for the next maintenance service accordingly.

### **Gear range**

Number of gears which are available to the automatic transmission for shifting. The automatic gear shifting process can be adapted to specific operating conditions using the gear selector lever.

### **GPS**

(Global Positioning System)

Satellite-based system for relaying geographic location information to and from vehicles equipped with special receivers. Employs CD digital maps for navigation.

**Instrument cluster**

The displays and indicator/warning lamps in the driver's field of vision, including the tachometer, speedometer, engine temperature display and fuel gauge.

**Kickdown**

Depressing the accelerator past the point of resistance shifts the transmission down to the lowest possible gear. This very quickly accelerates the vehicle and should not be used for normal acceleration needs.

**Lock button**

Button on the door which indicates whether the door is locked or unlocked. Pushing the lock button down on an individual door from inside will lock that door.

**Maintenance System (U.S. vehicles)**

Maintenance service indicator in the multifunction display that informs the driver when the next vehicle maintenance service is due. The Maintenance System in your vehicle tracks distance driven and the time elapsed since your last maintenance service, and calls for the next maintenance service accordingly.

**Memory function\***

Used to store three individual seat, steering wheel and mirror positions for each SmartKey.

**MON**

(Motor Octane Number)  
The Motor Octane Number for gasoline as determined by a standardized method. It is an indication of a gasoline's ability to resist undesired detonation (knocking). The average of both the MON (Motor Octane Number) and →RON (Research Octane Number) is posted at the pump, also known as ANTI-KNOCK INDEX.

**Multifunction display**

Display field in the instrument cluster used to present information provided by the control system.

**Multifunction steering wheel**

Steering wheel with buttons for operating the control system.

**Overspeed range**

Engine speeds within the red marking of the tachometer dial. Avoid this engine speed range, as it may result in serious engine damage that is not covered by the Mercedes-Benz Limited Warranty.

**Poly-V-belt drive**

Drives engine-components (alternator, AC compressor, etc.) from the engine.

## Technical terms

### Power train

Collective term designating all components used to generate and transmit motive power to the drive axles, including

- engine
- clutch/torque converter
- transmission
- transfer case
- drive shaft
- differential
- axle shafts/axles

### Program mode selector switch

Used to switch the automatic transmission between standard operation **S** and comfort operation **C**.

### REST

(Residual engine heat utilization)  
Feature that uses the engine heat stored in the coolant to heat the vehicle interior for a short time after the engine has been turned off.

### Restraint systems

Seat belts, belt tensioners, air bags and child restraint systems. As independent systems, their protective functions complement one another.

### RON

(Research Octane Number)  
The Research Octane Number for gasoline as determined by a standardized method. It is an indication of a gasoline's ability to resist undesired detonation (knocking). The average of both the →MON (Motor Octane Number) and RON (Research Octane Number) is posted at the pump, also known as ANTI-KNOCK INDEX.

### Shift lock

When the vehicle is parked, this lock prevents the transmission gear selector lever from being moved out of position **P** without SmartKey turned and brake pedal depressed.

### SRS

(Supplemental Restraint System)  
Seat belts, emergency tensioning device and air bags. Though independent systems, they are closely interfaced to provide effective occupant protection.

### **Tele Aid\* System**

(Telematic Alarm Identification on Demand)

The Tele Aid system consists of three types of response: automatic and manual emergency, roadside assistance and information. Tele Aid is initially activated by completing a subscriber agreement and placing an acquaintance call.

The Tele Aid system is operational provided that the vehicle's battery is charged, properly connected, not damaged and cellular and GPS coverage is available.

### **Telematics\***

A combination of the terms "telecommunications" and "informatics".

### **Tightening torque**

Force times lever arm (e.g. a lug wrench) with which threaded fasteners such as wheel bolts are tightened.

### **Tire speed rating**

Part of tire designation; indicates the speed range for which a tire is approved.

### **Traction**

Force exerted by the vehicle on the road via the tires.

### **VIN**

(Vehicle Identification Number)

The number set by the manufacturer and placed on the body to uniquely identify each vehicle produced.

### **Voice control system\*<sup>1</sup>**

Voice control system for car phones, portable cell phones and audio systems (radio, CD, etc.).

<sup>1</sup> Feature description is based on preliminary information at time of printing. At time of printing, no date for availability of voice control had been set. Contact an authorized Mercedes-Benz Center for details and availability for your vehicle model.





**A**

- ABS 79, 385
  - ABS control 79
  - Indicator lamp 25
  - Malfunction indicator lamp 294
  - Messages in display 302
- Accelerator position,
  - automatic transmission 159
- Accident
  - In case of 54
- Activating
  - Air conditioning (cooling) 173
  - Air recirculation mode 171
  - Anti-theft alarm system\* 86
  - Central locking (control system) 143
  - Climate control 167
  - Climate control system 169
  - Defrosting 171
  - Easy-entry/exit feature\* 144
  - ESP 83
  - Exterior headlamps 49
  - Exterior lamps 109
  - Exterior rear view mirror
    - parking position\* 163
  - Hazard warning flasher 113
  - Headlamps 49
  - High beam headlamps 49
  - High beams 112
  - Ignition 33
  - Immobilizer 57, 85
  - Low beam headlamps 49
  - Rear window defroster 165
  - Seat heating\* 104
  - Tow-away alarm\* 87
  - Windshield wipers 51
- Adding
  - Coolant 275
  - Engine oil 274
- Additional turn signals 333
- Adjustable air vents,
  - rear passenger compartment 174
- Adjusting 35
  - Air distribution 170
  - Air volume 170
  - Backrest contour 103
  - Backrest side bolsters 103
  - Backrest tilt, manual seat 36
  - Backrest tilt, power seat\* 38
  - Exterior rear view mirrors 41
  - Folding back rear seat
    - head restraints 101
  - Head restraint height,
    - manual seat 37
  - Head restraint height,
    - power seat\* 38
  - Head restraint height, rear seats 100
  - Head restraint tilt, manual seat 37
  - Head restraint tilt, power seat\* 39
  - Head restraint tilt, rear seats 102
  - Instrument cluster illumination 116
  - Interior rear view mirror 41
  - Manual seat 36

## Index

- Mirrors 41
- Multicontour seat\* 103
- Placing upright rear seat head restraints 101
- Power seat\* 38
- Rear seat head restraints 100
- Seat belt height 45
- Seat cushion depth 103
- Seat cushion tilt, manual seat 36
- Seat cushion tilt, power seat\* 38
- Seat fore and aft adjustment, manual seat 36
- Seat fore and aft adjustment, power seat\* 38
- Seat height, manual seat 36
- Seat height, power seat\* 38
- Seats 35
- Steering column height, electrical\* 41
- Steering column height, manual 40
- Steering column length, electrical\* 41
- Steering column length, manual 40
- Steering wheel 39
- Adjusting air distribution and volume 170
- Adjusting sound functions 179
- Adjusting the volume 179
- Aids for changing fuses 357
- Air bags 61
  - BabySmart™ deactivation system 72, 385
  - Children 62
  - Front 65
  - Passenger 65
  - Safety guidelines 64
  - Side impact 66
  - Window curtain 66
- Air conditioning (cooling) 173
  - Turning off 173
  - Turning on 173
- Air conditioning refrigerant 375
- Air distribution
  - Adjusting 170
- Air pressure see Tire inflation pressure
- Air recirculation mode 171
  - Activating 171
  - Deactivating 172
- Air vents, rear passenger compartment
  - Adjustable 174
- Air volume
  - Adjusting 170
- Alarm
  - Audible 78, 85
  - Canceling 86, 88
  - Visual 85
- Alarm system
  - Anti-theft\* 85
  - Tow-away\* 87
- Alignment bolt (vehicle tool kit) 344, 385
- Anticorrosion/antifreeze 380
- Antiglare
  - Automatic\* 162
  - Manual 161

- Antilock Brake System see ABS
- Anti-theft alarm system\*
  - Arming 86
  - Canceling alarm 86
  - Disarming 86
- Anti-theft systems 85
  - Anti-theft alarm system\* 85
  - Immobilizer 85
  - Tow-away alarm\* 87
- Aquaplaning see Hydroplaning
- Armrest
  - Changing inclination of 235
  - Storage spaces 235
- Armrest in rear
  - passenger compartment 236
- Ashtrays 238
- ATF 274
- AUDIO menu 125
  - Selecting radio station 126
  - Selecting satellite radio\* station 126
- Audio system 175
  - Audio and telephone, operation 175
  - Button and soft key operation 178
  - CD\* operation 193
  - Operating and display elements 176
  - Operating safety 175
  - Operation 178
  - Radio operation 183
  - Switching off 179
  - Switching on 178
  - Telephone\* operation 200
- Automatic antiglare\*
  - for rear view mirror 162
- Automatic central locking
  - Activating/deactivating (control system) 143
- Automatic headlamp mode 109
- Automatic lighting control
  - Activating 114
  - Deactivating 114
- Automatic locking when driving 95
- Automatic shift program
  - Automatic transmission 158
- Automatic time change
  - (Daylight Saving Time (DST) summer/winter) 137
- Automatic transmission 152
  - Accelerator position 159
  - Automatic shift program 158
  - Emergency operation (Limp Home Mode) 160
  - Fluid level 274
  - Gear ranges 155
  - Gear selector lever 46, 152
  - Gear selector lever position 152, 156
  - Gear shifting malfunctions 160
  - Kickdown 159
  - Manual shifting 154
  - One-touch gearshifting 154
  - Program mode selector switch, automatic shift program 158
  - Starting with 47
  - Transmission fluid 274
- Automatic Transmission Fluid see ATF

## Index

### B

#### BabySmart™

- Air bag deactivation system 72, 385
- Compatible child seats 72, 385
- Self-test 72

#### Backrest

- Folding forward 230
- Folding rearward 231

#### Backrest contour

- Adjusting 103

#### Backrest side bolsters

- Adjusting 103

#### Backrest tilt

- Manual seat 36
- Power seat\* 38

#### Backup lamps

- Messages in display 315
- Replacing bulbs 333

#### BAS 80, 385

- Messages in display 303

#### Batteries, SmartKey

- Changing 331
- Check lamp 92
- Checking 93

#### Battery discharged

- Jump starting 350

#### Battery, vehicle 276, 347

- Charging 348
- Disconnecting 348
- Reconnecting 349
- Reinstalling 348
- Removing 348

#### Bi-Xenon headlamps\* 385

#### Bi-Xenon type\*

- Front lamp bulbs 337

#### Block heater (Canada only) 283

#### Blocking

- Rear door window operation 77

#### Bolts

- For Minispare wheel 325

#### Brake Assist System see BAS

#### Brake fluid 375

- Checking 269
- Message in display 307

#### Brake lamp bulbs 333

#### Brake lamp, high mounted 333

#### Brake lamps

- Messages in display 315

#### Brake pads

- Message in display 307

#### Brakes 258

- Warning lamp 25, 295

#### Break-in period 256

#### Bulbs, replacing 332

- Additional turn signals 333

- Backup lamps 333, 340

- Brake lamps 333, 340

- Fog lamp, rear 333, 340

- Fog lamps, front 333

- Front lamps 333

- High beam flasher 333

- High beam headlamps 333

- High mounted brake lamp 333

- License plate lamps 333, 340

- Low beam headlamps 333

- Parking lamps, front 333, 336, 338

- Parking lamps, rear 333, 340

- Rear lamps 333

- Side marker lamps, front 333, 338

- Side marker lamps, rear 333, 340

- Standing lamps, front 333, 336, 338
- Standing lamps, rear 333, 340
- Tail lamp unit 339
- Tail lamps 333, 340
- Turn signal lamps,
  - front 333, 336, 338
  - rear 333, 340
- Button
  - Audio system 178
- C**
- CAC 385
- California
  - Important notice 11
- Calling up
  - Maintenance service indicator 285
  - Range (distance to empty) 148
- CAN system 385
- Cargo area see Cargo compartment
- Cargo compartment
  - Fuse box in 359
  - Lighting 115
  - Parcel net 226
  - Storage compartment inside 227
  - Tailgate 94
  - Tie-down rings 233
- Cargo tie-down rings 233
- Catalytic converter 264
- CD changer\* 193
- CD changer\* operation 195
- CD player\*
  - Operating 127
- CD\* operation 193
- Center console 27
  - Front passenger front air bag off indicator lamp 27, 65, 72, 300
  - Lower part 28
  - Upper part 27
- Center console ashtray 238
- Centigrade
  - Setting temperature units 133
- Central locking
  - Automatic 95
  - From inside 96
  - Locking from inside 96
  - Switch 96
  - Switching on/off (control system) 143
  - Unlocking from inside 96
- Central locking switch 96
- Central unlocking
  - Switch 96
  - Unlocking from inside 96
- Central unlocking switch 96
- Certification label 364
- Changing
  - Batteries (SmartKey) 331
  - CDs 193
- Changing key setting 145
- Charging
  - Vehicle battery 348

## Index

- Checking
    - Brake fluid 269
    - Coolant level 269, 275
    - Engine oil level 269, 272
    - Tire inflation pressure 269
    - Vehicle lighting 269
    - Washer reservoir level 269
  - Child safety 69
    - Air bags 62
    - Infant and child restraint systems 66, 69
    - LATCH-type child seat anchors 75
  - Child safety switch see Blocking of rear door window operation
  - Child seat anchors see LATCH-type child seat anchors
  - Cigarette lighter 239
  - Cleaning
    - Cloth upholstery 292
    - Cup holders 291
    - Gear selector lever 291
    - Hard plastic trim items 291
  - Headlamps 161
  - Headliner and shelf below rear window 291
  - Instrument cluster 290
  - Leather upholstery 291
  - Light alloy wheels 290
  - MB Tex upholstery 292
  - Plastic and rubber parts 292
  - Rear window 53
  - Seat belts 291
  - Steering wheel 291
  - Upholstery 291
  - Windows 290
  - Windshield 52
  - Wiper blades 290
  - Wood trims 292
- Climate control 166
  - Clock 25, 119, 135, 136
  - Closing
    - Cup holder, in rear seat armrest 238
    - Glove box 234
    - Hood 271
    - Tailgate 94
  - Tilt/sliding sunroof\* 219
  - Tilt/sliding sunroof\* in an emergency 329
  - Tilt/sliding sunroof\* with SmartKey 221
  - Windows 215, 216
  - Windows with SmartKey 217
- Cloth upholstery
    - Cleaning 292
  - Cockpit 22, 385
  - Cockpit Management and Data System see COMAND\*
  - Collapsible wheel chock 323
  - COMAND\* 386
  - COMAND\* see separate operating instructions
  - Combination switch 112
    - High beam flasher 49
    - Rear window wiper 53
    - Turn signals 50
    - Windshield wipers 50
  - Consumer information 382
  - Control and operation of radio transmitter 264

- Control system 119, 386
    - AUDIO menu 125
    - Convenience submenu 144
    - Display digital speedometer 125
    - Display outside temperature 125
    - Functions 120, 123
    - Instrument cluster
      - submenu 133, 135
    - Lighting submenu 139
    - Menus 122, 123
    - Multifunction display 119
    - Multifunction steering wheel 120
    - NAV\* menu 128
    - Selecting radio system 126
    - Selecting satellite radio\* system 126
    - Settings menu 130
    - Standard display menu 124
    - Submenu Time/Date 135
    - Submenus 121, 123
    - TEL\* menu 148
    - Trip computer menu 146
    - Vehicle status message
      - memory menu 128
    - Vehicle submenu 143
  - Controller Area Network see CAN system
  - Convenience submenu 144
    - Activating
      - easy-entry/exit feature\* 144
    - Setting key dependency 145
    - Setting parking position\* for
      - exterior rear view mirror 146
  - Coolant 275
    - Adding 275
    - Anticorrosion/antifreeze
      - quantity 379
    - Capacities 373
    - Checking level 275
    - Messages in display 308–310
    - Temperature 266
    - Temperature gauge 117
  - Coolant level
    - Checking 269, 275
  - Coolant temperature gauge 25
  - Coolants 379
  - Cruise control 223, 386
    - Canceling 224
    - Driving downhill 224
    - Driving uphill 224
  - Fine adjustment 225
  - Message in display 311
  - Setting current speed 224
  - Setting speeds 225
  - Cruise control lever 223
  - Cruising range, fuel 378
  - Cup holder
    - In rear seat armrest 237
  - Cup holders
    - Cleaning 291
    - In front of seat armrest 236
  - Customer Assistance Center see CAC
- D**
- Date (day)
    - Setting 138
  - Date (month)
    - Setting 137
  - Date (year)
    - Setting 139
  - Daytime running lamp mode 110
    - Setting 140

## Index

- Deactivating
  - Air conditioning (cooling) 173
  - Air recirculation mode 172
  - Alarm 86
  - Anti-theft alarm system\* 86
  - Central locking (control system) 143
  - Climate control 167
  - Climate control system 169
  - Cruise control 224
  - Defrosting 171
  - Engine with the SmartKey 57
  - ESP 82
  - Exterior lamps 109
  - Exterior lamps delayed shut-off 141
  - Hazard warning flasher 113
  - Headlamps 56
  - Immobilizer 85
  - Interior lighting delayed shut-off 143
  - Rear window defroster 165
  - Seat heating\* 104
  - Tow-away alarm\* 87
- Deep water see Standing water
- Defogging
  - Windshield 170
- Defrosting 171
- Delayed shut-off
  - Exterior lamps 141
  - Interior lighting 143
- Dialing
  - A number (telephone\*) 150
- Difficulties
  - While driving see Problems while driving
  - With starting 47
- Digital clock 119
- Digital speedometer 125
- Direction of rotation (tires) 279
- Discharged battery
  - Jump starting 350
- Disconnecting
  - Vehicle battery 348
- Display
  - Messages in display 311
- Display elements
  - Audio system 176
- Displays
  - Digital speedometer 125
  - Maintenance service indicator 284
  - Outside temperature 125
  - Selecting display for
    - status indicator 134
  - Showing vehicle status messages 129
  - Symbol messages 306
  - Text messages 302
  - Vehicle status messages 301
- Distance to empty (range)
  - Calling up 148
- Door control panel 30
- Door entry lamps 115
- Door handle 93
- Door unlock
  - With Tele Aid\* 248



- Doors
  - Message in display 311
  - Opening from inside vehicle 93
  - Opening from the outside 91
- Downhill driving
  - Cruise control 224
- Downshifting 154
- Drink holder see Cup holders
- Drinking and driving 257
- Driving
  - Driving abroad 263
  - General instructions 43, 257
  - Hydroplaning 260
  - In winter 262
  - Problems 54
  - Safety systems 79
  - Through standing water 263
- Driving abroad 263
- Driving instructions 257
- Driving off 259
- Driving safety systems
  - 4MATIC 84
  - ABS 79
  - BAS 80
  - ESP 81
- Driving systems 223
  - Cruise control 223
  - Driving safety systems 79
- E**
  - Easy-entry/exit feature\* 97
    - Activating 144
  - Electrical fuses 356
  - Electrical outlet 240
  - Electrical outlet in cargo compartment 240
  - Electrical outlet in rear passenger compartment 240
  - Electrical system
    - Technical data 370
  - Electronic Stability Program see ESP
- Emergency call
  - 911 213
- Emergency call system\* 242
- Emergency calls
  - Initiating an emergency call 244
  - With Tele Aid\* 243
- Emergency operation (Limp Home Mode) 160
- Emergency operations
  - Closing power
    - tilt/sliding sunroof\* 329
  - Locking the vehicle 327
  - Opening power
    - tilt/sliding sunroof\* 329
  - Remote door unlock 248
  - Unlocking the vehicle 326
- Emergency Tensioning Device see ETD
- Emission control 265
- Emission control information label 364
- Ending
  - A call (telephone\*) 150

## Index

- Engine
    - Compartment 270
    - Starting with
      - automatic transmission 47
    - Starting with the SmartKey 47
    - Technical data 366
    - Turning off with the SmartKey 57
  - Engine cleaning 289
  - Engine compartment 270
    - Fuse box in 358
    - Hood 270
  - Engine malfunction
    - indicator lamp 25, 296
  - Engine number 364, 386
  - Engine oil 272
    - Adding 274
    - Additives 375
    - Checking level 269, 272
    - Consumption 272
    - Display messages 273, 312–313
    - Filler neck 274
    - Messages in display 273, 312–313
    - Viscosity 386
  - Engine oil level
    - Checking 269, 272
  - Engine oils 375
  - ESP 81, 386
    - Four wheel electronic traction system with ESP 84
    - Messages in display 304–305
    - Switching off 82
    - Switching on 83
    - Warning lamp 25, 298
  - ETD 69, 386
    - Safety guidelines 64
  - Ethanol fuel
    - At the gas station 267
    - Requirements 377
    - Switching fuels 378
  - Exterior lamp switch 49, 108
  - Exterior lamps
    - Delayed shut-off 141
  - Exterior rear view mirrors
    - Adjusting 41
    - Parking position\* for 146
- F**
- Fahrenheit
    - Setting temperature units 133
  - Fastening the seat belts 43
  - Fine adjustment
    - Cruise control 225
  - First aid kit 321
  - Flat tire 342
    - Lowering the vehicle 346
    - Minispare wheel 324
    - Mounting the Minispare wheel 342
    - Preparing the vehicle 342
  - Flexible fuel vehicles 377
    - At the gas station 267
    - Switching fuels 378
  - Flexible Service System see FSS
  - Fog lamp, rear
    - Message in display 317
    - Replacing bulb 333
    - Switching on 112

- Fog lamps, front
  - Messages in display 315
  - Replacing bulbs 333
  - Switching on 111
- Four wheel electronic traction system (4MATIC) with ESP 84
- 4MATIC 84
- Front air bags 65
- Front fog lamps
  - Indicator lamp 108
  - Switching on 111
- Front lamps
  - Bi-Xenon\* type 337
  - Halogen-type 335
  - Messages in display 315–318
  - Replacing bulbs 333, 335
  - Switching on 108
- Front passenger front air bag off indicator lamp 27, 65, 72, 300
- Front seat head restraints
  - Installing, manual seat 99
  - Installing, power seat\* 100
- Manual seat 99
- Power seat\* 100
- Removing, manual seat 99
- Removing, power seat\* 100
- Front seats
  - Heating\* 104
- FSS (Flexible Service System) (Canada vehicles) 284, 386
- Fuel 268
  - Additives 377
  - Cruising range 378
  - E85 (Ethanol fuel) 378
  - Fuel reserve warning lamp 299
  - Gasoline additives 377
  - Premium unleaded gasoline 268, 374, 376
  - Requirements 376, 377
  - Switching (Flexible fuel vehicle) 378
  - Technical data 373, 374
- Fuel additives 377
- Fuel cap
  - Message in display 297, 314
- Fuel consumption statistics
  - After start 147
  - Since last reset 147
- Fuel filler flap 267
  - Locking 267
  - Opening in an emergency 328
  - Unlocking 267
- Fuel gauge 25
- Fuel requirements 376
  - For ethanol fuel 377
- Fuel reserve
  - Warning lamp 25
- Fuel tank
  - Capacity 374
  - Filler flap 267
- Fuels, coolants, lubricants etc. Capacities 373
- Functions (control system) 120, 123
  - Resetting 131
- Fuse box
  - In cargo compartment 359
  - In engine compartment 358

## Index

Fuse chart 357  
Fuse extractor 357  
Fuses 356  
    Aids for changing fuses 357  
    Fuse box in cargo compartment 359  
    Fuse box in engine compartment 358  
    Fuse chart 357  
    Fuse extractor 357  
    Main fuse box in passenger compartment 357  
    Spare fuses 357

### G

Garage door opener\* 249  
Gasoline additives 377  
Gasoline see Fuel  
Gear range 386  
    Automatic transmission 155  
    Limiting 155  
    Shifting into optimal 154

Gear range limit  
    Canceling 154  
Gear selector lever 46, 152  
    Cleaning 291  
    Lock 46  
    Position (automatic transmission) 119, 152, 156  
Global  
    Locking 91  
    Unlocking 91  
Global Positioning System see GPS  
Glove box 234  
    Closing 234  
    Locking 234  
    Opening 234  
    Unlocking 234  
Good visibility 161  
GPS 386

### H

Halogen-type  
    Front lamp bulbs 335  
Hands-free microphone 29  
Hard plastic trim items  
    Cleaning 291  
Hazard warning flasher 113  
    Switching off 113  
    Switching on 113  
Head restraints 99  
    Front seats, manual seat 99  
    Front seats, power seat\* 100  
    Manual seat 37  
    Power seat\* 38  
    Rear seats 100  
Head unit  
    Time synchronization\* with 135  
Headlamp cleaning system\* 277  
Headlamp shut-off delay see  
    Delayed shut-off, exterior lamps

- Headlamps
    - Automatic control 109
    - Bi-Xenon\* 385
    - Bi-Xenon\* type
      - Replacing bulbs 337
    - Cleaning 289
    - Cleaning system\* 161, 277, 381
    - Halogen-type, replacing bulbs 335
    - Refilling washer fluid 277
    - Switching off 56
    - Switching on 49
    - Washer fluid 381
  - Headliner and shelf below rear window
    - Cleaning 291
  - Heated seats\* 104
  - Height adjustment
    - Head restraints, manual seat 37
    - Head restraints, power seat\* 38
    - Rear seat head restraints 100
    - Seat belts 45
  - Steering wheel,
    - electrical\* adjustment 40
  - Steering wheel,
    - manual adjustment 40
  - High beam flasher 49, 112
  - High beam headlamps
    - Indicator lamp 25
    - Messages in display 316
    - Replacing bulbs 333, 336
    - Switching on 49, 112
  - High beam headlamps xenon type\*
    - Replacing bulbs 337
  - High mounted brake lamp 333
  - Hood 270
    - Closing 271
    - Message in display 314
    - Opening 270
  - Horn 23
  - Hydroplaning 260
- I**
- Identification labels 364
    - Certification label 364
    - Emission control
      - information label 364
    - Vacuum line routing
      - diagram label 364
    - Vehicle identification
      - number (VIN) 364
  - Ignition 33
  - Immobilizer 85
    - Activating 85
    - Deactivating 85
  - Indicator lamps see
    - Lamps, indicator and warning
  - Infant and child restraint systems 69
    - Installing 74
    - LATCH-type child seat anchors 75
  - Information
    - About service and warranty 10
  - Inside door handle 93

## Index

### Installing

- Infant and child restraint systems 74
  - Parcel net in cargo compartment 227
  - Towing eye bolt 355
  - Twin-reel roller blind 229
  - Wiper blades 341
- Instrument cluster 24, 116, 387
- Cleaning 290
  - Coolant temperature gauge 117
  - Illumination 116
  - Lamps in 294–299
  - Multifunction display 119
  - Outside temperature indicator 118
  - Selecting language 134
- Instrument lighting 116
- Instruments and controls see Cockpit
- Interior lighting 114
- Activating automatic control 114
  - Deactivating automatic control 114
  - Delayed shut-off 143
  - Manual operation 114

### Interior rear view mirror

- Adjusting 41
  - Antiglare 161
- Interior storage spaces 234
- Armrest 235
  - Cup holder in rear seat armrest 237
  - Cup holders in front of seat armrest 236
  - Glove box 234
  - Parcel net in front passenger footwell 238
- Intermittent wiping
- Rear window wiper 53
  - Windshield wipers 52

### J

- Jack 321, 322
- Jump starting 350

### K

- Key 183
- Key dependency memory Settings 145
- Key positions in starter switch 33
- Key, mechanical 326
- Key, SmartKey
  - Battery check lamp 91
  - Checking the batteries 93
  - Factory setting 91
  - Global locking 91
  - Global unlocking 91
  - Loss of 93
  - Messages in display 314
  - Positions in starter switch 33
  - Remote control 90
  - Restoring to factory setting 92
  - Selective setting 91
  - Starting the engine 47
  - Turning off the engine 57
  - Unlocking with 32
- Kickdown 159, 387
- Kilometers/miles in speedometer 133
- Km/h or mph in speedometer 133

**L**

- Labels, identification 364
- Lamp bulbs, exterior 332
- Lamp sensor
  - Message in display 316
- Lamps, exterior
  - Front 333
  - Light sensor 316
  - Messages in display 315–318
  - Rear 333
- Lamps, indicator and warning
  - ABS 25, 294
  - Battery (SmartKey) 91
  - Brakes 25, 295
  - Engine diagnostics 296, 299
  - Engine malfunction 25, 296–297
  - ESP 25, 298
  - Front fog lamps 108
  - Front passenger
    - front air bag off 27, 65, 72, 300
  - Fuel reserve 25, 299
  - High beam headlamps 25
  - Instrument cluster 294–299
  - Low beam headlamps 25
  - Maintenance service indicator 284
  - Rear fog lamp 108
  - Seat belt telltale 25, 299
  - SRS 25, 61, 299
  - Turn signals 25
- Language
  - Multifunction display 134
  - Setting 134
- LATCH-type child seat anchors 75
  - Folding back 76
- Layout of poly-V-belt drive 365
- Leather upholstery
  - Cleaning 291
- Lever for voice control system\* 23
- License plate lamps
  - Messages in display 316
  - Replacing bulbs 333
- Light alloy wheels
  - Cleaning 290
  - Technical data 368
- Light sensor 316
- Lighter see Cigarette lighter
- Lighting 108
  - Automatic headlamp mode 109
  - Cargo compartment 115
  - Combination switch 112
  - Daytime running lamp mode 110
  - Door entry lamps 115
  - Exterior lamp switch 108
  - Front fog lamps 111
  - High beams 112
  - Instrument cluster illumination 116
  - Instruments 116
  - Interior 114
  - Locator lighting 111
  - Low beam 108
  - Manual headlamp mode 109
  - Night security illumination 111
  - Parking lamps 108
  - Rear fog lamp 112
  - Settings (control system) 139
  - Standing lamps 108
- Limiting the gear range 155
- Limp Home Mode 160

## Index

- Loading 226
  - Cargo tie-down rings 233
  - Instructions 232
  - Roof rack\* 226
  - Split rear bench seat 230
- Locator lighting 111
  - Setting 141
- Lock button 387
- Locking 55, 90
  - Automatic while driving 95
  - Centrally from inside 96
  - Fuel filler flap 267
  - Global, SmartKey 91
  - Glove box 234
  - Vehicle in an emergency 327
- Loss of keys 93
- Loss of Service and Warranty Information Booklet 363
- Low beam headlamps
  - Indicator lamp 25
  - Messages in display 316–317
  - Replacing bulbs 333, 335
  - Switching on 49
- Lowering
  - Vehicle 346
- Lubricants
  - Technical data 373
- Luggage cover 229
  - Retractable 229
- M**
- Main dimensions 371
- Main fuse box
  - In passenger compartment 357
- Main odometer 119
- Maintenance 12, 284
  - Vehicles with E85 fuel 378
- Maintenance service
  - Calling up the maintenance service indicator 285
  - Major service (Service B) 284
  - Minor service (Service A) 284
  - Overdue 285
  - Types 285
  - When due 284
- Maintenance service indicator 284
  - Calling up 285, 286
  - Clearing 285, 286
- Maintenance System (U.S. vehicles) 284, 387
- Manual headlamp mode 109
- Manual operations
  - Fuel filler flap 328
  - Interior lighting control 114
  - Locking the vehicle 327
  - Tilt/sliding sunroof\* 329
  - Unlocking the driver's door 326
  - Unlocking the tailgate 326
  - Unlocking transmission gear selector lever 328
- Manual seat
  - Adjusting 36
  - Adjusting backrest tilt 36
  - Adjusting head restraint height 37
  - Adjusting head restraint tilt 37
  - Adjusting seat cushion tilt 36
  - Adjusting seat height 36
  - Front seat head restraints 99
  - Seat fore and aft adjustment 36



- MB Tex upholstery
  - Cleaning 292
- Mechanical key 326
- Memory
  - TV station 192
- Memory function\* 105, 387
  - Recalling positions
    - from memory 106
  - Storing exterior rear view mirror parking position 107
  - Storing key dependent settings 106
- Menus 120
  - AUDIO 125
  - In control system 122, 123
  - NAV\* 128
  - Settings menu 130
  - Standard display 124
  - Submenus 121
  - TEL\* 148
  - Trip computer 146
  - Vehicle status message memory 128
- Microphone
  - Hands-free microphone 29
- Miles/kilometers in speedometer
  - Setting 133
- Minispare wheel 324, 369
  - Bolts 325
  - Mounting 342
- Mirrors
  - Activating exterior rear view mirror parking position\* 163
  - Adjusting 41
  - Automatic antiglare\*
    - for interior mirror 162
  - Automatic antiglare\* for rear view mirror 162
  - Exterior rear view mirror 41
  - Exterior rear view mirror parking position\* 146
  - Interior rear view mirror 41
  - Storing exterior rear view mirror parking position\* 107
- MON 268, 387
- Motor Octane Number see MON
- Mph or km/h in speedometer 133
- Multicontour seats\* 103
- Multifunction display 119, 387
  - Displaying gear range 155
  - Selecting language 134
  - Setting date (day) 138
  - Setting date (month) 137
  - Setting date (year) 139
- Multifunction display messages
  - ABS 302
  - BAS 303
  - Brake fluid 307
  - Brake pads 307
  - Coolant 308–310
  - Cruise control 311
  - Display 311
  - Doors 311
  - Engine oil 312–313

## Index

ESP 304–305  
Fuel cap 297, 314  
Hood 314  
Key, SmartKey 314  
Lamps, exterior 315–318  
Oil 312–313  
Parking brake 307  
Restraint system 305  
Seat belt system 319  
SRS 305  
Steering gear oil level 319  
Tailgate 320  
Tele Aid\* 320  
Telephone\* 320  
Tilt/sliding sunroof\* 320  
Windshield washer fluid 320  
Multifunction steering  
wheel 26, 120, 387  
Buttons 120

## N

Navigation system\*  
Operating 128  
See separate COMAND\*  
operating instructions  
Night security illumination 111  
Setting 141

## O

Occupant safety 60  
Air bags 61  
Children and air bags 62  
Children in the vehicle 69  
Fastening the seat belt 43  
Infant and child restraint systems 69  
LATCH-type child seat anchors 75  
Seat belts 43, 64  
Odometer, main 119  
Oil  
Adding 274  
Filler neck 274

Oil level see Engine oil level  
Oil see Engine oil  
One-touch gearshifting 154  
Canceling gear range limit 154  
Downshifting 154  
Upshifting 154  
Opening  
Cup holder, in rear seat armrest 238  
Doors from the inside 93  
Fuel filler flap 268  
Fuel filler flap manually 328  
Glove box 234  
Hood 270  
Power tilt/sliding sunroof\*  
in an emergency 329  
Side windows 215  
Tailgate 94  
Tilt/sliding sunroof\* 219, 329  
Tilt/sliding sunroof\*  
with SmartKey 221  
Windows 215  
Windows with SmartKey 217

- Operating
    - Audio system 175
    - CD player\* 127
    - COMAND\* see separate operating instructions
    - Navigation system\* 128
    - Radio 126
    - Radio transmitters 264
    - Satellite radio\* 126
    - Telephone\* 148, 175, 200
    - Vehicle outside
      - the USA and Canada 13
  - Operating safety
    - Audio system 175
  - Operator's Manual 10
  - Ornamental moldings 289
  - Outer seats
    - Rear seat head restraints 100, 102
  - Outside temperature 125
  - Outside temperature indicator 118
  - Overdue maintenance service 285
  - Overhead control panel 29
  - Overspeed range 387
- P**
- Paintwork 288
  - Panic alarm\* 78
    - Panic button on SmartKey 78
  - Parcel net
    - In cargo compartment 226
    - In front passenger footwell 238
  - Parking 55, 259
  - Parking brake 47, 55
    - Engaging 55
    - Message in display 307
    - Releasing 47
  - Parking lamps
    - Messages in display 317
  - Parking lamps, front
    - Replacing bulbs 333
  - Parking lamps, rear
    - Replacing bulbs 333
  - Parking position\*
    - Exterior rear view mirrors 107, 146, 163
  - Partition net 228
  - Parts service 362
  - Passenger compartment 263
    - Interior lighting 114
    - Interior rear view mirror 41
    - Main fuse box in 357
    - Parcel net in front
      - passenger footwell 238
  - Passenger safety see Occupant safety
  - Pedals 257
  - Performance
    - In cold weather 378
    - In hot weather 378
  - Phone book\*
    - Loading 150
    - Quick search 151
  - Phone number\*
    - Dialing 150
    - Redialing 151
  - Plastic and rubber parts
    - Cleaning 292

## Index

- Playing
    - CDs 196
  - Poly-V-belt drive 387
    - Layout 365
  - Positions (Memory function\*)
    - Recalling from memory 106
    - Storing into memory 106
  - Power assistance 257
  - Power seat\*
    - Adjusting backrest tilt 38
    - Adjusting head restraint height 38
    - Adjusting head restraint tilt 39
    - Adjusting seat cushion tilt 38
    - Adjusting seat height 38
    - Memory function\* 105
    - Removing/installing front head restraints 100
    - Seat fore and aft adjustment 38
  - Power tilt/sliding sunroof\* 219
  - Power train 388
  - Power washer 288
  - Power windows 215
    - Blocking of rear door window operation 77
    - Side windows 215
    - Synchronizing 218
  - Practical hints
    - Collapsible wheel chock 323
    - First aid kit 321
    - Fuses 356
    - Lamp in center console 300
    - Lamps in instrument cluster 294
    - Minispare wheel 324
    - Symbol messages 306
    - Text messages 302
    - Towing the vehicle 352
    - Vehicle jack 321, 322
    - Vehicle status messages in the display 301
    - Vehicle tool kit 321
  - Premium unleaded gasoline 376
  - Problems
    - While driving 54
    - With vehicle 17
  - Product information 9
  - Program mode 119
  - Program mode selector switch 388
    - Automatic shift program, automatic transmission 158
- Q**
- Quick search
    - Phone book\* 151
- R**
- Radio
    - Selecting stations 126
  - Radio operation 183
  - Radio see Radio operation
  - Radio transmitter, control and operation 264
  - Range (distance to empty)
    - Calling up 148
  - Reading lamp 114
  - Rear bench seat
    - Foldable 230
  - Rear door window
    - Blocking operation 77

- Rear fog lamp 333
  - Bulb 333
  - Indicator lamp 108
  - Switching on 112
- Rear lamp bulbs
  - Replacing 339
- Rear lamps
  - Messages in display 315–318
- Rear lamps see Tail lamps
- Rear outer seats
  - Adjusting head restraint height 100
- Rear passenger compartment, adjustable air vents 174
- Rear seat ashtray 239
- Rear seat head restraints 100
  - Adjusting 100
  - Adjusting tilt 102
  - Folding back 101
  - Installing 102
  - Outer seats 102
  - Placing upright 101
  - Removing 102
- Rear view mirrors see Mirrors
- Rear window defroster 165
- Rear window wiper 53
  - Intermittent wiping 53
  - Wiping rear window with washer fluid 53
- Reconnecting
  - Vehicle battery 349
- Recovery services
  - For stolen vehicle 249
- Refrigerant
  - Air conditioning 375
- Refueling 267
- Regular checks 269
- Reinstalling vehicle battery 348
- Remote control
  - SmartKey 90
- Remote door unlock
  - With Tele Aid\* 248
- Removing
  - Parcel net in cargo compartment 227
  - Twin-reel roller blind 229
  - Vehicle battery 348
  - Wheel 344
  - Wiper blades 341
- Replacing
  - Backup lamp bulbs 340
  - Brake lamp bulbs 340
  - Bulbs 332
  - Fog lamp bulb, rear 340
  - Front lamp bulbs 333, 335
  - Fuses 357
  - High beam bulbs 336
  - High beam bulbs (xenon-type\* headlamps) 337
  - License plate lamp bulbs 340
  - Low beam bulbs 335
  - Parking lamp bulbs, front 336, 338
  - Parking lamp bulbs, rear 340
  - Rear lamp bulbs 333, 339

## Index

- Side marker lamp bulbs, front 338
- Side marker lamp bulbs, rear 340
- Standing lamp bulbs, front 336, 338
- Standing lamp bulbs, rear 340
- Tail lamp bulbs 340
- Turn signal lamp bulbs,  
front 336, 338
- Turn signal lamp bulbs,  
rear 340
- Wiper blades 341
- Reporting
  - Safety defects 18
- Research Octane Number see RON
- Reset button in the  
instrument cluster 116, 130, 131
- Resetting
  - All functions (control system) 130
  - All functions of a submenu 131
  - Fuel consumption 148
  - Maintenance service indicator 286
  - Trip odometer 117
- REST 388
- Restraint system
  - Message in display 305
- Restraint system see
  - Infant and child restraint systems
- Rims 367
- Roadside Assistance 12
- RON 268, 388
- Roof rack\* 226
- Rubber parts
  - Cleaning 292
- S**
- Safety
  - Occupant 60
- Safety belts see Seat belts
- Safety defects
  - Reporting 18
- Safety systems
  - Driving 79
- Satellite radio
  - additional text information 192
  - general information 188
  - manual channel input 190
  - storing of station 192
- Seat belt force limiter 69
- Seat belt height adjustment
  - Front seats 45
  - Rear outer seats 45
- Seat belt system
  - Message in display 319
- Seat belt telltale 25
- Seat belts 66
  - Cleaning 291
  - Fastening 43
  - Height adjustment 45
  - Proper use of 45, 68
  - Safety guidelines 64
  - Telltale 299
- Seat cushion depth
  - Adjusting 103
- Seat heating\*
  - Switching off 104
  - Switching on 104

- Seats 97
  - Adjusting 35
  - Easy entry/exit feature\* 97
  - Heating\* 104
  - Manual seat 36
  - Multicontour seat\* 103
  - Power seat\* 38
  - Split rear bench seat 230
- Securing cargo
  - Cargo tie-down rings 233
- Selecting
  - Automatic time change
    - (Daylight Saving Time  
(DST) summer/winter) 137
  - Display for status indicator 134
  - station (satellite radio) 190
- Selecting radio mode 183
- Selector lever see gear selector lever
- Self-test
  - BabySmart™ air bag  
deactivation system 72
  - Tele Aid\* 243
- Service
  - Parts 362
- Service and Warranty Booklet
  - Loss of 363
- Service and warranty information 10
- Service life (tires) 279
- Service see Maintenance
- Service System see FSS
- Setting
  - Convenience functions 132, 144
  - Cruise control 224
  - Date (day) 138
  - Date (month) 137
  - Date (year) 139
  - Daytime running lamp mode 140
  - Exterior rear view mirror  
parking position\* 107
  - Higher speed in cruise control 225
  - Hours (clock) 135
  - Individual vehicle settings 130
  - Instrument lighting 116
  - Interior lighting delayed shut-off 143
- Key dependent memory 145
- Lamps and lighting
  - (control system) 139
- Language, multifunction display 134
- Locator lighting 141
- Lower speed in cruise control 225
- Miles/kilometers
  - in speedometer 133
- Minutes (clock) 136
- Night security illumination 141
- Parking position\* for exterior  
rear view mirrors 146
- Radio station 190
- Slower speed in cruise control 225
- Speed in cruise control 225
- Speedometer display mode 133
- Temperature (interior) 169
- Temperature indicator 133
- Time display mode (Clock) 137
- Units
  - Speedometer 133
  - Temperature 133

## Index

- Setting current speed 224
- Setting the temperature 169
- Settings
  - Convenience functions 144
  - Factory, SmartKey 91
  - Individual, SmartKey 145
  - Lighting (control system) 139
  - Menus and submenus 121
  - Resetting all (control system) 130
  - Resetting in the submenu 131
  - Selective, SmartKey 91
- Settings menu
  - Functions in 130
  - Individual vehicle settings 130
  - Submenus 131
- Shift lock 388
- Shift program mode 119
- Shifting
  - Gear selector lever 46, 152
  - Gear selector lever positions 156
  - Into optimal gear range
    - (automatic transmission) 154
- Side impact air bags 66
- Side marker lamps, front
  - Messages in display 315
  - Replacing bulbs 333
- Side marker lamps, rear
  - Replacing bulbs 333
- Side markers
  - Cleaning 289
- Side windows
  - Automatic opening 216
  - Cleaning 290
  - Closing 215, 216, 217
  - Closing fully 216
  - Closing with SmartKey 217
  - Opening 215, 216, 217
  - Opening fully 216
  - Opening with SmartKey 217
  - Stopping 217
  - Synchronizing power windows 218
- Simultaneous wiping and washing
  - Rear window wiper 53
  - Windshield wipers 52
- Single CD mode selector 177
- Single wipe 52
- Sliding in
  - Swiveling cup holder,
    - in front of seat armrest 237
- Sliding out
  - Swiveling cup holder,
    - in front of seat armrest 236
- SmartKey 90
  - Changing batteries 331
  - Locking and unlocking 90
  - Opening and closing the tilt/sliding sunroof\* with 221
  - Opening and closing windows with 217
  - Unlocking with 32
- Snow chains 283
- Soft keys
  - Audio system 178
- Sound system\* 180
- Spare fuses 357
- Spare wheel 369



- Spare wheel bolts
  - For Minispare wheel 325
- Speed
  - Setting current 224
- Speed settings
  - Cruise control 225
- Speedometer 25
  - Settings units 133
- Speedometer display mode
  - Selecting 133
- Split rear bench seat 230
- SRS 68, 388
  - Indicator lamp 25, 299
  - Message in display 305
- Standing lamps, front
  - Replacing bulbs 333
- Standing lamps, rear
  - Replacing bulbs 333
- Standing water
  - Driving instructions 263
- Starter switch 23, 33
  - Positions 33
- Starting difficulties 47
- Starting position 33
- Starting the engine 46
- Station (satellite radio)
  - selecting 190
- Steering column
  - Height adjustment, electrical\* 41
  - Height adjustment, manual 40
  - Length adjustment, electrical\* 41
  - Length adjustment, manual 40
- Steering gear oil
  - Message in display 319
- Steering wheel
  - Adjusting 39
  - Buttons 26
  - Cleaning 291
  - Electrical adjustment\* 40
  - Manual adjustment 40
- Stolen vehicle
  - Recovery services 249
- Stopping
  - Tilt/sliding sunroof\* 221
  - Windows 217
- Storage compartments
  - Cargo compartment 227
  - Glove box 234
- Storage spaces
  - Cup holder in rear seat armrest 237
  - Cup holders in front of seat armrest 236
- Storing
  - station (satellite radio) 192
- Storing (Memory function\*)
  - Positions into memory 106
- Submenus
  - Convenience 144
  - For settings 121
  - In control system 123
  - Instrument cluster 133, 135

## Index

- Lighting 139
  - Resetting functions in
    - Control system 131
  - Selecting 131
  - Settings menu 131
  - Time/Date 135
  - Vehicle 143
- Substitute lamps
  - Bulbs 332
- Sun visors 164
- Supplemental Restraint System see SRS
- Switching
  - Fuel (Flexible fuel vehicle) 378
- Switching off
  - Audio system 178
  - Automatic central locking (control system) 143
  - Delayed (exterior lamps) 141
  - Engine 57
  - ESP 82
  - Hazard warning flasher 113
  - Headlamps 56
  - Seat heating\* 104
- Switching on
  - Audio system 178
  - Automatic central locking (control system) 143
  - ESP 83
  - Front fog lamps 111
  - Hazard warning flasher 113
  - Headlamps 49
  - High beam headlamps 49
  - High beams 112
  - Low beam headlamps 49
  - Rear fog lamp 112
  - Seat heating\* 104
  - Windshield wipers 51
- Symbols 15
- Synchronizing
  - Power windows 218
  - Tilt/sliding sunroof\* 222
- T**
  - Tachometer 25, 118
    - Overspeed range 118
  - Tail lamps
    - Cleaning 289
    - Messages in display 317
    - Replacing bulbs 333, 339
  - Tailgate
    - Closing 94
    - Message in display 320
    - Opening 94
  - Tar stains 288
  - Technical data
    - Air conditioning refrigerant 375
    - Brake fluid 375
    - Coolant 373
    - Coolants 379
    - Electrical system 370
    - Engine 366
    - Engine oil additives 375
    - Engine oils 375
    - Flexible fuel vehicles 377

- Fuel requirements 376
- Fuels 373, 374
- Gasoline additives 377
- Lubricants 373
- Main dimensions 371
- Premium unleaded gasoline 376
- Rims and tires 367
- Weights 372
- Windshield washer 374
- Windshield washer and headlamp cleaning\* system 374, 381
- Tele Aid\* 242
  - Emergency calls 243
  - Hands-free microphone 29
  - Information 246
  - Initiating an emergency call manually 244
  - Message in display 320
  - Remote door unlock 248
  - Roadside Assistance 245
- SOS button 244
- Stolen Vehicle Recovery services 249
- System self-check 243
- Tele Aid System 242, 389
- Upgrade scenario 247
- Telematics\* 389
- Telephone\* 26, 241
  - Answering a call 149
  - Dialing a number from the phone book 150
  - Ending a call 150
  - Hands-free microphone 29
  - Loading phone book 150
  - Message in display 320
  - Operation 148, 200
  - Redialing 151
- Temperature
  - Display mode 133
  - Grades of tires 383
  - Setting interior temperature 169
  - Setting units in display 133
  - Tires 280
- Tie-down rings
  - (Cargo compartment) 233
- Tightening torque
  - (Wheel bolts) 346, 389
- Tilt
  - Head restraint, manual seat 37
  - Head restraint, power seat\* 39
- Tilt/sliding sunroof\*
  - Closing 219, 329
  - Closing with SmartKey 221
  - Messages in display 320
  - Opening 219, 329
  - Opening with SmartKey 221
  - Stopping 221
  - Synchronizing 222
- Time
  - Setting hours 135
  - Setting minutes 136
- Time display
  - Setting 137
- Time synchronization\*
  - With head unit 135

## Index

- Tire inflation pressure
  - Checking 269, 279
- Tire speed rating 261, 389
- Tire traction 261
- Tires 278, 367
  - Consumer information 382
  - Direction of rotation 279
  - Driving instructions 260
  - Retreads 278
  - Rims and tires 367
  - Rotating 281
  - Service life 279
  - Temperature 280
  - Temperature grades 383
  - Traction 382
  - Tread depth 282
  - Wear pattern 281
  - Winter 282
- Tools 321
- Tow away alarm\*
  - Canceling alarm 88
- Tow-away alarm\* 87
  - Arming 87
  - Disarming 87
  - Disarming for transport 87
- Towing eye bolt (vehicle tool kit)
  - Installing 355
- Towing the vehicle 352
- Traction 158, 389
- Traction (Tires) 382
- Transmission gear selector lever
  - Unlocking manually 328
- Transmission see Automatic transmission
- Traveling abroad 263
- Tread depth (tires) 282
- Tread wear 382
- Trim panel
  - Closing 359
  - Opening 359
- Trip computer 146
- Trip odometer
  - Resetting 117
- Trunk see Cargo compartment
- Turn signal lamps, front
  - Messages in display 318
  - Replacing bulbs 333
- Turn signal lamps, in mirrors
  - Messages in display 318
- Turn signal lamps, rear
  - Messages in display 318
  - Replacing bulbs 333
- Turn signals 50
  - Additional in mirrors 333
  - Cleaning lenses 289
  - Front bulbs 333
  - Indicator lamps 25
  - Rear bulbs 333
- Turning inward
  - Swiveling cup holder,  
in front of seat armrest 237

Turning off  
 Engine 57  
 Turning outward  
 Swiveling cup holder,  
 in front of seat armrest 237  
 Twin-reel roller blind  
 Installing 229  
 Luggage cover and partition net 228  
 Removing 229

**U**

Units  
 Setting speedometer units 133  
 Setting temperature units 133  
 Unlocking 32, 90  
 Centrally from inside 96  
 Driver's door in an emergency 326  
 Fuel filler flap 267  
 Global 91  
 Glove box 234  
 In an emergency 326  
 Selective settings 91

Tailgate in an emergency 326  
 Transmission gear selector  
 lever manually 328  
 Vehicle in an emergency 248  
 With the SmartKey 32  
 Upgrade scenario  
 Tele Aid\* 247  
 Uphill driving  
 Cruise control 224  
 Upholstery  
 Cleaning 291  
 Upshifting 154  
 Useful features 234  
 Ashtrays 238  
 Cigarette lighter 239  
 Electrical outlet 240  
 Interior storage spaces 234  
 Tele Aid\* 242  
 Telephone\* 241

**V**

Vacuum line routing diagram label 364  
 Vehicle  
 Individual settings 130, 132  
 Locking 96  
 Locking in an emergency 327  
 Lowering 346  
 Performance in cold weather 378  
 Performance in hot weather 378  
 Service battery 347  
 Towing 352  
 Unlocking 96  
 Unlocking in an emergency 326  
 With flexible fuel 377  
 Vehicle battery 347  
 Vehicle care 287  
 Cloth upholstery 292  
 Cup holders 291  
 Engine cleaning 289  
 Gear selector lever 291  
 Hard plastic trim items 291  
 Headlamps 289

## Index

- Instrument cluster 290
- Leather upholstery 291
- Light alloy wheels 290
- MB Tex upholstery 292
- Ornamental moldings 289
- Paintwork 288
- Plastic and rubber parts 292
- Power washer 288
- Seat belts 291
- Side markers 289
- Steering wheel 291
- Tail lamps 289
- Tar stains 288
- Turn signals 289
- Upholstery 291
- Vehicle washing 289
- Window cleaning 290
- Wiper blades 290
- Wood trims 292
- Vehicle Identification Number see VIN
- Vehicle jack 322
- Vehicle lighting
  - Checking 269
- Vehicle status message memory 128
  - Calling up 128
  - Clearing 129
- Vehicle status messages
  - Displaying 129
- Vehicle tool kit 321
  - Alignment bolt 322
  - Collapsible wheel chock 322
  - Fuse extractor 322
  - Gloves 322
  - Jack 322
  - Spare fuses 322
  - Spare wheel bolts 322
  - Towing eye bolt 322
  - Vehicle jack 322
  - Wheel wrench 322
- Vehicle washing 289
- VIN 364, 389
- Voice control system\* 389
  - Hands-free microphone 29
- W**
- Warning lamps see
  - Lamps, indicator and warning
- Warning sounds
  - Drivers seat belts 66
  - Parking brake 48
- Warranty coverage 363
- Washer fluid
  - Wiping rear window with 53
  - Wiping windshield with 52
- Washer fluid see Windshield washer fluid
- Washer reservoir level
  - Checking 269
- Washing the vehicle 287
- Wear pattern (tires) 281
- Weights 372
- Wheel change
  - Tightening torque 346
- Wheels
  - Tires and wheels 278
- Window curtain air bags 66
- Windows see Side windows

Windshield  
 Defogging 170  
 Refilling washer fluid 277  
 Replacing wiper blades 341  
 Washer fluid 277, 381  
 Washer system 381  
 Windshield washer fluid 381  
 Message in display 320  
 Mixing ratio 381  
 Refilling 277  
 Windshield washer system 381  
 Windshield wipers 50  
 Fast wiper speed 51  
 Intermittent wiping 52  
 Replacing wiper blades 341  
 Single wipe 52  
 Switching on 51  
 Wiping windshield  
 with washer fluid 52

Winter driving 282  
 Block heater (Canada only) 283  
 Snow chains 283  
 Tires 282  
 Winter driving instructions 262  
 Winter tires 282  
 Wiper blades  
 Cleaning 290  
 Installing 341  
 Removing 341  
 Replacing 341  
 Wiping  
 Rear window with washer fluid 53  
 Windshield with washer fluid 52  
 Wood trims  
 Cleaning 292

**X**  
 Xenon headlamps  
 Bi-Xenon\* 385





### Service and Literature

Your authorized Mercedes-Benz Center has trained technicians and original Mercedes-Benz parts to service your vehicle properly.  
For expert advice and quality service, see an authorized Mercedes-Benz Center.

If you are interested in obtaining service literature for your vehicle, please contact an authorized Mercedes-Benz Center.  
We consider this the best way for you to obtain accurate information for your vehicle.

For further information you can find us on the Mercedes-Benz web-site [www.mbusa.com](http://www.mbusa.com) or [www.mercedes-benz.ca](http://www.mercedes-benz.ca).

#### Warning



To help avoid personal injury, be extremely careful when performing any service work or repairs. Improper or incomplete service or the use of incorrect or inappropriate parts or materials may damage the vehicle or its equipment, which may in turn result in personal injury.

If you have questions about carrying out any type of service, turn to the advice of an authorized Mercedes-Benz Center.

We reserve the right to modify the technical details of the vehicle as given in the data and illustrations of this Operator's Manual.  
Reprinting, translation and copying, even of excerpts, is not permitted without our prior authorization in writing.

Title illustration no. P00.01-2289-31

Press time 03/05/04

GSP/TIP

Printed in Germany

