



Operator's Manual
CLK-Class Coupe



Mercedes-Benz



2095848382

Order No. 6515 1287 13 Part No. 209 584 83 82 USA Edition A 2005

CLK 320

CLK 500

CLK 55 AMG

Our company and staff congratulate you on the purchase of your new Mercedes-Benz.

Your selection of our product is a demonstration of your trust in our company name. Furthermore, it exemplifies your desire to own an automobile that will be as easy as possible to operate and provide years of service.

Your Mercedes-Benz represents the efforts of many skilled engineers and craftsmen. To help assure your driving pleasure, and also the safety of you and your passengers, we ask you to make a small investment of time:

- Please read this manual carefully, then return it to your vehicle where it will be handy for your reference.
- Please follow the recommendations contained in this manual. They are designed to acquaint you with the operation of your Mercedes-Benz.
- Please pay attention to the warnings and cautions contained in this manual. They are designed to help improve the safety of the vehicle operator and occupants.

We extend our best wishes for many miles of safe, pleasurable driving.

Mercedes-Benz USA, LLC
A DaimlerChrysler Company

Contents

Introduction	9	At a glance	21	Getting started	31
Product information	9	Cockpit	22	Unlocking	32
Operator's Manual	10	Instrument cluster	24	Unlocking with the SmartKey	32
Service and warranty information ..	10	Multifunction steering wheel	26	Unlocking with KEYLESS-GO*	33
Important notice for California		Center console	27	Starter switch positions	34
retail buyers and lessees of		Upper part	27	Adjusting	37
Mercedes-Benz automobiles	11	Lower part	28	Seats	37
Maintenance	12	Overhead control panel	29	Steering wheel	40
Roadside Assistance	12	Door control panel	30	Mirrors	41
Change of address or ownership....	12			Driving	43
Operating your vehicle				Fastening the seat belts	43
outside the USA or Canada	13			Starting the engine	46
Where to find it	14			Switching on headlamps	50
Symbols	15			Turn signals	51
Operating safety	16			Windshield wipers	52
Proper use of the vehicle	16			Problems while driving	54
Problems with your vehicle	17			Parking and locking	55
Reporting safety defects	18			Parking brake	55
Reporting safety defects	18			Switching off headlamps	56
Vehicle data recording	19			Turning off the engine	56
Information regarding electronic					
recording devices	19				

Contents

Safety and Security	59	Controls in detail	93	Lighting	124
Occupant safety	60	Locking and unlocking	94	Exterior lamp switch	124
Air bags	61	SmartKey	94	Combination switch	129
Seat belts	67	SmartKey with KEYLESS-GO*	99	Cornering fog lamps* (CLK 320 with	
Children in the vehicle	70	Opening the doors		Bi-Xenon* headlamps)	130
Blocking of		from the inside	105	Hazard warning flasher	131
rear side window operation	82	Opening the trunk	106	Interior lighting	132
Panic alarm	83	Closing the trunk	107	Door entry lamps	133
Activating	83	Trunk lid emergency release	109	Trunk lamp	133
Deactivating	83	Automatic central locking	110	Instrument cluster	134
Driving safety systems	84	Locking and unlocking		Instrument cluster illumination	134
ABS	84	from the inside	110	Coolant temperature indicator	135
BAS	85	Seats	112	Trip odometer	135
ESP	86	Easy-entry/exit feature	112	Tachometer	136
Anti-theft systems	89	Removing and installing		Outside temperature indicator	136
Immobilizer	89	front seat head restraints	113		
Anti-theft alarm system	90	Rear seat head restraints	115		
Tow-away alarm	91	Multicontour seat*	118		
		Seat heating*	119		
		Seat ventilation*	120		
		Memory function	121		
		Storing positions into memory	122		
		Recalling positions from memory	122		
		Storing exterior rear view			
		mirror parking position	123		

Contents

Control system	137	Good visibility	178	Air recirculation mode	201
Multifunction display	137	Headlamp cleaning system*	178	Charcoal filter	202
Multifunction steering wheel	138	Rear view mirrors	178	Air conditioning	204
Menus	140	Sun visors	181	Residual heat and ventilation* (available on Automatic climate control panel design A only)	205
Standard display menu	142	Rear window sunshade*	182	Rear passenger compartment adjustable air vents	206
AUDIO menu	143	Rear window defroster	183	Audio system	207
NAV* menu	144	Climate control (CLK 320)	184	Audio and telephone, operation	207
Vehicle status message memory menu	145	Deactivating the climate control system	187	Operating safety	207
Settings menu	146	Setting the temperature	187	Operating and display elements ...	208
Trip computer menu	160	Adjusting air distribution and volume	188	Button and soft key operation	210
TEL menu*	162	Defrosting	189	Operation	210
Automatic transmission	165	Air recirculation mode	190	Radio operation	215
One-touch gearshifting	167	Air conditioning	191	Introduction to satellite radio* (USA only)	220
Gear ranges	168	Rear passenger compartment adjustable air vents	193	CD mode	225
Gear selector lever position	169	Automatic climate control (CLK 500/CLK 55 AMG)	194	GSM network phones	232
Automatic shift program	170	Deactivating the automatic climate control system	197	TDMA or CDMA network phones ..	238
Driving tips	171	Setting the temperature	197	Emergency calls "911"	245
Steering wheel gearshift control (Speedshift) - CLK 500 and CLK 55 AMG	172	Adjusting air distribution	198	Power windows	247
Manual shift program CLK 55 AMG	175	Adjusting air volume	199	Opening and closing the windows	247
Emergency operation (Limp Home Mode)	177	Defrosting	200	Synchronizing power windows	250
		Maximum cooling MAXCOOL	200		

Contents

Power tilt/sliding sunroof*	251		
Opening and closing			
the power tilt/sliding sunroof	251		
Synchronizing			
the power tilt/sliding sunroof	254		
Driving systems	255		
Cruise control.....	255		
Parktronic system			
(Parking assist)*	260		
Loading.....	264		
Roof rack.....	264		
Ski sack*	264		
Split rear bench seat	267		
Loading instructions	269		
Cargo tie-down rings	271		
Useful features	272		
Storage compartments.....	272		
Cup holders.....	275		
Ashtrays	276		
Cigarette lighter	277		
Electrical outlet in the			
rear passenger compartment	278		
Floor Mats*	278		
Telephone*	279		
Tele Aid	280		
Garage door opener	287		
		Operation	293
		The first 1000 miles (1500 km).....	294
		Driving instructions.....	295
		Drive sensibly – save fuel.....	295
		Drinking and driving	295
		Pedals	295
		Power assistance	295
		Brakes.....	296
		Driving off	297
		Parking.....	297
		Tires	298
		Hydroplaning.....	299
		Tire traction.....	299
		Tire speed rating	300
		Winter driving instructions	301
		Standing water	302
		Passenger compartment	302
		Driving abroad.....	302
		Control and operation	
		of radio transmitters	302
		Catalytic converter	303
		Emission control	304
		Coolant temperature	304
		At the gas station	305
		Refueling.....	305
		Check regularly and	
		before a long trip	307
		Engine compartment	308
		Hood	308
		Engine oil	309
		Transmission fluid level.....	312
		Coolant	313
		Battery	314
		Windshield washer system and	
		headlamp cleaning system*	315
		Tires and wheels.....	316
		Important guidelines	316
		Tire care and maintenance.....	317
		Direction of rotation.....	319
		Loading the vehicle	319
		Recommended	
		tire inflation pressure.....	325
		Checking tire inflation pressure ...	327
		Tire labeling	328
		Load identification	332
		DOT, Tire Identification Number	
		(TIN)	333
		Maximum tire load	334
		Maximum tire inflation pressure ..	335

Contents

Uniform Tire Quality Grading Standards (U.S. vehicles)	336		
Tire ply material	337		
Tire and loading terminology	338		
Rotating tires	341		
Winter driving	342		
Winter tires	342		
Block heater (Canada only)	343		
Snow chains	343		
Maintenance	344		
Clearing the maintenance service indicator	345		
Maintenance service term exceeded	345		
Calling up the maintenance service indicator	345		
Resetting the maintenance service indicator	346		
Vehicle care	347		
Cleaning and care of vehicle	347		
		Practical hints	353
		What to do if ...?	354
		Lamps in instrument cluster	354
		Lamp in center console	360
		Vehicle status messages in the multifunction display	362
		Where will I find...?	389
		First aid kit	389
		Vehicle tool kit	389
		Minispare wheel (except CLK 55 AMG)	393
		Collapsible tire (CLK 55 AMG only)	394
		Spare wheel bolts	396
		Unlocking/locking in an emergency... ..	397
		Unlocking the vehicle	397
		Locking the vehicle	398
		Fuel filler flap	399
		Manually unlocking the gear selector lever	400
		Opening/closing in an emergency	401
		Power tilt/sliding sunroof*	401
		Replacing batteries in the SmartKey/SmartKey with KEYLESS-GO*	402
		SmartKey	402
		SmartKey with KEYLESS-GO*	403
		Replacing bulbs	404
		Bulbs	404
		Replacing bulbs for front lamps	406
		Replacing bulbs for rear lamps	410
		Replacing wiper blades	411
		Removing wiper blades	411
		Installing wiper blades	411
		Flat tire	412
		Preparing the vehicle	412
		Mounting the spare wheel	413

Contents

Battery	420		
Disconnecting the battery	421		
Removing the battery	421		
Charging and reinstalling battery ..	422		
Reconnecting the battery	422		
Jump starting	423		
Towing the vehicle	425		
Towing the vehicle	425		
Installing towing eye bolt	427		
Fuses	429		
Aids for changing fuses	430		
Main fuse box in passenger			
compartment	430		
Fuse box in engine compartment ..	431		
Fuse box in trunk	432		
		Technical data	433
		Parts service	434
		Warranty coverage	435
		Loss of Service and Warranty	
		Information Booklet	435
		Identification labels	436
		Layout of poly-V-belt drive	437
		CLK 320/CLK 500/CLK 55 AMG ..	437
		Engine	438
		Rims and tires	439
		Same size tires	440
		Mixed size tires	441
		Minispare wheel	
		(except CLK 55 AMG)	443
		Collapsible tire	
		(CLK 55 AMG only)	443
		Electrical system	444
		Main dimensions	445
		Weights	446
		Fuels, coolants, lubricants, etc.	447
		Capacities	447
		Engine oils	449
		Engine oil additives	449
		Air conditioning refrigerant	450
		Brake fluid	450
		Premium unleaded gasoline	450
		Fuel requirements	451
		Gasoline additives	451
		Coolants	452
		Windshield washer system and	
		headlamp cleaning system*	454
		Technical terms	455
		Index	461

▼ **Product information**

Please observe the following in your own best interest:

We recommend using genuine Mercedes-Benz parts as well as conversion parts and accessories explicitly approved by us for your vehicle model.

We have tested these parts to determine their reliability, safety and special suitability for Mercedes-Benz vehicles.

We are unable to make an assessment for other products and therefore cannot be held responsible for them, even if in individual cases an official approval or authorization by governmental or other agencies should exist. Use of such parts and accessories could adversely affect the safety, performance or reliability of your vehicle. Please do not use them.

Genuine Mercedes-Benz parts as well as conversion parts and accessories approved by us are available at your authorized Mercedes-Benz Center where you will receive comprehensive information, also on permissible technical modifications, and where proper installation will be performed.

Introduction

Operator's Manual

This Operator's Manual contains a great deal of useful information. We urge you to read it carefully and familiarize yourself with the vehicle before driving.

For your own safety and longer service life of the vehicle, we urge you to follow the instructions and warnings contained in this manual. Ignoring them could result in damage to the vehicle or personal injury to you or others. Vehicle damage caused by failure to follow instructions is not covered by the Mercedes-Benz Limited Warranty.

Your vehicle may have some or all of the equipment described in this manual. Therefore, you may find explanations for optional equipment not installed in your vehicle. If you have any questions about the operation of any equipment, your authorized Mercedes-Benz Center will be glad to demonstrate the proper procedures.

We continuously strive to improve our product, and ask for your understanding that we reserve the right to make changes in design and equipment. Therefore, information, illustrations and descriptions in this Operator's Manual might differ from your vehicle.

Optional equipment is also described in this manual, including operating instructions wherever necessary. Since they are special-order items, the descriptions and illustrations herein may vary slightly from the actual equipment of your vehicle.

If there are any equipment details that are not shown or described in this Operator's Manual, your authorized Mercedes-Benz Center will be glad to inform you of correct care and operating procedures. The Operator's Manual and Maintenance Booklet are important documents and should be kept with the vehicle.

Service and warranty information

The Service and Warranty Information Booklet contains detailed information about the warranties covering your Mercedes-Benz, including:

- New Car Limited Warranty,
- Emission System Warranty,
- Emission Performance Warranty,
- California, Maine, Massachusetts, and Vermont Emission Control System Warranty (California, Maine, Massachusetts, and Vermont only),
- State Warranty Enforcement Laws (Lemon Laws).

Important notice for California retail buyers and lessees of Mercedes-Benz automobiles

Under California law you may be entitled to a replacement of your vehicle or a refund of the purchase price or lease price, if Mercedes-Benz USA, LLC and / or its authorized repair or service facilities fail to fix one or more substantial defects or malfunctions in the vehicle that are covered by its express warranty after a reasonable number of repair attempts. During the period of 18 months from original delivery of the vehicle or the accumulation of 18000 miles (approx. 29000 km) on the odometer of the vehicle, whichever occurs first, a reasonable number of repair attempts is presumed for a retail buyer or lessee if one or more of the following occurs:

- (1) the same substantial defect or malfunction results in a condition that is likely to cause death or serious bodily injury if the vehicle is driven, that defect or malfunction has been subject to repair two or more times, and you have directly notified Mercedes-Benz USA, LLC in writing of the need for its repair,
- (2) the same substantial defect or malfunction of a less serious nature than category (1) has been subject to repair four or more times and you have directly notified us in writing of the need for its repair, or
- (3) the vehicle is out of service by reason of repair of the same or different substantial defects or malfunctions for a cumulative total of more than 30 calendar days.

Written notification should be sent to us, not a dealer, at Mercedes-Benz USA, LLC, Customer Assistance Center, One Mercedes Drive, Montvale, NJ 07645-0350.

Introduction

Operator's Manual

Maintenance

The Maintenance Booklet describes all the necessary maintenance work which should be performed at regular intervals.

Always have the Maintenance Booklet with you when you take the vehicle to your authorized Mercedes-Benz Center for service. The service advisor will record each service in the booklet for you.

Roadside Assistance

The Mercedes-Benz Roadside Assistance Program provides factory trained technical help in the event of a breakdown. Calls to the toll-free Roadside Assistance number

1-800-FOR-MERCEdes (in the USA)
1-800-387-0100 (in Canada)

will be answered by Mercedes-Benz Customer Assistance Representatives 24 hours a day, 365 days a year.

For additional information refer to the Mercedes-Benz Roadside Assistance Program Brochure in your vehicle literature portfolio.

Change of address or ownership

If you change your address, be sure to send in the "Change of Address Notice" found in the Service and Warranty Information Booklet, or simply call the Mercedes-Benz Customer Assistance Center (in the USA) at 1-800-FOR-MERCEdes, or Customer Service (in Canada) at 1-800-387-0100. It is in your own interest that we can contact you should the need arise.

If you sell your Mercedes, please leave all literature with the vehicle to make it available to the next operator.

If you bought this vehicle used, be sure to send in the "Notice of Purchase of Used Car" found in the Service and Warranty Information Booklet, or call the Mercedes-Benz Customer Assistance Center (in the USA) at 1-800-FOR-MERCEdes, or Customer Service (in Canada) at 1-800-387-0100.

Operating your vehicle outside the USA or Canada

If you plan to operate your vehicle in foreign countries, please be aware that:

- service facilities or replacement parts may not be readily available,
- unleaded gasoline for vehicles with catalytic converters may not be available; the use of leaded fuels will damage the catalyts,
- gasoline may have a considerably lower octane rating, and improper fuel can cause engine damage.

Certain Mercedes-Benz models are available for delivery in Europe under our European Delivery Program. For details, consult an authorized Mercedes-Benz Center or write to:

In the USA:

Mercedes-Benz USA, LLC
European Delivery Department
One Mercedes Drive
Montvale, NJ 07645-0350

In Canada:

Mercedes-Benz Canada Inc.
European Delivery Department
98 Vanderhoof Avenue
Toronto, Ontario M4G 4C9

Introduction

Where to find it

This Operator's Manual is designed to provide comprehensive support information for you, the vehicle operator. Each section has its own reference color so you can find information quickly.

At a glance

Here you will find an overview of all the controls that can be operated from the driver's seat.

Getting started

Here you will find all the information you need for your first drive. You should read this section first if this is your first Mercedes-Benz vehicle or if you are renting or borrowing this vehicle.

Safety and Security

Here you will find descriptions of the safety features in your vehicle.

Controls in detail

Here you will find detailed information about the equipment installed in your vehicle. This section expands on the "Getting started" section and also describes technical innovations. If you are already familiar with the basic functions of your vehicle, this section will be of particular interest to you.

Operation

Here you will find all the information you need for the proper operation of your vehicle.

Practical hints

This section provides fast assistance for dealing with problems you may encounter.

Technical data

All important technical data for your vehicle can be found in this section.

Indexes

The glossary provides explanations of the most important technical terms.

The table of contents and the index are designed to help you find information quickly and easily.

The following publications are part of your vehicle documentation:

- this Operator's Manual
- the Maintenance Booklet

Separate operating instructions will be provided as required depending on the equipment options installed in your vehicle.

▼ Symbols

The following symbols are found in this Operator's Manual:

- * Optional equipment is identified with an asterisk. Since standard equipment varies between models, the descriptions and illustrations in this manual may differ slightly from the actual equipment of your vehicle.

Warning!



Warning notices draw your attention to hazards that may endanger your health or life, or the health or life of others.



Highlights hazards that may result in damage to your vehicle.



Helpful hints or further information you may find useful.

- ▶ This symbol points to instructions for you to follow.
- ▶ A number of these symbols appearing in succession indicates a multiple-step procedure.
 - ▷ Page This symbol tells you where to look for further information on a topic.
 - ▷▷ This continuation symbol marks an interrupted procedure which will be continued on the next page.
 - > In the glossary of technical terms, this symbol is used to indicate cross-references to term definitions.
 - Display Words appearing in the multi-function display are printed in the type shown here.

Introduction

Operating safety

Warning!



Work improperly carried out on electronic components and associated software could cause them to cease functioning. Because the vehicle's electronic components are interconnected, any modifications made may produce an undesired effect on other systems. Electronic malfunctions could seriously impair the operating safety of your vehicle.

See an authorized Mercedes-Benz Center for repairs or modifications to electronic components.

Other improper work or modifications on the vehicle could also have a negative impact on the operating safety of the vehicle.

Some safety systems only function while the engine is running. You should therefore never turn off the engine while driving.

Warning!



Heavy blows against the vehicle underbody or tires / wheels, for example when running over an obstacle, road debris or a pothole, may cause serious damage to and impair the operating safety of your vehicle. If you feel a sudden significant vibration or ride disturbance, or you suspect that damage to your vehicle has occurred, you should turn on your hazard warning flashers, carefully slow down, and drive with caution to an area which is a safe distance from the road.

Inspect the vehicle underbody and tires / wheels for possible damage. If the vehicle appears unsafe, have it towed to the nearest authorized Mercedes-Benz Center or other qualified maintenance or repair facility for further inspection or repairs.

Proper use of the vehicle

Proper use of the vehicle requires that you are familiar with the following information and rules:

- the safety precautions in this manual
- the “Technical data” section in this manual
- traffic rules and regulations
- motor vehicle laws and safety standards

Warning!



Various warning labels are attached to your vehicle. These warning labels are intended to make you and others aware of various risks. You should not remove any of these warning labels unless explicitly instructed to do so by information on the label itself. Removal of any of these labels may cause you and others to be unaware of certain risks which may result in an accident and/or personal injury.

▼ **Problems with your vehicle**

If you should experience a problem with your vehicle, particularly one that you believe may affect its safe operation, we urge you to immediately contact an authorized Mercedes-Benz Center to have the problem diagnosed and corrected if required. If the matter is not handled to your satisfaction, please discuss the problem with the Mercedes-Benz Center management, or if necessary contact us at one of the following addresses:

In the USA:

Customer Assistance Center
Mercedes-Benz USA, LLC
One Mercedes Drive
Montvale, NJ 07645-0350

In Canada:

Customer Relations Department
Mercedes-Benz Canada Inc.
98 Vanderhoof Avenue
Toronto, Ontario M4G 4C9

Introduction

Reporting safety defects

For the USA only:

The following text is published as required of manufacturers under Title 49, Code of U.S. Federal Regulations, Part 575 pursuant to the “National Traffic and Motor Vehicle Safety Act of 1966”.

Reporting safety defects

If you believe that your vehicle has a defect which could cause a crash or could cause injury or death, you should immediately inform the National Highway Traffic Safety Administration (NHTSA) in addition to notifying Mercedes-Benz USA, LLC.

If NHTSA receives similar complaints, it may open an investigation, and if it finds that a safety defect exists in a group of vehicles, it may order a recall and remedy campaign. However, NHTSA cannot become involved in individual problems between you, your dealer, or Mercedes-Benz USA, LLC.

To contact NHTSA, you may either call the Auto Safety Hotline toll-free at 1-888-327-4236 (or 366-0123 in Washington, D.C. area) or write to: NHTSA, U.S. Department of Transportation, Washington, D.C. 20590. You can also obtain other information about motor vehicle safety from the Hotline.

▼ Vehicle data recording**Information regarding electronic recording devices**

(Including notice pursuant to California Code § 9951)

Please note that your vehicle is equipped with devices that can record vehicle systems data and, if equipped with the Tele Aid system, may transmit some data in certain accidents.

This information helps, for example, to diagnose vehicle systems after a collision and to continuously improve vehicle safety. DaimlerChrysler may access the information and share it with others

- for safety research or vehicle diagnosis purposes
- with the consent of the vehicle owner or lessee
- in response to an official request by law enforcement or other government agency
- for use in dispute resolution involving DaimlerChrysler, its affiliates or sales/service organization and/or
- as otherwise required or permitted by law.

Please check the Tele Aid subscription service agreement for details regarding the information that may be recorded or transmitted via that system.





At a glance

Cockpit

Instrument cluster

Multifunction steering wheel

Center console

Overhead control panel

Door control panel

At a glance

Cockpit

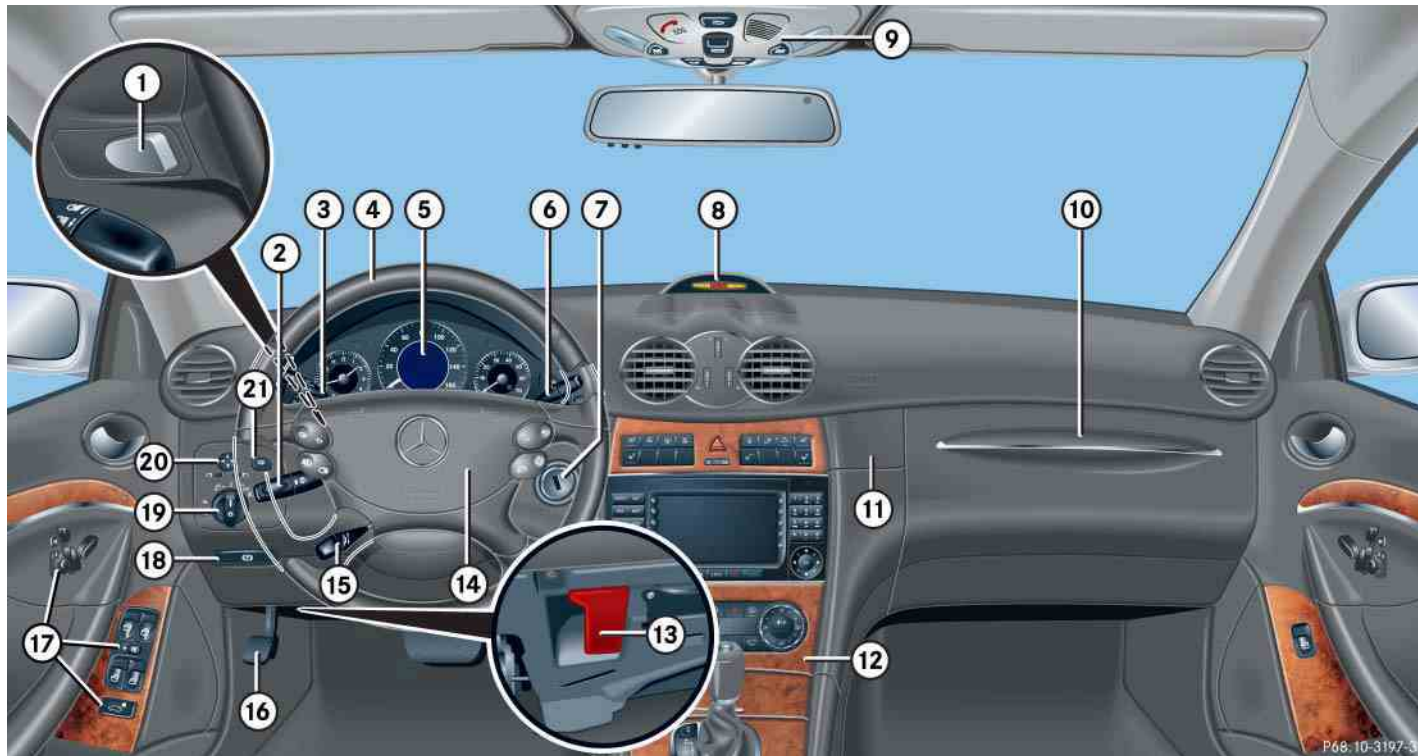

Item	Page
① Steering wheel gearshift buttons (CLK 500, CLK 55 AMG)	172
② Combination switch	
• Turn signals	51
• Windshield wipers	52
• High beam	51
③ Cruise control lever	255
④ Multifunction steering wheel	26, 138
⑤ Instrument cluster	24, 134
⑥ Lever for voice control system*, see separate operating instructions	
⑦ Starter switch	34
⑧ Front Parktronic* warning indicator	262

Item	Page
⑨ Overhead control panel	29
⑩ Glove box	272
⑪ Cup holder	275
⑫ Center console	27, 28
⑬ Hood lock release	308
⑭ Horn	
⑮ Steering wheel adjustment stalk	40
⑯ Parking brake pedal	49
⑰ Door control panel	30
⑱ Parking brake release	49
⑲ Exterior lamp switch	50, 124
⑳ Exterior rear view mirror adjustment	41
㉑ Headlamp washer switch*	178

At a glance





Instrument cluster













P54.32-2726-31

At a glance

Instrument cluster

Item	Page
①  Left turn signal indicator lamp	51
②  ESP warning lamp	358
③ Speedometer	
④ Multifunction display	137
⑤  Distance warning lamp	
Warning lamp without function. It illuminates with the ignition on. It should go out when the engine is running.	
⑥  Right turn signal indicator lamp	51
⑦ Coolant temperature indicator with:	135
 Coolant temperature warning lamp	357, 376

Item	Page
⑧ Tachometer with:	136
 Supplemental restraint system indicator lamp	359, 386
 Antilock Brake System (ABS) warning lamp	354
 Seat belt telltale	359, 386
 High beam headlamp indicator lamp	129
 Low beam headlamp indicator lamp	129
⑨ Main odometer with:	
• Gear selector lever position	166
• Program mode	170

Item	Page
⑩ Clock with:	151
 Brake warning lamp, USA only	355
 Brake warning lamp, Canada only	
 Engine malfunction indicator lamp, USA only	356
 Engine malfunction indicator lamp, Canada only	356
⑪ Fuel display with:	
 Fuel reserve warning lamp	359
⑫ Reset button for:	
• Resetting trip odometer	135
• Adjusting instrument cluster illumination	134
• Confirming new time settings	151

At a glance

Multifunction steering wheel



Item	Page
① Multifunction display	137
Operating control system	138
② Selecting the submenu or setting the volume: Press button	
up / to increase	
down / to decrease	
③ Telephone*: Press button	
to take a call	163
to dial a call	163
to end a call to reject an incoming call	163

Item	Page
④ Menu systems: Press button	
for next menu	
for previous menu	
⑤ Moving within a menu: Press button	
for next display	
for previous display	

At a glance

Center console

▼ Center console

Upper part



P68.20-3144-31

Item	Page
① Seat heater*, driver's side Seat ventilation*, driver's side	119
② Parktronic (Parking assist)* deactivation switch	263
③ Rear window sunshade* switch	182
④ ESP control switch	86
⑤ Hazard warning flasher switch - switching on/off	131
⑥ Central locking switch Central unlocking switch	110
⑦ Switch for folding down rear seat head restraints	116
⑧ Tow-away alarm switch Anti-theft alarm system indicator lamp	91 92

Item	Page
⑨ Seat heater*, passenger side Seat ventilation*, passenger side	119
⑩ Front passenger front air bag off indicator lamp	77, 360
⑪ Audio system, or COMAND* (see separate operating instructions)	143
⑫ Climate control (CLK 320) Automatic climate control (CLK 500, CLK 55 AMG) Rear window defroster	184 194 183

At a glance

Center console

Lower part

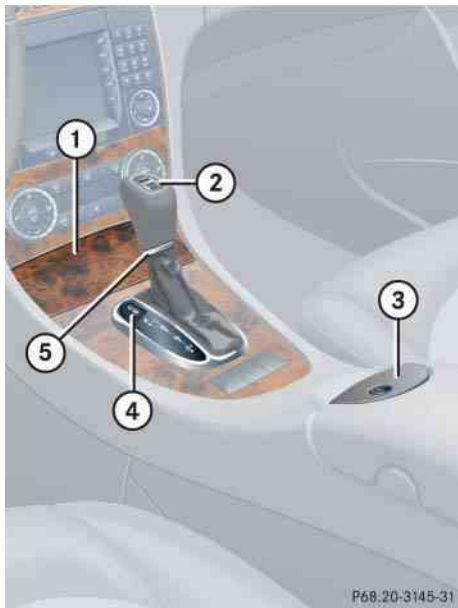

	Item	Page
①	Ashtray	276
	Cigarette lighter	277
②	KEYLESS-GO* start/stop button	35
③	Storage compartment	273
④	Program mode selector switch for automatic transmission	
	• Automatic shift program	170
	• Manual shift program (CLK 55 AMG)	176
⑤	Gear selector lever for automatic transmission	166

At a glance

Overhead control panel

▼ Overhead control panel

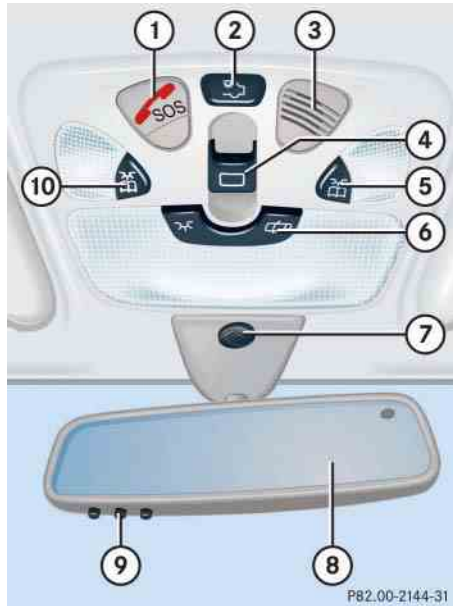

Item	Page
① Tele Aid (emergency call system) button	280
② Rear interior lighting on/off	133
③ Temperature sensor for automatic climate control	
④ Power tilt/sliding sunroof*	251
⑤ Right reading lamp on/off	133
⑥ Interior lighting control	132

Item	Page
⑦ Hands-free microphone for Tele Aid (emergency call system), telephone* and voice control system* (see separate operating instructions)	279
⑧ Interior rear view mirror	41, 178
⑨ Garage door opener	287
⑩ Left reading lamp on/off	133

At a glance

Door control panel



	Item	Page
①	Door handle	105
②	Seat adjustment	38, 112
③	Memory function (for storing seat, exterior mirror and steering wheel settings)	121
④	Switches for opening/closing front door windows	249
⑤	Rear window override switch	82
⑥	Switches for opening/closing rear windows	249
⑦	Remote trunk lid release switch	107



Getting started

Unlocking

Adjusting

Driving

Parking and locking

Getting started

Unlocking



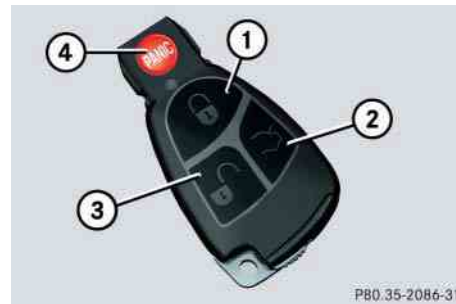

The “Getting started” section provides an overview of the vehicle’s most basic functions. First-time Mercedes-Benz owners should pay special attention to the information given here.

If you are already familiar with the basic functions described here, the “Controls in detail” section will provide you with further information. The corresponding page references are located at the end of each segment.

Unlocking with the SmartKey



SmartKey with remote control

- ①  Lock button
- ②  Opening button for trunk lid
- ③  Unlock button
- ④  Panic button (▷ page 83)

- ▶ Press unlock button  on the SmartKey.

All turn signal lamps flash once. The locking knobs in the doors move up.

- ▶ Enter the vehicle and insert the SmartKey in the starter switch.

Warning!



When leaving the vehicle, always remove the SmartKey from the starter switch, take it with you, and lock the vehicle. Do not leave children unattended in the vehicle, or with access to an unlocked vehicle. Unsupervised use of vehicle equipment may cause an accident and/or serious personal injury.

i

Opening a door causes the windows on that side of the car to open slightly. They will return to the up position when the door is closed.

For more information, see “SmartKey” (▷ page 94).

Unlocking with KEYLESS-GO*

If your vehicle is equipped with the KEYLESS-GO function, your vehicle checks whether the SmartKey with KEYLESS-GO is valid when you pull the door handle. If your SmartKey with KEYLESS-GO is valid, the doors will unlock, and you can open them.

The function of the SmartKey overrules the KEYLESS-GO function.



To unlock the vehicle, the SmartKey with KEYLESS-GO must be outside the vehicle, no further than approx. 3 feet (1 meter) away from the door.

- ▶ Pull the door handle.

The turn signal lamps flash once. The locking knobs on the doors move up.

If the SmartKey with KEYLESS-GO is inside the vehicle, pressing the KEYLESS-GO start/stop button on the gear selector lever corresponds to turning the SmartKey to the various starter switch positions.



Opening a door causes the windows on that side of the car to open slightly. They will return to the up position when the door is closed.

Warning!



When leaving the vehicle, always take the SmartKey with KEYLESS-GO with you, and lock the vehicle. Do not leave children unattended in the vehicle, or with access to an unlocked vehicle. Unsupervised use of vehicle equipment may cause an accident and/or serious personal injury.

For more information, see “SmartKey with KEYLESS-GO*” (▷ page 99).

Getting started

Unlocking

Starter switch positions

Warning!



When leaving the vehicle, always remove the SmartKey or SmartKey with KEYLESS-GO* from the starter switch, take it with you, and lock the vehicle. Do not leave children unattended in the vehicle, or with access to an unlocked vehicle. Unsupervised use of vehicle equipment may cause an accident and/or serious personal injury.

SmartKey

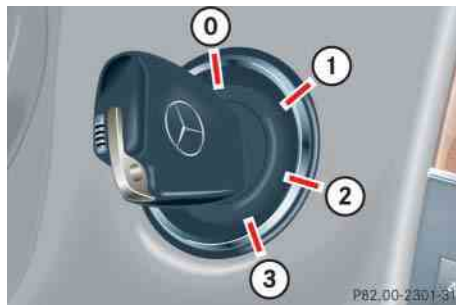

Starter switch

- 0 For removing SmartKey
- 1 Power supply to some electrical consumers, such as seat adjustment
- 2 Ignition (power supply for all electrical consumers) and driving position. All lamps (except low beam headlamp indicator lamp, high beam headlamp indicator lamp, and turn signal indicator lamps unless activated) in the instrument cluster come on. If a lamp in the instrument cluster fails to come on when the ignition is switched on, have it checked and replaced if necessary. If a lamp in the instrument cluster remains on after starting the engine or comes on while driving, refer to “Lamps in instrument cluster” (▷ page 354).
- 3 Starting position

i

When you switch on the ignition, the indicator and warning lamps (except low beam headlamp indicator lamp, high beam headlamp indicator lamp, and turn signal indicator lamps unless activated) in the instrument cluster come on. This indicates that the respective systems are operational. The indicator and warning lamps (except low beam headlamp indicator lamp, high beam headlamp indicator lamp, and turn signal indicator lamps if activated) should go out when the engine is running.

i

The SmartKey can only be removed from the starter switch with the gear selector lever in position **P**.



If the SmartKey cannot be turned in the starter switch, the battery may not be sufficiently charged.

- Check the battery and charge it if necessary (▷ page 420).
- Get a jump start (▷ page 423).

To prevent accelerated battery discharge or a completely discharged battery, always remove the SmartKey from the starter switch when the engine is not in operation.

For more information, see “SmartKey” (▷ page 94).

For information on starting the engine using the SmartKey, see “Starting with the SmartKey” (▷ page 47).

SmartKey with KEYLESS-GO*

Pressing the KEYLESS-GO start/stop button on the gear selector lever corresponds to turning the SmartKey to the various starter positions.

If you firmly depress the brake pedal during pressing the KEYLESS-GO start/stop button, the engine starts automatically.

You can also use the SmartKey with KEYLESS-GO like a normal SmartKey.



The function of the SmartKey overrules the KEYLESS-GO function.

Getting started

Unlocking



KEYLESS-GO start/stop button

- ① KEYLESS-GO start/stop button (U.S. vehicles)
- ② KEYLESS-GO start/stop button (Canada vehicles)

The SmartKey with KEYLESS-GO must be located in the vehicle.

- ▶ Make sure the gear selector lever is set to **P**.
- ▶ Do not depress the brake pedal.

Getting started

Unlocking

Position 0

Before you press the KEYLESS-GO start/stop button, the vehicle's on-board electronics have status **0** (as with SmartKey removed).

Position 1

- ▶ Press the KEYLESS-GO start/stop button once.

This supplies power to some electrical consumers, such as seat adjustment.



If you now press the KEYLESS-GO start/stop button

- once again, the ignition (position **2**) is switched on.
- twice, the power supply is again switched off.

Ignition (or position 2)

- ▶ Press the KEYLESS-GO start/stop button twice.

This supplies power to all electrical consumers. All the lamps (except low beam headlamp indicator lamp, high beam headlamp indicator lamp, and turn signal indicator lamps unless activated) in the instrument cluster come on. If a lamp in the instrument cluster fails to come on when the ignition is switched on, have it checked and replaced if necessary. If a lamp in the instrument cluster remains on after starting the engine or comes on while driving, refer to “Lamps in instrument cluster” (▷ page 354).



If you now press the KEYLESS-GO start/stop button once, the power supply is again switched off.



When you switch on the ignition, the indicator and warning lamps (except low beam headlamp indicator lamp, high beam headlamp indicator lamp, and turn signal indicator lamps unless activated) in the instrument cluster come on. This indicates that the respective systems are operational. The indicator and warning lamps (except low beam headlamp indicator lamp, high beam headlamp indicator lamp, and turn signal indicator lamps if activated) should go out when the engine is running.

For more information, see “SmartKey with KEYLESS-GO*” (▷ page 99).

For information on starting the engine using the KEYLESS-GO start/stop button, see “Starting with KEYLESS-GO*” (▷ page 47).

▼ Adjusting

Warning!



All seat, head restraint, steering wheel, and rear view mirror adjustments, as well as fastening of seat belts, must be done before the vehicle is put into motion.

Seats

Warning!



Do not adjust the driver's seat while driving. Adjusting the seat while driving could cause the driver to lose control of the vehicle.

Never ride in a moving vehicle with the seat back in an excessively reclined position as this can be dangerous. You could slide under the seat belt in a collision. If you slide under it, the belt would apply force at the abdomen or neck. That could cause serious or fatal injuries. The seat back and seat belts provide the best restraint when the wearer is in a nearly upright position and belts are properly positioned on the body.

Your seat must be adjusted so that you can correctly fasten your seat belt (▷ page 43).

Never place hands under the seat or near any moving parts while a seat is being adjusted.

Warning!



When leaving the vehicle, always remove the SmartKey or SmartKey with KEYLESS-GO* from the starter switch, take it with you, and lock the vehicle.

Even with the SmartKey or SmartKey with KEYLESS-GO* removed from the starter switch, or the SmartKey with KEYLESS-GO* removed from the vehicle, the power seats can be operated when the respective door is open. Therefore, do not leave children unattended in the vehicle, or with access to an unlocked vehicle. Unsupervised use of vehicle equipment may cause an accident and/or serious personal injury.

Getting started

Adjusting

Warning!



According to accident statistics, children are safer when properly restrained in the rear seating positions than in the front seating position. Thus, we strongly recommend that children be placed in the rear seats whenever possible. Regardless of seating position, children 12 years old and under must be seated and properly secured in an appropriate infant, or toddler restraint, or booster seat recommended for the size and weight of the child. For additional information, see "Children in the vehicle" (▷ page 70).

A child's risk of serious or fatal injuries is significantly increased if the child restraints are not properly secured in the vehicle and/or the child is not properly secured in the child restraint.

Getting started

Adjusting

Seat adjustment

The seat adjustment switches are located in each door.

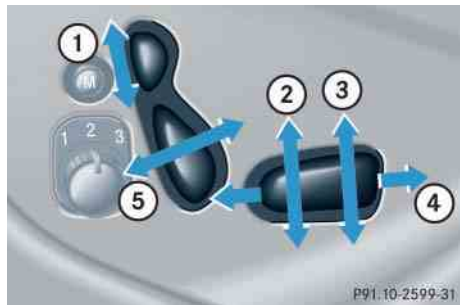

- ① Head restraint height
- ② Seat height
- ③ Seat cushion tilt
- ④ Seat fore and aft adjustment
- ⑤ Backrest tilt

▶ Switch on ignition (▷ page 34).

or

▶ Open the respective door.

Seat fore and aft adjustment

▶ Press switch forward or backward in direction of arrow ④.

Adjust seat to a comfortable seating position that still allows you to reach the accelerator / brake pedal safely. The position should be as far to the rear as possible, consistent with ability to properly operate controls.



When moving the seat, be sure that there are no items in the footwell or behind the seats. Otherwise you could damage the seats.



The memory function (▷ page 121) lets you store the setting for the seat position together with the setting for the steering wheel and the exterior rear view mirrors.

Seat height

▶ Press switch up or down in direction of arrow ②.

Seat cushion tilt

▶ Press switch up or down in direction of arrow ③ until your upper legs are lightly supported.

Seat backrest tilt

▶ Press switch forward or backward in direction of arrow ⑤ until your arms are slightly angled when holding the steering wheel.

Head restraint height

▶ Press switch up or down in direction of arrow ①.



Adjust the head restraint in such a way that it is as close to the head as possible.

Warning!



For your protection, drive only with properly positioned head restraints.

Adjust head restraint so that the center of the head restraint supports the back of the head at eye level. This will reduce the potential for injury to the head and neck in the event of an accident or similar situation.

Do not drive the vehicle without the seat head restraints. Head restraints are intended to help reduce injuries during an accident.

Head restraint tilt

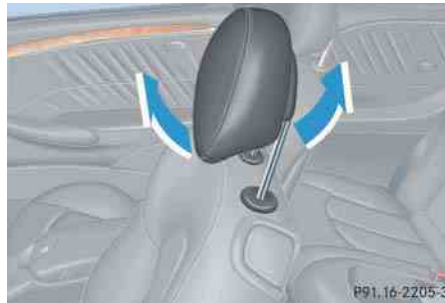

Manually adjust the angle of the head restraint.

- Push or pull on the lower edge of the head restraint cushion.

For more information, see “Seats” (▷ page 112).

Getting started

Adjusting

Folding front seat backrests forward

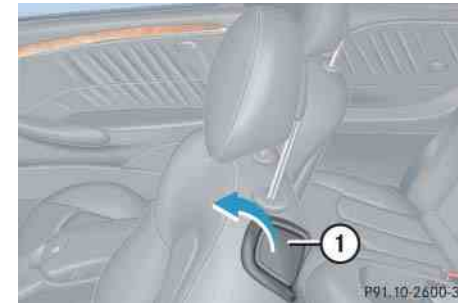

- ① Release lever



In addition to the front seat backrests, the front seat cushions can also be shifted forward to permit easy access to the rear whenever the seat is located in the rear half of its adjustment range. Swivel backrest forward by pulling the release lever until the seat moves in a combined forward and upward movement.

Getting started

Adjusting

Folding backrests forward

- ▶ Pull release lever ① forward and fold the backrest forward.

The head restraint will automatically move down.

Folding backrests back

- ▶ Fold and press the backrest rearward until it engages in driving position.

The head restraint returns to its previous position.

For more information, see “Easy-entry/exit feature” (▷ page 112).

Steering wheel

Warning!



Do not adjust the steering wheel while driving. Adjusting the steering wheel while driving could cause the driver to lose control of the vehicle.

When leaving the vehicle, always remove the SmartKey or SmartKey with KEYLESS-GO* from the starter switch, take it with you, and lock the vehicle.

Even with the SmartKey or SmartKey with KEYLESS-GO* removed from the starter switch, or the SmartKey with KEYLESS-GO* removed from the vehicle, the steering wheel adjustment feature can be operated when the driver's door is open. Therefore, do not leave children unattended in the vehicle, or with access to an unlocked vehicle. Unsupervised use of vehicle equipment may cause an accident and/or serious personal injury.

Steering wheel adjustment

The stalk for steering wheel adjustment is located on the steering column (lower left).



- ① Adjusting steering column, in or out
- ② Adjusting steering column, up or down

- ▶ Switch on ignition (▷ page 34).

or

- ▶ Open the driver's door.

Adjusting steering column in or out

- ▶ Move stalk forward or back in the direction of arrow ① until a comfortable steering wheel position is reached with your arms slightly bent at the elbow.

Adjusting steering column up or down

- ▶ Move stalk up or down in the direction of arrow ②.

Make sure your legs can move freely and all the displays (incl. malfunction and indicator lamps) on the instrument cluster are clearly visible.



The memory function (▷ page 121) lets you store the setting for the steering wheel together with the setting for the seat position and exterior rear view mirrors.

Mirrors

Adjust the interior and exterior rear view mirrors before driving so that you have a good view of the road and traffic conditions.

Warning!



In the case of an accident, liquid electrolyte may escape the mirror housing if the mirror glass breaks.

Electrolyte has an irritating effect. Do not allow the liquid to come into contact with eyes, skin, clothing, or respiratory system. In case it does, immediately flush affected area with water, and seek medical help if necessary.



Electrolyte drops coming into contact with the vehicle paint finish can only be completely removed while in their liquid state and by applying plenty of water

Interior rear view mirror

- ▶ Manually adjust the interior rear view mirror.

For more information, see “Rear view mirrors” (▷ page 178)

Exterior rear view mirror

Warning!



Exercise care when using the passenger-side exterior rear view mirror. The mirror surface is convex (outwardly curved surface for a wider field of view). Objects in mirror are closer than they appear. Check your interior rear view mirror or glance over your shoulder before changing lanes.

Getting started

Adjusting

The buttons are located above the exterior lamp switch.



- ① Adjustment button
- ② Passenger-side exterior rear view mirror button
- ③ Driver's side exterior rear view mirror button

- ▶ Switch on ignition (▷ page 34).
- ▶ Press button ③ for the driver's side exterior rear view mirror or button ② for the passenger-side exterior rear view mirror.
- ▶ Push adjustment button ① up, down, left, or right, according to the desired setting.



If an exterior rear view mirror was forcibly pushed forward (hit from the rear) or forcibly pushed rearward (hit from the front), reposition it by applying firm pressure until it snaps into place. The mirror housing is now properly positioned and you can adjust the mirror normally.



The memory function (▷ page 121) lets you store the setting for the exterior rear view mirrors together with the settings for the steering wheel and seat position.



At low ambient temperatures, the exterior rear view mirrors will be heated automatically.

For more information, see “Rear view mirrors” (▷ page 178).

▼ Driving

Warning!

Do not lay any objects in the driver's footwell. Be careful that floor mats or carpets in the driver's footwell have sufficient clearance for the pedals.

During sudden driving or braking maneuvers, the objects could get caught between the pedals. You could then no longer brake or accelerate.

Fastening the seat belts**Warning!**

Always fasten your seat belt before driving off. Always make sure your passengers are properly restrained, even those sitting in the rear and pregnant women.

Failure to wear and properly fasten and position your seat belt greatly increases your risk of injuries and their likely severity in an accident. You and your passengers should always wear seat belts.

If you are ever in an accident, your injuries can be considerably more severe without your seat belt properly buckled. Without your seat belt buckled, you are much more likely to hit the interior of the vehicle or be ejected from it. You can be seriously injured or killed.

In the same crash, the possibility of injury or death is lessened if you are wearing your seat belt. The air bags can only provide the protection they were designed to afford if the occupants are using their seat belts (> page 60).

Warning!

According to accident statistics, children are safer when properly restrained in the rear seating positions than in the front seating position. Thus, we strongly recommend that children be placed in the rear seats. Regardless of seating position, children 12 years old and under must be seated and properly secured in an appropriate infant or toddler restraint, or booster seat recommended for the size and weight of the child. For additional information, see "Children in the vehicle" (> page 70).

A child's risk of serious or fatal injuries is significantly increased if the child restraints are not properly secured in the vehicle and/or the child is not properly secured in the child restraint.

Getting started

Driving

Warning!



Never let more people ride in the vehicle than there are seat belts available. Be sure everyone riding in the vehicle is correctly restrained with a separate seat belt. Never use a seat belt for more than one person at a time.

Warning!



Never ride in a moving vehicle with the seat backrest in an excessively reclined position as this can be dangerous. You could slide under the seat belt in a collision. If you slide under it, the belt would apply force at the abdomen or neck. This could cause serious or even fatal injuries. The seat backrest and seat belt provide the best restraint when the wearer is in a nearly upright position and the belt is properly positioned on the body.

Warning!



Read and observe the additional warning notices printed in the “Safety and Security” section (▷ page 64).

The seat belt presenter for driver and passenger makes it easier to put on the seat belt.



① Seat belt presenter

The seat belt presenter slides out when the corresponding door is closed and the ignition is switched on (▷ page 34).

Getting started

Driving

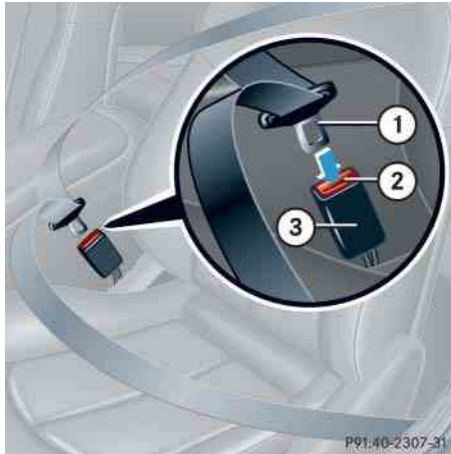

- ① Latch plate
- ② Release button
- ③ Buckle

- ▶ With a smooth motion, pull the belt out of the seat belt presenter.
- ▶ Place the shoulder portion of the belt across the top of your shoulder and the lap portion across your hips.
- ▶ Push latch plate ① into buckle ③ until it clicks.
- ▶ If necessary, tighten the lap portion to a snug fit by pulling shoulder portion up.

Proper use of seat belts

- Do not twist the belt when fastening.
- Adjust seat belt so that the shoulder portion is located as close as possible to the middle of the shoulder (it should not touch the neck). Never pass the shoulder portion of the belt under your arm.
- Position the lap belt as low as possible on your hips (over hip joint) and not across the abdomen.
- Place the seat backrest in a nearly upright position.
- Never use a seat belt for more than one person at a time.
- Do not fasten a seat belt around a person and another object at the same time. When using a seat belt to secure infant or toddler restraints or children in booster seats, always follow the child seat manufacturer's instructions.
- Check your seat belt periodically during travel to make sure that it is properly positioned.
- Make sure that the seat belt is always fitted snugly. Take special care of this when wearing loose clothing.

Getting started

Driving

Warning!



Do not pass belts over sharp edges. They could tear.

Do not allow the belt to get caught in the door or in the seat adjustment mechanism. This could damage the belt.

Never attempt to make modifications to seat belts. This could impair the effectiveness of the belts.

Do not bleach or dye seat belts as this may severely weaken them. In a crash they may not be able to provide adequate protection.

Damaged seat belts or belts that were highly stressed in an accident must be replaced. Contact an authorized Mercedes-Benz Center.

The seat belt presenter slides back:

- right after you pushed the latch plate ① into buckle ③ and heard it click.
- after approximately 30 seconds if you did not push latch plate ① into buckle ③.
- if your door is opened.
- if you turn the SmartKey in the starter switch to position 0.
- if you release a front seat backrest and fold it forward.

Warning!



The seat belt presenter must be retracted while the vehicle is in motion. Only when the seat belt presenter is retracted can the seat belt be properly positioned on the body and protect the occupant as intended.

Starting the engine

Warning!



Inhalation of exhaust gas is hazardous to your health. All exhaust gas contains carbon monoxide, and inhaling it can cause unconsciousness and lead to death.

Do not run the engine in confined areas (such as a garage) which are not properly ventilated. If you think that exhaust gas fumes are entering the vehicle while driving, have the cause determined and corrected immediately. If you must drive under these conditions, drive with at least one window fully open.

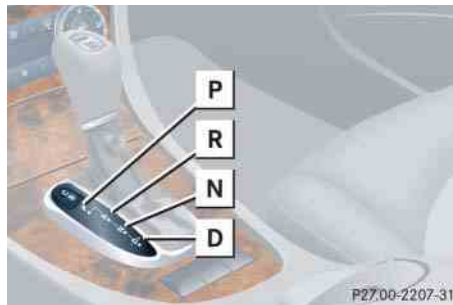
Automatic transmission**Gearshift pattern for automatic transmission**

- P** Park position with gear selector lever lock
- R** Reverse gear
- N** Neutral
- D** Drive position

For more information, see “Automatic transmission” (▷ page 165).

Starting with the SmartKey

- ▶ Make sure the gear selector lever is set to **P**.
- ▶ Do not depress accelerator
- ▶ Turn the SmartKey in the starter switch to position **3** (▷ page 34) and release it again immediately (“touch-start”).
The engine then starts automatically.
- ▶ Depress the brake pedal.

The gear selector lever lock is released.

For information on turning off the engine with the SmartKey, see (▷ page 56).

Starting with KEYLESS-GO*

You can start your vehicle without the SmartKey in the starter switch using the KEYLESS-GO start/stop button on the gear selector lever.

The SmartKey with KEYLESS-GO must be located in the vehicle.

**KEYLESS-GO start/stop button**

- ① KEYLESS-GO start/stop button (U.S. vehicles)
- ② KEYLESS-GO start/stop button (Canada vehicles)

▷▷

Getting started

Driving

- ▷▷ Make sure the gear selector lever is set to **P**.
- ▶ Do not depress accelerator.
- ▶ Depress the brake pedal during the starting procedure.
The gear selector lever lock is released.
- ▶ Press KEYLESS-GO start/stop button once.
The engine starts automatically if the SmartKey with KEYLESS-GO is in the vehicle.

For information on turning off the engine with KEYLESS-GO, see “Turning off the engine with KEYLESS-GO*” (▷ page 57).

Starting difficulties

If the engine does not start as described, carry out the following steps:

- ▶ If you are starting the engine with the SmartKey, turn SmartKey in starter switch to position **0** and repeat starting procedure.
- ▶ If you are starting the engine with KEYLESS-GO*: Close any doors that may be open to allow for better detection of the SmartKey with KEYLESS-GO*.
Or:
Start the engine with the SmartKey as radio signals from another source may be interfering with the SmartKey with KEYLESS-GO*.

- ▶ Repeat the starting procedure (▷ page 46).

Remember that extended starting attempts can drain the battery.

- ▶ Get a jump start (▷ page 423).

If the engine does not start after several starting attempts, there could be a malfunction in the engine electronics or in the fuel supply system.

- ▶ Notify an authorized Mercedes-Benz Center.

Parking brake

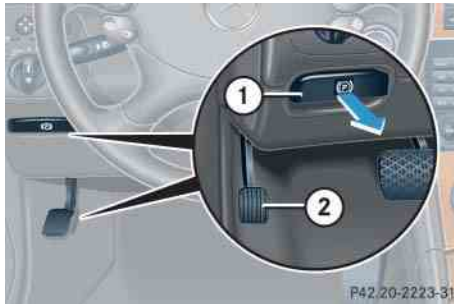

- ① Parking brake release handle
- ② Parking brake pedal

- ▶ Release the parking brake by pulling on handle ①.

The indicator lamp **BRAKE** (USA only) or **(P)** (Canada only) in the clock goes out.

Warning!

When leaving the vehicle, always remove the SmartKey or SmartKey with KEYLESS-GO* from the starter switch, take it with you, and lock the vehicle. Do not leave children unattended in the vehicle, or with access to an unlocked vehicle. Children could release the parking brake, which could result in an accident and/or serious personal injury.

Driving

- ▶ Depress the brake pedal.
- ▶ Move gear selector lever in position **D** or **R**.
- ▶ Release the brake pedal.
- ▶ Carefully depress the accelerator pedal.

Once the vehicle is in motion, the automatic central locking system engages and the locking knobs drop down.



You can open a locked door from the inside. Open door only when conditions are safe to do so.

You can deactivate the automatic locking using the control system (▷ page 158).



If you hear a warning signal and the message **Parking brake Release brake!** appears in the multifunction display when driving off, you have forgotten to release the parking brake.

Release the parking brake.

After a cold start, the automatic transmission shifts at a higher engine revolution. This allows the catalytic converter to reach its operating temperature earlier.

Getting started

Driving



Wait for the gear selection process to complete before setting the vehicle in motion.

Warning!



It is dangerous to shift the gear selector lever out of **P** or **N** if the engine speed is higher than idle speed. If your foot is not firmly on the brake pedal, the vehicle could accelerate quickly forward or in reverse. You could lose control of the vehicle and hit someone or something. Only shift into gear when the engine is idling normally and when your right foot is firmly on the brake pedal.



Simultaneously depressing the accelerator pedal and applying the brake reduces engine performance and causes premature brake and drivetrain wear.

Warning!



On slippery road surfaces, never downshift in order to obtain braking action. This could result in drive wheel slip and reduced vehicle control. Your vehicle's ABS will not prevent this type of loss of control.



Place the gear selector lever in position **R** or **P** only when the vehicle is stopped in order to avoid damaging the transmission.



Do not run cold engine at high engine speeds. Running a cold engine at high engine speeds may shorten the service life of the engine.

For more information on driving, see “Driving instructions” (▷ page 295).

Switching on headlamps

For more information on headlamps, see “Lighting” (▷ page 124).

Low beam headlamps

The exterior lamp switch is located on the dashboard to the left of the steering wheel.



Exterior lamp switch

- ① Off
- ② Low beam headlamps on

- ▶ Turn exterior lamp switch to position .

The low beam headlamp indicator lamp  in the instrument cluster comes on (▷ page 24).

High beam

The combination switch is located on the left of the steering column.



Combination switch

- ① High beam
- ② High beam flasher

- ▶ Push combination switch in direction of arrow ①.

The high beam headlamp indicator lamp  in the instrument cluster comes on (▷ page 24).

Turn signals



The combination switch is located on the left of the steering column.



Combination switch

- ① Turn signals, right
- ② Turn signals, left

- ▶ Press combination switch in direction of arrow ① or ②.

The corresponding turn signal indicator lamp  or  in the instrument cluster flashes (▷ page 24).

The combination switch resets automatically after major steering wheel movements.



To signal minor directional changes such as changing lanes, press combination switch only to the point of resistance and release. The corresponding turn signals will flash three times.

Getting started

Driving

Windshield wipers

The combination switch is located on the left of the steering column.

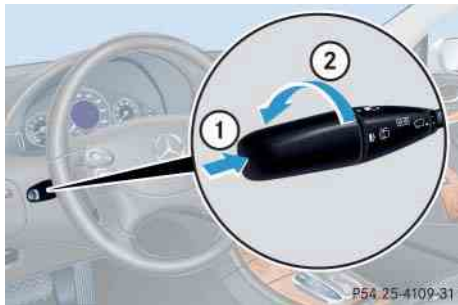

Combination switch

- ① Single wipe
 - ② Switching on windshield wipers
- Switch on ignition (▷ page 34).

Switching on windshield wipers

- Turn the combination switch to the desired position depending on the intensity of the rain.

- 0 Windshield wipers off
- I Intermittent wiping
- II Normal wiper speed
- III Fast wiper speed



The intermittent wiping interval is dependent on wetness of windshield. After the initial wipe, pauses between wipes are automatically controlled by the rain sensor.



Do not leave windshield wipers in intermittent setting when the vehicle is taken to an automatic car wash or during windshield cleaning. Wipers will operate in the presence of water sprayed on the windshield, and wipers may be damaged as a result.

The switch should not be left in intermittent setting as the wipers will wipe the windshield once every time the engine is started. Dust that accumulates on the windshield might scratch the glass and/or damage the wiper blades when wiping occurs on a dry windshield.

Intermittent wiping

- ▶ Turn the combination switch to position **I**.



The intermittent wiping is interrupted when the vehicle is at a standstill and a door is opened.

Single wipe

- ▶ Press combination switch briefly in the direction of arrow ①.

The windshield wipers wipe one time without washer fluid.

Wiping with windshield washer fluid

- ▶ Push combination switch in the direction of arrow ① past the resistance point.

The windshield wipers operate with washer fluid.

For information on filling up the washer reservoir, see “Windshield washer system and headlamp cleaning system*” (▷ page 315).



If anything blocks the windshield wipers (leaves, snow, etc.), switch them off immediately.

- For safety reasons,
 - turn off the engine by turning the SmartKey to position **0** and withdraw SmartKey from starter switch

or

- turn off the engine by pressing the KEYLESS-GO* start/stop button and open the driver’s door (with the driver’s door open, starter switch is in position **0**, same as with SmartKey removed from starter switch)

before attempting to remove any blockage.

- Remove blockage.
- Turn the windshield wipers on again.

If windshield wipers fail to function at all in switch position **I**,

- set the combination switch to the next highest wiper speed
- have the windshield wipers checked at the nearest authorized Mercedes-Benz Center

Getting started

Driving

Problems while driving

The engine runs erratically and misfires

- An ignition cable may be damaged.
- The engine electronics may not be operating properly.
- Unburned gasoline may have entered the catalytic converter and damaged it.
- ▶ Give very little gas.
- ▶ Have the problem repaired by an authorized Mercedes-Benz Center as soon as possible.

The coolant temperature is above 248°F (120°C)

The coolant is too hot and is no longer cooling the engine.

- ▶ Stop the vehicle as soon as possible and turn off the engine. Allow engine and coolant to cool.
- ▶ Check the coolant level and add coolant if necessary (▷ page 313).

In case of accident

If the vehicle is leaking gasoline:

- ▶ Do not start the engine under any circumstances.
- ▶ Notify local fire and/or police authorities.

If the extent of the damage cannot be determined:

- ▶ Notify an authorized Mercedes-Benz Center.

If no damage can be determined on the

- major assemblies
- fuel system
- engine mount:
- ▶ Start the engine in the usual manner.

▼ Parking and locking

You have now completed your first drive. You have properly stopped and parked your vehicle. End your drive as follows:

Warning!



With the engine not running, there is no power assistance for the brake and steering systems. In this case, it is important to keep in mind that a considerably higher degree of effort is necessary to brake and steer the vehicle.

Warning!



Do not park this vehicle in areas where combustible materials such as grass, hay or leaves can come into contact with the hot exhaust system, as these materials could be ignited and cause a vehicle fire.

Warning!



To reduce the risk of personal injury as a result of inadvertent vehicle movement, before turning off the engine and leaving the vehicle always:

- Keep right foot on brake pedal.
- Firmly depress parking brake pedal.
- Move the gear selector lever to position **P**.
- Slowly release brake pedal.
- When parked on an incline, turn front wheel towards the road curb.
- Turn the SmartKey to starter switch position **0** and remove, or press start/stop button (vehicles with KEYLESS-GO*).
- Take the SmartKey or the SmartKey with KEYLESS-GO* and lock vehicle when leaving.

Getting started

Parking and locking

Parking brake

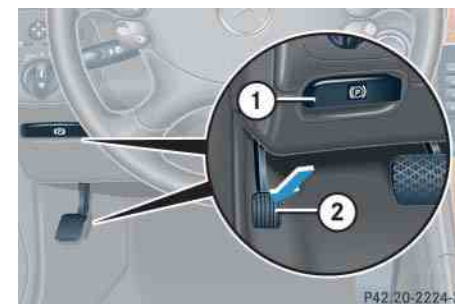

- ① Release handle
- ② Parking brake pedal

- Step firmly on parking brake pedal ②.

When the engine is running, the indicator lamp **BRAKE** (USA only) or **ⓐ** (Canada only) in the instrument cluster will be illuminated.

Getting started

Parking and locking

Warning!



When leaving the vehicle, always remove the SmartKey or SmartKey with KEYLESS-GO* from the starter switch, take it with you, and lock the vehicle. Do not leave children unattended in the vehicle, or with access to an unlocked vehicle. Children could release the parking brake and/or move the gear selector lever from position **P**, either of which could result in an accident and/or serious personal injury.

Warning!



Getting out of your vehicle with the gear selector lever not fully engaged in position **P** is dangerous. Also, when parked on an incline, position **P** alone may not prevent your vehicle from moving, possibly hitting people or objects.

Always set the parking brake in addition to shifting to position **P** (▷ page 169).

When parked on an incline, turn front wheels towards the road curb.

Switching off headlamps

- ▶ Turn the exterior lamp switch to **0** (▷ page 50).

For more information, see “Lighting” (▷ page 124).

Turning off the engine

- ▶ Place the gear selector lever in position **P**.



Always set the parking brake in addition to shifting to position **P**.

On slopes, turn the front wheels towards the curb.

Turning off the engine with the SmartKey

- ▶ Turn the SmartKey in the starter switch (▷ page 34) to position **0** and remove it. The immobilizer is activated.



The SmartKey can only be removed from the starter switch with the gear selector lever in position **P**.

Getting started

Parking and locking

- ▶ Press the seat belt release button (▷ page 45).
Allow the retractor to completely re-wind the seat belt by guiding the latch plate.



With the SmartKey removed and the driver's door open, a warning sounds if the vehicle's exterior lamps are not switched off.

Warning!



To prevent possible personal injury, always keep hands and fingers away from the door openings when closing the doors. Be especially careful when small children are around.

Before closing doors, make sure there is no possibility of someone getting caught in a door during closing.



Opening a door causes the windows on that side of the car to open slightly. They will return to the up position when the door is closed.

- ▶ After exiting the vehicle, press the lock button  on the SmartKey (▷ page 32).

All turn signal lamps flash three times. The locking knobs in the doors move down.

Warning!



When leaving the vehicle, always remove the SmartKey from the starter switch, take it with you, and lock the vehicle. Do not leave children unattended in the vehicle, or with access to an unlocked vehicle. Unsupervised use of vehicle equipment may cause an accident and/or serious personal injury.

For more information, see "Locking and unlocking" (▷ page 94).

Turning off the engine with KEYLESS-GO*

- ▶ Place the gear selector lever in **P**.
- ▶ Press the KEYLESS-GO start/stop button to shut off the engine.

With the driver's door closed, the starter switch is now in position **1**. With the driver's door opened, the starter switch is set to position **0**, same as SmartKey removed from starter switch (▷ page 34).

- ▶ Press the seat belt release button (▷ page 45).

Allow the retractor to completely re-wind the seat belt by guiding the latch plate. ▷▷

Getting started

Parking and locking



If you hear a warning signal you have either

- forgotten to switch off the vehicle's exterior lamps before opening the driver's door, or
- tried to turn off the engine while the gear selector lever is not in **P**.

Turn off the lights or place the gear selector lever in **P**.



Opening a door causes the windows on that side of the car to open slightly. They will return to the up position when the door is closed.

Warning!



To prevent possible personal injury, always keep hands and fingers away from the door openings when closing the doors. Be especially careful when small children are around.

Before closing doors, make sure there is no possibility of someone getting caught in a door during closing.

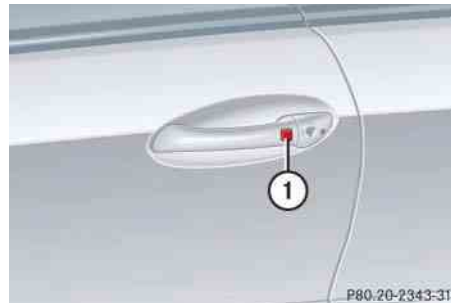

① Lock button on the door handle

- ▶ After exiting the vehicle, press lock button ① on the door handle or on the trunk lid.

All turn signal lamps flash three times. The locking knobs in the doors move down.

Warning!



When leaving the vehicle, always remove the SmartKey or SmartKey with KEYLESS-GO* from the starter switch, take it with you, and lock the vehicle. Do not leave children unattended in the vehicle, or with access to an unlocked vehicle. Unsupervised use of vehicle equipment may cause an accident and/or serious personal injury.

For more information, see “Locking and unlocking” (▷ page 94).

Safety and Security

Occupant safety

Panic alarm

Driving safety systems

Anti-theft systems

Safety and Security

Occupant safety

In this section you will learn the most important facts about the restraint system components of the vehicle.

- Seat belts (▷ page 67)
- Child restraints (▷ page 79)
- Lower anchors and tethers for children (LATCH) (▷ page 80)

Supplemental Restraint System (SRS) with

- Air bags (▷ page 61)
- Air bag control unit (with crash sensors)
- Emergency tensioning device (ETD) for seat belts (▷ page 69)

Air bag system components with

- Front passenger front air bag off indicator lamp (▷ page 77)
- Front passenger seat with Occupant Classification System (OCS) (▷ page 73)

As independent systems, their protective functions work in conjunction with each other.



For information on infants and children traveling with you in the vehicle and restraint systems for infants and children, see “Children in the vehicle” (▷ page 70).

The SRS system conducts a self-test when the ignition is switched on and in regular intervals while the engine is running. This facilitates early detection of malfunctions. The **SRS** indicator lamp in the instrument cluster comes on when the ignition is switched on and goes out no later than a few seconds after the engine has been started.

The SRS components are in operational readiness if the **SRS** indicator lamp is not lit when the engine is running.

A malfunction in the system has been detected if the **SRS** indicator lamp:

- fails to go out after approximately four seconds after the engine was started
- does not come on at all
- comes on after the engine was started or while driving

Safety and Security

Occupant safety

Warning!



In the event that the **SRS** indicator lamp comes on during driving or does not come on at all, the SRS self-check has detected a malfunction. For your safety, we strongly recommend that you visit an authorized Mercedes-Benz Center immediately to have the system checked; otherwise the SRS may not deploy when needed in an accident, which could result in serious or fatal injury, or it might deploy unexpectedly and unnecessarily which could also result in injury.

In addition, improper repair work on the SRS creates a risk of rendering the SRS inoperative or causing unintended air bag deployment. Work on the SRS must therefore only be performed by qualified technicians. Contact an authorized Mercedes-Benz Center.

If it is necessary to modify an air bag system to accommodate a person with disabilities, contact your local authorized Mercedes-Benz Center or call our Customer Assistance Center at 1-800-FOR-MERCEdes (1-800-367-6372) for details.

Air bags

Warning!



Air bags are designed to reduce the potential of injury and fatality in certain frontal impacts (front air bags) or side impacts (side impact air bags and head protection window curtain air bags). However, no system available today can totally eliminate injuries and fatalities.

The deployment of the air bags temporarily releases a small amount of dust from the air bags. This dust, however, is neither injurious to your health, nor does it indicate a fire in the vehicle. The dust might cause some temporary breathing difficulty for people with asthma or other breathing trouble. To avoid this, you may wish to get out of the vehicle as soon as it is safe to do so. If you have any breathing difficulty but cannot get out of the vehicle after the air bag inflates, then get fresh air by opening a window or door.

Safety and Security

Occupant safety

Warning!



To reduce the risk of injury when the front air bags inflate, it is very important for the driver and front passenger to always be in a properly seated position and to wear their respective seat belts.

For maximum protection in the event of a collision always be in normal seated position with your back against the backrest. Fasten your seat belt and make sure that it is properly positioned on your body.

Since the air bag inflates with considerable speed and force, a proper seating and hands on steering wheel position will help to keep you at a safe distance from the air bag. Occupants who are unbelted, out of position or too close to the air bag can be seriously injured by an air bag as it inflates with great force in the blink of an eye:

- Sit properly belted in a nearly upright position with your back against the seat backrest.

- Adjust the driver seat as far as possible rearward, still permitting proper operation of vehicle controls. The distance from the center of the driver's breastbone to the center of the air bag cover on the steering wheel must be at least ten inches (25 cm) or more. You should be able to accomplish this by a combination of adjustments to the seat and steering wheel. If you have any problems, please see an authorized Mercedes-Benz Center.
- Do not lean your head or chest close to the steering wheel or dashboard.
- Keep hands on the outside of steering wheel rim. Placing hands and arms inside the rim can increase the risk and potential severity of hand/arm injury when driver front air bag inflates.
- Adjust the front passenger seat as far as possible rearward from the dashboard when the seat is occupied.

- Occupants, especially children, should never place their bodies or lean their heads in the area of the door or the rear side trim panel where the side impact air bag inflates. This could result in serious injuries or death should the air bag be triggered. Always sit nearly upright, properly use the seat belts and use an appropriately sized infant or toddler restraint or booster seat recommended for the size and weight of the child.

Failure to follow these instructions can result in severe injuries to you or other occupants.

If you sell your vehicle, it is important that you make the buyer aware of this safety information. Be sure to give the buyer this Operator's Manual.

Safety and Security

Occupant safety

Warning!



Accident research shows that the safest place for children in an automobile is in the rear seat.

It should be noted that with respect to both front and rear side impact air bags there is a possibility for a side impact air bag related injury if occupants, especially children, are not properly seated or restrained when next to a side impact air bag which needs to deploy rapidly in a side impact in order to do its job.

To help avoid the possibility of injury, please follow these guidelines:

- (1) Occupants, especially children, should never place their bodies or lean their heads in the area of the door or the rear side trim panel where the side impact air bag inflates. This could result in serious injuries or death should the side impact air bag be deployed.

- (2) Always sit nearly upright, properly use the seat belts and for children 12 years old and under, use an appropriately sized infant or toddler restraint or booster seat recommended for the size and weight of the child.

- (3) Always wear seat belts properly.

If you believe that, even with the use of these guidelines, it would be safer for your rear seat occupants to have the rear mounted side impact air bags deactivated, then deactivation can be accomplished upon your written request to do so at an authorized Mercedes-Benz Center at an additional cost.

Please contact your local authorized Mercedes-Benz Center or call our Customer Assistance Center at 1-800-FOR-MERCEdes (1-800-367-6372) for details.



Air bags are designed to deploy only in certain frontal impacts (front air bags) and in side impacts (side impact and head protection window curtain air bags) which exceed preset thresholds. Only during these events will they provide their supplemental protection.

The driver and passenger should always wear their seat belts. Otherwise it is not possible for the air bags to provide their supplemental protection.

In case of other types of impacts and impacts below air bag deployment thresholds, air bags will not deploy. The driver and passenger will then be protected to the extent possible by a properly fastened seat belt. A properly fastened seat belt is also needed to provide the best possible protection in a rollover.

Safety and Security

Occupant safety

We caution you not to rely on the presence of the air bags in order to avoid wearing your seat belt.

It is important to your safety and that of your passengers that you replace deployed air bags and repair any malfunctioning air bags to make sure that the vehicle will continue to provide supplemental crash protection for occupants.

Safety guidelines for the seat belt, emergency tensioning device and air bag

Warning!



- Damaged seat belts or belts that were highly stressed in an accident must be replaced and their anchoring points must also be checked. Only use belts installed or supplied by an authorized Mercedes-Benz Center.
 - Air bags and emergency tensioning devices (ETDs) are designed to function on a one-time-only basis. An air bag or ETD that is deployed must be replaced.
 - Do not pass belts over sharp edges. They could tear.
 - Do not make any modification that could change the effectiveness of the belts.
 - Do not bleach or dye seat belts as this may severely weaken them. In a crash they may not be able to provide adequate protection.
- No modifications of any kind may be made to any components or wiring of the SRS. This includes changing or removing any component or part of the SRS, the installation of additional trim material, badges, etc. over the steering wheel hub, passenger front air bag cover, door trim panels, or door frame trims, and installation of additional electrical/electronic equipment on or near SRS components and wiring. Keep area between air bags and occupants free from objects (e.g. packages, purses, umbrellas, etc.).
 - Do not hang items such as coat hangers from the coat hooks or handles over the door. These items may turn into projectiles and cause head and other injuries when curtain air bag is deployed.
 - Air bag system components will be hot after an air bag has inflated. Do not touch.
 - Never place your feet on the instrument panel, dashboard, or on the seat. Always keep both feet on the floor in front of the seat.

- In addition, improper repair work on the SRS creates a risk of rendering the SRS inoperative or causing unintended air bag deployment. Work on the SRS must therefore only be performed by qualified technicians. Contact an authorized Mercedes-Benz Center.
- For your protection and the protection of others, when scrapping the air bag unit or emergency tensioning device, our safety instructions must be followed. These instructions are available from your authorized Mercedes-Benz Center.
- Given the considerable deployment speed, required inflation volume, and the textile structure of the air bags, there is the possibility of abrasions or other more significant injuries resulting from air bag deployment.

When you sell your vehicle, we strongly urge you to give notice to the subsequent owner that it is equipped with an SRS by alerting them to the applicable section in the Operator's Manual.

Front air bags



- ① Driver air bag
- ② Passenger air bag

Driver and front passenger air bags are deployed:

- in the event of certain frontal impacts
- if impact exceeds a preset deployment threshold
- independently of the side impact air bags

i

The front air bags in this vehicle have been designed to inflate in two stages. This allows the air bag to have different rates of inflation that are based on the rate of relevant vehicle deceleration as assessed by the air bag control unit.

On the front passenger side, the front air bag deployment is additionally influenced by the passenger's weight category as identified by the Occupant Classification System (OCS) (▷ page 73).

The lighter the front passenger side occupant, the higher the vehicle deceleration rate required for the second stage inflation of the air bag.

The air bags will not deploy in impacts which do not exceed the system's deployment thresholds. You will then be protected by the fastened seat belts.

Safety and Security

Occupant safety

The front passenger front air bag will only be deployed if:

- the system, based on OCS weight sensor readings, senses that the front passenger seat is occupied
- the  indicator lamp in the center console is not lit (▷ page 77).
- the impact exceeds a preset deployment threshold

Side impact air bags, window curtain air bags



- ① Front side impact air bags
- ② Rear side impact air bags
- ③ Window curtain air bag

The side impact air bags and window curtain air bags are deployed:

- on the impacted side of the vehicle
- in impacts exceeding a preset deployment threshold
- independently of the front air bags

The side impact air bags and window curtain air bags are not deployed in impacts which do not exceed the system's deployment threshold.

The front passenger side impact air bag will only deploy if the system senses that the front passenger seat is occupied.

Safety and Security

Occupant safety

Seat belts

When the engine is started, the seat belt telltale  illuminates to remind you and your passengers to fasten your seat belts.

If the driver's seat belt is not fastened before the engine is started, the seat belt telltale  illuminates and a warning chime sounds for approximately six seconds when the engine is started.

The use of seat belts and infant and child restraint systems is required by law in all 50 states, the District of Columbia, the U.S. territories and all Canadian provinces.

Even where this is not the case, all vehicle occupants should have their seat belts fastened whenever the vehicle is in motion.

For more information, see "Fastening the seat belts" (▷ page 43).



For information on infants and children traveling with you in the vehicle and restraint systems for infants and children, see "Children in the vehicle" (▷ page 70).

Warning!



Always fasten your seat belt before driving off. Always make sure all of your passengers are properly restrained, even those sitting in the rear and pregnant women.

Failure to wear and properly fasten and position your seat belt greatly increases your risk of injuries and their likely severity in an accident. You and your passengers should always wear seat belts.

If you are ever in an accident, your injuries can be considerably more severe without your seat belt properly buckled. Without your seat belt buckled, you are much more likely to hit the interior of the vehicle or be ejected from it. You can be seriously injured or killed.

In the same crash, the possibility of injury or death is lessened if you are properly wearing your seat belt. Air bags can only protect as they are designed if the occupants are properly wearing their seat belts.

Safety and Security

Occupant safety

Warning!



Never ride in a moving vehicle with the seat backrest in an excessively reclined position as this can be dangerous. You could slide under the seat belt in a collision. If you slide under it, the belt would apply force at the abdomen or neck. That could cause serious or even fatal injuries. The seat backrest and seat belt provide the best restraint when the wearer is in a nearly upright position and the belt is properly positioned on the body.

Warning!



Never let more people ride in the vehicle than there are seat belts available. Make sure everyone riding in the vehicle is correctly restrained with a separate seat belt. Never use a seat belt for more than one person at a time.

Warning!



Damaged seat belts or belts that were highly stressed in an accident must be replaced and their anchoring points must also be checked.

Only use seat belts which have been approved by Mercedes-Benz.

Do not make any modifications to the seat belts. This can lead to unintended activation of the ETDs or to failure.

Do not bleach or dye seat belts as this may severely weaken them. In a crash they may not be able to provide adequate protection.

Have all work carried out only by qualified technicians. Contact an authorized Mercedes-Benz Center.

Warning!



USE SEAT BELTS PROPERLY

- Seat belts can only work when used properly. Never wear seat belts in any other way than as described in this section, as that could result in serious injuries in case of an accident.
- Each occupant should wear their seat belt at all times, because seat belts help reduce the likelihood of and potential severity of injuries in accidents, including rollovers. The integrated restraint system includes SRS (driver air bag, passenger front air bag, side impact air bags, head protection window curtain air bags for side windows), ETD (seat belt emergency tensioning device), and front seat knee bolsters. The system is designed to enhance the protection offered to properly belted occupants in certain frontal (front air bags and ETD) and side (side impact, window curtain air bags and ETD) impacts which exceed preset deployment thresholds.

Safety and Security

Occupant safety

- Never wear the shoulder belt under your arm, against your neck or off your shoulder. In a frontal crash, your body would move too far forward. That would increase the chance of head and neck injuries. The belt would also apply too much force to the ribs or abdomen, which could severely injure internal organs such as your liver or spleen.
- Never wear belts over rigid or breakable objects in or on your clothing, such as eyeglasses, pens, keys, etc., as these might cause injuries.
- Position the lap belt as low as possible on your hips and not across the abdomen. If the belt is positioned across your abdomen, it could cause serious injuries in a crash.
- Never use a seat belt for more than one person at a time. Do not fasten a seat belt around a person and another person or other objects.

- Belts should not be worn twisted. In a crash, you wouldn't have the full width of the belt to distribute impact forces. The twisted belt against your body could cause injuries.
- Pregnant women should also use a lap-shoulder belt. The lap belt portion should be positioned as low as possible on the hips to avoid any possible pressure on the abdomen.
- Never place your feet on the instrument panel, dashboard, or on the seat. Always keep both feet on the floor in front of the seat.
- When using a seat belt to secure infant or toddler restraints or children in booster seats, always follow the child seat manufacturer's instructions.

Emergency tensioning device (ETD), seat belt force limiter

The seat belts are equipped with emergency tensioning devices and belt force limiters.

The ETD is designed to activate in the following cases:

- in frontal or rear-end impacts exceeding a preset severity level
- if the restraint systems are operational and functioning correctly, see **SRS** indicator lamp (▷ page 60)



The ETDs for the front seats will only activate if the front seat belts are fastened (latch plate properly inserted into buckle).

The ETDs for the rear seats will activate with or without the respective seat belts fastened.

Safety and Security

Occupant safety

In an impact, emergency tensioning devices remove slack from the belts. Belt force limiters reduce the force exerted by the seat belts on occupants during a crash.

Warning!



An emergency tensioning device (ETD) that was activated must be replaced.

When disposing of the emergency tensioning device, our safety instructions must be followed. These are available at your authorized Mercedes-Benz Center.

Automatic comfort-fit feature seat belt

An automatic comfort-fit feature for front seats reduces the retracting force of the seat belts when they are in normal use.

Children in the vehicle

If an infant or child is traveling with you in the vehicle:

- Secure the child using an infant or child restraint appropriate to the age and size of the child.
- Make sure that the infant or child is properly secured all times while the vehicle is in motion.

Infant and child restraint seats and information on choosing an appropriate restraint system can be obtained from any Mercedes-Benz Center.

Infant and child restraint systems

We recommend all infants and children be properly restrained at all times while the vehicle is in motion.

All lap-shoulder belts except the driver's seat belt have special seat belt retractors for secure fastening of child restraints.

To fasten a child restraint, follow child restraint instructions for mounting. Then pull the shoulder belt out completely and let it retract. During seat belt retraction, a ratcheting sound can be heard to indicate that the special seat belt retractor is activated. The belt is now locked. Push down on child restraint to take up any slack.

To deactivate, release seat belt buckle and let seat belt retract completely. The seat belt can again be used in the usual manner.

Safety and Security

Occupant safety



Information on child seats with anchor fittings for tether anchorages (▷ page 79).

For information on LATCH-type child seat anchors (▷ page 80).



The use of infant or child restraints is required by law in all 50 states, the District of Columbia, the U.S. territories, and all Canadian provinces.

Infants and small children should be seated in an appropriate infant or child restraint system, properly secured by a lap/shoulder belt or, if so equipped, a top tether anchorage point and a child restraint lower anchorage system that complies with U.S. Federal Motor Vehicle Safety Standards 213 and 225 and Canadian Motor Vehicle Safety Standards 213 and 210.2.

Warning!



Never release the seat belt buckle while the vehicle is in motion, since the special seat belt retractor will be deactivated.



A statement by the child restraint manufacturer of compliance with this standard can be found on the instruction label on the restraint and in the instruction manual provided with the restraint.

When using any infant or child restraint system, be sure to carefully read and follow all manufacturer's instructions for installation and use.

Please read and observe warning labels affixed to the inside of the vehicle and to infant or child restraints.

Warning!



According to accident statistics, children are safer when properly restrained in the rear seating positions than in the front seating position. Thus, we strongly recommend that children be placed in the rear seats whenever possible. Regardless of seating position, children 12 years old and under must be seated and properly secured in an appropriate infant or child restraint recommended for the size and weight of the child.

The infant or child restraint must be properly secured with the vehicle's seat belt, the seat belt and top tether strap, or lower anchors and top tether strap, fully in accordance with the child seat manufacturer's instructions.







Safety and Security

Occupant safety



Children can be killed or seriously injured by an inflating air bag. Note the following important information when circumstances require you to place a child in the front passenger seat:

- Your vehicle is equipped with air bag technology designed to turn off the front passenger front air bag in your vehicle when the OCS senses the weight of a typical 12-month-old child or less along with the weight of a standard appropriate child restraint on the front passenger seat.
 - A child in a rear-facing child restraint on the front passenger seat will be seriously injured or even killed if the front passenger front air bag inflates in a collision which could occur under some circumstances, even with the air bag technology installed in your vehicle. The only means to completely eliminate this risk is to never place a child in a rear-facing child restraint in the front seat. We therefore strongly recommend that you always place a child in a rear-facing child restraint in the back seat.
- If you must install a rear-facing child restraint on the front passenger seat because circumstances require you to do so, make sure that the  indicator lamp is illuminated, indicating that the front passenger front air bag is deactivated. Should the  indicator lamp not illuminate or go out while the restraint is installed, please check installation. Periodically check the  indicator lamp while driving to make sure the  indicator lamp is illuminated. If the  indicator lamp goes out or remains out, do not transport a child on the front passenger seat until the system has been repaired. A child in a rear-facing child restraint on the front passenger seat will be seriously injured or even killed if the front passenger front air bag inflates.
 - If you have to place a child in a forward-facing child restraint on the front passenger seat, move the seat as far back as possible, use the proper child restraint recommended for the age, size and weight of the child, and secure child restraint with the vehicle's seat belt according to the child seat manufacturer's instructions. For children larger than the typical 12-month-old child, the front passenger front air bag may or may not be activated (▷ page 75).

Safety and Security

Occupant safety

Warning!



Infants and small children should never share a seat belt with another occupant. During an accident, they could be crushed between the occupant and seat belt.

A child's risk of serious or fatal injuries is significantly increased if the child restraints are not properly secured in the vehicle and/or the child is not properly secured in the child restraint.

Children too big for a toddler restraint must ride in seats using regular seat belts. Position shoulder belt across chest and shoulder, not face or neck. A booster seat may be necessary to achieve proper belt positioning for children from 41 lbs until they reach a height where a lap/shoulder belt fits properly without a booster.

When the child restraint is not in use, remove it from the vehicle or secure it with the seat belt to prevent the child restraint from becoming a projectile in the event of an accident.

Do not leave children unattended in the vehicle, even if the children are secured in a child restraint system. Unsupervised children in a child restraint system may use vehicle equipment and may cause an accident and/or serious personal injury.

Occupant Classification System

The Occupant Classification System (OCS) automatically turns the front passenger front air bag on or off based on the classified occupant weight category determined by weight sensor readings from the front passenger seat.



The system does not deactivate the front passenger side impact air bag, the window curtain air bag and the emergency tensioning device.

Occupants must sit properly belted in a nearly upright position with their back against the seat backrest and feet on the floor to be correctly classified. If the occupant's weight is transferred to another object in the vehicle (e.g. by leaning on armrests), the OCS may not be able to properly approximate the occupant's weight category.

Safety and Security

Occupant safety





If your seat, including your trim cover and cushion needs to be serviced in any way, take the vehicle to an authorized Mercedes-Benz Center.

Only seat accessories approved by Mercedes-Benz may be used.

Both driver and the front passenger should always use the  indicator lamp as an indication of whether or not the front passenger is properly positioned.

Warning!



If the  indicator lamp illuminates when an adult or someone larger than a small individual is in the front passenger seat, have the front passenger re-position himself or herself in the seat until the  indicator lamp goes out.

More information about air bag display messages (▷ page 368).



In the event of a collision, the air bag control unit will not allow front passenger front air bag deployment when the OCS classified the front passenger seat occupant as being up to or less than the weight of a typical 12-month-old child in a standard child restraint or if the front passenger seat is sensed as being empty.

When the OCS senses that the front passenger seat occupant is classified as being up to or less than the weight of a typical 12-month-old child in a standard child restraint, the  indicator lamp will illuminate when the engine is started and remain illuminated, indicating that the front passenger front air bag is deactivated.

When the OCS senses that the front passenger seat is classified as being empty, the  indicator lamp will illuminate when the engine is started and remain illuminated, indicating that the front passenger front air bag is deactivated.

Safety and Security

Occupant safety

When the OCS senses that the front passenger seat occupant is classified as being heavier than the weight of a typical 12-month-old child seated in a standard child restraint or as being a small individual (such as a young teenager or a small adult), the  indicator lamp will illuminate for approximately six seconds when the engine is started and then, depending on occupant weight sensor readings from the seat, remain illuminated or go out. With the  indicator lamp illuminated, the front passenger front air bag is deactivated. With the  indicator lamp out, the front passenger front air bag is activated.

When the OCS senses that the front passenger seat occupant is classified as an adult or someone larger than a small individual, the  indicator lamp will illuminate for approximately six seconds when the engine is started and then go out, indicating that the front passenger front air bag is activated.

If the  indicator lamp is illuminated, the front passenger front air bag is deactivated and will not be deployed.

If the  indicator lamp is not illuminated, the front passenger front air bag is activated and will be deployed:

- in the event of certain frontal impacts
- if impact exceeds a preset deployment threshold
- independently of the side impact air bags.

If the front passenger front air bag is deployed, the rate of inflation will be influenced by:

- the rate of relevant vehicle deceleration as assessed by the air bag control unit
- front passenger's weight category as identified by the Occupant Classification System (OCS).

Warning!



According to accident statistics, children are safer when properly restrained in the rear seating positions than in the front seating position. Thus, we strongly recommend that children be placed in the rear seats whenever possible. Regardless of seating position, children 12 years old and under must be seated and properly secured in an appropriate infant or child restraint recommended for the size and weight of the child.

The infant or child restraint must be properly secured with the vehicle's seat belt, the seat belt and top tether strap, or lower anchors and top tether strap, fully in accordance with the child seat manufacturer's instructions.







Safety and Security

Occupant safety



Children can be killed or seriously injured by an inflating air bag. Note the following important information when circumstances require you to place a child in the front passenger seat:

- Your vehicle is equipped with air bag technology designed to turn off the front passenger front air bag in your vehicle when the system senses the weight of a typical 12-month-old child or less along with the weight of a standard appropriate child restraint on the front passenger seat.
 - A child in a rear-facing child restraint on the front passenger seat will be seriously injured or even killed if the front passenger front air bag inflates in a collision which could occur under some circumstances, even with the air bag technology installed in your vehicle. The only means to completely eliminate this risk is to never place a child in a rear-facing child restraint in the front seat. We therefore strongly recommend that you always place a child in a rear-facing child restraint in the back seat.
- If you must install a rear-facing child restraint on the front passenger seat because circumstances require you to do so, make sure that the  indicator lamp is illuminated, indicating that the front passenger front air bag is deactivated. Should the  indicator lamp not illuminate or go out while the restraint is installed, please check installation. Periodically check the  indicator lamp while driving to make sure the  indicator lamp is illuminated. If the  indicator lamp goes out or remains out, do not transport a child on the front passenger seat until the system has been repaired. A child in a rear-facing child restraint on the front passenger seat will be seriously injured or even killed if the front passenger front air bag inflates.
 - If you have to place a child in a forward-facing child restraint on the front passenger seat, move the seat as far back as possible, use the proper child restraint recommended for the age, size and weight of the child, and secure child restraint with the vehicle's seat belt according to the child seat manufacturer's instructions. For children larger than the typical 12-month-old child, the front passenger front air bag may or may not be activated (▷ page 75).

Safety and Security

Occupant safety



Deployment of the driver front air bag does not mean that the front passenger front air bag also should have deployed.

The Occupant Classification System (▷ page 73) may have determined:

- that the seat was empty or occupied by the weight up to or less than that of a typical 12-month-old child seated in a standard child restraint - both instances where the system suppresses deployment of the front passenger front air bag even though the impact met the criteria and was of sufficient severity to deploy the driver front air bag.

- that the seat was occupied by a small individual (such as a young teenager or a small adult) or a child weighing more than the weight of a typical 12-month-old child in a standard child restraint - instances where the system may suppress deployment of the front passenger front air bag even though the impact met the criteria and was of sufficient severity to deploy the driver front air bag.

The  indicator lamp is located in the center console.



① Front passenger front air bag off indicator lamp

The  indicator lamp ① will be illuminated, except with the SmartKey removed or in starter switch position 0.

Safety and Security

Occupant safety

Warning!





If the **SRS** indicator lamp and the  indicator lamp are lit at the same time, there is a malfunction in the Occupant Classification System. The front passenger front air bag will be deactivated in this case.

In order to ensure proper operation of the air bag system and OCS:

- Have the system checked as soon as possible by qualified technicians. Contact an authorized Mercedes-Benz Center.

- Sit properly belted in a nearly upright position with your back against the seat backrest.
- Do not lean on the armrests or lift yourself from the seat by using the handle over the door as this may cause the OCS to be unable to correctly approximate the occupant weight category.
- Only have the seat repaired or replaced by an authorized Mercedes-Benz Center.
- Read and observe all warnings in this chapter.

Self-test Occupant Classification System

After turning the SmartKey in the starter switch to position **1** or **2** or pressing the KEYLESS-GO* start/stop button once or twice, the  indicator lamp ① located in the center console illuminates. If an adult occupant is properly sitting on the front passenger seat and the system senses the occupant as being an adult, the  indicator lamp will illuminate and go out after approximately six seconds.

If the seat is not occupied and the system senses the front passenger seat as being empty, the  indicator lamp will illuminate and not go out.

Safety and Security

Occupant safety

Warning!



If the  indicator lamp should not illuminate, the system is not functioning. You must see an authorized Mercedes-Benz Center before seating any child on the front passenger seat.

More information can be found in the “Practical hints” section (▷ page 360).

Warning!



Never place anything between seat cushion and child seat (e.g. pillow), since it reduces the effectiveness of the Occupant Classification System. The bottom of the child seat must make full contact with the passenger seat cushion. An incorrectly mounted child seat could cause injuries to the child in case of an accident, instead of increasing protection for the child.

Follow the manufacturer’s instructions for installation of child seats.

Installation of infant and child restraint systems

This vehicle is equipped with tether anchorages for a top tether strap at each of the rear seating positions.

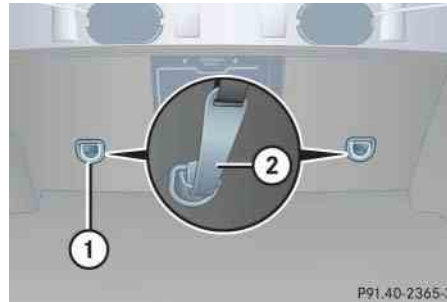

- ① Anchorage ring
- ② Hook

- ▶ Open the trunk and release the rear seat backrest (▷ page 268).
- ▶ Fold rear seat backrest slightly forward.

- ▶ Guide top tether strap between head restraint and top of seat back.

Head restraint must be installed and positioned such that the top tether strap can pass freely between the head restraint and the top of seat back.

Make sure the tether strap is not twisted.

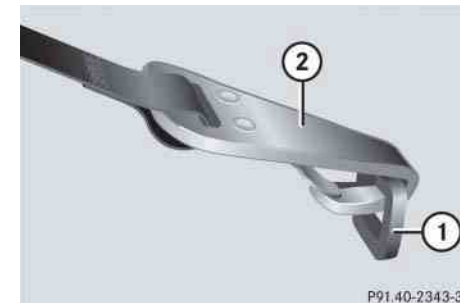

- ① Anchorage ring
- ② Hook

- ▶ Fold up anchorage ring ①.
- ▶ Securely fasten hook ②, which is part of the tether strap, to anchorage ring ①.

▷▷

Safety and Security

Occupant safety



For safety, make sure the hook ② has attached to the anchorage ring ① beyond the safety catch, as illustrated.

- ▶ Swing rear seat backrest to the rear until it engages.
- ▶ Check the rear seat backrest to be locked in its upright position (▶ page 269).

Warning!



Always lock backrest in its upright position when rear seat bench is occupied by passengers, or the extended cargo area is not in use. Check for secure locking by pushing and pulling on the backrest.

Once the top tether anchorage hook is attached, the child restraint itself can be secured. Tighten the top tether strap according to the child restraint manufacturer's instructions.

Child seat anchors – LATCH type

This vehicle is equipped with two LATCH (Lower Anchors and Tethers for Children) type anchors (at each of the rear seats) for the installation of a LATCH child seat with matching mounting fittings.

If child seats are not installed, the LATCH anchors can be folded back between the seat cushion and the seat backrest.

Safety and Security

Occupant safety

To fold anchors out



- ① Anchors
- ② Release button

- ▶ Grip inner side of anchors ① and fold forward until they audibly lock in place.
- ▶ Install child seat according to the manufacturer's instructions.



The child seat must be firmly attached in the right and left side anchors ①.

To fold anchors back

- ▶ Press down button ② on each anchor ① and return the anchor ① to its catch.



Non-LATCH type child seats may also be used and can be installed using the vehicle's seat belt system. Install child seat according to the manufacturer's instructions.

Warning!



Children too big for a toddler restraint must ride in seats using regular seat belts. Position shoulder belt across chest and shoulder, not face or neck.

A booster seat may be necessary to achieve proper belt positioning for children from 41 lbs until they reach a height where a lap/shoulder belt fits properly without a booster.

Before installing the child seat, make sure anchors ① are folded out and locked in place.

Install child seat according to manufacturer's instructions.

The child seat must be firmly attached in the right and left side anchor ①.

An incorrectly mounted child seat may come loose during an accident which could result in serious injury or death to the child.

Damaged or impact damaged child seats or child seat anchor fittings must be replaced.

Do not leave children unattended in the vehicle, even if the children are secured in a child restraint system.

Safety and Security

Occupant safety

Blocking of rear side window operation

You can block the rear door window operation (for instance when you have children riding in the rear passenger compartment).

The override switch is located on the door control panel of the driver's door.



- ① Deactivating override switch
- ② Activating override switch
- ③ Override switch

Warning!



Activate the override switch when children are riding in the back seats of the vehicle. The children may otherwise injure themselves, e.g. by becoming trapped in the window opening.

When leaving the vehicle, always remove the SmartKey or SmartKey with KEYLESS-GO* from the starter switch, take it with you, and lock the vehicle. Do not leave children unattended in the vehicle, or with access to an unlocked vehicle. Unsupervised use of vehicle equipment can cause an accident and/or serious personal injury.

Activating override switch

- ▶ Slide override switch ③ to the right in direction ②.

The rear side windows can no longer be operated using the respective switch located in the rear trim panels.



Operation of the rear side windows with the switches located on the door control panel of the driver's door is still possible.

Deactivating override switch

- ▶ Slide override switch ③ to the left in direction ①.

The rear side windows can be operated using the respective switch located in the rear trim panels.

For more information, see "Power windows" (▷ page 247).

▼ Panic alarm

An audible alarm and flashing exterior lamps will operate for approximately 2¹/₂ minutes.



① **PANIC** button

Activating

- ▶ Press and hold button ① for at least one second.

Deactivating

- ▶ Press button ① again
- or
- ▶ Insert SmartKey in starter switch.



USA only:

This device complies with Part 15 of the FCC Rules. Operation is subject to the following two conditions:

- (1) This device may not cause harmful interference, and
- (2) this device must accept any interference received, including interference that may cause undesired operation.

Any unauthorized modification to this device could void the user's authority to operate the equipment.



Canada only:

This device complies with RSS-210 of Industry Canada. Operation is subject to the following two conditions:

- (1) This device may not cause interference, and
- (2) this device must accept any interference received, including interference that may cause undesired operation of the device.

Any unauthorized modification to this device could void the user's authority to operate the equipment.

Safety and Security

Driving safety systems

In this section you will find information on the following driving safety systems:

- ABS (Antilock Brake System)
- BAS (Brake Assist System)
- ESP (Electronic Stability Program)



In winter operation, the maximum effectiveness of the ABS, the BAS, and the ESP is only achieved with winter tires (M+S tires) or snow chains as required.

Warning!



The following factors increase the risk of accidents:

- Excessive speed, especially in turns
- Wet and slippery road surfaces
- Following another vehicle too closely

The ABS, BAS, and ESP cannot reduce this risk.

Always adjust your driving style to the prevailing road and weather conditions.

ABS

Warning!



Do not pump the brake pedal. Use firm, steady brake pedal pressure instead. Pumping the brake pedal defeats the purpose of the ABS and significantly reduces braking effectiveness.

The Antilock Brake System (ABS) regulates the brake pressure so that the wheels do not lock during braking. This allows you to maintain the ability to steer your vehicle.

The ABS is functional above a speed of approximately 5 mph (8 km/h) independent of road surface conditions.

On slippery road surfaces, the ABS will respond even to light brake pressure.

The  indicator lamp in the instrument cluster (▷ page 24) comes on when you switch on ignition. It goes out when the engine is running.

Braking

At the instant one of the wheels is about to lock up, a slight pulsation can be felt in the brake pedal, indicating that the ABS is in the regulating mode.

- ▶ Keep firm and steady pressure on the brake pedal while experiencing the pulsation.

Continuous, steady brake pedal pressure yields the advantages provided by the ABS, namely braking power and the ability to steer the vehicle.

The pulsating brake pedal can be an indication of hazardous road conditions and functions as a reminder to take extra care while driving.

Emergency brake maneuver

- ▶ Keep continuous full pressure on the brake pedal.

Warning!



The ABS cannot prevent the natural laws of physics from acting on the vehicle, nor can it increase braking or steering efficiency beyond that afforded by the condition of the vehicle brakes and tires or the traction afforded. The ABS cannot prevent accidents, including those resulting from excessive speed in turns, following another vehicle too closely, or hydroplaning. Only a safe, attentive, and skillful driver can prevent accidents. The capabilities of an ABS equipped vehicle must never be exploited in a reckless or dangerous manner which could jeopardize the user's safety or the safety of others.

For more information, see "Practical hints" (▶ page 353).

BAS

The Brake Assist System (BAS) operates in emergency situations. If you apply the brakes very quickly, the BAS automatically provides full brake boost, thereby potentially reducing the braking distance. Apply continuous full braking pressure until the emergency braking situation is over. The ABS will prevent the wheels from locking.

When you release the brake pedal, the brakes function again as normal. The BAS is then deactivated.

Warning!



If the BAS is malfunctioning, the brake system is still functioning normally, but without the additional brake boost available that BAS would normally provide in an emergency braking maneuver. Therefore, the braking distance may increase.

Safety and Security

Driving safety systems

Warning!



The BAS cannot prevent the natural laws of physics from acting on the vehicle, nor can it increase braking efficiency beyond that afforded by the condition of the vehicle brakes and tires or the traction. The BAS cannot prevent accidents, including those resulting from excessive speed in turns, following another vehicle too closely, or hydroplaning. Only a safe, attentive, and skillful driver can prevent accidents. The capabilities of a BAS equipped vehicle must never be exploited in a reckless or dangerous manner which could jeopardize the user's safety or the safety of others.

For more information, see "Practical hints" (▷ page 353).

ESP

The Electronic Stability Program (ESP) is operational as soon as the engine is running and monitors the vehicle's traction (force of adhesive friction between the tires and the road surface) and handling.

The ESP recognizes when a wheel is spinning or if the vehicle starts to skid. By applying brakes to the appropriate wheel and by limiting the engine output, the ESP works to stabilize the vehicle. The ESP is especially useful while driving off and on wet or slippery road surfaces. The ESP also stabilizes the vehicle during braking maneuvers.

The ESP warning lamp  in the instrument cluster flashes when the ESP is engaged.

The warning lamp  in the instrument cluster comes on when you switch on the ignition. It goes out when the engine is running.

Warning!



Never switch off the ESP when you see the ESP warning lamp  flashing in the instrument cluster. In this case, proceed as follows:

- While driving off, apply as little throttle as possible.
- While driving, ease upon the accelerator.
- Adapt your speed and driving style to the prevailing road conditions.

Failure to observe these guidelines could cause the vehicle to skid.

The ESP cannot prevent accidents resulting from excessive speed.

Warning!



The ESP cannot prevent the natural laws of physics from acting on the vehicle, nor can it increase the traction afforded. The ESP cannot prevent accidents, including those resulting from excessive speed in turns or hydroplaning. Only a safe, attentive, and skillful driver can prevent accidents. The capabilities of an ESP equipped vehicle must never be exploited in a reckless or dangerous manner which could jeopardize the user's safety or the safety of others.



Because of the ESP's automatic operation, the engine must be shut off when

- the parking brake is being tested on a brake test dynamometer
- the vehicle is being towed with the front axle raised

Active braking action through the ESP may otherwise seriously damage the brake system.



The ESP will only function properly if you use wheels of the recommended tire size.

For more information, see "Practical hints" (▷ page 353).

Switching off the ESP

Warning!



The ESP should not be switched off during normal driving other than in the circumstances described below. Disabling of the system will reduce vehicle stability in standard driving maneuvers.

To improve the vehicle's traction, turn off the ESP in driving situations where it would be advantageous to have the drive wheels spin and thus cut into surfaces for better grip such as:

- starting out on slippery surfaces and in deep snow in conjunction with snow chains
- sand or gravel



Turn on the ESP immediately if the aforementioned circumstances do not apply anymore.

Safety and Security

Driving safety systems

When you switch off the ESP

- the ESP does not stabilize the vehicle
- the engine output is not limited, which allows the drive wheels to spin and thus cut into surfaces for better grip
- the traction control will still brake a spinning wheel
- the ESP continues to operate when you are braking



When the ESP is switched off and one or more drive wheels are spinning, the ESP warning lamp  in the instrument cluster flashes. However, the ESP will then not stabilize the vehicle.

The switch is located on the center console.



① ESP switch (off/on)

- ▶ Press switch ①.

The ESP warning lamp  in the instrument cluster comes on.

The ESP is deactivated.

Warning!



When the ESP warning lamp  is illuminated continuously, the ESP is switched off.

Adapt your speed and driving to the prevailing road conditions and to the non-operating status of the ESP.



Avoid spinning of a drive wheel for an extended period with the ESP switched off. This may cause serious damage to the drivetrain which is not covered by the Mercedes-Benz Limited Warranty.

Switching on the ESP

- ▶ Press switch ① again.

The ESP warning lamp  in the instrument cluster goes out.

You are now again in normal driving mode with ESP switched on.

▼ Anti-theft systems

Immobilizer

The immobilizer prevents unauthorized persons from starting your vehicle.

Activating

- With the SmartKey: Removing the SmartKey from the starter switch activates the immobilizer.
- With KEYLESS-GO*: Turning off the engine by means of the start/stop button on the gear selector lever activates the immobilizer.

Deactivating

- With the SmartKey: Inserting the SmartKey in the starter switch deactivates the immobilizer.
- With KEYLESS-GO*: Starting the engine by means of the start/stop button on the gear selector lever deactivates the immobilizer.



In case the engine cannot be started (yet the vehicle's battery is charged), the system is not operational. Contact an authorized Mercedes-Benz Center or call 1-800-FOR-MERCEdes (in the USA), or 1-800-387-0100 (in Canada).

Safety and Security

Anti-theft systems

Anti-theft alarm system

Once the alarm system has been armed, a visual and audible alarm is triggered when someone opens

- a door
- the trunk
- the hood.

The alarm system will also be triggered when

- someone attempts to raise the vehicle (▷ page 91)
- opening the vehicle with the mechanical key.



The alarm will stay on, even if the activating element (a door, for example) is immediately closed.



If the alarm stays on for more than 30 seconds, a call to the Response Center is initiated automatically by the Tele Aid system (▷ page 280) provided Tele Aid service was subscribed to and properly activated, and that necessary cellular service and GPS coverage are available.

Arming the alarm system

The indicator lamp is in the switch for the tow-away alarm in the center console.



① Indicator lamp

- ▶ Lock the vehicle with the SmartKey or KEYLESS-GO*.

The turn signal lamps flash three times to indicate that the alarm system is activated. Indicator lamp ① begins to flash after approximately 30 seconds after arming the alarm system.



If the turn signal lamps do not flash three times, one of the following elements may not be properly closed:

- a door
- the trunk lid
- the hood

Close the respective element and lock the vehicle again.

Safety and Security

Anti-theft systems

Disarming the alarm system

- ▶ Unlock your vehicle with the SmartKey or KEYLESS-GO*.

The turn signal lamps flash once to indicate that the alarm system is deactivated





The alarm system will rearm automatically after approximately 40 seconds if no door or the trunk lid was opened.

Canceling the alarm

To cancel the alarm:

With the SmartKey

- ▶ Press the  or  button on the SmartKey.

or

- ▶ Insert the SmartKey in the starter switch.

*With KEYLESS-GO**

- ▶ Pull the outside door handle.

or

- ▶ Press the KEYLESS-GO start/stop button.

Tow-away alarm

Once the tow-away alarm is armed, a visual and audible alarm will be triggered when someone attempts to raise the vehicle.



The tow-away protection alarm is triggered, for example, if the vehicle is lifted on one side.

If the alarm stays on for more than 30 seconds, a call to the Response Center is initiated automatically by the Tele Aid system (▷ page 280) provided Tele Aid service was subscribed to and properly activated, and that necessary cellular service and GPS coverage are available.

Safety and Security

Anti-theft systems

Arming tow-away alarm

- ▶ Lock the vehicle with the SmartKey or KEYLESS-GO*.

The tow-away alarm is automatically armed after about 30 seconds.



When you unlock the vehicle, the tow-away protection disarms automatically. The tow-away alarm remains disarmed until you lock the vehicle again.

Disarming tow-away alarm

To prevent triggering the tow-away alarm, switch off the tow-away alarm feature before towing the vehicle, or when parking on a surface subject to movement, such as a ferry or auto train.

The switch is located on the center console.



- ① Tow-away alarm off switch
- ② Indicator lamp

- ▶ Switch off the ignition and remove the SmartKey.



You cannot disarm the tow-away alarm while the ignition is switched on.

- ▶ Press switch ①.
Indicator lamp ② in switch ① comes on briefly.

- ▶ Exit and lock your vehicle with the SmartKey or (vehicles with KEYLESS-GO*) the lock button at each door handle.

The tow-away alarm remains disarmed until you lock your vehicle again.

Canceling the alarm

To cancel the alarm:

With the SmartKey

- ▶ Press the or button on the SmartKey.

or

- ▶ Insert the SmartKey in the starter switch.

*With KEYLESS-GO**

- ▶ Pull the outside door handle.

or

- ▶ Press the KEYLESS-GO start/stop button.

Controls in detail

Locking and unlocking

Seats

Memory function

Lighting

Instrument cluster

Control system

Automatic transmission

Good visibility

Climate control (CLK 320)

Automatic climate control (CLK 500/CLK 55 AMG)

Audio system

Power windows

Power tilt/sliding sunroof*

Driving systems

Loading

Useful features

Controls in detail

Locking and unlocking

In the “Controls in detail” section you will find detailed information on how to operate the equipment installed on your vehicle. If you are already familiar with the basic functions of your vehicle, this section will be of particular interest to you.

To quickly familiarize yourself with the basic functions of the, refer to the “Getting started” section of this manual. The corresponding page numbers are given at the beginning of each segment.

For more information on locking and unlocking, see “Getting started” (▷ page 32) and (▷ page 55).

SmartKey

Your vehicle comes supplied with two SmartKeys, each with remote control and a removable mechanical key.

The locking tabs for the mechanical key portion of the two SmartKeys are a different color to help distinguish each SmartKey unit.



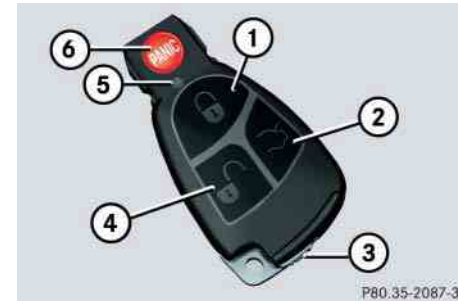

The SmartKey provides an extended operating range. To prevent theft, however, it is advisable to only unlock the vehicle when you are in close proximity to it.

The SmartKey centrally locks and unlocks:

- the doors
- the trunk
- the fuel filler flap



SmartKey with remote control

- ①  Lock button
- ②  Opening button for trunk lid
- ③ Mechanical key locking tab
- ④  Unlock button
- ⑤ Battery check lamp
- ⑥  PANIC Panic button (▷ page 83)

Controls in detail

Locking and unlocking

Warning!



When leaving the vehicle, always remove the SmartKey from the starter switch, take it with you, and lock the vehicle. Do not leave children unattended in the vehicle, or with access to an unlocked vehicle. It is possible for children to open a locked door from the inside, which could result in an accident and/or serious injury.



To prevent possible malfunction, avoid exposing the SmartKey to high levels of electromagnetic radiation.



USA only:

This device complies with Part 15 of the FCC Rules. Operation is subject to the following two conditions:

- (1) This device may not cause harmful interference, and
- (2) this device must accept any interference received, including interference that may cause undesired operation.

Any unauthorized modification to this device could void the user's authority to operate the equipment.



Canada only:

This device complies with RSS-210 of Industry Canada. Operation is subject to the following two conditions:

- (1) This device may not cause interference, and
- (2) this device must accept any interference received, including interference that may cause undesired operation of the device.

Any unauthorized modification to this device could void the user's authority to operate the equipment.



You can also open and close the power windows (▷ page 249) and power tilt/sliding sunroof* (▷ page 253) using the SmartKey.

Controls in detail

Locking and unlocking

Factory setting

Global unlocking

- ▶ Press button .

All turn signal lamps flash once. The locking knobs in the doors move up. The anti-theft alarm system is disarmed

The vehicle will lock again automatically and reactivate the anti-theft alarm system within approximately 40 seconds of unlocking if:

- neither door nor trunk is opened
- the SmartKey is not inserted in the starter switch
- the central locking switch is not activated



Global locking

- ▶ Press button .

All turn signal lamps flash three times. The locking knobs in the doors move down. The anti-theft alarm system is armed.

Selective setting

If you frequently travel alone, you may wish to reprogram the SmartKey so that pressing  only unlocks the driver's door and the fuel filler flap.

- ▶ Press and hold buttons  and  simultaneously for about five seconds until battery check lamp  flashes twice.

The SmartKey will then function as follows:

Unlocking driver's door and fuel filler flap

- ▶ Press button  once.

All turn signal lamps flash once. The locking knob in the driver's door moves up. The anti-theft alarm system is disarmed

Global unlocking

- ▶ Press button  twice.



All turn signal lamps flash once. The locking knobs in the doors move up. The anti-theft alarm system is disarmed

Global locking

- ▶ Press button .

All turn signal lamps flash three times. The locking knobs in the doors move down. The anti-theft alarm system is armed.

Restoring to factory setting

- ▶ Press and hold buttons  and  simultaneously for about six seconds until battery check lamp  flashes twice.



If you can no longer lock or unlock the vehicle with the SmartKey, then the batteries in the SmartKey are discharged, the SmartKey is malfunctioning or the vehicle battery is drained.



- Check the batteries in the SmartKey (▷ page 97) and replace them if necessary (▷ page 402).
- Use the mechanical key to unlock the driver's door (▷ page 397) and the trunk (▷ page 398).
- Have the vehicle battery and the battery connections checked (▷ page 420).
- Use the mechanical key to lock the driver's door (▷ page 398).

If the SmartKey is malfunctioning, contact an authorized Mercedes-Benz Center.

Controls in detail

Locking and unlocking

Checking the batteries

- ▶ Press button  or .

Battery check lamp  comes on briefly to indicate that the SmartKey batteries are in order.





If battery check lamp  does not come on briefly during check, then the SmartKey batteries are discharged.

Replace the batteries (▷ page 402).

You can obtain the required batteries at any authorized Mercedes-Benz Center.



If the batteries are checked within signal range of the vehicle, pressing the  or  button will lock or unlock the vehicle accordingly.

Controls in detail

Locking and unlocking

Unlocking and opening the trunk lid

You can unlock and open the trunk lid separately.

A minimum height clearance of 5.71 ft (1.74 m) is required to open the trunk lid.

- ▶ Press and hold button  until the trunk lid unlocks and begins to open.



The trunk lid swings open upwards automatically. Always make sure there is sufficient overhead clearance.



If the vehicle was previously centrally locked, the trunk lid will lock automatically when closed (▷ page 107). The turn signals will flash three times to confirm locking.

The trunk can also be opened from its inside in an emergency, see “Trunk lid emergency release” (▷ page 109).

Loss of SmartKey or mechanical key

If you lose a SmartKey or mechanical key, you should do the following:

- ▶ Have the SmartKey deactivated by an authorized Mercedes-Benz Center.
- ▶ Report the loss of the SmartKey or the mechanical key immediately to your car insurance company.
- ▶ If necessary, have the mechanical lock replaced.

Your authorized Mercedes-Benz Center will be glad to supply you with a replacement.

SmartKey with KEYLESS-GO*

Vehicles equipped with KEYLESS-GO come with two SmartKeys with KEYLESS-GO, each with remote control and a removable mechanical key. The locking tabs for the mechanical key portion of the two SmartKeys are a different color to help distinguish each SmartKey unit.

The KEYLESS-GO function is integrated into the SmartKey. On these vehicles, the validity of the SmartKey with KEYLESS-GO is checked every time you pull a door handle.

If the SmartKey with KEYLESS-GO is valid, your vehicle unlocks

- the doors
- the trunk lid
- the fuel filler flap

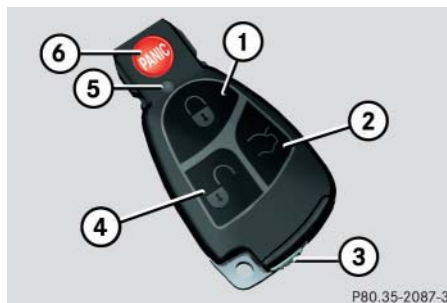

SmartKey with remote controls

- ① Lock button
- ② Opening button for trunk lid
- ③ Mechanical key locking tab
- ④ Unlock button
- ⑤ Battery check lamp
- ⑥ PANIC button (▷ page 83)



When the passenger outside door handle is pulled, the vehicle is centrally unlocked.

For more information on using the SmartKey buttons, see “SmartKey” (▷ page 94)

Controls in detail

Locking and unlocking

Warning!



When leaving the vehicle, always take the SmartKey with KEYLESS-GO* with you, and lock the vehicle. Do not leave children unattended in the vehicle, or with access to an unlocked vehicle. Unsupervised use of vehicle equipment may cause an accident and/or serious personal injury.



To prevent possible malfunction, avoid exposing the SmartKey with KEYLESS-GO to high levels of electromagnetic radiation.



You can also open and close the power windows (▷ page 249) and power tilt/sliding sunroof* (▷ page 253) using the SmartKey.

Controls in detail

Locking and unlocking

Important notes on using KEYLESS-GO*

- You can also use the SmartKey with KEYLESS-GO like a normal SmartKey (▷ page 94).
- You can combine KEYLESS-GO functions with normal SmartKey functions (e.g. unlocking with KEYLESS-GO and locking with the  button).
- Always carry the SmartKey with KEYLESS-GO with you.
- Never store the SmartKey with KEYLESS-GO together with:
 - electronic items such as a cellular phone or another SmartKey with KEYLESS-GO
 - metallic objects such as coins or metal foil

Doing so could impair the function of the KEYLESS-GO system.

- To lock or unlock the vehicle, the SmartKey with KEYLESS-Go must be located outside the vehicle within approximately 3 ft (1 m) of a door or the trunk.
- In order to start the engine with the SmartKey with KEYLESS-GO:
 - the SmartKey with KEYLESS-GO must be located in the vehicle
 - all the doors must be closed
 - the brake pedal must be depressed
- If you have started the engine with the KEYLESS-GO start/stop button (▷ page 35), you can only turn it off again with this button, even if you have put the SmartKey in the starter switch in the meantime.
- This does not apply if, after starting, the gear selector lever is still in position **P**, and the SmartKey is then inserted in the starter switch. The SmartKey will then have priority over the KEYLESS-GO function and the vehicle's electrical system will operate according to the position of the SmartKey in the starter switch, even stopping the engine.
- If the SmartKey with KEYLESS-GO is positioned farther away from the vehicle, the system may no longer recognize the SmartKey with KEYLESS-GO. The vehicle then cannot be locked or the engine started via the KEYLESS-GO system.

- If the SmartKey with KEYLESS-GO is removed from the vehicle while the ignition is switched on (e.g. if passenger exits the vehicle with the SmartKey with KEYLESS-GO), the message *Key not recognized!* will appear in the multifunction display while driving off.
Find the SmartKey with KEYLESS-GO or change its present location immediately (e.g. place it on the front passenger seat or insert it in shirt pocket).
- Remember that the engine can be started by anyone with a SmartKey with KEYLESS-GO that is left inside the vehicle. If you leave the SmartKey with KEYLESS-GO behind when exiting and locking the vehicle, the message *Key recognized in vehicle!* will appear in the multifunction display.

Factory setting

Warning!



When leaving the vehicle, always take the SmartKey with KEYLESS-GO* with you and lock the vehicle. Do not leave children unattended in the vehicle, or with access to an unlocked vehicle. It is possible for children to open a locked door from the inside, which could result in an accident and/or serious personal injury.

Global unlocking

- ▶ Pull the door handle.

All turn signal lamps flash once. The locking knobs in the doors move up. The anti-theft alarm system is disarmed



If the vehicle has been parked for a longer period of time, you must pull the door handle in order to activate the KEYLESS-GO function.

Controls in detail

Locking and unlocking

The vehicle will lock again automatically within approximately 40 seconds of unlocking if neither door nor trunk is opened.



The vehicles could inadvertently be unlocked if the SmartKey with KEYLESS-GO is within 3 ft (1 m) of the vehicle and:

- the door handle is splashed with water, or
- you attempt to clean the door handle.

Global locking

- ▶ Press lock button at door handle (▷ page 58) or trunk lid (▷ page 103).



All turn signal lamps flash three times. The locking knobs in the doors move down. The anti-theft alarm system is armed.

Controls in detail

Locking and unlocking

Selective setting

If you frequently travel alone, you may wish to reprogram the SmartKey with KEYLESS-GO so when you, pull the driver's door handle only the driver's door and the fuel filler flap unlocks.

- ▶ Press and hold buttons  and  simultaneously for about five seconds until battery check lamp  flashes twice.

The SmartKey with KEYLESS-GO will then function as follows:

Unlocking driver's door and fuel filler flap

- ▶ Pull the driver's door handle.
All turn signal lamps flash once. The locking knob in the driver's door moves up. The anti-theft alarm system is disarmed

Global unlocking

- ▶ Pull the door handle on the passenger side.

All turn signal lamps flash once. The locking knobs in the doors move up. The anti-theft alarm system is disarmed

Global locking



- ▶ Press lock button at door handle or trunk lid.

All turn signal lamps flash three times. The locking knobs in the doors move down. The anti-theft alarm system is armed.



You can also lock the vehicle using the lock button at trunk lid (▷ page 103).

Restoring to factory setting

- ▶ Press and hold buttons  and  simultaneously for about six seconds until battery check lamp  flashes twice.



If you can no longer lock or unlock the vehicle with the SmartKey with KEYLESS-GO, then the batteries in the SmartKey are discharged, the SmartKey with KEYLESS-GO is malfunctioning or the vehicle battery is drained.

- Check the batteries in the SmartKey (▷ page 103) and replace them if necessary (▷ page 402).
- Use the mechanical key to unlock the driver's door (▷ page 397) and the trunk (▷ page 398).

- Have the vehicle battery and the battery connections checked (▷ page 420).
- Use the mechanical key to lock the driver's door (▷ page 398).

If the SmartKey with KEYLESS-GO is malfunctioning, contact an authorized Mercedes-Benz Center.

Checking the batteries

- ▶ Press button  or .

Battery check lamp  comes on briefly to indicate that the SmartKey batteries are in order.





If battery check lamp  does not come on briefly during check, then the SmartKey batteries are discharged.

Replace the batteries (▷ page 402).

You can obtain the required batteries at any authorized Mercedes-Benz Center.



If the batteries are checked within signal range of the vehicle, pressing the  or  button will lock or unlock the vehicle accordingly.

Controls in detail

Locking and unlocking

Global locking using the lock button at trunk lid



To prevent a possible inadvertent lockout, the trunk lid will open automatically if a SmartKey with KEYLESS-GO* is recognized inside the vehicle or in the trunk.

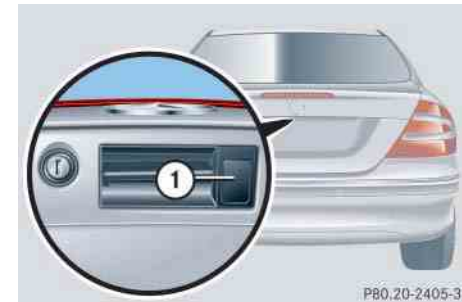

 Lock button at trunk

- ▶ Press lock button  at the trunk lid. ▷▷

Controls in detail

Locking and unlocking

- ▷▷ All turn signal lamps flash three times. The locking knobs in the doors move down. The anti-theft alarm system is armed.



You can also lock the vehicle using the lock button at outside door handle (▷ page 58).

Unlocking and opening the trunk lid

A minimum height clearance of 5.71 ft (1.74 m) is required to open the trunk lid.

The handle is located in the rear license plate recess.

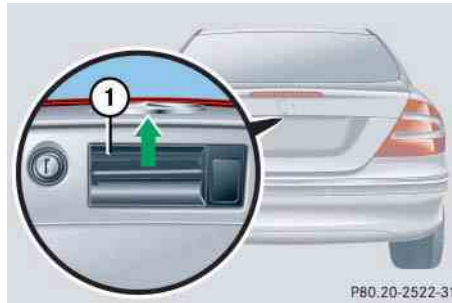

① Handle

- ▶ Pull on handle ①.

The trunk opens.

or

- ▶ Press and hold button  until the trunk unlocks and begins to open.



The trunk lid swings open upwards automatically. Always make sure there is sufficient overhead clearance.



If the vehicle was previously centrally locked, the trunk lid will lock automatically when closed (▷ page 107). The turn signals will flash three times to confirm locking.

The trunk can also be opened from its inside in an emergency, see “Trunk lid emergency release” (▷ page 109).

Loss of the SmartKey with KEYLESS-GO

If you lose your SmartKey with KEYLESS-GO, you should do the following:

- ▶ Have the SmartKey with KEYLESS-GO deactivated by an authorized Mercedes-Benz Center.
- ▶ Report the loss immediately to your car insurance company.
- ▶ Have the mechanical lock replaced if necessary.

Your authorized Mercedes-Benz Center will be glad to supply you with a replacement.

Opening the doors from the inside

You can open a locked door from the inside. Open doors only when conditions are safe to do so.

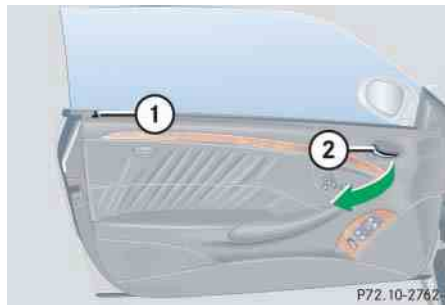

- ① Locking knob
- ② Inside door handle

- ▶ Pull on door handle ②.

If door was locked, locking knob ① will move up.

Controls in detail



Locking and unlocking



If the vehicle has previously been locked from the outside with the SmartKey, opening a door from the inside will trigger the anti-theft alarm system.

To cancel the alarm, do one of the following:

With the SmartKey

- Insert the SmartKey in the starter switch.
- Press button  or  on the SmartKey.

With KEYLESS-GO*

- Pull the outside door handle.
- Press the KEYLESS-GO* start/stop button.

Controls in detail

Locking and unlocking



If you open a door, the side windows on that side of the vehicle will lower slightly. The windows close again when you close the door.

Opening the trunk

Opening the trunk from outside (vehicles without KEYLESS-GO*)

A minimum height clearance of 5.71 ft (1.74 m) is required to open the trunk lid.

The handle is located in the rear license plate recess.

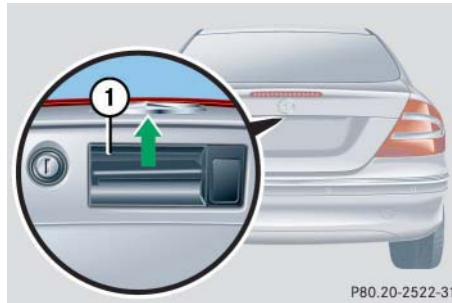

① Handle



The vehicle must be unlocked.

- ▶ Pull on handle ①.

The trunk lid unlocks and begins to open.



The trunk lid swings open upwards automatically. Always make sure there is sufficient overhead clearance.

The trunk can also be opened using button  on the SmartKey or from its inside in an emergency, see “Trunk lid emergency release” (▷ page 109).

Opening the trunk from the inside

You can open the trunk from the inside if the vehicle is stationary.

A minimum height clearance of 5.71 ft (1.74 m) is required to open the trunk lid.

The remote trunk lid switch is located on the driver's door.



① Remote trunk lid switch with indicator lamp

- ▶ Press remote trunk lid switch ① until the trunk begins to open.

The indicator lamp in the switch remains lit as long as the trunk is open.



The trunk lid swings open upwards automatically. Always make sure there is sufficient overhead clearance.



If the vehicle was previously centrally locked, the trunk lid will lock automatically when closed (▷ page 107). The turn signals will flash three times to confirm locking.

The trunk can also be opened using button  on the SmartKey or from its inside in an emergency, see “Trunk lid emergency release” (▷ page 109).

Controls in detail

Locking and unlocking

Closing the trunk

Depending on production date, your vehicle is equipped with either trunk design A or B.



Trunk design A

① Handle

- ▶ Lower trunk lid by pulling firmly on handle ①.
- ▶ Close trunk lid with hands placed flat on the trunk lid.

Controls in detail

Locking and unlocking

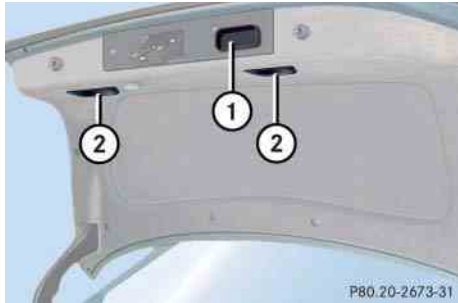

Trunk design B

- ① Handle
- ② Handles

- ▶ Lower trunk lid by pulling firmly on handle ① or handles ②.
- ▶ Close trunk lid with hands placed flat on the trunk lid.

Warning!



To prevent possible personal injury, always keep hands and fingers away from the trunk lid opening when closing the trunk. Be especially careful when small children are around.

When leaving the vehicle, always remove the SmartKey or SmartKey with KEYLESS-GO* from the starter switch, take it with you, and lock the vehicle. Do not leave children unattended in the vehicle, or with access to an unlocked vehicle. It is possible for children to open a locked door from the inside, which could result in an accident and/or serious personal injury.

Warning!



Only drive with the trunk closed. Among other dangers, such as your view being blocked, exhaust fumes may enter the vehicle interior.

i

Do not place the SmartKey in the open trunk. You may lock yourself out.

i

Vehicles with KEYLESS-GO*:
To prevent a possible inadvertent lock-out, the trunk lid will open automatically if a SmartKey with KEYLESS-GO* is recognized inside the vehicle or in the trunk.

Controls in detail

Locking and unlocking

Trunk lid emergency release

The emergency release button is located on the inside of the trunk lid.



① Emergency release button

- ▶ Briefly press emergency release button ①.

The trunk lid unlocks and the trunk lid opens.



The trunk lid swings open upwards automatically.

Illumination of the emergency release button:

- The button will flash for 30 minutes after opening the trunk.
- The button will flash for 60 minutes after closing the trunk.





The emergency release button unlocks and opens the trunk while the vehicle is standing still or in motion.



The emergency release button does not open the trunk lid if the vehicle battery is discharged or disconnected.



If the emergency release button is pressed and the vehicle was centrally locked, the exterior lamps will flash and the alarm will sound as the trunk lid opens. To cancel the alarm, do one of the following:

- press button  or  on the SmartKey.
- insert the SmartKey in the starter switch.

In vehicles with KEYLESS-GO*:

- pull the outside door handle.
- press the start/stop button.

Controls in detail

Locking and unlocking

Automatic central locking

The doors and the trunk automatically lock when the ignition is switched on and the wheels are turning at vehicle speeds of approximately 9 mph (15 km/h) or more.

You can open a locked door from the inside. Open doors only when conditions are safe to do so.



The doors unlock automatically after an accident if the force of the impact exceeds a preset threshold.

To prevent the vehicle door locks from locking, deactivate the automatic central locking when the vehicle

- is pushed or towed
- is on a test stand

You can deactivate the automatic locking mode using the control system, see “Setting automatic locking” (> page 158).

Locking and unlocking from the inside

You can lock or unlock the doors and the trunk from inside using the central locking or unlocking switch. This can be useful, for example, if you want to lock the vehicle before starting to drive.

You cannot lock or unlock the fuel filler flap with the central locking or unlocking switch.

Warning!



When leaving the vehicle, always remove the SmartKey or SmartKey with KEYLESS-GO* from the starter switch, take it with you, and lock the vehicle. Do not leave children unattended in the vehicle, or with access to an unlocked vehicle. Unsupervised use of vehicle equipment may cause an accident and/or serious personal injury.

The switch is located in the center console.



- ① Central locking switch
- ② Central unlocking switch



You can open a locked door from the inside. Open door only when conditions are safe to do so.

If the vehicle was previously centrally locked with the SmartKey or the SmartKey with KEYLESS-GO*, it will not unlock using the central unlocking switch ②.

If the vehicle was previously locked with the central locking switch ①

- while in the global remote control mode, the complete vehicle is unlocked when a door is opened from the inside.
- while in the selective remote control mode, only the door opened from inside is unlocked.

Locking

- ▶ Press central locking switch ①.

If both doors are closed, the vehicle locks.

Unlocking

- ▶ Press central unlocking switch ②.

The vehicle unlocks.

Controls in detail

Seats

For information on seat adjustment, see “Adjusting” (▷ page 37).

Easy-entry/exit feature

This feature allows for easier entry into and exit from the vehicle.

The easy-entry/exit feature can be activated or deactivated in the Convenience submenu of the control system (▷ page 159).

Warning!



You must make sure that no one can become trapped or injured by the moving steering wheel and driver's seat when the easy-entry/exit feature is activated.

To cancel seat /steering wheel movement, do one of the following:

- Press seat adjustment switch (▷ page 37).
- Move steering column stalk (▷ page 40).
- Press memory position switch (▷ page 122)

Do not leave children unattended in the vehicle, or with access to an unlocked vehicle. Children could open the driver's door and unintentionally activate the easy-entry/exit feature, which could result in an accident and/or serious personal injury.

When exiting the vehicle, with the easy-entry/exit feature activated and depending on your selection, the steering wheel tilts upwards and/or the driver's seat moves a few inches to the rear when you:

- remove the SmartKey from the starter switch,
or
- open the driver's door with the SmartKey in starter switch position **0** or **1** or the KEYLESS-GO* start/stop button (▷ page 35) in position **1**.



If the current position for the steering wheel is in the uppermost tilt position, the steering wheel will no longer be able to move upward when the easy-entry/exit feature is activated.

If the current seat position falls into a factory-set position range and the system recognizes the current seat position to be rearward enough for easy entry and exit, the driver's seat will not move to the rear when the easy-entry/exit feature is activated.

When entering the vehicle, with the easy-entry/exit feature activated, the steering wheel or, depending on your selection, the steering wheel and driver's seat will return to their last set position or a factory-set maximum forward position when you:

- close the driver's door with the ignition switched on.
or
- insert the SmartKey into the starter switch or press the KEYLESS-GO* start/stop button (▷ page 35) once with driver's door closed.



For safety reasons, the driver's seat will not return to its last set position with the easy-entry/exit feature activated if the system recognizes the last set position as an extreme forward position. Instead, the driver's seat will remain at or move to a factory-set maximum forward position. To again fully return the driver's seat to your last set position or to memory position, adjust the seat to the desired position or press and hold the respective memory position switch (▷ page 122).

Removing and installing front seat head restraints

For information on head restraint adjustment, see "Seats" (▷ page 37).



Adjust the head restraint in such a way that it is as close to the head as possible.

Warning!



For your protection, drive only with properly positioned head restraints.

Adjust head restraint so that the center of the head restraint supports the back of the head at eye level. This will reduce the potential for injury to the head and neck in the event of an accident or similar situation. ▷▷

Controls in detail

Seats

- ▷▷ Do not drive the vehicle without the seat head restraints. Head restraints are intended to help reduce injuries during an accident.

Do not interchange head restraints from front and rear seat.



Tilt the seat backrest to the rear for easier removal and installation of the head restraints.

Front seat head restraints

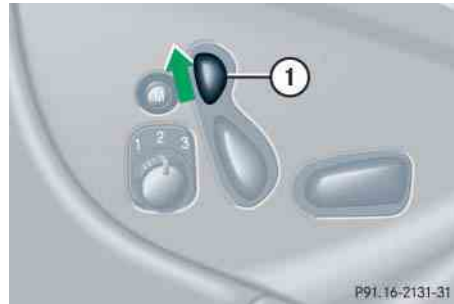

① Head restraint switch

- ▶ Switch on ignition (▷ page 36).

Removing front seat head restraints

- ▶ Press switch ① upwards and hold until the head restraint is fully extended.
- ▶ Pull out head restraint.

Installing front seat head restraints:

- ▶ Press switch ① upwards and hold for about five seconds.
- ▶ Push the head restraint down until it engages.
- ▶ Adjust head restraint to desired position (▷ page 38).

Rear seat head restraints

Warning!



For safety reasons, always drive with the rear head restraints in the raised position when the rear seats are occupied.

Keep the area around head restraints clear of articles (e.g. clothing) to not obstruct the folding operation of the head restraints.

Head restraint height

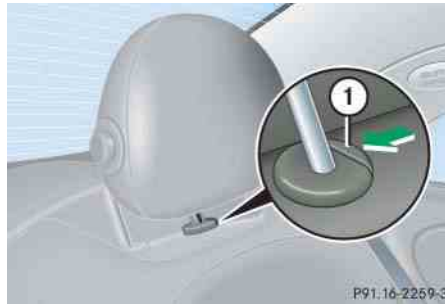

① Release button

Raising:

- ▶ Manually adjust the height of the head restraint by pulling it upward.

If the head restraint is fully retracted, push release button ① and pull the head restraint out.

Lowering:

- ▶ To lower the head restraint, push release button ① and push down on the head restraint.

Controls in detail

Seats

i

Adjust the head restraint in such a way that it is as close to the head as possible.

Warning!



For your protection, drive only with properly positioned head restraints.

Adjust head restraint so that the center of the head restraint supports the back of the head at eye level. This will reduce the potential for injury to the head and neck in the event of an accident or similar situation.

Do not drive the vehicle without the seat head restraints. Head restraints are intended to help reduce injuries during an accident.

Controls in detail

Seats

Folding head restraints back with release button



① Release button

- ▶ Push release button ①.
The head restraints will fold backward.



You can also fold the head restraints back using the switch in the center console.

Folding head restraints back with switch in the center console



① Rear head restraints folding switch

- ▶ Start the engine (▷ page 46).
- ▶ Press switch ① to release the head restraints.

The head restraints will fold backward.

Placing rear head restraints upright



- ▶ Pull the rear head restraint forward until it locks into position.

Warning!



Make sure the head restraints engage when placing them upright. Otherwise their protective function cannot be assured.

Head restraint tilt

Two different head restraint angle positions are available.

- ▶ Press the release button (▷ page 116) and tilt the head restraint to the desired position.

Removing and installing rear seats head restraints



Adjust the head restraint in such a way that it is as close to the head as possible.

Warning!



For your protection, drive only with properly positioned head restraints.

Adjust head restraint so that the center of the head restraint supports the back of the head at eye level. This will reduce the potential for injury to the head and neck in the event of an accident or similar situation.

Do not drive the vehicle without the seat head restraints. Head restraints are intended to help reduce injuries during an accident.

Do not interchange head restraints from front and rear seat.

Controls in detail

Seats

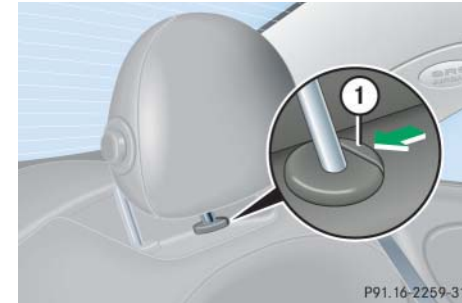

- ① Release button

Removing rear seat head restraints

- ▶ Fold back head restraint (▷ page 116).
- ▶ Pull head restraint to its highest position.
- ▶ Push release button ① and pull out head restraint.

Installing rear head restraints

- ▶ Insert head restraint and push it down until it engages.
- ▶ Push release button ① and adjust head restraint to desired position.

Controls in detail

Seats

Multicontour seat*

The multicontour seat has a movable seat cushion and inflatable air cushions built into the backrest to provide additional lumbar and side support.

The seat cushion movement, backrest cushion height and curvature can be continuously varied with switches on the side of the seat after starting the engine.

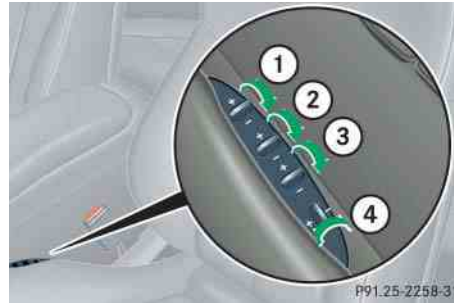

- ① Seat cushion depth
- ② Backrest bottom
- ③ Backrest center
- ④ Side bolster adjustment

► Start the engine.

Seat cushion depth

- Adjust the seat cushion depth to the length of your upper leg using switch ①.

Backrest contour

- Adjust the contour of the backrest to the desired position using switches ② and ③.

Backrest side bolsters

- Adjust the backrest side bolsters so that they provide good lateral support using switch ④.

Seat heating*

Both switches for the front seats are located in the center console.



① Seat heating switch

The red indicator lamps on the switch ① show which heating level you have selected.

Level	
3	Three indicator lamps on. After approximately five minutes, seat heating is automatically switched to level 2.
2	Two indicator lamps on. After approximately ten minutes, seat heating is automatically switched to level 1.
1	One indicator lamp on. After approximately 20 minutes, seat heating is automatically switched off.
off	No indicator lamp on.

- ▶ Switch on ignition (> page 36).
All the lamps in the instrument cluster come on.

Switching on seat heating

- ▶ Press seat heating switch ① twice.
Three red indicator lamps in the switch come on.
- ▶ Continue pressing seat heating switch ① until desired seat heating level is reached.

Switching off seat heating

- ▶ Press seat heating switch ① repeatedly until all red indicator lamps go out.



If one or all of the indicator lamps flash on the seat heating switch ①, there is insufficient voltage due to too many electrical consumers being switched on. The seat heating switches off automatically.

The seat heating will switch back on again automatically as soon as sufficient voltage is available.

Controls in detail

Seats

Seat ventilation*

Both switches for the front seats are located in the center console.



① Seat ventilation switch

The blue indicator lamps in the switch ① show which ventilation level you have selected:

Level	
3	Three indicator lamps on
2	Two indicator lamps on
1	One indicator lamp on
off	No indicator lamp on

- ▶ Switch on ignition (▷ page 36).
All lamps in the instrument cluster come on.

Switching on seat ventilation

- ▶ Press seat ventilation switch ①.
Three blue indicator lamps come on.
- ▶ Press seat ventilation switch ① repeatedly until the desired seat ventilation level is reached.

Switching off seat ventilation

- ▶ Press seat ventilation switch ① repeatedly until all blue indicator lamps go out.

i

If one or all of the indicator lamps flash on the seat ventilation switch ①, there is insufficient voltage due to too many electrical consumers being switched on. The seat ventilation switches off automatically.

The seat ventilation will switch back on again automatically as soon as sufficient voltage is available.

▼ Memory function



Prior to operating the vehicle, the driver should check and adjust the seat height, seat position fore and aft, and seat backrest angle if necessary, to ensure adequate control, reach and comfort. The head restraint should also be adjusted for proper height. See also the section on air bags (▷ page 61) for proper seat positioning.

In addition, adjust the steering wheel to ensure adequate control, reach, operation and comfort. Both the interior and exterior rear view mirrors should be adjusted for adequate rear vision.

Fasten seat belts. Infants and small children should be seated in a properly secured restraint system that complies with U.S. Federal Motor Vehicle Safety Standards 213 and 225 and Canadian Motor Vehicle Safety Standards 213 and 210.2.

You can store up to three different settings per SmartKey or SmartKey with KEYLESS-GO*.

The following settings are stored when using the buttons on the driver's door:

- Driver's seat, backrest and head restraint position
- Steering wheel position
- Exterior rear view mirror position

These key-dependent memory settings can be deactivated if desired. For information on key-dependent memory settings, see "Setting key-dependency" (▷ page 160).

Controls in detail

Memory function

The following settings are not key-dependent. They are stored when using the buttons on the passenger door:

- Front passenger seat, backrest and head restraint position

Warning!



Do not activate the memory function while driving. Activating the memory function while driving could cause the driver to lose control of the vehicle.

Controls in detail

Memory function

The memory button and memory position switch are located on the door.

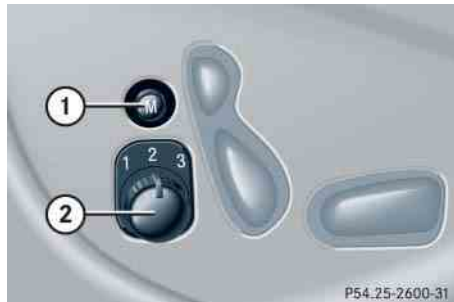

- ① Memory button
- ② Memory position switch

▶ Switch on ignition (▷ page 36).

or

▶ Open the respective door and insert the SmartKey in the starter switch.

Storing positions into memory

- ▶ Adjust the seats, steering wheel and exterior rear view mirrors to the desired position (▷ page 38).
- ▶ Turn memory position switch ② to the desired memory position.
- ▶ Press memory button ①.
- ▶ Release memory button ① and press memory position switch ② within three seconds.

All settings are stored to the selected position.

Recalling positions from memory



Do not operate the seats using the memory button if the seat backrest is in an excessively reclined position. Doing so could cause damage to front or rear seats.

First move the seat backrest to an upright position.

- ▶ Turn memory position switch ② to the desired memory position.
- ▶ Press and hold memory position switch ② until the seat, steering wheel and exterior rear view mirrors have completely moved to the stored positions.



Releasing the memory position switch stops movement to the stored positions immediately.

Storing exterior rear view mirror parking position

For easier parking, you can adjust the passenger-side exterior rear view mirror so that you can see the right rear wheel as soon as you engage reverse gear **R**.

For information on activating the parking position feature, see “Setting parking position for exterior rear view mirror” (> page 160) and “Activating exterior rear view mirror parking position” (> page 180).



You can store a parking position for the passenger-side exterior rear view mirror for each SmartKey or SmartKey with KEYLESS-GO*.

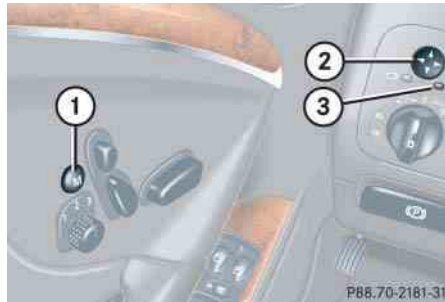

- ① Memory button
- ② Adjustment button
- ③ Passenger side exterior rear view mirror button

- ▶ Stop the vehicle.
- ▶ Switch on ignition (> page 36).
- ▶ Press button ③.

The passenger-side exterior rear view mirror is selected.

Controls in detail

Memory function

- ▶ Adjust the passenger-side exterior rear view mirror with button ② so that you see the rear wheel and the road curb.
- ▶ Press memory button ①.
- ▶ Within three seconds, press bottom of adjustment button ②.

The parking position is stored if the mirror does not move.



If the mirror does move, repeat the above steps. After the setting is stored you can move the mirror again.

Controls in detail

Lighting

For information on how to switch on the headlamps and use the turn signals, see “Switching on headlamps” (▷ page 50) and “Turn signals” (▷ page 51).







If you drive in countries where vehicles drive on the other side of the road than the country in which the vehicle is registered, you must have the headlamps modified for symmetrical low beams. Relevant information can be obtained at your authorized Mercedes-Benz Center

Exterior lamp switch

The exterior lamp switch is located on the dashboard to the left of the steering wheel.



Exterior lamp switch

- 0** Off
Daytime running lamp mode (▷ page 155)
- AUTO** Automatic headlamp mode
Daytime running lamp mode (▷ page 155)
-  Parking lamps (also tail lamps, license plate lamps, side marker lamps, instrument panel lamps)
-  Low beam headlamps (or high beam headlamps when the combination switch is pushed forward) and parking lamps
- P** → Standing lamps, right (turn left one stop)
- ← P** Standing lamps, left (turn left two stops)
-  Indicator lamp for front fog lamps
-  Indicator lamp for rear fog lamp



With the SmartKey removed from the starter switch or the engine turned off with KEYLESS-GO* and the driver's door open, a warning sounds if the parking lamps or low beam headlamps are switched on.

The message **Turn off lamps!** appears in the multifunction display

Manual headlamp mode

The low beam headlamps and the parking lamps can be switched on and off with the exterior lamp switch.

Automatic headlamp mode

The following lamps switch on and off automatically depending on the brightness of the ambient light:

- Low beam headlamps
- Tail and parking lamps
- License plate lamps
- Side marker lamps

Controls in detail

Lighting



Warning!



If the exterior lamp switch is set to **AUTO**,

- the headlamps may switch off unexpectedly when the system senses bright ambient light, for example light from oncoming traffic.
- the headlamps will not be automatically switched on under foggy conditions.

To minimize risk to you and to others, activate headlamps by turning exterior lamp switch to  when driving or when traffic and/or ambient lighting conditions require you to do so.

In low ambient lighting conditions, only switch from position **AUTO** to  with the vehicle at a standstill. Switching from **AUTO** to  will briefly switch off the headlamps. Doing so while driving in low ambient lighting conditions may result in an accident.



Controls in detail

Lighting



The automatic headlamp feature is only an aid to the driver. The driver is responsible for the operation of the vehicle's lights at all times.

- ▶ Turn the exterior lamp switch to position **AUTO**.

With the SmartKey in starter switch position **1** or the KEYLESS-GO* start/stop button pressed once, only the parking lamps will switch on and off automatically.

When the engine is running, the low beam headlamps, the tail and parking lamps, the license plate lamps, and the side marker lamps will switch on and off automatically.

Daytime running lamp mode

- ▶ Turn the exterior lamp switch to position **0** or **AUTO**.

When the engine is running, the low beam headlamps are switched on.

In low ambient light conditions, the following lamps will switch on additionally:

- Tail and parking lamps
- License plate lamps
- Side marker lamps

For nighttime driving you should turn the exterior lamp switch to position  to permit activation of the high beam headlamps.



With the daytime running lamp mode activated and the exterior lamp switch in position **0**, the high beam headlamps cannot be switched on.



The high beam flasher is available at all times.

Canada only

The daytime running lamp mode is mandatory and therefore in a constant mode.

When the engine is running, and you shift from a driving position to position **N** or **P**, the low beam headlamps will switch off with a three-minute delay.



When the engine is running, and you

- turn the exterior lamp switch to position , the parking lamps switch on additionally.
- turn the exterior lamp switch to position , the manual headlamp mode has priority over the daytime running lamp mode.

The corresponding exterior lamps switch on (▷ page 124).

USA only

By default, the daytime running lamp mode is deactivated. Activate the daytime running lamp mode using the control system, see “Setting daytime running lamp mode (USA only)” (▷ page 155).

When the engine is running, and you turn the exterior lamp switch to position  or , the manual headlamp mode has priority over the daytime running lamp mode.

The corresponding exterior lamps switch on (▷ page 124).

Locator lighting and night security illumination

The locator lighting and the night security illumination are described in the “Control system” section, see “Setting locator lighting” (▷ page 156) and “Setting night security illumination” (▷ page 156).



Controls in detail

Lighting

Fog lamps

Warning!



In low ambient lighting or foggy conditions, only switch from position **AUTO** to  with the vehicle at a standstill. Switching from **AUTO** to  will briefly switch off the headlamps. Doing so while driving in low ambient lighting conditions may result in an accident.



Fog lamps will operate with the parking lamps and/or the low beam headlamps on. Fog lamps should only be used in conjunction with low beam headlamps. Consult your State or Province Motor Vehicle Regulations regarding permissible lamp operation.

Controls in detail

Lighting



Fog lamps cannot be switched on with the exterior lamp switch in position **AUTO**. For switching on the fog lamps, turn the exterior lamp switch to position  first.

Front fog lamps

- ▶ Switch on the low beam headlamps (▷ page 50).
- ▶ Pull out the exterior lamp switch to first stop.

The front fog lamps switch on.

The green indicator lamp  in the exterior lamp switch comes on (▷ page 124).

- ▶ Push in the exterior lamp switch.

The front fog lamps switch off.

The green indicator lamp  in the exterior lamp switch goes out.

Rear fog lamp (driver's side only)

- ▶ Switch on the front fog lamps (▷ page 128).
- ▶ Pull out the exterior lamp switch to second stop.

The rear fog lamp switches on.

The yellow indicator lamp  in the exterior lamp switch comes on (▷ page 124).

- ▶ Push in the exterior lamp switch to first stop.

The rear fog lamp switches off.

The yellow indicator lamp  in the exterior lamp switch goes out.

The front fog lamps remain lit.

Combination switch

The combination switch is located on the left of the steering column.

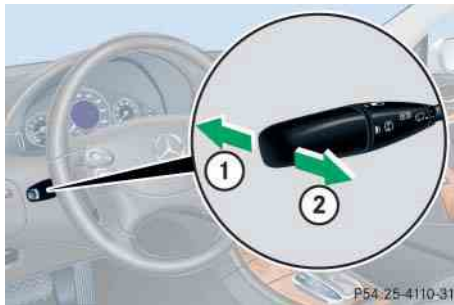

Combination switch

- ① High beam
- ② High beam flasher

High beam

- ▶ Turn the exterior lamp switch to position  or **AUTO** (▷ page 124).
- ▶ Push the combination switch in direction of arrow ① to switch on the high beam.

The high beam headlamp indicator lamp  in the instrument cluster comes on (▷ page 24).

- ▶ Pull the combination switch in direction of arrow ② to its original position to switch off the high beam.

The high beam headlamp indicator lamp  in the instrument cluster goes out.

High beam flasher

- ▶ Pull the combination switch briefly in direction of arrow ②.

Controls in detail

Lighting

Cornering fog lamps* (CLK 320 with Bi-Xenon* headlamps)

The cornering fog lamps improve illumination of the road into which you are turning.

Cornering fog lamps will operate with the engine running and with

- the exterior lamp switch in position  (▷ page 124)
or
- the exterior lamp switch in position **AUTO** (▷ page 124)
or
- the daytime running lamp mode activated (▷ page 126)



Cornering fog lamps will only come on in low ambient lighting conditions.

The cornering fog lamps function is not available at a vehicle speed above 25 mph (40 km/h).

Driving forward

Switching on cornering fog lamps

- ▶ Depending on whether you are turning left or right, switch on the left or right turn signal (▷ page 51).

The respective front fog lamp comes on and illuminates the road into which you are turning.



The cornering fog lamps will come on automatically depending on the steering angle, even if you did not switch on either turn signal. If the cornering fog lamps came on automatically, they will also go out automatically depending on the steering angle.

Switching off cornering fog lamps

The combination switch for the turn signal resets automatically after major steering wheel movements. This will switch off the cornering fog lamps if they were activated by switching on the left or right turn signal.

If the turn signal should stay on after making the turn, the turn signal and cornering fog lamps can be switched off by returning the combination switch to its original position.

Driving rearward

Switching on cornering fog lamps

- ▶ Place the gear selector lever in position **R**.

The inverse front fog lamp comes on automatically depending on the steering direction and steering angle.

Switching on cornering fog lamps

- ▶ Place the gear selector lever out of position **R**.

The respective front fog lamp goes out.

Hazard warning flasher

The hazard warning flasher can be switched on at all times, even with the SmartKey or the SmartKey with KEYLESS-GO* removed from the starter switch or with the SmartKey with KEYLESS-GO* removed from the vehicle.

The hazard warning flasher switches on automatically when an air bag deploys.

The hazard warning flasher switch is located on the upper part of the center console.



① Hazard warning flasher switch

Controls in detail

Lighting

Switching on hazard warning flasher

- ▶ Press hazard warning flasher switch ①.

All turn signals are flashing.



With the hazard warning flasher activated and the combination switch set for either left or right turn, only the respective turn signals will operate when the ignition is switched on.

Switching off hazard warning flasher

- ▶ Press hazard warning flasher switch ① again.



If the hazard warning flasher has been activated automatically, press hazard warning flasher switch ① once to switch it off.

Controls in detail

Lighting

Interior lighting

The controls are located in the overhead control panel.



- ① Rear interior lights
- ② Right front reading lamp
- ③ Rocker switch for automatic control system
- ④ Left front reading lamp

Activating automatic control

- ▶ Press rocker switch ③ to center position.

Interior lamps are switched on in darkness, even when you:

- unlock the vehicle
- open a door
- remove the SmartKey from the starter switch

The interior lamps are switched off after a preset time, see “Setting interior lighting delayed shut-off” (▷ page 157).



If the door remains open, the interior lamps switch off automatically after approximately five minutes, when the SmartKey is removed or in starter switch position **0**.

An interior lamp switched on manually does not go out automatically.

Deactivating automatic control

- ▶ Press the  symbol on rocker switch ③.

The interior lighting remains switched off in darkness, even when you:



- unlock the vehicle
- open a door
- remove the SmartKey from the starter switch

Manual control



Switching all front interior lights on and off

- ▶ Press the  symbol on rocker switch ③.
The front interior lights come on.
- ▶ Press rocker switch ③ to center position to activate the automatic control.



Switching rear interior lights on and off

- ▶ Press button .
The light in the rear passenger compartment come on.
- ▶ Press button  again.
The light in the rear passenger compartment go out.

Switching right front reading lamp on and off

- ▶ Press right button .
The right reading lamp comes on.
- ▶ Press right button  again.
The right reading lamp goes out.

Switching left front reading lamp on and off

- ▶ Press left button .
The left reading lamp comes on.
- ▶ Press left button  again.
The left reading lamp goes out.

Door entry lamps

The appropriate door entry lamp switches on if a door is opened in darkness and if the interior lighting is switched to automatic function.

The entry lamp switches off automatically when the door is closed.



If you turn the SmartKey in the starter switch to position **0** and switch off the exterior headlamps, the door entry lamps will remain lit for approximately five minutes.

Trunk lamp

The trunk lamp switches on if the trunk lid is opened.

If you leave the trunk open for an extended period of time, the trunk lamp will switch off automatically after approximately ten minutes.

Controls in detail

Instrument cluster

For a full view illustration of the instrument cluster, see “Instrument cluster” (▷ page 24).

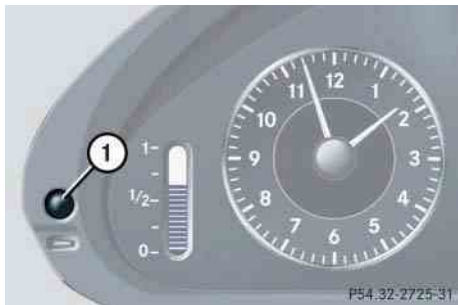

① Reset button

The instrument cluster is activated when you

- open a door
- switch on ignition (▷ page 36)
- press the reset button ①
- switch on the exterior lamps

You can change the instrument cluster settings in the Instrument cluster submenu of the control system (▷ page 149).

Instrument cluster illumination

Use the reset button ① to adjust the illumination brightness for the instrument cluster.



The instrument cluster illumination is dimmed or brightened automatically to suit ambient light conditions.

The instrument cluster illumination will also be adjusted automatically when you switch on the vehicle's exterior lamps.

To brighten illumination

- ▶ Turn reset button ① clockwise.
The instrument cluster illumination will brighten.

To dim illumination

- ▶ Turn reset button ① counterclockwise.
The instrument cluster illumination will dim.

Coolant temperature indicator

The coolant temperature indicator is on the right side in the instrument cluster (▷ page 24).

Warning!



- Driving when your engine is badly overheated can cause some fluids which may have leaked into the engine compartment to catch fire. You could be seriously burned.
- Steam from an overheated engine can cause serious burns and can occur just by opening the hood. Stay away from the engine if you see or hear steam coming from it.

Turn off the engine, get out of the vehicle and do not stand near the vehicle until the engine has cooled down.





Excessive coolant temperature triggers a warning in the multifunction display (▷ page 376) and the red coolant warning lamp in the instrument cluster comes on (▷ page 357).

During severe operating conditions, e.g. stop-and-go traffic, the coolant temperature may rise close to 120°C.

The engine should not be operated with the coolant temperature above 120°C.

Doing so may cause serious engine damage which is not covered by the Mercedes-Benz Limited Warranty.

Trip odometer

- ▶ Make sure you are viewing the standard display in the multifunction display (▷ page 142).
- ▶ If it is not displayed, press button  or  on the multifunction steering wheel repeatedly until the standard display appears (▷ page 138).
- ▶ Press and hold reset button on the instrument cluster (▷ page 134) until the trip odometer is reset.

Controls in detail

Instrument cluster

Tachometer

The red marking on the tachometer (▷ page 24) denotes excessive engine speed.



Avoid driving at excessive engine speeds, as it may result in serious engine damage that is not covered by the Mercedes-Benz Limited Warranty.

To help protect the engine, the fuel supply is interrupted if the engine is operated within the red marking.

Outside temperature indicator

Warning!



The outside temperature indicator is not designed to serve as an ice-warning device and is therefore unsuitable for that purpose.

Indicated temperatures just above the freezing point do not guarantee that the road surface is free of ice. The road may still be icy, especially in wooded areas or on bridges.

The outside temperature is indicated in the multifunction display (▷ page 137). For information on how to select the unit of the indicated temperature, i.e. degrees Celsius (°C) or degrees Fahrenheit (°F), see “Selecting temperature display mode” (▷ page 149)

The temperature sensor is located in the front bumper area. Due to its location, the sensor can be affected by road or engine heat during idling or slow driving. This means that the accuracy of the displayed temperature can only be verified by comparison to a thermometer placed next to the sensor, not by comparison to external displays (e.g. bank signs etc.).

When moving the vehicle into colder ambient temperatures (e.g. when leaving your garage), you will notice a delay before the lower temperature is displayed.

A delay also occurs when ambient temperatures rise. This prevents inaccurate temperature indications caused by heat radiated from the engine during idling or slow driving.

▼ Control system

The control system is activated as soon as the SmartKey in the starter switch is turned to position **1** or as soon as the KEYLESS-GO* start/stop button is in position **1**. The control system enables you to

- call up information about your vehicle
- change vehicle settings

For example, you can use the control system to find out when your vehicle is next due for service, to set the language for messages in the instrument cluster display, and much more.



The displays for the audio systems (radio, CD player) will appear in English, regardless of the language selected.

Warning!



A driver's attention to the road and traffic conditions must always be his/her primary focus when driving.

For your safety and the safety of others, selecting features through the multifunction steering wheel should only be done by the driver when traffic and road conditions permit it to be done safely.

Bear in mind that at a speed of just 30 mph (approximately 50 km/h), your vehicle is covering a distance of 44 feet (approximately 14 m) every second.

The control system relays information to the multifunction display.

Controls in detail

Control system

Multifunction display



- ① Outside temperature
- ② Trip odometer
- ③ Automatic transmission program mode
- ④ Main odometer
- ⑤ Current gear selector lever position

For more information on menus displayed in the multifunction display, see “Menus” (▷ page 140).

Controls in detail

Control system

Multifunction steering wheel

The displays in the multifunction display and the settings in the control system are controlled by the buttons on the multifunction steering wheel (▷ page 26).

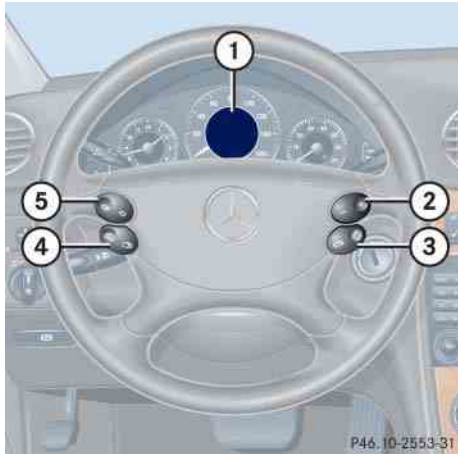

① Multifunction display

Operating the control system

② Selecting the submenu or setting the volume:
Press button

 up / to increase

 down / to decrease

③ Telephone*:
Press button

 to take a call

 to end a call

④ Menu systems:
Press button

 for next menu

 for previous menu

⑤ Moving within a menu:
Press button

 for next display





 for previous display

Pressing any of the buttons on the multifunction steering wheel will alter what is shown in the multifunction display.

The information available in the multifunction display is arranged in menus, each containing a number of functions or sub-menus.

The individual functions are then found within the relevant menu (radio or CD operations under *Audio*, for example). These functions serve to call up relevant information or to customize the settings for your vehicle.

It is helpful to think of the menus, and the functions within each menu, as being arranged in a circular pattern.

- If you press button  or  repeatedly, you will pass through each menu one after the other.
- If you press button  or  repeatedly, you will pass through each function display, one after the other, in the current menu.

In the *Settings* menu, instead of functions you will find a number of submenus for calling up and changing settings. For instructions on using these submenus, see “Submenus in the Settings menu” (▷ page 147).

The number of menus available in the system depends on which optional equipment is installed in your vehicle.

The menus are described on the following pages.

Controls in detail

Control system

Menus

This is what you will see when you scroll through the menus.

The table on the next page provides an overview of the individual menus.

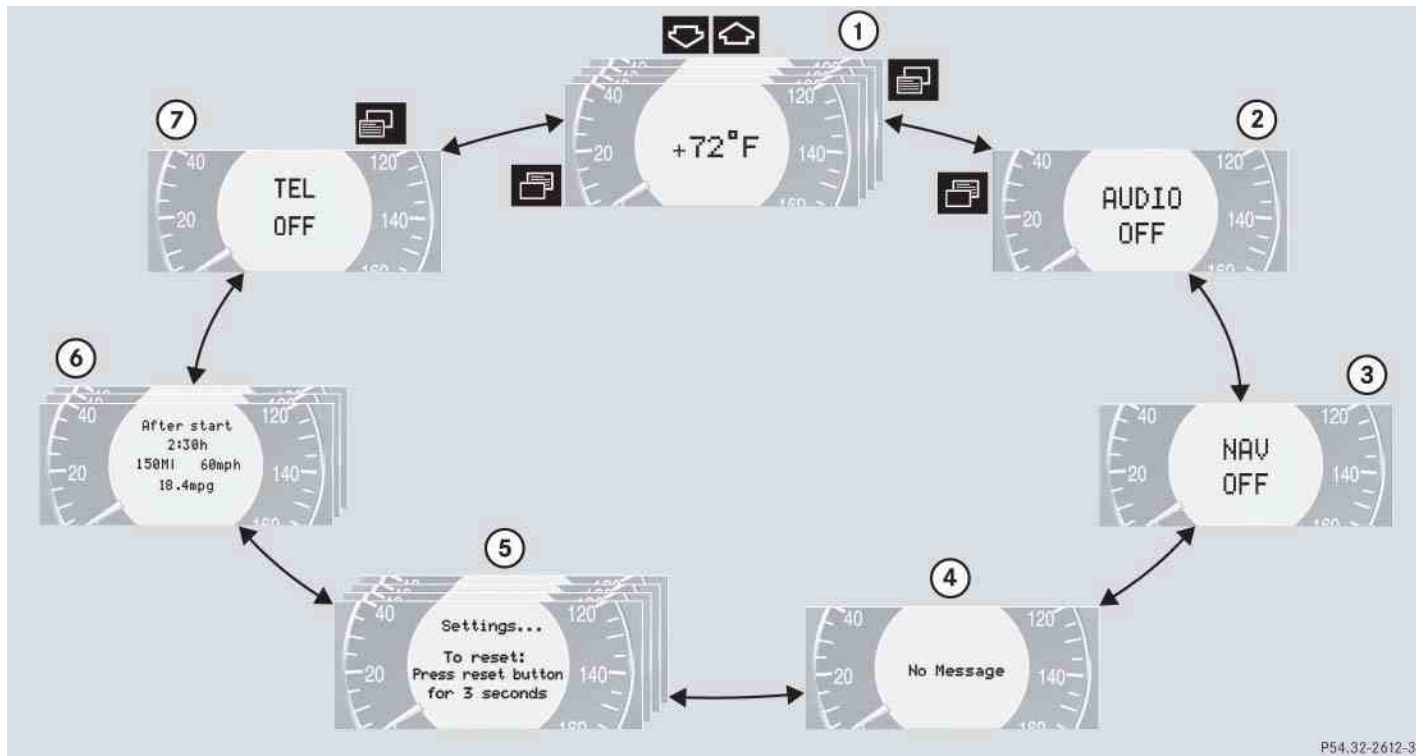

Menus, submenus and functions

	Menu ①	Menu ②	Menu ③	Menu ④	Menu ⑤	Menu ⑥	Menu ⑦
	Standard display	AUDIO	NAV*	Vehicle status message memory	Settings	Trip computer	Telephone
	(▷ page 142)	(▷ page 143)	(▷ page 144)	(▷ page 145)	(▷ page 146)	(▷ page 160)	(▷ page 162)
Commands/submenus	Digital speedometer	Select radio station	Activate route guidance	Call up vehicle malfunction, warning and system status messages stored in memory	Reset to factory settings	Fuel consumption statistics after start	Load phone book
	Call up maintenance service display	Select satellite radio station* (USA only)			Instrument cluster submenu	Fuel consumption statistics since the last reset	Search for name in phone book
	Check engine oil level	Operate CD player			Time/Date submenu	Call up range	
					Lighting submenu		
					Vehicle submenu		
					Convenience submenu		

Controls in detail

Control system



The headings used in the menus table are designed to facilitate navigation within the system and are not necessarily identical to those shown in the control system displays.

The first function displayed in each menu will automatically show you which part of the system you are in.

Standard display menu

In the standard display, the outside temperature and the trip odometer are shown in the multifunction display.



You can have the digital speedometer displayed instead of the outside temperature in the standard display. You can select the setting in the submenu Instr. cluster via the function Basic display (▷ page 151).



- ① Outside temperature
- ② Trip odometer

If you see another display, press button or repeatedly until the standard display appears.

You can select the functions in the standard display menu with button or .

The following functions are available:

Function	Page
Call up digital speedometer	142
Call up maintenance service display	345
Check engine oil level	310

Display digital speedometer

- ▶ Press button or repeatedly until the digital speedometer appears in the multifunction display.

The current vehicle speed is shown in the multifunction display and the status line appears.



- ① Digital Speedometer
- ② Status line with outside temperature
- ③ Trip odometer



You can have the digital speedometer displayed instead of the outside temperature in the status line. You can select the setting in the submenu Instr. cluster via the function Status line display (▷ page 150).

AUDIO menu



The functions in the *Audio* menu operate the audio equipment which you currently have turned on.

If no audio equipment is currently turned on, the message *Audio off* is shown in the multifunction display.

The following functions are available:



Function	Page
Select radio station	143
Select satellite radio station* (USA only)	143
Operate CD player	144

Select radio station

- ▶ Turn on the radio (▷ page 210). Vehicles with COMAND*: Refer to separate operating instructions.
- ▶ Press button  or  repeatedly until the currently tuned station appears in the multifunction display.



- ① Waveband setting
- ② Station frequency

- ▶ Press button  or  repeatedly until the desired station is found.



You can only store new stations using the corresponding feature on the radio (▷ page 218).

Vehicles with COMAND*: Refer to separate operating instructions.

You can also operate the radio in the usual manner.

Controls in detail

Control system



Select satellite radio station* (USA only)

The satellite radio is treated as a radio application.

- ▶ Select satellite radio with the corresponding soft key (SAT) in the radio menu.



- ① SAT mode and preset number
- ② Setting for station selection using memory
- ③ Channel name or number

- ▶ Press button  or  repeatedly until the desired channel is found.

Controls in detail

Control system



For more information on satellite radio operation, see “Introduction to satellite radio* (USA only)” (▷ page 220).

Vehicles with COMAND*: Refer to separate operating instructions.

Operate the CD player

- ▶ Turn on the radio and select the CD player (▷ page 227). Vehicles with COMAND*: Refer to separate operating instructions.
- ▶ Press button or repeatedly until the settings for the CD currently being played appear in the multifunction display.



- ① Current CD (for CD changer*)
- ② Current track

- ▶ Press button or repeatedly until the desired track is selected.



To select a CD from the magazine, press a number on the audio system or the COMAND* system key pad located in the center dashboard.

NAV* menu

The Nav menu contains the functions needed to operate your navigation system.

- ▶ Press button or repeatedly until the message Nav appears in the multifunction display.
 - If the navigation system is switched off, the message Nav off appears in the multifunction display.
 - If the navigation system is on, different messages, depending on the current state of the navigation system, appear in the multifunction display.

Please refer to the COMAND* manual for instructions on how to activate the route guidance system*.



Vehicle status message memory menu

Use the vehicle status message memory menu to scan malfunction and warning messages that may be stored in the system. Such messages appear in the multifunction display and are based on conditions or system status the vehicle's system recorded.

Warning!



Malfunction and warning messages are only indicated for certain systems and are intentionally not very detailed. The malfunction and warning messages are simply a reminder with respect to the operation of certain systems and do not replace the owner's and/or driver's responsibility to maintain the vehicle's operating safety by having all required maintenance and safety checks performed on the vehicle and by bringing the vehicle to an authorized Mercedes-Benz Center to address the malfunction and warning messages (▷ page 362).

- ▶ Press button  or  repeatedly until the vehicle status message memory appears in the multifunction display.

No vehicle status messages



If no conditions are recorded in memory, the message in the multifunction display is: No Message

Vehicle status messages have been recorded

If conditions have occurred causing status messages to be recorded, the number of messages appears in the multifunction display:



- ① Number of messages

- ▶ Press button  or .

The stored messages will now be displayed in the order in which they have occurred. For malfunction and warning messages, see “Vehicle status messages in the multifunction display” (▷ page 362).

Should the vehicle's system record any conditions while driving, the number of messages will reappear in the multifunction display when the SmartKey in the starter switch is turned to position **0** or removed from the starter switch. With KEYLESS-GO*, turn off the engine by pressing the KEYLESS-GO* start/stop button and open the driver's door.





The vehicle status message memory will be cleared when you switch on ignition. You will then only see high-priority messages in the multifunction display (▷ page 362).

Controls in detail

Control system

Settings menu

In the Settings menu there are two functions:

- The function **Reset to factory settings?**, with which you can reset all the settings to the original factory settings.
 - A collection of submenus with which you can make individual settings for your vehicle.
- ▶ Press button  or  repeatedly until the Settings menu appears in the display.



Resetting all settings

You can reset all the functions of all submenus to the factory settings.

- ▶ Press the reset button in the instrument cluster (▷ page 134) for approximately three seconds.

The request to press the reset button once more to confirm appears in the multifunction display.



- ▶ Press the reset button once more.

The functions of all the submenus will reset to factory settings.



The settings you have changed will not be reset unless you confirm the action by pressing the reset button a second time. After approximately five seconds, the Settings... menu reappears in the multifunction display.

For safety reasons, the following functions are not reset while driving:

- the Lamp circuit headlamp function in the Lighting submenu
- the Key-dependent function in the Convenience submenu

Submenus in the Settings menu



- ▶ Press button  or .



The collection of the submenus appears in the multifunction display.





- ▶ Press button .

The selection marker moves to the next submenu.

The submenus are arranged by hierarchy. Scroll down with button , scroll up with button .

Move within the submenus with button  or  to the individual functions.

The settings themselves are made with button  or .

Resetting the functions of a submenu

For each submenu you can reset all the functions to the factory settings.

- ▶ Move to a function in the submenu.
- ▶ Press the reset button (> page 134) in the instrument cluster for approximately three seconds.

The request to press the reset button once more to confirm appears in the multifunction display.

- ▶ Press the reset button once more.

All functions of the submenu will reset to factory settings.



The settings you have changed will not be reset unless you confirm the action by pressing the reset button a second time. After approximately five seconds, the Settings menu reappears in the multifunction display.

Controls in detail

Control system

The table below shows what settings can be changed within the various menus.

Detailed instructions on making individual settings can be found on the following pages.

INSTRUMENT CLUSTER	TIME/Date	LIGHTING	VEHICLE	CONVENIENCE
Selecting temperature display mode	Time synchronization with head unit*	Setting daytime running lamp mode (USA only)	Setting automatic locking	Activate easy-entry/exit feature
Selecting speedometer display mode	Setting time (hours)	Setting locator lighting		Setting key-dependency
Selecting language	Setting time (minutes)	Exterior lamps delayed shut-off		Setting parking position for exterior rear view mirror
Selecting display (speed display or outside temperature) for status indicator	Selecting automatic time change (Daylight Saving Time (DST) summer/Standard time winter)	Interior lighting delayed shut-off		
Selecting display (speed display or outside temperature) for standard display	Setting the date (month)			
	Setting the date (day)			
	Setting the date (year)			

Controls in detail

Control system

Instrument cluster submenu

Access the Instr. cluster submenu via the Settings menu. Use the Instr. cluster submenu to change the instrument cluster display settings.

The following functions are available:

Function	Page
Selecting temperature display mode	149
Selecting speedometer display mode	149
Selecting language	150
Selecting display (speed display or outside temperature) for status display	150
Selecting display (speed display or outside temperature) for standard display	151

Selecting temperature display mode

- ▶ Move the selection marker with button **+** or **-** to the Instr. cluster submenu.
- ▶ Press button **↶** or **↷** repeatedly until the message Temp. indicator appears in the multifunction display.

The selection marker is on the current setting.



- ▶ Press button **+** or **-** to set temperature unit to °C (degrees Celsius) or °F (degrees Fahrenheit).

Selecting speedometer display mode

- ▶ Move the selection marker with button **+** or **-** to the Instr. cluster submenu.
- ▶ Press button **↶** or **↷** repeatedly until the message Display unit Speed-/odometer appears in the multifunction display.

The selection marker is on the current setting.



- ▶ Press button **+** or **-** to set speedometer unit to km or miles.

Controls in detail

Control system

Selecting language

- ▶ Move the selection marker with button **+** or **-** to the Instr. cluster submenu.
- ▶ Press button **↶** or **↷** repeatedly until the message Language appears in the multifunction display.

The selection marker is on the current setting.



- ▶ Press button **+** or **-** to select the language to be used for the multifunction display messages.

Available languages:

- German
- English
- French
- Italian
- Spanish

Selecting display (speed display or outside temperature) for status indicator

- ▶ Move the selection marker with button **+** or **-** to the Instr. cluster submenu.
- ▶ Press button **↶** or **↷** repeatedly until the message Status line display appears in the display.

The selection marker is on the current setting.



- ▶ Press button **+** or **-** to select the desired setting.



You will see the status indicator when you have called up a different display from the standard display.

Selecting display (speed display or outside temperature) for standard display

- ▶ Move the selection marker with button **+** or **-** to the Instr. cluster submenu.
- ▶ Press button **↕** or **↘** repeatedly until the message **Basic display** appears in the display.

The selection marker is on the current setting.



- ▶ Press button **+** or **-** to select the display mode shown in the basic display.

Time/Date submenu

Access the Time/Date submenu via the Settings menu. Use the Time/Date submenu to change the instrument cluster display settings.

The following functions are available:

Function	Page
Time synchronization with head unit*	151
Setting the time (hours)	152
Setting the time (minutes)	152
Selecting automatic time change (Daylight Saving Time (DST) summer/Standard time winter)	153
Setting the date (month)	153
Setting the date (day)	153
Setting the date (year)	154

Time synchronization with head unit*

This function can only be seen on vehicles with COMAND* and navigation module*.

- ▶ Move the selection marker with button **+** or **-** to the Time/Date submenu.
- ▶ Press button **↕** or **↘** repeatedly until the message **Time sync. with head unit** appears in the multifunction display.

The selection marker is on the current setting.

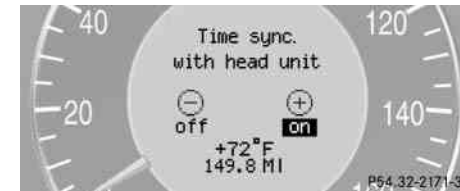

- ▶ Press button **+** or **-** to select the desired setting.

Controls in detail

Control system

Setting time (hours)

This function can only be seen with audio system.



Vehicles with COMAND*:

For information on setting the time, refer to the separate COMAND operating instructions.

- ▶ Move the selection marker with button **+** or **-** to the Time/Date submenu.
- ▶ Press button **↕** or **↔** repeatedly until the message **Clock, hours** Confirm by press. R appears in the multifunction display.

The selection marker is on the hour setting.



- ▶ Press button **+** or **-** to set the hour.
- ▶ Press the reset button in the instrument cluster (▷ page 134) to confirm.

The hour is set and stored.

Setting time (minutes)

This function can only be seen with audio system.



Vehicles with COMAND*:

For information on setting the time, refer to the separate COMAND operating instructions.

- ▶ Move the selection marker with button **+** or **-** to the Time/Date submenu.

- ▶ Press button **↕** or **↔** repeatedly until the message **Clock, minutes** Confirm by press. R appears in the multifunction display.

The selection marker is on the minutes setting.



- ▶ Press button **+** or **-** to set the minutes.
 - ▶ Press the reset button in the instrument cluster (▷ page 134) to confirm.
- The minutes are set and stored.

**Selecting automatic time change
(Daylight Saving Time (DST)
summer/Standard time winter)**

- ▶ Move the selection marker with button **+** or **-** to the Time/Date submenu.
- ▶ Press button **↶** or **↷** repeatedly until the message *Daylight savings Summer/winter Automatic* appears in the multifunction display.

The selection marker is on the current setting.



- ▶ Press button **+** or **-** to select if the changeover between summer and winter time should be automatic or manual.

Setting the date (month)

This function can only be seen with audio system.



Vehicles with COMAND*:
For information on setting the date, refer to the separate COMAND operating instructions.

- ▶ Move the selection marker with button **+** or **-** to the Time/Date submenu.
- ▶ Press button **↶** or **↷** repeatedly until the message *Set date month* appears in the multifunction display.

The selection marker is on the month setting.

Controls in detail

Control system



- ▶ Press button **+** or **-** to set the month.

Setting the date (day)

This function can only be seen with audio system.



Vehicles with COMAND*:
For information on setting the date, refer to the separate COMAND operating instructions.

- ▶ Move the selection marker with button **+** or **-** to the Time/Date submenu.
- ▶ Press button **↶** or **↷** repeatedly until the message *Set date day* appears in the multifunction display. ▷▷

Controls in detail

Control system

- ▷▷ The selection marker is on the day setting.



- ▶ Press button **+** or **-** to set the day.

Setting the date (year)

This function can only be seen with audio system.



Vehicles with COMAND*:
For information on setting the date, refer to the separate COMAND operating instructions.

- ▶ Move the selection marker with button **+** or **-** to the Time/Date submenu.

- ▶ Press button **▲** or **▼** repeatedly until the message Set date year appears in the multifunction display.

The selection marker is on the year setting.



- ▶ Press button **+** or **-** to set the year.

Lighting submenu

Access the Lighting submenu via the Settings menu. Use the Lighting submenu to change the lamp and lighting settings on your vehicle.

The following functions are available:

Function	Page
Setting daytime running lamp mode (USA only)	155
Setting locator lighting	156
Exterior lamps delayed switch-off	156
Interior lighting delayed switch-off	157

Setting daytime running lamp mode (USA only)



This function is not available in countries where the daytime running lamp mode is mandatory and therefore in a constant mode.

- ▶ Move the selection marker with button **+** or **-** to the **Lighting** submenu.
- ▶ Press button **↕** or **↔** repeatedly until the message **Lamp circuit headlamp** appears in the multifunction display.

The selection marker is on the current setting.



- ▶ Press **+** or **-** to select manual operation (**manual**) or daytime running lamp mode (**constant**) activated.

With daytime running lamp mode activated and the exterior lamp switch in position **0** or **AUTO** the low beam headlamps are switched on when the engine is running.

In low ambient light conditions the following lamps will switch on additionally:

- Parking lamps
- Tail lamps
- License plate lamps
- Side marker lamps

For more information on the daytime running lamp mode, see “Lighting” (▷ page 124).



If you turn the exterior lamp switch to another position, the corresponding lamp(s) will switch on.

For safety reasons, resetting the **Lighting** submenu to factory settings (▷ page 147) while driving will not deactivate the daytime running lamp mode.

The following message appears in the multifunction display:

Lighting - Cannot be completely reset to factory settings while driving.

Controls in detail

Control system

Setting locator lighting

With the locator lighting feature activated and the exterior lamp switch in position **AUTO**, the following lamps will switch on when the vehicle is unlocked with the SmartKey during darkness:

- Parking lamps
- Tail lamps
- License plate lamps
- Side marker lamps
- Front fog lamps

The locator lighting switches off when the driver's door is opened.

If you do not open a door after unlocking with the SmartKey the lamps will switch off automatically after approximately 40 seconds.

To activate locator lighting:

- ▶ Make sure the function surround lighting is set to on, see (▷ page 156).

- ▶ Move the selection marker with button **+** or **-** to the Lighting submenu.
- ▶ Press button **↶** or **↷** repeatedly until the message Function Surround lighting appears in the multifunction display.

The selection marker is on the current setting.



- ▶ Press button **+** or **-** to switch the locator lighting function On.
- ▶ Turn the exterior lamp switch to position **AUTO** when exiting the vehicle (▷ page 124).

The locator lighting feature is activated.

Setting night security illumination (Headlamps delayed shut-off)

Use this function to set whether and how long you would like the exterior lamps to illuminate during darkness after exiting the vehicle and all doors closed.

With the delayed shut-off feature activated and the exterior lamp switch in position **AUTO** before the engine is turned off, the following lamps will switch on after you have removed the SmartKey from the starter switch:

- Parking lamps
- Tail lamps
- License plate lamps
- Side marker lamps
- Front fog lamps

If you do not open a door after removing the SmartKey from the starter switch, the lamps will switch off automatically after approximately 60 seconds.



You can reactivate this function within ten minutes by opening a door.

- ▶ Move the selection marker with button **+** or **-** to the Lighting submenu.
- ▶ Press button **↶** or **↷** repeatedly until the message **Headlamps delayed shut-off** appears in the multifunction display.

The selection marker is on the current setting.



- ▶ Press **+** or **-** to select the desired lamp-on period.

You can select:

- 0 s, the delayed shut-off feature is deactivated
 - 15 s, 30 s, 45 s or 60 s, the delayed shut-off feature is activated
- ▶ Turn the exterior lamp switch to position **AUTO** before tuning off the engine (▷ page 124).

The headlamps delayed shut-off feature is activated.

You can temporarily deactivate the delayed shut-off feature:

- ▶ Before leaving the vehicle, turn the SmartKey in the starter switch to position **0**.
- ▶ Then turn it to position **2** and back to **0**.

The delayed shut-off feature is deactivated. It will reactivate as soon as you reinsert the SmartKey in the starter switch.

Controls in detail

Control system

Setting interior lighting delayed shut-off

Use this function to set whether and how long you would like the interior lighting to remain lit during darkness after you have removed the SmartKey from the starter switch.

- ▶ Move the selection marker with button **+** or **-** to the Lighting submenu.
- ▶ Press button **↶** or **↷** repeatedly until the message **Interior lamp delayed shut-off** appears in the multifunction display.

The selection marker is on the current setting.



- ▶ Press **+** or **-** to select the desired lamp-on time period.



Controls in detail

Control system

▷▷ You can select:

- 0 s, the delayed shut-off feature is deactivated.
- 5 s, 10 s, 15 s or 20 s, the interior lighting delayed shut-off feature is activated with the desired lamp-on period.

Vehicle submenu

Access the Vehicle submenu via the Settings menu. Use the Vehicle submenu to make general vehicle settings.

The following functions are available:

Function	Page
Setting automatic locking	158

Setting automatic locking

Use this function to activate or deactivate the automatic central locking. With the automatic central locking system activated, the vehicle is centrally locked at vehicle speeds of approximately 9 mph (15 km/h).

- ▶ Move the selection marker with button **+** or **-** to the Vehicle submenu.
- ▶ Press button **▲** or **▼** repeatedly until the message Automatic door lock appears in the multifunction display.

The selection marker is on the current setting.



- ▶ Press button **+** or **-** to switch the automatic central locking on or off.

Convenience submenu

Access the Convenience submenu via the Settings menu. Use the Convenience submenu to change the settings for a number of convenience features.

The following functions are available:

Function	Page
Activating easy-entry/exit feature	159
Setting key-dependency	160
Setting parking position for exterior rear view mirror	160

Activating easy-entry/exit feature

Use this function to activate and deactivate the easy-entry/exit feature.

Warning!



You must make sure no one can become trapped or injured by the moving steering wheel and the driver's seat when the easy-entry/exit feature is activated.

To cancel seat/steering wheel movement, do one of the following:

- Press seat adjustment switch (▷ page 38).
- Move steering column stalk (▷ page 40).
- Press memory position switch (▷ page 122).

Do not leave children unattended in the vehicle, or with access to an unlocked vehicle. Children could open the driver's door and unintentionally activate the easy-entry/exit feature, which could result in an accident and/or serious personal injury.

- ▶ Move the selection marker with button **+** or **-** to the Convenience submenu.
- ▶ Press button **↶** or **↷** repeatedly until the message **Function Easy-entry feature** appears in the multifunction display.

The selection marker is on the current setting.

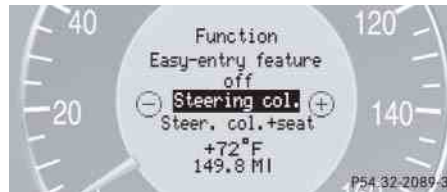

- ▶ Press button **+** or **-** to change the easy-entry/exit setting.

Controls in detail

Control system

The following settings are available for the easy-entry/exit feature:

off	The easy-entry/exit feature is deactivated.
Steering col.	Only the steering column is moved.
Steer. col. + seat	Both the steering column and the seat are moved.

Controls in detail

Control system

Setting key-dependency

Use this function to set whether the memory settings for the seats, the steering wheel and the mirrors should be stored separately for each SmartKey (▷ page 121).

- ▶ Move the selection marker with button **+** or **-** to the Convenience submenu.
- ▶ Press button **▲** or **▼** repeatedly until the message **Key-dependent** appears in the multifunction display.

The selection marker is on the current setting.



- ▶ Press button **+** or **-** to set key-dependency to on or off.

Setting parking position for exterior rear view mirror

Use the Mirror adjustment parking aid function to select whether the passenger-side exterior rear view mirror should be turned downward during parking maneuvers, when reverse gear **R** is engaged. For additional information, see “Activating exterior rear view mirror parking position” (▷ page 180).

- ▶ Move the selection marker with button **+** or **-** to the Convenience submenu.
- ▶ Press button **▲** or **▼** repeatedly until the message **Mirror adjustment parking aid** appears in the multifunction display.

The selection marker is on the current setting.



- ▶ Press button **+** or **-** to switch function on or off.





Trip computer menu

Use the trip computer menu to call up statistical data on your vehicle.

The following information is available:

Function	Page
Fuel consumption statistics after start	161
Fuel consumption statistics since last reset	161
Call up range (distance to empty)	162

Fuel consumption statistics after start

- ▶ Press button  or  repeatedly until the first function of the Trip computer menu appears in the multifunction display.
- ▶ Press button  or  repeatedly until the message *After start* appears in the multifunction display.







- ① Distance driven since start
- ② Time elapsed since start
- ③ Average speed since start
- ④ Average fuel consumption since start



All statistics stored since the last engine start will be reset approximately four hours after the SmartKey in the starter switch is turned to position **0** or removed from the starter switch.

Resetting will not occur if you turn the SmartKey back to position **1** or **2** within this time period.

Fuel consumption since last reset

- ▶ Press button  or  repeatedly until the first function of the Trip computer menu appears in the multifunction display.
- ▶ Press button  or  repeatedly until the message *After reset* appears in the multifunction display.



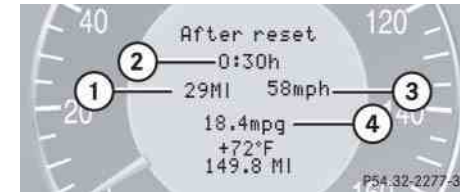

Controls in detail

Control system



- ① Distance driven since last reset
- ② Time elapsed since last reset
- ③ Average speed since last reset
- ④ Average fuel consumption since last reset





Resetting fuel consumption statistics

- ▶ Press button  or  repeatedly until the first function of the Trip computer menu appears in the multifunction display.
- ▶ Press button  or  repeatedly until the reading that you want to reset appears in the multifunction display.
- ▶ Press and hold the reset button in the instrument cluster ([▶ page 134](#)) until the value is reset to 0.

Controls in detail

Control system

Call up range (distance to empty)

- ▶ Press button  or  repeatedly until the first function of the Trip computer menu appears in the multifunction display.
- ▶ Press button  or  repeatedly until the message Range appears in the multifunction display.

The calculated range based on the current fuel tank level appears in the multifunction display.



TEL menu*

Warning!





A driver's attention to the road must always be his/her primary focus when driving. For your safety and the safety of others, we recommend that you pull over to a safe location and stop before placing or taking a telephone call. If you choose to use the telephone while driving, please use the hands-free device and only use the telephone when weather, road and traffic conditions permit.

Some jurisdictions prohibit the driver from using a cellular telephone while driving a vehicle.

Bear in mind that at a speed of just 30 mph (approximately 50 km/h), your vehicle is covering a distance of 44 feet (approximately 14 m) every second.

Never operate radio transmitters equipped with a built-in or attached antenna (i.e. without being connected to an external antenna) from inside the vehicle while the engine is running. Doing so could lead to a malfunction of the vehicle's electronic system, possibly resulting in an accident and /or personal injury.

You can use the functions in the Tel menu to operate your telephone, provided it is connected to a hands-free system and switched on.

- ▶ Switch on the telephone and Audio or COMAND*.
- ▶ Press button  or  on the steering wheel repeatedly until the message Tel appears in the multifunction display.

Which messages will appear in the multifunction display depends on whether your telephone is switched on or off:

- If the telephone is off, the message **Tel off** appears in the multifunction display.
- If the telephone is on:

The telephone will then search for a network. During this time the multifunction display is empty.

As soon as the telephone has found a network, the message **READY** appears in the multifunction display.



This standby message indicates that your telephone is ready for use and you can operate it using the control system.

Answering a call

When your telephone is ready to receive calls, you can answer a call at any time. In the multifunction display you will then see the message:



- ▶ Press button .

You have answered the call. The duration of the call appears in the multifunction display.



If you do not wish to accept a call, press button .

Controls in detail

Control system

Ending a call

- ▶ Press button .

You have ended the call. The standby message appears in the multifunction display.

Dialing a number from the phone book

If your telephone is ready to receive calls, you may select and dial a number from the phone book at any time.

- ▶ Press button  or  repeatedly until the message **Tel** appears in the multifunction display.



- ▶ Press button  or .

The control system reads the phone book which is stored in the telephone. This may take up to 30 seconds. The message **Please wait** appears in the multifunction display.

When the message **Please wait** disappears, the phone book has been loaded. >>

Controls in detail

Control system



- ▷▷ Press button  or  repeatedly until the desired name appears in the multifunction display.

The stored names are displayed in ascending or descending alphabetical order.



- ① Name from phone book



If you press and hold button  or  for longer than one second, the system scrolls rapidly through the list of names until you release the button again.

Cancel the quick search mode by pressing .

- ▶ Press button .

The system dials the selected phone number.

- If the connection is successful, the name of the party you called and the duration of the call will appear in the multifunction display.

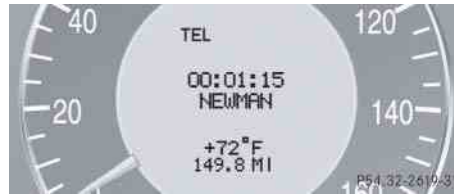

- If no connection is made, the control system stores the dialed number in the redial memory.



Redialing

The control system stores the most recently dialed phone numbers. This eliminates the need to search through your entire phone book.

- ▶ Press button  or  repeatedly until the message Tel appears in the multifunction display.

- ▶ Press button .

The first number in the redial memory appears in the multifunction display.

- ▶ Press button  or  repeatedly until the desired name appears in the multifunction display.



If you do not want to use the telephone, press button .

- ▶ Press button .

The control system dials the selected phone number.

▼ Automatic transmission

For more information on driving with an automatic transmission see “Automatic transmission” (page 47).

Your vehicle’s transmission adapts its gear shifting process to your individual driving style by continually adjusting the shift points up or down. These shift point adjustments are performed based on current operating and driving conditions.

If the operating conditions change, the automatic transmission reacts by adjusting its shift program.



During the brief warm-up, transmission upshifting is delayed. This allows the catalytic converter to heat up more quickly to operating temperature.

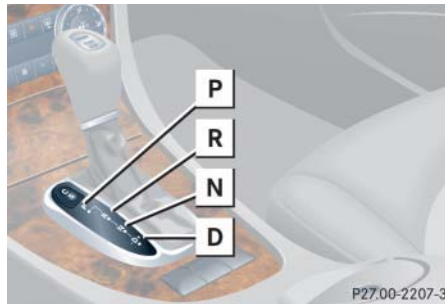

Gearshift pattern for automatic transmission

Controls in detail

Automatic transmission

The automatic transmission selects individual gears automatically, depending on:

- the gear selector lever position **D** (▷ page 169) with gear ranges (▷ page 168)
- the selected program mode:
(C/S) (▷ page 170)
or
(M/C/S) (CLK 55 AMG only) (▷ page 175)
- the position of the accelerator pedal (▷ page 171)
- the vehicle speed

Controls in detail

Automatic transmission



- ① Current gear range/gear selector lever position
- ② Current program mode

The current gear range/gear selector lever position and program mode (C/S) or (M/C/S) appear in the multifunction display.

An additional indication of the current gear selector lever position can be found on the cover of the shifting-gate.

The indicators come on when you activate a switch (e.g. unlocking the vehicle or opening a door) and go out after approximately 15 minutes.

Warning!



It is dangerous to shift the gear selector lever out of **P** or **N** if the engine speed is higher than idle speed. If your foot is not firmly on the brake pedal, the vehicle could accelerate quickly forward or reverse. You could lose control of the vehicle and hit someone or something. Only shift into gear when the engine is idling normally and when your right foot is firmly on the brake pedal.



Allow engine to warm up under low load use. Do not place full load on the engine until the operating temperature has been reached.

Shift into reverse gear **R** or parking position **P** only when the vehicle is stopped.

Avoid spinning of a drive wheel for an extended period when driving off on slippery road surfaces. This may cause serious damage to the drivetrain which is not covered by the Mercedes-Benz Limited Warranty.

When the gear selector lever is in position **D**, you can influence transmission shifting by:

- limiting the gear range
- changing gears manually

One-touch gearshifting

Even with an automatic transmission you can change the gears manually when the gear selector lever is in position **D**.

Downshifting

- ▶ Briefly press the gear selector lever to the left in the **D-** direction.

The transmission will shift from the current gear to the next lower gear as permitted by the shift program. This action simultaneously limits the gear range of the transmission (> page 168).

Warning!



On slippery road surfaces, never downshift in order to obtain braking action. This could result in drive wheel slip and reduced vehicle control. Your vehicle's ABS will not prevent this type of loss of control.



To avoid overrevving the engine when the gear selector lever is moved to the **D-** direction, the transmission will not shift to a lower gear if the engine's max. speed would be exceeded.

Upshifting

- ▶ Briefly press the gear selector lever to the right in the **D+** direction.

The transmission will shift from the current gear to the next higher gear as permitted by the shift program. This action simultaneously extends the gear range of the transmission.

Controls in detail

Automatic transmission

Canceling gear range limit

- ▶ Press and hold the gear selector lever in the **D+** direction until **D** reappears in the multifunction display.

The transmission will shift from the current gear range directly to gear range **D**.

Shifting into optimal gear range

- ▶ Press and hold the gear selector lever in the **D-** direction.

The transmission will automatically select the gear range suited for optimal acceleration and deceleration. This will involve shifting down one or more gears.

Controls in detail

Automatic transmission

Gear ranges

With the gear selector lever in position **D**, you can limit the transmission's gear range by pressing the gear selector lever to the left (**D-**), and reverse the gear range limit by pressing the gear selector lever to the right (**D+**).

The selected gear range appears in the multifunction display (▷ page 166). If you press on the accelerator when the engine has reached its rpm limit, the transmission will upshift beyond any gear range limit selected.

	Effect
6	The transmission shifts through sixth gear only (applies to vehicles with 7-speed automatic transmission only).
5	The transmission shifts through fifth gear only (applies to vehicles with 7-speed automatic transmission only).
4	The transmission shifts through fourth gear only.
3	The transmission shifts through third gear only. With this selection you can use the braking effect of the engine.

	Effect
2	The transmission shifts through second gear only. Allows the use of engine's braking power when driving: <ul style="list-style-type: none">• on steep downgrades• in mountainous regions• under extreme operating conditions
1	The transmission operates in first gear only. For maximum use of engine's braking effect on very steep or lengthy downgrades.

Controls in detail

Automatic transmission

Gear selector lever position

	Effect
P	Park position Gear selector lever position when the vehicle is parked. Place gear selector lever in position P only when vehicle is stopped. The park position is not intended to serve as a brake when the vehicle is parked. Rather, the driver should always set the parking brake in addition to placing the gear selector lever in position P to secure the vehicle.

	Effect
	The SmartKey can only be removed from the starter switch with the gear selector lever in position P . With the SmartKey removed, the gear selector lever is locked in position P . If the vehicle's electrical system is malfunctioning, the gear selector lever could remain locked in position P (page 352).
R	Reverse gear Place gear selector lever in position R only when vehicle is stopped.

	Effect
N	Neutral No power is transmitted from the engine to the drive axle. When the brakes are released, the vehicle can be moved freely (pushed or towed). To avoid damage to the transmission, never engage N while driving. If the ESP is deactivated or malfunctioning: Move gear selector lever to N only if the vehicle is in danger of skidding, e.g. on icy roads.
D	Drive The transmission shifts automatically. All forward gears are available.

Controls in detail

Automatic transmission



Coasting the vehicle, or driving for any other reason with gear selector lever in **N** can result in transmission damage that is not covered by the Mercedes-Benz Limited Warranty.

Warning!



Getting out of your vehicle with the gear selector lever not fully engaged in position **P** is dangerous. Also, position **P** alone is not intended to or capable of preventing your vehicle from moving, possibly hitting people or objects.

Always set the parking brake in addition to shifting to position **P** (page 54).

When parked on an incline, turn the front wheels towards the road curb.

Do not park this vehicle in areas where combustible materials such as grass, hay or leaves can come into contact with the hot exhaust system, as these materials could be ignited and cause a vehicle fire.

Warning!



When leaving the vehicle, always remove the SmartKey or SmartKey with KEYLESS-GO* from the starter switch, take it with you, and lock the vehicle. Do not leave children unattended in the vehicle, or with access to an unlocked vehicle. Children could move the gear selector lever from position **P**, which could result in an accident and/or serious personal injury.

Automatic shift program

The program mode selector switch is located on the lower part of the center console.

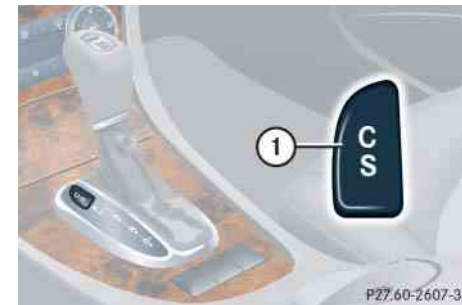

① Program mode selector switch

C Comfort For comfort driving

S Sport For standard driving

The current gear selector lever position and the selected program mode (C/S) are indicated in the multifunction display (> page 166).



Never change the program mode when the gear selector lever is out of position **P**. This could result in a change of driving characteristics for which you may not be prepared.



The last selected program mode (**C** or **S**) is switched on when the engine is restarted.

- ▶ Press program mode selector switch ① repeatedly until the letter of the desired program mode appears in the multifunction display.

Select **C** for comfort driving:

- The vehicle starts out in second gear (both forward and reverse) for gentler starts. This does not apply if full throttle is applied or gear range **1** is selected.
- Traction and driving stability are improved on icy roads.
- Upshifts occur earlier even when you give more gas. The engine then operates at lower rpms and the wheels are less likely to spin.

Controls in detail

Automatic transmission

Driving tips

Accelerator position

Your driving style influences the transmission's shifting behavior:

Less throttle	Earlier upshifting
More throttle	Later upshifting

Kickdown

Use kickdown when you want maximum acceleration.

- ▶ Press the accelerator past the point of resistance.
The transmission shifts into a lower gear.
- ▶ Ease on the accelerator when you have reached the desired speed.
The transmission shifts up again.

Controls in detail

Automatic transmission

Stopping

When you stop briefly, e.g. at traffic lights:

- ▶ Leave the transmission in gear.
- ▶ Hold the vehicle with the brake.

When you stop longer with the engine idling or on an uphill gradient:

- ▶ Move the gear selector lever to position **P**.
- ▶ Set the parking brake.

Maneuvering

When you maneuver in tight areas, e.g. when pulling into a parking space:

- ▶ Control the vehicle speed by gradually releasing the brakes.
- ▶ Accelerate gently.
- ▶ Never abruptly step on the accelerator.

Working on the vehicle

Warning!



When working on the vehicle, set the parking brake and move gear selector lever to position **P**. Otherwise the vehicle could roll away.

Steering wheel gearshift control (Speedshift) - CLK 500 and CLK 55 AMG

When driving in the automatic program modes **C** or **S**, or in the manual program mode **M** (CLK 55 AMG only), you can change the gears manually on the steering wheel or by using the gear selector lever (▷ page 167).



To avoid overrevving the engine when downshifting with steering wheel gearshift buttons, the transmission will not shift to a lower gear if the engine's max. speed would be exceeded.



Allow engine to warm up under low load use. Do not place full load on the engine until the operating temperature has been reached.

Shift into reverse gear **R** or parking position **P** only when the vehicle is stopped.

Avoid spinning of a drive wheel for an extended period when driving off on slippery road surfaces. This may cause serious damage to the drivetrain which is not covered by the Mercedes-Benz Limited Warranty.

Steering wheel gearshift control CLK 500

The steering wheel gearshift buttons are located to the left and right of the steering wheel.



- ① Button, inside: downshift
- ② Button, outside: upshift



You cannot shift with the steering wheel gearshift buttons when the gear selector lever is in position **P**, **N** or **R**.

The last selected program mode (**C** or **S**) is switched on when the engine is restarted.

Controls in detail

Automatic transmission

Downshifting

Warning!



On slippery road surfaces, never downshift in order to obtain braking action. This could result in drive wheel slip and reduced vehicle control. Your vehicle's ABS will not prevent this type of loss of control.

- ▶ Press the inside ① of one of the buttons on the steering wheel.

The transmission will shift to the next lower gear as permitted by the shift program. This action simultaneously limits the gear range of the transmission (▷ page 168).

Controls in detail

Automatic transmission

Upshifting

- ▶ Press outside ② of one of the buttons on the steering wheel.

The transmission will shift to the next higher gear as permitted by the shift program. This action simultaneously extends the gear range of the transmission.

Steering wheel gearshift control CLK 55 AMG

The steering wheel gearshift buttons are located to the left and right of the steering wheel.

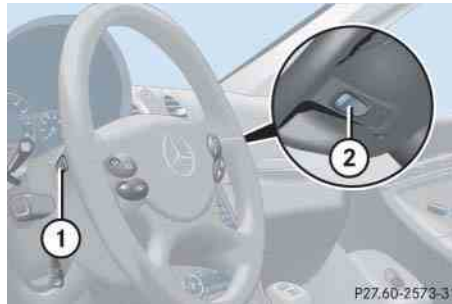

- ① Left button: downshift
- ② Right button: upshift

i

You cannot shift with the steering wheel gearshift buttons when the gear selector lever is in position **P**, **N** or **R**.

The manual program mode **M** will not be stored. When the engine is turned off with the manual program mode **M** selected, the transmission will go to the automatic program mode (**C** or **S**) when the engine is restarted.

The last selected program mode (**C** or **S**) is switched on when the engine is restarted in the automatic program mode.

Downshifting

Warning!



On slippery road surfaces, never downshift in order to obtain braking action. This could result in drive wheel slip and reduced vehicle control. Your vehicle's ABS will not prevent this type of loss of control.

- ▶ Press button ① on the left side of the steering wheel.

The transmission will shift to the next lower gear as permitted by the shift program. This action simultaneously limits the gear range of the transmission (▷ page 168) when you are driving in the automatic program mode (**C** or **S**).

Upshifting

- ▶ Press button ② on the right side of the steering wheel.

The transmission will shift to the next higher gear as permitted by the shift program. This action simultaneously extends the gear range of the transmission when you are driving in the automatic program mode (**C** or **S**).

Manual shift program CLK 55 AMG

In the manual program mode **M** you can change the gears manually on the steering wheel (▷ page 174) or by using the gear selector lever (▷ page 167).



Allow engine to warm up under low load use. Do not place full load on the engine until the operating temperature has been reached.

Shift into reverse gear **R** or parking position **P** only when the vehicle is stopped.

Avoid spinning of a drive wheel for an extended period when driving off on slippery road surfaces. This may cause serious damage to the drivetrain which is not covered by the Mercedes-Benz Limited Warranty.

Controls in detail

Automatic transmission

The program mode selector switch is located on the lower part of the center console.

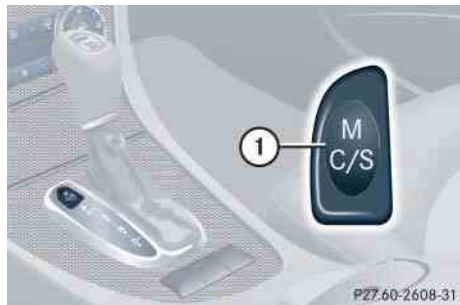

① Program mode selector switch

M Manual For manual gear shifting

C Comfort For comfort driving

S Sport For standard driving

The current gear selector lever position and the selected program mode (M/C/S) are indicated in the multifunction display (▷ page 166).

Activating manual shift program

- ▶ Press program mode selector switch ① repeatedly until the M for manual program mode **M** appears in the multifunction display.

The transmission switches to the manual program mode **M**. Automatic shifting is switched off. The gear range is not limited.

You can change the gears manually when the gear selector lever is in position **D**. You can upshift or downshift through the gears in succession.

Downshifting

Warning!



On slippery road surfaces, never downshift in order to obtain braking action. This could result in drive wheel slip and reduced vehicle control. Your vehicle's ABS will not prevent this type of loss of control.

- ▶ Briefly press the gear selector lever to the left in the **D-** direction (▷ page 167).

or

- ▶ Press button ① on the left side of the steering wheel (▷ page 174).

The transmission shifts to the next lower gear.

i

When you brake or stop, the transmission shifts down to a gear from which you can easily accelerate or take off.

Upshifting



In the manual program mode **M**, the transmission will not upshift, even if the engine has reached its overrevving range. Shift up to the next gear before the engine has reached its overrevving range. Make absolutely certain that the engine speed does not reach the red marking on the tachometer (page 24). Otherwise the engine could be damaged which is not covered by the Mercedes-Benz Limited Warranty

- ▶ Briefly press the gear selector lever to the right in the **D+** direction (▷ page 167).
- or
- ▶ Press button ② on the right side of the steering wheel (▷ page 174).

The transmission shifts to the next higher gear.

If, instead of the manual program mode symbol **M**, the  symbol appears in the multifunction display (▷ page 166), shift to the next higher gear. The fuel supply will otherwise be interrupted to prevent the engine from overrevving.

Kickdown

Using the kickdown when driving in the manual program mode **M** is not possible.

Deactivating manual shift program

- ▶ Press the program mode selector switch (▷ page 176) repeatedly until **C** or **S** appears in the multifunction display.

or

- ▶ Restart the engine.

The transmission will go to the automatic program mode (**C** or **S**).

The manual program mode **M** is not stored.

Emergency operation (Limp Home Mode)

If vehicle acceleration worsens or the transmission no longer shifts, the transmission is most likely operating in limp home (emergency operation) mode. In this mode only second gear and reverse gear can be activated.

- ▶ Stop the vehicle.
- ▶ Move gear selector lever to **P**.
- ▶ Turn off the engine.
- ▶ Wait at least ten seconds before restarting.
- ▶ Restart the engine.
- ▶ Move gear selector lever to position **D** (for second gear) or **R**.
- ▶ Have the transmission checked at an authorized Mercedes-Benz Center as soon as possible.

Controls in detail

Good visibility

For information on the windshield wipers, see “Windshield wipers” (▷ page 52).

Headlamp cleaning system*

The switch is located on the left side of the dashboard.



① Headlamp washer switch

- ▶ Switch on ignition (▷ page 36).
- ▶ Press switch ①.

The headlamps are cleaned with a high-pressure water jet.

For information on filling up the washer reservoir, see “Windshield washer system and headlamp cleaning system*” (▷ page 454).

Rear view mirrors

For more information on setting the rear view mirrors, see “Mirrors” (▷ page 41).

Auto-dimming rear view mirrors

The reflection brightness of the exterior rear view mirror on the driver’s side and the interior rear view mirror will respond automatically to glare when

- the ignition is switched on,
and
- incoming light from headlamps falls on the sensor in the interior rear view mirror.

The rear view mirror will not react if

- reverse gear **R** is engaged
- the interior lighting is turned on

Controls in detail

Good visibility

Warning!



The auto-dimming function does not react if incoming light is not aimed directly at sensors in the interior rear view mirror.

The interior rear view mirror and the exterior rear view mirror on the driver's side do not react, for example, if the rear window sun shade* is in raised position.

Glare can endanger you and others.

Warning!



In the case of an accident, liquid electrolyte may escape from the mirror housing if the mirror glass breaks.

Electrolyte has an irritating effect. Do not allow the liquid to come into contact with eyes, skin, clothing, or respiratory system. In case it does, immediately flush affected area with water, and seek medical help if necessary.



Electrolyte drops coming into contact with the vehicle paint finish can be completely removed only while in the liquid state and by applying plenty of water.

Warning!



Exercise care when using the passenger-side exterior rear view mirror. The mirror surface is convex (outwardly curved surface for a wider field of view). Objects in mirror are closer than they appear. Check your interior rear view mirror or glance over your shoulder before changing lanes.

Controls in detail

Good visibility

Activating exterior rear view mirror parking position

Follow these steps to activate the mirror parking position so that the passenger-side exterior rear view mirror will be turned downward to the stored position.

The buttons are located above the exterior lamp switch.



- ① Driver's side exterior rear view mirror button
- ② Passenger-side exterior rear view mirror button

- ▶ Make sure you have stored a parking position for the passenger-side exterior rear view mirror (▷ page 123).
- ▶ Make sure the Mirror adjustment parking aid function in the Convenience submenu of the control system is switched to on (▷ page 160).
- ▶ Switch on ignition (▷ page 36).
- ▶ Press button ② for the passenger-side exterior rear view mirror.
- ▶ Place the gear selector lever in reverse gear **R**.

The passenger-side exterior rear view mirror will be turned downward to the stored position.

The exterior rear view mirror returns to its previously stored driving position:

- ten seconds after you put the gear selector lever out of position **R**
- immediately once your vehicle exceeds a speed of approx. 6 mph (10 km/h)
- immediately when you press button ① for the driver's side mirror.

Sun visors

The sun visors protect you from sun glare while driving.

Warning!



Do not use the vanity mirror while driving. Keep the mirrors in the sun visors closed while vehicle is in motion. Reflected glare can endanger you and others.

- ▶ Swing sun visors down when you experience glare.

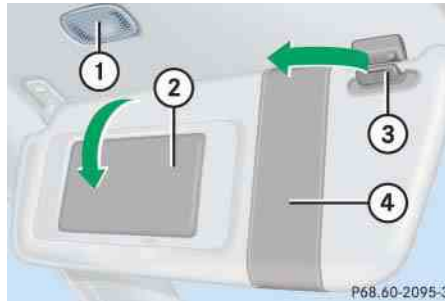

- ① Mirror lamp
- ② Mirror cover
- ③ Mounting
- ④ Sun visor

- ▶ To use mirror, lift up cover ②.

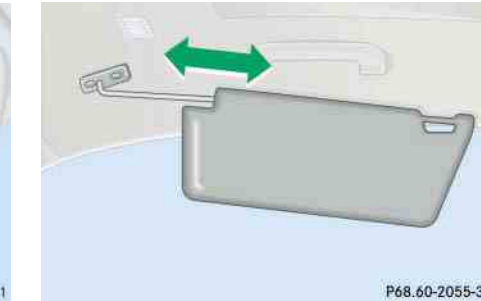

If sunlight enters through a side window:

- ▶ disengage sun visor from mounting ③.
- ▶ pivot sun visor to the side.

The sun visors are extendable.

- ▶ Adjust the sun visors by pushing or pulling in the direction of the arrows.



If you disengage the sun visor from mounting ③, mirror lamp ① will switch off.

Controls in detail

Good visibility

Controls in detail

Good visibility

Rear window sunshade*

The switch is located in the center console.



① Rear window sunshade switch



Make sure that the movement of the rear window sunshade is not restricted by objects on the rear window shelf. Otherwise, the sunshade or the objects could be damaged.

- ▶ Switch on ignition (▷ page 36).

Always raise the sunshade fully for its support against the window frame.

Raising the sunshade

- ▶ Press switch ① briefly.
The sunshade is raised completely.

Stopping the raising procedure

- ▶ Press switch ① again.
The sunshade stops.

Lowering the sunshade

- ▶ Press switch ① briefly.
The sunshade is lowered completely.

Stopping the lowering procedure

- ▶ Press switch ① again.
The sunshade stops.

Warning!



When operating the rear window sunshade, make sure there is no danger of anyone being harmed by the raising or lowering procedure.

The raising or lowering procedure can be immediately halted by briefly pressing the switch ①.

Briefly press switch ① again to raise or lower the rear window sunshade completely.

Warning!





When leaving the vehicle, always remove the SmartKey or SmartKey with KEYLESS-GO* from the starter switch, take it with you, and lock the vehicle. Do not leave children unattended in the vehicle, or with access to an unlocked vehicle. Unsupervised use of vehicle equipment may cause an accident and/or serious personal injury.

Rear window defroster

The rear window defroster uses a large amount of power. To keep the battery drain to a minimum, switch off the defroster as soon as the rear window is clear. The defroster is automatically deactivated after approximately 6 to 17 minutes of operation depending on the outside temperature.

Activating

- ▶ Press button  or  in the climate control panel (▷ page 195) or in automatic climate control panel (▷ page 195).

The indicator lamp on the button comes on.

Deactivating

- ▶ Press button  or  again.

The indicator lamp on the button goes out.

Controls in detail

Good visibility

Warning!



Any accumulation of snow and ice should be removed from the rear window before driving. Visibility could otherwise be impaired, endangering you and others.



If the rear window defroster switches off too soon and the indicator lamp starts flashing, this means that too many electrical consumers are operating simultaneously and there is insufficient voltage in the battery. The system responds automatically by deactivating the rear window defroster.

As soon as the battery has sufficient voltage, the rear window defroster automatically switches on again.

Controls in detail

Climate control (CLK 320)

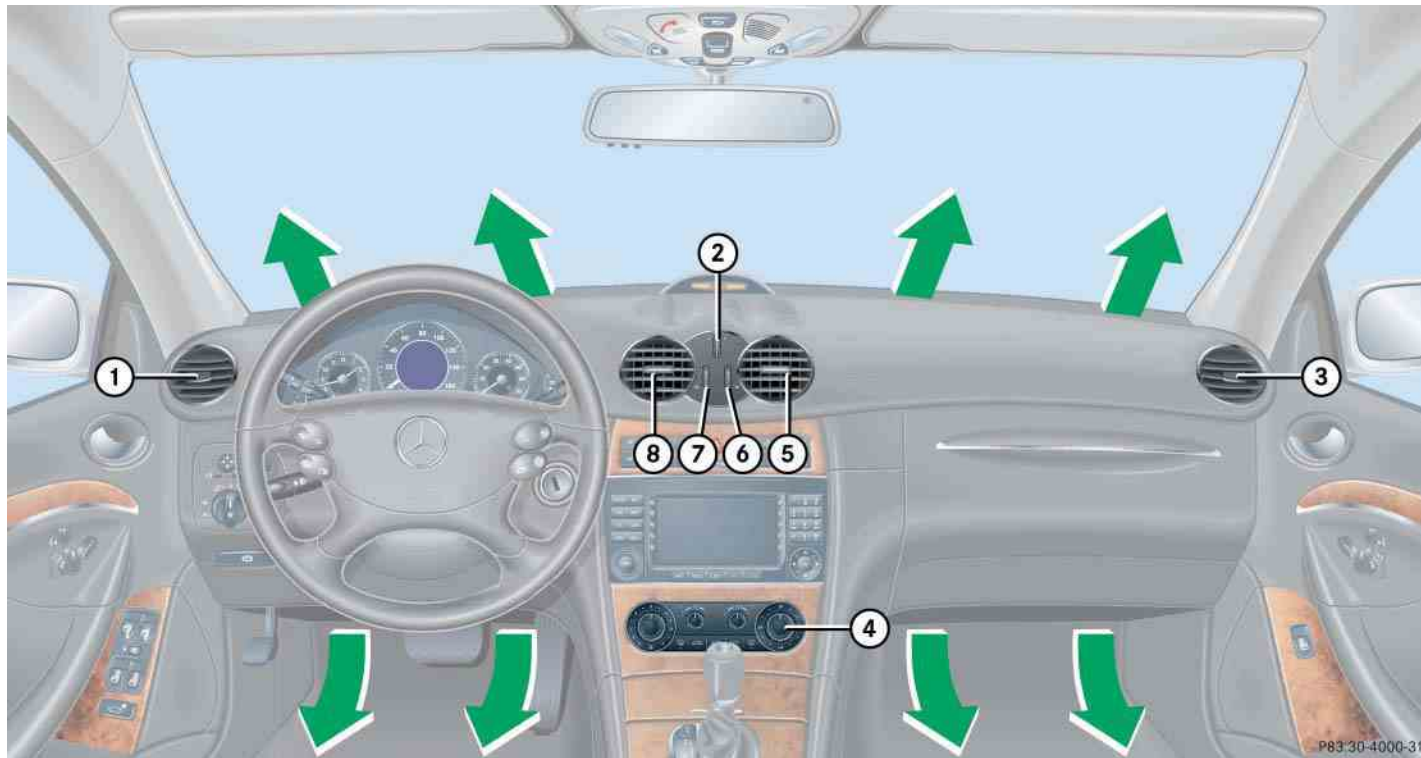

Item
① Left side air vent, adjustable
② Thumbwheel for air volume control for center air vents
③ Right side air vent, adjustable
④ Climate control panel
⑤ Right center air vent, adjustable
⑥ Thumbwheel for air volume control for right side center air vent
⑦ Thumbwheel for air volume control for left side center air vent
⑧ Left center air vent, adjustable



For draft-free ventilation, move the sliders for the side air vents ① and ③ and center air vents ⑤ and ⑧ to the middle position.

Depending on production date, your vehicle is equipped with either climate control panel design A or B.



Climate control panel design A



Climate control panel design B

Controls in detail

Climate control (CLK 320)

Item
① Air volume control
② Left side temperature control
③ Right side temperature control
④ Air distribution control
⑤ Rear window defroster
⑥ AC cooling on/off (AC^{OFF} or A/C)
⑦ Air distribution and air volume (automatic mode)
⑧ Air recirculation
⑨ Defrosting

Controls in detail

Climate control (CLK 320)

The climate control is operational whenever the engine is running. You can operate the climate control system in either the automatic or manual mode. The system cools or heats the interior depending on the selected interior temperature and the current outside temperature.

Warning!



When operating the climate control, the air that enters the passenger compartment through the air vents in the footwell can be very hot or very cold (depending on the set temperature). This may cause burns or frostbite on unprotected skin in the immediate area of the air vents. Always keep sufficient distance between unprotected parts of the body and the footwell air vents. If necessary, change the air flow using the air distribution controls to direct the air away from the footwell air vents (▷ page 188).

Nearly all dust particles, pollutants and odors are filtered out before outside air enters the passenger compartment through the air distribution system.

The air conditioning will not engage (no cooling) if the mode **AC^{OFF}** is activated or **A/C** is deactivated (▷ page 191).

Warning!



Follow the recommended settings for heating and cooling given on the following pages. Otherwise the windows could fog up, impairing visibility and endangering you and others.



Severe conditions (e.g. strong air pollution) may require replacement of the filter before its scheduled interval. A clogged filter will reduce the air volume to the interior.

If the vehicle interior is hot, ventilate the interior before driving off, see “Opening (Summer opening feature)” (▷ page 253).

Keep the air intake grille in front of the windshield free of snow and debris.

Do not obstruct air flow by placing objects on the air flow-through exhaust slots below the rear window.

Deactivating the climate control system

Deactivating

- ▶ Set air volume control ① (▷ page 185) to position **0**.



When the air conditioning is switched off, the outside air supply and circulation are also switched off. Only choose this setting for a short time. Otherwise the windows could fog up.

Reactivating

- ▶ Set air volume control ① (▷ page 185) to any speed.

Controls in detail

Climate control (CLK 320)

Setting the temperature

Use temperature controls ② and ③ (▷ page 185) to separately adjust the air temperature on each side of the passenger compartment. You should raise or lower the temperature setting in small increments, preferably starting at 72°F (22°C).



When operating the climate control system in automatic mode, you will only rarely need to adjust the temperature, air volume and air distribution.

Controls in detail

Climate control (CLK 320)

Increasing

- ▶ Turn temperature control ② or ③ (▷ page 185) slightly to the right.

The climate control system will correspondingly adjust the interior air temperature.





Decreasing

- ▶ Turn temperature control ② or ③ (▷ page 185) slightly to the left.

The climate control system will correspondingly adjust the interior air temperature.

Adjusting air distribution and volume

Use air distribution control ④ (▷ page 185) to adjust the air distribution. The following symbols are found on the controls:

Symbol	Function
	Directs air to the windshield and the side defroster vents
	Directs air into the entire vehicle interior
	Directs air to the footwells
	Directs air through the center, side and rear passenger compartment air vents

Use the air volume control ① (▷ page 185) to adjust the air volume. You can select between six air volume speeds.



Adjusting manually

- ▶ Press button **AUTO** (▷ page 185).
The indicator lamp on the button goes out.
- ▶ Select any of the six air volume speeds and the air distribution.

Adjusting automatically

- ▶ Press button **AUTO** (▷ page 185).
The indicator lamp on the button comes on. The temperature, air distribution and volume are adjusted automatically.

Windshield fogged on the outside



- ▶ Switch the windshield wipers on (▷ page 51).
- ▶ Switch to manual mode.
- ▶ Turn the air distribution control ④ to  or  (▷ page 185).

Defrosting



These settings should only be selected for a short time.

Activating



- ▶ Press button  or  (▷ page 185).

The indicator lamp on the button comes on.

The air conditioning switches automatically to the following functions:

- maximum blowing and heating power
- air flows onto the windshield and the front side windows
- the air recirculation mode is switched off

Deactivating

- ▶ Press button  or  (▷ page 185).

The indicator lamp on the button goes out. Defrosting is turned off.

Controls in detail

Climate control (CLK 320)

Air recirculation mode

Switch to air recirculation mode to prevent unpleasant odors from entering the vehicle from the outside. This setting cuts off the intake of outside air and recirculates the air in the passenger compartment.

Warning!



When the outside temperature is below 41°F (5°C), only switch to air recirculation mode for short periods to prevent window fogging.

Window fogging may impair visibility and endanger you and others.

Activating

- ▶ Press button  (▷ page 185).
The indicator lamp on the button comes on.





If you keep button  pressed the side windows and tilt/sliding sunroof* will close.

Warning



Never operate the side windows and the tilt/sliding sunroof* if there is the possibility of anyone being harmed by the closing procedure.

In the event that the procedure causes potential danger, the closing of the side windows can be immediately halted by releasing the  button or by pressing or pulling the respective window switch. The closing of the tilt/sliding sunroof* can be immediately halted by releasing the  button or by moving the tilt/sliding sunroof* switch in the overhead control panel in any direction.



The air recirculation mode is activated automatically at high outside temperatures.

The indicator lamp on the  button is not lit when the air recirculation mode is automatically switched on.

After approx. 30 minutes, outside air is added to the air inside the vehicle.

If you have turned off the air conditioning (▷ page 191) or the outside temperature is below 41°F (5°C), the air recirculation mode will not switch on automatically.

Controls in detail

Climate control (CLK 320)

Deactivating

► Press button  (▷ page 185).

The indicator lamp on the button goes out.



If you keep button  pressed the side windows and tilt/sliding sunroof* will return to their previous position.

The air recirculation mode is deactivated automatically:

- after five minutes if the outside temperature is below approximately 41°F (5°C)
- after five minutes if the air conditioning is turned off
- after 30 minutes if the outside temperature is above approximately 41°F (5°C)

At outside temperatures above 79°F (26°C) the system will not automatically switch back to outside air. A quantity of outside air is added after approximately 30 minutes.

Air conditioning

The air conditioning is operational while the engine is running and cools the interior air to the temperature set by the operator.



Condensation may drip out from underneath the vehicle. This is normal and not an indication of a malfunction.

Warning!



If you turn off the cooling function, the vehicle will not be cooled when weather conditions are warm. The windows can fog up more quickly. Window fogging may impair visibility and endanger you and others.

Controls in detail

Climate control (CLK 320)

Deactivating

It is possible to deactivate the air conditioning (cooling) function of the climate control system. The air in the vehicle will then no longer be cooled or dehumidified.

Climate control panel design A

- ▶ Press button **AC^{OFF}** (▷ page 185).

The indicator lamp on the button comes on.

The cooling function switches off after a short delay.

Climate control panel design B

- ▶ Press button **A/C** (▷ page 185).

The indicator lamp on the button goes out.

The cooling function switches off after a short delay.

Activating

Moist air can fog up the windows. You can dehumidify the air with the air conditioning.

Climate control panel design A

- ▶ Press button **AC^{OFF}** (▷ page 185) again.
The indicator lamp on the button goes out.

Climate control panel design B

- ▶ Press button **A/C** (▷ page 185) again.
The indicator lamp on the button comes on.

The air conditioning uses the refrigerant R134a. This refrigerant is free of CFCs which are harmful to the ozone layer.



If the air conditioning cannot be turned on again, this indicates that the air conditioning is losing refrigerant. The compressor has turned itself off.

Have the air conditioning checked at the nearest authorized Mercedes-Benz Center.

Rear passenger compartment adjustable air vents

The air conditioning for the rear passenger compartment is controlled via the climate control panel (▷ page 185).



The temperature at the center air vents for the rear passenger compartment ② and ③ is the same as at the dashboard center air vents.

The air vents for the rear passenger compartment are located in the rear center console.

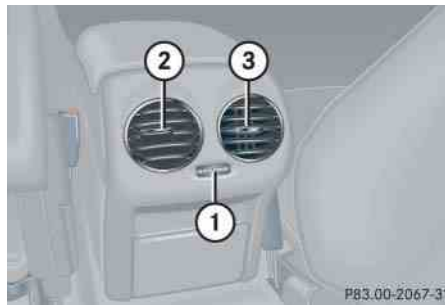

- ① Thumbwheel for air volume control for center air vents
- ② Left center air vent
- ③ Right center air vent

Controls in detail

Climate control (CLK 320)

Adjusting air distribution

- ▶ Push the slide for the left center vent ② or right center vent ③ to the left, right, up or down.

The air flow is directed in the corresponding direction.



For draft-free ventilation, push slides ② and ③ upward.

Adjusting air volume

- ▶ Turn thumbwheel ① to the left or right.

The air volume is increased or decreased.

Controls in detail

Automatic climate control (CLK 500/CLK 55 AMG)

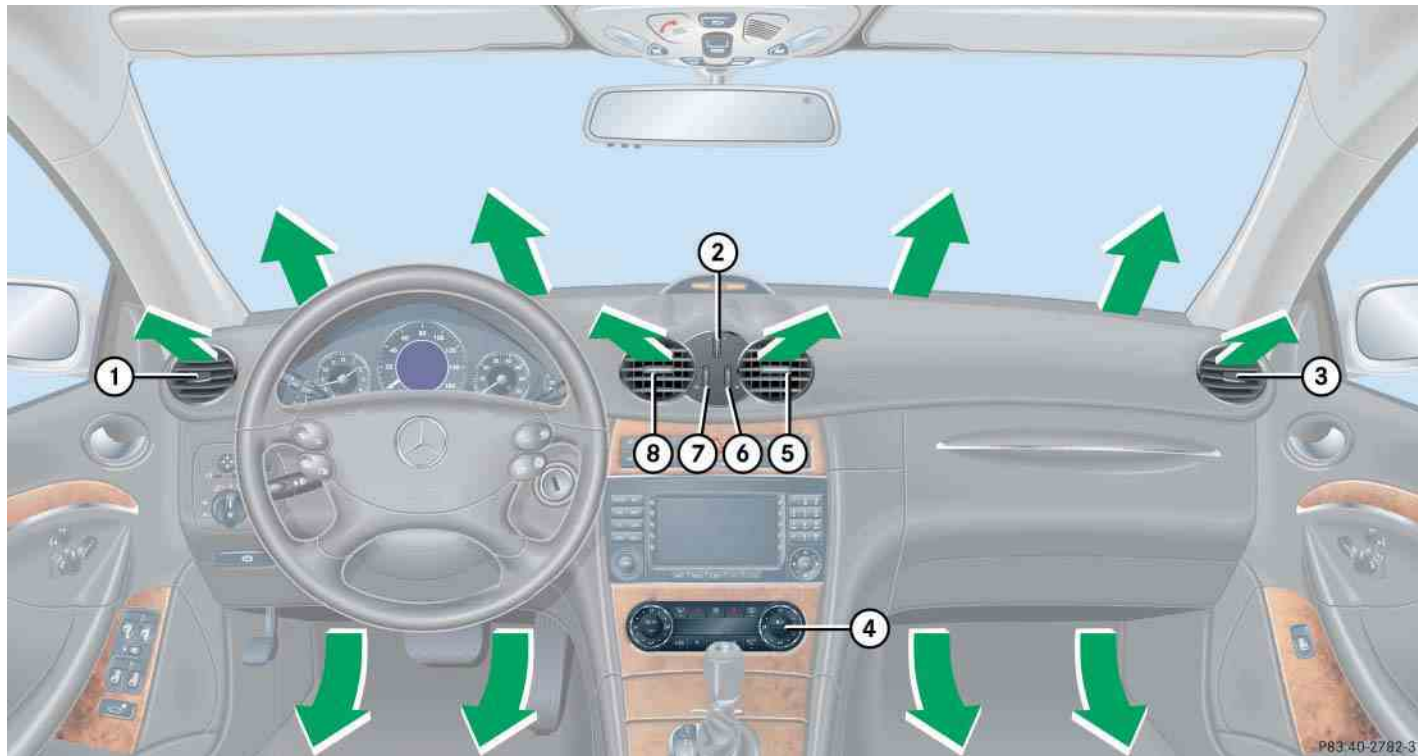

Controls in detail

Automatic climate control (CLK 500/CLK 55 AMG)

Item
① Left side air vent, adjustable
② Thumbwheel for air volume control for center air vents
③ Right side air vent, adjustable
④ Automatic climate control panel
⑤ Right center air vent, adjustable
⑥ Thumbwheel for air volume control for right side center air vent
⑦ Thumbwheel for air volume control for left side center air vent
⑧ Left center air vent, adjustable



For draft-free ventilation, move the sliders for the center air vents ①, ③, ⑤, ⑧ to the middle position.

Depending on production date, your vehicle is equipped with either automatic climate control panel design A or B.

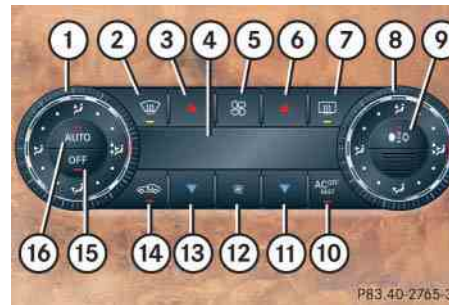

Automatic climate control panel design A



Automatic climate control panel design B

Item
① Left side air distribution control
② Defrosting
③ Temperature control, left, raising
④ Display
⑤ Air volume control, raising
⑥ Temperature control, right, raising
⑦ Rear window defroster
⑧ Right side air distribution control
⑨ Charcoal filter
⑩ AC cooling on/off (AC ^{OFF} or A/C) Residual heat/ventilation
⑪ Temperature control, right, lowering
⑫ Air volume control, lowering
⑬ Temperature control, left, lowering
⑭ Air recirculation
⑮ Automatic climate control on/off (complete system)
⑯ Air distribution and air volume (automatic mode)

Controls in detail

Automatic climate control (CLK 500/CLK 55 AMG)

The automatic climate control is operational whenever the engine is running. You can operate the climate control system in either the automatic or manual mode. The system cools or heats the interior depending on the selected interior temperature and the current outside temperature.

Warning



When operating the automatic climate control, the air that enters the passenger compartment through the air vents in the footwell can be very hot or very cold (depending on the set temperature). This may cause burns or frostbite on unprotected skin in the immediate area of the air vents. Always keep sufficient distance between unprotected parts of the body and the footwell air vents. If necessary change the air flow using the air distribution controls to direct the air away from the footwell air vents (▷ page 198).

Nearly all dust particles, pollutants and odors are filtered out before outside air enters the passenger compartment through the air distribution system.

The air conditioning will not engage (no cooling) if the mode **AC^{OFF}** is activated or **A/C** is deactivated (▷ page 204).

Warning!



Follow the recommended settings for heating and cooling given on the following pages. Otherwise the windows could fog up, impairing visibility and endangering you and others.



Severe conditions (e.g. strong air pollution) may require replacement of the filter before its scheduled interval. A clogged filter will reduce the air volume to the interior.

If the vehicle interior is hot, ventilate the interior before driving off, see “Opening (Summer opening feature)” (▷ page 253).

Keep the air intake grille in front of the windshield free of snow and debris.

Do not obstruct air flow by placing objects on the air flow-through exhaust slots below the rear window.

Deactivating the automatic climate control system

Deactivating

It is possible to deactivate the automatic climate control system.

- ▶ Press button **OFF** (▷ page 195).

The indicator lamp on the button **OFF** comes on.

The automatic climate control system is deactivated



When the air conditioning is switched off, the outside air supply and circulation are also switched off. Only choose this setting for a short time. Otherwise the windows could fog up.

Reactivating

- ▶ Press button **OFF** (▷ page 195).

The indicator lamp on the button **OFF** goes out.

The automatic climate control system is reactivated

Setting the temperature

Use temperature controls ③ and ⑬ for the left side or ⑥ and ⑪ for the right side (▷ page 195) to separately adjust the air temperature on each side of the passenger compartment. You should raise or lower the temperature setting in small increments, preferably starting at 72°F (22°C).



When operating the automatic climate control system in automatic mode, you will only rarely need to adjust the temperature, air volume and air distribution.

Controls in detail

Automatic climate control (CLK 500/CLK 55 AMG)

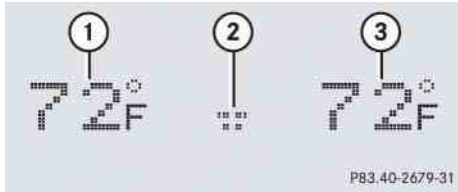

Display

- ① Temperature, left
- ② Blower speed
- ③ Temperature, right

Increasing

- ▶ Push temperature control ③ and/or ⑥ (▷ page 195).

The automatic climate control system will correspondingly adjust the interior air temperature.

Decreasing

- ▶ Push temperature control ⑪ and/or ⑬ (▷ page 195).

The automatic climate control system will correspondingly adjust the interior air temperature.

Adjusting air distribution

Use the button **AUTO** for automatic mode or air distribution controls ① and ⑧ (▷ page 195) to separately adjust the air distribution on each side of the passenger compartment. The following symbols are found on the controls:

Symbol	Function
	Directs air to the windshield and the side defroster vents
	Directs air into the entire vehicle interior
	Directs air to the footwells
	Directs air through the center, side and rear passenger compartment air vents

Adjusting manually

- ▶ Turn air distribution control ① or ⑧ (▷ page 195) to the desired symbol.

The indicator lamp on the button **AUTO** goes out.

The automatic air distribution is switched off. The air distribution is controlled according to the selected control setting.



Adjusting automatically

- ▶ Press button **AUTO** (▷ page 195).



The indicator lamp on the button comes on.

The air volume is controlled automatically for the entire vehicle, and the air distribution is controlled automatically for each separate half of the vehicle.

Windshield fogged on the outside



- ▶ Switch the windshield wipers on (▷ page 52).
- ▶ Switch to manual mode.
- ▶ Turn air distribution control ① or ⑧ to  or  (▷ page 195).

Adjusting air volume

Use button **AUTO** for automatic mode or air volume controls  or  (▷ page 195) to adjust air volume manually.

Adjusting manually

Seven blower speeds are available.

- ▶ Press air volume control  or  (▷ page 195) until the requested blower speed is attained.

The indicator lamp on the button **AUTO** goes out.

The automatic air distribution remains switched on.

Adjusting automatically

- ▶ Press button **AUTO** (▷ page 195).

The indicator lamp on the button comes on.

The air volume is controlled automatically for the entire vehicle, and the air distribution is controlled automatically for each separate half of the vehicle.

Controls in detail



Automatic climate control (CLK 500/CLK 55 AMG)

Defrosting



These settings should only be selected for a short time.

Activating



- ▶ Press button  or  (▷ page 195).

The indicator lamp on the button comes on.

The air conditioning switches automatically to the following functions:

- maximum blowing and heating power
- air flows onto the windshield and the front side windows
- the air recirculation mode is switched off

Deactivating

- ▶ Press button  or  (▷ page 195).

The indicator lamp on the button goes out. Defrosting is turned off.

The previous settings are once again in effect.

Maximum cooling MAXCOOL

If the left and right air distribution controls as well as the airflow volume control are set to **AUTO** (▷ page 195) and there is a high need for cooling, the display “MAXCOOL” appears.

This provides the fastest possible cooling of the vehicle interior (when side windows and tilt/sliding sunroof* are closed).

Automatic climate control (CLK 500/CLK 55 AMG)

Air recirculation mode

Switch to air recirculation mode to prevent unpleasant odors from entering the vehicle from the outside. This setting cuts off the intake of outside air and recirculates the air in the passenger compartment.

Warning!



When the outside temperature is below 41°F (5°C), only switch to air recirculation mode for short periods to prevent window fogging.

Window fogging may impair visibility and endanger you and others.

Activating

- ▶ Press button  (▷ page 195).
The indicator lamp on the button comes on.





If you keep button  pressed, the side windows and tilt/sliding sunroof* will close.

Warning



Never operate the side windows and the tilt/sliding sunroof* if there is the possibility of anyone being harmed by the closing procedure.

In the event that the procedure causes potential danger, the closing of the side windows can be immediately halted by releasing the  button or by pressing or pulling the respective window switch. The closing of the tilt/sliding sunroof* can be immediately halted by releasing the  button or by moving the tilt/sliding sunroof* switch in the overhead control panel in any direction.



The air recirculation mode is activated automatically:

- at high outside temperatures
- if the concentration of carbon monoxide and nitrogen oxide in the outside air increases, for example in a tunnel (charcoal filter must be activated for the air recirculation mode to be activated automatically)

The indicator lamp on the  button is not lit when the air recirculation mode is automatically switched on.

After approx. 30 minutes, outside air is added to the air inside the vehicle.

If you have turned off the air conditioning (▷ page 204) or the outside temperature is below 41°F (5°C), the air recirculation mode will not switch on automatically.

Controls in detail

Automatic climate control (CLK 500/CLK 55 AMG)

Deactivating

- ▶ Press button  (▷ page 195).

The indicator lamp on the button goes out.



If you keep button  pressed, the side windows and tilt/sliding sunroof* will return to their previous position.

The air recirculation mode is deactivated automatically:

- after five minutes if the outside temperature is below approximately 41°F (5°C)
- after five minutes if the air conditioning is turned off
- after 30 minutes if the outside temperature is above approximately 41°F (5°C)

At outside temperatures above 79°F (26°C) the system will not automatically switch back to outside air. A quantity of outside air is added after approximately 30 minutes.

Charcoal filter



An activated charcoal filter markedly reduces bad odors and removes pollutants from air entering the passenger compartment. The charcoal filter can be activated or deactivated.

The system switches automatically to the air recirculation mode, if the

- carbon monoxide (CO)
- or
- nitrogen oxide (NO_x)

concentration of the outside air increases beyond a predetermined level.



The automatic air recirculation mode does not function if the **AC^{OFF}** (indicator lamp on button  illuminated) mode is activated or **A/C** (indicator lamp on button  not lit) mode is deactivated, or if the outside temperature has fallen below 41°F (5°C).

Automatic climate control (CLK 500/CLK 55 AMG)

Activating

- ▶ Press button  (▷ page 195).

The indicator lamp on the button comes on.



If you keep button  pressed, the side windows and tilt/sliding sunroof* will close.





The activated charcoal filter should be switched off when windows fog up on the inside, or if the passenger compartment needs to be quickly heated or cooled down.

Warning



Never operate the side windows and the tilt/sliding sunroof* if there is the possibility of anyone being harmed by the closing procedure.

In the event that the procedure causes potential danger, the closing of the side windows can be immediately halted by releasing the  button or by pressing or pulling the respective window switch. The closing of the tilt/sliding sunroof* can be immediately halted by releasing the  button or by moving the tilt/sliding sunroof* switch in the overhead control panel in any direction.

Deactivating

- ▶ Press button  (▷ page 195).

The indicator lamp on the button goes out.



If you keep button  pressed, the side windows and tilt/sliding sunroof* will return to their previous position.

Controls in detail

Automatic climate control (CLK 500/CLK 55 AMG)

Air conditioning

The air conditioning is operational while the engine is running and cools the interior air to the temperature set by the operator.



Condensation may drip out from underneath the vehicle. This is normal and not an indication of a malfunction.

Warning!



If you turn off the cooling function, the vehicle will not be cooled when weather conditions are warm. The windows can fog up more quickly. Window fogging may impair visibility and endanger you and others.

Deactivating

It is possible to deactivate the air conditioning (cooling) function of the automatic climate control system. The air in the vehicle will then no longer be cooled or dehumidified.

Automatic climate control panel design A

- ▶ Press button  (▷ page 195).

The indicator lamp on the button comes on.

The cooling function switches off after a short delay.

Automatic climate control panel design B

- ▶ Press button  (▷ page 195).

The indicator lamp on the button goes out.

The cooling function switches off after a short delay.

Activating

Moist air can fog up the windows. You can dehumidify the air with the air conditioning.

Automatic climate control panel design A

- ▶ Press button  (▷ page 195) again.

The indicator lamp on the button goes out.

The cooling function is switched on.

Automatic climate control panel design B

- ▶ Press button  (▷ page 195) again.

The indicator lamp on the button comes on.

The cooling function is switched on.

The air conditioning uses the refrigerant R134a. This refrigerant is free of CFCs which are harmful to the ozone layer.



If the air conditioning cannot be turned on again, this indicates that the air conditioning is losing refrigerant. The compressor has turned itself off.

Have the air conditioning checked at the nearest authorized Mercedes-Benz Center.

Residual heat and ventilation* (available on Automatic climate control panel design A only)

With the engine switched off, it is possible to continue to heat or ventilate the interior for up to 30 minutes. This feature makes use of the residual heat produced by the engine.

Activating

- ▶ Switch off ignition (▷ page 36).
- ▶ Press button  (▷ page 195).

The indicator lamp on the button comes on.

Deactivating

- ▶ Press button  (▷ page 195).

The indicator lamp on the button goes out.

The residual heat is automatically turned off:

- when the ignition is switched on
- after about 30 minutes
- if the battery voltage drops



How long the system will provide heating depends on

- the coolant temperature
- the temperature set by the operator

The blower will run at speed setting 1 regardless of the air distribution control setting.

Controls in detail

Automatic climate control (CLK 500/CLK 55 AMG)

Rear passenger compartment adjustable air vents

The air conditioning for the rear passenger compartment is controlled via the automatic climate control panel (▷ page 195).



The temperature at the center air vents for the rear passenger compartment ② and ③ is the same as at the dashboard center air vents.

The air vents for the rear passenger compartment are located in the rear center console.

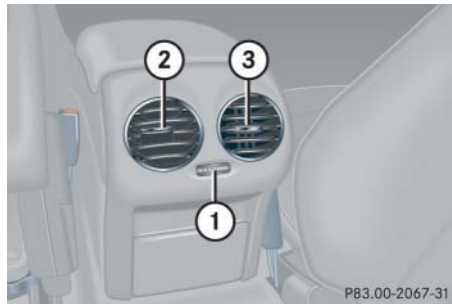

- ① Thumbwheel for air volume control for center air vents
- ② Left center air vent
- ③ Right center air vent

Adjusting air distribution

- ▶ Push the slide for the left center vent ② or right center vent ③ to the left, right, up or down.

The air flow is directed in the corresponding direction.



For draft-free ventilation, push slides ② and ③ upward.

Adjusting air volume

- ▶ Turn thumbwheel ① to the left or right.

The air volume is increased or decreased.

▼ Audio system

Audio and telephone, operation

These instructions are intended to help you become familiar with your Mercedes-Benz audio system. They contain useful tips and a detailed description of the user functions.

Warning!



In order to avoid distraction which could lead to an accident, the driver should enter system settings with the vehicle at a standstill and operate the system only when road and traffic conditions permit. Always pay full attention to traffic conditions first before operating system controls while driving.

Bear in mind that at a speed of just 30 mph (approximately 50 km/h), your car is covering a distance of 44 feet (approximately 14 m) every second.

Operating safety

Warning!



Any alterations made to electronic components can cause malfunctions.

The radio, amplifier, CD changer*, satellite radio*, telephone* and voice control system* are interconnected. When one of the components is not operational or has not been removed/replaced properly, the function of other components may be impaired.

This condition might seriously impair the operating safety of your vehicle.

We recommend that you have any service work on electronic components carried out by an authorized Mercedes-Benz Center.

Controls in detail

Audio system

Operating and display elements

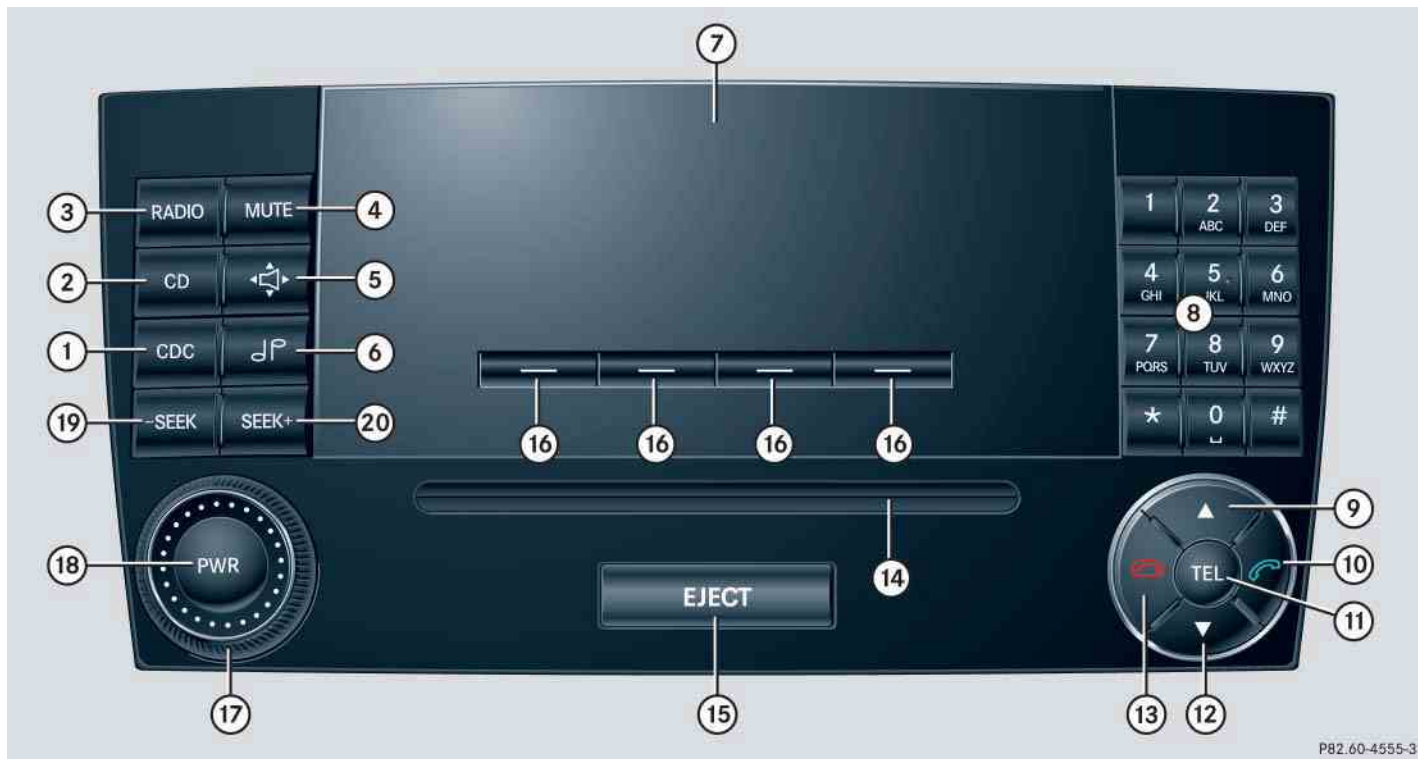

P82.60-4555-31

Controls in detail

Audio system

Item	Page
① CD changer mode selector	225
AUX mode selector	215
② Single CD mode selector	227
③ Radio mode selector	
④ Mute function (radio)	219
Pause (CD)	231
⑤ Volume distribution	213
⑥ Sound settings	211
⑦ Display	
⑧ Alphanumeric keypad	

Item	Page
⑨ Speed dialing memory (telephone) in descending order	
⑩ Accepting a call (telephone)	237
⑪ Telephone mode selector	232
⑫ Speed dialing memory (telephone) in ascending order	233
⑬ Terminating a call (telephone)	237
⑭ CD slot	
⑮ CD ejection	227

Item	Page
⑯ Soft keys	210
⑰ Volume	211
⑱ Switching on/off	210
⑲ Manual tuning / seek tuning (radio)	217
Track search, reverse (CD)	230
⑳ Manual tuning / seek tuning (radio)	217
Track search, fast forward (CD)	230

Controls in detail

Audio system

Button and soft key operation

In these instructions, the alphanumeric keypad (right side of radio panel) and the function buttons (left side of radio panel) are referred to as “buttons”. The four keys below the display panel are referred to as “soft keys”.



Do not press directly in the display face. Otherwise, the display will be damaged.

Operation

Switching the unit on/off

Switching on

- ▶ Turn the SmartKey in the starter switch to position **1** or **2**.
- ▶ If the audio system was on as you removed the SmartKey from the starter switch, the audio system will automatically come back on as you turn the SmartKey to position **1** or **2**.

or

- ▶ Press  button.



If the radio is switched on without the key in the starter switch, it will automatically switch off again after approx. 30 minutes.

If your vehicle is equipped with a telephone, the display may prompt you to enter your PIN (GSM network) or code (TDMA or CDMA network).

Switching off

- ▶ Remove SmartKey from starter switch.
or
- ▶ Press  button.



Should excessively high temperatures occur while the audio system is being operated, the display will dim. If temperatures continue to rise, HIGH TEMP will appear in the display, after which the audio system will be switched off for a cooling-down period.

Adjusting the volume

- ▶ Turn rotary control of  button.
The volume will increase or decrease depending on the direction turned.



If your vehicle equipment includes a Mercedes-Benz specified mobile telephone*, you can adjust its volume separately from the volume of the audio system while the telephone is being used.

Adjusting sound functions

The bass and treble functions are called up by pressing the  button.

Settings for bass and treble are stored separately for the AM and FM wavebands, weather band, CD mode and telephone mode.

Bass

- ▶ Press  button repeatedly until BASS appears in the display.

Controls in detail

Audio system



- ▶ Press + or - soft key to increase or decrease tone level accordingly.

or

- ▶ Press RES soft key briefly to reset bass tones to their center level.

The radio switches back to the standard radio menu eight seconds after the last soft key is pressed.

Controls in detail

Audio system

Adjusting treble

- ▶ Press **⏮** button repeatedly until TREBLE appears in the display.



- ▶ Press + or - soft key to increase or decrease tone level accordingly.

or

- ▶ Press RES soft key briefly to reset treble tones to their center level.

The radio switches back to the standard radio menu eight seconds after the last soft key is pressed.

Sound system*

You can either program the sound settings manually (▷ page 211) or choose settings via preset sound characteristics.

You can select from among the following settings:

- STANDARD: conventional stereo sound.
 - SURROUND: the sound is set for better three-dimensional acoustic characteristics.
 - SPEECH: the sound is optimized for the spoken word.
- ▶ Press **⏮** button repeatedly until STANDARD, SURROUND or SPEECH appears in the display.
 - ▶ Press <<< or >>> soft key repeatedly until the desired sound setting has been reached.

The sound is set accordingly.

or

- ▶ Press RES soft key briefly.

The sound setting is reset depending on the sound source activated.

- Radio mode: STANDARD
- CD/AUX mode: SURROUND
- Telephone: SPEECH

The radio switches back to the standard radio menu eight seconds after the last soft key is pressed.

Returning sound functions to factory settings

- ▶ Press  button to call up settings menu in the display.



- ▶ Press RES soft key briefly; the respective sound function is reset to its center level.

or

- ▶ Press and hold RES soft key until RESET appears in the display.

The sound settings for bass and treble are returned to their center level and the volume is set to a predefined level.

Vehicles with sound system*:

The sound setting is reset depending on the sound source activated.

- Radio mode: STANDARD
- CD/AUX mode: SURROUND
- Telephone: SPEECH

The radio switches back to the standard radio menu four seconds after the last soft key is pressed.

Adjusting volume distribution

Call up fader and balance functions by pressing the  button.



Fader

- ▶ Press  button repeatedly until FADER appears in the display.

Controls in detail

Audio system



- ▶ Press  or  soft key.

The volume is distributed accordingly between the front and rear of the vehicle.

or

- ▶ Press RES soft key briefly.

The fader is reset to its center level.

The radio switches back to the standard radio menu eight seconds after the last soft key is pressed.

Controls in detail

Audio system

Adjusting balance

- ▶ Press  button repeatedly until BALANCE appears in the display.



- ▶ Press <<< or >>> soft key.
The volume is distributed between the left and right sides of the vehicle.
- or
- ▶ Press RES soft key briefly.
The balance is reset to its center level.
The radio switches back to the standard radio menu eight seconds after the last button is pressed.

Returning volume distribution to factory settings

- ▶ Press  button to call up settings menu in the display.



- ▶ Press RES soft key briefly; the respective volume distribution is reset to its center (flat) level.

or

- ▶ Press and hold RES soft key until RESET appears in the display.
The volume distribution settings for fader and balance are set to their center level.

The radio switches back to the standard radio menu four seconds after the last soft key is pressed.

Telephone* muting

If your vehicle equipment includes a Mercedes-Benz specified mobile telephone*, you can adjust its volume separately from the volume of the audio system while the telephone is being used.

Connecting an external audio source (AUX) to the radio*

An optional dealer-installed cinch-connector* for connecting an external audio source may become available for your vehicle model. Feature description is based on preliminary information at time of printing. Contact an authorized Mercedes-Benz Center for availability.

You can adjust the volume (▷ page 211), the sound settings (▷ page 211) and the volume distribution (▷ page 213) for the AUX input.

Calling up AUX mode

- ▶ Press and hold **CD** button until AUX appears in the display.

Canceling AUX mode

- ▶ Press any audio source button.

Radio operation**Selecting radio mode**

- ▶ Press **RADIO** button.

Calling up wavebands

You can choose from among the FM, AM and WB wavebands.

Weather band (▷ page 219).



FM waveband: 87.7.....107.9 MHz
AM waveband: 530.....1710 KHz

Calling up wavebands for radios without SAT*

- ▶ Press FM or AM soft key to switch between FM and AM.

The FM and AM wavebands are called up one after another.

or

- ▶ Press WB soft key.

The weather band menu is called up.

The waveband currently selected appears in the upper left-hand corner of the display.

Controls in detail

Audio system

*Calling up wavebands for radios with SAT**

- ▶ Press FM, AM or WB soft key repeatedly until desired waveband has been selected.

The FM, AM and WB wavebands are called up one after another.

The waveband currently selected appears in the upper left-hand corner of the display.

Selecting a station

The following options are available for selecting a station:

- Direct frequency input (▷ page 216)
- Manual tuning (▷ page 217)
- Automatic seek tuning (▷ page 217)
- Scan search (▷ page 217)
- Station memory (▷ page 218)
- Automatic station memory (Autostore) (▷ page 218)

The station search proceeds in the following frequency increments:

- 200 kHz in FM range
- 10 kHz in AM range

Direct frequency input

- ▶ Select desired waveband.



- ▶ Press ***** button.
- ▶ Enter desired frequency with buttons **1** to **0**.



You can only enter frequencies within the respective waveband.

If a button is not pressed within four seconds, the radio will return to the last station tuned.

Manual tuning

- ▶ Select desired waveband.
- ▶ Press **SEEK+** or **SEEK-** button for approx. three seconds.
- ▶ Press button repeatedly until desired frequency has been reached.

Step-by-step station tuning takes place in ascending or descending order. Each time the button is pressed, the radio tunes further by 0.2 MHz. During manual tuning, the radio is muted.

Automatic seek tuning

- ▶ Select desired waveband.
- ▶ Press **SEEK+** or **SEEK-** button briefly.
The radio will tune to the next highest or next lowest receivable frequency.



If no station is received after two consecutive scans of the complete frequency range, then the scan stops at the frequency from which it began.

Controls in detail

Audio system

Scan search

- Starting scan search
 - ▶ Select desired waveband.



- ▶ Press SC soft key.

SC will appear in the display. The radio briefly tunes in all receivable stations on the waveband selected.

Controls in detail

Audio system

- Ending scan search
 - ▶ Press SC soft key or **SEEK+** or **-SEEK**.
The station last played will be selected and SC disappears from the display.

Station memory

You can store ten AM and ten FM stations in the memory.

- Storing stations
 - ▶ Tune in desired station.

- ▶ Press and hold desired station button **1** to **0** until a brief signal tone is heard.
The frequency is stored on the selected station button.

- Calling up stations

- ▶ Press desired station button **1** to **0** briefly.

Autostore – automatic station memory

The Autostore memory function provides an additional memory level. The station memory for manually stored stations is not overwritten.

- Calling up Autostore memory level and storing stations



- ▶ Press AS soft key briefly.

The radio switches to the Autostore memory level. AS and SEARCH appear in the display and the radio finds the ten stations with the strongest signals. These stations are stored on the station buttons **1** to **0** in order of signal strength.

- Calling up stations
 - ▶ Press desired station button **1** to **0**.
- Leaving the Autostore memory level
 - ▶ Press FM or AM soft key briefly.

Interrupting radio mode

The radio mode is interrupted by an incoming call on the telephone* (▷ page 237)

- Mute on
 - ▶ Press **MUTE** button.
The radio mode is interrupted and MUTED appears in the display.
- Mute off
 - ▶ Press **MUTE** button.
The radio mode is again active.

Weather band



- ▶ Press WB soft key.
The weather band station last received is tuned in.

Controls in detail

Audio system

Selecting a weather band station directly

- ▶ Select desired weather band station with buttons **1** to **7**.

If a station cannot be tuned in, a search is automatically started.

Search

- ▶ Press **SEEK+** or **-SEEK** button to tune in the next receivable weather band station.



If no weather band station is received after three consecutive scans of the complete frequency range, then the scan stops at the channel with which it began and NO WB FOUND appears in the display.

If this happens, switch back to standard radio mode.

Controls in detail

Audio system

Scan search

- Starting scan search
 - ▶ Press **SC** soft key.
SC will appear in the display. The radio briefly tunes in all receivable weather band stations.
- Ending scan search
 - ▶ Press **SC** soft key or **SEEK+** or **-SEEK**.
The weather band station last played will be selected and **SC** disappears from the display.

Introduction to satellite radio* (USA only)

SIRIUS satellite radio provides 100 channels of digital-quality radio, among others music, sports, news, and entertainment, free of commercials. SIRIUS satellite radio uses a fleet of high-power satellites to broadcast 24 hours per day, coast to coast, in the contiguous U.S.

This diverse, satellite-delivered programming is available for a monthly subscription fee.

For more information and service availability call the SIRIUS Service Center (▷ page 225), or contact www.siriusradio.com



Additional satellite radio equipment and a subscription to a satellite radio service provider are required for the satellite radio operation described here.

Contact an authorized Mercedes-Benz Center for details and availability for your vehicle.

Note that categories and channels shown in illustrations are dependent on programming content delivered by the service provider. Programming content is subject to change. Therefore, channels and categories shown in illustrations and descriptions contained in this manual may differ from the channels and categories delivered by the service provider.



Satellite radio service may be unavailable or interrupted from time to time for a variety of reasons, such as environmental or topographic conditions and other things beyond the service provider's or our control. Service might also not be available in certain places (e.g., in tunnels, parking garages, or within or next to buildings) or near other technologies.

Program categories

The channels are categorized. Categories allow you to tune to stations broadcasting a certain type of program (category mode) (▷ page 223).

Calling up the SAT main menu

- ▶ Press SAT soft key.

SAT is displayed in the upper left-hand corner of the display.

Prior to activation of the satellite radio service (▷ page 221).

After activation of satellite radio service (▷ page 221).

Prior to activation of the satellite radio service



The telephone number of the SIRIUS Service Center (888-539-7474) is displayed.

Controls in detail

Audio system

- ▶ Press ESN soft key.

The twelve-digit electronic serial number (ESN) of the SAT tuner* installed in your vehicle is displayed.

This information is required to call the SIRIUS Service Center for an activation request.



Credit card information may also be required for your application.

The activation process takes approximately five to ten minutes after calling the SIRIUS Service Center.

After activation of the satellite radio service

The satellite radio main menu appears. The radio station selected last is audible, provided it can be received.

Controls in detail

Audio system



The system will tune to a default station if no station had been selected previously.



The first channel 001 is called up and the PTY system changes to All categories.

If no station can be received, **ACQUIRING** appears in the display.

If the Satellite radio service is not activated, **ACQUIRING** will also appear in the radio display and **NO SAT** will appear in the multifunction display.

Selecting a station

The following options are available:

- Selecting a station using the selected category (▷ page 223),
- Tuning via station presets (▷ page 222),
- Tuning via scan search (▷ page 224).
- Tuning via manual channel input (▷ page 222).
- Tuning via the program category list (▷ page 223).

Tuning via station presets

Ten satellite radio station presets are available.

You can access the presets via number keys.

Accessing via number keys

- ▶ Enter number of preset you wish to select, e.g. **1**.

The radio plays the station stored under this number and the PTY function changes to the category corresponding to the station.

Tuning via manual channel input



Example: tuning in channel 16

- ▶ Press *****.

Input line appears in the main radio menu.

- ▶ Use number keys to enter desired channel within eight seconds, e.g. **1** **6**.

The system tunes to channel 16.

The station you have selected begins to play.



You can only enter available channel numbers.

Tuning via the program category list

The category list contains all currently receivable categories of programs. It is arranged alphabetically.

- Selecting a category
 - ▶ Press PTY soft key.



The current PTY category of the station is displayed.

- ▶ Press **<<<** or **>>>** soft key.

This switches between the individual categories.

When changing the category, the channel selected last in the new category becomes audible.

Controls in detail

Audio system

The system will automatically switch to a station of the selected category if the currently selected station is not of the selected category. Otherwise, the currently selected station remains tuned.

- Tuning a station within the selected category

The channels identified for the currently selected category are arranged numerically. Only one entry is visible at a time.

- ▶ Press **SEEK+** or **-SEEK** button briefly.

The next station within the category is started.

or

- ▶ Press and hold **SEEK+** or **-SEEK** button for approx. 3 seconds until desired station has been reached.

Controls in detail

Audio system

Tuning via scan search

Scan search is characterized as follows:

- Scan search plays a channel for approx. eight seconds and then skips to the next channel within the current category.
- Scan search can be terminated manually.
- ▶ Press **SC** soft key.
The search starts. **SC** appears in the display.
- ▶ Press **SC** soft key again.
The search stops.

Obtaining additional text information

Additional text information (artist, title) related to the current channel can be displayed.

- ▶ Press **INF** soft key.

The title being played is displayed.

- ▶ Press **INF** soft key again.

The name of the artist performing the title being played is displayed.



If a button is not pressed within four seconds, the radio will return to the standard display.

Storing stations

- ▶ Tune in desired station.
- ▶ Press and hold desired station button **1** to **0** until a brief signal tone is heard.

The frequency is stored on the selected station button.

The radio saves the current station at the memory preset selected. The memory preset selected appears in the status line, e.g. S3.



There are ten presets available.

An existing entry is overwritten in the memory list when a new entry is given.

Controls in detail

Audio system

Calling up the ESN information menu

- ▶ Press INF soft key.
- ▶ Press ESN soft key.

The twelve-digit electronic serial number (ESN) of the SAT tuner* installed in your vehicle is displayed.

- ▶ Press RET soft key to exit the menu.

CD mode

Safety precautions

Warning!



The single CD player and the CD changer* are Class 1 laser products. There is a danger of invisible laser radiation if the housing is opened or damaged.

Do not open the housing. The single CD player and the CD changer* do not contain any parts that can be serviced by the user. For safety reasons, have any service work which may be necessary performed only by qualified personnel.

Warning!



In order to avoid distraction which could lead to an accident, the driver should insert CDs with the vehicle at a standstill and operate the audio system only if permitted by road, weather and traffic conditions. Bear in mind that at a speed of just 30 mph (approximately 50 km/h), your car covers a distance of 44 feet (approximately 14 m) every second.

General notes

The system may not be able to play audio CDs with copy protection.

Playing copied CDs may cause malfunctions during playback.

Controls in detail

Audio system



If you affix stickers to the CDs, they can become warped due to the heat that develops in the CD drive or CD changer.

In certain situations, the CDs can then no longer be ejected and cause damage to the drive. Such damage is not covered by the Mercedes-Benz Limited Warranty.



Your CD drive or CD changer has been designed to play CDs which correspond to the EN 60908 standard. You can therefore only use CDs with a maximum thickness of 1.3 mm.

If you insert thicker data carriers, e.g. ones that have data on both sides (one side with DVD data, the other side with audio data), they cannot be ejected and will damage the drive.

Do not use CDs with an eight cm diameter, not even with a CD adapter. Attempting to play CDs with an eight cm diameter or playing such CDs with an adapter may cause damage to the CD drive. Such damage is not covered by the Mercedes-Benz Limited Warranty.

Should excessively high or low temperatures occur while in CD changer mode*, CD TEMP will appear in the display, and the CD will be muted until the temperature has reached an acceptable level for the system to continue operation.

The single CD player and the CD changer* play audio CDs.

Tips on handling CDs

- Handle CDs carefully to prevent interference during playback.
- Avoid scratches, fingerprints and dust on the CDs.
- Do not write on CDs or apply any labels or other material to them.
- Clean CDs from time to time with a commercially available cleaning cloth. Never wipe the CD in a circular motion; instead, wipe it in a straight line starting in the center and moving outward. Do not use solvents, anti-static sprays, etc. for cleaning.
- Replace the CD in its case after use.
- Protect CDs from heat and direct sunlight.

Operating the single CD player in the audio system unit

Loading a CD

The single CD player in the audio system unit has capacity for one CD. The CD slot for loading the drive is located underneath the soft keys.

- ▶ Make sure the system is switched on.
- ▶ Insert CD into CD slot. The label side of the CD must face upwards.

The system automatically pulls the CD into the CD slot. The audio CD begins to play.



If a CD is already loaded, it must be ejected before inserting a new CD. Inserting a second CD in the slot with another CD still loaded will cause damage to the CD drive not covered by the Mercedes-Benz Limited Warranty.



If a CD has been inserted incorrectly or cannot be read, **WRONG CDO** will appear in the display.

Ejecting a CD

- ▶ Make sure the system is switched on.
- ▶ Press **EJECT** button.
The system ejects the CD. **NO CD** will appear in the display.
- ▶ Remove CD from slot.



If you do not take the CD out of the CD slot within approx. 15 seconds, the system automatically pulls the CD back in and plays it.

If a CD is pulled back in, press **EJECT** button for five seconds; the CD will then be ejected.

Operational readiness of CD changer*

If a CD changer* has been installed in the vehicle, it can be operated from the front control panel of the audio system. A loaded magazine must be installed to play CDs.

The CD changer is located in the glove box.

Loading/unloading the CD magazine



The CD changer* may not be able to play audio CDs with copy protection.

- ▶ Slide changer door to the right and press  button.
- ▶ Magazine will be ejected.

Controls in detail

Audio system

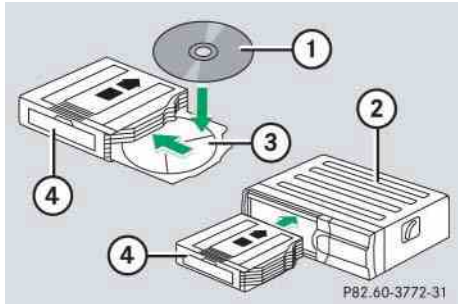

- ① CD
- ② CD changer
- ③ CD tray
- ④ CD magazine

- ▶ Remove magazine ④ and pull CD tray ③ fully out.
- ▶ Place CD ① in recess of tray, label side up.

- ▶ Push tray into magazine in direction of arrow.



CDs which have been inserted improperly or are unreadable will not be played.

- ▶ Push magazine into CD changer* ② in direction of arrow and close sliding door.

Playing CDs

Single CD player in the audio unit

- ▶ Press **CD** button.

CD 0 will appear in the upper left-hand corner of the display.

The CD will resume playback at the point where it was switched off.

*CD changer**

- ▶ Press **cdc** button.

CD and the selected magazine slot number appear in the upper left-hand corner of the display.

If you have not removed a CD since the last time the CD audio source was activated, the last CD listened to will begin to play at the point where it was switched off.

After the last track on a CD has finished, the next CD is automatically played.

Playing tracks

You have the following options:

- Audio system with CD changer*: selecting CDs
- Direct track entry
- Track skip forward/reverse
- Fast forward/reverse
- Scan
- Random tracks
- Repeat track

Selecting CDs in the audio unit with CD changer*



- ▶ You can select from among the inserted CDs with buttons

0 to **6**.

0 = CD player in the audio unit

1 to **6** = CDs in the CD changer*

The magazine slot number of the selected CD appears next to CD in the display, and the number of the currently played track appears next to TRACK.

Controls in detail

Audio system



If there is no CD in the selected magazine slot, NO CD appears in the display with the corresponding slot number.

Direct track entry



You can make a direct selection from among the tracks on a CD.

- ▶ Press ***** button.
- ▶ Enter track number using buttons **1** to **0**.

Controls in detail

Audio system

- ▷▷ The number of the track being played appears next to **TRACK** in the display. You can only enter available track numbers.

Skipping tracks forward/backward

- Skipping tracks forward
 - ▶ Press **SEEK+** button briefly. The next track will be played.
- Skipping tracks backward
 - ▶ Press **-SEEK** button briefly. If the track has been playing for more than ten seconds, the unit skips back to the beginning of the track currently playing. If less than ten seconds have been played, the unit skips back to the beginning of the previous track.

Pressing the **-SEEK** or **SEEK+** button repeatedly will result in multiple tracks being skipped.

Fast forward/reverse

- Fast forward
 - ▶ Press and hold **SEEK+** button until desired point has been reached.
- Reverse
 - ▶ Press and hold **-SEEK** button until desired point has been reached.



The track number and the relative time of the track is shown in the display during the search.

Scan

- Starting scan
 - ▶ Press **SC** soft key. **SC** will appear in the display. Each track on the current CD will be played for approx. eight seconds in ascending order.
- Ending scan
 - ▶ Press **SC** soft key or **-SEEK** or **SEEK+**.

Random play

The random function (RDM) plays the tracks of the current CD in random order.



When you start the RDM function, the RPT function is automatically switched off.

- Switching on random
 - ▶ Press RDM soft key.
RDM appears in the display. A randomly selected track is played.
- Switching off random
 - ▶ Press RDM soft key again.

Repeat

The track being played is repeated until the repeat function is switched off.



When you start the RPT function, the RDM function is automatically switched off.

- Switching on repeat
 - ▶ Press RPT soft key.
RPT appears in the display.
- Switching off repeat
 - ▶ Press RPT soft key again.

Pause function

The CD changer mode is interrupted by an incoming call on the telephone* (▷ page 237).

Controls in detail

Audio system

- Switching on pause function



- ▶ Press **MUTE** button.
The CD changer mode is interrupted and PAUSE appears in the display.
- Switching off pause function
 - ▶ Press **MUTE** button.
The CD changer mode is active again.

Controls in detail

Audio system

Track and time display



- ▶ Press T soft key.
The number of the track being played and the elapsed playing time appear in the display.
- ▶ Press T soft key again.
The total number of tracks and the total playing time of the CD appear in the display.
- ▶ Press T soft key.
The standard CD playback menu appears in the display.

GSM network phones

Using your Mercedes-Benz specified mobile telephone*, a number of functions and operating steps can be performed and displayed in the audio system display.

Further operating instructions not covered here can be found in the operating instructions for the multifunction steering wheel and the cellular telephone*.

If your audio system is set up for telephone operation, the  symbol will appear in the display.

When you insert your Mercedes-Benz specified mobile telephone* into the telephone cradle, you will be prompted to enter your PIN for 30 seconds (▷ page 233). This display disappears when you press any button.

When your mobile telephone is inserted into the telephone cradle, you will see the reception strength in the upper right-hand corner of the display.

Switching on the telephone

Switching on the telephone

- ▶ Press **TEL** button.

If the telephone was previously switched off, PROCESSING appears in the display and you will then be prompted to enter your PIN.

Switching off the telephone

- ▶ Press **TEL** button for approx. three seconds.

PROCESSING appears in the display until the telephone is off. Afterward, PHONE OFF appears in the display.

Controls in detail

Audio system

PIN entry



- ▶ Enter PIN number using buttons **1** to **0**.
- ▶ If necessary, correct number entered with the CLR soft key. Press soft key briefly to delete the last digit entered; press soft key and hold to delete the complete number.
- ▶ Press OK soft key after entering correct PIN.
- ▶ READY or ROAMING will appear in the display.



If the PIN is entered incorrectly three times, NEED PUK will appear in the display. Enter PUK via your telephone. Please refer to the separate telephone operating instructions for more information.

Adjusting the volume

- ▶ Turn rotary control of  button during a telephone call.

The volume will increase or decrease depending on the direction turned.



The volume can be adjusted separately for telephone mode and audio mode.

Adjusting sound

- ▶ Adjust sound during a telephone call. Sound adjustment (▷ page 211).

Placing a call

Entering a telephone number and starting the dialing process



- ▶ Enter desired telephone number using buttons **1** to **0**.

The number can have up to 32 digits, but only twelve of these are visible in the display. ▷▷

Controls in detail

Audio system

- ▶▶ If necessary, correct number entered with the CLR soft key. Press soft key briefly to delete the last digit entered; press soft key and hold to delete the complete number.
- ▶ After correct telephone number has been entered, press  button.



If the telephone number has been saved together with a name in the telephone book, the name will appear in the display.

Phone book

The numbers stored in the phone book of the telephone can be called up either by name or number.

In addition, incoming calls are stored in the phone book.







This is only possible, however, when the call information transmitted includes the number of the person calling. If the telephone number is not transmitted, NO NUMBER will be stored in the phone book.

- Searching and calling up telephone book entries by name



You can access your mobile telephone's phone book using the audio system. You can access both the main entries and the sub-entries of your phone book.





- ▶ Press MEM soft key or press  or .
- ▶ Press desired numerical key  to .

The stored entries are selected according to the alphabetical order of the initial letters (e.g. for S-Schneider, press button  four times).



or

- ▶ Press and hold button  or .

The system jumps from one initial letter to the next in ascending or descending order.

- ▶ Press and hold button  or  until desired initial letter has been reached.

or

- ▶ Press button  or  repeatedly until desired entry has been reached.

The stored entries are selected in alphabetical order with the sub-entries.



Several sub-entries can be stored for each main entry (name). These entries are marked by a corresponding abbreviation that appears in the upper left-hand corner of the display. The following abbreviations for sub-entries are possible:

CEL = Mobile phone
 HOM = Home
 WOR = Work
 FAX = Fax
 PAG = Pager
 TEL = Main

- ▶ When you have selected a number, press  button.

The call will be made.

- Viewing the telephone number of a telephone book entry

- ▶ Search for desired entry.

- ▶ Press NUM soft key.



The telephone number of the phone book entry appears in the display.

- Returning calls received





Controls in detail

Audio system

- ▶ Press MEM soft key or press  or .

- ▶ Press RCV soft key (received calls).

The number of received calls and then the call last received appear briefly in the display.

- ▶ Select desired telephone number with button  or .

The letter R and the number of the memory position appear in the upper left-hand corner of the display. The numbers are stored in the order of the calls received.

- ▶ When you have selected a number, press  button.

The call will be made.

Controls in detail

Audio system

- Speed dial

If you have stored telephone numbers as speed dial numbers in your telephone, you can also enter these with buttons **1** to **0** on the radio head unit.

- ▶ Press desired button **1** to **0** briefly.
- ▶ Press  button.
The call will be made.

- Turbo dial

If you have stored telephone numbers as turbo dial numbers in your telephone, you can also enter these with buttons **1** to **0** on the radio head unit.

- ▶ Press desired button **1** to **0** until the call is made.

Redial

If the number you have dialed is busy, you can again place calls to the last ten telephone numbers dialed using the redial function.





If you have activated the automatic redial function on your telephone, the number of the person being called is automatically redialed after a short waiting period if there is a busy signal. Refer to the separate operating instructions for the mobile telephone.

- Manual redial



- ▶ Press  button.

The telephone number last dialed will appear in the display.

- ▶ Select desired telephone number with button  or .

The letter L and the number of the memory position appears in the left-hand corner of the display. The numbers are stored in the order of the calls received.

- ▶ When you have selected a number, press  button.

The call will be made.

Accepting an incoming call

If the telephone is active in the background (reception symbol is visible in the display), the audio source is muted when an incoming call is received. A ringing tone can be heard and the caller's telephone number, or the name under which the telephone number has been saved in the phone book, appears in the display. If the caller's number is not transmitted with the call, CALL will appear in the display.

- ▶ Press  button.

The call is accepted.

Muting a call

It is possible to mute a call; the caller is then no longer able to hear you.

- Mute on
 - ▶ Press MUT soft key.
 - ▶ MIC MUTE will appear in the display.
- Mute off
 - ▶ Press MUT soft key again.

Terminating a call

- ▶ Press  button.

The current call is terminated and the muted audio source becomes active again.

Talking with two callers at the same time

If you wish to receive or place another call during an already active call, you can accept or place the second call and switch between the callers or combine them into one call. Note that the features described here are depending on availability from your mobile phone service provider.

- Placing/accepting a second call
 - ▶ Place new call by entering telephone number manually.
 - ▶ Press  button.

You are connected to the second caller; the first caller is kept on hold.

or

▶▶

Controls in detail



Audio system





- ▷▷ ▶ Press  button to accept a second call.



You will be notified of the second call acoustically, but you will not see this in the display.

You are connected with the second caller; the first caller is kept on hold.

- Switching between calls
 - ▶ Press  and  buttons.
This switches between the calls.
The non-active call is kept on hold.

- Terminating a call
 - ▶ Press  button.
The current call is terminated. You are again connected with the caller previously placed on hold.
- Combining two calls
 - ▶ Press  and  buttons.
The calls are combined into one call.
- Terminating a combined call
 - ▶ Press  button.
The connection to both callers is terminated.

TDMA or CDMA network phones

Using your Mercedes-Benz specified mobile telephone*, a number of functions and operating steps can be performed and displayed in the audio system display.

Further operating instructions not covered here can be found in the operating instructions for the multifunction steering wheel and the mobile telephone*.

If your audio system is set up for telephone operation, the  symbol will appear in the display.

When you insert your Mercedes-Benz specified mobile telephone* into the telephone cradle, you will be prompted to enter your PIN for 30 seconds (▷ page 239). This display disappears when you press any button.

When your mobile telephone is inserted into the telephone cradle, you will see the reception strength in the upper right-hand corner of the display.

Switching on the telephone

Switching on the telephone

- ▶ Press **TEL** button.

If you have programmed an unlock code for the telephone, you must now enter the code.



- ▶ Enter code using buttons **1** to **0**.
- ▶ If necessary, correct number entered with the CLR soft key. Press soft key briefly to delete the last digit entered; press soft key and hold to delete the complete number.

- ▶ Press OK soft key after entering correct code.

The telephone is unlocked. If you have entered an incorrect code, you must enter the correct code.

Switching off the telephone

- ▶ Press **TEL** button for approx. three seconds.

PROCESSING appears in the display until the telephone is off. Afterward, PHONE OFF appears in the display.

Adjusting the volume

- ▶ Turn rotary control of  button during a telephone call.

The volume will increase or decrease depending on the direction turned.



The volume can be adjusted separately for telephone mode and audio mode.

Controls in detail

Audio system

Adjusting sound

- ▶ Adjust sound during a telephone call. Sound adjustment (▷ page 211).

Placing a call

Entering a telephone number and starting the dialing process

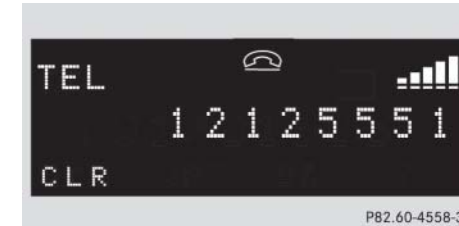

- ▶ Enter desired telephone number using buttons **1** to **0**.

The number can have up to 32 digits, but only twelve of these are visible in the display. ▷▷

Controls in detail

Audio system

- ▶▶ If necessary, correct number entered with the CLR soft key. Press soft key briefly to delete the last digit entered; press soft key and hold to delete the complete number.
- ▶ After correct telephone number has been entered, press  button.



If the telephone number has been saved together with a name in the phone book, the name will appear in the display.

Phone book

The numbers stored in the phone book of the mobile telephone can be called up either by name or number.

In addition, incoming calls are stored in the phone book.







This is only possible, however, when the call information transmitted includes the number of the person calling. If the telephone number is not transmitted, NO NUMBER will be stored in the phone book.

- Searching and calling up phone book entries by name



You can access your mobile telephone's phone book with the audio system. You can access both the main entries and the sub-entries of your phone book.





- ▶ Press MEM soft key or press  or  .
- ▶ Press desired numerical key  to  .

The stored entries are selected according to the alphabetical order of the initial letters (e.g. for S-Schneider, press button  four times).



or

- ▶ Press and hold button  or  .

The system jumps from one initial letter to the next in ascending or descending order.

- ▶ Press and hold button  or  until desired initial letter has been reached.

or

- ▶ Press button  or  repeatedly until desired entry has been reached.

The stored entries are selected in alphabetical order with the sub-entries.



Several sub-entries can be stored for each main entry (name). These entries are marked by a corresponding abbreviation that appears in the upper left-hand corner of the display. The following abbreviations for sub-entries are possible:

CEL = Mobile phone
 HOM = Home
 WOR = Work
 FAX = Fax
 PAG = Pager
 TEL = Main

- ▶ When you have selected a number, press  button.

The call will be made.

- Viewing the telephone number of a phone book entry

- ▶ Search for desired entry.

- ▶ Press NUM soft key.



The telephone number of the phone book entry appears in the display.

- Returning calls received





Controls in detail

Audio system

- ▶ Press MEM soft key or press  or .

- ▶ Press RCV soft key (received calls).

The number of received calls and then the call last received appear briefly in the display.

- ▶ Select desired telephone number with button  or .

The letter R and the number of the memory position appear in the upper left-hand corner of the display. The numbers are stored in the order of the calls received.

- ▶ When you have selected a number, press  button.

The call will be made.

Controls in detail

Audio system

- Speed dial

If you have stored telephone numbers as speed dial numbers in your telephone, you can also enter these with buttons **1** to **0** on the radio unit.

- ▶ Press desired button **1** to **0** briefly.
- ▶ Press  button.
The call will be made.

- Turbo dial

If you have stored telephone numbers as turbo dial numbers in your telephone, you can also enter these with buttons **1** to **0** on the radio unit.

- ▶ Press desired button **1** to **0** until the call is made.

Redial

If the number you have dialed is busy, you can again place calls to the last ten telephone numbers dialed using the redial function.





If you have activated the automatic redial function on your mobile telephone, the number of the person being called is automatically redialed after a short waiting period if there is a busy signal. Refer to the separate operating instructions for the mobile telephone.

- Manual redial



- ▶ Press  button.

The telephone number last dialed will appear in the display.

- ▶ Select desired telephone number with button  or .

The letter L and the number of the memory position appears in the left-hand corner of the display. The numbers are stored in the order of the calls received.

- ▶ When you have selected a number, press  button.

The call will be made.

Accepting an incoming call

If the telephone is active in the background (reception symbol is visible in the display), the audio source is muted when an incoming call is received. A ringing tone can be heard and the caller's telephone number, or the name under which the telephone number has been saved in the telephone book, appears in the display. If the caller's number is not relayed, CALL will appear in the display.

- ▶ Press  button.
The call is accepted.

Muting a call

It is possible to mute a call; the caller is then no longer able to hear you.

- Mute on
 - ▶ Press MUT soft key.
 - ▶ MIC MUTE will appear in the display.
- Mute off
 - ▶ Press MUT soft key again.

Terminating a call

- ▶ Press  button.

The current call is terminated and the muted audio source becomes active again.

Accepting a second incoming call

If you receive another call during an already active call, you can accept the second call and switch between the two.

- Accepting a second call
 - ▶ Place new call by entering telephone number manually.





You will be notified of the second call acoustically, but you will not see this in the display.

You are connected to the second caller; the first caller is kept on hold.

Controls in detail



Audio system

- Switching between calls
 - ▶ Press  button.
This switches between the calls.
The non-active call is kept on hold.
- Terminating a call
 - ▶ Press  button.
The current call is terminated. The connection to the caller previously kept on hold is also interrupted; however, reconnection is indicated by an acoustic signal.

Placing a second call

If you wish to place another call during an already active call, you can place the second call and switch between the callers or combine them into one call. Note that this feature is depending on availability from your mobile phone service provider.

- Placing a second call
 - ▶ Place a new call by entering telephone number manually.
 - ▶ Press  button.
You are connected to the second caller; the first caller is kept on hold.

- Terminating a call
 - ▶ Press  button.
The current call is terminated. The connection to the caller previously kept on hold is also interrupted; however, reconnection is indicated by an acoustic signal.
- Combining two calls
 - ▶ Press  button.
The calls are combined into one call.
- Terminating a combined call
 - ▶ Press  button.
The connection to both callers is terminated.

Emergency calls “911”

The following describes how to dial a “911” emergency call using the audio system head unit when a Mercedes-Benz specified mobile phone* is inserted in the phone cradle*. Unless otherwise specified, the descriptions refer to the audio system head unit.

Consult the separate telephone operating instructions that came with your mobile phone* for information on how to place a “911” emergency call on the mobile phone*.

Warning!



The “911” emergency call system is a public service. Using it without due cause is a criminal offense.

The following conditions must be met for a “911” emergency call:

- Telephone must be switched on.
- The corresponding mobile communications network must be available.



Emergency calls may not be possible with all telephone networks or if certain network services and/or telephone functions are active. Check with your local service providers.

If you cannot make an emergency call, you will have to initiate rescue measures yourself.

GSM network phones

Placing a “911” emergency call using audio head unit with the phone locked

- ▶ Press **TEL** button to switch to telephone operation.

PIN? appears in the audio display.

- ▶ Enter 911 using the number keypad on the audio head unit.
- ▶ Press OK soft key or  button for dialing to begin.

DIALING appears in the audio display while the telephone establishes the connection.

- ▶ Wait until the emergency call center answers, then describe the emergency.

Controls in detail

Audio system

Placing a “911” emergency call using audio head unit with the phone unlocked

- ▶ Press **TEL** button to switch to telephone operation.
- ▶ Enter 911 using the number keypad on the audio head unit.
- ▶ Press  button for dialing to begin. **DIALING** appears in the audio display while the telephone establishes the connection.
- ▶ Wait until the emergency call center answers, then describe the emergency.



If no SIM card is in the mobile phone, **NO SERVICE** appears in the audio display. In that case, you only can make an emergency call on the mobile phone itself, without the use of the head unit.

TDMA/CDMA network phones

Placing a “911” emergency call using audio head unit with the phone locked

- ▶ Press **TEL** button to switch to telephone operation. **CODE?** appears in the audio display.
- ▶ Enter 911 using the number keypad on the audio head unit.
- ▶ Press **OK** soft key or  button for dialing to begin. **DIALING** appears in the audio display while the telephone establishes the connection.
- ▶ Wait until the emergency call center answers, then describe the emergency.

Placing a “911” emergency call using audio head unit with the phone unlocked

- ▶ Press **TEL** button to switch to telephone operation.
- ▶ Enter 911 using the number keypad on the audio head unit.
- ▶ Press  button for dialing to begin. **DIALING** appears in the audio display while the telephone establishes the connection.
- ▶ Wait until the emergency call center answers, then describe the emergency.

▼ Power windows

Opening and closing the windows

The side windows are opened and closed electrically. The switches for all the side windows are on the driver's door. The switches for the respective windows are on the front passenger door and the rear side trim panels.



- ① Left front window
 - ② Right front window
 - ③ Right rear window
 - ④ Left rear window
 - ⑤ Rear window override switch
- (▷ page 82)

Warning!



When closing the windows, make sure there is no danger of anyone being harmed by the closing procedure.

The closing of the door windows can be immediately halted by releasing the switch or, if switch was pulled past the resistance point and released, by either pressing or pulling the respective switch.

The closing of the rear side windows can be immediately halted by releasing the switch.

The door windows are equipped with the express-close and automatic reversal function. If a door window encounters an obstruction that blocks its path in a circumstance where you pulled the switch past the resistance point and released it to close the window, the automatic reversal function will stop the window and open it slightly.

If a door window encounters an obstruction that blocks its path in a circumstance where you are closing the window by pulling and holding the switch, by pressing and holding button  on the SmartKey, or by pressing and holding the lock button (vehicles with KEYLESS-GO*) on the door handle, the automatic reversal function will not operate.



When leaving the vehicle, always remove the SmartKey or SmartKey with KEYLESS-GO* from the starter switch, take it with you, and lock the vehicle. Do not leave children unattended in the vehicle, or with access to an unlocked vehicle. Unsupervised use of vehicle equipment can cause an accident and/or serious personal injury.

Controls in detail

Power windows



You can also open or close the windows using the:

- SmartKey (summer opening/convenience feature) (▷ page 249)
- button  in the control panel of the climate control (▷ page 185) or automatic climate control (▷ page 195).
- button  in the control panel of the automatic climate control (▷ page 195).

- ▶ Switch on ignition (▷ page 36).

Opening the windows

- ▶ Press switch ① to ④ to the resistance point.

The corresponding window will move downwards until you release the switch.

Closing the windows

- ▶ Pull on switch ① to ④ to the resistance point.

The corresponding window will move upwards until you release the switch.

Warning!



If you pull and hold the switch up when closing the window, and upward movement of the window is blocked by some obstruction including but not limited to arms, hands, fingers, etc., the automatic reversal will not operate.

Fully opening the door windows (Express-open)

- ▶ Press switch ① or ② past the resistance point and release.

The corresponding window opens completely.

Fully closing the door windows (Express-close)

- ▶ Pull switch ① or ② past the resistance point and release.

The corresponding window closes completely.



If the upward movement of a door window is blocked during the closing procedure, the door window will stop and open slightly.

Remove the obstruction, pull the switch again past the resistance point and release.

If the door window still does not close when there is no obstruction, then pull the switch and hold it. The door window will then close without the obstruction sensor function.

Warning!



Driver's door only:

If within five seconds you again pull the switch past the resistance point and release, the automatic reversal will not function.

Stopping windows

- ▶ Press or pull respective switch again.

Opening and closing the windows with the SmartKey

The power tilt/sliding sunroof* (▷ page 251) will also be opened or closed when the power windows are operated with the SmartKey.



Controls in detail

Power windows

Warning!



Never operate the windows or tilt/sliding sunroof* if there is the possibility of anyone being harmed by the opening or closing procedure.

In the event that the procedure causes potential danger, the procedure can be immediately halted by releasing the button on the SmartKey. To reverse direction of movement, press  for opening or  for closing.



- ▶ Aim transmitter eye at the driver's door handle.

Controls in detail

Power windows

Opening (Summer opening feature)

- ▶ Press and hold button  after unlocking the vehicle.

The windows and tilt/sliding sunroof* begin to open after approximately one second.

- ▶ Release the  button to stop procedure.

Closing (Convenience feature)

- ▶ Press and hold button  after locking the vehicle.

The windows and tilt/sliding sunroof* begin to close after approximately one second.

- ▶ Release the  button to stop procedure.

Make sure all side windows and the tilt/sliding sunroof* are properly closed before leaving the vehicle.

Closing the side windows and power tilt/sliding sunroof* with KEYLESS-GO

- ▶ Press and hold lock button at door (▷ page 58) until the side windows and the tilt/sliding sunroof* are closed.

Warning!



When closing the windows and the tilt/sliding sunroof*, make sure there is no danger of anyone being harmed by the closing procedure.

The windows will not automatically re-open if blocked during convenience closing.

If potential danger exists, proceed as follows:

- Release the lock button.
- Pull on the door handle and hold firmly. The side windows and the tilt/sliding sunroof* will open for about two seconds if the door handle is held but the door not opened.

Synchronizing power windows

The power windows must be resynchronized each time

- after the battery has been disconnected.
 - if the power windows cannot be fully opened (Express-open) or closed (Express-close).
- ▶ Switch ignition on (▷ page 36).
 - ▶ Pull the power window switches until the side windows are closed.
Hold the switches for approximately one second.
The power windows are synchronized.

▼ Power tilt/sliding sunroof*

Opening and closing the power tilt/sliding sunroof

The tilt/sliding sunroof can be opened and closed electrically. The switch for the tilt/sliding sunroof is on the overhead control panel.

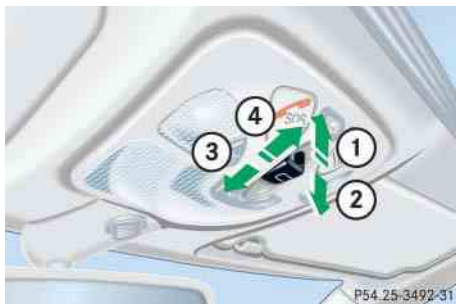

Sunroof switch

- ① Push up to raise roof at rear
- ② Pull down to lower roof at rear
- ③ Push forward to slide roof closed
- ④ Push back to slide roof open

With the roof closed or tilted open, a screen can be slid into the roof opening to guard against sun rays. When sliding the roof open, the screen will also retract.



Screen

Controls in detail

Power tilt/sliding sunroof*

Warning!



When closing the tilt/sliding sunroof, make sure there is no danger of anyone being harmed by the closing procedure.

The opening/closing procedure of the tilt/sliding sunroof can be immediately halted by releasing the switch or, if the switch was moved past the resistance point and released, by moving the switch in any direction.

The tilt/sliding sunroof is made out of glass. In the event of an accident, the glass may shatter. This may result in an opening in the roof.

In a vehicle rollover, occupants not wearing their seat belts or not wearing them properly may be thrown out of the opening. Such an opening also presents a potential for injury for occupants wearing their seat belts properly as entire body parts or portions of them may protrude from the passenger compartment.



Controls in detail

Power tilt/sliding sunroof*

▷▷ When leaving the vehicle, always remove the SmartKey or SmartKey with KEYLESS-GO* from the starter switch, take it with you, and lock the vehicle. Do not leave children unattended in the vehicle, or with access to an unlocked vehicle. Unsupervised use of vehicle equipment can cause an accident and/or serious personal injury.





To avoid damaging the seals, do not transport any objects with sharp edges which can stick out of the tilt/sliding sunroof.

Do not open the tilt/sliding sunroof if there is snow or ice on the roof, as this could result in malfunctions.

The tilt/sliding sunroof can be opened or closed manually should an electrical malfunction occur (▷ page 401).



You can also open or close the tilt/sliding sunroof using the:

- SmartKey (summer opening/convenience feature) (▷ page 249)
- button  in the control panel of the climate control (▷ page 185) or automatic climate control (▷ page 195)
- button  in the control panel of the automatic climate control (▷ page 195)

▶ Switch on ignition (▷ page 36).

Opening and closing the power tilt/sliding sunroof

- ▶ To open, close, raise, or lower the tilt/sliding sunroof, move the sunroof switch to resistance point in the required direction of arrows ① to ④.

Release the sunroof switch when the tilt/sliding sunroof has reached the desired position.

Fully opening (Express-open) and closing (Express-close) the power tilt/sliding sunroof

- ▶ To open or close the tilt/sliding sunroof, move the sunroof switch past the resistance point in the required direction of arrow ③ or ④ and release.

The tilt/sliding sunroof opens or closes completely.

Stopping the power tilt/sliding sunroof during Express-operation

- ▶ Move the sunroof switch in any direction.



If the movement of the tilt/sliding sunroof is blocked during the closing procedure, the tilt/sliding sunroof will stop and re-open slightly.



Opening and closing the power tilt/sliding sunroof with the SmartKey

The power windows (▷ page 249) will also be opened or closed when you operate the tilt/sliding sunroof with the SmartKey.

Warning!



Never operate the windows or tilt/sliding sunroof if there is the possibility of anyone being harmed by the opening or closing procedure.

In the event that the procedure causes potential danger, the procedure can be immediately halted by releasing the transmit button on the SmartKey. To reverse direction of movement, press button  for opening or  for closing.



- ▶ Aim transmitter eye at the driver's door handle.

Opening (Summer opening feature)

- ▶ Press and hold button  after unlocking the vehicle.

The windows and the tilt/sliding sunroof begin to open after approximately one second.

- ▶ Release the  button to stop procedure.

Controls in detail

Power tilt/sliding sunroof*

Closing (Convenience feature)

- ▶ Press and hold button  after locking the vehicle.

The windows and the tilt/sliding sunroof begin to close after approximately one second.

- ▶ Release  button to stop procedure.

Make sure all side windows and the tilt/sliding sunroof are properly closed before leaving the vehicle.

Closing the power tilt/sliding sunroof with KEYLESS-GO* (Convenience feature)

The power windows (▷ page 249) will also be closed when the power tilt/sliding sunroof is operated with the KEYLESS-GO function.

- ▶ Press and hold lock button at door (▷ page 58) until the side windows and the tilt/sliding sunroof are closed.

Controls in detail

Power tilt/sliding sunroof*

Warning!



When closing the windows and the tilt/sliding sunroof, make sure there is no danger of anyone being harmed by the closing procedure.

The tilt/sliding sunroof will not automatically reopen if blocked during convenience closing.

If potential danger exists, proceed as follows:

- Release the lock button.
- Pull on the door handle and hold firmly. The side windows and the tilt/sliding sunroof will open for as long as the door handle is held but the door not opened.

Synchronizing the power tilt/sliding sunroof

The tilt/sliding sunroof must be synchronized each time after:

- the battery has been disconnected or discharged
- the tilt/sliding sunroof has been closed manually (▷ page 401)
- the tilt/sliding sunroof does not open smoothly
- a malfunction

- ▶ Switch on the ignition (▷ page 36).
- ▶ Move and hold the sunroof switch in the direction of arrow ① (▷ page 251) until the tilt/sliding sunroof is fully raised at the rear.

Hold the sunroof switch for approximately one second.

- ▶ Check the Express-open feature (▷ page 252).

If the tilt/sliding sunroof opens completely, the tilt/sliding sunroof is synchronized. Otherwise repeat the above steps.

▼ Driving systems

The driving systems of your vehicle are described on the following pages:

- Cruise control, with which the vehicle can maintain a preset speed
- Parktronic*, which serves as a parking assistant.

For information on the BAS, ABS, and ESP driving systems, see “Driving safety systems” (▷ page 84).

Cruise control

Cruise control automatically maintains the speed you set for your vehicle.

Use of cruise control is recommended for driving at a constant speed for extended periods of time.

CLK 320/CLK 55 AMG:

You can set or resume cruise control at any speed over 20 mph (30 km/h).

CLK 500:

You can set or resume cruise control at any speed over 25 mph (40 km/h).

The cruise control function is operated by means of the cruise control lever.

The cruise control lever is the uppermost lever on the left-hand side of the steering column (▷ page 22).

Controls in detail

Driving systems

Warning!



Cruise control is a convenience system designed to assist the driver during vehicle operation. The driver is and must remain at all times responsible for the vehicle speed and for safe brake operation.

Only use cruise control if the road, traffic and weather conditions make it advisable to travel at a steady speed.

- The use of cruise control can be dangerous on winding roads or in heavy traffic because conditions do not allow safe driving at a steady speed.
- The use of cruise control can be dangerous on slippery roads. Rapid changes in tire traction can result in wheel spin and loss of control.
- Deactivate cruise control when driving in fog.

The “Resume” function should only be operated if the driver is fully aware of the previously set speed and wishes to resume this particular preset speed.

Controls in detail

Driving systems



- ① Set current or higher speed
- ② Set current or lower speed
- ③ Cancel cruise control
- ④ Resume at last set speed

Warning!



CLK 500:

Cruise control brakes automatically so that the set speed is not exceeded. The brake pedal is depressed automatically to do this.

Keep in mind that cruise control is a convenience system designed to assist the driver during vehicle operation. The driver is and must always remain responsible for the vehicle's speed and for safe brake operation.

Keep driver's foot area clear at all times, including the area under the brake pedal. Objects stored in this area may impair pedal movement which could interfere with the braking ability of the cruise control system.

Do not place your foot under the brake pedal - your foot could become caught.

Setting current speed

- ▶ Accelerate or decelerate to the desired speed.
- ▶ Briefly lift ① or depress ② the cruise control lever.
The current speed is set.
- ▶ Remove your foot from the accelerator pedal.

Cruise control is activated.

The selected speed appears in the multi-function display for approximately five seconds, and the corresponding speedometer segments from the selected speed to the vehicle maximum speed are illuminated.



On uphill or downhill grades, cruise control may not be able to maintain the set speed. Once the grade eases, the set speed will be resumed.

CLK 320/CLK 55 AMG:

If the engine's braking power does not brake the vehicle sufficiently on downhill grades, the automatic transmission will automatically downshift.

CLK 500:

On downhill grades, the cruise control will hold the set speed with active braking action.

In addition, on longer downhill grades the automatic transmission will automatically downshift.

Canceling cruise control

There are several ways to cancel cruise control:

- ▶ Step on the brake pedal.

Cruise control is canceled. The last speed set is stored for later use.

or

- ▶ Briefly push the cruise control lever to position ③.

Cruise control is canceled. The last speed set is stored for later use.



The last stored speed is canceled when you turn off the engine.

Controls in detail

Driving systems



Cruise control automatically switched off, if

CLK 320/CLK 55 AMG:

- you step on the brake pedal.
- you move the gear selector lever in position **N** while driving.
- the vehicle speed is under 20 mph (30 km/h).
- ESP is in operation.

The segments in the multifunction display are flashing.

CLK 500:

- you step on the brake pedal.
- you press the parking brake pedal.

In this case the segments in the multifunction display (▷ page 256) go out and no warning sounds.

Controls in detail

Driving systems

- the vehicle speed is under 25 mph (40 km/h).
- ESP is in operation or switched off with the ESP switch (▷ page 87)
- you move the gear selector lever in position **N** while driving

The segments in the multifunction display (▷ page 256) go out, and an acoustic warning sounds.



Moving gear selector lever to position **N** while driving also cancels cruise control. However, the gear selector lever should not be moved to position **N** while driving except to coast when the vehicle is in danger of skidding (e.g. on icy roads).

Setting a higher speed

- ▶ Lift cruise control lever to position ① and hold it up until the desired speed is reached.
- ▶ Release cruise control lever.

The new speed is set.



Depressing the accelerator pedal does not deactivate cruise control. After brief acceleration (e.g. for passing), cruise control will resume the last speed set.

Setting a lower speed

- ▶ Depress cruise control lever to position ② and hold it down until the desired speed is reached.
- ▶ Release cruise control lever.

The new speed is set.



CLK 320/CLK 55 AMG

When you use the cruise control lever to decelerate, the transmission will automatically downshift if the engine's braking power does not brake the vehicle sufficiently.

CLK 500:

When you use the cruise control lever to decelerate, the brake system will automatically brake the vehicle if the engine's braking power does not brake the vehicle sufficiently.

Fine adjustment in 1 mph (Canada: 1 km/h) increments

Faster

- ▶ Briefly tip cruise control lever in direction of arrow ①.

Slower

- ▶ Briefly tip cruise control lever in direction of arrow ②.

Setting to last stored speed ("Resume" function)

Warning!



The speed stored in memory should only be set again if prevailing road conditions permit. Possible acceleration or deceleration differences arising from returning to the pre-set speed could cause an accident and/or serious injury to you and others.

Controls in detail

Driving systems

- ▶ Briefly push cruise control lever to position ④.
The cruise control resumes the last set speed.
- ▶ Remove your foot from the accelerator pedal.

The selected speed appears in the multi-function display for approximately five seconds, and the corresponding speedometer segments from the selected speed to the vehicle maximum speed are illuminated (▷ page 256).

Controls in detail

Driving systems

Parktronic system (Parking assist)*

Warning!



Parktronic is a supplemental system. It is not intended to, nor does it replace, the need for extreme care. The responsibility during parking and other critical maneuvers always rests with the driver.

Special attention must be paid to objects with smooth surfaces or low silhouettes (e.g. trailer couplings, painted posts or road curbs). Such objects may not be detected by the system and can damage the vehicle.

The operational function of the Parktronic system can be affected by dirty sensors, especially at times of snow and ice, see “Cleaning the Parktronic system* sensors” (▷ page 350).

Interference caused by other ultrasonic signals (e.g. working jackhammers, car wash, or the air brakes of trucks) can cause the system to send erratic indications, and should be taken into consideration.

Warning!



Make sure no persons or animals are in the area in which you are maneuvering. You could otherwise injure them.

The Parktronic system is an electronic aid designed to assist the driver during parking maneuvers. It visually and audibly indicates the relative distance between the vehicle and an obstacle.

The Parktronic system is automatically activated when you switch on the ignition and placed the gear selector lever in position **D**, **R**, or **N**.

The Parktronic system deactivates at speeds over approximately 11 mph (18 km/h). At lower speeds the Parktronic system turns on again.

The Parktronic system also deactivates when you place the gear selector lever in position **P**.

The Parktronic system monitors the surroundings of your vehicle with six sensors in the front bumper and four sensors in the rear bumper.

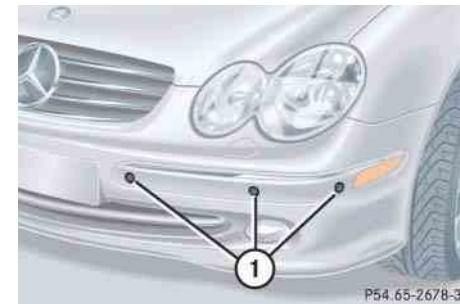

① Sensors in the front bumper

Range of the sensors

To function properly, the sensors must be free of dirt, ice, snow and slush. Clean the sensors regularly, being careful not to scratch or damage the sensors, see “Cleaning the Parktronic system* sensors” (▷ page 350).

Controls in detail

Driving systems

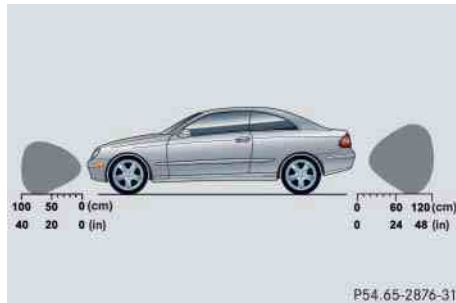

Front sensors

Center	approx. 40 in (100 cm)
Corners	approx. 24 in (60 cm)

Rear sensors

Center	approx. 48 in (120 cm)
Corners	approx. 32 in (80 cm)

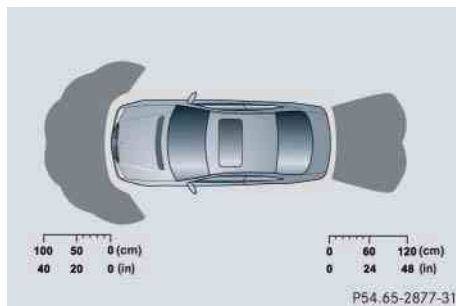

During parking maneuvers, pay special attention to objects located above or below the height of the sensors (e.g. planters or trailer hitches). The Parktronic system will not detect such objects at close range and damage to your vehicle or the object may result.

Ultrasonic signals from outside sources (e.g. truck air brakes, car wash, or jackhammers) may impair the operation of the Parktronic system.

Minimum distance

Center	approx. 8 in (20 cm)
Corners	approx. 6 in (15 cm)

If the system detects an obstacle in this range, all the distance warning segments illuminate and you hear a warning signal. If the obstacle is closer than the minimum distance, the actual distance may no longer be indicated by the system.

Controls in detail

Driving systems

Warning indicators

Visual signals indicate to the driver the relative distance between the sensors and an obstacle. The warning indicator for the front area is located above the center air vents in the dashboard. The warning indicator for the rear area is integrated in the rear dome lighting.



- ① Left side of the vehicle
- ② Right side of the vehicle

Each warning indicator is divided into six yellow and two red distance segments for either side of the vehicle. The Parktronic system is ready when the border around the indicator is illuminated.

The position of the gear selector lever determines which warning indicators will be activated.

Gear selector lever position	Warning indicator
D	Front area activated
R or N	Front and rear area activated
P	Neither activated

As your vehicle approaches an object, one or more distance segments will illuminate, depending on the distance. When the eighth distance segment illuminates, you have reached the minimum distance.

- **Front area:** An intermittent acoustic warning will sound as the first red distance segment illuminates and a constant acoustic warning lasting a maximum of two seconds will sound for the second red distance segment. The signal is canceled when the gear selector lever is placed in position **P**.
- **Rear area:** An intermittent acoustic warning will sound as the first red distance segment illuminates and a constant acoustic warning lasting a maximum of two seconds will sound for the second red distance segment. The signal is canceled when the gear selector lever is placed in position **D** or **P**.

Switching the Parktronic system on/off

The Parktronic system can be switched off manually.

The Parktronic switch is located in the upper part of the center console (▷ page 27).



- ① Parktronic switch
- ② Indicator lamp

Switching off the Parktronic system

- ▶ Press Parktronic switch ①.
- Indicator lamp ② comes on.

Switching on the Parktronic system

- ▶ Press Parktronic switch ① again.
- Indicator lamp ② goes out.



The Parktronic system is automatically switched on when the ignition is switched on (▷ page 36).

Parktronic system malfunction

If only the red distance segments illuminate and a acoustic warning sounds, there is a malfunction in the Parktronic system. The Parktronic system will automatically switch off after 20 seconds and the indicator lamp in the Parktronic switch comes on.

- ▶ Have the Parktronic system checked by an authorized Mercedes-Benz Center as soon as possible.

If only the red distance segments illuminate and no acoustic warning sounds, the Parktronic system sensors are dirty or there is an interference from other radio or ultrasonic signals. The Parktronic system will automatically switch off after 20 seconds and the indicator lamp in the Parktronic switch comes on.

- ▶ Switch off the ignition.
 - ▶ Clean the Parktronic system sensors (▷ page 350).
 - ▶ Switch on the ignition.
- or
- ▶ Check the Parktronic system operation at another location to rule out interference from outside radio or ultrasonic signals.

Controls in detail

Loading

Roof rack

Warning!



Only use roof racks approved by Mercedes-Benz for your vehicle model to avoid damage to the vehicle. Follow manufacturer's installation instructions.

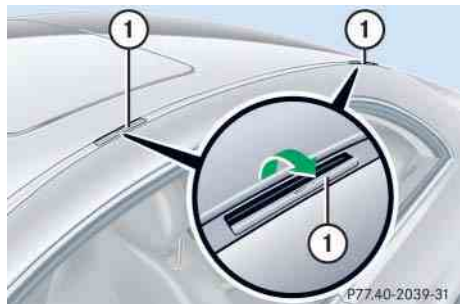

① Trim

Preparing roof rack installation

- ▶ Open trim ① at the trim strips in the roof.
- ▶ Secure the roof rack according to manufacturer's instructions for installation.



Load the roof rack in such a way that the vehicle cannot be damaged while driving.

Make sure

- you can fully raise the tilt/sliding sunroof*
- you can fully open the trunk

Ski sack*

Unfolding and loading



- ① Handle
- ② Cover
- ③ Armrest

- ▶ Fold armrest ③ down (arrow).
- ▶ Pull handle ① and swing cover ② down.

Controls in detail

Loading



- ④ Hook and loop fastener
- ▶ Unfasten hook and loop fastener ④.
- ▶ Pull ski sack into passenger compartment and unfold.

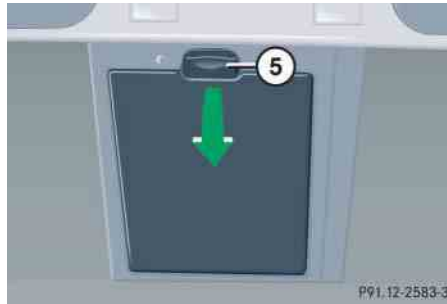

- ⑤ Button
- ▶ Open trunk lid.
- ▶ Press button ⑤.
The flap opens downward.



- ▶ From trunk, slide skis into ski sack.

Warning!



The ski sack is designed for up to four pairs of skis. Do not load the ski sack with other objects.

Always fasten the ski sack securely. In an accident, an unfastened ski sack can cause injury to vehicle occupants.



Controls in detail

Loading



⑥ Strap

- ▶ Tighten strap ⑥ by pulling at the loose end (arrow) until the skis in the ski sack are tightly secured.

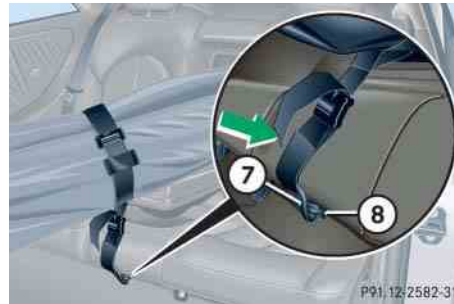

⑦ Hook

⑧ Eye

- ▶ Connect hook ⑦ to eye ⑧ located on center tunnel in front of rear seat bench.
- ▶ Tighten strap by pulling at the loose end (arrow).

Unloading and folding

- ▶ Loosen both straps.
- ▶ Disconnect hook ⑦ from eye ⑧.
- ▶ Unload skis.
- ▶ Close flap in trunk.
- ▶ Fold and flatten ski sack lengthwise.
- ▶ Place folded ski sack inside recess of backrest.
- ▶ Fasten hook and loop fastener



- ▶ Close ski sack compartment cover.

Removal of ski sack

You can remove the ski sack for cleaning or drying.



- ① Button
- ② Ski sack frame
- ③ Flap

- ▶ Open trunk lid.
- ▶ Press button ①.
- The flap ③ opens downward.
- ▶ Press button ① firmly until ski sack frame ② is released.
- ▶ Pull ski sack frame ② with ski sack out.

Warning!



Never drive vehicle with trunk open while the ski sack is removed. Deadly carbon monoxide (CO) gases may enter vehicle interior, resulting in unconsciousness and death.



To prevent unauthorized persons from access to the trunk, always close the flap.

Installing the ski sack

Install the ski sack in the reverse order.

- ▶ Push ski sack frame ② with ski sack inward until the ski sack frame snaps into place.
- ▶ Close flap ③.
- ▶ Close trunk lid.

Split rear bench seat

To expand the cargo area, you can fold down the left and right rear seat backrests. The two sections can be folded down separately.

Warning!



When expanding the luggage compartment, always fold the seat cushions fully forward. Unless you are transporting cargo, the backrests must remain properly locked in the upright position.

In an accident, during hard braking or sudden maneuvers, loose items will be thrown around inside the vehicle, and cause injury to vehicle occupants unless the items are securely fastened in the vehicle.

Always use the cargo tie down rings (▷ page 271).

Controls in detail

Loading

Folding the backrest forward

The release handle ① is located in the trunk.

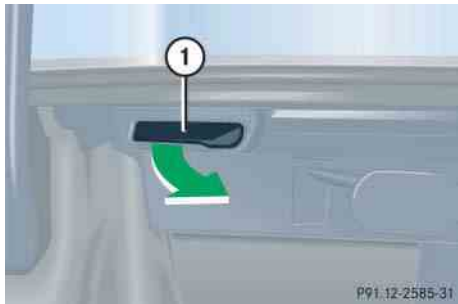

- ▶ Pull release handle ①.
- ▶ Fully retract and fold rearward head restraint (▷ page 116).



- ▶ Pull release handle ②.

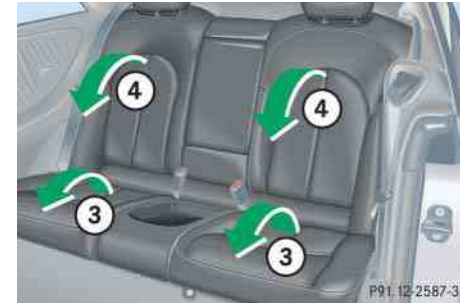

- ▶ Fold seat cushion ③ forward.
- ▶ Fold rear seat backrests ④ forward.

Setting up rear seat bench



- ▶ Fold backrest ④ rearward until it engages.
- ▶ Fold seat cushions ③ rearward until it locks into position.

If a backrest is not locked into position, a red indicator ⑤ or ⑥ will be visible.

- ▶ Check for secure locking by pushing and pulling on the backrest.

Warning!



If a red indicator is visible with the backrest up, then the backrest is not properly locked into position.

Always lock backrest in its upright position when rear seat bench is occupied, or the extended trunk compartment is not in use. Check for secure locking by pushing and pulling on the backrest.

In an accident, during hard braking or sudden maneuvers, loose items will be thrown around inside the vehicle, and cause injury to vehicle occupants unless the items are securely fastened in the vehicle.

To help avoid personal injury during a collision or sudden maneuver, exercise care when transporting cargo.



To prevent unauthorized persons from access to the trunk, always lock backrest in its upright position.

Loading instructions

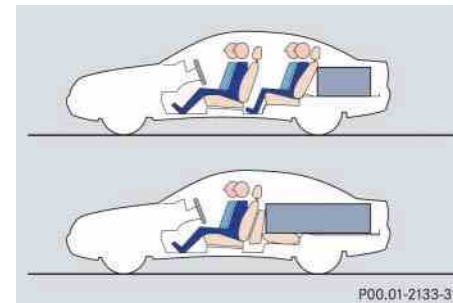

The total load weight including vehicle occupants and luggage/cargo should not exceed the load limit or vehicle capacity weight indicated on the corresponding placard located on the driver's door B-pillar.

The handling characteristics of a fully loaded vehicle depend greatly on the load distribution. It is therefore recommended to load the vehicle according to the illustrations shown, with the heaviest items being placed towards the front of the vehicle.

Controls in detail

Loading

Always place items being carried against front or rear seat backrests, and fasten them as securely as possible.

The heaviest portion of the cargo should always be kept as low as possible since it influences the handling characteristics of the vehicle.

Warning!



Always fasten items being carried as securely as possible.

In an accident, during hard braking or sudden maneuvers, loose items will be thrown around inside the vehicle and can cause injury to vehicle occupants unless the items are securely fastened in the vehicle.

To help avoid personal injury during a collision or sudden maneuver, exercise care when transporting cargo. Put luggage or cargo in the trunk if possible.

Never drive vehicle with trunk open. Deadly carbon monoxide (CO) gases may enter vehicle interior resulting in unconsciousness and death.



The trunk is the preferred place to carry objects.

The enlarged cargo area should only be used for items which do not fit in the trunk alone.

Cargo tie-down rings

The four cargo tie-down rings are located in the trunk.



Cargo tie-down rings

- ▶ Carefully secure cargo by applying even load on all rings with rope of sufficient strength to hold down the cargo.

Always follow loading instructions
(▷ page 269).

Controls in detail

Useful features

Storage compartments

Warning!



To help avoid personal injury during a collision or sudden maneuver, exercise care when stowing objects in the vehicle. Put luggage or cargo in the trunk if possible. Do not pile luggage or cargo higher than the seat backs.

Luggage nets cannot secure hard or heavy objects.

Keep compartment lids closed. This will help to prevent stored objects from being thrown about and injuring vehicle occupants during an accident.

Glove box

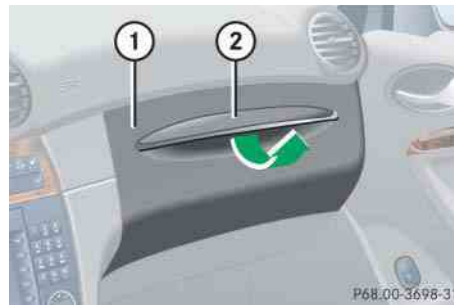

- ① Glove box
- ② Glove box lid release

Opening the glove box

- ▶ Pull lid release ②.
The glove box lid opens downward.

Closing the glove box

- ▶ Push lid up to close.



The glove box lid contains a compartment for eyeglasses.

Close the compartment for glasses first before closing the glove box.

Audio system/COMAND* with CD changer*: The CD changer is located in the glove box.

Armrest storage compartments

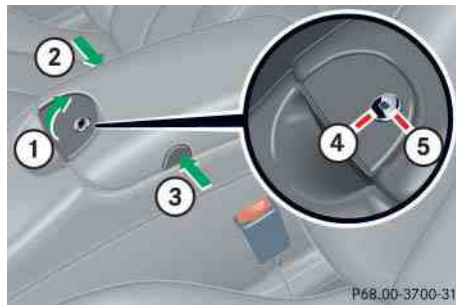

Opening compartment in armrest

- ▶ Lift armrest by pulling on handle ①.

Closing

- ▶ Lower armrest until it locks into place.

Opening telephone compartment

- ▶ Lift armrest by pushing button ② or ③.

Closing telephone compartment

- ▶ Lower armrest until it locks into place.

Locking compartment

- ▶ Remove the mechanical key from the SmartKey (▷ page 397).
- ▶ Turn the compartment lock to position ⑤.

Unlocking compartment

- ▶ Turn the compartment lock to position ④.
- ▶ Insert the mechanical key in the SmartKey.

Changing inclination of armrest

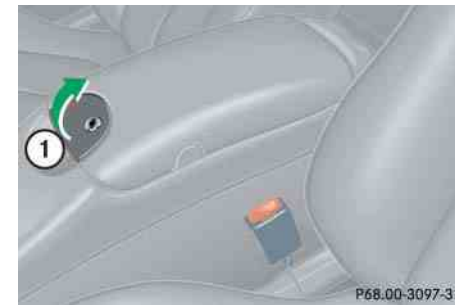

- ▶ Pull up on armrest.

Lowering armrest

- ▶ Pull handle ① to lower armrest.

Controls in detail

Useful features

Armrest in the rear passenger compartment



- Pull the top of the armrest out and fold it down.

Storage bags

Storage bags are located on the rear side of the front seats.

Warning!



Do not place heavy or fragile objects, or objects having sharp edges, in the storage bags.

In an accident, during hard braking or sudden maneuvers, they could be thrown around inside the vehicle, and cause injury to vehicle occupants.

Parcel net in front passenger footwell

A small convenience parcel net is located in the front passenger footwell. It is for small and light items, such as road maps, mail, etc.

Warning!



Do not place heavy or fragile objects, or objects having sharp edges, in the parcel net.

In an accident, during hard braking or sudden maneuvers, they could be thrown around inside the vehicle, and cause injury to vehicle occupants.

Cup holders

Warning!



In order to help prevent spilling liquids on vehicle occupants, only use containers that fit into the cup holder. Use lids on open containers and do not fill containers to a height where the contents, especially hot liquids, could spill during braking, vehicle maneuvers, or in an accident.

When not in use, keep the cup holder closed. An open cup holder may cause injury to you and others when contacted during braking, vehicle maneuvers, or in an accident.

Keep in mind that objects placed in cup holder may come loose during braking, vehicle maneuvers, or in an accident and be thrown around in the vehicle interior. Objects thrown around in the vehicle interior may cause an accident and/or serious personal injury.

Cup holder in the dashboard

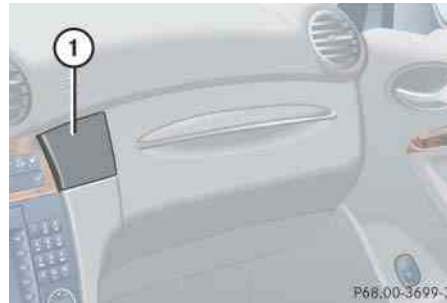

① Cover

Opening cup holder

- ▶ Push cover ①.
- The cup holder opens automatically.

Closing cup holder

- ▶ Push the cup holder back until it engages.

Cup holder in rear seat armrest



Opening cup holder

- ▶ Briefly press the front of cup holder. The cup holder slides out slightly.
- ▶ Pull out the cup holder until it stops.

Closing cup holder

- ▶ Slide cup holder back in direction of arrow ① until it engages.

Controls in detail

Useful features

Ashtrays

Center console ashtray



- ① Cover plate
- ② Sliding button
- ③ Ashtray insert

Opening ashtray

- ▶ Briefly press the bottom of cover plate ①.
The cover plate opens automatically.

Removing ashtray insert

Warning!



Remove front ashtray only with vehicle standing still. Set the parking brake to secure vehicle from movement. Move gear selector lever to position **N**. With gear selector lever in position **N**, turn off the engine.

- ▶ Secure vehicle from movement by setting the parking brake.
- ▶ Move the gear selector lever to position **N**.
Now you have more room to take out the insert.
- ▶ Push sliding button ② to the right.
The ashtray is disengaged and slides a short way in direction of arrow ③.
- ▶ Remove the ashtray insert.

Reinstalling the ashtray insert

- ▶ Push the ashtray insert ③ down into the retainer until it engages.
- ▶ Push down cover plate ① to close the ashtray.
The cover plate engages.

Rear seat ashtray

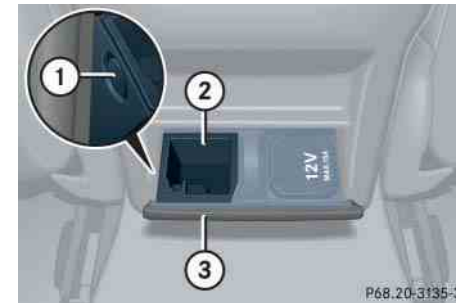

- ① Button
- ② Ashtray insert
- ③ Cover

Opening ashtray

- ▶ Pull at top of cover ③.

Removing ashtray insert

- ▶ Push button ① to disengage ashtray insert ② and remove it.

Reinstalling ashtray insert

- ▶ Push the ashtray insert ② down into the retainer until it engages.
- ▶ Push at top of cover ③ to close ashtray.

Cigarette lighter



① Cover

② Cigarette lighter

- ▶ Switch on ignition (▷ page 36).
- ▶ Briefly press the bottom of cover plate ①.
The cover plate opens automatically.
- ▶ Push in cigarette lighter ②.
The cigarette lighter will pop out automatically when hot.

Controls in detail

Useful features

Warning!



Never touch the heating element or sides of the lighter; they are extremely hot. Hold the knob only.

When leaving the vehicle, always remove the SmartKey or SmartKey with KEYLESS-GO* from the starter switch, take it with you, and lock the vehicle. Do not leave children unattended in the vehicle, or with access to an unlocked vehicle. Unsupervised use of vehicle equipment may cause an accident and/or serious personal injury.



The lighter socket can be used to accommodate electrical accessories up to a maximum 85 W.

- ▶ Push down cover plate ① to close the ashtray.
The cover plate engages.

Controls in detail

Useful features

Electrical outlet in the rear passenger compartment

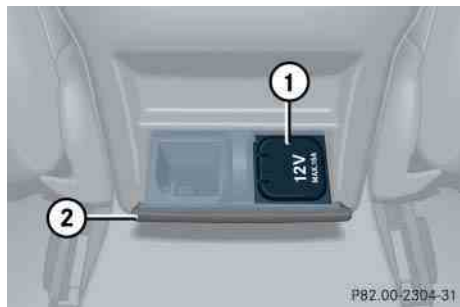

- ① Electrical outlet
- ② Cover
- ▶ Switch on ignition (▷ page 33).
- ▶ Pull at top of cover ②.
- ▶ Flip cover ① to the left and insert electrical plug (cigarette lighter type).



The electrical outlet can be used to accommodate electrical consumers (e.g. air pump, auxiliary lamps) up to a maximum of 180 W.

Floormats*

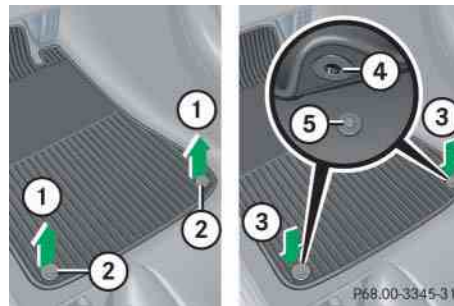

Removing

- ▶ Pull floormats off of retainer pins ② in direction of arrow ①.
- ▶ Remove the floormats.

Installing

- ▶ Lay down the floormat.
- ▶ Press the floormat eyelets ④ onto retainer pins ⑤ in direction of arrow ③.

Warning!



Whenever you are using floormats, make sure there is enough clearance and that the floormats are securely fastened.

Floormats should always be securely fastened using eyelets ④ and retainer pins ⑤.

Before driving off, check that the floormats are securely in place and adjust them if necessary. A loose floormat could slip and hinder proper functioning of the pedals.

Telephone*

Warning!



Never operate radio transmitters equipped with a built-in or attached antenna (i.e. without being connected to an external antenna) from inside the vehicle while the engine is running. Doing so could lead to a malfunction of the vehicle's electronic system, possibly resulting in an accident and/or serious personal injury.

Radio transmitters, such as a portable telephone or a citizens band unit, should only be used inside the vehicle if they are connected to an antenna that is installed on the outside of the vehicle.

The external antenna must be approved by Mercedes-Benz. Please contact an authorized Mercedes-Benz Center for information on the installation of an approved external antenna. Refer to the radio transmitter operation instructions regarding use of an external antenna.

Warning!





Please do not forget that your primary responsibility is to drive the vehicle. A driver's attention to the road must always be his/her primary focus when driving. For your safety and the safety of others, we recommend that you pull over to a safe location and stop before placing or taking a telephone call.

If you choose to use the telephone¹ while driving, please use the hands-free device and only use the telephone when road, weather and traffic conditions permit. Some jurisdictions prohibit the driver from using a cellular telephone while driving a vehicle.

Only operate the COMAND* (Cockpit Management and Data System)¹ if road, weather and traffic conditions permit.

Bear in mind that at a speed of just 30 mph (approximately 50 km/h), your vehicle is covering a distance of 44 feet (approximately 13.5 m) every second.

¹ Observe all legal requirements.

You can take and place telephone calls using the  and  buttons on the steering wheel. To carry out other telephone functions, use the control system (▷ page 162).

See separate operating manual for instructions on how to use the telephone.

Controls in detail

Useful features

Tele Aid



The initial activation of the Tele Aid system may only be performed by completing the subscriber agreement and placing an acquaintance call using the  button. Failure to complete either of these steps will result in a system that is not activated.

If you have any questions regarding activation, please call the Response Center at 1-800-756-9018 (in the USA) or 1-888-923-8367 (in Canada).



The Tele Aid system



(Telematic Alarm Identification on Demand)

The Tele Aid system consists of three types of response:

- automatic and manual emergency
- roadside assistance and
- information



The Tele Aid system is operational providing that the vehicle's battery is charged, properly connected, not damaged and cellular and GPS coverage is available.

The speaker volume of a Tele Aid call can be adjusted when using the volume control on the multifunction steering wheel. To raise, press button  and to lower, press button . The volume can also be adjusted using the volume knob on your audio system or COMAND* head unit.

- ▶ To activate, press the SOS button, the Roadside Assistance button  or the Information button , depending on the type of response required.



The SOS button is located above the interior rear view mirror.



The Roadside Assistance button  and the Information button  are located below the center armrest cover.

Shortly after the completion of your Tele Aid acquaintance call, you will receive a user ID and password. By visiting www.mbusa.com and selecting "Tele Aid" (USA only), you will have access to account information, remote door unlock and more.



The Tele Aid system utilizes the cellular network for communication and the GPS (Global Positioning System) satellites for vehicle location. If either of these signals is unavailable, the Tele Aid system may not function and if this occurs, assistance must be summoned by other means.

System self-check

Initially, after switching on ignition, malfunctions are detected and indicated (the indicator lamps in the SOS button, the Roadside Assistance button  and the Information button  stay on longer than ten seconds or do not come on).

The message **Tele Aid malfunction Drive to Workshop** appears in the multifunction display.

Warning!



If the indicator lamps in the SOS button, in the Roadside Assistance button and/or in the Information button remain illuminated constantly in red and/or message **Tele Aid malfunction Drive to Workshop** is displayed in the multifunction display after the system self-check, a malfunction in the system has been detected.

If a malfunction is indicated as outlined above, the system may not operate as expected. Have the system checked at the nearest Mercedes-Benz Center as soon as possible.

Emergency calls

An emergency call is initiated automatically following an accident in which the emergency tensioning devices (ETDs) or air bags deploy.

An emergency call can also be initiated manually by opening the cover next to the interior rear view mirror labeled SOS, then briefly pressing the button located under the cover. See (▷ page 282) for instructions on initiating an emergency call manually.

Once the emergency call is in progress, the indicator lamp in the SOS button will begin to flash. The message **Connecting call** appears in the multifunction display and the audio system is muted. When the connection is established, the message **Call connected** appears in the multifunction display. All information relevant to the emergency, such as the location of the vehicle (determined by the GPS satellite location system), vehicle model, identification number and color are generated.

Controls in detail

Useful features

A voice connection between the Response Center and the occupants of the vehicle will be established automatically soon after the emergency call has been initiated. The Response Center will attempt to determine more precisely the nature of the emergency provided they can speak to an occupant of the vehicle.

The Tele Aid system is available if

- it has been activated and is operational. Activation requires a subscription for monitoring services, connection and cellular air time
- the relevant cellular phone network and GPS signals are available and pass the information on to the Response Center



Location of the vehicle on a map is only possible if the vehicle is able to receive signals from the GPS satellite network and pass the information on to the Response Center.

Controls in detail

Useful features

Warning!



If the indicator lamp in the SOS button is flashing continuously and there was no voice connection to the Response Center established, then the Tele Aid system could not initiate an emergency call (e.g. the relevant cellular phone network is not available). The message *Call failed* appears in the multifunction display for approximately ten seconds.

Should this occur, assistance must be summoned by other means.

Initiating an emergency call manually



- ① Cover
- ② SOS button

- ▶ Briefly press on cover ①.
The cover will open.
- ▶ Press SOS button ② briefly.
The indicator lamp in SOS button ② will flash until the emergency call is concluded.

- ▶ Wait for a voice connection to the Response Center.
- ▶ Close cover ① after the emergency call is concluded.

Warning!





If you feel at any way in jeopardy when in the vehicle (e.g. smoke or fire in the vehicle, vehicle in a dangerous road location), please do not wait for voice contact after you have pressed the emergency button. Carefully leave the vehicle and move to a safe location. The Response Center will automatically contact local emergency officials with the vehicle's approximate location if they receive an automatic SOS signal and cannot make voice contact with the vehicle occupants.

Controls in detail

Useful features

Roadside Assistance button

The Roadside Assistance button  is located below the center armrest cover.

- ▶ Press and hold the  button (for longer than two seconds).

A call to a Mercedes-Benz Roadside Assistance dispatcher will be initiated. The  button will flash while the call is in progress. The message `Connecting call` will appear in the multifunction display and the audio system is muted.

When the connection is established, the message `Call connected` appears in the multifunction display. The Tele Aid system will transmit data generating the vehicle identification number, model, color and location (subject to availability of cellular and GPS signals).

A voice connection between the Roadside Assistance dispatcher and the occupants of the vehicle will be established.



- ▶ Describe the nature of the need for assistance.

The Mercedes-Benz Roadside Assistance dispatcher will either dispatch a qualified Mercedes-Benz technician or arrange to tow your vehicle to the nearest authorized Mercedes-Benz Center. For services such as labor and/or towing, charges may apply. Refer to the Roadside Assistance manual for more information.

The following is only available in the USA:

- Sign and Drive services: Services such as jump start, a few gallons of fuel or the replacement of a flat tire with the vehicle spare tire are obtainable.



The indicator lamp on the Roadside Assistance button  remains illuminated in red for approximately ten seconds during the system self-check after switching on ignition (together with the SOS button and the Information button ).

See system self-check (▷ page 280) when the indicator lamp does not come on in red or stays on longer than approximately ten seconds.

If the indicator lamp on the Roadside Assistance button  is flashing continuously and there was no voice connection to the Response Center established, then the Tele Aid system could not initiate a Roadside Assistance call (e.g. the relevant cellular phone network is not available). The message `Call failed` appears in the multifunction display.

Roadside Assistance calls can be terminated using the  button on the multifunction steering wheel or the respective button for ending a telephone call on the audio system or the COMAND* head unit.

Controls in detail

Useful features

Information button

The Information button  is located below the center armrest cover.

- ▶ Press and hold the  button (for longer than two seconds).

A call to the Customer Assistance Center will be initiated. The button will flash while the call is in progress. The message *Connecting call* will appear in the multifunction display and the audio system is muted.



When the connection is established, the message *Call connected* appears in the multifunction display. The Tele Aid system will transmit data generating the vehicle identification number, model, color and location (subject to availability of cellular and GPS signals).

A voice connection between the Customer Assistance Center representative and the occupants of the vehicle will be established. Information regarding the operation of your vehicle, the nearest

Mercedes-Benz Center or Mercedes-Benz USA products and services is available to you.

For more details concerning the Tele Aid system, please visit www.mbusa.com and use your ID and password (sent to you separately) to learn more (USA only).



The indicator lamp on the Information button  remains illuminated in red for approximately ten seconds during the system self-check after switching on ignition (together with the SOS button and the Roadside Assistance button ).

See System self-check (▶ page 280) when the indicator lamp does not come on in red or stays on longer than approximately ten seconds.

If the indicator lamp on the Information button  is flashing continuously and there was no voice connection to the Response Center established, then the Tele Aid system could not initiate an Information call (e.g. the relevant cellular phone network is not available). The message *Call failed* appears in the multifunction display.

Information calls can be terminated using the  button on the multifunction steering wheel or the respective button for ending a telephone call on the audio system or the COMAND* head unit.

Controls in detail

Useful features



If the indicator lamps do not start flashing after pressing one of the buttons or remain illuminated (in red) at any time, the Tele Aid system has detected a malfunction or the service is not currently active, and may not initiate a call. Visit an Mercedes-Benz Center and have the system checked or contact the Response Center at 1-800-756-9018 (in the USA) or 1-888-923-8367 (in Canada) as soon as possible.

Upgrade signals

An emergency call is possible even if other services are active.



If the indicator lamp continues to flash or the system does not reset, contact the Response Center at 1-800-756-9018 (in the USA), or 1-888-923-8367 (in Canada), or Mercedes-Benz Customer Assistance at 1-800-FOR-MERCEDES (1-800-367-6372) in the USA, or Customer Service at 1-800-387-0100 in Canada.



The indicator lamp in the respective button flashes until the call is concluded. Calls can only be terminated by a Response Center or Customer Assistance Center representative except Roadside Assistance and Information calls, which can also be terminated by pressing button  on the multifunction steering wheel or the respective button for ending a telephone call on the audio system or the COMAND* head unit.



When a Tele Aid call has been initiated, the audio system or the COMAND* system audio is muted and the selected mode (radio or CD) pauses. The optional cellular phone (if installed) switches off. If you must use this phone, the vehicle must be parked. Disconnect the coiled cord and place the call. The COMAND* navigation system (if engaged) will continue to run. The display in the instrument cluster is available for use, and spoken commands are only available by pressing the RPT button on the COMAND* head unit. A pop-up window will appear in the COMAND* display to indicate that a Tele Aid call is in progress.

Controls in detail

Useful features

Remote door unlock

In case you have locked your vehicle unintentionally (e.g. SmartKey inside vehicle), and the reserve SmartKey is not handy:

- ▶ Contact the Mercedes-Benz Response Center at 1-800-756-9018 (in the USA) or 1-888-923-8367 (in Canada).

You will be asked to provide your password which you provided when you completed the subscriber agreement.

- ▶ Then return to your vehicle and pull the trunk recessed handle for a minimum of 20 seconds until the SOS button is flashing.

The message *Connecting call* appears in the multifunction display.

As an alternative, you may unlock the vehicle via Internet using the ID and password sent to you shortly after the completion of your acquaintance call.

The Response Center will then unlock your vehicle with the remote door unlocking feature.



The remote door unlock feature is available if the relevant cellular phone network is available.

The SOS button will flash and the message *Connecting call* will appear in the multifunction display to indicate receipt of the door unlock command.

Once the vehicle is unlocked, a Response Center specialist will attempt to establish voice contact with the vehicle occupants.

If the trunk recessed handle was pulled for more than 20 seconds before door unlock authorization was received by the Response Center, you must wait 15 minutes before pulling the trunk recessed handle again.

Stolen Vehicle Recovery services

In the event your vehicle was stolen:

- ▶ Report the incident to the police.
The police will issue a numbered incident report.
- ▶ Pass this number on to the Mercedes-Benz Response Center along with your password issued to you when you subscribed to the service.

The Response Center will then attempt to covertly contact the vehicle's Tele Aid system. Once the vehicle is located, the Response Center will contact the local law enforcement and you. The vehicle's location will only be provided to law enforcement.



When the anti-theft alarm or the tow-away alarm stays on for more than 30 seconds, a call is initiated automatically to the Response Center, see "Anti-theft alarm system" (▷ page 90) and tow-away alarm (▷ page 91).

Garage door opener

The built-in remote control is capable of operating up to three separately controlled devices, for example garage door openers, gate openers, or other devices compatible with HomeLink® or some other systems.

You can program the signal transmitter buttons.

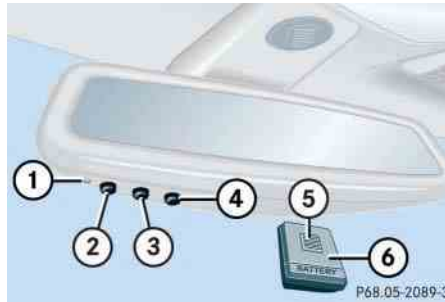

Remote control integrated into the interior rear view mirror

- ① Indicator lamp
- ② ③ ④ Signal transmitter button
- ⑤ Hand-held transmitter button
- ⑥ Hand-held remote control transmitter (not part of the vehicle equipment)

Controls in detail

Useful features

Warning!



Before programming the integrated remote control to a garage door opener or gate operator, make sure people and objects are out of the way of the device to prevent potential harm or damage. When programming a garage door opener, the door moves up or down. When programming a gate operator, the gate opens or closes.

Do not use the integrated remote control with any garage door opener that lacks safety stop and reverse features as required by U.S. federal safety standards (this includes any garage door opener model manufactured before April 1, 1982). A garage door that cannot detect an object - signaling the door to stop and reverse - does not meet current U.S. federal safety standards.

Controls in detail

Useful features



Certain types of garage door openers are incompatible with the integrated opener. If you should experience difficulties with programming the transmitter, contact an authorized Mercedes-Benz Center, or call Mercedes-Benz Customer Assistance Center (in the USA only) at 1-800-FOR-MERCEdes, or Customer Service (in Canada) at 1-800-387-0100.



USA only:
This device complies with Part 15 of the FCC Rules. Operation is subject to the following two conditions:

- (1) This device may not cause harmful interference, and
- (2) this device must accept any interference received, including interference that may cause undesired operation.

Any unauthorized modification to this device could void the user's authority to operate the equipment.



Canada only:
This device complies with RSS-210 of Industry Canada. Operation is subject to the following two conditions:

- (1) This device may not cause interference, and
- (2) this device must accept any interference received, including interference that may cause undesired operation of the device.

Any unauthorized modification to this device could void the user's authority to operate the equipment.

Programming or reprogramming the integrated remote control

Step 1:

- ▶ Switch on ignition (▷ page 36).

Step 2:

- ▶ If you have previously programmed an integrated signal transmitter button and wish to retain its programming, proceed to step 3. Otherwise, press and hold the two outer signal transmitter buttons ② and ④ and release them only when the indicator lamp ① begins to flash after approximately 20 seconds (do not hold the button for longer than 30 seconds). This procedure erases any previous settings for all three channels and initializes the memory. If you later wish to program a second and/or third hand-held transmitter to the remaining two signal transmitter buttons, do not repeat this step and begin directly with step 3.

Step 3:

- ▶ Hold the end of the hand-held remote control transmitter ⑥ of the device you wish to train approximately 2 to 5 in (5 to 12 cm) away from the surface of the integrated remote control located on the interior rear view mirror, keeping the indicator lamp ① in view.

Step 4:

- ▶ Using both hands, simultaneously press the hand-held transmitter button ⑤ and the desired integrated signal transmitter button (②, ③ or ④). Do not release the buttons until completing step 5.

The indicator lamp ① on the integrated remote control will flash, first slowly and then rapidly.

i

The indicator lamp ① flashes the first time the signal transmitter button is programmed. If this button has already been programmed, the indicator lamp will only start flashing after 20 seconds.

Step 5:

- ▶ When the indicator lamp ① flashes rapidly, release both buttons.

Step 6:

- ▶ Press and hold the just-trained integrated signal transmitter button and observe the indicator lamp ①.

If the indicator lamp ① stays on constantly, programming is complete and your device should activate when the integrated signal transmitter button is pressed and released.

Controls in detail

Useful features



If the indicator lamp ① blinks rapidly for about two seconds and then turns to a constant light, continue with programming steps 8 through 12 as your garage door opener may be equipped with the “rolling code” feature.

Step 7:

- ▶ To program the remaining two buttons, repeat the steps above starting with step 3.

Rolling code programming

To train a garage door opener (or other rolling code devices) with the rolling code feature, follow these instructions after completing the “Programming” portion (steps 1 through 6) of this text. (A second person may make the following training procedures quicker and easier.)

Step 8:

- ▶ Locate “training” button on the garage door opener motor head unit.

Exact location and color of the button may vary by garage door opener brand. Depending on manufacturer, the “training” button may also be referred to as “learn” or “smart” button. If there is difficulty locating the transmitting button, refer to the garage door opener operator’s manual.

Step 9:

- ▶ Press “training” button on the garage door opener motor head unit.

The “training light” is activated.

You have 30 seconds to initiate the following step.

Step 10:

- ▶ Firmly press, hold for two seconds and release the programmed integrated signal transmitter button (②, ③ or ④).

Step 11:

- ▶ Press, hold for two seconds and release same button a second time to complete the training process.

Some garage door openers (or other rolling code equipped devices) may require you to perform this procedure a third time to complete the training.

Controls in detail

Useful features

Step 12:

- ▶ Confirm the garage door operation by pressing the programmed integrated signal transmitter button (②, ③ or ④).

Step 13:

- ▶ To program the remaining two buttons, repeat the steps above starting with step 3.

Gate operator/Canadian programming

Canadian radio-frequency laws require transmitter signals to “time-out” (or quit) after several seconds of transmission which may not be long enough for the integrated signal transmitter to pick up the signal during programming. Similar to this Canadian law, some U.S. gate operators are designed to “time-out” in the same manner.

If you live in Canada or if you are having difficulties programming a gate operator (regardless of where you live) by using the programming procedures, replace step 4 with the following:

Step 4:

- ▶ Continue to press and hold the integrated signal transmitter button (②, ③ or ④) while you press and re-press (“cycle”) your hand-held remote control transmitter (⑥) every two seconds until the frequency signal has been learned. Upon successful training, the indicator lamp (①) will flash slowly and then rapidly after several seconds.
- ▶ Proceed with programming step 5 and step 6 to complete.

Controls in detail

Useful features

Operation of integrated remote control

- ▶ Switch on ignition (▷ page 36).
- ▶ Select and press the appropriate integrated signal transmitter button (②, ③ or ④) to activate the remote controlled device.

The integrated remote control transmitter continues to send the signal as long as the button is pressed – up to 20 seconds.

Erasing the integrated remote control memory

- ▶ Switch on ignition (▷ page 36).
- ▶ Simultaneously hold down the signal transmitter buttons ② and ④, for approximately 20 seconds, until the indicator lamp ① flashes rapidly. Do not hold for longer than 30 seconds.

The codes of all three channels are erased.



If you sell your vehicle, erase the codes of all three channels.

Reprogramming a single integrated signal transmitter button

To program a device using a signal transmitter button previously trained, follow these steps:

- ▶ Press and hold the desired signal transmitter button (②, ③ or ④). Do not release the button.
- ▶ The indicator lamp will begin to flash after 20 seconds. Without releasing the integrated signal transmitter button, proceed with programming starting with step 3.

Operation

The first 1000 miles (1500 km)

Driving instructions

At the gas station

Engine compartment

Tires and wheels

Winter driving

Maintenance

Vehicle care

Operation

The first 1 000 miles (1 500 km)

In the “Operation” section you will find detailed information on operating, maintaining and caring for your vehicle.

The more cautiously you treat your vehicle during the break-in period, the more satisfied you will be with its performance later on.

- Drive your vehicle during the first 1 000 miles (1 500 km) at varying but moderate vehicle and engine speeds.
- During this period, avoid heavy loads (full throttle driving) and excessive engine speeds (no more than $\frac{2}{3}$ of maximum rpm in each gear).
- Shift gears in a timely manner.
- Avoid accelerating by kickdown.
- Do not attempt to slow the vehicle down by shifting to a lower gear using the gear selector lever.
- Select positions **3**, **2** or **1** only when driving at moderate speeds (for hill driving).
- Select mode **C** as the preferred shift program (▷ page 170) for the first 1 000 miles (1 500 km).

After 1 000 miles (1 500 km), you may gradually increase vehicle and engine speeds to the permissible maximum.



Additional instructions for AMG vehicles:

- During the first 1 000 miles (1 500 km), do not exceed a speed of 85 mph (140 km/h).
- During this period, avoid engine speeds above 4 500 rpm in each gear.

All of the above instructions, as may apply to your vehicle type, also apply when driving the first 1 000 miles (1 500 km) after the engine or the rear differential has been replaced.



Always obey applicable speed limits.

▼ **Driving instructions**

Drive sensibly – save fuel

Fuel consumption, to a great extent, depends on driving habits and operating conditions.

To save fuel you should:

- Keep tires at the recommended inflation pressures.
- Remove unnecessary loads.
- Remove roof rack when not in use.
- Allow engine to warm up under low load use.
- Avoid frequent acceleration and deceleration.
- Have all maintenance work performed at the intervals specified in the Maintenance Booklet and as required by the Maintenance System (U.S. vehicles) or FSS (Canada vehicles). Contact an authorized Mercedes-Benz Center.

Fuel consumption is also increased by driving in cold weather, in stop-and-go traffic, on short trips and in hilly area.

Drinking and driving

Warning!



Drinking and driving and/or taking drugs and driving are very dangerous combinations. Even a small amount of alcohol or drugs can affect your reflexes, perceptions and judgement.

The possibility of a serious or even fatal accident are greatly increased when you drink or take drugs and drive.

Do not drink or take drugs and drive or allow anyone to drive who has been drinking or taking drugs.

Pedals

Warning!



Keep driver's foot area clear at all times. Objects stored in this area may impair pedal movement.

Power assistance

Warning!



With the engine not running, there is no power assistance for the brake and steering systems. In this case, it is important to keep in mind that a considerably higher degree of effort is necessary to brake and steer the vehicle.

Operation

Driving instructions

Brakes

Warning!



After driving in heavy rain for some time without applying the brakes or through water deep enough to wet brake components, the first braking action may be somewhat reduced and increased pedal pressure may be necessary to obtain expected braking effect. Maintain a safe distance from vehicles in front.

Resting your foot on the brake pedal will cause excessive and premature wear of the brake pads.

It can also result in the brakes overheating, thereby significantly reducing their effectiveness. It may not be possible to stop the vehicle in sufficient time to avoid an accident.

To help prevent brake disk corrosion after driving on wet road surfaces (particularly salted roads), it is advisable to brake the vehicle with considerable force prior to parking. The heat generated serves to dry the brakes.

If your brake system is normally only subject to moderate loads, you should occasionally test the effectiveness of the brakes by applying above-normal braking pressure at higher speeds. This will also enhance the grip of the brake pads.



Be very careful not to endanger other road users when you apply the brakes.

Refer to the description of the Brake Assist System (BAS) (> page 85).

If the parking brake is released and the brake warning lamp in the instrument cluster stays on, the brake fluid level in the reservoir is too low.

Brake pad wear or a leak in the system may be the reason for low brake fluid in the reservoir.

Have the brake system inspected immediately. Contact an authorized Mercedes-Benz Center.

All checks and service work on the brake system should be carried out by qualified technicians only. Contact an authorized Mercedes-Benz Center.

Only install brake pads and brake fluid recommended by Mercedes-Benz.

Warning!



If other than recommended brake pads are installed, or other than recommended brake fluid is used, the braking properties of the vehicle can be degraded to an extent that safe braking is substantially impaired. This could result in an accident.



When driving down long and steep grades, relieve the load on the brakes by shifting into a lower gear to use the engine's braking power. This helps prevent overheating of the brakes and reduces brake pad wear.

After hard braking, it is advisable to drive on for some time, rather than immediately parking, so that the air stream can cool down the brakes faster.

Driving off

Apply the brakes to test them briefly after driving off. Perform this procedure only when the road is clear of other traffic.

Warm up the engine gradually. Do not place full load on the engine until the operating temperature has been reached.

When starting off on a slippery surface, do not allow a drive wheel to spin for an extended period with the ESP switched off. Doing so may cause serious damage to the drivetrain which is not covered by the Mercedes-Benz Limited Warranty.



Simultaneously depressing the accelerator pedal and applying the brake reduces engine performance and causes premature brake wear and drivetrain wear.

Parking



Set the parking brake whenever parking or leaving the vehicle. In addition, move gear selector lever to position **P**. When parking on hills, turn front wheels towards the road curb.

Warning!



Do not park this vehicle in areas where combustible materials such as grass, hay or leaves can come into contact with the hot exhaust system, as these materials could be ignited and cause a vehicle fire.

Operation

Driving instructions

Warning!



To reduce the risk of personal injury as a result of inadvertent vehicle movement, before turning off the engine and leaving the vehicle always:

- Keep right foot firmly on brake pedal.
- Firmly depress parking brake pedal.
- Move the gear selector lever to position **P**.
- Slowly release brake pedal.
- When parked on an incline, turn front wheels towards the road curb.
- Turn the SmartKey in the starter switch to position **0** and remove the SmartKey from the starter switch, or press KEYLESS-GO* start/stop button (vehicles with KEYLESS-GO*).
- Take the SmartKey or the SmartKey with KEYLESS-GO* with you and lock the vehicle when leaving.

Tires

Warning!



If you feel a sudden significant vibration or ride disturbance, or you suspect that possible damage to your vehicle has occurred, you should turn on the hazard warning flashers, carefully slow down, and drive with caution to an area which is a safe distance from the road.

Inspect the tires and the vehicle underbody for possible damage. If the vehicle or tires appear unsafe, have it towed to the nearest Mercedes-Benz Center or tire dealer for repairs.

Treadwear indicators (TWI) are required by law. These indicators are located in six places on the tread circumference and become visible at a tread depth of approximately $\frac{1}{16}$ in (1.6 mm), at which point the tire is considered worn and should be replaced.

The treadwear indicator appears as a solid band across the tread.

Warning!



Although the applicable federal motor vehicle safety laws consider a tire to be worn when the treadwear indicators (TWI) become visible at approximately $\frac{1}{16}$ in (1.6 mm), we recommend that you do not allow your tires to wear down to that level. As tread depth approaches $\frac{1}{8}$ in (3 mm), the adhesion properties on a wet road are sharply reduced.

Depending upon the weather and/or road surface (conditions), the tire traction varies widely.

Specified tire inflation pressures must be maintained. This applies particularly if the tires are subject to extreme operating conditions (e.g. high speeds, heavy loads, high ambient temperatures).

Warning!



Do not drive with a flat tire. A flat tire affects the ability to steer or brake the vehicle. You may lose control of the vehicle. Continued driving with a flat tire or driving at high speed with a flat tire will cause excessive heat build-up and possibly a fire.

Hydroplaning

Depending on the depth of the water layer on the road, hydroplaning may occur, even at low speeds and with new tires. Reduce vehicle speed, avoid track grooves in the road and apply brakes cautiously in the rain.

Tire traction

The safe speed on a wet, snow covered or icy road is always lower than on a dry road.

You should pay particular attention to the condition of the road whenever the outside temperatures are close to the freezing point.

Warning!



If ice has formed on the road, tire traction will be substantially reduced. Under such weather conditions, drive, steer and brake with extreme caution.

Mercedes-Benz recommends M+S rated radial-ply tires with a minimum tread depth of approximately $\frac{1}{6}$ in (4 mm) on all four wheels for the winter season to ensure normal balanced handling characteristics. On packed snow, they can reduce your stopping distance compared to summer tires. Stopping distance, however, is still considerably greater than when the road is not covered with snow or ice. Exercise appropriate caution.



Avoid spinning of a drive wheel. This may cause serious damage to the drivetrain which is not covered by the Mercedes-Benz Limited Warranty.

Operation

Driving instructions

Tire speed rating

Regardless of the tire speed rating, local speed limits should be obeyed. Use prudent driving speeds appropriate to prevailing conditions.

Warning!



Even when permitted by law, never operate a vehicle at speeds greater than the maximum speed rating of the tires.

Exceeding the maximum speed for which tires are rated can lead to sudden tire failure, causing loss of vehicle control and possibly resulting in an accident and/or personal injury and possible death, for you and for others.

CLK 320 with Appearance Package

Your vehicle is factory equipped with “W”-rated tires, which have a speed rating of 168 mph (270 km/h).

An electronic speed limiter prevents your vehicle from exceeding a speed of 130 mph (210 km/h).

CLK 500

Your vehicle is factory equipped with “Y”-rated tires, which have a speed rating of 186 mph (300 km/h).

An electronic speed limiter prevents your vehicle from exceeding a speed of 130 mph (210 km/h).

CLK 55 AMG

Your vehicle is factory equipped with “Y”-rated tires, which have a speed rating of 186 mph (300 km/h).

An electronic speed limiter prevents your vehicle from exceeding a speed of 155 mph (250 km/h).



For information on tire speed rating for winter tires, see “Winter tires” (▷ page 342).

For additional general information on tire speed markings on tire sidewall, see “Tire speed rating” (▷ page 331).

Winter driving instructions

The most important rule for slippery or icy roads is to drive sensibly and to avoid abrupt acceleration, braking and steering maneuvers. Do not use the cruise control system under such conditions.

When the vehicle is in danger of skidding, move gear selector lever to position **N**. Try to keep the vehicle under control by corrective steering action.



For information on driving with snow chains, see “Snow chains” (▷ page 343).

Warning!



On slippery road surfaces, never downshift in order to obtain braking action. This could result in drive wheel slip and reduced vehicle control. Your vehicle’s ABS will not prevent this type of control loss.

Road salts and chemicals can adversely affect braking efficiency. Increased pedal force may become necessary to produce the normal braking effect.

Depressing the brake pedal periodically when traveling at length on salt-strewn roads can bring road-salt-impaired braking efficiency back to normal.

If the vehicle is parked after being driven on salt-treated roads, the braking efficiency should be tested as soon as possible after driving is resumed.

Warning



Make sure not to endanger any other road users when carrying out these braking maneuvers.

Operation

Driving instructions

Warning!



If the vehicle becomes stuck in snow, make sure snow is kept clear of the exhaust pipe and from around the vehicle with the engine running. Otherwise, deadly carbon monoxide (CO) gases may enter vehicle interior resulting in unconsciousness and death.

To assure sufficient fresh air ventilation, open a window slightly on the side of the vehicle not facing the wind.

Warning!



The outside temperature indicator is not designed to serve as an ice-warning device and is therefore unsuitable for that purpose. Indicated temperatures just above the freezing point do not guarantee that the road surface is free of ice.

For more information, see “Winter driving” (▷ page 342).

Operation

Driving instructions

Standing water



Do not drive through flooded areas or water of unknown depth. Before driving through water, determine its depth. Never accelerate before driving into water. The bow wave could force water into the engine and auxiliary equipment, thus damaging them.

If you must drive through standing water, drive slowly to prevent water from entering the passenger compartment or the engine compartment. Water in these areas could cause damage to electrical components or wiring of the engine or transmission, or could result in water being ingested by the engine through the air intake, causing severe internal engine damage. Any such damage is not covered by the Mercedes-Benz Limited Warranty.

Passenger compartment

Warning!



Always fasten items being carried as securely as possible.

In an accident, during hard braking or sudden maneuvers, loose items will be thrown around inside the vehicle, and cause injury to vehicle occupants unless the items are securely fastened in the vehicle.

The trunk is the preferred place to carry objects.

Driving abroad

Abroad, there is an extensive Mercedes-Benz service network at your disposal. If you plan to drive into areas which are not listed in the index of your Mercedes-Benz Center directory, you should request pertinent information from an authorized Mercedes-Benz Center.

Control and operation of radio transmitters

COMAND*, radio and telephone*

Warning!



Please do not forget that your primary responsibility is to drive the vehicle safely. Only operate the COMAND (Cockpit Management and Data System), radio or telephone¹ if road, weather and traffic conditions permit.

Bear in mind that at a speed of just 30 mph (approximately 50 km/h), your vehicle is covering a distance of 44 feet (approximately 14 m) every second.

¹ Observe all legal requirements.

Telephones* and two-way radios

Warning!



Never operate radio transmitters equipped with a built-in or attached antenna (i.e. without being connected to an external antenna) from inside the vehicle while the engine is running. Doing so could lead to a malfunction of the vehicle's electronic system, possibly resulting in an accident and/or serious personal injury.

Radio transmitters, such as a portable telephone or a citizens band unit should only be used inside the vehicle if they are connected to an antenna that is installed on the outside of the vehicle.

Refer to the radio transmitter operation instructions regarding use of an external antenna.

Catalytic converter

Your Mercedes-Benz is equipped with monolithic-type catalytic converters, an important element in conjunction with the oxygen sensors to achieve substantial control of the pollutants in the exhaust emissions. Keep your vehicle in proper operating condition by following our recommended maintenance instructions as outlined in your Maintenance Booklet.



To prevent damage to the catalytic converters, only use premium unleaded gasoline in this vehicle.

Any noticeable irregularities in engine operation should be repaired promptly. Otherwise, excessive unburned fuel may reach the catalytic converter, causing it to overheat and potentially start a fire.

Operation

Driving instructions

Warning!



As with any vehicle, do not idle, park or operate this vehicle in areas where combustible materials such as grass, hay, or leaves can come into contact with the hot exhaust system, as these materials could be ignited and cause a vehicle fire.

Operation

Driving instructions

Emission control

Certain systems of the engine serve to keep the toxic components of the exhaust gases within permissible limits required by law.

These systems, of course, will function properly only when maintained strictly according to factory specifications. Any adjustments to the engine should therefore be carried out only by qualified Mercedes-Benz Center authorized technicians.

Engine adjustments should not be altered in any way. Moreover, the specified service jobs must be carried out regularly according to Mercedes-Benz servicing requirements. For details refer to the Maintenance Booklet.

Warning!



Inhalation of exhaust gas is hazardous to your health. All exhaust gas contains carbon monoxide, and inhaling it can cause unconsciousness and lead to death.

Do not run the engine in confined areas (such as a garage) which are not properly ventilated. If you think that exhaust gas fumes are entering the vehicle while driving, have the cause determined and corrected immediately. If you must drive under these conditions, drive with at least one window fully open at all times.

Coolant temperature

During severe operating conditions and stop-and-go city traffic, the coolant temperature may rise close to approximately 248°F (120°C).

The engine should not be operated with the coolant temperature over 248°F (120°C). Doing so may cause serious engine damage which is not covered by the Mercedes-Benz Limited Warranty.

Warning!



- Driving when your engine is badly overheated can cause some fluids, which may have leaked into the engine compartment, to catch fire. You could be seriously burned.
- Steam from an overheated engine can cause serious burns and can occur just by opening the hood. Stay away from the engine if you see or hear steam coming from it.

Turn off the engine, get out of the vehicle and do not stand near the vehicle until the engine has cooled down.

▼ At the gas station

Refueling

Warning!



Gasoline is highly flammable and poisonous. It burns violently and can cause serious injury. Whenever you are around gasoline, avoid inhaling fumes and skin contact, extinguish all smoking materials. Never allow sparks, flame or smoking materials near gasoline!

Failure to remove the fuel cap slowly could result in personal injury.

The fuel filler flap is located on the right-hand side of the vehicle towards the rear. Locking/unlocking the vehicle with the SmartKey or the SmartKey with KEYLESS-GO* automatically locks/unlocks the fuel filler flap.

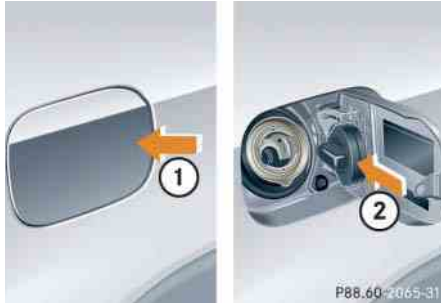

① To open the fuel filler flap

② To insert the fuel filler cap

- ▶ Turn the engine off
 - by turning the SmartKey to position **0**. Remove the SmartKey from the starter switch.
 - by pressing the KEYLESS-GO* start/stop button. Open the driver's door (with driver's door open, starter switch is now in position **0**, same as with SmartKey removed from starter switch).

Operation

At the gas station

- ▶ Open the fuel filler flap by pushing at the point indicated by the arrow ①. The fuel filler flap springs open.
- ▶ Turn fuel cap counterclockwise and hold on to it until possible pressure is released.
- ▶ Take off cap and set it in direction of arrow ② in the recess on the fuel filler flap.

To prevent fuel vapors from escaping into open air, fully insert filler nozzle unit.
- ▶ Only fill your tank until the filler nozzle unit cuts out – **do not top up or overfill.**



Operation

At the gas station



Warning!



Overfilling of the fuel tank may create pressure in the system which could cause a gas discharge. This could cause the gas to spray back out when removing the fuel pump nozzle, which could cause personal injury.

- ▶ Replace fuel cap by turning it clockwise.

You will hear when the fuel cap is tightened.

- ▶ Close fuel filler flap.





Only use premium unleaded gasoline with a minimum Posted Octane Rating of 91 (average of 96 RON / 86 MON).

Information on gasoline quality can normally be found on the fuel pump.

For more information on gasoline, see “Premium unleaded gasoline” (▷ page 450) or the Factory Approved Service Products pamphlet.



Leaving the engine running and the fuel cap open can cause the  malfunction indicator lamp (USA only) or the  malfunction indicator lamp (Canada only) to illuminate.

More information can be found in the “Practical hints” section (▷ page 356).

Check regularly and before a long trip

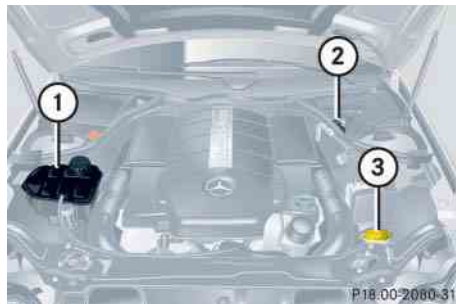

- ① Coolant level
- ② Brake fluid (fuse box cover removed)
- ③ Windshield washer and headlamp cleaning system*



Opening the hood, see (▷ page 308).

Coolant

For normal replenishing, use water (potable water quality). For more information, see “Coolant” (▷ page 313) and see “Fuels, coolants, lubricants, etc.” (▷ page 447).

Brake fluid

Removing fuse box cover (▷ page 431).



If you find that the brake fluid in the brake fluid reservoir has fallen to the minimum mark or below, have the brake system checked for brake pad thickness and leaks immediately. Notify an authorized Mercedes-Benz Center immediately. Do not add brake fluid as this will not solve the problem. For more information, see also “Practical hints” (▷ page 355).

Windshield washer and headlamp cleaning system*

For more information on filling up the washer reservoir, see “Windshield washer system and headlamp cleaning system**” (▷ page 315).

Engine oil level

For more information on engine oil, see “Engine oil” (▷ page 309).

Vehicle lighting

Check function and cleanliness. For more information on replacing light bulbs, see “Replacing bulbs” (▷ page 404).

For more information, see “Exterior lamp switch” (▷ page 50).

Tire inflation pressure

For more information, see “Checking tire inflation pressure” (▷ page 327).

Operation

Engine compartment

Hood

Warning!



Do not pull the release lever while the vehicle is in motion. Otherwise the hood could be forced open by passing air flow.

Opening

The hood lock release lever is located to the left of the steering wheel under the dashboard.



① Hood lock release lever

- ▶ Pull lever ① downwards.
The hood is unlocked.



To avoid damage to the windshield wipers or hood, never open the hood if the wiper arms are folded forward away from the windshield.



② Lever for opening the hood

- ▶ Push lever ② under the hood upwards.
- ▶ Pull up on the hood and then release it.

The hood will be automatically held open at shoulder height by gas-filled struts.

Warning!



To help prevent personal injury, stay clear of moving parts when the hood is open and the engine is running. Make sure the hood is properly closed before driving. When closing the hood, use extreme caution not to catch hands or fingers.

The radiator fan may continue to run for approximately 30 seconds or even restart after the engine has been turned off. Stay clear of fan blades.

Warning!



If you see flames or smoke coming from the engine compartment, or if the coolant temperature gauge indicates that the engine is overheated, do not open the hood. Move away from vehicle and do not open the hood until the engine has cooled. If necessary, call the fire department.

Warning!



The engine is equipped with a transistorized ignition system. Because of the high voltage it is dangerous to touch any components (ignition coils, spark plug sockets, diagnostic socket) of the ignition system

- with the engine running
- while starting the engine
- if ignition is “on” and the engine is turned manually

Closing

Warning!



Be careful that you do not close the hood on anyone.

- ▶ Let the hood drop from a height of approximately 1 ft (30 cm).

The hood will lock audibly.

- ▶ Check to make sure the hood is fully closed.

If you can raise the hood at a point above the headlamps, then it is not properly closed. Open it again and let it drop with somewhat greater force.

Engine oil

The amount of oil your engine needs will depend on a number of factors, including driving style. Higher oil consumption can occur when

- the vehicle is new
- the vehicle is driven frequently at higher engine speeds

Engine oil consumption checks should only be made after the vehicle break-in period.



Do not use any special lubricant additives, as these may damage the drive assemblies. Using special additives not approved by Mercedes-Benz may cause damage not covered by the Mercedes-Benz Limited Warranty. More information on this subject is available at any Mercedes-Benz Center.

Operation

Engine compartment

Checking engine oil level with the control system



When checking the oil level

- the vehicle must be parked on level ground
- with the engine at operating temperature, the vehicle must have been stationary for at least five minutes with the engine turned off
- with the engine not at operating temperature yet, the vehicle must have been stationary for at least 30 minutes with the engine turned off

To check the engine oil level via the multifunction display, do the following:

- ▶ Switch on ignition (▷ page 36).

The standard display (▷ page 142) should appear in the multifunction display.



- ▶ Press button  or  on the steering wheel until the following message is seen in the multifunction display:



One of the following messages will subsequently appear in the indicator:

- Engine oil level ok
- Add 1.0 qt. to reach max. oil level!
(Canada: 1.0 liter)
- Add 1.5 qt. to reach max. oil level!
(Canada: 1.5 liter)
- Add 2.0 qt. to reach max. oil level!
(Canada: 2.0 liter)



If you want to interrupt the checking procedure, press the  or  button on the multifunction steering wheel.

- ▶ If necessary, add engine oil.

For adding engine oil see (▷ page 312).

More information on engine oil can be found in the “Technical data” section (▷ page 447) and (▷ page 449).

Other display messages

If the SmartKey is not turned to position **2** in the starter switch, the following message will appear:

Turn on ignition
to see engine oil level!

- ▶ Switch on the ignition (▷ page 36).

If you see the message:

Observe waiting time

- ▶ If engine is at operating temperature, wait five minutes before repeating check procedure.
- ▶ If engine is not at operating temperature yet, wait 30 minutes before repeating check procedure.

If you see the message:

Engine oil level
Not when engine on!

- ▶ Turn off the engine.
- ▶ If the engine is at operating temperature, wait five minutes before checking oil.
- ▶ If the engine is not at operating temperature yet, you must wait 30 minutes before checking oil.

If there is excess engine oil with the engine at operating temperature, the following message will appear:

Engine oil level
Reduce oil level!

- ▶ Have excess oil siphoned or drained off. Contact an authorized Mercedes-Benz Center.



Excess oil must be siphoned or drained off. It could cause damage to the engine and catalytic converter not covered by the Mercedes-Benz Limited Warranty.

More information on messages in the display concerning engine oil can be found in the “Practical hints” section (▷ page 379).

Operation

Engine compartment

Adding engine oil



Only use approved engine oils and oil filters required for vehicles with Maintenance System (U.S. vehicles) or FSS (Canada vehicles). For a listing of approved engine oils and oil filters, refer to the Factory Approved Service Products pamphlet in your vehicle literature portfolio, or contact an authorized Mercedes-Benz Center.

Using engine oils and oil filters of specification other than those expressly required for the Maintenance System (U.S. vehicles) or FSS (Canada vehicles), or changing of oil and oil filter at change intervals longer than those called for by the Maintenance System (U.S. vehicles) or FSS (Canada vehicles) will result in engine damage not covered by the Mercedes-Benz Limited Warranty.



① Filler cap

- ▶ Unscrew filler cap ① from filler neck.
- ▶ Add engine oil as required. Be careful not to overfill with oil.

Be careful not to spill any oil when adding. Avoid environmental damage caused by oil entering the ground or water.



Excess oil must be siphoned or drained off. It could cause damage to the engine and catalytic converter not covered by the Mercedes-Benz Limited Warranty.

- ▶ Screw filler cap ① back on filler neck.

More information on engine oil can be found in the “Technical data” section (▷ page 447) and (▷ page 449).

Transmission fluid level

The transmission fluid level does not need to be checked. If you notice transmission fluid loss or gear shifting malfunctions, have an authorized Mercedes-Benz Center check the automatic transmission.

Coolant

The engine coolant is a mixture of water and anticorrosion/antifreeze. To check the coolant level, the vehicle must be parked on level ground and the engine must be cool.

The coolant expansion tank is located on the passenger side of the engine compartment.

Warning!



In order to avoid any possibly serious burns:

- Use extreme caution when opening the hood if there are any signs of steam or coolant leaking from the cooling system, or if the coolant temperature gauge indicates that the coolant is overheated.
- Do not remove pressure cap on coolant reservoir if the coolant temperature is above 158°F (70°C). Allow the coolant to cool down before removing cap. The coolant reservoir contains hot fluid and is under pressure.

- Using a rag, slowly open the cap approximately $\frac{1}{2}$ turn to relieve excess pressure. If opened immediately, scalding hot fluid and steam will be blown out under pressure.
- Do not spill antifreeze on hot engine parts. Antifreeze contains ethylene glycol which may burn if it comes into contact with hot engine parts.

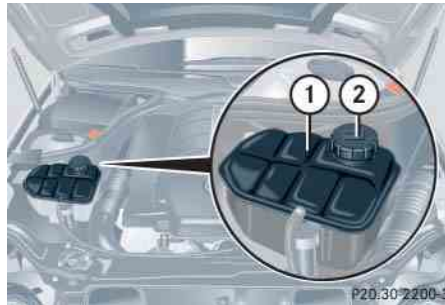

- ① Coolant expansion tank
- ② Cap

Operation

Engine compartment

- ▶ Using a rag, turn cap ② slowly approximately one half turn to the left to release any excess pressure.
- ▶ Continue turning the cap ② to the left and remove it.

The coolant level is correct if the level

- for cold coolant: reaches the black top part of the reservoir
 - for warm coolant: is approx. 0.6 in (1.5 cm) higher
- ▶ Add coolant as required.
 - ▶ Replace and tighten cap ②.

More information on coolant can be found in the “Technical data” section (▷ page 452).

Operation

Engine compartment

Battery

Your vehicle's battery is located in the engine compartment on the right hand side (▷ page 420).

The battery should always be sufficiently charged in order to achieve its rated service life. Refer to Maintenance Booklet for battery maintenance intervals.

If you use your vehicle mostly for short-distance trips, you will need to have the battery charge checked more frequently.

When replacing the battery, always use batteries approved by Mercedes-Benz.

If you do not intend to operate your vehicle for an extended period of time, consult an authorized Mercedes-Benz Center about steps you need to observe.



Observe all safety instructions and precautions when handling automotive batteries.



Risk of explosion



Keep flames or sparks away from battery. Do not smoke.



Battery acid is caustic. Do not allow it to come into contact with skin, eyes or clothing.

In case it does, immediately flush affected area with clear water and seek medical help if necessary.



Wear eye protection.



Keep children away.



Follow the instructions in this Operator's Manual.

Batteries contain materials that can harm the environment if disposed of improperly. Recycling of batteries is the preferred method of disposal. Many states require sellers of batteries to accept old batteries for recycling.

Windshield washer system and headlamp cleaning system*

The windshield washer reservoir is located in the engine compartment.



① Washer fluid reservoir cap

Fluid for the windshield washer system and the headlamp cleaning system* is supplied from the windshield washer reservoir. It has a capacity of approx. 6.4 US qt (6 l).

During all seasons, add MB Windshield Washer Concentrate “S” to water. Premix the windshield washer fluid in a suitable container.

- ▶ Refill the reservoir with MB Windshield Washer Concentrate “S” and water (or commercially available premixed windshield washer solvent / antifreeze, depending on ambient temperatures).

Always use washer solvent/antifreeze where temperatures may fall below the freezing point. Failure to do so could result in damage to the washer system/reservoir.



Only use washer fluid which is suitable for plastic lenses. Improper washer fluid can damage the plastic lenses of the headlamps.

Operation

Engine compartment

Warning!



Washer solvent/antifreeze is highly flammable. Do not spill washer solvent/antifreeze on hot engine parts, because it may ignite and burn. You could be seriously burned.

For more information, see “Windshield washer system and headlamp cleaning system*” (▷ page 454).

Operation

Tires and wheels

See an authorized Mercedes-Benz Center for information on tested and recommended rims and tires for summer and winter operation. They can also offer advice concerning tire service and purchase.

Warning!



Replace rims or tires with the same designation, manufacturer and type as shown on the original part. See an authorized Mercedes-Benz Center for further information. If incorrectly sized rims and tires are mounted:

- The wheel brakes or suspension components can be damaged.
- The operating clearance of the wheels and the tires may no longer be correct.

Warning!



Worn, old tires can cause accidents. If the tire tread is badly worn, or if the tires have sustained damage, replace them.

When replacing rims, only use genuine Mercedes-Benz wheel bolts specified for the particular rim type. Failure to do so can result in the bolts loosening and possibly an accident.

Retreaded tires are not tested or recommended by Mercedes-Benz, since previous damage cannot always be recognized on retreads. The operating safety of the vehicle cannot be assured when such tires are used.

See an authorized Mercedes-Benz Center for information on tested and recommended rims and tires for summer and winter operation.

Important guidelines

- Only use sets of tires and rims of the same type and make.
- Tires must be of the correct size for the rim.
- Break in new tires for approximately 60 miles (100 km) at moderate speeds.
- Regularly check the tires and rims for damage. Dented or bent rims can cause tire inflation pressure loss and damage to the tire beads.
- If vehicle is heavily loaded, check tire inflation pressure and correct as required.
- Do not allow your tires to wear down too far. Adhesion properties on wet roads are sharply reduced at tread depths under $\frac{1}{8}$ in (3 mm).
- When replacing individual tires, you should mount new tires on the front wheels first (on vehicles with same-sized wheels all around).

Tire care and maintenance

Warning!



Regularly check the tires for damage. Damaged tires can cause tire inflation pressure loss. As a result, you could lose control of your vehicle.

Worn, old tires can cause accidents. If the tire tread is badly worn, or if the tires have sustained damage, replace them.

Regularly check your tire inflation pressure at least once a month. For more information on checking tire inflation pressure see “Recommended tire inflation pressure” (> page 325).

Tire inspection

Every time you check your tire inflation pressure, you should also inspect your tires for the following:

- excessive tread wear (> page 318)
- cord or fabric showing through the tire’s rubber
- bumps, bulges, cuts, cracks or splits in the tread or side of the tire

Replace the tire if you find any of the above conditions.

Make sure you also inspect the spare tire periodically for condition and inflation. Spare tires will age and become worn over time even if never used, and thus should be inspected and replaced when necessary.

Life of tire

The service life of a tire is dependent upon varying factors including but not limited to:

- Driving style
- Tire inflation pressure
- Distance driven

Warning!



Tires and spare tire should be replaced after six years, regardless of the remaining tread.

Operation

Tires and wheels

Tread depth

Do not allow your tires to wear down too far. Adhesion properties on wet roads are sharply reduced at tread depths under $\frac{1}{8}$ in (3 mm).

Tread wear indicators (TWI) are required by law. These indicators are located in six places on the tread circumference and become visible at a tread depth of approximately $\frac{1}{16}$ in (1.6 mm), at which point the tire is considered worn and should be replaced.

Recommended minimum tire tread depth:

- Summer tires $\frac{1}{8}$ in (3 mm)
- Winter tires $\frac{1}{6}$ in (4 mm)

Warning!



Although the applicable federal motor safety laws consider a tire to be worn when the tread wear indicators (TWI) become visible at approximately $\frac{1}{16}$ in (1.6 mm), we recommend that you do not allow your tires

to wear down to that level. As tread depth approaches $\frac{1}{8}$ in (3 mm), the adhesion properties on a wet road are sharply reduced.

Depending upon the weather and/or road surface (conditions), the tire traction varies widely.

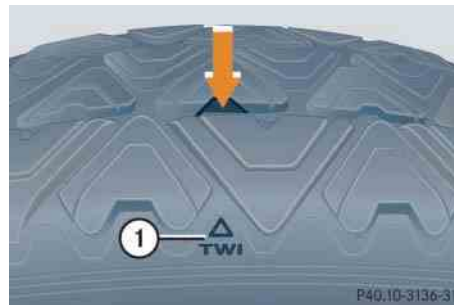

① TWI (Tread Wear Indicator)

The tread wear indicator appears as a solid band across the tread.

Storing tires



Keep unmounted tires in a cool, dry place with as little exposure to light as possible. Protect tires from contact with oil, grease and gasoline.

Cleaning tires



Never use a round nozzle to power wash tires. The intense jet of water can result in damage to the tire.

Always replace a damaged tire.

Direction of rotation

Unidirectional tires offer added advantages, such as better hydroplaning performance. To benefit, however, you must make sure the tires rotate in the direction specified.

An arrow on the sidewall indicates the intended direction of rotation (spinning) of the tire.



Spare wheels may be mounted against the direction of rotation (spinning) even with a unidirectional tire for temporary use only until the regular drive wheel has been repaired or replaced. Always observe and follow applicable temporary use restrictions and speed limitations indicated on the spare wheel.

Loading the vehicle

Two labels on your vehicle show how much weight it may properly carry.

- The Tire and Loading Information placard (Example A) or the Vehicle Tire Information placard (Example B) can be found on the driver's door B-pillar. This placard tells you important information about the number of people that can be in the vehicle and the total weight that can be carried in the vehicle. It also contains information on the proper size and recommended tire inflation pressures for the original equipment tires on your vehicle.

- The Certification label, also found on the driver's door B-pillar tells you about the gross weight capacity of your vehicle, called the Gross Vehicle Weight Rating (GVWR). The GVWR includes the weight of the vehicle, all occupants, fuel and cargo. The Certification label also tells you about the front and rear axle weight capacity, called the Gross Axle Weight Rating (GAWR). The GAWR is the total allowable weight that can be carried by a single axle (front or rear). Never exceed the GVWR or GAWR for either the front axle or rear axle.

Operation

Tires and wheels



① Driver's door B-pillar

Following is a discussion on how to work with the information contained on the two placards with regards to loading your vehicle.

Tire and Loading Information

Warning!



Do not overload the tires by exceeding the specified load limit or vehicle capacity weight as indicated on the placard on the driver's door B-pillar. Overloading the tires can overheat them, possibly causing a blowout. Overloading the tires can also result in handling or steering problems, or brake failure.

Your vehicle is equipped with either the Tire and Loading Information placard (Example A) or the Vehicle Tire Information placard (Example B).



Data shown on placard examples is for illustration purposes only. Load limit data is specific to each vehicle and may vary from data shown in the illustrations below. Refer to placard on vehicle for actual data specific to your vehicle.

Placard (Example A)

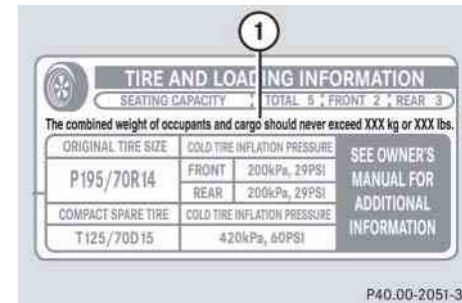

① Load limit information on the Tire and Loading Information placard

The placard showing the load limit information is located on the driver's door B-pillar. If your vehicle is equipped with the Tire and Loading Information placard (Example A), locate the statement "The combined weight of occupants and cargo should never exceed XXX kilograms or XXX lbs." on this placard. The combined weight of all occupants, cargo / luggage and trailer tongue load (if applicable) should never exceed the weight referenced in that statement.

Placard (Example B)

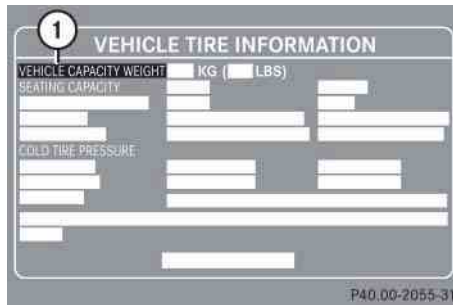

- ① Load limit information on the Vehicle Tire Information placard

The placard showing the load limit information is located on the driver's door B-pillar. If your vehicle is equipped with the Vehicle Tire Information placard (Example B), locate the heading "Vehicle Capacity Weight" on this placard. The combined weight of all occupants, cargo/luggage and trailer tongue (if applicable) should never exceed the weight listed next to vehicle capacity weight.

Seating capacity

The seating capacity gives you important information on the number of occupants that can be in the vehicle. Observe front and rear seating capacity. Your vehicle is equipped with either placard Example A or placard Example B located on the driver's door B-pillar (▷ page 320).



Data shown on placard examples is for illustration purposes only. Seating data is specific to each vehicle and may vary from data shown in the illustrations below. Refer to placard on vehicle for actual data specific to your vehicle.

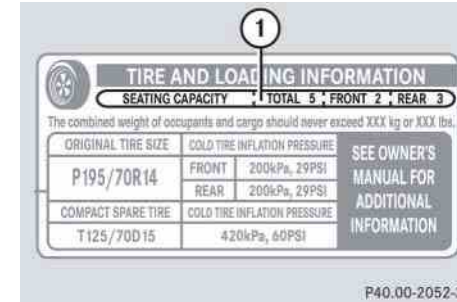

Placard (Example A)

- ① Seating capacity



Placard (Example B)

- ① Seating capacity

Operation

Tires and wheels

Steps for determining correct load limit

The following steps have been developed as required of all manufacturers under Title 49, Code of U.S. Federal Regulations, Part 575 pursuant to the “National Traffic and Motor Vehicle Safety Act of 1966”.

Step 1 (Vehicles equipped with placard Example A)

- ▶ Locate the statement “The combined weight of occupants and cargo should never exceed XXX kg or XXX lbs.” on your vehicle’s placard.

Step 1 (Vehicles equipped with placard Example B)

- ▶ Locate the heading “Vehicle Capacity Weight” on your vehicle’s placard.

Step 2

- ▶ Determine the combined weight of the driver and passengers that will be riding in your vehicle.

Step 3

- ▶ Subtract the combined weight of the driver and passengers from XXX kilograms or XXX lbs.

Step 4

- ▶ The resulting figure equals the available amount of cargo and luggage load capacity. For example, if the “XXX” amount equals 1400 lbs. and there will be five 150 lbs. passengers in your vehicle, the amount of available cargo and luggage load capacity is 650 lbs. (1400-750 (5 x150) = 650 lbs.)

Step 5

- ▶ Determine the combined weight of luggage and cargo being loaded on the vehicle. That weight may not safely exceed the available cargo and luggage load capacity calculated in step 4.

Step 6 (if applicable)

- ▶ If your vehicle will be towing a trailer, load from your trailer will be transferred to your vehicle. Consult this manual to determine how this reduces the available cargo and luggage load capacity of your vehicle (▷ page 324).

The following table shows examples on how to calculate total and cargo load capacities with varying seating configurations and number and size of occupants. The following examples use a load limit of 1500 lbs. **This is for illustration purposes only.** Make sure you are using the actual load limit for your vehicle stated on the vehicle’s placard (▷ page 320).

Example	Combined weight limit of occupants and cargo from placard	Number of occupants (driver and passengers)	Seating configuration	Occupants weight	Combined weight of all occupants	Available cargo/luggage and trailer tongue weight (total load limit or vehicle capacity weight from placard minus combined weight of all occupants)
1	1500 lbs	5	front: 2 rear: 3	Occupant 1: 150 lbs Occupant 2: 180 lbs Occupant 3: 160 lbs Occupant 4: 140 lbs Occupant 5: 120 lbs	750 lbs	1500 lbs - 750 lbs = 750 lbs
2	1500 lbs	3	front: 1 rear: 2	Occupant 1: 200 lbs Occupant 2: 190 lbs Occupant 3: 150 lbs	540 lbs	1500 lbs - 540 lbs = 960 lbs
3	1500 lbs	1	front: 1	Occupant 1: 150 lbs	150 lbs	1500 lbs - 150 lbs = 1350 lbs

The higher the weight of all occupants, the less cargo and luggage load capacity is available.

For more information, see “Trailer tongue load” (> page 324).

Operation

Tires and wheels

Certification label

Even after careful determination of the combined weight of all occupants, cargo and the trailer tongue load (if applicable) (▷ page 324) as to not exceed the permissible load limit, you must make sure that your vehicle never exceeds the Gross Vehicle Weight Rating (GVWR) and the Gross Axle Weight Rating (GAWR) for either the front or rear axle. You can obtain the GVWR and GAWR from the Certification label. The Certification Label can be found on the driver's door B-pillar, see "Technical data" (▷ page 436).

Gross Vehicle Weight Rating (GVWR): The total weight of the vehicle, all occupants, all cargo, and the trailer tongue load (▷ page 324) must never exceed the GVWR.

Gross Axle Weight Rating (GAWR): The total allowable weight that can be carried by a single axle (front or rear).

To assure that your vehicle does not exceed the maximum permissible weight limits (GVWR and GAWR for front and rear axle), have the loaded vehicle (including driver, passengers and all cargo and, if applicable, trailer fully loaded) weighed on a suitable commercial scale.

Trailer tongue load

The tongue load of any trailer is an important weight to measure because it affects the load you can carry in your vehicle. If a trailer is towed, the tongue load must be added to the weight of all occupants riding and any cargo you are carrying in the vehicle. The tongue load typically is ten percent of the trailer weight and everything loaded in it.

Your Mercedes-Benz has been designed primarily to carry passengers and their cargo. Mercedes-Benz does not recommend trailer towing with your vehicle.

Recommended tire inflation pressure

Warning!



Follow recommended tire inflation pressures.

Do not underinflate tires. Underinflated tires wear excessively and /or unevenly, adversely affect handling and fuel economy, and are more likely to fail from being overheated.

Do not overinflate tires. Overinflated tires can adversely affect handling and ride comfort, wear unevenly, increase stopping distance, and result in sudden deflation (blowout) because they are more likely to become punctured or damaged by road debris, potholes etc.

Your vehicle is equipped with either the Tire and Loading Information placard (Example A) or the Vehicle Tire Information placard (Example B) located on the driver's door B-pillar (> page 320).

The tire inflation pressure should be checked regularly and should only be adjusted on cold tires. The tires can be considered cold if the vehicle has been parked for at least three hours or driven less than one mile (1.6 km).

Follow recommended cold tire inflation pressures listed on placard.

Keeping the tires properly inflated provides the best handling, tread life and riding comfort.

In addition to the tire placard on the driver's door B-pillar, also consult the fuel filler flap for any additional information pertaining to special driving situations. For more information, see "Important notes on tire inflation pressure" (> page 326).



Data shown on placard examples is for illustration purposes only. Tire data is specific to each vehicle and may vary from data shown in the illustrations below. Refer to placard on vehicle for actual data specific to your vehicle.

Placard (Example A)

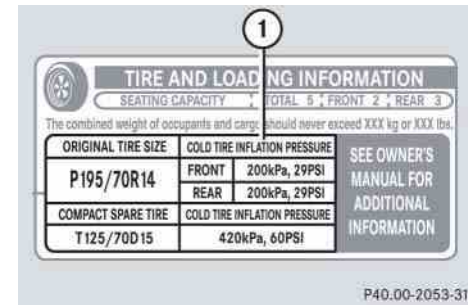

① Tire and Loading Information placard with recommended cold tire inflation pressures

Placard (Example A) lists the recommended cold tire inflation pressures for maximum loaded vehicle weight. The tire inflation pressures listed apply to the tires installed as original equipment.

Operation

Tires and wheels

Placard (Example B)

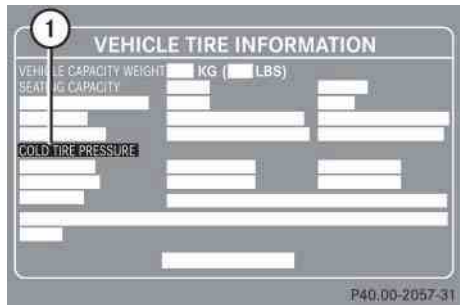

- ① Vehicle Tire Information placard with recommended cold tire inflation pressures

Placard (Example B) lists the recommended cold tire inflation pressures for maximum loaded vehicle weight. The tire inflation pressures listed apply to the tires installed as original equipment.



Placard (Example B) may list recommended cold tire inflation pressures for different vehicle loads.

Important notes on tire inflation pressure

Warning!



If the tire inflation pressure repeatedly drops:

- Check the tires for punctures from foreign objects.
- Check to see whether air is leaking from the valves or from around the rim.

Tire temperature and tire inflation pressure are also increased while driving, depending on the driving speed and the tire load.

If you will be driving your vehicle at high speeds of 100 mph (160 km/h) or higher, where it is legal and conditions allow, consult the placard on the inside of the fuel filler flap on how to adjust the cold tire inflation pressure. If you do not adjust the tire inflation pressure, excessive heat can build up and result in sudden tire failure.

Be sure to readjust the tire inflation pressure for normal driving speeds. You should wait until the tires are cold before adjusting the tire inflation pressure.

Some vehicles may have supplemental tire pressure information for vehicle loads less than the maximum loaded vehicle condition. If such information is provided, it can be found on the placard located on the inside of the fuel filler flap.

Tire inflation pressure changes by approximately 1.5 psi (0.1 bar) per 18°F (10°C) of air temperature change. Keep this in mind when checking tire inflation pressure where the temperature is different from the outside temperature.

Checking tire inflation pressure

Regularly check your tire inflation pressure at least once a month.

Check and adjust the tire inflation pressure when the tires are cold. The tires can be considered cold if the vehicle has been parked for at least three hours or driven less than one mile (1.6 km).

If you check the tire inflation pressure when the tires are warm (the vehicle has been driven for several miles or sitting less than three hours), the reading will be approximately 4 psi (0.3 bar) higher than the cold reading. This is normal. Do not let air out to match the specified cold tire inflation pressure. Otherwise, the tire will be underinflated.

Checking tire inflation pressure manually

Follow the steps below to achieve correct tire inflation pressure:

- ▶ Remove the cap from the valve on one tire.

- ▶ Firmly press a tire gauge onto the valve.
- ▶ Read tire inflation pressure on tire gauge and check against the recommended tire inflation pressure on the placard on the driver's door B-pillar (▷ page 325). If necessary, add air to achieve the recommended tire inflation pressure.



If you have overfilled the tire, release tire inflation pressure by pushing the metal stem of the valve with e.g. a tip of a pen. Then recheck the tire inflation pressure with the tire gauge.

- ▶ Install the valve cap.
- ▶ Repeat this procedure for each tire.

Potential problems associated with underinflated and overinflated tires

Underinflated tire inflation pressure

Underinflated tires can:

- cause excessive and uneven tire wear
- adversely affect fuel economy
- lead to tire failure from being overheated
- adversely affect handling characteristics

Warning!



Follow recommended tire inflation pressures.

Do not underinflate tires. Underinflated tires wear excessively and / or unevenly, adversely affect handling and fuel economy, and are more likely to fail from being overheated.

Operation

Tires and wheels

Overinflated tire inflation pressure

Overinflated tires can:

- adversely affect handling characteristics
- cause uneven tire wear
- be more prone to damage from road hazards
- adversely affect ride comfort
- increase stopping distance

Warning!



Follow recommended tire inflation pressures.

Do not overinflate tires. Overinflated tires can adversely affect handling and ride comfort, wear unevenly, increase stopping distance, and result in sudden deflation (blowout) because they are more likely to become punctured or damaged by road debris, potholes etc.

Tire labeling

Besides tire name (sales designation) and manufacturer name, a number of markings can be found on a tire.

Following are some explanations for the markings on your vehicle's tires:

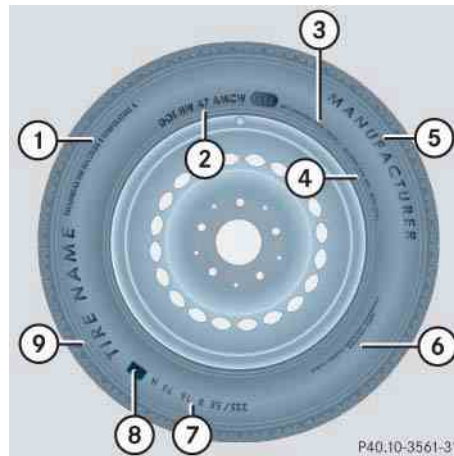

- ① Uniform Quality Grading Standards (▷ page 336)
- ② DOT, Tire Identification Number (TIN) (▷ page 333)
- ③ Maximum tire load (▷ page 334)
- ④ Maximum tire inflation pressure (▷ page 335)
- ⑤ Manufacturer
- ⑥ Tire ply material (▷ page 337)
- ⑦ Tire size designation, load and speed rating (▷ page 329)
- ⑧ Load identification (▷ page 332)
- ⑨ Tire name

i

For illustration purposes only. Actual data on tires is specific to each vehicle and may vary from data shown in above illustration.

For more information, see "Rims and tires" (▷ page 439).

Tire size designation, load and speed rating

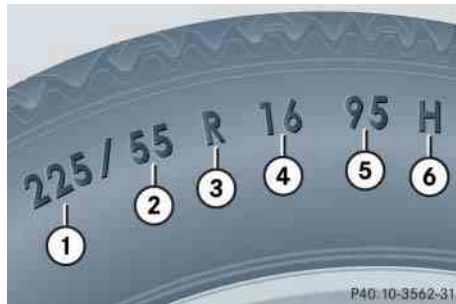

- ① Tire width
- ② Aspect ratio in %
- ③ Radial tire code
- ④ Rim diameter
- ⑤ Tire load rating
- ⑥ Tire speed rating



For illustration purposes only. Actual data on tires is specific to each vehicle and may vary from data shown in above illustration.

General:

Depending on the design standards used, the tire size molded into the sidewall may have no letter or a letter preceding the tire size designation.

No letter preceding the size designation (as illustrated above): Passenger car tire based on European design standards.

Letter “P” preceding the size designation: Passenger car tire based on U.S. design standards.

Letter “LT” preceding the size designation: Light Truck tire based on U.S. design standards.

Letter “T” preceding the size designation: Temporary spare tires which are high pressure compact spares designed for temporary emergency use only.

Tire width

The tire width ① (▷ page 329) indicates the nominal tire width in mm.

Aspect ratio

The aspect ratio ② (▷ page 329) is the dimensional relationship between tire section height and section width and is expressed in percentage. The aspect ratio is arrived at by dividing section height by section width.

Tire code

The tire code ③ (▷ page 329) indicates the tire construction type. The “R” stands for radial tire type. Letter “D” means diagonal or bias ply construction; letter “B” means belted-bias ply construction.

At the tire manufacturer’s option, any tire with a speed capability above 149 mph (240 km/h) can include a “ZR” in the size designation (for example: 245/40 ZR 18). For additional information, see “Tire speed rating” (▷ page 331).

Operation

Tires and wheels

Rim diameter

The rim diameter ④ (▷ page 329) is the diameter of the bead seat, not the diameter of the rim edge. Rim diameter is indicated in inches (in).

Tire load rating

The tire load rating ⑤ (▷ page 329) is a numerical code associated with the maximum load a tire can support.

For example, a load rating of 91 corresponds to a maximum load of 1356 lbs (615 kg) the tire is designed to support. See also “Maximum tire load” (▷ page 334) where the maximum load associated with the load index is indicated in kilograms and lbs.

Warning



The tire load rating must always be at least half of the GAWR (▷ page 338) of your vehicle. Otherwise, tire failure may be the result which may cause an accident and/or serious personal injury to you or others.

Always replace rims and tires with the same designation, manufacturer and type as shown on the original part.

Warning!



Do not overload the tires by exceeding the specified load limit or vehicle capacity weight as indicated on the placard located on the driver’s door B-pillar. Overloading the tires can overheat them, possibly causing a blowout. Overloading the tires can also result in handling or steering problems, or brake failure.

For additional information on tire load rating, see “Load identification” (▷ page 332).

i

Tire load rating ⑤ (▷ page 329) and Tire speed rating ⑥ (▷ page 329) are also referred to as “service description”.

Tire speed rating

The tire speed rating ⑥ (▷ page 329) indicates the approved maximum speed for the tire.

Warning!



Even when permitted by law, never operate a vehicle at speeds greater than the maximum speed rating of the tires.

Exceeding the maximum speed for which tires are rated can lead to sudden tire failure, causing loss of vehicle control and possibly resulting in an accident and/or personal injury and possible death, for you and for others.



Tire load rating ⑤ (▷ page 329) and Tire speed rating ⑥ (▷ page 329) are also referred to as “service description”.

Summer tires

Index	Speed rating
Q	up to 100 mph (160 km/h)
R	up to 106 mph (170 km/h)
S	up to 112 mph (180 km/h)
T	up to 118 mph (190 km/h)
H	up to 130 mph (210 km/h)
V	up to 149 mph (240 km/h)
W	up to 168 mph (270 km/h)
Y	up to 186 mph (300 km/h)
(Y)	above 186 mph (300 km/h)
ZR	above 149 mph (240 km/h)

- At the tire manufacturer’s option, any tire with a speed capability above 149 mph (240 km/h) can include a “ZR” in the size designation (for example: 245/40 ZR18). To determine the maximum speed capability of the tire, the service description for the tire must be referred to. The service description

is comprised of the tire load rating ⑤ (▷ page 329) and the tire speed rating ⑥ (▷ page 329).

If your tire includes “ZR” in the size designation and no service description ⑤ and ⑥ (▷ page 329) is given, the tire manufacturer must be consulted for the maximum speed capability.

If a service description ⑤ and ⑥ (▷ page 329) is given, the speed capability is limited by the speed symbol in the service description.

Example: 245/40 ZR18 97Y.

In this example, “97Y” is the service description. The letter “Y” designates the speed rating and the speed capability of the tire is limited to 186 mph (300 km/h).

Operation

Tires and wheels

- Any tire with a speed capability above 186 mph (300 km/h) must include a “ZR” in the size designation AND the service description must be placed in parenthesis. Example: 275/40 ZR 18 (99Y). The “(Y)” speed rating in parenthesis designates the maximum speed capability of the tire as being above 186 mph (300 km/h). Consult the tire manufacturer for the actual maximum permissible speed of the tire.

All-season and winter tires

Index	Speed rating
Q M+S	up to 100 mph (160 km/h)
T M+S	up to 118 mph (190 km/h)
H M+S	up to 130 mph (210 km/h)
V M+S	up to 149 mph (240 km/h)



The marking “M+S” next to the service description designates tires with mud and snow capabilities.

Load identification



① Load identification



For illustration purposes only. Actual data on tires is specific to each vehicle and may vary from data shown in above illustration.

In addition to tire load rating, special load information may be molded into the tire sidewall following the letter designating the tire speed rating ① (▷ page 332).

No specification given: absence of any text (like in above example) indicates a standard load (SL) tire.

XL or Extra Load: designates an extra load (or reinforced) tire.

Light Load: designates a light load tire.

C, D, E: designates load range associated with the maximum load a tire can carry at a specified pressure.

DOT, Tire Identification Number (TIN)

U.S. tire regulations require each new tire manufacturer or tire retreader to mold a TIN into or onto a sidewall of each tire produced.

The TIN is a unique identifier which facilitates efforts by tire manufactures to notify purchasers in recall situations or other safety matters concerning tires and gives purchasers the means to easily identify such tires.

The TIN is comprised of “Manufacturer’s identification mark”, “Tire size”, “Tire type code” and “Date of manufacture”.

Operation

Tires and wheels

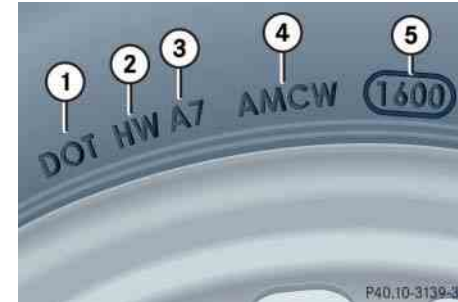

- ① DOT
- ② Manufacturer’s identification mark
- ③ Tire size
- ④ Tire type code (at the option of the tire manufacturer)
- ⑤ Date of manufacture

i

For illustration purposes only. Actual data on tires is specific to each vehicle and may vary from data shown in above illustration.

Operation

Tires and wheels

DOT (Department of Transportation)

A tire branding symbol ① (▷ page 333) which denotes the tire meets requirements of the U.S. Department of Transportation.

Manufacturer's identification mark

The manufacturer's identification mark ② (▷ page 333) denotes the tire manufacturer.

New tires have a mark with two symbols. Retreaded tires have a mark with four symbols. For more information on retreaded tires, see (▷ page 316).

Tire size

The code ③ (▷ page 333) indicates the tire size.

Tire type code

The code ④ (▷ page 333) may, at the option of the manufacturer, be used as a descriptive code for identifying significant characteristics of the tire.

Date of manufacture

The date of manufacture ⑤ (▷ page 333) identifies the week and year of manufacture.

The first two figures identify the week, starting with "01" to represent the first full week of the calendar year. The second two figures represent the year.

For example, "3202" represents the 32nd week of 2002.

Maximum tire load



① Maximum tire load rating



For illustration purposes only. Actual data on tires is specific to each vehicle and may vary from data shown in above illustration.

The maximum tire load is the maximum weight the tires are designed to support.

Warning!



Do not overload the tires by exceeding the specified load limit or vehicle capacity weight as indicated on the placard located on the driver's door B-pillar. Overloading the tires can overheat them, possibly causing a blowout. Overloading the tires can also result in handling or steering problems, or brake failure.

For more information on tire load rating (▷ page 330)

For information on calculating total and cargo load capacities (▷ page 322).

Maximum tire inflation pressure



- ① Maximum permissible tire inflation pressure



For illustration purposes only. Actual data on tires is specific to each vehicle and may vary from data shown in above illustration.

This is the maximum permissible tire inflation pressure for the tire.

Operation

Tires and wheels

Always follow the recommended tire inflation pressure (▷ page 325) for proper tire inflation.

Warning!



Never exceed the max. tire inflation pressure. Follow recommended tire inflation pressures.

Do not underinflate tires. Underinflated tires wear excessively and / or unevenly, adversely affect handling and fuel economy, and are more likely to fail from being overheated.

Do not overinflate tires. Overinflated tires can adversely affect handling and ride comfort, wear unevenly, increase stopping distance, and result in sudden deflation (blowout) because they are more likely to become punctured or damaged by road debris, potholes etc.

Operation

Tires and wheels

Uniform Tire Quality Grading Standards (U.S. vehicles)

Tire manufacturers are required to grade tires based on three performance factors: treadwear, traction and temperature resistance.

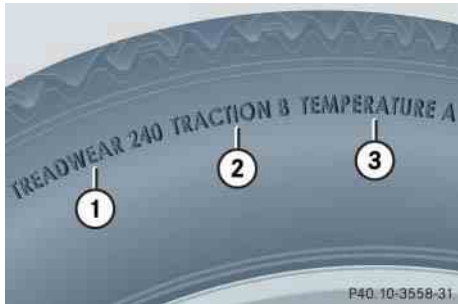

- ① Treadwear
- ② Traction
- ③ Temperature resistance



For illustration purposes only. Actual data on tires is specific to each vehicle and may vary from data shown in above illustration.

Quality grades can be found, where applicable, on the tire sidewall between tread shoulder and maximum section width. For example:

Treadwear	Traction	Temperature
200	AA	A

All passenger car tires must conform to federal safety requirements in addition to these grades.

Treadwear

The treadwear grade is a comparative rating based on the wear rate of the tire when tested under controlled conditions on a specified government test course. For example, a tire graded 150 would wear one and one-half ($1\frac{1}{2}$) times as well on the government course as a tire graded 100. The relative performance of tires depends upon the actual conditions of their use, however, and may depart significantly

from the norm due to variations in driving habits, service practices and differences in road characteristics and climate.

Traction

The traction grades, from highest to lowest, are AA, A, B, and C. Those grades represent the tire's ability to stop on wet pavement as measured under controlled conditions on specified government test surfaces of asphalt and concrete. A tire marked C may have poor traction performance.

Warning!



The traction grade assigned to this tire is based on straight-ahead braking traction tests, and does not include acceleration, cornering, hydroplaning, or peak traction characteristics.

Temperature

The temperature grades are A (the highest), B, and C, representing the tire's resistance to the generation of heat and its ability to dissipate heat when tested under controlled conditions on a specified indoor laboratory test wheel. Sustained high temperature can cause the material of the tire to degenerate and reduce tire life, and excessive temperature can lead to sudden tire failure. The grade C corresponds to a level of performance which all passenger car tires must meet under the Federal Motor Vehicle Safety Standard No. 109. Grades B and A represent higher levels of performance on the laboratory test wheel than the minimum required by law.

Warning!



The temperature grade for this tire is established for a tire that is properly inflated and not overloaded. Excessive speed, underinflation, or excessive loading, either separately or in combination, can cause excessive heat build-up and possible tire failure.

Operation

Tires and wheels

Tire ply material

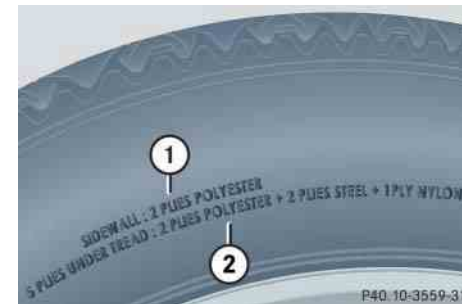

- ① Plies in sidewall
- ② Plies under tread



For illustration purposes only. Actual data on tires is specific to each vehicle and may vary from data shown in above illustration.

This marking tells you about the type of cord and number of plies in the sidewall and under the tread.

Operation

Tires and wheels

Tire and loading terminology

Accessory weight

The combined weight (in excess of those standard items which may be replaced) of automatic transmission, power steering, power brakes, power windows, power seats, radio, and heater, to the extent that these items are available as factory-installed equipment (whether installed or not).

Air pressure

The amount of air inside the tire pressing outward on each square inch of the tire. Air pressure is expressed in pounds per square inch (psi), or kilopascal (kPa) or bars.

Aspect ratio

Dimensional relationship between tire section height and section width expressed in percentage.

Bar

Another metric unit for air pressure. There are 14.5038 pounds per square inch (psi) to 1 bar; there are 100 kilopascals (kPa) to 1 bar.

Bead

The tire bead contains steel wires wrapped by steel cords that hold the tire onto the rim.

Cold tire inflation pressure

Tire inflation pressure when your vehicle has been sitting for at least three hours or driven no more than one mile (1.6 km).

Curb weight

The weight of a motor vehicle with standard equipment including the maximum capacity of fuel, oil, and coolant, and, if so equipped, air conditioning and additional optional equipment, but without passengers and cargo.

DOT (Department of Transportation)

A tire branding symbol which denotes the tire meets requirements of the U.S. Department of Transportation.

GAWR (Gross Axle Weight Rating)

The GAWR is the maximum permissible axle weight. The gross vehicle weight on each axle must never exceed the GAWR for the front and rear axle indicated on the certification label located on the driver's door B-pillar.

GVW (Gross Vehicle Weight)

The GVW comprises the weight of the vehicle including fuel, tools, spare wheel, installed accessories, passengers and cargo and, if applicable, trailer tongue load. The GVW must never exceed the GVWR indicated on the certification label located on the driver's door B-pillar.

GVWR (Gross Vehicle Weight Rating)

This is the maximum permissible vehicle weight of the fully loaded vehicle (weight of the vehicle including all options, passengers, fuel, and cargo and, if applicable, trailer tongue load). It is indicated on certification label located on the driver's door B-pillar.

Kilopascal (kPa)

The metric unit for air pressure. There are 6.9 kPa to one psi; another metric unit for air pressure is bars. There are 100 kilopascals (kPa) to one bar.

Maximum load rating

The maximum load in kilograms and pounds that can be carried by the tire.

Maximum loaded vehicle weight

The sum of curb weight, accessory weight, vehicle capacity weight and production options weight.

Maximum tire inflation pressure

This number is the greatest amount of air pressure that should ever be put in the tire under normal driving conditions.

Normal occupant weight

The number of occupants the vehicle is designed to seat, multiplied by 68 kilograms (150 lbs).

Occupant distribution

The distribution of occupants in a vehicle at their designated seating positions.

Production options weight

The combined weight of those installed regular production options weighing over 5 lbs (2.3 kilograms) in excess of those standard items which they replace, not previously considered in curb weight or accessory weight, including heavy duty brakes, ride levelers, roof rack, heavy duty battery, and special trim.

PSI (Pounds per square inch)

A standard unit of measure for air pressure -> bar, kilopascal (kPa).

Recommended tire inflation pressure

Recommended tire inflation pressure listed on placard located on driver's door B-pillar for normal driving conditions. Provides best handling, tread life and riding comfort.

Rim

A metal support for a tire or a tire and tube assembly upon which the tire beads are seated.

Sidewall

The portion of a tire between the tread and the bead.

Operation

Tires and wheels

TIN (Tire Identification Number)

Unique identifier which facilitates efforts by tire manufacturers to notify purchasers in recall situations or other safety matters concerning tires and gives purchasers the means to easily identify such tires. The TIN is comprised of “Manufacturer’s identification mark”, “Tire size”, “Tire type code” and “Date of manufacture”.

Tire load rating

Numerical code associated with the maximum load a tire can support.

Tire ply composition and material used

This indicates the number of plies or the number of layers of rubber-coated fabric in the tire tread and sidewall. Tire manufacturers also must indicate the ply materials in the tire and sidewall, which include steel, nylon, polyester, and others.

Tire speed rating

Part of tire designation; indicates the speed range for which a tire is approved.

Traction

Force exerted by the vehicle on the road via the tires. The amount of grip provided.

Tread

The portion of a tire that comes into contact with the road.

Treadwear indicators

Narrow bands, sometimes called “wear bars” that show across the tread of a tire when only $\frac{1}{6}$ in (1.6 mm) of tread remains.

Uniform Tire Quality Grading Standards

A tire information system that provides consumers with ratings for a tire’s traction, temperature and treadwear. Ratings are determined by tire manufacturers using government testing procedures. The ratings are molded into the sidewall of the tire.

Vehicle capacity weight

Rated cargo and luggage load plus 68 kilograms (150 lbs) times the vehicle’s designated seating capacity.

Vehicle maximum load on the tire

Load on an individual tire that is determined by distributing to each axle its share of the maximum loaded vehicle weight and dividing it by two.

Rotating tires

Warning!



Rotate front and rear wheels only if the tires are of the same dimension.

If your vehicle is equipped with mixed-size tires (different tire dimensions front vs. rear), tire rotation is not possible.

Tire rotation can be performed on vehicles with tires of the same dimension all around. If your vehicle is equipped with tires of the same dimension all around, tires can be rotated, observing a front-to-rear rotation pattern that will maintain the intended rotation (spinning) direction of the tire (▷ page 319).

In some cases, such as when your vehicle is equipped with mixed-size tires (different tire dimension front vs. rear), tire rotation is not possible.

If applicable to your vehicle's tire configuration, tires can be rotated according to the tire manufacturer's recommended intervals in the tire manufacturer's warranty pamphlet located in your vehicle literature portfolio. If none is available, tires should be rotated every 3000 to 6000 miles (5000 to 10000 km), or sooner if necessary, according to the degree of tire wear. The same rotation (spinning) direction must be maintained (▷ page 319).

Rotate tires before the characteristic tire wear pattern becomes visible (shoulder wear on front tires and tread center wear on rear tires).

Thoroughly clean the mounting face of wheels and brake disks, i.e. the inner side of the wheels/tires, during each rotation. Check for and ensure proper tire inflation pressure.

Operation

Tires and wheels

Warning!



Have the tightening torque checked after changing a wheel. Wheels could become loose if not tightened with a torque of 80 lb-ft (110 Nm).

Only use genuine Mercedes-Benz wheel bolts specified for your vehicle's rims.

For information on wheel change, see the "Practical hints" section (▷ page 389) and (▷ page 412).

Operation

Winter driving

Before the onset of winter, have your vehicle winterized at an authorized Mercedes-Benz Center. This service includes:

- Check of anticorrosion and antifreeze concentration.
- Addition of cleaning concentrate to the water of the windshield and headlamp cleaning system. Add MB Concentrate "S" to a premixed windshield washer solvent/antifreeze which is formulated for below freezing temperatures (▷ page 454).
- Battery test. Battery capacity drops with decreasing ambient temperature. A well charged battery helps to make sure that the engine can be started, even at low ambient temperatures.
- Tire change. Mercedes-Benz recommends M+S rated radial-ply tires with a minimum tread depth of approximately $\frac{1}{6}$ in (4 mm) on all four wheels for the winter season.

Winter tires

Always use winter tires at temperatures below 45°F (7°C) and whenever wintry road conditions prevail. Use of winter tires is the only way to achieve the maximum effectiveness of the ABS, ESP and 4MATIC in winter operation.

For safe handling, make sure that all mounted winter tires are of the same make and have the same tread design.

Warning!



Winter tires with a tread depth under $\frac{1}{6}$ in (4 mm) must be replaced. They are no longer suitable for winter operation.

Always observe the speed rating of the winter tires installed on your vehicle. If the maximum speed for which your tires are rated is below the speed rating of your vehicle, you must place a notice to this effect where it will be seen by the driver. Such notices are available from your tire dealer or from any authorized Mercedes-Benz Center.

Warning!



If you use your spare tire when winter tires are fitted on the other wheels, be aware that the difference in tire characteristics may very well impair turning stability and that overall driving stability may be reduced. Adapt your driving style accordingly.

Have the spare tire replaced with a winter tire at the nearest authorized Mercedes-Benz Center.

Block heater (Canada only)

The engine is equipped with a block heater.

The electrical cable may be installed at an authorized Mercedes-Benz Center.

Snow chains

Snow chains should only be driven on snow-covered roads at speeds not to exceed 30 mph (50 km/h). Remove chains as soon as possible when driving on roads without snow.



When driving with snow chains, you may wish to deactivate the ESP (▷ page 87) before setting the vehicle in motion. This will improve the vehicle's traction.

Please observe the following guidelines when using snow chains:

- Use of snow chains is not permissible with all wheel/tire combinations.
- Snow chains should only be used on the rear wheels. Follow the manufacturer's mounting instructions.

- Only use snow chains that are approved by Mercedes-Benz. Your authorized Mercedes-Benz Center will be glad to advise you on this subject.
- Use of snow chains may be prohibited depending on location. Always check local and state laws before installing snow chains.



Use of snow chains is not permissible with tire sizes:

- 225/50 R16 92H
- 245/40 R17 91W
- 245/40 R17 91Y
- 255/35 R18 94Y
- T 125/90 R 16 98M
- T 125/80 R17 99M

Operation

Maintenance

We strongly recommend that you have your vehicle serviced by an authorized Mercedes-Benz Center, in accordance with the Maintenance Booklet at the times called for by the maintenance service indicator display.

Failure to have the vehicle maintained in accordance with the Maintenance Booklet and maintenance service indicator at the designated times/mileage will result in vehicle damage not covered by the Mercedes-Benz Limited Warranty.



The maintenance service indicator will notify you when your next maintenance service is due.

Starting approximately one month before your next maintenance service is due, one of the following messages will appear in the multifunction display while you are driving or when you switch on the ignition (example service A):

Service A in XXXXX miles (km)
Service A in XXX days
Service A in X day
Service A due now!



The type of maintenance service due is indicated in the multifunction display:

-  Basic service (A)
-  Extended service (B)



Vehicles equipped with FSS (Flexible Service System) only (Canada vehicles): The interval between maintenance services depends on your driving habits. A gentle driving style, moderate engine speeds and the avoidance of short-distance trips will lengthen the interval between services.

Clearing the maintenance service indicator

The maintenance service indicator is automatically cleared

- after 30 seconds when you switch on the ignition or when reaching the maintenance service threshold while driving
- after 30 seconds, once the suggested maintenance service term has passed

You can also clear it yourself.

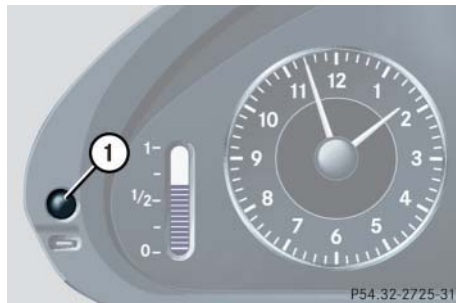

① Reset button

- ▶ Press the reset button ① on the instrument cluster.

Maintenance service term exceeded

If you have exceeded the suggested maintenance service term, you will see the following message in the multifunction display:

Service A exceeded by XXXXX miles (km)

Service A exceeded by XXX days

Service A exceeded by X day





In addition, a signal sounds when the message appears.

Any authorized Mercedes-Benz Center will reset the maintenance service indicator following a completed maintenance service.

Calling up the maintenance service indicator

- ▶ Switch on ignition (▷ page 36).

The standard display of the control system appears (▷ page 137).

- ▶ Press button  or  on the multifunction steering wheel until the maintenance service indicator with the service symbol  or  and the service deadline appears in the multifunction display.



If the battery is disconnected, the days of disconnection will not be included in the count shown by the maintenance service indicator. To arrive at the true maintenance service deadline, you will need to subtract these days from the days shown in the maintenance service indicator.

Do not confuse the maintenance service indicator with the engine oil level indicator .

Operation

Maintenance

Resetting the maintenance service indicator

In the event that the maintenance service on your vehicle is not carried out by an authorized Mercedes-Benz Center, you can have the maintenance service indicator reset. The automotive maintenance facility carrying out the maintenance service will find the information for resetting the maintenance service indicator in the maintenance-relevant information for your vehicle. Such information is available from either your authorized Mercedes-Benz Center or directly from Mercedes-Benz.



If the maintenance service indicator was inadvertently reset, have an authorized Mercedes-Benz Center correct it.

Only reset if the proper maintenance service has been performed. Resetting the system without performing the proper service as called for by the maintenance service indicator will result in engine damage and/or other vehicle damage not covered by the Mercedes-Benz Limited Warranty.

▼ Vehicle care

Cleaning and care of vehicle

Warning!



Many cleaning products can be hazardous. Some are poisonous, others are flammable. Always follow the instructions on the particular container. Always open your vehicle's doors or windows when cleaning the inside.

Never use fluids or solvents that are not designed for cleaning your vehicle.

While in operation, even while parked, your vehicle is subjected to varying external influences which, if gone unchecked, can attack the paintwork as well as the underbody and cause lasting damage.

Such damage is caused not only by extreme and varying climatic conditions, but also by:

- Air pollution
- Road salt
- Tar
- Gravel and stone chipping

To avoid paint damage, you should immediately remove:

- Grease and oil
- Fuel
- Coolant
- Brake fluid
- Bird droppings
- Insects
- Tree resins, etc.

Frequent washing reduces and /or eliminates the aggressiveness and potency of the above adverse influences.

More frequent washings are necessary to deal with unfavorable conditions:

- near the ocean
- in industrial areas (smoke, exhaust emissions)
- during winter operation

You should check your vehicle from time to time for stone chipping or other damage. Any damage should be repaired as soon as possible to prevent corrosion.

In doing so, do not neglect the underbody of the vehicle. A prerequisite for a thorough check is a washing of the underbody followed by a thorough inspection. Damaged areas need to be re-undercoated. Your vehicle has been treated at the factory with a wax-base rustproofing in the body cavities which will last for the lifetime of the vehicle. Post-production treatment is neither necessary nor recommended by Mercedes-Benz because of the possibility of incompatibility between materials used in the production process and others applied later.

Operation

Vehicle care

We have selected car-care products and compiled recommendations which are specially matched to our vehicles and which always reflect the latest technology. You can obtain Mercedes-Benz approved car-care products at an authorized Mercedes-Benz Center.

Scratches, corrosive deposits, corrosion or damage due to negligent or incorrect care cannot always be removed or repaired with the car-care products recommended here. In such cases it is best to seek aid at an authorized Mercedes-Benz Center.

The following topics deal with the cleaning and care of your vehicle and give important “how-to” information as well as references to Mercedes-Benz approved car-care products.

Power washer

When using a power washer for cleaning the vehicle, always observe the manufacturer’s operating instructions.



Vehicles with KEYLESS-GO*:
If a door handle is hit by a strong jet of water, and a SmartKey with KEYLESS-GO* is in close proximity, i.e. within approximately 3 ft (approximately 1 m), the vehicle could be inadvertently locked or unlocked.



Never use a round nozzle to power-wash tires. The intense jet of water can result in damage to the tire.

Always replace a damaged tire.

Always keep the jet of water moving across the surface. Do not aim directly at electrical parts, electrical connectors, seals, or other rubber parts.

Tar stains

Quickly remove tar stains before they dry and become more difficult to remove. A tar remover is recommended.

Paintwork, painted body components

Mercedes-Benz approved Paint Care should be applied when water drops on the paint surface do not “bead up”, normally every three to five months, depending on climate and washing detergent used.

Mercedes-Benz approved Paint Cleaner should be applied if the paint surface shows signs of embedded dirt (i.e. loss of gloss).

Do not apply any of these products or wax if your vehicle is parked in the sun or if the hood is still hot.

Use the appropriate MB-Touch-Up Stick for quick and provisional repairs of minor paint damage (i.e. chips from stones, vehicle doors, etc.).

Engine cleaning

Prior to cleaning the engine compartment, make sure to protect electrical components and connectors from the intrusion of water and cleaning agents.

Corrosion protection, such as MB Anticorrosion Wax, should be applied to the engine compartment after every engine cleaning. Before applying, all control linkage bushings and joints should be lubricated. The poly-V-belt and all pulleys should be protected from any wax.

Vehicle washing

Do not use hot water or wash your vehicle in direct sunlight. Only use a mild car wash detergent, such as Mercedes-Benz approved Car Shampoo.

Thoroughly spray the vehicle with a diffused jet of water. Direct only a very weak spray towards the ventilation intake. Use plenty of water and rinse the sponge and chamois frequently.

Rinse with clear water and thoroughly dry with a chamois. Do not allow cleaning agents to dry on the finish.

Due to the width of the vehicle, fold in exterior rear view mirrors prior to running the vehicle through an automatic car wash to prevent damage to the mirrors.

In the winter, thoroughly remove all traces of road salt as soon as possible.

When washing the underbody, do not forget to clean the inner sides of the wheels.



Vehicles with KEYLESS-GO*:
If a door handle is hit by a strong jet of water, and a SmartKey with KEYLESS-GO* is in close proximity, i.e. within approximately 3 ft (approximately 1 m), the vehicle could be inadvertently locked or unlocked.

Ornamental moldings

For regular cleaning and care of very dirty chrome-plated parts, use a chrome cleaner.

Headlamps, tail lamps, side markers, turn signal lenses

Use a mild car wash detergent, such as Mercedes-Benz approved Car Shampoo, with plenty of water.

To prevent scratches, never apply strong force and only use a soft, non-scratchy cloth when cleaning the lenses. Do not attempt to wipe dirty lenses with a dry cloth or sponge.

Operation

Vehicle care

Cleaning the Parktronic system* sensors

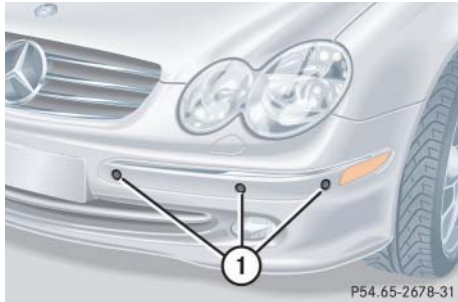

① Parktronic system* sensors

- ▶ Clean the sensors ① on the bumpers using a mild car wash detergent, such as Mercedes-Benz approved Car Shampoo, with plenty of water and a soft, non-scratchy cloth.

When using a steam cleaner or power washer, aim nozzle only briefly from a minimum distance of 12 in (30 cm) at sensors ①.

Do not apply strong pressure to the sensor cover, applying strong pressure may damage the sensor cover.

To prevent scratches, never apply strong force and only use a soft, non-scratchy cloth when cleaning the sensor. Do not attempt to wipe dirty sensors with a dry cloth or sponge.

Wiper blades

- ▶ Fold wiper arm forward until it snaps into place.

Warning!



For safety reasons, switch off wipers and remove SmartKey from starter switch (vehicles with KEYLESS-GO*: make sure the vehicle's on-board electronics have status **O**) before cleaning the wiper blades. Otherwise, the wiper motor could suddenly turn on and cause injury.

- ▶ Clean the wiper blade inserts with a clean cloth and detergent solution.

!

Fold the windshield wiper arms back onto the windshield before turning the SmartKey in the starter switch.

Hold on to the wiper when folding the wiper arm back. If released, the force of the impact from the tensioning spring could crack the windshield.

Window cleaning

- Fold wiper arm forward until it snaps into place.

Warning!

For safety reasons, switch off wipers and remove SmartKey from starter switch (vehicles with KEYLESS-GO*: make sure the vehicle's on-board electronics have status 0) before cleaning the windshield. Otherwise, the wiper motor could suddenly turn on and cause injury.

- Use a window cleaning solution on all glass surfaces.
An automotive glass cleaner is recommended.



Fold the windshield wiper arms back onto the windshield before turning the SmartKey in the starter switch.

Hold on to the wiper when folding the wiper arm back. If released, the force of the impact from the tensioning spring could crack the windshield.

Light alloy wheels

Mercedes-Benz approved Wheel Care should be used for regular cleaning of the light alloy wheels.

If possible, clean wheels once a week with Mercedes-Benz approved Wheel Care, using a soft bristle brush and a strong spray of water.

Follow instructions on container.



Only use acid-free cleaning materials. Acid may cause corrosion or damage the clear coat.

Instrument cluster

Use a gentle dishwashing detergent or mild detergent for delicate fabrics as a washing solution. Wipe with a cloth moistened in lukewarm solution. Do not use scouring agents.

Steering wheel and gear selector lever

Wipe with a damp cloth and dry thoroughly or clean with Mercedes-Benz approved Leather Care.

Cup holder

Use a gentle dishwashing detergent or mild detergent for delicate fabrics as a washing solution. Wipe with a cloth moistened in lukewarm solution. Do not use scouring agents.

Hard plastic trim items

Pour Mercedes-Benz approved Interior Care onto soft lint-free cloth and apply with light pressure.

Operation

Vehicle care

Headliner and rear window shelf

Clean with soft bristle brush, or use a dry-shampoo cleaner in case of excessive dirt.

Seat belts

The webbing must not be treated with chemical cleaning agents. Only use clear, lukewarm water and soap. Do not dry the webbing at temperatures above 176°F (80°C) or in direct sunlight.

Warning!



Do not bleach or dye seat belts as this may severely weaken them. In a crash they may not be able to provide adequate protection.

Upholstery

Using aftermarket seat covers or wearing clothing that have the tendency to give off coloring (e.g. when wet, etc.) may cause the upholstery to become permanently discolored. By lining the seats with a proper intermediate cover, contact-discoloration will be prevented.

Leather upholstery

Wipe leather upholstery with a damp cloth and dry thoroughly or clean with Mercedes-Benz approved Leather Care. Exercise particular care when cleaning perforated leather as its underside should not become wet.

Nubuck leather upholstery (CLK 55 AMG)

The nubuck leather upholstery is treated with a protective coating. Wipe nubuck leather upholstery with damp microfiber cloth to remove dust and other light stains.

Carefully dab nubuck leather upholstery with a dry microfiber cloth to remove oil stains.



Do not use Mercedes-Benz approved Leather Care or any solvents to clean nubuck leather upholstery.

Avoid hard scrubbing on nubuck leather upholstery.

Plastic and rubber parts

Do not use oil or wax on these parts.

Wood trims

Dampen cloth using water and use damp cloth to clean wood trims in your vehicle. Do not use solvents like tar remover or wheel cleaner nor polishes or waxes as these may be abrasive.

Practical hints

What to do if ...?

Where will I find...?

Unlocking/locking in an emergency

Opening/closing in an emergency

Replacing bulbs

Replacing wiper blades

Flat tire

Battery

Jump starting

Towing the vehicle

Fuses

Practical hints

What to do if ...?

Lamps in instrument cluster

General information:



If any of the following lamps in the instrument cluster fails to come on during the

bulb self-check when switching on ignition, have the respective bulb checked and replaced if necessary.

Problem	Possible cause	Suggested solution
 The yellow ABS malfunction indicator lamp comes on while driving.	<p>The ABS has detected a malfunction and has switched off. The BAS and the ESP are also switched off (see messages in display).</p> <p>The brake system is still functioning normally but without the ABS available.</p>	<ul style="list-style-type: none">▶ Continue driving with added caution. Wheels will lock during hard braking, reducing steering capability.▶ Have the system checked at an authorized Mercedes-Benz Center as soon as possible. <p>Failure to follow these instructions increases the risk of an accident.</p> <ul style="list-style-type: none">▶ Read and observe messages in the display (▷ page 364).
	<p>The charging voltage has fallen below 10 volts. The ABS has switched off.</p>	<p>When the voltage is above this value again, the ABS is operational again.</p> <ul style="list-style-type: none">▶ If necessary, have the generator (alternator) and battery checked.

Practical hints

What to do if ...?

Problem		Possible cause	Suggested solution
BRAKE 	(USA only) (Canada only)	The red brake warning lamp comes on while driving and you hear a warning sound.	You are driving with the parking brake set. ► Release the parking brake (▷ page 49).
BRAKE 	(USA only) (Canada only)	The red brake warning lamp comes on while driving.	There is insufficient brake fluid in the reservoir. ► Risk of accident! Carefully stop the vehicle and notify an authorized Mercedes-Benz Center. Do not add brake fluid! This will not solve the problem.

Warning!



Driving with the brake warning lamp illuminated can result in an accident. Have your brake system checked immediately if the brake warning lamp stays on. Do not add brake fluid before checking the brake system.



Overfilling the brake fluid reservoir can result in spilling brake fluid on hot engine parts and the brake fluid catching fire. You can be seriously burned.



If you find that the brake fluid in the brake fluid reservoir has fallen to the minimum mark or below, have the brake system checked for brake pad thickness and leaks.



Practical hints

What to do if ...?

Problem		Possible cause	Suggested solution
 (USA only)  (Canada only)	The yellow engine malfunction indicator lamp comes on while driving.	There is a malfunction in: <ul style="list-style-type: none"> • The fuel management system • The ignition system • The emission control system • Systems which affect emissions Such malfunctions may result in excessive emissions values and may switch the engine to its Limp-Home Mode (emergency operation).	► Have the vehicle checked as soon as possible by an authorized Mercedes-Benz Center. An on-board diagnostic connector is used by the service station to link the vehicle to the shop diagnostics system. It allows the accurate identification of system malfunctions through the readout of diagnostic trouble codes. It is located in the front left area of the footwell next to the parking brake pedal.
		A loss of pressure has been detected in the fuel system. The fuel cap may not be closed properly or the fuel system may be leaky.	► Check the fuel cap (▷ page 305). If it is not closed properly: ► Close the fuel cap. If it is closed properly: ► Have the fuel system checked by an authorized Mercedes-Benz Center.
		Your fuel tank is empty.	► After refuelling, start, turn off, and restart the engine three or four times in succession. The Limp-Home mode is canceled. You do not need to have your vehicle checked.

Practical hints

What to do if ...?

Problem	Possible cause	Suggested solution
 <p>The red coolant warning lamp comes on when the engine is running.</p>	There is insufficient coolant in the reservoir.	▶ Add coolant to prevent engine from overheating (▷ page 313).
	If this warning lamp comes on frequently, there is a leak in the cooling system.	▶ Have the cooling system checked.
	If the coolant level is correct, the electric radiator fan may be broken.	▶ If the coolant temperature is below 257 °F (125 °C), you can continue driving to the nearest authorized Mercedes-Benz Center. ▶ Avoid high engine loads (e.g. driving uphill) and stop-and-go driving.
 <p>The red coolant warning lamp comes on while driving and you hear a warning sound.</p>	The coolant temperature has exceeded 257 °F (125 °C).	▶ Stop as soon as possible and allow the engine and coolant to cool down.

Warning!





Driving when your engine is badly overheated can cause some fluids which may have leaked into the engine compartment to catch fire. You could be seriously burned.

Steam from an overheated engine can cause serious burns and can occur just by opening the hood. Stay away from the engine if you see or hear steam coming from it.

Turn off the engine, get out of the vehicle and do not stand near the vehicle until the engine has cooled down.



Practical hints

What to do if ...?

Problem	Possible cause	Suggested solution
 The yellow ESP warning lamp comes on while driving.	The ESP is deactivated. Risk of accident! Adapt your speed and driving to the prevailing road, weather and traffic conditions.	▶ Switch the ESP back on (▷ page 88). If the ESP cannot be switched back on, have the system checked at an authorized Mercedes-Benz Center as soon as possible.
 The yellow ESP warning lamp flashes while driving.	The ESP or traction control has come into operation because of detected traction loss in at least one tire.	▶ When driving off, apply as little throttle as possible. ▶ While driving, ease up on the accelerator. ▶ Adapt your speed and driving to the prevailing road, weather and traffic conditions. ▶ Do not deactivate the ESP. Exceptions: (▷ page 87). Failure to follow these instructions increases the risk of an accident.

Practical hints

What to do if ...?

Problem	Possible cause	Suggested solution
 The yellow fuel tank reserve warning lamp comes on while driving.	The fuel level has gone below the reserve mark.	▶ Refuel at the next gas station (▷ page 305).
 The red seat belt telltale illuminates for a brief period after starting the engine.	The seat belt telltale reminds you to fasten seat belts.	▶ Fasten your seat belt. The seat belt telltale goes out.
 The red seat belt telltale illuminates and a warning chime sounds for approximately six seconds after starting the engine.	The driver's seat belt is not fastened before the engine is started.	▶ Fasten the driver's seat belt. The seat belt telltale goes out.
SRS The red SRS indicator lamp comes on while driving.	There is a malfunction in the restraint systems. The air bags or emergency tensioning devices (ETDs) could deploy unexpectedly or fail to deploy in an accident.	▶ Drive with added caution to the nearest authorized Mercedes-Benz Center.

Warning!



In the event a malfunction of the SRS is indicated as outlined above, the SRS may not be operational. For your safety, we strongly recommend that you visit an authorized

Mercedes-Benz Center immediately to have the system checked; otherwise the SRS may not be deployed when needed in an accident, which could result in serious or fatal injury, or it might deploy unexpectedly and unnecessarily which could also result in an accident and /or injury to you or to others.

Practical hints

What to do if ...?

Lamp in center console

Problem	Possible cause	Suggested solution
 The front passenger front air bag off indicator lamp illuminates and remains illuminated with the weight of a typical adult or someone larger than a small individual on the front passenger seat.	The system is malfunctioning.	<ul style="list-style-type: none">▶ Have the system checked as soon as possible by an authorized Mercedes-Benz Center.▶ Also note any messages in the multi-function display and follow corrective steps (▷ page 368).

Warning!



If the  lamp illuminates and remains illuminated with the weight of a typical adult or someone larger than a small individual on the front passenger seat, do not have any passenger use the front passenger seat until the system has been repaired.

Practical hints

What to do if ...?

Problem	Possible cause	Suggested solution
 The front passenger front air bag off indicator lamp does not illuminate and/or does not remain illuminated with the weight of a typical 12-month-old child in a standard child restraint or less on the front passenger seat.	The system is malfunctioning.	<ul style="list-style-type: none">▶ Make sure that there is nothing between seat cushion and child seat and check installation of the child seat.▶ Make sure that no objects applying supplemental weight onto the seat are present.▶ If the front passenger front air bag off indicator lamp remains out, have the system checked as soon as possible by an authorized Mercedes-Benz Center. Do not transport a child on the front passenger seat until the system has been repaired.▶ Also note any messages in the multi-function display and follow corrective steps (▷ page 368).

Warning!



If the  indicator lamp does not illuminate or remains out with the

weight of a typical 12-month-old child in a standard child restraint or less on the front passenger seat, do not transport a child on the front passenger seat until the system has been repaired.

Practical hints

What to do if ...?

Vehicle status messages in the multifunction display





Warning and malfunction messages appear in the multifunction display located in the instrument cluster.





Certain warning and malfunction messages are accompanied by an audible signal.

Address these messages accordingly and follow the additional instructions given in this Operator's Manual.

Selecting the vehicle status message memory menu in the control system (▷ page 145) displays both cleared and uncleared messages.

High-priority messages appear in the multifunction display in red color.

Certain messages of high priority cannot be cleared from the multifunction display using the reset button (▷ page 134) or button , , , or  on the steering wheel.

Other messages of high priority and messages of less immediate priority can be cleared from the multifunction display using the reset button (▷ page 134) or button , , , or  on the steering wheel. They are then stored in the vehicle status message memory (▷ page 145). Remember that clearing a message will only make the message disappear. Clearing a message will not correct the condition that caused the message to appear.

Warning!



All categories of messages contain important information which should be taken note of and, where a malfunction is indicated, addressed as soon as possible at an authorized Mercedes-Benz Center.

Failure to repair condition noted may cause damage not covered by the Mercedes-Benz Limited Warranty, or result in property damage or personal injury.

Warning!



No messages will be displayed if either the instrument cluster or the multifunction display is inoperative.

Contact your nearest authorized Mercedes-Benz Center.



Switching on the ignition causes all instrument cluster lamps (except low beam headlamp indicator lamp, high beam headlamp indicator lamp, and turn signal indicator lamps unless activated) as well as the multifunction display to come on. Make sure the lamps and the multifunction display are in working order before starting your journey.

On the pages that follow, you will find a compilation of the most important warning and malfunction messages that may appear in the display.

For your convenience the messages are divided into two sections:

- Text messages (▷ page 364)
- Symbol messages (▷ page 373)

Practical hints

What to do if ...?

Text messages

Display	Display message	Possible cause	Possible solution
ABS	malfunction Visit workshop	<p>The ABS has detected a malfunction and has switched off. The ESP and the BAS are also deactivated.</p> <p>The brake system is still functioning normally but without the ABS available.</p>	<ul style="list-style-type: none">▶ Continue driving with added caution. Wheels will lock during hard braking, reducing steering capability.▶ Have the system checked at an authorized Mercedes-Benz Center as soon as possible. <p>Failure to follow these instructions increases the risk of an accident.</p>
	Display defective Visit workshop!	The ABS or the ABS display is malfunctioning.	<ul style="list-style-type: none">▶ Continue driving with added caution. Wheels will lock during hard braking, reducing steering capability.▶ Have the system checked at an authorized Mercedes-Benz Center as soon as possible. <p>Failure to follow these instructions increases the risk of an accident.</p>

Practical hints

What to do if ...?

Display	Display message	Possible cause	Possible solution
ABS	Anti-lock braking system not working!	<p>The charging voltage has fallen below 10 volts and the ABS has switched off.</p> <p>The brake system is still functioning normally but without the ABS available.</p>	<ul style="list-style-type: none">▶ When the voltage is above this value again, the ABS is operational again.▶ Continue driving with added caution. Wheels will lock during hard braking, reducing steering capability.▶ Have the system checked at an authorized Mercedes-Benz Center as soon as possible. <p>Failure to follow these instructions increases the risk of an accident.</p>

Practical hints

What to do if ...?

Display	Display message	Possible cause	Possible solution
BAS	malfunction Visit workshop	The BAS has detected a malfunction and switched off.	<ul style="list-style-type: none"> ▶ Continue driving with added caution. ▶ Have the system checked at an authorized Mercedes-Benz Center as soon as possible. <p>Failure to follow these instructions increases the risk of an accident.</p>
	Display defective Visit workshop!	BAS or the BAS display is malfunctioning.	<ul style="list-style-type: none"> ▶ Continue driving with added caution. ▶ Have the system checked at an authorized Mercedes-Benz Center as soon as possible. <p>Failure to follow these instructions increases the risk of an accident.</p>
	unavailable See Operator's Manual	<p>The charging voltage has fallen below 10 volts and the BAS has switched off.</p> <p>The brake system is still functioning normally but without the BAS available.</p>	<ul style="list-style-type: none"> ▶ When the voltage is above this value again, the BAS is operational again. ▶ Have the system checked at an authorized Mercedes-Benz Center as soon as possible. <p>Failure to follow these instructions increases the risk of an accident.</p>

Practical hints

What to do if ...?

Display	Display message	Possible cause	Possible solution
Cruise Control	Cruise control Drive to workshop	Cruise control is malfunctioning.	<ul style="list-style-type: none"> ▶ Have cruise control checked by an authorized Mercedes-Benz Center.
ESP	malfunction Visit workshop	The ESP was deactivated because of a malfunction or interrupted power supply. The ABS might not be operational.	<ul style="list-style-type: none"> ▶ Continue driving with added caution. ▶ Visit an authorized Mercedes-Benz Center as soon as possible. <p>Failure to follow these instructions increases the risk of an accident.</p>
	Display defective Visit workshop!	The ESP or the ESP display is malfunctioning.	<ul style="list-style-type: none"> ▶ Continue driving with added caution. ▶ Visit an authorized Mercedes-Benz Center as soon as possible. <p>Failure to follow these instructions increases the risk of an accident.</p>
	unavailable See Operator's Manual	The charging voltage has fallen below 10 volts and the ESP has switched off.	<p>When the voltage is above this value again, the ESP is operational again.</p> <ul style="list-style-type: none"> ▶ If necessary, have the generator (alternator) and battery checked.
		The self-diagnosis has not been completed.	The display will clear after driving a short distance at more than 12 mph (20 km/h).

Practical hints

What to do if ...?

Display	Display messages	Possible cause	Possible solution
	Front passenger airbag activated see Oper.'s Man.	Air bag is activated while driving even though a child, small individual, or object below the system's weight threshold is on the front passenger seat, or the front passenger seat is empty. Objects on the seat or forces acting on the seat may make the system sense supplemental weight.	Stop the vehicle in a safe location as soon as possible and check the following: <ul style="list-style-type: none">▶ Make sure that there is nothing between seat cushion and child seat and check installation of the child seat.▶ Make sure that no objects applying supplemental weight onto the seat are present. The system may recognize such supplemental weight and sense that an occupant on the front passenger seat is of a heavier weight than actually present. (Continued on next page)

Practical hints

What to do if ...?

Display	Display messages	Possible cause	Possible solution
	Front passenger airbag activated see Oper.'s Man.		<p>If performing any of the above corrective steps is successful, the message Front passenger airbag deactivated see Oper.'s Man. will appear in the multifunction display, confirming the situation has been remedied. Note that after performing the corrective steps, it may take up to 60 seconds for the message Front passenger airbag deactivated see Oper.'s Man. to appear.</p> <p>If the message Front passenger airbag activated see Oper.'s Man. remains on in the multifunction display and/or the  indicator lamp remains out even after performing the above corrective steps, have the system checked as soon as possible by an authorized Mercedes-Benz Center.</p>

Warning!



If the message Front passenger airbag activated see Oper.'s Man. remains

on in the multifunction display and/or the  indicator lamp remains out even after performing the above corrective steps,

do not have any children 12 years old and under and other small individuals use the front passenger seat until the system has been repaired.

Practical hints

What to do if ...?

Display	Display messages	Possible cause	Possible solution
	Front passenger airbag deactivated see Oper.'s Man.	Air bag is deactivated while driving even though an adult or someone larger than a small individual is occupying the front passenger seat. Forces acting on the seat may make the system sense a decrease in weight.	<p>Stop the vehicle in a safe location as soon as possible and check the following:</p> <ul style="list-style-type: none"> ▶ Do not lean on armrests or lift yourself up using handle over the door. This may make the system sense that an occupant of a lesser weight than actually present is on the front passenger seat. ▶ Re-position yourself. ▶ Sit properly belted in a nearly upright position with your back against the seat backrest. <p>If performing any of the above corrective steps is successful, the message Front passenger airbag activated see Oper.'s Man. will appear in the multifunction display, confirming the situation has been remedied.</p> <p>(Continued on next page)</p>

Practical hints

What to do if ...?

Display	Display messages	Possible cause	Possible solution
	Front passenger airbag deactivated see Oper.'s Man.		<p>Note that after performing the corrective steps, it may take up to 60 seconds for the message Front passenger airbag activated see Oper.'s Man. to appear.</p> <p>If the message Front passenger airbag deactivated see Oper.'s Man. remains on in the multifunction display and/or the  indicator lamp remains on even after performing the above corrective steps, have the system checked as soon as possible by an authorized Mercedes-Benz Center.</p> <p>Do not have any passenger use the front passenger seat until the system has been repaired.</p>

Warning!



If the message Front passenger airbag deactivated see Oper.'s Man. remains on in the multifunction display and/or

the  indicator lamp remains illuminated even after performing the above corrective steps, do not have any passenger use the front passenger seat until the system has been repaired.

Practical hints

What to do if ...?





Display	Display message	Possible cause	Possible solution
P	Selector lever in park position	You have turned off the engine with the KEYLESS-GO* start/stop button in gear selector lever position N and opened the driver's door. or You have attempted to switch off the engine with the KEYLESS-GO* start/stop button while the gear selector lever was in position R or D .	▶ Place the gear selector lever in position P .
	Please shift to P or N	You have attempted to start the engine with the KEYLESS-GO* start/stop button while the gear selector lever was in position R or D .	▶ Place the gear selector lever in position P or N .

Symbol messages

Display symbol	Display message	Possible cause	Possible solution
	Visit Workshop!	The battery is no longer charging. Possible causes: <ul style="list-style-type: none"> • broken poly-V-belt • alternator malfunctioning 	<ul style="list-style-type: none"> ▶ Stop immediately and check the poly-V-belt. If it is broken: <ul style="list-style-type: none"> ▶ Do not continue to drive. Otherwise the engine will overheat due to an inoperative water pump which may result in damage to the engine. Notify an authorized Mercedes-Benz Center. If it is intact: <ul style="list-style-type: none"> ▶ Drive immediately to the nearest authorized Mercedes-Benz Center.
	Undervoltage Charge battery	The battery has insufficient voltage.	<ul style="list-style-type: none"> ▶ Start the engine (> page 46).
	Undervoltage Switch off consumers	The battery has insufficient voltage.	<ul style="list-style-type: none"> ▶ Turn off unnecessary electrical consumers.

Practical hints

What to do if ...?

Display symbol	Display message	Possible cause	Possible solution
	Brake wear Visit workshop	The brake pads have reached their wear limit.	▶ Have the brake pads replaced as soon as possible.
 (USA only)  (Canada only)	Parking brake Release brake!	You are driving with the parking brake set.	▶ Release the parking brake (▷ page 49).
	Brake fluid Visit workshop	There is insufficient brake fluid in the reservoir.	▶ Risk of accident! Stop the vehicle and notify an authorized Mercedes-Benz Center. Do not add brake fluid! This will not solve the problem.

Warning!



Driving with this message displayed can result in an accident. Have your brake system checked immediately. Do not add brake fluid before checking the brake system. Overfilling the brake fluid reservoir can result in spilling brake fluid on hot engine parts and the brake fluid catching fire. You can be seriously burned.





If you find that the brake fluid in the brake fluid reservoir has fallen to the minimum mark or below, have the brake system checked for brake pad thickness and leaks.



Brake pad thickness must be visually checked by a qualified technician at the intervals specified in the Maintenance Booklet.

Practical hints

What to do if ...?

Display symbol	Display message	Possible cause	Possible solution
	Visit workshop!	There may be a malfunction in the <ul style="list-style-type: none">• fuel injection system• ignition system• exhaust system• fuel system	▶ Have the measuring system checked by an authorized Mercedes-Benz Center.
	Coolant Check level	The coolant level is too low.	▶ Add coolant (▷ page 313). ▶ If you have to add coolant frequently, have the cooling system checked by an authorized Mercedes-Benz Center.

Warning!



Do not spill antifreeze on hot engine parts. Antifreeze contains ethylene glycol which may burn if it comes into contact with hot engine parts. You can be seriously burned.



Do not ignore the low engine coolant level warning. Extended driving with the message and symbol displayed may cause serious engine damage not covered by the Mercedes-Benz Limited Warranty.

Do not drive without sufficient amount of coolant in the cooling system. The engine will overheat, causing major engine damage.

Practical hints

What to do if ...?

Display symbol	Display message	Possible cause	Possible solution
	Coolant Stop, engine off!	The coolant is too hot.	<ul style="list-style-type: none">▶ Stop the vehicle and turn off the engine.▶ Only start the engine again after the message disappears. You could otherwise damage the engine.

Warning!



Driving when your engine is badly overheated can cause some fluids which may have leaked into the engine compartment to catch fire. You could be seriously burned.

Steam from an overheated engine can cause serious burns and can occur just by opening the hood. Stay away from the engine if you see or hear steam coming from it.

Turn off the engine, get out of the vehicle and do not stand near the vehicle until the engine has cooled down.

During severe operating conditions and stop-and-go city traffic, the coolant temperature may rise close to 248°F (120°C).



The engine should not be operated with the coolant temperature above 248°F (120°C). Doing so may cause serious engine damage which is not covered by the Mercedes-Benz Limited Warranty.



Practical hints

What to do if ...?

Display symbol	Display message	Possible cause	Possible solution
	Coolant Stop, engine off!	The poly-V-belt could be broken.	<ul style="list-style-type: none">▶ Stop immediately and check the poly-V-belt. If it is broken: <ul style="list-style-type: none">▶ Do not continue to drive. Otherwise the engine will overheat due to an inoperative water pump which may result in damage to the engine. Notify an authorized Mercedes-Benz Center. If it is intact: <ul style="list-style-type: none">▶ Do not continue to drive the vehicle with this message displayed. Doing so could result in serious engine damage that is not covered by the Mercedes-Benz Limited Warranty.▶ Drive immediately to the nearest authorized Mercedes-Benz Center.
	Coolant Visit workshop!	The cooling fan for the coolant is malfunctioning.	<ul style="list-style-type: none">▶ Observe the coolant temperature display.▶ Have the fan replaced as soon as possible.

Practical hints

What to do if ...?

Display symbol	Display message	Possible cause	Possible solution
	Display malfunction Visit workshop	<p>The instrument cluster display is malfunctioning.</p> <p>The displays for several systems have malfunctioned. Some systems themselves may also have malfunctioned.</p>	<ul style="list-style-type: none"> ▶ Continue driving with added caution. ▶ Visit an authorized Mercedes-Benz Center as soon as possible. ▶ Have the electronic systems checked by an authorized Mercedes-Benz Center.
	Display defective Visit workshop!	<p>Certain electronic systems are unable to relay information to the control system. The following systems may have failed:</p> <ul style="list-style-type: none"> • Coolant temperature display • Tachometer • Cruise control display 	<ul style="list-style-type: none"> ▶ Have the electronic systems checked by an authorized Mercedes-Benz Center.
	Doors open!	You are attempting to drive with one or more doors open.	<ul style="list-style-type: none"> ▶ Close the doors.

Practical hints

What to do if ...?

Display symbol	Display message	Possible cause	Possible solution
	<p>USA only: Add 1 qt. engine oil at next refueling</p> <p>Canada only: Add 1 liter engine oil at next refueling</p>	The engine oil level is too low.	<ul style="list-style-type: none"> ▶ Add engine oil (▷ page 312) and check the engine oil level (▷ page 310).
	<p>Engine oil level Reduce oil level!</p>	You have added too much engine oil. There is a risk of damaging the engine or the catalytic converter.	<ul style="list-style-type: none"> ▶ Have oil siphoned or drained off. Observe all legal requirements with respect to its disposal.
	<p>Engine oil level Stop, engine off!</p>	There is no oil in the engine. There is a danger of engine damage.	<ul style="list-style-type: none"> ▶ Carefully bring the vehicle to a halt as soon as possible. ▶ Turn off the engine. ▶ Add engine oil (▷ page 312) and check the engine oil level (▷ page 310).

Practical hints

What to do if ...?

Display symbol	Display message	Possible cause	Possible solution
	Engine oil Visit workshop!	It may be that there is water in the engine oil.	▶ Have the engine oil checked.
	Engine oil level Visit workshop!	The engine oil has dropped to a critical level.	▶ Check the engine oil level (▷ page 310) and add oil as required (▷ page 312). ▶ If you must add engine oil frequently, have the engine checked for possible leaks.
		The measuring system is malfunctioning.	▶ Have the measuring system checked by an authorized Mercedes-Benz Center.

When the message Add 1 qt. engine oil at next refueling (Canada: 1 liter) appears while the engine is running and at operating temperature, the engine oil level has dropped to approximately the minimum level.

When this occurs, the warning will first come on intermittently and then stay on if the oil level drops further.



Visually check for oil leaks. If no obvious oil leaks are noted, drive to the nearest service station where the engine oil should be topped to the required level with an approved oil specified in the Factory Approved Service Products pamphlet.



The engine oil level warnings should not be ignored. Extended driving with the symbol displayed could result in serious engine damage that is not covered by the Mercedes-Benz Limited Warranty.



Practical hints

What to do if ...?

Display symbol	Display message	Possible cause	Possible solution
	Reserve fuel	The fuel level has dropped below the reserve mark.	▶ Refuel at the next gas station (▷ page 305).
	Hood open!	You are driving with the hood open.	▶ Close the hood (▷ page 309).
	Remove key	You have forgotten to remove the SmartKey.	▶ Remove the SmartKey from the starter switch.
	Replace key	No additional code available for SmartKey or SmartKey with KEYLESS-GO*	▶ Visit an authorized Mercedes-Benz Center as soon as possible.
	Key Check battery!	The SmartKey with KEYLESS-GO* batteries are discharged.	▶ Change the batteries (▷ page 402).
	Key not recognized!	The SmartKey with KEYLESS-GO* is not recognized while the engine is running because <ul style="list-style-type: none"> • the SmartKey is not in the vehicle • there is strong radio-frequency interference 	▶ Stop the vehicle as soon as it is safe to do so. ▶ Search for the SmartKey. Otherwise the vehicle cannot be centrally locked nor can the engine be started again after the engine has been stopped.
		The SmartKey with KEYLESS-GO* is momentarily not recognized.	▶ Change the position of the SmartKey in the vehicle. ▶ Operate the vehicle with the SmartKey in the starter switch if necessary.
	Keyless Go Check system	The KEYLESS-GO* system is malfunctioning.	▶ Visit an authorized Mercedes-Benz Center as soon as possible.

Practical hints

What to do if ...?

Display symbol	Display message	Possible cause	Possible solution
	Key recognized in vehicle!	A SmartKey with KEYLESS-GO* left in the vehicle was recognized while locking the vehicle from the outside.	▶ Take the SmartKey out of the vehicle.
	Key do not forget key	This display appears (for a maximum of 60 seconds) if the driver's door is opened with the engine shut off and no SmartKey in the starter switch. Message is only a reminder.	▶ Insert SmartKey in the starter switch. ▶ Take the SmartKey with KEYLESS-GO* with you when leaving the vehicle.
	3rd brake lamp	The high mounted brake lamp is malfunctioning.	▶ Visit an authorized Mercedes-Benz Center as soon as possible.
	Brake lamp Drive to workshop	Stop lamp illumination is delayed or lamp is permanently on.	▶ Visit an authorized Mercedes-Benz Center as soon as possible.
	Brake lamp, left	The left brake lamp is malfunctioning.	▶ Visit an authorized Mercedes-Benz Center as soon as possible.
	Brake lamp, right	The right brake lamp is malfunctioning.	▶ Visit an authorized Mercedes-Benz Center as soon as possible.
	Display malfunction Visit workshop	The display for the lamps or the system is malfunctioning.	▶ Visit an authorized Mercedes-Benz Center as soon as possible.
	Front foglamp, left	The left front fog lamp is malfunctioning.	▶ Replace the bulb as soon as possible.
	Front foglamp, right	The right front fog lamp is malfunctioning.	▶ Replace the bulb as soon as possible.

Practical hints

What to do if ...?

Display symbol	Display message	Possible cause	Possible solution
	High beam, left	The left high beam lamp is malfunctioning.	▶ Replace the bulb as soon as possible.
	High beam, right	The right high beam lamp is malfunctioning.	▶ Replace the bulb as soon as possible.
	Lamp sensor Drive to workshop	The lamp sensor is malfunctioning. The headlamps switch on automatically.	<ul style="list-style-type: none"> ▶ In the control system, set lamp operation to manual (▷ page 155). ▶ Switch on headlamps using the exterior lamp switch. ▶ Visit an authorized Mercedes-Benz Center as soon as possible.
	License plate lamp, left	The left license plate lamp is malfunctioning.	▶ Replace the bulb as soon as possible.
	License plate lamp, right	The right license plate lamp is malfunctioning.	▶ Replace the bulb as soon as possible.
	Low beam, left	The left low beam lamp is malfunctioning.	<p>Halogen headlamp:</p> <ul style="list-style-type: none"> ▶ Replace the bulb as soon as possible. <p>Bi-Xenon* headlamp:</p> <ul style="list-style-type: none"> ▶ Visit an authorized Mercedes-Benz Center as soon as possible.

Practical hints

What to do if ...?

Display symbol	Display message	Possible cause	Possible solution
	Low beam, right	The right low beam lamp is malfunctioning.	Halogen headlamp: ▶ Replace the bulb as soon as possible. Bi-Xenon* headlamp: ▶ Visit an authorized Mercedes-Benz Center as soon as possible.
	Parking lamp front left	The left front parking lamp is malfunctioning.	▶ Visit an authorized Mercedes-Benz Center as soon as possible.
	Parking lamp front right	The right front parking lamp is malfunctioning.	▶ Visit an authorized Mercedes-Benz Center as soon as possible.
	Rear foglamp back-up lamp on	The foglamp is malfunctioning. A back-up bulb is being used.	▶ Visit an authorized Mercedes-Benz Center as soon as possible.
	Reverse lamp, left	The left backup lamp is malfunctioning.	▶ Replace the bulb as soon as possible.
	Reverse lamp, right	The right backup lamp is malfunctioning.	▶ Replace the bulb as soon as possible.
	Side marker lamp front left	The front left side marker lamp is malfunctioning.	▶ Replace the bulb as soon as possible.
	Side marker lamp front right	The front right side marker lamp is malfunctioning.	▶ Replace the bulb as soon as possible.
Tail lamp left back-up lamp on	The left tail lamp is malfunctioning. A back-up bulb is being used.	▶ Visit an authorized Mercedes-Benz Center as soon as possible.	



Practical hints

What to do if ...?

Display symbol	Display message	Possible cause	Possible solution
	Tail lamp right back-up lamp on	The right tail lamp is malfunctioning. A back-up bulb is being used.	► Visit an authorized Mercedes-Benz Center as soon as possible.
	Turn off lamps!	Lamps have been turned on although the SmartKey in the starter switch is in position 0 .	► Turn off the headlamps.
	Turn signal, front left	The left front turn signal lamp is malfunctioning.	► Replace the bulb as soon as possible.
	Turn signal, front right	The right front turn signal lamp is malfunctioning.	► Replace the bulb as soon as possible.
	Turn signal, left mirror	The left turn signal in the side mirror is malfunctioning. This message will only appear if all light emitting diodes have stopped working.	► Have the LEDs replaced as soon as possible.
	Turn signal, right mirror	The right turn signal in the side mirror is malfunctioning. This message will only appear if all light emitting diodes have stopped working.	► Have the LEDs replaced as soon as possible.
	Turn signal rear left back-up lamp on	The left rear turn signal lamp is malfunctioning. A back-up bulb is being used.	► Replace the bulb as soon as possible.
	Turn signal rear right back-up lamp on	The right rear turn signal lamp is malfunctioning. A back-up bulb is being used.	► Replace the bulb as soon as possible.

Practical hints

What to do if ...?

Display symbol	Display message	Possible cause	Possible solution
	Seat belt system Drive to Workshop	The seat belt system is malfunctioning.	▶ Visit an authorized Mercedes-Benz Center as soon as possible.
	Tele Aid malfunction Drive to Workshop	One or more main functions of the Tele Aid system are malfunctioning.	▶ Have the Tele Aid system checked by an authorized Mercedes-Benz Center.
	Restraint system defective Drive to Workshop	The system is malfunctioning.	▶ Drive with added caution to the nearest authorized Mercedes-Benz Center.

Warning!



In the event a malfunction of the SRS is indicated as outlined above, the SRS may not be operational.

For your safety, we strongly recommend that you visit an authorized Mercedes-Benz Center immediately to have the system checked; otherwise the SRS may not be deploy when needed in an accident, which could result in serious or fatal injury, or it might deploy unexpectedly and unnecessarily which could also result in injury.

Practical hints

What to do if ...?

Display symbol	Display message	Possible cause	Possible solution
	Steering oil Visit workshop!	The steering gear oil level is too low. There is a danger of steering gear damage.	► Have the system checked by an authorized Mercedes-Benz Center.

Warning!









If the level of steering gear oil in reservoir is too low, the steering power assistance could fail. Much greater effort will then be needed to turn the steering wheel.

Do not add steering oil without checking the steering system.

Do not drive the vehicle. Have the system checked at an authorized Mercedes-Benz Center as soon as possible.

Practical hints

What to do if ...?

Display symbol	Display message	Possible cause	Possible solution
	Close sunroof!	You have opened the driver's door with the SmartKey removed from the starter switch and the tilt/sliding sunroof open.	▶ Close the tilt/sliding sunroof (▷ page 251).
	Close sunroof!	You have opened the driver's door with the SmartKey removed from the starter switch and the tilt/sliding sunroof open.	▶ Close the tilt/sliding sunroof (▷ page 251).
	Function Unavailable	This display appears if button  or  on the multifunction steering wheel is pressed and the vehicle is not equipped with a telephone.	
	Trunk open!	This message will appear whenever the trunk lid is open.	▶ Close the trunk lid.
	Washer fluid Check level	The fluid level has dropped to about $\frac{1}{3}$ of total reservoir capacity.	▶ Add washer fluid (▷ page 315).

▼ Where will I find...?

First aid kit

The first aid kit is located in the trunk on the left side secured by a hook and loop fastener.



- ▶ Loosen hook and loop fastener.
- ▶ Remove first aid kit.



Check expiration dates and contents for completeness at least once a year and replace missing/expired items.

Vehicle tool kit

The vehicle tool kit is located in the storage compartment underneath the trunk floor.

The following is included:

- Towing eye bolt
- Wheel wrench
- Alignment bolt
- Vehicle jack
- Spare wheel bolts
- Spare fuses
- Valve extractor (CLK 55 AMG only)
- Protective wrap (CLK 55 AMG only)
- Collapsible wheel chock
- A pair of gloves

Practical hints

Where will I find...?

Removing the vehicle tool kit (except CLK 55 AMG)

- ▶ Lift up trunk floor cover and engage trunk floor handle in upper edge of trunk.



- ① Retaining screw
- ② Storage well casing
- ▶ Loosen retaining screw ① in the middle of storage well casing by turning it counterclockwise.

- ▶ Remove storage well casing ②. ▷▷

Practical hints

Where will I find...?

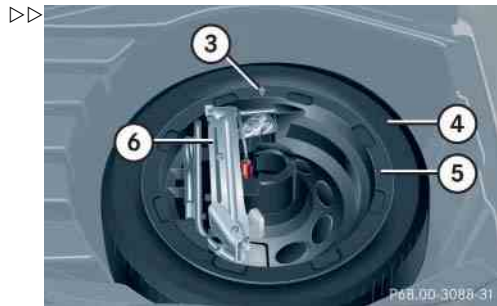

- ③ Arrow
- ④ Minispare wheel
- ⑤ Vehicle tool kit storage well casing
- ⑥ Vehicle tool kit

- ▶ Remove vehicle tool kit ⑥.

Storing the vehicle tool kit

- ▶ Place vehicle tool kit ⑥ in vehicle tool kit storage well casing ⑤.
- ▶ Place storage well casing ② over the vehicle tool kit storage well casing ⑤ and turn retaining screw ① clockwise as far it will go to secure the Minispare wheel.

- ▶ Disengage trunk floor handle in upper edge of trunk and lower trunk floor cover.



Arrow ③ on vehicle tool kit storage well casing ⑤ must point in the direction of travel. Otherwise you cannot place the storage well casing ② on top and secure the Minispare wheel with retaining screw ①.



To prevent damage, always disengage trunk floor handle from upper edge of trunk and lower trunk floor before closing the trunk lid.

Removing the vehicle tool kit (CLK 55 AMG only)

- ▶ Lift up trunk floor cover and engage trunk floor handle in upper edge of trunk.

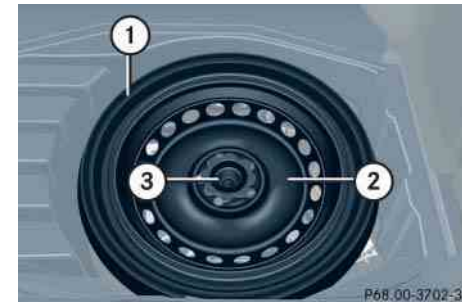

- ① Collapsible tire
- ② Vehicle tool kit (under collapsible tire)
- ③ Retaining screw

- ▶ Loosen retaining screw ③ by turning it counterclockwise.
- ▶ Remove collapsible tire ①.
- ▶ Remove vehicle tool kit ②.

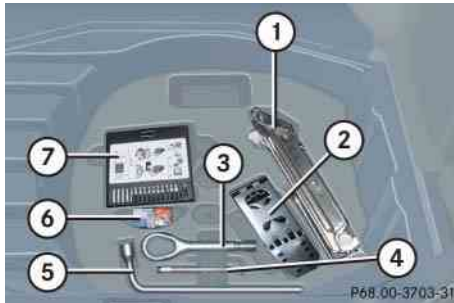

- ① Vehicle jack
- ② Collapsible wheel chock and spare wheel bolts
- ③ Towing eye bolt
- ④ Alignment bolt
- ⑤ Wheel wrench
- ⑥ Spare fuses and valve extractor
- ⑦ Electric air pump

Vehicle jack

Warning!



The jack is designed exclusively for jacking up the vehicle at the jack take-up brackets built into both sides of the vehicle. To help avoid personal injury, use the jack only to lift the vehicle during a wheel change. Never get beneath the vehicle while it is supported by the jack. Keep hands and feet away from the area under the lifted vehicle. Always firmly set parking brake and block wheels before raising vehicle with jack.

Do not disengage parking brake while the vehicle is raised. Be certain that the jack is always vertical (plumb line) when in use, especially on hills. Always try to use the jack on level surface. Make sure the jack arm is fully seated in the jack take-up bracket. Always lower the vehicle onto sufficient capacity jackstands before working under the vehicle.

Practical hints

Where will I find...?

The vehicle jack is located in the storage compartment underneath the trunk floor.

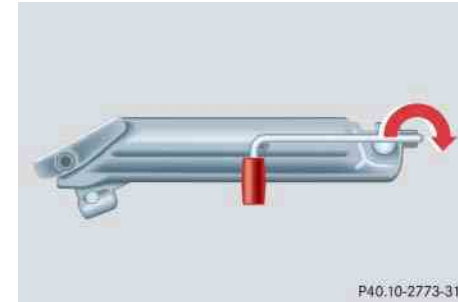

Storage position

- ▶ Remove vehicle jack from its compartment.
- ▶ Push crank handle up.

Practical hints

Where will I find...?

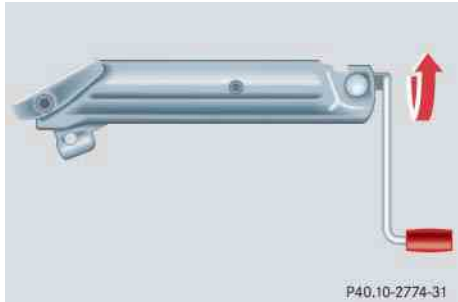

Operational position

- ▶ Turn crank handle clockwise until it engages (operational position).

Before storing the vehicle jack in its compartment:

- It should be fully collapsed.
- The handle must be folded in (storage position).

Setting up the collapsible wheel chock

The collapsible wheel chock serves to additionally secure the vehicle, e.g. while changing the wheel.

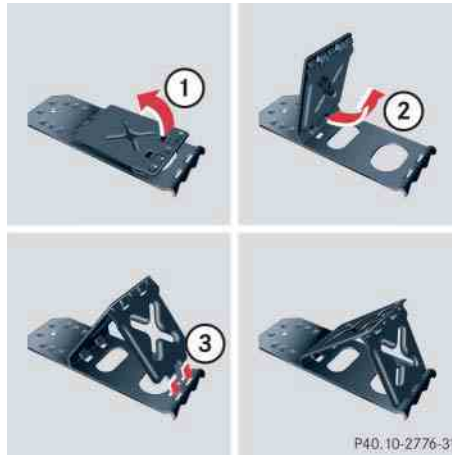

- ① Tilt the plate upward
- ② Fold the lower plate outward
- ③ Insert the plate

- ▶ Tilt both plates upward ①.
- ▶ Fold the lower plate outward ②.
- ▶ Guide the tabs of the lower plate all the way into the openings of the base plate ③.

Minispare wheel (except CLK 55 AMG)

The Minispare wheel is located in the storage compartment underneath the trunk floor.

Removing the Minispare wheel

- ▶ Lift up trunk floor cover and engage trunk floor handle in upper edge of trunk.
- ▶ Loosen the retaining screw in the middle of storage well casing by turning it counterclockwise (▷ page 389).
- ▶ Remove the storage well casing (▷ page 389).

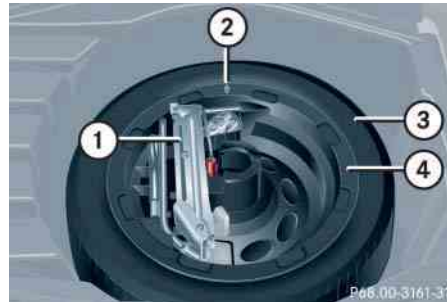

- ① Vehicle tool kit
 - ② Arrow
 - ③ Minispare wheel
 - ④ Vehicle tool kit storage well casing
- ▶ Remove vehicle tool kit storage well casing ④.
 - ▶ Remove Minispare wheel ③.

Practical hints

Where will I find...?

Storing the Minispare wheel

- ▶ Place Minispare wheel ③ in wheel well.
- ▶ Place vehicle tool kit storage well casing ④ over the Minispare wheel.

Make sure arrow ② on vehicle tool kit storage well casing ④ points in the direction of travel.

- ▶ Place storage well casing (▷ page 389) over vehicle tool kit storage well casing ④ and turn the retaining screw (▷ page 389) clockwise as far it will go to secure the Minispare wheel.



Arrow ② on vehicle tool kit storage well casing ④ must point in the direction of travel. Otherwise you cannot place the storage well casing (▷ page 389) on top and secure the Minispare wheel with the retaining screw (▷ page 389).

Practical hints

Where will I find...?



To prevent damage, always disengage trunk floor handle from upper edge of trunk and lower trunk floor before closing the trunk lid.

Warning!



The dimensions of the Minispare wheel are different from those of the road wheels. As a result, the vehicle handling characteristics change when driving with a Minispare wheel mounted.

The Minispare wheel should only be used temporarily, and should be replaced with a regular road wheel as quickly as possible.

In the case of a flat tire, you may temporarily use the Minispare wheel when observing the following restrictions:

- Do not exceed a vehicle speed of 50 mph (80 km/h).
- Drive to the nearest tire repair facility to have the flat tire repaired or replaced as appropriate.
- Do not operate vehicle with more than one Minispare wheel mounted.

For more information, see “Rims and tires” (▷ page 439).

Collapsible tire (CLK 55 AMG only)

The collapsible tire is located in the storage compartment underneath the trunk floor.

Removing the collapsible tire

- ▶ Lift up trunk floor cover and engage trunk floor handle in upper edge of trunk.

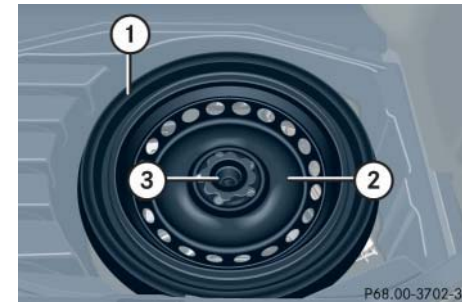

- ① Collapsible tire
- ② Vehicle tool kit (under collapsible tire)
- ③ Retaining screw

- ▶ Loosen retaining screw ③ by turning it counterclockwise.
- ▶ Remove collapsible tire ①.

Storing the collapsible tire

If you wish to store the collapsible tire after use, carry out the following steps. Otherwise the collapsible tire will not fit the storage compartment.



Make sure the collapsible tire is dry when storing it.

- ▶ Unscrew the valve cap from the valve of the collapsible tire.
- ▶ Take the valve extractor from the vehicle tool kit (▷ page 391).

- ▶ Unscrew the valve insert from the valve and allow the air to escape.



It may take a few minutes for the collapsible tire to deflate completely.

- ▶ Screw the valve insert back into the valve.
- ▶ Screw the valve cap back on the valve.
- ▶ Pull the protective wrap provided with the vehicle tool kit over the collapsible tire.
- ▶ Store the collapsible tire and the valve extractor in the storage compartment underneath the trunk floor.
- ▶ Pierce the protective wrap with retaining screw ③.
- ▶ Secure the collapsible tire by turning retaining screw ③ clockwise.

Practical hints

Where will I find...?



To prevent damage, always disengage trunk floor handle from upper edge of trunk and lower trunk floor before closing the trunk lid.

Warning!



The dimensions of the collapsible tire are different from those of the road wheels. As a result, the vehicle handling characteristics change when driving with a collapsible tire mounted.

The collapsible tire should only be used temporarily, and should be replaced with a regular road wheel as quickly as possible.

Practical hints

Where will I find...?

In the case of a flat tire, you may temporarily use the collapsible tire when observing the following restrictions:

- Do not exceed a vehicle speed of 50 mph (80 km/h).
- Drive to the nearest tire repair facility to have the flat tire repaired or replaced as appropriate.
- Do not operate vehicle with more than one collapsible tire mounted.

For more information, see “Rims and tires” (▷ page 439).

Spare wheel bolts

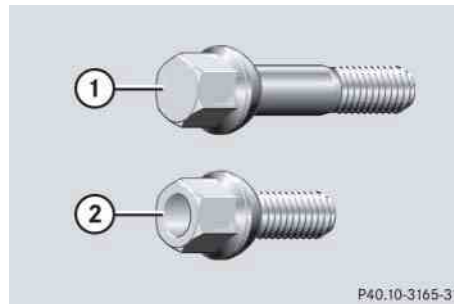

- ① Wheel bolt for light alloy rims
- ② Wheel bolt for Minispare wheel, collapsible tire, or other steel rims (located in trunk with spare wheel)



Wheel bolts ② must be used when mounting the Minispare wheel, collapsible tire, or other steel rims. The use of any wheel bolts other than wheel bolts ② for the Minispare wheel, collapsible tire, or other steel rims will physically damage the vehicle's brakes.

Warning!



Make sure to use the original length wheel bolts when remounting the original wheel after it has been repaired.

▼ **Unlocking/locking in an emergency**

Unlocking the vehicle

If you are unable to unlock the vehicle with the SmartKey or KEYLESS-GO*, open the driver's door and the trunk using the mechanical key.



Unlocking your vehicle with the mechanical key will trigger the anti-theft alarm system. To cancel the alarm, do one of the following:

- Press button or on the SmartKey.
- Insert the SmartKey in the starter switch.

Vehicles with KEYLESS-GO*

- Pull the outside door handle.
- Press the KEYLESS-GO* start/stop button (▷ page 35).



- ① Mechanical key locking tab
- ② Mechanical key

- ▶ Move locking tab ① in direction of arrow.
- ▶ Slide mechanical key ② out of the housing.

Unlocking the driver's door



- ① Unlocking

- ▶ Insert the mechanical key into the driver's door lock until it stops.
- ▶ Turn the mechanical key counterclockwise to position ①.

The driver's door is unlocked.

Practical hints

Unlocking/locking in an emergency

Unlocking the trunk

A minimum height clearance of 5.71 ft (1.74 m) is required to open the trunk lid.

The trunk lid lock is located next to the handle above the rear license plate recess.

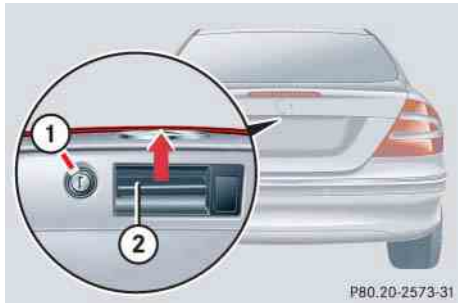

① Unlocking in an emergency

② Handle

- ▶ Insert the mechanical key into the trunk lid lock until it stops.
- ▶ Turn the mechanical key counterclockwise to position ① and hold it in this position.
- ▶ Pull the trunk lid handle ② and lift the trunk lid.

The trunk opens.



Always make sure there is sufficient overhead clearance.

- ▶ Turn the mechanical key back and remove it from the trunk lid lock.

Locking the vehicle

If you are unable to lock the vehicle with the SmartKey, do the following:

- ▶ Close the passenger door and the trunk lid.
- ▶ Press the central locking switch in the center console (▷ page 110).
- ▶ Check to see whether the locking knob on the passenger door have moved down.
- ▶ If necessary push it down manually.

Except for the driver's door, the vehicle should now be locked.

Practical hints

Unlocking/locking in an emergency



② Locking

- ▶ Insert the mechanical key into the driver's door lock until it stops.
- ▶ Turn the mechanical key clockwise to position ②.

The driver's door is locked.

Fuel filler flap

In case the central locking system does not release the fuel filler flap, you can open it manually.

Warning!



If you operate the emergency release button, be careful of the sharp edges so that you do not injure yourself.

The release button is on the right-hand side of the luggage compartment behind the side trim.

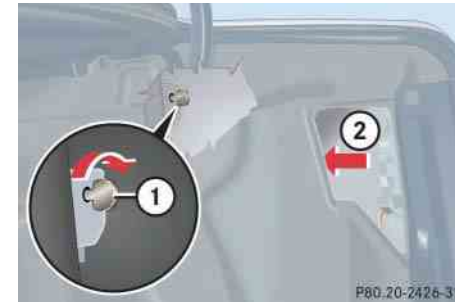

- ▶ Open trunk lid.
- ▶ Remove the side trim from the right-hand side of the luggage compartment.
- ▶ Reach inside through opening ② in direction of arrow.
- ▶ Turn release knob ① clockwise (arrow) as far as will go.
The fuel filler flap can be opened.
- ▶ Open the fuel filler flap from outside.

Practical hints

Unlocking/locking in an emergency

Manually unlocking the gear selector lever

In case of power failure, the gear selector lever can be manually unlocked, e.g. to tow the vehicle.

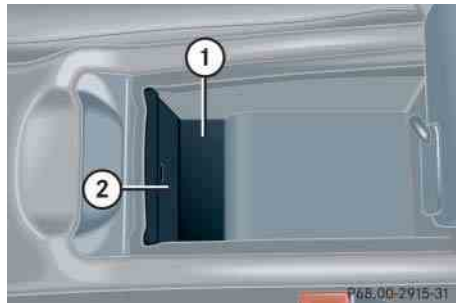

- ▶ Open the storage compartment under the center armrest (▷ page 273).
- ▶ Take out cover ①.
- ▶ Insert a pin into the opening of division ② and pry the division out.

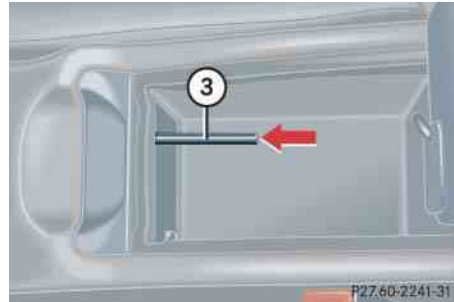

- ▶ Insert a tool ③ (e.g. flade blade screwdriver) into the opening.
- ▶ Perform the following two steps simultaneously:
 - ▶ Push pin ③ forward in the direction of the arrow.
 - ▶ Move gear selector lever from position **P**.
- ▶ Reinstall the division and cover after removing the tool from the opening.



The gear selector lever is locked again when moving it to position **P**.

▼ Opening/closing in an emergency

Power tilt/sliding sunroof*

You can open or close the tilt/sliding sunroof manually should an electrical malfunction occur.

The tilt/sliding sunroof drive is located behind the lens ① of the interior overhead light.



- ▶ Remove SmartKey from the starter switch.
- ▶ Pry off lens ① using a flat blade screwdriver.



- ▶ Slide both locking tabs ② in direction of arrows.
- ▶ Lower the rear of the cover and remove.
- ▶ Remove the cover.
- ▶ Take the crank ③ out of the Operator's Manual pouch.



Do not disconnect electrical connectors.

- ▶ Insert crank ③ through hole on the left side.

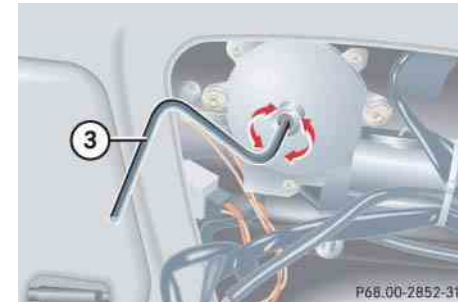

- ▶ Turn crank ③ clockwise to:
 - slide sunroof closed
 - raise sunroof at the rear
- ▶ Turn crank ③ counterclockwise to:
 - slide sunroof open
 - lower sunroof at the rear



Turn crank ③ slowly and smoothly.

The tilt/sliding sunroof must be synchronized after being operated manually (▷ page 254)

Practical hints

Replacing batteries in the SmartKey/SmartKey with KEYLESS-GO*

If the batteries in the SmartKey or the SmartKey with KEYLESS-GO* are discharged, the vehicle can no longer be locked or unlocked. It is recommended to have the batteries replaced at an authorized Mercedes-Benz Center.

Warning!



Keep the batteries out of reach of children.

If a battery is swallowed, seek medical help immediately.

Batteries contain materials that can harm the environment if disposed of improperly. Recycling of batteries is the preferred method of disposal. Many states require sellers of batteries to accept old batteries for recycling.



When inserting the batteries, make sure they are clean and free of lint.



When changing batteries, always replace both batteries.

The required replacement batteries are available at any Mercedes-Benz Center.

SmartKey

Replacement batteries: Lithium, type CR 2025 or equivalent.

- ▶ Remove mechanical key ① (▷ page 397).

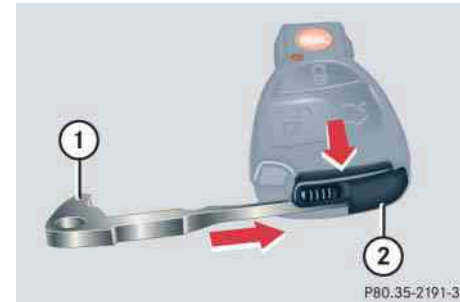

- ① Mechanical key
- ② Battery compartment

- ▶ Insert mechanical key ① in side opening and push gray slide. Battery compartment ② is unlatched.
- ▶ Pull battery compartment ② out of the SmartKey housing in direction of arrow.

Replacing batteries in the SmartKey/SmartKey with KEYLESS-GO*

- ▶ Remove the batteries.

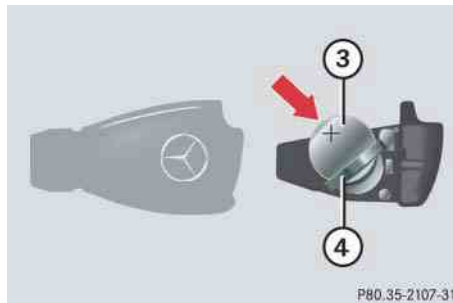

- ③ Battery
- ④ Contact spring

- ▶ Using a lint-free cloth, insert new batteries ③ under the contact spring ④ with the plus (+) side facing up.
- ▶ Return battery compartment ② into housing until it locks into place.
- ▶ Slide mechanical key ① back into the SmartKey.
- ▶ Check the operation of the SmartKey.

SmartKey with KEYLESS-GO*

Replacement batteries: Lithium, type CR 2025 or equivalent.

- ▶ Remove mechanical key (▷ page 397).
- ▶ Insert the mechanical key in side opening and push grey slide. The battery compartment is unlatched.
- ▶ Pull the battery compartment out of the SmartKey housing.

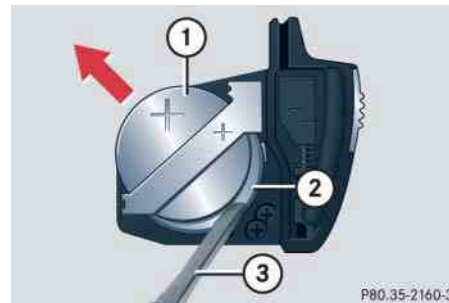

- ① Battery
- ② Tilt battery up
- ③ Mechanical key

- ▶ Using mechanical key ③, apply pressure to position ②. Battery ① tilts up slightly.
- ▶ Pull batteries ① out in direction of arrow.
- ▶ Using a lint-free cloth, insert new batteries ① with the plus (+) side facing up.
- ▶ Return battery compartment into housing until it locks into place.
- ▶ Slide mechanical key ③ back into the SmartKey.
- ▶ Check the operation of the SmartKey and the KEYLESS-GO*.

Practical hints

Replacing bulbs

Safe vehicle operation depends on proper exterior lighting and signaling. It is therefore essential that all bulbs and lamp assemblies are in good working order at all times.

Correct headlamp adjustment is extremely important. Have headlamps checked and readjusted at regular intervals and when a bulb has been replaced. See an authorized Mercedes-Benz Center for headlamp adjustment.



If the headlamps or front fog lamps are fogged up on the inside as a result of high humidity, driving the vehicle a distance with the lights on should clear up the fogging.



Back-up bulbs will be brought into use when lamps malfunction. Observe the messages in the multifunction display (▷ page 382).

Bulbs

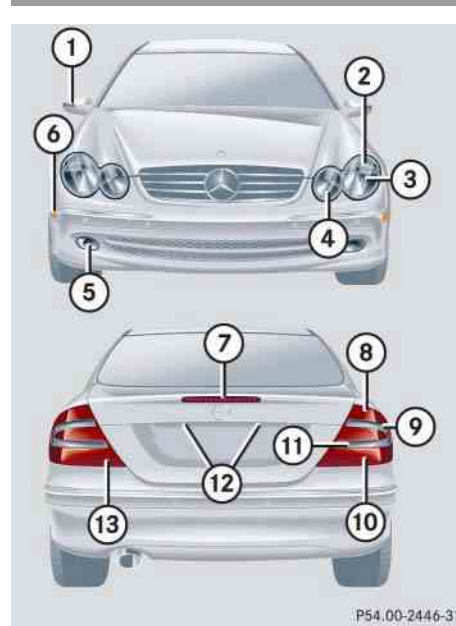

Front lamps

Lamp	Type
① Additional turn signal lamps	LED
② Turn signal lamp	1156 NA
③ Halogen headlamp: Low beam	H7 (55 W)
Bi-Xenon* headlamp: Low and high beam ¹	D2S-35 W
④ Halogen headlamp: High beam/high beam flasher	H7 (55 W)
Bi-Xenon* headlamp: High beam flasher	H7 (55 W)
Parking and standing lamps	W 5 W
⑤ Fog lamp	HB4 (51 W)
Cornering fog lamp*	H7 (55 W)
⑥ Side marker lamp	W 5 W

¹ Vehicles with Bi-Xenon headlamps* do not replace the Bi-Xenon bulbs yourself.

Rear lamps

Lamp	Type
⑦ High mounted brake lamp	LED
⑧ Brake lamp	P 21 W
⑨ Turn signal lamp	P 21 W
⑩ Tail, parking and standing lamp, side marker	P 21/4 W W 5 W
⑪ Backup lamp	P 21 W
⑫ License plate lamps	C 5 W
⑬ Rear fog lamp, driver's side	P 21/4 W

Warning!



Keep bulbs out of reach of children.

Bulbs and bulb sockets can be very hot. Allow the lamp to cool down before changing a bulb.

Halogen lamps contain pressurized gas. A bulb can explode if you:

- touch or move it when hot
- drop the bulb
- scratch the bulb

Wear eye and hand protection.

Because of high voltage in Xenon lamps, it is dangerous to replace the bulb or repair the lamp and its components. We recommend that you have such work done by a qualified technician.

Notes on bulb replacement

- Only use 12 volt bulbs of the same type and with the specified watt rating.
- Switch lights off before changing a bulb to prevent short circuits.
- Always use a clean lint-free cloth when handling bulbs.

Practical hints

Replacing bulbs

- Your hands should be dry and free of oil and grease.
- If the newly installed bulb does not come on, visit an authorized Mercedes-Benz Center.
- Have the LEDs and bulbs for the following lamps replaced by an authorized Mercedes-Benz Center.
 - Additional turn signal lamps in the exterior rear view mirrors
 - High mounted brake lamp
 - Bi-Xenon* lamps
 - Front fog lamps



Have the headlamp adjustment checked regularly.

Practical hints

Replacing bulbs

Replacing bulbs for front lamps

Before you start to replace a bulb for a front lamp, do the following first:

- ▶ Turn the exterior lamp switch to position **0** (▷ page 124).
- ▶ Open the hood (▷ page 308) (except for side marker lamps).

Front lamps halogen-type

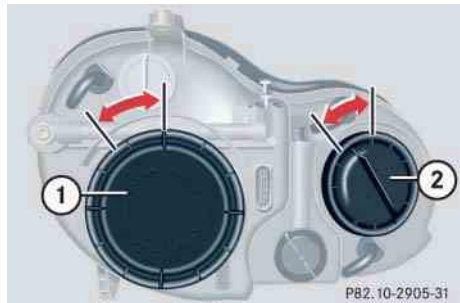

- ① Housing cover for low beam headlamp
- ② Housing cover for high beam headlamp, parking and standing lamp

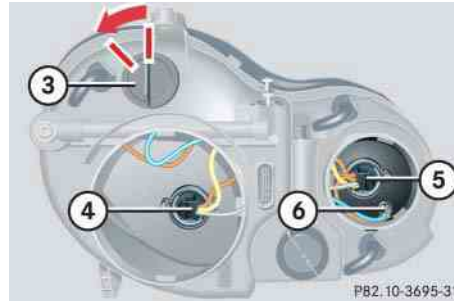

- ③ Bulb socket for turn signal lamp bulb
- ④ Bulb holder of low beam bulb
- ⑤ Bulb holder of high beam bulb
- ⑥ Bulb socket for parking and standing lamp bulb

Low beam bulb

- ▶ Turn housing cover ① counterclockwise and remove it.
- ▶ Turn bulb holder ④ with the bulb counterclockwise and remove it.
- ▶ Pull the bulb at its socket out of bulb holder ④.
- ▶ Insert the new bulb so that its socket locates in the recess of bulb holder ④ and is level to it.
- ▶ Reinsert bulb holder ④ with the bulb in the lamp and turn clockwise.
- ▶ Align housing cover ① and turn it clockwise.

Practical hints

Replacing bulbs

High beam bulb

- ▶ Turn housing cover ② counterclockwise and remove it.
- ▶ Turn bulb holder ⑤ with the bulb counterclockwise and remove it.
- ▶ Pull the bulb at its socket out of bulb holder ⑤.
- ▶ Insert the new bulb so that its socket locates in the recess of bulb holder ⑤ and is level to it.
- ▶ Reinsert bulb holder ⑤ with the bulb in the lamp and turn clockwise.
- ▶ Align housing cover ② and turn it clockwise.

Front turn signal lamp bulb

- ▶ Turn bulb socket ③ counterclockwise and remove it.
- ▶ Press gently onto the bulb and turn counterclockwise out of bulb socket ③.
- ▶ Press the new bulb gently into bulb socket ③ and turn clockwise until it engages.
- ▶ Place bulb socket ③ back into the lamp and turn it clockwise.

Parking and standing lamp bulb

- ▶ Turn housing cover ② counterclockwise and remove it.
- ▶ Pull out bulb socket ⑥ with the bulb.
- ▶ Pull the bulb out of the bulb socket ⑥.
- ▶ Press the new bulb into bulb socket ⑥.
- ▶ Press bulb socket ⑥ back into the lamp.
- ▶ Align housing cover ② and turn it clockwise.

Practical hints

Replacing bulbs

Front lamps Bi-Xenon*-type

Warning!



Do not remove the cover (3) for the Bi-Xenon* headlamp. Because of high voltage in xenon lamps, it is dangerous to replace the bulb or repair the lamp and its components. We recommend that you have such work done by a qualified technician.

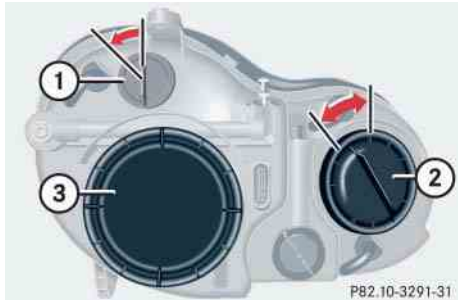

- ① Bulb socket for turn signal lamp
- ② Housing cover for high beam flasher, parking and standing lamp
- ③ Housing cover for Bi-Xenon* headlamp

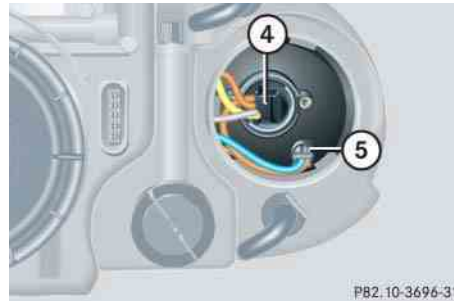

- ④ Bulb holder for high beam flasher bulb
- ⑤ Bulb socket for parking and standing lamp bulb

High beam bulb for high beam flasher

- ▶ Turn housing cover (2) counterclockwise and remove it.
- ▶ Turn bulb holder (4) with the bulb counterclockwise and remove it.
- ▶ Pull the bulb at its socket out of bulb holder (4).
- ▶ Insert the new bulb so that its socket locates in the recess of bulb holder (4) and is level to it.
- ▶ Reinsert bulb holder (4) with the bulb in the lamp and turn clockwise.
- ▶ Align housing cover (2) and turn it clockwise.

Practical hints

Replacing bulbs

Front turn signal lamp bulb

- ▶ Turn bulb socket ① counterclockwise and remove it.
- ▶ Press gently onto the bulb and turn counterclockwise out of bulb socket ①.
- ▶ Press the new bulb gently into bulb socket ① and turn clockwise until it engages.
- ▶ Place bulb socket ① back into the lamp and turn it clockwise.

Parking and standing lamp bulb

- ▶ Turn housing cover ② counterclockwise and remove it.
- ▶ Pull out bulb socket ⑤ with the bulb.
- ▶ Pull the bulb out of the bulb socket ⑤.
- ▶ Press the new bulb into bulb socket ⑤.
- ▶ Press bulb socket ⑤ back into the lamp.
- ▶ Align housing cover ② and turn it clockwise.

Side marker lamp bulb

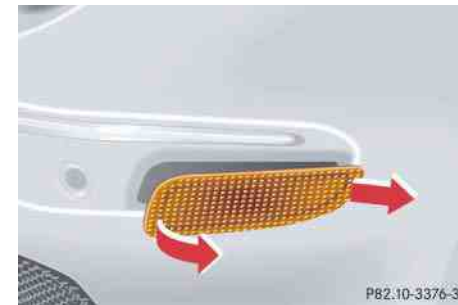

- ▶ Carefully slide the lamp towards the rear in direction of arrows.
- ▶ Remove front end first.
- ▶ Turn the bulb socket with the bulb counterclockwise and remove it.
- ▶ Pull the bulb out of the bulb socket.
- ▶ Insert the new bulb into the bulb socket.
- ▶ Place the bulb socket back into the lamp and turn it clockwise.
- ▶ To reinstall the lamp, set rear end in the bumper and let the front end engage.

Practical hints

Replacing bulbs

Replacing bulbs for rear lamps

Before you start to replace a bulb for a rear lamp, do the following first:

- ▶ Turn the exterior lamp switch to position **0** (▷ page 124).

Tail lamp unit

- ▶ Open trunk lid.
- ▶ Swing the trim panel covering the corresponding rear lights to the side.

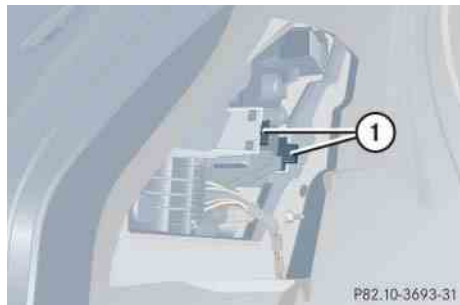

① Tab

- ▶ Press tabs ① together.
- ▶ Remove the bulb carrier.

- ▶ Press gently onto the respective bulb and turn counterclockwise out of its bulb socket.
- ▶ Press the new bulb gently into its bulb socket and turn clockwise until it engages.

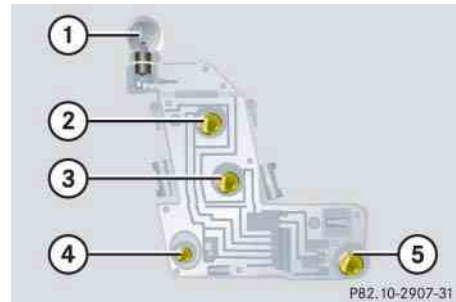

- ① Brake lamp
- ② Turn signal lamp
- ③ Backup lamp
- ④ Standing and side marker lamp
- ⑤ Rear fog lamp (driver's side)/tail

- ▶ Reinstall the bulb carrier.
Let tabs ① engage.
- ▶ Reinstall trim panel.

License plate lamp

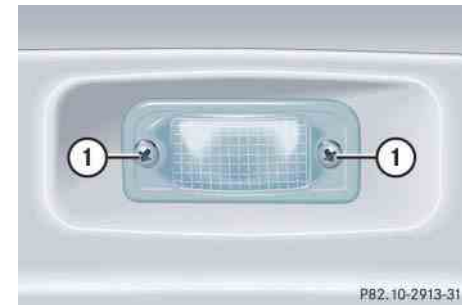

① Screws

- ▶ Loosen both screws ①.
- ▶ Remove the license plate lamp.
- ▶ Replace the tubular lamp.
- ▶ Reinstall the license plate lamp.
- ▶ Retighten the screws ①.

▼ Replacing wiper blades

Removing wiper blades

Warning!



For safety reasons, switch off wipers and remove SmartKey from starter switch (vehicles with KEYLESS-GO*: make sure the vehicle's on-board electronics have status **0**) before replacing a wiper blade. Otherwise, the wiper motor could suddenly turn on and cause injury.

- ▶ Remove SmartKey from starter switch.
- ▶ Fold the wiper arm forward.

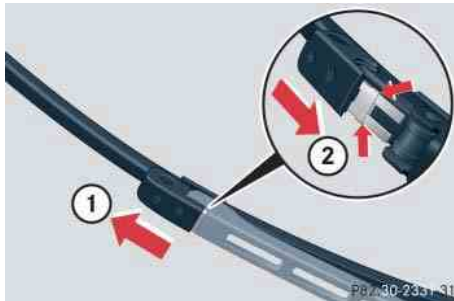

- ① Unlock
- ② Lock

- ▶ Pull the tab in direction of arrow ① and remove windshield wiper.

Installing wiper blades

- ▶ Slide the wiper blade into the cutout on the wiper arm (see arrows).
- ▶ Slide the tab back in the direction of arrow ② until it audibly engages.

Practical hints

Replacing wiper blades

- ▶ Fold the wiper arm backward to rest on the windshield. Make sure you hold on to the wiper when folding the wiper arm back.



Never open the hood when the wiper arms are folded forward.

Hold on to the wiper when folding the wiper arm back. If released, the force of the impact from the tensioning spring could crack the windshield.

Do not allow the wiper arms to contact the windshield glass without a wiper blade inserted.

Make certain that the wiper blades are properly installed. Improperly installed wiper blades may cause windshield damage.

For your convenience, we recommend that you have this work carried out by an authorized Mercedes-Benz Center.

Practical hints

Flat tire

Warning!



The dimensions of the spare wheel (Minispare or collapsible tire) are different from those of the road wheels. As a result, the vehicle handling characteristics change when driving with a spare wheel mounted. Adapt your driving style accordingly.

The spare wheel is for temporary use only. When driving with spare wheel mounted, ensure proper tire pressure and do not exceed a vehicle speed of 50 mph (80 km/h).

Drive to the nearest Mercedes-Benz Center as soon as possible to have the spare wheel replaced with a regular road wheel.

Never operate the vehicle with more than one spare wheel mounted.

Preparing the vehicle

- ▶ Park the vehicle as far as possible from moving traffic on a hard surface.
- ▶ Turn on the hazard warning flasher (▷ page 131).
- ▶ Turn the steering wheel so that the front wheels are in a straight ahead position.
- ▶ Set the parking brake (▷ page 55).
- ▶ Move the gear selector lever to **P**.

Vehicles with SmartKey:

- ▶ Turn off the engine (▷ page 56).
- ▶ Remove the SmartKey from the starter switch.

Vehicles with SmartKey with KEYLESS-GO*:

- ▶ Turn off the engine by pressing the KEYLESS-GO* start/stop button on the gear selector lever once (▷ page 57).
- ▶ Open the driver's door (this puts the ignition in position **0**, same as with the SmartKey removed from the starter switch). The driver's door then can be closed again.



Open door only when conditions are safe to do so.

- ▶ Have any passenger exit the vehicle at a safe distance from the roadway.

Mounting the spare wheel

Preparing the vehicle

Prepare the vehicle as described (▷ page 412).

Vehicles with Minispare wheel:

- ▶ Take the wheel wrench, the wheel bolts, and the jack out of the trunk (▷ page 389).
- ▶ Take the Minispare wheel out of the trunk (▷ page 393).

Vehicles with collapsible tire (CLK 55 AMG only):

- ▶ Take the collapsible tire, wheel wrench, wheel bolts, jack, and electric air pump out of the trunk (▷ page 390).

Lifting the vehicle

- ▶ Prevent the vehicle from rolling away by blocking wheels with wheel chocks or other sizable objects.

One wheel chock is included with the vehicle tool kit (▷ page 389).

When changing wheel on a level surface:

- ▶ Place the wheel chock in front of and another sizable object behind the wheel that is diagonally opposite to the wheel being changed.

When changing wheel on a hill:

- ▶ Place the wheel chock and another sizable object on the downhill side blocking both wheels of the other axle.

Practical hints

Flat tire

Warning!



The jack is designed exclusively for jacking up the vehicle at the jack take-up brackets built into both sides of the vehicle. To help avoid personal injury, use the jack only to lift the vehicle during a wheel change. Never get beneath the vehicle while it is supported by the jack. Keep hands and feet away from the area under the lifted vehicle. Always firmly set parking brake and block wheels before raising vehicle with jack.

Do not disengage parking brake while the vehicle is raised. Be certain that the jack is always vertical (plumb line) when in use, especially on hills. Always try to use the jack on level surface. Make sure the jack arm is fully seated in the jack take-up bracket. Always lower the vehicle onto sufficient capacity jackstands before working under the vehicle.

Practical hints

Flat tire

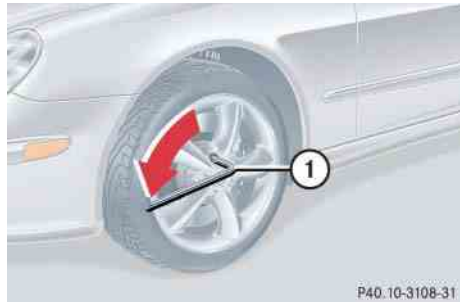

① Wheel wrench

- ▶ On wheel to be changed, loosen but do not yet remove the wheel bolts (approximately one full turn with wrench ①).

The jack take-up brackets are located directly behind the front wheel housings and in front of the rear wheel housings.



② Jack

③ Take-up bracket

- ▶ Place jack ② on firm ground.
- ▶ Position jack ② under take-up bracket ③ so that it is always vertical (plumb-line) as seen from the side, even if the vehicle is parked on an incline.

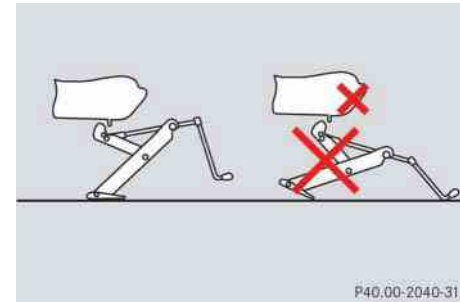

- ▶ Jack up the vehicle until the wheel is a maximum of 1.2 in (3 cm) from the ground. Never start engine while vehicle is raised.

Warning!



The jack is intended only for lifting the vehicle briefly for wheel changes. It is not suited for performing maintenance work under the vehicle.

- Never start the engine when the vehicle is raised.
- Never lie down under the raised vehicle.

Practical hints

Flat tire

Removing the wheel



① Alignment bolt

- ▶ Unscrew upper-most wheel bolt and remove.
- ▶ Replace this wheel bolt with alignment bolt ① supplied in the tool kit.
- ▶ Remove the remaining bolts.



Do not place wheel bolts in sand or dirt. This could result in damage to the bolts and wheel hub threads.

- ▶ Remove the wheel.

Mounting the spare wheel

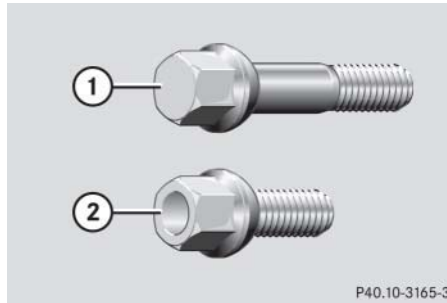

- ① Wheel bolt for light alloy rims
- ② Wheel bolt for Minispare wheel, collapsible tire, or other steel rims (located in trunk with spare wheel)



Wheel bolts ② must be used when mounting the Minispare wheel, collapsible tire, or other steel rims. The use of any wheel bolts other than wheel bolts ② for the Minispare wheel, collapsible tire, or other steel rims will physically damage the vehicle's brakes.

- ▶ Clean contact surfaces of wheel and wheel hub.



To avoid paint damage, place wheel flat against hub and hold it there while installing first wheel bolt.

Warning!



Always replace wheel bolts that are damaged or rusted.

Never apply oil or grease to wheel bolts.

Damaged wheel hub threads should be repaired immediately. Do not continue to drive under these circumstances! Contact an authorized Mercedes-Benz Center or call Roadside Assistance.

Incorrect wheel bolts or improperly tightened wheel bolts can cause the wheel to come off. This could cause an accident. Make sure to use the correct wheel bolts.

Practical hints

Flat tire



- ▶ Guide spare wheel onto the alignment bolt and push it on.
- ▶ Insert wheel bolts and tighten them slightly.

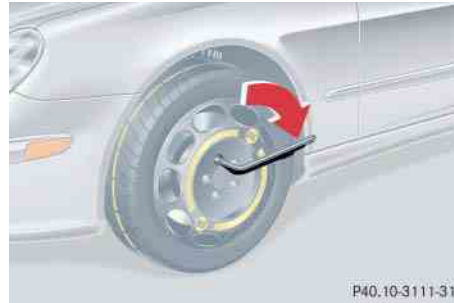

- ▶ Unscrew the alignment bolt, install last wheel bolt and tighten slightly.

Warning!



Only use genuine equipment Mercedes-Benz wheel bolts. Other wheel bolts may come loose.

Do not tighten the wheel bolts when the vehicle is raised. Otherwise the vehicle could fall off the jack.

Inflating the collapsible tire (CLK 55 AMG only)

Warning!



Vehicles with collapsible tire (CLK 55 AMG only):

Inflate collapsible tire only after the wheel is properly mounted.

Inflate the collapsible tire using the electric pump (▷ page 416) before lowering the vehicle.

Warning!



Observe instructions on air pump label.



Do not lower the vehicle before inflating the collapsible tire. Otherwise the rim may be damaged.

Practical hints

Flat tire

- ▶ Take the electric air pump out of the trunk (▷ page 391).

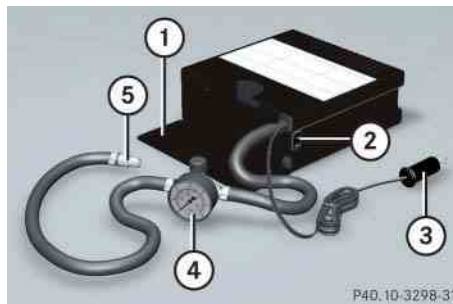

- ① Flap
 - ② On/off switch
 - ③ Electrical plug
 - ④ Air hose with pressure gauge and vent screw
 - ⑤ Union nut
- ▶ Open flap ① on electric air pump.
 - ▶ Pull out electrical plug ③ and air hose with pressure gauge ④.
 - ▶ Remove the valve cap from the collapsible tire valve.

- ▶ Screw air hose ④ onto the collapsible tire valve.
 - ▶ Insert electrical plug ③ into vehicle cigarette lighter socket.
 - ▶ Turn the SmartKey in the starter switch to position 1.
 - ▶ Press I on electric air pump switch ②.
- The electric air pump should now switch on and inflate the collapsible tire.
- ▶ Inflate the tire to approximately 36 psi (2.5 bar).

This takes about five minutes for the collapsible tire. Air hose ④ and union nut ⑤ can become hot during inflation. Exercise proper caution to avoid burning yourself when using the equipment.



Do not operate the electric air pump longer than six minutes without interruption. Otherwise it may overheat.

You may operate the electric air pump again after it has cooled off.

- ▶ Press 0 on electric air pump switch ②.
- ▶ Turn the SmartKey in the starter switch to position 0.
- ▶ If the tire pressure is above 36 psi (2.5 bar), release excess tire pressure using the vent screw. ▷▷

Practical hints

Flat tire



Warning!



Follow recommend inflation pressures.

Do not overinflate tires. Overinflating tires can result in sudden deflation (blowout) because they are more likely to become punctured or damaged by road debris, potholes, etc.

Do not underinflate tires. Underinflated tires wear unevenly, adversely affect handling and fuel economy, and are more likely to fail from being overheated.

- ▶ Detach the electric air pump.
- ▶ Store the electrical plug and the air hose behind the flap and place the electric air pump back in the trunk.

Lowering the vehicle

Warning!



Vehicles with collapsible tire (CLK 55 AMG only):

Inflate collapsible tire only after the wheel is properly mounted.

Inflate the collapsible tire using the electric pump (▶ page 416) before lowering the vehicle.

- ▶ Lower vehicle by turning crank counterclockwise until vehicle is resting fully on its own weight.
- ▶ Remove the jack.

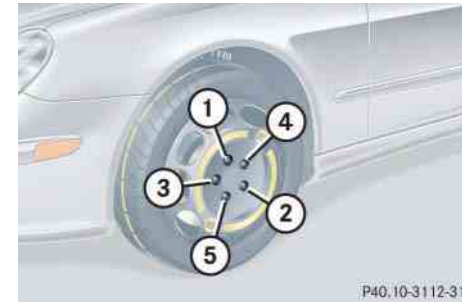

① - ⑤ Wheel bolts

- ▶ Tighten the five wheel bolts evenly, following the diagonal sequence illustrated (① to ⑤), until all bolts are tight. Observe a tightening torque of 80 lb-ft (110 Nm).

Warning!



Have the tightening torque checked after changing a wheel. The wheels could come loose if they are not tightened to a torque of 80 lb-ft (110 Nm).

Before storing the jack, it should be fully collapsed, with handle folded in (storage position) (▷ page 391).

- ▶ Store the jack and the other vehicle tools in the trunk.

Practical hints

Battery

The battery is located in the engine compartment on the right hand side.

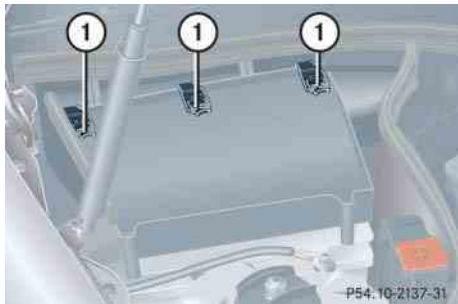

① Clamps

Removing filter box:

- ▶ Release clamps ①.
- ▶ Remove filter box.

Installing filter box:

- ▶ Insert filter box properly.
- ▶ Secure it with clamps ①.

Warning!



Failure to follow these instructions can result in severe injury or death.

Observe all safety instructions and precautions when handling automotive batteries (> page 314).

Never lean over batteries while connecting, you might get injured.

Battery fluid contains sulfuric acid. Do not allow this fluid to come in contact with eyes, skin or clothing. In case it does, immediately flush affected area with water and seek medical help if necessary.

A battery will also produce hydrogen gas, which is flammable and explosive. Keep flames or sparks away from battery, avoid improper connection of jumper cables, smoking, etc.



Never loosen or detach battery terminal clamps while the engine is running or the SmartKey is in the starter switch. Otherwise the alternator and other electronic components could be severely damaged.

Have the battery checked regularly by an authorized Mercedes-Benz Center.

Refer to Maintenance Booklet for maintenance intervals or contact an authorized Mercedes-Benz Center for further information.

Warning!



Do not place metal objects on the battery as this could result in a short circuit.

Use leak-proof battery only to avoid the risk of acid burns in the event of an accident.

Warning!



With a disconnected battery

- you will no longer be able to turn the SmartKey in the starter switch and pressing the KEYLESS-GO* start/stop button on the gear selector lever will have no effect
- the gear selector lever will remain locked in position **P**

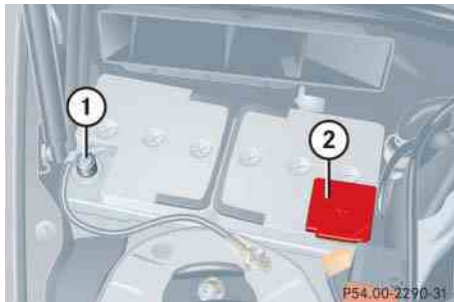

- ① Negative terminal
- ② Positive terminal cover

Disconnecting the battery

- ▶ Turn off the engine (▷ page 46).
 - ▶ Turn off all electrical consumers.
 - ▶ Remove SmartKey from starter switch.
- Vehicles with KEYLESS-GO*:
- ▶ Press the start/stop button until the engine shuts off.
 - ▶ Open the driver's door.
- ▶ Open the hood (▷ page 308).
 - ▶ Remove the filter box (▷ page 420).
 - ▶ Disconnect the battery negative lead from negative terminal ①.
 - ▶ Remove cover ② from the positive terminal.
 - ▶ Disconnect the battery positive lead.

Removing the battery

- ▶ Remove the screw securing the battery.
- ▶ Remove the battery support and bracket.
- ▶ Take out the battery.

Practical hints

Battery

Charging and reinstalling battery

Warning!



Never charge a battery while still installed in the vehicle. Gases may escape during charging and cause explosions that may result in paint damage, corrosion or personal injury.

- ▶ Charge battery in accordance with the instructions of the battery charger manufacturer.
- ▶ Reinstall the charged battery. Follow the previously described steps in reverse order.

Reconnecting the battery

- ▶ Turn off all electrical consumers.
- ▶ Remove SmartKey from starter switch.

Vehicles with KEYLESS-GO*:

- ▶ Press the start / stop button until the engine shuts off.
- ▶ Open the driver's door.
- ▶ Connect the battery positive lead and fasten its cover ②.
- ▶ Connect the battery negative lead.



NEVER invert the terminal connections!

- ▶ Reinstall the filter box (▷ page 420).



The battery, its filler caps and the vent tube must always be securely installed when the vehicle is in operation.



The following procedures must be carried out following any interruption of battery power (e.g. due to reconnecting):

- Set the clock (▷ page 151) (vehicles with COMAND*: see COMAND operator's manual).
- Resynchronize the side windows (▷ page 250).
- Resynchronize the tilt/sliding sunroof* (▷ page 254).

Batteries contain materials that can harm the environment if disposed of improperly. Large 12-volt storage batteries contain lead. Recycling of batteries is the preferred method of disposal. Many states require sellers of batteries to accept old batteries for recycling.

▼ Jump starting

Warning!



Failure to follow these directions will cause damage to the electronic components, and can lead to a battery explosion and severe injury or death.

Never lean over batteries while connecting or jump starting, you might get injured.

Battery fluid contains sulfuric acid. Do not allow this fluid to come in contact with eyes, skin or clothing. In case it does, immediately flush affected area with water, and seek medical help if necessary.

A battery will also produce hydrogen gas, which is flammable and very explosive. Keep flames or sparks away from battery, avoid improper connection of jumper cables, smoking, etc.

Attempting to jump start a frozen battery can result in it exploding, causing personal injury.

Read all instructions before proceeding.

If the battery is discharged, the engine can be started with jumper cables and the battery of another vehicle. Observe the following:

- Jump starting should only be performed when the engine and catalytic converter are cold.
- Do not start the engine if the battery is frozen. Let the battery thaw out first.
- Only jump start from batteries with the same voltage rating (12 V). Jump starting with a more powerful battery could damage the vehicle's electrical system, which will not be covered by the Mercedes-Benz Limited Warranty.
- Only use jumper cables with sufficient cross-section and insulated terminal clamps.
- Always make sure the jumper cables are not on or near pulleys, fans or other parts that move when an engine is started or running.

Practical hints

Jump starting



Avoid repeated and lengthy starting attempts.

Do not attempt to start the engine using a battery quick charge unit.

If the engine does not run after several unsuccessful starting attempts, have it checked at the nearest authorized Mercedes-Benz Center.

Excessive unburned fuel generated by repeated failed starting attempts may damage the catalytic converter and may present a fire risk.

Make sure the jumper cables do not have loose or missing insulation.

Make sure the cable clamps do not touch any other metal part while the other end is still attached to a battery.

Practical hints

Jump starting

Warning!



Keep flames or sparks away from battery. Do not smoke.

Observe all safety instructions and precautions when handling automotive batteries (▷ page 314).

The battery is located on the right side of the engine compartment. For jump starting use the terminals in front of the battery.

- ▶ Make sure the two vehicles do not touch.
- ▶ Turn off all electrical consumers.
- ▶ Apply parking brake.
- ▶ Shift gear selector lever to position **P**.
- ▶ Open the hood.

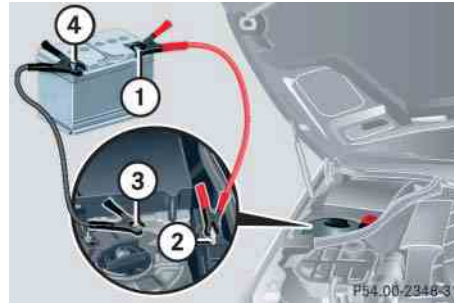

- ① Positive terminal of charged battery
 - ② Positive under hood terminal in front of discharged battery
 - ③ Negative under hood terminal in front of discharged battery
 - ④ Negative terminal of charged battery
- ▶ Connect the positive terminal ① of the charged battery with the positive under hood terminal ② in front of the discharged battery. Clamp cable to charged battery ① first.



Never invert the terminal connections.

- ▶ Start engine of the vehicle with the charged battery and run at idle speed.
- ▶ Connect the negative terminal ④ of the charged battery with the negative under hood terminal ③ in front of the discharged battery with the jumper cable. Clamp cable to charged battery ④ first.
- ▶ Start the engine of the disabled vehicle.

You can now turn on the electrical consumers. Do not turn on the lights under any circumstances.

- ▶ Remove the jumper cables first from the negative terminals ③ and ④ and then from the positive terminals ① and ②.

You can now turn on the lights.

- ▶ Have the battery checked at the nearest authorized Mercedes-Benz Center.



Do not tow-start the vehicle.

▼ Towing the vehicle

Towing the vehicle

Mercedes-Benz recommends that the vehicle be transported with all wheels off the ground using flatbed or appropriate wheel lift/dolly equipment.



Use flatbed or wheel lift/dolly equipment with SmartKey in starter switch turned to position **0**.

Do not tow with sling-type equipment. Towing with sling-type equipment over bumpy roads will damage radiator and supports.

To prevent damage during transport, do not tie down vehicle by its chassis or suspension parts.

Switch off the tow-away alarm (▷ page 91) and the automatic central locking (▷ page 158).

When circumstances do not permit the recommended towing methods, the vehicle may be towed with all wheels on the ground or front wheels raised only so far as necessary to have the vehicle moved to a safe location where the recommended towing methods can be employed.



If the vehicle is towed with the front axle raised, the engine must be shut off (SmartKey in starter switch position **0** or **1**). Otherwise, the ESP will immediately be engaged and will apply the rear wheel brakes.

When towing the vehicle with all wheels on the ground, the selector lever must be in position **N** and the SmartKey must be in starter switch position **2**.

When towing the vehicle with all wheels on the ground or the front axle raised, the vehicle may be towed only for distances up to 30 miles (50 km) and at a speed not to exceed 30 mph (50 km/h).

Practical hints

Towing the vehicle



To be certain to avoid a possibility of damage to the transmission, however, we recommend the drive shaft be disconnected at the rear axle drive flange for any towing beyond a short tow to a nearby garage.

Practical hints

Towing the vehicle

Warning!



Prior to towing the vehicle with all wheels on the ground, make certain that the SmartKey is in starter switch position **2**.

If the SmartKey is left in starter switch position **0** for an extended period of time, it can no longer be turned in the switch. In this case, the steering is locked. To unlock, remove SmartKey from starter switch and reinsert.

If circumstances require towing the vehicle with all wheels on the ground, always tow with a tow bar if:

- the engine will not run
- there is a malfunction in the power supply or in the vehicle's electrical system as that will be necessary to adequately control the towed vehicle.

Warning!



With the engine not running, there is no power assistance for the brake and steering systems. In this case, it is important to keep in mind that a considerably higher degree of effort is necessary to brake and steer the vehicle. Adapt your driving accordingly.



To signal turns while being towed with the hazard warning flasher in use, switch on ignition and activate the combination switch for the left or right turn signal in the usual manner – only the selected turn signal will operate.

Upon canceling the turn signal, the hazard warning flasher will operate again.



When towing the vehicle with all wheels on the ground, please note the following:

With the automatic central locking activated and the SmartKey in starter switch position **2**, or KEYLESS-GO* start/stop button in position **2**, the vehicle doors lock if the left front wheel as well as the right rear wheel are turning at vehicle speeds of approx. 9 mph (15 km/h) or more.

Switch off the tow-away alarm (▷ page 91).

To prevent the vehicle door locks from locking, deactivate the automatic central locking (▷ page 158).

Towing of the vehicle should only be done using the properly installed towing eye bolt. Never attach tow cable, tow rope or tow rod to the vehicle chassis, frame or suspension parts.



If the battery is disconnected or discharged

- the SmartKey will not turn in the starter switch. For more information, see “Battery” (▷ page 420) and “Jump starting” (▷ page 423).
- the gear selector lever will remain locked in position **P**. For information on manually unlocking the transmission gear selector lever see (▷ page 400).

Installing towing eye bolt

Towing eye bolt CLK 320/CLK 500

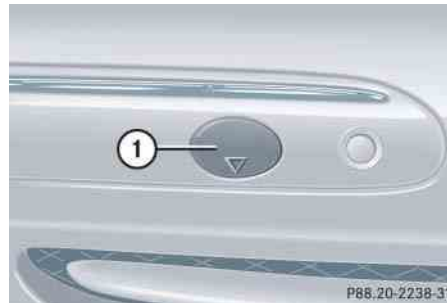

① Cover on right side of front bumper

Practical hints

Towing the vehicle

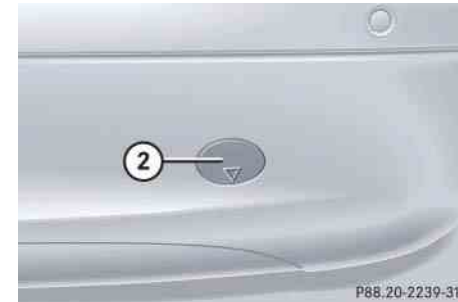

② Cover on right side of rear bumper

To remove cover:

- ▶ Press mark on cover in direction of arrow.
- ▶ Lift cover off to reveal threaded hole for towing eye bolt.

The towing eye bolt is supplied with the tool kit (located in the compartment underneath the trunk floor).

- ▶ Screw towing eye bolt to its stop and tighten with lug wrench.

To reinstall cover:

- ▶ Fit cover and snap into place.

Practical hints

Towing the vehicle

Towing eye bolt CLK 55 AMG

Towing eye bolt in front bumper

The cover for the towing eye bolt in the front bumper is identical to the cover on the models CLK320/CLK500.

To remove and to reinstall cover, see "Towing eye bolt CLK 320/CLK 500" (▷ page 427)

Towing eye bolt in rear bumper

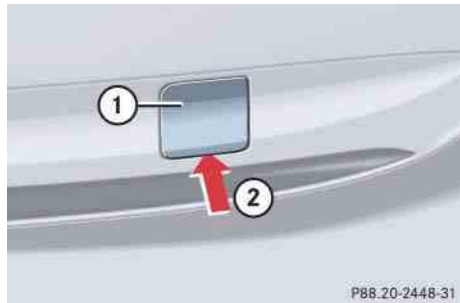

- ① Cover on right side of rear bumper
- ② Recess in the cover

To remove cover:

- ▶ Insert flat, blunt object as a lever in recess ② on the edge of cover ①.
- ▶ Loosen cover ① from the bumper using lever, to reveal threaded hole for towing eye bolt.

The towing eye bolt is supplied with the tool kit (located in the compartment underneath the trunk floor).

- ▶ Screw towing eye bolt to its stop and tighten with lug wrench.

To reinstall cover:

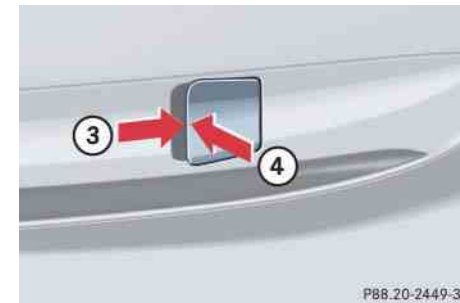

- ▶ Hook right-hand side of the cover into opening.
- ▶ Slide cover as far as it will go in the direction of the arrow ③.
- ▶ Gently press left-hand side of cover in direction of the arrow ④.

The hooks on the left-hand side engage.



When closing the cover, make sure the cover's check strap does not get caught.

▼ Fuses

The electrical fuses in your vehicle serve to stop the supply of electricity to a device that is malfunctioning. This helps to prevent damage to the other vehicle electronics.

The following aids are available to help you change fuses (▷ page 430):

- Fuse chart
- Spare fuses
- Fuse extractor

Warning!



Only use fuses approved for Mercedes-Benz with the specified amperage for the system in question. Otherwise, a short circuit could result and cause a fire.



Only install fuses that have been tested and approved by Mercedes-Benz and that have the specified amperage rating.

Otherwise, electrical parts or systems could be damaged.

Never attempt to repair or bridge a blown fuse. Have the cause determined and remedied by an authorized Mercedes-Benz Center.

Practical hints

Fuses

The electrical fuses are located in different fuse boxes:

- Main fuse box in passenger compartment (▷ page 430)
- Fuse box in engine compartment (▷ page 431)
- Fuse box in trunk (▷ page 432)

Practical hints

Fuses

Aids for changing fuses

Fuse chart

The fuse chart is found in the main fuse box in the passenger compartment (▷ page 430). The amperages of the fuses are also given there.

Spare fuses

Spare fuses are found in the vehicle tool kit in the spare wheel well (▷ page 390).

Fuse extractor

The fuse extractor is located in the cover of the auxiliary fuse box in the trunk (▷ page 432).

Main fuse box in passenger compartment

The main fuse box is located in the passenger compartment on the driver's side of the cockpit.



① Main fuse box cover

Opening

- ▶ Open the driver's door.
- ▶ Pull fuse box cover ① open with a screw driver or similar tool (see arrow).
- ▶ Remove fuse box cover ① rearward.

Closing

- ▶ Attach fuse box cover ① in the front.
- ▶ Fold fuse box cover ① in until it engages.

Fuse box in engine compartment

The fuse box is located in the engine compartment on the driver's side.

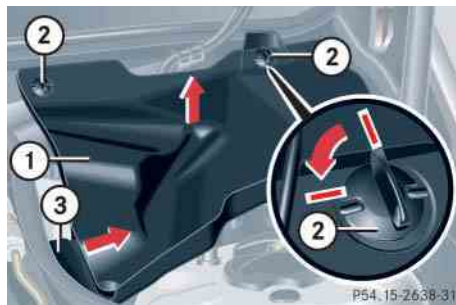

- ① Cover
- ② Screw
- ③ Retainer

Removing cover

- ▶ Twist screws ② 90° counterclockwise.
- ▶ Lift the rear of cover ①.
- ▶ Slide out retainer ③ and remove cover ① by pulling towards front.

Opening fuse box

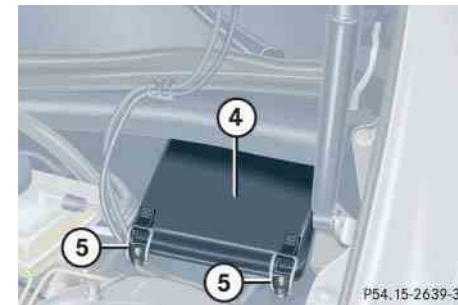

- ④ Fuse box cover
- ⑤ Clamps
- ▶ With a dry cloth, remove any moisture from the fuse box.
- ▶ Release clamps ⑤.
- ▶ Remove cover ④.

Practical hints

Fuses

Closing fuse box

- ▶ Make sure that the sealing rubber is properly positioned.
- ▶ Press fuse box cover ④ down and secure with clamps ⑤.

Installing cover

- ▶ Insert cover ① sideways into retainer ③.
- ▶ Twist screws ② 90° clockwise.

Fuse box in trunk

The fuse box is located in the trunk behind the left-hand trim panel.

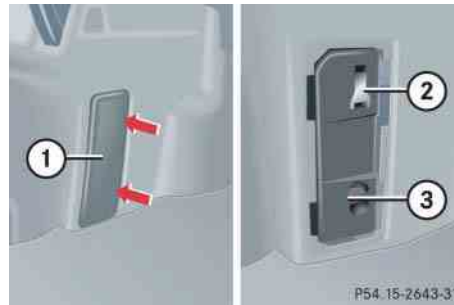

- ① Trim
- ② Spare extractor
- ③ Cover

Opening fuse box

- ▶ Pull off trim ①.
- ▶ Remove cover ③.

Closing fuse box

- ▶ Place cover ③ back on.
- ▶ Press trim ① back into place.

Technical data

Parts service

Warranty coverage

Identification labels

Layout of poly-V-belt drive

Engine

Rims and tires

Electrical system

Main dimensions

Weights

Fuels, coolants, lubricants, etc.

Technical data

Parts service

The “Technical data” section provides the necessary technical data for your vehicle.

All authorized Mercedes-Benz Centers maintain a stock of genuine Mercedes-Benz parts required for maintenance and repair work. In addition, strategically located parts distribution centers provide quick and reliable parts service.

More than 300 000 different parts for Mercedes-Benz models are available.

Genuine Mercedes-Benz parts are subjected to stringent quality inspections. Each part has been specifically developed, manufactured or selected for and adapted to Mercedes-Benz vehicles.

Therefore, genuine Mercedes-Benz parts should be installed.



The use of non-genuine Mercedes-Benz parts and accessories not authorized by Mercedes-Benz could damage the vehicle, which is not covered by the Mercedes-Benz Limited Warranty, or could compromise the vehicle's durability or safety.

▼ **Warranty coverage**

Your vehicle is covered under the terms of the warranties printed in the Service and Warranty Information booklet. Your authorized Mercedes-Benz Center will exchange or repair any defective parts originally installed in the vehicle in accordance with the terms of the following warranties:

- New Vehicle Limited Warranty
- Emission System Warranty
- Emission Performance Warranty
- California, Maine, Massachusetts, and Vermont Emission Control Systems Warranty

Replacement parts and accessories are covered by the Mercedes-Benz Parts and Accessories warranties, copies of which are available at any Mercedes-Benz Center.

Loss of Service and Warranty Information Booklet

Should you lose your Service and Warranty Information booklet, have an authorized Mercedes-Benz Center arrange for a replacement. It will be mailed to you.

Technical data

Identification labels

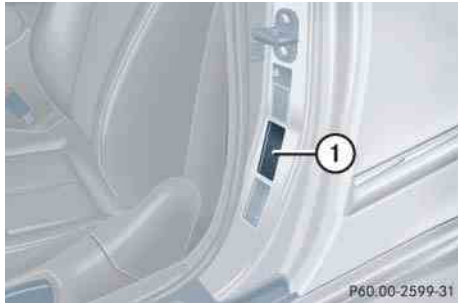

- ① Certification label (includes Paintwork code)

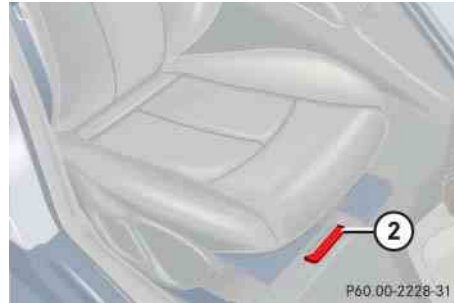

- ② Vehicle Identification Number (VIN)

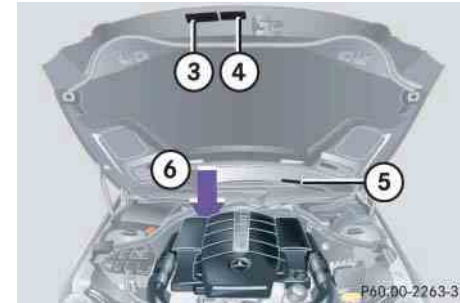

- ③ Vacuum line routing diagram label
④ Emission control information label, includes both federal and California certification exhaust emission standards
⑤ VIN, visible (lower edge of windshield)
⑥ Engine number (engraved on engine)

i

When ordering parts, please specify vehicle identification and engine numbers.

▼ **Layout of poly-V-belt drive**

CLK 320/CLK 500/CLK 55 AMG

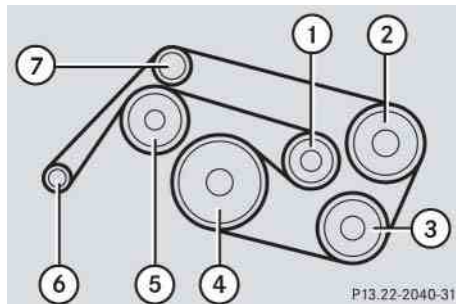

- ① Automatic belt tensioner
- ② Power steering pump
- ③ Air conditioning compressor
- ④ Crankshaft
- ⑤ Coolant pump
- ⑥ Generator (alternator)
- ⑦ Idler pulley

Technical data

Engine

Model	CLK 320 (209.365) ¹	CLK 500 (209.375) ¹	CLK 55 AMG (209.376) ¹
Engine	112	113	113
Mode of operation	4-stroke engine, gasoline injection	4-stroke engine, gasoline injection	4-stroke engine, gasoline injection
No. of cylinders	6	8	8
Bore	3.54 in (89.90 mm)	3.82 in (97.00 mm)	3.82 in (97.00 mm)
Stroke	3.31 in (84.00 mm)	3.31 in (84.00 mm)	3.62 in (92.00 mm)
Total piston displacement	195.2 cu in (3 199 cm ³)	303.0 cu in (4 966 cm ³)	331.8 cu in (5 439 cm ³)
Compression ratio	10:1	10:1	11:1
Output acc. to SAE J 1349	215 hp / 5 700 rpm ² (160 kW / 5 700 rpm)	302 hp / 5 600 rpm ² (225 kW / 5 600 rpm)	362 hp / 5 750 rpm ² (270 kW / 5 750 rpm)
Maximum torque acc. to SAE J 1349	229 lb-ft / 3 000-4 600 rpm (310 Nm / 3 000-4 600 rpm)	339 lb-ft / 2 700-4 250 rpm (460 Nm / 2 700-4 250 rpm)	376 lb-ft / 4 000 rpm (510 Nm / 4 000 rpm)
Maximum engine speed	6 000 rpm	6 000 rpm	6 700 rpm
Firing order	1-4-3-6-2-5	1-5-4-2-6-3-7-8	1-5-4-2-6-3-7-8
Poly-V-belt	2 380 mm	2 380 mm	2 380 mm

¹ The quoted data apply only to the standard vehicle. See an authorized Mercedes-Benz Center for the corresponding data of all special bodies and special equipment.

² Premium fuel required. Performance may vary with fuel octane rating.

▼ Rims and tires

Only use tires and rims which have been specifically developed for your vehicle and tested and approved by Mercedes-Benz. Other tires and rims can have detrimental effects, such as

- poor handling characteristics
- increased noise
- increased fuel consumption



Moreover, tires and rims not approved by Mercedes-Benz may, under load, exhibit dimensional variations and different tire deformation characteristics that could cause them to come into contact with the vehicle body or axle parts. Damage to the tires or the vehicle may be the result.



Further information on tires and rims is available at any authorized Mercedes-Benz Center. A placard with the recommended tire inflation pressures is located on the driver's door B-pillar. Some vehicles may have supplemental tire pressure information for driving at high speeds (▷ page 326) or for vehicle loads less than the maximum loaded vehicle condition. If such information is provided, it can be found on the placard located on the inside of the fuel filler flap. The tire inflation pressure should be checked regularly and should only be adjusted on cold tires. Follow tire manufacturer's maintenance recommendation included with vehicle.

Technical data

Rims and tires

Technical data

Rims and tires

Same size tires

16" tires

	CLK 320	CLK 500 CLK 320 (Appearance Package)	CLK 55 AMG
Rims (light alloy)	7J x 16 H2	-	-
Wheel offset	1.45 in (37 mm)	-	-
Winter tires (radial-ply tires)	205/55 R16 91H M+S	-	-

17" tires

	CLK 320 (Appearance Package)	CLK 500	CLK 55 AMG
Rims (light alloy)	7 ¹ / ₂ J x 17 H2	7 ¹ / ₂ J x 17 H2	7 ¹ / ₂ J x 17 H2
Wheel offset	1.42 in (36 mm)	1.45 in (37 mm)	1.45 in (37 mm)
Winter tires (radial-ply tires)	225/45 R17 91 H M+S	225/45 R17 91 H M+S	225/45 R17 91 H M+S

Technical data

Rims and tires

Mixed size tires

	CLK 320	CLK 320 (Appearance Package)	CLK 500
Front axle:			
Rims (light alloy)	7 J x 16 H2	7 ¹ / ₂ J x 17 H2	7 ¹ / ₂ J x 17 H2
Wheel offset	1.45 in (37 mm)	1.42 in (36 mm)	1.45 in (37 mm) ¹
Summer tires (radial-ply tires)	-	225/45 R17 91W	225/45 ZR17 91Y
All-season tires (radial-ply tires)	205/55 R16 91H M+S	-	-
Rear axle:			
Rims (light alloy)	8 J x 16 H2	8 ¹ / ₂ J x 17 H2	8 ¹ / ₂ J x 17 H2
Wheel offset	1.26 in (32 mm)	1.18 in (30 mm)	1.18 in (30 mm)
Summer tires (radial-ply tires)	-	245/40 R17 91W ²	245/40 ZR17 91Y ²
All-season tires (radial-ply tires)	225/50 R16 92H M+S ²	-	-

¹ Applies to AMG wheel only

² Must not be used with snow chains.

Technical data

Rims and tires

	CLK 55 AMG
Front axle:	
Rims (light alloy)	7 ¹ / ₂ J x 18 EH2
Wheel offset	1.45 in (37 mm) ¹
Summer tires (radial-ply tires)	225/40 ZR18 92Y XL (Extra Load) ²
All-season tires (radial-ply tires)	-
Rear axle:	
Rims (light alloy)	8 ¹ / ₂ J x 18 EH2
Wheel offset	1.18 in (30 mm)
Summer tires (radial-ply tires)	255/35 ZR18 94Y XL (Extra Load) ²
All-season tires (radial-ply tires)	-

¹ Applies to AMG wheel only.

² Must not be used with snow chains.

Technical data

Rims and tires

Minispare wheel (except CLK 55 AMG)

	CLK 320 CLK 320 (Appearance Package*)	CLK 500
Rim	3.5 B x 16 H2	3.5 B x 17 H2
Wheel offset	0.67 in (17 mm)	0.67 in (17 mm)
Tire	T 125/90 R 16 98M ¹	T 125/80 R 17 99M ¹

¹ Must not be used with snow chains.

Collapsible tire (CLK 55 AMG only)

Model	CLK 55 AMG
Rim (steel)	4.5 B x 17 H2
Wheel offset	0.47 in (12 mm)
Tire	145/70 - 17 92P ¹

Technical data

Electrical system

Model	CLK 320	CLK 500	CLK 55 AMG
Generator (alternator)	14 V/120 A	14 V/150 A	14 V/150 A
Starter motor	14 V/1.4 KW	14 V/1.7 KW	14 V/1.7 KW
Battery	12 V/100 Ah	12 V/100 Ah	12 V/100 Ah
Spark plugs	Bosch F8 DPP 332 NGK PFR 5R-11	Bosch F8 DPP 332 NGK PFR 5R-11	NGK ILFR 6A
Electrode gap	0.039 in (1.00 mm)	0.039 in (1.00 mm)	0.031 in (0.8 mm)
Tightening torque	18.5 - 22 lb-ft (25 - 30 Nm)	18.5 - 22 lb-ft (25 - 30 Nm)	18.5 - 22 lb-ft (25 - 30 Nm)

Technical data

Main dimensions

▼ Main dimensions

Model	CLK 320	CLK 500	CLK 55 AMG
Overall vehicle length	182.8 in (4 643 mm)	182.8 in (4 643 mm)	182.8 in (4 643 mm)
Overall vehicle width	68.5 in (1 740 mm)	68.5 in (1 740 mm)	68.5 in (1 740 mm)
Overall vehicle height	55.4 in (1 406 mm)	55.4 in (1 408 mm)	55.4 in (1 408 mm)
Wheelbase	106.9 in (2 715 mm)	106.9 in (2 715 mm)	106.9 in (2 715 mm)
Track, front	58.8 in (1 493 mm)	58.9 in (1 497 mm)	58.9 in (1 497 mm)
Track, rear	58.0 in (1 474 mm)	58.2 in (1 478 mm)	58.2 in (1 478 mm)

Technical data

Weights

Roof load max.	220 lb (100 kg)
----------------	-----------------

Trunk load max.	220 lb (100 kg)
-----------------	-----------------

Technical data

Fuels, coolants, lubricants, etc.

▼ Fuels, coolants, lubricants, etc.

Capacities

Vehicle components and their respective lubricants must match. Therefore only use products tested and approved by Mercedes-Benz.

Please refer to the Factory Approved Service Products pamphlet, or inquire at your Mercedes-Benz Center.

	Model	Capacity	Fuels, coolants, lubricants, etc.
Engine with oil filter	CLK 320	8.5 US qt (8.0 l)	Approved engine oils
	CLK 500	7.5 US qt (7.0 l)	
	CLK 55 AMG	9.0 US qt (8.5 l)	
Automatic transmission	CLK 320	8.0 US qt (7.5 l)	MB Automatic Transmission Fluid
	CLK 500	9.3 US qt (8.7 l)	
	CLK 55 AMG	9.3 US qt (8.7 l)	
Rear axle	CLK 320	1.28 US qt (1.2 l)	Hypoid gear oil SAE 85 W 90
	CLK 500	1.5 US qt (1.4 l)	
	CLK 55 AMG	1.5 US qt (1.4 l)	
Power steering		approx. 1.1 US qt (1.0 l)	MB Power Steering Fluid (Pentosin CHF 11S)
Front wheel hubs		approx. 3.0 oz (85 g) each	High temperature roller bearing grease
Brake system		0.64 US qt (0.6 l)	MB Brake Fluid (DOT 4+)

Technical data

Fuels, coolants, lubricants, etc.

	Model	Capacity	Fuels, coolants, lubricants, etc.
Cooling system	CLK 320 CLK 500 CLK 55 AMG	approx. 10.7 US qt (10.0 l) approx. 12.8 US qt (12.0 l) approx. 12.8 US qt (12.0 l)	MB 325.0 Anticorrosion/Antifreeze Agent
Fuel tank including a reserve of	CLK 320 CLK 500 CLK 55 AMG	16.35 US gal (62.0 l) 2.11 US gal (8.0 l) 2.11 US gal (8.0 l) 2.64 US gal (10.0 l)	Premium unleaded gasoline: Minimum Posted Octane 91 (Avg. of 96 RON / 86 MON)
Air conditioning system			R-134a refrigerant and special PAG lubricant oil (never R-12)
Windshield washer and headlamp cleaning system*		6.4 US qt (6.0 l)	MB Windshield Washer Concentrate ¹

¹ Use MB Windshield Washer Concentrate "S" and water for temperatures above freezing point or MB Windshield Washer Concentrate "S" and commercially available premixed windshield washer solvent / antifreeze for temperatures below freezing point. Follow suggested mixing ratios (▷ page 454).

Technical data

Fuels, coolants, lubricants, etc.

Engine oils

Engine oils are specifically tested for their suitability in our engines and durability for our service intervals. Therefore, only use approved engine oils and oil filters required for vehicles with Maintenance System (U.S. vehicles) or FSS (Canada vehicles). For a listing of approved engine oils and oil filters, refer to the Factory Approved Service Products Pamphlet, or contact an authorized Mercedes-Benz Center.

Using engine oils and oil filters of specification other than those expressly required for the Maintenance System (U.S. vehicles) or FSS (Canada vehicles), or changing of oil and oil filter at change intervals longer than those called for by the Maintenance System (U.S. vehicles) or FSS (Canada vehicles) will result in engine damage not covered by the Mercedes-Benz Limited Warranty.

Please follow Maintenance System (U.S. vehicles) or FSS (Canada vehicles) recommendations for scheduled oil changes. Failure to do so will result in engine damage not covered by the Mercedes-Benz Limited Warranty.

Engine oil additives

Do not blend oil additives with engine oil. They may damage the engine.

Damage or malfunctions resulting from blending oil additives are not covered by the Mercedes-Benz Limited Warranty.

Technical data

Fuels, coolants, lubricants, etc.

Air conditioning refrigerant

R-134a (HFC) refrigerant and special PAG lubricating oil are used in the air conditioning system.

Never use R-12 (CFC) or mineral-based lubricating oil. Otherwise damage to the system will occur.

Brake fluid

During vehicle operation, the boiling point of the brake fluid is continuously reduced through the absorption of moisture from the atmosphere. Under extremely strenuous operating conditions, this moisture content can lead to the formation of bubbles in the system, thus reducing the system's efficiency.

Therefore, the brake fluid must be replaced every two years, preferably in the spring.

Only brake fluid approved by Mercedes-Benz is recommended. Your authorized Mercedes-Benz Center will provide you with additional information.

Premium unleaded gasoline



To maintain the engine's durability and performance, premium unleaded gasoline must be used. If premium unleaded is not available and low octane fuel is used, follow these precautions:

- Have the fuel tank only partially filled with unleaded regular and fill up with premium unleaded as soon as possible.
- Avoid full throttle driving and abrupt acceleration.
- Do not exceed an engine speed of 3000 rpm if the vehicle is loaded with a light load such as two persons and no luggage.
- Do not exceed $\frac{2}{3}$ of maximum accelerator pedal position if the vehicle is fully loaded or operating in mountainous terrain.

Fuel requirements

Only use premium unleaded fuel:

- The octane number (posted at the pump) must be 91 min. It is an average of both the Research (R) octane number and the Motor (M) octane number: $(R+M) / 2$. This is also known as the ANTI-KNOCK INDEX.

Unleaded gasoline containing oxygenates such as ethanol, IPA, IBA and TBA can be used provided the ratio of any one of these oxygenates to gasoline does not exceed 10%; MTBE not to exceed 15%.

The ratio of methanol to gasoline must not exceed 3% plus additional cosolvents.

Using mixtures of ethanol and methanol is not allowed. Gasohol, which contains 10% ethanol and 90% unleaded gasoline, can be used.

These blends must also meet all other fuel requirements, such as resistance to spark knock, boiling range, vapor pressure, etc.

Gasoline additives

A major concern among engine manufacturers is carbon build-up caused by gasoline. Mercedes-Benz recommends only the use of quality gasoline containing additives that prevent the build-up of carbon deposits.

After an extended period of using fuels without such additives, carbon deposits can build up especially on the intake valves and in the combustion area, leading to engine performance problems such as:

- Warm-up hesitation
- Unstable idle
- Knocking/pinging
- Misfire
- Power loss

In areas where carbon deposits may be encountered due to lack of availability of gasolines which contain these additives, Mercedes-Benz recommends the use of additives approved by us for use on Mercedes-Benz vehicles. Refer to Factory Approved Service Products pamphlet for a listing of approved product(s). Follow directions on product label.

Do not blend any specific fuel additives with fuel. This only results in unnecessary cost and may be harmful to the engine operation.

Damage or malfunction resulting from poor fuel quality or from blending additional fuel additives other than those tested and approved by us for use on Mercedes-Benz vehicles listed in the Factory Approved Service Products pamphlet are not covered by the Mercedes-Benz Limited Warranty.

Technical data

Fuels, coolants, lubricants, etc.

Coolants

The engine coolant is a mixture of water and anticorrosion / antifreeze, which provides:

- Corrosion protection
- Freeze protection
- Boiling protection (by increasing the boiling point)

The cooling system was filled at the factory with a coolant providing freeze protection to approximately -22°F (-30°C) and corrosion protection.

If the antifreeze mixture is effective to -22°F (-30°C), the boiling point of the coolant in the pressurized cooling system is reached at approx. 266°F (130°C).

The coolant solution must be used year-round to provide the necessary corrosion protection and increase boil-over protection. Refer to Maintenance Booklet for replacement interval.

Coolant system design and coolant used determine the replacement interval. The replacement interval published in the Maintenance Booklet is only applicable if MB 325.0 anticorrosion/antifreeze solution or other Mercedes-Benz approved products of equal specification (see Factory Approved Service Products pamphlet) are used to renew the coolant concentration or bring it back up to the proper level.

To provide important corrosion protection, the solution must be at least 45% anticorrosion/antifreeze (equivalent to freeze protection to approx. -22°F [-30°C]). If you use a solution that is more than 55% anticorrosion/antifreeze (freeze protection to approx. -49°F [-45°C]), the engine temperature will increase due to the lower heat transfer capability of the solution. Therefore, do not use more than this amount of anticorrosion/antifreeze.

If the coolant level is low, water and MB Anticorrosion /Antifreeze should be used to bring it up to the proper level (have cooling system checked for signs of leakage). Please make sure the mixture is in accordance with label instructions.

The water in the cooling system must meet minimum requirements, which are usually satisfied by normal drinking water. If you are not sure about the water quality, consult an authorized Mercedes-Benz Center.

Technical data

Fuels, coolants, lubricants, etc.

Anticorrosion/antifreeze

Your vehicle contains a number of aluminum parts. The use of aluminum components in motor vehicle engines necessitates that anticorrosion/antifreeze coolant used in such engines be specifically formulated to protect the aluminum

parts. (Failure to use such anticorrosion/antifreeze coolant will result in a significantly shortened service life.)

Therefore, the following product is strongly recommended for use in your vehicle: Mercedes-Benz 325.0 anticorrosion/antifreeze agent

Before the start of the winter season (or once a year in hot southern regions), you should have the anticorrosion/antifreeze concentration checked. The coolant is also regularly checked each time you bring your vehicle to an authorized Mercedes-Benz Center for service.

Anticorrosion/antifreeze quantity

Model	Approx. freeze protection	
	-35°F (-37°C)	-49°F (-45°C)
CLK 320	5.3 US qt (5.0 l)	5.9 US qt (5.5 l)
CLK 500	6.4 US qt (6.0 l)	7.0 US qt (6.6 l)
CLK 55 AMG	6.4 US qt (6.0 l)	7.0 US qt (6.6 l)

Technical data

Fuels, coolants, lubricants, etc.

Windshield washer system and headlamp cleaning system*

Both the windshield washer and headlamp cleaning system are supplied from the windshield washer fluid reservoir.

The washer fluid reservoir has a capacity of approx. 6.4 US qt (6.0 l).

- ▶ Refill the reservoir with MB Windshield Washer Concentrate “S” and water (or concentrate and commercially available premixed windshield washer solvent / antifreeze, depending on ambient temperatures).

Warning!



Washer solvent / antifreeze is highly flammable. Do not spill washer solvent / antifreeze on hot engine parts, because it may ignite and burn. You could be seriously burned.

Windshield and headlamp washer fluid mixing ratio

For temperatures above freezing point, use MB Windshield Washer Concentrate “S” and water:

- 1 part “S” to 100 parts water
(1.34 fl oz [40 ml] “S” to 1 gallon [4.0 l] water)

For temperatures below freezing point, use MB Windshield Washer Concentrate “S” and commercially available premixed windshield washer solvent / antifreeze:

- 1 part “S” to 100 parts solvent
(1.34 fl oz [40 ml] “S” to 1 gallon [4.0 l] solvent)

ABS

(Antilock Brake System)

Prevents the wheels from locking up during braking so that the vehicle can continue to be steered.

Alignment bolt

Metal pin with thread. The centering pin is an aid used when changing a tire to align the wheel with the wheel hub.

BAS

(Brake Assist System)

System for potentially reducing braking distances in emergency braking situations. The system is activated when it senses an emergency based on how fast the brake is applied.

Bi-Xenon headlamps*

Headlamps which use an electric arc as the light source and produce a more intense light than filament headlamps. Bi-Xenon headlamps produce low beam and high beam.

CAC

(Customer Assistance Center)

Mercedes-Benz customer service center, which can help you with any questions about your vehicle and provide assistance in the event of a breakdown.

CAN system

(Controller Area Network)

Data bus network serving to control vehicle functions such as door locking or windshield wiping.

Cockpit

All instruments, switches, buttons and indicator/warning lamps in the passenger compartment needed for vehicle operation and monitoring.

Technical terms

COMAND

(Cockpit Management and Data System)

Information and operating center for vehicle sound and communications systems, including the radio and the navigation system, as well as other optional equipment (CD changer, telephone, etc.).

Control system

The control system is used to call up vehicle information and to change component settings. Information and messages appear in the multifunction display. The driver uses the buttons on the multifunction steering wheel to navigate through the system and to adjust settings.

Cruise control

Driving convenience system for automatically maintaining the vehicle speed set by the driver.

Engine number

The number set by the manufacturer and placed on the cylinder block to uniquely identify each engine produced.

Engine oil viscosity

Measurement for the inner friction (viscosity) of the oil at different temperatures. The higher the temperature an oil can tolerate without becoming thin, or the lower the temperature it can tolerate without becoming viscous, the better the viscosity.

ESP

(Electronic Stability Program)
Improves vehicle handling and directional stability.

ETD

(Emergency Tensioning Device)
Device which deploys in certain frontal and rear collisions exceeding the system's threshold to tighten the seat belts.
->SRS

FSS (Canada vehicles)

(Flexible Service System)

Maintenance service indicator in the multifunction display that informs the driver when the next vehicle maintenance service is due. FSS evaluates engine temperature, oil level, vehicle speed, engine speed, distance driven and the time elapsed since your last maintenance service, and calls for the next maintenance service accordingly.

Gear range

Number of gears which are available to the automatic transmission for shifting. The automatic gear shifting process can be adapted to specific operating conditions using the gear selector lever.

GPS

(Global Positioning System)
Satellite-based system for relaying geographic location information to and from vehicles equipped with special receivers. Employs CD digital maps for navigation.

Instrument cluster

The displays and indicator/warning lamps in the driver's field of vision, including the tachometer, speedometer, coolant temperature and fuel gauge.

KEYLESS-GO*

System for entering and operating the vehicle without the use of a SmartKey.

Kickdown

Depressing the accelerator past the point of resistance shifts the transmission down to the lowest possible gear. This very quickly accelerates the vehicle and should not be used for normal acceleration needs.

Line of fall

The direct line that an object moves downhill when influenced by the force of gravity alone.

Lock button

Button on the door which indicates whether the door is locked or unlocked. Pushing the lock button down on an individual door from inside will lock that door.

Maintenance System (U.S. vehicles)

Maintenance service indicator in the multifunction display that informs the driver when the next vehicle maintenance service is due. The Maintenance System in your vehicle tracks distance driven and the time elapsed since your last maintenance service, and calls for the next maintenance service accordingly.

Memory function*

Used to store three individual seat, steering wheel and mirror positions for each SmartKey or, if so equipped, KEYLESS-GO* feature.

Menu

The control system displays are arranged in menus. Each menu contains a number of commands for particular systems.

MON

(Motor Octane Number)
The Motor Octane Number for gasoline as determined by a standardized method. It is an indication of a gasoline's ability to resist undesired detonation (knocking). The average of both the MON (Motor Octane Number) and ->RON (Research Octane Number) is posted at the pump, also known as ANTI-KNOCK INDEX.

Multifunction display

Display field in the speedometer used to present information provided by the control system.

Technical terms

Multifunction steering wheel

Steering wheel with buttons for operating the control system.

OCS

(Occupant Classification System)

The system automatically turns the front passenger front air bag on or off based on the classified occupant size category determined by weight sensor readings from the seat.

Overspeed range

Engine speeds within the red marking on the tachometer dial. Avoid this engine speed range, as it may result in serious engine damage that is not covered by the Mercedes-Benz Limited Warranty.

Parktronic (Parking assist)*

System which uses visual and acoustic signals to assist the driver during parking maneuvers.

Poly-V-belt drive

Drives engine-components (alternator, AC compressor, etc.) from the engine.

Power train

Collective term designating all components used to generate and transmit motive power to the drive axles, including

- engine
- clutch/torque converter
- transmission
- transfer case
- drive shaft
- differential
- axle shafts/axles

Program mode selector switch

Used to switch the automatic transmission between standard operation **S** and comfort operation **C**.

CLK 55 AMG with steering wheel gear-shift control and manual shift program: In addition to **S** and **C** (for standard **S** or comfort **C** operation, see above) you can use the **M** for manual shift program.

REST

(Residual engine heat utilization)
Feature that uses the engine heat stored in the coolant to heat the vehicle interior for a short time after the engine has been turned off.

Restraint systems

Seat belts, child restraints, lower anchors and tethers for children (LATCH). As independent systems, their protective functions complement one another.

RON

(Research Octane Number)
The Research Octane Number for gasoline as determined by a standardized method. It is an indication of a gasoline's ability to resist undesired detonation (knocking). The average of both the →MON (Motor Octane Number) and RON (Research Octane Number) is posted at the pump, also known as ANTI-KNOCK INDEX.

Shift lock

When the vehicle is parked, this lock prevents the gear selector lever from being inadvertently moved out of position **P** without SmartKey turned and brake pedal depressed.

Speedshift (CLK 500*, CLK 55 AMG)

Steering wheel gearshift control. You can change the gears yourself with the steering wheel gearshift buttons.

SRS

(Supplemental Restraint System)
Air bags, air bag control unit (with crash sensor), emergency tensioning device. Though independent systems, they are closely interfaced to provide effective occupant protection.

Technical terms

Tele Aid System

(Telematic Alarm Identification on Demand)

The Tele Aid system consists of three types of response: automatic and manual emergency, roadside assistance and information. Tele Aid is initially activated by completing a subscriber agreement and placing an acquaintance call.

The Tele Aid system is operational provided that the vehicle's battery is charged, properly connected, not damaged and cellular and GPS coverage is available.

Telematics*

A combination of the terms "telecommunications" and "informatics".

Tightening torque

Force times lever arm (e.g. a lug wrench) with which threaded fasteners such as wheel bolts are tightened.

Tire speed rating

Part of tire designation; indicates the speed range for which a tire is approved.

Traction

Force exerted by the vehicle on the road via the tires.

VIN

(Vehicle Identification Number)

The number set by the manufacturer and placed on the body to uniquely identify each vehicle produced.

Voice control system*

Voice control system for car phones, portable cell phones and audio systems (radio, CD, etc.).

A

- ABS 25, 84, 455
 - Malfunction indicator lamp 354
 - Messages in display 365
- Accelerator position,
 - automatic transmission 171
- Accessory weight 338
- Accident
 - In case of 54
- Activating
 - Air conditioning (cooling) 192, 204
 - Air recirculation mode 190, 201
 - Anti-theft alarm system 90
 - Automatic climate control 195
 - Central locking (control system) 158
 - Charcoal filter 203
 - Climate control 185
 - Climate control system 187
 - Defrosting 189
 - Automatic climate control 200
 - Easy-entry/exit feature 159
 - Electric air pump 417
 - ESP 88
 - Exterior headlamps 50
 - Exterior lamps 125
 - Exterior rear view
 - mirror parking position 180
 - Front and rear fog lamp 128
 - Hazard warning flasher 131
 - Headlamps 50
 - High beams 129
 - Ignition 34
 - Ignition with KEYLESS-GO* 36
 - Immobilizer 56, 89
 - Rear window defroster 183
 - Residual heat 205
 - Seat heating* 119
 - Seat ventilation* 120
 - Tow-away alarm 91, 92
 - Windshield wipers 52
- Adding
 - Coolant 313
 - Engine oil 312
- Additional turn signals 404
- Adjustable air vents, rear
 - passenger compartment 193, 206
- Adjusting 37
 - Air distribution 188, 198
 - Air volume 199
 - Backrest tilt 38
 - Exterior rear view mirror 41
 - Head restraint height 38
 - Head restraint tilt 39
 - Instrument cluster illumination 134
 - Interior rear view mirror 41
 - Mirrors 41
 - Multicontour seat* 118
 - Seat cushion depth 118
 - Seat cushion tilt 38
 - Seat fore and aft adjustment 38
 - Seat height 38
 - Seats 37
 - Steering column in/out 41
 - Steering column up/down 41
 - Steering wheel 40
- Aids for changing fuses 430

Index

- Air bags 61
 - Children 62
 - Front 65
 - Passenger 65
 - Safety guidelines 64
 - Side impact 66
 - Window curtain 66
- Air conditioning (cooling) 191
 - Turning off 192, 204
 - Turning on 192, 204
- Air conditioning refrigerant 450
- Air distribution
 - Adjusting 188, 198
- Air pressure 338
- Air pressure see Tire inflation pressure
- Air pump, electric
 - Turning on 417
- Air recirculation mode 190, 201
 - Activating 190, 201
 - Deactivating 191, 202
- Air vents, rear passenger compartment
 - Adjustable 193, 206
- Air volume
 - Adjusting 199
- Alarm
 - Audible 83, 91, 92
 - Canceling 91, 92
 - Visual 90
- Alarm system
 - Anti-theft 90
- Alignment bolt (vehicle tool kit) 415, 455
- Anticorrosion/antifreeze 453
- Antiglare
 - Auto-dimming 178
- Antilock brake system (ABS) 455
- Anti-theft alarm system
 - Arming 90
 - Canceling alarm 91, 92
 - Disarming 91
- Anti-theft systems 89
 - Anti-theft alarm system 90
 - Immobilizer 89
 - Tow-away alarm 91
- Aquaplaning see Hydroplaning
- Armrest
 - Front 273
 - Rear 274
 - Storage compartments 273
- Ashtray (Center console) 276
 - Opening 276
 - Reinstalling 276
 - Removing 276
- Ashtray (Rear seat) 276
 - Opening 277
 - Reinstalling 277
 - Removing 277
- Aspect ratio 338
- At the gas station 305
- ATF (automatic transmission fluid) 312
- AUDIO menu 143
 - Operate CD player 144
 - Selecting radio station 143
 - Selecting satellite radio* station 143
- Audio system 207
 - Audio and telephone, operation 207
 - Button and soft key operation 210
 - CD operation 225
 - Operating and display elements 208
 - Operating safety 207
 - Operation 210
 - Radio operation 215
 - Switching off 211
 - Switching on 210
 - Telephone* operation 232

- Auto-dimming rear view mirrors 178
 - Automatic central locking
 - Activating/deactivating (control system) 158
 - Automatic climate control 194
 - Activating 195
 - Adjusting air distribution 198
 - Air recirculation mode 201
 - Deactivating 195
 - Defrosting 200
 - Rear window defroster 183
 - Setting the temperature 197
 - Automatic headlamp mode 125
 - Automatic lighting control
 - Activating 132
 - Deactivating 132
 - Automatic locking when driving 110
 - Automatic shift program 170
 - Automatic time change (Daylight Saving Time (DST) summer/winter) 153
 - Automatic transmission 165
 - Accelerator position 171
 - Comfort program mode 170
 - Emergency operation (Limp Home Mode) 177
 - Fluid level 312
 - Gear ranges 168
 - Gear selector lever 165
 - Gear selector lever position 165, 169
 - Gear shifting malfunctions 177
 - Kickdown 171
 - Manual shifting 167
 - One-touch gearshifting 167
 - Program mode selector switch 170
 - Starting the engine 47
 - Transmission fluid 312
 - Auxiliary fuse box 432
- B**
- Backrest
 - Folding forward 268
 - Folding rearward 269
 - Backup lamp 405, 410
 - Bulbs 405
 - Back-up lamps
 - Bulbs 404
 - Bar 338
 - BAS 85, 455
 - Messages in display 366
 - Batteries, SmartKey
 - Check lamp 97, 102
 - Checking 97, 103
 - Replacing 402
 - Batteries, SmartKey with KEYLESS-GO*
 - Check lamp 97, 102
 - Checking 97, 103
 - Replacing 403
 - Battery discharged
 - Jump starting 423

Index

- Battery, vehicle 314, 420
 - Charging 422
 - Disconnecting 421
 - Messages in display 373
 - Reconnecting 422
 - Reinstalling 422
 - Removing 421
- Bead 338
- Bi-Xenon headlamps* 455
- Block heater (Canada only) 343
- Blocking
 - Rear window operation 82
- Bolts
 - For spare wheel 396
- Brake assist system (BAS) 455
- Brake fluid 450
 - Message in display 374
- Brake lamp bulbs 405
- Brake lamp, high mounted 405
- Brake pads
 - Message in display 374
- Brakes 296
 - Warning lamp 355
- Break-in period 294
- Bulbs, replacing 404
 - Additional turn signals 404
 - Backup lamps 405
 - Brake lamps 405
 - Fog lamps 404
 - Front lamps 404
 - High beam (Bi-Xenon*) 404
 - High beam (Halogen) 404
 - High beam flasher (Bi-Xenon*) 404
 - High beam flasher (Halogen) 404
 - High mounted brake lamp 405
 - License plate lamps 405, 410
 - Low beam (Bi-Xenon*) 404
 - Low beam (Halogen) 404
 - Parking lamps 404, 405, 407, 409
 - Rear fog lamp 405, 410
 - Side marker lamps 404, 409
 - Standing lamps 404, 405, 407, 409
 - Tail lamp assemblies 405, 410
 - Turn signal lamps 404, 405
- Button
 - Audio system 210
- C**
 - CAC (Customer Assistance Center) 455
 - Calling up
 - Maintenance service indicator 345
 - Range (distance to empty) 162
 - CAN system 455
 - Canceling
 - Cruise control 257
 - Capacities
 - Fuels, coolants, lubricants, etc. 447
 - Cargo tie-down rings 271
 - Catalytic converter 303
 - CD changer* 225
 - CD operation 225
 - CD player
 - Operating 144
 - Center console 27
 - Front passenger front
 - air bag off indicator lamp 360
 - Lower part 28
 - Upper part 27
 - Centigrade
 - Setting temperature units 149

Central locking
 Automatic 110
 From inside 110
 Switch 110
 Switching on/off
 (control system) 158
 Unlocking from inside 110
 Central locking switch 110
 Changing
 CDs 225
 Key setting 158
 Charcoal filter 202
 Activating 203
 Deactivating 203
 Charging
 Vehicle battery 422
 CHECK ENGINE
 malfunction indicator lamp 356
 Checking
 Coolant level 313
 Oil level 307, 310
 Tire inflate pressure 307
 Vehicle lighting 307

Child safety 70
 Air bags 62
 Front passenger front
 air bag off indicator lamp 77
 Infant and child
 restraint systems 67, 70
 LATCH child seat anchors 80
 OCS 73
 Child safety switch see
 Blocking of rear window operation
 Child seat anchors see
 LATCH child seat anchors
 Cigarette lighter 277

Cleaning 347
 Cup holder 351
 Gear selector lever 351
 Hard plastic trim items 351
 Headlamps 178
 Headliner 352
 Instrument cluster 351
 Leather upholstery 352
 Light alloy wheels 351
 Nubuck leather upholstery
 (CLK 55 AMG) 352
 Parktronic system* sensor 350
 Plastic and rubber parts 352
 Seat belts 352
 Steering wheel 351
 Upholstery 352
 Windows 351
 Windshield 53
 Wiper blades 350
 Wood trims 352
 Cleaning and care of vehicle 347
 Cleaning tires 318

Index

- Climate control 184
 - Activating 185
 - Adjusting air distribution 188
 - Air recirculation mode 190
 - Deactivating 185
 - Defrosting 189
 - Rear window defroster 183
- Clock 25, 152
- Closing
 - Cup holder 275
 - Glove box 272
 - Hood 309
 - Power tilt/sliding sunroof* 251, 401
 - Power tilt/sliding sunroof*
 - with KEYLESS-GO* 250, 253
 - Power tilt/sliding sunroof*
 - with SmartKey 253
 - Side windows 248
 - Trunk 107
 - Windows 247
 - Windows
 - with KEYLESS-GO* 250, 253
 - Windows
 - with SmartKey 249
- Closing power tilt/sliding sunroof*
 - In an emergency 401
- Cockpit 22, 455
- Cockpit management
 - and data system (COMAND*) 456
- Cold tire inflation pressure 338
- Collapsible tire (CLK 55 AMG only) 394
- Collapsible wheel chock 392
- COMAND* see separate
 - operating instructions
- Combination switch 129
 - High beam flasher 129
 - Turn signals 51
 - Windshield wipers 52
- Comfort driving
 - Transmission program mode 170
- Control and
 - operation of radio transmitters 302
- Control system 137, 456
 - AUDIO menu 143
 - Convenience submenu 158
 - Display digital speedometer 142
 - Functions 138, 141
 - Instrument
 - cluster submenu 149, 151
 - Lighting submenu 154
 - Menus 140, 141, 457
 - Multifunction display 137
 - Multifunction steering wheel 138
 - NAV menu 144
 - Operate CD player 144
 - Selecting radio system 143
 - Selecting satellite radio* system 143
 - Settings menu 146
 - Standard display menu 142
 - Submenus 139, 141
 - TEL* menu 162
 - Trip computer menu 160
 - Vehicle status
 - message memory menu 145
 - Vehicle submenu 158

- Convenience submenu 158
 - Activating
 - easy-entry/exit feature 159
 - Setting key-dependency 160
 - Setting parking position for
 - exterior rear view mirror 160
 - Coolant 313, 452
 - Adding 313
 - Anticorrosion/antifreeze
 - quantity 452
 - Capacities 447
 - Checking level 313
 - Messages in display 375
 - Temperature 304
 - Temperature indicator 135
 - Warning lamp 357, 376
 - Coolant level
 - Checking 313
 - Cornering fog lamps* 130
 - Driving forward 130
 - Driving rearward 131
 - Cruise control 255, 456
 - Canceling 257
 - Driving downhill 257
 - Driving uphill 257
 - Fine adjustment 259
 - Messages in display 367
 - Setting current speed 256
 - Setting to last stored speed
 - ("Resume" function) 259
 - Cruise control lever 255
 - Cup holder
 - Cleaning 351
 - Closing 275
 - In rear seat armrest 275
 - In the dashboard 275
 - Opening 275
 - Curb weight 338
 - Customer Assistance Center (CAC) 455
- D**
- Date (day)
 - Setting 153
 - Date (month)
 - Setting 153
 - Date (year)
 - Setting 154
 - Daytime running lamp mode 126
 - Setting 155
 - Deactivating
 - Air conditioning (cooling) 192, 204
 - Air recirculation mode 191, 202
 - Alarm 91
 - Anti-theft alarm system 91
 - Automatic climate control 195
 - Central locking (control system) 158
 - Charcoal filter 203
 - Climate control 185
 - Climate control system 187
 - Defrost 200
 - Defrosting 189
 - Engine with KEYLESS-GO* 57
 - Engine with the SmartKey 56
 - ESP 87
 - Exterior lamps 125
 - Hazard warning flasher 131

Index

- Headlamps 56
- Immobilizer 89
- Interior lighting
 - delayed switch-off 157
- Rear window defroster 183
- Residual heat 205
- Seat heating* 119
- Seat ventilation* 120
- Tow-away alarm 91, 92
- Deep water see Standing water
- Defogging
 - Windshield 189, 199
- Defrosting 189, 200
- Delayed switch-off
 - Interior lighting 157
- Department of Transportation see DOT
- Dialing
 - A number (telephone) 163
- Difficulties
 - While driving see
 - Problems while driving
 - With starting 48
- Digital speedometer 142
- Direction of rotation (tires) 319
- Discharged battery
 - Jump starting 423
- Disconnecting
 - Vehicle battery 421
- Display
 - Selecting 150, 151
- Display elements
 - Audio system 208
- Displays
 - Digital speedometer 142
 - Maintenance service indicator 344
 - Messages 311, 362
 - Selecting 150
 - Showing vehicle
 - status message memory 145
- Distance to empty (range)
 - Calling up 160
- Door control panel 30
- Door entry lamps 133
- Door handle 30
- Door unlock
 - With Tele Aid 286
- Doors
 - Message in display 378
 - Opening from inside vehicle 105
 - Opening from outside 96, 101
- DOT 338
- Downhill driving
 - Cruise control 257
- Downshifting
 - Automatic transmission 167
- Drinking and driving 295
- Driving
 - General instructions 43, 295
 - Hydroplaning 299
 - In winter 301
 - Problems 54
 - Safety systems 84
 - Through standing water 302
 - Traveling abroad 302
- Driving instructions 295
- Driving off 297
- Driving safety systems
 - ABS 84
 - BAS 85
 - ESP 86
- Driving systems 255
 - Cruise control 255
 - Parktronic system* 260

E

- Easy-entry/exit feature 112
 - Activating 159
- Electrical fuses 429
- Electrical outlet in
 - rear passenger compartment 278
- Electrical system
 - Technical data 444
- Electronic Stability Program see ESP
- Emergency call
 - 911 245
- Emergency call system* 280
- Emergency calls
 - Initiating an emergency call 282
 - With Tele Aid 281
- Emergency operation
 - (Limp Home Mode) 177
- Emergency operations
 - Closing
 - power tilt/sliding sunroof* 401
 - Locking the vehicle 398
 - Opening
 - power tilt/sliding sunroof* 401
 - Remote door unlock 286
 - Unlocking the vehicle 397
- Emergency tensioning device see ETD
- Emission control 304
- Emission control information label 436
- Ending
 - A call (telephone) 163
- Engine
 - Compartment 308
 - Message in display 356
 - Starting 47
 - Starting with KEYLESS-GO* 47
 - Starting with the SmartKey 47
 - Technical data 438
 - Turning off 56
- Engine cleaning 349
- Engine compartment 308
 - Fuse box in 431
 - Hood 308
- Engine malfunction
 - indicator lamp 25, 356
- Engine number 436, 456
- Engine oil 309, 449
 - Adding 312
 - Additives 449
 - Checking level 310
 - Consumption 309
 - Filler cap 312
 - Filler neck 312
 - Message in display 379
 - Messages in display 311
 - Viscosity 456
- Engine oil level see Oil level
- ESP 25, 86, 456
 - Messages in display 367
 - Switching off 87
 - Switching on 88
 - Warning lamp 358
- ETD 69, 456
 - Safety guidelines 64
- Exterior lamp switch 124
- Exterior rear view mirrors
 - Adjusting 41
 - Parking position for 160

Index

F

Fahrenheit

Setting temperature units 149

Fastening the seat belts 43

Fine adjustment

Cruise control 259

First aid kit 389

Flat tire 412

Collapsible tire

(CLK 55 AMG only) 394

Lowering the vehicle 418

Minispare wheel

(except CLK 55 AMG) 393

Mounting the spare wheel 413

Preparing the vehicle 412

Flexible Service System (Canada vehicles)

see Maintenance service system

Flexible Service System (FSS) 456

Floormats*

Removing 278

Installing 278

Fog lamp, rear 128, 405

Fog lamps

Replacing bulbs 404

Fog lamps, front

Messages in display 382

Replacing bulbs 405

Switching on 128

Front air bags 65

Front lamps

Messages in display 382–384

Replacing bulbs 404, 406

Switching on 124

Front passenger front

air bag off indicator lamp 77, 360

Front seat head restraints

Installing 114

Power seat 114

Removing 114

Front seats

Seat heating* 119

Ventilation* 120

FSS (Canada vehicles) see

Maintenance service system

FSS (Flexible Service System) 456

Fuel 306

Additives 451

Fuel reserve warning lamp 359

Gasoline additives 451

Premium

unleaded gasoline 306, 448, 450

Requirements 451

Reserve warning 25

Technical data 447

Fuel additives 451

Fuel cap

Message in display 356

Fuel consumption statistics

After start 161

Since last reset 161

Fuel filler flap 305

Locking 305

Opening 399

Unlocking 305

Fuel requirements 451

Fuel reserve tank

Message in display 381

Fuel tank

Capacity 448

Filler flap 305

- Fuels, coolants, lubricants etc.
 - Capacities 447
 - Functions (control system) 138, 141
 - Resetting 147
 - Fuse box 430, 431
 - Fuse chart 430
 - Fuse extractor 430
 - Fuses 429
 - Aids for changing fuses 430
 - Auxiliary fuse box in trunk 432
 - Fuse box in engine compartment 431
 - Fuse box in
 - passenger compartment 430
 - Fuse chart 430
 - Fuse extractor 430
 - Spare fuses 430
- G**
- Garage door opener 29, 287
 - Gasoline see Fuel
 - Gasoline additives 451
 - GAWR 338
 - Gear range 456
 - Automatic transmission 168
 - Limiting 168
 - Shifting into optimal 167
 - Gear range limit
 - Canceling 167
 - Gear selector lever 25, 165, 400
 - Cleaning 351
 - Lock 47
 - Message in display 372
 - Position 25
 - Position
 - (Automatic transmission) 165, 169
 - Unlocking manually 400
- Global**
- Locking 96
 - Locking with KEYLESS-GO* 101
 - Unlocking 96
 - Unlocking with KEYLESS-GO* 101
 - Global Positioning System (GPS) 456
 - Glove box 23, 272
 - Closing 272
 - Opening 272
 - Good visibility 178
 - GPS 456
 - Gross Axle Weight Rating see GAWR
 - Gross Vehicle Weight Rating see GVWR
 - Gross Vehicle Weight see GVW
 - GVW 338
 - GVWR 339

Index

H

- Hands-free microphone 29
- Hard plastic trim items
 - Cleaning 351
- Hazard warning flasher 131
 - Switching off 131
 - Switching on 131
- Head restraints 113
- Head unit
 - Time synchronization* with 151
- Headlamp cleaning system* 315
- Headlamps
 - Automatic control 125
 - Bi-Xenon 455
 - Cleaning 349
 - Cleaning system* 178, 315
 - Refilling washer fluid 315
 - Switching off 56
 - Switching on 50
 - Washer fluid 454
 - Washer system* 454
- Headliner
 - Cleaning 352
- Height adjustment
 - Head restraints 38

- High beam flasher 129
 - Replacing bulbs (Bi-Xenon*) 404
 - Replacing bulbs (Halogen) 404
- High beam headlamps
 - Messages in display 383
 - Replacing bulbs (Bi-Xenon*) 404
 - Replacing bulbs (Halogen) 404, 406
 - Replacing bulbs for
 - high beam flasher (Bi-Xenon*) 408
 - Switching on 129
- High mounted brake lamp 405
- Hood 308
 - Closing 309
 - Message in display 381
 - Opening 308
- Hydroplaning 299

I

- Identification labels 436
- Ignition 34, 36
 - Switching on 47
- Immobilizer 89
 - Activating 89
 - Deactivating 89
- Infant and child restraint systems 70
 - Installing 79
 - LATCH child seat anchors 80
- Information
 - About service and warranty 10
 - Button for Tele Aid 284
- Installing
 - Floormats* 278
 - Infant and child restraint systems 79
 - Towing eye bolt 427
 - Towing eye bolt (CLK 55 AMG) 428
 - Wiper blades 411

Instrument cluster 24, 134, 457
 Cleaning 351
 Coolant temperature indicator 135
 Illumination 134
 Lamps in 354–359
 Multifunction display 137
 Outside temperature indicator 136
 Selecting language 150
 Instruments and controls see Cockpit
 Interior lighting 132
 Activating automatic control 132
 Deactivating automatic control 132
 Delayed switch-off 157
 Manual operation 133
 Interior rear view mirror
 Adjusting 41
 Auto-dimming 178
 Interior storage compartments 272
 Intermittent wipe 53

J

Jack 389
 Jump starting 423

K

Key, mechanical 397
 Key, SmartKey with KEYLESS-GO*
 Replacing the batteries 403
 Key-dependency memory
 Settings 160
 KEYLESS-GO* 457
 Activating ignition with 36
 Closing power
 tilt/sliding sunroof* with 250, 253
 Closing windows with 250, 253
 Factory setting 101
 Global locking 101
 Global unlocking 101
 Important notes 100
 Locking the vehicle 103
 Messages in display 381
 Remote controls 99
 Starting the engine 47
 Turning off the engine 57
 Unlocking with 33
 Unlocking, trunk lid 104
 Kickdown 171, 457
 Kilometers/miles in speedometer 149
 Kilopascal 339
 Km/h or mph in speedometer 149

L

Labels, identification 436
 Lamp bulbs, exterior 404
 Lamp sensor
 Messages in display 383
 Lamps, exterior
 Front 404
 Light sensor 383
 Messages in display 382–385
 Rear 405
 Lamps, indicator and warning
 ABS 354
 Battery (SmartKey) 96, 102
 Brakes 355
 Center console 360
 CHECK ENGINE 356
 Coolant 357, 375
 Engine diagnostics 356
 ESP 358
 Front passenger front
 air bag off indicator lamp 66, 360
 Fuel reserve 359
 Instrument cluster 354–359

Index

- Maintenance service indicator 344
- Parktronic system*
 - warning indicators 262
- Seat belts 359
- SRS 61, 359
- Turn signals 25
- Language
 - Multifunction display 150
 - Setting 150
- LATCH child seat anchors 80
 - Folding back 81
 - Folding out 81
- Layout of poly-V-belt drive 437
- Leather upholstery
 - Cleaning 352
- License plate lamps
 - Messages in display 383
 - Replacing bulbs 405, 410
- Light alloy wheels
 - Cleaning 351
 - Technical data 440
- Light sensor 383
- Lighter see Cigarette lighter
- Lighting 124
 - Automatic headlamp mode 125
 - Combination switch 129
 - Cornering fog lamps* 130
 - Daytime running lamp mode 126
 - Door entry lamps 133
 - Exterior lamp switch 124
 - Front fog lamps 128
 - High beam flasher 129
 - High beams 129
 - Instrument cluster illumination 134
 - Interior 132
 - Locator lighting 127
 - Low beam 124
 - Manual headlamp mode 125
 - Night security illumination 127
 - Parking lamps 124
 - Rear fog lamp 128
 - Settings (control system) 154
- Limiting the gear range 168
- Limp Home Mode 177
- Line of fall 457
- Loading 264
 - Cargo tie-down rings 271
 - Instructions 269
 - Roof rack 264
 - Ski sack* 264
 - Split rear bench seat 267
- Loading terminology 338
- Loading the vehicle 319
- Locator lighting 127
 - Setting 156
- Lock buttons 457
 - Door handle (KEYLESS-GO*) 58
- Locking 55, 94
 - Fuel filler flap 305
 - Global with KEYLESS-GO* 101
 - Global, SmartKey 96
 - The vehicle with KEYLESS-GO* 103
 - Vehicle in an emergency 398
- Loss of Service and
 - Warranty Information Booklet 435
- Loss of SmartKey 98
- Loss of SmartKey
 - with KEYLESS-GO* 105

- Low beam headlamps
 - Messages in display 383
 - Replacing bulbs (Bi-Xenon*) 404
 - Replacing bulbs (Halogen) 404, 406
- Lowering
 - Vehicle 418
- Lubricants
 - Technical data 447
- M**
- Main dimensions 445
- Maintenance 12, 344
- Maintenance service 344
 - Basic service (Service A) 344
 - Calling up the
 - maintenance service indicator 345
 - Extended service (Service B) 344
 - Overdue 345
 - Types 344
 - When due 344
- Maintenance service indicator 344
 - Calling up 345
 - Clearing 345
 - Resetting 346
- Maintenance service system 344
- Maintenance system 457
- Malfunction
 - Vehicle status message memory 362
- Manual headlamp mode 125
- Manual operations
 - Fuel filler flap 399
 - Interior lighting control 133
 - Locking the vehicle 398
 - Power tilt/sliding sunroof* 401
 - Unlocking gear selector lever 400
 - Unlocking the driver's door 397
- Manual shift program 175
- MAXCOOL maximum cooling 200
- Maximum inflation pressure 339
- Maximum load rating 339
- Maximum loaded vehicle weight 339
- Mechanical key 397
- Memory function 121, 457
 - Recalling
 - positions from memory 122
 - Storing exterior rear view
 - mirror parking positions 123
 - Storing key-dependent settings 122

Index

- Menus 138
 - AUDIO 143
 - Control system 140, 457
 - NAV 144
 - Settings menu 146
 - Standard display 142
 - Submenus 139
 - TEL* 162
 - Trip computer 160
 - Vehicle status message memory 145
- Messages
 - Displaying 145
 - Vehicle status message memory 145
- Microphone
 - Hands-free microphone 29
- Miles/kilometers in speedometer
 - Setting 149
- Minispare wheel
 - (except CLK 55 AMG) 393
 - Technical data 443
- Mirrors
 - Activating exterior rear
 - view mirror parking position 180
 - Adjusting 41
 - Auto-dimming rear view mirrors 178
 - Exterior rear view mirror 41
 - Exterior rear
 - view mirror parking positions 160
 - Interior rear view mirror 41
 - Storing exterior rear
 - view mirror parking position 123
- MON (Motor Octane Number) 306, 457
- Mph or km/h in speedometer 149
- Multicontour seat* 118
- Multifunction display 137, 457
 - Displaying gear range 168
 - Selecting language 150
 - Setting date (day) 153
 - Setting date (month) 153
 - Setting date (year) 154
 - Standard display 141
- Multifunction display messages
 - ABS 365
 - BAS 366
 - Battery 373
 - Brake fluid 374
 - Brake pads 374
 - Check engine 356
 - Coolant 376
 - Coolant level 375
 - Cruise control 367
 - Display 378
 - Doors 378
 - Engine 356
 - Engine oil 379
 - ESP 367
 - Fog lamps, front 382
 - Fuel cap 356
 - Fuel reserve tank 381
 - Gear selector lever 372
 - High beam headlamps 383
 - Hood 381
 - Key 381
 - Lamp sensor 383
 - Lamps 383
 - License plate lamp 383
 - Low beam 383

- Parking brake 374
 - SmartKey with KEYLESS-GO* 381
 - Steering gear oil level 387
 - Sunroof* 388
 - Symbol messages 373–388
 - Tele Aid 386
 - Telephone* 388
 - Text messages 364–372
 - Trunk 388
 - Washer fluid 388
- Multifunction
- steering wheel 26, 138, 458
 - Buttons 138
- N**
- Navigation system
 - Operating 144
 - See separate COMAND*
 - operating instructions
 - Night security illumination 127
 - Normal occupant weight 339
 - Nubuck leather upholstery (CLK 55 AMG)
 - Cleaning 352
- O**
- Occupant Classification System see OCS
 - Occupant distribution 339
 - Occupant safety 60
 - Air bags 61
 - Children and air bags 62
 - Children in the vehicle 70
 - Fastening the seat belts 43
 - Front passenger front
 - air bag off indicator lamp 77, 360
 - Infant and child restraint systems 70
 - LATCH child seat anchors 80
 - OCS 73
 - Seat belts 43, 64
 - OCS 73, 458
 - Self-test 78
 - Odometer, main 25
 - Oil
 - Adding 312
 - Checking level 310
 - Consumption 309
 - Filler cap 312
 - Filler neck 312
 - Viscosity 456
 - Oil level
 - Checking 307
 - One-touch gearshifting 167
 - Canceling gear range limit 167
 - Downshifting 167
 - Upshifting 167

Index

Opening

- Ashtray (Center console) 276
- Ashtray (Rear seat) 277
- Cup holder 275
- Doors from the inside 105
- Fuel filler flap 305
- Fuel filler flap manually 399
- Glove box 272
- Hood 308
- Power tilt/sliding sunroof* 251, 401
- Power tilt/sliding sunroof*
in an emergency 401
- Power tilt/sliding sunroof*
with SmartKey 253
- Side windows 248
- Trunk 106
- Trunk from the inside 107
- Windows 247
- Windows with SmartKey 249

Operating

- Audio system 207
 - CD player 144
 - COMAND* see
separate operating instructions
 - Navigation system 144
 - Radio 143
 - Radio transmitters 302
 - Telephone* 162, 207, 232
 - Vehicle outside the
USA and Canada 13
- ### Operating safety
- Audio system 207
- ### Operator's Manual 10
- Ornamental moldings 349
 - Outside temperature indicator 136
 - Overdue maintenance service 345
 - Overhead control panel 29
- ### Override switch
- Activating 82
 - Deactivating 82
- ### Overspeed range 458

P

- Paintwork 348
- Panic alarm 83
 - Panic button on SmartKey 83
- Parcel net in
 - front passenger footwell 274
- Parking 55, 297
- Parking assist* see Parktronic system*
- Parking brake 49, 55
 - Engaging 55
 - Message in display 374
 - Releasing 49
- Parking lamps
 - Replacing bulbs 404, 405, 407, 409
 - Switching on 124
- Parking position
 - Exterior rear
 - view mirrors 123, 160, 180
- Parktronic system* 260, 458
 - Cleaning the sensors 350
 - Malfunction 263
 - Range of the sensors 260
 - Switching on/off 263
 - Warning indicators 262
 - Warning sounds 262, 263

- Parts service 434
- PASS AIR BAG OFF indicator lamp see
 - Front passenger front air bag off indicator lamp
- Passenger compartment 302
 - Fuse box in 430
 - Interior lighting 132
 - Interior rear view mirror 41
 - Parcel net in
 - front passenger footwell 274
 - Rear armrest 274
 - Storage bags, rear side
 - of the front seats 274
- Passenger safety see Occupant safety
- Pedals 295
- Phone book*
 - Loading 163
 - Quick search 164
- Phone number*
 - Dialing 163
 - Redialing 164
- Plastic and rubber parts
 - Cleaning 352
- Playing
 - CDs 228
- Poly-V-belt drive 458
 - Layout 437
- Positions (Memory function)
 - Recalling from memory 122
 - Storing into memory 122
- Potential problems associated with under-inflated and overinflated tires 327
- Power assistance 295
- Power seat
 - Adjusting backrest tilt 38
 - Adjusting head restraint height 38
 - Adjusting head restraint tilt 39
 - Adjusting seat cushion tilt 38
 - Adjusting seat height 38
 - Front seat head restraints 114
 - Seat fore and aft adjustment 38
- Power tilt/sliding sunroof* 251
 - Closing 251, 401
 - Closing with KEYLESS-GO* 250, 253
 - Closing with SmartKey 253
 - Opening 251, 401
 - Opening with SmartKey 253
 - Stopping 252
 - Synchronizing 254
- Power train 458
- Power washer 348
- Power windows 247
 - Blocking of rear window operation 82
 - Side windows 247
 - Synchronizing 250
- Practical hints
 - Collapsible tire
 - (CLK 55 AMG only) 394
 - Collapsible wheel chock 392
 - First aid kit 389
 - Fuses 429
 - Lamp in center console 360
 - Lamps in instrument cluster 354
 - Messages in the display 362
 - Minispare wheel
 - (except CLK 55 AMG) 393
 - Spare wheel bolts 396
 - Towing the vehicle 425
 - Unlocking/locking
 - in an emergency 397
 - Vehicle jack 389, 391
 - Vehicle tool kit 389

Index

Premium unleaded gasoline 450
Problems
 While driving 54
 With vehicle 17
Product information 9
Production options weight 339
Program mode selector switch 458
 Automatic transmission 170
PSI 339

Q

Quick search
 Phone book* 164

R

Radio
 Selecting stations 143
 Selecting stations (satellite*) 143
Radio operation 215
Radio transmitters,
 control and operation 302
Range (distance to empty)
 Calling up 162
Reading lamp 29
Rear bench seat
 Foldable 267
Rear fog lamp 405
 Bulb 405
 Switching on 128
Rear lamp bulbs
 Replacing 410
Rear lamps see Tail lamps
Rear passenger compartment
 Adjustable air vents 193, 206

Rear seat head restraints
 Folding back with release button 116
 Folding back with switch 116
 Installing 117
 Placing upright 116
 Rear seats 115
 Removing 117
Rear seats
 Rear seat head restraints 115
Rear view mirrors auto-dimming 178
Rear view mirrors see Mirrors
Rear window
 Blocking operation 82
Rear window defroster 183
 Activating 183
 Deactivating 183
Rear window sunshade* 182
Recommended inflation pressure 339
Reconnecting
 Vehicle battery 422
Refrigerant
 Air conditioning 450
Refueling 305
Regular checks 307

- Reinstalling
 - Ashtray (Center console) 276
 - Ashtray (Rear seat) 277
 - Vehicle battery 422
- Remote controls
 - SmartKey 94
 - SmartKey with KEYLESS-GO* 99
- Remote door unlock
 - With Tele Aid 286
- Removing
 - Ashtray (Center console) 276
 - Ashtray (Rear seat) 277
 - Floormats* 278
 - Ski sack* 267
 - Vehicle battery 421
 - Vehicle tool kit
 - (CLK 55 AMG only) 390
 - Vehicle tool kit
 - (except CLK 55 AMG) 389
 - Wheel 415
 - Wiper blades 411
- Replacing
 - Backup lamp bulbs 410
 - Batteries (SmartKey
 - with KEYLESS-GO*) 403
 - Batteries (SmartKey) 402
 - Brake lamp bulbs 410
 - Bulbs 404
 - Front lamp bulbs 406
 - Front turn signal bulbs (Halogen) 407
 - Fuses 430
 - High beam bulbs (Halogen) 406
 - High beam bulbs for
 - high beam flasher (Bi-Xenon*) 408
 - License plate lamp bulbs 410
 - Low beam bulbs (Halogen) 406
 - Parking lamp bulbs 407, 409
 - Rear fog lamp bulb 410
 - Rear lamp bulbs 405, 410
 - Rear turn signal bulbs 410
 - Side marker lamp bulbs 409
 - Standing lamp bulbs 407, 409
 - Wiper blades 411
- Reporting
 - Safety defects 18
- Reset button
 - in the instrument cluster 146, 147
- Resetting
 - All functions (control system) 146
 - All functions of a submenu 147
 - Fuel consumption 161
 - Maintenance service indicator 346
 - Trip odometer 135
- Residual heat utilization 205, 459
- Residual ventilation 205
- REST
 - (Residual engine heat utilization) 459
- Restraint system see
 - Infant and child restraint systems 79
- Restraint systems 459
- Rim 339
- Rims 439
- Roadside Assistance 12, 283
 - Information button 284
 - Tele Aid 280
- RON
 - (Research Octane Number) 306, 459
- Roof rack 264
- Rubber parts
 - Cleaning 352

Index

S

- Safety
 - Occupant 60
- Safety belts see Seat belts
- Safety defects
 - Reporting 18
- Safety systems
 - Driving 84
- Seat belt force limiter 69
- Seat belts 67
 - Cleaning 352
 - Fastening 43
 - Proper use of 45, 68
 - Safety guidelines 64
 - Warning lamp 359
- Seat cushion depth
 - Adjusting 118
- Seat heating* 119
 - Switching off 119
 - Switching on 119
- Seat ventilation* 120
 - Switching off 120
 - Switching on 120
- Seating capacity 321
- Seats 112
 - Adjusting 37
 - Easy entry/exit feature 112
 - Multicontour seat* 118
 - Seat heating* 119
 - Seat ventilation* 120
 - Split rear bench seat 267
- Securing cargo
 - Cargo tie-down rings 271
- Selecting
 - Automatic time change (Daylight Saving Time (DST) summer/winter) 153
 - Display 150
- Selecting display 151
- Self-test
 - OCS 78
 - Tele Aid 280
- Service
 - Parts service 434
- Service (maintenance) 344
- Service and Warranty Booklet
 - Loss of 435
- Service and warranty information 10
- Service life (tires) 317
- Service System see Maintenance service system
- Setting
 - Convenience functions 148, 158
 - Cruise control 256
 - Date (day) 153
 - Date (month) 153
 - Date (year) 154
 - Daytime running lamp mode 155
 - Higher speed in cruise control 258
 - Hours (clock) 152
 - Individual vehicle settings 146
 - Interior lighting
 - delayed switch-off 157
 - Key-dependent memory 160
 - Lamps and lighting (control system) 154
 - Language, multifunction display 150
 - Locator lighting 156
 - Lower speed in cruise control 258
 - Miles/kilometers
 - in speedometer 149
 - Minutes (clock) 152
 - Parking position for
 - exterior rear view mirrors 160
 - Slower speed in cruise control 258

- Speedometer display mode 149
- Temperature (Interior) 187
- Temperature (interior) 197
- Temperature indicator 149
- To last stored speed
 - ("Resume" function)
 - in cruise control 259
- Units
 - Speedometer 149
 - Temperature 149
- Setting current speed 256
- Setting the temperature 187
- Settings
 - Convenience functions 158
 - Factory, KEYLESS-GO* 101
 - Factory, SmartKey 96
 - Individual (SmartKey) 160
 - Lighting (control system) 154
 - Menus and submenus 139
 - Resetting all (control system) 146
 - Resetting in the submenu 147
 - Selective 96, 102
- Settings menu
 - Functions in 146
 - Individual vehicle settings 146
 - Submenus 147
- Shift lock 459
- Shifting
 - Gear selector lever 165
 - Gear selector lever positions 169
 - Into optimal gear range
 - (Automatic transmission) 167
- Side impact air bags 66
- Side marker lamps
 - Replacing bulbs 404, 405, 409
- Side windows
 - Automatic opening 248
 - Cleaning 351
 - Closing 247, 248, 249
 - Closing with KEYLESS-GO* 250, 253
 - Closing with SmartKey 249
 - Opening 247, 248, 249
 - Opening fully 248
 - Opening with SmartKey 249
 - Stopping 249
 - Synchronizing power windows 250
- Sidewall 339
- Simultaneous wiping and washing
 - Windshield wipers 53
- Single wipe 53
- Ski sack* 264
 - Removing 267
 - Unfolding and loading 264
 - Unloading and folding 266
- SmartKey 94
 - Battery check lamp 96, 102
 - Checking the batteries 97, 103
 - Factory setting 96
 - Global locking 96
 - Global unlocking 96
 - Locking and unlocking 94
 - Loss of 98
 - Message in display 381
 - Opening and closing the power
 - tilt/sliding sunroof* with 253
 - Opening and closing
 - windows with 249
 - Positions in starter switch 34
 - Remote controls 94
 - Replacing the batteries 402
 - Restoring to factory setting 97, 102
 - Selective setting 96, 102
 - Starting the engine 47
 - Turning off the engine 56
 - Unlocking with 32

Index

- SmartKey with KEYLESS-GO*
 - Checking the batteries 97, 103
 - Global locking and unlocking 101
 - Locking the vehicle 103
 - Loss of 105
 - Message in display 381
 - Messages in display 381
 - Remote controls 99
 - Restoring to factory setting 97, 102
 - Turning off the engine 57
 - Unlocking with 33
- Snow chains 343
- Soft keys
 - Audio system 210
- Spare fuses 430
- Spare parts service see Parts service
- Spare wheel
 - Bolts 396
 - Mounting 413
- Speed
 - Setting current 256
- Speed settings
 - Cruise control 258
 - To last stored speed ("Resume" function) in Cruise control 259
- Speed shift 459
- Speedometer 25
 - Settings units 149
- Speedometer display mode
 - Selecting 149
- Split rear bench seat 267
- SRS 68, 459
 - Indicator lamp 61, 359
- Standing lamps 124
 - Replacing bulbs 404, 405, 407, 409
- Standing water
 - Driving instructions 302
- Starter switch 23, 34
 - Positions 34
- Starting difficulties 48
- Starting position 34
- Starting the engine 46
- Steering column
 - In/out adjustment 41
 - Up/down adjustment 41
- Steering gear oil
 - Message in display 387
- Steering wheel 40
 - Adjusting 40
 - Buttons 26
 - Cleaning 351
 - Height adjustment 41
- Steering wheel gearshift control 172
 - CLK 500 only 173
 - CLK 55 AMG only 174
- Stolen vehicle
 - Tracking services 286
- Stopping
 - Power tilt/sliding sunroof* 252
 - Windows 249
- Storage bags 274
- Storage compartments 272
 - Armrest 273
 - Cup holder 275
 - Glove box 272
 - Parcel net 274
 - Storage bags 274
- Storing (Memory function)
 - Positions into memory 122
- Storing tires 318

Submenus

- Control system 141
 - Convenience 158
 - For settings 139
 - Instrument cluster 149, 151
 - Lighting 154
 - Resetting functions
 - in Control system 147
 - Selecting 147
 - Settings menu 147
 - Vehicle 158
- Sun visors 181
- Sunroof*
- Message in display 388
- Supplemental Restraint System see SRS
- Switching off
- Audio system 210
 - Automatic central locking
 - (control system) 158
 - Engine 56
 - ESP 87
 - Hazard warning flasher 131
 - Headlamps 56
 - Parktronic system* 263

Switching on

- Audio system 210
 - Automatic central locking
 - (control system) 158
 - ESP 88
 - Front fog lamps 128
 - Front lamps 124
 - Hazard warning flasher 131
 - Headlamps 50
 - High beams 129
 - Parking lamps 124
 - Parktronic system* 263
 - Rear fog lamp 128
 - Windshield wipers 52
- Synchronizing
- Power tilt/sliding sunroof* 254
 - Power windows 250

T

- Tachometer 25, 136
- Overspeed range 136
- Tail lamps
- Cleaning 349
 - Replacing bulbs 405, 410
- Tar stains 348
- Technical data 450
- Brake fluid 450
 - Coolant 447
 - Coolants 452
 - Electrical system 444
 - Engine 438
 - Engine oil 449
 - Engine oil additives 449
 - Fuel requirements 451
 - Fuels 447
 - Gasoline additives 451
 - Lubricants 447
 - Main dimensions 445
 - Premium unleaded gasoline 450
 - Rims and tires 439
 - Weights 446
 - Windshield and headlamp
 - washer* system 448, 454

Index

- Tele Aid 280
 - Emergency calls 281
 - Information 284
 - Initiating an
 - emergency call manually 282
 - Messages in display 386
 - Remote door unlock 286
 - Roadside Assistance 283
 - Stolen vehicle tracking services 286
 - System self-check 280
 - Tele Aid System 280
 - Upgrade signals 285
- Tele Aid System 460
- Telematics* 460
- Telephone* 26, 279
 - Answering a call 163
 - Dialing a number
 - from the phone book 163
 - Ending a call 163
 - Hands-free microphone 29
 - Loading phone book* 163
 - Messages in display 388
 - Operating 162
 - Operation 232
 - Redialing 164
- Temperature
 - Display mode 149
 - Setting interior temperature 187
 - Setting units in display 149
- Tires 326
- Tie-down rings (Trunk) 271
- Tightening torque 460
- Tightening torque (Wheel bolts) 418
- Time
 - Setting hours 152
 - Setting minutes 152
- Time synchronization*
 - With head unit 151
- TIN 340
- Tire
 - Vehicle maximum load on 340
- Tire and Loading Information 320
- Tire and loading terminology 338
- Tire care and maintenance 317
- Tire Identification Number see TIN
- Tire inflation pressure
 - Checking 307, 325, 327
- Tire inspection 317
- Tire load rating 340
- Tire ply composition
 - and material used 340
- Tire speed rating 300, 331, 340, 460
- Tire terminology 338
- Tire traction 299
- Tires 316, 439
 - Direction of rotation 319
 - Driving instructions 298
 - Retreads 316
 - Rims and tires 439
 - Rotating 341
 - Service life 317
 - Temperature 326, 337
 - Tread depth 318, 342
 - Wear pattern 341
 - Winter 342
- Tools 389
- Tow-away alarm 27, 91
 - Arming 91
 - Disarming 91
 - Disarming for transport 91

- Towing eye bolt (vehicle tool kit)
 - CLK 320/CLK 500 427
 - CLK 55 AMG 428
 - Installing 427
 - Installing (CLK 55 AMG) 428
- Towing the vehicle 425
- Tracking services
 - For stolen vehicle 286
- Traction 171, 340, 460
- Transmission see Automatic transmission
- Traveling abroad 302
- Tread 340
- Tread depth 318
- Tread depth (tires) 342
- Treadwear indicators 340
- Trip computer 160
- Trip odometer
 - Resetting 135

- Trunk
 - Auxiliary fuse box 432
 - Closing 107
 - Lock button, KEYLESS-GO* 103
 - Message in display 388
 - Opening 106
 - Opening from inside vehicle 107
 - Tie-down rings 271
 - Trunk lid 106
 - Trunk lock 398
 - Unlocking with KEYLESS-GO* 104
 - Unlocking with SmartKey 98
- Trunk lid emergency release 109
- Turn signal lamps
 - Replacing bulbs 405
- Turn signals 51
 - Additional in mirrors 404
 - Cleaning lenses 349
 - Front bulbs 404
 - Front bulbs (Bi-Xenon*) 409
 - Front bulbs (Halogen) 407
 - Indicator lamps 25
 - Rear bulbs 405, 410
 - Replacing bulbs 404
- Turning off
 - Engine 56

U

- Uniform Tire Quality
 - Grading Standards 340
- Units
 - Setting speedometer units 149
 - Setting temperature units 149
- Unlocking 32, 94
 - Driver's door in an emergency 397
 - Fuel filler flap 305
 - Gear selector lever manually 400
 - Global 96
 - Global with KEYLESS-GO* 101
 - In an emergency 397
 - Selective setting 96, 102
 - Trunk lid with KEYLESS-GO* 104
 - Trunk lid with SmartKey 98
 - Vehicle in an emergency 286
 - With KEYLESS-GO* 33
 - With the SmartKey 32

Index

- Upgrade signals
 - Tele Aid 285
- Uphill driving
 - Cruise control 257
- Upholstery
 - Cleaning 352
- Upshifting 167
- Useful features 272
 - Ashtray (Center console) 276
 - Ashtray (Rear seat) 276
 - Cigarette lighter 277
 - Electrical outlet 278
 - Floor mats* 278
 - Storage compartments 272
 - Tele Aid 280
 - Telephone* 279

V

- Vacuum line routing diagram label 436
- Vehicle
 - Individual settings 146, 148
 - Locking 27
 - Locking in an emergency 398
 - Lowering 418
 - Service battery 420
 - Towing 425
 - Unlocking 27
 - Unlocking in an emergency 397
- Vehicle battery 314, 420
 - Messages in display 373
- Vehicle capacity weight 340

- Vehicle care 347
 - Cup holder 351
 - Engine cleaning 349
 - Gear selector lever 351
 - Hard plastic trim items 351
 - Headlamps 349
 - Instrument cluster 351
 - Leather upholstery 352
 - Light alloy wheels 351
 - Nubuck leather upholstery (CLK 55 AMG) 352
 - Ornamental moldings 349
 - Paintwork 348
 - Parktronic system* sensor 350
 - Plastic and rubber parts 352
 - Power washer 348
 - Seat belts 352
 - Steering wheel 351
 - Tail lamps 349
 - Tar stains 348
 - Turn signals 349
 - Upholstery 352
 - Vehicle washing 349
 - Window cleaning 351
 - Wiper blades 350
 - Wood trims 352

- Vehicle identification number (VIN) 436
- Vehicle jack 391
- Vehicle lighting
 - Checking 307
- Vehicle loading terminology 338
- Vehicle maximum load on the tire 340
- Vehicle status message memory 145
 - Calling up 145
 - Displaying 145
- Vehicle status messages 362
- Vehicle tool kit 389
 - Alignment bolt 389
 - Collapsible wheel chock 389
 - Gloves 389
 - Jack 389
 - Protective wrap
 - (CLK 55 AMG only) 389
 - Removing (CLK 55 AMG only) 390
 - Removing (except CLK 55 AMG) 389
 - Spare fuses 389
 - Spare wheel bolts 389
 - Towing eye bolt 389
 - Valve extractor
 - (CLK 55 AMG only) 389
 - Vehicle jack 389
 - Wheel wrench 389
- Vehicle washing 349
- VIN (Vehicle Identification Number) 460
- Voice control system* 460
 - Hands-free microphone 29
- W**
- Warning indicators
 - Parktronic system* 262
- Warning sounds
 - Drivers seat belts 67
 - Parking brake 49
 - Parktronic system* 262, 263
- Warranty coverage 435
- Washer fluid see Windshield washer fluid
- Washing the vehicle 347
- Wear pattern (tires) 341
- Weights 446
- Wheel bolts 396
- Wheel change
 - Tightening torque 418
- Wheels
 - Tires and wheels 316
- Window curtain air bags 66
- Windows see Side windows

Index

- Windshield
 - Defogging 189, 199
 - Refilling washer fluid 315
 - Replacing wiper blades 411
 - Washer fluid 315, 454
 - Washer system 454
 - Windshield washer fluid 454
 - Message in display 388
 - Mixing ratio 454
 - Refilling 315
 - Wiping with 53
 - Windshield washer system 454
 - Windshield wipers 52
 - Fast wiper speed 52
 - Intermittent wipe 53
 - Intermittent wiping 52
 - Replacing wiper blades 411
 - Single wipe 53
 - Switching on 52
 - Wiping with
 - windshield washer fluid 53
 - Winter driving 342
 - Block heater (Canada only) 343
 - Snow chains 343
 - Tires 342
 - Winter driving instructions 301
 - Winter tires 342
 - Wiper blades
 - Cleaning 350
 - Installing 411
 - Removing 411
 - Replacing 411
 - Wiping
 - And washing simultaneously 53
 - Interval 52
 - With windshield washer fluid 53
 - Wood trims
 - Cleaning 352
- X**
- Xenon headlamps*
 - Bi-Xenon* 455

Service and Literature

Your authorized Mercedes-Benz Center has trained technicians and original Mercedes-Benz parts to service your vehicle properly. For expert advice and quality service, see an authorized Mercedes-Benz Center.

If you are interested in obtaining service literature for your vehicle, please contact an authorized Mercedes-Benz Center. We consider this the best way for you to obtain accurate information for your vehicle.

For further information you can find us on the Mercedes-Benz web-site www.mbusa.com or www.mercedes-benz.ca.

Warning!



To help avoid personal injury, be extremely careful when performing any service work or repairs. Improper or incomplete service or the use of incorrect or inappropriate parts or materials may damage the vehicle or its equipment, which may in turn result in personal injury.

If you have questions about carrying out any type of service, turn to the advice of an authorized Mercedes-Benz Center.

We reserve the right to modify the technical details of the vehicle as given in the data and illustrations of this Operator's Manual. Re-printing, translation and copying, even of excerpts, is not permitted without our prior authorization in writing.

Title illustration no. P00.01-2912-31

Press time April 7, 2004

GSP/TIP

Printed in Germany

